

# Process Design Manual

## Land Treatment of Municipal Wastewater Effluents



EPA/625/R-06/016  
September 2006

## **Process Design Manual**

# **Land Treatment of Municipal Wastewater Effluents**

Land Remediation and Pollution Control Division  
National Risk Management Research Laboratory  
Office of Research and Development  
U.S. Environmental Protection Agency  
Cincinnati, Ohio

---

## **Notice**

This document has been reviewed in accordance with U.S. Environmental Protection Agency policy and approved for publication. Mention of trade names or commercial products does not constitute endorsement or recommendation for use.

---

## Foreword

The U.S. Environmental Protection Agency (EPA) is charged by Congress with protecting the Nation's land, air, and water resources. Under a mandate of national environmental laws, the Agency strives to formulate and implement actions leading to a compatible balance between human activities and the ability of natural systems to support and nurture life. To meet this mandate, EPA's research program is providing data and technical support for solving environmental problems today and building a science knowledge base necessary to manage our ecological resources wisely, understand how pollutants affect our health, and prevent or reduce environmental risks in the future.

The National Risk Management Research Laboratory (NRMRL) is the Agency's center for investigation of technological and management approaches for preventing and reducing risks from pollution that threaten human health and the environment. The focus of the Laboratory's research program is on methods and their cost-effectiveness for prevention and control of pollution to air, land, water, and subsurface resources; protection of water quality in public water systems; remediation of contaminated sites, sediments and ground water; prevention and control of indoor air pollution; and restoration of ecosystems. NRMRL collaborates with both public and private sector partners to foster technologies that reduce the cost of compliance and to anticipate emerging problems. NRMRL's research provides solutions to environmental problems by: developing and promoting technologies that protect and improve the environment; advancing scientific and engineering information to support regulatory and policy decisions; and providing the technical support and information transfer to ensure implementation of environmental regulations and strategies at the national, state, and community levels.

This publication has been produced as part of the Laboratory's strategic long-term research plan. It is published and made available by EPA's Office of Research and Development to assist the user community and to link researchers with their clients.

Sally Gutierrez, Director  
National Risk Management Research Laboratory

---

## Abstract

The U.S. Environmental Protection Agency guidance on land treatment of municipal and industrial wastewater was updated for the first time since 1984. Significant new technological changes include phytoremediation, vadose zone monitoring, new design approaches to surface irrigation, center-pivot irrigation, drip and micro-sprinkler irrigation, and capital and operating costs. Also included in the new manual are new performance data on soil-aquifer treatment, a rational model for balancing oxygen uptake with BOD loadings, and industrial wastewater land application guidance, emphasizing treatment of food processing wastewater. Costs and energy use of land treatment technologies are updated.

Slow-rate land treatment remains the most popular type of land treatment system. Many slow-rate systems are now designed as water reuse systems. Trends in distribution have been toward sprinkler and drip irrigation systems.

A CD which accompanies the document contains copies of earlier editions of the land treatment manual and the latest manual for water reuse.

**KEYWORDS:** land treatment, soil aquifer treatment, spray irrigation, groundwater monitoring, vadose zone sampling, costs

---

## Contents

Notice .....	ii
Foreword .....	iii
Abstract .....	iv
Contents .....	v
Figures .....	viii
Tables.....	x
Acknowledgments .....	xiii
Chapter 1 Introduction and Process Capabilities.....	1-1
1.1 Purpose .....	1-1
1.2 Scope .....	1-1
1.3 Treatment Processes .....	1-1
1.4 Slow Rate Land Treatment .....	1-2
1.5 Overland Flow Treatment.....	1-4
1.6 Soil Aquifer Treatment .....	1-4
1.7 Limiting Design Parameter Concept .....	1-7
1.8 Guide to Intended Use of Manual .....	1-7
1.9 References.....	1-7
Chapter 2 Wastewater Constituents and Removal Mechanisms .....	2-1
2.1 Biochemical Oxygen Demand.....	2-1
2.2 Total Suspended Solids .....	2-2
2.3 Oil and Grease .....	2-2
2.4 pH.....	2-3
2.5 Pathogenic Organisms.....	2-3
2.6 Metals.....	2-6
2.7 Nitrogen.....	2-8
2.8 Phosphorus .....	2-11
2.9 Potassium .....	2-14
2.10 Sodium .....	2-14
2.11 Macronutrients and Micronutrients.....	2-14
2.12 Trace Organics.....	2-16
2.13 Phytoremediation .....	2-18
2.14 References.....	2-19
Chapter 3 Water Movement in Soil and Groundwater .....	3-1
3.1 Soil Properties .....	3-2
3.2 Water Movement through Soil .....	3-4
3.3 Saturated Hydraulic Conductivity .....	3-7
3.4 Unsaturated Hydraulic Conductivity .....	3-8
3.5 Percolation Capacity .....	3-8
3.6 Mounding of Groundwater .....	3-9
3.7 Drainage Requirements .....	3-11
3.8 Field Testing Procedures .....	3-12
3.9 References.....	3-18

Chapter 4	Role of Plants in Land Treatment.....	4-1
4.1	Vegetation in Land Treatment.....	4-1
4.2	Evapotranspiration .....	4-1
4.3	Plant Selection .....	4-4
4.4	Crop Management, Water Quality, and Nutrient Cycle.....	4-14
4.5	References.....	4-16
Chapter 5	Site Planning and Selection .....	5-1
5.1	Preliminary Land Requirements.....	5-1
5.2	Site Identification.....	5-4
5.3	Site Selection .....	5-8
5.4	Phase 2 Planning .....	5-8
5.5	Cost and Energy Considerations .....	5-17
5.6	References.....	5-23
Chapter 6	Preapplication Treatment and Storage .....	6-1
6.1	EPA Guidance.....	6-1
6.2	Types of Preapplication Treatment.....	6-2
6.3	Design of Storage Ponds .....	6-7
6.4	Operation of Storage Ponds .....	6-12
6.5	References.....	6-12
Chapter 7	Distribution Systems .....	7-1
7.1	Types of Distribution Systems .....	7-1
7.2	General Design Considerations for All Types of Distribution Systems.....	7-3
7.3	Surface Distribution.....	7-4
7.4	Sprinkler Distribution .....	7-11
7.5	Micro Irrigation Distribution System Planning and Design.....	7-22
7.6	Pumping Stations and Mainlines.....	7-26
7.7	Distribution Pumping .....	7-26
7.8	Tailwater Pumping .....	7-26
7.9	Mainlines .....	7-27
7.10	References.....	7-27
Chapter 8	Process Design – Slow Rate Systems.....	8-1
8.1	System Types .....	8-1
8.2	Land Area Determination .....	8-1
8.3	Total Acidity Loading.....	8-4
8.4	Salinity.....	8-4
8.5	Design Considerations.....	8-7
8.6	Crop, Soil, and Site Management Requirements .....	8-9
8.7	References.....	8-15
Chapter 9	Process Design – Overland Flow Systems.....	9-1
9.1	System Concept.....	9-1
9.2	Design Procedures.....	9-2
9.3	Land Area Requirements .....	9-5
9.4	Design Considerations.....	9-6
9.5	System Monitoring and Management .....	9-8
9.6	References.....	9-9
Chapter 10	Process Design – Soil Aquifer Treatment.....	10-1
10.1	Treatment Requirements .....	10-1
10.2	Aquifer Characteristics.....	10-4
10.3	Hydraulic Loading Rates.....	10-5

---

10.4	Land Area Requirements .....	10-7
10.5	Hydraulic Loading Cycle .....	10-7
10.6	Design Considerations .....	10-8
10.7	Cold Weather Operation .....	10-9
10.8	Drainage.....	10-10
10.9	References.....	10-12
Chapter 11 Industrial Wastewater Land Application.....		11-1
11.1	Types of Industrial Wastewaters Applied.....	11-1
11.2	Water Quality and Pretreatment Requirements.....	11-1
11.3	Design Considerations.....	11-4
11.4	Slow-Rate Land Treatment .....	11-6
11.5	Overland Flow Treatment.....	11-7
11.6	Soil Aquifer Treatment .....	11-8
11.7	References.....	11-9



## Figures

Number		Page
1-1	Slow Rate Hydraulic Pathways .....	1-3
1-2	Overland Flow.....	1-5
1-3	SAT Hydraulic Pathways .....	1-6
2-1	Nitrogen Cycle in Soil.....	2-9
3-1	Natural Resources Conservation Service (NRCS) Soil Textural Classes .....	3-2
3-2	Porosity, Specific Yield, Specific Retention vs. Soil Grain Size for In situ Consolidated Soils, Coastal Basin, CA.....	3-6
3-3	Specific Yield vs. Hydraulic Conductivity .....	3-6
3-4	Soil Moisture Characteristics .....	3-6
3-5	Approximate Preliminary Percolation Rate vs. NRCS Soil Permeability for SR and SAT. ....	3-9
3-6	Schematic of Groundwater Mound .....	3-9
3-7	Mounding Curve for Center of a Square Recharge Area.....	3-10
3-8	Mounding Curve for Center of a Rectangular recharge Area, with Different Ratios of Length L to Width W.....	3-10
3-9	Rise and Horizontal Spread of a Mound Below a Square Recharge Area.....	3-11
3-10	Rise and Horizontal Spread of Mounds Below a Rectangular Recharge Area when L = 2W.....	3-11
3-11	Parameters Used in Drain Design .....	3-12
3-12	Small-scale Pilot Test Basin .....	3-13
3-13	U.S. Army Corps of Engineers (USACE) Basin Test.....	3-13
3-14	Grove Preparation for USACE Test.....	3-14
3-15	Grove Preparation for USACE Test.....	3-14
3-16	Typical Test Results, USACE Infiltration Test.....	3-14
3-17	Test Installation for Cylinder Infiltrometer .....	3-15
3-18	Definition Sketch for Air Entry Permeameter .....	3-15
3-19	Air Entry Permeameter in Use .....	3-15
3-20	Definition Sketch for Auger Hole Technique.....	3-17
3-21	Equipment Setup for Auger Hole Test.....	3-17
4-1	Evaporation from Bare Soil which was Initially Wet .....	4-1
4-2	Nitrogen Uptake for Annual and Perennial Crops.....	4-9
4-3	Effect of Salinity on Growth of Field Crops .....	4-11
4-4	Suitable pH of Mineral Soils for Various Crops.....	4-12
5-1	Two-Phase Planning Process.....	5-1
5-2	Estimated Storage Days Based on Climatic Factors Alone.....	5-2
5-3	Landscape Positions.....	5-6
5-4	Sample Log for Test Pit Data.....	5-15
5-5	Well and Piezometer Installations.....	5-16
5-6	Vertical Flow Direction Indicated by Piezometers.....	5-16
5-7	Typical Shallow Monitoring Well .....	5-17
5-8	Solid Set Sprinkling (buried) Costs, ENR CCI = 6076. (a) Capital Cost; (b) Operation and Maintenance Cost .....	5-19
5-9	Center Pivot Sprinkling Costs, ENR CCI = 6076. (a) Capital Cost; (b) Operation and Maintenance Cost .....	5-20
5-10	Gated Pipe — Overland Flow or Ridge-and-Furrow Slow Rate Costs, ENR CCI = 6076. (a) Capital Cost; (b) Operation and Maintenance Cost.....	5-20
5-11	Rapid Infiltration Basin Costs, ENR CCI + 6076. (a) Capital Cost; (b) Operation and Maintenance Cost .....	5-21

Number		Page
6-1	Virus Removal in Ponds.....	6-6
6-2	Fecal Coliform Removal in Ponds – Detention Time vs. Liquid Temperature.....	6-6
7-1	Typical Surface Distribution Methods – Ridge and Furrow.....	7-4
7-2	Typical Gated Pipe Distribution Unit.....	7-6
7-3	Equal Opportunity Time Along Entire Strip.....	7-8
7-4	Greater Opportunity Time at Head of Strip: Flow Rate Too Small.....	7-9
7-5	Greater Opportunity Time at Tail End of Strip: Flow Rate Too Large.....	7-10
7-6.	Typical Discharge Valve for Border Strip Application.....	7-10
7-7	Forest Solid Set Sprinkler Irrigation at Clayton County.....	7-14
7-8	Move-Stop Sprinkler Systems.....	7-15
7-9	Side-Wheel Roll Sprinkler System.....	7-16
7-10	Continuous Move Sprinkler Systems.....	7-17
7-11	Reel-Type Traveling Gun Sprinkler.....	7-18
7-12	Center Pivot Sprinkler Unit.....	7-19
7-13	Center Pivot Irrigation System.....	7-19
7-14	Intersection Between an Elliptical Moving Application Rate Profile Under a Center-pivot Lateral and a Typical Infiltration Curve.....	7-20
7-15	Schematic of the Revolving –Sprinkler Infiltrometer.....	7-20
7-16	Comparison of Relative Application Rates Under Various Center Pivot Sprinkler Packages.....	7-20
7-17	Anticipated Center Pivot Performance versus Soil Texture.....	7-21
7-18	Comparison of Wetting Profiles in Sandy Soil.....	7-23
7-19	Typical Micro Irrigation System Layout.....	7-23
7-20	Distribution Pumps in the Side of a Storage Pond Dike.....	7-26
7-21	Typical Tailwater Pumping Station.....	7-27
8-1	Leaching Requirement as a Function of Applied Salinity and ECe of Crop Salinity Threshold.....	8-5
8-2	Example Spreadsheet Used to Calculate the Irrigation Requirements Including Irrigation Efficiency and Leaching Requirements.....	8-7
8-3	Slow Rate Design Procedure.....	8-8
9-1	Distribution Alternatives for Overland Flow.....	9-1
9-2	Overland-Flow Application Rates and Slope Length.....	9-3
9-3	Bale Wrappers Tightly Seal Each Bale of Hay in Plastic for Storage.....	9-9
9-4	Plastic Silage Bags for Storing Cut Hay.....	9-9
10-1	Definition Sketch for Lateral Drainage from SAT Systems Underdrains.....	10-10
10-2	Centrally Located Underdrain.....	10-11
10-3	Underdrain System Using Alternating Infiltration and Drying Strips.....	10-11
11-1	Side Roll Sprinklers Apply Potato-Processing Wastewater Throughout the Winter at Aberdeen, Idaho.....	11-6
11-2	Solid Set Sprinklers Apply Tomato-Processing Wastewater to Overland Flow Slopes.....	11-8



## Tables

Number		Page
1-1	Comparison of Land Treatment Process Design Features.....	1-1
1-2	Site Characteristics for Land Treatment Processes.....	1-2
1-3	Expected Effluent Water Quality from Land Treatment Processes .....	1-2
2-1	Typical Organic Loading Rates for Land Treatment Systems .....	2-1
2-2	BOD5 Removal at Typical Land Treatment Systems .....	2-2
2-3	Suspended Solids Removal at Land Treatment Systems.....	2-3
2-4	Virus Transmission through Soil at SAT Land Application Sites .....	2-5
2-5	Aerosol Bacteria at Various Sources .....	2-6
2-6	Recommended Limits for Constituents in Reclaimed Water for Irrigation .....	2-7
2-7	WHO Recommended Annual and Cumulative Limits for Metals Applied to Agricultural Crop Land ..	2-7
2-8	Trace Metals in Groundwater Under Hollister, CA Soil Aquifer Treatment Site, mg/L .....	2-8
2-9	Total Nitrogen Removal in Typical Land Treatment Systems.....	2-10
2-10	Annual Mineralization Rates for Organic Matter in Biosolids.....	2-11
2-11	Typical Percolate Phosphorus Concentrations .....	2-12
2-12	Sulfur Uptake by Selected Crops.....	2-15
2-13	Boron Tolerance of Crops .....	2-16
2-14	Values of ECD for Crops with No Yield Reduction .....	2-16
2-15	Volatile Organic Removal by Wastewater Sprinkling.....	2-17
2-16	Physical Characteristics for Selected Organic Chemicals .....	2-18
2-17	Percent Removal of Organic Chemicals in Land Treatment Systems.....	2-19
3-1	Soil Textural Classes and General Terminology Used in Soil Descriptions .....	3-2
3-2	Range of Available Soil Moisture for Different Soil Types .....	3-6
3-3	Field Estimating of Soil Moisture Content .....	3-7
3-4	Measured Ratios of Horizontal to Vertical Conductivity.....	3-8
3-5	Comparison of Infiltration Measurement Techniques .....	3-13
4-1	Range of Seasonal Crop Evapotranspiration.....	4-2
4-2	Selected Examples of Monthly Normal ETo.....	4-2
4-3	Example Evapotranspiration Values for Southern San Joaquin Valley of California.....	4-3
4-4	Pan Coefficient for Class A Evaporation Pans Placed in a Reference Crop Area .....	4-3
4-5	Length of Four Crop Growth Stages for Typical Annual Crops .....	4-4
4-6	Crop Coefficient, Kc, for Midseason and Late Season Conditions .....	4-4
4-7	Crop Coefficient, Kc, for Perennial Forage Crops.....	4-5
4-8	Yield Based N, P, and K Uptake of Various Crops .....	4-5
4-9	Typical Effective Rooting Depth of Plants .....	4-8
4-10	Grasses Used at Overland Flow Sites .....	4-9
4-11	General Effects of Trace Element Toxicity on Common Crops .....	4-10
4-12	Forested Land Treatment Systems in the United States .....	4-11
4-13	Nitrogen Uptake for Selected Forest Ecosystems with Whole Tree Harvesting.....	4-13
4.14	Biomass and Nitrogen Distributions by Tree Component for Stands in Temperate Regions .....	4-14
4-15	Golf Course Grass Salt Tolerances .....	4-14
4-16	Pasture Rotation Cycles for Different Numbers of Pasture Areas .....	4-17
5-1	Typical Composition of Raw Municipal Wastewater .....	5-1
5-2	Characteristics of Food Processing Wastewaters Applied to the Land .....	5-2
5-3	Preliminary Loading Rates for Initial Estimate of Land Requirements.....	5-2
5-4	Summary of Climatic Analyses .....	5-3

5-5	Site Identification Land Requirements, ha/m <sup>3</sup> -d (acres/mgd).....	5-4
5-6	Types and Sources of Data Required for Land Treatment Site Evaluation.....	5-4
5-7	Land Use Suitability Factors for Identifying Land Treatment Sites.....	5-5
5-8	Grade Suitability Factors for Identifying Land Treatment Sites.....	5-5
5-9	Soil Textural Classes and General Terminology Used in Soil Descriptions.....	5-6
5-10	Typical Soil Permeabilities and Textural Classes for Land Treatment.....	5-7
5-11	Rating Factors for Site Selection.....	5-9
5-12	Economic Rating Factors for Site Selection.....	5-9
5-13	Subsurface Factors for Forested SR.....	5-10
5-14	Soil Factors for Forested SR.....	5-10
5-15	Surface Factors for Forested SR.....	5-10
5-16	Composite Evaluation of SR Forested Sites.....	5-11
5-17	Sequence of Field Testing - Typical Order of Testing.....	5-11
5-18	Summary of Field Tests for Land Treatment Processes.....	5-11
5-19	Interpretation of Soil Physical and Hydraulic Properties.....	5-12
5-20	Interpretation of Soil Chemical Tests.....	5-13
5-21	Textural Properties of Mineral Soils.....	5-14
5-22	Soil Structure Grades.....	5-14
5-23	Description of Soil Mottles.....	5-15
5-24	Costs of Field Preparation.....	5-18
5-25	Comparison of Sprinkler Distribution Capital Costs.....	5-19
5-26	Costs of Underdrains.....	5-21
5-27	Costs of Tailwater Return Systems.....	5-21
5-28	Costs of Runoff Collection for Overland Flow.....	5-21
5-29	Costs of Recovery Wells.....	5-21
5-30	Options for Land Acquisition and Management at Selected SR Systems.....	5-22
5-31	Benefits of Land Treatment Systems.....	5-22
5-32	Energy Requirements for Land and Aquatic Treatment Systems.....	5-23
5-33	Energy Value of Nutrients in Wastewater.....	5-23
6-1	Guidelines for Assessing the Level of Preapplication Treatment.....	6-2
6-2	Reaction Rates for Aerated Ponds, BOD.....	6-3
6-3	Variation of Plug Flow Apparent Rate Constant with Organic Loading Rate for Facultative Ponds....	6-3
6-4	Typical pH and Alkalinity Values in Facultative Ponds.....	6-5
6-5	Changes of Microorganisms Concentration During Storage.....	6-6
6-6	Application of Membranes for the Removal of Constituents Found in Wastewater.....	6-7
6-7	Estimation of Storage Volume Requirements Using Water Balance Calculations.....	6-9
6.8	Final Storage Volume Requirement Calculations.....	6-10
7-1	Description, Advantages, and Disadvantages, of Distribution Systems.....	7-1
7-2	Sprinkler System Characteristics.....	7-3
7-3	Optimum Furrow Spacing.....	7-5
7-4	Suggested Maximum Lengths of Furrows, ft.....	7-5
7-5	Design Guidelines for Graded Borders for Deep-Rooted Crops.....	7-6
7-6	Design Guidelines for Graded Borders for Shallow-Rooted Crops.....	7-7
7-7	Recommended Reductions in Application Rates Due to Grade.....	7-12
7-8	Recommended Spacing of Sprinklers.....	7-13
7-9	Pipe Friction Loss Factors to Obtain Actual Loss in Line with Multiple Outlets.....	7-13
7-10	Recommended Maximum Lane Spacing for Traveling Gun Sprinklers.....	7-18
7-11	Typical Values for Surface Storage.....	7-21
7-12	Recommended Soil Contact Pressure for Center Pivots.....	7-22
7-13	Relative Resistance to Plugging for Various Emission Devices.....	7-24
7-14	Recommended Design Factors for Tailwater Return Systems.....	7-27
8-1	Nitrogen Loss Factor for Varying C:N Ratios.....	8-4
8-2	Suggested Minimum Process Control Monitoring.....	8-10

8-3	Suggested Minimum Effluent Monitoring .....	8-11
8-4	Flow Measurement Alternatives.....	8-11
8-5	Soil Monitoring Parameters.....	8-13
8-6	Vadose Zone Sampling/Monitoring Alternatives.....	8-14
8-7	Example Crop Monitoring Parameters.....	8-15
8-8	Routine Maintenance Inspection Checklist for Land Application Sites.....	8-15
9-1	Comparison of Actual and Predicted OF Effluent BOD Concentrations Using Primary and Raw Municipal Wastewater .....	9-4
9-2	BOD Removal for Overland Flow Systems.....	9-4
9-3	Application Rates Suggested for BOD Removal in Overland Flow Design, m <sup>3</sup> /h · m (gal/min · ft)....	9-4
9-4	Ammonia Concentrations (in g/m <sup>3</sup> ) in OF Systems in Garland, TX .....	9-5
10-1	BOD Removal for Soil Aquifer Treatment Systems.....	10-1
10-2	Nitrogen Removal for Soil Aquifer Treatment Systems.....	10-3
10-3	Phosphorus Removal for Soil Aquifer Treatment Systems .....	10-3
10-4	Fractional Attenuation of Estrogenic Activity (Relative to Primary Effluent) During Secondary Treatment and Soil Aquifer Treatment.....	10-4
10-5	Typical Wet/Dry Ratios for SAT Systems .....	10-6
10-6	Typical Hydraulic Loading Rates for SAT Systems.....	10-6
10-7	Suggested Hydraulic Loading Rates Based on Different Field Measurements.....	10-7
10-8	Suggested SAT Loading Cycles.....	10-8
10-9	Minimum Number of Basins Required for Continuous Wastewater Application.....	10-8
11-1	Characteristics of Various Industrial Wastewaters Applied to Land .....	11-2
11-2	Comparison of Inorganic and Total Dissolved Solids Measurements in Milk Processing Wastewater and Shallow Groundwater.....	11-2
11-3	Water Quality Parameters in the Settling Basin and First Cell of a Wetland Receiving Dairy Wastewater, Mercer Co., KY .....	11-4
11-4	BOD Loading Rates at Existing Industrial Slow Rate Systems .....	11-5
11-5	Nitrogen Mineralization of Industrial Wastewaters .....	11-5
11-6	Performance of Paris, TX., Overland Flow System .....	11-7
11-7	Performance of Overland Flow System at Davis, CA.....	11-8
11-8	Treatment Performance for Hilmar Cheese Soil Aquifer Treatment System.....	11-9

---

## Acknowledgments

This document was developed with the assistance of many individuals. It is an update of the land treatment manuals that were written in the 1970s and 1980s, and all the contributors have attempted to present up-to-date and useful information. They include the authors and technical expert reviewers listed here:

**Project Officer and Author:**

Dr. James E. Smith, Jr.  
US EPA National Risk Management Research Laboratory, (G-75), Cincinnati, OH 45268

**Coordinating Author:**

Robert B. Brobst, P.E.  
Biosolids Program Manager, US EPA Region 8, 999 18<sup>th</sup> St., Suite 500, Denver, CO 80202-2466

**Contractor:**

Brown and Caldwell, 2701 Prospect Park Dr., Rancho Cordova, CA 95670  
Ronald W. Crites – Lead  
Robert A. Beggs  
Lance Hershman  
Diane Nascimento  
Jordan W. Smith

**Special Contributions, Technical Assistance and Review:**

Robert K. Bastian  
US EPA Office of Wastewater Management, Washington, DC

Robert B. Brobst, P.E.  
US EPA Region 8, Denver, CO

Dr. Micheal Overcash  
North Carolina State University, Raleigh, NC

Antonio Palazzo  
US Army Cold Regions Research and Engineering Laboratory, Hanover, NH

Dr. Robert Rubin  
North Carolina State University, Raleigh, NC

**Preparation of Manual for Publication:**

US EPA National Risk Management Research Laboratory, Cincinnati, OH  
Jean Dye  
Ann White  
Steve Wilson

The authors wish to dedicate this manual to the memory of Sherwood C. "Woody" Reed whose advocacy of the use of natural systems for wastewater treatment, including land treatment, ponds, and constructed wetlands generated much of the scientific data that went into the development of the 1977 and 1981 editions of this manual. He conducted or managed numerous field investigations and developed guidance materials, project case studies, cost curves, and other materials that have been used extensively in EPA, Water Environment Federation, and Corps of Engineers publications. He has also written numerous journal articles, conference papers, and textbooks and taught courses on natural systems and wastewater treatment throughout the U.S. and around the world.

# Chapter 1

## Introduction and Process Capabilities

### 1.1. Purpose

The purpose of this manual is to provide design criteria and supporting information for the planning, design, construction, and operation of land treatment systems. Recommended procedures for the planning, design, and evaluation of land treatment systems for wastewater management are presented along with information on the expected performance and removal mechanisms.

This document is a revision and supplement to the Process Design Manual for Land Treatment of Municipal Wastewater published in 1981 (US EPA, 1981) and the Supplement on Rapid Infiltration and Overland Flow that was published in 1984 (US EPA, 1984). EPA has chosen to provide copies of these manuals, as well as a copy of the original manual (US EPA, 1977) on a CD, which is included with this manual.

### 1.2. Scope

Land treatment is defined as the application of appropriately pre-treated municipal and industrial wastewater to the land at a controlled rate in a designed and engineered setting. The purpose of the activity is to obtain beneficial use of these materials, to improve environmental quality, and to achieve treatment goals in a cost-effective and environmentally sound manner. In many cases the production and sale of crops can partially offset the cost of treatment. In arid climates the

practice allows the use of wastewaters for irrigation and preserves higher quality water sources for other purposes.

The scope of this manual is limited to the three principal land treatment processes, which are:

- Slow Rate (SR)
- Overland Flow (OF)
- Soil Aquifer Treatment (SAT), also known as Rapid Infiltration (RI)

Subjects that are new to this revision of the design manual include phytoremediation or phytoextraction and land application of food processing wastewater.

### 1.3. Treatment Processes

Typical design features for the three land treatment processes are compared in Table 1-1. The typical site characteristics are compared in Table 1-2. The expected quality of the treated water from each process is presented in Table 1-3. In most cases the compliance standards are imposed at the treatment boundary. The average and expected upper range values are valid for the travel distances and applied wastewater as indicated. The lower values of expected concentrations may reflect background shallow groundwater, especially for slow rate. The fate of these materials (plus metals, pathogens, salts, and trace organics) is discussed in Chapter 2.

**Table 1-1.** Comparison of Land Treatment Process Design Features

Feature	Slow rate (SR)	Overland flow (OF)	Soil aquifer treatment (SAT)
Minimum pretreatment	Primary sedimentation	Screening	Primary sedimentation
Annual loading rate, m/yr	0.5 - 6	3 - 20	6 - 125
Typical annual loading rate, m/yr	1.5	10	30
Field area required, ha <sup>a</sup>	23 - 280	6.5 - 44	3 - 23
Typical weekly loading rate, cm/wk	1.9 - 6.5	6 - 40 <sup>b</sup>	10 - 240
Disposition of applied wastewater	Evapotranspiration and percolation	Evapotranspiration and surface runoff, limited percolation	Mainly percolation
Application techniques	Sprinkler, surface or drip	Sprinkler or surface	Usually surface
Need for vegetation	Required	Required	Optional

<sup>a</sup>Field area in hectares not including buffer area, roads, or ditches for 3,785 m<sup>3</sup>/d (1 mgd) flow.

<sup>b</sup>Range includes screened wastewater to secondary effluent, higher rates for higher levels of pre-application treatment.



**Table 1-2.** Site Characteristics for Land Treatment Processes

Parameter	Slow Rate (SR)	Overland Flow (OF)	Soil aquifer treatment (SAT)
Slope	0 to 20%, Cultivated site 35%, Uncultivated	2 to 8 % for final slopes <sup>a</sup>	Not critical
Soil permeability	Moderate to slow	Slow to none	Rapid
Groundwater depth	0.6 to 3 m <sup>b</sup> (2 to 10 ft)	Not critical <sup>b</sup>	1 m (3 ft) during application <sup>c</sup> 1.5 to 3 m (5-10 ft) during drying
Climate	Winter storage in cold climates <sup>d</sup>	Same as SR	Not critical

<sup>a</sup>Steeper slopes may be feasible at reduced application rates.

<sup>b</sup>Impact on groundwater should be considered for more permeable soils.

<sup>c</sup>Underdrains can be used to maintain this level at locations with shallow groundwater.

<sup>d</sup>May not be required for forested systems.

**Table 1-3.** Expected Effluent Water Quality from Land Treatment Processes<sup>a</sup> (mg/L unless otherwise noted)

Parameter	Slow rate <sup>b</sup> (SR)	Overland flow <sup>c</sup> (OF)	Soil aquifer treatment <sup>d</sup> (SAT)
BOD <sub>5</sub>	< 2	10	5
TSS	< 1	10	2
NH <sub>3</sub> /NH <sub>4</sub> (as N)	< 0.5	< 4	0.5
Total N	3 <sup>e</sup>	5 <sup>f</sup>	10
Total P	< 0.1	4	1
Fecal coli (#/100 mL)	≤1	200 +	10

<sup>a</sup>Quality expected with loading rates at the mid to lower end of the range shown in Table 1-1.

<sup>b</sup>Percolation of primary or secondary effluent through 1.5 m (5 ft) of unsaturated soil.

<sup>c</sup>Treating comminuted, screened wastewater using a slope length of 30-36 m (100-120 ft).

<sup>d</sup>Percolation of primary or secondary effluent through 4.5 m (15 ft) of unsaturated soils; phosphorus and fecal coliform removals increase with flow path distance.

<sup>e</sup>Concentration depends on loading rate, C:N ratio, and crop uptake and removal.

<sup>f</sup>Higher values expected when operating through a moderately cold winter or when using secondary effluent at high rates.

All three processes require intermittent loading. The application period may range from a few hours for overland flow systems to a few days for soil aquifer treatment systems. The resting or drying period is critical to renew aerobic conditions in the soil, renew infiltration rates in SR and SAT systems, and allow oxidation of BOD and ammonia.

#### 1.4. Slow Rate Land Treatment

Slow rate land treatment is the application of wastewater to a vegetated soil surface. The applied wastewater receives significant treatment as it flows through the plant root/soil matrix. The potential hydraulic pathways for the treated water are shown in Figure 1-1. The design flow path depends on infiltration, percolation, lateral flow, and evapotranspiration within the boundaries of the treatment site. Solids removal generally occurs at the soil surface and biological, chemical and additional physical treatment occurs as the wastewater percolates through the plant root/soil matrix. Off-site runoff of any of the applied wastewater is

specifically avoided by the system design. The hydraulic pathways of the applied water can include:

- Vegetation irrigation with incremental percolation (e.g., precipitation or non-contaminated water for salt management).
- Vegetative uptake with evapotranspiration.
- Percolation to underdrains or wells for water recovery and reuse.
- Percolation to groundwater and/or lateral subsurface flow to adjacent surface waters.

Slow rate land treatment can be operated to achieve a number of objectives including:

- Further treatment of the applied wastewater.
- Economic return from the use of water and nutrients to produce marketable crops.
- Exchange of wastewater for potable water for irrigation purposes in arid climates to achieve overall water conservation.
- Development and preservation of open space and greenbelts.

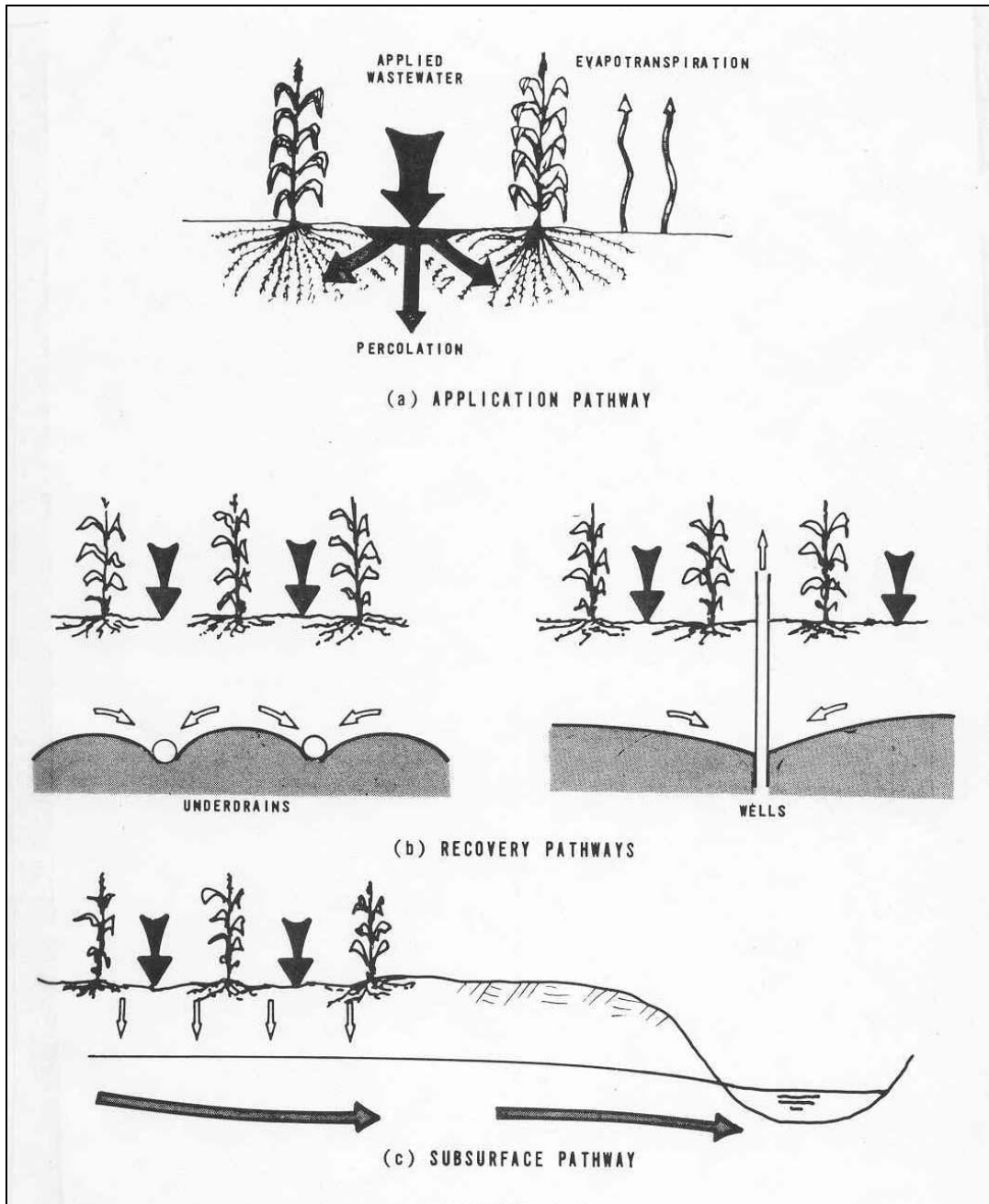


Figure 1-1. Slow Rate Hydraulic Pathways.

These goals are not mutually exclusive but it is unlikely that all can be brought to an optimum level within the same system. In general, maximum cost effectiveness for both municipal and industrial systems will be achieved by applying the maximum possible amount of wastewater to the smallest possible land area. That will

in turn restrict the choice of suitable vegetation and possibly the market value of the harvested crop. In the more humid parts of the United States, optimization of treatment is usually the major objective for land treatment systems. Optimization of agricultural potential or water conservation goals are generally more

---

important in the more arid western portions of the United States.

Optimization of a system for wastewater treatment usually results in the selection of perennial grasses because a longer application season, higher hydraulic loadings, and greater nitrogen loadings compared to other annual agricultural crops. Site selection is important with municipal wastewater which requires greater hydraulic capacity. Annual planting and cultivation can also be avoided with perennial grasses. However, corn and other crops with higher market values are also grown on systems where treatment is a major objective. Muskegon, MI (US EPA, 1980) was a noted example with over 2020 ha (5,000 acres) of corn, alfalfa and soybeans under cultivation.

Forested systems also offer the advantage of a longer application season and higher hydraulic loadings than typical agricultural crops, but may be less efficient than perennial grasses for nitrogen removal depending on the type of tree, stage of growth and general site conditions. Early research at the Pennsylvania State University (US EPA, 1974) established the basic criteria for full-scale forested systems. Subsequent work in Georgia, Michigan, and Washington State further refined the criteria for regional and species differences (McKim, 1982). A large-scale slow rate forested system in Clayton County, GA, designed for 75,700 m<sup>3</sup>/d (20 mgd) uses 1460 ha (3650 acres) and has been in continuous operation since 1981 (Reed and Bastian, 1991; Nutter et al., 1996). The largest operational land treatment system in the United States is the 3232-ha (8,000-acre) forested system in Dalton, GA.

### **1.5. Overland Flow Treatment**

Overland flow (OF) is the controlled application of wastewater to relatively impermeable soils on gentle grass covered slopes. The hydraulic loading is typically several inches of liquid per week and is usually higher than for most SR systems. Vegetation (e.g., perennial grasses) in the OF system contributes to slope stability, erosion protection, and treatment.

The design flow path is essentially sheet flow down the carefully prepared vegetated surface with runoff

collected in ditches or drains at the toe of each slope (Figure 1-2). Treatment occurs as the applied wastewater interacts with the soil, the vegetation, and the biological surface growths. Many of the treatment responses are similar to those occurring in trickling filters and other attached growth processes. Wastewater is typically applied from gated pipe or nozzles at the top of the slope or from sprinklers located on the slope surface. Industrial wastewaters and those with higher solids content typically use the latter approach. A small portion of the applied water may be lost to deep percolation and evapotranspiration, but the major portion is collected in the toe ditches and discharged, typically to an adjacent surface water. Because these systems discharge to surface waters, a National Pollutant Discharge Elimination System (NPDES) permit is required.

The SR and SAT concepts may include percolate recovery and discharge, but the OF process almost always includes a surface discharge and the necessary permits are required. The purpose of overland flow is cost-effective wastewater treatment. The harvest and sale of the cover crop may provide some secondary benefit and help offset operational costs, but the primary objective is treatment of the wastewater. Crop removal should be encouraged since removing the crop also removes N and P. Design procedures are presented in Chapter 9. One of the largest municipal overland flow systems in the U.S. is in Davis, CA (Crites et al., 2001) designed for 18,925 m<sup>3</sup>/d (5 mgd) flow and covering 80 ha (200 acres).

### **1.6. Soil Aquifer Treatment**

SAT land treatment is the controlled application of wastewater to earthen basins in permeable soils at a rate typically measured in terms of meters of liquid per week. As shown in Table 1-2, the hydraulic loading rates for SAT are usually higher than SR systems. Any surface vegetation that is present has a marginal role for treatment due to the high hydraulic loadings. In these cases, water-tolerant grasses are typically used. Treatment in the SAT process is accomplished by biological, chemical and physical interactions in the soil matrix with the near surface layers being the most active zone.

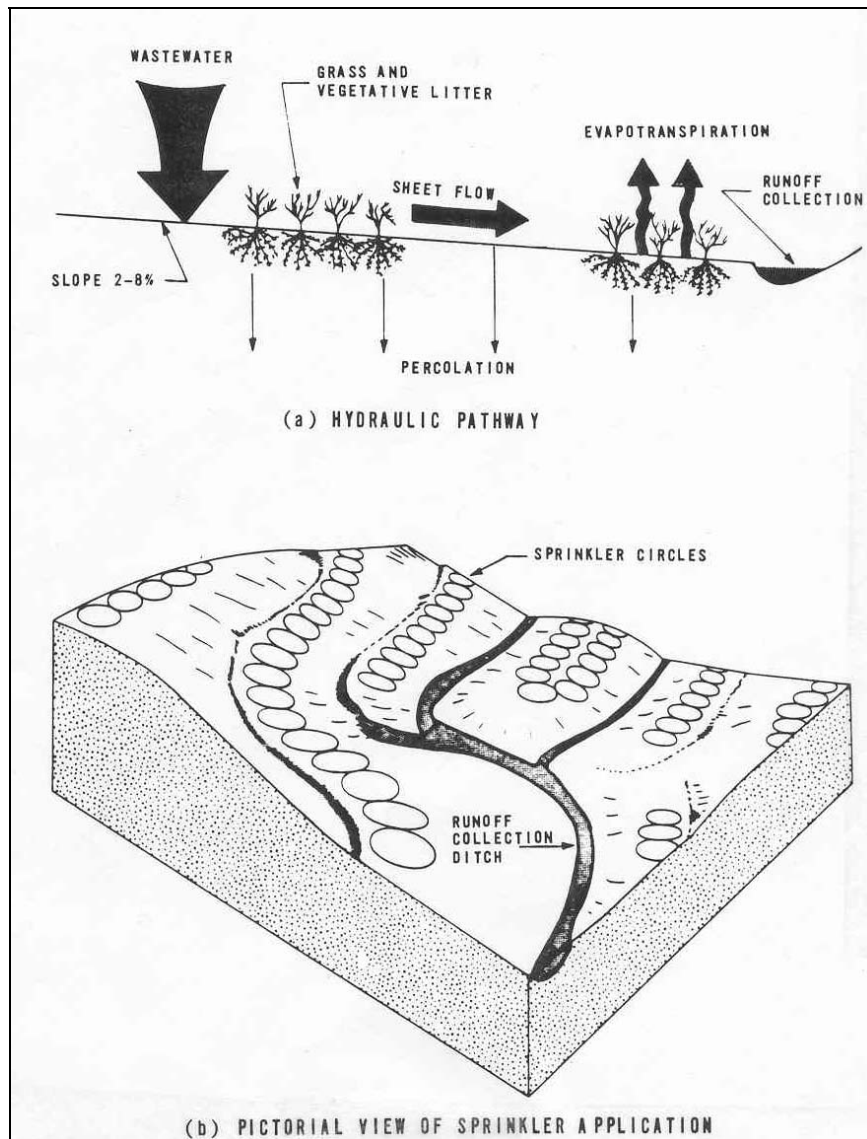


Figure 1-2. Overland Flow.

The design flow path involves surface infiltration, subsurface percolation and lateral flow away from the application site (Figure 1-3). A cyclic application, as described in Chapter 10, is typical when the operational mode includes a flooding period followed by days or weeks of drying. Continuous application of well treated wastewater can be accomplished with low application

rates. This allows aerobic restoration of the infiltration surface and drainage of the applied percolate. The geohydrological aspects of the SAT site are more critical than for the other processes and a proper definition of subsurface conditions and the local groundwater system is essential for design.

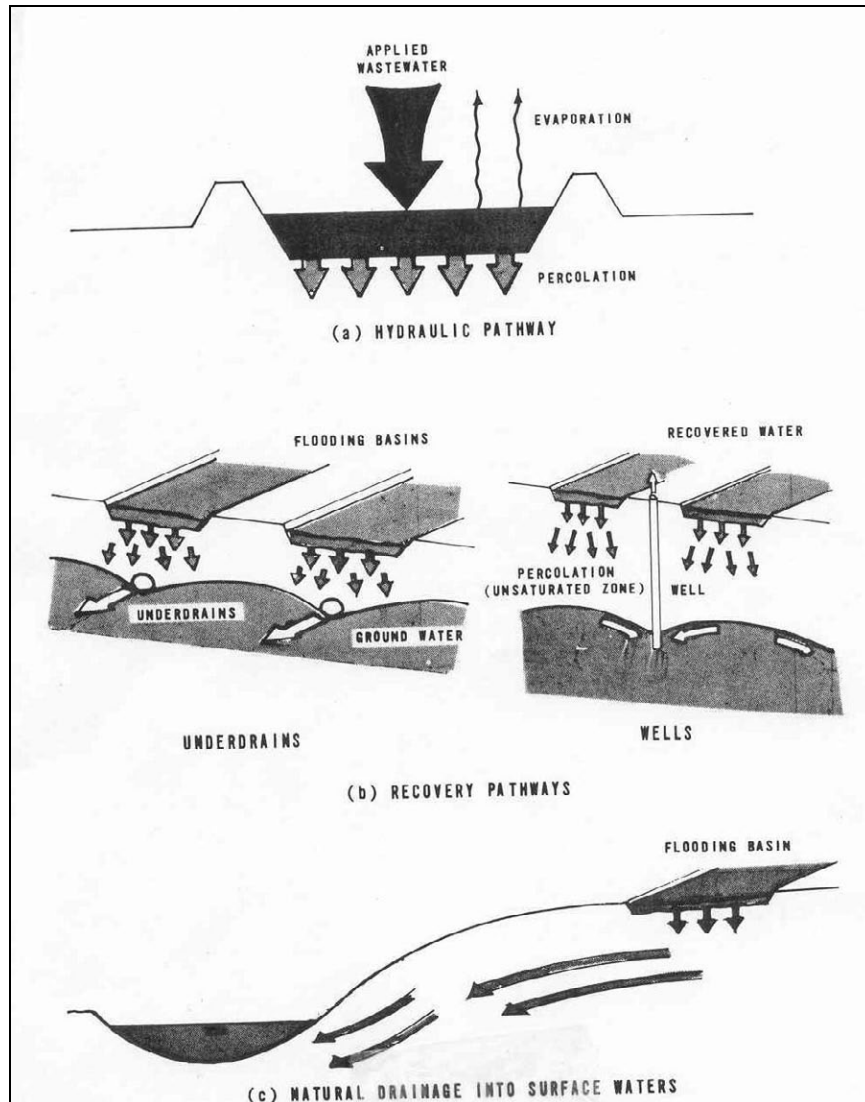


Figure 1-3. SAT Hydraulic Pathways.

The purpose of a soil aquifer treatment system is to provide a receiver aquifer capable of accepting liquid intended to recharge shallow groundwater. System design and operating criteria are developed to achieve that goal. However, there are several alternatives with respect to the utilization or final fate of the treated water:

- Groundwater recharge.
- Recovery of treated water for subsequent reuse or discharge.
- Recharge of adjacent surface streams.
- Seasonal storage of treated water beneath the site with seasonal recovery for agriculture.

The recovery and reuse of the treated SAT effluent is particularly attractive in dry areas in arid regions and studies in Arizona, California, and Israel (Idelovich,

1981) have demonstrated that the recovery of the treated water may be suitable for unrestricted irrigation on any type of crop. Groundwater recharge may also be attractive, but special attention is required for nitrogen if drinking water aquifers are involved. Unless special measures (described in Chapter 10) are employed, it is unlikely that drinking water levels for nitrate nitrogen (10 mg/L as N) can be routinely attained immediately beneath the application zone with typical municipal wastewaters. If special measures are not employed, there must then be sufficient mixing and dispersion with the native groundwater prior to the downgradient extraction points. In the more humid regions neither recovery nor reuse are typically considered. Examples of SAT include the Lake George, NY, system operating since 1939, the Calumet, MI, site operating since 1888,

---

and the Hollister, CA, system operating since 1946 (US EPA., 1978).

### 1.7. Limiting Design Parameter Concept

The design of all land treatment systems, wetlands, and similar processes is based on the *Limiting Design Parameter* (LDP) concept (Crites et al., 2000). The LDP is the factor or the parameter, which controls the design and establishes the required size and loadings for a particular system. If a system is designed for the LDP it will then function successfully for all other less-limiting parameters of concern. Detailed discussions on the interactions in land treatment systems with the major wastewater constituents can be found in Chapter 2. Experience has shown that the LDP for systems that depend on significant infiltration, such as SR and SAT, is either the hydraulic capacity of the soil or the ability to remove nitrogen to the specified level, when typical municipal wastewaters are applied. Whichever of these two parameters requires the largest treatment area controls design as the LDP, and the system should then satisfy all other performance requirements. Overland flow, as a discharging system, will have an LDP which depends on the site-specific discharge limits, and the parameter which requires the largest treatment area controls the design.

### 1.8. Guide to Intended Use of Manual

The first chapter introduces the processes and the concept of limiting design parameter. In Chapter 2 all of the wastewater constituents of concern are discussed along with their fate in land treatment systems and the removal mechanisms. In Chapter 3 the movement of water through soil and groundwater is discussed including equations and physical test methods and procedures. In Chapter 4 the vegetation used in land treatment, the nutrient uptake and sensitivity to wastewater constituents, and management are described.

Planning guidance is provided in Chapter 5 including site selection procedures. Preapplication treatment and storage guidance is presented in Chapter 6 and wastewater distribution systems are introduced in Chapter 7. The process design chapters are 8, 9, and 10 covering slow rate, overland flow, and soil aquifer treatment, respectively. Equations and procedures are presented along with a brief case study of each process.

Much design and research activity in recent years has focused on industrial wastewater. In Chapter 11, the unique aspects of treating high-strength wastewater from food processors and other sources are discussed. Guidance on land application of biosolids can be found in Crites and Tchobanoglous (1998) and US EPA (1995).

### 1.9. References

- Crites, R.W. and G. Tchobanoglous (1998) *Small and Decentralized Wastewater Management Systems*. McGraw-Hill Book Co. New York.
- Crites, R.W., S.C. Reed, and R.K. Bastian (2000) *Land Treatment Systems for Municipal and Industrial Wastes*. McGraw-Hill Book Co. New York.
- Crites, R.W., S.C. Reed, and R.K. Bastian (2001) *Applying Treated Wastewater to Land*. BioCycle, 42(2) 32-36.
- Idelovitch, E. (1981) *Unrestricted Irrigation with Municipal Wastewater*, in: *Proceedings, National Conference on Environmental Engineering*, ASCE, Atlanta GA, July 8-10.
- McKim, H.L. (1982) *Wastewater Application in Forest Ecosystems*, Report 82-19, USA CRREL, Hanover, NH.
- Nutter, W.L., L. Philpott, and L.A. Morris (1996) *Long-Term Environmental Impacts of Municipal Wastewater Irrigation to Forests at Clayton County, Georgia*, *Proceedings, Land Application of Wastes in Australia and New Zealand: Research and Practice*, Australian Conference.
- Olson, J.V., R.W. Crites, and P.E. Levine (1980) *Groundwater Quality at a Rapid Infiltration Site*, *Journal Envir. Engr. Div*, Vol 106(5):885-889, American Society of Civil Engineers.
- Reed, S.C. and R.K. Bastian (1991) *Potable Water Via Land Treatment and AWT*, *Water Envir. Technology*, 3(8)40-47, WEF, Alexandria, VA.
- US EPA (1974) *Renovation of Secondary Effluent for Reuse as a Water Resource*, EPA 660/2-74-016, US EPA CERL, Cincinnati, OH.
- US EPA (1977) *Process Design Manual for Land Treatment of Municipal Wastewater*, EPA 625/1-77-008, US EPA CERL, Cincinnati, OH.
- US EPA (1978) *Long-Term Effects of Land Application of Domestic Wastewater*. US EPA. EPA-600/2-78-084. Ada, OK.
- US EPA (1980) *Muskegon County Wastewater Management System*, EPA 905/2-80-004, US EPA Great Lakes Programs Office, Chicago, IL.
- US EPA (1981) *Process Design Manual for Land Application of Municipal Wastewater*, EPA 625/1-81-013, US EPA CERL, Cincinnati, OH.

---

US EPA (1984) Process Design Manual, Land Treatment of Municipal Wastewater: Supplement on Rapid Infiltration and Overland Flow, EPA 625/1-81-013A, US EPA CERL, Cincinnati, OH.

US EPA (1995) Process Design Manual, Land Application of Sewage Sludge and Domestic Septage, EPA/625/R-95/001, US EPA NRMRL, Cincinnati, OH

## Chapter 2

# Wastewater Constituents and Removal Mechanisms

An understanding of the basic interactions between the wastewater constituents of concern and the soil treatment system is essential for the determination of the limiting design parameter (LDP) for a particular system. These interactions are generally the same for all of the land treatment processes and are therefore discussed together in this chapter.

### 2.1 Biochemical Oxygen Demand

All land treatment processes are very efficient at removal of biodegradable organics, typically characterized as biochemical oxygen demand (BOD<sub>5</sub>). Removal mechanisms include filtration, absorption, adsorption, and biological reduction and oxidation. Most of the responses in slow rate (SR) and soil aquifer treatment (SAT) occur at the soil surface or in the near-surface soils where microbial activity is most intense. Treatment oxidation-reduction reactions generally occur in the upper 1/3 of the slope on the OF sites. Intermittent or cyclic wastewater application on these systems is necessary to allow the restoration of aerobic conditions in the soil profile and maintenance of the infiltration capacity at the soil surface.

#### 2.1.1 BOD Loading Rates

To establish a basis for the amount of degradable organic matter that can be land applied, the BOD loading rate is calculated. The BOD loading rate is defined as follows:

$$L_{\text{BOD}} = (\text{kg of BOD applied/day}) / (\text{area loaded per day}) (\text{cycle time})$$

(2-1)

<b>Where</b>	
$L_{\text{BOD}}$	= kg/ha-d
Kg of BOD applied per day	= concentration, mg/L x flow, m <sup>3</sup> /d x 1000 L/1 m <sup>3</sup> x 0.001 kg/g x 1 g/1000 mg
Area loaded	= total wetted area receiving wastewater per day, ha
Cycle time	= time between subsequent applications to a given subplot (days of application plus days of drying), days

Example 2.1	BOD Loading Rates
<b>Conditions:</b>	Wastewater with a BOD of 250 mg/L. Slow rate land treatment field area of application of 2 ha/day. Flow of 1000 m <sup>3</sup> /d. Cycle time of 7 days between wastewater applications.
<b>Find:</b>	Cycle-average BOD loading rate
<b>Solution:</b>	1. Calculate the kg of BOD applied per day Kg of BOD applied = 250 mg/L x 1,000 m <sup>3</sup> /d x 0.001 kg/g = 250 kg/d
	2. Calculate the BOD loading rate using Eq. 2-1 $L = 250 \text{ kg/d} / (2 \text{ ha/d})(7 \text{ d}) = 17.9 \text{ kg/ha-d}$

The BOD is a 5-day test of the oxygen demand required by microorganisms to biodegradable organics. Other quicker tests, often more reliable, include the chemical oxygen demand (COD) which is always larger than the BOD and the total organic carbon (TOC) test, which ranges from greater than the BOD for untreated wastewater to less than the BOD for treated effluent (Tchobanoglous et al., 2002). The treatment of BOD occurs throughout the loading (application period), drainage, and the reaeration (drying or resting) period or cycle. To maintain aerobic conditions in the soil, the rate of reaeration in a given cycle should match or exceed the rate of BOD exertion. A "rational" model that predicts the rate of reaeration depending on soil conditions, the depth of application and the reaeration period has been developed (Smith and Crites, 2001) and is presented in Chapter 8. Typical BOD loading rates for the three processes are presented in Table 2-1.

**Table 2-1.** Typical Organic Loading Rates for Land Treatment Systems (adapted from Reed et al., 1995)

Process	BOD loading (kg BOD <sub>5</sub> /ha•d) <sup>a,b</sup>
Slow Rate (SR)	50 – 500
Soil Aquifer Treatment (SAT)	145 – 1000
Overland Flow (OF)	40 – 110

<sup>a</sup>kg/ha•d x 0.89 = lb BOD<sub>5</sub>/ac•d

<sup>b</sup>Lower end of range is typical of municipal systems and upper end is typical of industrial strength wastewater.



Essentially all of the treatment in overland flow systems (OF) occurs at or near the soil surface or in the mat of plant litter and microbial material. Settling of most particulate matter occurs rapidly in OF systems as the applied wastewater flows in a thin film down the slope. Algae removal is an exception since the detention time on the slope may not be sufficient to permit complete removal by physical settling (Witherow and Bledsoe, 1983). The biological material and slimes which develop on the OF slope are primarily responsible for ultimate pollutant removal. These materials are similar to those found in other fixed film processes, such as trickling filters, and the presence of aerobic zones and anaerobic microsites within the slime layer is to be expected. In a properly managed system, with acceptable loadings, the aerobic zones dominate. However, there are still numerous anaerobic sites that contribute to the breakdown of the more refractory organics (Crites et al., 2000).

### 2.1.2 BOD Removal

A few examples of removal of BOD by land treatment processes receiving municipal wastewater are summarized in Table 2-2. Long-term effects studies (US EPA, 1979; Hossner et al., 1978; Koerner and Haws, 1979; Leach et al., 1980; and US EPA, 1978) generated much of the available data. Because the basic treatment mechanism is biological, all three processes have a continually renewable capacity for BOD<sub>5</sub> removal as long as the loading rate and cycle allows for preservation and/or restoration of aerobic conditions in the system. Laboratory studies in 1998 with soil columns indicated that BOD<sub>5</sub> removal to low "background" levels was independent of the level of pretreatment, independent of soil type, and essentially independent of infiltration rate

(ASU et al., 1998). These responses confirm the results presented in Table 2-2 and also confirm the fact that high levels of preapplication treatment are not necessary for effective BOD<sub>5</sub> removal in municipal land treatment systems.

## 2.2 Total Suspended Solids

Total suspended solids (TSS) are generally not an LDP in the design of municipal land treatment systems. SR and SAT systems are very effective for removal of suspended solids. Filtration through the soil profile is the principal removal mechanism. OF systems depend on sedimentation and entrapment in the vegetative litter or on the biological slimes and are typically less efficient than SR or SAT. However, OF systems can produce better than secondary effluent quality for total suspended solids when either screened wastewater or primary effluent is applied.

TSS removal at a number of land treatment systems receiving municipal wastewaters is summarized in Table 2-3. Suspended solids removal in OF systems receiving facultative lagoon effluents is not always effective due to the variability of algal species present and the short detention time on the slope. The seasonal variation in performance of the Davis, CA system, shown in Table 2-3, clearly illustrates this problem. See Chapter 9 for additional information on this issue.

## 2.3 Oil and Grease

Oil and grease, also known as fats, oil, and grease (FOG), should not be a factor for land treatment of typical municipal wastewaters unless there is a spill somewhere in the municipal collection system. There is

**Table 2-2.** BOD<sub>5</sub> Removal at Typical Land Treatment Systems (adapted from Crites et al., 2000)

Process/Location	Hydraulic Loading (m/yr <sup>a</sup> )	BOD <sub>5</sub>		
		Applied (mg/L)	Soil Water Drainage (mg/L)	Sample Depth (m <sup>b</sup> )
<b>SR</b>				
Hanover, NH	1.2–7.6	40–92	0.9–1.7	1.5
San Angelo, TX	3	89	1.0	7.6
Yarmouth, MA <sup>c</sup>	1	85	<2.0	1.0
<b>SAT</b>				
Lake George, NY	43	38	1.2	3.2
Phoenix, AZ	110	15	1.0	9
Hollister, CA	15	220	8.0	7.6
<b>OF</b>				
Hanover, NH	7.6	72	9	--
Easley, SC	8.2	200	23	--
Davis, CA	12.5	112	10	--

<sup>a</sup>m/yr x 3.28 = ft/yr.

<sup>b</sup>m x 3.28 = ft.

<sup>c</sup>Giggey et al., 1989.

**Table 2-3.** Suspended Solids Removal at Land Treatment Systems (adapted from Leach et al., 1980 and Crites et al., 2000)

Process/location	Soil Water Drainage - Total suspended solids, mg/L	
	Applied	Effluent <sup>a</sup>
<b>Slow Rate (SR)</b>		
Hanover, NH	60	<1
Typical value	120	<1
<b>Soil Aquifer Treatment (SAT)</b>		
Phoenix, AZ	20 – 100	<1
Hollister, CA	274	10
Typical Value	120	2
<b>Overland Flow (OF)</b>		
Ada, OK (raw wastewater)	160	8
Hanover, NH (primary)	59	7
Easley, SC (screened wastewater)	186	8
Utica, MS (fac. lagoon)	30	8
Davis, CA (fac. lagoon)		
Summer	121	80
Fall	86	24
Winter	65	13

<sup>a</sup>Example depths and loading rates for SR and SAT systems are shown in Table 2-2.

still no need to design the land treatment component for such an emergency because standard containment and clean-up procedures can be used when needed. Oil and grease are more likely to be a routine component in industrial wastewaters. The most likely sources are petroleum, and animal and vegetable oils. Loading rates and removals are discussed in Chapter 11 (US EPA, 1972).

## 2.4 pH

The pH range suitable for biological treatment is typically between 5 and 9 (Crites and Tchobanoglous, 1998). Soil generally has a large buffer capacity such that wastewater pH can be attenuated and biological treatment efficiency is not impaired. Organic acids in food processing wastewater are easily degradable, as described in Chapter 11, and do not impose a limitation on wastewater treatment.

Crops can also tolerate a relatively large range in pH. Optimum pH for crop growth has been reported to be between 6.4 and 8.4. Low soil pH can result in metals becoming more soluble and potentially leaching to groundwater. A pH of 6 or above is currently considered adequate to protect against crop uptake of most metals (Page et al., 1987). Metal concentrations in municipal effluent are typically well below the values of concern in Section 2.6. If the practitioner is concerned about excess metal uptake into the crop, monitoring of the crop would be prudent.

## 2.5 Pathogenic Organisms

The known pathogens of concern in land treatment systems are parasites, bacteria, and viruses. The potential pathways of concern are to groundwater, contamination of crops, translocation or ingestion by grazing animals, and human contact through off site transmission via aerosols or runoff. The removal of

pathogens in land treatment systems is accomplished by adsorption, desiccation, radiation, filtration, predation, and decay due to exposure to sunlight (UV) and other adverse conditions. Fecal coliforms are used as an indicator of fecal contamination. Fecal contamination occurs from livestock as well as other warm blood animals. It is not uncommon to find “background” fecal coliform concentrations of  $10^2$  or greater concentration. The SR process is the most effective, removing about five logs ( $10^5$ ) of fecal coliforms within a depth of a 0.6 m (2 ft). The SAT process typically can remove two to three logs of fecal coliforms within several meters of travel, and the OF process can remove about 90 percent of the applied fecal coliforms (Reed et al., 1995).

### 2.5.1 Parasites

Parasites may be present in all municipal wastewaters. Parasites, such as *Ascaris*, *E.histolytica* and *Cryptosporidium* have been recovered from wastewaters. Under optimum conditions the eggs of these parasites, particularly *Ascaris* can survive for many years in the soil (US EPA. 1985). Because of their weight and size, parasite cysts and eggs will settle out in preliminary treatment or in storage ponds, so, if present most will be found in the raw sludge and possibly in the biosolids.

There is no evidence available indicating transmission of parasitic disease from application of wastewater in properly operated land treatment systems. Transmission of parasites via sprinkler aerosols should not be a problem due to the weight of the cysts and eggs. The World Health Organization (WHO) considers parasite exposure by field workers to be the most significant risk for irrigation with wastewater. They recommend ponds for the short-term retention of untreated wastewater as a simple solution for the problem (Chang et al, 1995).

---

### **2.5.2 Crop Contamination**

The major concerns for crop contamination are directed toward retention and persistence of the pathogens on the surfaces of the plant until consumed by humans or animals, or the internal infection of the plant via the roots. The persistence of polio virus on the surfaces of lettuce and radishes, for up to 36 days, has been demonstrated. About 99 percent of the detectable viruses were gone in the first five to six days. The general policy in the U.S. is not to grow vegetables to be consumed raw on land treatment systems without high levels of treatment, including filtration and disinfection. Internal contamination of plants with viruses has been demonstrated with transport from the roots to the leaves. However, these results were obtained with soils inoculated with high concentrations of viruses and then the roots were damaged or cut. No contamination was found when roots were undamaged or when soils were not inoculated with the high virus concentrations (Crites et al., 2000; US EPA 1985).

Criteria for irrigation of pasture with primary effluent in Germany require a period of 14 days before animals are allowed to graze. Bell and Bole demonstrated that fecal coliforms from sprinkling of wastewater on the surfaces of alfalfa hay were killed by ten hours of bright sunlight (Bell and Bole 1978). Similar experiments with Reed canarygrass found 50 hours of sunlight were required. It was recommended that a one-week rest period prior to grazing be provided to ensure sufficient sunlight, for Reed canary, orchard, and brome grasses used for forage or hay (Bell and Bole, 1978). Because fecal coliforms have survival characteristics similar to salmonella, these results should be applicable to both organisms. However, the current management practice for restricting grazing at biosolids application sites is a minimum of 30 days in the U.S.A.

### **2.5.3 Runoff Contamination**

Wastewater constituents that are applied to the land enter the plant root/soil matrix. Suspended solids become part of the soil after these are filtered out of the wastewater. The rainfall runoff from fields irrigated with wastewater may contain dissolved wastewater constituents.

Runoff from a land treatment site might be a potential pathway for pathogen transport. Proper system design and operation should eliminate runoff from adjacent lands entering the site and runoff of applied wastewater from the site. Overland flow is an exception in the latter case because treated effluent and stormwater runoff are discharged from the site. The quality of rainfall runoff from an overland flow system is equal or better in quality

than the normal (non-rainfall induced) renovated wastewater runoff.

The NPDES permitting authority should be consulted with respect to the current storm water regulations (40 CFR 122.26). Storage of runoff for up to one "time-of-concentration" or 24 hours may be necessary to capture the first flush of stormwater.

### **2.5.4 Groundwater Contamination**

The risk of groundwater contamination by pathogens involves the movement of bacteria or virus to aquifers that are then used for drinking purposes without further treatment. The risk is minimal for OF systems but highest for SAT systems due to the high hydraulic loading and the coarse texture and relatively high permeability of the receiving soils.

The removal rate of bacteria can be quite high in the finer-textured agricultural soils commonly used for SR systems. Results from a five-year study in Hanover, NH (Jenkins and Palazzo, 1981) applying both primary and secondary effluent to two different soils indicated essentially complete removal of fecal coliforms within a 1.5 m (5 ft) soil profile. The soils involved were a fine textured silt loam and a coarser textured loamy sand and the concentrations of fecal coliform in the applied wastewaters ranged from  $10^5$  for primary effluent to  $10^3$  for secondary effluent. In similar research in Canada (Bell and Bole, 1978), undisinfected effluent was applied to grass-covered loamy sand. Most of the coliform were retained in the top 75 mm (3 in) of soil and none penetrated below 0.68 m (27 in). Die-off occurred in two phases: an initial rapid phase within 48 hours of application when 90 percent of the bacteria died, followed by a slower decline during a two-week period when the remaining 10 percent were eliminated (Jenkins and Palazzo, 1981).

Removal of virus, which is at least partially dependent on cation exchange and adsorption reactions, is also quite effective in these finer textured agricultural soils. Most of the concern and the research work on virus transmission in soils have focused on SAT systems. A summary of results from several studies is presented in Table 2-4. The SAT basins in the Phoenix system consisted of about 0.77 m (30 in) of loamy sand underlain by coarse sand and gravel layers. During the study period indigenous virus were always found in the applied wastewater, but none were recovered in the sampling wells.

At Santee, CA, secondary effluent was applied to percolation beds in a shallow stratum of sand and gravel. The percolate moved laterally to an interceptor trench approximately 458 m (1,500 ft) from the beds. Enteric virus was isolated from the applied effluent but

none were ever found at the 61 m (200 ft) and 122 m (400 ft) percolate sampling points.

Lance and others have examined the problem of virus desorption in the laboratory (Lance and Gerba, 1980). Using soil columns it was shown that applications of distilled water or rainwater could cause adsorbed viruses to move deeper into the soil profile under certain conditions. However, viruses were not desorbed if the free water in the column drained prior to application of the distilled water. This suggests that the critical period would be the first day or two after wastewater application. Rainfall after that period should not cause additional movement of viruses in the soil profile. A desorbed virus should have further opportunities for readsorption in the natural case, assuming there are no macropores. Lance's work with polio virus in soil columns, containing calcareous sand, indicated that most viral particles are retained near the soil surface. Increasing the hydraulic loading from 0.6 m/d per day to 1.2 m/d (2 to 4 ft/d) caused a virus breakthrough (about one percent of the applied load) at the bottom of the 2.4 m (8 ft) column (Lance and Gerba, 1980). However, 99 percent of the viral particles were still removed at hydraulic loadings as high as 12 m/d (39 ft/d). Lance suggested that the velocity of water movement through the soil may be the single most important factor affecting the depth of virus penetration in soils. Column studies (Arizona State University et al, 1998) have confirmed the earlier work by Lance. In this recent study, high virus removal efficiencies (>99%) were observed in one meter of soil at low infiltration rates. Assuming a first order decay relationship, if 99 percent removal of virus occurred in one meter of soil then 99.999 percent would be removed in three meters of soil. This same study routinely observed a four log (99.99%) removal of *Cryptosporidium* after passing through one meter of soil even at the highest infiltration rates.

### 2.5.5 Aerosols

Pathogen concentrations in aerosols caused by sprinkling wastewater is a function of their concentration

in the applied wastewater and the aerosolization efficiency. Aerosolization efficiency, which is the percentage of the wastewater that is converted to aerosols during sprinkling, can vary from 0.1 percent to nearly 2 percent, with 0.3 to 1 percent being typical (Crook, 1998).

The potential for aerosol transport of pathogens from land treatment sites is a controversial health issue. The lay public, and many professionals, tend to misunderstand what aerosols are and confuse them with the water droplets, which emerge from sprinkler nozzles. Aerosols are almost colloidal in size ranging from 20 microns in diameter and smaller. UV light, heat and desiccation significantly reduce small aerosol particles. It is prudent to design any land treatment systems so that the larger water droplets emerging from the sprinklers are contained within the site. The public acceptance of a project will certainly be enhanced if it is understood that neither their persons nor their property will become "wet" from the sprinkler droplets (Reed et al., 1995).

Bacterial aerosols are present in all public situations and will tend to increase with the number of people and their proximity. Sporting events, theaters, public transportation, public toilets, etc., are all potential locations for airborne infection. Bacterial concentrations in aerosols at various locations, all of which involve the use or treatment of wastewaters, are summarized in Table 2-5. The cooling water for the power plant that is cited uses some disinfected effluent as make-up water. The aerosol concentration at this cooling tower is roughly the same as measured just outside the sprinkler impact zone at the California (Pleasanton) operation where undisinfected effluent is used. It does not appear that bacterial aerosols at or near land treatment sites are any worse than other sources. In fact, the opposite seems true, the aerated pond in Israel and the activated sludge systems have higher aerosol concentrations than the land treatment systems listed in the table. Aerosol studies in metropolitan areas for example have indicated a bacterial concentration of 0.11 particles/m<sup>3</sup> (4 particles/ft<sup>3</sup>) per cubic foot of air in downtown Louisville,

**Table 2-4.** Virus Transmission through Soil at SAT Land Application Sites (Reed et al., 1995)

Location	Sampling depth or distance (m)	Virus concentration (pfu/L)	
		Applied	Soil water drainage at sample point
Phoenix, AZ (Jan to Dec 1974)	3-9	8	0
		27	0
		24	0
		2	0
		75	0
		11	0
Gainesville, FL (Apr to Sept 1974)	7	0.14	0.005
		0.14	0
		0.14	0
		0.14	0
		0.14	0
		0.14	0
		0.14	0
Santee, CA (1966)	61	Concentrated type 3 polio virus	0

**Table 2-5.** Aerosol Bacteria at Various Sources (Reed et al., 1995)

Location	Downwind distance, m (ft)	Total aerobic bacteria, #/m <sup>3</sup> (#/ft <sup>3</sup> ) <sup>a</sup>	Total coliform bacteria, #/m <sup>3</sup> (#/ft <sup>3</sup> ) <sup>a</sup>
Activated sludge tank, Chicago, IL	9-30 (30-100)	11.2 (396)	0.006 (0.2)
Activated sludge tank, Sweden	0 (0)	80 (2,832)	--
Power plant cooling tower, California	0 (0)	2.4 (83)	--
Aerated pond, Israel	30 (100)	--	0.23 (8)
Sprinklers <sup>b</sup> , Ohio	30 (100)	0.4 (14)	0.003 (0.1)
Sprinklers <sup>c</sup> , Israel	30 (100)	--	0.094 (3.3)
Sprinklers <sup>c</sup> , Arizona	45 (150)	0.6 (23)	0.006 (0.2)
Sprinklers <sup>c</sup> , Pleasanton, CA	9-30 (30-100)	2.1 (73)	0.006 (0.2)

<sup>a</sup>Aerosol counts are per cubic meter of air sampled (#/ft<sup>3</sup>). <sup>b</sup> Disinfected effluent applied. <sup>c</sup> Undisinfected effluent applied.

KY, during daylight hours, and an annual average of 1.6 bacterial particles/m<sup>3</sup> in Odessa, Russia. The aerosols from the land treatment systems listed in Table 2-5 fall within this range.

An epidemiological study at an activated sludge plant in the Chicago area (Camann, 1978) documented bacteria and virus in aerosols on the plant site. However, the bacterial and viral content of the air, the soil, and the surface waters in the surrounding area were not different than background levels and no significant illness rates were revealed within a 4.8 km (3 mile) radius of the activated sludge plant. A similar effort was undertaken at an activated sludge plant in Oregon with a school playground approximately 10 m (30 ft) from the aeration tanks. It can be inferred from these studies, since the concentrations of bacteria and viruses in land treatment aerosols are similar to those from activated sludge treatment systems. The risks of adverse health effects should be similar to those presented by properly operated land treatment systems.

The aerosol measurements at the Pleasanton, CA land treatment system demonstrated that salmonella and viruses survived longer than the traditional coliform indicators (Camann, 1978). However, the downwind concentration of viruses was very low at  $1.1 \times 10^{-5}$  plaque-forming units (pfu/m<sup>3</sup>) (0.0004 pfu/ft<sup>3</sup>).

The source for these measurements was undisinfected effluent from high-pressure impact sprinklers, and the sampling point was 49 m (160 ft) from the sprinkler nozzle. The concentration cited is equal to one virus particle in every 7 m<sup>3</sup> (250 ft<sup>3</sup>) of air. Assuming a normal breathing intake of about 0.002 m<sup>3</sup>/min (0.07 ft<sup>3</sup>/min) it would take 59 hours of continuous exposure by a system operator to inhale that much air. In normal practice an operator at Pleasanton might spend up to one hour per day within 49 m (160 ft) of the sprinklers. This is equivalent to the time an activated sludge operator spends servicing the aeration tanks. At this rate the operator at Pleasanton would be exposed to less than

four virus particles per year and the risk to the adjacent population would appear to be non-existent.

US EPA guidelines have recommended a fecal coliform count of 1,000/100 mL for recreational applications, based on standards for general irrigation water and for bathing waters and body contact sports. With respect to the aerosol risk of spraying such waters, Shuval has reported that when the coliform concentration at the nozzle was below 1,000/100 mL, no viruses were detected at downwind sampling stations, the nearest of which was 10 m (33 ft) away. (Shuval and Teltch, 1979). Procedures have been developed for estimating the downwind concentrations of aerosol microorganisms from sprinkler application of wastewater (US EPA, 1982).

## 2.6 Metals

The removal of metals in the soil is a complex process involving the mechanisms of adsorption, precipitation, ion exchange, biogeochemical reactions, uptake (by plants and microorganisms) and complexation. Adsorption of most trace elements occurs on the surfaces of clay minerals, metal oxides, and organic matter; as a result, fine textured and organic soils have a greater length of time that water is in contact with the soil. The SR land treatment process is the most effective for metals removal because of the finer textured soils and the greater opportunity for contact and adsorption. SAT can also be quite effective but a longer travel distance in the soil will be necessary due to the higher hydraulic loadings and coarser textured soils. Overland flow (OF) systems allow minimal contact with the soil and typically remove between 60 and 90 percent depending on the hydraulic loading and the particular metal.

### 2.6.1 Micronutrients

Several metals are micronutrients that are considered essential for plant nutrition, for example:

- Copper
- Iron
- Manganese
- Molybdenum
- Nickel
- Zinc

## 2.6.2 Metals

The major concern with respect to metals is the potential for accumulation in the soil profile and then subsequent translocation, via crops or animals, through the food chain to man. The metals of greatest concern are cadmium (Cd), lead (Pb), mercury (Hg), and arsenic (As). The concentrations of metals that can be safely applied to crops are presented in Table 2-6. Most crops do not accumulate lead but there is some concern with respect to ingestion by animals grazing on forages or soil to which biosolids have been applied. In general, zinc, copper, and nickel will be toxic to the crop before their concentration in plant tissues reaches a level that poses a significant risk to human or animal health. Cadmium is the greatest concern because the concentration of concern for human health is far below the level that could produce toxic effects in the plants. WHO has published guidelines for annual and cumulative metal additions (based on US EPA's Part 503 rule) to agricultural crop land (Chang et al., 1995). Adverse effects should not be expected at these loading rates. These loading rates are presented in Table 2-7. Although they were developed for biosolids applications, it is prudent to apply the same criteria for wastewater applications.

## 2.6.3 Metals Removal in Crops and Soils

It is not possible to predict the total renovative capacity of a land treatment site with simple ion exchange or soil adsorption theories. Although the metals are accumulated in the soil profile, the accumulation resulting from repeated applications of wastewater does not seem to be continuously available for crop uptake. Work by several investigators with biosolids demonstrates that the metals uptake in a given year is more dependent on the concentration of metals in the biosolids most recently applied and not on the total accumulation of metals in the soil.

The capability of metal uptake varies with the type of crop grown. Swiss chard, and other leafy vegetables take up more metals than other types of vegetation. Metals tend to accumulate in the liver and kidney tissue of animals grazing on a land treatment site or if fed harvested products. Tests done on a mixed group of 60 Hereford and Angus steers that graze directly on the pasture grasses at the Melbourne, Australia land treat-

**Table 2-6.** Recommended Limits for Constituents in Reclaimed Water for Irrigation (Rowe, D.R. and I. M. Abel-Magid, 1995)

Element	For waters used continuously on all soil, mg/L	For use up to 20 years on fine-textured soils of pH 6.0 to 8.5, mg/L
Aluminum	5.0	20.0
Arsenic	0.10	2.0
Beryllium	0.10	0.50
Boron	0.75	2.0-10.0
Cadmium	0.010	0.050
Chromium	0.10	1.0
Cobalt	0.050	5.0
Copper	0.20	5.0
Fluoride	1.0	15.0
Iron	5.0	20.0
Lead	5.0	10.0
Lithium	2.5 <sup>a</sup>	2.5 <sup>a</sup>
Manganese	0.20	10.0
Molybdenum	0.010	0.050 <sup>b</sup>
Nickel	0.20	2.0
Selenium	0.020	0.020
Zinc	2.0	10.0

<sup>a</sup>Recommended maximum concentration for irrigating citrus is 0.075 mg/L.

<sup>b</sup>For only acid fine-textured soils or acid soils with relatively high iron oxide contents.

**Table 2-7.** WHO Recommended Annual and Cumulative Limits for Metals Applied to Agricultural Crop Land (Chang et al., 1995)

Metal	Annual loading rate <sup>a</sup> (kg/ha <sup>c</sup> )	Cumulative loading rate <sup>a</sup> (kg/ha <sup>c</sup> )
Arsenic	2.0	41
Cadmium	1.9	39
Chromium	150	3,000
Copper	75	1,500
Lead	15	300
Mercury	0.85	17
Molybdenum	0.90	18
Nickel	21.0	420
Selenium	5.0	100
Zinc	140	2,800

<sup>a</sup>Loading kg/ha per 365 day period.

<sup>b</sup>Cumulative loading over lifetime of site.

<sup>c</sup>kg/ha x 0.89 = lb/ac.

ment site (untreated raw sewage applied) showed that "the concentrations of cadmium, zinc and nickel found in the liver and kidney tissues of this group are within the expected normal range of mammalian tissue." (Anderson, 1976). Anthony (1978) has reported on metals in bone, kidney and liver tissue in mice and rabbits which were indigenous to the Pennsylvania State University land treatment site and no adverse impacts were noted.

The average metal concentrations in the shallow groundwater beneath the Hollister, CA, rapid infiltration site are shown in Table 2-8. After 33 years of operation

**Table 2-8.** Trace Metals in Groundwater Under Hollister, CA Soil Aquifer Treatment Site, mg/L (Pound, Crites and Olson, 1978)

Metal	Groundwater concentration
Cadmium	0.028
Cobalt	0.010
Chromium	<0.014
Copper	0.038
Iron	0.36
Lead	0.09
Manganese	0.96
Nickel	0.13
Zinc	0.081

the concentration of cadmium, chromium, and cobalt were not significantly different from normal off-site groundwater quality. The concentration of the other metals listed was somewhat higher than the off-site background levels.

The metal concentrations in the upper foot of soils in the SAT basins at the Hollister, CA system are still below or near the low end of the range for typical agricultural soils, after 33 years of operation.

In OF systems, the major mechanisms responsible for trace element removal include sorption on clay colloids and organic matter at the soil surface and in the litter layer, precipitation as insoluble hydroxy compounds, and formation of organometallic complexes. The largest proportion of metals accumulates in the biomass on the soil surface and close to the initial point of application.

## 2.7 Nitrogen

The removal of nitrogen in land treatment systems is complex and dynamic due to the many forms of nitrogen ( $N_2$ , organic N,  $NH_3$ ,  $NH_4$ ,  $NO_2$ ,  $NO_3$ ) and the relative ease of changing from one oxidation state to the next. The nitrogen present in typical municipal wastewater is usually present as organic nitrogen (about 40 percent) and ammonia/ammonium ions (about 60 percent). Activated sludge and other high-rate biological processes can be designed to convert all of the ammonia ion to nitrate (nitrification). Typically only a portion of the ammonia nitrogen is nitrified and the major fraction in most system effluents is still in the ammonium form (ammonia and ammonium are used interchangeably in this text).

Because excessive nitrogen is a health risk, it is important in the design of all three land treatment concepts to identify the total concentration of nitrogen in the wastewater to be treated as well as the specific forms (i.e., organic, ammonia, nitrate, etc.) expected. Experience with all three land treatment processes demonstrates that the less oxidized the nitrogen is when entering the land treatment system the more effective will be the retention and overall nitrogen removal.

### 2.7.1 Soil Responses

The soil plant system provides a number of interrelated responses to wastewater nitrogen. The organic N fraction, usually associated with particulate matter is entrapped or filtered out of the applied liquid stream. The ammonia fraction can be lost by volatilization, taken up by the crop or adsorbed by the clay minerals in the soil. Nitrate can be taken up by the vegetation, or converted to nitrogen gas via denitrification in macro or micro anaerobic zones and lost to the atmosphere or leached through the soil profile. The decomposition (mineralization) of organic nitrogen contained in the particulate matter proceeds slowly. This aspect is more critical for sludge and biosolids application systems where the solids fraction is a very significant part of the total application. As the organic solids decompose, the contained organic nitrogen is mineralized and released as ammonia. This is not a major concern for most municipal wastewater land treatment systems, with the exception of those systems receiving facultative lagoon effluent containing significant concentrations of algae. The organic content of the algae must be considered in project design because it can represent a significant ammonia load on the system.

Nitrification is effective in all three of the basic land treatment concepts as long as the necessary aerobic status of the site is maintained or periodically restored. However, having the system produce nitrate from ammonium reduces the efficiency to remove nitrogen since it increases leaching to groundwater. Under favorable conditions (i.e., sufficient alkalinity, suitable temperatures, etc.) nitrification ranging from 5 to 50 mg/L per day is possible. Assuming that these reactions are occurring with the adsorbed ammonia ions in the top four inches of a fine-textured soil means that up to 67 kg/ha (60 lb/acre) can be converted to nitrate per year.

The maintenance and/or restoration of aerobic conditions in the soil are the reason for the short application periods and cyclic operations that are required in land treatment systems. In SAT systems, for example, the ammonia adsorption sites are saturated with ammonium during the early part of the application cycle. The aerobic conditions are restored as the system drains during the rest period and the soil microbes convert the adsorbed ammonium to nitrate. At the next application cycle ammonium adsorption sites are again available and much of the nitrate is denitrified as anaerobic conditions develop. Denitrifying bacteria are common soil organisms and the occurrence of anaerobic conditions, at least at microsites, can be expected at both SR and OF systems as well as SAT.

## 2.7.2 Nitrogen Cycle

The nitrogen cycle in soil is presented in Figure 2-1. Nitrification is a conversion process, not a removal process for nitrogen. Denitrification, volatilization, soil storage and crop uptake are the only true removal pathways available. Crop uptake is the major pathway considered in the design of most slow-rate systems, but the contribution from denitrification and volatilization can be significant depending on site conditions and wastewater type. Immobilization and soil storage can be

significant with wastewaters having a carbon-to-nitrogen (C:N) ratio of 12:1 or more. In SAT, ammonia adsorption on the soil particles followed by nitrification typically occurs, but denitrification is the only important actual removal mechanism. For OF, crop uptake, volatilization, and denitrification can all contribute to nitrogen removal. Crop uptake of nitrogen is discussed in detail in Chapter 4 and in the process design chapters. Nitrogen removal data for typical SR, SAT, and OF systems are shown in Table 2-9.

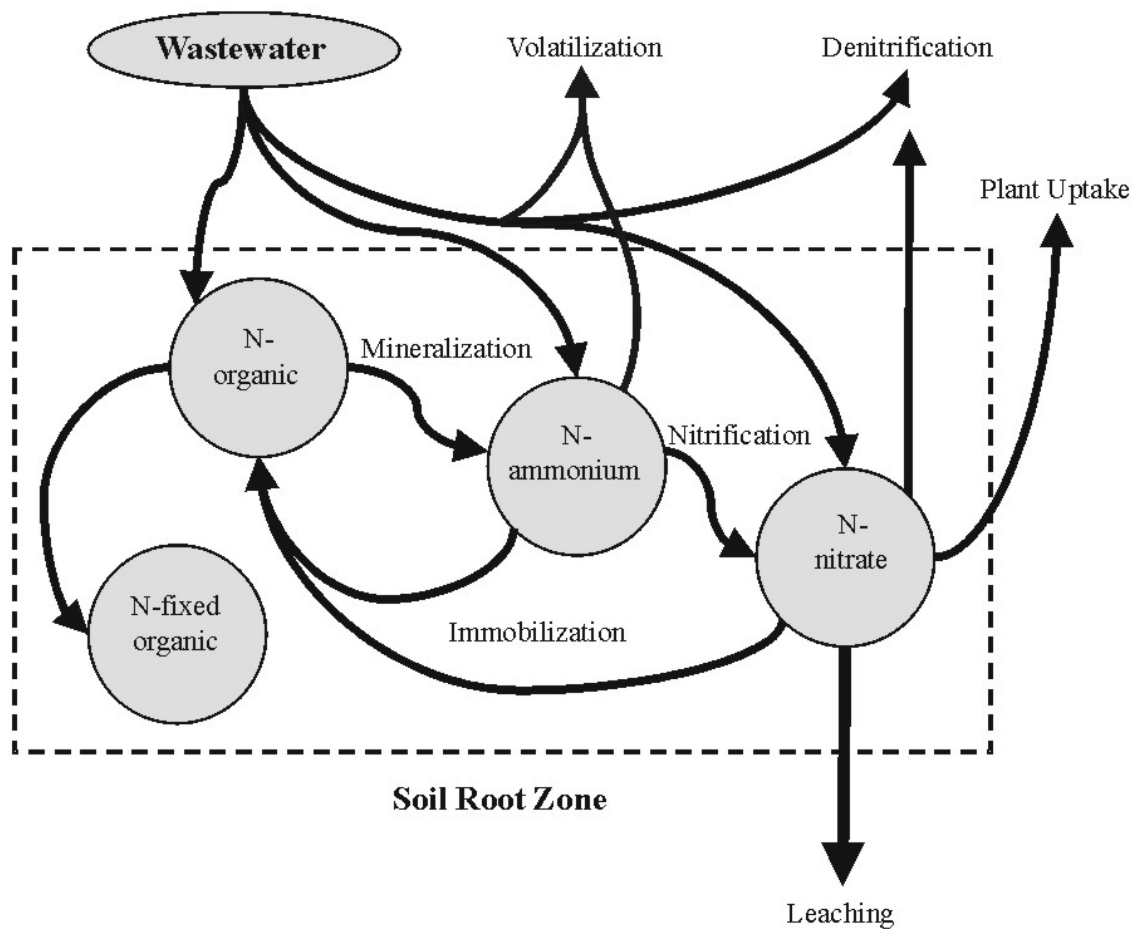


Figure 2-1. Nitrogen Cycle in Soil.



**Table 2-9.** Total Nitrogen Removal in Typical Land Treatment Systems (US EPA, 1981 and Crites et al., 2000)

Process/Location Process	Applied Wastewater (mg/L)	Soil Water Drainage (mg/L)
<b>SR</b>		
Dickinson, ND	12	3.9
Hanover, NH	28	7.3
Roswell, NM	66	10.7
San Angelo, TX	35	6.1
<b>SAT</b>		
Calumet, MI	24	7
Ft. Devens, MA	50	20
Hollister, CA	40	3
Phoenix, AZ	27	10
<b>OF</b>		
Ada, OK (raw wastewater)	34	7
(primary effluent)	19	5
(secondary effluent)	16	8
Easley, SC (pond effluent)	7	2
Utica, MS (pond effluent)	20	7

### 2.7.3 Nitrates

The U.S. primary drinking water standard for nitrate (as N) is set at 10 mg/L. The pathway of concern in SR and SAT systems is conversion of wastewater nitrogen to nitrate and then percolation to drinking water aquifers. When potable aquifers, sole source aquifers, or wellhead protection areas are involved, the current guidance requires that all drinking water standards be met at the land treatment project boundary. As a result, nitrogen often becomes the LDP for SR systems because of its relatively high concentration as compared to other drinking water parameters. Chapter 8 presents complete design details for nitrogen removal in these systems. There are a number of safety factors inherent in the approach that insures a conservative design. The procedure assumes that all of the applied nitrogen will appear as nitrate (i.e., complete nitrification) and within the same time period assumed for the application (no time lag or mineralization of ammonia) and there is no credit for mixing or dispersion with the in-situ groundwater.

### 2.7.4 Design Factors

The nitrogen mass balance for SAT systems would not usually include a component for crop uptake. The percolate nitrogen concentration is not a concern for OF systems since the percolate volume is generally considered to be negligible. As indicated previously, application of biosolids does include a mineralization factor to account for the previous organic nitrogen deposits. There are four potential situations where a mineralization factor might be included in the nitrogen balance for SR and OF systems:

- Industrial wastewaters with high solids concentrations having significant organic nitrogen content.
- Grass covered systems where the grass is cut but not removed.
- Pasture systems with intense animal grazing and animal manure left on the site.
- Biosolids or manure added to the site as supplemental fertilizers.

#### 2.7.4.1 Organic Nitrogen

Mineralization rates, developed for wastewater biosolids are given in Table 2-10. The values are the percent of the organic nitrogen present that is mineralized (i.e., converted to inorganic forms such as ammonia, nitrate, etc.) in a given year. The fraction of the biosolids organic N initially applied, or remaining in the soil, that will be mineralized during the time intervals shown are provided as examples only and may be quite different for different biosolids, soils and climates. Therefore, site-specific data, or the best judgment of individuals familiar with N dynamics in the soil-plant system involved, should always be used in preference to these suggested values. For example, 40 percent of the organic nitrogen in raw sludge would be mineralized during the first year, 20 percent the second year, and so forth. With consistent annual applications to a site, the cumulative mineralization approaches 60 percent.

The mineralization rate is related to the initial organic nitrogen content, which in turn is related to treatment level for the biosolids in question. Easily degraded

**Table 2-10.** Annual Mineralization Rates for Organic Matter in Biosolids (US EPA 1995)

Time after biosolids application (years)	Mineralization rate (%)			
	Unstabilized primary	Aerobically digested	Anaerobically digested	Composted
0-1	40	30	30	10
1-2	20	15	10	5 <sup>a</sup>
2-3	10	8	5 <sup>a</sup>	5 <sup>a</sup>
3-4+	5	4		--

<sup>a</sup>Annual rate drops to 3%. Once the mineralization rate becomes less than 3%, no net gain of plant available nitrogen above that normally obtained from the mineralization of soil organic matter is expected. Therefore, additional credits for residual biosolids N do not need to be calculated.

industrial biosolids would be comparable to raw municipal biosolids. Industrial solids with a high percentage of refractory or stable humic substances might be similar to composted biosolids. A specific test procedure is available to determine under incubation what the actual mineralization rate is for a particular waste that is high in organic nitrogen (Gilmour and Clark, 1988; Gilmour et al., 1996).

Animal manures would be similar to digested sludges and it would be conservative to assume that grass cuttings and other vegetative litter would decay at the same rates as digested sludges. The examples below illustrate the use of the factors in Table 2-10 for two possible situations.

**Example 2.2 Nitrogen Cycling in Greenbelts**

**Conditions:** Slow-rate land treatment site used as a greenbelt parkway. The grasses are cut but not removed from the site. At the annual wastewater loading rates used, the grasses will take up about 250 kg/ha•yr (222 lb/ac•yr).

**Find:** The nitrogen contribution from the on-site decay of the cut grass.

**Solution:** The most conservative assumption is to use aerobically digested sludge rates from Table 2-10 and to assume that all of the nitrogen is in the organic form.

1. In first year:	250 kg/ha (0.30)	= 75 kg/ha
2. In second year: The 2nd year cutting Residue from 1st year Total, 2 <sup>nd</sup> year	250 (0.3) (250-75) (0.15)	= 75kg/ha = 26 = 101 kg/ha
3. In third year: The 3rd year cutting Residue from 2nd year Residue from 1st year Total, 3 <sup>rd</sup> year	(250)(0.30) (250-75)(0.15) (250-101)(0.08)	= 75 kg/ha = 26 = 12 = 113kg/ha
4. In fourth year: The 4th year cutting Residue from 3rd year Residue from 2nd year Residue from 1st year Total, 4th year	(250-113)(0.04)	= 75kg/ha = 26 = 12 = 5 = 118 kg/ha
5. In fifth year:		= 75 kg/ha

The 5th year cutting		= 26
Residue from 4th year		= 12
Residue from 3rd year		= 5
Residue from 2nd year		= 5
Residue from 1st year	(250-118)(0.04)	= 5
Total, 5th year		= 123 kg/ha

6. As shown by the sequence above, the amount of nitrogen contributed becomes relatively stable after the third or fourth year and increases only slightly thereafter. In this example, it can be assumed that about 120 kg/ha of nitrogen is returned to the soil each year from the cut grass. For this case, that would be about 48 percent of the nitrogen originally taken up by the grass, so the net removal is still very significant (52 percent). The 48 percent returned is also significant, and would be included in the nitrogen mass balance in a conservative design.

1. Annual available organic nitrogen	(300 kg/ha)(0.50)	= 150 kg/ha
2. Using digested mineralization rates from Table 2-11: First year contribution	(150)(0.30)	= 45 kg/ha
Second year contribution	45 + (150-45)(0.15)	= 61 kg/ha
Third year contribution And so forth	45 + 16+ ((150-61)(0.08))	= 68 kg/ha

These two examples illustrate the critical importance of knowing the form of nitrogen is in when it is applied to the land treatment site. This is particularly important if elaborate pretreatment is provided because the nitrogen may not then be in the simple, and easily managed, combination of organic nitrogen and ammonia that is present in untreated municipal wastewater and primary effluents. Any nitrogen losses which occur during this preapplication treatment or storage should be considered. Facultative lagoons or storage ponds can remove up to 85 percent of the contained nitrogen under ideal conditions (Reed et al., 1995). Such losses are especially significant when nitrogen is the LDP for design because any reduction in nitrogen prior to land application will proportionally reduce the size and therefore the cost of the land treatment site.

**2.8 Phosphorus**

The presence of phosphorus in drinking water supplies does not have any known health significance but

phosphorus is considered to be the limiting factor for eutrophication of fresh, non-saline surface waters so its removal from wastewaters is often necessary. Phosphorus is present in municipal wastewater as orthophosphate, polyphosphate, and organic phosphates. The orthophosphates are immediately available for biological reactions in soil ecosystems. The necessary hydrolysis of the polyphosphates proceeds very slowly in typical soils so these forms are not as readily available. Industrial wastewaters may contain a significant fraction of organic phosphorus.

### 2.8.1 Removal Mechanisms

Phosphorus removal in land treatment systems can occur through plant uptake, biological, chemical, and/or physical processes. The nitrogen removal described in the previous section is almost entirely dependent on biological processes so the removal capacity can be maintained continuously or restored by proper system design and management. In contrast, phosphorus removal in the soil depends to a significant degree on chemical reactions which are slowly renewable. As a result, the retention capacity for phosphorus will be gradually reduced over time, but not exhausted. At a typical SR system for example it has been estimated that a 0.3 m (1 ft) depth of soil may become saturated with phosphorus every ten years (US EPA, 1981). The removal of phosphorus will be almost complete during the removal period and percolate phosphorus should not be a problem until the entire design soil profile is utilized. Some SR sites phosphorus may limit the design life of

the site; an example might be a site with coarse textured sandy soils with underdrains at a shallow depth which discharge to a sensitive surface water. In this case the useful life of the site might range from 20 to 60 years depending on the soil type, underdrain depth, wastewater characteristics, and loading rates.

Crop uptake contributes to phosphorus removal at SR systems, but the major removal pathway in both SR and RI systems is in the soil. Typical plant concentrations for nitrogen are 1 percent to 2 percent and for phosphorus the concentrations are 0.2 percent to 0.4 percent. The phosphorus is removed by adsorption/precipitation reactions when clay, oxides of iron and aluminum, and calcareous substances are present. The phosphorus removal increases with increasing clay content and with increasing contact time in the soil. The percolate phosphorus values listed in Table 2-11 for SR systems are close to the background levels for natural groundwater at these locations.

### Soil Aquifer Treatment

There is no crop uptake in SAT systems and the soil characteristics and high hydraulic loading rates typically used require greater travel distances in the soil for effective phosphorus removal. Data from several of the SAT systems in Table 2-11 indicate a percolate phosphorus concentration approaching background levels after travel through the sub soils. Most of these systems (Vineland, Lake George, Calumet, Ft Devens) had been in operation for several decades prior to collection of the percolate samples.

**Table 2-11.** Typical Percolate Phosphorus Concentrations<sup>a</sup> (Crites et al., 2000)

Location	Soil type	Travel distance <sup>b</sup> (m)	Soil water drainage phosphorus (mg/L)
<b>SR</b>			
Hanover, NH	Sandy loam	1.5	0.05
Muskegon, MI	Loamy sand	1.5	0.04
Tallahassee, FL	Fine sand	1.2	0.1
Penn. State, PA <sup>c</sup>	Silt loam	1.2	0.8
Helen, GA <sup>c</sup>	Sandy loam	1.2	0.17
<b>SAT</b>			
Hollister, CA	Gravely sand	6.7	7.4
Phoenix, AZ	Gravely sand	9.1	4.5
Ft. Devens, MA	Gravely sand	1.5	9.0
Calumet, MI	Gravely sand	9.1	0.1
Boulder, CO	Gravely sand	3.0	2.3
Lake George, NY	Sand	0.9	1.0
		183	0.014
Vineland, NJ	Sand	9.1	1.5
		122	0.27

<sup>a</sup> Applied wastewater, typical municipal effluent, TP ≈ 8 to 14 mg/L.

<sup>b</sup> Total percolate travel distance from soil surface to sampling point SR systems.

<sup>c</sup> Forested SR system.

An equation to predict phosphorus removal at SR and SAT land treatment sites has been developed from data collected at a number of operating systems (US EPA 1980). The equation was developed from performance data with the coarse textured soils at SAT sites.

Equation 2-2 is solved in two steps, first for the vertical flow component, from the soil surface to the subsurface flow barrier (if one exists) and then for the lateral flow to the outlet point x. The calculations are assuming saturated flow conditions, so the shortest possible detention time will result. The actual vertical flow in most cases will be unsaturated, so the actual detention time will be much longer than is calculated with this procedure, and therefore the actual phosphorus removal will be greater. If the equation predicts acceptable phosphorus removal then there is some assurance that the site will perform reliably and detailed tests should not be necessary for preliminary work. Detailed phosphorus removal tests should be conducted for final design of projects where phosphorus removal is critical.

### 2.8.3 Overland Flow

The opportunities for contact between the applied wastewater and the soil are limited to surface reactions in OF systems and as a result phosphorus removals typically range from 40 to 60 percent. Phosphorus removal in overland flow can be improved by chemical addition and then precipitation on the treatment slope. At Ada, OK, the US EPA demonstrated the use of alum additions (Al to TP mole ratio 2:1) to produce a total phosphorus concentration in the treated runoff of 1 mg/L (US EPA, 1981). At Utica, MS, mass removals ranged between 65 and 90 percent with alum as compared to less than 50 percent removal without alum (Crites, 1983).

$$P_x = P_o (e^{-kx}) \quad (2-2)$$

**Where:**

- $P_x$  = total phosphorus in percolate at distance x on the flow path (mg/L)
- $P_o$  = total phosphorus in applied wastewater, mg/L
- $k$  = rate constant, at pH 7,  $d^{-1}$   
= 0.048  $d^{-1}$  (pH 7 gives most conservative value)
- $t$  = detention time to point x, d  
=  $(x)(W)/(K_x)(G)$
- $x$  = distance along flow path, m (ft)
- $W$  = saturated soil moisture content, assume 0.4
- $K_x$  = hydraulic conductivity of soil in direction x, m/d (ft/d)

**Thus:**

- $K_v$  = vertical conductivity,  $K_H$  = horizontal conductivity
- $G$  = hydraulic gradient for flow system, dimensionless  
= 1.0 for vertical flow  
=  $\Delta h/L$  for horizontal flow
- $\Delta h$  = elevation difference of water surface between origin of horizontal flow and end point x, m (ft)
- $L$  = length of horizontal flow path, m (ft).

Example 2.4	Phosphorus Removal
<b>Conditions:</b>	Assume a site where wastewater percolate moves 5 m vertically through the soil to the groundwater table and then 45 m horizontally to emergence in a small stream. The initial phosphorus concentration is 10 mg/L, the vertical hydraulic conductivity $K_v = 1$ m/d, the horizontal hydraulic conductivity $K_H = 10$ m/d, and the difference in groundwater surface elevations between the site and the stream is 1 m.
<b>Find:</b>	The phosphorus concentration in the percolate when emerging in the stream and the total detention time in the soil.
<b>Solution:</b>	Use Equation 2-2. Phosphorus concentration at end of vertical flow :  $t = \frac{(5\text{ m})(0.4)}{1\text{ m/d}} = 2.0\text{ d}$ $P_x = (10\text{ mg/L})(e^{-(0.048)(2.0)})$ $= 9.1\text{ mg/L}$ Percolate phosphorus concentration at the stream:  $t = (45\text{ m})(0.4)/(10\text{ m/d})(1\text{ m}/45\text{ m}) = 81\text{ d}$ $P_x = (9.1\text{ mg/L})(e^{-(0.048)(81)})$ $= 0.18\text{ mg/L}$ Total detention time in soil = 2 d + 81 d = 83 d

Typical municipal wastewaters will have between 5 and 20 mg/L of total phosphorus. Industrial wastewaters can have much higher concentrations, particularly from fertilizer and detergent manufacturing. Food processing operations can also have high phosphate effluents. Some typical values are: Dairy products 9 to 210 mg/L  $PO_4$ , Grain Milling 5 to 100 mg/L  $PO_4$ , Cattle feed lots 60 to 1,500 mg/L  $PO_4$ .

Example 2.5	Determine Phosphorus Loading to Match Useful Life of Site
<b>Conditions:</b>	Assume a silty loam soil, adsorption tests indicate a useful capacity for phosphorus equal to 9,000 kg/ha per meter of depth. Site to be grass covered, grass uptake of phosphorus is 35 kg/ha•yr, grass to be harvested and taken off site. The projected operational life of the factory and the treatment site is equal to 30 years. The phosphorus concentration in the wastewater is 20 mg/L. The treatment site is underdrained with drainage water discharged to adjacent surface waters with an allowable discharge limit of 1.0 mg/L TP. Because of the underdrains, the practical soil treatment depth is 2 m.
<b>Find:</b>	The acceptable annual wastewater loading during the 30 yr useful life.

- Solution:**
1. Lifetime crop contribution =  $(35 \text{ kg/ha}\cdot\text{yr})(30 \text{ yr}) = 1050 \text{ kg/ha}$
  2. Lifetime soil contribution =  $(9000 \text{ kg/ha}) (2 \text{ m}) = 18000 \text{ kg/ha}$
  3. Total 30 yr phosphorus removal capacity =  $19,050 \text{ kg/ha}$  (Step 1 + Step 2).
  4. Average annual phosphorus loading =  $(19,050 \text{ kg/ha})/(30 \text{ yr}) = 635 \text{ kg/ha}\cdot\text{yr}$
  5. Wastewater loading (Q) =  $(635 \text{ kg/ha}\cdot\text{yr})/(20 \text{ g/m}^3) = 3.175 \text{ m/yr}$

Note: Design credit is not taken in this example for the 1.0 mg/L TP allowed in the underdrain effluent. This is because the treatment system will essentially remove all of the phosphorus during the useful life of the system until breakthrough occurs; until that point is reached the effluent concentration should be well below the allowable 1 mg/L level.

## 2.9 Potassium

As a wastewater constituent, potassium usually has no health or environmental significance. It is, however, an essential nutrient at sufficient levels for vegetative growth, and is not typically present at sufficient levels in wastewaters in the optimum combination with nitrogen and phosphorus. If a land treatment system depends on crop uptake for nitrogen removal, it may be necessary to add supplemental potassium to maintain nitrogen removals at the optimum level. Equation 2-3, developed by A. Palazzo, can be used to estimate the supplemental potassium that may be required where the in-situ soils have a low level of natural potassium. This most commonly occurs in the northeastern part of the U.S.

$$K_s = (0.9)(U) - K_{ww} \quad (2-3)$$

**Where:**

- $K_s$  = annual supplemental potassium needed, (kg/ha)  
 $U$  = estimated annual nitrogen uptake of crop, (kg/ha)  
 $K_{ww}$  = potassium applied in wastewater, (kg/ha)  
 (kg/ha) x (0.8922) = lb/ac

## 2.10 Sodium

Sodium is typically present in all wastewaters. High levels of sodium can be directly toxic to plants but most often its influence on soil salinity or soil alkalinity is the more important problem. Growth of sensitive plants becomes impaired where the salt content of the soil exceeds 0.1 percent. Salinity also has a direct bearing on the osmotic potential of the soil solution, which controls the ability of the plant to absorb water. Adverse crop effects can also occur from sprinkler operations in arid climates using water with significant concentrations of sodium or chloride (see Chapter 4). The leaves can

absorb both elements rapidly and their accumulation on the leaf surfaces in arid climates can result in toxicity problems (Reed et al., 1995).

Sodium is not permanently removed in the soil but is rather involved in the soil cation exchange process. These reactions are similar to those occurring in water softening processes and involve sodium, magnesium, and calcium. In some cases, where there is an excess of sodium with respect to calcium and magnesium in the water applied to high clay content soils, there can be an adverse effect on soil structure. The resulting deflocculation and swelling of clay particles can significantly reduce the hydraulic capacity of the soil. The relationship between sodium, calcium, and manganese is expressed as the Sodium Adsorption Ratio (SAR) as defined by Equation 2-4.

$$\text{SAR} = (\text{Na})/[(\text{Ca} + \text{Mg})/2]^{0.5} \quad (2-4)$$

**Where:**

- $\text{SAR}$  = Sodium adsorption ratio  
 $\text{Na}$  = Sodium concentration, milliequivalents/L  
 $\text{Ca}$  = Calcium concentration, milliequivalents/L  
 $\text{Mg}$  = Magnesium concentration, milliequivalents/L

A SAR of 10 or less should be acceptable on soils with significant clay content (15 percent clay or greater). Soils with little clay, or non-swelling clays can tolerate an SAR up to 20. It is unlikely that problems of this type will occur with application of municipal effluents in any climate since the SAR of typical effluents seldom exceeds 5 to 8. Industrial wastewaters can be of more concern. The washwater from ion exchange water softening could have an SAR of 50, and some food processing effluents range from about 30 to over 90. As discussed in Chapter 4, SAR problems are affected by the TDS of the wastewater, with more adverse effects occurring with low TDS water. Many western states have recommended irrigation water quality for SAR and EC. Local state agricultural universities should be consulted.

The common remedial measure for SAR induced soil swelling or permeability loss is the surface application of gypsum or another inexpensive source of calcium. The addition of water allows the calcium to leach into the soil to exchange with the sodium. An additional volume of water is then required to leach out the salt solution.

## 2.11 Macronutrients and Micronutrients

Most plants also require magnesium, calcium, and sulfur, and depending on soil characteristics, there may be deficiencies in some locations. Other micronutrients important for plant growth include iron, manganese, zinc, boron, copper, molybdenum and nickel. Generally, there is a sufficient amount of these elements in municipal

wastewaters, and in some cases an excess can lead to phytotoxicity problems.

### 2.11.1 Sulfur

Sulfur is usually present in most wastewaters either in the sulfate or sulfite form. The source can be either waste constituents or background levels in the community water supply. Sulfate is not strongly retained in the soil but is usually found in the soil solution. Sulfates are not typically present in high enough concentrations in municipal wastewaters to be a concern for design of land treatment systems. Secondary drinking water standards limit sulfate to 250 mg/L, irrigation standards recommend 200 to 600 mg/L depending on the type of vegetation. Industrial wastewaters from sugar refining, petroleum refining, and Kraft process paper mills might all have sulfate or sulfite concentrations requiring special consideration. Crop uptake accounts for most sulfur removal with the low levels in municipal wastewater.

If sulfur is the LDP, then the design procedure is similar to that described previously for nitrogen. It is prudent to assume that all of the sulfur compounds applied to the land will be mineralized to sulfate. The 250 mg/L standard for drinking water sulfate would then apply at the project boundary when drinking water aquifers are involved. It should be assumed in sizing the system that the major permanent removal pathway is to the harvested crop and the values in Table 2-12 can be used for estimating purposes. If industrial wastes have particularly high organic contents there may be additional immobilization of sulfur. It is recommended that specific pilot tests be run for industrial wastewaters of concern to determine the potential for removal under site specific conditions.

### 2.11.2 Boron

Boron is an essential micronutrient for plants but becomes toxic at relatively low concentrations (<1 mg/L) for sensitive plants. The soil has some

**Table 2-12. Sulfur Uptake by Selected Crops**

Crop	Harvested mass		Sulfur removed	
	Metric tons/ha	As noted	(kg/ha)	lbs/ac
Corn	12.5	200 bu/ac	49	43.8
Wheat	5.6	83 bu/ac	25	22.3
Barley	5.4	100 bu/ac	28	25
Alfalfa	13.4	6 ton/ac	34	30.4
Clover	9.0	4 ton/ac	20	17.9
Coastal Bermuda grass	22.4	10 ton/ac	50	44.6
Orchard grass	15.7	7 ton/ac	56	50
Cotton	1.3(USA)	2.5 bale/ac	26	23.2

adsorptive capacity for boron if aluminum and iron oxides are present. The soil reactions are similar to those described previously for phosphorus but the capacity for boron is low. A conservative design approach assumes that any boron not taken up by the plant is available for percolation to the groundwater. Plant uptake of boron in corn silage of about 0.006 kg/ha•yr (0.005 lb/ac•yr) and in alfalfa of 0.91 to 1.8 kg/ha•yr (0.81 to 1.6 lb/ac•yr) have been reported (Overcash and Pal, 1979). At the SR land treatment site in Mesa, AZ the applied municipal effluent had 0.44 mg/L boron, and the groundwater beneath the site contained 0.6 mg/L. At another SR operation at Camarillo, CA the wastewater boron was 0.85 mg/L and the groundwater beneath the site was 1.14 mg/L. The increase in boron, in both cases, is probably due to water losses from evapotranspiration. Table 2-13 lists the boron tolerance of common vegetation types.

**Table 2-13. Boron Tolerance of Crops (Reed et al., 1995)**

I. Tolerant	II. Semi-tolerant	III. Sensitive
Alfalfa	Barley	Fruit crops
Cotton	Corn	Nut trees
Sugar beets	Milo	
Sweet clover	Oats	
Turnip	Tobacco	
	Wheat	

Industrial wastewaters with 2 to 4 mg/L boron could be successfully applied to crops in Category I in Table 2-13, 1 to 2 mg/L boron for Category II and less than 1 mg/L for Category III (Overcash and Pal, 1979). Boron may not be the LDP for process design and may be the determinant on which crop to select. Both OF and SAT systems will be less effective for boron removal than SR systems because of the same factors discussed previously for phosphorus. Injection experiments at the Orange County, CA, groundwater recharge project injected treated municipal effluent with 0.95 mg/L boron. After 166 m (545 ft) travel in the soil the boron concentration was still 0.84 mg/L (Reed, 1972).

Example 2.6	Sodium Adsorption Ratio
<b>Conditions:</b>	A municipal effluent with: Na 50 mg/L, Ca 15 mg/L, Mg 5 mg/L
<b>Find:</b>	The SAR of this effluent.
<b>Solution:</b>	Atomic weights: Na = 22.99, Ca = 40.08, Mg = 24.32 $\text{Meq Na} = (1)(50 \text{ mg/L})/(22.99) = 2.17$ $\text{Meq Ca} = (2)(15 \text{ mg/L})/(40.08) = 0.75$ $\text{Meq Mg} = (2)(5 \text{ mg/L})/(24.32) = 0.41$ $\text{SAR} = (2.17) / [(0.75 + 0.41)/2]^{0.5} = 2.85$

### 2.11.3 Selenium

Selenium is a micronutrient for animals but is non essential for plants. However, in high concentrations it is toxic to animals and birds and many plants can accumulate selenium to these toxic levels without any apparent effect on the crop. Plants containing 4 to 5 mg/L selenium are considered toxic to animals (Reed et al., 1995). Selenium can be adsorbed weakly by the hydrous iron oxides in soils and this is of more concern in the southeastern US where soils tend to have very high iron oxide contents. In arid climates with significant evaporation, surficial soils can eventually accumulate toxic levels of selenium as occurred at the famous Kesterson Marsh in California. Selenium is not likely to be the LDP for land treatment design with municipal wastewaters.

### 2.11.4 Fixed Dissolved Solids

There are a number of potential measurements of salinity including total dissolved solids (TDS), electrical conductivity (EC), and fixed dissolved solids (FDS). The FDS is the more appropriate test for salinity in any wastewater with a significant portion of volatile dissolved solids (VDS). For industrial wastewaters (see Chapter 11), FDS is the most appropriate test. Alternatively, the sum of the inorganic cations and anions can be used as a measure of salinity.

Salinity problems are of most concern in arid regions because applied water will be increased in salinity due to evapotranspiration, and because system design in arid regions is typically based on applying the minimal amount of water needed for the crop to grow. The combination of these factors will result in a rapid build-up of salts in the soil unless mitigation efforts are applied. A standard approach is to determine crop water needs and then add to that a leaching requirement (LR) to ensure that an adequate volume of water passes through the root zone to remove excess salts. The LR can be determined if the salinity or electrical conductivity (EC) of the irrigation water, and the maximum allowable EC in the percolate to protect a specific crop are known (Reed et al., 1995). The salt content of irrigation waters is often expressed as mg/L of TDS, and can be converted to conductivity terms (mmho/cm) by dividing mg/L by 0.640. [Note: this relationship is only valid for water with essentially no volatile dissolved solids.] Equation 2-5 can be used to estimate the LR.

$$LR = [(EC)/(EC)_b] \times 100 \quad (2-5)$$

**Where:**

- LR = leaching requirement as a percent
- EC<sub>i</sub> = average conductivity of irrigation water (including natural precipitation), mmho/cm
- EC<sub>b</sub> = required conductivity in drainage water to protect the crop, mmho/cm

Typical values of EC<sub>D</sub> for crops without yield reduction are given in Table 2-14.

**Table 2-14.** Values of EC<sub>D</sub> for Crops with No Yield Reduction (Ayers, 1977)

Crop	Electrical Conductivity EC <sub>D</sub> , mmho/cm
Bermuda grass	13
Barley	12
Sugar beets	10
Cotton	10
Wheat	7
Tall fescue	7
Soybeans	5
Corn	5
Alfalfa	4
Orchard grass	3

Once the leaching requirement (LR) has been determined the total water application can then be calculated with Equation 2-6.

$$L_w = (CU)/(1 - LR/100) \quad (2-6)$$

**Where:**

- L<sub>w</sub> = required total water application, inches
- CU = consumptive water use by the crop between water applications, inches
- LR = leaching requirement (as a percent)

Example 2.7	Leaching Requirement
<b>Conditions:</b>	Given a wastewater effluent with 800 mg/L salinity, corn is the growing crop with EC <sub>D</sub> = 5 mmho/cm, consumptive use between irrigations = 3 inches.
<b>Find:</b>	The total water requirement.
<b>Solution:</b>	Conductivity of the effluent = (800/0.640) = 1.25 mmho/cm LR = (1.25)/(5) x 100 = 25% L <sub>w</sub> = (3)/(1 - 0.25) = 4 inches

A "rule of thumb" for total water needs to prevent salt buildup in arid climates is to apply the crop needs plus about 10 to 15 percent. Salinity problems and leaching requirements are not to be expected for land treatment systems in the more humid portions of the US because natural precipitation is higher and higher hydraulic loadings are typically used to minimize the land area required.

### 2.12 Trace Organics

Volatilization, adsorption, and then biodegradation are the principal methods for removing trace organic compounds in land treatment systems. Volatilization can

occur at the water surface of treatment and storage ponds, and SAT basins, in the water droplets used in sprinklers, in the water films on OF slopes, and on the exposed surfaces of biosolids. Adsorption occurs primarily on the organic matter, such as plant litter and similar residues, present in the system. Microbial activity then degrades the biologically degradable adsorbed materials.

### 2.12.1 Volatilization

The loss of volatile organics from a water surface can be described with first order kinetics, since it is assumed that the concentration in the atmosphere above the water surface is essentially zero. Equation 2-7 is the basic kinetic equation and Equation 2-8 can be used to estimate the "half life" of the contaminant of concern.

$$C_t/C_0 = e^{-(K_{VOL})t/(y)} \quad (2-7)$$

**Where:**

$C_t$  = concentration at time t, mg/L  
 $C_0$  = concentration at t = 0, mg/L  
 $K_{VOL}$  = volatilization mass transfer coefficient, cm/h  
 = (K)(y)  
 $K_M$  = overall volatilization rate coefficient, h<sup>-1</sup>  
 y = depth of liquid, cm

$$t_{1/2} = (0.6930(y))/(K_{VOL}) \quad (2-8)$$

**Where:**

$t_{1/2}$  = time when concentration  $C_t = 1/2(C_0)$ , h

The volatilization mass transfer coefficient ( $K_M$ ) is a function of the molecular weight of the contaminant and the air/water partition coefficient as defined by the Henry's law constant as shown by Equation 2-9.

$$K_{VM} = [(B_1)/(y)][(H)/(B_2 + H)(M^{1/2})] \quad (2-9)$$

**Where:**

$K_{VM}$  = volatilization mass transfer coefficient, h<sup>-1</sup>  
 H = Henry's law constant, 10<sup>5</sup> (atm)(m<sup>3</sup>)(mol<sup>-1</sup>)  
 M = molecular weight of contaminant of concern, g/mol  
 $B_1, B_2$  = coefficients specific to system of concern, dimensionless

Dilling (Dilling, 1977) determined values for a variety of volatile chlorinated hydrocarbons at a well mixed water surface:

$$B_1 = 2.211 \quad B_2 = 0.01042$$

Jenkins et al (Jenkins et al., 1985) determined values for a number of volatile organics on an overland flow slope:

$$B_1 = 0.2563 \quad B_2 = 5.86 \times 10^{-4}$$

The coefficients for the overland flow case are much lower because the movement of water down the slope is non turbulent and may be considered almost laminar

flow (Reynolds number 100 to 400). The average depth of flowing water on this slope was about 1.2 cm.

Using a variation of Equation 2-9, Parker and Jenkins determined the volatilization losses from the droplets at a low-pressure, large droplet wastewater sprinkler (Parker and Jenkins, 1986). In this case the y term in the equation is equal to the average droplet radius; as a result, their coefficients are only valid for the particular sprinkler used. Equation 2-10 was developed by Parker and Jenkins for the organic compounds listed in Table 2-15.

$$\ln(C_t/C_0) = 4.535[K'_M + 11.02 \times 10^{-4}] \quad (2-10)$$

**Table 2-15.** Volatile Organic Removal by Wastewater Sprinkling (Parker and Jenkins, 1986)

Substance	Calculated $K'_M$ for Eq. 2-12, (cm/min)
Chloroform	0.188
Benzene	0.236
Toluene	0.220
Chlorobenzene	0.190
Bromoform	0.0987
n-Dichlorobenzene	0.175
Pentane	0.260
Hexane	0.239
Nitrobenzene	0.0136
m-nitrotoluene	0.0322
PCB 1242	0.0734
Napthalene	0.144
Phenanthrene	0.0218

### 2.12.2 Adsorption

Sorption of trace organics to the organic matter present in the land treatment system is thought to be the primary physicochemical mechanism of removal. The concentration of the trace organic which is sorbed relative to that in solution is defined by the partition coefficient  $K_P$  which is related to the solubility of the chemical. This value can be estimated if the octanol-water partition coefficient  $K_{OW}$  and the percentage of organic carbon in the system are defined. Jenkins, et al., 1985 determined that sorption of trace organics on an overland flow slope could be described with first order kinetics with the rate constant defined by Equation 2-11.

$$K_{SORB} = (B_3/y)[K_{OW}/(B_4 + K)(M)^{1/2}] \quad (2-11)$$

**Where:**

$K_{SORB}$  = sorption coefficient, h<sup>-1</sup>  
 $B_3$  = coefficient specific to the treatment system  
 = 0.7309 for the OF system studied  
 y = depth of water on OF slope, 1.2 cm  
 $K_{OW}$  = octanol-water partition coefficient  
 $B_4$  = coefficient specific to the system  
 = 170.8 for the overland flow system studied  
 M = molecular weight of the organic chemical, g/mol

In many cases the removal of these organics is due to a combination of sorption and volatilization. The overall



process rate constant  $K_{SV}$  is then the sum of the coefficients defined with Equations 2-9 and 2-11, with the combined removal described by Equation 2-12.

$$C_t/C_0 = e^{-(K_{SV})t} \quad (2-12)$$

**Where:**

- $K_{SV}$  = overall rate constant for combined volatilization and sorption
- =  $K_{VM} + K_{SORB}$
- $C_t$  = concentration at time t, mg/L (or  $\mu\text{g/L}$ )
- $C_0$  = initial concentration, mg/L (or  $\mu\text{g/L}$ )

Table 2-16 presents the physical characteristics of a number of volatile organics for use in the equations presented above for volatilization and sorption.

### 2.12.3 Removal Performance

A number of land treatment systems have been studied extensively to document the removal of priority pollutant organic chemicals. This is probably due to the concern for groundwater contamination. Results from these studies have generally been positive. The removal performance for the three major land treatment concepts is presented in Table 2-17. The removals observed in the SR systems were after 1.5 m (5 ft) of travel in the soils specified, and a low pressure, large droplet sprinkler was used for the applications. The removals noted for the OF system were measured after a flow on a terrace about 30 m (100 ft) long, with application via gated pipe at the top of the slope. The SAT data were obtained from sampling wells about 200 m (600 ft) down-gradient of the application basins.

The removals reported in Table 2-17 for SR systems represent concentrations in the applied wastewater ranging from 2 to 111  $\mu\text{g/L}$ , and percolate concentrations ranging from 0 to 0.4  $\mu\text{g/L}$ . The applied concentrations in

the OF system ranged from 25 to 315  $\mu\text{g/L}$  and from 0.3 to 16  $\mu\text{g/L}$  in the OF runoff. At the SAT system influent concentrations ranged from 3 to 89  $\mu\text{g/L}$  and the percolate ranged from 0.1 to 0.9  $\mu\text{g/L}$ .

### 2.13 Phytoremediation

Phytoremediation involves the use of plants to treat or stabilize contaminated soils and groundwater (US EPA, 2000). The technology is complex and is only introduced here. The technology has emerged as a response to the clean-up efforts for sites contaminated with toxic and hazardous wastes. Contaminants which have been successfully remediated with plants include petroleum hydrocarbons, chlorinated solvents, metals, radionuclides, and nutrients such as nitrogen and phosphorus. In 1998 it was estimated by Glass that at least 200 field remediations or demonstrations have been completed or are in progress around the world (Glass, 1999). However, the "remediation" technology as currently used is not "new" but rather draws on the basic ecosystem responses and reactions documented in this and other chapters in this book. The most common applications depend on the plants to draw contaminated soil water to the root zone where either microbial activity or plant uptake of the contaminants provides the desired removal. Evapotranspiration, during the growing season provides for movement and elimination of the contaminated groundwater. Once taken up by the plant the contaminants are either sequestered in plant biomass or possibly degraded and metabolized to a volatile form and transpired. In some cases the plant roots can also secrete enzymes which contribute to degradation of the contaminants in the soil.

Obviously, food crops and similar vegetation, which might become part of the human food chain, are not used on these remediation sites. Grasses and a number of tree species are the most common choices. Hybrid

**Table 2-16.** Physical Characteristics for Selected Organic Chemicals (Reed et al., 1995)

Substance	$K_{OW}^a$	$H^b$	Vapor pressure <sup>c</sup>	$M^d$
Chloroform	93.3	314	194	119
Benzene	135	435	95.2	78
Toluene	490	515	28.4	92
Chlorobenzene	692	267	12.0	113
Bromoform	189	63	5368	253
m-Dichlorobenzene	$2.4 \times 10^3$	360	2.33	147
Pentane	$1.7 \times 10^3$	125,000	520	72
Hexane	$7.1 \times 10^3$	170,000	154	86
Nitrobenzene	70.8	1.9	0.23	122
m-nitrotoluene	282	5.3	0.23	137
Diethylphthalate	162	0.056	$7 \times 10^{-4}$	222
PCB 1242	$3.8 \times 10^5$	30	$4 \times 10^{-4}$	26
Napthalene	$2.3 \times 10^3$	36	$8.28 \times 10^{-2}$	128
Phenanthrene	$2.2 \times 10^4$	3.9	$2.03 \times 10^{-4}$	178
2,4-Dinitrophenol	34.7	0.001	--	184

a. Octanol-water partition coefficient.  
d. Molecular weight, g/mol.

b. Henry's law constant, 105 atm(m<sup>3</sup>/mol) at 20°C and 1 atm.

c. Vapor pressure at 25°C.

**Table 2-17.** Percent Removal of Organic Chemicals in Land Treatment Systems (Reed et al., 1995)

Substance	SR		OF	SAT
	Sandy soil	Silty soil		
Chloroform	98.57	99.23	96.50	>99.99
Benzene	>99.99	>99.99	99.00	99.99
Toluene	>99.99	>99.99	98.09	>99.99
Chlorobenzene	99.97	99.98	98.99	>99.99
Bromoform	99.93	99.96	97.43	>99.99
Dibromochloromethane	99.72	99.72	98.78	>99.99
m-nitrotoluene	>99.99	>99.99	94.03	a
PCB 1242	>99.99	>99.99	96.46	>99.99
Napthalene	99.98	99.98	98.49	96.15
Phenanthrene	>99.99	>99.99	99.19	a
Pentachlorophenol	>99.99	>99.99	98.06	a
2,4-Dinitrophenol	a	a	93.44	a
Nitrobenzene	>99.99	>99.99	88.73	a
m-Dichlorobenzene	>99.99	>99.99	a	82.27
Pentane	>99.99	>99.99	a	a
Hexane	99.96	99.96	a	a
Diethylphthalate	a	a	a	90.75

a. Not reported.

Poplar trees have emerged as the most widely used species. These trees grow faster than other northern temperate zone trees, they have high rates of water and nutrient uptake, they are easy to propagate and establish from stem cuttings, and the large number of species varieties permit successful use at a variety of different site conditions. Cottonwood, willow, tulip, eucalyptus, and fir trees have also been used. Wang, et al., for example, have demonstrated the successful removal by hybrid poplar trees (H11-11) of carbon tetrachloride (15 mg/L in solution) (Wang et al., 1999). The plant degrades and dechlorinates the carbon tetrachloride and releases the chloride ions to the soil and carbon dioxide to the atmosphere.

Indian mustard and maize have been studied for the removal of metals from contaminated soils (Lombi et al., 2001). Alfalfa has been used to remediate a fertilizer spill (Russelle et al., 2001).

## 2.14 References

Anderson, N. (1976) *Notice Paper Number 15*, Legislative Assembly, Victoria, Australia.

Anthony, R.G. (1978) *Effects of Municipal Wastewater Irrigation on Selected Species of Animals*, in: Proceedings, Land Treatment Symposium, U.S.A. CRREL, Hanover, NH.

Arnold, R.G., D.D. Quanrad, G. Wilson, P. Fox, B. Alsmadi, G. Amy, and J. Debroux (1996) *The Fate of Residual Wastewater Organics During Soil-Aquifer Treatment*, presented at: Joint AWWA/WEF Water Reuse Conference, San Diego, CA.

Arizona State University, University of Arizona, University of Colorado (1998) *Soil Treatability Pilot Studies to Design and Model Soil Aquifer Treatment*

*Systems*, AWWA Research Foundation, Denver, CO.

Asano T., Editor (1998) *Wastewater Reclamation and Reuse* Vol. 10 Water Quality Management Library, Technomic Publishing Co., Lancaster, PA.

Ayers, R.S. (1977) *Quality of Water for Irrigation*, Jour. Irrigation Division, ASCE, Vol 103(IRZ):135-154, ASCE, New York, NY.

Bastian, R.K. (1993) *Summary of 40CFR Part 503, Standards for the Use or Disposal of Sewage Sludge*, US EPA, OWM, Washington, DC.

Bausmith, D.S. and R.D. Neufeld (1999) *Soil Biodegradation of Propylene Glycol Based Aircraft Deicing Fluids*, Jour. WEF, 71(4):459-464.

Bell, R.G. and J.B. Bole (1978) *Elimination of Fecal Coliform Bacteria from Soil Irrigated with Municipal Sewage Lagoon Effluent*, Jour. Envir. Qual. Vol. 7, 193-196.

Burken, J.G., J.L. Schnoor (1996) *Phytoremediation: Plant Uptake of Atrazine and Role of Root Exudates*, Jour. ASCE EED 122/11 958-963, ASCE, New York, NY.

Camann, D (1978) *Evaluating the Microbiological Hazard of Wastewater Aerosols*, Contract Report DAMD 17-75-C-5072, US AMBRDL, Ft. Detrick, MD.

Chang, A.C., A.L. Page, and T. Asano (1995) *Developing Human Health-related Chemical Guidelines for Reclaimed Wastewater and Sewage Sludge Applications in Agriculture*, WHO/EOS/95.20, World Health Organization, Geneva, 114 pp.

- 
- Crites, R.W. (1983) *Chapter 9 - Land Treatment*, WPCF MOP FD-7 Nutrient Control, WPCF, Alexandria, VA.
- Crites, R. and G. Tchobanoglous (1998) *Small and Decentralized Wastewater Management Systems*, McGraw Hill Co., New York, NY.
- Crites, R.W., S.C. Reed, and R.K. Bastian (2000) *Land Treatment Systems for Municipal and Industrial Wastes*. McGraw-Hill Book Co. New York.
- US EPA (1980) *Muskegon County Wastewater Management System*, EPA 905/2-80-004, US EPA RS Kerr Laboratory, Ada, OK.
- Dilling, W.L. (1977) Interphase Transfer Processes II, Evaporation of Chloromethanes, Ethanes, Ethylenes, Propanes, and Propylenes from Dilute Aqueous Solutions, Comparisons with Theoretical Predictions, *Environ. Sci. Technol.* 11:405-409.
- Giggey, M.D., R.W. Crites, and K.A. Brantner (1989) Spray Irrigation of Treated Septage on Reed Canarygrass, *JWPCF*, 61:333-342.
- Gilmour, J.T. and M.D. Clark (1988) Nitrogen Release from Wastewater Sludge: A Site-Specific Approach, *JWPCF*, 60:494-498.
- Gilmour, J.T., M.D. Clark and S.M. Daniel (1996) Predicting Long-Term Decomposition of Biosolids with the Seven Day Test. *Jour. Env. Qual.*, 25:766-770.
- Glass, D.G. (1999) *International Activities in Phytoremediation: Industry and Market Overview*, Phytoremediation and Innovative Strategies for Specialized Remedial Applications, p 95-100, Battelle Press, Columbus, OH.
- Harrison, R.B., C. Henry, D. Xue, J. Canary, P. Leonard, and R. King (1997) *The Fate of Metals in Land Application Systems*, in: Proceedings "The Forest Alternative - Principals and Practice of Residuals Use, University of Washington, Seattle, WA.
- Hutchins, S.R., M.B. Thomsom, P.B. Bedient, and C.H. Ward (1985) *Fate of Trace Organics During Land Application of Municipal Wastewater*, Critical Review Environmental Control, 15(4)355-416.
- Jenkins, T.F. and A.J. Palazzo (1981) *Wastewater Treatment by a Slow Rate Land Treatment System*, CRREL Report 81-14, USA CRREL, Hanover, NH.
- Jenkins, T.F., D.C. Leggett, L.V. Parker, and J.L. Oliphant (1985) *Trace Organics Removal Kinetics in Overland Flow Land Treatment*, *Water Research*, 19(6)707-718.
- Lance, J.C. and C.P. Gerba (1980) *Poliovirus Movement During High Rate Land Filtration of Sewage Water*, *Jour. Env. Qual.*, 9(1):31-34.
- Lombi, E., F.J. Zhao, S.J. Dunham, and S.P. McGrath (2001) Phytoremediation of Heavy Metal – Contaminated Soils: Natural Hyperaccumulation versus Chemically Enhanced Phytoextraction. *JEQ*, Vol. 30, pp. 1919-1926.
- Overcash, M.R. and D. Pal (1979) *Design of Land Treatment Systems for Industrial Wastes*, Ann Arbor Science, Ann Arbor, MI.
- Page, A.L., T.J. Logan, and J.A. Ryan (1987) *Land Application of Sludge: Food Chain Implications*. Lewis Publishers, Chelsea, MI.
- Parker, L.V. and T.F. Jenkins (1986) *Removal of Trace-Level Organics by Slow-Rate Land Treatment*, *Water Research*, 20(11)1417-1426.
- Reed, S.C. (ed) (1972) *Wastewater Management by Disposal on the Land*, Special Report 171, USA CRREL, Hanover, NH.
- Reed, S.C., R.W. Crites and E.J. Middlebrooks (1995) *Natural Systems for Waste Management and Treatment - Second Edition*, McGraw Hill, New York, NY.
- Rowe, D. R. and I. M. Abdel-Magid (1995), *Handbook of Wastewater Reclamation and Reuse*, CRC Press, Inc., 550 pp.
- Russelle, M.P., J.F.S Lamb, B.R. Montgomery, D.W. Elsenheimer, B.S. Miller, and C.P. Vance (2001) Alfalfa Rapidly Remediate Excess Inorganic Nitrogen at a Fertilizer Spill Site. *JEQ*, Vol. 30, pp. 30-36.
- Sheikh, B., P. Cort, W. Kirkpatrick, R. Jaques and T. Asano (1990) *Monterey Wastewater Reclamation Study for Agriculture*. Research JWPCF, 62:216-226, WEF, Alexandria, VA.
- Shuval, H.I. and B. Teltch (1979) *Hygienic Aspects of the Dispersion of the Enteric Bacteria and Virus by Sprinkled Irrigation of Wastewater*, in Proceedings of AWWA Water Reuse Symposium.
- Smith, J.W. and R.W. Crites (2001) *Rational Method for the Design of Organic Loading Rates in a Land Application System*. Proceedings of WEFTEC 2001, Atlanta, GA.
- Tchobanoglous, G., F.L. Burton and H.D. Stensel (2002) *Wastewater Engineering, Treatment and Reuse*, Fourth Edition, McGraw-Hill, New York.
- US EPA (1972) *Oily Waste Disposal by Soil Cultivation*, EPA-R2-72-110, US EPA, Washington, DC.

- 
- US EPA (1973) National Academy of Science – National Academy of Engineering Water Quality Criteria 1972: A Report of the Committee on Water Quality Criteria. EPA-R3-73-033. Washington, DC.
- US EPA (1978) *Long Term Effects of Land Application of Domestic Wastewater - Hollister, CA Rapid Infiltration Site*, EPA/600/2-78-084, US EPA, Cincinnati, OH.
- US EPA (1978) Sewage Disposal on Agricultural Soils: Chemical and Microbiological Implications. EPA-600/2-78-131a.
- US EPA, (1979) *Long Term Effects of Land Application of Domestic Wastewater, Dickinson, ND Slow Rate*, EPA-600/2-79-144, US EPA ORD, Washington, DC.
- US EPA (1979) *Long Term Effects of Land Application of Domestic Wastewater - Roswell, NM*, EPA 600/2-79-047, ORD, US EPA Washington, DC.
- US EPA (1979) *Long Term Effects of Land Application of Domestic Wastewater - Roswell, NM*, EPA 600/2-79-047, ORD, US EPA Washington, DC.
- US EPA (1980) *Summary of Long Term Rapid Infiltration Studies*, EPA-600/2-80-165, US EPA R.S. Kerr Laboratory, Ada, OK.
- US EPA (1981) *Process Design Manual for Land Treatment of Municipal Wastewater*, EPA-625/1-81-013, US EPA CERL, Cincinnati, OH.
- US EPA (1982) *Estimating Microorganism Densities in Aerosols from Spray Irrigation of Wastewater*, US EPA/600/9-82-003, US EPA, Cincinnati, OH.
- US EPA (1984) *Process Design Manual Land Treatment of Municipal Wastewater - Supplement on Rapid Infiltration and Overland Flow*, EPA-625/1-81-013a, US EPA CERL, Cincinnati, OH.
- US EPA (1985) *Health Effects of Land Application of Municipal Sludge*, EPA/600/1-85/015, NTIS #PB86-19745678, NTIS, Springfield, VA.
- US EPA. (1995) *Process Design Manual for Land Application of Sewage Sludge and Domestic Septage*. EPA/625/R-95/001.
- US EPA (2000) *Introduction to Phytoremediation*, EPA/600/R-99/107. Washington, DC.
- Wang, X., L.E. Newman and M.P. Gordon (1999) *Biodegradation of Carbon Tetrachloride by Poplar Trees: Results from Cell culture and field Experiments*, in: *Phytoremediation and Innovative Strategies for Specialized Remedial Applications*, Battelle Press, Columbus, OH.
- Witherow, J.L. and B.E. Bledsoe (1983) *Algae Removal by the Overland Flow Process*, JWPCF, Vol. 55, No. 10, 1256-1262.

---

## Chapter 3

### Water Movement in Soil and Groundwater

The hydraulic capacity of the soil to accept and transmit water is crucial to the design of soil aquifer treatment (SAT) systems and important in the design of most slow rate (SR) systems. The physical and chemical and microbial properties of soil influence the ability of water to move through soil. The important hydraulic factors for SAT and SR treatment systems that are discussed in this section are infiltration, vertical permeability (percolation), horizontal permeability, groundwater mounding, and the relationship between predicted capacity and actual operating rates.

#### 3.1 Soil Properties

The hydraulics of soil systems are controlled by the physical, biological, and chemical properties of soil. Important physical properties include texture, structure, and soil depth. Chemical characteristics that can be important include soil pH and buffer capacity, the redox potential of soil, organic matter, cation exchange capacity, exchangeable sodium percentage, and background nutrient levels. Preliminary information on these soil properties and on soil permeability can be obtained from the Natural Resources Conservation Service (NRCS) and its soil surveys and maps.

Soil surveys will normally provide broad scale soil maps delineating the apparent boundaries of soil series with the surface texture and slope. A written description of each soil series provides limited information on chemical properties, engineering applications, interpretive and management information, slopes, drainage, erosion potentials, and general suitability for most kinds of crops grown in the particular area. Additional information on soil characteristics and information regarding the availability of soil surveys can be obtained directly from the NRCS. The NRCS serves as the coordinating agency for the National Cooperative Soil Survey, and as such, cooperates with other government agencies, universities, the Agricultural Extension Services, and private consultants in obtaining and distributing soil survey information. Such information is valuable in preliminary evaluations for land treatment systems, but verification at any specific site is critical and essential in design and permitting. Much of the NRCS information is available on the Internet at [www.nrcs.usda.gov/technical/efotg](http://www.nrcs.usda.gov/technical/efotg) including soil survey information.

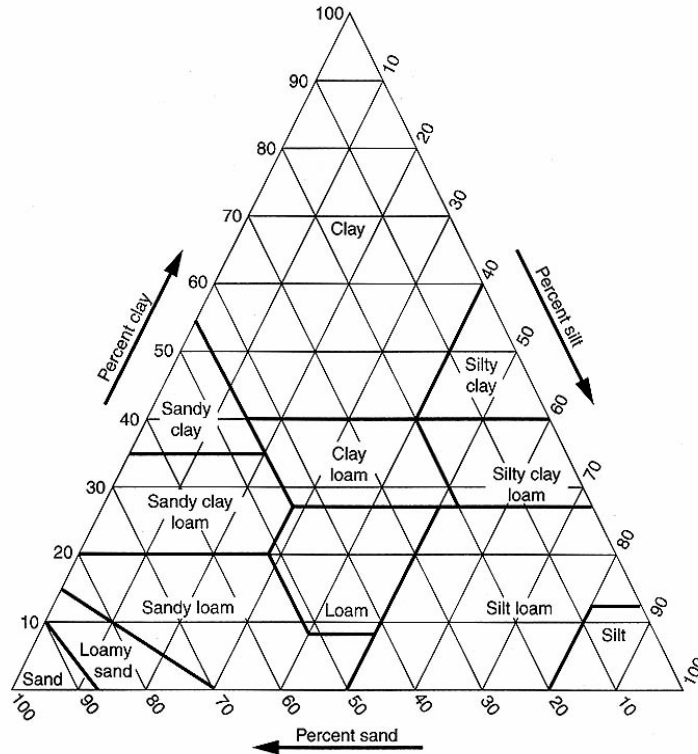
#### 3.1.1 Physical Properties

Physical properties of soils relate to the solid particles of the soil and the manner in which they are aggregated. Soil texture describes the size and distribution of the soil particles. The manner in which soil particles are aggregated is described as the soil structure. Together, soil texture and structure help determine the ability of the soil to hold and transport water and air. Soil structure and texture are important characteristics that relate to permeability and suitability for land treatment.

##### Texture

Soil textural classes are defined on the basis of the relative percentage of the three classes of particle size-- sand, silt, and clay. Sand particles range in size from 2.0 mm to 0.05 mm; silt particles range from 0.05 mm to 0.002 mm; and particles smaller than 0.002 mm are clay. From the particle size distribution, the Natural Resources Conservation Service's (NRCS's) textural class can be determined using the textural triangle shown in Figure 3-1. Common soil-texture terms and the relationship to textural class names are listed in Table 3-1. The particle size classification used by NRCS is the USDA classification system; others include AASHO, ASTM, and ISSS.

Fine-textured soils do not drain rapidly and retain large percentages of water for long periods of time. As a result, infiltration and percolation are slower and crop management is more difficult than with more freely drained soils such as loams. Fine-textured soils are generally best suited to overland flow systems. Medium-textured soils exhibit the best balance for wastewater renovation and drainage. Loam (medium texture) soils are generally best suited for slow rate systems. Coarse-textured soils (sandy soils) can accept large quantities of water and do not retain moisture in the root zone very long. This feature is important for crops that cannot withstand prolonged submergence or saturated root zones. A moderately coarse-textured soil is best for SAT systems. Coarse-textured soils with a significant silt or clay content (>10%) are not desirable for SAT systems because these soils have relatively low permeabilities.



**Figure 3-1.** Natural Resources Conservation Service (NRCS) Soil Textural Classes (Nielson et al., 1973).

**Table 3-1.** Soil Textural Classes and General Terminology Used in Soil Descriptions

3.2 General terms		3.2.1 Basic soil textural class names
3.2.2 Common name	Texture	
Sandy soils	Coarse	Sand Loamy Sand Sandy loam
	Moderately coarse	Fine sandy loam
Loamy soils	Medium	Very fine sandy loam Loam Silt loam Silt
	Moderately fine	Clay loam Sandy clay loam Silty clay loam
		Fine
Clayey soils		

**Structure**

Structure refers to the shape and degree of soil particle aggregation. The pattern of pores and aggregates defined by soil structure influences water movement, heat transfer, air movement, and porosity in soils. If soil aggregates resist disintegration when the soil is wetted or tilled, it is well structured. The large pores in well-structured soils conduct water and air,

making well-structured soils desirable for infiltration. A well-structured soil is generally more permeable than unstructured material of the same type. SAT systems are suited for sand or loamy sand.

**Soil Depth to Annual High Water Level**

Adequate soil depth is needed for retention of wastewater constituents on soil particles, for plant root development, and for microbial action. Adequate depth is also required in SR and SAT systems to separate the zone of wastewater treatment from the saturated soil layers. Retention of wastewater constituents, is a function of residence time of wastewater in the soil. Residence time depends on the application rate and the soil permeability.

The type of land treatment process being considered will determine the minimum acceptable soil depth. For SR, the soil depth can be 0.6 to 1.5 m (2 to 5 ft), depending on the soil texture and crop type. For example, soil depths of 0.3 to 0.6 m (1 to 2 ft) can support grass or turf, whereas deep rooted crops do better on soil depths of 1.2 to 1.5 m (4 to 5 ft). Because soils form in layers, the horizontal layering is important in assessing soil depth. Forested SR systems can be established with soil depths of 0.3 m (1 ft) or more.

The soil depth for SAT should be at least 1.5 m (5 ft) and preferably 1.5 to 3 m (5 to 10 ft). Overland flow systems require sufficient soil depth to form slopes that are uniform and to maintain a vegetative cover. A finished slope should have a minimum of 0.15 to 0.3 m (6 to 12 in) of soil depth.

### 3.1.2 Chemical Properties

Soil chemical properties affect plant growth, wastewater renovation, and can affect hydraulic conductivity. Soil pH affects plant growth, bacterial growth, and retention of elements such as phosphorus in the soil. Soil pE (redox potential) affects the existence of oxidized or reduced species of chemical elements in the soil. Organic matter can improve soil structure and thereby improve the hydraulic conductivity. Sodium can reduce the hydraulic conductivity of soil by dispersing clay particles and destroying the structure that allows water movement. The chemical properties of soil should be determined prior to design to evaluate the capacity of the soil to support plant growth and to renovate wastewater.

#### Soil pH and Buffer Capacity

Soil pH has been called the master variable because it affects chemical, biological, and physical soil properties. Likewise, soil pH is influenced by many factors such as precipitation, irrigation water, carbonic acid dissociation, organic matter, mineral weathering, bio-uptake and release, aluminum hydroxy polymers, and nitrogen fertilizers (Sposito, 1989). Soil pH has a significant influence on the solubility of various compounds, the activities of microorganisms, and the bonding of ions to exchange sites. Soil pH can limit crop growth by influencing the availability of root uptake of elements, including nutrients and metals. The activity of soil microorganisms is also affected by pH. Soil pH affects chemical solubility, biochemical breakdown by microorganisms, and adsorption to soil particles, thereby influencing the mobility of chemical constituents in the soil. Soil physical properties can also be influenced by soil pH by influencing the dispersion of clays and the formation of soil aggregates. The soil buffering capacity is important to prevent drastic fluctuations in soil pH that can have a detrimental affect on plants and soil microorganisms. Most buffering is provided by cation exchange or the gain or loss of H<sup>+</sup> ions of pH-dependent exchange sites on clay and humus particles. The well-buffered soil would have a higher amount of organic matter and/or highly charged clay than the moderately buffered soil (Brady and Weil, 2002). Soil organic matter has many reactive sites in which hydrogen ions can associate and dissociate. Exchangeable ions on the surface of clay minerals and humus can also associate or dissociate with hydrogen ions. Therefore, the cation

exchange capacity (CEC), the quantity of exchangeable cations that a particular soil can adsorb, influences the soil's buffering capacity.

#### Soil Redox

The redox potential ( $E_h$ ) of soil is a measure of the reduction and oxidation states of chemical elements in soil and affects soil aeration. The redox potential of a soil is dependent on the presence of oxidizing agents such as oxygen and pH. Redox potential is measured in volts with an electrode. The electron activities of chemical species in soil can also be expressed as pE, a nondimensional parameter related to  $E_h$  by the following equation:

$$E_h = \frac{2.3RT}{F} pE \quad (3-1)$$

**Where**  $E_h$  = redox potential in volts  
 R (universal gas constant) = 8.314 Jmol<sup>-1</sup>K<sup>-1</sup>  
 T = temperature in Kelvin  
 F (Faraday constant) = 96,500 coulombs mol<sup>-1</sup>  
 2.3 RT/F = 0.059 volts at 25 deg C

pE = hypothetical electron activity

The influence of soil redox on both chemical and microbial species can greatly affect the mobility of chemical constituents in the soil as well as wastewater renovation. In addition, soil pE indirectly affects soil structure because of the influence on microbial activity.

If a soil is well aerated, oxidized states such as Fe(III) and nitrate (NO<sub>3</sub><sup>-</sup>) are dominant. Reduced forms of elements, such as Fe(II) and ammonium (NH<sub>4</sub><sup>+</sup>), are found in poorly aerated soils. Low pE's correspond to highly reducing species and high pE's to oxidizing species. The largest pE value observed in the soil environment is just below +13.0 and the smallest is near -6.0 (Sposito, 1989). The most important chemical elements affected by soil redox reactions are carbon, nitrogen, oxygen, sulfur, manganese, and iron. As the pE of a soil drops below +11.0, oxygen can be reduced to water. Below pE +5.0, oxygen is consumed in the respiration processes of aerobic microorganisms. With no oxygen present in the soil, nitrate can be reduced at pE values below +8.0 and nitrate is utilized by microorganisms as an electron acceptor. Generally, denitrifying bacteria function in the pE range between +10 and 0. As the soil pE drops between +7 and +5, iron and manganese are reduced. Iron reduction does not occur until oxygen and nitrate are depleted. Manganese reduction however can proceed in the presence of nitrate. As the pE decreases below +2.0, a soil becomes anoxic. Sulfate reduction can occur when pE is less than 0 and is catalyzed by anaerobic

---

microorganisms. Sulfate reducing bacteria do not grow at pE values above +2.0.

## Organic Matter

Soil organic matter (SOM generally only referred to as OM) contents range from 0.5 to 5 percent on a weight basis in the surface of mineral soils to 100 percent organic matter, if fertilizers are added (Sparks, 1995). The organic content of soil influences the structure and formation of soil aggregates. Water retention of the soil is increased by organic matter because the infiltration rate and water holding capacity of the soil is increased through improved soil structure. Organic matter provides the energy substrate for soil microorganisms, which in turn aid in the formation of aggregates. Decaying organic matter (humic substances) reacts with silicate clay particles and iron and aluminum oxides and form bridges between soil particles. In addition, the pH and buffer capacity of a soil is influenced by organic matter content.

Soil organic matter has a high specific surface area and the majority of the surface soil cation exchange capacity (CEC) is attributed to SOM. Because of the large amount of surface sites, organic matter is an important sorbent of plant nutrients, metal cations, and organic chemicals. The uptake and availability of plant nutrients, particularly micronutrients, is greatly affected by soil organic matter. Organic matter also forms stable complexes with polyvalent cations such as  $\text{Fe}^{3+}$ ,  $\text{Cu}^{2+}$ ,  $\text{Ca}^{2+}$ ,  $\text{Mn}^{2+}$ , and  $\text{Zn}^{2+}$ , and decreases the uptake of metals by plants and the mobility of metals in the soil.

## Salinity and Exchangeable Sodium Percentage

Soil salinity and sodicity (high sodium content) can have a major effect on the structure of soils. Salinity, the concentration of soluble ionic substances, affects plant growth primarily in the soil root zone. Electrical conductivity (EC) is a measure of soil salinity. Guidelines exist for controlling root zone salinity and calculating leaching requirements of applied irrigation water for varying types of crops according to salt tolerance. High levels of salinity in the root zone of crops can reduce the ability of plants to move water from the soil through the plant.

Soils containing excessive exchangeable sodium are termed "sodic" or "alkali." A soil is considered sodic if the percentage of the CEC occupied by sodium, the exchangeable sodium percentage (ESP), exceeds 15 percent. If a soil has high quantities of sodium and the EC is low, soil permeability, hydraulic conductivity, and the infiltration rate is decreased due to the swelling and dispersion of clays and slaking of aggregates (Sparks, 1995). Fine-textured soils may be affected at an ESP

above 10 percent, but coarse-textured soil may not be damaged until the ESP reaches about 20 percent.

## 3.2 Water Movement through Soil

Estimates of the hydraulic properties of the site are crucial to designing land treatment systems. The capacity of the soils to accept and transmit water is important for the design of SAT systems and may be limiting in the design of SR systems. Water movement in soil can be characterized as either saturated flow or unsaturated flow.

### 3.2.1 Infiltration Rate

The rate at which water enters the soil surface, measured in millimeters per hour (mm/hr) or inches per hour (in/hr), is the infiltration rate. The infiltration rate is usually higher at the beginning of water application than it is several hours later. Infiltration rates are related to the extent of large, interconnected pore spaces in the soil. Coarse textured soils with many large pores have higher infiltration rates than fine textured-soils or soils in which the pore space is reduced in size by compaction or a breakdown of soil aggregates.

For a given soil, initial infiltration rates may vary considerably, depending on the initial soil moisture level. Dry soil has a higher initial rate than wet soil because there is more empty pore space for water to enter. The drier the deeper layer of soil, the larger the potential gradient between the wetting front and the soil beneath, and hence the more rapid the intake rate (Withers and Vipond, 1987). The short-term decrease in infiltration rate is primarily due to the change in soil structure and the filling of large pores as clay particles absorb water and swell. Thus, adequate time must be allowed when running field tests to achieve a steady intake rate.

Infiltration rates are affected by the ionic composition of the soil-water, the type of vegetation, the rate and duration of water application, and tillage of the soil surface. Factors that have a tendency to reduce infiltration rates include clogging by suspended solids in wastewater, classification of fine soil particles, clogging due to biological growths, gases produced by soil microbes, swelling of soil colloids, and air entrapped during a wetting event (Jarrett and Fritton, 1978) (Parr and Bertran, 1960). These influences are all likely to be experienced when a site is developed into a land treatment system. The net result is to restrict the hydraulic loadings of land treatment systems to values substantially less than those predicted from the steady-state intake rates, requiring reliance on field-developed correlations between clean water infiltration rates and satisfactory operating rates for full-scale systems. Generally, whenever water is ponded over the soil surface, the rate of water application exceeds the soil



---

infiltration or permeability. It should be recognized that good soil management practices can maintain or even increase operating rates, whereas poor practices can lead to substantial decreases.

Techniques for measuring soil infiltration rate in the field are discussed in Section 3.8.1. Infiltration rates can also be estimated with the use of simple mathematical models. The US EPA funded research for the determination of methods based on soil physics to quantify the rate of soil water movement due to infiltration. The three types of methods are divided into empirical models (examples are Kostikov and Horton), and Mechanistic Approaches such as Green-Ampt models, and Richards equation models, and the Philips model (an analytical solution to the Richards equation). Evaluations of selected models under different site conditions were also conducted (US EPA 1998; US EPA, 1998).

### **3.2.2 Intake**

The rate at which water in a furrow enters the soil is referred to as the intake rate (Hansen et al., 1980). Irrigation texts have used the term "basic intake rate" as synonymous with infiltration rate (Pair et al., 1975). In furrow irrigation the intake rate is influenced by the furrow size and shape. Therefore, when the configuration of the soil surface influences the rate of water entry, the term intake rate should be used rather than the term infiltration rate (which refers to a relatively level surface covered with water).

### **3.2.3 Permeability**

The permeability or hydraulic conductivity (used interchangeably in this manual) is the velocity of flow caused by a unit hydraulic gradient. Permeability is an intrinsic soil property, not influenced by the gradient, and this is an important difference between infiltration and permeability.

Vertical permeability is also known as percolation. Lateral flow is a function of the gradient and the horizontal permeability (which is generally different from the percolation rate). Permeability is affected mostly by the soil physical properties. Changes in water temperature can affect permeability slightly (Hansen et al., 1980).

### **3.2.4 Transmissivity**

Transmissivity of an aquifer is the product of the permeability (K) and the aquifer thickness. It is the rate at which water is transmitted through a unit width of aquifer under a unit hydraulic gradient.

### **3.2.5 Specific Yield**

The term specific yield is the volume of water released from a known volume of saturated soil under the force of gravity and inherent soil tension (U.S. Department of the Interior, 1978). The specific yield is also referred to as the storage coefficient and the drainable voids. The primary use of specific yield is in aquifer calculations such as drainage and mound height analyses.

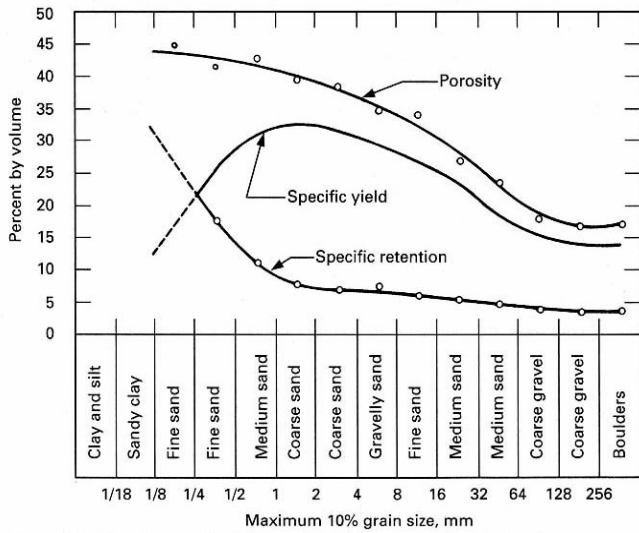
For relatively coarse-grained soils and deep water tables, it is usually satisfactory to consider the specific yield a constant value. As computations are not extremely sensitive to small changes in the value of specific yield, it is usually satisfactory to estimate it from knowledge of other soil properties, either physical as in Figure 3-2 (Todd, 1964), or hydraulic as in Figure 3-3 (U.S. Department of the Interior, 1978). To clarify Figure 3-2, specific retention is equal to the porosity minus the specific yield.

For fine-textured soils, especially as the water table moves higher in the profile, the specific yield may not have a constant value because of capillarity (Childs, 1969) (Duke, 1972). The effect of decreasing specific yield with increasing water table height can lead to serious difficulties with mound height analysis.

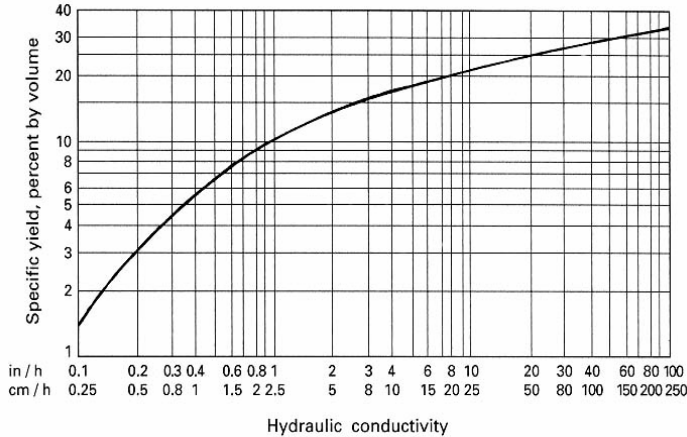
### **3.2.6 Water-Holding Capacity**

Soil water can be classified as hygroscopic, capillary, and gravitational. Hygroscopic water is a very thin film on the surface of soil particles and is not removed by gravity or by capillary forces. Capillary water is the water held by surface tension in soil pores against gravity.

Gravitational water is the water that occupies the larger pores of the soil and will drain by gravity if favorable drainage is provided (Hansen et al., 1980). The water-holding capacity of a soil refers to the condition where the volumetric water content at saturation is essentially the same as total porosity.

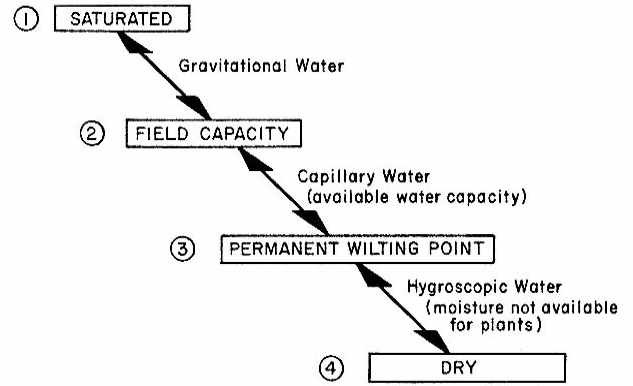


**Figure 3-2.** Porosity, Specific Yield, Specific Retention vs. Soil Grain Size for In situ Consolidated Soils, Coastal Basin, CA (Todd, 1964).



**Figure 3-3.** Specific Yield Vs. Hydraulic Conductivity (Department of the Interior, 1978).

Soil water can also be classified according to its availability to plant root systems. As illustrated in Figure 3-4, the maximum available water occurs at saturation (point 1), when all the pore space is filled with water. When the soil water drops to point 3, only hygroscopic water is left, which is mostly unavailable to plants.



**Figure 3-4.** Soil Moisture Characteristics (Crites et al., 2000).

### 3.2.7 Field Capacity

When gravitational water has been removed, the moisture content of the soil has been called the field capacity. In this condition, water has moved out of the macropores and been replaced by air in the surface profile. In practice the field capacity is measured two days after water application and can range from 3 percent moisture for fine sand to 40 percent for clay. The range of moisture percentages for field capacity for various soil types is presented in Table 3-2. Relationships of field conditions to soil moisture content are presented in Table 3-3.

At field capacity, a soil is holding the maximum amount of water useful to plants. Additional water would occupy large pores and reduce the potential for aeration, before draining of gravitational water. Sufficient pore space is filled with air at field capacity to allow optimum aeration for support of aerobic microorganisms.

It should be noted that field capacity as described can not truly exist. Water will continue to drain under gravity to an impermeable barrier. However drainage does decrease rapidly for coarse grain soils – perhaps in two days. However fine grained soils do not show the same abrupt decrease and therefore the term field capacity is less meaningful.

**Table 3-2.** Range of Available Soil Moisture for Different Soil Types

Soil type	3.3 Moisture percentage		Depth of available water per unit depth of soil, mm/m (in/ft)
	Field capacity	Permanent wilting point	
Fine sand	3-5	1-3	25-42 (0.3-0.5)
Sandy loam	5-15	3-8	42-108 (0.5-1.3)
Silt loam	12-18	6-10	58-133 (0.7-1.6)
Clay loam	15-30	7-16	100-183 (1.2-2.2)
Clay	25-40	12-20	167-292 (2.0-3.5)

**Table 3-3.** Field Estimating of Soil Moisture Content\*

Fine texture	Medium texture	Moderately coarse texture	Coarse texture
No free water after squeezing, wet, outline on hand	Same as fine texture	Same as fine texture	Same as fine texture
0.0	0.0	0.0	0.0
Easily ribbons out between fingers, has slick feeling	Forms a very pliable ball, sticks readily if high in clay	Forms weak ball, breaks easily, will not stick	Sticks together slightly, may form a very weak ball under pressure
0.0-0.6	0.0-0.5	0.0-0.4	0.0-0.2
Forms a ball, ribbons out between thumb and forefinger	Forms a ball, sometimes sticks slightly with pressure	Tends to ball under pressure but will not hold together	Appears dry, will not form a ball when squeezed
0.6-1.2	0.5-1.0	0.4-0.8	0.2-0.5
Somewhat pliable, will form a ball when squeezed	Somewhat crumbly but hold together from pressure	Appears dry, will not form a ball	Appears dry, will not form a ball
1.2-1.9	1.0-1.5	0.8-1.2	0.5-0.8
Hard, baked, cracked	Powdery, dry, sometimes slightly crusted but easily broken down into powdery condition	Dry, loose, flows through fingers	Dry, loose, single grained flows through fingers
1.9-2.5	1.5-2.0	1.2-1.5	0.8-1.0

\* The numerical values are the amount of water (in) that would be needed to bring the top foot of soil to field capacity.

### 3.2.8 Permanent Wilting Point

The soil moisture content at which plants will wilt from lack of water is known as the permanent wilting point. By convention, the permanent wilting point for most cultivated plants is taken to be that amount of water retained by the soil when the water potential is -15 bars. The soil will appear to be dusty, but some water remains in the micropores and in thin films around soil particles. The available moisture content or plant available water is generally defined as the difference between the field capacity and the permanent wilting point (between -0.1 to -0.3 and -15 bars). This represents the moisture that can be stored in the soil for subsequent use by plants. The amount of capillary water remaining in the soil that is unavailable to plants can be substantial, especially in fine-textured soils and soils high in organic matter. For SR systems with poorly drained soils, this stored moisture is important to design loadings.

As an approximation the permanent wilting percentage can be obtained by dividing the field capacity by 2. For soils with high silt content, divide the field capacity by 2.4 to obtain permanent wilting percentage.

## 3.3 Saturated Hydraulic Conductivity

Saturated flow through soils takes place when soil pores are completely filled with water. At least part of the soil profile may be completely saturated under certain conditions. Hydraulic conductivity is a measure of the ease with which liquids and gases pass through soil. In general, water moves through saturated soils or porous media in accordance with Darcy's equation:

$$q = \frac{Q}{A} = K \frac{dH}{dl} \quad (3-2)$$

#### Where

q = flux of water, the flow, Q per unit cross-sectional area, A, m/d (ft/d)  
 Q = flow rate, m<sup>3</sup>/d (ft<sup>3</sup>/d)  
 A = area of cross-section perpendicular to the flow, m<sup>2</sup> (ft<sup>2</sup>)  
 K = hydraulic conductivity (permeability), m/d (ft/d)  
 dH/dl = hydraulic gradient, m/m (ft/ft)

The total head (H) can be assumed to be the sum of the soil-water pressure head (h), and the head due to gravity (Z), or H = h + Z. The hydraulic gradient is the change in total head (dH) over the path length (dl).

The hydraulic conductivity is defined as the proportionality constant, K. The conductivity (K) is not a true constant but a rapidly changing function of water content. Even under conditions of constant water content, such as saturation, K may vary over time due to increased swelling of clay particles, change in pore size distribution due to classification of particles, and change in the chemical nature of soil-water. However, for most purposes, saturated conductivity (K) can be considered constant for a given uniform soil. The K value for flow in the vertical direction will not necessarily be equal to K in the horizontal direction. This condition is known as anisotropy. It is especially apparent in layered soils and those with large structural units. An illustration of anisotropic conditions is shown in Table 3-4.

The value of K depends on the size and number of pores in the soil or aquifer material. Orders of magnitudes for vertical conductivity (K<sub>v</sub>) values in ft/day for typical soils are (Bouwer, 1978):

Soil or Aquifer Material	K <sub>v</sub> , ft/d
Clay soils (surface)	0.03 – 0.06
Deep clay beds	3 x 10 <sup>-8</sup> – 0.03
Clay, sand, gravel mixes (till)	0.003 – 0.3
Loam soils (surface)	0.3 – 3.0
Fine sand	3 – 16
Medium sand	16 – 66
Coarse sand	66 – 300
Sand and gravel mixes	16 – 330
Gravel	330 – 3300

The conductivity of soils at saturation is an important parameter because it is used in Darcy's equation to

estimate groundwater flow patterns and is useful in estimating soil infiltration rates. Conductivity is frequently estimated from other physical properties, but much experience is required and results are not sufficiently accurate for design purposes (Bouwer, 1978) (Freeze and Cherry, 1979) (Taylor and Ashcroft, 1972) (Richard, 1965) (O'Neal, 1952). For example, hydraulic conductivity is largely controlled by soil texture: coarser materials having higher conductivities. However, in some cases the soil structure may be equally important:

well-structured fine soils having higher conductivities than coarser unstructured soils.

In addition, hydraulic conductivity for a specific soil may be affected by variables other than those relating to grain size, structure, and pore distribution. Temperature, ionic composition of the water, and the presence of entrapped air can alter conductivity values (Bouwer, 1978).

**Table 3-4.** Measured Ratios of Horizontal to Vertical Conductivity

Site	Horizontal conductivity $K_h$ , m/d (ft/day)	$K_h/K_v$	Remarks
1	42 (138)	2.0	Silty
2	75 (246)	2.0	
3	56 (184)	4.4	
4	100 (328)	7.0	Gravelly
5	72 (236)	20.0	Near terminal moraine
6	72 (236)	10.0	Irregular succession of sand and gravel layers (from K measurements in field)
6	86 (282)	16.0	(From analysis of recharge flow system)

### 3.4 Unsaturated Hydraulic Conductivity

Darcy's law for velocity of flow in saturated soils also applies to unsaturated soils. As the moisture content decreases, however, the cross-sectional area through which the flow occurs also decreases and the conductivity is reduced.

The conductivity of soil varies dramatically as water content is reduced below saturation. As an air phase is now present, the flow channel is changed radically and now consists of an irregular solid boundary and the air-water interface. The flow path becomes more and more tortuous with decreasing water content as the larger pores empty and flow becomes confined to the smaller pores. Compounding the effect of decreasing cross-sectional area for flow is the effect of added friction as the flow takes place closer and closer to solid particle surfaces. The conductivity of sandy soils, although much higher at saturation than loam soils, decreases more rapidly as the soil becomes less saturated. In most cases, the conductivities of sandy soils eventually become lower than finer soils. This relationship explains why a wetting front moves more slowly in sandy soils than in medium or fine textured soils after irrigation has stopped, and why there is little horizontal spreading of moisture in sandy soils after irrigation.

### 3.5 Percolation Capacity

The percolation capacity of SR and SAT systems is a critical parameter in planning, design, and operation. The capacity will vary within a given site and may change with time, season and different management. For planning purposes the infiltration capacity can be

estimated from the vertical permeability rates assigned by the NRCS (Figure 3-5).

#### 3.5.1 Design Percolation Rate

To account for required intermittent applications (reaeration), the variability of the actual soil permeability within a site, and the potential reduction with time, a small percentage of the vertical permeability is used as the design percolation rate. This small percentage ranges from 4 to 10 percent of the saturated vertical permeability as shown in Figure 3-5. The value used for clear water permeability should be for the most restrictive layer in the soil profile. Design rates based on field measurement (Section 3.8) may be calculated using different percentages. If the planned application season is less than 365 days, the percolation rate should be reduced to coincide with the planned application period.

#### 3.5.2 Calculation of Vertical Permeability

The rate at which water percolates through soil depends on the average saturated permeability ( $K$ ) of the profile. If the soil is uniform,  $K$  is assumed to be constant with depth. Any differences in measured values of  $K$  are then due to normal variations in the measurement technique. Thus, average  $K$  may be computed as the arithmetic mean of  $n$  samples:

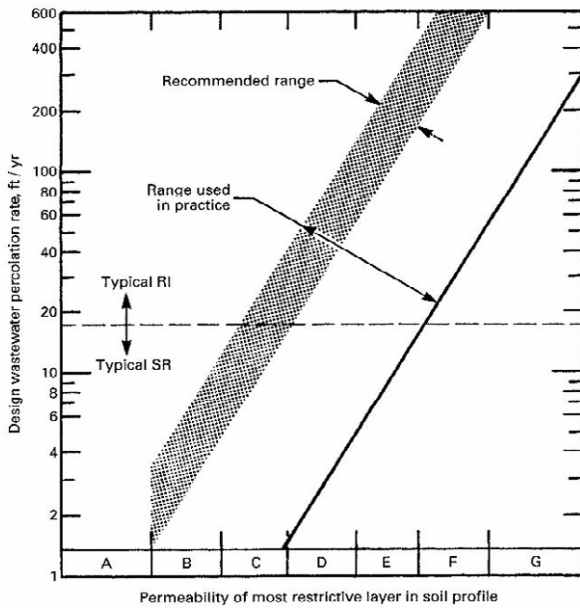
$$K_{am} = \frac{K_1 + K_2 + K_3 + \dots + K_n}{n} \quad (3-3)$$

Where  $K_{am}$  = arithmetic mean vertical conductivity

Many soil profiles approximate a layered series of uniform soils with distinctly different K values, generally decreasing with depth. For such cases, it can be shown that average K is represented by the harmonic mean of the K values from each layer (Bouwer, 1969):

$$K_{hm} = \frac{D}{\frac{d_1}{K_1} + \frac{d_2}{K_2} + \dots + \frac{d_n}{K_n}} \quad (3-4)$$

Where D = overall soil profile depth  
 $d_n$  = depth of nth layer  
 $K_{hm}$  = harmonic mean conductivity



**Figure 3-5.** Approximate Preliminary Percolation Rate vs. NRCS Soil Permeability for SR and SAT.

The Zones A through G Refer to Clearwater Permeability for the Most Restrictive Layer in the Soil Profile ( $K_v$  = in/h): A = very slow, <0.06; B = slow, 0.06 to 0.20; C = moderately slow, 0.20 to 0.60; D = moderate, 0.60 to 2.0; E = moderately rapid, 2.0 to 6.0; F = rapid, 6.0 to 20; G = very rapid, >20

If a bias or preference for a certain K value is not indicated by statistical analysis of field test results, a random distribution of K for a certain layer or soil region must be assumed. In such cases, it has been shown that the geometric mean provides the best and most conservative estimate of the true K (Bouwer, 1969) (Rogowski, 1972) (Nielson et al., 1973):

$$K_{gm} = (K_1 \cdot K_2 \cdot K_3 \cdot \dots \cdot K_n)^{1/n} \quad (3-5)$$

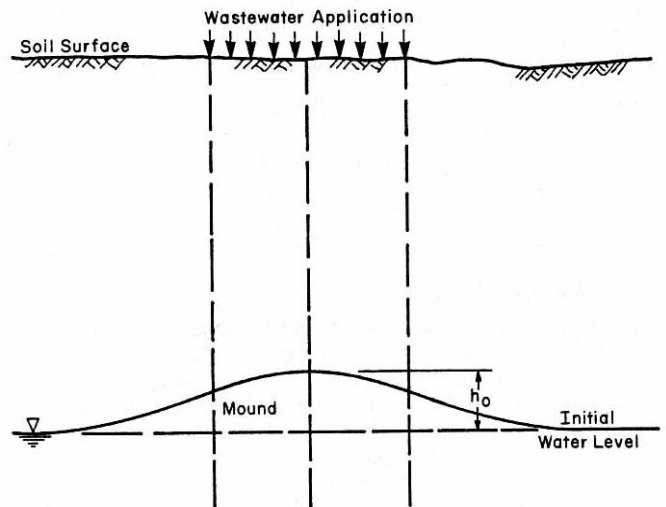
Where  $K_{gm}$  = geometric mean conductivity

### 3.5.3 Profile Drainage

For SR and SAT systems the soil profile must drain between applications to allow the soil to reerate. The time required for profile drainage is important to system design and varies with the soil texture and the presence of restrictions (such as fragipans, clay pans, and hardpans). In sandy soils without vertical restrictions, the profile can drain in one to two days. In clayey soils drainage may take five days or more. The drying period between applications also depends on the evaporation rate.

### 3.6 Mounding of Groundwater

If water that infiltrates the soil and percolates vertically through the zone of aeration (also known as vadose zone or unsaturated zone) encounters a water table or an impermeable (or less permeable) layer, a groundwater "mound" will begin to grow (Figure 3-6).



**Figure 3-6.** Schematic of Groundwater Mound.

If the mound height continues to grow, it may eventually encroach on the zone of aeration to the point where renovation capacity is affected. Further growth may result in intersection of the mound with the soil surface, which will reduce infiltration rates. This problem can usually be identified and analyzed before the system is designed and built if the prior geologic and hydrologic information is available for analysis.

#### 3.6.1 Prediction of Mounding

Groundwater mounding can be estimated by applying heat-flow theory and the Dupuit-Forchheimer assumptions (Rogowski, 1972). These assumptions are as follows:

1. Flow within groundwater occurs along horizontal flow lines whose velocity is independent of depth.
2. The velocity along these horizontal streamlines is proportional to the slope of the free water surface.

Using these assumptions, heat-flow theory has been successfully compared to actual groundwater depths at several existing SAT sites. To compute the height at the center of the groundwater mound, one must calculate the values of:

$$W/[4 \alpha t]^{1/2} \text{ and } Rt \quad (3-6)$$

Where  $W$  = width of the recharge basin, ft

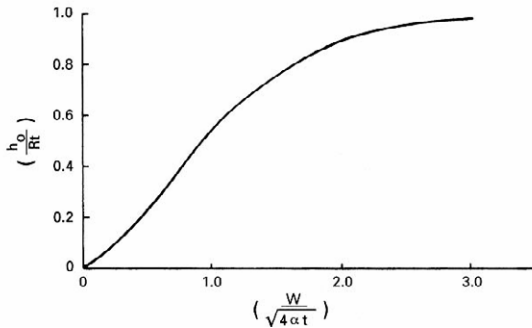


Figure 3-7. Mounding Curve for Center of a Square Recharge Area (Bianchi and Muckel, 1970).

$$\alpha = \text{aquifer constant} = \frac{KD}{V}, \text{ ft}^2/\text{d} \quad (3-7)$$

Where:

- $K$  = aquifer (horizontal) hydraulic conductivity, ft/d
- $D$  = saturated thickness of the aquifer, ft
- $V$  = specific yield or fillable pore space of the soil, ft<sup>3</sup>/ft<sup>3</sup>
- $t$  = length of wastewater application, d
- $R$  =  $l/V$ , ft/d, rate of rise if no lateral flow occurred
- where  $l$  = application rate, ft/d

Once the value of  $W/[4\alpha t]^{1/2}$  is obtained, one can use dimensionless plots of  $W/[4\alpha t]^{1/2}$  versus  $h_o/Rt$ , provided as Figure 3-7 (for square recharge areas) and Figure 3-8 (for rectangular recharge areas), to obtain the value of  $h_o/Rt$ , where  $h_o$  is the rise at the center of the mound. Using the calculated value of  $Rt$ , one can solve for  $h_o$ .

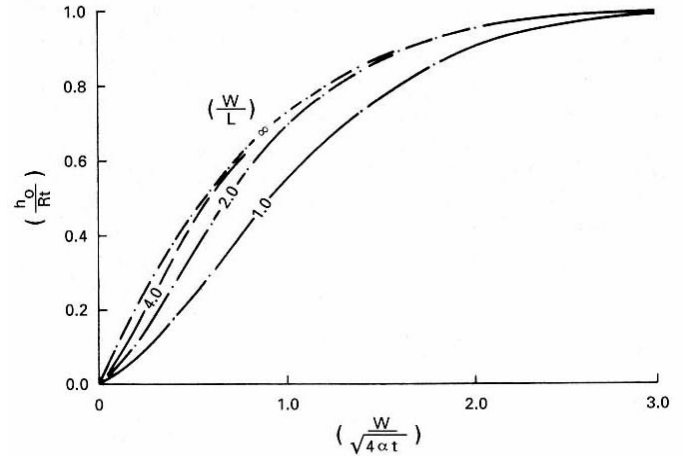
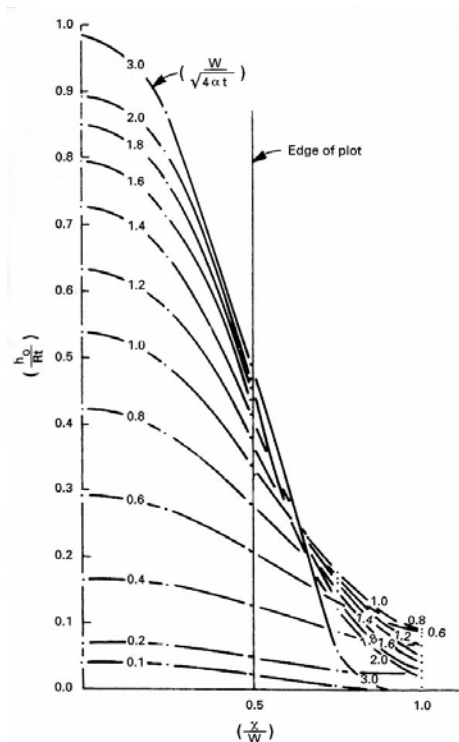


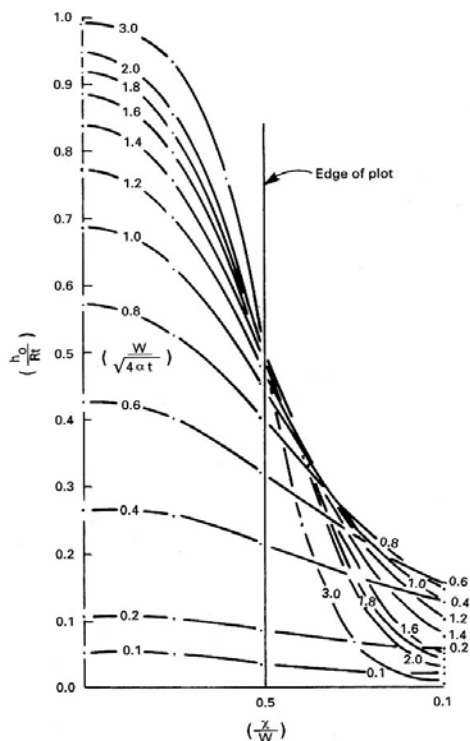
Figure 3-8. Mounding Curve for Center of a Rectangular recharge Area, with Different Ratios of Length  $L$  to Width  $W$  (Bianchi and Muckel, 1970).

Figure 3-9 (for square recharge areas) and Figure 3-10 (for recharge areas that are twice as long as they are wide) can be used to estimate the depth to the mound at various distances from the center of the recharge basin. Again, the values of  $W/[4 \alpha t]^{1/2}$  and  $Rt$  must be determined first. Then, for a given value of  $x/W$ , where  $x$  equals the horizontal distance from the center of the recharge basin, one can obtain the value of  $h_o/Rt$  from the correct plot. Multiplying this number by the calculated value of  $Rt$  results in the rise of the mound,  $H_o$ , at a distance  $x$  from the center of the recharge site. The depth to the mound from the soil surface is then the difference between the distance to the groundwater before recharge and the rise due to the mound.

To evaluate mounding beneath adjacent basins, Figure 3-9 and Figure 3-10 should be used to plot groundwater table mounds as functions of distance from the center of the plot and time elapsed since initiation of wastewater application. Then, critical mounding times should be determined, such as when adjacent or relatively close basins are being flooded, and the mounding curves of each basin at these times should be superimposed. Additional discussions on groundwater mounding and predicting mounds is included in reference (Bouwer, 1999) (Bouwer et al., 1999). At sites where drainage is critical because of severe land limitations or extremely high groundwater tables, the engineer should use the approach described in reference (Nielson et al., 1973) to evaluate mounding.



**Figure 3-9.** Rise and Horizontal Spread of a Mound Below a Square Recharge Area (Bianchi and Muckel, 1970).



**Figure 3-10.** Rise and Horizontal Spread of Mounds Below a Rectangular Recharge Area when  $L = 2W$  (Bianchi and Muckel, 1970).

In areas where both the water table and the impermeable layer underneath the aquifer are relatively close to the soil surface, it may be possible to avoid the complicated mounding analysis by using the following procedure:

1. Assume underdrains are needed and calculate the underdrain spacing (Section 3.7).
2. If the calculated underdrain spacing is between 15 and 50 m (50 and 160 ft), underdrains will be required and there is no need to verify that the mound will reach the soil surface.
3. If the calculated spacing is less than about 10 m (30 ft), the loading rate may have to be reduced for the project to be economically feasible.
4. If the calculated spacing is greater than about 50 m (160 ft), mounding should be evaluated to determine if any underdrains will be necessary.

This procedure is not appropriate for unconfined or relatively deep aquifers. For such aquifers, mounding should always be evaluated.

### 3.7 Drainage Requirements

Generally, underdrains are spaced 15 m (50 ft) or more apart. Depths of drains vary from 0.9 to 2.4 m (3 to 8 ft) for SR systems and 2.4 to 4.6 m (8 to 15 ft) for SAT systems. In soils with high lateral permeability, the underdrains may be as much as 150 m (500 ft) apart. The closer the drain spacing is, the more control there will be over depth of the groundwater table. The cost of drains increases with decreasing drain spacing, so the economics of using more drains must be weighed against finding a site with deeper groundwater, or less vertical restriction to percolation, or using a lower application rate.

One method of determining drain spacing is the Hooghoudt method. The parameters used in the method are shown in Figure 3-11. The assumptions used in this method are (Luthin, 1978):

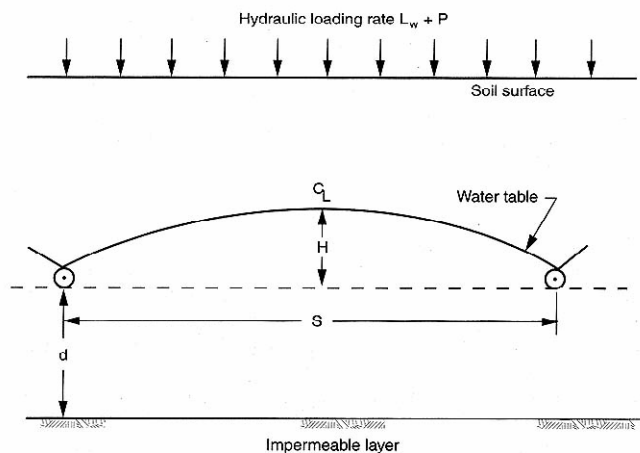


Figure 3-11. Parameters Used in Drain Design (Luthin, 1978).

1. The soil is homogeneous with a lateral permeability,  $K$ .
2. The drains are evenly spaced a distance  $S$  apart.
3. The hydraulic gradient at any point is equal to the slope of the water table above that point.
4. Darcy's Law is valid.
5. An impermeable layer underlies the drain at a depth  $d$ .
6. The rate of replenishment (wastewater application plus natural precipitation) is  $L_w + P$ .

To determine drain placement, the following equation is useful (Luthin, 1978):

$$S = \left[ \frac{4KH}{L_w + P} (2d + H) \right]^{0.5} \quad (3-8)$$

**where**  $S$  = drain space, m (ft)  
 $K$  = horizontal hydraulic conductivity of the soil, m/d (ft/d)  
 $H$  = height of the ground water mound above the drains, m (ft)  
 $L_w$  = annual wastewater loading rate, expressed as a daily rate, m/d (ft/d)  
 $P$  = average annual precipitation rate, expressed as a daily rate, m/d (ft/d)  
 $d$  = distance from drains to underlying impermeable layer, m (ft).

Once the drain spacing has been calculated, drain sizing should be determined. Usually, 150 or 200 mm (6 or 8 in) drainage laterals are used. The laterals connect to a collector main that must be sized to convey the

expected drainage flow. Drainage laterals should be placed so that they will be free flowing; the engineer should check drainage hydraulics to determine necessary drain slopes. The outlet conditions associated with drainage are critical and, once established, must not be modified.

### 3.8 Field Testing Procedures

Field testing procedures for measuring and estimating the infiltration rate and permeability of a soil are summarized in this section.

#### 3.8.1 Infiltration Rate

The infiltration rate of a soil is defined as the rate at which water enters the soil from the surface. When the soil profile is saturated with negligible ponding above the surface, the infiltration rate is equal to the effective saturated conductivity of the soil profile.

Although the measured infiltration rate on a particular site may decrease in time due to surface clogging phenomena, the subsurface vertical permeability at saturation will generally remain constant. Thus, the short-term measurement of infiltration serves reasonably well as an estimate of the long-term saturated vertical permeability if infiltration is measured over a large area.

The value that is required in land treatment design is the long-term acceptance rate of the entire soil surface on the proposed site for the actual wastewater effluent to be applied. The value that can be measured is only a short-term equilibrium acceptance rate for a number of particular areas within the overall site.

There are many potential techniques for measuring infiltration including flooding basin, cylinder infiltrometers, sprinkler infiltrometers and air-entry permeameters. A comparison of these four techniques is presented in Table 3-5. In general, the test area and the volume of water used should be as large as practical. The two main categories of measurement techniques are those involving flooding (ponding over the soil surface) and rainfall simulators (sprinkling infiltrometer). The flooding type of infiltrometer supplies water to the soil without impact, whereas the sprinkler infiltrometer provides an impact similar to that of natural rain. Flooding infiltrometers are easier to operate than sprinkling infiltrometers, but they almost always give higher equilibrium infiltration rates. The sprinkler test is especially useful for agricultural SR operations. As discussed previously, soil sorting and surface sealing can occur with some soils and a sprinkler test will evaluate the possibility. Sprinkler tests are not really needed for grassed or forested sites or where surface application of wastewater is anticipated.



Because the basic intent of all these tests is to define the saturated vertical hydraulic conductivity of the soil ( $K_v$ ), and since wastewater will typically be "clean" after a few inches of travel, it is usually acceptable to use clean water for these tests. There are exceptions, and the actual wastewater should be used when:

1. High suspended solids or algae are expected in effluents used for SAT.
2. Industrial effluents with significantly different pH or ionic composition than the soil and soil water.
3. Effluents that will contain toxic or hazardous materials with potential for reaction with the soil components.

### Basin Tests

All infiltration tests should always be run at the actual locations and depths that will be used for the operational system. This is especially important for SAT systems. Pilot-scale basin tests are strongly recommended. These should be at least 9.3 m<sup>2</sup> (100 ft<sup>2</sup>) in area, located in the same soil zone that will be used in the full-scale system. Construction of the test basin should be done with the same techniques that will be employed full scale. The test basin should then be operated for

several weeks using the same wet and dry cycles that are planned for full scale. A typical small-scale pilot test basin is illustrated in Figure 3-12.

The number of test basins required will depend on the system size and the uniformity of the soils and topography. One will serve for relatively small systems with uniform soils. In larger systems a separate basin should be used for every major soil type, which may require one basin for every 2-4 ha (5-10 acres) of total system area. When extremely variable conditions are encountered, the test basin should be full sized (0.4 to 1.2 ha or 1 to 3 acres) to insure reliability. If successful, it can then be incorporated into the operational system.

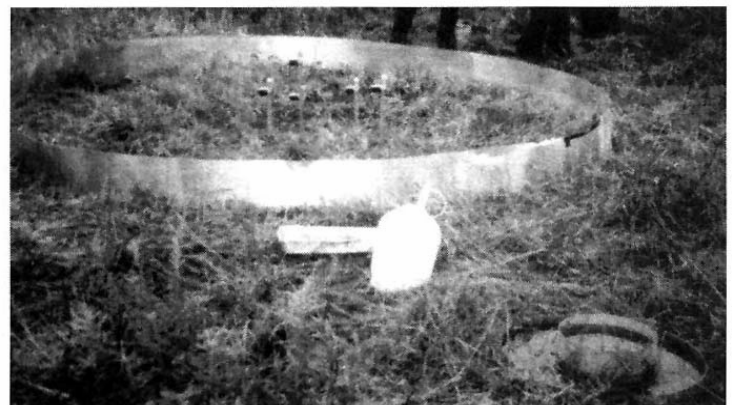
A smaller-scale basin type test has been developed by the U.S. Army Corps of Engineers (Abele et al., 1980). The purpose was to have a reproducible procedure with a larger surface area and zone of influence than existing infiltrometers and permeameters. The test facility prior to flooding (note the cylinder infiltrometer in the right foreground) is illustrated in Figure 3-13. The metal ring is aluminum flashing and is 3 m (10 ft) in diameter. Installation details are provided in Figure 3-14 and Figure 3-15.

**Table 3-5.** Comparison of Infiltration Measurement Techniques

Measurement technique	3.8.2 use per test, L	Water use per test, L	Time per test, h	Equipment needed	Comments
3.8.3 Flooding basin	2,000-10,000		4-12	Backhoe or blade	Tensiometers may be used
Cylinder infiltrometer	400-700		1-6	Cylinder or earthen berm	Should use large-diameter cylinders (3 ft diameter) (1 meter)
Sprinkler infiltrometer	1,000-1,200		1.5-3	Pump, pressure tank sprinkler, cans	For sprinkler applications, soil should be at field capacity before test
Air entry permeameter (AEP)	10		0.5-1	AEP apparatus, standpipe with reservoir	Measures vertical hydraulic conductivity. If used to measure rates of several different soil layers, rate is harmonic mean of conductivities from all soil layers



**Figure 3-12.** Small-scale Pilot Test Basin (Crites, et. al., 2000).



**Figure 3-13.** U.S. Army Corps of Engineers (USACE) Basin Test.

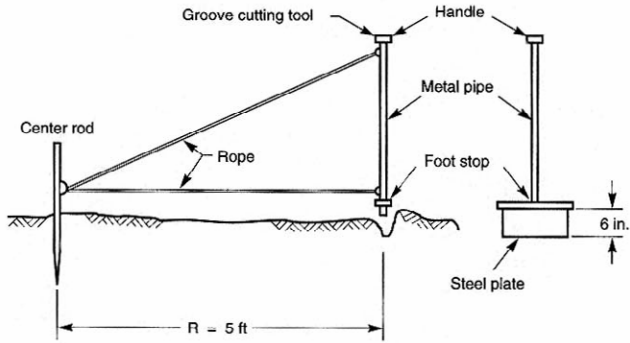


Figure 3-14. Groove Preparation for USACE Test.

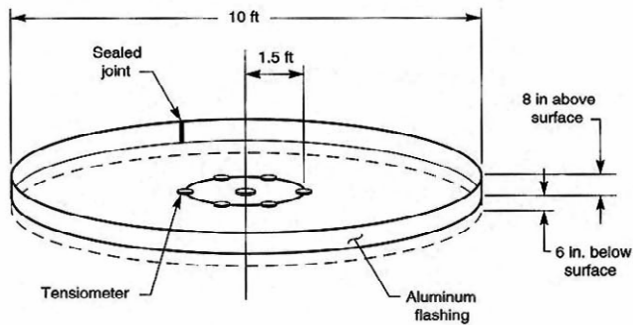


Figure 3-15. Groove Preparation for USACE Test.

Tensiometers are used in the central part of the test area to insure that saturated conditions prevail during the test period. One should be placed in each soil horizon. In soils lacking well-developed horizons, a uniform spacing down to about 0.6 m (2 ft) will be suitable. Following installation and calibration of the tensiometers, a few preliminary flooding events are executed to achieve saturation. Evidence of saturation is the reduction of tensiometer readings to near zero through the upper soil profile. Then a final flooding event is monitored to derive a cumulative intake versus time curve.

Typical test results are illustrated in Figure 3-16. The "limiting" value of 6.35 mm/h (0.25 in./h) was selected for design in this case.

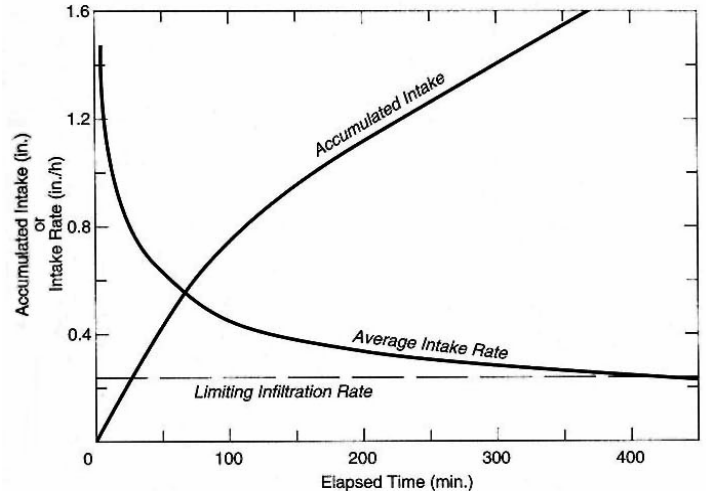


Figure 3-16. Typical Test Results, USACE Infiltration Test.

### Cylinder Infiltrometers

The equipment setup for a test is shown in Figure 3-17. To run a test, a metal cylinder is carefully driven or pushed into the soil to a depth of about 100 to 150 mm (4 to 6 in). Cylinders from 150 to 350 mm (6 to 14 in) diameter have generally been used in practice, with lengths of about 250 to 300 mm (10 to 12 in). Lateral flow is minimized by means of "buffer zone" surrounding the central ring. The buffer zone is commonly provided by another cylinder 400 to 750 mm (16 to 30 in) diameter, driven to a depth of 50 to 100 mm (2 to 4 in), and kept partially full of water during the time of infiltration. This particular mode of making measurements has come to be known as the double-cylinder or double-ring infiltrometer method. Care must be taken to maintain the water levels in the inner and outer cylinders at the same level during the measurements. Alternately, buffer zones are provided by diking the area around the intake cylinder with low (75 to 100 mm or 3 to 4 in) earthen dikes.

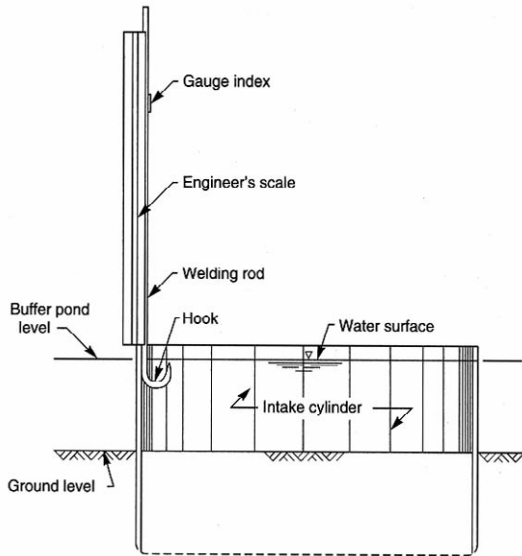


Figure 3-17. Test Installation for Cylinder Infiltrometer.

If the cylinder is installed properly and the test carefully performed, the technique should produce data that at least approximate the vertical component of flow. In most soils, as the wetting front advances downward through the profile, the infiltration rate will decrease with time and approach a steady-state value asymptotically. This may require as little as 20 to 30 minutes in some soils and many hours in others.

Test results can be plotted as shown on Figure 3-16 and design values derived. The procedure is relatively simple and quick and uses a small amount of water. The test has been commonly used for some time in agricultural projects and is familiar to most field investigation firms. However, the small size of the test limits the zone of influence. A large number of tests would be required for most situations. An ASTM standard exists for the test.

### Air Entry Permeameters (AEP)

This device, developed by Dr. Herman Bouwer (Bouwer, 1978) has been successfully used for the investigation and design of land treatment systems. A sketch of the device is shown on Figure 3-18 and Figure 3-19 illustrates the device in use. The cylinder is steel, about 10 in (250 mm) in diameter and about 5 in (125 mm) deep. Operating instructions for the unit are:

1. The cylinder is driven into the ground to a depth of 3 to 4 in (75 to 100 mm) (a cylinder driver with sliding weight is used for this purpose).
2. Using a section of 1-in x 2-in (25 to 50 mm) lumber and a hammer, the soil along the inner perimeter of the cylinder is packed down and against the cylinder

wall to insure a good bond between the cylinder and the soil. In loose or cracked soil, compacting around the outside of the cylinder may also be necessary.

3. In case of a bare soil surface, the soil is covered with a 12.5 to 25 mm (1/2- to 1-in) layer of coarse, clean sand. A disk or similar object is placed on the sand in the center of the cylinder to break the water stream from the supply pipe.
4. The surface of the foam rubber gasket is cleaned and a thin coat of grease is applied.

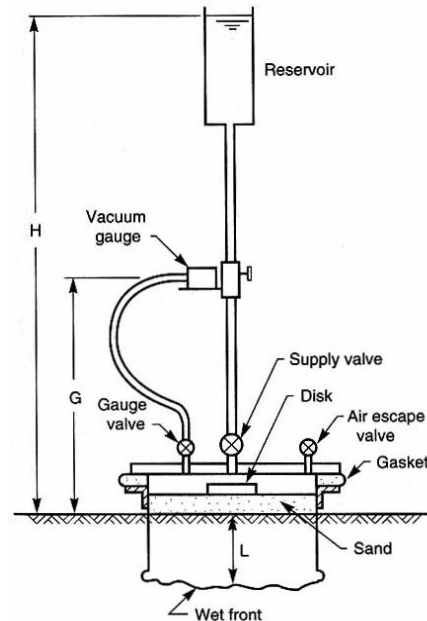


Figure 3-18. Definition Sketch for Air Entry Permeameter.



Figure 3-19. Air Entry Permeameter in Use (from H. Bouwer).

5. The lid-assembly with the air valve open and the gauge and supply valves closed is placed on the cylinder. The gauge should be properly primed and air bubbles should not be present in the tubing connecting the gauge to the cylinder. A round bubble-level is placed on the lid to determine the highest point. The lid assembly is then rotated so that the air escape valve is at the highest point.
6. The lid is fastened with four small C-clamps or welder's vice-grip pliers until it rests firmly on the rim of the metal cylinder. Lead weights are placed on the lid to offset the upward hydrostatic force when the supply valve is open.
7. The plastic reservoir at the top of the galvanized pipe is filled with water and the air in the pipe is allowed to escape. The supply valve at the bottom of the galvanized pipe is opened while maintaining the water supply to the plastic reservoir. When the water has driven out the air from inside the cylinder, the air valve is closed.
8. The vacuum gauge is removed from the holder and lifted to about the water level in the plastic reservoir. The gauge valve at the plastic lid is opened, which causes the needle on the gauge to go to zero. Tilting the gauge will then reset the memory pointer to zero. The gauge valve is closed and the gauge is replaced on the gauge holder.
9. Time and water level readings are taken so that the rate of fall of the water level in the reservoir,  $dH/dt$ , (just before closing the supply valve) can be calculated.
10. When the depth of the wet front is expected to be at about 100 mm (4 in) the supply valve is closed. Experience will tell how much or how long water needs to be applied to achieve this depth.
11. The gauge valve is opened. When the gauge indicates approximately atmospheric pressure inside the cylinder, the weights are removed from the plastic lid.
12. When the memory pointer has lost contact with the gauge needle, minimum pressure has occurred. As soon as loss of contact is observed, the memory pointer is read, the gauge valve is closed, and the air escape valve is opened. The lid assembly is removed and the depth of the wet front is measured. This can be done by pushing a quarter-inch rod into the soil and observing the depth where the penetration resistance is considerably increased. Another way is to quickly remove any remaining water in the cylinder, taking the cylinder out of the soil, and digging with a spade to visually determine the position of the wet front. Dyes and electric-

conductivity probes may also offer possibilities for wet-front detection. To facilitate accurate assessment of the depth of the wet front, the soil should not be too wet at the time of the test.

13. Calculate  $P_a$  as:

$$P_a = P_{\min} + G + L \quad (3-9)$$

**Where**

$P_a$  = air entry value of soil in inches of water  
 $P_{\min}$  = minimum pressure head in inches water as determined by maximum reading on the vacuum gage  
 $G$  = height of gage above soil surface, in.  
 $L$  = depth of wet front, in.

If, for example, the maximum gage reading corresponds to -33 in. water and  $L + G = 18$  in.,  $P_a$  is calculated as -14 in. water.

14. Calculate the water entry (air exit) value  $P_w$  as 0.5  $P_a$ .

15. Calculate the saturated hydraulic conductivity  $K_s$  as

$$K_s = \frac{2(dH/dt)LR_r^2}{H_t + L - 0.5P_aR_c} \quad (3-10)$$

**Where**

$dH/dt$  = rate of fall of water level in reservoir just before closing supply valve.  
 $H_t$  = height above soil surface of water level in reservoir when supply valve is closed.  
 $R_r$  = radius of plastic reservoir.  
 $R_c$  = radius of permeameter cylinder

16. Calculate  $K$  at zero soil water pressure head for sorption as 0.5  $K_s$ .

Note: For most agricultural and coarse-textured soils,  $P_a$  numerically will be small compared to  $H_t$ . Under those conditions,  $P_a$  is not important and can be taken as zero (or as some arbitrary small value, for example - 4 in.) in the above equation. This greatly simplifies the equipment and the field procedure, since the vacuum gage and the measurement of minimum pressure inside the cylinder are then not needed.

The AEP test takes less time and less water than cylinder infiltrometers, and the simplicity of the test permits a very large number of repetitions with very small quantities of water. However, the small size of the apparatus limits the zone of influence so the results are only valid for the few inches below the test surface. Several repetitions with depth will be necessary to characterize the soil profile at a particular location. A successful approach is to dig a test pit with a backhoe with one end of the pit inclined to the surface. Benches can then be excavated by hand in the different horizons or at depths of choice and an AEP test run on each

"step." The bench should be about 3 ft wide. The other walls of the test pit can then be used for the routine soils investigations. A combination of test basins on the site, supplemented by AEP tests in the remaining areas is recommended as the investigation techniques for most projects.

### 3.8.2 Horizontal Hydraulic Conductivity

The groundwater flow path will be parallel to the hydraulic gradient. In the general situation this is essentially horizontal, except immediately beneath an application zone when mounding occurs. The flow of water will be vertical at the center of the mound and at an angle parallel to the gradient at the edge of the mound. The capability of the soil at the edge of the mound to transmit the applied flow in a lateral direction in time. The determination of this horizontal conductivity is therefore essential, particularly for SAT systems.

Most soils are not homogeneous, but rather are at least somewhat stratified, reflecting deposition or consolidation patterns. There are often thin layers or lenses of fine textured material that will impede vertical flow between highly permeable layers of soil. As a result the potential for flow in the horizontal direction is often many times greater than in the vertical direction. In situations with shallow groundwater or where mounding or lateral flow are a significant factor for design, it is necessary to measure the horizontal conductivity ( $K_h$ ) in the field.

#### Auger Hole Test

The auger hole test is the most common and most useful of the field tests available for determining horizontal hydraulic conductivity. A hole is bored to a certain distance below the water table. The water in the hole is then pumped out. The rate at which the hole refills is a function of the hydraulic conductivity of the soil, and the geometry of the hole. It is possible to calculate the  $K_h$  with the measured rate of rise and the other factors defined on Figure 3-20. The general set up for the test is shown in Figure 3-21. The equipment required includes a suitable pump, an auger, a stopwatch, and a device for measuring the depth of water in the hole as it rises. In unstable soils a perforated casing or well screens will be necessary to maintain an open hole. The Bureau of Reclamation uses 100 mm (4 in) thin wall pipe with 60, 1/8 in by 1-in slots per ft of length.

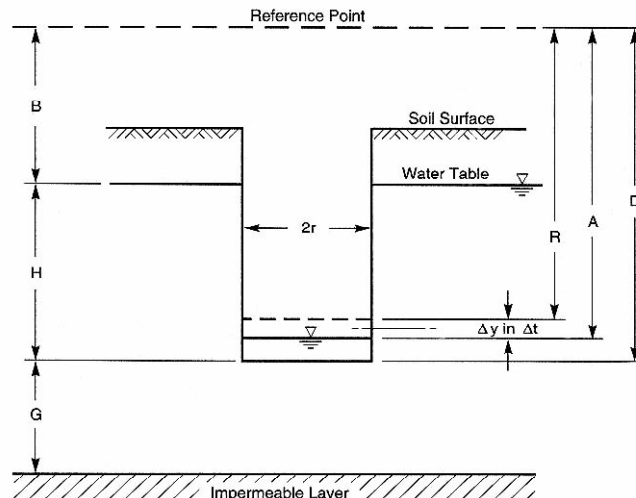


Figure 3-20. Definition Sketch for Auger Hole Technique.

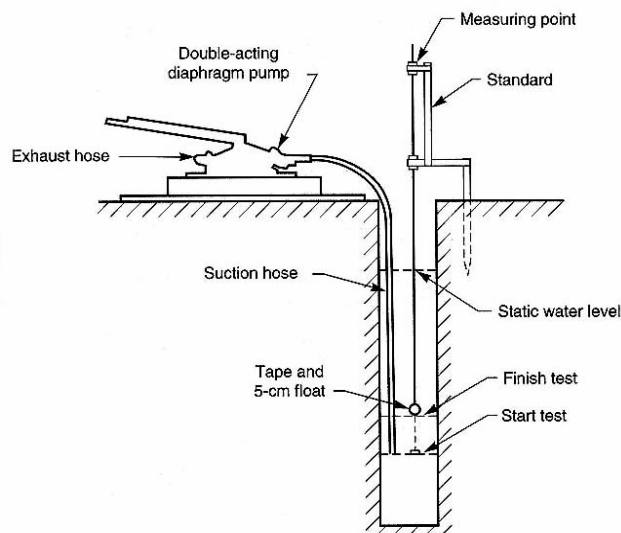


Figure 3-21. Equipment Setup for Auger Hole Test.

The determination of hydraulic conductivity is affected by the location of the barrier or lower impermeable layer. In the case where the barrier is at the bottom of the hole,  $K_h$  can be defined as (terms as shown on):

$$K_h = \frac{15,000r^2}{(H+10r)\left(2-\frac{y}{H}\right)y} \left(\frac{\Delta y}{\Delta t}\right) \quad (3-11)$$

#### Where

- $K_h$  = horizontal hydraulic conductivity, m/d
- $r$  = radius of hole, m
- $H$  = initial depth of water in hole, m
- $H = (D-B)$
- $A$  = depth (from reference point) to water after pumpout, m
- $R$  = depth (from reference point) to water after refill, m

$y$  = average depth to water in hole during the refill period, m  
 $y = (R-B) - 1/2\Delta y$   
 $\Delta y$  = raise of water level in the timed interval  $\Delta t$ , m  
 $\Delta y = (A-R)$   
 $\Delta t$  = time required to give  $\Delta y$ , s

The more usual case is when the impermeable layer is some distance below the bottom of the hole; in this case  $K_h$  is given by:

$$K_h = \frac{16,667r^2}{(H+20r)\left(2-\frac{y}{H}\right)y} \left(\frac{\Delta y}{\Delta t}\right) \quad (3-12)$$

All terms as defined previously.  
 This equation is only valid when:  
 $2 \frac{1}{2} \text{ in} < 2r < 5 \frac{1}{2} \text{ in}$   
 $10 \text{ in} < H < 80 \text{ in}$   
 $y > 0.2H$   
 $G > H$   
 $y < \frac{1}{4} H - (D - A)$

Measurement of horizontal hydraulic conductivity may still be necessary in the absence of a groundwater table. An example might be the presence of fragipan or other hard pan layers at shallow depth. These would restrict vertical flow and might result in unacceptable mounding unless the horizontal conductivity of the overlying material is suitable. The shallow well pump-in test described in U.S. Department of the Interior (1978) can be used in such cases. In effect, it is the reverse of the auger hole test described above.

### 3.9 References

- Abele, G., H. McKim, B. Brockett, and J. Ingersol (1980) Infiltration Characteristics of Soils at Apple Valley, MN, Clarence Cannon Dam, MO., and Deer Creek, OH., Land Treatment Sites.
- Bianchi, W.C. and C. Muckel (1970) *Ground-Water Recharge Hydrology*. U.S. Department of Agriculture, Agricultural Research Service. ARS 41161. December.
- Bouwer, H. (1999) *Artificial Recharge of Groundwater: Systems, Design, and Management*. In: Hydraulic Design Handbook. Mays, L.W. (ed.). Mc Graw-Hill, New York, NY.
- Bouwer, H., J.T. Back, and J.M. Oliver (1999) *Predicting Infiltration and Ground-Water Mounds for Artificial Recharge*. Journal of Hydrologic Engineering. October.
- Bouwer, H. (1978) *Groundwater Hydrology*, New York: McGraw-Hill Book Co.
- Bouwer, H. (1969) *Planning and Interpreting Soil Permeability Measurement*. Journal Irrigation and Drainage Div. ASCE 28:391-402.
- Brady, N. C. and R.R. Weil (2002) *The Nature and Properties of Soils, Thirteenth Edition*. Prentice Hall. Upper Saddle River, NJ.
- Childs, E.C. (1969) *An Introduction to the Physical Basis of Soil Water Phenomena*. John Wiley & Sons, Ltd. London.
- Crites, R. W., R. K. Bastian, and S. C. Reed. 2000. Land Treatment System for Municipal and Industrial Wastes. McGraw-Hill, New York, NY.
- Duke, H.R. (1972) *Capillary Properties of Soils – Influence upon Specific Yield*. Transcripts of the American Society of Agricultural Engineers. 15:688-691.
- Freeze, R.A., and J.A. Cherry (1979) *Groundwater*. Prentice-Hall. Englewood Cliffs, NJ.
- Hansen, V.E., O.W. Israelson and G.E. Stringham (1980) *Irrigation Principles and Practices*, Fourth Edition. John Wiley & Sons, New York.
- Jarrett, A.R. and D.D.Fritton (1978) *Effect of Entrapped Soil Air on Infiltration*. Transactions American Society of Agricultural Engineers. 21:901-906.
- Luthin, J. N. (1978) *Drainage Engineering*, Third Edition, Water Science and Civil Engineering Department, University of California - Davis, Robert E. Krieger Publishing Company, Huntington, NY.
- Nielson, D.R., J.W. Biggar and K.T. Erb (1973) *Spatial Variability of Field-Measured Soil-Water Properties*. Hilgardia. 42:215-259.
- O'Neal, A.M. (1952) *A Key for Evaluating Soil Permeability by Means of Certain Field Clues*. In: Proceedings Soil Science Society of America. 16:312-315.

- 
- Pair, C.H. et al. (1975) *Sprinkler Irrigation*, Fourth Edition. Sprinkler Irrigation Association, Silver Spring, MD.
- Parr, J.F. and A.R. Bertran (1960) *Water Infiltration into Soils*. In: *Advances in Agronomy*, Norman, A.G. (Ed.) Academic Press, New York; pp. 311-363.
- Richards, L.A (1965) *Physical Condition of Water in Soil*. In: *Methods of Soil Analysis. Part 1, Agronomy 9*. Black, C.A. (ed.). American Society of Agronomy, Inc., Madison, WI. pp. 131-136.
- Rogowski, A.S. (1972) *Watershed Physics: Soil Variability Criteria*. *Water Resources Research* 8:1015-1023.
- Sparks, D. L (1995) *Environmental Soil Chemistry*. Academic Press. San Diego.
- Sposito, G. (1989) *The Chemistry of Soils*. Oxford University Press, Inc., New York.
- Taylor, S.A. and Q.L. Ashcroft (1972) *Physical Edaphology*. W.H. Freeman & Co., San Francisco.
- Todd, D.K. (1964) *Groundwater*. In: *Handbook of Applied Hydrology*. Chow, V.T. (Ed.) McGraw-Hill Book Co., New York.
- U.S. Department of the Interior, Bureau of Reclamation (1978) *Drainage Manual*, 1st edition.
- US EPA (1998) *Estimation of Infiltration Rate in the Vadose Zone: Compilation of Simple Mathematical Models*. Volume I. U.S. Environmental Protection Agency, Subsurface Protection and Remediation Division, National Risk Management Research Laboratory, Ada, OK 74820. EPA/600/R-97/128a.
- US EPA. (1998) *Estimation of Infiltration Rate in the Vadose Zone: Application of Selected Mathematical Models*, Volume II. National Risk Management Research Laboratory, US EPA, Ada. OK. EPA/600/R-97/128b.
- Withers, B. and S. Vipond (1987) *Irrigation Design and Practice*, Second Edition. Cornell University Press, Ithaca, NY.

## Chapter 4

# Role of Plants in Land Treatment

In this chapter the characteristics of crops that affect their use in land treatment -- water use and tolerance, nutrient uptake, and toxicity concerns -- are described. Guidance on crop selection for each land treatment process is provided. Crop management aspects of agricultural, silvicultural, and horticultural crops are also discussed.

### 4.1 Vegetation in Land Treatment

The primary role of vegetation in a land treatment system is to recycle nutrients in the waste into a harvestable crop, but vegetation plays a distinct role in each land treatment process. SR also offers an opportunity for economic return by sale of harvested crops. In OF vegetation is the support media for biological activity and is needed for erosion protection. The grass in OF systems also removes significant nutrients and slows the flow of wastewater so that suspended solids can be filtered and settled out of the flow stream. Vegetation is not typically part of SAT systems. It can play a role in stabilization of the soil matrix and can maintain long-term infiltration rates, but does not appear to have a major impact on treatment performance for SAT systems.

Plant uptake is not the only form of nutrient transformation or removal from the soil-plant systems utilized in land treatment, but plant growth does impact all mechanisms either directly or indirectly. Municipal effluent often has an insufficient carbon to nitrogen ratio to support high rates of denitrification. Plant roots can supply a source of degradable carbon that can assist denitrification (Meyer, 2002).

### 4.2 Evapotranspiration

Evapotranspiration (ET) is the sum of plant transpiration and evaporation from plant and soil surfaces. As commonly defined, ET does not include other components of evaporation or losses such as:

- Deep percolation
- Wind drift
- Droplet evaporation in the air
- Run-off

Sophisticated computer models separate transpiration and evaporation components of ET. However, more site-specific data for reference ET are available. Crop ET based on reference ET adjusted for a specific crop is sufficiently accurate for water balances and irrigation scheduling.

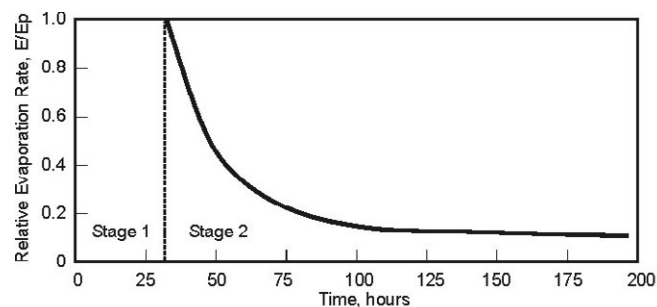
#### 4.2.1 Transpiration

Transpiration is the water that passes from the soil into the plant roots. Less than 1 percent of the water taken up by plants is actually consumed in the metabolic activity of the plant (Rosenberg, 1974) the remainder passes through the plant and leaves by evaporation through the stomata.

The drier and hotter the air, the higher the transpiration rate. The drier the soil, the slower the transpiration, because the water is held tighter to the soil and plants adjust the stomata to conserve liquid, reducing growth. A specific plant variety will have a genetic potential to transpire a certain quantity during the growing season. The transpiration on a given day depends on the plant growth stage, weather conditions, the availability of water, and general plant health. Non-plant based models used to calculate ET assume transpiration is not impacted by plant health or water stress.

#### 4.2.2 Evaporation

Evaporation is water converted from liquid to vapor that does not pass through the plant. Evaporation may occur from wet soil or plant surfaces. When plants are young, a large portion of ET is evaporation from the soil surface. When plants achieve 70 to 80 percent canopy cover, soil evaporation will increase ET by only 10 to 25 percent. The increase of ET due to soil evaporation only occurs immediately after irrigation when the soil surface is wet (stage 1) as illustrated in Figure 4-1. Actual evaporation (E) drops off with time, relative to potential evaporation ( $E_p$ ) stage 2 in Figure 4-1.



**Figure 4-1.** Evaporation from Bare Soil which was Initially Wet (Hanks, 1992).

Soil evaporation is increased by maintaining moist surface conditions. Surface or sprinkler irrigation losses are similar to drip irrigation on a wetted surface area



basis. However, with drip irrigation a small percentage of the surface is wet all the time compared to surface and sprinkler irrigation that has a large percentage of the area wet for only a small amount of time. The exceptions are sub-surface drip, which has very little evaporation, and surface sprinklers with small frequent sprinkler applications, which can evaporate up to 100 percent of the applied water. When applications are so small that only the plant canopy and soil surface is wetted nearly all the water is lost to evaporation without any infiltration into the soil. Research is inconclusive whether water evaporated from the plant surface reduces plant transpiration requirements.

### 4.2.3 Calculating ET

Crop evapotranspiration (ET<sub>c</sub>) is commonly estimated based on a rigorously defined reference crop evapotranspiration (ET<sub>o</sub>) and a crop coefficient (K<sub>c</sub>) representing the specific crop and growth stage.

$$ET_c = ET_o \cdot K_c \quad (4-1)$$

Crop ET<sub>c</sub> allows for the calculation of required irrigation water. The difference between applied water and ET<sub>c</sub> is equal to the amount of deep percolation. Table 4-1 contains a range of expected ET<sub>c</sub> of a variety of crops throughout the United States. Further discussion of ET<sub>o</sub> and K<sub>c</sub> is included in the subsequent subsections.

**Table 4-1.** Range of Seasonal Crop Evapotranspiration

Crop	ET <sub>c</sub> , in	Crop	ET <sub>c</sub> , in
Alfalfa	24-74	Grass	18-45
Avocado	26-40	Oats	16-25
Barley	15-25	Potatoes	18-24
Beans	10-20	Rice	20-45
Clover	34-44	Sorghum	12-26
Corn	15-25	Soybeans	16-32
Cotton	22-37	Sugar beets	18-33
Deciduous trees	21-41	Sugarcane	39-59
Grains (small)	12-18	Vegetables	10-20
Grapes	16-35	Wheat	16-28

**Table 4-2.** Selected Examples of Monthly Normal ET<sub>o</sub> (US EPA, 1981)

Month	Centimeters/Month (Inches/Month)					
	Paris, TX	Central, MO	Jonesboro, GA	Seabrook, NJ	Hanover, NH	Brevard, NC
Jan	0.6	0.3	0.5	0.1	0.0	0.1
Feb	0.6	0.5	0.5	0.1	0.0	0.1
Mar	1.4	1.2	1.2	0.8	0.0	0.8
Apr	2.7	2.6	2.3	1.6	1.2	1.8
May	4.0	4.3	4.4	3.0	3.3	3.0
June	5.9	5.8	5.9	4.6	5.2	4.1
July	6.4	6.8	6.3	5.6	5.5	4.6
Aug	6.5	6.1	6.0	5.4	4.8	4.2
Sept	3.9	4.1	4.4	4.0	3.0	3.0
Oct	2.6	2.5	2.3	2.0	1.6	1.8
Nov	1.1	1.0	1.0	0.8	0.1	0.6
Dec	0.6	0.4	0.5	0.1	0.0	0.1
Annual	36.3	35.6	35.3	28.1	24.7	24.2

In humid regions, ET<sub>o</sub> is sufficiently accurate to predict ET for perennial full cover crops. Table 4-2 contains monthly estimated reference ET values for various humid and subhumid climates. In areas such as the San Joaquin Valley of California monthly ET rarely varies more than 10 percent.

Table 4-3 shows an example of alfalfa and grass ET<sub>o</sub> with the corresponding evapotranspiration rates of various crops.

### 4.2.4 Reference ET

Reference ET (ET<sub>o</sub>) is a term used to describe the evapotranspiration rate from a known surface, such as grass or alfalfa (alfalfa ET<sub>o</sub> normal exceeds grass ET<sub>o</sub> by 0 to 30 percent). ET<sub>o</sub> is expressed in either centimeters or inches. The ET<sub>o</sub> for an average year is referred to as normal year ET<sub>o</sub>.

Rather than measuring the water consumption in the reference crop, ET<sub>o</sub> is often calculated from weather data or pan evaporation. Pan evaporation, as defined by the U.S. Weather Bureau's Class A pan, is commonly used for sizing pond systems and therefore, is often available to engineers designing land application systems. Pans store more heat than crops and consequently result in more evaporation. The pan evaporation is normally higher than ET (10 percent for humid conditions and 15 percent for dry conditions). The coefficients in Table 4-4 can be used to convert pan evaporation to ET<sub>o</sub> using Equation 4-2.

$$ET_o = K_{pan} \cdot E_{pan} \quad (4-2)$$

Where, ET<sub>o</sub> = reference evapotranspiration  
 K<sub>pan</sub> = pan coefficient (Table 4-4)  
 E<sub>pan</sub> = pan evaporation

Evaporation pans are difficult to maintain and numerous weather networks now gather ET data with models that have been developed over the last 50 years. The evapotranspiration models are based on different

**Table 4-3.** Example Evapotranspiration Values for Southern San Joaquin Valley of California (Burt, 1995)

Month	Evapotranspiration Rate, Millimeters/Month (Inches/Month)								
	ET <sub>o</sub> , alfalfa	ET <sub>o</sub> , grass	Alfalfa Hay	Cotton	Citrus	Deciduous orchard w/o cover drop	Deciduous orchard w/ cover drop	Grape Vines	Small Grains
January	0.88	0.69	0.73		0.85		0.68		0.41
February	2.41	1.97	1.99		1.52		1.98		1.99
March	3.75	3.13	3.11		2.32	1.49	3.33	0.05	3.92
April	6.19	5.24	5.11	0.48	3.75	3.63	5.89	1.16	6.37
May	7.98	6.78	6.71	2.06	4.85	5.58	8.10	4.13	6.24
June	9.03	7.65	7.32	6.68	5.06	6.83	9.08	6.00	0.63
July	9.32	7.92	7.80	10.03	5.27	7.59	9.58	6.72	
August	8.44	7.14	6.92	8.76	4.73	6.85	8.41	5.96	
September	6.03	5.08	5.16	4.47	3.57	4.87	5.89	3.30	
October	4.55	3.75	3.63	0.77	2.69	3.02	3.90	1.22	
November	1.92	1.52	1.61		1.18	0.07	1.58	0.14	
December	0.71	0.55	0.60		0.38		0.50		0.09
TOTAL	61.2	51.4	50.7	33.3	35.9	40.8	58.9	28.7	19.8

**Table 4-4.** Pan Coefficient for Class A Evaporation Pans Placed in a Reference Crop Area (Doorenbos and Pruitt, 1977)

Wind, km/h (mi/h)	Relative Humidity, %		
	Low, <40	Medium, 40-70	High, >70
Light, <4.5	0.75	0.85	0.85
Moderate, 4.5	0.70	0.80	0.80
Strong, 11-18	0.65	0.70	0.75
Very Strong, >18	0.55	0.60	0.65

climatic variables. Relationships were often subject to rigorous local calibrations, but proved to have limited global validity. Testing the accuracy of the methods under a new set of conditions is laborious, time-consuming and costly, and yet evapotranspiration data are frequently needed at short notice for project planning or irrigation scheduling design.

In an effort to meet the need for reliable evapotranspiration data, the Food and Agriculture Organization of the United Nations (FAO) published Irrigation and Drainage Paper No. 24 (Doorenbos and Pruitt, 1977). The paper presented four methods with different data needs to calculate the reference crop evapotranspiration (ET<sub>o</sub>): the Blaney-Criddle, radiation, modified Penman, Penman-Monteith and pan evaporation methods. The modified Penman method was considered to offer the best results with minimum possible error in relation to a living grass reference crop. The Blaney-Criddle method was recommended when only mean air temperature was available (Jensen et al., 1973).

The methods reviewed by FAO were calibrated for ten-day or monthly calculations. The Blaney-Criddle method was recommended for periods of one month or longer. Proliferation of remote sensing of climatic data and the more accurate assessment of crop water use has revealed weaknesses in the methodologies (Allen et al.,

1998). Deviations from computed to observed values were often found to exceed ranges indicated by FAO Paper 24. The modified Penman was frequently found to overestimate ET<sub>o</sub>, even by up to 20 percent for low evaporative conditions. The FAO published Irrigation and Drainage Paper No. 56 (Allen et al., 1998) and recommend the FAO Penman-Monteith method as the sole ET<sub>o</sub> method for determining reference evapotranspiration. The FAO Penman-Monteith equation with 24-hour data produces accurate results (Allen et al., 1998). The method, the derivation, the required meteorological data and the corresponding definition of the reference surface are described in FAO paper 56.

While the Blaney-Criddle is not recommended for irrigation scheduling it has sufficient accuracy for initial planning. The Arizona Department of Environmental Quality uses a water reuse model based on Blaney-Criddle.

Unless the site is remote, seasonal ET<sub>o</sub> data are normally available from the local agricultural extension offices, Land Grant Universities, or agricultural research stations. The California Irrigation Management Information System (CIMIS) operates over 100 weather stations. CIMIS uses the Modified Penman to define normal monthly ET<sub>o</sub> and daily ET<sub>o</sub>. Daily ET<sub>o</sub> is available for download via the internet the following morning. The state climatologist often will be aware of such networks. A list of state climatology offices is included in Appendix A.

#### 4.2.5 Crop Coefficients

Crop coefficients (K<sub>c</sub>) are determined by the ratio of the measured ET<sub>c</sub> and ET<sub>o</sub>. The derived K<sub>c</sub> is a dimensionless number (usually between 0.1 and 1.2) that is multiplied by the ET<sub>o</sub> value to arrive at a crop ET (ET<sub>c</sub>) estimate. Because of the method of calculation,

Kc is dependent on the reference ETo used in the calculation. Crop coefficients vary by crop, stage of growth, and by climate. Care should be used to match the Kc to the proper ETo. Local agricultural extension offices have Kc values for crops commonly grown in their area.

Crop coefficients change based on the growth stage of the plant and are commonly divided into four growth stages. Table 4-5 shows the estimated length of growth stages for various crops.

- 1 Initial growth stage (10 percent ground cover)
- 2 Crop-development (up to 80 percent groundcover)
- 3 Midseason stage (effective full groundcover)
- 4 Late-season stage (full maturity until harvest)

If local crop coefficients are not available, estimates from Table 4-6 and Table 4-7 can be used. The reference ETo in Tables 4-6 and 4-7 is calculated from FAO modified Penman-Montieth. Coefficients for annual crops (row crops) will vary widely through the season, with a small coefficient in the early stages of the crop (when the crop is just a seedling) to a large coefficient when the crop is at full cover (the soil completely shaded). Orchards with cover crops between tree rows will have larger coefficients than orchards without cover crops.

### 4.3 Plant Selection

Varieties (cultivars) of major grain, food, and fiber crops are bred specifically for different regions of the United States because of differences in growing seasons, moisture availability, soil type, winter temperatures, and incidence of plant diseases. Other regional issues include infrastructure for post-harvest processing and demand for harvested products. A regional approach, therefore, is recommended for selection and management of vegetation at land treatment sites (Jensen et al., 1973). One of the easiest methods for determining regional compatibility is to investigate the surrounding plant systems. Once regional issues are considered, the final criteria should be based

**Table 4-6.** Crop Coefficient, Kc, for Midseason and Late Season Conditions (Doorenbos and Pruitt, 1977)

Crop	Crop stage	Kc Humid <sup>a</sup>	Kc Dry <sup>b</sup>
Alfalfa <sup>c</sup>	1-4	0.85	0.95
Barley	3	1.05	1.15
	4	0.25	0.20
Clover	1-4	1.00	1.05
Corn	3	1.05	1.15
	4	0.55	0.60
Cotton	3	1.05	1.20
	4	0.65	0.65
Grain	3	1.05	1.15
	4	0.30	0.25
Grapes	3	0.80	0.90
	4	0.65	0.70
Oats	3	1.05	1.15
	4	0.25	0.20
Pasture grass	1-4	0.95	1.00
Rice	3	1.1	1.25
Sorghum	3	1.00	1.10
	4	0.50	0.55
Soybeans	3	1.00	1.10
	4	0.45	0.45
Sugar beets	3	1.05	1.15
	4	0.90	1.00
Wheat	3	1.05	1.15
	4	0.25	0.20

<sup>a</sup> Humidity 70 percent, light wind 0-16 mi/h.

<sup>b</sup> Humidity 20 percent, light wind 0-16 mi/h.

<sup>c</sup> Peak factors are 1.05 for humid conditions and 1.15 for dry conditions.

on nutrient uptake, compatibility with hydraulic loading (quantity and timing), and salt tolerance.

#### 4.3.1 Nutrients

Historically, EPA Design Manuals have presented nutrient management as a simple load per acre determination. The recommended loading did not consider the site specific nutrient requirements of a crop. The description that follows is intended to add a component of comprehensive nutrient management to the EPA guidelines on wastewater irrigation and reuse. Crop nutrient additions should be based on the development of a nutrient management plan (NMP). A NMP is a pollution prevention plan applied to agricultural

**Table 4-5.** Length of Four Crop Growth Stages for Typical Annual Crops (Doorenbos and Pruitt, 1977)

Crop	Growth Stage (Days)			
	1	2	3	4
Barley	15	20-30	50-65	30-40
Corn	20-30	35-50	40-60	30-40
Cotton	30	50	55-60	45-55
Grain, small	20-25	30-35	60-65	40
Sorghum	20	30-35	40-45	30
Soybeans	20	30-35	60	25
Sugar beets	25-45	35-60	50-80	30-50

**Table 4-5.** Crop Coefficient, Kc, for Perennial Forage Crops (Doorenbos and Pruitt, 1977)

Crop	Condition	
	Kc Humid, light to moderate wind	Kc Dry, light to moderate wind
Alfalfa		
Minimum	0.50	0.40
Mean	0.85	0.95
Peak	1.05	1.15
Grass for hay		
Minimum	0.60	0.55
Mean	0.80	0.90
Peak	1.05	1.10
Clover, grass legumes		
Minimum	0.55	0.55
Mean	1.00	1.05
Peak	1.05	1.15
Pasture		
Minimum	0.55	0.50
Mean	0.95	1.00
Peak	1.05	1.10

Kc (minimum) represents conditions just after cutting.  
 Kc (mean) represents value between cuttings.  
 Kc (peak) represents conditions before harvesting under dry soil conditions. Under wet conditions increase values by 30 percent.

and silvicultural operations. The elements of a NMP include:

1. Site maps, including a soil map
2. Location and description of sensitive resource areas
3. Soil, plant, water, and organic material sample analysis results
4. Current and planned crop production sequence or crop rotation
5. Expected yield
6. Quantification of all nutrient sources available
7. A nutrient budget for the crop rotation being planned
8. Recommended rates, timing, and method of nutrient application
9. Operation and maintenance of the nutrient management plan

Crop yields are measured in units of production. Typically yields for crops such as soybeans, corn and other grain crops are expressed in bushels per acre while forage crop yields are expressed as pounds per acre. Bushel is a volumetric unit (30.3 L/bu) and the mass per bushel varies with the crop. Yield-based

uptake of N, P, and K for various crops is presented in Table 4-8.

The specific yield expected for a site can be estimated from soil information available from the NRCS or from local offices of the Cooperative Extension Service. Responsible farm operators, as a part of normal production records, will develop accurate measures of crop yield. Crop nutrient requirements are based on an assessment of realistic yield estimates of the receiver site.

A key component of a comprehensive nutrient management plan is to balance the required level of those nutrients necessary for plant growth with the nutrient loading from the wastewater and subsequent nutrient losses. Insufficient levels of plant nutrient will result in deficiencies in crop quality and reduced crop yield while the over-application of nutrients may result in adverse environmental impact. The relationship of nutrient availability to yield is non-linear. If the nitrogen loading is reduced to half of the expected uptake, it can not be assumed that half the uptake will result. The actual yield and nutrient uptake will be a function of the initial soil reserve and resulting nutrient stress. Soil and tissue analysis are used determine proper nutrient deficiency and proper nutrient loading.

Plants require 16 essential nutrients to produce biomass. Wastewater from municipal, industrial and agricultural sources generally contain many of these essential nutrients. These nutrients should be applied to sites at rates to optimize plant production while creating no adverse environmental conditions. Nutrient management efforts must consider all nutrients managed on a site including: soil reserves, nutrient applications from commercial sources and waste addition, crop residues, and legume credits.

Nitrogen, phosphorus, and potassium are considered the essential macronutrients and are required at moderately high levels to support a healthy crop. Nitrogen is particularly sensitive because of the potential for this nutrient to migrate through the root zone of plants and to groundwater. Recently regulatory agencies are beginning to consider phosphorus as a limiting nutrient because of the potential to exit a site with runoff. Any wastewater treatment operation should include a nutrient management plan that incorporates plans for management of nitrogen, phosphorus, and potassium.

**Table 4-6.** Yield Based N, P, and K Uptake of Various Crops

Crop	Dry Weight lb/bu	Typical Yield/acre-yr Plant Part	Percent of Dry Harvested Material		
			N	P	K
<b>Grain Crops</b>					
Barley	48	50 bu	1.82	0.34	0.43
		1 Ton straw	0.75	0.11	1.25
Buckwheat	48	30 bu	1.65	0.31	0.45
		0.5 Tons straw	0.78	0.05	2.26

Crop	Dry Weight lb/bu	Typical Yield/acre-yr Plant Part	Percent of Dry Harvested Material		
			N	P	K
Corn	56	120 bu	1.61	0.28	0.40
		4.5 Tons straw	1.11	0.20	1.34
Oats	32	80 bu	1.95	0.34	20.49
		2 Tons straw	0.63	0.16	1.66
Rice	45	5,500 lb	1.39	0.24	0.23
		2.5 Tons straw	0.60	0.09	1.16
Rye	56	30 bu	2.08	0.26	0.49
		1.5 Tons straw	0.50	0.12	0.69
Sorghum	56	60 bu	1.67	0.36	0.42
		3 Tons straw	1.08	0.15	1.31
Wheat	60	40 bu	2.08	0.62	0.52
		1.5 Tons straw	0.67	0.07	0.97
<b>Oil Crops</b>					
Flax	56	15 bu	4.09	0.55	0.84
		1.75 Tons straw	1.24	0.11	1.75
Oil palm	--	22,000 lb	1.13	0.26	0.16
		5 Tons fronds & stems	1.07	0.49	1.69
Peanuts	22-30	2,800 lb	3.60	0.17	0.50
		2.2 Tons vines	2.33	0.24	1.75
Rapeseed	50	35 bu	3.60	0.79	0.76
		3 Tons straw	4.48	0.43	3.37
Soybeans	60	35 bu	6.25	0.64	1.90
		2 Tons stover	2.25	0.22	1.04
Sunflower	25	1,100 lb	3.57	1.71	1.11
		4 Tons stover	1.50	0.18	2.92
<b>Fiber Crops</b>					
Cotton		600 lb. Lint and 1,000 lb seeds	2.67	0.85	0.83
		burs & stalks	1.75	0.22	1.45
Pulpwood		98 cords	0.12	0.02	0.06
		bark, branches	0.12	0.02	0.06
<b>Forage Crops</b>					
Alfalfa		4 tons	2.25	0.22	1.87
Bahiagrass		3 tons	1.27	0.13	1.73
Big bluestem		3 tons	0.99	0.85	1.75
Birdsfoot trefoil		3 tons	2.49	0.22	1.82
Bluegrass-pasted		2 tons	2.91	0.43	1.95
Bromegrass		5 tons	1.87	0.21	2.55
Clover-grass		6 tons	1.52	0.27	1.69
Dallisgrass		3 tons	1.92	0.20	1.72
Guineagrass		10 tons	1.25	0.44	1.89
Bermudagrass		8 tons	1.88	0.19	1.40
Indiangrass		3 tons	1.00	0.85	1.20
Lespedeza		3 tons	2.33	0.21	1.06
Little bluestem		3 tons	1.10	0.85	1.45
Orchardgrass		6 tons	1.47	0.20	2.16
Pangolagrass		10 tons	1.30	0.47	1.87
Paragrass		10.5 tons	0.82	0.39	1.59
Red clover		2.5 tons	2.00	0.22	1.66
Reed		6.5 tons	1.35	0.18	
canarygrass					
Ryegrass		5 tons	1.67	0.27	1.42
Switchgrass		3 tons	1.15	0.10	1.90
Tall fescue		3.5 tons	1.97	0.20	2.00
Timothy		2.5 tons	1.20	0.22	1.58
Wheatgrass		1 ton	1.42	0.27	2.68
<b>Forest</b>					
Leaves			0.75	0.06	0.46
Northern hardwoods		50 tons/harvest	0.20	0.02	0.10
Douglas fir		76 tons/harvest	0.16		
<b>Fruit Crops</b>					
Apples		12 tons	0.13	0.02	0.16
Bananas		9,900 lb.	0.19	0.02	0.54
Cantaloupe		17,500 lb.	0.22	0.09	0.46
Grapes		12 tons	0.28	0.10	0.50
Oranges		54,000 lb.	0.20	0.02	0.21
Peaches		15 tons	0.12	0.03	0.19
Pineapple		17 tons	0.43	0.35	1.68
Tomatoes		22 tons	0.30	0.04	0.33
<b>Silage Crops</b>					

Crop	Dry Weight lb/bu	Typical Yield/acre-yr Plant Part	Percent of Dry Harvested Material		
			N	P	K
Alfalfa haylage (50%dm)		10 wet/5 dry	2.79	0.33	2.32
Corn silage (35% dm)		20 wet/7 dry	1.10	0.25	1.09
Forage sorghum (30% dm)		20 wet/6 dry	1.44	0.19	1.02
Oat haylage (40% dm)		10 wet/4 dry	1.60	0.28	0.94
Sorghum-sudan (50% dm)		10 wet/5 dry	1.36	0.16	1.45
<b>Sugar Crops</b>					
Sugarcane		37 tons	0.16	0.04	0.37
Sugar beets		20 tons	0.20	0.03	0.14
Tops			0.43	0.04	1.03
<b>Tobacco</b>					
All types		2,100 lb.	3.75	0.33	4.98
<b>Turf Grass</b>					
Bluegrass		2 tons	2.91	0.43	1.95
Bentgrass		2.5 tons	3.10	0.41	2.21
Bermudagrass		4 tons	1.88	0.19	1.40
<b>Vegetable Crops</b>					
Bell peppers		9 tons	0.40	0.12	0.49
Beans, dry		0.5 ton	3.13	0.45	0.86
Cabbage		20 tons	0.33	0.04	0.27
Carrots		13 tons	0.19	0.04	0.25
Cassava		7 tons	0.40	0.13	0.63
Celery		27 tons	0.17	0.09	0.45
Cucumbers		10 tons	0.20	0.07	0.33
Lettuce (heads)		14 tons	0.23	0.08	0.46
Onions		18 tons	0.30	0.06	0.22
Peas		1.5 tons	3.68	0.40	0.90
Potatoes		14.5 tons	0.33	0.06	0.52
Snap beans		3 tons	0.88	0.26	0.96
Sweet corn		5.5 tons	0.89	0.24	0.58
Sweet potatoes		7 tons	0.30	0.04	0.42
Table beets		15 tons	0.26	0.04	0.28
<b>Wetland Plants</b>					
Cattails		8 tons	1.02	0.18	
Rushes		1 ton	1.67		
Saltgrass		1 ton	1.44	0.27	0.62
Sedges		0.8 ton	1.79	0.26	
Water hyacinth				3.65	0.87
Duckweed			3.36	1.00	2.13
Arrowweed			2.74		
Phragmites			1.83	0.10	0.52

Treated wastewater contains many essential nutrients, but in ratios often inadequate for many plants. The nutrients often present in treated wastewater include nitrate nitrogen, ammonium nitrogen, and organic nitrogen, organic and inorganic phosphorus, potassium, and others. Prior to developing a nutrient management plan, the form of nutrient present in a wastestream must be determined and specific plans must be developed to assure proper utilization. All crops require a balanced nutrient input: optimum N:P:K ratios are generally 4:1:2. If these ratios are not available in wastewater, adjustments should be made to correct the imbalances.

### 4.3.2 Agricultural Crops

Common agricultural forage and field crops are integral to SR process for nitrogen removal. OF systems require a perennial close-growing grass crop to support microbial populations. Both systems require crops with low sensitivity to wastewater constituents and minimum management requirements.

The highest uptake of nitrogen, phosphorus, and potassium can generally be achieved by perennial grasses and legumes. It should be recognized that whereas legumes normally fix nitrogen from the air, they will preferentially take up nitrogen from the soil-water solution if it is present. The potential for harvesting nutrients with annual crops is generally less than with perennials because annuals use only part of the available growing season for growth and active uptake.

Alfalfa removes nitrogen and potassium in larger quantities and at a deeper rooting depth than most agricultural crops as shown in Table 4-7. Corn is an attractive crop because of the potentially high rate of economic return as grain or silage. Intercropping is a method of expanding the nutrient and hydraulic capacity of a field corn crop system. A dual system of rye intercropped with corn to maximize the period of nutrient uptake was studied in Michigan and Minnesota (Brockway et al., 1982). For such dual corn-ryegrass cropping systems, rye can be seeded in the standing corn in August, or after the harvest in September. The

growth of rye in the spring, before the corn is planted, allows the early application of high nitrogen wastewater. While planting the corn, a herbicide can be applied in strips to kill some rye so that the corn can be seeded in the killed rows. With the remaining rye absorbing nitrogen, less is leached during the early growth of the corn. Alternatively, forage grasses can be intercropped with corn. This "no-till" corn management consists of planting grass in the fall and then applying a herbicide in the spring before planting the corn. When the corn completes its growth cycle, grass is reseeded. Thus, cultivation is reduced; water use is maximized; nutrient uptake is enhanced; and revenue potential is increased.

**Table 4-7.** Typical Effective Rooting Depth of Plants (Burt, 1995)

Plant	Effective rooting depth, m (ft)
Alfalfa	1.2-2.0 (4-6)
Avocado	0.6-1.0 (2-3)
Banana	0.6-1.0 (2-3)
Barley	1.0-1.5 (3-5)
Beans	0.3-1.0 (1-3)
Citrus	0.6-1.5 (2-5)
Corn	1.0-1.5 (3-5)
Cotton	1.2-2.0 (4-6)
Deciduous Orchard	1.2-2.0 (4-6)
Grains, small	1.0-1.2 (3-4)
Grapes	1.0-2.0 (3-6)
Grass	1.0-1.2 (3-4)
Lettuce	0.3-0.6 (1-2)
Melons	0.6-1.0 (2-3)
Potatoes	0.6-1.0 (2-3)
Safflower	1.5-2.0 (5-6)
Sorghum	1.0-1.5 (3-5)
Strawberries	0.3-0.6 (1-2)
Sugarbeet	1.0-1.5 (3-5)
Sugarcane	1.2-2.0 (4-6)
Tomatoes	1.0-1.5 (3-5)
Turf grass	0.2-0.5 (0.5-1.5)

In areas with a long growing season, such as California, selection of a double crop is an excellent means of increasing the revenue potential as well as the annual consumptive water use and nitrogen uptake of the crop system. Double crop combinations that are commonly used include summer crops of short season varieties of soybeans, silage corn, or sorghum and winter crops of barley, oats, wheat, vetch, or annual forage grass as a winter crop.

The most common agricultural crops grown for revenue using wastewater are corn (silage), alfalfa (silage, hay, or pasture), forage grass (silage, hay or pasture), grain sorghum, cotton, and grains. However, any crop, including food crops, may be grown with reclaimed wastewater after suitable preapplication treatment. In Monterey, CA, disinfected tertiary effluent is used to grow lettuce, broccoli, celery, cauliflower, and artichokes. At the level of treatment achieved at

Monterey, the use of the reclaimed water is more of a recycled water project than a land treatment. Fewer metals were found in the reclaimed wastewater than conventional fertilizers. Because recycled water quality is similar to that of other water sources, Monterey is not labeling the produce to indicate that it is grown with recycled water (Jaques et al., 1999).

The grass crop for OF must have high moisture tolerance, long growing season, and be suited to the local climate. A mixture of grasses is generally preferred over a single species as shown in Table 4-8. The mixture should contain grasses whose growth characteristics complement each other, such as sod formers and bunch grasses and species that are dormant at different times of the year.

Another advantage of using a mixture of grasses is that, due to natural selection, one or two grasses will often predominate. A successful combination of grasses has been Reed canarygrass, tall fescue, and ryegrass (see Table 4-8). In the south and southwest, dallisgrass, bermudagrass and redtop have also been successful. In northern climates, substitution of orchardgrass for the dallisgrass and redtop is recommended.

At Hanover, NH, barnyardgrass invaded the OF slopes and began to dominate the perennial grasses. Being an annual grass, when the barnyardgrass died, it left bare areas that were subject to erosion (Palazzo et al., 1982).

Grasses to be avoided include those sensitive to salt (like clover) and those that have long slender seed stalks (Johnson grass and yellow foxtail). In the early stages of development Johnson grass will provide an effective cover; however, with maturity the bottom leaves die off and the habitat for microorganisms becomes reduced.

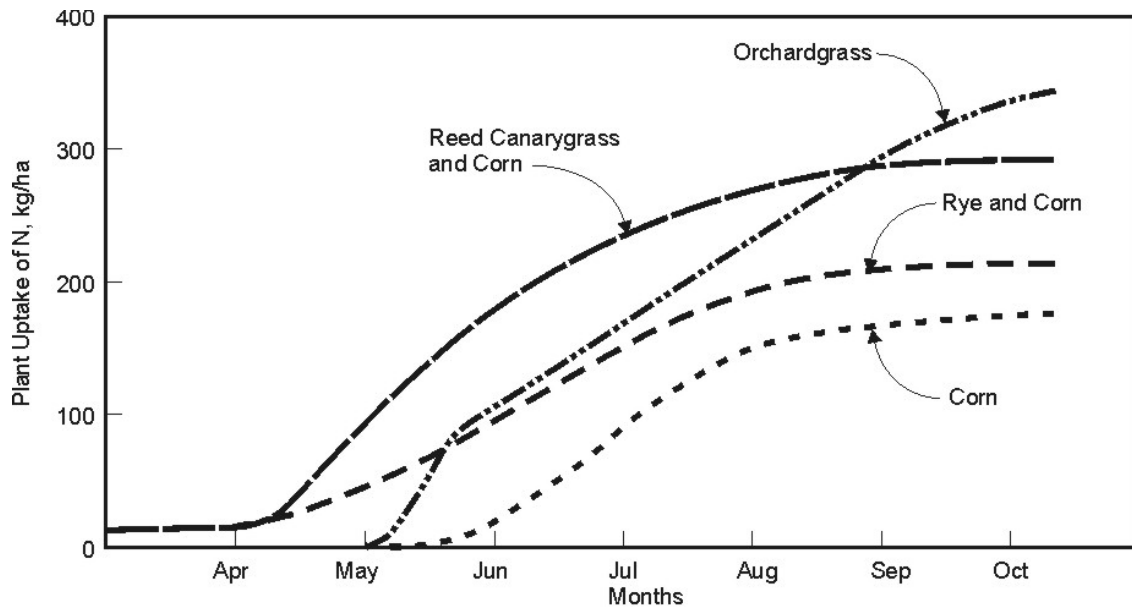
## Nitrogen

The rate of nitrogen uptake by crops changes during the growing season and is a function of the rate of dry matter accumulation and the nitrogen content of the plant. For planning and nutrient balances, the rate of nitrogen uptake can be correlated to the rate of plant transpiration. Consequently, the pattern of nitrogen uptake is subject to many environmental and management variables and is crop specific. Examples of measured nitrogen uptake rates versus time are shown in Figure 4-2 for annual crops and perennial forage grasses receiving wastewater. The plant uptake curves assume that the applied nitrogen exceeds the rate of uptake (is not limiting growth) and that the applied nitrogen is plant-available (in the inorganic form).

Some forage crops can have even higher nitrogen uptakes than those in. Californiagrass, a wetland

**Table 4-8.** Grasses Used at Overland Flow Sites (US EPA, 1973)

Site	Type of Grass
Ada, OK.	Annual ryegrass, bermudagrass, and Kentucky 31 fescue
Carbondale, IL	Tall fescue
Davis, CA	Fescue and perennial ryegrass
Easley, SC.	Kentucky 31 fass fescue
Hanover, NH	Orchardgrass, quackgrass, Reed canarygrass, perennial ryegrass
Hunt-Wesson (Davis, CA.)	Fescue, trefoil, Reed canarygrass
Campbell Soup Co. (Paris, TX.)	Reed canarygrass, redtop, tall fescue
Utica, MS	Reed canarygrass, Kentucky 31 fescue, perennial ryegrass, common bermudagrass



**Figure 4-2.** Nitrogen Uptake for Annual and Perennial Crops.

species, widely distributed in the subtropics, was grown with effluent in Hawaii (Handley, 1981). Mean crop yield was 96 mt/ha-yr (43 tons/acre-yr and nitrogen uptake was 2.1 mt/ha-yr (1,870 lb/acre-yr). The nitrogen crop uptake for turfgrasses in Tucson (common bermudagrass overseeded with winter ryegrass) is 0.59 mt/ha-yr (525 lb/acre-yr) (Pepper, 1981).

Essentially all nitrogen absorbed from the soil by plant roots is in the inorganic form of either nitrate ( $\text{NO}_3$ ) or ammonium ( $\text{NH}_4$ ). Generally young plants absorb ammonium more readily than nitrate; however, as the plant ages the reverse is true. Soil conditions that promote plant growth (warm and well aerated) also promote the microbial conversion of ammonium to nitrate. As a result, nitrates are generally more abundant when growing conditions are most favorable. Once inside the plant, the majority of the nitrogen is incorporated into amino acids, the building blocks of protein. Protein is approximately 16 percent nitrogen by

weight. Nitrogen makes up from 1 to 4 percent of the plants harvested dry weight.

### Phosphorus

Phosphorus is part of the plant genetic material ribonucleic (RNA) and energy transfer with adenosine triphosphate (ATP). Phosphorus is available for absorption by plants from the soil as the orthophosphate ions ( $\text{H}_2\text{PO}_4^{-2}$  and  $\text{HPO}_4^{-3}$ ). Aluminum, iron, calcium, and organic matter quickly bind phosphorus into highly insoluble compounds. The concentration of orthophosphate ion in soil solution is commonly less than 0.05 mg/L, so an equilibrium is established between the soluble ion and the adsorbed form in soil.

The amount of phosphorus in municipal effluent is usually higher than plant requirements. Fortunately, the relative immobility of phosphorus in soil profile allows for application of phosphorus in excess of crop requirements.



**Table 4-9.** General Effects of Trace Element Toxicity on Common Crops (Kabata-Pendias and Pendias 2000)

Element	Symptoms	Sensitive Crop
Al	Overall stunting, dark green leaves, purpling of stems, death of leaf tips, and coralloid and damaged root system.	Cereals
As	Red-brown necrotic spots on old leaves, yellowing and browning of roots, depressed tillering.	No specific crop
B	Margin or leaf tip chlorosis, browning of leaf points, decaying growing points, and wilting and dying-off of older leaves.	Cereals, potatoes, tomatoes, cucumbers, sunflowers, mustard
Cd	Brown margin of leaves, chlorosis, reddish veins and petioles, curled leaves, and brown stunted roots.	Legumes (bean, soybean), spinach radish, carrots, and oats.
Co	Interveinal chlorosis in new leaves followed by induced Fe chlorosis and white leaf margins and tips, and damaged root tips.	No specific crop
Cr	Chlorosis of new leaves, injured root growth.	No specific crop
Cu	Dark green leaves followed by induced Fe Chlorosis, thick, short, or barbed-wire roots, depressed tillering.	Cereals and legumes, spinach, citrus, seedlings, and gladiolus.
F	Margin and leaf tip necrosis; chlorotic and red-brown points of leaves.	Gladiolus, grapes, fruit trees, and pine trees
Fe	Dark green foliage, stunted growth of tops and roots, dark brown to purple leaves of some plants ("bronzing" disease of rice).	Rice and tobacco
Hg	Severe stunting of seedlings and roots, leaf chlorosis and browning of leaf points.	Sugarbeets, corn and roses.
Mn	Chlorosis and necrotic lesions on old leaves, blackish-brown or red necrotic spots, accumulation of MnO <sub>2</sub> particles in epidermal cells, drying tips of leaves, and stunted roots.	Cereals, legumes, potatoes, and cabbage.
Mo	Yellowing or browning of leaves, depressed root growth, depressed tillering.	Cereals
Ni	Interveinal chlorosis in new leaves, gray-green leaves, and brown and stunted roots.	Cereals
Pb	Dark green leaves, wilting of older leaves, stunted foliage, and brown short roots.	No specific crop
Rb	Dark Leaves, stunted foliage, and increasing amount of shoots.	No specific crop
Se	Interveinal chlorosis or black spots at Se content at about 4 mg/L and complete bleaching or yellowing of younger leaves at higher Se content; pinkish spots on roots.	No specific crop
Zn	Chlorotic and necrotic leaf tips, interveinal chlorosis in new leaves, retarded growth of entire plant, injured roots resemble barbed wire.	Cereals and spinach.

## Potassium

Potassium is used in large amounts by many crops, but typical wastewater is relatively deficient in this element. For example, at 15 mg/L, a typical wastewater contains 40 lb/acre-ft. In many cases, fertilizer potassium (or biosolids potassium) may be needed for optimal plant growth depending on the soil and crop. For soils having low levels of natural potassium, a relationship has been developed to estimate potassium loading requirements, see Equation 2-3 in Chapter 2 (US EPA, 1981).

## Micronutrients

In addition to the three major macronutrients, calcium and sulfur are also macronutrients, and there are many micronutrients. The micronutrients important to plant growth (in descending order) are: iron, manganese, zinc, boron, copper, molybdenum, nickel and occasionally, sodium, silicon, chloride, and cobalt. Most wastewaters contain an ample supply of these elements. Symptoms of trace element toxicity are presented in Table 4-9. The descriptions should be used to indicate sensitive crops and diagnoses of toxicity should be confirmed with

tissue analysis. The concentration of these elements in most municipal wastewaters is well below the toxic level of all crops; however, phytotoxicity may occur as a result of long-term accumulation of these elements in the soil.

## Salinity

Salts can accumulate in the soil causing osmotic stress on plants. Osmotic stress caused by salt is similar to the impact of moisture stress and is amplified as soil dries. All water has salts. Municipal effluent has an approximate increase of 150 to 380 mg/L total dissolved solids (not all inorganic salts) over the source water depending on what industries also discharge (Metcalf and Eddy, 1991). Under dry conditions, salts are not adequately leached out of the root zone and can build up to cause osmotic stress. Plants that are salt sensitive or only moderately tolerant show progressive decline in growth and yields as levels of salinity increase. Figure 4-3 contains salt tolerance of common crops. Some species are tolerant to salinity, yet sensitive during germination. It is general practice to use supplemental water for germination when available.

## pH

Natural biochemical reactions drive the soil pH to a stable condition. A range of pH between 3 and 11 has been applied successfully to land treatment systems. Extended duration of low pH can change the soil fertility and lead to leaching of metals. When the acidity is comprised of mostly organic acids, then the water will be neutralized as the organics are oxidized.

Most field crops grow well in soils with a pH range of 5.5 to 8.0. Some crops, like asparagus or cantaloupes with a high calcium requirement, prefer a soil pH greater than 7.0. If the pH of the soil begins to drop, liming is recommended to return the pH to the desirable range for crop production. Figure 4-4 shows a range optimal pH of various crops on a mineral soil. The pH range shown in Figure 4-4 is that of the soil extract, not the effluent, which will be neutralized in the soil.

Because soil can treat large amounts of organics acids, it is recommended the pH of wastewater be pH 5.0 and 9.0). Chemical acids and bases used during pH adjustment will add to the dissolved solids and should be avoided if salinity is a problem. Organic acids, such as acetic acid, can be used to reduce pH without adding to the fixed dissolved solids, but the organic component will increase BOD.

### 4.3.3 Silviculture

Existing forested land or newly planted stands provide an excellent area for land treatment systems. The most common forest crops used in SR systems have been mixed hardwoods and pines. A summary of representative operational systems and types of forest crops used is presented in Table 4-10. The growth response of trees will vary in accordance with a number of factors; one of the most important is the adaptability of the selected species to the local climate. Local foresters should be consulted for specific recommendations on the likely response of selected species.

Vegetative uptake and storage of nutrients depend on the species and forest stand density, structure, age, length of season, and temperature. In addition to the trees, there is also nutrient uptake and storage by the understory tree and herbaceous vegetation.

The role of the understory vegetation is particularly important in the early stages of tree establishment. Forests take up and store nutrients and return a portion of those nutrients back to the soil in the form of leaf fall and other debris such as dead trees. Upon decomposition, the nutrients are released and taken up by the trees. During the initial stages of growth (1 to 2 yr), tree seedlings are establishing a root system;

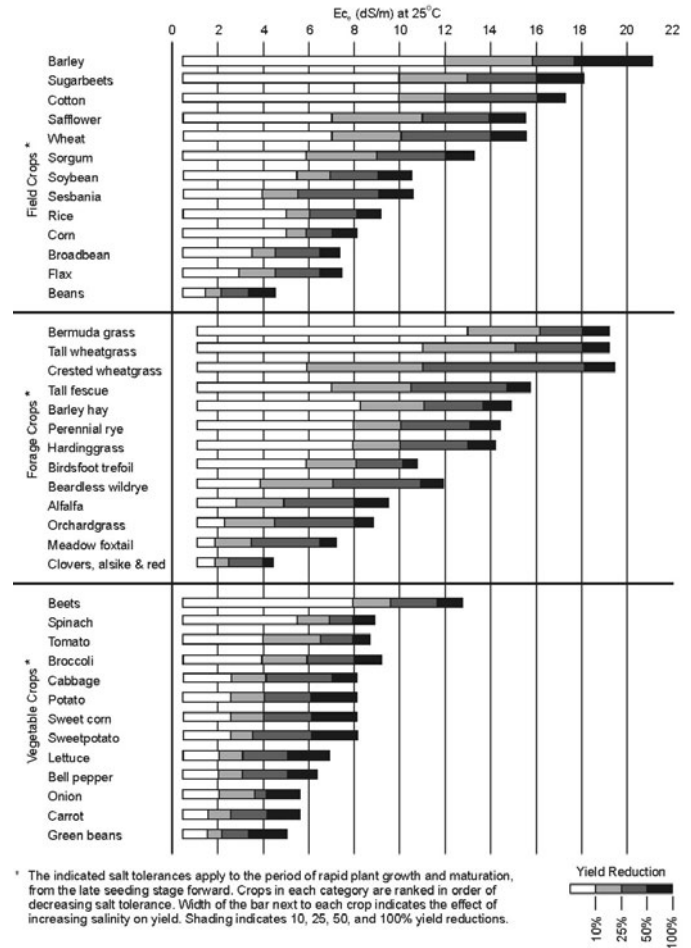


Figure 4-3. Effect of Salinity on Growth of Field Crops (USDA, 1992).

Table 4-10. Forested Land Treatment Systems in the United States (Crites et al., 2000)

Location	Design Flow, mgd	Tree Types
Dalton, GA	30.0	Pines
Clayton, Co., GA	19.5	Loblolly pines, hardwood
Helen, GA	0.02	Mixed pine and hardwood
St. Marys, GA	0.3	Slash pine
Mackinaw City, MI	0.2	Aspen, birch, white pine
State College, PA	3.0	Mixed hardwood, pine
West Dover, VT	0.55	Hardwood balsam, hemlock, spruce

## Nitrogen Uptake

biomass production and nutrient uptake are relatively slow. To prevent leaching of nitrogen to groundwater during this period, nitrogen loading must be limited or understory vegetation must be established that will take up and store applied nitrogen that is in excess of the tree crop needs.

The estimated annual nitrogen uptake of forest ecosystems in selected regions of the United States is presented in Table 4-11. These rates are considered

		Soil pH			
		4	5	6	7+
		Strongly acid and very strongly acid soils	Range of moderately acid soils	Slightly acid and slightly alkaline soils	
Herbaceous plants	Trees & shrubs				
Alfalfa Sweet clover Asparagus Buffalo grass Wheatgrass (tall)	Walnut Alder Eucalyptus Arborvitae			[Shaded bar from pH 6 to 7+]	
Garden beets Sugar beets Cauliflower Lettuce Cantaloupe	Currant Ash Beech Sugar maple Poplar			[Shaded bar from pH 6 to 7+]	
Spinach Red clovers Peas Cabbage Kentucky blue grass	White clovers Carrots Juniper Myrtle elm Apricot Red oak			[Shaded bar from pH 6 to 7+]	
Cotton Timothy Barley Wheat Fescue (tall & meadow) Corn Soybeans Oats Alsike clover Crimson clover	Rice Bermuda grass Tomatoes Vetches Millet Cowpeas Lespedeza Rye Buckwheat	Birch Dogwood Douglas fir Magnolia Oaks Red cedar Hemlock (Canadian) Cypress Flowering cheery Laurel	Andromeda Willow oak Pine oak Red spruce Honey Locust Bitter hickery	[Shaded bar from pH 5 to 6]	
Red top Potatoes Bent grass (except creeping) Fescue (red & sheep's) Western wheatgrass Tobacco	American holy Aspen White spruce White Scotch pine Loblolly pine Black locust		[Shaded bar from pH 4 to 5]		
Poverty grass eastern gamagrass Love grass, weeping Redtop grass Cassava Napier grass	Autumn olive Blueberries Cranberries Azalea Rhododendron white pine Red pine	Teaberry Tea Blackjack oak Sumac Birch Coffee	[Shaded bar from pH 4 to 5]		

Ranges of pH in mineral soils that present appropriate conditions for optimal growth of various plants. Note that the pH ranges are quite broad, but that plant requirement for calcium and sensitivity to aluminum toxicity generally decreases from the top group to the bottom group.

**Figure 4-4.** Suitable pH of Mineral Soils for Various Crops.

**Table 4-11.** Nitrogen Uptake for Selected Forest Ecosystems With Whole Tree Harvesting

	Tree Age, Years	Average Annual Nitrogen Uptake lb/(acre-year)
Eastern forests:		
Mixed hardwoods	40-60	200
Red pine	25	100
Old field with white spruce plantation	15	200
Pioneer succession	5-15	200
Aspen sprouts	-	100
Southern forests:		
Mixed hardwoods	40-60	250
Loblolly pine with no understory	20	200
Loblolly pine with understory	20	250
Lake states forests:		
Mixed hardwoods	50	100
Hybrid poplar <sup>a</sup>	5	140
Western forests:		
Hybrid poplar <sup>a</sup>	4-5	270
Douglas fir plantation	15-25	200

<sup>a</sup>Short-term rotation with harvesting at 4 to 5 years; represents first-growth cycle from planted seedlings.

\*lb/acre-yr = 1.12 lg/ha-yr<sup>1</sup>.

maximum estimates of net nitrogen uptake including both the understory and overstory vegetation during the period of active tree growth.

Because nitrogen stored within the biomass of trees is not uniformly distributed among the tree components, the amount of nitrogen that can actually be removed with a forest crop system will be substantially less than the storage estimates given in Table 4-11 unless 100 percent of the aboveground biomass is harvested (whole-tree harvesting). If only the merchantable stems are removed from the system, the net amount of nitrogen removed by the system will be less than 30 percent of the amount stored in the biomass (Keeney, 1980).

The distributions of biomass and nitrogen for naturally growing hardwood and conifer (pines, Douglas fir, fir, larch, etc.) stands in temperate regions are shown in Table 4-12. For deciduous species, whole-tree harvesting must take place in the summer when the leaves are on the trees if maximum nitrogen removal is to be achieved.

Leaves make only 2 percent of the biomass on a dry weight for northern hardwoods. Harvesting hardwoods with leaves will increase nutrient removal by the following percentages:

- 12% Calcium
- 15% Potassium
- 4% Phosphorus
- 19% Nitrogen (Hornbeck and Kropelin, 1982).

Following the initial growth stage, the rates of growth and nutrient uptake increase and remain relatively constant until maturity is approached and the rates decrease. When growth rates and nutrient uptake rates begin to decrease, the stand should be harvested or the nutrient loading decreased. Maturity may be reached at 20 to 25 yr for southern pines, 50 to 60 yr for hardwoods, and 60 to 68 yr for some of the western conifers such as Douglas fir. Of course, harvesting may be practiced well in advance of maturity as with short-term rotation management.

**Eastern Forests.** During the past 35 years wastewater has been applied to several forest ecosystems at the Pennsylvania State University (Sopper and Kerr, 1979). Satisfactory renovation was obtained in all systems (eastern mixed hardwoods and red pine) when wastewater was applied during the growing season at 2.54 cm/wk (1 in/wk) with annual nitrogen loadings of 150 kg/ha (134 lb/acre). The white spruce/old field forest ecosystem produced a percolate nitrogen concentration of 7.4 mg/L (nitrate-N) when the hydraulic loading was 5 cm/wk (2 in/wk) and the annual nitrogen loading was 308 kg/ha (275 lb/acre).

**Southern Forests.** In a study of a southern mixed hardwood (80% hardwood, 20% pine) forest near Helen, Georgia on a 30% slope with a loading rate of 7.5 cm/wk (3 in/wk), about 60% of the applied nitrogen was accounted for in uptake and denitrification. The nitrogen loading was 680 kg/ha (608 lb/acre) and the percolate nitrate-N concentration was 3.7 mg/L (Nutter and Schultz, 1978).

**Lake States Forests.** Studies at Michigan State University have shown rather poor nitrogen removal by mature northern hardwoods. Younger forest systems and poplar plantations have shown greater nitrogen uptake, especially during the years when herbaceous cover is present (McKim et al., 1982).

**Western Forests.** The wastewater renovation capacity of a newly established plantation of Douglas fir and a mature 50-yr old Douglas fir forest was studied with wastewater nitrogen loadings of 350 to 400 kg/ha-yr (310 to 360 lb/acre-yr) (Cole and Schiess, 1978). The uptake rates, presented in Table 4-11, reflect a substantial uptake by the understory grasses.

**Table 4-12.** Biomass and Nitrogen Distributions by Tree Component for Stands in Temperate Regions (US EPA, 1981)

Tree component	Conifers, %		Hardwoods, %	
	Biomass	Nitrogen	Biomass	Nitrogen
Roots	10	17	12	18
Stems	80	50	65	32
Branches	8	12	22	42
Leaves	2	20	1	8

## Phosphorus and Trace Metals

The assimilative capacity for both phosphorus and trace metals is controlled more by soil properties than plant uptake. The relatively low pH (4.2 to 5.5) of most forest soils is favorable to the retention of phosphorus but not trace metals. However, the high level of organic matter in forest soil improves the metal removal capacity. The amount of phosphorus in trees is small, usually less than 30 kg/ha (27 lb/acre); therefore, the amount of annual phosphorus accumulation in the biomass is quite small.

### 4.3.4 Horticultural

Horticultural plants offer a benefit over agricultural production crops because the harvest is not ingested. Although it has been clearly demonstrated that reuse irrigation with highly treated effluent meets the water quality criteria for turf grass use (USGA, 1994), many golf course managers are reluctant to use effluent at the risk of loss from visual appearance in both irrigation ponds and turf quality. Devitt and Morris (2000) monitored golf course quality at both courses with effluent and with municipal water. Because of the nutrient content of the effluent irrigation ponds with effluent had increased algal growth and loss of clarity. However, effluent ponds with aquatic vegetation phosphate levels were lower and clarity higher,

suggesting that the plant played a significant role in maintaining healthier ponds. Turf quality without sufficient leaching showed impaired quality independent of water type. Various golf course grasses can be chosen as a salt management strategy. Table 4-13 shows salt tolerances of various grasses. Salt issues for turf quality can be managed with sufficient leaching, but a greater concern is associated with mixed landscape plant receiving overhead spray irrigation (Devitt and Morris, 2000).

## 4.4 Crop Management, Water Quality, and Nutrient Cycle

Crop planting, harvesting and pest control are management areas requiring proper techniques to ensure a healthy crop.

### 4.4.1 Crop Planting, Harvesting Cultivating

Local extension services or other experts should be consulted regarding planting techniques and schedules. Most crops require a period of dry weather before harvest to mature and reach a moisture content compatible with harvesting equipment. Soil moisture at harvest time should be low enough to minimize compaction by harvesting equipment. For these reasons,

**Table 4-13.** Golf Course Grass Salt Tolerances

ECe (dS/m)	Grass	
Very Sensitive (<1.5)	Annual bluegrass	Rough bluegrass
	Colonial bentgrass	Centipedegrass
Moderately Sensitive (1.6 - 3.0)	Kentucky bluegrass	Most zoysia spp.
Moderately Tolerant (3.1 - 6.0)	Creeping bentgrass	Buffalograss
	Fine-leaf fescues	Blue grama
	Bahiagrass	Annual ryegrass
Tolerant (6.1 – 10.0)	Seaside bentgrass	Zoysia japonica (some)
	Common bermudagrass	Zoysia matrella (some)
	Tall Fescue	Kikuyu
	Perennial ryegrass	Wheatgrasses
Very Tolerant (10.1 to 20.0)	Hybrid bermudagrasses (some)	Salt grass
	St. Augustinesgrass	Alkaligrass (Fulfs, Salty)
Superior Tolerance (>20.0)	Seashore paspalum (some)	

<sup>a</sup>The plant classification values and rankings are based on those traditionally used for all plants (Carrow and Duncan, 1998). The exception is the "Superior Tolerance" class, which is added to classify grasses that are true halophytes with salinity tolerances well above most plants.

---

application should be discontinued well in advance of harvest. The time required for drying will depend on the soil drainage and the weather. A drying time of 1 to 2 weeks is usually sufficient if there is no precipitation. However, advice on this should be obtained from local experts and sufficient land area should be available to account for the time required for drying.

Harvesting of grass crops and alfalfa involves regular cuttings, and a decision regarding the trade-off between yield and quality must be made. Advice can be obtained from local agricultural experts. In the northeast and north central states, three cuttings per season have been successful with grass crops. When supplemental fertilizer is required, records should be kept documenting the type of fertilizer used, area of application, amount applied.

#### **4.4.2 Grazing**

Grazing of pasture by beef cattle or sheep can provide an economic return for SR systems. No health hazard has been associated with the sale of the animals for human consumption. Grazing animals return nutrients to the ground in their waste products. The chemical state (organic and ammonia nitrogen) and rate of release of the nitrogen reduces the threat of nitrate pollution of the groundwater. Much of the ammonia-nitrogen volatilizes and the organic nitrogen is held in the soil where it is slowly mineralized to ammonium and nitrate forms. See Chapter 2 for nitrogen cycling from livestock.

In terms of pasture management, cattle or sheep must not be allowed on wet fields to avoid severe soil compaction and reduced soil infiltration rates. Wet grazing conditions can also lead to animal hoof diseases. Pasture rotation should be practiced so that wastewater can be applied immediately after the livestock are removed. In general, a pasture area should not be grazed longer than 7 days. Typical regrowth periods between grazings range from 14 to 36 days. Depending on the period of regrowth provided, one to three water applications can be made during the regrowth period. Rotation grazing cycles for 2 to 8 pasture areas are given in Table 4-16. At least 3 to 4 days of drying time following an application should be allowed before livestock are returned to the pasture.

#### **4.4.3 Agricultural Pest Control**

Problems with weeds, insects, and plant diseases are aggravated under conditions of frequent water application, particularly when a single crop is grown year after year or when no-till practices are used. Most pests can be controlled by selecting resistant or tolerant crop varieties and by using pesticides in combination with appropriate cultural practices. State and local experts

should be consulted in developing an overall pest control program for a given situation.

#### **4.4.4 Overland Flow Crop Management**

After the cover crop has been established, the OF slopes will need little, if any, maintenance work. It will, however, be necessary to mow the grass periodically. A few systems have been operated without cutting, but the tall grass tends to interfere with maintenance operations. Normal practice has been to cut the grass two or three times a year. The first cutting may be left on the slopes. After that, however, it is desirable to remove the cut grass. The advantages of doing so are that additional nutrient removal is achieved, channeling problems may be more readily observed, and revenue can sometimes be produced by the sale of hay. Depending on the local market conditions, the cost of harvesting can at least be offset by the sale of hay (US EPA, 1981).

Slopes must be allowed to dry sufficiently such that mowing equipment can be operated without leaving ruts or tracks that will later result in channeling of the flow. The drying time required before mowing varies with the soil and climatic conditions and can range from a few days to a few weeks. The downtime required for harvesting can be reduced by a week or more, if green-chop harvesting is practiced instead of mowing, raking, and baling. Care must be taken to minimize pathogen effects. However, local markets for green-chop must exist for this method to be feasible.

It is common for certain native grasses and weeds to begin growing on the slopes, but usually they have little impact on treatment efficiency and it is generally not necessary to eliminate them. However, there are exceptions, and the local extension services should be consulted for advice.

Proper management of the slopes and the application schedule will prevent conditions conducive to mosquito breeding. Other insects are usually no cause for concern, although an invasion of certain pests such as army worms may be harmful to the vegetation and may require periodic insecticide application.

#### **4.4.5 Forest Crop Management**

The type of forest crop management practice selected is determined by the species mix grown, the age and structure of the stand, the method of reproduction best suited and/or desired for the favored species, terrain, and type of equipment and technique used by local harvesters. The most typical forest management situations encountered in land treatment are management of existing forest stands reforestation, and short-term rotation.

**Table 4-14.** Pasture Rotation Cycles for Different Numbers of Pasture Areas

Number of Pastures	Rotation Cycle Days	Regrowth Period Days	Grazing Period Days
2	28	14	14
3	30	20	10
4	28	21	7
5	35	28	7
6	36	30	6
7	42	36	6
8	40	35	5

**Established Forests.** The general objective of the forest management program is to maximize biomass production. The compromise between fully attaining a forest's growth potential and the need to operate equipment efficiently (distribution and harvesting equipment) requires fewer trees per unit area. These operations will assure maintenance of a high nutrient uptake by the forest.

In even-aged forests, trees will all reach harvest age at the same time. The usual practice is to clear-cut these forests at harvest age and regenerate a stand by either planting seedlings, sprouting from stumps (called coppice), or a combination of several of the methods. Even-aged stands may require a thinning at an intermediate age to maintain maximum biomass production. Coniferous forests, in general, must be replanted, whereas hardwood forests can be reproduced by coppice or natural seeding. For uneven-aged forests, the desired forest composition, structure, and vigor can be best achieved through thinning and selective harvest. However, excessive thinning can make trees susceptible to wind throw and caution is advised in windy areas. The objectives of these operations would be to maintain an age class distribution in accordance with the concept of optimum nutrient storage. The maintenance of fewer trees than normal would permit adequate sunlight to reach the understory to promote reproduction and growth of the understory. Thinning should be done initially prior to construction of the distribution system and only once every 10 years or so to minimize soil and site damage.

The concept of "whole-tree harvesting" should be considered for all harvesting operations, whether it be thinning, selection harvest, or clear-cut harvest. Whole-tree harvesting removes the entire standing tree: stem, branches, and leaves. Thus, 100 percent of nitrogen accumulated in the aboveground biomass would be removed.

Prescribed fire is a common management practice in many forests to reduce the debris or slash left on the site during conventional harvesting methods. During the operation, a portion of the forest floor is burned and nitrogen is volatilized. Although this represents an immediate benefit in terms of nitrogen removal from the site, the buffering capacity that the forest floor offers is

reduced and the likelihood of a nitrate leaching to the groundwater is increased when application of wastewater is resumed.

**Reforestation.** Wastewater nutrients often stimulate the growth of the herbaceous vegetation to such an extent that it competes with and shades out the desirable forest species. Herbaceous vegetation is necessary to act as a nitrogen sink while the trees are becoming established, and therefore, cultural practices must be designed to control but not eliminate the herbaceous vegetation. As the tree crowns begin to close, the herbaceous vegetation will be shaded and its role in the renovation cycle reduced. Another alternative to control of the herbaceous vegetation is to eliminate it completely and reduce the hydraulic and nutrient loading during the establishment period.

**Short-Term Rotation.** Short-term rotation forests are plantations of closely spaced hardwood trees that are harvested repeatedly on cycles of less than 10 yr. The key to rapid growth rates and biomass development is the rootstock that remains in the soil after harvest and then resprouts. Short-term rotation harvesting systems are readily mechanized because the crop is uniform and relatively small.

Using conventional tree spacings of 8 to 12 ft (2.4 to 3.6 m), research on systems where wastewater has been applied to short-term rotation plantations has shown that high growth rates and high nitrogen removal are possible (US EPA, 1981). Planted stock will produce only 50 percent to 70 percent of the biomass produced following cutting and resprouting (US EPA, 1981). If nitrogen and other nutrient uptake is proportional to biomass, the first rotation from planted stock will not remove as much as subsequent rotations from coppice. Therefore, the initial rotation must receive a reduced nutrient load or other herbaceous vegetation must be employed for nutrient storage. Alternatively, closer tree spacings may be used to achieve desired nutrient uptake rates during initial rotation.

## 4.5 References

Allen, R. G., L. S. Pereira, D. Raes, and M. Smith (1998) *Crop evapotranspiration - Guidelines for computing crop water requirements* - FAO Irrigation

- and drainage paper 56. FAO - Food and Agriculture Organization of the United Nations. Rome.
- Brockway, D.G. et al. (1982) The Current Status on the Selection and Management of Vegetation for Slow Rate and Overland Flow Application Systems to Treat Municipal Wastewater in the North Central Region of the United States. In: Land Treatment of Municipal Wastewater, D'Itri, F.M. (Ed.) Ann Arbor, MI: Ann Arbor Science, pp.5-18.
- Burt, C. M. (1995) The Surface Irrigation Manual. Waterman Industries, Inc.
- Carrow, R. N. and R. R. Duncan (1998) Salt-Affected Turfgrass Sites: Assessment and Treatment. Ann Arbor Press, Chelsea, MI.
- Crites, R.W., S.C. Reed, and R.K. Bastian (2000) *Land Treatment Systems for Municipal and Industrial Wastes*. McGraw-Hill Book Co. New York.
- Cole, D.W. and P. Schiess (1978) *Renovation of Wastewater and Response of Forest Ecosystems: the Pack Forest Study*. Proceedings of the International Symposium on Land Treatment of Wastewater. Vol. 1, Hanover, NH. pp. 323-331.
- Devitt, D. A. and R. L. Morris (2002) *Monitoring Golf Course Transition to Reuse Water in Southern Nevada*. *American Water Works: Water Sources Conference-Reuse, Resources, Conservation*. January 27-30, 2002, Las Vegas, NV.
- D'Itri, F.M. (1982) Land Treatment of Municipal Wastewater: Vegetation Selection and Management, Ann Arbor, MI: Ann Arbor Science.
- Doorenbos, J. and W. O. Pruitt (1977) *Crop Requirements*, FAO Irrigation and Drainage Paper 24. Food and Agricultural Organization of the United Nations, Rome.
- Handley, L.L. (1981) Effluent Irrigation of Californiagrass. Proceedings Water Reuse Symposium II, Vol. 2, AWWA Research Foundation, Washington, DC.
- Hanks, R.J. (1992) Applied Soil Physics. Second edition. Springer-Verlag. New York.
- Hornbeck, J. W. and W. Kropelne (1982) *Nutrient removal and leaching from a whole-tree harvest of northern hardwoods*. Journal of Environmental Quality. 11:309-316.
- Jaques, R., G. Antosz, R. Cooper, and B. Sheikh (1999) *Pathogen Removal Effectiveness of a Full-Scale Recycling Plant*. WEFTEC '99, New Orleans, LA.
- Jensen, M.E. et al. (1973) *Consumptive Use of Water and Irrigation Water Requirements*. ASCE Committee on Irrigation Water Requirements.
- Kabata-Pendias, A and H. Pendias. (2000). Trace Elements in Soil and Plants, 3rd ed. CRC, Boca Raton, FL.
- Keeney, D.R. (1980) *Prediction of soil nitrogen availability in forest ecosystems: a literature review*. Forest Science. 26:159-171.
- Metcalf and Eddy (1991) Wastewater Engineering: Treatment, Disposal, Reuse. 3<sup>rd</sup> Edition. Rev. G. Tchobanoglous and F. Burton. McGraw-Hill, Inc.
- Nutter, W.L., R.C. Schultz, and G.H. Brister (1978) *Land Treatment of Municipal Wastewater on Steep Forest Slopes in the Humid Southeastern United States*. Proceedings of the International Symposium on Land Treatment of Wastewater, Vol. 1. Hanover, NH. pp. 265-274.
- Palazzo, A.J., T.F. Jenkins, and C.J. Martel (1982) Vegetation Selection and Management for Overland Flow Systems. In: Land Treatment of Municipal Wastewater, D'Itri, F.M. (Ed.) Ann Arbor, MI: Ann Arbor Science, pp. 135-154.
- Pepper, I.L. (1981) Land Application of Municipal Effluent on Turf. In: Proceedings of the 1981 Technical Conference Silver Spring, MD: The Irrigation Association.
- Rosenberg, N. J. (1974) Microclimate: The Biological Environment. John Wiley & Sons. New York.
- Sopper, W.E. and S.N. Kerr (1979) *Renovation of Municipal Wastewater in Eastern Forest Ecosystems*, In: Utilization of Municipal Sewage Effluent and Sludge on Forest and Disturbed Land. University Park, PA: The Pennsylvania State University Press. pp. 61-76.
- USDA. (1992) Part 651 – Agricultural Waste Management Field Handbook.
- US EPA (1973) *Wastewater Treatment and Reuse by Land Application*. Vol. II. EPA-660/02-73-006B, Aug. 1973.
- US EPA (1981) *Process Design Manual: Land Treatment of Municipal Wastewater*. EPA 625/1-81-013.
- USGA (1994) Wastewater Reuse for Golf Course Irrigation. Lewis Publishers.



## Chapter 5 Site Planning and Selection

Site selection and process considerations in land treatment are interrelated. The ability of the land treatment processes to remove wastewater constituents described in Chapter 2, the discharge quality criteria, and the soil and other site characteristics affect the choice of the appropriate land treatment process. The presence of a suitable site within an economical transmission distance from the wastewater source will determine if a land treatment system can be implemented. Because the selection of a process and site for land treatment are related, a 2-phased planning procedure is often used. The two phases are presented in Figure 5-1 (US EPA, 1981b). Phase 1 involves identification of potential sites via screening of available information and experience. If potential sites for any land treatment processes are identified, the study moves into Phase 2. Phase 2 includes an in-depth consideration of the processes including field investigations, preliminary design and cost estimates, evaluation of the alternatives, and selection of the most economical and appropriate alternative.

### 5.1 Preliminary Land Requirements

The first phase involves estimating preliminary land area requirements based on wastewater and climate characteristics, identifying potential sites and, evaluating the sites based on technical and economic factors, and selecting potential sites.

Preliminary land requirements can be estimated for each land treatment process, based on wastewater characteristics, required loading rates, storage needs and climatic conditions.

#### 5.1.1 Wastewater Characteristics

Wastewater characteristics include average annual flows and concentrations of constituents such as BOD<sub>5</sub>, suspended solids, nitrogen, phosphorus and trace elements.

Municipal wastewater flows range typically from 246 – 379 liters per capita per day [65 to 100 gallons per capita per day (gpcd)] (Crites and Tchobanoglous, 1998). Industrial wastewater flows are too variable to generalize and must be estimated from information specific to the product and wastewater generating operations. Existing wastewater flow records or water use records should be used whenever available.

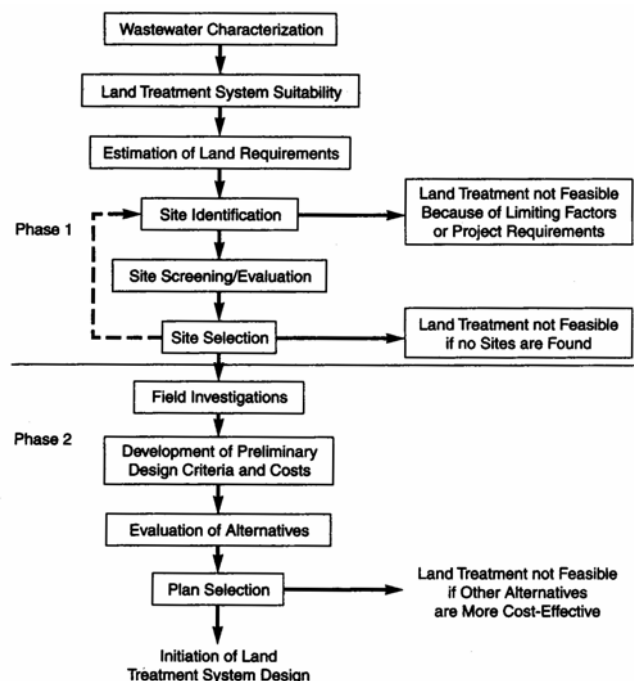


Figure 5-1. Two-Phase Planning Process.

Constituent concentrations that are seen typically in municipal wastewater are presented in Table 5-1. These characteristics represent typical medium strength wastewater. For municipal land treatment systems, BOD<sub>5</sub> and suspended solids loadings seldom limit system capacity. If nitrogen removal is required, nitrogen loading may limit the system capacity. Nitrogen removal capacity depends on the crop grown, if any, and on system management practices. In some cases, other wastewater constituents such as phosphorus or trace elements may control design. This is rare, however, and most municipal systems will be limited either by hydraulic capacity or nitrogen loading.

Table 5-1. Typical Composition of Raw Municipal Wastewater (Crites and Tchobanoglous, 1998)

Constituent	Concentration, g/m <sup>3</sup> (mg/L)
BOD <sub>5</sub>	210
Suspended Solids	210
Nitrogen, total	35
Organic nitrogen	13
Ammonia nitrogen	22
Phosphorus, total	7
Potassium	15

Industrial wastewaters vary widely in their characteristics, especially for organics, metals, and nitrogen. Characteristics of food processing wastewaters that have been applied directly to the land are presented in Table 5-2 (Crites, 1982a). Wastewater characterization is necessary in planning for industrial land application systems (see Chapter 11). It is important to consider whether there are sufficient nutrients in industrial wastewaters to support plant growth in SR systems. Applications may need to supplement nutrients with other sources for proper plant fertility (e.g., commercial fertilizers).

**Table 5-2.** Characteristics of Food Processing Wastewaters Applied to the Land

Constituent	Concentration, g/m <sup>3</sup> (mg/L)*
BOD <sub>5</sub>	200 - 33,000
Suspended Solids	200 - 3,000
Total fixed dissolved solids	<1,800
Total nitrogen	10 - 1,900
pH, units	3.5 - 12.0
Temperature, °C	< 65

\*Except as noted.

### 5.1.2 Preliminary Loading Rates

In the absence of site information, typical loading rates can be assumed to initiate the planning process. For SR systems the degree of preapplication treatment (either primary or secondary) has little effect on the loading rate. For OF and SAT systems, higher loading rates can usually be used with higher quality effluent. Typical loading rates for preliminary estimates of land requirements are presented in Table 5-3 (Crites, et al., 2000). The rates in Table 5-3 are necessarily conservative. Once a potential site has been analyzed and the ability to meet discharge requirements is assessed, the loading rates can be modified. In calculating the annual loading rates in SR systems it should be noted that annual crops (e.g., corn) differ from perennial (e.g., grass). Loading rates will vary annually with annual crops and may be more consistent with perennial crops.

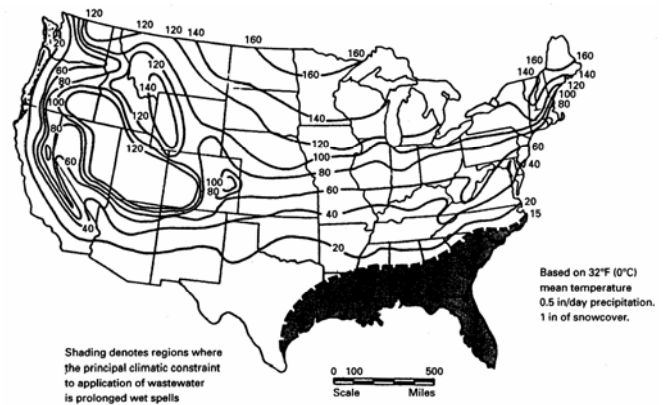
**Table 5-3.** Preliminary Loading Rates for Initial Estimate of Land Requirements

Process	Loading Rate, mm/week (in/week)
Slow rate	
Agricultural	38 (1.5)
Forest	25 (1.0)
Soil Aquifer Treatment	
Primary effluent	305 (12)
Secondary effluent	508 (20)
Overland flow	
Screened wastewater and primary effluent	102 (4)
Secondary effluent	203 (8)

### 5.1.3 Storage Needs

Storage for wastewater may be necessary due to cold weather, excessive precipitation, or crop management. Land treatment systems also may need storage for flow equalization, system backup and reliability, and system management, including crop harvesting (SR and OF) and spreading basin maintenance (SAT). Reserve application areas can be used instead of storage for these system management requirements.

For preliminary estimates it is usually sufficient to base storage needs on climatic factors. A map showing storage days based on cold weather and excessive precipitation is presented in Figure Figure 5-2 (Whiting, 1976). This figure should be used for a preliminary estimate of storage needed for OF systems. For SR systems using agricultural crops, the crop management time for harvesting and planting should be added to the storage days taken from Figure 5-2. The values in Figure 5-2 may not be valid for SAT and forested SR systems, since both are sometimes operated during subfreezing weather. For SAT and forested SR system, a minimum storage of 7 to 14 days can be assumed for preliminary estimates of land area. If application rates are reduced during cold weather, additional storage will be required.



**Figure 5-2.** Estimated Storage Days Based on Climatic Factors Alone.

### 5.1.4 Climatic Factors and Data Sources

Local climate may affect (1) the water balance (and thus the acceptable wastewater hydraulic loading rate), (2) the length of the growing season, (3) the number of days per year that a land treatment system cannot be operated, (4) the storage capacity requirement, (5) the loading cycle of SAT systems, (6) crop selection, and (7) the amount of stormwater runoff. For this reason, local precipitation, evapotranspiration, temperature, and wind values must be determined before design criteria can be

established. Whenever possible, at least 10 years of data should be used to obtain these values.

Three publications of the National Oceanic and Atmospheric Administration (NOAA) provide sufficient data for most communities. The "Monthly Summary of Climatic Data" provides basic information, including total precipitation, temperature maxima and minima, and relative humidity, for each day of the month and every weather station in a given area. Whenever available, evaporation data are included. An annual summary of climatic data, entitled "Local Climatological Data", is published for a small number of major weather stations. Included in this publication are the means, and extremes of all the data on record to date for each station. The "Climate Summary of the United States" provides 10-year summaries of the monthly climatic data. Other data included are:

- Total precipitation for each month of the 10-year period
- Mean number of days that precipitation exceeded 0.25 and 1.27 cm (0.10 and 0.50 inch) during each month (see www for further information).
- Total snowfall for each month of the period
- Mean temperature for each month of the period
- Mean daily temperature maxima and minima for each month
- Mean number of days per month that the temperature was less than or equal to 0°C or greater than or equal to 32.5°C

A fourth reference that can be helpful is EPA's "Annual and Seasonal Precipitation Probabilities" (Thomas and Whiting, 1977a). This publication includes precipitation probabilities for 93 stations throughout the United States. Data requirements for planning purposes are summarized in Table 5-4 (Crites et al., 2000).

### 5.1.5 Site Area Estimate

The amount of land required for a land treatment system includes the area needed for buffer zones, preapplication treatment, storage, access roads, pumping stations, and maintenance and administration buildings, environmental sensitivity, in addition to the

land actually required for treatment. Depending on growth patterns in the study area, and on the accessibility of the land treatment site, additional land may be required for future expansion or for emergencies.

Preliminary site area requirements can be estimated from wastewater flows, storage needs, and preliminary loading rates. The relationship between field area, loading rates, and operating period is shown in Equation 5-1, presented in both metric and English standard units.

$$F = 3.65 \frac{Q}{LP} \quad (\text{metric})$$

or

$$F = 13,443 \frac{Q}{LP} \quad (\text{U.S. customary}) \quad (5-1)$$

**Where:**

- F = field area, ha (acres)
- Q = average flow, m<sup>3</sup>/d (mgd)
- L = loading rate, cm/wk (in/wk)  
(Preliminary values from Table 5-3)
- P = period of application, wk/yr
- 3.65 = metric conversion factor =

$$0.0001 \frac{ha \cdot m}{m^3/d} \times \frac{100 \text{ cm} \times 365 \text{ days}}{year} \times 1/m$$

13,443 = conversion factor =

$$3.069 \frac{acre \cdot ft}{mgd} \times \frac{12 \text{ inch} \times 365 \text{ days}}{year} \times 1/ft$$

The period of application (P) from Equation 5-1 can be approximated by dividing the estimated storage period from Figure 5-2 by 52 wks./yr. Typical site areas requirements for a 3,785 m<sup>3</sup>/day (some editors like 0.044m<sup>3</sup>sec<sup>-1</sup>) (1 mgd) flow for all three systems are presented in Table 5-5 (Crites et al., 2000). For SR and SAT systems the numbers in Table 5-5 include 20 percent extra area over the calculated field area to account for unusable land. For OF systems, in Table 5-5, the extra land area is 40 percent to account for the additional inefficiency in constructing OF slopes.

**Table 5-4.** Summary of Climatic Analyses

Factor	Data Required	Analysis	Use
Precipitation	Annual average, maximum, minimum	Frequency	Water balance
Rainfall storm	Intensity, duration	Frequency	Runoff estimate
Temperature	Days with average below freezing	Frost-free period	Storage, treatment efficiency, crop growing season
Wind	Velocity, direction	—	Cessation of sprinkling
Evapotranspiration	Annual, monthly average	Annual distribution	Water balance

## 5.2 Site Identification

To identify potential land treatment sites it is necessary to obtain data on land use, soil types, topography, geology, groundwater, surface water hydrology, and applicable water rights issues. The types and sources of data needed to identify and evaluate potential sites are presented in Table 5-6 (Crites et al., 2000).

### 5.2.1 Use of Overlay Maps

The complexity of site identification depends on the size of the study area and the nature of the land use. One approach is to start with land use plans and identify undeveloped land. Map overlays can then help the planner or engineer to organize and study the combined effects of land use, slope, relief, and soil permeability. Use of Geographic Information Systems (GIS) will ease this process. Criteria can be set on these four factors,

and areas that satisfy the criteria can then be located. If this procedure is used as a preliminary step in site identification, the criteria should be reassessed during each iteration. Otherwise, strict adherence to such criteria may result in overlooking either sites or land treatment opportunities.

### 5.2.2 Site Suitability Factors

Potential land treatment sites are identified using a deductive approach (Sills et al., 1978). First, any constraints that might limit site suitability are identified. In most study areas, all land within the area should be evaluated for each land treatment process. The next step is to classify broad areas of land near the area where wastewater is generated according to their land treatment suitability. Factors that should be considered include current and planned land use, topography, soils, geology, groundwater and surface water hydrology.

**Table 5-5.** Site Identification Land Requirements, ha/m<sup>3</sup>-d (acres/mgd)

System	Land Requirements, ha/m <sup>3</sup> -d (acres/mgd)
Slow rate, agricultural:	
No storage	0.021 (200)
1 month's storage	0.024 (225)
2 month's storage	0.027 (250)
3 month's storage	0.029 (275)
4 month's storage	0.034 (315)
5 month's storage	0.037 (350)
6 month's storage	0.044 (415)
Slow rate, forest:	
No storage	0.033 (310)
1 month's storage	0.036 (335)
Soil aquifer treatment:	
Primary effluent	0.0032 (30)
Secondary effluent	0.0016 (15)
Overland flow:	
Storage (months)	Applying screened wastewater      Applying secondary effluent
0	0.0096 (90)      0.019 (180)
1	0.0107 (100)      0.021 (200)
2	0.0117 (110)      0.023 (220)
3	0.0128 (120)      0.026 (240)
4	0.0149 (140)      0.030 (280)

**Table 5-6.** Types and Sources of Data Required for Land Treatment Site Evaluation

Type of Data	Principal Source
Topography	USGS topographic quads
Soil type and permeability	NRCS soil survey
Temperature (mean monthly and growing season)	NRCS soil survey, NOAA, local airports, newspapers
Precipitation (mean monthly, maximum monthly)	NRCS soil survey, NOAA, local airports, newspapers
Evapotranspiration and evaporation (mean monthly)	NRCS soil survey, NOAA, local airports, newspapers, agricultural extension service
Land Use	NRCS soil survey, aerial photographs from the Agricultural Stabilization and Conservation Service, and county assessor's plats
Zoning	Community planning agency, city or county zoning maps
Agricultural practices	NRCS soil survey, agricultural extension service, county agents, crop consultants
Surface and groundwater discharge requirements	State or EPA
Groundwater (depth and quality)	State water agency, USGS, driller's logs of nearby wells

## Land Use

Land use in most communities is regulated by local, county and regional zoning laws. Land treatment systems must comply with the appropriate zoning regulations. For this reason, the planner should be fully aware of the actual land uses and proposed land uses in the study area. The planner should attempt to develop land treatment alternatives that conform to local land use goals and objectives. Land treatment systems may conform with the following land use objectives:

- Protection of open space that is used for land treatment
- Production of agricultural or forest products using wastewater on the land treatment site
- Reclamation of land by using wastewater to establish vegetation on scarred land
- Augmentation of parklands by irrigating such lands with wastewater
- Management of flood plains by using flood plain areas for land treatment, thus precluding land development on such sites
- Formation of buffer areas around major public facilities, such as airports

To evaluate present and planned land uses, city, county and regional land use plans should be consulted. Because such plans often do not reflect current land use, site visits are recommended to determine existing land use. Aerial photographic maps may be obtained from the Natural Resources Conservation Service (NRCS) or the local assessor's office. USGS is an additional source for aerial photo or satellite images. Many of the information sources are available on Internet. Other useful information may be available from the USGS, including true color, false color, infrared, and color infrared aerial photos of the study area.

Once the current and planned land uses have been determined, these should be plotted on a study area map. Then, land use suitability may be plotted using the factors shown in Table 5-7 (Moser, 1978).

Both land acquisition procedures and treatment system operation are simplified when few land parcels (few land owners) are involved and contiguous parcels are used. Therefore, parcel size is an important parameter. Usually, information on parcel size can be obtained from county assessor or county recorder maps. Again, the information should be plotted on a map of the study area.

## Topography

Steep grades limit a site's potential because the amount of runoff and erosion that may occur is increased, crop cultivation is made more difficult, and saturation of steep slopes may lead to unstable soil conditions. The maximum acceptable grade depends on soil characteristics and the land treatment process used (Table 1-2).

Grade and elevation information can be obtained from USGS topographic maps, which usually have scales of 1:24,000 (7.5 minute series) or 1:62,500 (15 minute series). Grade suitability may be plotted using the criteria listed in Table 5-8 (Moser, 1978).

Relief is another important topographical consideration and is the difference in elevation between one part of a land treatment system and another. The primary impact of relief is the effect on the cost of conveying wastewater to the land application site. Often, the economics of pumping wastewater to a nearby site must be compared with the cost of constructing gravity conveyance to more distant sites.

**Table 5-7.** Land Use Suitability Factors for Identifying Land Treatment Sites (Moser, 1978)

Land Use Factor	Type of System			
	Agricultural Slow Rate	Forest Slow Rate	Overland Flow	Soil Aquifer Treatment
Open or cropland	High	Moderately high	High	High
Partially forested	Moderate	High	Moderate	Moderate
Heavily forested	Low	High	Low	Low
Built upon (residential, commercial, or industrial)	Low	Very low	Very low	Very low

**Table 5-8.** Grade Suitability Factors for Identifying Land Treatment Sites (Moser, 1978)

Grade Factor, %	Slow Rate Systems		Overland Flow	Soil Aquifer Treatment
	Agricultural	Forest		
0 – 12	High	High	High	High
12 – 20	Low	High	Moderate	Low
20+	Very low	Moderate	Eliminate	Eliminate

A site's susceptibility to flooding also can affect its desirability. The flooding hazard of each potential site should be evaluated in terms of both the possible severity and frequency of flooding as well as the extent of flooding. In some areas, it may be preferable to allow flooding of the application site provided offsite storage is available. Further, crops can be grown in flood plains if flooding is infrequent enough to make farming economical.

The landscape position and landform for each suitable area should be noted. Figure 5-3 can be used as a guide for identifying landscape positions. This information is useful in estimating surface and subsurface drainage patterns. For example, hilltops and sideslopes can be expected to have good surface and subsurface drainage, while depressions and footslopes are more likely to be poorly drained (US EPA, 1980).

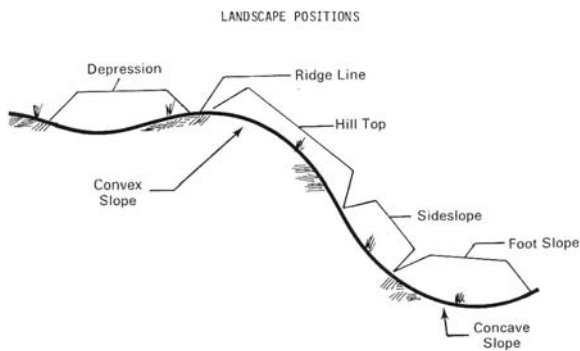


Figure 5-3. Landscape Positions.

Overland flow sites can be located in flood plains provided they are protected from direct flooding which could erode the slopes. Flood plain sites for SAT basins should be protected from flooding by the use of levees.

Summaries of notable floods and descriptions of severe floods are published each year as the USGS Water Supply Papers. Maps of certain areas inundated in past floods are published as Hydrologic Investigation Atlases by the USGS. The USGS also has produced more recent maps of flood prone areas for many regions of the country as part of the Uniform National Program for Managing Flood Losses. These maps are based on

7.5 minute (1:24,000) topographic sheets and identify areas that lie within the 100 year flood plain. Additional information on flooding susceptibility is available from local offices of the U.S. Army Corps of Engineers and local flood control districts. Many county/city zoning offices have flood plain information

### Soils

Common soil-texture terms and the relationship to the NRCS textural class names are listed in Table 5-9 (Crites et al., 2000).

In general, Fine-textured soils do not drain well and retain water for long periods of time. Thus, infiltration is slower and crop management is more difficult than for freely drained soils such as loamy soils. Fine-textured sloping soils are best suited for the OF process. Loamy or medium-textured soils are desirable for the SR process, although sandy soils may be used with certain crops that grow well in rapidly draining soils. Soil structure and soil texture are important characteristics that relate to permeability and acceptability for land treatment. Structure refers to the degree of soil particle aggregation. A well structured soil is generally more permeable than unstructured material of the same type. The SAT process is suited for sandy or loamy soils.

Soils surveys are usually available from the NRCS. Soil surveys normally contain maps showing soil series boundaries and textures to a depth of about 1.5 m (5 ft). In a survey, limited information on chemical properties, grades, drainage, erosion potential, general suitability for locally grown crops, and interpretive and management information is provided. Where published surveys are not available, information on soil characteristics can be obtained from the NRCS, through the local county agent. Much of this information is now available on the web at NRCS's Electronic Field Office Guide (<http://www.nrcs.usda.gov/technical/efotg/>, (verified August 22, 2005).

Although soil depth, permeability, and chemical characteristics significantly affect site suitability, data on these parameters are often not available before the site investigation phase. If these data are available, they should be plotted on a study area map along with soil

Table 5-9. Soil Textural Classes and General Terminology Used in Soil Descriptions

Common Name	General Terms		Basic Soil Textural Class Names
	Texture		
Sandy soils	Coarse		Sand, loamy sand
	Moderately coarse		Sandy loam, fine sandy loam
Loamy soils	Medium		Very fine sandy loam, loam, silt loam, silt
	Moderately fine		Clay loam, sandy clay loam, silty clay loam
Clayey soils	Fine		Sandy clay, silty clay, clay

texture. In identifying potential sites, the planner should keep in mind that adequate soil depth is needed for root development and for thorough wastewater treatment. Further, permeability requirements vary among the land treatment processes. Desirable permeability ranges are shown by process in Table 5-10 together with desired soil texture (Crites et al., 2000). The NRCS permeability class definitions are also shown in Figure 3-5.

## Geology

Certain geological formations are of interest during phase 1 investigations. Discontinuities and fractures in bedrock may cause short-circuiting or other unexpected groundwater flow patterns. Impermeable or semi-permeable layers of rock, clay, or hardpan can result in perched groundwater tables. The USGS and many state geological surveys have maps indicating the presence and effects of geological formations. These maps and other USGS studies may be used to plot locations within the study area where geological formations may limit the suitability for land treatment.

## Groundwater

A knowledge of the regional groundwater conditions is particularly important for SAT and SR sites. Overland flow will not usually require an extensive hydrogeologic investigation. There is sufficient removal of pollutants in the applied wastewater before reaching a permanent groundwater resource is the primary concern. The depth to groundwater and seasonal fluctuation are measures of the aeration zone. When several layers of stratified groundwater underlie a particular site, the occurrence of the vertical leakage between layers should be evaluated. Direction and rate of groundwater flow and aquifer permeability together with groundwater depth are useful in predicting the effect of applied wastewater on the groundwater regime. The extent of recharge mounding, interconnection of aquifers, perched water tables, the potential for surfacing groundwater, and design of monitoring and withdrawal wells are dependent on groundwater flow data.

Much of the data required for groundwater evaluation may be determined through use of existing wells. Wells that could be used for monitoring should be listed and the relative location described. Historical data on quality, water levels, and quantities pumped from the operation

of existing wells may be of value. Such data include seasonal groundwater-level variations, as well as variations over a period of years. The USGS maintains a network of about 15,800 observation wells to monitor water levels nationwide. Records of about 3,500 of these wells are published in Water-Supply Paper Series, "Groundwater-Levels in the United States." Many local, regional, and state agencies compile drillers' boring logs that are also valuable for defining groundwater hydrology. Even though USGS has the monitoring well network the local, state people have better data.

Land treatment of wastewater can provide an alternative to surface discharge of conventionally treated wastewater. However, the adverse impact of percolated wastewater on the quality of the groundwater must be considered. Existing groundwater quality should be determined and compared to quality standards for its current or intended use. The expected quality of the renovated wastewater can then be compared to determine which constituents in the renovated water might be limiting. The USGS "Groundwater Data Network" monitors water quality in observation wells across the country. In addition, the USGS undertakes project investigations or groundwater studies in cooperation with local, state, or other federal agencies to appraise groundwater quality. Such reports may provide a large part of the needed groundwater data.

## Surface Water Hydrology

Surface water hydrology is of interest in land treatment processes because of stormwater run-on and runoff. Considerations relating to surface runoff control apply to both SR and OF. SAT processes are designed for no runoff.

The control of stormwater runoff both onto and off a land treatment site must be considered. First, the facilities constructed as part of the treatment system must be protected against erosion and washout from extreme storm events. For example, where earthen ditches and/or terraces are used, erosion control from stormwater runoff must be provided. The degree of control of runoff to prevent the destruction of the physical system should be based on the economics of replacing equipment and structures. There is no standard extreme storm event in the design of drainage and runoff

**Table 5-10.** Typical Soil Permeabilities and Textural Classes for Land Treatment

	Land Treatment Processes		
	Slow Rate	Soil Aquifer Treatment	Overland Flow
Soil permeability range, mm/h (in/h)	1.5 – 50 (0.06 – 2.0)	> 50 (> 2.0)	< 5 (< 0.2)
Permeability class range	Moderately slow to moderately rapid	Rapid	Slow
Textural class	Clay loams to sandy loams	Sandy and sandy loams	Clays and clay loams
Unified soil classification	GM-d, SM-d, ML, OL, MH, PT	GW, GP, SW, SP	GM-u, GC, SM-u, SC, CL, OL, CH, OH

---

collection systems, although a 10-year return, 24-hr storm is suggested as a minimum. See Chapter 9 for further discussion of storm water runoff of overland flow sites.

### **5.2.3 Water Rights**

Land application of wastewaters may cause several changes in drainage and flow patterns (Dewsnup and Jensen, 1973):

1. Site drainage may be affected by land preparation, soil characteristics, slope, method of wastewater application, cover crops, climate, buffer zones, and spacing of irrigation equipment.
2. Land application may alter the pattern of flow in the body of water that would have received the wastewater discharge. Although this may diminish the flow in the body of water, it also may increase the quality. The change may be continuous or seasonal.
3. Land application may cause surface water diversion, because wastewaters that previously would have been carried away by surface waters are now applied to land and often diverted to a different watershed.

Two basic types of water rights laws exist in the United States: riparian laws, which emphasize the right of riparian landowners along a watercourse to use of the water, and appropriative laws, which emphasize the right of prior users of the water (Dewsnup and Jensen, 1973). Most riparian or land ownership rights are in effect east of the Mississippi, whereas most appropriative rights are in effect west of the Mississippi River.

Most states divide their water laws into three categories: (1) waters in well-defined channels or basins (natural watercourses), (2) superficial waters not in channels or basins (surface waters), and (3) underground waters not in well-defined channels or basins (percolating waters or groundwater).

The state or local water master or water rights engineer should be consulted to avoid potential problems. Other references to consider are the publications, "A Summary-Digest of State Water Laws," available from the National Water Commission (US EPA, 1977b), and "Land Application of Wastewater and State Water Law," Volumes I and II (US EPA, 1977b and 1978). If problems develop or are likely with any of the feasible alternatives, a water rights attorney should also be consulted.

## **5.3 Site Selection**

Once the data on site characteristics are collected and mapped, the site evaluation and selection process can

proceed. If the number of sites are few and their relative suitability clearly apparent, a simple economic comparison will lead to selection of the best site. If a number of sites are to be compared, a site screening procedure can be used.

### **5.3.1 Site Screening Procedure**

The general procedure for site suitability rating can be used to compare different sites or it can be used to screen a large site that may have portions suitable to different land treatment processes. A procedure incorporating economic factors is presented for SAT and OF systems. A procedure specific to SR forest systems is also included.

The general procedure is to assign numerical values to various site characteristics, with larger numbers indicating highest suitability. The individual numbers for each site or sub-area are then added together to obtain the overall suitability rating. The rating factors in Table 5-11 are applicable to all processes. Site rating factors and weightings should vary to suit the needs of the local area and type of sites available.

### **5.3.2 Screening Procedure with Economic Factors**

In addition to the rating factors listed in Table 5-11 (Taylor, 1981) the economics of site development are often critical. These include distance from the wastewater source, elevation differences and the costs for land acquisition and management. Table 5-12 presents rating factors for these concerns (Crites et al., 2000).

### **5.3.3 Procedure for Forested SR Systems**

A procedure has been developed for forested SR systems that incorporates climatic, soil, geologic, hydrologic and vegetation factors (Taylor, 1981). The procedure involves the use of rating values for subsurface factors (Table 5-13), soils (Table 5-14), and surface factors (

Table 5-15) together with the composite rating in Table 5-16.

Based on the ratings in these tables, an estimate of the preliminary hydraulic loading can be made using Table 5-16. This procedure was developed for sprinkler irrigation of forested sites in the southeastern United States.

## **5.4 Phase 2 Planning**

Phase 2, the site investigation phase, occurs only if sites with potential have been identified in Phase 1.



During Phase 2, field investigations are conducted at the selected sites to determine whether land treatment is

**Table 5-11.** Rating Factors for Site Selection (Taylor, 1981)

Characteristic	Slow Rate Systems		Overland Flow	Rapid Infiltration
	Agricultural	Forest		
Soil depth, ft <sup>(a)</sup>				
1 – 2	E <sup>†</sup>	E	0	E
2 – 5	3	3	4	E
5 – 10	8	8	7	4
> 10	9	9	7	8
Minimum depth to groundwater, ft				
<4	0	0	2	E
4 – 10	4	4	4	2
> 10	6	6	6	6
Permeability, in/h <sup>(b)</sup>				
< 0.06	1	1	10	E
0.06 – 0.2	3	3	8	E
0.2 – 0.6	5	5	6	1
0.6 – 2.0	8	8	1	6
> 2.0	8	8	E	9
Grade, %				
0 – 5	8	8	8	8
5 – 10	6	8	5	4
10 – 15	4	6	2	1
15 – 20	0	5	E	E
20 – 30	0	4	E	E
30 – 35	E	2	E	E
> 35	E	0	E	E
Existing or planned land use				
Industrial	0	0	0	0
High-density residential/urban	0	0	0	0
Low-density residential/urban	1	1	1	1
Forested	1	4	1	1
Agricultural or open space	4	3	4	4
Overall suitability rating <sup>§</sup>				
Low	< 15	< 15	< 16	< 16
Moderate	15 – 25	15 – 25	16 – 25	16 – 25
High	25 – 35	25 – 35	25 – 35	25 – 35

Note: The higher the maximum number in each characteristic, the more important the characteristic; the higher the ranking, the greater the suitability.

\* Depth of the profile to bedrock.

† Excluded; rated as poor.

‡ Permeability of most restrictive layer in soil profile.

§ Sum of values.

<sup>a</sup>ft x 0.3048 = m

<sup>b</sup>in/h x 2.54 = cm/h

**Table 5-12.** Economic Rating Factors for Site Selection (Taylor, 1981)

Characteristic	Rating Value
Distance from wastewater source, miles <sup>a</sup>	
0 – 2	8
2 – 5	6
5 – 10	3
> 10	1
Elevation difference, ft <sup>b</sup>	
< 0	6
0 – 50	5
50 – 200	3
> 200	1
Land cost and management	
No land purchase, farmer-operated	5
Land purchased, farmer-operated	3
Land purchased, city- or industry-operated	1

<sup>a</sup>mile x 1.609 = km

<sup>b</sup>ft x 0.3048 = m

technically feasible. When sufficient data have been collected, preliminary design criteria are calculated for each potential site. Using these criteria, capital and operation and maintenance costs are estimated. These cost estimates and other nonmonetary factors are used to evaluate the sites selected during Phase 1 for cost effectiveness. On the basis of this evaluation, a land treatment alternative is selected for design.

### 5.4.1 Field Investigations

The factors regarding groundwater conditions, soil properties, and other site attributes not only influence the initial site selection and concept feasibility decisions but are critical for the final system design. As with all other engineering projects, the type of test required and the specific procedure are relatively easy to describe. The more difficult decision is how many tests, and in what

locations, for a particular project. Too little field data may lead to erroneous conclusions while too much will result in unnecessarily high costs with little refinement in the design concept. Experience indicates that where uncertainty exists, it is prudent to adopt a conservative posture relative to data-gathering requirements.

**Table 5-13.** Subsurface Factors for Forested SR (Taylor, 1981)

Characteristics	Rating Value*
Depth to groundwater on barrier, ft <sup>a</sup>	
< 4	0
4 – 10	4
> 10	6
Depth to bedrock, ft <sup>a</sup>	
< 5	0
5 – 10	4
> 10	6
Type of bedrock	
Shale	2
Sandstone	4
Granite-gneiss	6
Exposed bedrock, % of total area	
< 33	0
10 – 33	2
1 – 10	4
None	6

\*0 – 9, site not feasible; 10 – 13, poor; 14 – 19, good; and 20 – 24, excellent.

<sup>a</sup>ft x 0.3048 = m .

**Table 5-14.** Soil Factors for Forested SR (Taylor, 1981)

Characteristics	Rating Value*
Infiltration rate, in/h <sup>a</sup>	
< 2	2
2 – 6	4
> 6	6
Hydraulic conductivity, in/h <sup>a</sup>	
> 6	2
< 2	4
2 – 6	6
CEC, meq/100 g	
< 10	1
10 – 15	2
> 15	3
Shrink-swell potential (NRCS)	
High	1
Low	2
Moderate	3
Erosion classification (NRCS)	
Severely eroded	1
Eroded	2
Not eroded	3

\*5 – 11, poor; 12 – 16, good; and 17 – 21, excellent.

<sup>a</sup>in/h x 2.54 = cm/h.

**Table 5-15.** Surface Factors for Forested SR (Taylor, 1981)

Characteristics	Rating Value*
Dominant vegetation	
Pine	2
Hardwood or mixed	3
Vegetation age, years	
Pine	
> 30	3
20 – 30	3
< 20	4
Hardwood	
> 50	1
30 – 50	2
< 50	3
Mixed pine/hardwood	
> 40	1
25 – 40	2
< 25	3
Slope, %	
> 35	0
0 – 1	2
2 – 6	4
7 – 35	6
Distance to flowing stream, ft <sup>a</sup>	
50 – 100	1
100 – 200	2
> 200	3
Adjacent land use	
High-density residential/urban	1
Low-density residential/urban	2
Industrial	2
Undeveloped	3

\*3 – 4, not feasible; 5 – 9, poor; 9 – 14 good; and 15 – 19, excellent.

<sup>a</sup>ft x 0.3048 = m.

Table 5-17 presents field tests for a land treatment project. When possible, available data are first used for calculations or decisions that may then necessitate additional field tests. Guidance for wastewater constituents and soil properties is provided for each land treatment process in Table 5-18 (Crites et al., 2000). Generally relatively modest programs of field testing and data analysis will be satisfactory, especially for small systems.

## 5.4.2 Soil Properties

A critical element in site selection and process design is the capability of the site soils to move the design quantities of water in the expected direction at the expected rates. These are important requirements for slow rate (SR) systems and are absolutely critical for soil aquifer treatment (SAT) because of the much higher hydraulic loadings.

**Table 5-16.** Composite Evaluation of SR Forested Sites (Taylor, 1981)

Evaluation ratings from Tables 5-13 to 5-15			Hydraulic Loading, in/week <sup>a</sup>
Poor	Good	Excellent	
3	0	0	Not feasible
2	1	0	< 1.0
2	0	1	< 1.0
1	2	0	1.0 – 1.5
1	1	1	1.0 – 1.5
1	0	2	1.5 – 2.0
0	3	0	2.0 – 2.5
0	2	1	2.0 – 2.5
0	1	2	2.5 – 3.0
0	0	3	2.5 – 3.0

<sup>a</sup> in/week x 2.54 = cm/week

**Table 5-17.** Sequence of Field Testing - Typical Order of Testing (US EPA, 1981b)

Remarks	Field Tests			
	Test Pits	Bore Holes	Infiltration Rate	Soil Chemistry
Information to obtain	Usually with a backhoe, includes inspection of existing NRCS reports, road cuts, etc.	Drilled or augered includes inspection of driller's logs for local wells, water table levels	Match the expected method of application, if possible	Includes review of NRCS survey
Estimates now possible	Depth of profile, texture, structure, soil layers restricting percolation	Depth to groundwater, depth to impermeable layer(s)	Expected minimum infiltration rate	Specific data relating to crop and soil management, phosphorus and heavy metal retention
Additional field tests	Need for vertical conductivity testing	Groundwater flow direction	Hydraulic capacity based on soil permeability (subject to drainage restrictions)	Crop limitations. Soil amendments. Possible preapplication requirements
Additional estimates	Vertical conductivity (optional)	Horizontal conductivity	—	Quality of percolate
Number of tests	Refinement of loading rates	Mounding analysis, dispersion, need for drainage	Depends on size of site, uniformity of soil. Typical minimum of 2 per site.	Depends on uniformity of soil types, type of test, size of site
	Depends on size, soil uniformity, needed soil tests, type of system. Typical minimum of 3-5 per site	Depends on system type (more for RI than SR), soil uniformity, site size. Typical minimum of 3 per site		

**Table 5-18.** Summary of Field Tests for Land Treatment Processes

Properties	Processes		
	Slow Rate (SR)	Soil Aquifer Treatment (SAT)	Overland Flow (OF)
Wastewater constituents	Nitrogen, phosphorus, SAR*, EC*, boron	BOD, SS, nitrogen, phosphorus	BOD, SS, nitrogen, phosphorus
Soil physical properties	Depth of profile, texture and structure	Depth of profile, texture and structure	Depth of profile, texture and structure
Soil hydraulic properties	Infiltration rate Subsurface permeability	Infiltration rate Subsurface permeability	Infiltration rate (optional)
Soil chemical properties	pH, CEC, exchangeable cations (% of CEC), EC*, metals <sup>†</sup> , phosphorus adsorption (optional)	pH, CEC, phosphorus adsorption (optional)	pH, CEC, exchangeable cations (% of CEC)

\*May be more significant for arid and semiarid areas.

<sup>†</sup>Background levels of metals in the soil should be determined if food chain crops are planned.

## Physical Characteristics

Site identification and selection will ordinarily be based on existing field data available from a NRCS county soil survey and other sources. The next step involves some physical exploration on the site. This preliminary exploration is of critical importance to subsequent

phases of the project. The field exploration is important and has two purposes: (1) verification of existing data and (2) identification of probable, or possible, site limitations. For example, the presence of wet areas, water-loving plant species, or surficial salt crusts should alert the designer to the need for detailed field studies directed toward the problem of drainage. The presence

of rock outcroppings would signify the need for more detailed subsurface investigations than might normally be required. If a stream were located near the site, there would need to be additional study of the surface and near-surface hydrology; nearby wells require details of the groundwater flow, and so on. These points may seem obvious. There are many systems that have failed because of just such obvious conditions: limitations that were not recognized until after design and construction were complete.

The methods of construction and system operation that will be used can also be critically important depending on the soil properties encountered and must be considered in the site and concept selection process. The characteristics of the soil profile in the undisturbed state may be completely altered when the design surface is exposed or by inadvertent compaction during construction. Fine textured soils are particularly susceptible to compaction. For example, if the design surface layer contains a significant clay fraction and if that surface is exposed for growth of row crops in a SR system the impact of rainfall and sprinkler droplets may result in sorting of the clay fines and a partial sealing of the surface. Such problems can be managed, but the field investigation must provide sufficient data so that such conditions can be anticipated in the design.

## SAT Systems

Soil properties, topography, and construction methods are particularly critical for SAT systems. A site with a heterogeneous mixture of soil types containing scattered lenses of fine textured soil may be impossible to adequately define with a typical investigation program. If such a site cannot be avoided for SAT, a large-scale pilot test basin is suggested for definition of site hydraulic characteristics. If the pilot test is successful, the test basin, if properly located, can then be included in the full scale system.

An SAT site with undulating topography may require a scattered array of basins to remain in desirable soils or may necessitate major cut and fill operations for a compact site. SAT basins should always be constructed in cut section if at all possible. Experience has shown that construction with soils that have a fine fraction (passing No. 200 sieve [ $< 0.075\text{mm}$ ]) of more than 5 percent can result in problems (Reed, 1982). Clayey sands with fines exceeding 10 percent by weight should be avoided altogether as fill material for basin infiltration surfaces. Pilot scale test basins are recommended whenever SAT systems are to be designed on backfilled soils.

## Construction

Construction activity, either cut or fill, for SAT or SR systems can have a drastic effect on soil permeability if clayey sands are present. Such activity should only be permitted when the soil moisture is on the dry side of "optimum." Optimum Moisture refers to a moisture soil density relationship: used in the construction industry to obtain optimum soil compaction. Inadvertent compaction with the soil on the wet side of optimum moisture content could result in the same bulk density for the soil but an order of magnitude reduction in permeability. If such compaction is limited to the top foot of the surface layer, a final ripping and diking may correct the problem. Compaction of this type on sequential layers of fill may not be correctable.

The importance of soil texture for concept and site selection was described in Chapter 3 of this manual, and is based on the USDA soil classes (Figure 3-1). Table 5-19 summarizes the interpretation of these physical and hydraulic properties.

**Table 5-19.** Interpretation of Soil Physical and Hydraulic Properties (Crites, et al., 2000)

Property	Interpretation
Depth of soil profile, ft <sup>a</sup>	
< 1 – 2	Suitable for OF*
> 2 – 5	Suitable for SR and OF
5 – 10	Suitable for all processes
Texture and structure	
Fine texture, poor structure	Suitable for OF
Fine texture, well-structured	Suitable for SR and possibly OF
Coarse texture, well-structured	Suitable for SR and SAT
Infiltration rate, in/h <sup>b</sup>	
0.2 – 6	Suitable for SR
> 2.0	Suitable for SAT
< 0.2	Suitable for OF
Subsurface permeability	
Exceeds or equals infiltration rate	Infiltration rate limiting
Less than infiltration	May limit application rate

\*Suitable soil depth must be available for shaping of overland flow slopes.

Slow rate process using a grass crop may also be suitable.

<sup>a</sup>ft x 0.3048 = m

<sup>b</sup>in/h x 2.54 = cm/h.

## Chemical Properties

The influence of soil chemical properties on permeability and infiltration was discussed in detail in Chapter 3. Adverse chemical reactions between the wastewater and the soil are not expected for municipal and most industrial effluents. The main concern is usually retention or removal of a particular chemical by the soil system and Chapter 2 provides more details.

Differences in the chemical characteristics between the applied wastewater and the soil may induce chemical changes in the soil. At Muskegon, MI, for

example, the initial wastewater applications flushed dissolved iron out of the soil profile, showing up as a reddish turbidity in the drain water. Fresno, CA, also had turbidity problems when high-quality river water (snowmelt) was applied to relatively saline soils (Nightingale, 1983). This low salinity water dispersed the submicron soil colloids in the upper 3.66 m (12 ft) of the soil profile. The colloids are then flocculated as mixing occurs with the more saline groundwater. This turbidity problem has persisted for 10 years but does not affect water quality in down gradient wells.

Soil chemistry data is usually obtained via routine laboratory tests on representative samples obtained from test pits or borings. Table 5-20 summarizes the interpretation of typical soil chemical tests.

### Test Pits and Borings

Following an initial field reconnaissance, some subsurface exploration will be needed. In the preliminary stages, this consists of digging pits, usually with a backhoe, at several carefully selected locations. Besides exposing the soil profile for inspection and sampling, the purpose is to identify subsurface features that could develop into site limitations, or that point to potential adverse features. Conditions such as fractured, near-surface rock, hardpan layers, evidence of mottling in the profile, lenses of gravel and other anomalies should be carefully noted. For OF site evaluations, the depth of soil profile evaluation can be the top 0.9 m (3 ft)

or so. The evaluation should extend to 1.5 m (5 ft) for SR and 3 m (10 ft) or more for SAT systems.

Representative samples are obtained from the test pits and analyzed to determine the physical and chemical properties discussed above. It is possible with experience to estimate soil texture in the field with small samples taken directly from the walls of the test pit. To determine the soil texture, moisten a sample of soil about 12.7 to 25.4 mm (0.5 to 1 in) in diameter. There should be just enough moisture so that the consistency is like putty. Too much moisture results in a sticky material, which is hard to work. Press and squeeze the sample between the thumb and forefinger. Gradually press the thumb forward to try to form a ribbon from the soil. By using this procedure, the texture of the soil can be easily described with the criteria given in Table 5-21 (US EPA, 1980).

If the soil sample ribbons (loam, clay loam, or clay), it may be desirable to determine if sand or silt predominate. If there is a gritty feel and a lack of smooth talc-like feel, then sand very likely predominates. If there is a lack of a gritty feel but a smooth talc-like feel, then silt predominates. If there is not a predominance of either the smooth or gritty feel, then the sample should not be called anything other than a clay, clay loam, or loam. If a sample feels quite smooth with little or no grit in it, and will not form a ribbon, the sample would be called silt loam.

**Table 5-20.** Interpretation of Soil Chemical Tests (US EPA, 1981)

Test Results	Interpretation
pH of saturated soil paste	
< 4.2	Too acid for most crops to do well
4.2 – 5.5	Suitable for acid-tolerant crops and forest systems
5.5 – 8.4	Suitable for most crops
> 8.4	Too alkaline for most crops; indicates a possible sodium problem
CEC, meq/100 g	
1 – 10	Sandy soils (limited adsorption)
12 – 20	Silty loam (moderate adsorption)
> 20	Clay and organic soils (high adsorption)
Exchangeable cations, % of CEC (desirable range)	
Sodium	5
Calcium	60 – 70
Potassium	5 – 10
Magnesium	10 – 20
ESP, % of CEC	
< 5	Satisfactory
> 10	Reduced permeability in fine-textured soils
> 20	Reduced permeability in coarse-textured soils
EC <sub>e</sub> , mmhos/cm at 25% of saturation extract	
< 2	No salinity problems
2 – 4	Restricts growth of very salt-sensitive crops
4 – 8	Restricts growth of many crops
8 – 16	Restricts growth of all but salt-tolerant crops
> 16	Only a few very salt-tolerant crops make satisfactory yields

**Table 5-21.** Textural Properties of Mineral Soils

Soil Class	Feeling and Appearance	
	Dry Soil	Moist Soil
Sand	Loose, single grains which feel gritty. Squeezed in the hand, the soil mass falls apart when the pressure is released	Squeezed in the hand, it forms a cast which crumbles when touched. Does not form a ribbon between thumb and forefinger
Sandy Loam	Aggregates easily crushed; very faint velvety feeling initially, but with continued rubbing the gritty feeling of sand soon dominates	Forms a cast which bears careful handling without breaking. Does not form a ribbon between thumb and forefinger
Loam	Aggregates are crushed under moderate pressure; clods can be quite firm. When pulverized, loam has velvety feel that becomes gritty with continued rubbing. Cast bear careful handling	Cast can be handled quite freely without breaking. Very slight tendency to ribbon between thumb and forefinger. Rubbed surface is rough
Silt loam	Aggregates are firm but may be crushed under moderate pressure. Clods are firm to hard. Smooth, flourlike feel dominates when soil is pulverized.	Cast can be freely handled without breaking. Slight tendency to ribbon between thumb and forefinger. Rubbed surface has a broken or rippled appearance
Clay loam	Very firm aggregates and hard clods that strongly resist crushing by hand. When pulverized, the soil takes on a somewhat gritty feeling due to the harshness of the very small aggregates which persist	Cast can bear much handling without breaking. Pinched between the thumb and forefinger, it forms a ribbon whose surface tends to feel slightly gritty when dampened and rubbed. Soil is plastic, sticky, and puddles easily.
Clay	Aggregates are hard; clods are extremely hard and strongly resist crushing by hand. When pulverized, it has a gritlike texture due to the harshness of numerous very small aggregates which persist	Cast can bear considerable handling without breaking. Forms a flexible ribbon between thumb and forefinger and retains its plasticity when elongated. Rubbed surface has a very smooth, satin feeling. Sticky when wet and easily puddled

Beginning at the top or bottom of the pit sidewall, obvious changes in texture with depth are noted. Boundaries that can be seen are marked. When the textures have been determined for each horizon (layer), its depth, thickness, and texture layer are recorded.

Soil structure (Table 5-22) has a significant influence on soil acceptance and transmission of water. Soil structure refers to the aggregation of soil particles into clusters of particles, called peds, that are separated by surfaces of weakness. These surface of weakness are often seen as cracks in the soil. These planar pores can greatly modify the influence of soil texture on water movement. Well-structured soils with large voids between peds will transmit water more rapidly than structureless soils of the same texture, particularly if the soil has become dry before the water is added. Fine-textured, massive soils (soils with little structure) have very slow percolation rates.

**Table 5-22.** Soil Structure Grades (US EPA, 1980)

Grade	Characteristics
Structureless	No observable aggregation
Weak	Poorly formed and difficult to see. Will not retain shape on handling
Moderate	Evident but not distinct in undisturbed soil. Moderately durable on handling
Strong	Visually distinct in undisturbed soil. Durable on handling

Soil structure can be examined in the pit with a pick or similar device to expose the natural cleavages and planes of weakness. The color and color patterns in soil are also good indicators of the drainage characteristics of the soil. It is often advantageous to prepare the soil pit so the sun will be shining on the face during the observation period. Natural light will give true color interpretations. Artificial lighting should not be used.

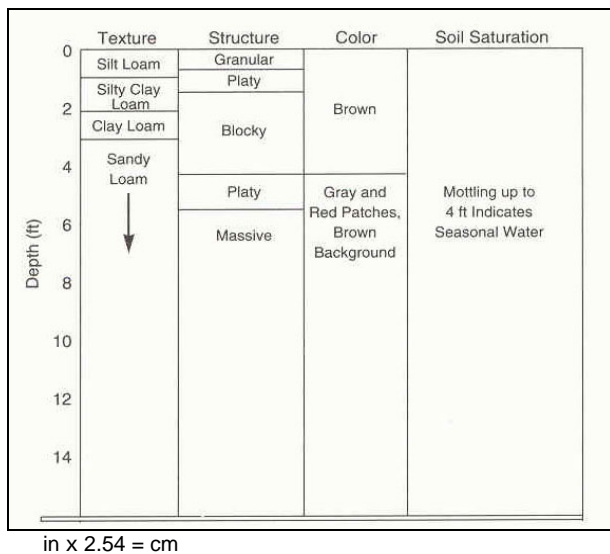
Color may be described by estimating the true color for each horizon or by comparing the soil with the colors in a soil color book. In either case, it is particularly important to note the colors or color patterns. Soil color is generally measured by a Munsell Soil Color Chart (see [www.munsell.com](http://www.munsell.com)) verified August 25, 2005.

Seasonally high groundwater tables are preferably detected by borings made during the wet season of the year for the site. An indication of seasonally high groundwater can be observed by the presence of redox features (mottles or discolored soils) in the wall of the test pit. Mottling in soils is described by the color of the soil matrix and the color or colors, size, and number of the mottles. Each color may be given a Munsell designation and name. However, it is often sufficient to say the soil is mottled. A classification of mottles used by the USDA is shown in Table 5-23. Color photographs of typical soil mottles can be used to assist in identification (US EPA, 1980).

**Table 5-23.** Description of Soil Mottles (US EPA, 1980)

Character	Class	Limit
Abundance	Few Common Many	2% of exposed face 2 – 20% of exposed face 20% of exposed face
Size	Fine Medium Coarse	0.25 in <sup>a</sup> longest dimension 0.25 – 0.75 in <sup>a</sup> longest dimension 7 – 75 in <sup>a</sup> longest dimension
Contrast	Faint Distinct Prominent	Recognized only by close observation Readily seen but not striking Obvious and striking

All of the data collected in the test pit on texture, thickness of each horizon, structure, color, and presence of water should be recorded in the field. A sample log is shown in Figure 5-4 (Crites et al., 2000).



**Figure 5-4.** Sample Log for Test Pit Data.

In some site evaluations, the backhoe pits will not yield sufficient information on the profile. Auger holes or bore holes are frequently used to explore soil deposits below the limits of pit excavation. Augers are useful to relatively shallow depths compared to other boring techniques. Depth limitation for augering varies with soil type and conditions, as well as hole diameter. In unconsolidated materials above water tables, 12.7-cm (5-in) diameter holes have been augered beyond 3.51 m (11.5 ft). Cuttings that are continuously brought to the surface during augering are not suitable for logging the soil materials. Withdrawal of the auger flights for removal of the cuttings near the tip represents an improvement as a logging technique. The best method is to withdraw the flights and obtain a sample with a Shelby tube or split-spoon sampler.

Boring methods, which can be used to probe deeper than augering, include churn drillings, jetting, and rotary

drilling. When using any of these methods it is preferable to clean out the hole and secure a sample from the bottom of the hole with a Shelby tube or split-spoon sampler.

### 5.4.3 Groundwater Conditions

The position, the rate of flow, and the direction of flow of the natural groundwater beneath the site are critical elements in the field investigation. Some key questions to be answered by the investigation are:

1. How deep beneath the surface is the (undisturbed) water table?
2. How does the natural water table depth fluctuate seasonally?
3. How will the groundwater table respond to the proposed wastewater loadings?
4. In what direction and how fast will the mixture of percolate and groundwater move from beneath the area of application? Is there any possibility of transport of contaminants to deeper potable aquifers?
5. What will be the quality of this mixture as it flows away from the site boundaries?
6. Do any restrictions exist along the site boundary that may limit the groundwater flow?
7. If any of the conditions measured or predicted above are found to be unacceptable, what steps can be taken to correct the situation?

### Groundwater Depth and Hydrostatic Head

A groundwater table is defined as the contact zone between the free groundwater and the capillary zone. It is the level assumed by the water in a hole extended a short distance below the capillary zone. Groundwater conditions are regular when there is only one groundwater surface and when the hydrostatic pressure increases linearly with depth. Under this condition, the piezometric pressure level is the same as the free groundwater level regardless of the depth below the groundwater table at which it is measured. Referring to Figure 5-5 (US EPA, 1981b), the water level in the "piezometer" would stand at the same level as the "well" in this condition.

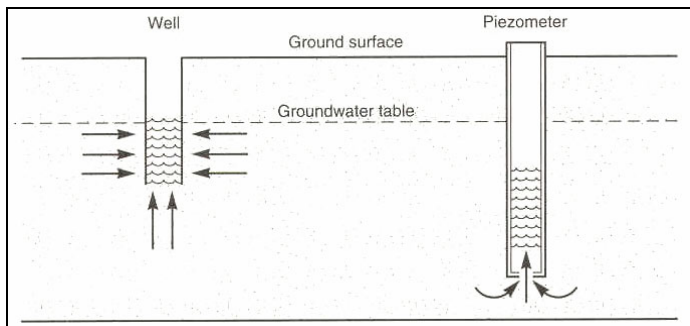


Figure 5-5. Well and Piezometer Installations.

In contrast to a well, a piezometer is a small diameter open pipe driven into the soil such that (theoretically) there can be no leakage around the pipe. As the piezometer is not slotted or perforated, it can respond only to the hydrostatic head at the point where its lower open end is located. The basic difference between water level measurement with a well and hydrostatic head measurement with a piezometer is shown in Figure 5-5.

Occasionally there may be one or more isolated bodies of water "perched" above the main water table because of lenses of impervious strata that inhibit or even prevent seepage past them to the main body of groundwater below.

Reliable determination of either groundwater levels or pressures requires that the hydrostatic pressures in the bore hole and the surrounding soil be equalized. Attainment of stable levels may require considerable time in impermeable materials. Called hydrostatic time lag, this may be from hours to days in materials of practical interest.

Two or more piezometers located together, but terminating at different depth, can indicate the presence, direction and magnitude (gradient) of components of vertical flow if such exists. Their use is indicated whenever there is concern about movement of contaminants downward to lower living aquifers. Figure 5-6 shows several observable patterns with explanations. Details on the proper installation of wells and piezometers are described in the US DOI "Drainage Manual" (1978).

### Groundwater Flow

Exact mathematical description of flow in the saturated zones beneath and adjacent to (usually downgradient) land treatment systems is a practical impossibility. However, for the majority of cases the possession of sufficient field data will allow an application of Darcy's equation (see Equation 3-1, and related discussion in Chapter 3) to determine the volume of flow and the mean travel time, as well as estimating the mounding

that will be created by the wastewater applications. The calculation procedures are presented in detail. The necessary field data include:

1. Depth to groundwater.
2. Depth to any impermeable barrier.
3. Hydraulic gradient determined from water levels in several observation wells at known distances apart. Establishing the gradient also determines the direction of flow.
4. Specific yield (see Chapter 3).
5. Hydraulic conductivity in the horizontal direction (see Chapter 3).

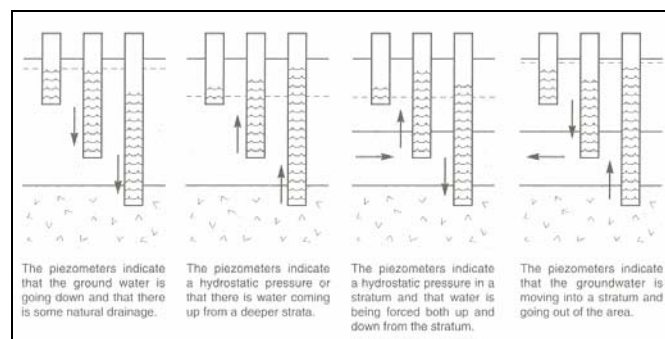


Figure 5-6. Vertical Flow Direction Indicated by Piezometers (US EPA, 1981).

Data for items 1 and 3 can be obtained from periodic water-level observations, over a period of months, from simple wells installed on the site. Figure 5-7 illustrates a typical shallow well.

The number and locations required will depend on the size of the project and the complexity of the groundwater system. Typical locations are up gradient of the site, several on the site, and on the down-gradient boundary. In general, groundwater levels will tend to reflect the surface contours and flow toward adjacent surface waters. In a complex situation it may be necessary to install a few exploratory wells and then complete the array based on the preliminary data. If properly located, many of these wells can also serve for performance monitoring during system operation. It is necessary to determine the elevation at the top of each well. The depth to water can then be determined with a weighted, chalked tape or other sensing devices. Contours showing equal groundwater elevation can then be interpolated from the well data and plotted on a site map. This in turn allows determination of the hydraulic gradient and the flow direction.

### Subsurface Permeability and Infiltration Rate

Methods for investigating subsurface permeability and infiltration rate are discussed in Sections 3.8.1 and 3.8.2, respectively.



## Mixing of Wastewater Percolate with Groundwater

An analysis of the mixing of percolate with native groundwater is needed for SR and SAT systems that discharge to groundwater if the quality of this mixture as it flows away from the site boundaries is a concern. The concentration of any constituent in this mixture can be calculated as follows:

$$C_{mix} = \frac{C_p Q_p + C_{gw} Q_{gw}}{Q_p + Q_{gw}} \quad (5-2)$$

### Where

$C_{mix}$	=	concentration of constituent in mixture
$C_p$	=	concentration of constituent in percolate
$Q_p$	=	flow of percolate
$C_{gw}$	=	concentration of constituent in groundwater
$Q_{gw}$	=	flow of groundwater

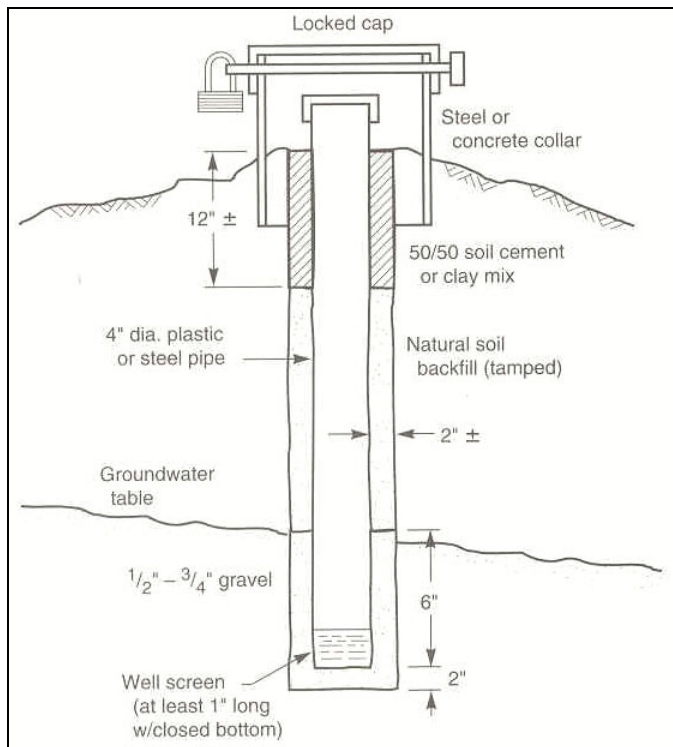


Figure 5-7. Typical Shallow Monitoring Well (Crites et al., 2000).

The flow of groundwater can be calculated from Darcy's Law (Equation 3-1) if the gradient and horizontal hydraulic conductivity are known. This is not the entire groundwater flow, but only the flow within the mixing depth. Equation 5-2 is only valid if there is complete mixing between the percolate and the native groundwater. This is usually not the case. Mixing in the vertical direction may be substantially less than mixing in

the horizontal direction, and density, salinity, and temperature differences between the percolate and groundwater may inhibit mixing and the percolate may in some cases "float" as a plume on top of the groundwater for some distance. The percolation of natural rainfall down gradient of the application site can also serve to dilute the plume.

An alternative approach to estimating the initial dilution is to relate the diameter of the mound developed by the percolate to the diameter of the application area. This ratio has been estimated to be 2.5 to 3.0. This ratio indicates the relative spread of the percolate and can be used to relate the mixing of percolate with groundwater. Thus, an upper limit of 3 for the dilution ratio can be used when groundwater flow is substantially (5 to 10 times) more than the percolate flow. If the groundwater flow is less than 3 times the percolate flow, the actual groundwater flow should be used in Equation 5-2.

### 5.4.4 Selection of Preliminary Design Criteria

From information collected during the field investigations, the engineer can confirm the suitability of the sites for the identified land treatment process(es). Using the loading rates described previously (Section 5.6.2), the engineer should then select the appropriate hydraulic loading rate for each land treatment process that is suitable for each site under consideration. Based on the hydraulic loading rates, estimates for land area, preapplication treatment, storage, and other system requirements can be determined. Reuse and recovery options should also be outlined.

### 5.5 Cost and Energy Considerations

Once the preliminary design criteria have been identified, the land treatment alternatives should be evaluated on the basis of capital costs, revenue-producing benefits, and energy requirements. Based on these final evaluations, an appropriate plan can then be selected and the land treatment system design initiated.

There are eight major categories of capital costs for land treatment systems:

1. Transmission
2. Pumping
3. Preapplication treatment
4. Storage
5. Field preparation/Crop establishment
6. Distribution
7. Recovery
8. Land acquisition

In addition, there are costs associated with monitoring, administration buildings, roads, and service and interest factors. There also may be costs for fencing, relocation

of residents and purchase of water rights. Depending on the site management, SR and OF systems may have costs associated with crop planting, cultivating and harvesting.

Operation and maintenance (O&M) costs associated with all of the eight categories of capital costs except for land purchase and field preparation. These O&M costs can be divided into categories of labor, power and materials. Labor and materials for distribution and recovery are presented in this chapter. Power costs for pumping can be estimated from the energy requirements. All costs in this chapter are for July 1999 using an Engineering News-Record Construction Cost Index (ENRCCI) of 6076. These costs are only planning level values and should not be used for designed system cost estimating.

### 5.5.1 Transmission

Transmission of wastewater to application sites can involve gravity pipe, open channels or pressure force mains. Pumping can also be involved with gravity flow transmission, but is required for force main transmission. Costs of transmission depend on the pipe or the channel size and can be estimated using US EPA (1981c).

### 5.5.2 Pumping

Pumping facilities for land treatment, as described in Chapter 7, range from full pumping stations to tailwater pumping facilities (see Section 5.5.7). Capital costs for transmission pumping depend on the type of structure that is designed. For example, a fully enclosed wet well/dry well structure, pumps, piping and valves, controls and electrical can cost \$500,000 for a 3,785 m<sup>3</sup>/d (1 mgd) peak flow and a 45-m (150-ft) of total pumping head. For structures that are built into the dike of a pond, the capital cost of the pumping station for the same flow and head can be \$300,000.

### 5.5.3 Preapplication Treatment

Preapplication treatment for land treatment (Chapter 6) ranges from preliminary screening to advanced secondary treatment where reuse systems are developed. Where a completely new land treatment system is to be constructed, it is usually cost-effective to minimize preapplication treatment and use screening or short detention-time ponds for OF and treatment ponds for SR and SAT. Costs of preapplication can be estimated from data in Reed, et al. (1979), US EPA (1981c), Tchobanoglous, et al. (1979), and Asano and Tchobanoglous (1992). Many processes can be used for preapplication treatment, including wetlands or overland flow for treatment prior to SAT or SR systems.

Overland flow slope construction costs include the same items as for land leveling. A cut of 265 m<sup>3</sup>/ha (500

yd<sup>3</sup>/acre) would correspond to nominal construction on pre-existing slopes. A cut of 529 m<sup>3</sup>/ha (1,000 yd<sup>3</sup>/acre) corresponds to constructing 45-m (150-ft) wide slopes at 2 percent slope from initially level ground. A cut of 741 m<sup>3</sup>/ha (1,400 yd<sup>3</sup>/acre) corresponds to 75-m (250-ft) slope widths on 2.5 percent slopes from initially level ground.

### 5.5.4 Storage

Storage ponds vary in cost depending on initial site conditions, need for liners, and the depth and volume of wastewater to be stored. Cost data are available from Reed et al. (1979), US EPA (1981c), Tchobanoglous et al. (1979), and Crites (1998).

### 5.5.5 Field Preparation

Costs for field preparation can include site clearing and rough grading, land leveling and overland flow slope construction. Costs of each of these types of field preparation are presented in Table 5-24 for various conditions. Site clearing costs include bulldozing of existing vegetation, rough grading, and disposal of debris onsite. Offsite disposal of debris will cost 1.8 to 2.2 times the values in Table 5-24 (US EPA., 1979b). Land leveling costs include surveying, earthmoving, finish grading ripping in two directions, disking, equipment mobilization, and landplaning. In many cases, 106 m<sup>3</sup>/ha (200 yd<sup>3</sup>/acre) will be sufficient, while 397 m<sup>3</sup>/ha (750 yd<sup>3</sup>/acre) represents considerable earthmoving.

**Table 5-24.** Costs of Field Preparation

ENR CCI = 6076	
Type of Cost	Capital Cost, \$/acre <sup>b</sup>
<b>Site Clearing</b>	
Grass only	30
Open field, some brush	220
Brush and trees	1,450
Heavily wooded	2,890
<b>Land Leveling</b>	
200 yd <sup>3</sup> /acre <sup>a</sup>	360
500 yd <sup>3</sup> /acre	720
750 yd <sup>3</sup> /acre	1,010
<b>Overland flow slope construction</b>	
500 yd <sup>3</sup> /acre	1,300
1,000 yd <sup>3</sup> /acre	2,170
1,500 yd <sup>3</sup> /acre	2,890

<sup>a</sup> yd<sup>3</sup>/acre x 1.9 = m<sup>3</sup>/ha

<sup>b</sup> acre x 0.4047 = ha

### 5.5.6 Distribution

Slow rate systems are capable of using a wide variety of sprinkler and surface distribution systems. In contrast, OF systems usually employ fixed sprinkler or gated pipe surface distribution and RI systems generally employ surface spreading basins.

Solid set sprinkling, described in Chapter 7, is the most expensive type of sprinkler system. As shown in Table 5-25 (Crites, 1998), portable and continuous-move systems are considerably less expensive on an initial capital cost basis. Capital and O&M costs are presented in detail for solid set and center pivot sprinkling.

**Table 5-25.** Comparison of Sprinkler Distribution Capital Costs

Sprinkler Type	Comparative Cost
Portable hand move	0.13
Traveling gun	0.22
Side roll	0.22
Center pivot	0.50
Linear move	0.65
Solid set	1.00

### Solid Set Sprinkling

The capital and O&M costs for buried solid set systems are presented in Figure 5-8. For the SR system in Figure 5-8, the laterals are spaced 30 m (100 ft) apart and the sprinklers are 24 m (80 ft) apart on the lateral. Laterals are buried 0.45 m (18 in) and mainlines are buried 0.9 m (36 in). The pipe material is PVC while the risers are galvanized steel. Flow to the laterals is controlled by hydraulically operated automatic valves. There are 5.4 sprinklers per acre at the specified spacing. If more sprinklers are included (smaller spacing), increase the capital and labor costs by using Equation 5-3:

$$\text{Cost Factor} = 0.68 + 0.06(S) \quad (5-3)$$

**Where:**

Cost factor = multiplier times from Figure 5-8

S = sprinklers/acre

Conversion factor: acre = 0.4047 ha

For overland flow, the slopes are 75 m (250 ft) wide at a 2.5 percent grade. The laterals are 21 m (70 ft) from the top of the slope and sprinklers are 30 m (100 ft) apart. Other factors are the same as for the SR system. For O&M, the labor rate is \$15.00/h including fringes. Materials cost includes replacement of sprinklers and valve controllers every 10 year.

### Center Pivot Sprinkling

Capital and O&M costs for center pivot sprinkling in Figure 5-9. The center pivot machines are electrically-driven and heavy-duty units. Multiple units are included for areas over 16 ha (40 acres) with a maximum area per unit of 53 ha (132 acres). Distribution piping is buried 0.9 m (3 ft). Labor costs are based on \$15.00/h and power costs are based on 3.5 days/week operation for

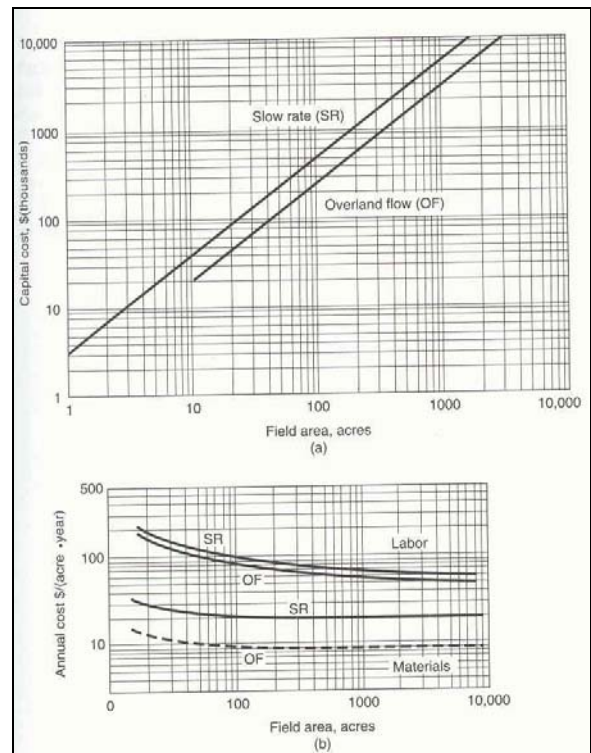
each unit and \$0.02/MJ (\$0.08/kWh). Materials cost includes minor repair parts and overhaul of units every 10 years.

### Surface Distribution for OF or SR

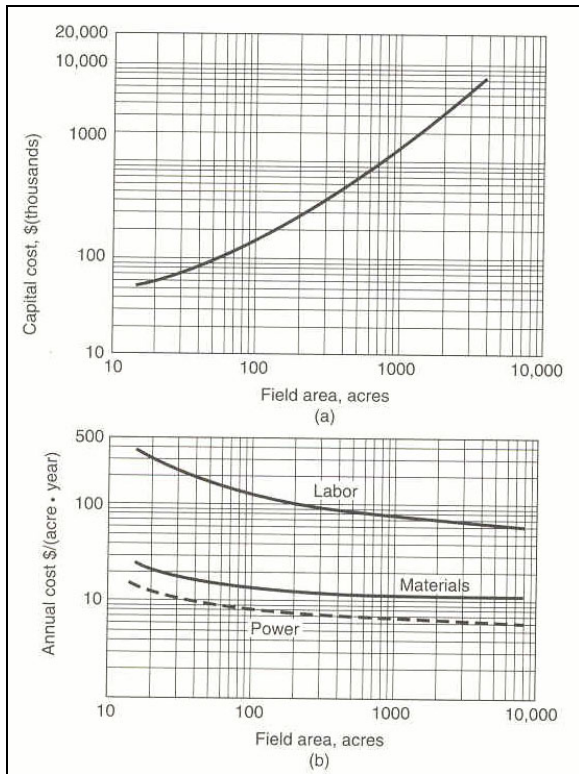
Costs for gated pipe distribution for OF and SR systems are presented in Figure 5-10. The OF slope is 60 m (200 ft) wide with the gated aluminum pipe distribution at the top of the slope. For SR systems, the furrows or borders are 360 m (1,200 ft) long on rectangular-shaped fields. Graded border systems, under similar conditions of border length, can use buried pipelines with alfalfa valves at similar capital costs. Labor costs are based on a \$15.00/h wage including fringes. Materials cost includes replacement of gated pipe after 10 years.

### Soil Aquifer Treatment Basins

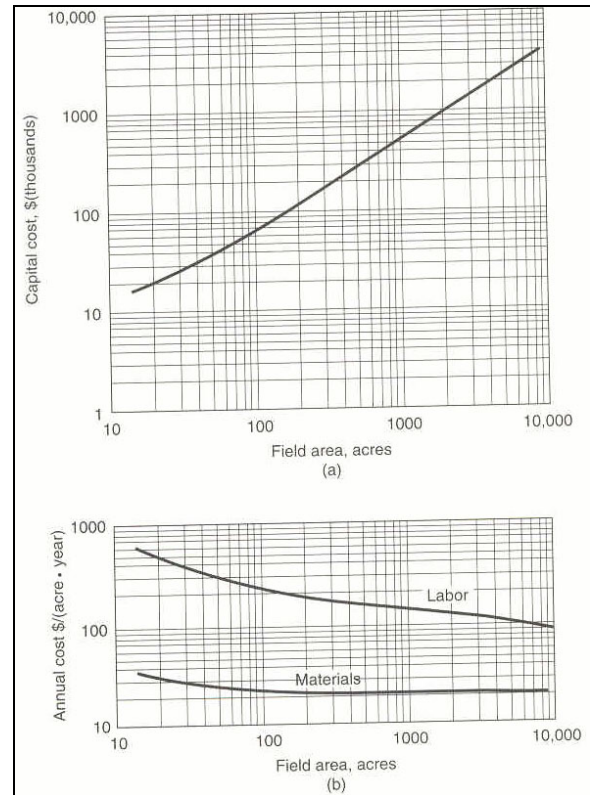
Costs for SAT basins are presented in Figure 5-11. There are a minimum of 2 basins and a maximum basin size of 8 ha (20 acres). Costs include inlet and outlet control structures and control valves. Dikes are 1.2 m (4 ft) high with an inside slope of 3:1, an outside slope of 2:1 and a 1.8-m (6-ft) wide dike crest. Dikes or berms are formed from excavated native material. Labor costs



**Figure 5-8.** Solid Set Sprinkling (buried) Costs, ENR CCI = 6076. (a) Capital Cost; (b) Operation and Maintenance Cost.



**Figure 5-9.** Center Pivot Sprinkling Costs, ENR CCI = 6076. (a) Capital Cost; (b) Operation and Maintenance Cost.



**Figure 5-10.** Gated Pipe — Overland Flow or Ridge-and-Furrow Slow Rate Costs, ENR CCI = 6076. (a) Capital Cost; (b) Operation and Maintenance Cost.

are based on a \$15.00/h wage including fringe benefits. Materials cost includes rototilling or disking the basin surface every 6 months and major repair of the dikes every 10 years.

### 5.5.7 Recovery

Recovery systems can include underdrains (for SR or SAT), tailwater return for SR surface application, runoff collection for OF, and recovery wells for SAT.

#### Underdrains

Costs for underdrain systems are presented in Table 5-26 for spacings between drains of 30 and 120 m (100 and 400 ft). Drains are buried 1.8 to 2.4 m (6 to 8 ft) deep and discharge into an interception ditch along the length of the field.

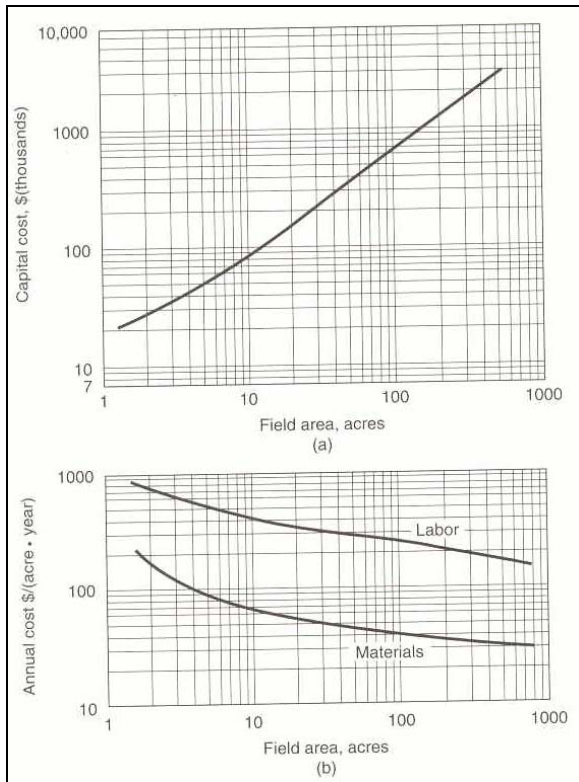
Labor costs are based on a \$15.00/h wage rate including fringes, and labor involves inspection and unclogging of drains at the outlets. Materials cost includes high-pressure jet cleaning of drains every 5 years, annual cleaning of interception ditches, and major repair of the interception ditch after 10 years.

### Tailwater Return

Tailwater from ridge-and-furrow or graded border systems must be recycled either to the storage ponds or to the distribution system. Typically 25 to 30 percent of the applied flow should be expected as tailwater. Capital costs, presented in Table 5-27, include drainage-collection ditches, storage sump or pond, pumping facilities, and a 60-m (200-ft) return force main. Labor, at \$15.00/h including fringe benefits, includes operation of the pumping system and maintenance of the ditches, sump, pump, and return system. Materials cost includes major repair of the pumping station after 10 years. Power cost is based on \$0.02/MJ (\$0.08/kWh).

### Runoff Collection for OF

Runoff collection can consist of an open ditch or a buried pipeline with inlets. Costs for open ditches, presented in Table 5-28, include a network of ditches sized for a 5.1-cm/h (2-in/h) storm, culverts under service roads, and concrete drop structures every 300 m (1,000 ft) (for larger systems). For gravity pipe systems,



**Figure 5-11.** Rapid Infiltration Basin Costs, ENR CCI = 6076. (a) Capital Cost; (b) Operation and Maintenance Cost.

**Table 5-26.** Costs of Underdrains (US EPA., 1979b)

ENR CCI = 6076	
Type of Cost	\$/acre <sup>b</sup>
<b>Capital costs</b>	
100-ft <sup>a</sup> spacing	2,890
400-ft spacing	1090
<b>O&amp;M costs</b>	
<b>Labor</b>	
100-ft spacing	52
400-ft spacing	22
<b>Materials</b>	
100-ft spacing	140
400-ft spacing	90

<sup>a</sup>ft x 0.3048 = m.

<sup>b</sup>acre x 0.4047 = ha.

**Table 5-27.** Costs of Tailwater Return Systems (Reed et al., 1979)

ENR CCI = 6076	
Type of Cost	Cost
<b>0.1 mgd<sup>a</sup> of Recovered Water</b>	
Capital, \$	60,000
<b>O&amp;M:</b>	
Power, \$/year	375
Labor, \$/year	375
Materials, \$/year	180
<b>1.0 mgd of Recovered Water</b>	
Capital, \$	145,000
<b>O&amp;M:</b>	
Power, \$/year	4,000
Labor, \$/year	900
Materials, \$/year	700

<sup>a</sup> mgd x 3.7854x10<sup>3</sup> = m<sup>3</sup>/day.

the costs include a network of interceptor pipes with inlets every 75 m (250 ft) and accessholes every 150 m (500 ft).

Labor costs are based on \$15.00/h including fringe benefits. Materials cost includes biannual cleaning of ditches and major repair every 10 years.

**Table 5-28.** Costs of Runoff Collection for Overland Flow (Reed et al., 1979)

ENR CCI = 6076	
Type of Cost	\$/acre <sup>a</sup>
<b>Capital costs:</b>	
Gravity pipe system	2,300
Open ditch system	360
<b>O&amp;M costs:</b>	
<b>Labor</b>	
Gravity pipe	8
Open ditch	30
<b>Materials</b>	
Gravity pipe	7
Open ditch	40

<sup>a</sup> acre x 0.4047 = ha.

## Recovery Wells

Costs for recovery wells for SAT systems are presented in Table 5-29 for well depths of 15 and 30 m (50 and 100 ft). Capital costs include gravel-packed wells, vertical turbine pumps, simple shelters over each well, controls, and electrical work. Labor, at \$15.00/h, includes operation and preventative maintenance. Materials cost includes repair work performed by contract, and replacement of parts. Power cost is based on \$0.02/MJ (\$0.08/kWh). Monitoring wells are generally a minimum of 100 mm (4 in) in diameter and typically cost \$130 to \$200/m (\$40 to \$60/ft) (US EPA, 1979).

**Table 5-29.** Costs of Recovery Wells (Reed et al., 1979)

ENR CCI = 6076	
Type of Cost	Cost
<b>1.0 mgd<sup>a</sup> of recovered water:</b>	
<b>Capital, \$:</b>	
50 ft <sup>b</sup> depth	29,000
100 ft depth	50,000
<b>O&amp;M, \$/yr:</b>	
Power, 50-ft depth	9,500
Power, 100-ft depth	18,900
Labor	6,000
Materials	800

<sup>a</sup>mgd x 3.7854x10<sup>3</sup> = m<sup>3</sup>/day.

<sup>b</sup>ft x 0.3048 = m.

## 5.5.8 Land

Land can be controlled by direct purchase, lease, or contract. The land for preapplication treatment and storage is usually purchased, however, field area for SR

systems is sometimes leased or a contract is formed with the landowner. Options used by selected communities for land acquisition and management for selected SR systems are presented in Table 5-31 (Crites, 1981 and Christensen, 1982). As shown in Table 5-31, contracts for effluent use are utilized in several SR systems. Fee simple purchase is generally used for OF and SATsites.

### 5.5.9 Benefits

Revenue producing benefits from land treatment systems can include sale of crops, lease of land, sale of wastewater or recycled water, and contracts that may involve all of these benefits. Examples of revenue-producing benefits are presented in Table 5-30 (Crites, 1981, 1982, and 1998, Christensen, 1982, US EPA, 1995, and US EPA, 1979a). The examples are for SR systems, which generally have the greatest potential for revenue production. Crop sale from OF systems can offset a small portion of O&M costs, but generally cannot be expected to more than offset the cost of harvesting and removal of the grass or hay. For SAT systems in water-short areas, the potential for recovery and reuse of the percolate should be investigated.

Sale of crops can be a significant source of revenue if the community is willing to invest in the necessary equipment for crop harvest and storage. For example, Muskegon County realized gross revenues of \$1,000,000 from the sale of corn (US EPA 1979a).

Cash rent for SR cropland is very popular in the west with 5-year agreements being common. Rents range from \$2 to \$32/ha (\$5 to \$80/acre). Contracts for wastewater irrigation, rental of irrigation equipment, or for the use pastureland for cattle grazing have also been utilized. Examples include El Reno, OK; Dickinson, ND; Mitchell, SD; Tuolumne County, CA; Santa Rosa, CA; and Petaluma, CA.(Crites, 1982 and NACD, 1981).

### 5.5.10 Energy Requirements

The energy requirements for land treatment systems include power for pumping, preapplication treatment,

wastewater distribution, and fuel for crop planting and harvesting and for biosolids transport and spreading. In addition, energy is needed for heating and cooling of buildings, lighting and vehicle operation.

Pumping. Pumping for transmission, distribution, tailwater return, and recovery is a major energy use in most land treatment systems. The energy required can be calculated using Equation 5-4:

$$Energy\ Use = \frac{(Q)(TH)(t)}{(F)(E)} \quad (5-4)$$

#### Where

- Energy Use = annual usage, kWh/year
- Q = flowrate, gal/min
- TH = total head, ft
- t = pumping time, h/year
- F = constant, 3960 x 0.746 = 2954
- E = overall pumping efficiency, decimal

The overall efficiency depends on the type of wastewater and the specifics of pump and motor selection. In the absence of specific information on pump and motor efficiency, the following overall pumping system efficiencies can be used:

**Table 5-30.** Benefits of Land Treatment Systems

Sale of crops	\$/yr
Muskegon, MI	900,000 – 1,000,000
San Angelo, TX	58,000 – 71,000
Lease of land	\$/acre-yr <sup>a</sup>
Bakersfield, CA	80
Coleman, TX	5
Manteca, CA	40
Mesa, CA	50
Winters, CA	20
Sale of effluent	\$/acre-ft <sup>b</sup>
Cerritos, CA	40
Irvine Ranch, CA	118
Las Virgines, CA	160
Marin MWD, CA	300

acre x 0.4047 = ha.

acre-ft x 0.123 = ha-m.

**Table 5-31.** Options for Land Acquisition and Management at Selected SR Systems

Location	Area, acres <sup>a</sup>	Acquisition Option	Management Option
Bakersfield, CA	2,400	Fee simple	Leaseback to farmer
Camarillo, CA	475	Contract	Landowner accepts water
Dickinson, ND	250	Contract	Cash lease for water sale to farmer
Lubbock, TX	4,000	Fee simple and contract	Leaseback, farmer owns effluent
Mesa, AZ	160	Fee simple	Leaseback for cash rent
Muskegon, MI	10,400	Fee simple	Managed by county
Petaluma, CA	550	Contract	Cash rent for irrigation equipment
Roswell, NM	285	Contract	Cash lease for water sale to farmer
San Antonio, TX	740	Fee simple	Managed by city
Tooele, UT	1,200	Contract	Cash lease for water sale to farmer

<sup>a</sup> acre x 0.4047 = ha.

and Middlebrooks et al., (1979). Energy for crop production is minor compared to energy for distribution. For example, energy requirements for corn production are 51.3 MJ/ha (5.7 kWh/acre) and for alfalfa are 22.5 MJ/ha (2.5 kWh/acre). Fuel usage can be converted to energy using 34,596 KJ/L (124,000 Btu/gal) for gasoline and 3,906 KJ/L (14,000 Btu/gal) for diesel (US EPAij, 1978 and WPCF, 1981).

### 5.5.11 Energy Conservation

Sprinkler distribution systems are candidates for energy conservation. Impact sprinklers may require 45 to 60 m (150 to 200 ft) of head to operate. Recent advances have been made in sprinkler nozzle design to allow operation at lower pressures without sacrificing uniformity of application. Use of drop nozzles with

pressure requirements of 15 m (50 ft) of head can result in significant energy conservation.

Energy conservation is also possible in land treatment systems through the use of surface distribution. A comparison of primary and secondary energy usage of various land and aquatic treatment systems is presented in Table 5-32 (Tchobanoglous et al., 1979). Primary energy is that fuel or power used directly in operations. Secondary energy is that used in the construction of facilities or manufacturing of chemicals.

Energy conservation through the use of land application of wastes can also be realized through savings in energy use for manufacturing of commercial fertilizer. A presentation of energy needs to produce fertilizer and the energy value of nutrients in wastewater is given in Table 5-33 (Middlebrooks et al., 1979 and WPCF, 1981).

**Table 5-32.** Energy Requirements for Land and Aquatic Treatment Systems

System	Primary Energy	Secondary Energy	Total Energy
PT + SAT	187	102	289
Ponds and wetlands	121	198	319
PT + SR(surface)	187	135	322
PT + OF	192	159	351
Ponds and hyacinths	167	195	362
PT + SR(spray)	327	173	500

Note: PT = primary treatment; SAT = soil aquifer treatment; SR = slow rate and OF = overland flow.  
<sup>a</sup>kWh x 3.6 = MJ.

**Table 5-33.** Energy Value of Nutrients in Wastewater

Nutrient	Content of effluent, mg/L <sup>a</sup>	Content of effluent, lb/acre-ft <sup>b</sup>	Energy to produce, transport and apply fertilizer, kWh/lb <sup>c</sup>	Energy value of nutrients in wastewater, kWh/acre-ft <sup>d</sup>
Nitrogen as N	20	54	2.79	190
Phosphorus as P	10	27	0.10	13
Potassium as K	15	38	0.10	10

<sup>a</sup>mg/L = g/m<sup>3</sup>.  
<sup>b</sup>lb/acre-ft x 3.69 = kg/ha-m.  
<sup>c</sup>kWh/lb x 7.9 = MJ/kg.  
<sup>d</sup>kWh/acre-ft x 29.3 = MJ/ha-m.

## 5.6 References

Christensen, L.A. (1982) *Irrigating with Municipal Effluent*, USDA, ERS-672, Washington, DC.

Crites, R.W. (1981) Economics of Reuse, Proceedings of the Water Reuse Symposium II, Volume 3, AWWA, p. 1745-1751.

Crites, R.W. (1982) *Land Treatment and Reuse of Food Processing Waste, Proceedings of the Industrial Wastes Symposia*, Water Pollution Control Federation, 55th Annual Conference, St. Louis, MO.

Crites, R.W. (1982) *Innovative and Alternative Treatment at Petaluma, CA*, .Presented at the Hawaii Water Pollution Control Association Annual Conference, Honolulu, HI.

Crites, R.W. and G. Tchobanoglous (1998) *Small and Decentralized Wastewater Management Systems*, McGraw-Hill, New York, NY.

Crites, R.W. (1998) *Costs of Constructed Wetlands, Proceedings WEFTEC '98*, Orlando, FL. Water Environment Federation, Alexandria, VA.

Crites, R.W., S.C. Reed, and R.K. Bastian (2000) *Land Treatment of Municipal and Industrial Wastewater*, McGraw-Hill Book Co., New York, NY.

- Dewsnup, R.L. and Jensen, D.W. (Eds.) (1973) *A Summary Digest of State Water Laws*, National Water Commission, Washington, DC.
- Loehr, R.C. (1974) *Agricultural Waste Management—Problems, Processes, and Approaches*, New York: Academic Press.
- Metcalf & Eddy, Inc. (1976) *Land Application of Wastewater in the Salinas-Monterey Peninsula Area*, U.S. Army Engineer District San Francisco, CA.
- Middlebrooks, E.J. and C.H. Middlebrooks (1979) *Energy Requirements for Small Flow Wastewater Treatment Systems*, USA CRREL, Special Report 79-7.
- Moser, M.A. (1978) *A Method for Preliminary Evaluation of Soil Series Characteristics to Determine the Potential for Land Treatment Processes*, Proceedings of the Symposium on Land Treatment of Wastewater, Hanover, NH.
- Nightingale, H.I. et al. (1983) *Leaky Acres Recharge Facility: A Ten-Year Evaluation*, AWRA Water Resources Bulletin, Vol. 19, 3, p. 429.
- Reed, S.C. (1982) *The Use of Clayey Sands for Rapid Infiltration Wastewater Treatment*, USA CRREL IR 805, p.55.
- Richard, D., T. Asano, and G. Tchobanoglous (1992) *The Cost of Wastewater Reclamation in California*, Department of Civil and Environmental Engineering, University of California, Davis.
- Sills, M.A., et al. (1978) *Two-Phase Evaluation of Land Treatment as a Wastewater Treatment Alternative – A Rational Approach to Federal and State Planning and Design Requirements*, Proceedings of the Symposium on Land Treatment of Wastewater, Hanover, NH.
- Taylor, G.L. (1981) *Land Treatment Site Evaluation in Southeastern Mountainous Areas*, Bulletin of the Association of Engineering Geologists, 18: 261-266.
- Tchobanoglous, G., J.E. Colt, and R.W. Crites (1979) *Energy and Resource Consumption in Land and Aquatic Treatment Systems*, Proceedings: Energy Optimization of Water and Wastewater Management for Municipal and Industrial Applications Conference, USDOE, Volume 2, New Orleans.
- US DOI (1978) *Drainage Manual*, U.S. Department of the Interior, Bureau of Reclamation.
- US EPA (1976) *Use of Climatic Data in Estimating Storage Days for Soil Treatment Systems*, EPA - 600/2-76-250, U.S. Environmental Protection Agency, Cincinnati, OH.
- US EPA (1977a) *Annual and Seasonal Precipitation Probabilities*, EPA-600/2-77-182, U.S. Environmental Protection Agency, Cincinnati, OH.
- US EPA (1977b) *Land Application of Wastewater and State Water Law: An Overview (Volume I)*, EPA-600/2-77-232, U.S. Environmental Protection Agency, Cincinnati, OH.
- US EPA (1978a) *Land Application of Wastewater and State Water Law: State Analyses (Volume II)*, EPA-600/2-78-175, U.S. Environmental Protection Agency, Cincinnati, OH.
- US EPA (1978b) *Energy Conservation in Municipal Wastewater Treatment*, EPA-430/9-77-011.
- US EPA (1978) *Energy Conservation in Municipal Wastewater Treatment*, EPA-430/9-77-011.
- US EPA (1979a) *Wastewater: Is Muskegon County's Solution Your Solution?* EPA-905/2-76-004, U.S. Environmental Protection Agency, Washington, DC.
- US EPA (1979b) *Cost of Land Treatment Systems*, EPA 430/9-75-003, U.S. Environmental Protection Agency, Washington, DC.
- US EPA (1980) *Design Manual - Onsite Wastewater Treatment and Disposal Systems*, EPA 625/1-80-012 U.S. Environmental Protection Agency, Cincinnati, OH.
- US EPA (1981a) *The Role of Conservation Districts and the Agricultural Community in Wastewater Land Treatment*, EPA-430/9-77-011.
- US EPA (1981b) *Process Design Manual for Land Treatment of Municipal Wastewater*, EPA 625/1-81-013, U.S. Environmental Protection Agency, Cincinnati, OH.
- US EPA (1981c) *Construction Costs for Municipal Wastewater Conveyance Systems: 1973-1979*, EPA 430/9-81-003, U.S. Environmental Protection Agency, Washington, DC.
- US EPA (1982) *Operation and Maintenance Considerations for Land Treatment Systems*, EPA-600/2-82-039.
- US EPA (1995) *Process Design Manual – Land Application of Sewage Sludge and Domestic Septage*, EPA/625/R-95/001, U.S. Environmental Protection Agency, Washington, DC.
- Water Pollution Control Federation (1981) *Energy Conservation in the Design and Operation of Wastewater Treatment Facilities, Manual of Practice No. FD-2*.



---

## Chapter 6

### Preapplication Treatment and Storage

The level of preapplication treatment required prior to any of the land treatment processes should involve both engineering and economic decisions that recognize the potential performance of the land treatment process and the sensitivity of the receiver environment. An approach would be to start with the final effluent or percolate quality requirements for the site and climatic conditions and, then determine the contribution the land treatment processes can provide. A level of preapplication treatment can then be adopted for those constituents that will not be removed or reduced to an acceptable concentration by the land treatment process. The method of preapplication treatment should then be selected as the simplest and most cost-effective system possible.

#### 6.1 EPA Guidance

The level of preapplication treatment required should also be based on the degree of public access to the site and/or on the type and end use of the crop grown. The guidelines for preapplication treatment developed by the US EPA are summarized in Table 6-1. The level of treatment increases as the degree of public access increases when the crop is for direct human consumption and when environmental sensitivity increases. The chemical and microbiological standards in general are based on water quality requirements for irrigation with surface water and on bathing water quality limits for the recreational case (Thomas and Reed, 1980).

##### 6.1.1 Slow Rate Systems

SR systems may require preapplication treatment for several reasons, including public health protection relating to human consumption of crops and crop byproducts that are eaten uncooked or direct exposure

to applied effluent, prevention of nuisance conditions during storage, distribution system protection, or soil and crop considerations and watershed considerations (e.g., TMDLs). Preliminary treatment, except for solids removal, is often de-emphasized because SR systems are capable of achieving final water quality objectives with minimal pretreatment. In many cases, SR systems are designed for regulatory compliance following preliminary treatment so the potential for reuse can be realized. Systems designed to emphasize reuse potential require greater flexibility in the handling of effluent, which can be achieved with higher pretreatment levels.

The treatment objective should be to maximize nitrification if surface discharge is required and ammonia discharge requirements are stringent. Nitrification may be achieved using either primary or secondary treatment prior to application.

##### 6.1.2 Soil Aquifer Treatment Systems

Primary sedimentation or the equivalent is the minimum recommended preapplication treatment for all SAT systems. This level of treatment reduces wear on the distribution system, prevents unmanageable soil clogging, reduces the potential for nuisance conditions, and allows the potential for maximum nitrogen removal. For small systems, a short-detention-time pond is recommended. Long-detention-time facultative or aerobic ponds are not recommended because of their propensity to produce high concentrations of algae. The algae produced in stabilization ponds will reduce infiltration rates significantly. If facultative or stabilization ponds are to be used with SAT, it is recommended that an aquatic treatment or constructed wetland system be used between the pond and the SAT basins to reduce TSS levels (Crites and Tchobanoglous, 1998).

**Table 6-1.** Guidelines for Assessing the Level of Preapplication Treatment (Thomas and Reed, 1980)

<b>I. Slow Rate Systems</b>	
A.	Primary treatment – acceptable for isolated locations with restricted public access and when limited to crops not for direct human consumption
B.	Biological treatment by lagoon or in-plant processes plus control of fecal coliform count to less than 1,000 MPN/100 ml – acceptable for controlled agricultural irrigation except for human food crops to be eaten raw
C.	Biological treatment by lagoons or in-plant processes with additional BOD or TSS removal as needed for aesthetics plus disinfection to a geometric mean of 125 E.coli per 100 mL and 33 enterococci per 100 mL (EPA water quality criteria for bathing waters) – acceptable for application in public access areas such as parks and golf courses
<b>II. Rapid Infiltration Systems (Soil Aquifer Treatment)</b>	
A.	Primary treatment – acceptable for isolated locations with restricted public access
B.	Biological treatment by lagoons or in-plant processes – acceptable for urban locations with controlled public access
<b>III. Overland Flow Systems</b>	
A.	Screening or comminution – acceptable for isolated sites with no public access
B.	Screening or comminution plus aeration to control odors during storage or application – acceptable for urban locations with no public access

### 6.1.3 Overland Flow Systems

Preapplication treatment before OF is provided to prevent operating problems with distribution systems, to prevent nuisance conditions during storage and possibly to meet stream discharge requirements. Preapplication treatment to protect public health is not usually a consideration with OF systems because public contact with the treatment site is usually controlled and no crops are grown for human consumption.

Municipal wastewater contains rags, paper, hair and other coarse solids that can impair and clog orifices and valves in surface and sprinkler distribution systems. Comminution is generally not sufficient to eliminate clogging problems. Fine screening or primary sedimentation with surface skimming is necessary to prevent operating difficulties. For small systems, Imhoff tanks or 1- to 2-day aerated detention ponds are recommended. Static or rotating fine screens have also been used successfully at Davis, CA. and Hall’s Summit, LA. (WPCF, 1989). For sprinkler distribution systems, screen sizes should be less than one-third the diameter of the sprinkler nozzle. Static inclined screens with 1.5 mm openings have been used successfully for raw wastewater screening (US EPA, 1981).

Grit removal is advisable for wastewaters containing high grit loads. Grit reduces pump life and can deposit in low-velocity distribution pipelines.

## 6.2 Types of Preapplication Treatment

Preapplication treatment operations and processes can include fine screening, primary treatment, lagoons or ponds, constructed wetlands, biological treatment, membranes, and disinfection. Removal efficiencies and design criteria for these treatment operations and processes are documented in Crites and Tchobanoglous (1998). Because ponds and constructed wetlands are often compatible with land treatment systems, the efficiencies of these preapplication treatment methods are described in the following sections. In addition,

biological nutrient removal and membrane processes are also discussed.

### 6.2.1 Constituent Removals in Ponds

Effluent from any conventional wastewater treatment process can be applied successfully to the land as long as the site and soils are compatible. In many cases, a pond or lagoon will be the most cost-effective choice for treatment. Ponds can be used with land treatment for basic treatment, flow equalization, for emergency storage, and where there are seasonal constraints on the operation of land treatment systems. In cases where storage is needed, it will usually be most cost-effective to combine the treatment and storage functions in a multiple cell pond system. Where odor control or high strength wastes are a factor, the initial cell may be aerated and followed by one or more deep storage cells. In remote locations an anaerobic primary cell can be designed for the treatment of high-strength wastes and solids removal and be followed by storage cells. The treatment occurring in the storage cells will be similar to that in a facultative pond. Basic design criteria for conventional pond systems are available from a number of sources (Crites and Tchobanoglous, 1998; Reed et al., 1995; US EPA, 1983; and Middlebrooks et al., 1982).

The pond unit can be specifically designed for the removal of a particular wastewater constituent. More typically, the detention time in the pond component is established by the storage requirements for the system. The removal of various constituents that will occur within that detention time can then be calculated. If additional removal is required, the cost-effectiveness of providing more detention time in the pond can be compared to alternative removal processes. The removal of nitrogen in the pond unit is particularly important because nitrogen is often the Limiting Design Parameter (LDP) for slow rate systems. Any reduction of nitrogen in the pond unit directly impacts on the design of the land treatment component.

## 6.2.2 BOD and TSS Removal in Ponds

BOD<sub>5</sub> is usually not the LDP for design of the municipal land treatment component in any of the processes. However, many regulatory agencies specify a BOD<sub>5</sub> requirement for the wastewater to be applied, so it may be necessary to estimate the removal that will occur in the pond components. There may be a combination of an aerated or anaerobic cell followed by the storage pond.

### Aerated Ponds

The BOD<sub>5</sub> removal that will occur in aerated cells can be estimated with:

$$\frac{C_n}{C_o} = \frac{1}{(1 + k_c t)^n} \quad (6-1)$$

**Where:**

- C<sub>n</sub> = effluent BOD<sub>5</sub> from cell n, mg/L
- C<sub>o</sub> = influent BOD<sub>5</sub> to system, mg/L
- k<sub>c</sub> = reaction rate constant (see Table 6-2) at 20°C
- t = total hydraulic resident time, d
- n = number of cells

The reaction rate constant, k<sub>c</sub>, is dependent on the water temperature, as shown in Equation 6-2:

$$k_{cT} = k_{20} \theta^{(T-20)} \quad (6-2)$$

**Where:**

- k<sub>cT</sub> = reaction rate const. at temperature T
- k<sub>20</sub> = reaction rate const. at 20°C (see Table 6-2)
- θ = 1.036
- T = temperature of pond water, °C

The temperature of the pond can be estimated with the following equation:

$$T_w = \frac{AfT_a + QT_i}{Af + Q} \quad (6-3)$$

**Where:**

- T<sub>w</sub> = pond temperature, °C
- T<sub>a</sub> = ambient air temperature, °C
- T<sub>i</sub> = pond influent temperature
- A = surface area of pond, m<sup>2</sup>
- f = proportionality factor = 0.5
- Q = wastewater flow rate, m<sup>3</sup>/d

The selection of an apparent reaction rate value from Table 6-2 depends on the aeration intensity to be used. The "complete mix" value assumes high intensity aeration [about 20 W/m<sup>3</sup> (100 HP/MG)], sufficient to maintain the solids in suspension. The "partial mix" value assumes that there is sufficient air supplied to satisfy the oxygen demand [about 2 W/m<sup>3</sup> (10 HP/MG)], but that solids deposition will occur.

**Table 6-2.** Reaction Rates for Aerated Ponds, BOD<sub>5</sub>

Type of Aeration	k at 20°C
Complete mix	2.5
Partial mix	0.276

The suspended solids in the effluent from a complete mix aerated cell will be nearly the average concentration in the cell. The suspended solids in the partial mix pond effluent will be lower, depending on the detention time. For a detention time of 1 day, assume the suspended solids are similar to primary effluent [60 to 80 g/m<sup>3</sup> (mg/L)].

### Facultative Ponds

The BOD<sub>5</sub> removal that will occur in a facultative cell can be estimated using Equation 6-4.

$$\frac{C_n}{C_o} = e^{-K_p t} \quad (6-4)$$

**Where:**

- C<sub>n</sub> = effluent BOD<sub>5</sub>, g/m<sup>3</sup> (mg/L)
- C<sub>o</sub> = influent BOD<sub>5</sub>, g/m<sup>3</sup> (mg/L)
- K<sub>p</sub> = plug flow apparent reaction rate constant (see Table 6-3)
- t = detention time, days

The apparent rate constant for plug flow also varies with temperature with a θ value of 1.09.

**Table 6-3.** Variation of Plug Flow Apparent Rate Constant with Organic Loading Rate for Facultative Ponds (Neel et al., 1961)

Organic Loading Rate, kg/ha-day*	k <sub>p</sub> , per day
22	0.045
45	0.071
67	0.083
90	0.096
112	0.129

\*kg/ha-day x 0.8928 = lb/acre-day.

The TSS concentrations from facultative cells depend on the temperature and detention time. Algae concentrations can reach 120 to 150 g/m<sup>3</sup> (mg/L) or more in warm temperatures and may be as low as 40 to 60 g/m<sup>3</sup> (mg/L) in cooler temperatures (Stowell, 1976).

### Anaerobic Ponds

Anaerobic ponds are rarely used with municipal wastewaters unless there is a large industrial waste component. The ponds are typically 3 to 4.5 m (10 to 15 ft) deep. BOD<sub>5</sub> loading rates may be as high as 500 kg/ha-day (450 lb/ac-day), detention times range from 20 to 50 days, depending on the climate, and a BOD<sub>5</sub> conversion of about 70 percent is typical. Effluent TSS values range from 80 to 160 g/m<sup>3</sup> (mg/L).

A primary anaerobic cell is used at a number of municipal pond systems in rural areas of the western provinces of Canada (Higo, 1966). The anaerobic cells are also designed for solids removal and retention and are typically followed by one or more long-detention-time facultative cells. Effluent from these cells is comparable to primary effluent. Detectable odors have been noted to at least 305 m (1,000 ft) around these systems, so a remote location or other odor control is needed.

### 6.2.3 Constituent Removals in Constructed Wetlands

Constructed wetlands have been used to remove BOD<sub>5</sub>, TSS, nitrate-nitrogen, and metals, among other constituents, from wastewater (Crites and Tchobanoglous, 1998; Reed et al., 1995; Reed 1999; USEPA 1999). Constructed wetlands can be free water surface (FWS) or subsurface flow (SF). Free water surface constructed wetlands are best suited to preapplication treatment, especially for flows above 0.1 mgd (387 m<sup>3</sup>/d).

#### Area for BOD Removal

The field area needed for a constructed wetland can be calculated using Equation 6-5.

$$A = \frac{Q(\ln C_o - \ln C_e)}{K(y)(\eta)} \quad (6-5)$$

**Where:**

- A = field area, m<sup>2</sup> (acres)
- Q = average flow, (in + out)/2 m<sup>3</sup>/d (acre-ft/d)
- C<sub>o</sub> = influent BOD, mg/L
- C<sub>e</sub> = effluent BOD, mg/L
- K = apparent removal rate constant  
= 0.678 d<sup>-1</sup> for FWS wetlands at 20°C  
= 1.104 d<sup>-1</sup> for SF wetlands at 20°C
- y = water depth, m (ft)
- η = porosity  
= 0.75 to 0.9 for FWS wetlands  
= 0.28 to 0.45 for SF wetlands

The average flow should be the annual average flow into the wetlands plus the effluent flow divided by two. The apparent K factor is temperature dependent and Equation 6-2 can be used for different water temperatures, with the θ factor being 1.06. The porosity of FWS wetlands depends on the density of the vegetation, with 0.75 being appropriate for high plant densities and 0.85 being appropriate for moderate plant densities. Where open water areas are interspersed with vegetated zones the porosity will be 0.8 to 0.9. For SF constructed wetlands the porosity depends on the particle size of the gravel used. Coarse sand and gravelly sand has a porosity of 0.28 to 0.35. Fine gravel, widely used in SF systems, has a porosity of 0.35 to 0.38. Medium to coarse gravel has a porosity of 0.36 to 0.45 (Reed et al., 1995). These porosity values are

measured by a field test and are much higher than those given in Figure 3-2, which are measured in a laboratory using a standard ASTM method. The values from Figure 3-2 are for *in-situ* soil and gravel deposits which have been naturally consolidated, and they are not appropriate for design of SF constructed wetlands.

#### Area for Nitrate Removal

Constructed wetlands can be effectively designed for nitrate removal for effluents containing high nitrate. Equation 6-6 can be used to predict nitrate reduction. For water temperatures of 1°C or less, assume that denitrification effectively ceases.

$$t = \frac{\ln(C_i/C_f)}{k_n} \quad (6-6)$$

**Where:**

- t = actual detention time, days
- C<sub>i</sub> = influent nitrate concentration, g/m<sup>3</sup> (mg/L)
- C<sub>f</sub> = effluent nitrate concentration, g/m<sup>3</sup> (mg/L)
- k<sub>n</sub> = rate constant, use 1.0 for temperature of 20°C

The temperature adjustment can be made using Equation 6-2, using a θ value of 1.15.

### 6.2.4 Nitrogen Losses in Storage Ponds

The loss of nitrogen from ponds and water bodies has been recognized and predictive models are available (Reed, 1984). The removal of nitrogen in a pond is dependent on pH, temperature, and detention time. Under ideal conditions up to 95 percent has been observed. Volatilization of the ammonia fraction is believed to be the major pathway responsible for long-term permanent losses.

Because nitrogen is often the limiting design parameter (LDP) for land treatment design, it is essential to determine (i.e., operationally monitor) the losses that will occur in any preliminary pond units for treatment or storage. This may influence the basic feasibility of a particular process, or control the amount of land needed.

The equations presented below can be used for facultative ponds and for storage ponds. The nitrogen losses in short detention time aerated ponds can usually be neglected. The procedure is based on total nitrogen in the system because numerous transformations from one form of nitrogen to another are likely during the long detention time.

The first design equation is (Reed et al., 1995):

$$\frac{N_e}{N_o} = \exp \left\{ -k_{nt} \left[ t + 60.6 (pH - 6.6) \right] \right\} \quad (6-7)$$

**Where:**

- N<sub>e</sub> = effluent total N, g/m<sup>3</sup> (mg/L)
- N<sub>o</sub> = influent total N, g/m<sup>3</sup> (mg/L)
- k<sub>nt</sub> = temperature-dependent reaction rate const., d<sup>-1</sup>

$\theta = 0.0064$  at  $20^{\circ}\text{C}$   
 $t$  = detention time, days  
 $\text{pH}$  = median pH in pond during time  $t$

The temperature adjustment can be made using Equation 6-2, using a theta value of 1.039.

The second design equation is presented below (Reed et al., 1995):

$$N_e = N_0 \frac{1}{1 + t (0.000576T - 0.00028) \exp [(1.08 - 0.042T)(\text{pH} - 6.6)]} \quad (6-8)$$

Terms are the same as for Equation 6-7.

Application of Equation 6-7 requires information on the wastewater nitrogen concentration, the detention time, pH and temperature conditions to be expected. In a typical case the nitrogen concentration will vary from month to month so actual long-term data are desirable for design.

For the first iteration, the detention time should be determined based on (a) any BOD removal required, or (b) by the storage time needed. If additional nitrogen removal is necessary then the cost-effectiveness of providing more detention time can be compared to other alternatives.

Equation 6-7 is based on plug flow kinetics and is valid when a pond is discharging and the detention time is then the total detention time in the system. A value of one-half the detention time should be used for the filling and storage (non-discharge) periods for storage ponds.

The pH is controlled by the algae interactions with the carbonate buffering system in the pond. If possible, pH values should be obtained from an operating pond in the vicinity. The median pH values for four facultative ponds in the U.S. are given in Table 6-4 (US EPA, 1977; US EPA, 1977; and US EPA, 1977). A rough estimate of the pH to be expected can be obtained with:

$$\text{pH} = 7.3 \exp [0.005 (\text{Alk})] \quad (6-9)$$

**Where:**

$\text{pH}$  = median pH in the bulk liquid  
 $\text{Alk}$  = alkalinity of the influent (as  $\text{CaCO}_3$ ),  $\text{g/m}^3$  (mg/L)

**Table 6-4.** Typical pH and Alkalinity Values in Facultative Ponds

Location	Annual Median pH	Annual Average Alkalinity, $\text{g/m}^3$ (mg/L)
Peterborough, NH	7.1	85
Eudora, KS	8.4	284
Kilmichael, MS	8.2	116
Corinne, UT	9.4	557

### 6.2.5 Phosphorus Removal in Ponds

Phosphorus removal in ponds is limited. Chemical addition using alum or ferric chloride has been used to reduce phosphorus to below  $1 \text{ g/m}^3$  (mg/L) (Reed et al., 1995). Application of chemicals can be on a batch or continuous-feed basis. For controlled release ponds the batch process is appropriate. The State of Minnesota has 11 facultative pond systems that use the addition of liquid alum directly into secondary cells via motorboat to meet a spring and fall discharge limitation of  $1 \text{ g/m}^3$  (mg/L) (Surampalli et al., 1993).

For continuous-flow applications, a mixing chamber is often used between the last two ponds or between the last pond and a clarifier. In Michigan, both aerated ponds and facultative ponds have been used with continuous-flow applications. Influent phosphorus concentrations for 21 treatment facilities ranged from  $0.5$  to  $15 \text{ g/m}^3$  (mg/L) with an average of  $4.1 \text{ g/m}^3$  (mg/L) and the effluent target is  $1 \text{ g/m}^3$  (mg/L) (Surampalli et al., 1993).

### 6.2.6 Pathogen Removal in Ponds

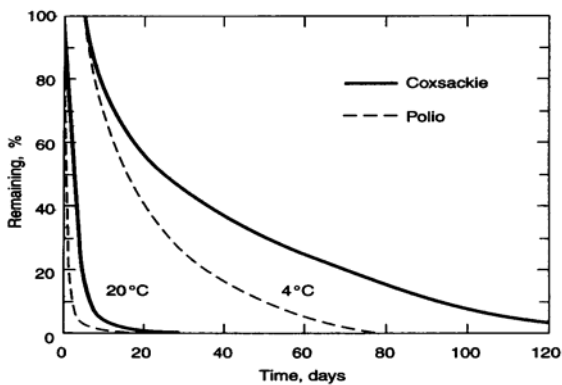
The design of systems that include a pond component should evaluate the bacteria and virus reductions that will occur in the pond. In some cases the reductions that will occur in a pond will produce acceptable levels so an extra disinfection step will not be required. At Muskegon, MI, for example, the fecal coliforms in the storage pond effluents were consistently below required levels so that chlorination was terminated (Reed, 1979). The effluent in this case is applied to corn, with poultry feed a major use of the harvested corn. Water-quality changes through the storage pond at Muskegon, MI, and in a pilot-scale pond in Israel are summarized in Table 6-5 (US EPA, 1976; Kott, 1978).

Removal of bacteria and virus in ponds is strongly dependent on temperature and detention time. Virus removal in model ponds is illustrated in Figure 6-1 (Sagik, 1978). Similar results were observed at operational facultative ponds in the southwest, southeast and north central United States. In summer months,

virus removal exceeded 2 log (i.e., 99 percent) in the first two cells of these systems. The overall removal on a year-round basis exceeded 1.5 log (i.e., 95 percent). Removal of fecal coliforms was even higher.

**Table 6-5.** Changes of Microorganisms Concentration During Storage (US EPA, 1979)

Location	Input Concentration, count/100 mL	Output Concentration, count/100 mL
Muskegon County, MI (winter): Fecal coliform	$1 \times 10^6$	$1 \times 10^3$
Haifa, Israel (winter, 73 days): Total coliform	$2.3 \times 10^7$	$1.84 \times 10^4$
Fecal coliform	$1.1 \times 10^6$	$2.4 \times 10^3$
Fecal streptococcus	$1.1 \times 10^6$	$5.0 \times 10^2$
Enterovirus	$1.1 \times 10^3$	0
Haifa, Israel (summer, 35 days): Total coliform	$1.4 \times 10^7$	$2.3 \times 10^4$
Fecal coliform	$3.5 \times 10^6$	$2.4 \times 10^4$
Fecal streptococcus	$6.0 \times 10^5$	$3.7 \times 10^3$
Enterovirus	200	0



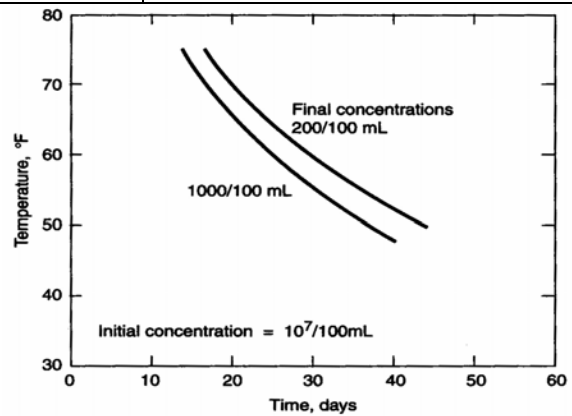
**Figure 6-1.** Virus Removal in Ponds (Sagik, 1978).

Results very similar to those in Figure 6-1 have been demonstrated for fecal coliforms in facultative ponds in Utah (Bowles et al., 1979). An equation was developed, based on Chick's Law which describes the die-off of fecal coliforms in a pond system as a function of time and temperature:

$$t = \frac{\ln(C_i / C_f)}{k_{fc}} \quad (6-10)$$

**Where:**

- t = actual detention time, d
- $C_i$  = influent fecal coliforms, #/100 mL
- $C_f$  = final fecal coliforms, #/100 mL
- $k_{fc}$  = rate constant, use 0.5 for temperature of 20°C



**Figure 6-2.** Fecal Coliform Removal in Ponds – Detention Time vs. Liquid Temperature.

Removal of fecal coliform with time is shown in Figure 6-2. Temperature and detention times to achieve final concentrations of 200 CFU/100 mL for irrigation standards and 1,000 CFU/100 mL for recreation water standards are shown in Figure 6-2. The detention time used in the equation is the actual detention time as measured by dye studies. In the ponds used for model development the actual detention time ranged from 25 to 89 percent of the theoretical design detention time due to short-circuiting. The geometric mean was 46 percent. If the actual detention time in the pond system is not known, it is suggested that this factor be applied when using the equation to estimate fecal coliform die-off to ensure a conservative prediction.

### 6.2.7 Biological Nutrient Removal

Because both nitrogen and phosphorus can impact receiving water quality, the discharge of one or both of these constituents must often be controlled. Nitrogen may be present in wastewaters in various forms (e.g., organic, ammonia, nitrites, or nitrates). Most of the available nitrogen in both septic tank effluent and in municipal wastewater is in the form of organic or ammonia nitrogen. In wastewater treatment, about 20 percent of the total nitrogen settles out in sedimentation processes. During biological nitrogen removal treatment, ammonia nitrogen is converted to nitrate nitrogen, and then to nitrogen gas (Crites and Tchobanoglous, 1998).

Phosphorus is present in municipal wastewaters in organic form, as inorganic orthophosphate, or as complex phosphates. The complex phosphates represent about one-half of the phosphates in municipal wastewater and result from the use of these materials in synthetic detergents. Complex phosphates are hydrolyzed during biological treatment to the orthophosphate form ( $PO_4^{3-}$ ). Of the total average phosphorous concentration, about 10 percent is removed as particulate material during primary sedimentation and another 10 to 20 percent is

incorporated into bacterial cells during biological treatment. The remaining 70 percent is normally discharged with secondary treatment plant effluents.

Although ponds can act as a pretreatment method, more aggressive biological processes, allowing increased hydraulic loading rates and enhanced nitrogen removal, may be required to comply with discharge standards. Details on biological nutrient removal can be found in Crites and Tchobanoglous (1998) and WEF (1998).

### 6.2.8 Membrane Processes

With the development of various membranes for a wide range of applications, membrane treatment is rapidly becoming widespread and effectively competing with conventional water treatment processes. Membrane processes include microfiltration (MF), ultrafiltration (UF), nanofiltration (NF), reverse osmosis (RO), and electrodialysis (ED). Membrane treatment is generally used for total dissolved solids (TDS) reduction and removal of viruses, pathogens, and bacteria prior to the reuse of the treated effluent. The principal applications of the various membrane technologies for the removal of the constituents found in wastewater are summarized in Table 6-6.

**Table 6-6.** Application of Membranes for the Removal of Constituents Found in Wastewater (Crites and Tchobanoglous, 1998)

Constituents	Type of Membrane				Comments
	MF	UF	NF	RO	
Biodegradable organics		√	√	√	
Hardness			√	√	
Heavy metals			√	√	
Nitrate			√	√	
Priority organic pollutants		√	√	√	
Synthetic organic compounds			√	√	
TDS			√	√	
TSS	√	√			Removed as pretreatment for NF and RO.
Bacteria	√	√	√	√	Used for membrane disinfection. Removed as pretreatment for NF and RO with MF and UF.
Protozoan oocysts and cysts	√	√	√	√	
Viruses			√	√	Used for membrane disinfection.

### 6.3 Design of Storage Ponds

For SR and OF systems, adequate storage must be provided when climatic conditions require operations to be curtailed or hydraulic loading rates to be reduced. Most SAT systems are operated year-round, even in areas that experience cold winter weather. SAT systems may require cold weather storage during periods when the temperature of the wastewater to be applied is near freezing and the ambient air temperature at the site is below freezing. Land treatment systems also may need storage for flow equalization, system backup and reliability, and system management, including crop harvesting (SR and OF) and spreading basin maintenance (SAT). Reserve application areas can be

used instead of storage for these system management requirements.

The approach used to determine storage requirements is to first estimate a storage volume requirement using a water balance computation or computer programs developed to estimate storage needs based on observed climatic variations throughout the United States. The final design volume is then determined by adjusting the estimated volume for net gain or loss due to precipitation and evaporation using a monthly water balance on the storage pond. These estimating and adjustment procedures are described in the following sections. As discussed in Section 6.2.1, ponds can offer additional treatment benefits. These benefits should be determined

and considered when calculating the final size of the storage pond.

### 6.3.1 Estimation of Storage Volume Using Water Balance Calculations

An initial estimate of the storage volume requirements may be determined using a water balance calculation procedure, as described below:

1. Determine the design monthly hydraulic loading rate.
2. Convert the actual volume of wastewater available each month to units of depth (cm) using the following relationship:

$$W_a = \frac{(Q_m)(10^2)}{A_w} \quad (6-11)$$

**Where:**

- $W_a$  = depth of available wastewater, cm
- $Q_m$  = volume of available wastewater for the month,  $m^3$
- $A_w$  = field area, ha

3. Formulate a water balance table listing the results for each month. In some instances, influent wastewater flow varies significantly with the time of year. The values used for  $Q_m$  should reflect monthly flow variation based on historical records.
4. Compute the net change in storage each month by subtracting the monthly hydraulic loading from the available wastewater in the same month.
5. Compute the cumulative storage at the end of each month by adding the change in storage during one month to the accumulated quantity from the previous month. The computation should begin with the

reservoir empty at the beginning of the largest storage period.

6. Compute the required storage volume using the maximum cumulative storage and the field area.

The water balance calculation method is illustrated by Example 6-1.

---

#### Example 6-1. Storage Volume Requirements Using Storage Water Balance Calculations.

---

**Conditions**

1. Annual wastewater hydraulic loading rate,  $LW = 1.2$  m/yr
2. Total yearly flow is  $365,000$   $m^3$ /yr, with monthly flow rates given in Column (2) of Table 6-7.
3. Assume total land application area of  $30.4$  ha.

**Calculations**

1. Tabulate the design monthly hydraulic loading rate as indicated in Column (1) of Table 6-7.
2. Convert actual volume of wastewater available each month to units of depth (cm) with Equation 6-11. Results are tabulated in Column (3) of Table 6-6.

For example, April:

$$W_a = \left( \frac{40,000 \text{ m}^3}{30.4 \text{ ha}} \right) \left( \frac{\text{ha}}{10,000 \text{ m}^2} \right) \left( \frac{100 \text{ cm}}{\text{m}} \right) = 13.2 \text{ cm}$$

3. Compute the net change in storage each month by subtracting the monthly hydraulic loading rate from the available wastewater, as indicated in Column (4) of Table 6-7.
4. Compute the cumulative storage at the end of the each month by adding the change in storage during one month to the accumulated quantity from the previous month, as indicated in Column (5) of Table 6-7.
5. Calculate the required storage volume using the maximum cumulative storage.

$$\text{Required Storage Volume} = (23.9 \text{ cm})(30.4 \text{ ha}) \left( \frac{10,000 \text{ m}^2}{\text{ha}} \right) \left( \frac{\text{m}}{100 \text{ cm}} \right) = 72,656 \text{ m}^3$$


---



**Table 6-7.** Estimation of Storage Volume Requirements Using Water Balance Calculations

Month	(1) L <sub>w</sub> , cm	(2) W <sub>m</sub> , m <sup>3</sup>	(3) W <sub>a</sub> , cm	(4) Change in Storage, cm (3)-(2)	(5) Cumulative Storage, cm
April	10	40,000	13.2	3.2	0
May	10	42,500	14.0	4.0	3.2
June	10	50,000	16.4	6.4	7.1
July	10	42,500	14.0	4.0	13.6
August	10	45,000	14.8	4.8	17.6
September	10	35,000	11.5	1.5	22.4
October	10	25,000	8.2	-1.8	23.9*
November	10	15,000	4.9	-5.1	22.1
December	10	15,000	4.9	-5.1	17.0
January	10	15,000	4.9	-5.1	12.0
February	10	15,000	4.9	-5.1	6.9
March	10	25,000	8.2	-1.8	1.8

\* Maximum storage month.

### 6.3.2 Final Design of Storage Volume Calculations

The estimated storage volume requirement obtained by water balance calculation or computer programs must be adjusted to account for net gain or loss in volume due to precipitation or evaporation. The required storage volume should be determined by conducting a monthly water balance, which must include the net precipitation, evaporation, and seepage from the pond. This method requires an iterative solution with some assumed initial conditions because the pond area is not known. The overall storage volume must be increased to include enough freeboard to retain an appropriate storm event (i.e., at a minimum a 25y24h precipitation event. It is usually convenient to assume a depth for the initial calculation. This procedure is illustrated in the following example:

#### Example 6-2. Calculations to Determine Final Storage Volume Requirements

##### Conditions

1. Monthly evapotranspiration (ET) and precipitation (P<sub>r</sub>) data indicated in Table 6-8, Columns (1) and (2).
2. Assume seepage from pond is negligible.
3. Initial conditions and estimated storage volume from Example 6-1.

##### Calculations

1. Using the initial estimated storage volume and an assumed storage pond depth compatible with local conditions, calculate a required surface area for the storage pond:

$$A_s = \frac{V_s(\text{est})}{d_s} \quad (6-12)$$

##### Where:

A<sub>s</sub> = area of storage pond, m<sup>2</sup>  
 V<sub>s</sub>(est) = estimated storage volume, m<sup>3</sup>  
 d<sub>s</sub> = assumed pond depth, m  
 For example, assume d<sub>s</sub> = 4 m

$$A_s = \frac{72,656 \text{ m}^3}{4 \text{ m}} = 18,164 \text{ m}^2$$

2. Calculate the monthly net volume of water gained or lost from storage due to precipitation, evaporation, and seepage:

$$\Delta V_s = (P_r - E - S) \left( A_s \left( \frac{\text{m}}{100 \text{ cm}} \right) \right) \quad (6-13)$$

##### Where:

ΔV<sub>s</sub> = net gain or loss of storage volume, m<sup>3</sup>  
 P<sub>r</sub> = monthly precipitation, cm  
 E = monthly evaporation, cm  
 S = monthly seepage, cm  
 A<sub>s</sub> = storage pond area, m<sup>2</sup>

3. Estimated lake evaporation in the local area should be used for E, if available. Potential ET values may be used if no other data are available. Tabulate monthly values and sum to determine the net annual ΔV<sub>s</sub>. Results are tabulated in Column (3) of Table 6-8.
4. Tabulate the volume of wastewater available each month (Q<sub>m</sub>), given in Example 6-1.
5. Calculate an adjusted field area to account for annual net gain/loss in storage volume.

$$A_w' = \frac{\Sigma \Delta V_s + \Sigma Q_m}{(L_w) \left( 10,000 \frac{\text{m}^2}{\text{ha}} \right) \left( 0.01 \frac{\text{m}}{\text{cm}} \right)} \quad (6-14)$$

##### Where:

A<sub>w</sub>' = adjusted field area, ha  
 ΣΔV<sub>s</sub> = annual net storage gain/loss, m<sup>3</sup>  
 ΣQ<sub>m</sub> = annual available wastewater, m<sup>3</sup>  
 L<sub>w</sub> = design annual hydraulic loading rate, cm  
 For example:

$$A_w' = \frac{-24,104 \text{ m}^3 + 365,000 \text{ m}^3}{(120 \text{ cm}) \left( 10,000 \frac{\text{m}^2}{\text{ha}} \right) \left( 0.01 \frac{\text{m}}{\text{cm}} \right)} = 28.4 \text{ ha}$$

Note: The final design calculation reduced the field area from 30.4 ha to 28.4 ha.

6. Calculate the monthly volume of applied wastewater using the design monthly hydraulic loading rate and adjusted field area:

$$V_w = (L_w)(A_w) \left( 10,000 \frac{m^2}{ha} \right) \left( 0.01 \frac{m}{cm} \right) \quad (6-15)$$

**Where:**

$V_w$  = monthly volume of applied wastewater,  $m^3$   
 $L_w$  = design annual hydraulic loading rate,  $cm$   
 $A_w$  = adjusted field area,  $ha$   
 Results are tabulated in Column (5) of Table 6-8.

7. Calculate the net change in storage each month by subtracting the monthly applied wastewater (VW) from the sum of available wastewater (Qm) and net storage gain/loss ( $\Delta V_s$ ) in the same month. Results are tabulated in Column (6) of Table 6-8.

8. Calculate the cumulative storage volume at the end of each month by adding the change in storage during one month to the accumulated total from the previous month. The maximum

monthly cumulative volume is the storage volume requirement used for design. Results are tabulated in column (7) of Table 6-8. For this example, design  $V_s = 64,565 m^3$ .

9. Adjust the assumed value of storage pond depth (ds) to yield the required design storage volume using Equation 6-16.

$$d_s = \frac{V_s}{A_s} \quad (6-16)$$

$$d_s = \frac{64,565 m^3}{18,164 m^2}$$

$$d_s = 3.55 m$$

If the pond depth cannot be adjusted due to subsurface constraints, then the surface area must be adjusted to obtain the required design volume. However, if the surface area is changed, another iteration of the above procedure will be necessary because the value of net storage gain/loss ( $\Delta V_s$ ) will be different for a new pond area.

**Table 6-8.** Final Storage Volume Requirement Calculations

Month	(1) ET, cm	(2) P <sub>r</sub> , cm	(3) $\Delta V_s$ Net gain/loss, $m^3$	(4) Q <sub>m</sub> , $m^3$	(5) V <sub>w</sub> , $m^3$	(6) $\Delta V_s$ , $m^3$ (3)+(4)-(5)	(7) Cumulative Storage, $m^3$
April	13.2	2	-2,034	40,000	28,400	9,566	0
May	17.7	0.5	-3,124	42,500	28,400	10,976	9,566
June	21.8	0.3	-3,905	50,000	28,400	17,695	20,541
July	23.9	0	-4,341	42,500	28,400	9,759	38,236
August	22.1	0	-4,014	45,000	28,400	12,586	47,995
September	14.7	0.3	-2,616	35,000	28,400	3,984	60,581
October	10.9	0.8	-1,835	25,000	28,400	-5,235	64,565*
November	5.1	1.3	-690	15,000	28,400	-14,090	59,331
December	2.5	2.5	0	15,000	28,400	-13,400	45,240
January	2.3	3	127	15,000	28,400	-13,273	31,840
February	5.1	2.8	-418	15,000	28,400	-13,818	18,567
March	9.7	2.8	-1,253	25,000	28,400	-4,653	4,750
Annual			-24,104	365,000	340,800		

Maximum monthly cumulative volume.

### 6.3.3 Storage for Overland Flow

Storage facilities may be required at an OF system for any of the following reasons:

1. Storage of water during the winter due to reduced hydraulic loading rates or system shutdown
2. Storage of stormwater runoff to meet mass discharge limitations
3. Equalization of incoming flows to permit constant application rates

### 6.3.4 Storage Requirements for Cold Weather

In general, OF systems must be shut down for the winter when effluent quality requirements cannot be met due to cold temperature even at reduced application rates or when ice begins to form on the slope. The duration of the shutdown period and, consequently, the required storage period will, of course, vary with the local climate and the required effluent quality.

In studies at Hanover, NH, a storage period of 112 days, including acclimation, was estimated to be required when treating primary effluent to BOD and TSS limits of 30  $g/m^3$  ( $mg/L$ ).

In areas of the country below the 40-day storage contour on Figure 5.2, OF systems generally can be operated year-round. However, winter temperature data at the proposed OF site should be compared with those at existing systems that operate year-round to determine if all year operation is feasible.

Storage is required at those OF sites where winter loading rates are reduced below the average design rate. The required storage volume can be calculated using Equation 6-17.

$$V = (Q_w)(D_w) - (A_s)(L_{ww})(D_{aw}) \quad (\text{Metric})$$

$$V = (Q_w)(D_w) - (A_s)(L_{ww})(D_{aw})(7.48/10^6) \quad (\text{U.S. Customary}) \quad (6-17)$$

**Where:**

$V$  = storage volume,  $m^3$  (million gallons)  
 $Q_w$  = average daily flow during winter,  $m^3/d$  ( $mgd$ )

$D_w$	= number of days in the winter period
$A_s$	= slope area, $m^2$ ( $ft^2$ )
$L_{ww}$	= hydraulic loading rate during winter, $m/d$ ( $ft/d$ )
$D_{aw}$	= number of operating days in winter period

The duration of the reduced loading period at existing systems generally has been about 90 days.

### 6.3.5 Storage for Stormwater Runoff

Stormwater runoff from the overland slopes must be considered because OF is a surface discharging system. Facilities that have a discharge must be covered by a multisector stormwater permit or obtain coverage under an individual NPDES permit. In such cases, stormwater runoff may need to be stored and discharged at a later time when mass discharge limits would not be exceeded. A procedure for estimating storage requirements for stormwater runoff is outlined below.

1. Determine the maximum monthly mass discharge allowed by the permit for each regulated constituent.
2. Determine expected runoff concentrations of regulated constituents under normal operation (no precipitation).
3. Estimate monthly runoff volumes from the system under normal operation by subtracting estimated monthly ET and percolation losses from design hydraulic loading.
4. Estimate the monthly mass discharge under normal operation by multiplying the values from Steps 2 and 3.
5. Calculate the allowable mass discharge of regulated constituents resulting from storm runoff by subtracting the estimated monthly mass discharge in Step 5 from the permit value in Step 1.
6. Assuming that storm runoff contains the same concentration of constituents as runoff during normal operation, calculate the volume of storm runoff required to produce a mass discharge equal to the value of Step 5.
7. Estimate runoff as a fraction of rainfall for the particular site soil conditions. Consult the local NRCS office for guidance.
8. Calculate the total rainfall required to produce a mass discharge equal to the value in Step 5 by dividing the value in Step 6 by the value in Step 7.
9. Determine for each month a probability distribution for rainfall amounts and the probability that the rainfall amount in Step 8 will be exceeded.
10. In consultation with regulatory officials, determine what probability is an acceptable risk before storm

runoff storage is required and use this value ( $P_d$ ) for design.

11. Storage must be provided for those months in which total rainfall probability exceeds the design value ( $P_d$ ) determined in Step 10.
12. Determine the change in storage volume each month by subtracting the allowable runoff volume in Step 6 from the runoff volume expected from rainfall having an occurrence probability of  $P_d$ . In months when the expected storm runoff exceeds the allowable storm runoff, the difference will be added to storage. In months when allowable runoff exceeds expected runoff, water is discharged from storage.
13. Determine cumulative storage at the end of each month by adding the change in storage during one month to the accumulated quantity from the previous month. The computation should begin at the start of the wettest period. Cumulative storage cannot be less than zero.
14. The required storage volume is the largest value of cumulative storage. The storage volume must be adjusted for net gain or loss due to precipitation and evaporation.

If stored storm runoff does not meet the discharge permit concentration limits for regulated constituents, then the stored water must be reapplied to the OF system. The amount of stored storm runoff is expected to be small, relative to the total volume of wastewater applied, and therefore, increases in slope area should not be necessary. The additional water volume can be accommodated by increasing the application period as necessary.

### 6.3.6 Storage for Equalization

From a process control standpoint, it is desirable to operate an OF system at a constant application rate and application period. For systems that do not have storage facilities for other reasons, small equalizing basins can be used to even out flow variations that occur in municipal wastewater systems. A storage capacity of 1-day flow should be sufficient to equalize flow in most cases. The surface area of basins should be minimized to reduce intercepted precipitation. However, an additional half-day of storage can be considered to hold intercepted precipitation in wet climates.

For systems providing only screening or primary sedimentation as preapplication treatment, aeration should be provided to keep the storage basin contents mixed and the surface zone aerobic. The added cost of aeration, in most cases, will be offset by savings resulting from reduced pump sizes and peak power

demands. The designer should analyze the cost-effectiveness of this approach for the system in question.

#### 6.4 Operation of Storage Ponds

The scheduling of inputs or withdrawals from storage ponds will depend on the overall process, including agricultural operations and the treatment functions expected for the pond unit. Storage units in an SAT system are typically only for emergency conditions and should be used accordingly. These ponds should remain dry during routine operations and then be drained as rapidly as possible after the emergency is resolved. In some cases a separate pond is not provided in SAT systems but extra freeboard is constructed into one or more of the infiltration basins.

Storage ponds for OF systems may be bypassed in many cases during the late spring and summer months to avoid performance problems caused by algae. The storage pond contents are then gradually blended with the main wastewater stream so that the pond is drawn down to the specified level at the start of the next storage period. In areas with non-continuous algal blooms, the pond discharges should be coordinated with periods of low algae concentration.

Operation of storage ponds for SR systems will depend on whether or not any treatment function has been assigned to the pond. If a specified level of nitrogen or fecal coliform removal is expected, then the incoming wastewater should continue to flow into the pond and the withdrawals should be sufficient to reach the required pond level at the end of the application season. When these factors are not a concern, or when it is desired to maximize the nitrogen application to the land, the main wastewater stream should bypass the storage and be applied directly. Regular withdrawals over the season can then draw down the pond.

For SR systems emphasizing water reuse and urban irrigation, steps may be needed to minimize algae in the storage ponds. These steps can include pre-storage treatment in constructed wetlands, post-storage treatment by constructed wetlands, dissolved air flotation (DAF), filtration, or reservoir management that may include mixing, aeration, or selective depth removal of the highest quality water.

#### 6.5 References

Brown and Caldwell (2000) *Screening of Feasible Technologies*, Prepared for the San Francisco Public Utilities Commission.

Bowles, D.S., E.J. Middlebrooks, and J.H. Reynolds (1979) *Coliform Decay Rates in Waste Stabilization Ponds*, Journal WPCF, 51:87-99.

Chudoba, P. and Pujol, R. (1998) *A Three-Stage Biofiltration Process: Performances of a Pilot Plant*, Water Science Technology, 38(8-9):257-265.

Crites, R.W. and G. Tchobanoglous (1998) *Small and Decentralized Wastewater Management Systems*, McGraw-Hill, New York, NY.

Crites, R.W., S.C. Reed, and R.K. Bastian (2000) *Land Treatment Systems for Municipal and Industrial Wastes*, McGraw-Hill, New York, NY.

Higo, T.T. (1966) *A Study of the Operation of Sewage Ponds in the Province of Alberta*, Department of Public Health, Government of Alberta.

Kott, Y. (1978) *Lagooned Secondary Effluents as Water Source for Extended Agricultural Purposes*, Water Research, 12(12):1101-1106.

Middlebrooks, E.J. et al. (1982) *Wastewater Stabilization Lagoon Design, Performance and Upgrading*, Macmillan Publishing Co., New York.

Neel, J.K., J.H. McDermott, and C.A. Monday (1961) *Experimental Lagooning of Raw Sewage*, Journal WPCF, 33(6):603-641.

Reed, S.C. (1984) *Nitrogen Removal in Wastewater Ponds*, CRREL Report 84-13, Cold Regions Research and Engineering Laboratory, Hanover, NH.

Reed, S.C., R.W. Crites, E.J. Middlebrooks (1995) *Natural Systems for Waste Management and Treatment*, Second Edition, McGraw-Hill, New York, NY.

Reed, S.C. (2001) *Wetland Systems. Chapter 9 in: Natural Systems for Wastewater Treatment*, WEF Manual of Practice, Second Edition, Water Environment Federation, Alexandria, VA.

Pano, A. and E.J. Middlebrooks (1982) *Ammonia Nitrogen Removal in Facultative Wastewater Stabilization Ponds*, Journal WPCF, 54(4):344-351.

Sagik, B.P. (1978) *The Survival of Human Enteric Viruses in Holding Ponds*, Contract Report DAMD 17-75-C-5062, United States Army Medical Research and Development Command, Ft. Detrick, MD.

Stowell, R. (1976) *A Study of Screening of Algae from Stabilization Ponds*, Masters Thesis, Department of Civil Engineering, University of California, Davis.

Surampalli, R.Y., et al. (1993) *Phosphorus Removal in Ponds*, Proceedings of the 2<sup>nd</sup> International Association of Water Quality International Specialist Conference, Oakland, CA.

- 
- Thomas, R.E. and S.C. Reed (1980) *EPA Policy on Land Treatment and the Clean Water Act of 1977*, Journal WPCF, 52:452.
- US EPA (1976a) *Use of Climatic Data in Estimating Storage Days for Soil Treatment Systems*, EPA-600/2-76-250, U.S. Environmental Protection Agency, Office of Research and Development, Cincinnati, OH.
- US EPA (1976b) *Is Muskegon County's Solution, Your Solution?*, U.S. Environmental Protection Agency, Region V, Chicago, IL.
- US EPA (1977a) *Performance Evaluation of Existing Lagoons, Peterborough, N.H.*, EPA-600/2-77-085, U.S. Environmental Protection Agency, Cincinnati, OH.
- US EPA (1977b) *Performance Evaluation of an Existing Seven Cell Lagoon System*, EPA 600/2-77-086, U.S. Environmental Protection Agency, Cincinnati, OH.
- US EPA (1977c) *Performance Evaluation of an Existing Lagoon System at Eudora, Kan.*, EPA-600/2-77-167, U.S. Environmental Protection Agency, Cincinnati, OH.
- US EPA (1977d) *Preliminary Survey of Toxic Pollutants at the Muskegon Wastewater Management System*, U.S. Environmental Protection Agency, ORD, Washington, DC.
- US EPA (1979) *Health Aspects of Land Treatment*, US GPO 1979-657-093/7086, U.S. Environmental Protection Agency, Cincinnati, OH.
- US EPA (1980) *Enteric Virus Removal in Wastewater Lagoon Systems*, Report IAG 79-0-X0728, U.S. Environmental Protection Agency HER, Cincinnati, OH.
- US EPA (1981) *Process Design Manual for Land Treatment of Municipal Wastewater*, EPA 625/1-81-013, U.S. Environmental Protection Agency, Cincinnati, OH.
- US EPA (1983) *Design Manual – Municipal Wastewater Stabilization Ponds*, EPA-625/1-83-015, U.S. Environmental Protection Agency, Cincinnati, OH.
- US EPA (1999) *Manual: Constructed Wetlands Treatment of Municipal Wastewaters*, EPA/625/R-99/010, September 1999, National Risk Management Research Laboratory, Office of Research and Development, U.S. Environmental Protection Agency, Cincinnati, OH.
- WPCF (2001) *Natural Systems, Manual of Practice*, No. FD-16, Water Pollution Control Federation, Alexandria, VA.

## Chapter 7 Distribution Systems

Design of the distribution system involves two steps: (1) selection of the type of distribution system, and (2) detailed design of system components. The three major types of distribution systems are surface, sprinkler, and drip systems. Only basic design principles for each type of distribution system are presented in this manual, and the designer has referred to several standard agricultural engineering references for further design details (e.g., Burt, 1995; Pair, 1983). Factors that distinguish land treatment from conventional irrigation include:

- Supplemental irrigation water source may be needed to meet crop water use requirements
- Application generally occurs over a longer season than conventional irrigation. There is often abundant treated effluent available in the late summer and fall when irrigation requirements are decreasing.
- Water use efficiency is not always the optimum approach for managing treated effluent.

- A higher level of environmental monitoring is required including accurate flow measurements, controls on runoff, and documentation of water and constituent loading rates.
- Additional factors control irrigation rate and frequency when compared to conventional irrigated agriculture.

### 7.1 Types of Distribution Systems

SR systems utilize all types of distribution systems. OF systems are generally sprinkler, spray or surface irrigation with gated pipe. The goal of a distribution for a SR systems is to obtain even distribution through the entire application area, while the goal of the OF distribution system is to spread the water evenly at the top of the slope, creating uniform flow across the slope. SAT (rapid infiltration) systems employ infiltration basins, which are often operated similar to level border irrigation systems. Table 7-1 contains the description, advantages and disadvantages of various system types.

**Table 7-1.** Description, Advantages, and Disadvantages of Distribution Systems

Type	Description	Advantages/Disadvantages
Surface Irrigation	Broad Class of irrigation where water is distributed over the soil surface by gravity.	
Wild Flooding	Uncontrolled application to a vegetated surface via gravity or low head pumping	Poor uniformity of application Not generally suitable for effluent application
Furrow	Application to a graded field via small ditches between crop rows	Primarily for row crops Careful leveling is required. Uniform application is difficult on coarse textured soils.
Border	Application to a leveled field in 20 – 100 foot wide strips, bordered by dikes.	Primarily for grass or perennial crops Careful leveling is required. Uniform application is difficult on coarse textured soils. Remaining solids not distributed evenly.
Sprinkler Irrigation	Application of water to the soil through sprinkling or spraying	Components can be sensitive to process water chemistry. Almost eliminates runoff. Susceptible to wind drift. Highest pumping cost Good method for coarse textured soils or uneven ground
Solid Set	Permanently or semi-permanently installed sprinklers are used in blocks.	Good for winter irrigation if subsurface piping is used. Harvest and tillage are difficult around the sprinkler risers. Rapid rotation among blocks is feasible to provide smaller applications.
Hand Move	Moveable sprinkler lateral segments cover field in sets.	High labor Labor requirement to move sprinklers makes long sets common. Least expensive system
End Tow	Entire sprinkler laterals are towed to new set locations after each irrigation.	Less labor than hand move sprinkler lines Labor requirement to move sprinklers makes long sets common. Requires sturdy laterals and care during moves Limited to grass or hay crops
Wheel Line	Engine moveable sprinklers cover field in sets.	Less labor than hand move sprinkler lines Labor requirement to move sprinklers makes long sets common. Only suitable for low height crops and rectangular fields Inexpensive equipment
Big Gun	Large diameter orifices operating at high pressure spread water. Travelling hose reels allow big guns to irrigate strips over uneven ground.	Requires high pressure for maximum area coverage Water impact can damage crops and soil at low pressure. Relatively high irrigation rate

Type	Description	Advantages/Disadvantages
Center Pivot	Mechanical sprinkler system with fixed central water supply moves in a circle to irrigate 20 to more than 400 acres.	Moderate initial capital expense but less labor Flexible, efficient irrigation with proper design. Frequent light irrigation of fields is used in winter to minimize soil storage May not be suitable for boggy or sticky soils High instantaneous application rates
Linear Move	Mechanical sprinkler system with end or center feed water supply moves in a straight line to irrigate fields up to 5000 feet long.	High initial capital expense but less labor Efficient irrigation with proper design May not be suitable for boggy or sticky soils High instantaneous application rates Covers large rectangular fields
Micro Irrigation	Water is applied to the soil surface as drops or smaller streams through emitters. Preferred term is drip irrigation.	Emitter clogging limits utility of micro irrigation Some difficulties with animal damage High capital cost Precise control of irrigation water Popular for permanent crops
Surface Drip	Low flow emitters placed on the ground surface apply water to crop root zone but not between rows	Easier to observe emitter performance and system plugging than with subsurface emitters
Subsurface Drip	Emitters are buried 6 – 12 inches deep as a semi-permanent installation.	More difficult to observe system performance Buried lines sometimes damaged by tillage operations Eliminates exposure to wastewater
Micro-Spray	Small spray heads or jets on stakes next to permanent crops	Only suitable for permanent crops Easier to observe performance than with drip emitters Generally more resistant to plugging than drip emitters

### 7.1.1 Surface Distribution

With surface distribution systems, water is applied to the ground surface at one end of a field and allowed to spread over the field by gravity. Conditions favoring the selection of a surface distribution system include the following:

1. Capital is not available for the initial investment required for more sophisticated systems.
2. Surface topography of land requires little additional preparation to make uniform grades for surface distribution.

The principal limitations or disadvantages of surface systems include the following:

1. Land leveling costs may be excessive on uneven terrain.
2. Uniform distribution cannot be achieved with highly permeable soils.
3. Runoff control and a return system must be provided when applying wastewater.
4. Periodic maintenance of leveled surfaced is required to maintain uniform grades.

The two general types of surface distribution are the ridge and furrow and the diked border systems. Variations of these two types of methods can be found in standard references (e.g., Burt, 1995; Hart, 1975; Booher, 1974).

### 7.1.2 Sprinkler Distribution

Sprinkler distribution uses a rotating nozzle as opposed to spray distribution which refers to a fixed nozzle orifice. Most nozzles used in land treatment systems are of the sprinkler type.

Sprinkler distribution systems simulate rainfall by creating a rotating jet of water that breaks up into small droplets that fall to the soil surface. The advantages and disadvantages of sprinkler distribution systems relative to surface and micro distribution systems were summarized in Table 7-1.

In this chapter, sprinkler systems are classified according to their movement during and between applications because this characteristic determines the procedure for design. There are three major categories of sprinkler systems based on movement: (1) solid set, (2) move-stop, and (3) continuous move. A summary of the various types of sprinkler systems under each category is given in Table 7-2 along with respective operating characteristics.

### 7.1.3 Micro Irrigation Distribution

Micro irrigation (also referred to as drip or trickle irrigation) includes surface and subsurface low-flow emission devices that supply water to the root zone of each individual plant. The three major categories of micro irrigation devices are:

- surface drip emitters
- subsurface drip emitters
- micro-sprays

Drip emitters can be discreet devices manually inserted into drip lateral hose or can be manufactured integrally into the lateral hose. Drip emitters can also be installed on short "pigtail" tubes coupled to the drip lateral hose. Thin wall hose with integrated emitters is sometimes referred to as "drip tape." Micro-sprays are small, low flow spray or jet devices. The advantages and disadvantages of micro irrigation for distribution of effluent compared with surface and sprinkler irrigation methods were listed in Table 7-1.

**Table 7-2.** Sprinkler System Characteristics

Type	Typical application rate, in/h	Labor required per application, h/acre	Nozzle pressure range, lb/in <sup>2</sup>	Size of single system, acres	Maximum grade, %
<b>Solid Set</b>					
Permanent	0.05-2.0	0.008-0.016	30-100	No limit	40
Portable	0.05-2.0	0.03-0.04	30-60	No limit	40
<b>Move-stop</b>					
Hand-move	0.01-2.0	0.08-0.24	30-60	2-40	20
End tow	0.01-2.0	0.03-0.06	30-60	20-40	5-10
Side roll	0.1-2.0	0.016-0.048	30-60	20-80	5-10
Stationary gun	0.25-2.0	0.03-0.06	50-100	20-40	20
<b>Continuous move</b>					
Traveling gun	0.25-1.0	0.016-0.048	50-100	40-100	20-30
Center pivot	0.25-1.0	0.008-0.024	15-60	40-160	15-20
Linear move	0.25-1.0	0.008-0.024	15-60	40-360	15-20

## 7.2 General Design Considerations for All Types of Distribution Systems

The hydraulic loading rate will be determined based on the limiting design factor as shown in Chapters 8, 9, and 10 depending on the treatment system.

Design parameters that are common to all distribution systems are defined as follows:

**Depth of Wastewater Applied.** The depth of wastewater applied is determined using the relationship:

$$D = L_w/F \quad (7-1)$$

**Where:**

- D = depth of wastewater applied per application, mm (in.)
- $L_w$  = monthly hydraulic loading, per application mm/mo (in./mo)
- F = frequency of applications, applications/mo

### 7.2.1 Application Frequency

The application frequency is defined as the number of applications per month or per week. The application frequency used for design is a judgment decision made by the designer considering: (1) the objectives of the system, (2) the water and nutrient needs or tolerance of the crop, (3) the moisture retention properties of the soil, (4) the labor requirement of the distribution system, (5) the application characteristics of the type of distribution system, and (6) the capital cost of the distribution system. Some general guidelines for determining an appropriate application frequency are presented here, but consultation with a local farm adviser is recommended.

Except for the water tolerant forage grasses, most crops, including forest crops, generally require a drying period after reaching saturation to allow aeration of the root zone to achieve optimum growth and nutrient uptake. Thus, more frequent applications are appropriate as the ET rate and the soil permeability increase. In practice, application frequencies range from once every 3 or 4 days for sandy soils to about once every 2 weeks for heavy clay soils. An

application frequency of once per week is commonly used for most distribution methods, with continuous move sprinkler and micro irrigation methods being the exception.

Continuous move sprinkler and micro irrigation methods have a higher irrigation frequency, but still maintain adequate root zone aeration. Continuous move sprinkler irrigation systems usually apply water at a rate higher than the long-term infiltration rate of the soil. In order to take advantage of surface micro-storage and the high initial infiltration rate of most soils, continuous move sprinkler systems typically apply water for a brief period of time every 1 to 4 days. The smaller application amounts and brief application periods allow adequate root zone aeration to take place between irrigations. Micro irrigation systems usually apply water for several hours every day. Because of low average application rate and that the soil surface area is not saturated, micro irrigation practices allow for root zone aeration.

The operating and capital costs of distribution systems can affect the selection of application frequency. With distribution systems that must be moved between applications (move-stop systems), it is usually desirable to minimize labor and operating costs by minimizing the number of moves and therefore the frequency of application. On the other hand, capital costs of the distribution system are directly related to the flow capacity of the system. Thus, the capital cost may be reduced by increasing the application frequency to reduce the capacity needed in each part of the distribution system.

### 7.2.2 Application Rate

Treated wastewater application rate is the rate at which water is applied to the field by the distribution system. In general, the application rate should be restricted by the infiltration rate of the soil and/or vegetated surface to prevent unpermitted runoff and tailwater return requirements. Specific guidelines relating application rates



to infiltration properties are discussed under the different types of distribution systems.

### 7.2.3 Application Period

The application period is the time necessary to apply the desired depth of water (D). Application periods vary according to the type of distribution system, but, in general, are selected to be convenient to the operator and compatible with regular working hours. For most distribution systems application periods are less than 24 h.

### 7.2.4 Application Zone

In most systems, wastewater is not applied to the entire field area during the application period. Rather, the field area is divided into application plots or zones and wastewater is applied to only one zone at a time.

Application is rotated among the zones such that the entire field area receives wastewater within the time interval specified by the application frequency. Application zone area can be computed with the following:

$$A_a = A_w/N_a \quad (7-2)$$

Where:

- $A_a$  = application zone area
- $A_w$  = field area
- $N_a$  = No. of application zones

The number of application zones is equal to the number of applications that can be made during the time interval between successive applications on the same zone as specified by the application frequency.

For example, if the application period is 11 h, effectively two applications can be made each operating day. If the application frequency is once per week and the system is operated 7 d per week, then there are 7 operating days between successive applications on the same zone and the number of application zones is:

$$N_a = (2 \text{ applications/day})(7 \text{ operating days}) = 14$$

If the field area is 35 acres, then the application zone is:

$$A = \frac{35}{14} = 2.5 \text{ acres}$$

### 7.2.5 System Capacity

Whatever type of distribution system is selected, the maximum flow capacity of the system must be determined so that components, such as pipelines and pumping stations, can be properly sized. For systems with a constant application rate throughout the application period, the flow capacity of the system can be computed using the following formula:

$$Q = CA_aD/t_a \quad (7-3)$$

Where:

- $Q$  = discharge capacity, L/s (gal/min)
- $C$  = constant, 28.1 (453)
- $A_a$  = total application area, ha (acres)
- $D$  = gross depth of water applied during peak periods, cm (in.)
- $t_a$  = application period, h

Values for water applied and application period on a per-day basis are usually incorporated into the above formula. The effective amount of time available per day for application must take into account time lost in moving distribution equipment and system maintenance.

## 7.3 Surface Distribution

Ridge and furrow and graded border distribution are most often associated with slow rate systems. For overland flow, surface application can be used with either gated aluminum pipe or bubbling orifices. For soil aquifer treatment, the common method of application is basin flooding.

### 7.3.1 Ridge and Furrow Distribution

The design procedure for ridge and furrow systems is empirical and is based on past experience with good irrigation systems and field evaluation of operating systems. The design variables for furrow systems (see Figure 7-1) include furrow grade, spacing, length, and stream size (flowrate). The furrow grade will depend on the site topography. A grade of 2 percent is the recommended maximum for straight furrows. Furrows can be oriented diagonally across fields to reduce grades. Contour furrows or corrugations can be used with grades in the range of 2 to 10 percent.

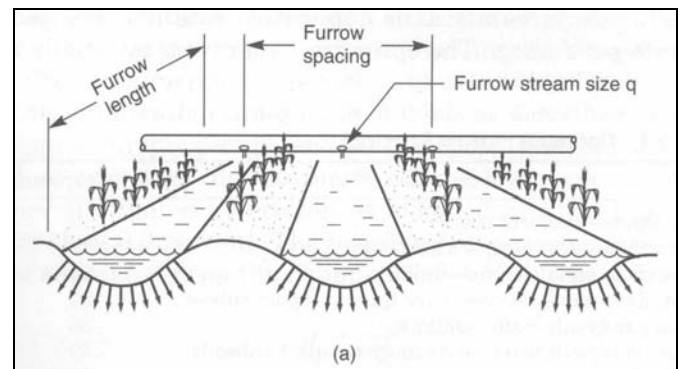


Figure 7-1. Typical Surface Distribution Methods – Ridge and Furrow.

The furrow spacing depends on the water intake characteristics of the soil. The principal objective in selecting furrow spacing is to make sure that the lateral movement of the water between adjacent furrows will wet the entire root zone before it percolates beyond the root zone. Suggested furrow spacings based on different soil and subsoil conditions are given in Table 7-3.

The length of the furrow should be as long as will permit reasonable uniformity of application, because labor requirements and capital costs increase as furrows become shorter. Suggested maximum furrow lengths for different grades, soils, and depths of water applied are given in Table 7-4.

**Table 7-3.** Optimum Furrow Spacing

Soil condition	Optimum spacing, in <sup>1</sup>
Coarse sands-uniform profile	12
Coarse sands-over compact subsoils	18
Fine sands to sandy loams-uniform	24
Fine sands to sandy loams-over more compact subsoils	30
Medium sandy-silt loam-uniform	36
Medium sandy-silt loam-over more compact subsoils	40
Silty clay loam-uniform	48
Very heavy clay soils-uniform	36

<sup>1</sup>2.54 centimeters per inch.

**Table 7-4.** Suggested Maximum Lengths of Furrows, ft<sup>2</sup>

Furrow grade, %	Average depth of wastewater applied, in <sup>1</sup>											
	Clays				Loams				Sands			
	3	6	9	12	2	4	6	8	2	3	4	5
0.05	1000	1300	1300	1300	400	900	1300	1300	200	300	500	600
0.2	1200	1540	1740	2030	720	1200	1540	1740	400	600	800	1000
0.5	1300	1640	1840	2460	920	1200	1540	1740	400	600	800	1000
1.0	920	1300	1640	1970	820	980	1200	1540	300	500	700	800
2.0	720	890	1100	1300	590	820	980	1100	200	300	500	600

<sup>1</sup>2.54 centimeters per inch.

<sup>2</sup>30.48 centimeters per foot.

The application period is the time needed to infiltrate the desired depth of water plus the time required for the stream to advance to the end of the furrow. The time required for infiltration depends on the water intake characteristics of the furrow. There is no standard method for estimating the furrow intake rate. The recommended approach is to determine furrow intake rates and infiltration times by field trials as described in Merriam and Keller, (1978).

Design of supply pumps and transmission systems should be based on the maximum allowable stream size, which is generally limited by erosion considerations when grades are greater than 0.3 percent. The maximum nonerosive stream size can be estimated from the equation:

$$q_e = C/G \quad (7-4)$$

**Where:**

- q<sub>e</sub> = maximum unit stream size, gpm.
- C = constant, 10
- G = grade, %

The furrow stream size or application rate is expressed as a flow rate per furrow. The optimum stream size is usually determined by trial and adjustment in the field after the system has been installed (Merriam and Keller, 1978). The most uniform distribution (highest application efficiency) generally can be achieved by starting the application with the largest stream size that can be safely carried in the furrow. Once the stream has reached the end of the furrow, the application rate can be reduced or cut back to reduce the quantity of runoff that must be handled. As a general rule, it is desirable to have the stream size large enough to reach the end of the furrow within one-fifth of the total application period. This practice will result in a theoretical application efficiency of greater than 90 percent for most soils if tailwater is returned.

For grades less than 0.3 percent, the maximum allowable stream size is governed by the flow capacity of the furrow, estimated as follows:

$$q_c = CF_a \quad (7-5)$$

**Where:**

- q<sub>c</sub> = furrow flow capacity, gpm
- C = constant, 74
- F<sub>a</sub> = cross-sectional area of furrow, ft<sup>2</sup>

For wastewater distribution, pipelines are generally used. If buried pipelines are used to convey water, vertical riser pipes with valves are usually spaced at frequent intervals to release water into temporary ditches equipped with siphon tubes or into hydrants connected to gated surface pipe (Figure 7-2).



**Figure 7-2.** Typical Gated Pipe Distribution Unit.

The spacing of the risers is governed either by the head loss in the gated pipe or by widths of border strips when graded border and furrow methods are alternated on the same field. The valves used in risers are alfalfa valves (mounted on top of the riser) or orchard valves (mounted inside the riser). Valves must be sized to deliver the design flow rate.

Gated surface pipe may be aluminum or plastic. Outlets along the pipe are spaced to match furrow spacings. The pipe and hydrants are portable so that they may be moved for each irrigation. The hydrants are mounted on valved risers, which are spaced along the buried pipeline that supplies the wastewater. Operating handles extend through the hydrants to control the alfalfa or orchard valves located in the risers. Control of flow into each furrow is accomplished with slide gates or screw adjustable orifices at each outlet. Slide gates are recommended for use with wastewater. Gated outlet capacities vary with the available head at the gate, the velocity of flow passing the gate, and the gate opening. Gate openings are adjusted in the field to achieve the desired stream size.

### 7.3.2 Graded Border Distribution

**Table 7-5.** Design Guidelines for Graded Borders for Deep-Rooted Crops<sup>1,2,3</sup>

Soil type and infiltration rate, in/h	Grade, %	Unit flow per foot of strip width, gal/min	Average dept of water applied, in	Border strip, ft	
				Width	Length
<b>Sand</b>					
>1.0	0.2-0.4	50-70	4	40-100	200-300
	0.4-1.6	40-50	4	30-40	200-300
	0.6-1.0	25-40	4	20-30	250
<b>Loamy sand</b>					
0.75-1.0	0.2-0.4	30-50	5	40-100	250-500
	0.4-0.6	25-40	5	25-40	250-500
	0.6-1.0	13-25	5	25	250
<b>Sandy loam</b>					
0.5-0.75	0.2-0.4	25-35	6	40-100	300-800
	0.4-0.6	18-30	6	20-40	300-600
	0.6-1.0	9-18	6	20	300
<b>Clay loam</b>					
0.25-0.5	0.2-0.4	13-18	7	40-100	600-1000
	0.4-0.6	9-13	7	20-40	300-600

The design variables for graded border distribution are:

1. Grade of the border strip
2. Width of the border strip
3. Length of the border strip
4. Unit stream size

Graded border distribution can be used on grades up to about 7 percent. Terracing of graded borders can be used for grades up to 20 percent. Graded border irrigation may not be suitable for the application of wastewater with substantial amounts of settleable solids to grass or hay crops because of poor resulting solids distribution.

The widths of border strips are often selected for compatibility with farm implements, but they also depend to a certain extent upon grade and soil type, which affect the uniformity of distribution across the strip. A guide for estimating strip widths is presented in Table 7-5 and Table 7-6.

The length of border strips should be as long as practical to minimize capital and operating costs. However, extremely long runs are not practical due to time requirements for patrolling and difficulties in determining stream size adjustments. Lengths in excess of 400 m (1,300 ft) are not recommended. In general, border strips should not be laid out across two or more soil types with different intake characteristics or water holding capacities, and border strips should not extend across slope grades that differ substantially. The appropriate length for a given site depends on the grade, the allowable stream size, the depth of water applied, the intake characteristics of the soil, and the configuration of the site boundaries. For preliminary design, the length of the border may be estimated using Table 7-5 and Table 7-6.

	0.6-1.0	5-9	7	20	300
Clay	0.10-0.25	0.2-0.3	9-18	8	40-100
					1200

<sup>1</sup>2.54 centimeters per inch.  
<sup>2</sup>30.48 centimeters per foot.  
<sup>3</sup>3.785 liters per 1 US gallon.

**Table 7-6.** Design Guidelines for Graded Borders for Shallow-Rooted Crops<sup>1,2,3</sup>

Soil profile	Grade, %	Unit flow per foot of strip width, gal/min	Average depth of water applied, in	Border strip, ft	
				Width	Length
Clay loam, 24 in deep over permeable subsoil	0.15-0.6	25-35	2-4	15-60	300-600
	0.6-1.5	18-30	2-4	15-20	300-600
	1.5-4.0	9-18	2-4	15-20	300-600
Clay, 24 in deep over Permeable subsoil	0.15-0.6	13-18	4-6	15-60	600-1000
	0.6-1.5	9-13	4-6	15-20	600-1000
	1.5-4.0	5-9	4-6	15-20	600
Loam, 6 to 18 in deep over hardpan	1.0-4.0	5-20	1-3	15-20	300-1000

<sup>1</sup>2.54 centimeters per inch.  
<sup>2</sup>30.48 centimeters per foot.  
<sup>3</sup>3.785 liters per 1 US gallon.

The application rate or unit stream size for graded border irrigation is expressed as a flow rate per unit width of border strip. The stream size must be such that the desired volume of water is applied to the strip in a time equal to, or slightly less than, the time necessary for the water to infiltrate the soil surface. When the desired volume of water has been delivered onto the strip, the stream is turned off. Shutoff normally occurs when the stream has advanced about 75 percent of the length of the strip. The objective is to have sufficient water remaining on the border after shutoff to apply the desired water depth to the remaining length of border limiting runoff or ponding at the bottom end.

Use of a proper stream size is necessary to achieve uniform and efficient application. Too rapid a stream results in inadequate application at the upper end of the strip or in excessive ponding or surface runoff at the lower end. If the stream is too small, the lower end of the strip receives inadequate water or the upper end has excessive deep percolation. Actually achieving uniform distribution with minimal runoff requires a good deal of skill and experience on the part of the operator. The range of stream sizes given in Table 7-5 and Table 7-6 for various soil and crop conditions may be used for preliminary design. Wastewater with significant amounts of settleable solids should be applied at relatively higher flow rates to improve the distribution of solids on the field. Procedures given in the Border Irrigation chapter of the USDA NRCS National Engineering Handbook (USDA, 1980) may be used to obtain a more accurate estimate of stream size.

The application period necessary to apply the desired depth of water may be determined from the following equation:

$$t_a = LD/Cq \quad (7-6)$$

Where:

- $t_a$  = application period, h
- $L$  = border strip length, ft
- $D$  = depth of applied water, in
- $C$  = constant, 96.3
- $q$  = unit stream size, gpm/ft of width

### Opportunity Time (Shut-off Time)

The majority of graded border systems used for wastewater land treatment are operated with diked ends, allowing no runoff. For this case, the duration of application is not a simple function of calculating the run time based on the flow rate and the area of the border strip. Uniform infiltration of water is achieved when the entire length of the system has equal opportunity to infiltrate. Equal opportunity time occurs when the advance rate of the wetting front is equal to the recession of the water. The recession of water is a function of the slope and percolation rate. A guideline to assist the applicator in achieving uniform distribution is to set the flow rate so the total volume is applied when the wetting front advances 60 percent of the strip length for clay soil and 90 percent of the length for sandy soils.

The percolation rate changes throughout the season and depends on the surface preparation. Unfortunately, the same flow rate will not supply equal distribution throughout the season.

The results of equal opportunity time at the head and tail of the strip are shown in Figure 7-3. Equal opportunity time is achieved when the advance time matches the recession time. With diked ends, the water which would normally runoff, ponds and adds to the opportunity time at the end of the strip. If the shut-off advance distance is left constant

provides much more uniform distribution at the head of border strips and allows the flexibility of easily changing to ridge and furrow distribution if crop changes are desired.

### 7.3.3 Surface Distribution for Overland Flow

Municipal wastewater can be surface applied to overland flow slopes, but industrial wastewater should usually be sprinkler applied if there are higher concentrations of BOD and solids. Surface distribution methods include gated aluminum pipe commonly used for agricultural irrigation, and slotted or perforated plastic pipe. Commercially available gated pipe can have gate spaces ranging from 0.6 to 1.2 m (2 to 4 ft) and gates can be placed on one or both sides of the pipe. A 0.6 m (2-ft) spacing is recommended to provide operating flexibility. Slide gates rather than screw adjustable orifices are recommended for wastewater distribution. Gates can be adjusted manually to achieve reasonably uniform distribution along the pipe. However, the pipe should be operated under low pressure, 2 to 5 lb/in.<sup>2</sup>, to achieve good uniformity at the application rates recommended in Chapter 9, especially with long pipe lengths. Pipe lengths up to 520 m (1,700 ft) have been used, but shorter lengths are recommended. For pipe lengths greater than 90 m (300 ft), inline valves should be provided along the pipe to allow additional flow control and isolation of pipe segments for separate operation.

and the flow rate is reduced, the head of the strip receives a greater opportunity time. In Figure 7-4, the opportunity at the head of the strip, T1, is greater than the opportunity time as the tail of the strip, T2. If the flow rate is reduced even further the wetting front will not even reach the end of the strip. If the flow rate is increased above the optimal, the tail end of the strip receives a greater opportunity time from the ponded water and T2 is greater than T1, as shown in Figure 7-5 (Burt, 1995).

The conveyance and application devices used for border distribution are basically the same as described for ridge and furrow distribution. Open ditches with several evenly spaced siphon tubes are often used to supply the required stream size to a border strip. When buried pipe is used for conveyance, vertical risers with valves are usually spaced at intervals equal to the width of the border strip and are located midway in the border strip. With this arrangement, one valve supplies each strip. Water is discharged from the valve directly to the ground surface, as indicated in Figure 7-6, and is distributed across the width of the strip by gravity flow. For border strip widths greater than 9 m (30 ft), at least two outlets per strip are necessary to achieve good distribution across the strip. Hydrants and gated pipe can be used with border systems. Use of gated pipe

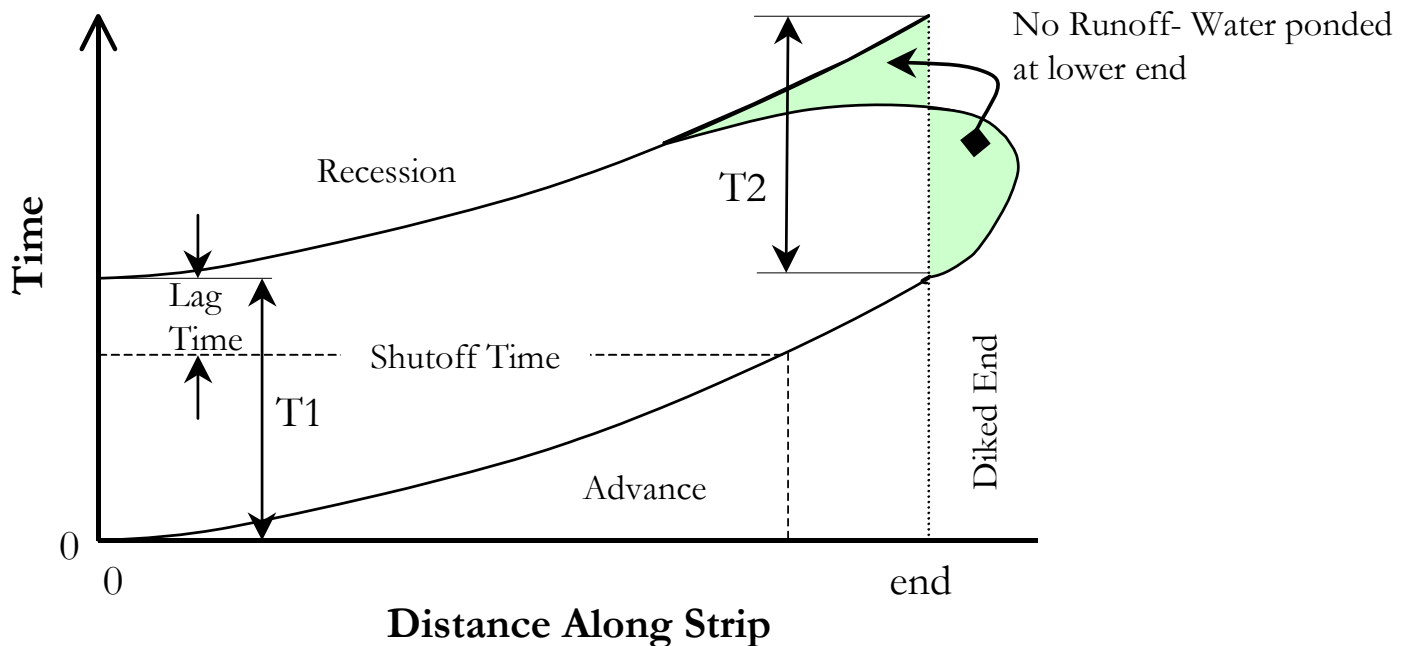


Figure 7-3. Equal Opportunity Time Along Entire Strip (Burt, 1995).

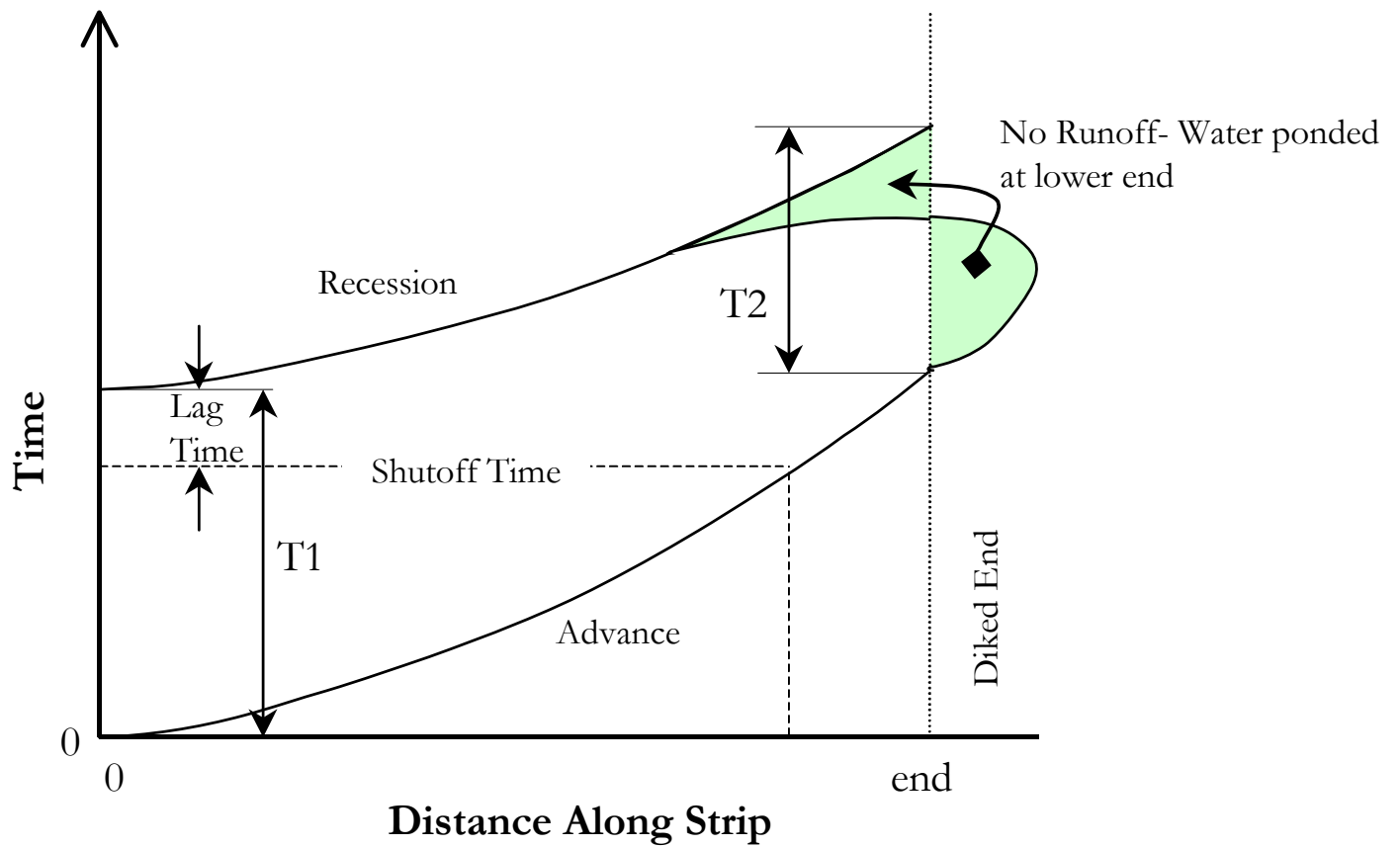
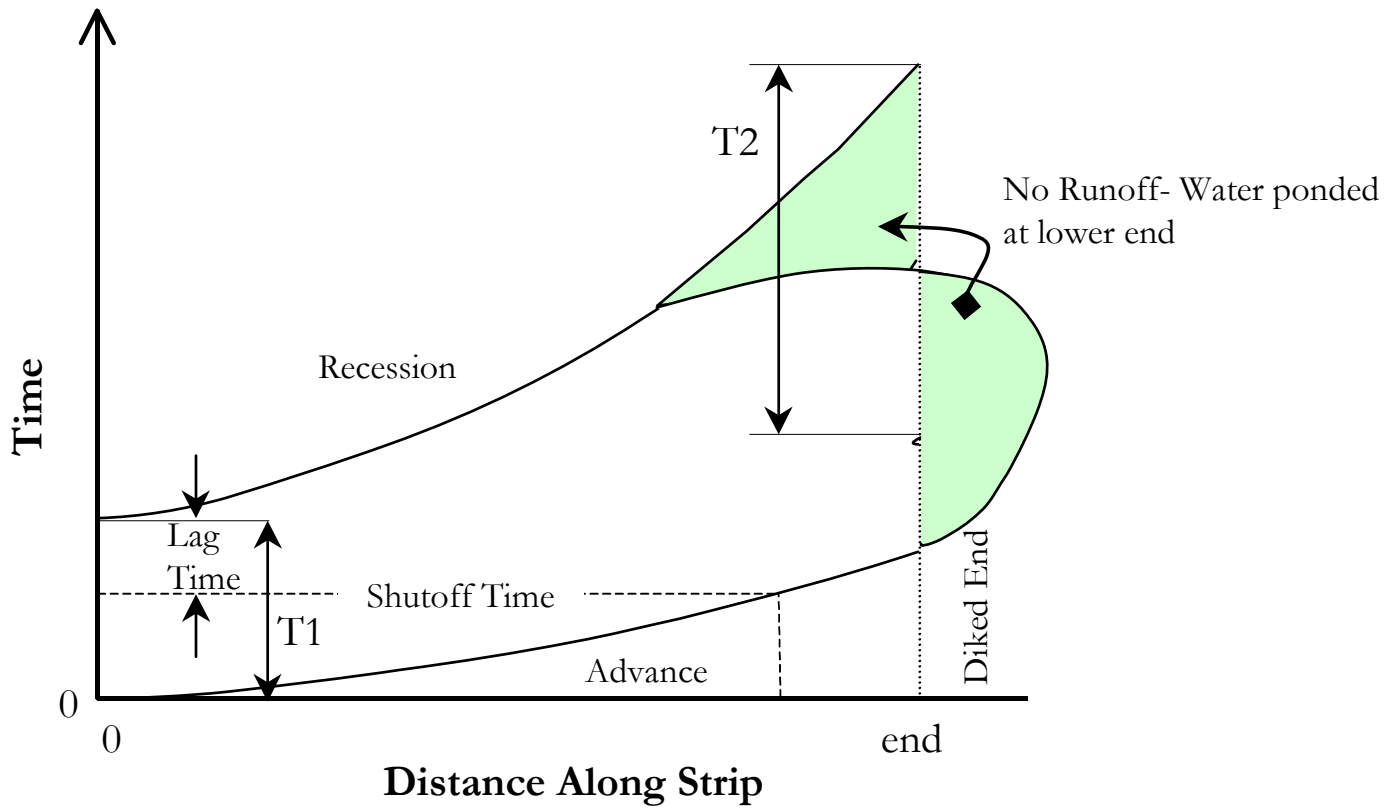


Figure 7-4. Greater Opportunity Time at Head of Strip: Flow Rate Too Small (Burt, 1995).



**Figure 7-5.** Greater Opportunity Time at Tail End of Strip: Flow Rate Too Large (Burt, 1995).



**Figure 7-6.** Typical Discharge Valve for Border Strip Application.

**Example 7-1: Establish Preliminary Design Criteria for a Graded Border System**

**Conditions**

Deep clay loam soil, finished grade, G: 0.3%,  
maximum monthly hydraulic loading,  $L_w$ : 12 in,

application frequency, F : 3 times per month, field  
area,  $A_w$ : 120 acres, crop: pasture.

**Solution**

1. Calculate the depth of wastewater to be applied using Equation 7-1.  

$$D = \frac{L_w}{F}$$

$$D = \frac{12 \text{ in}}{3} = 4 \text{ in}$$
2. Select border width and length from Table 7-6 for design conditions for shallow-rooted crops.  
 Width = 40 ft  
 Length = 600 ft
3. Select unit flow per width of strip, gpm from Table 7-6.  
 $q = 30 \text{ gpm/ft of width}$
4. Calculate the period of application,  $t_a$ , using Equation 7-6.  

$$t_a = LD / 96.3 q$$

$$t_a = (600 \text{ ft})(4) / (96.3)(30)$$

$$= 0.83 \text{ h}$$

5. Determine number of applications per day assuming a 12 h/d operating period.  
Number of applications =  $12 \text{ h/d} / 0.83 \text{ application}$
  
6. Determine the number of application zones.  
Application cycle is 10 day ( $\frac{30 \text{ d/mo}}{3 \text{ cycles/mo}}$ )  
Application zones =  $(10 \text{ d}) (15 \text{ applications/d}) = 150$
  
7. Calculate the area per zone,  $A_a$ .  
 $A_a = A_w / \text{number of zones}$   
 $= \frac{120 \text{ acres}}{150 \text{ zones}}$   
 $A_a = 0.8 \text{ acres}$
  
8. Determine the number of border strips per application zone.  
Number of borders =  $\frac{A_a}{(L)(W)}$   
 $= \frac{(0.8 \text{ acres})(43,560 \text{ ft}^2/\text{acre})}{(600 \text{ ft})(40 \text{ ft})}$   
 $= 1.45$ , use 2
  
9. Determine system flow capacity,  $Q$ .  
 $Q = (2 \text{ borders})(W)(q) = (2)(40 \text{ ft})(30 \text{ gpm/ft})$   
 $= 2,400 \text{ gpm}$   
The system must be capable of supplying 2,400 gpm during the maximum month.

Engineers (ASAE). Outlets used at currently operating systems include valved risers for underground piping systems and turnout gates from distribution ditches.

Basin layout and dimensions are controlled by topography, distribution system hydraulics, and loading rate. The number of basins is also affected by the selected loading cycle. As a minimum, the system should have enough basins so that at least one basin can be loaded at all times, unless storage is provided.

The number of basins also depends on the total area required for infiltration. Optimum basin size can range from 0.2 to 2 ha (0.5 to 5 ac) for small to medium sized systems to 2 to 8 ha (5 to 20 ac) for large systems. For a 24-ha (62-ac) system, if the selected loading cycle is 1 day of wastewater application alternated with 10 days of drying, a typical design would include 22 basins of 1.3 ha (2.8 ac) each. Using 22 basins, two basins would be flooded at a time and there would be ample time for basin maintenance before each flooding period.

At many sites, topography makes equal-sized basins impractical. Instead, basin size is limited to what will fit into areas having suitable slope and soil type. Relatively uniform loading rates and loading cycles can be maintained if multiple basins are constructed. However, some sites will require that loading rates or cycles vary with individual basins.

In flat areas, basins should be adjoining and should be square or rectangular to maximize land use. In areas where groundwater mounding is a potential problem, less mounding occurs when long, narrow basins with their length normal to the prevailing groundwater flow are used than when square or round basins are constructed. Basins should be at least 300 mm (12 in) deeper than the maximum design wastewater depth, in case initial infiltration is slower than expected and for emergencies. Basin walls are normally compacted soil with slopes ranging from 1:1 to 1:2 (vertical distance to horizontal distance). In areas that experience severe winds or heavy rains, basin walls should be planted with grass or covered with riprap to prevent erosion.

If basin maintenance will be conducted from within the basins, entry ramps should be provided. These ramps are formed of compacted soil at grades of 10 to 20 percent and are from 3 to 3.6 m (10 to 12 ft) wide. Basin surface area for these ramps and for wall slopes should not be considered as part of the necessary infiltration area.

## 7.4 Sprinkler Distribution

Sprinkler distribution is common to SR systems, is generally used with industrial OF systems, and can be used with SAT systems. Forest SR, OF and many agricultural SR systems use solid set (stationary) sprinkler

Slotted or perforated plastic pipe have fixed openings at intervals ranging from 0.3 to 1.2 m (1 to 4 ft). These systems operate under gravity or very low pressure and the pipe must be level to achieve uniform distribution. Consequently, such methods should be considered only for small systems having relatively short pipe lengths that can be easily leveled. The advantages and disadvantages of surface, spray, and sprinkler systems are compared in Chapter 9.

### 7.3.4 Surface Distribution for Soil Aquifer Treatment (SAT)

Although sprinklers may be used, wastewater distribution for SAT is usually by surface spreading. This distribution technique employs gravity flow from piping systems or ditches to flood the application area. To ensure uniform basin application, basin surfaces should be reasonably flat.

Overflow weirs may be used to regulate basin water depth. Water that flows over the weirs is either collected and conveyed to holding ponds for recirculation or distributed to other infiltration basins. If each basin is to receive equal flow, the distribution piping channels should be sized so that hydraulic losses between outlets to basins are insignificant. Design standards for distribution systems and for flow control and measurement techniques are published by the American Society of Agricultural



distribution, whereas move-stop and continuous move sprinklers are restricted to SR systems.

### 7.4.1 Design Application Rates

For all SR sprinkler systems the design application rate cm/h (in./h) should be less than the infiltration rate of the surface soil to avoid surface runoff. For final design, the application rate should be based on field infiltration rates determined from previous experience with similar soils and crops or from direct field measurements.

For solid set or move-stop sprinkler irrigation systems, the design application rate should be less than the saturated permeability or infiltration rate of the surface soil (see Chapter 3) to prevent runoff and uneven distribution. Application rates can be increased when a full cover crop is present (see Section 4.3.2.4). The increase should not exceed 100 percent of the bare soil application rate. Application rates for continuous move irrigation systems should not exceed the instantaneous infiltration rate and any available surface micro-storage during the period of water application. Recommended reductions in application rate for sloping terrain are given in Table 7-7. A practical minimum design application rate is 0.5 cm/h (0.2 in./h). For final design, the application rate should be based on field infiltration rates determined on the basis of previous experience with similar soils and crops or from direct field measurements.

**Table 7-7.** Recommended Reductions in Application Rates Due to Grade [McCulloch et al, 1973]

Percent Grade	Application rate reduction
0-5	0
6-8	20
9-12	40
13-20	60
Over 20	75

### Solid Set Systems

Solid set sprinkler systems remain in one position during the application season. The system consists of a grid of mainline and lateral pipes covering the field to be irrigated. Impact sprinklers are mounted on riser pipes extending vertically from the laterals. Riser heights are determined by crop heights and spray angle. Sprinklers are spaced at prescribed equal intervals along each lateral pipe, usually 12 to 30 m (40 to 100 ft). A system is called fully permanent or stationary when all lines and sprinklers are permanently located. Permanent systems usually have buried main and lateral lines to minimize interference with farming operations. Solid set systems are called fully portable when portable surface pipe is used for main and lateral lines. Portable solid set systems can be used in situations where the surface pipe will not interfere with farming operations and when it is desirable to remove the pipe from the field during periods of winter storage. When the mainline is

permanently located and the lateral lines are portable surface pipe, the system is called semipermanent or semiportable. The primary advantages of solid set systems are low labor requirements and maintenance costs, and adaptability to all types of terrain, field shapes, and crops. They are also the most adaptable systems for climate control requirements. The major disadvantages are high installation costs and obstruction of farming equipment by fixed risers.

### Application Rate

For solid set systems, the application rate is expressed as a function of the sprinkler discharge capacity, the spacing of the sprinklers along the lateral, and the spacing of the laterals along the main according to the following equation:

$$R = q_s C / S_s S_L \quad (7-7)$$

**Where:**

- R = application rate, in./h
- $q_s$  = sprinkler discharge rate, gpm
- C = constant = 96.3
- $S_s$  = sprinkler spacing along lateral, ft
- $S_L$  = lateral spacing along main, ft

Detailed procedures for sprinkler selection and spacing determination to achieve the desired application rate are given in the references (e.g., Fry et al., 1971; NRCS 1983; and Pair et al., 1983).

### Sprinkler Selection and Spacing Determination

Sprinkler selection and spacing determination involves an iterative process. The usual procedure is to select a sprinkler and lateral spacing, then determine the sprinkler discharge capacity required to provide the design application rate at the selected spacing. The required sprinkler discharge capacity may be calculated using Equation 7-7.

Manufacturers' sprinkler performance data are then reviewed to determine the nozzle sizes, operating pressures, and wetted diameters of sprinklers operating at the desired discharge rate. The wetted diameters are then checked with the assumed spacings for conformance with spacing criteria. Recommended spacings are based on a percentage of the wetted diameter and vary with the wind conditions. Recommended spacing criteria are given in Table 7-8.

The sprinkler and nozzle size should be selected to operate within the pressure range recommended by the



$$\begin{aligned} \text{Lateral spacing, } S_L &= \frac{60}{125} \\ &= 48\% < 65\% \end{aligned}$$

6. Change sprinkler spacing to 50 ft (OK at 40%), and lateral spacing to 80 ft (OK at 64%). Recalculate  $q_s = 10.4$  gpm. The same nozzle is satisfactory if the pressure is increased to 55 lb/in<sup>2</sup>. Wetted diameter is 127 ft.
7. Determine system flow capacity, Q.  
 $Q = A_s R = (10 \text{ acres})(0.25 \text{ in/h})(27,154 \text{ gal/acre}\cdot\text{in})(1 \text{ hr} / 60 \text{ min}) = 1,131 \text{ gpm}$

### 7.4.2 Solid Set Forest Systems

Solid set irrigation systems are the most commonly used systems in forests. Buried systems are less susceptible to damage from ice and snow and do not interfere with forest management activities (thinning, harvesting, and regeneration). Solid set sprinkler systems for forest crops have some special design requirements. Spacing of sprinkler heads must be closer and operating pressures lower in forests than other vegetation systems because of the interference from tree trunks and leaves and possible damage to bark. An 18-m (60-ft) spacing between sprinklers and a 24-m (80-ft) spacing between laterals has proven to be an acceptable spacing for forested areas. This spacing, with sprinkler overlap, provides good wastewater distribution at a reasonable cost. Operating pressures at the nozzle should not exceed 379 kPa (55 lb/in<sup>2</sup>), although pressures up to 586 kPa (85 lb/in<sup>2</sup>) may be used with mature or thickbarked hardwood species. The sprinkler risers should be high enough to raise the sprinkler above most of the understory vegetation, but generally not exceeding 1.5-m (5-ft). Low-trajectory sprinklers should be used so that water is not thrown into the tree canopies, particularly in the winter when ice buildup on pines and other evergreen trees can cause the trees to be broken or uprooted.

A number of different methods of applying wastewater during subfreezing temperatures in the winter have been attempted. These range from various modifications of rotating and nonrotating sprinklers to furrow and subterranean applications. General practice is to use low-trajectory, single nozzle impact-type sprinklers, or low-trajectory, double nozzle hydraulic driven sprinklers.

Installation of a buried solid set irrigation system in existing forests must be done with care to avoid excessive damage to the trees or soil. Alternatively, solid set systems can be placed on the surface if adequate line drainage is provided (see Figure 7-7). For buried systems, sufficient vegetation must be removed during construction to ensure ease of installation while minimizing site disturbance so that site productivity is not decreased or erosion hazard increased. A 3-m (10-ft) wide path cleared for each lateral

meets these objectives. Following construction, the disturbed area must be mulched or seeded to restore infiltration and prevent erosion. During operation of the land treatment system, a 1.5-m (5-ft) radius should be kept clear around each sprinkler. This practice allows better distribution and more convenient observation of sprinkler operation. Water distribution patterns will still not meet agricultural standards, but this is not as important in forests because the roots are quite extensive.



Figure 7-7. Forest Solid Set Sprinkler Irrigation at Clayton County.

### 7.4.3 Solid Set Overland Flow Systems

Sprinkler distribution systems recommended for OF systems are discussed in Chapter 9. High pressure, 50 to 80 lb/in<sup>2</sup>, impact sprinklers have been used successfully with food processing wastewaters containing suspended solids concentration >500 mg/L. The position of the impact sprinkler on the slope is also discussed in Chapter 9. Spacing for low-pressure fixed spray heads at the top of the overland flow slopes should meet the same criteria as spacing for rotating sprinklers.

The spacing of the sprinkler along the slope depends on the design application rate and must be determined in conjunction with the sprinkler discharge capacity and the diameter of coverage. The relationship between OF application rate and sprinkler spacing and discharge capacity is given by the following equation:

$$R = \frac{q}{S_s} \quad (7-8)$$

Where:

- R = OF application rate, gpm/ft of slope width
- q = sprinkler discharge rate, gpm
- S<sub>s</sub> = sprinkler spacing, ft

The sprinkler spacing should allow for some overlap of sprinkler diameters. A spacing of about 80 percent of the wetted diameter should be adequate for OF. Using the

design OF application rate and the above criteria for overlap, a sprinkler can be selected from a manufacturer's catalog.

### 7.4.4 Move-Stop Sprinkler Systems

With move-stop systems, sprinklers (or a single sprinkler) are operated at a fixed position in the field during application. After the desired amount of water has been

applied, the system is turned off and the sprinklers (or sprinkler) are moved to another position in the field for the next application. Multiple sprinkler move-stop systems include portable hand-move systems, end tow systems, and wheel line (also known as side-roll) systems. Single sprinkler move-stop systems include stationary gun systems. Diagrams of operation for the different types of move-stop sprinkler systems are shown in Figure 7-8.

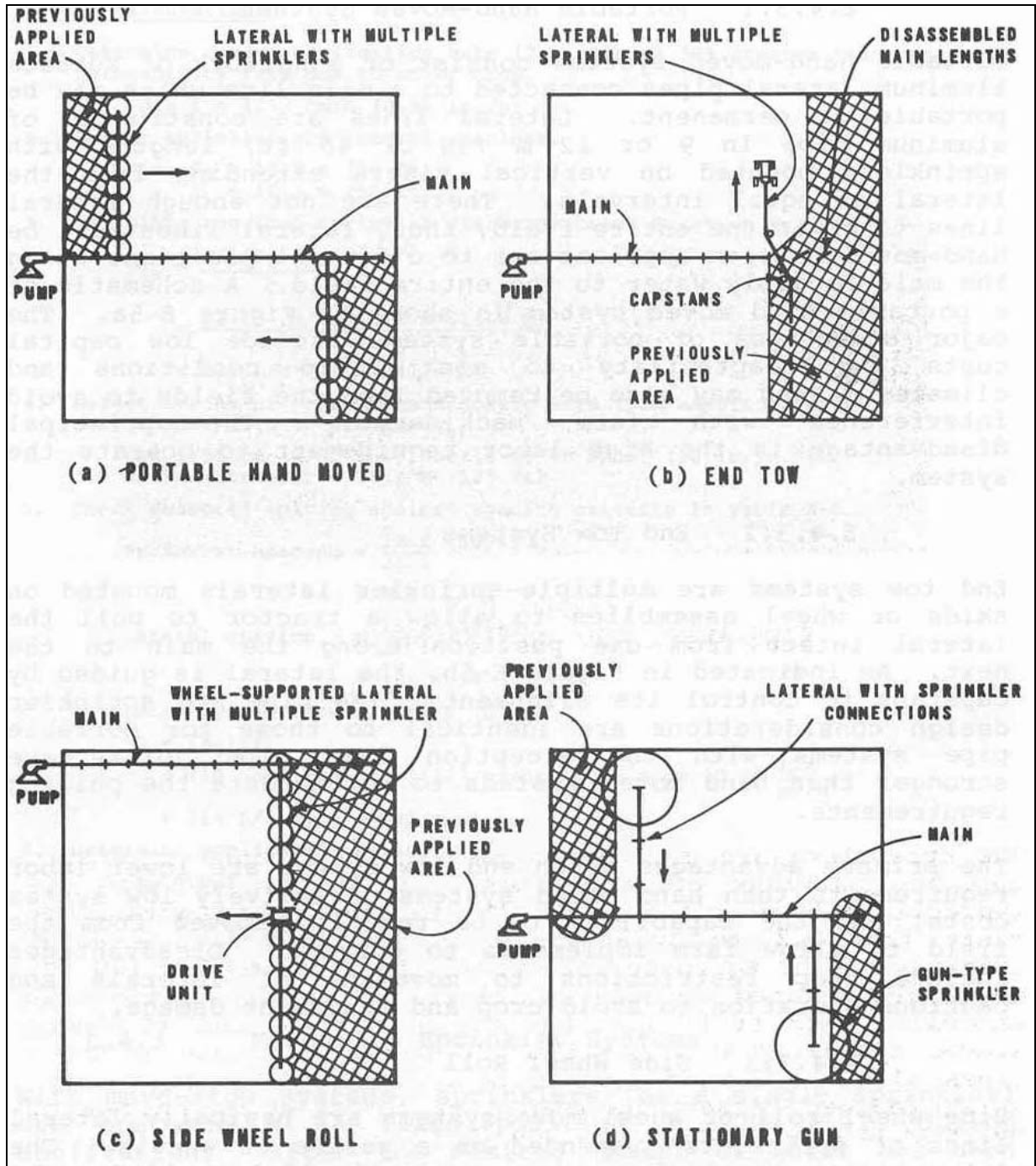


Figure 7-8. Move-Stop Sprinkler Systems.

## Portable Hand Move Systems

Portable hand move systems consist of a network of surface aluminum lateral pipes connected to a main line which may be portable or permanent. The major advantages of these systems include low capital costs and adaptability to most field conditions and climates. They may also be removed from the fields to avoid interference with farm machinery. The principal disadvantage is the high labor requirement to operate the system.

## End Tow Systems

End tow systems are multiple-sprinkler laterals mounted on skids or wheel assemblies to allow a tractor to pull the lateral intact from one position along the main to the next. The pipe and sprinkler design considerations are identical to those for portable pipe systems with the exception that pipe joints are stronger than hand-moved systems to accommodate the pulling requirements.

The primary advantages of an end tow system are lower labor requirements than hand-moved systems, relatively low system costs, and the capability to be readily removed from the field to allow farm implements to operate. Disadvantages include crop restrictions to movement of laterals and cautious operation to avoid crop and equipment damage.

## Wheel Line

Wheel line or side-roll systems are basically lateral lines with sprinklers that act as the axle for a series of large diameter wheels. The lateral line is aluminum pipe, typically 100 to 125 mm (4 to 5 in) in diameter and up to 406 m (1,320 ft) long. The wheels are aluminum and are 1.5 to 2.1 m (5 to 7 ft) in diameter (see Figure 7-9). The end of the lateral is connected by a flexible hose to hydrants located along the main line. The unit is stationary during application and is moved between applications by an integral engine powered drive unit located at the center or end of the lateral.

The principal advantages of wheel line systems are lower labor requirements and overall cost than hand-move systems, and freedom from interference with farm implements. Disadvantages include restrictions to crop height and field shape, and misalignment of the lateral caused by uneven terrain.

## Stationary Gun Systems

Stationary gun systems are wheel-mounted or skid-mounted single sprinkler units, which are moved manually between hydrants located along the laterals. The advantages of a stationary gun are similar to those of portable pipe systems with respect to capital costs and versatility. In addition, the larger nozzle of the gun-type sprinkler is relatively free from clogging. The drawbacks to

this system are similar to those for portable pipe systems in that labor requirements are high due to frequent sprinkler moves. Power requirements are relatively high due to high pressures at the nozzle, and windy conditions adversely affect distribution of the fine droplets created by the higher pressures.



Figure 7-9. Side-Wheel Roll Sprinkler System.

## Design Procedures

The design procedures regarding application rate, sprinkler selection, sprinkler and lateral spacing, and lateral design for move-stop systems are basically the same as those described for solid set sprinkler systems. An additional design variable for move-stop systems is the number of units required to cover a given area. The minimum required number of units is a function of the area covered by each unit, the application frequency, and the period of application. More than the minimum number of units can be provided to reduce the number of moves required to cover a given area. The decision to provide additional units should be based on the relative costs and availability of equipment and labor.

### 7.4.5 Continuous Move Systems

Continuous move sprinkler systems are self-propelled and essentially move continuously during the application period. The three types of continuous move systems are (1) traveling gun, (2) center pivot, and (3) linear move. Diagrams showing the operation of continuous move sprinkler systems are shown in Figure 7-10.

## Traveling Gun Systems

Traveling gun systems are self-propelled, single large gun sprinkler units that are connected to the supply source by a hose 63 to 127 mm (2.5 to 5 in) in diameter. Two types of travelers are available, the hose drag-type and the reel-type. The hose drag traveler is driven by a hydraulic or gas-driven winch located within the unit, or a gas-driven winch located at the end of the run. In both cases, a cable anchored at the end of the run guides the unit in a straight

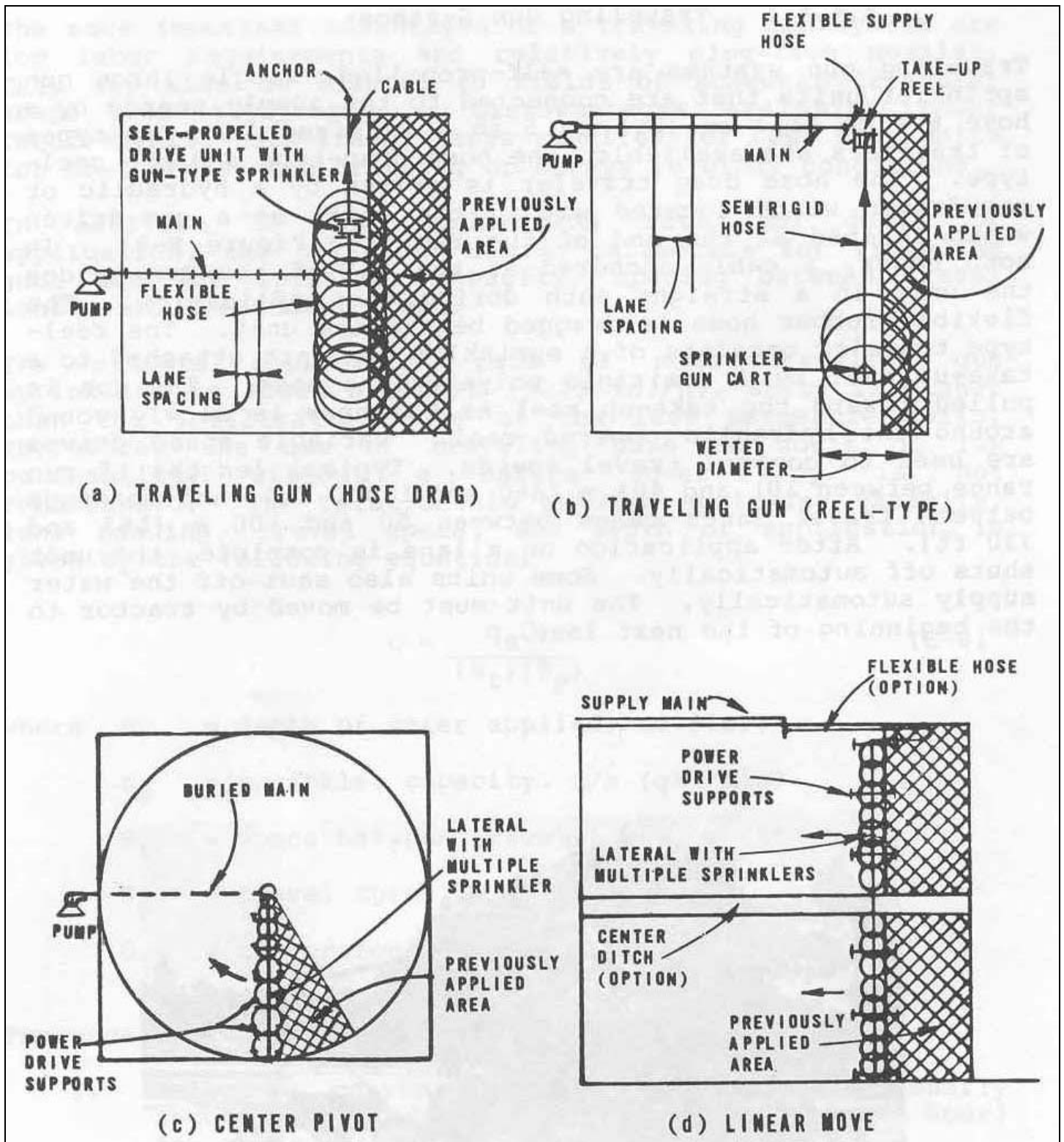


Figure 7-10. Continuous Move Sprinkler Systems.

path during the application. The flexible rubber hose is dragged behind the unit. The reel-type traveler (see Figure 7-11) consists of a sprinkler gun cart attached to a take-up reel by a semi-rigid polyethylene hose. The gun is pulled toward the take-up reel as the hose is slowly wound around the hydraulic powered reel. Variable speed drives are used to control travel speeds. Typical lengths of run range between 201 to 403 m (660 and 1,320 ft), and spacings between travel lanes range between 50 to 100 m (165 and 330 ft). After application on a lane is complete, the unit shuts off automatically. Some units also shut off the water supply automatically. The unit must be moved by tractor to the beginning of the next lane.



**Figure 7-11.** Reel-Type Traveling Gun Sprinkler.

The more important advantages of a traveling gun system are low labor requirements and relatively clog-free nozzles. They may also be adapted to fields of somewhat irregular shape and topography. Disadvantages are high power requirements, hose travel lanes required for hose drag units for most crops, and drifting of sprays in windy conditions. Traveling gun systems are generally more suited to systems with low operating hours per year.

In addition to the application rate and depth of application, the principal design parameters for traveling guns are the sprinkler capacity, spacing between travel lanes (see Table 7-10), and the travel speed.

**Table 7-10.** Recommended Maximum Lane Spacing for Traveling Gun Sprinklers

Wind speed, mi/h	Lane spacing, % of wetted diameter
0	80
0-5	70-75
5-10	60-65
>10	50-55

The minimum application rate of most traveling gun sprinklers is about 5.8 mm/h (0.23 in./h), which is higher than the infiltration rate of the less permeable soils. Therefore, the use of traveling guns on soils of low permeability without a mature cover crop is not recommended. The relationship between sprinkler capacity, lane spacing, travel speed, and depth of application is given by the following equation:

$$D = \frac{q_s C}{(s_t)(S_p)} \quad (7-9)$$

**Where:**

- D = depth of water applied, in
- q<sub>s</sub> = sprinkler capacity, gpm
- S<sub>t</sub> = space between travel lanes, ft
- S<sub>p</sub> = travel speed, ft/min
- C = conversion constant, 1.60

The typical design procedure is as follows:

1. Select a convenient application period, h/d, allowing at least 1 h between applications to move the gun.
2. Estimate the area to be irrigated by a single unit. This value should not exceed 80 acres (32 ha).
3. Calculate the sprinkler discharge capacity using Equation 7-7.

$$q_s = \frac{(435)(D)(A)}{Ct} \quad (7-10)$$

**Where:**

- q<sub>s</sub> = sprinkler discharge capacity, gpm
- D = depth of wastewater applied per application, in
- A = area irrigated per unit, acres
- C = cycle time between applications, d
- t = operating period, h/d

4. Select a sprinkler size and operating pressure from manufacturer's performance tables that will provide the estimated discharge capacity.
5. Calculate the application rate using Equation 7-8.

$$R = \frac{96.3 Q}{r^2} \quad (7-11)$$

**Where:**

- R = application rate, in/h
- Q = sprinkler capacity, gpm
- r = sprinkler wetted radius, ft

6. Compute the lane spacing as a percentage of the wetted diameter against spacing criteria in Table 7-10.
7. Adjust sprinkler selection and lane spacing as necessary to be compatible with soil intake rate.

8. Calculate the travel speed using Equation 7-9 as rearranged:

$$S_p = \frac{1.6q_s}{D S_t}$$

9. Calculate the area covered by a single unit.

$$A = \frac{S_t(\text{travel distance, ft/d})(\text{cycle, d})}{43,560 \text{ ft}^2/\text{acre}}$$

10. Determine the total number of units required.

$$\text{Units required} = \frac{\text{field area}}{\text{unit area}}$$

11. Determine the system capacity, Q  
 $Q = (q_s)(\text{number of units})$

---

**Example 7-3: Establish Preliminary Design Criteria for Reel Type Traveling Gun System**

---

**Conditions**

Loam soil, infiltration rate : 0.4 in/h, depth of wastewater applied, D : 3 in, field area : 100 acres, application cycle : every 10 d, average wind speed : 5 mph.

**Solution**

1. Select a 15 h/d application period
2. Estimate 25 acres/unit
3. Calculate the sprinkler discharge capacity

$$q_s = \frac{(435)(3)(25)}{(10)(15)}$$

$$= 217.5 \text{ gpm}$$

4. Select a sprinkler with a 230 gpm capacity and a wetted diameter of 340 ft.
5. Calculate the application rate

$$R = \frac{96.3(230)}{(170)^2}$$

$$= 0.24 \text{ in./h } (< 0.4 \text{ in./h, OK})$$

6. Lane spacing should be less than 70% to 75% of wetted diameter

$$S_t = 0.7(340) = 238 \text{ ft}$$

use 240 ft

7. Calculate the travel speed

$$S_p = \frac{(1.6)(230)}{(3)(240)}$$

$$= 0.5 \text{ ft/min}$$

8. Calculate the area covered by a single unit

$$A = \frac{(240)(0.5)(15 \text{ h})(-h)(10 \text{ d})}{43,560}$$

$$= 24.8 \text{ acres}$$

9. Calculate the number of units required

$$\text{Units required} = \frac{100 \text{ acres}}{24.8 \text{ acres/unit}}$$

$$= 4.03$$

use 4 units

10. Calculate the system capacity, Q

$$Q = (q_s)(\text{number of units}) = (230 \text{ gpm})(4) = 920 \text{ gpm}$$


---

## Center Pivot Systems

Center pivot systems consist of a truss supported lateral with multiple sprinklers or spray nozzles that are mounted on self-propelled, continuously moving tower units (see Figure 7-12 and Figure 7-13) rotating about a fixed pivot in the center of the field. Sprinklers on the lateral may be high-pressure impact sprinklers; however, the trend is toward use of low-pressure spray nozzles or other low-pressure sprinkling devices to reduce energy requirements. Water is supplied by a buried main to the pivot, where

power is also furnished. The lateral is usually constructed of 150 to 200 mm (6 to 8 in.) steel pipe 60 to 780 m (200 to 2,600 ft) in length. A typical system with a 393 m (1,288 ft) lateral is centered on a 64 ha (160-ac) parcel. The circular pattern reduces coverage to about 52 ha (130 ac), although systems with swing out corner laterals or high-pressure corner guns are available to irrigate a portion of the corners.

The tower units are driven electrically or hydraulically and may be spaced from 24 to 76 m (80 to 250 ft) apart. Control of the travel speed is achieved by varying the average speed of the end tower motor. Most systems run the end tower motor for an adjustable percentage of a short interval (1 to 2 minutes), while a few systems control the speed directly. Cable or other guidance mechanisms are employed to sense the alignment of the towers and actuate the inner tower motors to keep up with the outer tower.



**Figure 7-12** Center Pivot Sprinkler Unit.



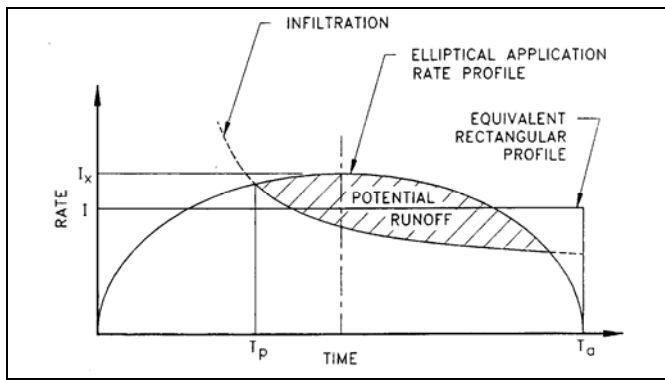
**Figure 7-13.** Center Pivot Irrigation System.

An important limitation of the center pivot system is the required variation in sprinkler discharge rates along the length of the pivot lateral. Because the area circumscribed by a given length of pivot lateral increases with distance from the pivot point (as does the ground speed of the unit), the discharge per unit of lateral length provided by the



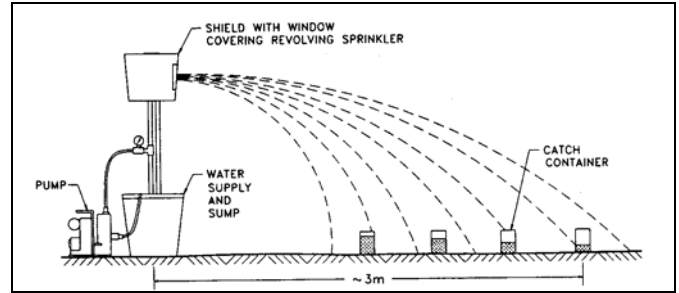
sprinklers must increase with distance from the center to provide a uniform depth of application. Increasing the discharge rate can be accomplished by decreasing the spacing of the sprinklers along the lateral and increasing the discharge capacity of the individual sprinklers. The resulting application rates at the outer end of the pivot lateral can be so high as to be unacceptable for many soils.

Since center pivot sprinkler systems typically apply water on a more frequent basis and for shorter durations than move-stop sprinkler systems, short term soil infiltration and surface storage characteristics are more important than the long-term infiltration rate. On a short term basis, the infiltration rate normally decreases exponentially with the amount of water infiltrated. In addition, infiltration rates normally decrease over the season due to surface soil sealing from sprinkler droplet impact. Figure 7-14 shows a graphical representation of water application, infiltration rate, and potential runoff with center pivot irrigation. Potential runoff will become actual runoff if there is not sufficient surface storage to retain the excess water.



**Figure 7-14.** Intersection Between an Elliptical Moving Application Rate Profile Under a Center-pivot Lateral and a Typical Infiltration Curve.

Equation 7-12 can be used to describe short-term infiltration characteristics of soils (Keller and Bleisner, 1990). The coefficients for Equation 7-12 can be determined by fitting a curve (or regression of the logarithms) of sprinkling infiltration test data which measures depth to ponding at various application rates as shown in Figure 7-15 (Reinders and Louw, 1985). Soil surface and moisture conditions should be as close to anticipated field conditions as possible.



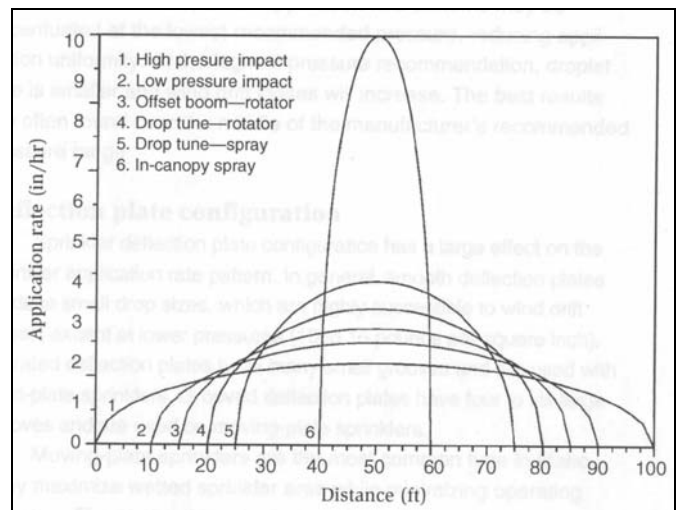
**Figure 7-15.** Schematic of the Revolving – Sprinkler Infiltrometer.

$$D_i = k_p(T_p)^P \quad (7-12)$$

Where:

- $D_i$  = depth infiltrated for average sprinkle application rate at time of ponding
- $k_p$  = time-to-ponding coefficient dependent on soil and water characteristics at the time of the test and the measurement units used
- $P$  = time-to-ponding exponent dependent on soil and water characteristics at the time of the test

A variety of sprinkler spacing packages are available from the manufacturers along with various types of impact sprinklers, rotating plate sprinklers, and fixed sprays. The rotating plate sprinklers and fixed sprays can also be placed on offset booms to increase the wetted width and thereby decrease application rates. The selection of the sprinkler package should take into account the soil infiltration rate curve, slope, wind conditions, potential for soil compaction, and pressure requirements. Typical relative application rates for various types of application packages are shown in Figure 7-16. The center pivot flow rate and application rate near the end of the center pivot can be calculated using Equations 7-12 and 7-13, respectively.



**Figure 7-16.** Comparison of Relative Application Rates Under Various Center Pivot Sprinkler Packages.

The flow capacity of a center pivot system is given by Equation 7-10.

$$Q = 1,890 D A \quad (7-13)$$

**Where:**

- Q = flow capacity, gpm
- D = average daily depth of wastewater application, in/d
- A = area of application, acres

The average application rate at the end of the center pivot lateral is given by Equation 7-14.

$$I = \frac{2\pi L}{W} \cdot \frac{D}{T} \quad (7-14)$$

**Where:**

- I = average application rate of the last sprinklers, in/h (mm/h)
- L = center pivot length, ft (m)
- D = average daily depth of wastewater application, in/d (mm/d)
- W = wetted width of the last few sprinklers or sprays (including offset boom length, if offset booms are used), ft (m)
- T = average operating hours per day

Surface storage is dependent upon slope, crop, and cultural practices. Some preliminary values for surface storage as a function of slope are shown in Table 7-11 (Rogers et al, 1994).

**Table 7-11.** Typical Values for Surface Storage

Slope	Storage (in.)
0 - 1%	0.5
1% - 3%	0.3
3% - 5%	0.1
>5%	0.0

Operating center pivots at a higher rotation rate will decrease the depth of application per irrigation. This takes greater advantage of surface storage and higher early instantaneous infiltration rates to reduce runoff. If the coefficients for Equation 7-9 can be estimated from infiltrometer or other data and surface storage is estimated from Table 7-11, the application time that will not cause runoff can be calculated with Equation 7-12. The maximum rotational time that will not cause runoff can then be calculated using Equation 7-13. (Keller and Bleisner, 1990).

$$SS = \frac{I(T_a)}{60} - K_p (T_a)^P \quad (7-15)$$

**Where:**

- SS = Surface Storage
  - I = Average application rate near end of center pivot
  - T<sub>a</sub> = Time of application to pond and fill surface storage
  - K<sub>p</sub> = Time to ponding coefficient from Eq. 7-9.
  - P = Time to ponding exponent from Eq. 7-9.
- Solve for T<sub>a</sub> by convergent trial and error.

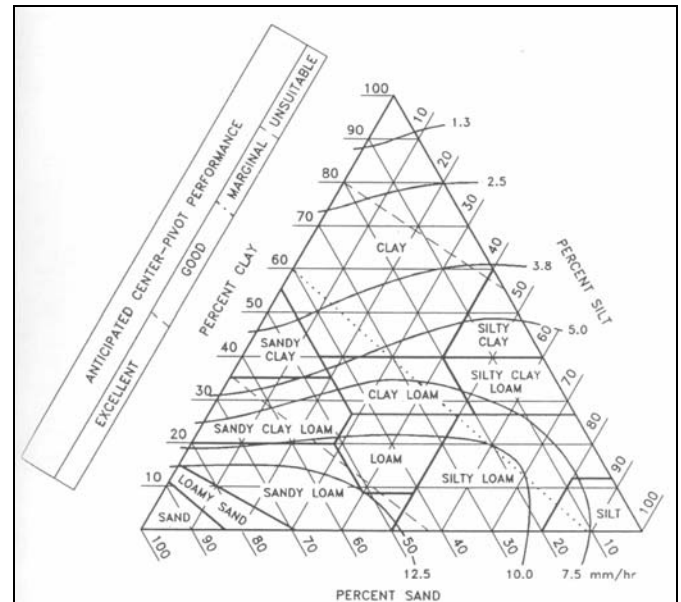
$$T_{cr} = \frac{2\pi L}{60} \frac{W}{T_a} \quad (7-16)$$

**Where:**

- T<sub>cr</sub> = Critical maximum rotation time which will not cause runoff
- L = Length of center pivot lateral
- W = Wetted width of sprinklers at end of center pivot lateral (including offset booms)
- T<sub>a</sub> = Time of application to pond and fill surface storage from Eq.7-15

A sprinkler package with a sufficient wetted width should be selected such that the calculated time of rotation for no runoff is greater than 24 hours at a minimum. Short rotation times can cause crops to be shallow rooted, and the more frequent wetting can increase mold disease in some crops. Ideally, design rotation times should be 48 hours or greater.

Sprinkler packages should be selected to minimize or eliminate estimated runoff. If good soil infiltration test data are not available, it is usually best to rely upon local experience in the selection of sprinkler packages. Figure 7-17 can also be used to obtain a rough idea of the feasibility of center pivot irrigation if only soil texture is known.



**Figure 7-17.** Anticipated Center Pivot Performance versus Soil Texture.

Water droplet kinetic energy can adversely affect infiltration rates as an irrigation season progresses. For soils that have low structural cohesion or are otherwise susceptible to sealing, water droplet energy should be considered when selecting a sprinkler package. Water sprinkler or spray devices have relatively smaller nozzles droplet energy is typically lower for fixed sprays than for

sprinklers. Water droplet energy is also lower when and/or are operated in the higher end of their pressure ranges.

A limitation of center pivots is mobility under certain soil conditions. Some clay soils can build up on wheels and eventually cause the unit to stop. Drive wheels can lose traction on slick (silty) soils and can sink into soft soils and become stuck. Runoff exacerbates these conditions. As a result, high flotation tires are used and low tire pressures are recommended according to the data in Table 7-12.

**Table 7-12.** Recommended Soil Contact Pressure for Center Pivots

Percent fines	Pounds per square inch
20	25
40	16
50	12

## Linear Move Systems

Linear move systems are constructed and driven in a similar manner to center pivot systems, except that the unit moves continuously in a linear path rather than a circular path. Complete coverage of rectangular fields can thus be achieved while retaining all the advantages of a continuous move system. Water can be supplied to the unit through a flexible hose that is pulled along with the unit or it can be pumped from an open center ditch constructed down the length of the linear path. Slopes greater than 5 percent restrict the use of center ditches. Manufacturers should be consulted for design details.

Application rate under a linear move system is a function of the system flow, wetted width of the sprinkler package, and the system length as shown in Equation 7-17. Equation 7-15 can then be used to calculate the maximum time of application for a linear move system for no runoff, where time of application is equal to wetted width divided by travel speed. Flow, wetted width, total travel distance, and travel speed are all factors which can be adjusted during the planning process to arrive at a linear move system design which minimizes potential runoff.

$$I = \frac{C Q}{L W} \quad (7-17)$$

**Where:**

- I = average application rate, mm/h (in/h)
- C = unit conversion factor = 1 (96.3)
- Q = system flow rate, L/h (gpm)
- L = linear move length, m (ft)
- W = wetted width of the sprinklers or sprays (including offset boom length, if offset booms are used), m (ft)

## 7.5 Micro Irrigation Distribution System Planning and Design

Micro irrigation encompasses drip or trickle irrigation and micro-spray irrigation systems. Micro irrigation systems usually deliver water to emission devices immediately adjacent to individual plants. Flow rates of micro irrigation emission devices range from 2 L/h (0.5 gal/h) for low flow emitters to 120 L/h (30 gal/h) for the largest micro-sprays.

Micro irrigation is not typically used for large-scale wastewater land treatment systems. It is most commonly used for landscape irrigation with effluent that has been treated to tertiary levels (oxidation, filtration, and disinfection). Micro irrigation can be used to distribute wastewater with lower degrees of treatment than tertiary, but much more care is then needed in equipment selection and operation. Micro irrigation is gaining increased attention as a distribution method for wastewater from small and onsite treatment systems. Micro irrigation is also used for such specialized applications such as landscape irrigation around treatment plants and to provide water for odor biofilters. Micro irrigation has little to offer for OF and conventional SAT systems.

There are a number of very good references for micro irrigation design (e.g., Keller and Bliesner, 1990). Rather than cover that material extensively, the information provided in this chapter will give an overview of micro irrigation design issues with special attention to the prevention of plugging.

### 7.5.1 Soil Wetting

Micro irrigation devices typically only wet a portion of the horizontal cross sectional area of the soil (see Figure 7-18). The target percentage of area wetted is generally 33 percent to 67 percent for wide spaced crops such as trees and vines (Keller and Bliesner, 1990). Yields can suffer at wetted areas lower than 33 percent while some of the benefits such as reduced water use and fewer weeds diminish at values above 67 percent. The minimum target percentage for closely spaced crops is also 33 percent, but the higher density of emission devices often translates into a wetted area of over 67 percent. Field tests with emission devices are usually the best way to determine wetted width for a given type of device at the planned irrigation site.

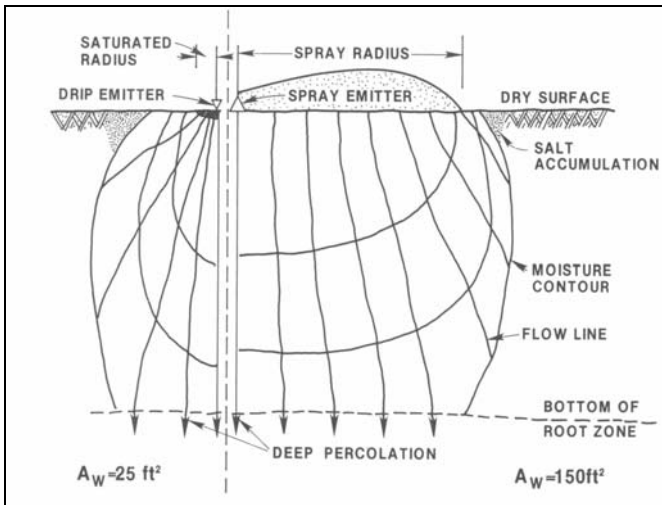


Figure 7-18. Comparison of Wetting Profiles in Sandy Soil.

### 7.5.2 Micro Irrigation Design Criteria

In addition to wetted width, the most important micro irrigation system design criteria are as follows:

- Efficiency of filtration
- Permissible variations of pressure head
- Base operating pressure to be used
- Degree of control of flow or pressure
- Relation between discharge and pressure at the pump or hydrant supplying the system
- Allowance for temperature correction for long path emitters
- Chemical treatment to dissolve or prevent deposits
- Use of secondary safety screening
- Incorporation of flow monitoring
- Allowance for reserve system capacity or pressure to compensate for reduced flow due to clogging

Of the above criteria, the filtration and chemical treatment criteria are critical when wastewater is to be used in the micro irrigation system.

### 7.5.3 General System Layout

Agricultural scale micro irrigation distribution systems normally include mainlines, submains, laterals, and emitters. Sometimes manifolds are also utilized to control flow and pressure to a number of laterals off a submain. Landscape or small scale micro irrigation may only have submain and lateral piping. A typical layout for an agricultural micro irrigation system is shown in Figure 7-19.

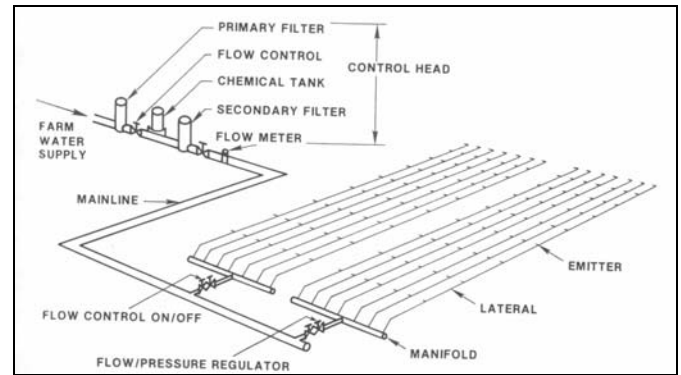


Figure 7-19. Typical Micro Irrigation System Layout.

### 7.5.4 Emission Device Flow Characteristics

Flow from emission devices can usually be characterized by the following equation:

$$Q = KH^X \quad (7-18)$$

Where:

- Q = flow
- K = discharge coefficient
- H = pressure head
- X = emitter discharge exponent

The most common types of emission devices based on flow characteristics are long path, turbulent flow, orifice, and pressure compensating. Flow exponents range from zero for fully compensating devices to 0.5 for orifice and turbulent flow devices to approximately 0.7 for smooth long path devices. The flow exponents are very important in the design of micro irrigation systems for discharge uniformity. Low flow exponents generally provide higher uniformity and greater latitude in system design, especially for systems on undulating terrain.

Coefficient of manufacturing variability is important in the overall uniformity of application. Flow rate coefficients of variability less than 0.05 are generally considered excellent, while coefficients greater than 0.11 are considered poor.

### 7.5.5 Selection of Emission Devices to Minimize Plugging

When micro irrigation systems are used to distribute effluent, the selection of the proper emission device can be critical for preventing plugging. The best emission devices are those which have automatic flushing features built into

them. The relative resistance to plugging of various types of emitters is shown in Table 7-13.

Susceptibility to gradual plugging can usually be overcome with an aggressive chemical treatment and flushing program, except in the case of porous pipe.

It should be noted that the flow rate for an emission device is determined by the size of the flow path within the emission device. An 8 L/h emitter will have a larger flow path than a 2 L/h emitter, and therefore be much more resistant to plugging. Distribution systems for effluent should always use emission devices with the highest

possible flow rates that still meet the basic system design criteria.

Inline drip emitters or drip tape can be especially sensitive to plugging because of the low flow rates of each emitter. Emission devices incorporating inlet filtering, automatic flushing, and larger flow paths are strongly recommended when considering inline or tape products. Manufacturer's specific recommendations should also be considered in the selection of emission devices and the corresponding filtration and water treatment for any specific application.

**Table 7-13.** Relative Resistance to Plugging for Various Emission Devices

Emitter Type	Resistance to Catastrophic Particulate Plugging	Resistance to Gradual Plugging
Multiple Flexible Orifice (continuous flushing)	High	Moderate
Compensating Diaphragm – turbulent path (continuous flushing)	Moderately High	Moderately High
Micro-Sprays	Moderate	High
Compensating Diaphragm – straight path or groove	Moderate	Moderately Low
Long Path Turbulent	Moderate	Moderate
Long Path Straight or Spiral	Moderately Low	Low
Porous Pipe*	High	Very Low

\*Not recommended for use in any wastewater irrigation system.

### **7.5.6 Submain, Manifold and Lateral Design**

The distribution piping should be designed to minimize overall costs (capital and energy) and maintain a high uniformity. Pressure regulator valves or devices are normally installed either at the beginning of the submain or at the inlet to the manifold. Piping downstream of the last pressure regulation point should be designed to keep the minimum emitter flow rate greater than 90 percent of the average emitter flow rate. Lateral length and diameter are usually key factors for emission uniformity. When barbed emitters or couplings are used, it is important to include minor losses caused by the barbs in the laterals. There are graphical and numerical solutions available in micro irrigation design guides that combine emitter flow characteristics with losses in laterals, manifolds, and submains to enable calculation of average and minimum flow rates.

Laterals should also be designed with automatic flush valves or a flushing manifold at the ends of the laterals to enable regular flushing and prevent the buildup of sediments in the lateral. This is critical for the long term prevention of plugging in effluent distribution systems.

### **7.5.7 Subsurface Drip Irrigation System Considerations**

Subsurface drip irrigation is appealing because the laterals are out of the way for cultural practices and less susceptible to physical damage. With subsurface drip

irrigation, wetting of the ground surface is minimal. This can be a desirable aesthetic consideration for disposal/reuse of treated effluent.

The main disadvantage of subsurface drip irrigation is that emitter performance is not readily observable, so plugging can become serious before the irrigator recognizes the problem. Subsurface emitters can also be susceptible to root intrusion, and laterals can be subject to root pinching. Emitters impregnated with herbicide to prevent root intrusion are commercially available. Root intrusion can also be prevented by regular shock chlorination as discussed later in this section.

### **7.5.8 Subsurface Drip Irrigation for Small and Onsite Systems**

There is an increasing level of interest in using drip irrigation components for the subsurface distribution of effluent from small and on-site wastewater treatment systems. These systems typically have septic tank or other sedimentation treatment followed by intermittent sand filtration or other small scale secondary treatment. The effluent is then applied below grass or landscape areas to provide supplemental irrigation and disposal. The emission device selection and system design considerations are the same as discussed in this section. One of the differences for small and on-site systems is that relatively higher flow rate emitters can be used. A second difference is that emission devices should be designed to prevent root intrusion through chemical impregnation or physical

---

features. The designer may also want to consider sleeving the laterals in larger PVC or polyethylene perforated drain pipes for easy replacement if the laterals become irreversibly plugged.

### **7.5.9 Micro-Spray System Considerations**

In comparison to drip emitters, micro-sprays have a direct area of coverage. The area of spray coverage plus subsurface lateral movement of water should provide adequate coverage of the root zone of the crop at maturity.

Micro-sprays are commonly used for trees and landscape beds in place of multiple drip emitters. The proper functioning of micro-sprays is easier to observe than for drip emitters, and micro-sprays are generally less susceptible to gradual plugging than drip emitters. The main disadvantage of micro-sprays is that the mounting stakes are generally more susceptible to damage than individual drip emitters.

### **7.5.10 Filtration**

Primary wastewater treatment must be provided as an absolute minimum prior to any micro irrigation system filters. Partial or full secondary treatment is also highly recommended. High-rate automatic sand media filtration is the filtration of choice for effluent micro irrigation systems. For systems smaller than 10 L/s (150 gpm), more advanced biological treatment followed by automated disk filters may be satisfactory. Screen filters are only recommended for highly treated effluent, and should be very significantly oversized.

In general, filtration should be provided to 74 micron (200 mesh) equivalent screen size. Small systems with emitters which are highly resistant to plugging can use somewhat coarser filtration depending upon the manufacturer's recommendations. Filter units should be oversized and should have plenty of backflush flow capacity. For automated filter banks, three or more filter units per bank will provide better backflushing performance than two unit banks.

### **7.5.11 Chemical Treatment to Prevent Plugging**

Chemical water treatment should be provided for all effluent micro irrigation systems except possibly tertiary effluent with adequate residual chlorine. Chemical treatment is used to prevent and dissolve organic (algae and bacterial slime) and mineral deposits which can form in lateral lines and emission devices. Chlorine and acids are most commonly used for chemical treatment. Hydrogen peroxide can be substituted for chlorine when high concentrations of oxidant are needed to restore system capacity.

For tertiary treated wastewater, maintaining 1.0 mg/L of free residual chlorine at the ends of laterals is generally

adequate to prevent plugging. For primary or secondary effluent, the most effective strategy is to inject sufficient chlorine to bring the concentration of free chlorine at the ends of the laterals to 10 mg/L during the last 20 minutes of the irrigation cycle or to at least 2 mg/L during the last hour of an irrigation cycle (Tajrishy, 1993). If a micro irrigation system has to be restored from a gradual buildup of organic material in the emission devices, concentrations of up to 100 mg/L chlorine can be temporarily used to treat the system. Liquid sodium hypochlorite is generally the preferred form of chlorine because of safety and handling considerations.

Depending upon water chemistry, acid injection may also be needed. Acid injection may be needed to keep effluent pH below 7.5 during chlorination to maintain chlorine effectiveness. Acid is also sometimes used on an intermittent basis to dissolve mineral precipitates. During intermittent acid treatment, the pH may be reduced to a range of 3 to 4. Care must be taken during intermittent acid treatment to keep the pH above the level specified by the manufacturer where emitter damage could occur.

Positive displacement chemical injection pumps or differential pressure venturi tube injectors are the most common devices used for chemical injection.

### **7.5.12 Water Use and Scheduling**

Irrigation water needs are based on ET and leaching fraction in a similar manner as for sprinkler or surface irrigation. With micro irrigation, there is less evaporative loss from the soil surface and a lower leaching requirement than for other types of irrigation. When scheduling micro irrigation, the evapotranspiration can be estimated by multiplying the ET for a crop with full coverage by the percentage of the area that is actually wet or shaded by the crop, whichever is greater. Micro irrigation systems typically irrigate the entire area daily, rotating through each flow zone for several hours to apply the appropriate depth of water.

### **7.5.13 Other Operational Considerations**

Regular flushing of micro irrigation laterals is very important for preventing the buildup of solids and sediments in the laterals. For larger systems, flush manifolds with automatic valves connected to the ends of a group of laterals are preferred. These can be operated briefly at the beginning and/or end of every irrigation. For smaller systems, automatic flush caps can be installed on the end of every lateral. Monthly manual flushing should also be performed for laterals with automatic end flush caps because the automatic flush caps do not flush at full operating flow and pressure.

One other operational issue for the irrigation of crops using effluent with elevated salinity is that light rains during the growing season can move salts into the root zone. For

this reason, the irrigation system should be turned on during light rains to help flush salts away from the roots.

## 7.6 Pumping Stations and Mainlines

Different types of pumping stations are used for transmission, distribution, and tailwater pumping. Transmission pumping of either raw or treated wastewater usually involves a conventional wastewater pumping station. Distribution pumping of treated wastewater can involve either a conventional wastewater pumping station or structure built into a treatment/storage pond. Tailwater pumping is used with surface distribution systems and may also be used with some sprinkler distribution systems.

The number of pumps to be installed depends on the magnitude of the flow and the range of flows expected. Unless there is storage available for many days of operation, the pumps should have capacity equal to the maximum expected inflow with at least one pump out of service. Pumps should be selected with head-capacity characteristics that correspond as nearly as possible to the flow and head requirements of the overall system (Sanks et al., 1989).

The horsepower required for pumping can be estimated using Equation 7-19.

$$H_p = \frac{QH}{3960 e} \quad (7-19)$$

**Where:**

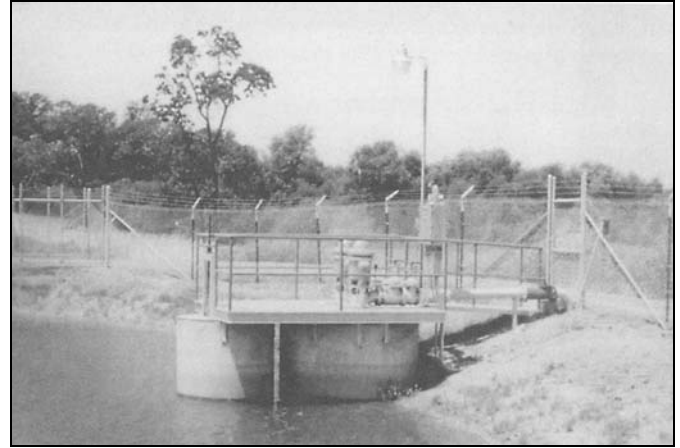
- $H_p$  = horsepower required, hp
- $Q$  = flow, gpm
- $H$  = total head, ft
- 3960 = conversion factor
- $e$  = pumping system efficiency

Efficiencies range from about 40 to 50 percent when pumping raw wastewater up to a range of 65 percent to 80 percent when pumping primary or secondary effluent.

## 7.7 Distribution Pumping

Distribution pumping stations can be located next to preapplication treatment facilities or can be built into the dikes of treatment/storage ponds (see Figure 7-20). Depending on the method of distribution the pumps may discharge under pressure. Peak flows depend on the operation plan and the variation in application rates throughout the operating season. For example, if the land application site is to receive wastewater for only 8 h/d, the pumps must be able to discharge at least three times the average daily flow rate ( $24/8 = 3$ ).

The basis of the pump design is the total head (static plus friction) and the peak flow requirements. Flow



**Figure 7-20.** Distribution Pumps in the Side of a Storage Pond Dike.

requirements are determined based on the hours of operation per day or per week and the system capacity (see next section). Details of pumping station design are available in standard references (Sanks et al., 1989; Hydraulic Institute, 1983).

## 7.8 Tailwater Pumping

Most surface distribution systems will produce some runoff that is referred to as tailwater. When partially treated wastewater is applied, tailwater must be contained within the treatment site and reapplied. Thus, a tailwater return system is an integral part of an SR system using surface distribution methods. A typical tailwater return system consists of a sump or reservoir, a pump(s), and return pipeline (see Figure 7-21).

The simplest and most flexible type of system is a storage reservoir system in which all or a portion of the tailwater flow from a given application is stored and either transferred to a main reservoir for later application or reapplied from the tailwater reservoir to other portions of the field. Tailwater return systems should be designed to distribute collected water to all parts of the field, not consistently to the same area. If all the tailwater is stored, pumping can be continuous and can commence at the convenience of the operator. Pumps can be any convenient size, but a minimum capacity of 25 percent of the distribution system capacity is recommended. If a portion of the tailwater flow is stored, the reservoir capacity can be reduced but pumping must begin during tailwater collection. Cycling pump systems and continuous pumping systems can be designed to minimize the storage volume requirements, but these systems are much less flexible than storage systems.



**Figure 7-21.** Typical Tailwater Pumping Station.

The principal design variables for tailwater return systems are the volume of tailwater and the duration of tailwater flow. The expected values of these parameters for a well-operated system depend on the infiltration rate of the soil. Guidelines for estimating tailwater volume, the duration of tailwater flow, and suggested maximum design tailwater volume are presented in Table 7-14.

**Table 7-14.** Recommended Design Factors for Tailwater Return Systems

Permeability Class	Permeability Rate, in/h	Texture range	Maximum duration of tailwater flow, % of application time	Estimated tailwater volume, % of application volume	Suggested maximum design tailwater volume, % of application volume
Very slow to slow	0.06-0.2	Clay to clay loam	33	15	30
Slow to moderate	0.02-0.06	Clay loam to silt loam	33	25	50
Moderate to moderately rapid	0.6-6	Silt loams to sandy loams	75	35	70

## 7.10 References

- Booher, L.J., (1974) *Surface Irrigation*,. FAO Agricultural Development Paper NO. 94, Food and Agricultural Organization of the United Nations, Rome.
- Burt, C.M., (1995) *The Surface Irrigation Manual*. Waterman Industries, Inc., Exeter, CA.
- Dillon, R.C., Hiler, E.A., and Vittetoe, G., (1972). *Center-pivot Sprinkler Design Based on Intake Characteristics*, ASAE Trans. 15: 996-1001.
- Fry, A.W. and A. S. Gray, (1971). *Sprinkler Irrigation Handbook, 10<sup>th</sup> Ed.*, Rain Bird Sprinkler Manufacturing Corporation, Glendora, CA.
- Hart, W.E., (1975). *Irrigation System Design*, Colorado State University, Department of Agricultural Engineering, Ft. Collins, CO.
- Hydraulic Institute, (1983) *Hydraulic Institute Standards*, Cleveland, OH.
- Keller, J. and Bliesner, R. D., (1990) *Sprinkle and Trickle Irrigation*, Chapter 14, Van Nostrand Reinhold, New York, NY.
- King, B.A., and Kincaid, D.C., (1997) *Optimal Performance from Center Pivot Sprinkler Systems*, University of Idaho Cooperative Extension System Bulletin 797.
- McCulloch, A.W. et al, (1973) *Lockwood-Ames Irrigation Handbook*, Lockwood Corporation, Gering, NB.
- Merriam, J.L. and Keller, J., (1978) *Irrigation System Evaluation: A Guide for Management*, Utah State University, Logan, UT
- Pair, C.H. et al, (1983) *Irrigation*, Fifth Ed., Irrigation Association, Silver Spring, MD

Runoff of applied wastewater from sites with sprinkler distribution systems should not occur because the design application rate of the sprinkler system is less than the infiltration rate of the soil-vegetation surface. However, some runoff from systems on steep (10 to 30 percent) hillsides should be anticipated. In these cases, runoff can be temporarily stored behind small check dams located in natural drainage courses. The stored runoff can be reapplied with portable sprinkling equipment.

## 7.9 Mainlines

Mainlines are pressurized pipelines that transmit the wastewater from the pumping station to the application site. The considerations in mainline design are velocity and friction loss. Velocities should be in the range of 1 to 1.5 m/s (3 to 5 ft/s) to keep any solids in suspension without developing excessive friction losses. Optimum velocities and pipe sizes depend on the cost of energy and the cost of pipe.

Mainlines are usually buried. Pipe materials for conveyance of pressurized effluent are usually PVC (polyvinyl plastic) or ductile iron. Under some low pressure conditions reinforced concrete pipe (RCP) may also be used.



---

Reinders, F. B. and Louw, A..A.. (1985) *The Measurement of Infiltration as a Design Input for Mechanized Irrigation Systems*. S.A. Irrigation 7(1):9-21.

Rogers, D.H., et al. (1994) *Sprinkler Package Effects on Runoff*, Cooperative Extension Service, Kansas State University, Publication L-903.

Sanks, R.L., G. Tchobanoglous, B.E. Bosserman, D. Newton, and G.M. Jones (1989) *Pumping Station Design*, Butterworth Publishers, Stoneham, MA.

Tajrishy, Massoud A.M., *Pretreatment Requirements of Secondary Effluent for Drip Irrigation*. Dissertation, UC Davis, 1993.

U.S. Department of Agriculture, Soil Conservation Service, (1980) *Border Irrigation*, Irrigation, Chapter 4, *Natural Resources Conservation Service National Engineering Handbook*, Section 15.

U.S. Department of Agriculture, Soil Conservation Service, (1983) *Sprinkler Irrigation*, Irrigation, Chapter 11 in *NRCS National Engineering Handbook*, Section 15.

## Chapter 8

# Process Design – Slow Rate Systems

The process design approach to slow rate (SR) systems for land treatment of municipal wastewater, must address water, nutrient and oxygen balances. These balances are discussed in this chapter. The expected treatment performance and removal mechanisms were described in Chapter 2.

### 8.1 System Types

Slow rate (SR) land treatment involves the controlled application of wastewater or to a vegetated land surface. There are two basic types of SR systems:

Type 1 – maximum hydraulic loading, i.e.: apply the maximum amount of water to the least possible land area; a “treatment” system.

Type 2 – optimum irrigation potential, i.e.: apply the least amount of water that will sustain the crop or vegetation; an irrigation or “water reuse” system with treatment capacity being of secondary importance.

Many of the system components (vegetation, preapplication treatment, transmission, distribution, etc.) may be identical for both types. A Type-1 SR “treatment system” may be limited by soil permeability or by nitrogen loading. The Type-1 system utilizes deep percolation of treated wastewater for additional capacity beyond evapotranspiration. To optimize reuse, the capacity of a Type-2 SR is limited by crop water or nutrient requirements.

In general, industrial operations with easily degraded wastes and municipalities in the humid parts of the country will seek to minimize land and distribution system costs, and will implement Type-1 systems. In the arid parts of the world, where the water has a significant economic value, it is often cost-effective to design a Type-2 system.

### 8.2 Land Area Determination

The *Limiting Design Parameter* (LDP) for a slow rate system can be determined after completing a series of constituent balances including a water balance, organic loading, and nutrient balance.

For Type-1 systems, the maximum deep percolation rate or drainage determines the hydraulic loading. The percolation rate and the hydraulic loading are determined as:

$$L_n = Etc - P + Pw \quad (8-1)$$

**Where:**

$L_n$  = hydraulic loading rate, cm/mo

Etc = crop evapotranspiration, cm/mo

P = precipitation, cm/mo

Pw = deep percolation rate, cm/month

If a Type-1 system is being designed, the design percolation rate, Pw, is a function of the limiting permeability or hydraulic conductivity in the soil profile. The hydraulic conductivity can be measured in the field, as described in Chapter 3. If published data on soil permeability are used, a safety factor of 4 to 10 percent of the published value should be used. (See Example 8-1.)

If a Type-2 system is being designed, then the Pw is the amount of water required to leach salts out of the root zone so plant growth will not be inhibited. Limiting permeability is discussed in Chapter 3 and leaching is described in Section 8.4.

In a Type-1 system, the limiting permeability may determine a hydraulic loading rate in excess of the crop water tolerance, so care must be taken to ensure proper growing conditions.

The monthly value of the design percolation rate depends on crop management, precipitation, and freezing conditions:

- *Crop management.* Downtime must be allowed for harvesting, planting, and cultivation as applicable.
- *Precipitation.* Downtime for precipitation is already factored into the water balance computation. No further adjustments are necessary. Where rainfall runoff occurs during periods of non-operation, the runoff may be subtracted from the total precipitation.
- *Freezing temperature.* Subfreezing temperatures may cause soil frost that reduces infiltration rates. Operation is usually stopped when this occurs. The most conservative approach to adjusting the monthly percolation rate for freezing conditions is to allow no operation for days during the month when the mean temperature is less than 0°C (32 °F). A less conservative, but acceptable, approach is to use a lower minimum temperature. The recommended lowest mean temperature for operation is -4°C (25°F). For forested sites, operation can often continue during subfreezing

conditions, with special attention to prevent freezing in the distribution system.

- *Seasonal crops.* When a single annual crop is grown, wastewater is not normally applied during the winter season, although applications may occur after harvest and before the next planting.

Procedures for determining the storage days needed based on climatic factors are presented in Chapter 6. The additional agronomic factors listed above can be determined from local experience in the area once the type of crop is tentatively identified. It is necessary to select the general type of vegetation at an early stage of design so that the crop uptake of nitrogen or other constituents can be estimated.

#### Example 8-1: Water Balance for Type-1 SR System

**Given:** Type-1 system in a humid climate with soils having a limiting permeability of 2 cm/hr. Flow is 1,000 m<sup>3</sup>/d. Storage needs are 3 mo/yr, precipitation is 50 cm/yr and ET is 40 cm/yr. Conduct a preliminary water balance and initial land area requirements evaluation.

**Solution:** Hydraulic loading rate is based on the 2 cm/hr soil permeability. Use a safety factor of 7 percent (midpoint between 4 and 10 percent).

1. Determine annual percolation:  
Percolation is 2 cm/hr x 24 hr/d x 0.07 = 3.36 cm/d  
Assume 1 application per week for 9 months (9 mo x 4.33 wk/mo = 39 weeks)  
39 weeks x 3.36 cm/wk = 131 cm/yr
2. Determine water balance for application area:  
 $L_h = ET_c - P + P_w$   
 $L_h = 40 \text{ cm/yr} - 50 \text{ cm/yr} + 131 \text{ cm/yr} = 121 \text{ cm/yr}$
3. Determine land required for application:  
Annual flow = 1,000 m<sup>3</sup>/d x 365 = 365,000 m<sup>3</sup>/yr

Although the storage reservoir will accumulate 10 cm/yr from excess rainfall, the percolation from the storage reservoir is assumed equal to the gain from rainfall.

$$\text{Area} = 365,000 \text{ m}^3/\text{yr} \div 1.21 \text{ m/yr} = 301,600 \text{ m}^2$$

$$\text{Area} = 301,600 \text{ m}^2/10,000 \text{ m}^2/\text{ha} = 30.16 \text{ ha}$$

An estimate of the design precipitation on an annual basis is suitable for preliminary calculations during site planning. Monthly values are needed for final design. The monthly precipitation should be based on a 5-year return period analysis. When monthly precipitation data are not available a 10-year return period may be distributed monthly based on the ratio of average monthly-to-average-annual precipitation.

The design ET rate is a critical component in the water balance for both crop production and water quality concerns. In the latter case, a high water loss due to ET will tend to increase the concentration of constituents in the remaining percolate. See Chapter 4 for discussion and procedures for estimating ET for a particular crop.

A further modification is necessary to account for water losses to percolation and evaporation in the

conveyance and distribution systems. This overall efficiency of a distribution system ranges from about 75 percent to over 95 percent. The final water balance equation for the irrigation case (Type-2 system) is:

$$L_h = (ET_c - P) \cdot \frac{(1 - LR)}{ES} \quad (8-2)$$

$L_h$	=	hydraulic loading, cm/month
$P$	=	design precipitation, cm/month
$ET_c$	=	crop evapotranspiration, cm/month
$ES$	=	distribution system efficiency, fraction (0.65 to 0.75 for surface systems) (0.70 to 0.85 for sprinklers)
$LR$	=	leaching requirement, fraction, defined in Equation 8-10

The land area required can be calculated using Equation 8-3.

$$A = Q/C L_h \quad (8-3)$$

#### Where:

$A$  = field area, ha  
 $Q$  = Annual flow, m<sup>3</sup>/yr  
 $C$  = conversion factor, 10,000 m<sup>2</sup>/ha  
 $L_h$  = hydraulic loading rate, m/yr

## 8.2.1 Oxygen Balance

The plant/soil system removes biodegradable organics through filtration, adsorption, and biological reduction and oxidation. Most of the biological activity occurs near the surface where organics are filtered by the soil and oxygen is present to support biological oxidation. However, biological activity continues with depth.

The BOD loading rate is defined in Equation 2-1 as the average BOD applied over the field area in one application cycle. The oxygen demand created by the BOD is balanced by the atmospheric reaeration of the soil profile during the drying period.

Excess organic loading can result in (1) odorous anaerobic conditions (2) untreated organics passing through the soil profile, (3) reduced environments mobilizing oxidized forms of iron and manganese and/or (4) increases in alkalinity via carbon dioxide dissolution. Prevention from excess loading of organics is a function of maintaining an aerobic soil profile, which is managed by organic loading, hydraulic loading, drying time, oxygen flux, and cycle time.

Aerobic conditions and carbon dioxide venting can be maintained by balancing the total oxygen demand with oxygen diffusion into the soil. McMichael and McKee (1966) reviewed methods for determining oxygen diffusion in the soil after an application of wastewater. They discussed three principal mechanisms for reaeration: (1) dissolved air carried in the soil by percolating water, (2) the hydrodynamic flow of air resulting from a "piston-like" movement of a slug of

water, and (3) diffusion of air through the soil pores. Dissolved oxygen in wastewater has an insignificant impact on high BOD waste streams. The “piston-like” effect may have a substantial impact on the oxygen available immediately after drainage, but quantifying the exact amount is dependent on the difficult to model dynamics of draining soils. McMichael and McKee (1966) solved the non-steady state equation of oxygen diffusion based on Fick’s law. They used the equation as a tool for determining the flux of oxygen (mass of O<sub>2</sub> per area) that diffuses in the soil matrix over a given time.

The flux of oxygen across the soil surface does not address the destination of the oxygen, but as long as a gradient exists the oxygen will continue to diffuse into the soil pores. The gradient is based on the oxygen concentration at the soil surface and the initial concentration in the soil. McMichael and McKee (1966) assumed total depletion of oxygen in the soil matrix. Overcash and Pal (1979) assumed a more conservative 140 g/m<sup>3</sup> based on a plant growth limiting concentration (Hagen et al. eds., 1967).

The total oxygen demand (TOD) is the sum of the BOD and the nitrogenous oxygen demand (NOD) and plant requirement. The NOD is defined as:

$$\text{NOD} = 4.56 \times \text{Nitrifiable Nitrogen} \quad (8-4)$$

Nitrifiable nitrogen is the ammonium concentration, which is often insignificant when compared to high BOD waste streams.

$$\text{TOD} = \text{BOD} + \text{NOD} \quad (8-5)$$

From the TOD the time required to diffuse an equivalent amount of oxygen can be determined. The diffusion equation follows:

$$\text{No}_2 = 2(\text{Co}_2 - \text{Cp}) \cdot [\text{Dp} \cdot t / \pi]^{1/2} \quad (8-6)$$

- No<sub>2</sub> = flux of oxygen crossing the soil surface (g/m<sup>2</sup>)
- Co<sub>2</sub> = vapor phase O<sub>2</sub> concentration above the soil surface (310 g/m<sup>3</sup>)
- Cp = vapor phase O<sub>2</sub> concentration required in soil to prevent adverse yields or root growth (140 g/m<sup>3</sup>)
- t = aeration time; t = Cycle time – infiltration time
- Dp = effective diffusion coefficient  
Dp = 0.6 (s)(Do<sub>2</sub>)  
where s = fraction of air filled soil pore volume at field capacity  
Do<sub>2</sub> = oxygen diffusivity in air (1.62 m<sup>2</sup>/d)

Equation 8-6 can be rearranged to solve for time:

$$t = \frac{\pi}{\text{Dp}} \cdot [\text{No}_2 / 2(\text{Co}_2 - \text{Cp})]^2 \quad (8-7)$$

Cycle time is a function of required aeration time plus the time for the soil to reach field capacity. The time to reach field capacity is estimated with the infiltration time calculated by dividing the depth applied by the steady state infiltration rate.

$$t_i = 3600 \cdot d / I \quad (8-8)$$

- t<sub>i</sub> = time to infiltrate, hours
- d = depth, cm
- I = steady state infiltration rate, cm/s

There are numerous variables involved in determining the oxygen balance, all which must be evaluated on a site-specific basis. An important point to note is that supplemental irrigation water without a significant oxygen demand can increase the required cycle time due to increasing drain and reaeration time. The time required for the upper zone of the soil to drain is a function of climatic conditions and the depth of the wastewater applied. To achieve the desired loading in surface applications mixing, of supplemental water is often required because of larger applications. Most surface applications can not apply less than 7.6 cm (3 inches) in a uniform manner.

## 8.2.2 Nitrogen Balance

Nitrogen loading is commonly the LDP. However, when the wastewater contains a high carbon to nitrogen (C:N) ratio, significant denitrification and immobilization occur. The main concern associated with the land application of wastewater with high nitrogen concentrations is the potential for nitrate to be transported into the groundwater.

Nitrogen in wastewater goes through transformations when applied to the soil matrix. The transformations are both chemical and biological and are a function of temperature, moisture, pH, C:N ratio, plant interactions, and equilibrium with other forms of nitrogen.

Because of large influence of organic carbon on available nitrogen, a factor has been developed to account for nitrogen lost to denitrification, volatilization, and soil storage.

Table 8-1 contains the nitrogen loss factor as a function of the C:N. Actual losses are dependent on other factors including climate, forms of the nitrogen applied, and application method.

**Table 8-1.** Nitrogen Loss Factor for Varying C:N Ratios

C:N ratio	Example	f
>8	Food processing wastewater	0.5 - 0.8
1.2-8	Primary treated effluent	0.25 - 0.5
0.9-1.2	Secondary treated effluent	0.15 - 0.25
<0.9	Advanced treatment effluent	0.1

Adapted from Reed et al., 1995.

While existing inorganic and organic nitrogen in the soil may supply short-term crop needs, nitrogen deficiencies and resulting reduced yield and nitrogen uptake will result if the gross applied nitrogen does not exceed crop demand. Also, depletion of the soil organic reserves will reduce soil health. Combining the crop uptake and the nitrogen loss factor will estimate the desired nitrogen loading. For additional information see Chapter 4.

$$L_n = U/(1-f) \quad (8-9)$$

**Where:**

$L_n$  = Nitrogen loading, kg/ha (lb/acre)  
 $f$  = nitrogen loss factor (

Table 8-1)

$U$  = Estimated crop uptake as a function of yield, kg/ha (lb/acre) (Chapter 4)

### 8.3 Total Acidity Loading

Natural biochemical reactions maintain the soil pH near neutral. A range of wastewater pH between 3 and 11 has been applied successfully to land treatment systems. Extended duration of low pH can change the soil fertility and lead to leaching of metals. When the acidity is comprised of mostly organic acids, the water will be neutralized as the organics are oxidized.

The acidity of wastewater can be characterized by the total acidity with units of mg CaCO<sub>3</sub>/L. The total acidity represents the equivalent mass as CaCO<sub>3</sub> required to adjust the pH to a specific pH, commonly defined as 7.0. The soil buffer capacity is reported as mg CaCO<sub>3</sub>/kg or tons CaCO<sub>3</sub>/acre. The buffer capacity represents the soil response to neutralize an equivalent amount of acidity. A balance between the total acidity applied in the wastewater and the buffer capacity of the soil can indicate the capacity of the soil to effectively neutralize the acid in the wastewater. The buffer capacity of the soil is restored after organic acids are cleaved.

Most field crops grow well in soils with a pH range of 5.5 to 7.0. Some crops like asparagus or cantaloupes with a high calcium requirement prefer a soil pH greater than 7.0. If the pH of the soil begins to drop, liming is recommended to return the pH to the desirable range for crop production. Likewise, if the pH increases, sulfuric acid addition may be recommended. Chapter 4 contains the range optimal soil pH of various crops.

Because of the soil capability to treat large amounts of organics acids, it is recommended that the pH of wastewater only be adjusted for extreme pH conditions (pH < 5.0 and > 9). If the mineral (non-organic) cause of the high or low pH is a threat to crops or groundwater, adjustment may be necessary.

### 8.4 Salinity

Municipal WWTP treated effluent has a TDS of 150-380 mg/l of TDS over the source water. In non-oxidized wastestreams, approximately 40 percent of the dissolved solids will consist of volatile dissolved solids that will be removed in the treatment process or will degrade in the soil. Plant macronutrients, such as nitrogen, phosphorous and potassium; and minerals, such as calcium and magnesium, are part of the fixed dissolved solids (FDS) and are partially removed in land application systems that incorporate growing and harvesting of crops. The remaining inorganic dissolved solids are either leached from the soil profile or precipitate out into non-soluble forms. When inorganic dissolved solids accumulate in the soil, an increase in the osmotic stress in plants may result in reduced yields or failed germination.

Salt removal by plants is estimated using the ash content of the harvested crop and can be calculated similarly to nutrient uptake. Ash content is approximately 10 percent of the dry weight. Often salts in excess of crop uptake are applied and leaching of salts is required to limit salt build-up in the root zone.

The leaching requirement is the ratio of the depth of deep percolation to the depth of the applied water (see Equation 8-10). The same ratio exists between the concentration of the conservative salts applied and the concentration of conservative salts in the percolate. The EC of water can reliably indicate the salt concentration when little or no dissolved organics are present. The equation is only valid when weathering and precipitation of salts are insignificant (Hoffman, 1996).

$$LR = \frac{D_d}{D_a} = \frac{C_a}{C_d} \quad (8-10)$$

**Where:**

LR = leaching fraction, unitless  
 $D_d$  = drainage depth, m  
 $D_a$  = depth applied, m  
 $C_a$  = concentration of salt applied, dS/m  
 $C_d$  = concentration of salt in drainage, dS/m

If Equation 8-10 is solved for  $C_d$ , the salt concentration of the drainage is equal to the concentration of the salt applied divided by the leaching fraction as presented in Equation 8-11.

$$C_a = \frac{C_d}{LR} \quad (8-11)$$

All terms are described above.

The leaching requirement is determined based on the crop sensitivity presented in Chapter 4. The average root zone salts calculated based on solving the continuity equation for salt throughout the root zone (Hoffman and van Genchten, 1983):

$$\frac{\bar{C}}{C_a} = \frac{1}{L} + \frac{\delta}{Z \cdot LR} \cdot \ln[L + (1-L)e^{-Z\delta}] \quad (8-12)$$

Where:

- $\bar{C}$  = mean rootzone salt concentration, dS/m
- $C_a$  = salt concentration of applied water, dS/m
- LR = leaching fraction as defined in EQ 8-10
- Z = root zone depth, m
- $\delta$  = empirical constant = 0.2Z

To determine the desired EC value of drainage, both the crop sensitivity to salinity and the groundwater quality should be reviewed. The groundwater uses, quality, and flux beneath the site should be reviewed to determine the impact of the leachate of groundwater. High EC values can be offset by small leaching depths resulting in insignificant loading to the groundwater. Also precipitation of minerals continues to occur below the root zone reducing the loading to groundwater.

The salinity thresholds presented in Chapter 4 are based on EC extracts of the soil (ECe) normally measured under trial conditions of 50 percent leaching. The average root zone salinity is adjusted to the ECe by dividing by a factor of two. The osmotic stress of 50 percent leaching fraction is accounted by subtracting  $\bar{C}$  at a given leaching fraction by the  $\bar{C}$  at 50 percent leaching. Hoffman (1985) found the best agreement when comparing this model to published ECe threshold values. The results of this model are presented in Figure 8-1.

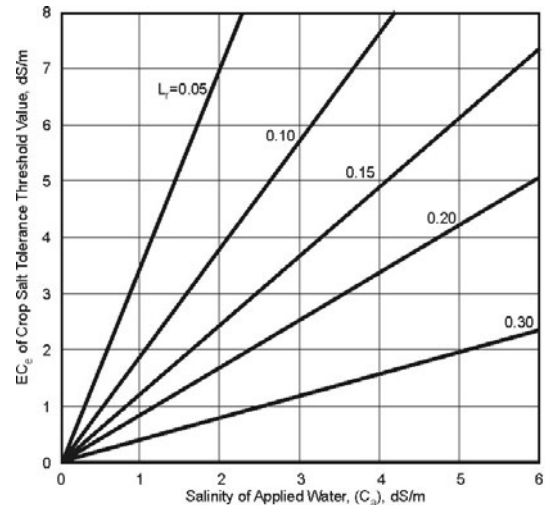


Figure 8-1. Leaching Requirement as a Function of Applied Salinity and ECe of Crop Salinity Threshold.

### Example 8-2. Type-2 SR Design Loading Rate and Required Area

Given:

Secondary treated wastewater is used to irrigate sudan grass and winter wheat in Merced, CA. The historical yield of the area is 8 tons/acre and for sudan and 75 bushels/acre for winter wheat and an additional 1.5 tons/acre of straw. The field configuration and soil type allow for uniform distribution with a minimum of application of 10 cm (3.9 inches) with 12 hour sets.

Waste Stream

Flow = 3,785 m<sup>3</sup>/d (1.0 mgd)  
 BOD<sub>5</sub> = 40 mg/L  
 Nitrifiable ammonia = 4 mg/L

Soil

Total pore space = 42%  
 Field capacity = 0.18 mm/mm  
 Steady state infiltration = 18.3 cm/d

Total nitrogen = 15 mg/L  
 EC = 1.2 dS/m

Solution:

**Oxygen Balance**

The total oxygen demand (TOD) is the sum of the BOD and the nitrogenous oxygen demand (NOD) and plant requirement.

Using Equation 8-5, the total oxygen demand can be determined.

$$40 \text{ mg/L} + 4 \text{ mg/L} \times 4.56 = 58.2 \text{ mg/L TOD}$$

At a hydraulic loading rate of 10 cm the organic loading is 58 kg/ha (52 lb/acre) or 5.8 g/m<sup>2</sup>. The time required to diffuse an equivalent amount of oxygen can be determined with Equation 8-7.

$$t = \pi \frac{\pi}{D_p} \bullet [N_{O_2}/2(C_{O_2}-C_p)]^2$$

**Where:**

D<sub>p</sub> = effective diffusion coefficient  
 D<sub>p</sub> = 0.6 (s)(D<sub>O<sub>2</sub></sub>)

**Where:**

s = fraction of air filled soil pore volume at field capacity  
 D<sub>O<sub>2</sub></sub> = oxygen diffusivity in air (1.62 m<sup>2</sup>/d)  
 D<sub>p</sub> = 0.6 • (0.42-0.18) • 1.62 m<sup>2</sup>/d = 0.388 m<sup>2</sup>/d  
 t = π (0.388 m<sup>2</sup>/d) • [5.8 g/m<sup>2</sup>/2(310 g/m<sup>3</sup>-140 g/m<sup>3</sup>)]<sup>2</sup> = 0.002 days

The small time required for diffusion of secondary treated wastewater shows that drain time is more critical than the diffusion time for small application depths of treated municipal effluent. Equation 8-8 can be used to estimate the time to reach field capacity.

$$t_i = \frac{10 \text{ cm}}{18.3 \text{ cm/d}} = 0.54 \text{ d}$$

The minimum cycle time is the sum of the application time, the diffusion time, and the drain time. The resulting minimum cycle time is just over 1 day. The oxygen balance then limits application to 10 cm every third set or 1.5 days.

$$\text{Total Area for oxygen balance} = 1.5 \text{ days} \times 3,785 \text{ m}^3/\text{d} \div 0.1 \text{ m} = 56,780 \text{ m}^2 = 5.7 \text{ ha}$$

The frequent irrigation suggested by the small oxygen demand does not consider the water logging from a crop.

### Nitrogen Balance Based on Crop Removal

The nitrogen loading is determined by the nitrogen uptake and estimates of nitrogen losses. The C:N ratio can be estimated from the BOD:N ratio. The result is a C:N ratio of 2.6. The corresponding nitrogen loss factor from

Table 8-1 is 0.25. Table 4-9 lists the average N

percentage of sudan as 1.36 percent N. A 8 ton/acre harvest will require 245 kg-N/ha (218 lb-N/acre). Winter wheat at 75 bushel/acre at 60 lb/bushel is equivalent to 4,000 kg/ha (4,500 lb/acre). At 2.08 percent nitrogen, wheat removes an additional 105 kg/ha (94 lb/acre). If the 1.5 tons of straw per acre is also removed an additional 22 kg/ha (20 lb/acre) of nitrogen is removed. Equation 8-8 provides the nitrogen limited loading.

$$L_n = U/(1-f)$$

**Where:**

L<sub>n</sub> for sudan = 245/(1-0.25) = 327 kg-N/ha  
 L<sub>n</sub> for winter wheat = 127/(1-0.25) = 169 kg-N/ha

At a total nitrogen content of 15 mg/L, the sudan grass nitrogen requirement is met with an application of 2.18 m (86 inches). The winter wheat requires an application of 1.13 m (44 inches). The minimum area for a nitrogen balance could be achieved when the area was double cropped and a total of 3.31 meters was applied.

$$\text{Total Area for nitrogen balance} = 3,785 \text{ m}^3/\text{d} \times 365 \text{ d/yr} \div 3.31 \text{ m/yr} = 417,000 \text{ m}^2 = 41.7 \text{ ha}$$

A hydraulic load of 3.31 m per year exceeds the crop irrigation requirements and a Type-2 SR system could be designed around 42 ha, if considerations for percolation and crop water-logging are made.

### Salinity

The leaching fraction is a function of the crop and the water quality. Figure 4-3 shows that 10 percent yield reduction occurs at 5.9 dS/m for sorghum and 7.0 dS/m for wheat. The most restrictive crop is sorghum. Using an EC<sub>e</sub> of 5.9 dS/m and an applied EC of 1.1 dS/m, Figure 8-1 suggests a leaching requirement less than 0.05. To ensure productivity a leaching fraction of 0.05 should be used.

### Water Balance

Crop coefficients gathered from local extension service are utilized in the water balance below. The area used to calculate the irrigation requirement including irrigation efficiency and leaching requirement is adjusted until the irrigation requirement meets the flow.

Month	days	1 2 3 4 5 6 7 8 9 10 11 12												
		Wastewater Volume MG	Precipitation 5-yr in.	Normal ETo in.	Winter Wheat 30 Acres				Sudan 90 Acres				Water Balance MG	
					k	ETc In	Irrigation		k	ETc In	Irrigation			
							in	MG			in	MG		
January	31	31.0	3.56	1.0	1	1.0	0.0	0.0		0.0	0.0	0.0	0.0	31.0
February	28	28.0	3.14	1.5	1	1.5	0.0	0.0		0.0	0.0	0.0	0.0	28.0
March	31	31.0	2.97	3.2	1	3.3	0.4	0.3		0.0	0.0	0.0	0.0	30.7
April	30	30.0	1.77	4.7		0.0	0.0	0.0	0.8	3.8	2.5	6.0		24.0
May	31	31.0	0.91	6.6		0.0	0.0	0.0	1.1	6.9	7.4	18.2		12.8
June	30	30.0	0.19	7.9		0.0	0.0	0.0	1.1	8.3	10.0	24.5		5.5
July	31	31.0	0.02	8.5		0.0	0.0	0.0	1.1	8.9	11.0	26.9		4.1
August	31	31.0	0.03	7.2		0.0	0.0	0.0	1.1	7.6	9.3	22.7		8.3
September	30	30.0	0.33	5.3		0.0	0.0	0.0	1.1	5.6	6.5	15.8		14.2
October	31	31.0	0.99	3.4		0.0	0.0	0.0	1.1	3.6	3.2	7.8		23.2
November	30	30.0	2.10	1.4	0.2	0.3	0.0	0.0	0.8	1.1	0.0	0.0		30.0
December	31	31.0	2.83	0.7	1	0.7	0.0	0.0		0	0.0	0.0		31.0
<b>TOTAL</b>	<b>365</b>	<b>365.0</b>	<b>18.8</b>	<b>51.4</b>			<b>0.4</b>	<b>0.3</b>			<b>49.9</b>	<b>121.8</b>		

Figure 8-2. Example Spreadsheet Used to Calculate the Irrigation Requirements Including Irrigation Efficiency and Teaching Requirements.

**Are Associated with Columns**

**Notes:**

- 1 Wastewater flow based on design flow x number of days per month (in this case 1 MGD)
- 2 Monthly precipitation with a 5-yr return period
- 3 Normal monthly ETo
- 4 Crop coefficient from local extension office
- 5  $ET_c = k \times ETo$
- 6 Irrigation Requirement =  $Precipitation - [k \times ETo \times (1 + Leaching\ Fraction)] \div Irrigation\ Efficiency$
- 7 Irrigation Requirement converted to volume = inches x .027152 x acres = MG
- 8 -11 Same as 5 -6
- 12 Total wastewater volume - crop requirement

A Type-2 system can be managed with a crop rotation plan allowing for a portion of the available area to be fallow at all time. The fallow area can receive water during harvesting and planting when applications are not possible. During the summer, application could be applied to the fallow portion that will be planted in wheat the subsequent fall. During the winter months, one or two applications per month can be applied to wheat with the remainder going on the fallow ground where the sudan will be planted. The crop rotation will allow for application all winter.

## 8.5 Design Considerations

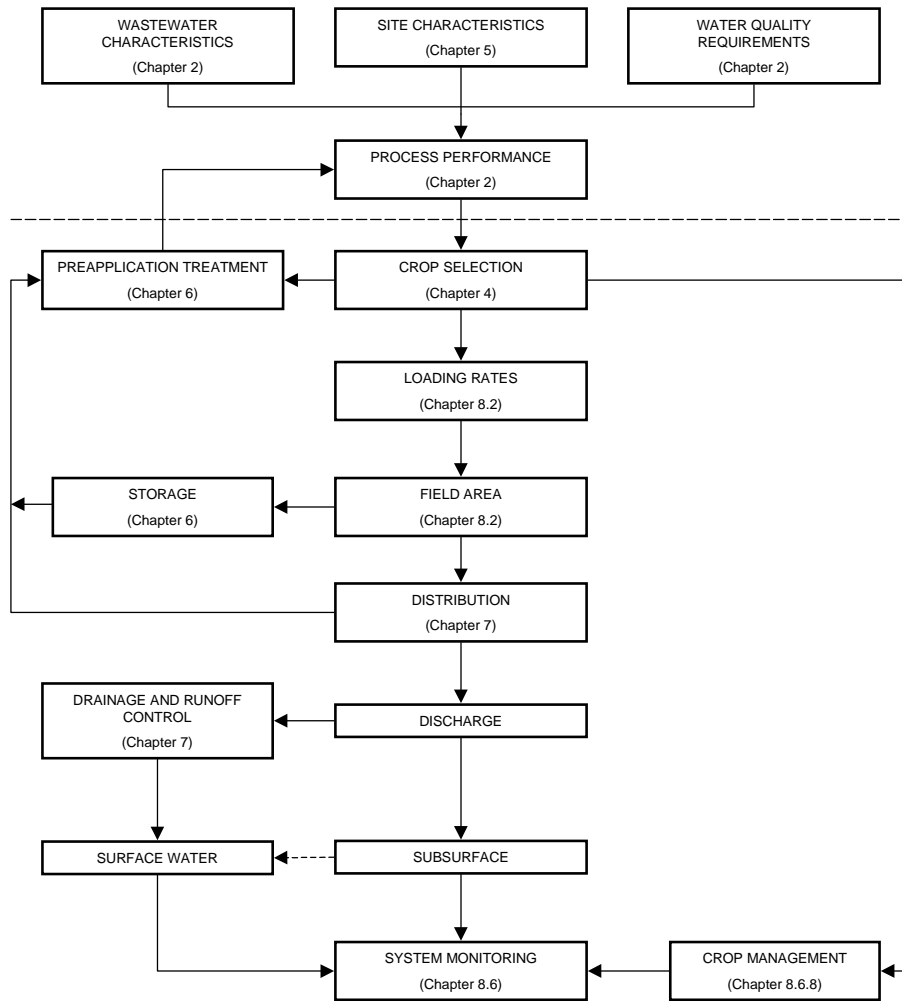
The design procedure is outlined in Figure 8-2 (US EPA., 1981). Additional design consideration of buffer zone,

storage requirements, distribution system, and crop selection must also be addressed for both Type-1 and Type-2 systems.

### 8.5.1 Buffer Zone Requirements

The objectives of buffer zones around land treatment sites are to control public access, and in some cases, improve project aesthetics. There are no universally accepted criteria for determining the width of buffer zones around SR treatment systems. In practice, the widths of buffer zones range from zero for remote systems to 200 ft or more for systems using sprinklers near populated areas. In many states, the width of buffer zones is prescribed by regulatory agencies and the designer should determine if such requirements exist.





**Figure 8-3.** Slow Rate Design Procedure.

The requirements for buffer zones in forest SR systems are generally less than those of other vegetation systems because forests reduce wind speeds and, therefore, the potential movement of aerosols. Forests also provide a visual screen for the public. A minimum buffer zone width of 50 ft should be sufficient to meet all objectives, if the zone contains trees with a dense leaf canopy.

### 8.5.2 Storage Requirements

A detailed discussion and calculation procedures for storage are presented in Chapter 6. When storage is a component in a SR system, it may be advantageous not to bypass the pond in the application season to allow reductions in coliforms and nitrogen to occur as described in Chapter 6. Algal production in storage ponds should not affect SR operations. In fact, algae will incorporate the inorganic nitrogen into cells as inorganic nitrogen, which will reduce the leaching potential of the nitrogen

### 8.5.3 Crop Selection

The type of crop selected will directly influence the land area required, if crop uptake is a critical factor in determining the design hydraulic loading. In most cases, crop selection will be one of the first design decisions in SR design. See Chapter 4 for discussion of crop selection procedures.

### 8.5.4 Distribution System

It is necessary for Type-2 irrigation systems to decide on the method of distribution that will be used, at an early stage of design. The system efficiency (see Equation 8-2) is a significant factor in determining the  $L_h$  and the amount of land that can be irrigated. An early decision on distribution method is less critical for Type-1 treatment system. Distribution systems are discussed further in Chapter 7.

### 8.5.5 Application/Irrigation Scheduling

A regular, routine application schedule is usually adopted for Type-1 SR treatment systems for operational convenience. Sprinklers with an application rate of 0.2 to 0.3 in/hr are often employed in SR systems. This will not usually exceed the intake rate of most soils, so surface runoff is avoided. It is then typical to operate the sprinkler unit continuously for a sufficient number of hours to achieve the design loading. The application is then repeated at regular cycle intervals. Operation can either be manual, automated with time switches or some combination.

The scheduling of a Type-2 SR irrigation system is dependent on the climate and the crop to be grown. The purpose is to maintain sufficient moisture in the root

zone to sustain plant growth. The water available for plant use is defined as the difference between the field capacity and the wilting point (see Chapter 3).

The usual range of the deficit that is allowed ranges from 30 to 50 percent of the available water in the root zone, depending on the crop type and the stage of growth, and soil type (Figure 3-2). An irrigation event is scheduled when the soil moisture reaches the predetermined deficit. Ideally irrigation maintains soil moisture level for optimum plant growth. This can be measured using soil moisture sensors or estimated based on ETc. Soil moisture sensors can be used in a completely automated system to start-up, shutdown and shift applications from field to field.

The amount of water to be applied in each irrigation event can be determined with:

$$I_T = I_D \cdot \frac{(1-LR)}{ES} \quad (8-13)$$

Where

- $I_T$  = total depth of water to be applied during an irrigation, cm
- $I_D$  = soil moisture deficit to be replaced, cm
- LR = leaching requirement as defined in EQ 8-10
- ES = irrigation efficiency, fraction

## 8.6 Crop, Soil and Site Management Requirements

Site management is a critical part of operating and monitoring a land application system. Detailed monitoring and observations provide information for documenting and evaluating performance of a facility's land application program.

This section addresses routine land application site monitoring including:

- Documentation of flow and water quality;
- Use of supplemental irrigation water;
- Soil conditions;
- Soil sampling and analysis;
- Groundwater sampling and analysis;
- Crop yield and biomass data collection; and
- Maintenance and routine inspection observations.

In all of these areas, interrelated data gathering, short-term and long-term observations, and some analysis of basic data is required to maximize the usefulness of the information. Data organization, calculations, analysis, and record keeping are critical to the success of a monitoring program.

### 8.6.1 Basic Structure of a Monitoring Program

The personnel responsible for operating the land application system often conduct monitoring. During site

monitoring, the system operator will collect data required to document operations and will make both quantitative and qualitative observations. These observations may include details regarding functioning of the physical infrastructure, as well as crop management issues, including both field management, such as disking or leveling, and irrigation. During the course of monitoring, the observer will learn more about the behavior of the land application system. This often leads to developing improved operating procedures based on experience and can be invaluable for solving temporary problems that occur within the land application site.

The monitoring and operations activities described above fall in the general category of “process control.” These observations are made in order to develop and implement protocols for managing the land application system. This can include changing irrigation practices; scheduling harvesting, replanting, and other crop management activities; scheduling preventative maintenance and repair; and expanding or improving the system.

A second, equally important monitoring objective is to provide system operations documentation for regulatory oversight and compliance. Often, process control monitoring and regulatory reporting requirements are similar in scope. Table 8-2 provides examples of typical conditions that address site monitoring for process control. Regulatory requirements vary from state to state, and often within states, so the individual state agency should be contacted. Process control observations are often gathered more frequently than regulatory monitoring requirements for short-term decision-making. Those short-term decisions may require more complex evaluation and decision-making

than the more straight-forward task of documenting compliance.

For a land application site with more than one field, field-by-field flows must also be recorded to determine loading rates. Process control monitoring also requires that irrigation amounts (including both effluent and supplemental irrigation water) be measured on a daily basis so that a decision about where to apply facility flows for the following day can be made. This decision must also incorporate additional information as well as a more complex analysis that takes into account time of last irrigation, soil moisture status in the field, current and projected weather conditions, cropping patterns, and scheduling needs for other fields within the land application program.

### 8.6.2 Water Monitoring

Permits issued to a facility for land application routinely require measurement of flow and detailed observations to document timing and distribution of flows. Monitoring of supplemental water flow, if used, is also required for land application systems. A supplemental irrigation water supply is required when effluent cannot be used to meet all irrigation water requirements. Table 8-3 summarizes monitoring for flow and water quality that may be required as part of a monitoring plan.

Sampling locations must be selected to allow collection of samples from a location that is representative of the flow to be monitored. Effluent quality can change from point to point within the distribution system, particularly when storage is a component. Facility personnel should consider these changes when selecting a sampling point for regulatory compliance or to calculate field loading rates. For

**Table 8-2.** Suggested Minimum Process Control Monitoring

Sampling Category	Operational Management
Effluent	<ul style="list-style-type: none"> <li>Total daily flow (gallons)</li> <li>BOD, TSS, FDS, Total N, SAR</li> </ul>
Field-by-Field Loadings	<ul style="list-style-type: none"> <li>Monthly effluent application, inches</li> <li>Daily climate data (precipitation, evapotranspiration)</li> <li>Calculation of loading rate for LDP</li> </ul>
Soil Testing	<ul style="list-style-type: none"> <li>Annual pH, EC, TKN, K, NH<sub>3</sub>-N, ESP (Sample each field, 3 depths per application zone, composite samples from a minimum of 3 locations)</li> <li>Annual available P, available K for crop nutrient supply analysis</li> </ul>
Crop Sampling	<ul style="list-style-type: none"> <li>Date, biomass, and crop harvested</li> <li>Annual tissue ash weight, total N</li> </ul>
Groundwater	<ul style="list-style-type: none"> <li>Quarterly NO<sub>3</sub>-N, pH, EC, water level for each well</li> <li>Annual Ca, Mg, Na, K, Cl, SO<sub>4</sub>, HCO<sub>3</sub>, CO<sub>3</sub> for each well</li> </ul>
Routine Inspection Needs	<ul style="list-style-type: none"> <li>Pumping system operating pressures, field operating pressures, proper operation of irrigation system, leaks along pipeline, ponding, crop health, runoff, etc.</li> </ul>

Definitions: Biochemical Oxygen Demand (BOD), Total suspended solids (TSS), Electroconductivity (EC), Total Kjeldahl Nitrogen (TKN), Nitrate-Nitrogen (NO<sub>3</sub>-N), NH<sub>3</sub>-N, Ammonia Nitrogen (NH<sub>4</sub>-N)

operations monitoring, sampling in more than one location within a distribution system is performed to evaluate changes or problems such as uneven distribution.

Samples can be either grab or composite and sample collection can be performed either manually or using automated sampling equipment. Samples meant to represent a single point in time and give a “snapshot” of conditions at that instant are usually collected via grab sampling. Grab sampling involves filling containers manually.

### 8.6.3 Flow Measurement

Detailed measurements of effluent flow are required to determine irrigation volumes and field constituent loading rates. Flow monitoring and sampling for water quality analysis are typically conducted at a central, accessible location. Ideally, there should be one exit location identified for sampling. Table 8-4 outlines methods used to measure effluent flows and summarizes the advantages and disadvantages of these methods.

**Table 8-3.** Suggested Minimum Effluent Monitoring

Parameter	Flow	Water Quality
Effluent	<ul style="list-style-type: none"> <li>Daily or monthly facility flow</li> </ul>	<ul style="list-style-type: none"> <li>Monthly nitrogen (TKN, NO<sub>3</sub>-N, NH<sub>3</sub>-N), FDS, salt ions, BOD, other parameters known to be of concern and present</li> </ul>
Lagoon or storage pond	<ul style="list-style-type: none"> <li>Water level in relation to maximum and minimum operating levels</li> </ul>	<ul style="list-style-type: none"> <li>Monthly nitrogen species, salt ions, BOD, other parameters known to be of concern and present (If all water passes through the pond, the pond water quality should be used rather than effluent quality into the pond.)</li> </ul>
Field by field application amounts	<ul style="list-style-type: none"> <li>Effluent application</li> <li>Visible inspection for runoff, equipment malfunctioning, erosion, crop condition</li> </ul>	<ul style="list-style-type: none"> <li>Constituent loading can be calculated from flows and constituent concentrations</li> </ul>
Pumps and pipelines	<ul style="list-style-type: none"> <li>Visible inspection for leaks</li> <li>Pressure checks to identify leaks, other equipment failures, need for maintenance</li> <li>Vibration in pumps and excess heat</li> </ul>	
Climate	<ul style="list-style-type: none"> <li>Daily or weekly precipitation and temperature</li> <li>Daily or weekly evapotranspiration</li> </ul>	

**Table 8-4.** Flow Measurement Alternatives

Method	Alternatives	Advantages/Disadvantages
Intrusive flow meters	<ul style="list-style-type: none"> <li>Impeller, paddle wheel</li> <li>Hot wire anemometer</li> </ul>	<ul style="list-style-type: none"> <li>Intrusive devices can clog with solids or from biological growth; higher friction loss/pressure drop</li> <li>Low pH or high EC can cause failure of sensing components resulting in higher maintenance</li> </ul>
Non-intrusive flow meters	<ul style="list-style-type: none"> <li>Magnetic</li> <li>Ultrasonic/Doppler</li> </ul>	<ul style="list-style-type: none"> <li>These sensors have no parts in the flow</li> <li>Higher capital cost: often, these are used at main pump station and alternate methods are used for individual fields</li> </ul>
Open channel flow measurements	<ul style="list-style-type: none"> <li>Weir-type</li> </ul>	<ul style="list-style-type: none"> <li>Requires controlled channel to establish proper conditions for measurement</li> <li>Simple, reliable operation; measurements can be recorded</li> </ul>
Incoming water supply correlation	<ul style="list-style-type: none"> <li>Discharge volume is estimated as a percentage of incoming water consumption</li> </ul>	<ul style="list-style-type: none"> <li>Supply water is clean, relatively simple to measure using meters</li> <li>A correlation between incoming flow, in-plant loss, and effluent discharge is required</li> </ul>
Pump run time and output calculation	<ul style="list-style-type: none"> <li>Flow for individual fields can be estimated proportionally from total flow</li> </ul>	<ul style="list-style-type: none"> <li>Requires a master pump station flow meter or some calibration</li> <li>Irrigation fields must be maintained so they operate according to specifications</li> <li>Primarily applicable to sprinkler irrigation systems or surface irrigation using siphon tubes or gated pipe</li> </ul>
In-field methods	<ul style="list-style-type: none"> <li>Rain gauge/catch cans in individual fields</li> <li>Use of soil water measurements to calculate net irrigation</li> </ul>	<ul style="list-style-type: none"> <li>Measures net irrigation (amounts actually applied) rather than gross irrigation</li> <li>Assumptions in water budget method make method approximate; calibration required. Measurement of soil moisture at bottom of root zone provides useful information related to leaching</li> <li>Rain gauges are applicable to sprinkler irrigation only</li> </ul>

---

Direct flow measurement devices provide reliable data when properly installed and maintained (including periodic inspection, preventative maintenance, and calibration). The type of measurement device or flowmeter selected depends upon the flow conveyance used in the facility.

The type of meter installed should allow measurement of both the instantaneous and record the total volume – this type of meter is known as a totalizing flowmeter. Flow measurement requires sufficient straight length of pipe or channel to develop uninterrupted, smooth non-turbulent flow to provide consistent and reliable data. Typically, a straight length of approximately ten (10) diameters should be available upstream of the flowmeter and the piping should remain straight for approximately four (4) pipe diameters downstream.

### **8.6.4 In-Field Distribution of Irrigation Water**

For land application systems, total flow and the distribution of effluent among irrigation fields (for facilities with multiple fields) should be measured. This is required to calculate hydraulic and other constituent loadings for the land application area. The type of application method (pumped conveyance, surface irrigation, sprinklers, etc.) influences the choice of in-field distribution monitoring method. The most commonly used flow measurement methods are listed in Table 8-4 and described in this section. These typically involve either direct measurement of flow at the field inlet; estimating the flow based on readings taken at the field inlet, estimating application amounts based on readings taken of soil moisture, or direct measurement of the amounts applied in the field.

For systems where effluent is pumped to the field(s), the direct measurement flowmeters described in the previous section are appropriate for in-field flow measurement. Use of hour-meters and estimation of flow from pump discharge and system pressure data are also feasible for estimating in-field distribution of water. Use of on-going pressure measurements in conjunction with this method is recommended because suspended solids may affect system pressures and water delivery by restricting flow in the pipelines or plugging sprinkler nozzles or gated pipe openings. Monitoring pressures in the field can be combined with performing on-going maintenance/inspection of the irrigation system.

For a facility using surface irrigation methods, with either gated pipe openings or siphon tubes for

transferring water from the irrigation ditches to the field sections, these can be calibrated to allow measurement of flow to the different portions of the field. Gated openings are holes in horizontal pipe sections to allow water to spill out into the field and siphon tubes are smaller diameter tubing laying in the irrigation ditch to convey the water by siphoning. Estimates of field flows must take into account the loss and return or “tailwater” flow, if return of the tailwater from the end of the irrigated area is practiced.

For facilities applying with sprinkler type systems, net irrigation, can be measured using rain gauges placed within the fields. This method is a simple and effective way to measure the actual water applied to different areas. Rain gauges are installed in land application fields and are typically read weekly, although some facilities use daily measurements. Since the measurement technology is simple and inexpensive, several rain gauges should be installed at each site for comparison. For fields that receive both effluent and supplemental irrigation water, field notes regarding dates and hours of water flow from these two sources must be used to separate these water sources. Background rainfall amounts are recorded separately, usually at a nearby location not receiving irrigation, and subtracted from the total recorded in the field locations.

### **8.6.5 Soil Monitoring and Testing**

Soil testing and analysis is an important part of land application site monitoring. Soils data are used for three primary purposes in land application systems, as follows:

- Assessment of nutrient supply for crops;
- Evaluation of treatment efficiency of the soil plant system;
- Assessment of the land application site condition over time.

A well-designed soil sampling program addresses both environmental and agricultural production objectives. Your state land grant university should be consulted for extraction solutions and analytical methods for your local area. Basic monitoring parameters and the use of the measurements are summarized in Table 8-5.

The most common soil sampling methods for land application systems rely on removal of a soil core or soil sample within land application fields. Sampling depths vary and your local land grant university has recommendations. Generally pastures are samples 0-4” and row crop fields 0.6”. Increasingly, in-situ measurements of soil aeration status and moisture content have been used. These latter methods are

**Table 8-5.** Soil Monitoring Parameters

Parameters	Sampling considerations
General	Measure following harvest of each crop:
pH, EC, Organic matter,	<ul style="list-style-type: none"> <li>• Make a composite sample from a minimum of 3 locations per application zone, depending on field size</li> </ul>
TKN, NO <sub>3</sub> -N, NH <sub>3</sub> -N, PO <sub>4</sub> ,	<ul style="list-style-type: none"> <li>• Basic soil test to assess general condition</li> <li>• Nutrient analysis to assess loading impacts</li> </ul>
Na, Ca, Mg, HCO <sub>3</sub> ,	<ul style="list-style-type: none"> <li>• Salt analysis to calculate the Sodium Adsorption Ratio and Exchangeable Percentage</li> </ul>
Available K, Available P, SO <sub>4</sub> ,	<ul style="list-style-type: none"> <li>• Nutrient analysis to assess soil fertility (SR and OF systems look for K deficiency)</li> </ul>
CO <sub>3</sub> , Cl	<ul style="list-style-type: none"> <li>• Additional ions to complete a salt balance. This need not be done at every sampling event.</li> </ul>

customarily used for more research-oriented purposes and are included here for completeness. Soil sampling is commonly done once or twice during cropping years at multiple depths and at multiple locations in the field. Often samples from different locations in the field are composited so that average conditions can be assessed. It is recommended that soil samples be collected before planting and following harvest for evaluation of the nutrient requirements and uptake of crops.

Since soil moisture monitoring is primarily performed for operational purposes, rather than regulatory compliance, the frequency and depths of sampling can be selected based on site-specific needs. Soil moisture depth monitored below the root can be used to document the presence of leaching.

### 8.6.6 Vadose Zone Sampling

The unsaturated soil from the soil surface to groundwater is the vadose zone. Monitoring or sampling of the vadose zone can be accomplished by sampling soil or soil-water. Vadose zone samples are too variable and therefore of little value to measure performance of land treatment.

Vadose zone monitoring has been used to assess land application programs primarily for research purposes. Vadose zone monitoring is more complex than monitoring of other media in a land application system because both water movement and solution concentrations must be measured. In fact, vadose zone monitoring is often considered to be primarily a research tool because considerable analysis is required to properly interpret results and measurement methods are intricate and susceptible to error due to installation method and operation. Use of these techniques for operational management or regulatory compliance does

not appear to be as useful as other methods for addressing soil and groundwater conditions.

Common techniques used to measure vadose zone properties are summarized in Table 8-6. Additional technical information is available in ASTM standards (ASTM 1992). All but one of the methods in Table 8-6 is designed to measure concentrations of constituents in the water in the vadose zone soil pores. Key differences among methods include ability to measure water flow as well as water quality, disturbance required to install the device, and the need to install replicate sensors to address measurement variability. The different types of lysimeters used to measure soil water constituent concentrations are summarized in Table 8-6.

Soil sampling can be included in a list of vadose zone sampling methods because this can yield basic monitoring information. Soil concentrations of constituents of interest are measured and a water budget developed using techniques discussed previously can provide an estimate of water flow. Changes in soil concentrations at a given depth over time can be used to assess whether a land application site is managed properly.

Suction lysimeters are relatively simple to operate. Samples are collected from the device by applying a vacuum (generally for 24 hours prior to sampling), which draws soil solution into the lysimeter, and samples can then be collected. The sample is analyzed to determine concentrations but interpretation of this "simple" result is complex. Suction lysimeters often appear to be a low-cost monitoring choice because the basic sampling equipment is relatively inexpensive. This is often not the case when replicate installations to provide representative results and the requirement to provide an accompanying water flow measurement are included in the cost of monitoring.

The more capital-intensive pan and basin lysimeters are improvements over the suction lysimeter method because these provide a solution sample that has been collected as a result of downward flow of water. These provide both a sample for chemical analysis and an estimate of water flow based on the volume of water collected. These sensors are often considered to be a permanent installation because of the relatively complex installation procedure. The disadvantage of pan lysimeters is that the sample can exceed holding time for some constituents because it is not necessarily withdrawn as soon as it appears in the sampler. In addition, if the soil profile is disturbed by the installation, the movement and water quality changes represented by the sample may not reflect that of the undisturbed soil profile.

**Table 8-6.** Vadose Zone Sampling/Monitoring Alternatives

Method	Description	Advantages/Disadvantages
Soil Sampling	Soil samples are collected and analyzed for pH, EC, Cl, NO <sub>3</sub> -N	Simple and reliable Samples totals, not just solution fraction Destructive sample Requires a soil water balance calculation to determine whether flow occurs
Suction Lysimeter	A porous ceramic tube is placed in the soil so soil solution samples can be collected and analyzed	Inexpensive, simple technique to implement Extracts soil solution that is not mobile Known to have large measurement variability Requires a soil water balance calculation to determine whether flow occurs
Pan Lysimeter	A small collection pan (1-5 ft <sup>2</sup> ) is buried at a selected depth so that soil solution samples can be collected via gravity drainage for analysis	Extracts soil solution during flow events Provides a measure of both flow and water quality Installation can approximate undisturbed conditions Moderate variability among replicate samples
Basin Lysimeter	A large collection pan (50-400 ft <sup>2</sup> ) is constructed and covered with soil so that soil solution samples can be collected via gravity drainage for analysis	Extracts soil solution during flow events Provides a measure of both flow and water quality Installation creates disturbed soil conditions Large sample decreases variability
Wick Lysimeter	A porous wick designed to match the soil water retention characteristics of the soil is buried at a selected depth so that solution samples can be collected using a low negative pressure.	Extracts soil solution at near zero water potential Installation can approximate undisturbed conditions Requires a soil water balance calculation to determine whether flow occurs

### 8.6.7 Groundwater

Groundwater monitoring is required at most land application sites. Details regarding the establishment of a program, monitoring well construction, hydrogeologic evaluation, and monitoring methods follow agency guidelines and industry standards.

### 8.6.8 Crop Management and Biomass Removal

Crop management is an important part of operating and maintaining a land application system. A healthy and productive crop is required to remove nutrients and salts. Plant material quality is an indicator of the biological integrity of the site. Although it is of secondary importance, the value of crops harvested from the site may provide an additional incentive to assure that proper attention is paid to the land application fields. Attention to crop needs, including irrigation water and nutrients, will result in better management for agricultural production, water treatment, and environmental protection objectives.

Much of crop management is accomplished in the same way for a land application site and conventional agricultural operations. Because effluent supplies organic fertilizer, crop responses to effluent irrigation differ from those in a conventional irrigation water/inorganic commercial fertilizer scenario. Daily monitoring (addressed in the next section) is required to assess whether each crop is healthy enough or whether some management action must be taken.

Recommendations for routine monitoring of crops are provided in Table 8-7. Local county representatives and

land grant universities should be contacted to help in developing crop management plans. Careful daily observations are important for ongoing management activities and should be maintained in a field log for reference. The actual measurements required for crop monitoring include biomass removal and tissue sampling to determine constituent levels removed. Because nutrient uptake is the primary function of the crop, analysis for nitrogen is recommended. Salt management at land application sites includes a number of soil processes, salt loading and crop uptake need not match as closely as nitrogen levels.

### 8.6.9 Routine Maintenance and Inspection

Thorough daily inspections to identify operational problems and gather data to make irrigation and cropping decisions are recommended as part of routine monitoring. Each facility should develop a customized inspection form. Table 8-8 provides an example Inspection form useful for guiding daily inspections.

It is common that a routine inspection form also incorporates collection of meter readings, pressure checks, times that various activities take place, etc. This is an appropriate combination of tasks and should be encouraged. Because land application treatment is a biological process, it is somewhat unpredictable and observations used to adjust management according to actual field conditions are important. In addition, results and observations made during inspection are an appropriate topic at periodic facility staff meetings or informal meeting of field or maintenance personnel.

**Table 8-7.** Example Crop Monitoring Parameters

Parameter	Description
Crop management chronology	Dates of cropping activities should be logged including date of planting, date of harvest, dates of primary tillage operations, application of fertilizer, observations of crop health
Biomass removed	This can be accomplished by counting bales, bushels, trucks or other field-scale measurements. Water content should be determined so that data can be converted to dry weight.
Constituents removed	Sample crops for TKN, NO <sub>3</sub> -N Salts can be evaluated if appropriate for a specific site.

**Table 8-8.** Routine Maintenance Inspection Checklist for Land Application Sites

Feature	Condition	Recommended Action
Facility Discharge	Check amount of flow, evidence of unusual conditions	
Lagoon or Pond	Pond level, odor, scum on surface, presence of excessive solids	
Main Pump Station	Current operations, flow, pressure, odor, leaks, mechanical concerns	
Transmission Piping	Leaks, odor, pressure at intermediate locations	
Booster Pumps	Current operations, flow pressure, odor, leaks, mechanical concerns	
Fields irrigated	For each field: list irrigation run times, effluent or supplemental water supply, odor	
Fields condition	For each field: assess irrigation uniformity, runoff, erosion, irrigation system condition, odor, solids on surface	
Crop condition	For each field: general crop health, need for farming activities	
Samples Collected	List samples taken	

## 8.7 References

- American Society of Agronomy. 1986. *Methods of Soil Analysis, Part 1, Physical and Mineralogical Methods* 2nd edition, A. Klute, Editor, Madison, WI.
- Crites, R. W., S. C. Reed, and R. K. Bastian. 2000. *Land Treatment Systems for Municipal and Industrial Wastes*. McGraw-Hill. New York, NY.
- Hagen, R. M., H. R. Haise, T. W. Edminster, eds. 1967. *Irrigation of Agriculture Lands, Agronomy Series No. 11*. Madison, WI.
- Hoffman, G. J. and M. van Genuchten. 1983. "Water Management of Salinity Control." *Limitation to Efficient Water Use in Crop Production*, Chapter 2C. H. Taylor, W. Jordan, and T. Sinclair, eds. ASA. Monograph, pp 73-85.
- Hoffman, G. J. 1985. *Drainage Required to Manage Salinity*. Journal of Irrigation and Drainage Division. ASCE 111. pp 199-206.
- Hoffman, G. J. 1996. "Leaching Fraction and Root Zone Salinity Control", *Agricultural Salinity Assessment and Management*. ASCE No. 71. K. K. Tanji, ed. Corrected Edition. ASCE. New York, NY.
- McMichael, F. C. and J. E. McKee. 1956. *Wastewater Reclamation at Whittier Narrows*. State Water Quality Control Board. Publication No. 33.
- US EPA 1981. *Process Design Manual for Land Treatment of Municipal Wastewater*, EPA-625/1-81-013, U.S. Environmental Protection Agency, CERL, Cincinnati, OH.
- US EPA. (1982). *Handbook for Chemical and Sample Preservation of Water and Wastewater*, EPA-600/4-82-029, Washington, DC.
- US EPA. (1983). *Methods for Chemical Analysis of Water and Waste*, EPA-600/4-79-020, Washington, DC.
- US EPA. (1995). *Groundwater Well Sampling, Standard Operating Procedure* 2007.



## Chapter 9

# Process Design – Overland Flow Systems

The process design approach to overland flow (OF) systems for land treatment of municipal wastewater is discussed in this chapter. The expected performance and removal mechanisms are described in Chapter 2. Because OF systems discharge, permit conditions and rainfall runoff must be considered in the design.

### 9.1 System Concept

Overland flow (OF) is defined as the controlled application of wastewater onto grass-covered, uniformly-graded, gentle slopes, with relatively impermeable surface soils. The process was first applied in the United States for industrial wastewaters in Napoleon, OH and Paris, TX (Bendixen et al., 1969; Gilde et al., 1971). Early application of the process for municipal wastewaters occurred in England, where it was termed "grass filtration," and in Melbourne, Australia (Scott and Fulton, 1979; US EPA, 1975). Many of these OF systems have been in continuous and successful operation since the late 19<sup>th</sup> century. Research efforts by EPA (US EPA, 1976) and the U.S. Army Corps of Engineers (Peters et al., 1978; Carlson et al., 1974) and the performance of operational systems (Peters et al., 1981; US EPA, 1979; US EPA., 1981) led to modeling efforts and the development of rational design criteria (Jenkins et al., 1978; US EPA, 1981; Smith and Schroeder, 1982).

#### 9.1.1 Site Characteristics

Overland flow is best suited for use at sites having surface soils that are slowly permeable (clays), or that have a restrictive layer, such as a hardpan or claypan at depths of 0.3 to 0.6 m (1 to 2 ft). Moderately permeable soils can be used if the subsurface layer is compacted to restrict deep percolation and ensure a sheet flow down the graded slope.

Overland flow may be used at sites with grades between 1 and 12 percent. Slopes can be constructed on level terrain by creating a 2 percent slope. Grades steeper than 10 percent should be terraced (slopes of 2 to 8 percent built up, followed by a steep drop and another terrace) so that erosion (from heavy rainfall and heavy wastewater application) is minimized. For the desired slope range of 2 to 8 percent, the actual slope does not affect the treatment performance (Jenkins et al., 1978). The slope must be graded so that it is smooth and of nearly constant grade. This is especially true near the upper reaches of the slope to prevent channeling of wastewater and poor treatment. Site grades less than 2 percent may require special

measures to avoid ponding of water on the slope. The potential for short-circuiting and erosion is higher for slopes greater than 8 percent.

#### 9.1.2 System Configuration

The general system layout should match as closely as possible the natural topography at the site to minimize expensive earthwork. The total field area for treatment is determined by methods described later in this chapter. Individual treatment slopes are laid out on a topographic map of the site until the field area requirements are satisfied. The individual slopes must be connected with a network of ditches for collection of treated runoff and stormwater runoff for conveyance to the final system discharge point.

The choice of the system layout is also influenced by the type of wastewater distribution. High-solids-content wastewaters typically are applied using high-pressure sprinklers to ensure uniform distribution of the solids on the treatment slope. Low-pressure systems involving gated pipe or sprinklers have been used successfully for screened, primary, secondary or pond effluents. The various possibilities for both high- and low-pressure types are illustrated in Figure 9-1 (Jenkins et al., 1978). Chapter 7 contains design details on both types of distribution systems.

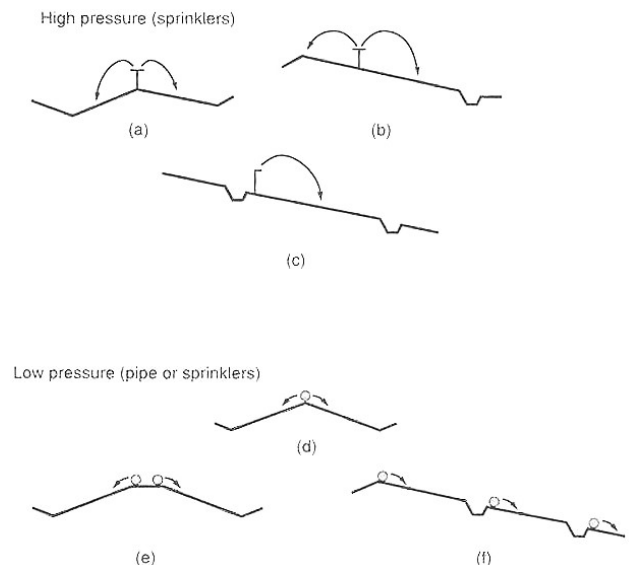


Figure 9-1. Distribution Alternatives for Overland Flow.

Most industrial systems are of the type shown in Figure 9-1 (a) or (b), with the sprinklers for type (b)

located at the one-third point down the slope so that all the wastewater applied is contained on the treatment surface. Empirical criteria were developed through trial-and-error experience, so that slope lengths from 30 to 45 m (100 to 150 ft) would provide adequate treatment for most wastewaters. If, for example, a sprinkler with a 30 m (100 ft) diameter wetted circle is located at the one-third point on a 45 m (150 ft) long slope, the "average" travel distance for all the applied wastewater would then be 30 m (100 ft). Solids content of less than 100 g/m<sup>3</sup> typically allows the use of low-pressure systems. A slotted or gated pipe at the top of a 30 m (100 ft) slope should provide the same degree of treatment as the 45 m (150 ft) slope with the pressure sprinklers at the one-third point. Low-pressure systems are not suitable for high-solids content wastewater because deposition of the solids will occur in the immediate vicinity of the application point, results in excess accumulation and either maintenance requirements or incomplete treatment and the production of odors.

### 9.1.3 Performance Standards and System Capabilities

OF systems can be designed to achieve high levels of treatment. OF can be used as a pretreatment step to a water reuse system or can be used to achieve secondary treatment, advanced secondary treatment, or nitrogen removal, depending on discharge requirements. Most OF systems have an outlet to surface water for the treated runoff and therefore require NPDES discharge permits. For municipalities depending on WQS the permit will limit BOD and TSS, and that is the basis for the design approach presented in this chapter. If the permit contains other requirements (i.e.: nitrification of ammonium, phosphorus removal, etc.), then the following multi-step procedure can be used to determine the limiting design parameter (LDP) for the system:

1. Determine the slope length, loading rates, etc. for BOD removal.
2. Estimate the slope length and loading rate for other parameters.
3. Select the parameter that results in the lowest application rate as the LDP.

The effluent quality from properly designed and operated OF systems can consistently produce effluents with 10 g/m<sup>3</sup> (mg/L) BOD and 15 g/m<sup>3</sup> (mg/L) TSS (WEF, 2001). OF systems can be designed to nitrify to 1 g/m<sup>3</sup> (mg/L) of ammonium-nitrogen and can produce effluent total nitrogen concentrations of 5 g/m<sup>3</sup> (mg/L) (WEF, 2001). In concept, the system can be thought of as a plug-flow, attached-growth biological reactor with a vegetated surface (Martel, 1982). The near-surface soil and surface deposits and the grass stems and roots provide a matrix for the microbial components that result

in the bulk of the treatment. The grass also serves as a sink for nutrients as well as water removal by evapotranspiration.

Vegetation on the treatment slopes is essential to regulate and retard the flow, minimize velocity, and minimize erosion, short-circuiting and channeling. The choice of vegetation is more limited for OF systems as compared to SR systems because perennial, water-tolerant grasses are the only feasible possibilities for OF systems, as described in Chapter 4. Reed canarygrass, tall fescue and other similar grasses can withstand daily saturation and flourish under frequently anaerobic conditions.

In some respects the OF process offers more flexibility and control of effluent quality than SAT and SR systems do. For most SAT or SR systems there is no access to the wastewater once it is applied to the soil. All of the responses and constraints have to be anticipated and programmed into the design because there will be limited opportunities to control the responses once the system is operational. In contrast, most of the wastewater is continuously accessible in an OF system and this allows greater flexibility in operational adjustments.

## 9.2 Design Procedures

The procedure for design of OF systems is to establish the limiting design parameter; select the application rate, application period, and slope length; calculate the hydraulic loading rate; and calculate the field area required. The storage volume, if any, must also be determined, and the field area increased to account for stored volume. Because BOD is often the LDP for municipal systems, the design approach discussed in this section is tailored for BOD removal. Design considerations for systems limited by nitrogen and total suspended solids are also described below.

### 9.2.1 BOD<sub>5</sub>

Laboratory and field research at the University of California at Davis has resulted in the development and validation of a rational design procedure for OF when BOD is the limiting design parameter (Smith, 1981; Smith and Schroeder, 1982 and 1983). The design model assumes first-order, plug-flow kinetics which can be described with the following equation:

$$\frac{C_z - R}{C_0} = A \exp\left(\frac{-kz}{q^n}\right) \quad (9-1)$$

Where:

- C<sub>z</sub> = BOD<sub>5</sub> concentration of runoff at a distance (z) downslope, g/m<sup>3</sup> (mg/L)
- R = background BOD<sub>5</sub> concentration, typically 5 g/m<sup>3</sup> (mg/L)
- C<sub>0</sub> = BOD<sub>5</sub> concentration of applied wastewater, g/m<sup>3</sup> (mg/L)
- A = empirically-determined coefficient dependent on the value of q

- k = empirically-determined exponent (less than one)
- z = distance downslope, m or ft
- q = application rate, m<sup>3</sup>/h·m (downslope) (gal/min·ft (downslope))
- n = empirically-derived exponent

The equation is presented graphically in Figure 9-2 for primary effluent (Smith and Schroeder, 1985). It has been validated for screened raw wastewater and primary effluent, as shown in Table 9-1 (Smith and Schroeder, 1982). The equation has not been validated for industrial wastewater with BOD values of 400 g/m<sup>3</sup> (mg/L) or more. The OF process does not produce an effluent free of suspended and organic material. This is because the effluent from an OF slope will approach a nonzero, steady-state concentration value regardless of slope length. The 5 g/m<sup>3</sup> (mg/L) BOD residual or background concentration is due to the release of natural decaying organic material and solids from the soil-plant system rather than a component of the influent BOD (Reed et al., 1995; Tedaldi and Loehr, 1991). For facultative pond effluent, the application rate should not exceed 0.10 m<sup>3</sup>/h·m (0.12 gal/min·ft).

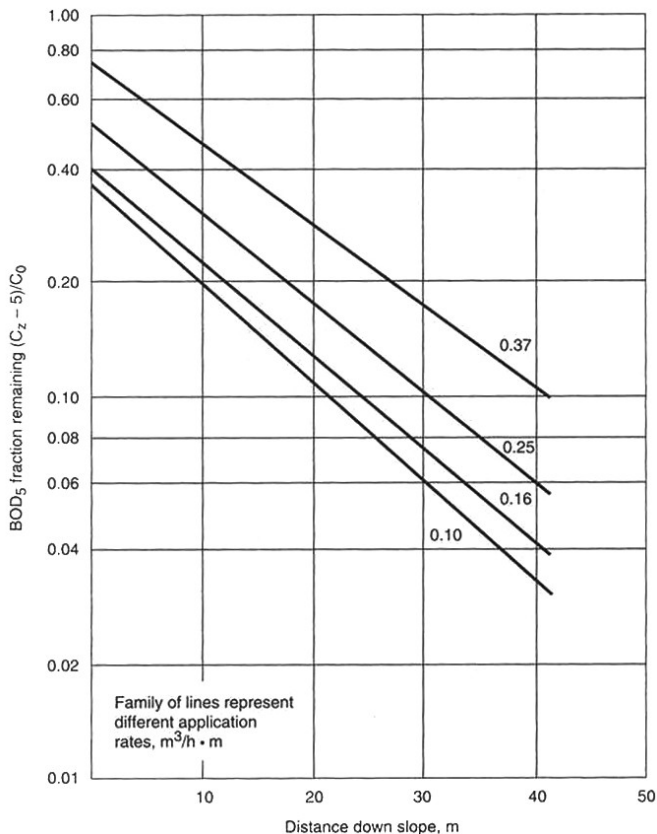


Figure 9-2. Overland-Flow Application Rates and Slope Length.

## Application Rate

The application rate is defined as the flowrate applied to the slope per unit width of slope. The application rate used for design of municipal OF systems depends on the limiting design factor (usually BOD), the preapplication treatment, and the climate. The removal of BOD for various application rates and different types of wastewater is presented in Table 9-2 (Crites and Tchobanoglous, 1998). A range of suggested application rates is presented in Table 9-3 for different climates and levels of required removal (Crites and Tchobanoglous, 1998; Reed et al., 1995).

## Application Period

Application periods usually range from 6 to 12 h/d for 5 to 7 d/wk. For municipal wastewater an 8 h/d application period is typical. For industrial wastewaters the application period can be as short as 4 h/d. Occasionally, municipal OF systems can operate 24 h/d for relatively short periods. The ability to nitrify is impaired with an application schedule beyond 12 h on and 12 h off (Kruzic and Schroeder, 1990). The typical 8 h on and 16 h off schedule allows the total field area to be divided into three subareas and for the system to operate 24 h/d when required.

## Slope Length

Slope lengths in OF practice have ranged typically from 30 to 60 m (100 to 200 ft). The longer the slope the greater the removal of BOD, TSS, and nitrogen. The recommended slope length depends on the method of application. For gated pipe or spray heads where the wastewater is applied at the top of the slope, a slope length of 36 to 45 m (120 to 150 ft) is recommended. For high-pressure sprinkler application, the slope should be between 45 to 61 m (150 and 200 ft). The minimum slope length for sprinkler application should be the wetted diameter of the sprinkler plus about 20 to 21 m (65 to 70 ft) (Crites and Tchobanoglous, 1998).

## Hydraulic Loading Rate

A rational approach to design is to first select the application rate and then determine the hydraulic loading rate. Using the application rate approach allows for the designer to consider varying the application rate and application period to accomplish a reduction or increase in hydraulic loading. The relationship between the application rate and the hydraulic loading rate is presented in Equation 9-2.

$$L_w = \frac{qPF}{Z} \tag{9-2}$$

**Where:**

- $L_w$  = wastewater hydraulic loading rate, m/d (in/d)
- $q$  = application rate per unit width of slope,  $m^3/\text{min} \cdot m$  (gal/min-ft)
- $P$  = application period, h/d
- $F$  = conversion factor,  $60 \text{ min} \cdot h$  ( $96.3 \text{ min} \cdot \text{ft}^2 \cdot \text{in}/h \cdot \text{gal}$ )

$Z$  = slope length, m (ft)

Hydraulic loading rates have generally ranged from 20 to 100 mm/d (0.8 to 4 in/d).

**Table 9-1.** Comparison of Actual and Predicted OF Effluent BOD Concentrations Using Primary and Raw Municipal Wastewater

Location	Applied Wastewater	Application Rate ( $m^3/h \cdot m$ ) <sup>a</sup>	Slope Length (m) <sup>b</sup>	BOD <sub>5</sub> Concentration ( $g/m^3$ ) <sup>c</sup>	
				Actual	Predicted
Hanover, NH	Primary	0.25	30.5	17	16.3
	Primary	0.37	30.5	19	17.5
	Primary	0.12	30.5	8.5	9.7
Ada, OK	Primary	0.10	36	8	8.2
	Raw	0.13	36	10	9.9
Easley, SC	Raw	0.21	53.4	23	9.6

<sup>a</sup> $m^3/h \cdot m \times 1.34 = \text{gal}/\text{min} \cdot \text{ft}$ .

<sup>b</sup> $m \times 3.28 = \text{ft}$ .

<sup>c</sup> $g/m^3 = 1 \text{ mg}/L$ .

**Table 9-2.** BOD Removal for Overland Flow Systems

Location	Municipal Wastewater Type	Application Rate* ( $m^3/h \cdot m$ ) <sup>a</sup>	Slope Length (m) <sup>b</sup>	BOD Concentration ( $g/m^3$ ) <sup>c</sup>	
				Influent	Effluent
Ada, OK	Raw wastewater	0.09	36.6	150	8
	Primary effluent	0.12	36.6	70	8
	Secondary effluent	0.24	36.6	18	5
Easley, SC	Raw wastewater	0.26	54.9	200	23
	Pond effluent	0.28	45.7	28	15
Hanover, NH	Primary effluent	0.15	30.5	72	9
	Secondary effluent	0.09	30.5	45	5
Melbourne, Australia	Primary effluent	0.29	250	507	12

\*Application rate is average flow,  $m^3/h$ , divided by the width of the slope, m.

<sup>a</sup> $m^3/h \cdot m \times 1.34 = \text{gal}/\text{min} \cdot \text{ft}$ .

<sup>b</sup> $m \times 3.28 = \text{ft}$ .

<sup>c</sup> $g/m^3 = 1 \text{ mg}/L$ .

**Table 9-3.** Application Rates Suggested for BOD Removal in Overland Flow Design,  $m^3/h \cdot m$  (gal/min-ft)

Preapplication Treatment	Stringent Requirements and Cold Climates*	Moderate Requirements and Climates†	Least Stringent Requirements and Warm Climates‡
Screening/primary	0.08–0.12 (0.11–0.16)	0.19–0.29 (0.25–0.39)	0.30–0.45 (0.40–0.60)
Aerated cell (1-day detention)	0.09–0.12 (0.12–0.16)	0.19–0.39 (0.25–0.52)	0.39–0.48 (0.52–0.64)
Secondary	0.19–0.24 (0.25–0.32)	0.24–0.39 (0.32–0.52)	0.39–0.48 (0.52–0.64)

\*Stringent requirements: BOD = 10  $g/m^3$ , TSS = 15  $g/m^3$ .

†Moderate requirements: BOD and TSS  $\leq 20 \text{ } g/m^3$ .

‡Least stringent requirements: BOD and TSS  $\leq 30 \text{ } g/m^3$ .

**Organic Loading Rate.** Organic loading rates for OF are typically less than 100  $kg/ha \cdot d$  (90  $lb/acre \cdot d$ ). The oxygen transfer efficiency through the thin water film (usually 5 mm or 0.2 in) limits the aerobic treatment capacity of the OF process to the above rates. The organic loading rate can be calculated using Equation 9-3.

$$L_{BOD} = 0.1(L_w)(C_0) \quad (9-3)$$

**Where:**

- $L_{BOD}$  = BOD loading rate,  $kg/ha \cdot d$  ( $lb/acre \cdot d$ )
- 0.1 = conversion factor (0.225 in U.S. customary units)

- $L_w$  = hydraulic loading rate,  $mm/d$  (in/d)
- $C_0$  = influent BOD<sub>5</sub> concentration,  $g/m^3$  (mg/L)

When the BOD of the applied wastewater exceeds about 800  $g/m^3$  (mg/L), the treatment efficiency becomes impaired by the oxygen transfer efficiency. Effluent recycle has been used to reduce the concentration to around 500  $g/m^3$  (mg/L) and achieve 97 percent BOD removal at a BOD loading rate of 56  $kg/ha \cdot d$  (50  $lb/acre \cdot d$ ) (Perry et al., 1981). It should be noted that Figure 9-2 has only been validated to 400  $g/m^3$  (mg/L) BOD.

## 9.2.2 Total Suspended Solids

With the exception of algae, wastewater solids will not be the LDP for overland flow design. Suspended and colloidal solids are effectively removed because of the low velocity and the shallow depth of flow on the treatment slope. Maintenance of a thick grass cover and elimination of channel flow are essential for solids removal. The removal of suspended matter is relatively unaffected by cold weather or other process loading parameters (US EPA, 1981).

When lagoons or storage ponds are used in overland flow systems the presence of algae in the wastewater may result in high suspended solids in the final effluent because of the inability to remove some types of algae (Witherow and Bledsoe, 1983). Many small-diameter, free floating species of algae and diatoms have little or no tendency to aggregate and are particularly difficult to remove. Examples are the green algae *Chamdomonas* and *Chlorella* and the diatoms *Anomoeoneis*. In contrast, the green algae *Protococcus* has a “sticky” surface and is effectively removed on the OF slope. Because control of algal species in ponds may be a problem, it may be necessary to isolate or bypass the ponds with the algal blooms. Therefore, during periods of algal blooms, storage ponds for OF systems should be off-line and only used when absolutely necessary. Once the algal bloom periods have passed, the affected pond cell can be returned to service.

If overland flow is otherwise best suited to a site with an existing pond system, design and operational procedures are available to improve algae removal. The application rate should not exceed 0.10 m<sup>3</sup>/h · m (0.13 gal/min · ft) for such systems, and a nondischarge mode of operation can be used during algae blooms. In the

nondischarge mode, short application periods (15 to 30 min) are followed by 1- to 2-h rest. The OF systems at Heavener, OK and Sumrall, MI operate in this manner during algae blooms (Crites and Tchobanoglous, 1998).

## 9.2.3 Nitrogen

There are many mechanisms that remove nitrogen in OF systems, but the major pathways are nitrification/denitrification, crop uptake, and adsorption of ammonium on materials with cation exchange capacity (CEC). Nitrification/denitrification, which accounts for most of the nitrogen removal, depends on adequate detention time, temperature, and BOD/nitrogen ratios (Reed et al., 1995). Denitrification appears to be most effective when screened raw or primary effluent is applied, because of the high BOD/nitrogen ratio. Soil temperatures below 4°C (39°F) will limit the nitrification reaction.

Up to 90 percent removal of ammonium was reported at application rates of 0.10 m<sup>3</sup>/h · m (0.13 gal/min · ft) at the OF system at Davis, CA (Kruzic and Schroeder, 1990). Slope lengths of 45 to 60 m (150 to 200 ft) may be required to achieve this level of ammonia removal.

At Garland, TX, nitrification studies were conducted with secondary effluent to determine if a 2-g/m<sup>3</sup> (mg/L) summer limit for ammonia and a 5-g/m<sup>3</sup> (mg/L) winter limit could be attained. Removal data for the two periods are presented in Table 9-4 for different application rates (Zirschky et al., 1989). Winter air temperatures ranged from 3° to 21°C (26° to 70°F). The recommended application rate for Garland was 0.43 m<sup>3</sup>/h · m (0.56 gal/min · ft) for a slope length of 60 m (200 ft) with sprinkler application (Zirschky et al., 1989).

**Table 9-4.** Ammonia Concentrations (in g/m<sup>3</sup>) in OF Systems in Garland, TX

Month	Application Rate (m <sup>3</sup> /h · m) <sup>a</sup>	Length Downslope (m) <sup>b</sup>		
		46	61	91
Summer	0.57	1.51	0.40	0.12
Mar. – Oct.	0.43	0.65	0.27	0.11
	0.33	0.14	0.03	0.03
Winter	0.57	2.70	1.83	0.90
Nov. – Feb.	0.43	1.29	0.39	0.03
	0.33	0.73	0.28	0.14

<sup>a</sup>m<sup>3</sup>/h · m × 1.34 = gal/min · ft.

<sup>b</sup>m × 3.28 = ft.

Note: Summer-applied ammonia nitrogen = 16.0 g/m<sup>3</sup>; winter-applied ammonia nitrogen = 14.1 g/m<sup>3</sup>.

## 9.3 Land Area Requirements

The field area, the area of land to which wastewater is actually applied, for OF depends on the flow, the application rate, the slope length, and the period of application. The total land area required for an OF system should include land for preapplication treatment,

administration and maintenance buildings, service roads, buffer zones, and storage facilities. If there is no seasonal storage, the field area can be calculated using Equation 9-4.

$$A = \frac{QZ}{qPF} \quad (9-4)$$

**Where:**

- A = field area, ha (acres)  
 Q = wastewater flowrate, m<sup>3</sup>/d (gal/min)  
 Z = slope length, m (ft)  
 q = application rate, m<sup>3</sup>/h·m (gal/min·ft)  
 P = period of application h/d  
 F = conversion factor, 10,000 in SI units (726 in U.S. units)

If wastewater storage is a project requirement, the application field area is determined using Equation 9-5. Equation 9-5 was developed using an application rate of 0.048 m<sup>3</sup>/h·m (0.06 gal/min·ft).

$$A = \frac{365Q + V_s}{DL_w F} \quad (9-5)$$

**Where:**

- A = field area, ha (acres)  
 Q = wastewater flow, m<sup>3</sup>/d (ft<sup>3</sup>/d)  
 V<sub>s</sub> = net loss or gain in storage volume due to precipitation, evaporation, and seepage, m<sup>3</sup>/yr (ft<sup>3</sup>/yr)  
 D = number of operating days per year  
 L<sub>w</sub> = hydraulic loading rate, cm/d (in/d)  
 F = conversion factor, 100 in SI units (3630 in U.S. units)

## 9.4 Design Considerations

Considerations for design of overland flow systems include winter operation, storage of wastewater required for rainfall runoff or crop harvesting, distribution systems, runoff collection and permit requirements for rainfall runoff, slope design and construction, and vegetation selection.

### 9.4.1 Winter Operation

In general, OF systems shut down for cold winter weather when effluent quality requirements cannot be met because of cold temperatures or when ice begins to form on the slope. Sometimes the reduction of the application rate can allow the operation to continue during cold weather. If a shutdown is required, wastewater must be stored. The most conservative approach would be to assume a storage period that is equal in length to that required for SR systems (Chapter 6 and 8). At wastewater and soil temperatures above 8°C (50°F), the BOD removal efficiency is independent of temperature (Smith and Schroeder, 1982). In low temperature studies in New Hampshire, the following relationship between effluent BOD and temperature was developed (Jenkins et al., 1978):

$$E_{BOD} = 0.226T^2 - 6.53T + 53 \quad (9-6)$$

**Where:**

- E<sub>BOD</sub> = effluent BOD, g/m<sup>3</sup> (mg/L)  
 T = soil temperature, °C

Equation 9-5 was developed for an application rate of 0.048 m<sup>3</sup>/h·m (0.06 gal/min·ft). At a soil temperature of

less than 3.9°C (39°F) the effluent BOD will exceed 30 g/m<sup>3</sup> (mg/L), based on Equation 9-6.

Wastewater applications should cease when an ice cover forms on the slope. Operation of sprinkler systems can be very difficult at air temperatures below freezing. In locations where night-time air temperatures fall below 0°C (32°F) but daytime air temperatures exceed 2°C (36°F), a day-only operation may be chosen in which all the field area is used within 10 to 12 hours.

### 9.4.2 Storage of Rainfall Runoff

A detailed discussion and calculation procedures for storage are presented in Chapter 6. Research and field studies at a number of systems have found that rainfall runoff either during or after wastewater applications did not significantly affect the concentration of the major constituents in the runoff (Smith and Schroeder, 1982; US EPA, 1981). This must be considered as part of total maximum daily load (TMDL) requirements.

Based on work at the Davis, CA, overland flow system stormwater discharges are the result of natural organics and litter on the slope and not wastewater constituents and in fact were less than the losses from control slopes where no wastewater had been applied.

### 9.4.3 Distribution Systems

Municipal wastewater can be surface-applied to OF slopes; however, industrial wastewater should be sprinkler-applied. Surface application using gated pipe offers lower energy demand and avoids aerosol generation. Slide gates at 0.6-m (2-ft) spacings are recommended over screw-adjusted orifices. Pipe lengths of 100 m (300 ft) or more require in-line valves to allow adequate flow control and isolation of pipe segments for separate operation.

With the orifice-pipe or fan-spray types of low-pressure distribution, the wastewater application is concentrated along a narrow strip at the top of each slope. As a consequence, a grass-free application strip 1.2 to 2 m (4 to 6 ft) wide should be provided with these types of distribution systems to allow operators to inspect the area easily and to access the outlets without damaging wet slopes. Gravel is a suitable material for this unvegetated strip, but it tends to work into the soil and requires replacement over time.

Sprinkler distribution is recommended for wastewater with BOD or TSS levels of 300 g/m<sup>3</sup> (mg/L) or more. Impact sprinklers located about one-third of the way down the slope are generally used. Wind speed and direction must be considered in spacing between sprinklers (Reed et al., 1995).

---

#### **9.4.4 Runoff Collection**

The purpose of the runoff collection channels is to transport the treated runoff and storm runoff to a final discharge point and allow runoff to flow freely off the slopes. The collection channels are usually vegetated with the same species of grasses growing on the slopes and should be graded to prevent erosion. Runoff channels should be graded to no greater than 25 percent of the slope grade to prevent cross flow on the slope.

In humid regions, particularly where the topography is quite flat and the runoff channels have small grades, grass covered channels may not dry out entirely. This may increase channel maintenance problems and encourage mosquito populations. In these cases, concrete or asphalt can be used to construct the channels. Small channels are normally V-shaped, while major conveyance channels have a trapezoidal cross-sections.

In addition to transporting treated effluent to the final discharge point, the runoff channels must also be capable of transporting all stormwater runoff from the slopes. The channels should be designed, as a minimum, to carry runoff from a storm with a 25-year-return frequency. Both intensity and duration of the storm must be considered. A frequency analysis of rainfall intensity must be performed and a rainfall-runoff relationship developed to estimate the flowrate due to storm runoff that must be carried in the channels. In most cases, it is desirable to provide a perimeter drainage channel around the OF site to exclude offsite stormwater from entering the OF drainage channels.

#### **9.4.5 Slope Design and Construction**

The OF site is divided into individual treatment slopes each having the selected design length. Site geometry may require that the slope lengths vary somewhat. Slopes should be grouped into a minimum of four or five hydraulically-separated, approximately-equal application zones to allow operating and harvesting or mowing flexibility. This arrangement allows one zone to be taken out of service for mowing or maintenance while continuing to operate the system at design application and loading rates (WEF, 2001).

Smooth, uniform sheet flow down the slope is critical to consistent process performance, so emphasis must be placed on the proper construction of the slopes. Naturally occurring slopes, even if these are the required length and grade, seldom have the uniform grade and overall smoothness required to prevent channeling, short-circuiting and ponding. Therefore, it is necessary to completely clear the site of all vegetation and to regrade it into a series of OF slopes and runoff collection channels. The first phase of the grading operation

should be accomplished within a grade tolerance of 0.03 m (0.1 ft). If buried piping is used, this grading phase is generally followed by the installation of the distribution piping and appurtenances.

After the slopes have been formed in the first grading operation, a farm disk should be used to break up the clods, and the soil should then be smoothed with a land plane. Usually a grade tolerance of plus or minus 0.015 m (0.05 ft) can be achieved with three passes of the land plane. Surface distribution piping may be installed at this stage.

Soil samples of the regraded site should be taken and analyzed by an agricultural laboratory to determine the amount of lime (or gypsum) and fertilizer that are needed to optimize crop establishment. The appropriate amounts should then be added prior to seeding. A light disk should be used to eliminate any wheel tracks on the slopes as final preparation for seeding.

#### **9.4.6 Vegetation Selection and Establishment**

The various grass mixtures used for overland flow systems are described in Chapter 4. An OF cover crop should have the following characteristics: perennial grasses; high moisture tolerance; long growing season; high nutrient uptake; and suited for the local climate and soil conditions, and possibly market potential. In the northern humid zones, various combinations of orchard grass, Reed canarygrass, tall fescue and Kentucky bluegrass have been most successful since this mixture contains species that produce high biomass and are rhizomatous. Including rhizomatous species in the mixture is important to prevent channeling of water running down the slope. The use of a nurse grass such as annual ryegrass is recommended because it will grow quickly and protect the soil surface while the other grasses establish.

A Brillion seeder is capable of doing an excellent job of seeding the slopes on newly prepared sites that contain bare soils. The Brillion seeder carries a precision device to drop seeds between cultipacker-type rollers so that the seeds are firmed into shallow depressions. This allows for quick germination and protection against erosion. When reseeding existing sites, a no till seeder can be used. This seeder slices the soil surface and drops seed into the slices. Hydroseeding may also be used if the range of the distributor is sufficient to provide coverage of the slopes so that the vehicle does not have to travel on the slopes. Traffic on the slopes in the direction of the water flow should be avoided whenever possible to keep channelization to a minimum. Vehicle access should be in the cross-slope direction and allowed only when the soil is dry. If a vehicle creates ruts

---

over 2.5 cm (1 inch) in depth, then field traffic should stop.

A good vegetative cover is essential prior to application of wastewater. Grass planting should be undertaken only during the optimum periods for planting in particular, and the overall construction schedule must be adjusted accordingly. In arid and semiarid climates, portable sprinklers may be necessary to provide moisture for germination and growth of the grass. The wastewater distribution system should not be used until the grass is established to avoid erosion of the bare soil. The construction contract should have a contingency to cover reseeding or erosion repair in the case of intense rainfall during the period between final site grading and grass establishment.

As a general rule, wastewater should not be applied at design rates until the grass has grown enough to receive one cutting. Cut grass from the first cutting may be left on the slope to help build an organic mat as long as the clippings are relatively short (0.3 m, < 1 ft). Long clippings tend to remain on top of the cut grass, thus shading the surface and retarding regrowth.

A period of slope aging or maturing and acclimation is required following initial startup before process performance will approach satisfactory levels. During this period, the microbial population on the slopes is increasing and the slime layers are forming. The initial acclimation period may be as long as 3 to 4 months. If a variance to allow discharge during this period cannot be obtained, provisions should be made to store and/or recycle the effluent until effluent quality improves to the required level.

An acclimation period also should be provided following winter storage periods for those systems in cold climates. Acclimation following winter shutdown should require less than a month. Acclimation is not necessary following shutdown for harvest unless the harvest period is extended to more than 2 or 3 weeks due to inclement weather.

## **9.5 System Monitoring and Management**

The primary objective of the OF system is to produce a treated effluent that is within the permit requirements. Therefore, a monitoring program and a preventive maintenance program are necessary to ensure continued compliance with discharge requirements. A detailed description of crop, soil, and site management requirements for land treatment systems is given in Chapter 8.

### **9.5.1 Crop Management**

After the cover crop has been established, the slopes will need little maintenance work. Grass should be cut two or three times a year. Removal of cut grass from the slopes is optional, especially if the system is designed for BOD/TSS removal. Removal from the slope is mainly to allow the new grass to grow and to avoid decomposition byproducts from being discharged off the slope. Other advantages are that additional nutrient removal is achieved, channeling problems may be more readily observed, and revenue can be generated from the sale of hay. Before harvesting, each slope must be allowed to dry out so that equipment can travel over the soil surface without leaving ruts. If a vehicle creates ruts over 2.5 cm (1 inch) in depth, access to the site should cease. Ruts could develop into channeling, especially if oriented downslope, and ruts across the slope may create a mosquito problem. The drying time necessary before mowing is usually about 1 to 2 weeks; however, this can vary depending on the soil and climatic conditions. After mowing and conditioning, the hay should be dried before raking and baling. This may take another week or so depending on the weather. However, during unusually wet years, site conditions limit vehicle access and mobility. Under these circumstances, weather permitting, hay can be shredded on the treatment slopes and left in place with no baling or removal (Tedaldi and Loehr, 1991).

If the necessary drying times can not be met, the cut grass can be collected and stored. Two methods include bale wrapping and storing cut grass in plastic silage bags. The bale wrappers tightly seal each bale in a sturdy, UV resistant plastic to resist sun damage and adverse weather conditions. Wrapped bales undergo a fermentation process that prevents spoilage from yeasts, aerobic bacteria, molds, and insects, while maintaining a high protein and nutrient content. A bale wrapper is shown in Figure 9-3. Alternatively, unbaled hay can be compacted tightly into silage bags (Figure 9-4). The airtight environment encourages anaerobic conditions to produce feed quality silage low in nitrates and free from pest contamination. These methods allow storage of grasses with high moisture content, minimizing the time needed for drying cut grass. Both, wrapped bales and silage bags may be stored away from the treatment slopes, allowing the application of wastewater to continue without too much off-time for drying and conditioning of cut vegetation.





**Figure 9-3.** Bale wrappers tightly seal each bale of hay in plastic for storage. (Courtesy of New Holland.)



**Figure 9-4.** Plastic silage bags for storing cut hay. (Courtesy of Ag-Bag, International, Ltd.)

Monitoring programs for soils and vegetation are the same for OF as for SR systems (Chapter 8). If the grass is used as fodder, samples may be required during each harvest and may be analyzed for various nutritional parameters such as protein, fiber, total digestible nutrients, phosphorus, nitrate, and dry matter.

## 9.6 References

- Bendixen, T.W., R.D. Hill, F.T. DuByne, and G.G. Robeck (1969) *Cannery Waste Treatment by Spray Irrigation-Runoff*, Journal WPCF, 41: 385.
- Carlson, C.A., et al. (1974) *Overland Flow Treatment of Wastewater*, USA, WES Misc., Paper Y-74-3, Vicksburg, MS.
- Crites, R.W. and G. Tchobanoglous (1998) *Small and Decentralized Wastewater Management Systems*, McGraw-Hill, New York, NY.
- Gilde, L.C., A.S. Kester, J.P. Law, C.H. Neeley, and D.M. Parmelee (1971) *A Spray Irrigation System for Treatment of Cannery Wastes*, Journal WPCF, 43: 2011.
- Jenkins, T.F., et al. (1978) *Pilot Scale Study of Overland Flow Land Treatment in Cold Climates*, In: Proceedings: Developments in Land Methods of Wastewater Treatment and Utilization – Melbourne, Australia, Pergamon Press, New York, Progress in Water Technology, 11 (4-5): 207.
- Jenkins, T.F., et al. (1978) *Performance of Overland Flow Land Treatment in Cold Climates*, In: Proceedings State of Knowledge in Land Treatment of Wastewater, Vol.2, USA, CRREL, Hanover, NH.
- Kruzic, A.J. and E.D. Schroeder (1990) *Nitrogen Removal in the Overland Flow Wastewater Treatment Process – Removal Mechanisms*, Res. J. Water Pollution Control Federation, 62(7): 867-876.
- Martel, C.J. (1982) *Development of a Rational Design Procedure for Overland Flow Systems*, CRREL Report 82-2, CRREL, Hanover, NH.
- Peters, R.E., et al. (1978) *Field Investigations of Advanced Treatment of Municipal Wastewater by Overland Flow*, Vol.2, Proceedings of the International Symposium on Land Treatment of Wastewater, USACOE, CRREL, Hanover, NH.
- Peters, R.E., C.R. Lee and D.J. Bates (1981) *Field Investigations of Overland Flow Treatment of Municipal Lagoon Effluent*, USA, WES, Tech. Report EL-81-9, Vicksburg, MS.
- Perry, L.E., E.J. Reap, and M. Gilliland (1981) *Pilot Scale Overland Flow Treatment of High Strength Snack Food Processing Wastewaters*, Proceedings National Conference on Environmental Engineering, ASCE, EED, Atlanta, GA.
- Reed, S.C., R.W. Crites and E.J. Middlebrooks (1995) *Natural Systems for Waste Management and Treatment*, Second Edition, McGraw-Hill, New York, NY.
- Scott, T.M. and D.M. Fulton (1979) *Removal of Pollutants in the Overland Flow (Grass Filtration) System*, Progress in Water Technology, 11 (4 and 5):301-313.
- Smith, R.G. and E.D. Schroeder (1982) *Demonstration of the Overland Flow Process for the Treatment of Municipal Wastewater – Phase II Field Studies*, Dept of Civil Engineering, University of California, Davis, Report to California State Water Resources Control Board.

- 
- Smith, R.G. and E.D. Schroeder (1983) *Physical Design of Overland Flow Systems*, Journal WPCF, 55(3): 255-260.
- Smith, R.G. and E.D. Schroeder (1985) *Field Studies of the Overland Flow Process for the Treatment of Raw and Primary Treated Municipal Wastewater*, Journal WPCF, 57(7): 785-794.
- Tedaldi, D.J. and R.C. Loehr (1991) *Performance of an Overland Flow System Treating Food-Processing Wastewater*, Research Journal WPCF, 63: 266.
- US EPA (1975). *Land Application of Wastewater in Australia*, EPA 430/9-75-017, U.S. Environmental Protection Agency, OWPO, Washington, DC.
- US EPA (1976). *Overland Flow Treatment of Raw Wastewater with Enhanced Phosphorus Removal*, EPA-660/2-76-131, U.S. Environmental Protection Agency, ORD.
- US EPA (1979). *Municipal Wastewater Treatment by the Overland Flow Method of Land Application*, EPA 600/2-79-178, U.S. Environmental Protection Agency, RSKERL, Ada, OK.
- US EPA (1981). *Process Design Manual for Land Treatment of Municipal Wastewater*, EPA 625/1-81-013, U.S. Environmental Protection Agency, CERI, Cincinnati, OH.
- US EPA (1981). *Development of a Rational Basis for Design and Operation of the Overland Flow Process*, Proceedings: National Seminar on Overland Flow Technology for Municipal Wastewater, EPA 600/9-81-022, U.S. Environmental Protection Agency, Washington, DC.
- US EPA (1981). *Overland Flow Treatment of Poultry Processing Wastewater in Cold Climates*, EPA 600/S1-81-234, U.S. Environmental Protection Agency, RSKERL, Ada, OK.
- WEF (2001) *Natural Systems for Wastewater Treatment*, Draft, Manual of Practice, Alexandria, VA.
- Zirschky, J. et al. (1989) *Meeting Ammonia Limits Using Overland Flow*, Journal WPCF, 61: 1225-1232.

## Chapter 10

### Process Design – Soil Aquifer Treatment

The process design of soil aquifer treatment (SAT) systems is generally governed by the infiltration rate into and permeability through the soil to a defined outlet (e.g., groundwater for recharge).. SAT systems utilize the highest hydraulic loading rate of any land treatment system. The site selection criteria for SAT are also more stringent. The typical design procedure for soil aquifer treatment is outlined as follows:

1. Characterize the soil and groundwater conditions with field measurements.
2. Predict the hydraulic pathway of percolate, based on the site hydrogeology and discharge requirements to adjacent surface water or groundwater.
3. Select the infiltration rate from field test data (see Chapter 5).
4. Determine the overall treatment requirements by comparing wastewater characteristics to the water quality requirements, including potential restrictions on the system imposed by downstream users.
5. Select the appropriate preapplication treatment level appropriate for the site and the treatment needs (see Chapter 6).
6. Calculate the annual hydraulic loading rate based on the treatment needs, the infiltration rate, and the preliminary wet/dry ratio.
7. Calculate the land requirements.
8. Check the potential for groundwater mounding and determine the need for underdrains (see Chapter 3).
9. Select the hydraulic loading cycle and the number of basin sets.
10. Calculate the application rate and check the final wet/dry ratio.
11. Lay out the basins and design berms, structures, etc.

12. Determine monitoring requirements and locate monitoring wells.

#### 10.1 Treatment Requirements

Soil aquifer treatment is an especially effective process for BOD, TSS, and pathogen removal and can provide significant removals of nitrogen, phosphorus, metals, and trace organics. Removal mechanisms of wastewater constituents such as BOD, suspended solids, nitrogen, phosphorus, heavy metals, microorganisms, and trace organics are discussed in Chapter 2. Typical results from various operating systems are discussed for BOD, TSS, nitrogen, phosphorus, and trace organics.

##### 10.1.1 BOD and Suspended Solids

Particulate BOD and suspended solids are removed by filtration at or near the soil surface. Soluble BOD may be adsorbed by the soil or may be removed from the percolating wastewater by soil biota. BOD and suspended solids removals are generally not affected by the level of preapplication treatment. However, high hydraulic loadings of wastewaters with high concentrations of BOD and suspended solids can cause clogging of the soil.

BOD loadings on industrial SAT systems range from 112 to 667 kg/ha · d (100 to 600 lb/ac · d). BOD loadings beyond 336 kg/ha · d (300 lb/ac · d) require careful management to avoid production of adverse odors. Suspended solids loadings of 112 to 224 kg/ha · d (100 to 200 lb/ac · d) or more require frequent disking or scarifying of the basin surface to avoid sealing of the surface soil. Typical values of BOD loadings and BOD removals for SAT systems are presented in Table 10-1 (Crites and Tchobanoglous, 1998).

**Table 10-1.** BOD Removal for Soil Aquifer Treatment Systems (Crites and Tchobanoglous, 1998)

Location	Applied Wastewater BOD, lb/ac·d*	Applied Wastewater BOD, mg/L	Percolate Concentration, mg/L	Removal, %
Boulder, CO	48 <sup>†</sup>	131 <sup>†</sup>	10 <sup>†</sup>	92
Brookings, SD	11	23	1.3	94
Calumet, MI	95 <sup>†</sup>	228 <sup>†</sup>	58 <sup>†</sup>	75
Ft. Devens, MA	77	112	12	89
Hollister, CA	156	220	8	96
Lake George, NY	47	38	1.2	97
Milton, WI	138	28	5.2	81
Phoenix, AZ	40	15	0 – 1	93 – 100
Vineland, NJ	43	154	6.5	96

\*Total lb/ac·yr applied divided by number of days in the operating season.

<sup>†</sup>COD basis.

Conversion units: 1 lb/ac·d = 1.12 kg/ha·d; 1 mg/L = 1 g/m<sup>3</sup>.

## 10.1.2 Nitrogen

Nitrogen removal has been observed during SAT at many sites recharging effluent containing ammonia-nitrogen. A common hypothesis for this nitrogen removal in SAT is the two-step process of autotrophic nitrification and heterotrophic denitrification. Recharge basins are typically operated to consist of a wetting cycle when water is applied followed by a drying cycle. Due to the net positive charge of the ammonium ion, it is adsorbed onto the soil in the upper region of the vadose zone during the wetting cycle. As the soil dries and air/oxygen enters the soil, the oxidation of ammonia to nitrate by autotrophic nitrifiers may occur. This process results in a high nitrate concentration at the beginning of the following wetting cycle. This nitrate, which tends to be more mobile, is transported with the percolating water deeper into the vadose zone. Once the nitrate reaches an anoxic zone, heterotrophic denitrification may convert the nitrate to nitrogen gas in the absence of oxygen (Gable and Fox, 2000). The nitrogen gas then migrates through unsaturated soil back to the surface where it is lost to the atmosphere. Some volatilization of the ammonia can also occur at the soil surface.

Both nitrification and denitrification are accomplished by soil bacteria. The optimum temperature for nitrogen removal is 30°C to 35°C (86°F to 95°F). Both processes proceed slowly between 2°C and 5°C (36°F and 41°F) and stop near 0°C (32°F). Nitrification rates decline sharply in acidic soil conditions and reach a limiting value at approximately pH 4.5. The denitrification reaction rate is reduced substantially by pH values below 5.5. Thus, both soil temperature and pH must be considered if nitrogen removal is important. Furthermore, alternating aerobic and anaerobic conditions must be provided for significant nitrogen removal. Because aerobic bacteria deplete soil oxygen during flooding periods, resting and flooding periods must be alternated to result in sequencing aerobic and anaerobic soil conditions.

Nitrogen removal is also a function of detention time, BOD:N ratio (adequate organic carbon source), and anoxic conditions. Experiments with secondary effluent at Phoenix, AZ, showed for effective nitrogen removal (80 percent or more), the liquid loading rate should not exceed 150 mm/day (6 in/d) (Lance et al., 1976). When primary effluent is used, the maximum hydraulic application rate is recommended not to exceed 200 mm/day (8 in/day). Nitrogen removal by denitrification requires both adequate organic carbon, which acts as a "food" source for microorganisms, and adequate detention time. The potential limitation on the amount of nitrogen removal can be approximated using the following equation:

$$N = \frac{TOC - 5}{2} \quad (10-1)$$

Where:

N = change in total nitrogen, g/m<sup>3</sup> (mg/L)  
TOC = total organic carbon in the applied wastewater, g/m<sup>3</sup> (mg/L)

The 5 g/m<sup>3</sup> (5 mg/L) of residual TOC, in Equation 10-1, is typical for municipal wastewater after passage through about 1.5 m (5 ft) of soil. The coefficient 2 in the denominator of Equation 10-1 is based on experimental data where 2 g of wastewater carbon were required to denitrify 1 g of wastewater nitrogen (US EPA, 1980). In terms of BOD:N ratio, a ratio of 3:1 or more is recommended to ensure adequate carbon to drive the denitrification reaction.

The two-step nitrification-denitrification process is consistent with field observations. However, few SAT systems have the BOD:N ratios that can sustain heterotrophic denitrification. Most secondary effluents applied to SAT systems have BOD:N ratios of approaching 1, where a BOD:N ratio of greater than 3 (occurring in most primary effluents) is necessary to sustain high nitrogen removal efficiencies. Additionally, most SAT systems have carbon (C) to nitrogen ratios of 1, where typically a C:N ratio greater than 2 is needed to carry out optimal heterotrophic denitrification (Kopchynski et al., 1999). These conditions would result in nitrogen removal efficiencies of about 30 percent, whereas, much higher nitrogen removal efficiencies have been observed in SAT systems. This would suggest that some other mechanisms are responsible for the additional nitrogen removal. The anaerobic ammonium oxidation (Anammox) process is proposed as a sustainable mechanism for denitrification in SAT systems (Gable and Fox, 2000).

Anammox is an anaerobic, autotrophic bacterial process that occurs when both nitrate and ammonium are present (Van de Graaf et al., 1995, 1996, 1997). The nitrate is reduced to nitrogen gas while the nitrate oxygen is used for the oxidation of ammonium. Since the process is autotrophic, no organic carbon is required. The infiltration process provides an ideal environment for the growth of Anammox microorganisms. While the true mechanisms of Anammox are still being researched and defined, recent tests provide evidence that some type of anaerobic ammonium oxidation could be occurring in SAT systems (Gable and Fox, 2000; Woods et al., 1999; Van de Graaf et al., 1997).

Experience with nitrification has been that rates of up to 67 kg/ha · d (60 lb/ac · d) can be achieved under favorable moisture and temperature conditions. Total nitrogen loadings should be checked to verify that these are not in excess of the 56 to 67 kg/ha · d (50 to 60

lb/ac·d) range. Ammonia will be retained in the upper soil profile when temperatures are too low [below 2.2°C (36°F)] for nitrification. Recent field studies at an SAT site in Truckee, CA, demonstrated that predictable and consistent biological nitrogen removal occurred both in multiple years of treating normally fluctuating flows and loadings and during a short term study in which effluent total nitrogen concentrations were increased up to 80 percent (Woods et al., 1999). Typical removals of total nitrogen and percolate concentration of nitrate nitrogen

and total nitrogen are presented in Table 10-2. To determine the nitrogen loading rate from the hydraulic loading rate, use:

$$L_n = \frac{L_w CF}{D} \quad (10-2)$$

Where:

- $L_n$  = nitrogen loading rate, kg/ha·d (lb/ac·d)
- $L_w$  = wastewater hydraulic loading rate, m/yr (in/yr)
- $C$  = wastewater nitrogen concentration, g/m<sup>3</sup> (mg/L)
- $F$  = conversion factor, 10 kg·m<sup>2</sup>/g·ha (0.226 lb·L/mg·ac·in)
- $D$  = number of operating days per year

**Table 10-2.** Nitrogen Removal for Soil Aquifer Treatment Systems\*

Location	Applied Total Nitrogen		Percolate, mg/L		Total N Removal, %
	lb/ac·d	mg/L	Nitrate-N	Total N	
Calumet, MI	20.7	24.4	3.4	7.1	71
Dan Region, Israel	28.9	13.0	6.5	7.2	45
Ft. Devens, MA	37.0	50.0	13.6	19.6	61
Hollister, CA	14.9	40.2	0.9	2.8	93
Lake George, NY	12.5	12.0	7.0	7.5	38
Phoenix, AZ	40.0	18.0	5.3	5.5	69
W. Yellowstone, MT	115.6	28.4	4.4	14.1	50

\*Adapted from Crites (1985a).

Conversion units: 1 lb/ac·d = 1.12 kg/ha·d; 1 mg/L = 1 g/m<sup>3</sup>.

### 10.1.3 Phosphorus

Phosphorus removal in SAT is accomplished by adsorption and chemical precipitation. The adsorption occurs quickly and the slower occurring chemical precipitation replenishes the adsorption capacity of the soil. Typical phosphorus removals for SAT are presented in Table 10-3, including travel distances through the soil.

If phosphorus removal is critical, a phosphorus adsorption test using the specific site soil can be conducted (Reed and Crites, 1984). To conduct an adsorption test, about 10 g of soil is placed in containers

solution. After periodic shaking for up to 5 days the solution is decanted and analyzed for phosphorus. The difference in concentrations is attributed to adsorption onto the soil particles. The detailed procedure is presented (US EPA 1975). Actual phosphorus retention at an SAT site (long term) will be 2 to 5 times greater than the values obtained in the 5-day phosphorus adsorption test (US EPA, 1981). An equation to predict phosphorus removal is presented in Section 2.8.2. Phosphorus removal can also be tested using mathematical models detailed in Ryden et al. (1982) and Enfield (1978).

**Table 10-3.** Phosphorus Removal for Soil Aquifer Treatment Systems\*

Location	Average Concentration in Applied Wastewater, mg/L	Distance of Travel, ft		Average Concentration in Renovated Water, mg/L	Removal, %
		Vertical	Horizontal		
Boulder, CO <sup>†</sup>	6.2 <sup>†</sup>	8 – 10	0	0.2 – 4.5	40 – 97
Brookings, SD <sup>‡</sup>	3.0 <sup>‡</sup>	2.6	0	0.45	85
Calumet, MI <sup>†</sup>	3.5 <sup>†</sup>	10 – 30 <sup>§</sup>	0 – 400	0.1 – 0.4	89 – 97
	3.5 <sup>†</sup>		5580 <sup>§</sup>	0.03	99
Ft. Devens, MA <sup>‡</sup>	9.0 <sup>‡</sup>	50	100	0.1	99
Hollister, CA <sup>‡</sup>	10.5 <sup>‡</sup>	22	0	7.4	29
Lake George, NY <sup>‡</sup>	2.1 <sup>‡</sup>	10	0	< 1	>52
	2.1 <sup>‡</sup>	<sup>§</sup>	1970 <sup>§</sup>	0.014	99
Phoenix, AZ <sup>†</sup>	8 – 11 <sup>†</sup>	30	0	2 – 5	40 – 80
	7.9 <sup>†</sup>	20	100	0.51	94
Vineland, NJ <sup>†</sup>	4.8 <sup>†</sup>	6.5 – 60	0	1.54	68
	4.8 <sup>†</sup>	13 – 52	850 – 1700	0.27	94

\*Adapted from US EPA (1981).

<sup>†</sup>Total phosphate measured.

<sup>‡</sup>Soluble phosphate measured.

<sup>§</sup>Seepage.

Conversion units: 1 mg/L = 1 g/m<sup>3</sup>; 1 ft = 0.305 m.

### 10.1.4 Trace Organics

Trace organics can be removed by volatilization, sorption, and degradation. Degradation may be either chemical or biological; trace organic removal from the soil is primarily the result of biological activity. Removal rates depend on the constituent, the applied concentration, the loading rate, and the presence of easily degradable organics to serve as a primary substrate (Crites, 1985b).

If local industries contribute large concentrations of synthetic organic chemicals and the SAT system overlies a potable aquifer, industrial pretreatment should be considered. Further, since chlorination prior to land application causes formation of chlorinated trace organics that may be more difficult to remove, chlorination before application should be avoided whenever possible.

SAT systems have been utilized for the removal of endocrine disrupting chemicals found in municipal wastewaters (Conroy et al., 2001; Quanrud et al., 2002). Endocrine disruptors originate from industrial, agricultural, and domestic sources. These include a combination of natural hormones, pharmaceutical products, and industrial chemicals such as polychlorinated biphenyls, organochlorine pesticides, phenoxyacid herbicides, phthalates and tirazines. Following conventional secondary treatment, percolation through approximately 36 m (120 ft) of unconsolidated sediments to the local aquifer reduced residual estrogenic activity by >95 percent (Table 10-4) (Quanrud et al., 2002). The fate of micropollutants originating from pharmaceuticals and active ingredients in personal care products have been studied at two groundwater recharge facilities in Arizona (Drewes et al., 2001a). Preliminary studies indicate that groundwater recharge offers a high potential to remove acidic drugs such as lipid regulators and analgesics. Other compounds such as antiepileptic drugs and X-ray contrast agents showed no clear indication of removal during travel times of more than six years.

Additional studies of long-term SAT at field sites in Mesa, AZ, indicate that substantial removal of effluent organic matter can occur. Identified trace organics were efficiently removed as a function of travel time to very low concentrations or below detection limits. Drewes et al (2001b) found that the character of bulk organics present in final SAT water resembled the character of natural organic matter present in drinking water.

**Table 10-4.** Fractional Attenuation of Estrogenic Activity (Relative to Primary Effluent) During Secondary Treatment and Soil Aquifer Treatment

Sample Location	Fractional Removal
Primary	0.00
Secondary Unchlorinated	0.62
Secondary Chlorinated	0.65
Secondary Dechlorinated	0.65
Storage Pond	0.68
0.8m (2.5 ft)	0.77
3.1 m (10 ft)	0.83
5.2 m (17 ft)	0.83
18.3 m (60 ft)	0.93
36.6 m (120 ft)	0.99

## 10.2 Aquifer Characteristics

The geohydrological aspects of the SAT site are more critical than for the other processes, and a proper definition of subsurface conditions and the local groundwater system is essential for design. Therefore, site selection is critical to the success of an SAT project. Important factors in subsurface evaluation and selection are the soil depth, soil permeability and aquifer transmissivity, depth to groundwater, groundwater flow direction, and distance to outlet. In addition, due to high loading rates of applied wastewater in SAT, the effects of groundwater mounding and the transport of percolate within an aquifer should be considered.

### 10.2.1 Soils Investigation

Potential sites are located using the methods detailed in Chapter 5. SAT sites require deep, permeable soil without a shallow groundwater. Once a potential site is located, it is necessary to investigate the soil profile. Soil investigations can include backhoe pits, soil borings, and groundwater wells.

Backhoe pits are excavated normally to a depth of 2.4 to 3 m (8 to 10 ft). Pits should be located on each major soil type and landscape aspect. The number of pits will vary with the site size. For example, an 8-ha (20-ac) site may need 6 to 10 backhoe pits to define the variability of the soil profile within the treatment zone. Backhoe pits are excavated so that a soil scientist can walk into the pit and can observe the soil profile. The various soil horizons can be identified visually, and the presence of fractured near-surface rock, hardpan, redoximorphic features, layers or lenses of gravel or clay, or other anomalies can be identified and recorded. If the pit extends into groundwater, it can also be used for in-place testing of lateral soil permeability. Soil samples can be taken from each soil layer and analyzed for particle size, pH, and

---

EC. Once observations are complete, level benches can be excavated at different depths in the soil profile (coinciding with different soil layers) to allow infiltration testing (US EPA, 1984).

Soil borings are used to characterize the deeper soils [greater than 3 m (10 ft)] and to determine depth to bedrock and groundwater. All borings should penetrate below the water table if it is within 9 to 15 m (30 to 50 ft) of the surface. Fewer borings are needed typically than backhoe pits, with 1 soil boring per 2 ha (5 ac) being typical. Backhoe pits should be used to characterize soils typical on a site. Generally this requires pits in each landscape position represented on the site.

### **10.2.2 Groundwater Investigations**

The depth to groundwater, thickness and permeability of the aquifers, and groundwater quality are important to determine. Because of the expense of drilling wells, the site and the SAT process should be well established as the preferred wastewater management alternative prior to drilling. Existing onsite and nearby wells should be surveyed and sampled, and well logs should be analyzed prior to drilling onsite wells. Once the SAT site appears to be acceptable, groundwater wells should be drilled. The EPA recommends three wells for a complete SAT site investigation (US EPA, 1984). If the general groundwater flow direction has been identified, the wells should be located so that one is in the middle of the basin area, one is upgradient, and the third well is downgradient near the project boundary. A triangulation (pump-out) test can be used to characterize groundwater flow and direction.

### **10.2.3 Infiltration Test**

A critical element of SAT site evaluation is to conduct field measurements of infiltration rates, permeability, and transmissivity. The limiting rate of hydraulic flow in an SAT system may be the basin surface, a subsurface layer, or the lateral flow away from the site. All three elements must be considered and measured. The surface and subsurface permeability can be measured using infiltration tests located at the elevation that will correspond to the basin surface and at critical depths in the subsurface.

The backhoe pits and soil borings can be used to estimate the presence of restriction to vertical flow and to locate layers that need to be tested for infiltration rate (permeability or hydraulic conductivity). There are a number of infiltration tests, but the preferred tests for SAT systems are the flooded basin technique and the cylinder infiltrometer (see Section 3.8.1).

### **10.2.4 Groundwater Mounding**

During SAT, the applied wastewater travels initially downward to the ground water, resulting in a temporary groundwater mound beneath the infiltration site. Mounds continue to rise during the flooding period and only recede during the resting discharge period.

Excessive mounding will inhibit infiltration and reduce the effectiveness of treatment. For this reason, the capillary fringe above the groundwater mound should never be closer than 0.6 m (2 ft) to the bottom of the infiltration basin. This distance corresponds to a water table depth of about 1 to 2 m (3 to 7 ft), depending on the soil texture. The distance to groundwater should be 1.5 to 3 m (5 to 10 ft) below the soil surface within 2 to 3 days following a wastewater application. An analysis that can be used to estimate the mound height that will occur at various loading conditions is discussed in Chapter 3. The Hantusch method can be used to estimate whether a site has adequate natural drainage or whether mounding will exceed the recommended values without constructed drainage.

## **10.3 Hydraulic Loading Rates**

Selecting the appropriate design hydraulic loading rate is the most critical step in the process design procedure. As indicated in Chapter 5, an adequate number of measurements must be made of the infiltration rate and of the subsurface permeability. The hydraulic loading rate is a function of the site-specific hydraulic characteristics, including infiltration, percolation, lateral flow, and depth to groundwater, as well as quality of the applied wastewater and the treatment requirements.

### **10.3.1 Design Infiltration Rate**

The tests for infiltration rate described in Chapter 5 should be reviewed and an appropriate test selected. Using Equation 3-2 or 3-3 in Chapter 3, the mean infiltration rate is then calculated from the field data. During preliminary design the infiltration rate can be estimated from the NRCS permeability data which is based on soil texture. For final design, however, actual field data should be used.

### **10.3.2 Wet/Dry Ratio**

Intermittent application is critical to the successful operation of all land treatment systems. The ratio of wetting to drying in successful SAT systems varies, but is always less than 1.0. Typical wet/dry ratios are presented in Table 10-5 (Crites et al., 2000). For primary effluent the ratios are generally less than 0.2 to allow for adequate drying and scarification/removal of

the applied solids. For secondary effluent, the ratio varies with the treatment objective, from 0.1 or less where nitrification or maximum hydraulic loading is the objective, to 0.5-1.0 where nitrogen removal is the

treatment objective. These drying periods are necessary to restore the infiltration capacity and to renew the biological and chemical treatment capability of soil system.

**Table 10-5.** Typical Wet/Dry Ratios for SAT Systems (Crites et al., 2000)

Location	Preapplication Treatment	Application Period, days	Drying Period, days	Wet/Dry Ratio
Barnstable, MA	Primary	1	7	0.14
Boulder, CO	Secondary	0.1	3	0.03
Calumet, MI	Untreated	2	14	0.14
Ft. Devens, MA	Primary	2	14	0.14
Hollister, CA	Primary	1	14	0.07
Lake George, NY	Secondary	0.4	5	0.08
Phoenix, AZ	Secondary	9	12	0.75
Vineland, NJ	Primary	2	10	0.20

### 10.3.3 Design Hydraulic Loading Rate

The design hydraulic loading rate for SAT systems depends on the design infiltration rate and the treatment requirements. The procedure is to calculate the hydraulic loading rate based on a percentage of the test infiltration rate. This value is then compared to the loading rate based on treatment requirements and the lower rate is selected for design. The most commonly used measurements for infiltration rates are the basin infiltration test and the cylinder infiltrometer (see Chapter 5).

The saturated vertical hydraulic conductivity is a constant with time, whereas infiltration rates decrease as wastewater solids clog the soil surface. Thus, vertical conductivity measurements overestimate the wastewater infiltration rates that can be maintained over long periods of time. For this reason, and to allow adequate time for drying periods and for proper basin management, annual hydraulic loading rates should be limited to a fraction of the measured clear water permeability of the most restrictive soil layer.

Basin infiltration tests are the preferred method. However, the small area compared to the full-scale basin, allows a larger fraction of the wastewater to flow

horizontally through the soil from the test site than from the operating basin. Therefore, test infiltration rates are higher than the rates operating systems would achieve. Thus, design annual hydraulic loading rates should be no greater than 7 to 10 percent of measured basin test infiltration rates (US EPA, 1981).

Cylinder infiltrometers greatly overestimate operating infiltration rates. When cylinder infiltrometer measurements are used, annual hydraulic loading rates should be no greater than 2 to 4 percent of the minimum measured infiltration rates. Annual hydraulic loading rates based on air entry permeameter test results should be in the same range.

Typical hydraulic loading rates for SAT systems and the relationship between the actual loading rates and the loading rates determined by operating basin infiltration rates and cylinder infiltrometer rates are shown in Table 10-6 (US EPA, 1981). Design guidance for hydraulic loading rates is summarized in Table 10-7 (Crites et al., 2000). Where high wet/dry ratios and mild climates are expected, the upper end of the range of values in Table 10-7 can be used. Conversely, where long drying periods are needed, the lower end of the range should be used.

**Table 10-6.** Typical Hydraulic Loading Rates for SAT Systems (Crites et al., 2000)

Location	Actual Annual Loading Rate, ft/year	Annual Loading Rate	
		% of operating basin infiltration rate	% of cylinder infiltrometer rate
Boulder, CO	100 – 160	10 – 38	4 – 10
Brookings, SD	78 – 118	16 – 24	—
Ft. Devens, MA	95	13	2
Hollister, CA	50	24	3
Phoenix, AZ	200	27	—
Vineland, NJ	70	—	1.6

Conversion unit: ft = 0.3048 m.



**Table 10-7.** Suggested Hydraulic Loading Rates Based on Different Field Measurements

Field Measurement	Annual Loading Rate
Basin infiltration test	7 to 10% of minimum measured infiltration rate
Cylinder infiltrometer and air entry permeameter measurements	2 to 4% of minimum measured infiltration rate
Vertical hydraulic conductivity measurements	4 to 10% of conductivity of most restricting soil layer

## 10.4 Land Area Requirements

The application area for SAT systems can be determined using Equation 10-3.

$$A = \frac{Q(0.0001)(365)}{L_w} \text{ (metric)}$$

$$A = \frac{Q(3.06)(365)}{L_w} \text{ (U.S. customary)} \quad (10-3)$$

**Where:**

- A = application area, ha (acres)
- Q = average design flow, m<sup>3</sup>/day (mgd)
- L<sub>w</sub> = annual hydraulic loading, m/yr (ft/yr)
- 365 = days/yr
- 0.0001 = metric conversion, ha · m to m<sup>3</sup>/day
- 3.06 = U.S. customary conversion, acre · ft to mgd

Other land requirements include area for buffer zones, preapplication treatment, access roads, berms, and storage (if necessary). Buffer zones can be used to screen SAT sites from public view. Access roads and ramps, typically 3 to 3.6 m (10 to 12 ft) wide, are needed so that maintenance equipment for surface scarification can enter each basin. Climatic storage is generally unnecessary for SAT systems. The equivalent of short storage for emergencies can be attained by making the basins deep enough so that some storage can be realized. Area for future expansion should also be considered.

**Table 10-8.** Suggested SAT Loading Cycles

Loading Cycle Objective	Applied Wastewater	Season	Application period*, days	Drying Period, days
Maximize infiltration rates	Primary	Summer	1 – 2	5 – 7
		Winter	1 – 2	7 – 12
	Secondary	Summer	1 – 3	4 – 5
		Winter	1 – 3	5 – 10
Maximize nitrogen removal	Primary	Summer	1 – 2	10 – 14
		Winter	1 – 2	12 – 16
	Secondary	Summer	7 – 9	10 – 15
		Winter	9 – 12	12 – 16
Maximize nitrification	Primary	Summer	1 – 2	5 – 7
		Winter	1 – 2	7 – 12
	Secondary	Summer	1 – 3	4 – 5
		Winter	1 – 3	5 – 10

\*Regardless of season or cycle objective, application periods for primary effluent should be limited to 1 to 2 days to prevent excessive soil clogging.

## 10.5 Hydraulic Loading Cycle

Loading cycles are selected to maximize either the infiltration rate, nitrogen removal, or nitrification. To maximize infiltration rates include drying periods that are long enough for soil reaeration and for drying and oxidation of filtered soils.

Loading cycles used to maximize nitrogen removal vary with the level of preapplication treatment and with the climate and season. In general, application periods must be long enough for soil bacteria to deplete soil oxygen, resulting in anaerobic conditions.

Nitrification requires short application periods followed by longer drying periods. Thus, hydraulic loading cycles used to achieve nitrification are essentially the same as the cycles used to maximize infiltration rates.

Recommended hydraulic loading cycles are summarized in Table 10-8 (Crites et al., 2000). Generally the shorter drying periods in Table 10-8 should only be used in mild climates. In cold climates the longer drying periods should be used.

### 10.5.1 Number of Basin Sets

The number of basins or sets of basins depends on the topography and the hydraulic loading cycle. The decision on the number of basins and the number to be flooded at one time affects both the distribution system hydraulics and the final wet/dry ratio. As a minimum, the system should have enough basins so that at least one basin can be flooded at all times. The minimum number of basins required for continuous wastewater application is presented in Table 10-9 as a function of the loading cycle (Crites et al., 1998).

## 10.5.2 Application Rate

The application rate is set by the annual loading rate and the loading cycle. The application rate is used to determine the required hydraulic capacity of the piping to the basins. The application rate is calculated as follows:

1. Add the application period to the drying period to obtain the total cycle time, days.
2. Divide the number of application days per year, usually 365 except where storage is planned, by the total cycle time to obtain the number of cycles per year.
3. Divide the annual hydraulic loading by the number of cycles per year to obtain the loading per cycle.
4. Divide the loading per cycle by the application period to obtain the application rate, cm/d (ft/d).

The discharge rate to the basins can then be determined using Equation 10-4.

$$Q = 6.94AR \text{ (metric)}$$

$$Q = 18.9AR \text{ (U.S. customary)} \quad (10-4)$$

### Where:

- Q = discharge capacity, m<sup>3</sup>/min (gpm)  
 A = basin area, ha (acres)  
 R = application rate, m/day (in/d)  
 6.94 = metric conversion constant  
 18.9 = U.S. customary conversion constant

**Table 10-9.** Minimum Number of Basins Required for Continuous Wastewater Application

Loading Application Period, days	Cycle Drying Period, days	Minimum Number of Infiltration Basins
1	5 – 7	6 – 8
2	5 – 7	4 – 5
1	7 – 12	8 – 13
2	7 – 12	5 – 7
1	4 – 5	5 – 6
2	4 – 5	3 – 4
3	4 – 5	3
1	5 – 10	6 – 11
2	5 – 10	4 – 6
3	5 – 10	3 – 5
1	10 – 14	11 – 15
2	10 – 14	6 – 8
1	12 – 16	13 – 17
2	12 – 16	7 – 9
7	10 – 15	3 – 4
8	10 – 15	3
9	10 – 15	3
7	12 – 16	3 – 4
8	12 – 16	3
9	12 – 16	3

## 10.6 Design Considerations

Issues to be addressed during SAT system design include wastewater distribution, basin layout, surfaces, and drainage, and flow equalization or storage.

## 10.6.1 Distribution

Although sprinklers may be used, wastewater distribution is usually accomplished by surface spreading. This distribution technique employs gravity flow from piping systems or ditches to flood the application area. To ensure uniform basin application, basin surfaces should be reasonably flat. At the SAT system in Truckee, CA, with a 12.1 ha (30 ac) leach field, wastewater effluent is distributed throughout eight leach fields with 29,000 m (75,000 ft) of perforated plastic piping buried at a depth of 1.5 to 1.8 m (5 to 6 ft) (Woods et al., 1999).

Overflow weirs may be used to regulate basin water depth. Water that flows over the weirs is either collected and conveyed to holding ponds for recirculation or distributed to other infiltration basins. If each basin is to receive equal flow, the distribution piping channels should be sized so that hydraulic losses between outlets to basins are insignificant. Outlets used at currently operated systems include valved raisers for underground piping systems and turnout gates from distribution ditches.

## 10.6.2 Basin Layout

Basin layout and dimensions are controlled by topography, distribution system hydraulics, and loading rate. At many sites, topography makes equal-sized basins impractical. Instead, basin size is limited to what will fit into areas having suitable slope and soil type. Relatively uniform loading rates and loading cycles can be maintained if multiple basins are constructed. However, some sites will require that loading rates or cycles vary with individual basins.

In flat areas, basins should be adjoining and should be square or rectangular to maximize land use. In areas where ground water mounding is a potential problem, less mounding occurs when long, narrow basins with their length normal to the prevailing ground water flow are used than when square or round basins are constructed. Basins should be at least 30 cm (12 in) deeper than the maximum design wastewater flooding depth, in case initial infiltration is slower than expected and for emergencies. Basin dikes and berms are normally compacted soil with slopes ranging from 1:1 to 1:2 (vertical distance to horizontal distance). Basin dikes and berms should be planted with grass or covered with rip rap to prevent erosion.

Entry ramps should be provided for all basins. These ramps are formed of compacted soil at grades of 10 to 20 percent and are from 3 to 3.7 m (10 to 12 ft) wide. Basin surface area for these ramps and for wall slopes should not be considered as part of the necessary infiltration area.

---

The basin surface may be bare or covered with vegetation. Vegetation covers tend to remove suspended solids by filtration and maintain infiltration rates. However, vegetation also limits the application depth to a value that avoids drowning of vegetation, increases basin maintenance needs, requires an increased application frequency to promote growth, and reduces the soil drying rate. Gravel covered basins are not recommended. The long-term infiltration capacity of gravel covered basins is lower than the capacity of sand covered basins, because sludge-like solids collect in the voids between gravel particles and because gravel prevents the underlying soil from drying (Bouwer et al., 1980).

The type of drainage used must be incorporated into the basin design. See Section 10.9 for a discussion on drainage. If underdrains are required, basin design must consider placement of drains and drain outlet characteristics.

### **10.6.3 Storage and Flow Equalization**

Although SAT systems usually are capable of operating during adverse climatic conditions, storage may be needed to regulate wastewater application rates or for emergencies. Flow equalization may be required if significant daily or seasonal flow peaking occurs. Equalization also may be necessary to store wastewater between application periods, particularly when only one or two infiltration basins are used and drying periods are much longer than application periods.

One example of flow equalization at an SAT site occurs at the Milton, WI, system. Milton discharges secondary effluent to three lagoons. One of these lagoons is used as an infiltration basin, the other two lagoons are used for storage. In this way, Milton is able to maintain a continuous flow into the infiltration basin (US EPA., 1979).

In contrast, the City of Hollister formerly equalized flow with an earthen reservoir that was ahead of the treatment plant headworks. In addition, one infiltration basin was kept in reserve for primary effluent during periods when wastewater flows were excessive (US EPA, 1978).

### **10.6.4 Construction Considerations**

Construction of rapid infiltration basins must be conducted carefully to avoid compacting the infiltrative surface. Basin surfaces should be located in cut compacted in the berms. The berms need not be higher sections, with excavated material being placed and than 1 to 1.3 m (3 to 4 ft) in most cases. Erosion of the berm slopes should be avoided because erodible material is often fine-textured and can blind or seal the infiltrative surface.

## **10.7 Cold Weather Operation**

In regions that experience cold weather, longer loading cycles may be necessary during winter months. Nitrification, denitrification, oxidation (of accumulated organics), and drying rates all decrease during cold weather, particularly as the temperature of the applied wastewater decreases. Longer application periods are needed for denitrification so that the application rate is reduced as the rate of nitrogen removal decreases. Similarly, longer resting periods are needed to compensate for reduced nitrification and drying rates.

Ponds in cold climates can be used as preliminary treatment during the winter months. Ice may form in the SAT basin, but will float under normal conditions, so applications of warmer wastewater can continue. In addition, proper thermal protection is needed for pumps, piping, and valves (Crites et al., 2000).

SAT systems that operate successfully during cold winter weather without any cold weather modifications can be found in Victor, MT, Calumet, MI, and Lake George, NY. However, some modifications have been used to improve cold weather treatment in other communities. Basin surfaces that are covered with grass or weeds should be mowed during fall. Mowing followed by disking should prevent ice from freezing to vegetation near the soil surface. Floating ice helps insulate the applied wastewater, whereas ice that freezes at the soil surface prevents infiltration. Problems with ice freezing to vegetation have been reported at Brookings, SD, where basins were not mowed. Applied wastewater froze on top of the existing ice, preventing infiltration completely (Dornbush, 1978).

Another cold weather modification involves digging a ridge and furrow system in the basin surface. Following wastewater application, ice forms on the surface of the water and forms bridges between the ridges as the water level drops. Subsequent loadings are applied beneath the surface of the ice, which insulates the wastewater and the soil surface. For bridging to occur, a thick layer of ice must form before the wastewater surface drops below the top of the ridges. This modification has been used successfully in Boulder, CO, and Westby, WI.

The third type of basin modification involves the use of snow fencing or other materials to keep a snow cover over the infiltration basins. The snow insulates both applied wastewater and soil.

At Truckee, CA the SAT distribution system consists of subsurface perforated piping, similar to an onsite leachfield (Woods et al., 1999).

## 10.8 Drainage

SAT systems require adequate drainage to maintain infiltration rates and treatment efficiencies. The infiltration rate may be limited by the horizontal hydraulic conductivity of the underlying aquifer. Also, if there is insufficient drainage, the soil will remain saturated and re-aeration will be inadequate for oxidation of ammonia nitrogen to occur.

Renovated water may be isolated to protect either or both the groundwater and the renovated water. In both cases, there must be some method of engineered drainage to keep renovated water from mixing with native groundwater.

Natural drainage often involves flow through the subsurface to surface waters. If water rights are important, the engineer must determine whether the renovated water will drain to the correct watershed or whether wells or underdrains will be needed to convey the renovated water to the required surface water. In all cases, the engineer needs to determine the direction of subsurface flow due to drainage from SAT basins. Outlet devices must be stabilized to assure no loss of soil material around drainage outlets.

### 10.8.1 Subsurface Drainage to Surface Waters

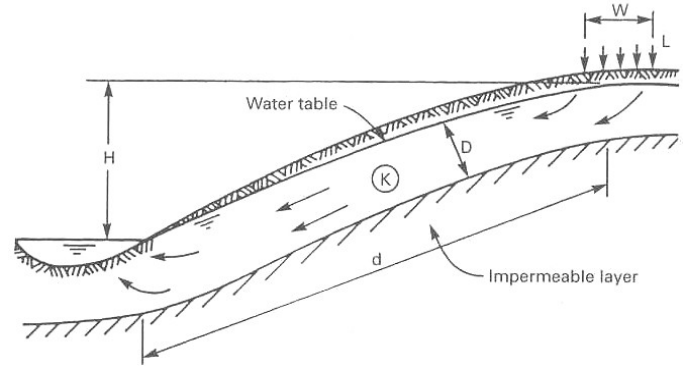
If natural subsurface drainage to surface water is planned, soil characteristics can be analyzed to determine if the renovated water will flow from the recharge site to the surface water. For subsurface discharge to a surface water to occur, the width of the infiltration area must be limited to values equal to or less than the width calculated in the following equation (Bouwer, 1974):

$$W = \frac{KDH}{dL} \quad (10-5)$$

**Where:**

- W = total width of infiltration area in direction of groundwater flow, m (ft)
- K = permeability of aquifer in direction of groundwater flow, m/d (ft/d)
- D = average thickness of aquifer below the water table and perpendicular to the direction of flow, m (ft)
- H = elevation difference between the water level of the water course and the maximum allowable water table below the spreading area, m (ft)
- d = lateral flow distance from infiltration area to surface water, m (ft)
- L = annual hydraulic loading rate (including rainfall input), m/d (ft/d)

Examples of these parameters are shown in Figure 10-1.



**Figure 10-1.** Definition Sketch for Lateral Drainage from SAT Systems Underdrains.

For SAT systems located in areas where both the water table and the impermeable layer underneath the aquifer are relatively close to the soil surface, renovated water can be collected by underdrains. In such areas, when drains can be installed at depths of 5 m (16 ft) or less, underdrains are more effective and less costly than wells for removing renovated water from the aquifer.

SAT systems using underdrains may consist of two parallel infiltration strips with a drain midway between the strips or a series of strips and drains. These two types of configurations are shown in Figures 10-2 and 10-3 (US EPA, 1974a). In the first system, the drains are left open at all times during the loading cycle. If the second system is used, the drains below the strips receiving wastewater are closed and renovated water is collected from drains beneath the resting strips. When infiltration beds are rotated, the drains that were closed before are opened and those that were open are closed. This procedure allows maximum underground detention times and travel distance.

Procedures for estimating underdrain spacings are provided in Chapter 3. When designing a drainage system, different values of 'd' should be selected and used to Calculate 'S', so that the optimum combination of 'd', 'H', and 'S' can be determined. Detailed information on drainage may be found in the US Bureau of Reclamation "Drainage Manual" and in the American Society of Agronomy manual, "Drainage for Agriculture."

Simulation methods for design and evaluation of drainage systems for wastewater land treatment sites are also available. One such water management model, DRAINMOD, can be used for describing the performance of an artificially drained land treatment system over a long period of climatological record (Skaggs et al., 1982; Skaggs, 1991). The model is a computer simulation program which predicts, on an hour-by-hour, day-by-day basis, the response of the water table and the soil water regime above it to rainfall,

evapotranspiration, given intensities of surface and subsurface drainage, controlled drainage, subirrigation and sprinkler, or surface irrigation. The model keeps track of the amount of water irrigated, water table depths, drainage volumes and evapotranspiration, on a daily basis, with monthly and yearly summaries. Thus, a given drainage design and irrigation strategy can be analyzed for a long period of climatological record to determine their suitability. More specifically, the effects of drain spacing, surface drainage, application frequency, and loading rates on water table depth, drainage outflow volumes, and required wastewater storage volumes can be analyzed. An economic analysis can be conducted to demonstrate how the model can be used to optimize the design of wastewater irrigation-drainage systems.

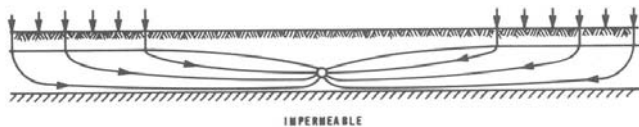


Figure 10-2. Centrally Located Underdrain.

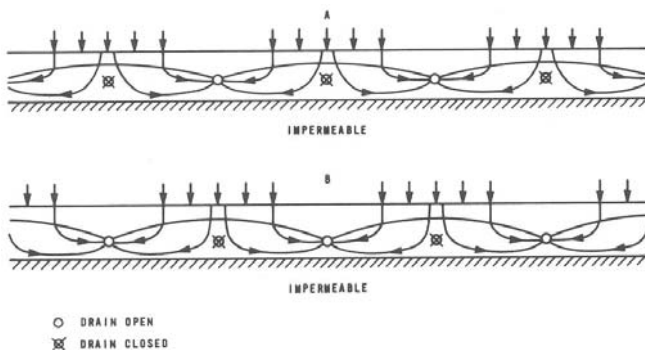


Figure 10-3. Underdrain System Using Alternating Infiltration and Drying Strips.

### 10.8.2 Recovery Wells

Soil aquifer treatment systems that utilize unconfined and relatively deep aquifers should use wells if necessary to improve drainage or to remove renovated water for reuse. Wells are used to collect renovated water directly beneath the SAT sites at both Phoenix, AZ. and Fresno, CA. Wells are also involved in the reuse of recharged wastewater at Whittier Narrows, CA; however, the wells pump groundwater that happens to contain reclaimed water, rather than pumping specifically for renovated water.

The arrangement of wells and recharge areas varies; wells may be located midway between two recharge areas, may be placed on either side of a single recharge

strip, or may surround a central infiltration area. Well design is described in detail in Campbell and Lehr (1973).

### 10.8.3 Aquifer Storage

Use of highly treated wastewater for aquifer storage is an increasingly important practice in many regions of the world where conventional freshwater resources are limited and local aquifers are overused. There are several advantages to storing treated wastewater underground: (1) the cost of artificial recharge may be less than the cost of equivalent surface reservoirs; (2) the aquifer serves as an eventual distribution system and may eliminate the need for surface pipelines or canals; (3) water stored in surface reservoirs is subject to evaporation, to potential taste and odor problems caused by algae and other aquatic growth, and to pollution; (4) suitable sites for surface reservoirs may not be available or environmentally acceptable; and (5) the storage of treated wastewater within an aquifer may also provide psychological and aesthetic secondary benefits as a result of the transition between reclaimed wastewater and groundwater (Metcalf and Eddy, 1991).

Locating the extraction wells as great a distance as possible from the spreading basins increases the flow path length and residence time of the applied wastewater. These separations in space and time contribute to the assimilation of the treated wastewater with the other aquifer contents.

To minimize potential health risks, careful attention must be paid to groundwater recharge operations when a possibility exists to augment substantial portions of potable groundwater supplies (Metcalf and Eddy, 1991). Long-term loading of aquifers can pose a serious threat to groundwater quality, especially in dry climates with static or very slow moving aquifers. Chemicals of concern include salts, pesticide residues and nitrates, disinfection byproducts (DBPs), pharmaceutically active chemicals, pathogens, and DBP precursors such as humic substances and other dissolved organic matter which produce a new suite of DBPs when groundwater is abstracted again and chlorinated or otherwise disinfected for potable use. Fujita et al. (1996) identified dissolved organic carbon characteristics and evaluated specific trace organic monitoring techniques, which allow operators of groundwater recharge programs to acquire information about the movement and mixing of wastewater introduced into aquifer systems. All significant aquifer recharge projects should have a groundwater impact analysis to allow the best possible

predictions of how the project will affect groundwater quality and water table levels, how the situations can best be handled, and what damage and liability aspects can be expected (Bouwer et al, 1999).

---

## 10.9 References

- Bouwer, H. (1974) *Infiltration-Percolation Systems*, In: Proceedings of the Symposium on Land Application of Wastewater, Newark, DE, p.85.
- Bouwer, H., et al. (1980) *Rapid-Infiltration Research at Flushing Meadows Project, Arizona*, Journal WPCF 52(10): 2457-2470.
- Bouwer, H., P. Fox, and P. Westerhoff (1999) *Integrating Water Management and Re-use: Causes for Concern?*, Water Quality International, January/February, pp. 19-22.
- Campbell, M.D. and Lehr, J.H. (1973) *Water Well Technology*, McGraw-Hill, New York, NY.
- Conroy, O., K.D. Turney, K.E. Lansey, and R.G. Arnold (2001) *Endocrine Disruption in Wastewater and Reclaimed Water*, In: Proceedings of the Tenth Biennial Symposium on Artificial Recharge of Groundwater, Tucson, AZ, pp. 171-179.
- Crites, R.W. (1985a) *Micropollutant Removal in Rapid Infiltration*, in T. Asano (ed.), *Artificial Recharge of Groundwater*, Butterworth Publishers, Stoneham, MA, pp. 579-608. Crites, R.W. (1985b) *Nitrogen Removal in Rapid Infiltration Systems*, Journal of Environmental Engineering Division ASCE, 111 (6): 865-873.
- Crites, R.W. and G. Tchobanoglous (1998) *Small and Decentralized Wastewater Management Systems*, McGraw-Hill, New York, NY.
- Crites, R.W., S.C. Reed, and R.K. Bastian (2000) *Land Treatment Systems for Municipal and Industrial Wastes*, McGraw-Hill, New York, NY.
- Davis, S.N. (1969) *Flow Through Porous Media*, R.J.M. DeWeist, Editor, Academic Press, New York, NY.
- Dornbush, J.N. (1978) *Infiltration Land Treatment of Stabilization Pond Effluent*, Technical Progress Report 3, South Dakota State University, Brookings, SD.
- Drewes, J., A. Sollner, A. Sarikaya, M. Reinhard, P. Fox, and W. Montgomery-Brown (2001a) *Membrane Treatment versus Soil-Aquifer Treatment for Indirect Potable Reuse – Performance, Limitations, and Concerns*, American Water Works Association, Membrane Conference Proceedings.
- Drewes, J., T. Heberer, and K. Reddersen (2001b) *Fate of Pharmaceuticals During Groundwater Recharge*, In: Proceedings of the Tenth Biennial Symposium on Artificial Recharge of Groundwater, Tucson, AZ, pp. 181-190.
- Enfield, C.G. (1978) *Evaluation of Phosphorus Models for Prediction of Percolate Water Quality in Land Treatment*, Proceedings of the International Symposium on Land Treatment of Wastewater, Volume 1, CRREL, Hanover, NH, p.153.
- Fujita, Y., W. Ding, and M. Reinhard (1996) *Identification of Wastewater Dissolved Organic Carbon Characteristics in Reclaimed Wastewater and Recharged Groundwater*, Water Environment Research, 68 (5): 867-876.
- Gable, J.E. and P. Fox (2000) *Nitrogen Removal During Soil Aquifer Treatment By Anaerobic Ammonium Oxidation (ANAMMOX)*, Proceedings of the Joint Conference Held by WEF and AWWA, San Antonio, TX.
- Kopchynski, T., P. Fox, and M. Berner (1999) *Pilot Scale Studies to Determine Mechanisms of DOC and Nitrogen Removal in Soil Aquifer Treatment (SAT) Systems*, Submitted to Water Research.
- Lance, J.C., F.D. Whisler, and R.C. Rice (1976) *Maximizing Denitrification During Soil Filtration of Sewage Water*, Journal of Environmental Quality, 5: 102.
- Metcalf and Eddy, Inc. (1991) *Wastewater Engineering Treatment, Disposal, and Reuse*, Third Edition, McGraw-Hill, Inc.
- Quanrad, D., Q. Conroy, K. Turney, K. Lansey, and R. Arnold (2002) *Fate of Estrogenic Activity in Reclaimed Water During Soil Aquifer Treatment*, Water Sources Conference Proceedings, American Water Works Association, Las Vegas, NV.
- Reed, S.C. and R.W. Crites (1984) *Handbook of Land Treatment Systems for Industrial and Municipal Wastes*, Noyes Publications, Park Ridge, NJ.
- Ryden, J.C., J.K. Syers, and I.K. Iskandar (1982) *Evaluation of a Simple Model for Predicting Phosphorus Removal by Soils During Land Treatment of Wastewater*, U.S. Army Corps of Engineers, CRREL, Special Report 82-14.
- Skaggs, R.W. and A. Nassehzadeh-Tabrizi (1982) *Drainage Systems for Land Treatment of Wastewater*, Journal of the Irrigation and Drainage Division, Proceedings of the American Society of Civil Engineers, Vol. 108, No. IR3, pp. 196-211.
- Skaggs, R.W. (1991) *Modeling Plant and Soil Systems*, Agronomy Monograph No. 31, pp. 205-243.
- US EPA (1974a). *Renovating Secondary Effluent by Groundwater Recharge with Infiltration Basins*, In: Conference on Recycling Treated Municipal Wastewater Through Forest and Cropland, EPA-

- 
- 660/2-74-003, U.S. Environmental Protection Agency.
- US EPA (1975) *Kinetic Model from Orthophosphate Reactions in Mineral Soils*, EPA-660/2-75-022, U.S. Environmental Protection Agency, Office of Research and Development, Ada, OK.
- US EPA (1978) *Long-Term Effects of Land Application of Domestic Wastewater: Hollister, California, Rapid Infiltration Site*, EPA-600/2-78-084, U.S. Environmental Protection Agency.
- US EPA (1979). *Long-Term Effects of Land Application of Domestic Wastewater: Milton, Wisconsin, Rapid Infiltration Site*, EPA-600/2-79-145, U.S. Environmental Protection Agency.
- US EPA (1980) *Summary of Long-Term Rapid Infiltration System Studies*, EPA-600/2-80-165
- Metcalf and Eddy, Inc. (1991) *Wastewater Engineering: Treatment, Disposal, and Reuse*, Third Edition, McGraw-Hill, Inc.
- US EPA (1981). *Process Design Manual for Land Treatment of Municipal Wastewater*, EPA-625/1-81-013, U.S. Environmental Protection Agency, CERL, Cincinnati, OH. US EPA (1984) *Process Design Manual for Land Treatment of Municipal Wastewater, Supplement on Rapid Infiltration and Overland Flow*, EPA 625/1-81-0139, Center for Environmental Research Information (CERI), U.S. Environmental Protection Agency, Cincinnati, OH.
- Van de Graaf, A., A. Mulder, P. De Bruijn, M. Jetten, L. Robertson, and G. Kuenen (1995) *Anaerobic Oxidation of Ammonium Is a Biologically Mediated Process*, *Applied and Environmental Microbiology*, 61(4): 1246-1251.
- Van de Graaf, A., P. De Bruijn, L. Robertson, M. Jetten, and G. Kuenen (1996) *Autotrophic Growth in Anaerobic Ammonium-oxidizing Micro-organisms in a Fluidized Bed Reactor*, *Microbiology*, 142: 2187-2196.
- Van de Graaf, A., P. De Bruijn, L. Robertson, M. Jetten, and G. Kuenen (1997) *Metabolic Pathway of Anaerobic Ammonium Oxidation on the Basis of <sup>15</sup>N Studies in a Fluidized Bed Reactor*, *Microbiology*, 143: 2415-2421.
- Woods, C., H. Bouwer, R. Svetich, S. Smith, and R. Prettyman (1999) *Study Finds Biological Nitrogen Removal in Soil Aquifer Treatment System Offers Substantial Advantages*, *Water Environment Federation, WEFTEC '99*, New Orleans, CA.

---

## Chapter 11

# Industrial Wastewater Land Application

Land treatment, in many ways, was rediscovered for treatment of industrial wastewater. In 1934, corn and pea canning wastewater was reported to be applied successfully using the ridge and furrow method in Hampton, Iowa (Bolton, 1947). In addition to food processing wastewaters, pulp and paper, chemical, fertilizer, meat processing, dairy, brewery, and winery wastewaters have been land applied successfully for many years (Crites, 1982; Ludwig et al., 1951; US EPA, 1973). This chapter is adapted from Chapter 13 of Land Treatment Systems for Municipal and Industrial Wastes (Crites et al., 2000).

### 11.1 Types of Industrial Wastewaters Applied

#### 11.1.1 Food Processing

Because of the rural location of many food processing facilities, and because waste from food processing facilities is suitable for application to land, this technology has been used widely. Vegetable processing in New York (Adamczyk, 1977), citrus processing in Florida (Wright, 1993) and potato processing in Idaho (Smith, 1977) are industrial wastewaters and areas where land application is the treatment process of choice. Soup and tomato processing wastewater were two of the first food processing wastewaters that were treated by spray-runoff or overland flow (Bendixen, 1969; Gilde, 1971; US EPA, 1973). Winery wastewaters were treated successfully using rapid infiltration (Coast Laboratories, 1947; Crites et al., 1981). Additional sources of information can be found for brewery wastes (Crites et al., 1978; Keith et al., 1986), vegetables (Beggs et al., 1990; Canham, 1958; Lane, 1955; Luley, 1963; Madison et al., 1993), soup (Law et al., 1970), fruit (Crites et al., 1974; Luley, 1963; Ludwig, 1951; Crites et al., 1994) coffee and tea (Loehr et al., 1988; Molloy, 1964), dairy products (Breska et al., 1957; Lawton et al., 1959; McKee, 1955; Scott, 1962), meat processing (Henry et al., 1954; Schraufnagel, 1962), and winery stillage and wastewater (Crites, 1996).

#### 11.1.2 Pulp and Paper

There have been many types of pulp and paper mill wastewaters that have been land applied successfully (Wallace, 1976). Much of the literature on land application of pulp and paper wastewater dates from the 1950s and 1960s (Billings, 1958; Blosser et al., 1964; Flower, 1969; Koch et al., 1959; Meighan, 1958; Parsons, 1967; Voights, 1955). Experiments with insulation board mill wastewater resulted in the

demonstration that BOD loading rates over 2,240 kg/ha · d (2,000 lb/ac · d) caused vegetation to be killed (Phillip, 1971).

#### 11.1.3 Other Industrial Wastes

Other industrial wastewaters that have been land applied include chemical (Overcash et al., 1979; Woodley, 1968), fertilizer, tannery (Parker, 1967), pharmaceutical (Coloves, 1962), explosives (Lever, 1966), wood distillation (Hickerson et al., 1960) and oily wastewaters.

### 11.2 Water Quality and Pretreatment Requirements

All wastewaters to be land applied must be characterized before the limiting design parameter (see Chapter 2) can be determined. The limiting design parameter is based upon the fact that soil has a finite assimilative capacity for inorganic and organic constituents. That capacity must not be exceeded if an environmentally sound and economically feasible land treatment system is to result. A variety of parameters can limit waste application rates. Examples include nitrate leached from the site to groundwater; synthetic organic compounds in surface water, groundwater, and crops; salts that inhibit seed germination or alter soil structure; or metals that may be toxic to plants (Loehr et al., 1985). In-plant source control or pretreatment to reduce the concentrations of specific constituents may be required or the size of the land treatment system must be expanded to assimilate the most restrictive constituent.

#### 11.2.1 Wastewater Constituents

Industrial wastewaters may contain significant concentrations and wide variations of constituents such as BOD, COD, TSS, TDS, nitrogen, pH, organic compounds, and metals. Ranges of concentrations in land-applied wastewaters are summarized in Table 11-1 (US EPA, 1973). The impact and importance of these constituents are described in the following.

##### BOD

The degradable organic matter, as measured by the BOD test, can be present in very high concentrations in industrial wastewater. Because the soil mantle is very efficient in the removal of BOD, it is often more cost-effective to apply the wastewater to the land than to remove it by pretreatment.



**Table 11-1.** Characteristics of Various Industrial Wastewaters Applied to Land

Constituent	Food Processing	Pulp and Paper	Dairy
BOD, g/m <sup>3</sup>	200 – 10,000	60 – 30,000	4,000
COD, g/m <sup>3</sup>	300 – 15,000		
TSS, g/m <sup>3</sup>	200 – 3,000	200 – 100,000	
Fixed Dissolved Solids (FDS), g/m <sup>3</sup>	1,800	2,000	1,500
Total Nitrogen, g/m <sup>3</sup>	10 – 100		90 – 400
pH, units	3.2 – 12	6 – 11	5 – 7
Temperature, °C	63	91	

Conversion units: g/m<sup>3</sup> = mg/L.

Organics in the form of sugars are more readily degradable than starchy or fibrous material. Consequently, those industrial wastewaters that contain predominantly sugars, such as food processing wastewaters, may be applied at a higher organic loading rate than wastewaters from the pulp and paper industry, which often contain starchy or fibrous organic material that are resistant to degradation.

### Total Suspended Solids

Suspended solids may include coarse solids, such as peelings and chips, or fine solids such as pulp or silt. The presence of high concentrations of suspended solids in a wastewater does not restrict its application to a land treatment system because suspended solids can normally be separated quite simply by physical pretreatment. Failure to provide adequate suspended solids removal, however, can lead to operational problems with clogging of sprinkler nozzles or nuisance problems with solids settlement in surface irrigation systems. Surface buildup as a result of uneven distribution or high concentrations of TSS can lead to reduced infiltration rates and inhibition of plant growth in ponded areas of irrigated fields.

### Total Inorganic Dissolved Solids

Salts, correctly measured only by the total inorganic (fixed, not volatile) solids test, are important to land treatment systems because there are no effective removal mechanisms for salt. The plants will take up a minor amount of TDS (usually the macronutrients and

micronutrients) and some compounds will precipitate in the soil (metal complexes and phosphate compounds). As a result of the minimal removal, mineral salts either build up in soil concentration or are leached to the groundwater. Industrial wastewaters with very high inorganic solids concentrations are generally not suitable for land application unless special provisions are made to collect soil drainage.

It is very important to measure the inorganic dissolved solids in the industrial process water because the standard total dissolved solids (TDS) test will include the organic acids, alcohols and other dissolved organic compounds that may be present in the wastewater. As an example, a milk processing wastewater was tested for fixed dissolved solids (FDS), TDS, electrical conductivity (EC) for both the wastewater and the shallow groundwater (after slow-rate land treatment). The results are summarized in Table 11-2 (Crites et al., 2000). The ratios of FDS/TDS and FDS/EC are presented for both waters and for upgradient shallow groundwater. A typical ratio of FDS/EC in clean water is 0.64 (Westcot et al., 1984). As the wastewater infiltrates through the soil, a significant portion of the TDS, in the form of organic material, is removed. Initially, the organic portion consists of 48 percent of the TDS and exceeds 1,000 g/m<sup>3</sup> (mg/L). The slow-rate land treatment process reduces the organic TDS to 200 g/m<sup>3</sup> (mg/L), approximately 17 percent of the TDS. The FDS portion of the wastewater increases from 53 percent of the TDS to 83 percent after treatment, resulting in a buildup of inorganic salts in the groundwater.

**Table 11-2.** Comparison of Inorganic and Total Dissolved Solids Measurements in Milk Processing Wastewater and Shallow Groundwater

Water Source	Fixed Dissolved Solids (FDS), g/m <sup>3</sup>	TDS, g/m <sup>3</sup>	EC, g/m <sup>3</sup>	FDS/TDS ratio	FDS/EC ratio
Process Wastewater	1,203	2,250	1,680	0.53	0.71
Shallow Groundwater	1,000	1,200	1,700	0.83	0.58
Upgradient Groundwater	200	300	310	0.67	0.64

Conversion units: g/m<sup>3</sup> = mg/L.

---

## Nitrogen

Industrial wastewaters from livestock, potato, dairy, meat-packing, and explosives production may be high in nitrogen. For these wastewaters, nitrogen is often the limiting design factor. The C:N ratio does not have to be in as close a balance for land treatment as it does for suspended growth systems, however, C:N ratios beyond 30:1 will affect crop growth or biological nutrient removal because of the competition for available nitrogen.

## pH

The pH of industrial wastewater can vary tremendously, even hourly, depending on the type of wastewater and the cleaning agents used. A range of pH between 3 and 11 has been applied successfully to the land (Crites, 1982). If the low pH is from the presence of organic acids, land treatment will have a neutralizing effect as the organic acids are oxidized or degraded.

## Temperature

High-temperature industrial wastewater, such as spent cooking liquors from pulping operations, can sterilize soil, thereby precluding the growth of vegetation and reducing the treatment capability of the soil mantle (Guerri, 1971). High-temperature wastewaters should, therefore, be cooled prior to land application.

## Color

The color in most industrial wastewaters is associated with degradable organic material and is effectively removed as the wastewater percolates through the soil mantle. In some wastewaters, such as spent sulfite liquor, the color is due to inert compounds such as lignins. It has been observed that the color from inert compounds can move through the soil (Blosser et al., 1964). Groundwater contamination is of concern from land application of industrial wastewaters with color resulting from inert components.

## Metals

Heavy metals are effectively removed by most soil systems. Metals can be the limiting design factor in slow-rate and rapid infiltration systems and the rate of retention in the soil may affect the longevity of a soil system due to buildup in the soil.

## Sodium

The sodium adsorption ratio (SAR), and the problems caused by high values, are defined in Chapter 2. Some industrial wastewaters that use caustic for cleaning may have a high sodium adsorption ratio and may require pretreatment for correction. Municipal systems should consider industrial discharges to the system (e.g., in cold climates de-icing salts may cause a problem).

## 11.2.2 Pretreatment Options

Options for pretreatment of industrial wastewaters may need to be evaluated because of more stringent discharge and land application limits. Pretreatment for industrial wastewaters may range from fine screening to biological treatment. The more typical of the pretreatment operations and processes are described in the following.

### Fine Screening

Fine screening is usually a minimum level of pretreatment prior to land application of industrial process/rinse water. Fine screens can range from fixed parabolic inclined screens to rotary drum screens (Crites et al., 1998). Coarse solids that can clog sprinkler heads or settle out at the head end of flood irrigation checks can be removed economically using fine screens. Screens also protect downstream pumps or other pretreatment units from large objects that may get washed into the wastewater stream.

### Ponds

Ponds can range from anaerobic to deep facultative to aerated. Aerated lagoons or ponds are quite common to the pulp and paper industry and to many food processing wastewaters. Ponds can be used to equalize the flows, reduce peak organic loadings, and store the wastewater for short periods of time. A sedimentation pond or lagoon can be a lined basin or concrete basin. The ponds can be designed by overflow rate or detention time. Sludge may be allowed to accumulate for season operations and cleared out after the season concludes. If significant winter storage is required and the wastewater has a relatively high BOD, pretreatment will usually be needed to reduce the BOD to 100 g/m<sup>3</sup> (mg/L) or less (US EPA, 1973) to avoid odor production. Alternatively, the storage pond can be aerated to avoid odor production.

### Adjustment of pH

If the pH of the wastewater is outside the range of 4 to 9 due to inorganic acids or bases, pH adjustment may be needed. Sometimes an equalization pond will serve to let the wastewater self-neutralize, particularly if large swings in the wastewater pH occur diurnally. Generally the pH will attenuate quickly as a result of land treatment and adjustment is not normally needed.

### Cooling

High-temperature wastewaters [above 66°C (150°F)] should be cooled so that adverse effects on vegetation and soil do not occur. High-temperature wastewaters can also have detrimental effects on plastic pipelines. If

the wastewater temperature needs to be reduced, either ponding or cooling towers can be used.

### Dissolved Air Flotation

Dissolved air flotation (DAF) is a unit process in which pressurized flow containing tiny air bubbles is introduced at the bottom of a special tank or clarifier (Crites et al., 1998). The dissolved air will float suspended solids and the DAF unit will remove the solids through a float skimming device. Sedimentation also occurs in DAF units so that the settled solids must be removed. DAF units are most effective for treating settleable solids and fats, oil and grease (FOG).

### Constructed Wetlands

Constructed wetlands are being used for pretreatment of industrial wastewaters (Crites, 1996; Crites et al., 1998; Reed et al., 1995). Treatment of livestock wastewater with constructed wetlands after treatment through ponds is becoming more prevalent (Hunt et al., 1995). Removals of various constituents through the settling basin and first cell of a wetland receiving dairy wastewater in Mercer Co., KY are summarized in Table 11-3 (Hunt et al., 1995).

**Table 11-3.** Water Quality Parameters in the Settling Basin and First Cell of a Wetland Receiving Dairy Wastewater, Mercer Co., KY

Constituent	Settling Basin, g/m <sup>3</sup>	Influent, g/m <sup>3</sup>	Effluent, g/m <sup>3</sup>	Percent Reduction
DO	0.5	0.6	0.8	—
BOD	465	452	158	66
TSS	3,516	1,132	408	88
VSS	2,085	898	357	83
TP	113.8	71.6	47.1	59
SP	60.5	26.5	15.0	75
TKN	197.0	107.5	123.8	37
NH <sub>3</sub> -N	78.8	32.8	10.3	87

Conversion units: g/m<sup>3</sup> = mg/L.

Dairy wastewater has been treated using constructed wetlands using a detention time of 7.7 days, a hydraulic loading rate of 39.4 mm/d (1.55 in/d), and a mass COD loading rate of 554 kg/ha · d (494 lb/ac · d) (Moore et al., 1995).

### Anaerobic Digestion

Anaerobic digestion can be used to reduce the organic content of wastewater and produce methane gas (also known as biogas). Anaerobic digestion can be conducted in a variety of reactors and using a variety of processes (Crites et al., 1998). Typically a BOD of about 2,500 g/m<sup>3</sup> (mg/L) or higher is needed in an industrial wastewater to make anaerobic digestion attractive. Anaerobic digestion using some of the low-rate methods is generally favored in the food processing industry.

### 11.3 Design Considerations

Design considerations specific to industrial wastewaters include higher solids and organic loadings, nitrogen transformations, and the control and attenuation of pH.

#### 11.3.1 BOD Loading Rates and Soil Reaeration

An important design consideration specific to industrial wastewater is an accurate assessment of solids and

organic loadings. Oxygen exchange into soils greatly depends on air-filled pore spaces because the diffusion coefficient of oxygen is over 10,000 times more rapid in air than in water. As a result, if organic loadings are intermittent and atmospheric oxygen is allowed to diffuse directly into the soil, high organic loading rates can be sustained without the generation of odors (Reed et al., 1995).

Research at Cornell on acclimated soils of SR systems receiving food processing wastewater documented that organic loading rates on a COD basis can exceed 4,480 and 19,094 kg/ha · d (4,000 and 17,000 lb/acre · d) for soil temperatures of 16°C and 28°C (61°F and 82°F), respectively (Jewell et al., 1975). Field sampling of the groundwater at application rates exceeding 8,960 kg/ha · d (8,000 lb/acre · d) of COD was less than 0.8 percent of the applied COD (Jewell et al. 1978). Based on the experience in New York State, guidelines have been established that organic loading rates should not exceed 560 kg/ha · d (500 lb/acre · d) based on BOD (Adamczyk, 1977). BOD loading rates for various food processing slow rate systems are summarized in Table 11-4 (Crites et al., 1998; Reed et al., 1984).

**Table 11-4.** BOD Loading Rates at Existing Industrial Slow-Rate Systems

Location	Industry	BOD Loading Rate, kg/ha·day (lb/acre·day)
Almaden, McFarland, CA.	Winery stillage	470 (420)
Anheuser-Busch, Houston, TX.	Brewery	403 (360)
Bisceglia Brothers, Madera, CA.	Winery stillage	312 (279)
Bronco Wine, Ceres, CA.	Winery	143 (128)
Citrus Hill, Frostproof, FL.	Citrus	447 (399)
Contadina, Hanford, CA.	Tomato processing	103 (92)
Frito-Lay, Bakersfield, CA.	Potato processing	94 (84)
Harter Packing, Yuba City, CA.	Tomato processing	393 (351)
Hilmar Cheese, Hilmar, CA.	Cheese processing	249 (222)
Ore-Ida Foods, Plover, WI.	Potato processing	213 (190)
Tri Valley Growers, Modesto, CA.	Tomato processing	224 (200)

In OF treatment, organic loading rates and BOD concentrations must be limited to avoid overloading the oxygen transfer to the attached microorganisms. The initial work by Campbell Soup Company (Gilde et al., 1971) indicated that excellent BOD removals could be expected at applied BOD concentrations of about 800 g/m<sup>3</sup> (mg/L) (Crites, 1982). When higher strength wastewaters were applied at similar loading rates [16 to 36 mm/d (0.6 to 1.4 in/d)], however, an oxygen transfer problem began to develop. To overcome this problem, pretreat or recycling of the treated effluent can be used (Crites, 1982). If a recycle operation is used, the collection system should include a sump from which the treated runoff can be returned to the distribution system.

**Nitrogen Transformations**

Permit limits in the past have focused on ammonia, nitrate, and total Kjeldahl nitrogen (TKN), with the assumption that organic nitrogen measured in the TKN test is biodegradable. It is recognized that nonbiodegradable organic nitrogen exists and that the TKN test, a chemical digestion procedure, is not always a good indicator of the biodegradability of an organic nitrogen compound. Although nonbiodegradable organic nitrogen may remain after exposure to rigorous anaerobic and aerobic treatment, studies support the premise that this form of TKN does not pose the same hazards to the environment as biodegradable organic nitrogen (Kobylinski et al., 1995). The presence of nonbiodegradable organic nitrogen may, however,

impact the ability of an industrial land treatment system to comply TKN limits written into NPDES permits.

Industrial wastewaters have a common tendency to have very high C:N ratios, which may effect the biological nutrient removal processes of the treatment system. Incubation studies conducted on various industrial wastewaters demonstrated the effect of C:N ratios on the mineralization of organic nitrogen. The data presented in Table 11-5 indicate that wastewaters with relatively low C:N ratios maintain a higher mineralization potential than wastewaters with high C:N ratios (King, 1984). In this review wastewaters with C:N ratios greater than 23:1 displayed negative mineralization values, indicating inefficient conversion of organic nitrogen into inorganic forms of nitrogen.

### 11.3.2 pH Control and Attenuation

Many food-processing wastewaters have a low pH that can range from 3.7 to 6, as the result of the presence of organic acids. The action of the soil microbes in oxidizing the organic acids and the soil buffering capacity usually result in a relatively rapid attenuation of the pH. A review of sites receiving winery stillage waste with a typical pH of 3.7 found that the soil pH was reduced from 6.7 to 5.8 in the topsoil [0 to 15 cm (0 to 6 in)], but only from 7.1 to 6.6 at the 0.6 m (2 ft) depth, and only from 7.45 to 7.16 at the 1.8 m (6 ft) depth (Crites et al., 1981).

**Table 11-5.** Nitrogen Mineralization of Industrial Wastewaters

Wastewater	C:N	Organic-N Mineralized (%)
Textile Sludge		
Vacuum Filtered Solids	2.5	43
Solids from Lagoon	4.4	9
Wood Processing Wastes		
Paper Mill Sludge	82.2	-45
Fiberboard Mill Sludge	23.0	-12
Poultry Processing Waste		
Waste-Activated Sludge	3.0	52
Fermentation Waste		
Sludge from Brewery Wastewater Treatment Plant	2.4	46
Sludge from Enzyme Production	8.0	24

## 11.4 Slow-Rate Land Treatment

The procedure for design of slow-rate land treatment systems is presented in Chapter 8. The preferred method of wastewater distribution is sprinkler application (irrigation). Although surface application methods (flood or furrow irrigation) have been used successfully, a number of disadvantages have been observed. The applied solids tend to settle out near the point of application, producing a nonuniform distribution of solids and organics through the field. Flood or furrow irrigation also results in saturated flow through the soil and may reduce the effectiveness of treatment for some constituents and result in anaerobic conditions that can cause leaching of iron and manganese. Relatively low-cost methods of sprinkler application, such as center pivots, are usually preferred. See Chapter 7 for details on sprinkler application. Two brief case studies are included here.

### 11.4.1 Typical Examples

Slow-rate land treatment is the most popular method of industrial wastewater land treatment. Two examples of food processing wastewater land application are presented in the following illustrating a year-round application in Idaho and a seasonal application of tomato processing wastewater in California.

#### Potato Process Water— Idaho

Bruner et al., 1999 reported the J.R. Simplot Company Food Group has operated a potato processing plant in Aberdeen, Idaho since 1973. This facility produces a variety of fried potato products. The 330-day processing season begins on about September 1 and ends on about July 31 each year. The current average daily flow from the facility is about 2,650 m<sup>3</sup>/d (0.7 Mgal/d, for an annual flow of about 874,427 m<sup>3</sup> (231 million gallons). All water used for potato processing is recycled through sprinkler irrigation on to a 190 ha (469 acre) agricultural receiver site containing silt loam soil and grass as the receiver crop. Groundwater is about 10 to 20 m (30 to 60 ft) below the ground surface at this site.

Process water is generated during the washing, cutting, blanching, and cooling of the potatoes. Water used to wash soil from the potatoes in the raw product receiving area is screened to remove potato vines, rocks, and small potatoes, and then is diverted to a set of settling basins. The settled effluent is land applied on a designated area of the facility's agricultural land, and the overflow from the basins is pumped to the land application site with the process water stream. Water used within the processing plant is screened and then directed to a primary clarifier. The underflow potato solids from the clarifier are mechanically separated using centrifuges and are fed to cattle. Excess oil from the

fyers is removed by a separate clarifier and recycled off site.

Southern Idaho has a semi-arid climate, with an annual average precipitation of about 23 centimeters (9 inches). The growing season for grass occurs during the months of April through October. Under intensely managed conditions, grass on land application sites in southern Idaho typically consumes about 107 centimeters (42 inches) of water annually.

The objective of Simplot's potato process water irrigation system is to provide a cost-effective, reliable, and environmentally sound beneficial reuse of the water, nitrogen, and other crop nutrients. The challenging aspects of this system have been the management of applied salts and organics to protect groundwater quality, and to minimize odors.

A view of the side roll sprinkler system is shown in Figure 11-1.



**Figure 11-1.** Side roll sprinklers apply potato processing wastewater throughout the winter at Aberdeen, Idaho. (Courtesy of Cascade Earth Science.)

#### Tomato Processing System in California

Tomato processing wastewater has been land applied at a number of sites in California's Central Valley for many years. Operations include direct land application to open land; furrow, flood and sprinkler irrigation of agricultural crops; and provision of irrigation water to private farmers for pasture application. One site has 36 ha (90 acres) for the direct land application of 3,875 m<sup>3</sup>/d (1.0 Mgal/d). Wastewater is passed through a fine screen and applied to border strips for flood irrigation. BOD and TSS concentrations have averaged 1,700 g/m<sup>3</sup> (mg/L) and 300 g/m<sup>3</sup> (mg/L), respectively, resulting in a BOD loading of 190 kg/ha · d (170 lb/acre · d) and a TSS loading rate 33 kg/ha · d of (30 lb/acre · d). The regulatory agency has placed a limit of 224 kg/ha · d (200

lb/acre · d) of BOD to avoid the generation of odors. Upgradient and downgradient groundwater monitoring wells have been sampled regularly and have demonstrated improvement of water quality after land application and no adverse impacts on quality of the groundwater (Beggs et al., 1990).

## 11.5 Overland Flow Treatment

The procedure for design of overland flow land treatment systems is presented in Chapter 9. Overland flow systems receiving high-strength wastewater are recommended to use sprinkler application to distribute the solids and organics evenly. Two brief case studies are included here.

### 11.5.1 Typical Examples

Overland flow has been used to treat a variety of food processing wastewaters including apple, tomato, potato, soup, meat packing, poultry, peanuts, and pimientos (Crites, 1982). Two examples are presented briefly to illustrate a year-round system and a seasonal system. In the year-round example the treated runoff is discharge to surface water. In the more seasonal operation, the treated runoff is reused for crop irrigation.

#### Soup Producer in Texas

One of the oldest and best-known overland flow systems is the Campbell Soup Company's Paris, TX operation. Developed in the 1960s, the Paris site has had its origins documented (Gilde et al., 1971), performance evaluated (Law et al., 1970), microbiology investigated (Vela, 1974), and long-term effects studied (Tedaldi, 1991 and 1992).

The original 120 ha (300 acre) site was expanded to 360 ha (900 acres) by 1976. The original slopes ranged from 1 to 12 percent, but those from 2 to 6 percent

demonstrated the best performance, least erosion and least ponding. Before application, the wastewater is screened to remove large solids, and grease is skimmed. No storage of the screened wastewater occurs and the screened wastewater is pumped continuously from a 375-m<sup>3</sup> (99,075-gal) sump to spray the application slopes. The overland flow terraces are 60 to 90 m (200 to 300 ft) long. The hydraulic loading rate was 15 mm/d (0.6 in/d). The slopes are seeded to a mixture of Reed canarygrass, tall fescue, red top and perennial ryegrass. Wastewater is applied using standard agricultural impact-type solid set sprinklers [8.0-mm (0.315-in) nozzle diameter]. Application periods are 6 to 8 hr/d for 5 d/wk. Long-term operation and performance data collected at the site indicate that the OF system consistently achieved very high removal efficiencies from a surface discharge standpoint. The performance of the system is summarized in Table 11-6 (Crites, 1982; Gilde et al., 1971; Law et al., 1970).

#### Tomato Processor in California

A 129 ha (320 acre) overland flow treatment system was constructed near Davis, California in 1969 to treat 15,100 m<sup>3</sup>/d (4 Mgal/d) of tomato processing wastewater. Screened wastewater is pumped to the overland flow field and sprinkled onto constructed 2.5 percent slopes. The slopes are 53 m (175 ft) long based on the experience at Paris, TX. Reed canarygrass predominates as the vegetation. The cannery operates 3 to 4 months during the summer (July through mid-October) fresh processing season and, for the past few years, operates a remanufacturing processing season from October through March. The solid-set sprinklers are shown in Figure 11-2.

**Table 11-6.** Performance of Paris, TX, Overland Flow System

Constituent	Influent	Effluent	Percent Removal
BOD, g/m <sup>3</sup>	572	3.1	99.5
COD, g/m <sup>3</sup>	806	45	94.4
TSS, g/m <sup>3</sup>	245	38	84.5
Total N, g/m <sup>3</sup>	17.2	2.8	83.7
Total P, g/m <sup>3</sup>	7.4	4.3	41.9
Chloride, g/m <sup>3</sup>	44	43	2.3
pH, units	4.4 – 9.3	6.6	—

Conversion units: g/m<sup>3</sup> = mg/L.



**Figure 11-2.** Solid set sprinklers apply tomato processing wastewater to overland flow slopes.

Treated runoff averages 7,550 m<sup>3</sup>/d (2 Mgal/d). The treated runoff is reused for crop irrigation on a nearby

**Table 11-7.** Performance of Overland Flow System at Davis, CA.

Constituent	Influent	Effluent	Percent Removal
BOD, g/m <sup>3</sup> (mg/L)	1,490	17	98.9
TSS, g/m <sup>3</sup> (mg/L)	1,180	25	97.9
pH, units	4.5	8.16	—

Source: Brown and Caldwell files, Sacramento, CA.

### 11.6.1 Cheese Processing Wastewater in California

Hilmar Cheese Company has been producing cheese products and land-applying the process water at their plant near the Town of Hilmar, five miles south of Turlock, CA, since 1985. The land use surrounding the plant site is primarily agricultural, with a mixture of fodder, orchard, and pasture crops being grown. The soils in the area are characteristically sandy, and there is a relatively shallow groundwater table (3 m or 10 ft). The land has been leveled for surface irrigation.

The area used for soil aquifer treatment has been expanded with each increase in process water flow, reaching 56 ha (140 acres) by 1998. The process water flowrate is 2,840 m<sup>3</sup>/d (0.75 Mgal/d). The average loading rate is 65 mm/wk (2.6 in/wk) because the application area is rotated between wastewater applications for about 6 months and cropping with either corn or barley for 6 months. The BOD loading rate can range from 89 to 734 kg/ha · d (80 to 655 lb/acre · d), with 248 kg/ha · d (222 lb/acre · d) being typical.

A comparison of the process water characteristics and the monitoring well groundwater quality is presented in Table 11-8 (Nolte and Associates, 1996). As shown in Table 11-8 the upgradient groundwater has much higher nitrate-nitrogen values as a result of areawide

ranch. The performance of the overland flow system is summarized in Table 11-7.

### 11.6 Soil Aquifer Treatment

The design of soil aquifer treatment systems is described in Chapter 10. Few SAT systems exist for industrial wastewater. The reasons include the difficulty in siting SAT systems and the typical high strength of industrial wastewater, which requires a high level of treatment.

The few SAT systems that exist are at the low end of the hydraulic loading rate range for municipal wastewater. The loading rates for BOD, TSS, and nitrogen, however, are generally quite high.

fertilization practices. The downgradient wells have much lower nitrate-nitrogen as a result of denitrification. Hilmar Cheese is reclaiming byproducts from the cheese production including the whey protein and lactose. However, it should be noted that TKN, EC, TDS and FDS increased significantly. An ultrafiltration system concentrates the remaining fats and proteins into a slurry that is used for cattle feed (Struckmeyer, 1999).

### 11.6.2 Winery Wastewater in California

Winery wastewater is characterized by low pH, relatively high BOD, and a low nutrient content. Land application using soil aquifer treatment has been practiced successfully at a number of California wineries for many years (Coast Laboratories, 1947; Crites, 1987; Crites et al., 1974).

A Central Valley winery was constructed in 1974 with a soil aquifer treatment system for treatment and disposal of process water. Products include wine and wine coolers. Washwater is collected into a central sump and pumped to a series of seven individual infiltration basins. Washwater flows vary by the season, being highest during the August to October crush period. Annual average washwater flows are 760 m<sup>3</sup>/d (0.2 Mgal/d).

Operation of the infiltration system is cyclical. Washwater is loaded onto one basin at a time for a period of several days and then the washwater is moved

to the next basin. The basins cover 4 ha (10 acres) and are rectangular. In the late winter, when the flows are reduced, about half the basins are taken out of service and planted to an annual cereal crop, such as oats, wheat or barley. During July, after the crop is harvested, the basins are ripped to a depth of 2-m (6-ft). The basins are then disked and leveled for the next washwater application (Crites, 1987).

The washwater quality varies with the season. BOD values are highest during the crush [up to 4,700 g/m<sup>3</sup> (mg/L)] and lowest during the spring [about 300 g/m<sup>3</sup> (mg/L)], with an average of 950 g/m<sup>3</sup> (mg/L). The total nitrogen concentration averages 33 g/m<sup>3</sup> (mg/L) and the BOD to nitrogen ratio averages 28:1. The pH ranges from 4.1 to 7.9. The low values of pH occur during the crush, but do not have an adverse effect on either the soil or the groundwater (Crites, 1987).

**Table 11-8.** Treatment Performance for Hilmar Cheese Soil Aquifer Treatment System

Constituent	Process Water	Upgradient Groundwater	Downgradient Groundwater
BOD, g/m <sup>3</sup>	2,852	2	2
TKN, g/m <sup>3</sup>	93	1.1	9.3
Nitrate-N, g/m <sup>3</sup>	18	35	0.4
EC, dS/m	1,688	650	1,100
TDS, g/m <sup>3</sup>	2,727	480	600
FDS, g/m <sup>3</sup>	1,155	340	540

Conversion units: g/m<sup>3</sup> = mg/L.

## 11.7 References

- Adamczyk, A.F. (1977) *Land Disposal of Food Processing Wastewaters in New York State*, In: Land as a Waste Management Alternative, Loehr, R.C. (ed.), Ann Arbor Science Publishers, Ann Arbor, MI.
- Beggs, R.A. and R.W. Crites (1990) *Odor Management for Land Application of Food Processing Wastewater*, Proceedings of the 6<sup>th</sup> International Symposium on Agricultural and Food Processing Wastes, Chicago, IL.
- Bendixen, T.W., et al. (1969) *Cannery Waste Treatment by Spray Irrigation-Runoff*, Journal WPCF, 41: 385.
- Billings, R.M. (1958) *Stream Improvement through Spray Disposal of Sulphite Liquor at the Kimberly-Clark Corporation, Niagara, Wisconsin, Mill*, Proceedings of the 13<sup>th</sup> Industrial Waste Conference, Purdue University, 96: 71.
- Blosser, R.O. and E.L. Owens (1964) *Irrigation and Land Disposal of Pulp Mill Effluents*, Water and Sewage Works, 111: 424.
- Bolton, P. (1947) *Disposal of Canning Plant Wastes by Irrigation*, Proceedings of the Third Industrial Waste Conference, Purdue University, Lafayette, IN.
- Breska, G.J., et al. (1957) *Objectives and Procedures for a Study of Spray Irrigation of Dairy Wastes*, Proceedings of the 12<sup>th</sup> Industrial Waste Conference, Purdue University, 94: 636.
- Bruner, D J., S.B. Maloney and H. Hamanishi (1999) *Expansion of a Spray Irrigated Land Application System for a Year-Round Potato Processing Facility in Idaho*, Cascade Earth Science, Pocatello, ID.
- Canham, R.A. (1958) *Comminuted Solids Inclusion with Spray Irrigated Canning Waste*, Sewage & Industrial Wastes, 30: 1028.
- Coast Laboratories (1947) *Grape Stillage Disposal by Intermittent Irrigation*, Prepared for Wine Institute, San Francisco, CA.
- Colovos, G.C. and N. Tinklenberg (1962) *Land Disposal of Pharmaceutical Manufacturing Wastes*, Biotech. Bioengineering. 4: 153.
- Crites, R.W. (1982) *Land Treatment and Reuse of Food Processing Waste*, Presented at the 55<sup>th</sup> Annual Conference of the Water Pollution Control Federation, St. Louis, MO.
- Crites, R.W. (1987) *Winery Wastewater Land Application*, Proceedings of a Conference on Irrigation Systems for the 21<sup>st</sup> Century, Irrigation and Drainage Division, American Society of Civil Engineering, Portland, OR.
- Crites, R.W. (1996) *Constructed Wetlands for Wastewater Treatment and Reuse*, Presented at the Engineering Foundation Conference, Environmental Engineering in the Food Processing Industry, XXVI, Santa Fe, NM.
- Crites, R.W., et al. (1978) *Treatment of Brewery Spent Grain Liquor by Land Application*, Proceedings of the Third Annual Conference on Treatment and Disposal of Industrial Wastewater and Residues, Houston, TX.



- Crites, R.W. and R.C. Fehrmann (1981) *Land Application of Winery Stillage Wastes*, Industrial Wastes, 27: 14.
- Crites, R.W., C.E. Pound, and R.G. Smith (1974) *Experience with Land Treatment of Food Processing Wastewater*, Proceedings of the Fifth National Symposium on Food Processing Wastes, Monterey, CA.
- Crites, R.W. and R.G. Stratton (1994) *Land Application of Pineapple Process Water for Reuse*, Presented at the Hawaii WPCA, Honolulu, HI.
- Crites, R.W. and G. Tchobanoglous (1998) *Small and Decentralized Wastewater Management Systems*, McGraw-Hill, New York, NY.
- Crites, R.W., S.C. Reed, and R.K. Bastian (2000) *Land Treatment Systems for Municipal and Industrial Wastes*, McGraw-Hill, New York, NY.
- Flower, W.A. (1969) *Spray Irrigation for the Disposal of Effluents Containing Deinking Wastes*, TAPPI, 52: 1267.
- Gilde, L.C., et al. (1971) *A Spray Irrigation System for Treatment of Cannery Wastes*, Journal WPCF, 43: 2011.
- Guerri, E.A. (1971) *Sprayfield Application Handles Spent Pulping Liquors Efficiently*, Pulp & Paper, 45: 93-95.
- Henry, C.D., et al. (1954) *Sewage Effluent Disposal Through Crop Irrigation*, Sewage & Industrial Wastes, 26: 123.
- Henry, C.L. and S.A. Wilson (1988) *Denitrification Following Land Application of Potato Processing Wastewater*, Agronomy Abstracts, American Society of Agronomy, Madison, WI.
- Hickerson, R.D. and E.K. McMahon (1960) *Spray Irrigation of Wood Distillation Wastes*, Journal WPCF, 32: 55.
- Hunt, P.G., et al. (1995) *State of the Art for Animal Wastewater Treatment in Constructed Wetlands*, Proceedings of the Seventh International Symposium on Agricultural and Food Processing Wastes, ASAE, Chicago, IL.
- Jewell, W.J. and R.C. Loehr (1975) *Land Treatment of Food Processing Wastes*, Presented at the American Society of Agricultural Engineering, Winter Meeting, Paper No. 75-2513, Chicago, IL.
- Jewell, W.J., et al. (1978) *Limitations of Land Treatment of Wastes in the Vegetable Processing Industries*, Cornell University, Ithaca, NY.
- Keith, L.W. and W.D. Lehman (1986) *Land Treatment of Food Processing Wastewater—Case History, Utilization, Treatment, and Disposal of Waste on Land*, Soil Science Society of America, Madison, WI.
- King, L.D. (1984) *Availability of Nitrogen in Municipal, Industrial, and Animal Wastes*, Journal of Environmental Quality, 13 (4): 609-612.
- Kobylinski, E.A., Davey, J.W., and Shamskhorzani, R. (1995) *Nonbiodegradable Organic Nitrogen is an Enigma for Regulations*, In: Proceedings of the WEF 68<sup>th</sup> Annual Conference and Exposition, Miami Beach, FL., No. 3, pp. 501-511.
- Koch, H.C. and D.E. Bloodgood (1959) *Experimental Spray Irrigation of Paperboard Mill Wastes*, Sewage & Industrial Wastes, 31: 827.
- Lane, L.C. (1955) *Disposal of Liquid and Solid Wastes by Means of Spray Irrigation in the Canning and Dairy Industries*, Proceedings of the 10<sup>th</sup> Industrial Waste Conference, Purdue University, 89: 508.
- Law, J.P., R.E. Thomas, and L.H. Myers (1970) *Cannery Wastewater Treatment by High-Rate Spray on Grassland*, Journal Water Pollution Control Federation, 42: 1621-1631.
- Lawton, G.W., et al. (1959) *Spray Irrigation of Dairy Wastes*, Sewage & Industrial Wastes, 31: 923.
- Lever, N.A. (1966) *Disposal of Nitrogenous Liquid Effluent from Modderfontein Dynamite Factory*, Proceedings of the 21<sup>st</sup> Industrial Waste Conference, Purdue University, 121: 902.
- Loehr, R.C. and M.R. Overcash (1985) *Land Treatment of Wastes: Concepts and General Design*, ASCE; Journal of Environmental Engineering, 111 (2): 141-160.
- Loehr, R.C., et al. (1988) *Full-Scale Land Treatment of Coffee Processing Wastewater*, Journal Water Pollution Control Association, 60 (11): 1948-1952.
- Ludwig, H., et al. (1951) *Disposal of Citrus Byproducts Wastes at Ontario, California*, Sewage & Industrial Wastes, 23: 1255-1266.
- Luley, H.G. (1963) *Spray Irrigation of Vegetable and Fruit Processing Wastes*, Journal WPCF, 35: 1252.
- McKee, F.J. (1955) *Spray Irrigation of Dairy Wastes*, Proceedings of the 10<sup>th</sup> Industrial Waste Conference, Purdue University, 89: 514.
- Madison, M and M. Henderson (1993) *Zero Discharge All-Weather Land Application with Soil Storage*, Proceedings of the 66<sup>th</sup> Annual Conference of the Water Environment Federation, Anaheim, CA.

- 
- Meighan, A.D. (1958) *Experimental Spray Irrigation of Strawboard Wastes*, Proceedings of the 13<sup>th</sup> Industrial Waste Conference, Purdue University, 96: 456.
- Molloy, D.J (1964) *'Instant' Waste Treatment*, Water Works Wastes Engineering, 1: 68.
- Nolte and Associates (1996) *Report of Waste Discharge*, Hilmar Cheese Company, Sacramento, CA.
- Overcash, M.R. and D. Pal (1979) *Design of Land Treatment for Industrial Wastes, Theory and Practice*, Ann Arbor Science Publishers, Ann Arbor, MI.
- Parker, R.R. (1967) *Disposal of Tannery Wastes*, Proceedings of the 22<sup>nd</sup> Industrial Waste Conference, Purdue University, 129: 36.
- Parsons, W.C. (1967) *Spray Irrigation of Wastes from the Manufacture of Hardboard*, Proceedings of the 22<sup>nd</sup> Industrial Waste Conference, Purdue University, 129: 602.
- Philipp, A.H. (1971) *Disposal of Insulation Board Mill Effluent by Land Irrigation*, Journal WPCF, 43: 1749.
- Reed, S.C. and R.W. Crites (1984) *Handbook on Land Treatment Systems for Industrial and Municipal Wastes*, Noyes Data, Park Ridge, NJ.
- Reed, S.C., R.W. Crites and E.J. Middlebrooks (1995) *Natural Systems for Waste Management and Treatment*, Second Edition, McGraw-Hill, New York, NY.
- Schraufnagel, F.H. (1962) *Ridge-and-Furrow Irrigation for Industrial Waste Disposal*, Journal WPCF, 34: 1117.
- Scott, R.H. (1962) *Disposal of High Organic Content Wastes on Land*, Journal WPCF, 34: 1117.
- Smith, J.H. et al. (1977) *Treatment of Potato Processing Wastewater on Agricultural Land: Water and Organic Loading, and the Fate of Applied Plant Nutrients*, In: Land as a Waste Management Alternative, Loehr, R.C. (ed.), Ann Arbor Science Publishers, Ann Arbor, MI.
- Struckmeyer, T. (1999) *Personal Communication*, Vice President Hilmar Cheese Company, Hilmar, CA.
- Tedaldi, D.J. and R.C. Loehr (1991) *Performance of an Overland Flow System Treating Food-Processing Wastewater*, Research Journal Water Pollution Control Federation, 63, 266.
- Tedaldi, D.J. and R.C. Loehr (1992) *Effects of Waste-Water Irrigation on Aqueous Geochemistry Near Paris, Texas*, Ground Water, 30 (5): 709-719.
- US EPA (1973) *Wastewater Treatment and Reuse by Land Application, Volume II*, U.S. Environmental Protection Agency, EPA-660/2-73-006b, Washington, DC.
- Vela, G.R. (1974) *Effect of Temperature on Cannery Waste Oxidation*, Journal Water Pollution Control Federation, 46 (1): 198-202.
- Voights, D. (1955) *Lagooning and Spray-Disposal of Neutral Sulfite Semi-Chemical Pulp Mill Liquors*, Proceedings of the 10<sup>th</sup> Industrial Waste Conference, Purdue University, 89: 497.
- Wallace, A.T. (1976) *Land Disposal of Liquid Industrial Wastes*, In: R.L. Sanks and T. Asano, Land Treatment and Disposal of Municipal and Industrial Wastewater, Ann Arbor Science, Ann Arbor, MI.
- Westcot, D.W. and R.S. Ayers (1984) *Irrigation Water Quality Criteria*, In: Asano, T. and G.S. Pettygrove, Irrigation with Reclaimed Municipal Wastewater — A Guidance Manual, California State Water Resources Control Board, Report No. 84-1.
- Woodley, R.A. (1968) *Spray Irrigation of Organic Chemical Wastes*, Proceedings of the 23<sup>rd</sup> Industrial Waste Conference, Purdue University, 132: 251.
- Wright, J.F. (1993) *Land Application of Citrus Wastewater*, Florida Department of Environmental Protection, State of Florida.