

*Proceedings Report*

# **Symposium on Cooling Water Intake Technologies to Protect Aquatic Organisms**

May 6-7, 2003

Hilton Crystal City at National Airport

Arlington, VA



# Proceedings Report

## A Symposium on Cooling Water Intake Technologies to Protect Aquatic Organisms

May 6-7, 2003  
Arlington, Virginia

U.S. Environmental Protection Agency

Office of Water  
Office of Science and Technology  
Washington, DC

Office of Research and Development  
National Risk Management Research Laboratory  
Cincinnati, OH

U.S. Department of Energy  
National Energy Technology Laboratory  
Pittsburgh, PA • Fairbanks, AK  
Morgantown, WV • Tulsa, OK

## **NOTICE**

The views expressed in these Proceedings are those of the individual authors and do not necessarily reflect the views and policies of the U.S. Environmental Protection Agency (EPA). Scientists in EPA's Office of Research and Development have prepared the EPA sections, and those sections have been reviewed in accordance with EPA's peer and administrative review policies and approved for presentation and publication. Mention of trade names or presentation of commercial products does not constitute endorsement or recommendation for use.

# CONTENTS

---

<b>Acknowledgments</b> .....	<b>iv</b>
<b>Introduction</b> .....	<b>1</b>
<b>Symposium Agenda</b> .....	<b>2</b>
<b>Summaries and Technical Papers of Conference Presentations</b> .....	
<b>I. Opening Remarks</b> .....	<b>6</b>
<i>Scott Minamyer, U.S. EPA Office of Research and Development</i> .....	6
<b>II. Keynote Addresses</b> .....	<b>6-7</b>
<i>Benjamin Grumbles, Deputy Assistant Administrator, U.S. EPA Office of Water</i> .....	6
<i>Alex Matthiessen, Executive Director, Riverkeeper, Inc.</i> .....	6-7
<i>Charles Goodman, Senior Vice President, Research and Environmental Affairs, Southern Company</i> .....	7
<b>III. Overview Presentations</b> .....	<b>8-31</b>
An Overview of Fish Protection Technologies and Costs for Cooling Water Intake Structures .....	8-23
<i>Edward Taft and Thomas Cook, Alden Research Laboratory, Inc.</i>	
An Overview of Flow Reduction Technologies for Reducing Aquatic Impacts at Cooling Water Intake Structures .....	23-30
<i>Reed Super, Riverkeeper, Inc.</i>	
Question & Answer for Overview Presentations .....	31
<b>IV. Session A: State-Level Issues</b> .....	<b>32-79</b>
Maryland .....	32-41
<i>Richard McLean, Director of Nuclear Programs, Maryland Department of Natural Resources</i>	
New York .....	41-53
<i>Edward W. Radle (retired) and Michael J. Calaban, New York State Department of Environmental Conservation, Steam Electric Unit</i>	
California .....	54-79
<i>Richard L. Wantuck, NOAA Fisheries, Santa Rosa, California</i>	
Question & Answer for Session A .....	79
<b>V. Session B: Flow Reduction</b> .....	<b>80-111</b>
Retrofit of Closed-Cycle Cooling with Unit Specific Mechanical Draft Wet Cooling Towers with By-Pass Capability: A Case Study .....	80
<i>Reed Super, Riverkeeper, Inc. and John Torgan, Save the Bay – People for Narragansett Bay</i>	

	Proposed Innovative Cooling System for Heat and Flow Reduction at the Brayton Point Power Station .....	81-94
	<i>Thomas Englert, Lawler, Matusky and Skelly Engineers, LLP</i>	
	Design and Performance of Optimized Air-Cooled Condenser at Crockett Cogeneration Plant.....	95-101
	<i>Bill Powers, P.E., Powers Engineering</i>	
	Evaluation of Variable Pumping Rates as a Means to Reduce Entrainment Mortalities.....	101-110
	<i>John Young, ASA Analysis &amp; Communications, Inc.</i>	
	Question & Answer for Session B .....	110-111
<b>VI.</b>	<b>Session C: Costs Associates with Flow Reduction .....</b>	<b>112-150</b>
	Cooling System Retrofit Costs.....	112-125
	<i>John Maulbetsch, Maulbetsch Consulting</i>	
	Estimating Energy Penalties for Wet and Dry Cooling Systems at New Power Plants .....	125-137
	<i>Wayne Micheletti, Wayne C. Micheletti, Inc.</i>	
	A Tool for Budgetary Estimation of Cooling Towers Unit Costs Based on Flow .....	138-149
	<i>Faysal Bekdash and Mike Moe, SAIC</i>	
	Power Plant Repowering as a Strategy for Reducing Water Consumption at Existing Electric Generating Facilities .....	149
	<i>David Schlissel, Synapse Energy Economics, Inc.</i>	
	Question & Answer for Session C .....	150
<b>VII.</b>	<b>Session D-1: Screening and Other Fish Diversion/ Deterrent Technologies.....</b>	<b>151-186</b>
	Fish Return System Efficacy and Monitoring Studies for JEA's Northside Generating Station .....	151-162
	<i>Isabel C. Johnson, Golder Associates, Inc.</i>	
	Effectiveness, Operation and Maintenance, and Costs of a Barrier Net System for Impingement Reduction at the Chalk Point Generating Station.....	162-176
	<i>David Bailey, Mirant Mid-Atlantic</i>	
	Reductions in Impingement Mortality Resulting from Enhancements to Ristroph Traveling Screens at an Estuarine Cooling Water Intake Structure .....	177-184
	<i>Kenneth Strait, PSEG Services Corporation</i>	
	Question & Answer for Session D-1 .....	185-186
<b>VIII.</b>	<b>Session D-2: Screening and Other Fish Diversion/ Deterrent Technologies (cont'd) .....</b>	<b>187-265</b>
	Development and Operation of Acoustic Fish Deterrent Systems at Estuarine Power Stations .....	187-200
	<i>Andy Turnpenny and Jeremy Nedwell, Fish Guidance Systems, Ltd.</i>	
	Objective Design of Acoustic Fish Deterrent Systems .....	200-206
	<i>Jeremy Nedwell, Andy Turnpenny, and David Lambert, Fish Guidance Systems Ltd.</i>	

	Induced Sweeping Flows at CWIS for Reducing Fish Impingement.....	206-218
	<i>Charles C. Coutant, Oak Ridge National Laboratory</i>	
	The Use of Angled Bar Racks and Louvers for Protecting Fish at Water Intakes.....	218-219
	<i>Stephen Amaral, Alden Research Laboratory, Inc.</i>	
	A Review of Impingement Survival Studies at Steam-Electric Power Stations.....	219-241
	<i>Steven Jinks, ASA Analysis &amp; Communications, Inc.</i>	
	Question & Answer for Session D-2.....	242
<b>IX.</b>	<b>Session D-3: Screening and Other Fish Diversion/ Deterrent Technologies (cont'd) .....</b>	<b>243-311</b>
	Optimal Slot-Width Selection for Wedgewire Screens .....	243-356
	<i>William Dey, ASA Analysis Communications, Inc.</i>	
	Development of Filter Fabric Technology to Reduce Aquatic Impacts at Water Intake Structures .....	256-268
	<i>Matthew J. Raffenberg, Lawler, Matusky and Skelly Engineers, LLP</i>	
	Vulnerability of Biofouling of Filter Curtain Materials Used for Entrainment Reduction .....	269-279
	<i>Peter Henderson, Pisces Conservation Ltd &amp; University of Oxford and Richard Seaby, Pisces Conservation, Ltd.</i>	
	Laboratory Evaluation of Wedgewire Screens for Protecting Fish at Cooling Water Intakes .....	279-302
	<i>Stephen Amaral, Alden Research Laboratory, Inc.</i>	
	Selection and Design of Wedgewire Screens and a Fixed-Panel Aquatic Filter Barrier System to Reduce Impingement and Entrainment at a Cooling Water Intake Structure on the Hudson River .....	303-309
	<i>Mark Strickland, PSEG Service Corporation, and James E. Mudge, Ph.D. Civil and Environmental Consultants, Inc.</i>	
	Question & Answer for Session D-3.....	309-311
<b>X.</b>	<b>Open Discussion: Identify Research Needs .....</b>	<b>312-313</b>

**Appendices**

- Appendix A: Steering Committee Members
- Appendix B: List of Symposium Attendees
- Appendix C: Slide Presentations
- Appendix D: Poster Abstracts
- Appendix E: Vendor Displays

## Acknowledgments

Several people contributed to the success of the symposium and the preparation of this report. EPA would like to thank all of the symposium presenters and the following members of the Planning Committee and Technical Paper Peer Reviewer Team for their significant efforts:

### Symposium Planning Committee

Scott Minamyer, Chair	USEPA, Office of Research and Development, Cincinnati, OH
Ashley Allen	USEPA, Office of Water, Washington, DC
David Bailey	Mirant Mid-Atlantic, Upper Marlboro, MD (Now with EPRISolutions, Springfield, VA)
Thomas Bigford	NOAA, National Marine Fisheries Service, Silver Spring, MD
Thomas Feeley	DOE, National Energy Technology Laboratory, Pittsburgh, PA
Robert Gross	DOE, National Energy Technology Laboratory, Morgantown, WV
Lisa Kline	Atlantic States Marine Fisheries Commission, Washington, DC
Deborah Nagle	USEPA, Office of Water, Washington, DC
Martha Segall	USEPA, Office of Water, Washington, DC
Carrie Selberg	Atlantic States Marine Fisheries Commission, Washington, DC
Reed Super	River Keeper, Inc., Garrison, NY
Tom Wall	USEPA, Office of Water, Washington, DC
Kent Zammit	Electric Power Research Institute, Palo Alto, CA

Melissa Canfield, Melissa DeSantis, and Elicia Blumberg of Tetra Tech, Inc. provided symposium logistical support.

### Technical Paper Peer Reviewers

Stephen Amaral	Alden Research Laboratory, Inc., Holden, MA
Regno Arulgnanendran	Tetra Tech, Inc., Fairfax, VA
David Bailey	Mirant Mid-Atlantic, Upper Marlboro, MD (Now with EPRISolutions, Springfield, VA)
Faysal Bekdash	SAIC, Reston, VA
Tom Bigford	NOAA Fisheries, Silver Spring, MD
Elicia Blumberg	Tetra Tech, Inc., Fairfax, VA
Michael Calaban	New York State Department of Environmental Conservation, Albany, NY
Doug Dixon	Electric Power Research Institute, Gloucester Point, VA
Alan Gaulke	American Electric Power, Columbus, OH
Robert Gross	DOE, National Energy Technology Laboratory, Morgantown, WV
Lisa Kline	Atlantic States Marine Fisheries Commission, Washington, DC
Shreekant Malvadkar	U.S. DOE, National Energy Technology Laboratory, Morgantown, WV
John Matousek	Lawler, Matusky & Skelly Engineers LLP, Pearl River, NY
John Maulbetsch	Maulbetsch Consulting, Menlo Park, CA
Paul Mayer	USEPA, Office of Research and Development, Ada, OK
Joe O'Hagan	California Energy Commission, Sacramento, CA
Edward Parsons	DOE, National Energy Technology Laboratory, Morgantown, WV
Brian Pawlak	NOAA Fisheries, Silver Spring, MD
Robert Reider	The Detroit Edison Company, Detroit, MI
William Shuster	USEPA, National Risk Management Research Laboratory, Cincinnati, OH
James Stine	National Rural Electric Cooperative Association, Arlington, VA
Richard Takacs	NOAA Restoration Center, Annapolis, MD
John Veil	Argonne National Laboratory, Washington, DC
Kent Zammit	Electric Power Research Institute, Palo Alto, CA
Lynn Zipf	USEPA, Office of Water, Washington, DC

Scott Minamyer, Ashley Allen, and Martha Segall of USEPA and Robert Gross of DOE provided technical direction for this report, which was prepared by Melissa Canfield and Melissa DeSantis of Tetra Tech, Inc.

## Introduction

The *Symposium on Cooling Water Intake Technologies to Protect Aquatic Organisms* brought together professionals from federal, state, and tribal regulatory agencies; industry; environmental organizations; engineering consulting firms; science and research organizations; academia; and other organizations concerned with mitigating harm to the aquatic environment by cooling water intake structures. The efficacy and costs of various technologies to mitigate impacts on aquatic organisms from cooling water intake structures, as well as research and other future needs, were discussed. The Symposium was cosponsored by USEPA's Office of Water and Office of Research and Development, National Oceanic and Atmospheric Administration, U.S. Department of Energy, and Electric Power Research Institute and in cooperation with Riverkeeper, Inc., Utility Water Act Group and Atlantic States Marine Fisheries Commission and was held May 6-7, 2003 in Arlington, Virginia.

This document presents the proceedings of the Symposium. It includes, where available, technical papers, copies of the slides used by presenters, a transcription of questions and answers raised during the symposium, as well as other information presented at the symposium.



## Symposium Agenda

### Tuesday, May 6, 2003

**8:10 am – 8:15 am**      **Opening Remarks**  
**Scott Minamyer, U.S. EPA Office of Research and Development**

#### **Keynote Addresses**

*Moderator: Scott Minamyer, U.S. EPA Office of Research and Development*

8:15 – 8:30              Benjamin Grumbles, Deputy Assistant Administrator, U.S. EPA Office of Water

8:30 – 8:45              Alex Matthiessen, Executive Director, Riverkeeper, Inc.

8:45 – 9:00              Charles Goodman, Senior Vice President, Research and Environmental Affairs, Southern Company

#### **Overview Presentations**

*Moderator: Scott Minamyer, U.S. EPA Office of Research and Development*

9:00 – 9:30              **An Overview of Fish Protection Technologies and Costs for Cooling Water Intake Structures**  
Edward Taft and Thomas Cook, Alden Research Laboratory, Inc.

9:30 – 10:00            **An Overview of Flow Reduction Technologies for Reducing Aquatic Impacts at Cooling Water Intake Structures**  
Reed Super, Riverkeeper, Inc.

10:00 – 10:30          BREAK

#### **Session A: State-Level Issues**

*Moderator: Tom Bigford, NOAA, National Marine Fisheries Service*

10:30 – 11:00          Richard McLean, Director of Nuclear Programs, Maryland Department of Natural Resources

11:00 – 11:30          Edward W. Radle (retired) and Michael J. Calaban, New York State Department of Environmental Conservation, Steam Electric Unit

11:30 – 12:00          Richard L. Wantuck, NOAA Fisheries, Santa Rosa, California

12:00 – 1:30            LUNCH (on your own)

#### **Session B: Flow Reduction**

*Moderator: Martha Segall, USEPA Office of Water*

1:30 – 1:50              **Retrofit of Closed-Cycle Cooling with Unit-Specific Mechanical Draft Wet Cooling Towers with By-Pass Capability: A Case Study**  
Reed Super, Riverkeeper, Inc. and John Torgan, Save The Bay – People for Narragansett Bay

1:50 – 2:10              **Innovative Cooling System for Heat and Flow Reduction at the Brayton Point Power Station**  
Thomas Englert, Lawler, Matusky and Skelly Engineers, LLP

2:10 – 2:30              **Design and Performance of Optimized Air-Cooled Condenser at Crockett Cogeneration Plant**  
Bill Powers, P.E., Powers Engineering

2:30 – 2:50              **Evaluation of Variable Pumping Rates as a Means to Reduce Entrainment Mortalities**  
John Young, ASA Analysis & Communications, Inc.

2:50 - 3:00                    **Q&A for Session B**

3:00 – 3:30                    BREAK

**Session C: Costs Associated with Flow Reduction**

*Moderator: David Bailey, Mirant Corporation and Utility Water Act Group*

3:30 – 3:50                    **Cooling System Retrofit Costs**  
John Maulbetsch, Maulbetsch Consulting

3:50 – 4:10                    **Estimating Energy Penalties for Wet and Dry Cooling Systems at New Power Plants**  
Wayne Micheletti, Wayne C. Micheletti, Inc.

4:10 – 4:30                    **A Tool for Budgetary Estimation of Cooling Towers Unit Costs Based on Flow** Faysal Bekdash  
and Mike Moe, SAIC

4:30 – 4:50                    **Power Plant Repowering as a Strategy for Reducing Water Consumption at Existing Electric  
Generating Facilities**  
David Schlissel, Synapse Energy Economics, Inc.

4:50 – 5:00                    **Q&A for Session C**

6:00 pm – 8:00 pm            **Poster and Vendor Exhibit Social**  
Conference participants are invited to convene for drinks and discussion. Twelve displays prepared by scientists and industry experts will be presented, covering a range of innovative technologies for reducing impingement and entrainment by cooling water intake structures. Displays will include the latest developments in screening technologies, behavioral barriers, aquatic filter barriers, velocity caps, and more. Beverages will be available at a cash bar.

## **Wednesday, May 7, 2003**

8:15 – 8:20

### **Opening Remarks**

*Scott Minamyer, U.S. EPA Office of Research and Development*

### **Session D-1: Screening and Other Fish Diversion/Deterrent Technologies**

*Moderator: Rob Gross, DOE, National Energy Technology Laboratory*

8:20 – 8:40

**Fish Return System Efficacy and Monitoring Studies for JEA's Northside Generating Station**  
Isabel C. Johnson, Golder Associates, Inc.

8:40 – 9:00

**Effectiveness, Operation and Maintenance, and Costs of a Barrier Net System for Impingement Reduction at the Chalk Point Generating Station**  
David Bailey, Mirant Mid-Atlantic

9:00 – 9:20

**Reductions in Impingement Mortality Resulting from Enhancements to Ristroph Traveling Screens at an Estuarine Cooling Water Intake Structure,**  
Kenneth Strait, PSEG Services Corporation

9:20 – 9:30

**Q&A for Session D-1**

9:30 – 10:00

BREAK

### **Session D-2: Screening and Other Fish Diversion/Deterrent Technologies (cont'd)**

*Moderator: Lisa Kline, Atlantic States Marine Fisheries Commission*

10:00 – 10:20

**Development and Operation of Acoustic Fish Deterrent Systems at Estuarine Power Stations**  
Andy Turnpenny and Jeremy Nedwell, Fish Guidance Systems, Ltd.

10:20 – 10:40

**Induced Sweeping Flows at CWIS for Reducing Fish Impingement**  
Charles C. Coutant, Oak Ridge National Laboratory

10:40 – 11:00

**The Use of Angled Bar Racks and Louvers for Protecting Fish at Water Intakes** Stephen Amaral,  
Alden Research Laboratory, Inc.

11:00 – 11:20

**A Review of Impingement Survival Studies at Steam-Electric Power Stations**  
Steven Jinks, ASA Analysis & Communications, Inc.

11:20 – 11:30

**Q&A for Session D-2**

11:30 – 1:00

LUNCH (on your own)

### **Session D-3: Screening and Other Fish Diversion/Deterrent Technologies (cont'd)**

*Moderator: Kent Zammit, Electric Power Research Institute*

1:00 – 1:20

**Optimal Slot-Width Selection for Wedgewire Screens**  
William Dey, ASA Analysis & Communications

1:20 – 1:40

**Development of Filter Fabric Technology to Reduce Aquatic Impacts at Water Intake Structures**  
Matthew J. Raffenberg, Lawler, Matusky and Skelly Engineers, LLP

1:40 – 2:00

**Vulnerability of Biofouling of Filter Curtain Materials Used for Entrainment Reduction**  
Peter Henderson, Pisces Conservation Ltd. & University of Oxford and Richard Seaby, Pisces Conservation, Ltd.

2:00 – 2:20	<b>Laboratory Evaluation of Wedgewire Screens for Protecting Fish at Cooling Water Intakes</b> Stephen Amaral, Alden Research Laboratory, Inc.
2:20 – 2:40	<b>Selection and Design of Wedgewire Screens and a Fixed-Panel Aquatic Filter Barrier System to Reduce Impingement and Entrainment at a Cooling Water Intake Structure on the Hudson River</b> Mark Strickland, PSEG Service Corporation, and James E. Mudge, Ph.D., Civil and Environmental Consultants, Inc.
2:40 – 2:50	<b>Q&amp;A for Session D-3</b>
2:50 – 3:15	BREAK
3:15 – 4:15	<b>Open Discussion: Identify Research Needs</b> Facilitated by Jim Elder
4:15 – 4:30	<b>Wrap-up and Summary</b>
4:30 pm	<b>Closing Remarks and Adjourn</b> Scott Minamyer, U.S. EPA Office of Research and Development

## I. Opening Remarks

*Scott Minamy, Environmental Scientist, U.S. EPA, Office of Research and Development*

Mr. Minamy, chair of the Planning Committee for the symposium, welcomed the attendees and set the stage for the 2-day gathering by providing a brief overview of the agenda and goals of the symposium. He then introduced the keynote speakers.

## II. Keynote Addresses

*Benjamin Grumbles, Deputy Assistant Administrator, U.S. EPA Office of Water*

### **BIOSKETCH**

Mr. Benjamin H. Grumbles was appointed Deputy Assistant Administrator for the Office of Water at U.S. EPA in February of 2002. Before coming to EPA, Mr. Grumbles was Deputy Chief of Staff and Environmental Counsel for the House Science Committee since February 2001. Prior to that, he was Senior Counsel for the Water Resources and Environment Subcommittee of the Transportation and Infrastructure Committee. During his 15 years of service on the Transportation and Infrastructure Committee staff, Ben focused on programs and activities of the Environmental Protection Agency, the Army Corps of Engineers, the National Oceanic and Atmospheric Administration, the U.S. Department of Transportation, the Federal Emergency Management Agency, and the Tennessee Valley Authority. He is also an adjunct professor of law at the George Washington University Law School, as well as a member of the faculty advisory board of the Environmental Law and Policy Program at the USDA/Graduate School. He currently teaches courses in water pollution control, the Clean Water Act, and environmental policy. Mr. Grumbles has written numerous articles on water quality, wetlands, water resources management, oil spills, hazardous waste, and environmental policy. His degrees include a B.A., Wake Forest University; J.D., Emory University; and LL.M. in Environmental Law, the George Washington University Law School.

### **PRESENTATION**

Mr. Grumbles opened his remarks by noting that on the 30th anniversary of the Clean Water Act (CWA), President Bush signed a proclamation making this the year of clean water and called water quality/quantity the “key” environmental issue of the 21st century. Mr. Grumbles then gave an overview of EPA activities relative to the CWA. He indicated that there was much optimism at the Agency about using a watershed-based approach to achieving water quality goals. He challenged the group to address future issues, such as the use of degraded water sources in cooling, desalination in conjunction with power production, and advanced cooling technologies such as dry cooling.

---

*Alex Matthiessen, Executive Director, Riverkeeper, Inc.*

### **Biosketch**

Mr. Alex Matthiessen is the River’s most visible and aggressive advocate. With the help of a team of attorneys and the Pace Environmental Litigation Clinic, he investigates potential threats to the watershed and enforces environmental law in order to safeguard the Hudson River valley and the New York City drinking water supply.

Mr. Matthiessen came to Riverkeeper in 2000 from the U.S. Department of Interior, where he served as Special Assistant to the Deputy Secretary on matters of special importance to Secretary Bruce Babbitt. Mr. Matthiessen’s primary responsibility was overseeing a government-wide task force to reform the Federal Energy Regulatory Commission’s hydropower licensing process. While at the Department of the Interior, Mr. Matthiessen also conceived and developed the Green Energy Parks initiative, a joint program of the National Parks Service and the Department of Energy, which promotes clean and sustainable energy use throughout the national park system. For his leadership on the project, Mr. Matthiessen received a Presidential Award from the White House. Prior to joining the Department of the Interior, Mr. Matthiessen spent a year in Indonesia as a Macroeconomic Policy Analyst for the

Harvard Institute for International Development and a summer working at the White House Council on Environmental Quality. In a stint as an independent environmental consultant, Mr. Matthiessen wrote foundation grants and authored papers on the potential social and environmental impacts of international trade liberalization. Earlier in his career, he served as the Grassroots Program Director for the Rainforest Action Network in San Francisco, organizing and managing an international network of affiliate activist groups.

Mr. Matthiessen earned a Masters of Public Administration from the John F. Kennedy School of Government at Harvard University in 1995 and a Bachelor of Arts, with degrees in Biology and Environmental Studies, from the University of California at Santa Cruz in 1988.

#### **PRESENTATION**

Mr. Matthiessen presented a brief overview and history of Riverkeeper, Inc., and noted some of the milestones in the organization's efforts to protect the Hudson River, beginning with the group's first victory — stopping the Storm King pump storage facility. He explained that Riverkeeper favors the following flow reduction technologies: dry cooling at new facilities, retrofit wet cooling at existing facilities, repowering, use of degraded water sources, and seasonal flow reductions. The organization prefers not to promote the use of screening technologies because of maintenance and operational issues that can cause degradation of performance. He also referred to PSE & G's permit for its Bethlehem facility, where cooperation led to a success story: Air pollution and fish impacts will be reduced by more than 98 percent. Riverkeeper is also working with Mirant at Lovett on the evaluation of Gunderboom over the next 5 years.

---

*Charles Goodman, Senior Vice President, Research and Environmental Affairs, Southern Company*

#### **BIOSKETCH**

Dr. Charles Goodman is the Senior Vice President of Research and Environmental Affairs for Southern Company, one of the largest generators of electricity in the United States, serving more than four million customers in the southeastern U.S.

Dr. Goodman joined Southern Company in 1971. He received his B.S. in Mechanical Engineering from the University of Texas at Arlington and his M.S. and Ph.D. degrees in Mechanical Engineering from Tulane University. Dr. Goodman directs the environmental policy, research, and the compliance strategy development program of Southern Company. Reporting to Dr. Goodman are the Environmental Stewardship, Customer Technologies, Power Technologies, Economic Analysis, Environmental Assessment, and the Environmental Compliance Strategies and Permitting departments. Dr. Goodman is a member of the U.S. Environmental Protection Agency Clean Air Act Advisory Committee. He is also a member of Electric Power Research Institute's Research Advisory Committee and chairman of the EPRI Environment Sector Council. In his current role, he is the lead officer for Southern Company's environmental policy, and he oversees the company's research and environmental affairs activities.

#### **PRESENTATION**

Mr. Goodman opened his address by indicating that he felt a need to find a balance between effectiveness and cost as they pertain to the protection of aquatic life from intake structures. He pointed out the work that EPRI and the industry overall have already done to address Section 316(b) of the Clean Water Act. The best solutions consider site-specific issues. Some 316(b) alternatives are associated with other environmental impacts, such as those associated with wet cooling. Goodman emphasized that a single, "one size fits all" solution is not the optimum one, but rather one that maximizes net benefits.

### III. Overview Presentations

#### *An Overview of Fish Protection Technologies and Cooling Water Intake Structures (CWISs)*

*Edward Taft and Thomas Cook, Alden Research Laboratory, Inc.*

#### **BIOSKETCHES**

Mr. Ned Taft is President of Alden Research Laboratory. He received his B.S. in Biology from Brown University and his M.S. in Biology from Northeastern University. In addition to his role as President, Mr. Taft is responsible for Alden's environmental services. He has over 30 years experience in developing and testing fish protection technologies for both cooling water and hydroelectric project intakes. He is currently heading the 316(b) team at Alden.

Mr. Thomas Cook is Director of Environmental Engineering at Alden Research Laboratory. Mr. Cook received his B.S. in Civil Engineering from the University of Vermont. He is responsible for conceptual and detailed design engineering efforts related to fish protection and passage at steam electric, hydroelectric, and water resource projects. He specializes in economic analyses of alternative fish protection and provides the hydraulic, hydrologic, and structural expertise necessary for their installation.

#### **TECHNICAL PAPER**

##### **Abstract**

There are several technology options available for the protection of aquatic organisms at Cooling Water Intake Structures (CWISs). These technologies, used alone or in some combination, have the potential to meet EPA's proposed national performance standards. The ability of a technology to meet the standard at any given site is dictated by species and site-specific factors. The costs of these technologies also vary widely between sites.

##### **Introduction**

The United States Environmental Protection Agency's (EPA) proposed Phase II Existing Facilities Rule (the Rule) (EPA 2002) requires a thorough understanding of fish protection technologies that can be considered for potential use at CWISs to address concerns over fish entrainment and impingement. For over thirty years, industry groups and government agencies have been working to develop both biologically and cost-effective technologies. These efforts have led to the development of a suite of technologies that address a wide array of biological, environmental, and engineering characteristics associated with different target species, water body types (e.g., rivers, lakes, estuaries), and physical locations (e.g., offshore, onshore, in-river). Research continues on new technologies, as well as on modifications to, and enhancements of, existing technologies. Costs associated with intake technologies vary not only by flow rate, but by other site-specific factors.

Emphasis in this discussion is on those technologies for which EPA developed costs in either the proposed Rule or the Notice of Data Availability (NODA) (EPA 2003). For each technology, the following information is presented:

- (1) a general description of the technology;
- (2) the current status of available technologies and results of research to date;
- (3) the potential for available technologies to meet the proposed national performance standards (reduction in impingement mortality of 80 to 95% and a reduction in entrainment of 60 to 90%); and
- (4) the costs associated with retrofitting the technology to an existing intake.

The costs include a comparison between the site-specific costs generated from historical data and those presented by EPA in the Rule and the NODA. The site- and species-specific factors that impact a technology's ability to meet the performance standards are highlighted.

**Overview of Intake Technologies**

Depending on their mode of action, available fish protection systems fall into one of four categories: physical barriers, which physically block fish passage; collection systems, which actively collect fish for their return to a safe release location; diversion systems, which divert fish to bypasses for return to a safe release location; and behavioral barriers, which alter or take advantage of natural behavior patterns to attract or repel fish (Table 1). A review of the biological effectiveness, engineering practicability, and costs of these systems and devices is presented in detail in three Electric Power Research Institute (EPRI) reports prepared in 1986, 1994, and 1999 (EPRI 1986, 1994b, 1999).

Extensive research has been conducted since the early 1970s in an attempt to develop technologies that will minimize entrainment and impingement at CWISs. An additional 25 years of research has been conducted at other water withdrawals (e.g., hydroelectric dams). As a result, a suite of technologies is available that can be considered for application at CWISs. The ability of a given technology to meet the national performance standards is influenced by a wide variety of biological, environmental, and engineering factors that must be evaluated on a site-specific basis. Below is a discussion of those technologies that show the greatest potential for wide-scale applicability in meeting the national performance standards. It should be noted that other technologies may be highly effective under certain conditions and with certain species. However, in this discussion, emphasis is placed on those technologies that have been most studied for use at CWIS. Inclusion or omission is not meant to be an endorsement or condemnation of specific technologies.

**Table 1.** Fish Protection Technologies by Category and Their Mode of Action

<b>Technology Category</b>	<b>Mode of Action</b>	<b>System/Technology</b>
Physical Barriers	Physically block fish passage (usually in combination with low water velocity)	Traveling screens Stationary screens Drum screens Cylindrical wedge wire screens Barrier nets Aquatic filter barrier Porous dikes Radial wells Artificial filter beds Rotary disk screens
Collection Systems	Actively or passively collect fish for transport through a return system	Modified traveling screens Fish pumps
Diversion Systems	Divert fish to a return system or safe area	Angled screens Modular Inclined Screen Eicher Screen Angled rotary drum screens Louvers/angled bar racks Inclined plane screens Vertical/horizontal traveling screens
Behavioral Deterrent Technologies	Alter or take advantage of natural behavior patterns to repel or attract fish	Strobe light Mercury light Other light sources Acoustic systems Infrasound Air bubble curtains Hybrid systems Other behavioral technologies

**Physical Barriers**

Traveling Screens (Through flow, Dual flow, Center flow, Drum, etc).

The traveling water screen is a standard feature at most CWISs. The ability of traveling screens to act as a barrier to fish while, not resulting in impingement, is dependent on many site-specific factors such as size of the fish, flow



velocity, location of screens, and presence of escape routes. As barrier devices, traveling screens cannot be considered for protection of early life stages or aquatic organisms that have little or no motility. Since EPA defines the baseline as the impingement mortality and entrainment that would occur with a shoreline intake and no fish protection, a traditional traveling screen can not meet the impingement mortality standard. However, depending upon the species present in the vicinity of a CWIS, a traditional traveling screen coupled with a fish return trough can result in high extended survival (e.g., Oyster Creek and Roseton before the installation of Ristroph screens [Thomas and Miller 1976; LMS 1991]).

#### Cylindrical Wedge Wire Screens

Wedge wire screens have the potential to reduce both entrainment and impingement at water intakes. In order to effectively reduce impingement and entrainment, the following conditions must exist:

- sufficiently small screen slot size to physically block passage of the smallest life stage to be protected (typically 0.5 to 1.0 mm for egg and larval life stages);
- low through-slot velocity (on the order of 0.5 to 1.0 ft/s); and
- an ambient current cross-flow to carry organisms and debris around and away from the screen);

To date, large-scale CWIS applications of wedge wire screens have been limited to two plants (J.H. Campbell, Unit 3 and Eddystone Station) where relatively large slot openings have been used (i.e., they have not been targeted specifically to prevent entrainment of early life stages). These screens have been biologically effective in preventing impingement of larger fish and have not caused unusual maintenance problems.

Under a grant from the U. S. Environmental Protection Agency (EPA), EPRI sponsored laboratory evaluations of wedge wire screens with eggs and/or larvae of nine fish species commonly entrained at CWISs (EPRI 2003). General entrainment and impingement trends observed in the data collected included: 1) impingement decreased with increases in slot size; 2) entrainment increased with increases in slot size; 3) entrainment and impingement increased with increases in through-slot velocities; 4) entrainment and impingement decreased with increases in channel velocity, and 5) within a species, larval fish length did not appear to be a factor, although the lengths of most species evaluated were within a narrow size range.

Wedge wire screens can be generally considered for application at CWIS. Since the only two large CWISs to employ wedge wire screens to date use 6.4 and 10.0 mm slot openings, the potential for clogging and fouling with slot sizes as small as 0.5 to 1.0 mm (as would be required for protection of many entrainable life stages) is unknown. A follow-up EPRI study is being conducted in 2004 to test a pilot scale wedge wire screen under a variety of operating conditions and in several water body types with local fish populations. In general, consideration of wedge wire screens with small slot dimensions for application at a given CWIS should include *in situ* pilot studies to determine potential biological effectiveness and identify the ability to control clogging and fouling in a way that does not impact station operation. As the information database on biological and engineering effectiveness in different water bodies grows, the future need for such such studies will diminish.

#### Aquatic Filter Barrier (AFB)

The aquatic filter barrier (AFB) is a relatively recent technology designed to protect all life stages of fish at water intakes. As a result, there are limited data available on its deployment for this purpose. The AFB consists of polyester fiber strands that are pressed into a water-permeable fabric mat. Beginning in 1995, Mirant, New York, LLC has sponsored an evaluation of the AFB to determine its ability to minimize ichthyoplankton entrainment at the Lovett Generating Station on the Hudson River (ASA 1999, 2001). Despite difficulties in keeping the boom deployed and providing adequate cleaning in the 1995-1997 studies, results of studies in 1998 showed a large reduction in entrainment. It appears that most of the AFB deployment and cleaning problems may have been resolved for this site. Results analyzing the rate of ichthyoplankton entrainment between two side-by-side water intakes (one protected by an AFB and the other unprotected) have shown the potential biological effectiveness of this technology (ASA 1999, 2001).

Laboratory studies on retention and survival of the early lifestages of five species of fish exposed to aquatic filter barrier fabric were conducted in 2002 (Black et al., in press). Results of testing with three perforation sizes (0.5, 1.0, and 1.5 mm) and two flow rates (10 gpm/ft<sup>2</sup> and 20 gpm/ft<sup>2</sup>) indicate that, in general, survival of organisms was not significantly correlated to either flow rate or perforation size. Retention (the inverse of entrainment) of organisms, however, appeared to decrease significantly with increasing flow rate for one species of fish (rainbow smelt). In addition, increasing perforation sizes decreased retention of three species of fish tested (common carp, rainbow smelt, and striped bass), which potentially limits the effectiveness of larger perforation sizes in protecting the earliest lifestages of these species.

At this time, we consider the AFB system to be experimental despite its high potential for effectively reducing entrainment and impingement. However, continued improvements in anchoring and cleaning systems make the AFB a technology to be considered when evaluating fish protection alternatives.

### Barrier Nets

Under the proper hydraulic conditions (primarily low velocity) and without heavy debris loading, barrier nets have been effective in blocking fish passage into water intakes. There have been several recent applications of barrier nets in the Midwest (Michaud and Taft 1999). At the Ludington Pumped Storage Plant on Lake Michigan, a 2.5-mile long barrier net, set in open water around the intake jetties, has been successful in reducing entrainment of all fish species occurring in the vicinity of the intake (Reider et al. 1997). The net was first deployed in 1989 and modifications to the design in subsequent years have led to a net effectiveness for target species (five salmonid species, yellow perch, rainbow smelt, alewife, and chub) of over 80% since 1991, with an overall effectiveness of 96% in 1995 and 1996.

In 1993 and 1994, Orange and Rockland Utilities, Inc. sponsored a study of a 3.0-mm, fine mesh net at its Bowline Point Generating Station on the Hudson River (LMS 1996). In 1993, clogging with fine suspended silt caused the net to clog and sink. In 1994, spraying was not effective in cleaning the net when it became fouled by the algae *Ectocarpus*. Excessive fouling caused two of the support piles to snap, ending the evaluation (LMS 1996). In both years, abundance of the target ichthyoplankton species, bay anchovy, was too low to determine the biological effectiveness of the net. On the basis of studies to date, the researchers concluded that a fine mesh net may be a potentially effective method for preventing entrainment at Bowline Point (LMS 1996). However, pending further evaluation, this concept is considered to be experimental.

In conclusion, barrier nets can be considered a viable option for protecting fish provided that relatively low velocities (generally  $\leq 1.0$  ft/sec) can be achieved and debris loading is light. A thorough evaluation of site-specific environmental and operational conditions is generally recommended. At this time, barrier nets can only be considered for reducing impingement of larger fish at CWISs.

## **Fish Collection Systems**

### Modified Traveling Water Screens

Conventional traveling water screens have been altered to incorporate modifications that improve survival of impinged fish. Such state-of-the-art modifications minimize fish mortality associated with screen impingement and spraywash removal. Screens modified in this manner are commonly called "Ristroph screens." Each screen basket is equipped with a water filled lifting bucket that safely contains collected organisms as they are carried upward with the rotation of the screen. The screens typically operate continuously to minimize impingement time. As each bucket passes over the top of the screen, fish are rinsed into a collection trough by a low pressure spraywash system. Once collected, the fish are transported back to a safe release location. Such features have been incorporated into through flow, dual flow, and center flow screens.

Ristroph screens have been shown to improve fish survival and have been installed and evaluated at a number of power plants. Improvements to the Ristroph screen design, made in the late-1980s and early-1990s, have resulted in increased fish survival. The most important advancement in state-of-the-art Ristroph screen design was developed through extensive laboratory and field experimentation. A series of studies conducted by Fletcher (1990) indicated

that substantial injury associated with these traveling screens was due to repeated buffeting of fish inside the lifting buckets as a result of undesirable hydraulic conditions. To eliminate these conditions, a number of alternative bucket configurations were developed to create a sheltered area in which fish could safely reside during screen rotation. After several attempts, a bucket configuration was developed that achieved the desired conditions (Envirex 1996). In 1995, Public Service Electric and Gas (PSE&G) performed a biological evaluation of the improved screening system installed at the Salem Generating Station in the Delaware River (Heimbuch 1999; Ronafalvy 1999). The reported survival rates for this installation are among the highest for any traveling screen system (Heimbuch 1999).

Modified traveling water screens continue to be an available technology that can reduce fish losses due to impingement. Unless modified to incorporate fine mesh, as discussed below, these screens do not reduce entrainment losses.

#### Fine Mesh Traveling Screens

In addition to the fish handling provisions noted above, traveling water screens have been further modified to incorporate screen mesh with openings as small as 0.5 mm to collect fish eggs and larvae and return them to the source water body. For many species and early life stages, mesh sizes of 0.5 to 1.0 mm are required for effective screening. Various types of traveling screens, such as through flow, dual flow, and center flow screens, can be fitted with fine mesh screen material.

Because collection systems, such as fine mesh screens, physically handle organisms, some mortality of organisms is inevitable. The likelihood of an organism surviving impingement on screens is species- and life stage-specific, with heartier organisms experiencing higher survival. As currently written, the proposed Rule does not address the fate of organisms prevented from being entrained. However, the final Rule may require a reduction in entrainment *mortality* rather than a simple reduction in entrainment. Such a requirement would have a very different implication in terms of the ability of fine-mesh screens to meet the performance standard.

A number of fine mesh screen installations have been evaluated for biological effectiveness. Results of these studies indicate that survival is highly species- and life stage-specific. Species such as bay anchovy and *Alosa* spp. have shown low survival while other species, such as striped bass, white perch, yellow perch, and invertebrates have shown moderate to high survival. If entrainment survival is a consideration, evaluating fine mesh screens for potential application at CWISs requires careful review of all available data on the survival potential of the species and life stages to be protected, as well as non-target species.

In addition to these field applications, survival data on a variety of species and life stages following impingement on fine-mesh screens is available from extensive laboratory studies. In these studies, larval life stages of striped bass, winter flounder, alewife, yellow perch, walleye, channel catfish, and bluegill were impinged on a 0.5 mm screen mesh at velocities ranging from 0.5 to 3.0 ft/sec and for durations of 2, 4, 8 or 16 minutes. As in the field evaluations, survival was variable between species, larval stages, and impingement duration and velocity (ESSERCO 1981).

The primary concern with fine mesh screens is that they function by impinging early organism life stages that are entrained through coarse mesh screens. Depending on species and life stage, mortality from impingement can exceed entrainment mortality. In order for fine mesh screens to provide a meaningful benefit in protecting fish, impingement survival of target species and life stages must be substantially greater than survival through the circulating water system.

#### **Fish Diversion Systems**

##### Angled Screens

A variety of species have been shown to be effectively guided on screens given suitable hydraulic conditions. Angled screens require uniform flow conditions, a fairly constant approach velocity, and a low through-screen velocity to be biologically effective. Angled screen systems have been installed and biologically evaluated at a number of CWISs on a prototype and full-scale basis. Angled screen diversion efficiency varies by species, but is generally relatively

high for most species evaluated. Survival following diversion and pumping (as required to return fish to their natural environment) has been more variable. Overall survival rates of relatively fragile species following diversion can be low. Heartier species exhibit higher survival rates resulting in overall system efficiency values (diversion and survival) ranging from 50 to nearly 100%.

In addition to the CWIS applications, angled fish diversion screens leading to bypass and return pipelines are being used extensively for guiding salmonids in the Pacific Northwest. These screens are mostly of the rotary drum or vertical, flat panel (non-moving) types and have provided effective downstream protection for juvenile salmonids at several diversion projects in the Pacific Northwest (Neitzel et al. 1991; EPRI 1998). Like other angled screens, suitable hydraulic conditions at the screen face and a safe bypass system are required for the screens to effectively protect fish from entrainment and impingement and to divert them to a bypass for return to the source water body (Pearce and Lee 1991).

Angled screens can be considered a viable option for protecting juvenile and adult life stages provided that proper hydraulic conditions can be maintained and that debris can be effectively removed. To date, all angled screen applications at cooling water intakes have involved the use of conventional traveling water screens modified to provide a flush surface on which fish can guide to a bypass. Fish eggs, larvae, and small invertebrates would not be protected by angled screens unless fine mesh screening was used.

#### Modular Inclined Screens

The Modular Inclined Screen (MIS) has recently been developed and tested by the Electric Power Research Institute (EPRI 1994; EPRI 1996; Taft et al. 1997). The MIS is intended to protect juvenile and adult life stages of fish at all types of water intakes. An MIS module consists of an entrance with trash racks, dewatering stop logs in slots, an inclined screen set at a shallow angle to the flow (10 to 20 degrees), and a bypass for directing diverted fish to a transport pipe. The module is completely enclosed and is designed to operate at relatively high water velocities ranging from 2 to 10 ft/sec, depending on the species and life stages to be protected.

The MIS was evaluated in laboratory studies to determine the design configuration which yielded the best hydraulic conditions for safe fish passage, and the biological effectiveness of the optimal design in diverting selected fish species to a bypass (EPRI 1994). Biological tests were conducted in a large flume with juvenile walleye, bluegill, channel catfish, American shad, blueback herring, golden shiner, rainbow trout (two size classes), brown trout, chinook salmon, coho salmon, and Atlantic salmon. Screen effectiveness (diversion efficiency and latent mortality) was evaluated at water velocities ranging from 2 ft/sec to 10 ft/sec. Diversion rates approached 100% for all species except American shad and blueback herring at water velocities up to at least 6 ft/sec. Generally, latent mortality of test fish that was adjusted for control mortality was low (0 to 5%).

Based on the laboratory results, a pilot scale evaluation of the MIS was conducted at Niagara Mohawk Power Corporation's Green Island Hydroelectric Project on the Hudson River near Albany, NY (EPRI 1996). The results obtained in this field evaluation with rainbow trout, largemouth and smallmouth bass, yellow perch, bluegill, and golden shiners were similar to those obtained in laboratory studies (Taft et al. 1997).

The combined results of laboratory and field evaluations of the MIS have demonstrated that this screen is an effective fish diversion device that has the potential for protecting fish at water intakes. Studies to date have only evaluated possible application at hydroelectric projects. Further, no full-scale MIS facility has been constructed and evaluated. As a result, the potential for effective use at CWISs is unknown. Any consideration of the MIS for CWIS application should be based on future large-scale, prototype evaluations.

#### Louvers

A louver system consists of an array of evenly spaced, vertical slats aligned across a channel at a specified angle and leading to a bypass. Bar racks can also be angled to act as louvers. Results of louver studies to date have varied by species and site. Most of the louver installations in the U.S. are in the Pacific Northwest at water supply intakes. Louvers generally are not considered acceptable by the fishery resource agencies in that region since they do not meet

the current 100% effectiveness criterion. However, numerous studies have demonstrated that louvers can be on the order of 70 to 95% effective in diverting a wide variety of species over a wide range of conditions (EPRI 1986; Stira and Robinson 1997).

Until recently, the effectiveness of diversion devices for non-anadromous fish has been largely unknown. Recent studies by the Electric Power Research Institute (EPRI) evaluated the potential for 15 and 45 degree louvers for guiding river species (smallmouth bass, largemouth bass, walleye, channel catfish, and golden shiner) and others (lake sturgeon, shortnose sturgeon, and American eel) (EPRI 2001, Amaral et al., 2002). Results indicate that 15 degree structures have considerable potential for guiding fish to a bypass.

Most of the louver applications to date have been with migratory species in river environments. The ability of louvers to protect species commonly impinged at CWISs is largely unknown because there have been so few louvers installed at CWISs. A system of guiding vanes and louvers has been installed at San Onofre Nuclear Generating Station (SONGS) to direct fish away from the traveling screens into a collection area. Biological effectiveness of these louvers is unknown.

Due to the large spacing of the louver slats, louver systems do not protect early life stages of fish. Future consideration of louver systems for protecting fish at cooling water intakes is warranted but will require large-scale evaluations.

## **Behavioral Barriers**

### Strobe Lights

The use of strobe lights to elicit a behavioral response is supported by the results of laboratory and cage test studies that have demonstrated strong avoidance by several fish species. Strobe has been evaluated for repelling or guiding fish away from water intakes and, in many cases, towards bypasses for transport to a safe release location (EPRI 1994, 1999). Early studies with light examined the response of salmonids to both flashing and continuous sources (Brett and MacKinnon 1953; Craddock 1956). The results from these studies indicated that flashing light produced stronger avoidance reactions than continuous light and that responses appeared to be affected by species tested, developmental stage (i.e., age or size of fish), and adaptation light level (Feist and Anderson 1991). More recent studies with salmonids have corroborated these findings (Puckett and Anderson 1987; EPRI 1990; Nemeth and Anderson 1992).

Research examining the potential for strobe light to be used as a fish deterrent expanded considerably in the 1980s, including laboratory studies with anadromous salmonids and *Alosa* species, several riverine and estuarine species, and the catadromous American eel. These studies involved both controlled experiments (laboratory and cage tests) and field studies. Extensive research with strobe lights has continued in the 1990s, including laboratory and/or cage test evaluations with Pacific salmon, American eel, and several freshwater species, open water tests with kokanee salmon, and field tests with freshwater species and Atlantic salmon.

Although many studies have evaluated strobe lights as a primary barrier system, strobes are often evaluated as part of an integrated fish protection and passage system that includes other devices such as screens, narrow-spaced bar racks, bypasses, and/or other behavioral systems (EPRI 1994, 1999). As a secondary system, strobe lights have the potential to incrementally increase fish protection effectiveness.

### Air Bubble Curtains

These curtains generally have been ineffective in blocking or diverting fish in a variety of field applications. Air bubble curtains have been evaluated at number of sites on the Great Lakes with a variety of species. All air bubble curtains at these sites have been removed from service. Recently, however, their use in combination with sound has shown promise in diverting salmon smolts to a bypass at a European power facility (Welton et al. 2003).

## Sound

The focus of recent fish protection studies involving underwater sound technologies has been on the use of new types of low and high frequency acoustic systems that have not previously been available for commercial use. High frequency (120 kHz) sound has been shown to effectively and repeatedly repel members of the Genus *Alosa* (American shad, alewife and blueback herring) at sites throughout the U. S. (Ploskey et al. 1995; Dunning 1995; Consolidated Edison 1994). Other studies have not shown sound to be consistently effective in repelling species such as largemouth bass, smallmouth bass, yellow perch, walleye, rainbow trout (EPRI 1998), gizzard shad, Atlantic herring, and bay anchovy (Consolidated Edison 1994).

Given the species-specific responses to different frequencies that have been evaluated and the variable results that often have been produced, additional research is warranted at any sites where there is little or no data to indicate that the species of concern may respond to sound.

## **Costs**

There is a variety of factors that influence the cost of retrofitting a given technology to an existing intake. Broadly speaking, those factors can be divided into six categories:

- Biology
- Hydraulic / hydrodynamic
- Fouling
- Geotechnical
- Navigation and space requirements
- Climate

For example, the species present near the intake can influence the design of a modified traveling screen retrofit. If the species present are relatively fragile, then the velocity approaching the screens may have to be reduced. One method for reducing the velocity is to expand the intake. Expansion of the intake to reduce the through-screen velocity would require more civil/structural construction, a greater number of screens, and more pumps and piping for the screenwash systems. The additional hardware and construction activities will increase the overall cost for retrofit. In this example, biology clearly plays a role in impacting the costs.

For example, with modified traveling water screens, the relative hardness of the organisms could affect the cost of their installation. If the most frequently impinged organisms are fragile, reduction in through-screen velocity may increase post-impingement survival. One method for reducing through-screen velocity is to expand the intake and add more traveling screens. Such an expansion would require more civil/structural modifications and a greater number of screens and screen wash systems. In this example, the biology of the organisms to be protected can substantially impact the overall cost of the technology retrofit.

Alden Research Laboratory, Inc. (Alden) maintains a database of project conceptual design costs for over 35 plants. Costs in Alden's database typically reflect the following assumptions:

- ▶ 2002 prices and fully contracted labor rates;
- ▶ Forty-hour workweek with single shift operation for construction activities that do not impact facility operations;
- ▶ fifty-hour workweek with double shift operation for construction activities that impact facility operations;
- ▶ Direct costs for material and labor required for construction of all project features;
- ▶ Distributable costs for site non-manual supervision, temporary facilities, equipment rental, and support services incurred during construction. These costs are estimated to be 85-100% of the labor portion of the direct costs for each alternative;
- ▶ Indirect costs for labor and related expenses for engineering services to prepare drawings, specifications, and design documents. The indirect costs are estimated to be 10% of the direct costs for each alternative;
- ▶ Allowance for indeterminates to cover uncertainties in design and construction at this preliminary stage of study. An allowance for indeterminates is a judgment factor that is added to estimated figures to complete the

final cost estimate, while still allowing for other uncertainties in the data used in developing these estimates. The allowance for indeterminates is estimated to be 10% of the direct, distributable, and indirect costs of each alternative; and

- ▶ Contingency factor to account for possible additional costs that might develop but cannot be predetermined (e.g., labor difficulties, delivery delays, weather). The contingency factor is estimated to be 15% of the direct, distributable, indirect, and allowance for indeterminate costs of each concept.

The database costs typically do not include the following items that should be included to estimate total capital costs:

- ▶ Costs to perform additional pilot studies including laboratory or field studies that may be required;
- ▶ Costs to dispose of any hazardous or non-hazardous materials that may be encountered during excavation and dredging activities;
- ▶ Costs for administration of project contracts and for engineering and construction management incurred by plant owners;
- ▶ Escalation (increases in wages, materials, and other costs as a result of various economic factors); and
- ▶ Permitting costs.

For developing appraisal level estimates for a specific facility, database costs can be adjusted for identifiable differences in project size and operations. However, these estimates of costs should only be used to identify the relative cost differences between alternatives and the cost EPA estimated for a facility. More detailed cost estimates based on detailed quantity takeoffs would be required if a utility planned to apply one of these alternative technologies or for submittal with the Comprehensive Cost Evaluation Study as part of the Information to Support Site Specific Determination of BTA.

The range of capital costs by technology contained in the Alden database is provided in Table 2. Table 2 does not include lost generation or potential lost revenue associated with construction shutdowns and energy penalties, which all have to be added to the capital costs to determine the total cost of an alternative. Baseline O&M costs from Alden's database are presented in

Table 3. In Tables 2 and 3, the average cost per ft<sup>3</sup>/sec (cfs) of CWIS flow is a weighted average calculated by taking the total costs and dividing them by the total flow. For comparison purposes, EPA's annualized capital and O&M costs from Appendix A of the Rule are presented in Tables 5 and 6, respectively.

To assist facilities in understanding the costs EPA used in determining the national cost, EPA supplied two appendices with the Rule. Appendix A is the EPA cost for each facility identification number (ID) whose flow rate was not considered Confidential Business Information. Appendix B is a list of facilities with ID numbers. Table 4 and Table 5 present a summary of EPA's construction and O&M cost ranges for the data provided in Appendix A of the Rule. EPA's costs are driven largely by cost. In our experience, while flow is an important component of cost, it is not the sole driver. For example, Table 6 shows a comparison of retrofit costs associated with two hypothetical facilities in which the only substantial difference is the water body type. Facility A is on an estuary and is required to meet the entrainment reduction standard. In addition, existing entrainment data indicate that the numerically dominant species at this site is the bay anchovy, which has relatively small eggs (0.7 – 1.2 mm) and narrow-bodied larvae. To ensure that the eggs and larvae of this species are protected, the wedge wire screen installation will require 0.5 mm slots designed with a slot velocity of 0.5 ft/s. By contrast, Facility B is located on a fresh water river and withdraws less than 5% of the mean annual flow and therefore is not required to meet the entrainment reduction standard. Therefore, wedge wire with 9.5 mm (3/8 in.) slots can be used.

**Table 2:** Annualized Construction Cost Ranges for Fish Protection Technologies based upon Historic Data (Source: Alden Research Laboratory, Inc.)

Technology	Construction (\$) <sup>1</sup>			Construction (\$/cfs) <sup>1</sup>		
	Low	High	Weighted Average	Low	High	Weighted Average
Aquatic Filter Barrier	\$6,700,000	\$74,000,000	\$30,947,000	\$12,500	\$48,500	\$23,100
Bar Rack Barriers	\$100,000	\$7,910,000	\$2,633,000	\$300	\$7,600	\$2,100
Barrier Nets	\$40,000	\$14,000,000	\$1,310,000	\$100	\$6,000	\$800
Behavioral Barriers	\$330,000	\$17,000,000	\$2,955,000	\$100	\$8,200	\$1,200
Coarse Mesh Ristroph Screens	\$930,000	\$31,238,000	\$6,830,000	\$1,800	\$15,200	\$4,400
Fine Mesh Ristroph Screens	\$900,000	\$44,000,000	\$10,867,000	\$1,300	\$17,800	\$8,200
Fish Pump	\$100,000	\$100,000	\$100,000	\$100	\$100	\$100
Fixed Panel Screens	\$246,000	\$9,550,000	\$3,818,000	\$600	\$9,100	\$3,400
Modular Inclined Screen	\$1,620,000	\$22,091,000	\$8,124,000	\$2,200	\$12,200	\$4,000
Narrow Slot Wedge Wire	\$1,240,000	\$119,298,000	\$25,240,000	\$5,100	\$41,100	\$14,600
Velocity Cap	\$524,000	\$4,666,000	\$8,608,000	\$800	\$1,300	\$800
Wide Slot Wedge Wire	\$670,000	\$35,900,000	\$2,595,000	\$2,100	\$16,100	\$5,100

<sup>1)</sup> Construction costs rounded to the nearest \$100 and expressed in 2002 \$

**Table 3:** Annual O&M Cost Ranges for Fish Protection Technologies Based on Historic Data (Source: Alden Research Laboratory, Inc.)

Technology	O&M (\$) <sup>2</sup>			O&M (\$/cfs) <sup>3</sup>		
	Low	High	Weighted Average	Low	High	Weighted Average
Aquatic Filter Barrier	\$139,500	\$8,060,000	\$2,263,000	\$310	\$5,600	\$1,700
Bar Rack Barriers	\$19,000	\$153,000	\$89,000	\$40	\$200	\$70
Barrier Nets	\$10,000	\$613,000	\$135,000	\$10	\$410	\$90
Behavioral Barriers	\$10,000	\$676,000	\$180,000	\$10	\$330	\$70
Coarse Mesh Ristroph Screens	\$61,000	\$2,619,000	\$546,000	\$50	\$1,800	\$350
Fine Mesh Ristroph Screens	\$110,000	\$1,730,000	\$609,000	\$60	\$1,300	\$460
Fish Pump	\$83,000	\$83,000	\$83,000	\$80	\$80	\$80
Fixed Panel Screens	\$16,000	\$540,000	\$251,000	\$20	\$500	\$220
Modular Inclined Screen	\$22,000	\$382,000	\$71,000	\$10	\$100	\$40
Narrow Slot Wedge Wire	\$20,000	\$3,870,000	\$640,000	\$90	\$2,200	\$370
Velocity Cap	\$3,000	\$81,000	\$42,000	\$10	\$10	\$10
Wide Slot Wedge Wire	\$10,000	\$1,243,000	\$163,000	\$10	\$550	\$100

<sup>2)</sup> O&M costs rounded to the nearest \$1,000 and expressed in 2002 \$.

<sup>3)</sup> Rounded to the nearest \$100 and expressed in 2002 \$.



**Table 4:** EPA's Annualized Construction Cost Estimates based on Appendix A of the Rule

EPA Module	Construction (\$)⁴			Construction (\$/cfs)		
	Low	High	Average	Low	High	Weighted Average
1. Addition of fish handling and return system	\$26,000	\$11,094,300	\$1,952,700	\$300	\$43,600	\$2,300
2. Addition of fine mesh screens to an existing traveling screen system.	\$30,600	\$8,127,400	\$1,580,900	\$100	\$28,700	\$1,700
3. Addition of a new, larger intake with fine-mesh screens and fish handling and return system in front of existing screen.	\$2,706,300	\$39,708,800	\$12,067,500	\$7,900	\$34,300	\$11,800
4. Addition of passive fine-mesh screen system (cylindrical wedgewire) near shoreline with mesh width of 1.75 mm.	\$305,300	\$27,395,500	\$4,463,700	\$3,800	\$23,500	\$7,300
5. Addition of fish net barrier system.	\$10,800	\$929,800	\$147,300	\$0	\$500	\$100
6. Addition of an aquatic filter barrier system.	\$2,349,600	\$5,809,800	\$4,079,700	\$9,900	\$10,200	\$10,100
7. Relocation of existing intake to a submerged offshore location with passive fine-mesh screen inlet with mesh width of 1.75 mm	\$865,300	\$16,998,700	\$10,065,100	\$3,800	\$36,100	\$9,100
8. Addition of a velocity cap inlet to an existing offshore intake.	\$34,600	\$375,000	\$213,500	\$600	\$12,900	\$800
9. Addition of passive fine-mesh screen to an existing offshore intake with mesh width of 1.75 mm	\$987,100	\$106,025,000	\$26,675,500	\$5,400	\$24,400	\$16,400
11. Addition of a dual-entry, single-exit traveling screen (with fine mesh) to a shoreline intake system.	\$360,500	\$32,926,800	\$3,589,700	\$1,100	\$14,400	\$3,200
12. Addition of passive fine-mesh screen system (cylindrical wedgewire) near shoreline with mesh width of 0.76 mm	\$1,422,600	\$48,835,300	\$11,835,400	\$4,200	\$12,800	\$7,500
13. Addition of a passive fine mesh screen to an existing offshore intake with a mesh width of 0.76 mm	\$848,600	\$6,614,100	\$2,815,700	\$3,600	\$15,900	\$11,500
14. Relocation of an existing intake to a submerged offshore location with passive fine-mesh screen inlet with mesh of 0.76 mm.	\$9,461,500	\$42,822,200	\$26,141,900	\$10,400	\$25,200	\$20,100

⁴) Costs rounded to the nearest \$100 and expressed in 2002 \$.

**Table 5:** EPA's Annualized O&M Cost Estimates based on Appendix A of the Rule

EPA Module	Construction (\$) <sup>5</sup>			Construction (\$/cfs)		Weighted Average
	Low	High	Average	Low	High	
1. Addition of fish handling and return system	\$16,000	\$1,533,600	\$320,600	\$200	\$11,800	\$400
2. Addition of fine mesh screens to an existing traveling screen system.	\$48,600	\$3,318,600	\$415,500	\$0	\$7,200	\$400
3. Addition of a new, larger intake with fine-mesh screens and fish handling and return system in front of existing screen.	\$26,200	\$678,800	\$180,500	\$1,200	\$5,100	\$200
4. Addition of passive fine-mesh screen system (cylindrical wedgewire) near shoreline with mesh width of 1.75 mm.	\$17,200	\$603,300	\$87,500	\$600	\$3,600	\$100
5. Addition of fish net barrier system.	\$13,800	\$269,100	\$59,400	\$0	\$300	\$0
6. Addition of an aquatic filter barrier system.	\$242,600	\$431,100	\$336,800	\$2,200	\$2,400	\$800
7. Relocation of existing intake to a submerged offshore location with passive fine-mesh screen inlet with mesh width of 1.75 mm	\$22,000	\$398,500	\$134,900	\$500	\$5,200	\$100
8. Addition of a velocity cap inlet to an existing offshore intake.	\$4,700	\$10,700	\$8,400	\$100	\$3,600	\$0
9. Addition of passive fine-mesh screen to an existing offshore intake with mesh width of 1.75 mm	\$13,300	\$769,000	\$225,100	\$900	\$3,500	\$100
11. Addition of a dual-entry, single-exit traveling screen (with fine mesh) to a shoreline intake system.	\$13,600	\$1,072,100	\$129,400	\$100	\$2,200	\$100
12. Addition of passive fine-mesh screen system (cylindrical wedgewire) near shoreline with mesh width of 0.76 mm	\$37,400	\$989,900	\$227,200	\$700	\$1,700	\$100
13. Addition of a passive fine mesh screen to an existing offshore intake with a mesh width of 0.76 mm	\$13,800	\$85,700	\$38,700	\$600	\$2,500	\$200
14. Relocation of an existing intake to a submerged offshore location with passive fine-mesh screen inlet with mesh of 0.76 mm.	\$78,000	\$281,600	\$179,800	\$1,500	\$3,700	\$100

<sup>5)</sup> Costs rounded to the nearest \$100 and expressed in 2002 \$.

**Table 6:** A Comparison of Hypothetical CWISs on Different Water Bodies

	<b>Site A</b>	<b>Site B</b>
Fuel Type	Fossil	Fossil
Flow (cfs)	1,000	1,000
Flow (gpm)	448,830	448,830
Water Body	Estuary	River
Minimum Water Depth (ft)	12	12
Pipe Length (ft)	410	410
Screen Size	T-72	T-72
Slot Size (mm)	0.5	9.5
Flow per Screen (gpm)	9,000	38,000
Number of Screens	50	12
EPA Cost <sup>6)</sup>	\$11.9 M	\$10.9 M
Site-Specific Cost	\$11.8 M	\$3.7 M

<sup>6)</sup> EPA costs based on 1.75 mm mesh

### Conclusions

There are many intake technologies currently available that, when used alone or in some combination, hold potential to meet the proposed national performance standards. The biological effectiveness and engineering practicability of these technologies is largely dependent upon site- and species-specific factors. For any given facility, therefore, the number of options available may be many or few. In some cases, there will be no technology that can be installed to meet the performance standards. The costs associated with the installation of technologies at a given location are also greatly influenced by site-specific factors.

### References

- Amaral, S. V., J. L. Black, B. J. McMahon, and D. A. Dixon. 2002. Evaluation of Angled Bar Racks and Louvers for Guiding Lake and Shortnose Sturgeon. American Fisheries Society Symposium 28: 197-210
- Applied Science Associates (ASA). 1999. Ichthyoplankton Monitoring Study: Development of a Gunderboom System at Lovett Generating Station Unit 3 1998 Final Report.
- ASA 2001. Ichthyoplankton Monitoring Study: Development of the Gunderboom MLES™ at Lovett Generating Station Unit 3 2000 Final Report
- Black, J.L., T. W. Hogan, G. S. Allen, E. S. Perry, and K. D. Zammit. In press. Laboratory Evaluation of an Aquatic Filter Barrier (AFB) for Protecting Early Life Stages of Fish. American Fisheries Society Bioengineering Symposium 4. Bethesda, MD.
- Brett, J. R. and D. McKinnon. 1953. Preliminary Experiments Using Lights and Bubbles to Deflect Migrating Young Spring Salmon. J. Fish. Res. Bd. Canada 10(8): 548-556.
- Beak Consultants, Inc. 1988. Dunkirk Steam Station Biological Studies – SPDES Permit No. NY0002321; Final Report January-December 1987. Prepared for Niagara Mohawk Power Corporation.
- Consolidated Edison Company of New York, Inc. 1994. Evaluation of Underwater Sound to Reduce Impingement at the Arthur Kill Station.

- Craddock, D. R. 1956. A review of Studies in Guiding Downstream Migrating Salmon with Light. In: Progress Report on Fisheries Engineering Research Program. U. S. Army, North Pacific Division, Corps of Engineers, Portland, Oregon, pg. 1-13.
- Dunning, D. 1995. Ultrasound Deterrence: Alewife at a Nuclear Generating Station in New York. In T. J. Carlson and A. N. Popper (eds.): Using Sound to Modify Fish Behavior at Power-Production and Water-Control Facilities: A Workshop. Prepared for U.S. Department of Energy and Bonneville Power Administration, DOE/BP-62611-11.
- Electric Power Research Institute (EPRI). 1986. Assessment of Downstream Migrant Fish Protection Technologies for Hydroelectric Application. 2694-1.
- EPRI. 1994a. Biological Evaluation of a Modular Inclined Screen for Protecting Fish at Water Intakes. TR-104121.
- EPRI. 1994b. Research Update on Fish Protection Technologies for Water Intakes. TR-104122.
- EPRI. 1996. Evaluation of the Modular Inclined Screen (MIS) at the Green Island Hydroelectric Project: 1995 Test Results. TR-106498.
- EPRI. 1999. Fish Protection at Cooling Water Intakes. TR-114013
- EPRI. 2001. Evaluation of Angled Racks and Louvers for Guiding Fish at Water Intakes. 1005193
- EPRI. 2003. Laboratory Evaluation of Wedge Wire Screens for Protecting Early Life Stages of Fish at Cooling Water Intakes. 1005339
- Empire State Electric Energy Research Corporation (ESEERCO). 1981. Laboratory Evaluation of Fine-mesh Screening for the Protection of Fish Larvae at Intakes. Empire State Electric Energy Research Corporation Research Report EP 8-6, Final Report.
- Envirex, Inc. 1996. Fish Survival Enhancement with Envirex Non-Metallic Fish Baskets and Improved Fish Spray Wash Design. Envirex, Inc., Waukesha, WI.
- Feist, B. A., and J. J. Anderson. 1991. Review of Fish Behavior Relevant to Fish Guidance Systems. Fisheries Research Institute, FRI-UW-9102. University of Washington, Seattle WA.
- Fletcher, R. I. 1990. Flow Dynamics and Fish Recovery Experiments: Water Intake Systems. Transactions of the American Fisheries Society. 119:393-415.
- Heimbuch, D. E. 1999. *Biological Efficacy of Intake Structure Modifications*. PSE&G Renewal Application Salem Generating Station. Permit No. NJ0005622.
- Lawler, Matusky & Skelly Engineers (LMS). 1996. Effectiveness Evaluation of a Fine Mesh Barrier Net Located at the Cooling Water Intake of the Bowline Point Generating Station. Prepared for Orange and Rockland Utilities, Inc.
- LMS. 1991. Intake Debris Screen Post-Impingement Survival Evaluation Study, Roseton Generating Station, 1990.
- Michaud, D. T. and E. P. Taft. 1999. Recent Evaluation of Physical and Behavioral Barriers for reducing Fish Entrainment at Hydroelectric Projects in the Upper Midwest," Proceedings of the EPRI/DOE Power Generation Impacts on Aquatic Resources Conference, Atlanta, GA (April 1999).

Neitzel, D. A., C. S. Abernethy, and E. W. Lusty. 1991. Evaluating of Rotating Drum Screen Facilities in the Yakima River Basin, South-Central Washington State.” In: Fisheries Bioengineering Symposium. American Fisheries Society Symposium 10: 325-334.

Nemeth, R. S. and J. J. Anderson. 1992. Response of Juvenile Coho and Chinook Salmon to Strobe and Mercury Vapor Lights. North American Journal of Fisheries Management. Vol. 12: 684-692.

Pearce, R. O. and R. T. Lee. 1991. Some Design Considerations for Approach Velocities at Juvenile Salmonid Screening Facilities. In: Fisheries Bioengineering Symposium. American Fisheries Society 10:237-248.

Ploskey, G. R., J. M. Nestler, G. N. Weeks, and C. Schilt. 1995. Evaluation of an Integrated Fish-Protection System. Waterpower 95, Proceedings of the International Conference on Waterpower. American Society of Civil Engineers, New York, NY.

Puckett, K.J., and J.J. Anderson. 1987. Behavioral Responses of Juvenile Salmonids to Strobe and Mercury Lights. Fisheries Research Institute, University of Washington. FRI-UW-8717.

Reider, R. H., D. D. Johnson, P. Brad Latvaitis, J. A. Gulvas, E. R. Guilfoos. 1997. Operation and Maintenance of the Ludington Pumped Storage Project Barrier Net.” Proceedings of Fish Passage Workshop, Milwaukee, Wisconsin, May 6-8, 1997. Sponsored by Alden Research Laboratory, Conte Anadromous Fish Research Laboratory, Electric Power Research Institute, and Wisconsin Electric Power Company.

Ronafalvy, J. P. 1999. Circulating Water Traveling Screen Modifications to Improve Impinged Fish Survival and Debris Handling at Salem Generating Station. Proceedings of the EPRI/DOE Power Generation Impacts on Aquatic Resources Conference, Atlanta, GA.

Ronafalvy, J. P., R. Roy Cheesman, W. M. Matejek, 1997. Circulating Water Traveling Screen Modifications to Improve Fish Survival and Debris Handling at Salem Generating Station”. Proceedings of Fish Passage Workshop, Milwaukee, Wisconsin, May 6-8, 1997. Sponsored by Alden Research Laboratory, Conte Anadromous Fish Research Laboratory, Electric Power Research Institute, and Wisconsin Electric Power Company.

Stira, R. J. and D. A. Robinson. 1997. Effectiveness of a Louver Bypass System for Downstream Passage of Atlantic Salmon smolts and Juvenile Clupeids in the Holyoke Canal, Connecticut River, Holyoke, Massachusetts. In: Proceedings of Fish Passage Workshop, Milwaukee, Wisconsin, May 6-8, 1997. Sponsored by Alden Research Laboratory, Conte Anadromous Fish Research Laboratory, Electric Power Research Institute, and Wisconsin Electric Power Company (1997).

Taft, E. P., A. W. Plizga, E. M. Paolini, and C. W. Sullivan. 1997. Protecting Fish with the New Modular Inclined Screen. The Environmental Professional 19(1):185-191.

Thomas, D. L. and G. J. Miller. 1976. Impingement Studies at the Oyster Creek Generating Station, Forked River, New Jersey, from September to December 1975. In: Third National Workshop on Entrainment and Impingement: Section 316(b) – Research and Compliance. L. D. Jensen (Ed.).

United States Environmental Protection Agency (EPA). 2002. National Pollutant Discharge Elimination System – Proposed Regulations to Establish Requirements for Cooling Water Intake Structures at Phase II Existing Facilities. Federal Register 67(68): 17122-17225.

United States Environmental Protection Agency (EPA). 2003. National Pollutant Discharge Elimination System – Proposed Regulations to Establish Requirements for Cooling Water Intake Structures at Phase II Existing Facilities; Notice of Data Availability. Federal Register 68 No. 53: 13522-13587.

Welton, J. S., W. R. C. Beaumont, and R. T. Clarke. 2002. The Efficacy of Air, Sound and Acoustic Bubble Screens in Deflecting Atlantic Salmon, *Salmo salar* L., Smolts in the River Frome, UK

---

### ***An Overview of Flow Reduction Technologies for Reducing Aquatic Impacts at Cooling Water Intake Structures***

*Reed Super, Riverkeeper, Inc.*

#### **BIOSKETCH**

Mr. Reed Super received his JD and MBA degrees from the University of Virginia. He has practiced environmental law since 1992, and since 1994 has been working on clean water issues with Waterkeeper Alliance programs. Since 2000, Mr. Super has directed Riverkeeper's National Fisheries and Power Plant Program. He is the author with David Gordon of *Minimizing Adverse Environmental Impact: How Murky the Waters?* and teaches Preservation Law as an adjunct professor at Hofstra University School of Law.

#### **TECHNICAL PAPER**

##### **Abstract**

Power plants and factories withdraw more than 100 trillion gallons per year from U.S. waters for cooling. As a result, hundreds of billions of adult and juvenile fish, eggs, larvae and other aquatic biota are killed as they are sucked through the plants' heat exchangers (entrained) or trapped against intake screens (impinged). Two fundamental methods exist for reducing entrainment and impingement: flow reduction, which reduces the volume and velocity of water withdrawals; and screening, which attempts to screen or divert fish away from the intakes.

This paper presents an overview of flow reduction technologies. It reviews the most compelling reasons for reducing flow to minimize aquatic impacts. A variety of flow reduction technologies are discussed and the level of flow reduction available from each technology is assessed. Such technologies include closed-cycle wet cooling, dry cooling, repowering (i.e., adding a combustion turbine to a steam plant), variable speed pumps, changing source water (from surface water to municipal, groundwater or treated effluent from sewage plants), seasonal outages (as a technology operational measure), and combinations of the above. The paper assesses issues of concern in evaluating flow reduction technologies, such as the extent of reduction in impingement and entrainment obtained as compared with other technologies, the effect on energy generation efficiency (energy penalty), technical feasibility, and costs to plant owners and electricity consumers. Finally, recent examples of the use or proposed use and evaluation of flow reduction technologies at new, existing and replacement power plants are discussed.

##### **Introduction**

According to the US Environmental Protection Agency, power plants and factories withdraw more than 100 trillion gallons per year (279 billion gallons per day) from rivers, lakes, estuaries, and ocean waters in the United States for cooling. (U.S. EPA, 66 Fed. Reg. 65,262). The largest users of cooling water are steam-electric power plants, which cool and recondense exhaust steam from their turbines. As a result of these large cooling water withdrawals, hundreds of billions of adult and juvenile fish, eggs, larvae and other aquatic biota are killed or damaged, either by entrainment as they are sucked through the plants' heat exchangers or by impingement as they are trapped against intake screens. Entrainment and impingement can be reduced through two primary methods: flow reduction, which reduces the volume and velocity of water withdrawals, thereby reducing the number of organisms that are drawn into cooling water intakes; and screening mechanisms, which attempt to screen or otherwise divert fish away from the intakes.

##### **Why Reduce Flow?**

Reducing cooling water intake flows at steam-electric power plants is desirable for a variety of reasons. Most significantly, because entrainment and impingement are directly related to the volume and velocity of water withdrawals, reducing flow directly reduces the number of organisms killed and otherwise harmed by power plant

cooling water intake structures. As explained below, by “closing the loop” at direct-cooled power plants, water withdrawals and fish kills can be reduced by 95 percent or more.

Furthermore, reducing water withdrawals is the most reliable method of reducing aquatic mortality. Because intake flow reduction targets the source of the problem and eliminates its cause, and because it is less dependent upon factors such as screen maintenance and fish behavior, the reductions in aquatic mortality are more certain and reliable across plants and species as compared screening fish from intake flows.

Reducing intake flows also facilitates lower intake velocity and allows for the installation of better intake screens. For example, wedgewire screens with small slot widths can be an effective screening mechanism. However, such devices can become impractical on large capacity intake structures because as slot width shrinks, the overall size of the screen increases, thereby requiring a larger area for the intakes and screens. Thus, once-through cooled facilities must substantially reduce their withdrawal rates in order to fit their intakes with wedgewire screens.

Using cooling towers to reduce water withdrawals also reduces or eliminates thermal impacts. Because cooling towers dissipate heat the air through evaporation (in the case of wet towers) or in radiator-like dry cooling towers, the aggregate amount of heat and the relative temperature change in cooling water discharged is drastically reduced. Cooling water withdrawals and related discharges can cause other physical, chemical, and biological impacts on aquatic systems including destruction of aquatic vegetation and other habitat, scouring near outfalls, effects on plumes, mixing, ponding and recirculation, discharge of chemicals in cooling water, changes in oxygen content, the of spreading alien or exotic species, among other things.

Once cooling withdrawals are reduced from hundreds or millions of gallons per day (which is typical for direct-cooled fossil fuel power plants) to less than ten million gallons per day (typical for plants using evaporative cooling towers), it becomes possible to decouple power generation from large natural bodies of water and rely on municipal water sources or groundwater instead. In addition, once water requirements are sufficiently reduced, reclaimed sources of water such as treated wastewater effluent or treated mine drainage can be used. Such innovative reuse not only eliminates aquatic mortality but provides more flexibility in the power plant siting decision to locate such facilities away from limited, valuable, and sensitive shoreline, wetland and coastal areas.

## **Flow Reduction Technologies**

Several technologies are available to reducing cooling water withdrawals:

- ▶ Once-Through Cooling System to Closed-Cycle Wet Cooling System (Benefit: 96% reduction in volume of cooling water withdrawal). Once-through or “direct” cooling uses the sink energy of a natural waterbody to cool exhaust steam from a plant’s turbines and recondense it to water for reuse in the boiler. In this process, cooling water is drawn from a river, lake, estuary or ocean into a heat-exchanging condenser containing the steam pipes. Heat is transferred from the steam pipes to the cooling water which is discharged in this heated state to the waterbody. This form of cooling requires large volumes of water: medium to large power plants use hundreds of millions to billions of gallons of cooling water per day. The largest user of cooling water, the Salem Nuclear Generating Station in New Jersey, uses approximately 3.3 billion gallons per day.

In contrast, closed-cycle cooling reduces the volume of cooling water required by recycling cooling water after it leaves the condenser. Instead of discharging this heated water, closed-cycle plants direct it to a cooling tower, which cools the cooling water so it can be reused for cooling.

There are two basic types of closed-cycle cooling towers, wet and dry, as well as hybrid wet-dry towers which combine the two technologies. In wet cooling towers, (also known as evaporative) the heated cooling water is pumped to the top of the tower and then released through a fan (in mechanical draft towers) or through baffles (in natural draft towers) which cools the water largely through evaporation. Plants using wet

cooling towers require additional water withdrawals only to replace the evaporation and to dilute the cooling water when mineral concentrations become too high. Such replacement water constitutes only about four percent of the water required for once-through cooling, thereby resulting in an approximate ninety-six percent reduction in cooling water withdrawals. Because the magnitude of entrainment and impingement is roughly proportional to the volume of withdrawals, replacing once-through cooling with closed-cycle evaporative cooling towers reduces fish kills by approximately ninety-six percent. U.S. EPA, 66 Fed. Reg. 65,273 .

Closed-cycle cooling is standard technology for new power plants. As EPA reports, 100% of combined-cycle natural gas plants and 73% of coal-fired plants built in the last 20 years have closed-cycle cooling. Power plants of many fuels types and in many different regions of the U.S. have converted from once-through cooling to closed-cycle cooling.

- ▶ Closed-Cycle Wet Cooling to Dry Cooling (Benefit: 96-100% reduction in volume of cooling water withdrawal). Dry cooling towers are of two types: direct and indirect. In a direct system, steam exhausted from the turbines flows through a large radiator-like tower, typically equipped with circulating fans, to radiate heat to the air and recondense the steam for reuse in the boiler. Indirect dry cooling systems work much like direct systems, except that an intermediate cooling loop cools the steam in a wet condenser before being directed to a radiator tower for cooling. Dry cooling systems reduce water withdrawals by approximately ninety-six percent as compared to wet cooling towers. In other words, dry systems reduce water consumption by 96% more than wet systems and by approximately 99.9% as compared to once-through cooling. In direct dry cooling, where no cooling water is used (although these plants still require small amounts of water for other purposes), or where dry cooling allows the use of an alternative water source, cooling water withdrawals from waters of the U.S. is completely eliminated. In either case, aquatic mortality is eliminated or reduced to negligible levels. Dry cooling technology is increasingly commonplace. More than 60 dry-cooled plants are in operation
- ▶ Repowering (addition of a combustion turbine) (Benefit: 67% reduction in volume of cooling water withdrawal). Older power plants recovered energy only from the steam cycle. In other words, a fuel source was used to heat water to boiling, and the resulting steam drove a turbine which generated electricity. Modern combined-cycle natural gas plants (not to be confused with closed-cycle cooling), add a heat recovery combustion turbine to the steam turbine, thereby generating electricity from the gas combustion as well as from the resulting steam. Because two thirds of the electricity in a combined-cycle plant comes from the combustion turbine, only one third is attributable to the steam turbine which uses cooling water. Thus, adding a combustion turbine allows three times as much energy to be generated with the same amount of water, resulting in approximately a sixty-seven percent reduction in cooling water withdrawals and a similar reduction in fish kills. In addition, due to greater thermal efficiency, the temperature differential between intake and discharge of cooling water will be reduced, providing additional aquatic benefits.
- ▶ Variable Speed Pumps (Benefit: reduction in volume of cooling water withdrawal varies). Many power plants use one or more single speed pumps to withdraw cooling water through the intake structure. When running at full capacity, plants will typically need to have all of these intake pumps (except backups) running. However, most plants run at far less than capacity. Some “peaker” plants (i.e., those running only during daily or seasonal periods of peak demand) may supply fifteen percent or less of their maximum capacity. Even “base load” plants (i.e., those supplying power during both peak and offpeak times) typically operate at capacity factors of fifty to eighty percent. Because single speed pumps cannot adjust the volume of water they draw, plants often use a disproportionately large volume of water to generate power at less than full capacity. Variable speed pumps allow plants to scale down their water withdrawals to match reduced energy generation. The amount of reduction depends upon many variables, including a plants capacity factor, the number of pumps operating, the volume each pump can withdraw, and thermal discharge limits. As explained below, to properly calculate the percentage reduction attributable to variable speed pumps, it is



important to use a baseline flow representing the plant's actual operational characteristics, rather than a hypothetical maximum annual cooling water capacity.

- ▶ Changing Source Water (Benefit: 100% reduction in cooling water withdrawals from biologically-productive water). As discussed, reducing cooling water volume can facilitate a change in cooling water sources. While dry cooling can reduce water withdrawals to negligible levels, wet cooling towers still can still require millions of gallons per day, resulting in significant aquatic mortality. But either form of closed cycle cooling, wet or dry, can reduce water needs to a level (typically, less than 10 million gallons per day at an average-sized combined cycle natural gas plant) capable of being satisfied by municipal, groundwater, or treated effluent sources. Once-though cooling at any large power plant will require hundreds of millions of gallons per day, at a minimum, which can only be met from large natural waterbodies, resulting in substantial aquatic mortality. Where possible, a switch from a biologically productive waterbody to a source where aquatic organisms are not present, will reducing entrainment and impingement by one hundred percent.
- ▶ Seasonal Outages (benefit: reduction in cooling water withdrawals varies). One operational method of reducing the volume of biologically productive water withdrawn for cooling purposes is to schedule plant outages during the spawning season when large numbers of entrainable organisms are present in the water column. Six and a half weeks of outages, for example, would result in a cooling water flow reduction of 12.5 percent and a commensurate reduction in aquatic mortality. And by timing some or all of these outages to coincide with spawning season, entrainment would be reduced by an even greater percentage. Since all facilities must go out of service for maintenance at times, scheduling such outages with environmental considerations in mind can provide substantial benefits.
- ▶ Combinations of the Above (reduction varies). Many of the technologies discussed here can be used in combination, in order to further reduce impacts. For example, a direct-cooled single-cycle plant drawing cooling water from a river, could simultaneously repower by adding a combustion turbine, retrofit with closed-cycle cooling and switch to treated effluent for its cooling water source. Such combination of technologies would increase the electricity generated while eliminating aquatic mortality. At least one such plant has done exactly that.

### **Issues in Flow Reduction**

In evaluating flow reduction technologies, the primary issues to be considered are the levels of reduction in flow (and corresponding reductions in impingement and entrainment) that can be achieved with these technologies as compared to each other and compared to other methods of addressing aquatic impacts, such as screening technologies; the technical feasibility of each technology under various circumstances and in varying climates; the effect on plant efficiency (i.e., an "energy penalty"); and the costs of the technology to the plant owner and to the ratepayer.

### **Flow/Impingement Relationship**

Cooling water intake flow is positively correlated with impingement and entrainment levels. Thus, reducing flow reduces both impingement and entrainment. The relationship can be expressed with regression formulas, as shown in Figures 1 and 2. Figure 1 demonstrates the flow-entrainment relationship in a function derived from 14 direct cooled power plants on fresh water, including the Great Lakes, and 15 power plants on ocean and estuary waters. The formulas were derived by Pisces Conservation, Ltd. of Lymington, U.K. The functions were derived by plotting points on a graph and fitting a curve to the data points.

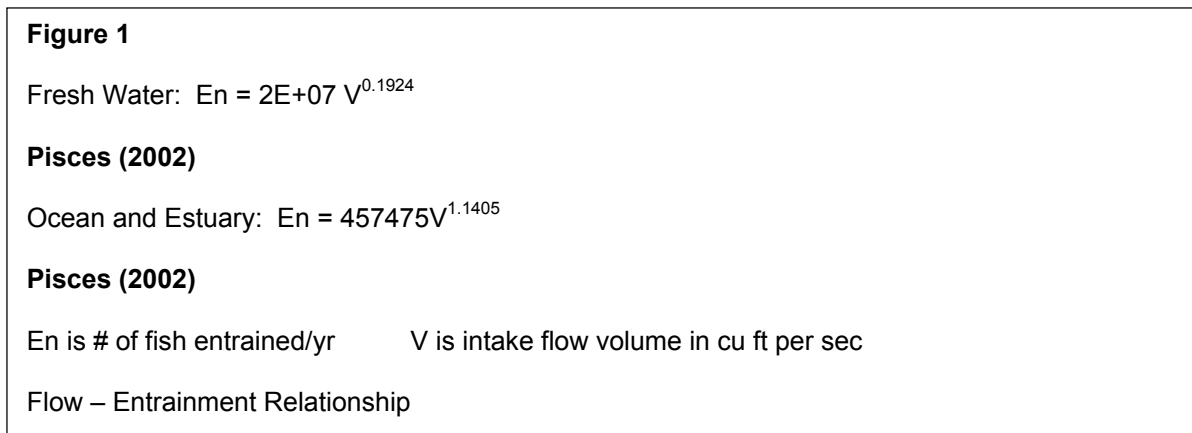
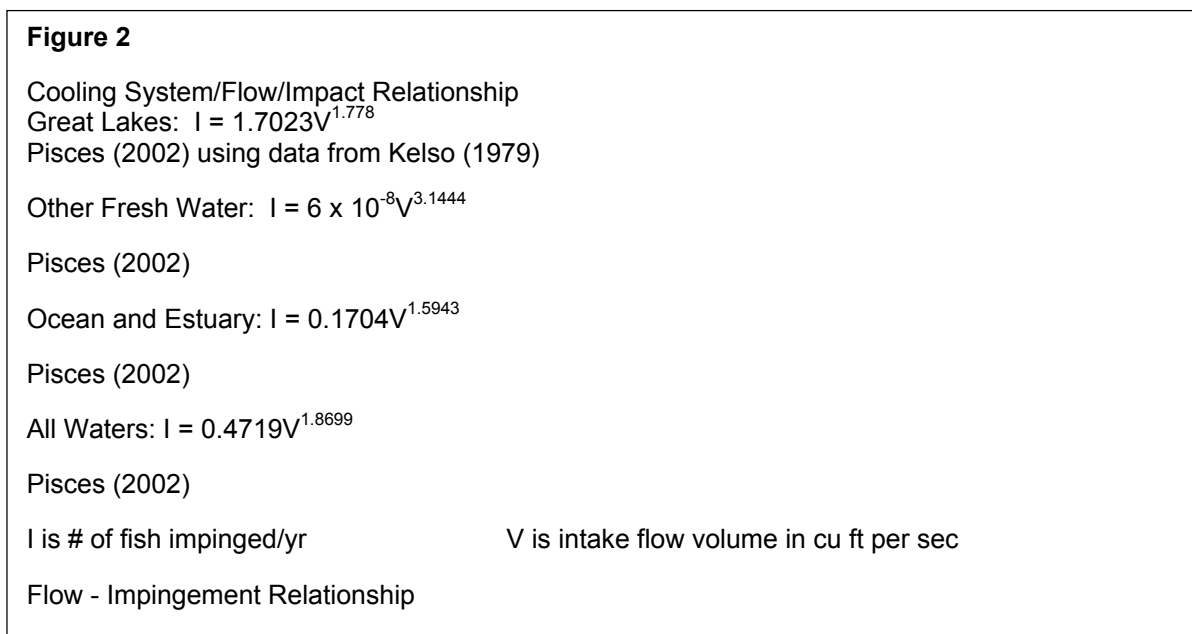


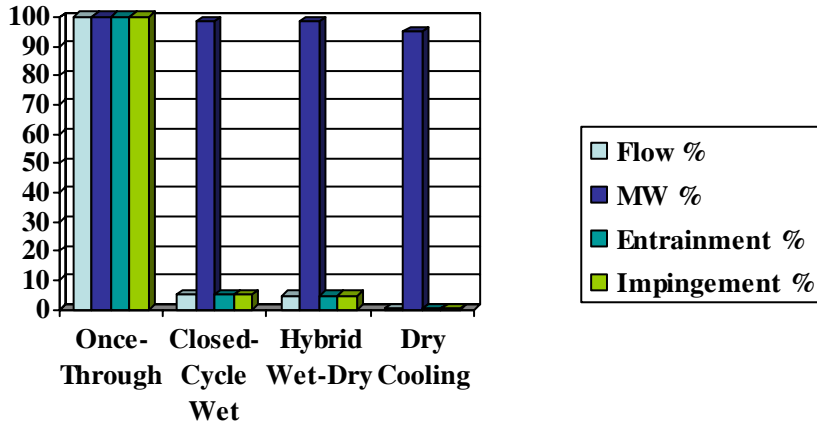
Figure 2 shows the flow-impingement relationship in formulas derived by Pisces from work by Kelso on 37 direct-cooled plants on the Great Lakes, and by Pisces from 13 other fresh water plants and 28 ocean and estuary plants.



**Cooling Systems, Megawatts, Flow, and Impingement and Entrainment**

The choice of cooling system technology has a significant effect on the volume of cooling water used, and consequently a significant effect on impingement and entrainment, but a minimal effect on the amount of electricity generated. As illustrated in Figure 3, closed-cycle wet or hybrid wet-dry cooling reduces flow and aquatic mortality by approximately 95 percent compared to once-through cooling, yet the average energy loss associated with the change in cooling system averages only about 1.5 percent. Similarly, dry cooling reduces flow and fish kills by 99.9 percent compared to once-through cooling, while resulting in a energy penalty of only about 5 percent. The environmental benefits therefore far exceed the energy losses.

Figure 3



Comparison of Cooling Systems, Megawatts Flow and Impingement and Entrainment Units are relative percentages, using Once-Through Cooling as the base case Energy Penalty based on EPA and DOE estimates.

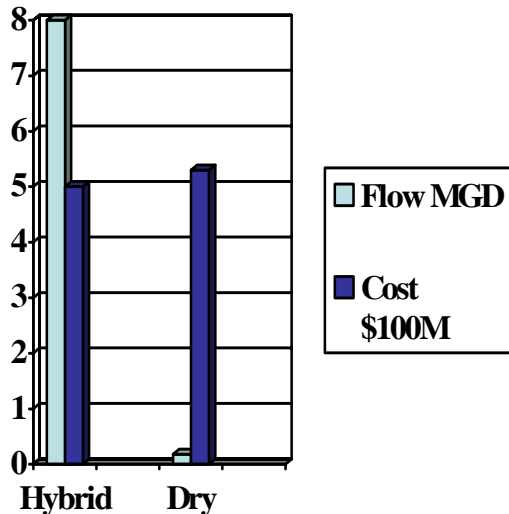
**Flow Reduction at New Facilities**

The siting and construction of new facilities provides an opportunity to install state-of-the-art technology to reduce intake flow and minimize environmental impacts. Figure 4 provides compares two different cooling technologies considered for use at a new power plant recently built in Athens, New York on the basis of flow and cost. The plant operator proposed installing a hybrid wet-dry steam plume abatement cooling system, which would withdraw between 4.53 and 8 million gallons per day (mgd). Environmentalists proposed and New York State’s regulatory agencies ultimately required a dry cooling system requiring only 0.18 mgd. The cost difference between the two technologies was approximately \$30 million dollars in addition to the \$500 million cost of the plant. Figure 4 shows the drastic reduction in flow compared to the modest increase in cost. This figure addresses capital costs only. There may be additional costs associated with revenue losses if efficiency is reduced during certain times of year.

**Flow Reduction at a Replacement Plant**

Where a new plant is proposed to replace an existing plant, dramatic reductions in flow can be obtained. In Morro Bay, California, a plant operator is proposing to replace an existing direct-cooled plant, built in 1954, which generates

Figure 4



(Note: graph uses same axis for both flow and cost – flow is shown in scale of millions of gallons per day; cost is shown in scale of \$100 million)

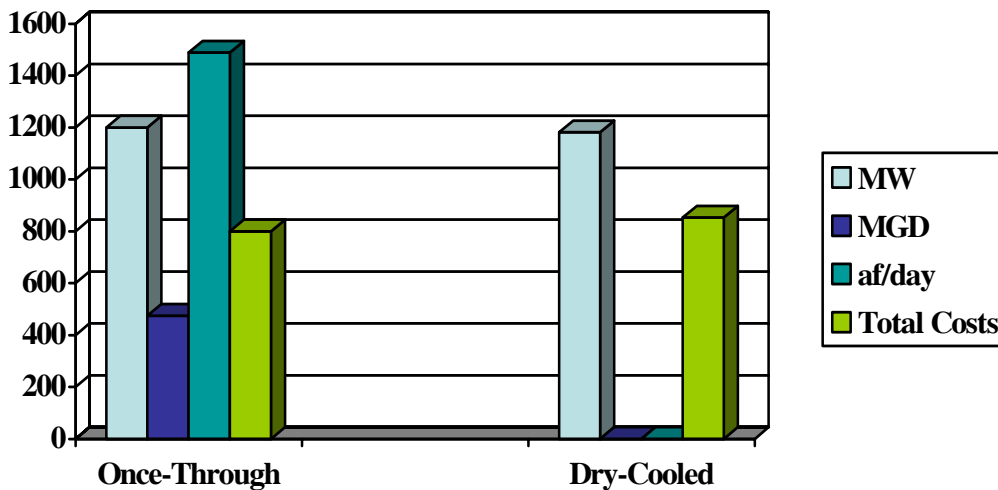
Hybrid Cooling vs. Dry Cooling (Athens, NY)

1000 megawatts of power and uses 707 mgd of water at full capacity and 387 mgd under recent operational conditions. Then static subtidal volume of the Morro Bay is 2400 acre feet. At full capacity (707 mgd), the existing plant cycles 95 percent of the volume of the bay though the plant each day. Two cooling systems are being considered for the 1200 megawatt replacement plant: a once-through system and a dry cooling system.

The once-through system would withdraw 475 mgd, which is 1489 acre feet per day or 62 percent of the bay’s volume. The conditional mortality rates (CMRs), or percentage of the year class of fish that would be entrained, range from 17 to 33 percent depending on species, according to the California Energy Commission, the Regional Water Quality Control Board, and California Department of Fish and Game and the National Marine Fisheries Service. A more recent study conducted by a consultant to the Regional Water Quality Control Board determined that the CMRs would range from 20 to 37 percent. The cost of the plant would be \$800 million.

The dry-cooled system would draw a minute amount of water from a municipal source and no cooling water from Morro Bay, and would cost approximately \$852 million and have an estimated energy penalty of 1.5 percent. The comparison between the two proposed systems is illustrated in Figure 5. As above for new plants, this illustration considers capital costs only, not potential lost revenue from reduced capacity caused by any efficiency losses.

Figure 5

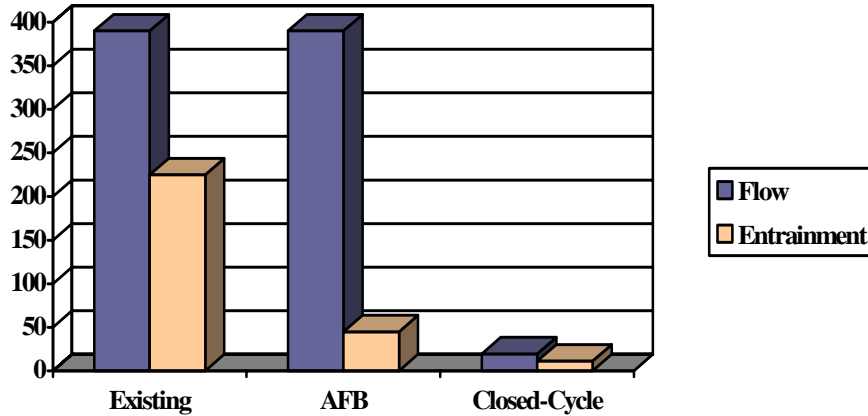


Once-Through Cooling vs. Dry Cooling  
(Morro Bay, CA)  
(note: af/day = acre feet per day)

**Comparison of Technology Types: Flow Reduction vs. Screening**

Flow reduction technologies can reduce aquatic impacts to a far greater degree than fish screening technologies. Figure 6 illustrates this concept by comparing the performance of an aquatic filter barrier (AFB), which is designed to prevent entrainable organisms from entering the intake structure, to closed-cycle cooling towers. An existing direct-cooled plant withdrawing 390 mgd per day is shown as a baseline. The cooling towers reduce flow and entrainment by 95 percent, from 390 mgd and 225 x 10<sup>7</sup> fish per year to 19.5 mgd and 11.25 x 10<sup>7</sup> fish. By comparison, the AFB, even if it meets the 80% reduction standard which it has been predicted as capable of achieving, will not reduce flow at all and will reduce entrainment only to 45 x 10<sup>7</sup> fish killed per year, which is four times as many fish kills as with the flow reduction approach.

**Figure 6**



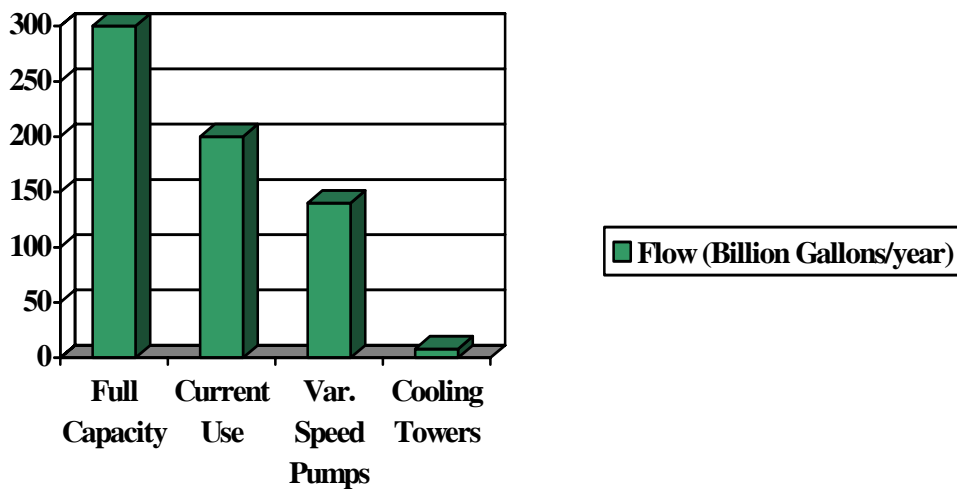
Flow Reduction vs. Aquatic Filter Barriers  
(An Illustration at a plant withdrawing 390 mgd)

(note: graph uses same axis for flow and entrainment; scale for flow is millions of gallons per day; scale for entrainment is tens of millions of fish killed per year)

**Comparison of Flow Reduction Methods**

Illustrative comparisons can also be made between different types of flow reduction technologies. Figure 7 shows the reduction in water usage achieved from the retrofit of cooling towers on a direct-cooled plant as compared to the retrofit of variable speed pumps. While the percent reduction attributable to variable speed pumps depends on a variety of factors, it is unlikely to ever approach the 96 percent reduction achievable with cooling towers. Reductions on the order of 30 percent from current volumes are probably typical, although the amount of reduction is highly plant-specific and it is difficult to generalize the flow reduction potential. Moreover, to make a proper and consistent comparison with cooling towers, the proper baseline usage is the current operation of the plant, not the hypothetical full capacity operation of the plant.

**Figure 7**



Variable Speed Pumps vs. Cooling Towers  
(An Illustration – Current Use as Baseline)

## Overview Session Questions and Answers

- Q. Greg Seegert, EA Engineering, asked about the mathematical relationships that Reed Super, Riverkeeper, Inc., presented and the reliability of those relationships; he also asked whether Mr. Super could site an  $R^2$  value. Also, for Lovett, Mr. Seegert had understood that Mr. Super was dealing with entrainment but had used formulas from the Pisces paper, which are actually based on impingement. He asked Mr. Super to explain.
- A. In answer to the second question, Mr. Super said that he showed formulas for the volume:impingement relationship as well as the volume: entrainment relationship, and used the volume:entrainment relationship for the Lovett numbers. Mr. Super deferred to Peter Henderson, a statistician, to answer questions about reliability of the mathematical relationships. He explained that the points were plotted using actual facility data, and that the resulting line was the best line that could be drawn.
- Q. Paul Martin, TRC Environmental, asked Mr. Super whether he had used the energy cost of running the cooling towers as part of the costs in calculating the energy penalty.
- A. Mr. Super answered that there are two components to the energy penalty: backpressure and energy penalty associated with mechanical draft tower fans. He used the energy penalties on average as discussed in the USDOE reports to illustrate that the penalty is only a small percentage as compared with orders of magnitude of reduction in environmental impacts.
- Q. Andy Turnpenny, Fish Guidance Systems, asked Mr. Super how he addressed climate impacts as traded off for fish impacts.
- A. Mr. Super indicated that it often takes a small amount of one resource to protect another resource and that one must look at the relative benefits. He emphasized that it does not mean sacrificing air for water but rather taking advantage of huge benefits to water. If people were concerned about side effects of pollution technologies, there would be none, because all of the technologies (recycling, for example) require some smaller expenditure of other resources. These smaller impacts may be reduced by other methods.
- Q. Steve Cibiki, ENSR, stated that discharge of blowdown and consumption are detriments of recirculated systems.
- A. Mr. Super pointed out that dry cooling addresses both, and that thermal plumes do contribute to evaporative losses.
- Q. Geoff Grubbs, USEPA, asked Mr. Taft to speculate about which are the most promising emerging technologies and where R&D dollars should be spent, given future demands from population growth and resulting resource pressures from activities such as overfishing.
- A. Mr. Taft indicated that there is a need for an improved understanding of technologies such as cylindrical wedge wire screens and aquatic filter barriers in order to know how to apply them nationally would be helpful. For example, combining technologies such as AFB for impingement together with fine mesh screens for entrainment, needs to be examined. Historically we have over studied certain technologies and under-studied others. There is a need to fill in these data gaps.
- Q. Debra Littleton, USDOE, pointed out that USDOE has never said the energy penalty for dry cooling was 1.5 percent.
- A. Mr. Super indicated that he cited the USDOE 1.5 percent penalty for wet cooling and that the 1.5 percent number for dry cooling came from the Morro Bay analysis from the California Energy Commission.

## IV. Session A: State-Level Issues

### *Maryland*

*Richard McLean, Director of Nuclear Programs*

#### **BIOSKETCH**

Mr. Richard McLean is Senior Administrator and Manager of Nuclear Programs for the Power Plant Research Program of Maryland's Department of Natural Resources. He received his B.S. degree in Biology in 1968 from Pennsylvania State University, and subsequently worked in the monitoring and evaluation of power plant environmental effects with the Academy of Natural Sciences of Philadelphia before joining MDNR. He has been involved in all aspects of ecological impact assessment of power plants, particularly relating to nuclear facilities, for more than 25 years.

#### **TECHNICAL PAPER**

##### **Abstract**

Maryland is a state to which the U.S. Environmental Protection Agency (EPA) has delegated authority to administer the National Pollutant Discharge Elimination System (NPDES). In the late 1970's the state developed and implemented regulations for cooling water withdrawal and intakes in accordance with EPA guidance on implementation of Clean Water Act Section 316b provided at that time. The Code of Maryland Regulations (COMAR), 26.08.03.04-05, established procedures for determining adverse environmental impacts due to impingement and entrainment at cooling water intake structures (CWIS) relative to determination of best technology available (BTA) for minimizing these impacts. Maryland has applied these regulations to all power plants in Maryland that operate CWIS, including facilities located on both freshwater and estuarine waters. Over the past 30 years, the Power Plant Research Program (PPRP) of the Maryland Department of Natural Resources (MdDNR), has participated in or conducted studies of a wide range of technologies and processes including, for example, wedgewire screens, modifications to intake structures, Royce "Smooth Tex" intake screens, altered plant operations (e.g., screen rotation times), and installation of barrier nets. These evaluations resulted in a range of determinations, from deciding whether an existing CWIS already featured BTA to requiring installation of tested technologies at some facilities. Our 30 years of experience supports our contention that there is no single technology or suite of technologies that can be applied on a state-wide or national basis. However, we believe it is important to have a consistent national process for identifying BTA at the site-specific level.

##### **Introduction**

Maryland facilities that utilize cooling water intake structures (CWIS) are regulated by the Maryland Department of Environment (MDE), the state agency with authority and responsibility for National Pollutant Discharge Elimination System (NPDES) permitting, as delegated by the U.S. Environmental Protection Agency (EPA). Maryland's regulations relating to CWIS were developed based on EPA guidance on implementation of Clean Water Act Section 316b when that legislation was enacted in 1972, and are documented in the Code of Maryland Regulations (COMAR), 26.08.03.04-05. These regulations address all potential impact sources associated with withdrawal of cooling water, including entrainment and impingement. While MDE is responsible for regulation of CWIS, a sister agency, the Maryland Department of Natural Resources (MdDNR), provides the technical support employed to address CWIS impacts at power plants.

MdDNR's Power Plant Research Program (PPRP) was established in 1971 to ensure that Maryland meets its electricity demands at reasonable costs while protecting the State's valuable natural resources. It provides a continuing program for evaluating electricity generation issues and recommending responsible, long-term solutions. The Maryland legislature created the Power Plant Siting Program, precursor to the current PPRP, in 1971 as a result of extensive public debate regarding the potential effects on the Chesapeake Bay from the Calvert Cliffs Nuclear Power Plant. Calvert Cliffs was a source of concern because the plant uses a once-through cooling system that withdraws 3.5 billion gallons of water per day from the Bay and discharges the water back to the Bay with a temperature elevation of about 12° F. The controversy over potential environmental impacts during the licensing of Calvert Cliffs prompted the creation of PPRP to ensure a comprehensive, technically based evaluation and resolution of environmental and

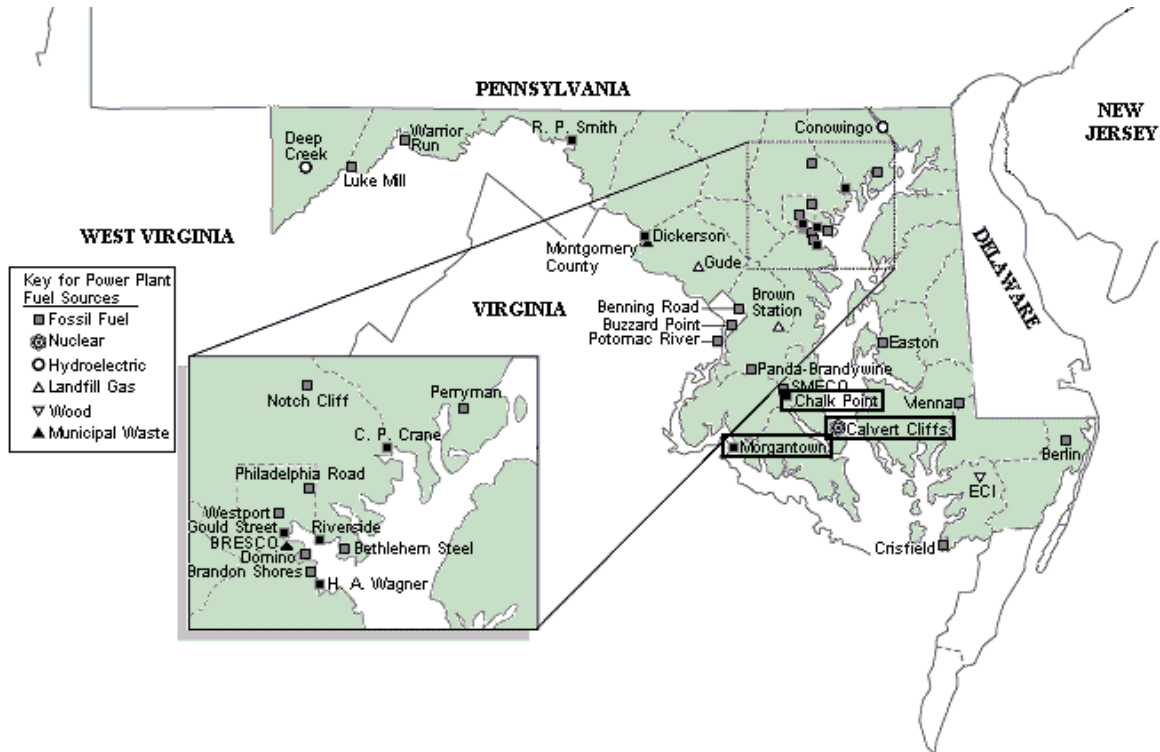
economic issues before decisions were made regarding whether and where to build other generating facilities. Today, PPRP continues to play this role in providing a comprehensive set of technically based licensing recommendations for proposed generating facilities. PPRP also conducts research on power plant impacts to the Chesapeake Bay, one of Maryland's greatest natural resources, and provides technical support to MDE regarding all power plant NPDES permits and variances associated with those permits. In addition to surface water concerns, PPRP's evaluations consider impacts to Maryland's ground water, air, land, and human resources.

PPRP operates with a small administrative and technical staff, supported by contractors with special expertise in engineering, economics, biology/ecology, and atmospheric sciences. The program is funded from an Environmental Trust Fund that is maintained through a surcharge on users of electricity. The surcharge amounts to about 25 cents per month for average residential customers, and has provided a relatively stable source of funding to address the State's power plant assessment needs for nearly three decades. The manner in which PPRP carries out its responsibilities with regard to CWIS assessments is varied and customized to address issues and circumstances specific to individual facilities and impacts. As a result of review of a permit or variance application from a given facility, PPRP may recommend CWIS studies be performed by the applicant. In such instances, PPRP utilizes its contractors to conduct technical reviews, the product of which provides support for recommendations from PPRP to MDE concerning disposition of the applicant's application and compliance with COMAR. In cases where an issue may be relatively generic and findings may be relevant to broader state-wide issues, PPRP may develop cooperative CWIS studies with an applicant, with PPRP contractors working with the applicant and their consultants to develop and implement studies. In cases where potential impacts are of concern, or where the efficacy of new technologies may be of interest, PPRP may conduct independent CWIS studies. Since inception of the program, PPRP has carried out all of these modes of study at all power plants in Maryland with regard to cooling water intake impacts and structures. Findings from a number of these studies are presented in this paper and provide the basis for the State's perspective on CWIS impact assessment methodologies, significance and solutions.

### **Maryland's General CWIS Perspective**

Thirty years of experience in assessing and resolving CWIS impact issues serve as the basis for Maryland's underlying perspective. The first major aspect of this perspective is that CWIS issues are not simply technology/structural issues. While CWIS may stand for "cooling water intake structure," many factors, beyond simply the structure, influence the biological consequences of the operation of a CWIS. Location of the CWIS is critical, both in terms of ecosystem (e.g., fresh water river versus low salinity estuarine waters) and site characteristics (e.g., intake flush with shoreline versus long, dredged intake canal). The mode of operation of the CWIS is also very important, particularly in influencing the extent of mortality of organisms that may be affected by the CWIS. For example, the frequency of intake screen rotation and washing can have a significant effect on the level of mortality that is imposed on impinged fish. Similarly, the strength of the screen washing water stream, and the location at which impinged fish may be returned to the source water body can similarly impact the resulting mortality rate. The major point here is that CWIS impacts, and the means of minimizing those impacts, must be viewed holistically; taking into account the intake hardware, its mode of operation, and the site-specific characteristics of the ecosystem on which the CWIS effects are exerted. Such a perspective precludes simple solutions such as standardized technology applications and requires site-specific assessments and considerations. In the remainder of this paper, I describe a number of types of studies that have been done and actions that have been taken to reduce CWIS impacts throughout Maryland over the past 30 years, and provide examples to illustrate how the evolution of diverse actions taken at various power plants have resulted in significant CWIS impact reductions or resource enhancements. Figure 1 shows the locations of power plants in Maryland, with three plants that will be addressed below highlighted: Chalk Point, Calvert Cliffs, and Morgantown.

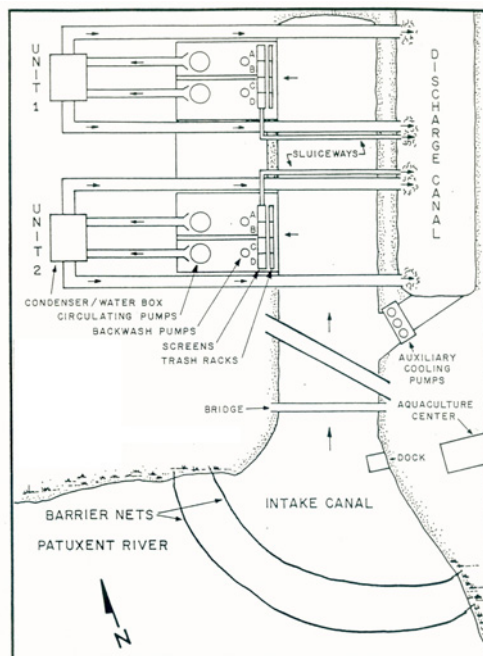




**Figure 1.** Locations of power generating facilities in Maryland.

**Chalk Point Steam Electric Station**

The Chalk Point Steam Electric Station (SES), owned by Mirant Energy (formerly PEPCO), is located on the estuarine portion of the Patuxent River in Prince George's County. It is the largest generating facility in Maryland, with a total generation capacity of 2,415 MW provided by a mix of oil, coal and gas generating facilities. Units 1 and 2 utilize a once-through cooling system, withdrawing a maximum of 250,000 gal/min per unit from and discharging the heated water into the Patuxent River. Units 3 and 4 have closed-cycle cooling, using natural draft cooling towers and re-circulating water at a rate of 260,000 gal/min per unit, with make-up and blow-down taken from and discharged into the intake and discharge streams of the once-through cooling system. Seven combustion turbine generators are also located on the site. The plant has dredged intake and discharge canals, as seen in Figure 2. One feature of the cooling water system to note in Figure 2 is the location of what are termed auxiliary cooling pumps. These pumps shunted water from the intake canal directly to the discharge canal as a means of ensuring compliance with a 100° F maximum temperature of waters discharged to the Patuxent River.

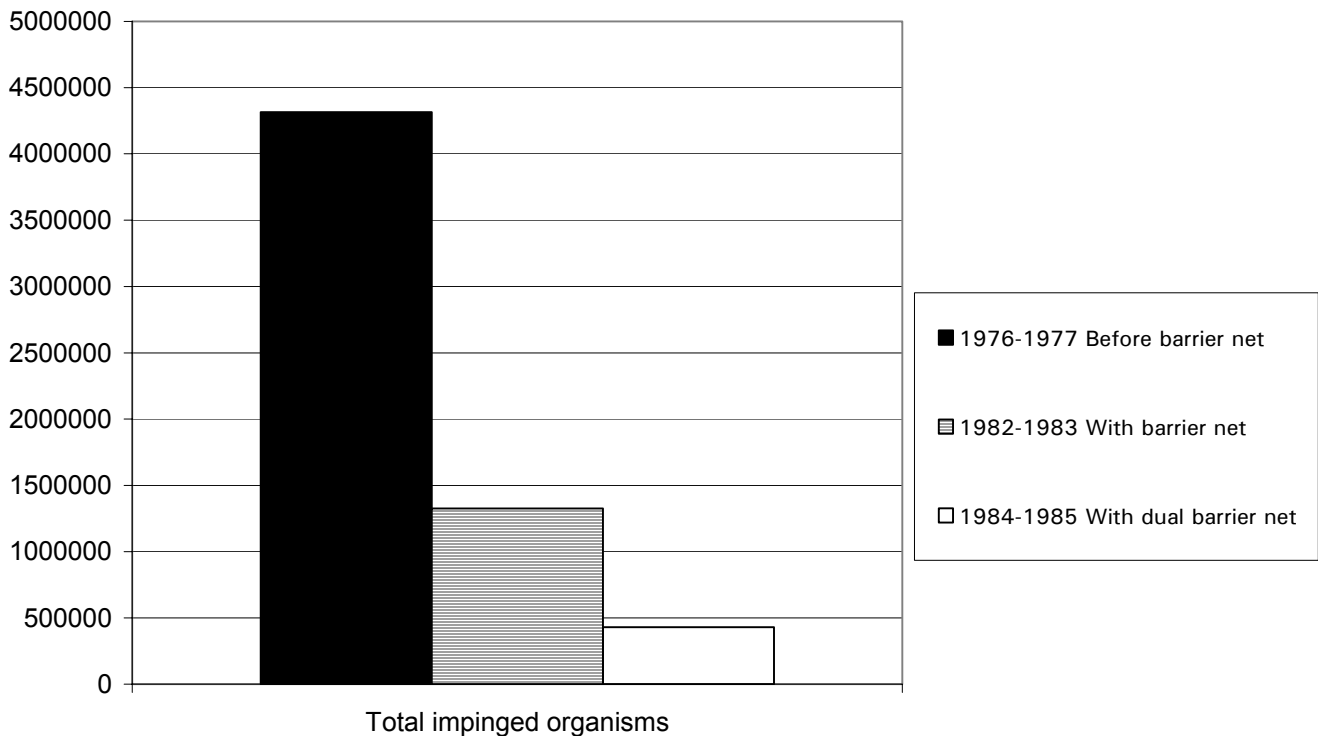


**Figure 2.** Plan view diagram of the Chalk Point SES, showing the configuration of the intake canal, cooling system, and discharge canal; note the location of the auxiliary cooling pumps

When Chalk Point first began operating in 1964, a number of potentially significant biological impacts became evident. Large numbers of fish and crabs were being impinged, with potential for adverse biological impacts in addition to causing significant operational difficulties (e.g., small crabs were carried over the traveling screens and then blocked condenser tubes, requiring plant shutdowns for cooling system clean-up). Extensive on-going monitoring studies revealed the potential for other sources of significant impacts (MMES 1985). The three primary areas of concern identified by PPRP included: mortality of fish and crabs entrained through the auxiliary cooling pumps, primarily due to physical damage; impingement of fish and crabs on CWIS traveling screens; and, significant entrainment of forage fish, specifically bay anchovy. The manner in which these issues were addressed and resolved are illustrative of Maryland's approach to resolving CWIS issues.

*Tempering pump entrainment* - Auxiliary cooling water pumps, also called tempering pumps, were not screened. Thus, when operated, all ages and sizes of fish and crabs could be passed through the pumps and suffer physical damage from striking pump impellers and experiencing pressure changes. Large concentrations of fish and crabs were present in the intake canal, most likely because the intake flows and configuration of the canal were attractive to these organisms, which resulted in large numbers of organisms being entrained through the pumps. PPRP carried out a detailed assessment of the effectiveness of the tempering pumps for reducing plant-induced mortality of aquatic biota, using data collected by the facility owner and their contractors (Cadman and Holland, 1986). Several Representative Important Species (RIS) and dominant benthic and zooplankton species were used in the evaluation as indicators of overall system-wide responses. Expected mortality with and without auxiliary pump operation was estimated using thermal tolerance data available from the literature for blue crabs, white perch, striped bass, spot, *Macoma balthica* (a shellfish), and *Acartia tonsa* (a zooplankton). PPRP concluded that the operation of the pumps increased plant-induced mortality of spot, white perch, striped bass, and zooplankton, but could reduce blue crab mortality slightly under some circumstances. *Macoma* mortality was largely unaffected by their operation. The overall conclusion was that cessation of use of the tempering pumps would result in a 50% decline in losses of fish and crabs from CWIS operations. A sensitivity analysis confirmed that the conclusions drawn were not significantly affected by uncertainties in the input data used. As a result of this evaluation, PPRP recommended to MDE that the Chalk Point NPDES permit be modified to eliminate the requirement for use of auxiliary pumps. Thermal criteria in the permit were later changed to a thermal loading cap rather than a specific discharge temperature cap.

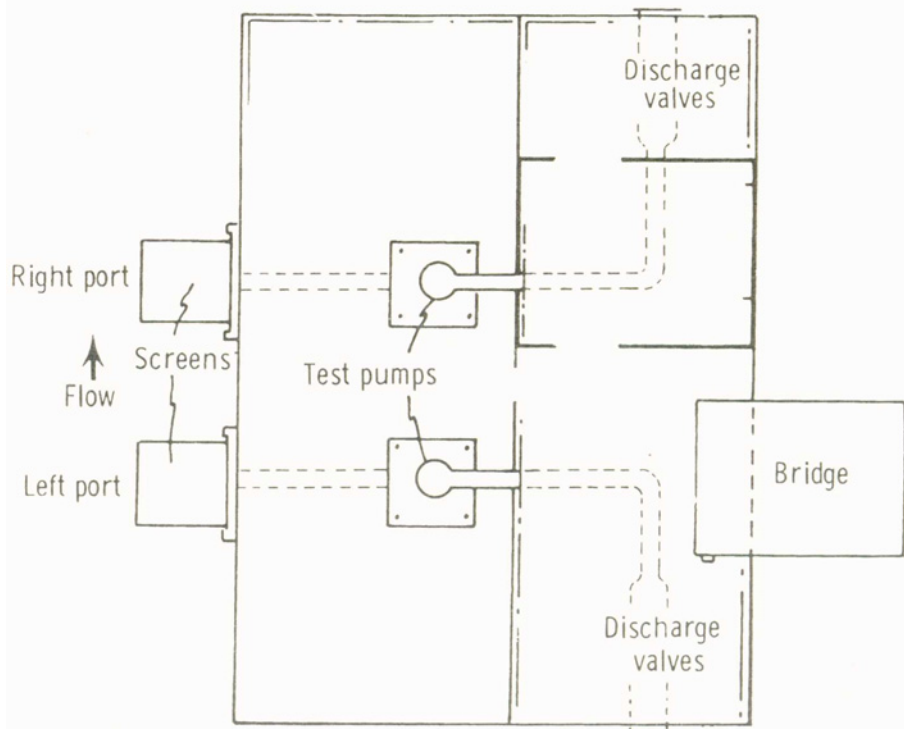
*CWIS Traveling Screen Impingement* – As noted above, impingement rates at the Chalk Point facility were very high when the facility first began operation, with on the order of 2 million fish and 2 million crabs being impinged annually (Figure 3). The primary factor contributing to these high impingement rates was the apparent attractiveness of the intake canal to both fish and crabs, with the result that high densities of organisms would regularly occur in front of the intake screens. Chalk Point consulted with PPRP on means of reducing impingement that would have costs within the limits specified in Maryland’s CWIS regulations (BTA is defined in Maryland regulations as being CWIS modifications the cost of which would be less than five times the value of the organisms lost to impingement). Because the cause of the high impingement was the high densities of organisms in the intake canal, the first feasible method tested was the deployment in 1981 of a single, 1.25-inch stretch mesh barrier net at the intake canal entrance, that would prevent organisms from moving into and concentrating in the canal. Deployment of this net reduced impingement by more than 75% (Figure 3), but did not resolve some of the operational problems. In particular, small crabs continued to occur in the intake canal in high abundances. Thus, in 1984, a second, smaller mesh net (0.75-inch stretch mesh) was deployed behind the first net, net supports and anchors were modified, and the manner in which the net was deployed was changed. These modifications resulted in further declines in impingement rates, with a total reduction of about 90% (Figure 3) (Loos, 1987). More detailed documentation of the Chalk Point barrier net studies can be found in the paper by David Bailey of Mirant Energy in this volume.



**Figure 3.** Average annual total number of fish and crabs impinged at the Chalk Point SES prior to installation of a barrier net (1976-1977), after installation of a single 1.25 in mesh barrier net (1982-1983), and after installation of a double barrier net system, with 1.25 in and 0.75 in mesh (1984-1985).

*Bay anchovy entrainment* – PPRP assessments of biological impacts at Chalk Point included extensive modeling to quantify the effects of entrainment on the Patuxent River ecosystem (MMES 1985). Using hydrodynamic modeling and field data on ichthyoplankton densities and distributions, PPRP estimated that as much as 76% of the Patuxent River bay anchovy stock was being lost to the ecosystem as a result of entrainment mortality. Bay anchovy is a forage fish of great value to recreationally and commercially important predator species in the river. PEPCO consultants conducting independent modeling concluded that entrainment losses were only as high as 25%. Many factors contributed to the divergent modeling results, with no clear means of firmly establishing which estimate was

most reliable or realistic. Given the potential significance of entrainment losses of this magnitude, PPRP concluded that it was appropriate to investigate the feasibility of intake technologies that could reduce entrainment at Chalk Point. Thus, PPRP initiated studies of wedge-wire screens at an in-situ testing facility at the plant. PEPCO cooperated in the study by providing on-site testing locations and a variety of support. Details of the testing methods and procedures can be found in Weisberg et al. (1987). The exclusion efficiency of cylindrical wedge-wire screens was investigated by measuring entrainment of larval bay anchovy and naked goby through screens with slot sizes of 1, 2 and 3 mm, and through an unscreened intake, with the screens mounted on a barge moored in the Chalk Point intake canal (Figure 4). The degree of exclusion by the screens increased with fish size. Fish less than 5 mm were not excluded by any of the screens, while ichthyoplankton larger than 10 mm were excluded by screens of all slot sizes (Weisberg et al., 1987). While the screens were confirmed to have the capability for significantly reducing entrainment, issues arose concerning the potential for screen fouling and corrosion in an estuarine environment, and the high cost of employing fine mesh screens for intake volumes as large as those at Chalk Point. The questionable feasibility for successful deployment of this technology at this facility, and disagreement on the magnitude of the entrainment problem, led to negotiations between PPRP and PEPCO on alternative resolutions of the entrainment issue. The outcome of these negotiations was an agreement, incorporated into the Chalk Point NPDES permit, on fisheries enhancements that would serve as out-of-kind mitigation for the entrainment impacts. PEPCO was required to implement several different enhancement projects, including removal of barriers to anadromous fish migration in tributaries to the Patuxent River, and implementing an aquaculture program to produce striped bass, yellow perch, and American shad for stocking in the river. Maryland DNR believes that the gradual recovery of stocks of these species in the Patuxent River over the past 20 years has been enhanced as a result of this mitigation program.



**Figure 4.** Plan view diagram of the PPRP wedge-wire *in-situ* testing barge; water was withdrawn through test screens and samples collected at the pump discharge points.

### Calvert Cliffs Nuclear Power Station

Calvert Cliffs is owned by Constellation Nuclear, a member of Constellation Power Source, Inc., (formerly Baltimore Gas and Electric Company, BGE). Maryland's only nuclear power plant, it is located on the Chesapeake Bay mainstem in Calvert County. It has a generating capacity of 1,675 MW, and employs a once-through cooling system utilizing 2.5M gpm. It has a shoreline intake embayment with a curtain wall that extends 8.5 m below the surface,

and a 1,460 m long, 15.5 m deep dredged intake channel from the curtain wall to the main channel of the Bay. Units 1 and 2 began operating in May 1975 and April 1977, respectively.

Because of its size and the extent of controversy surrounding its location and construction, Calvert Cliffs was the subject of intense scrutiny and environmental assessment. Utility contractors conducted a wide range of intense environmental studies to satisfy Nuclear Regulatory Commission license technical specifications. These utility studies were augmented by extensive PPRP-funded studies. All of these studies and their findings are described in detail in MMC (1980), which summarized PPRP’s conclusions regarding biological impacts of Calvert Cliffs. At this facility, impingement of fish and crabs was the issue of greatest concern. When the plant first began operating, very large numbers of both fish and blue crabs, often more than 1 million annually, were impinged (Figure 5; data from Ringger, 2000). At issue to PPRP was whether this magnitude of impingement would have an adverse impact on fish and blue crabs stocks within Chesapeake Bay. This issue was addressed in a number of ways, three of which are discussed here: evaluation of species-specific mortality rates due to impingement; investigation of alternative intake technologies to reduce entrainment and/or impingement; and, assessment of factors causing impingement and means of mitigating for those factors.

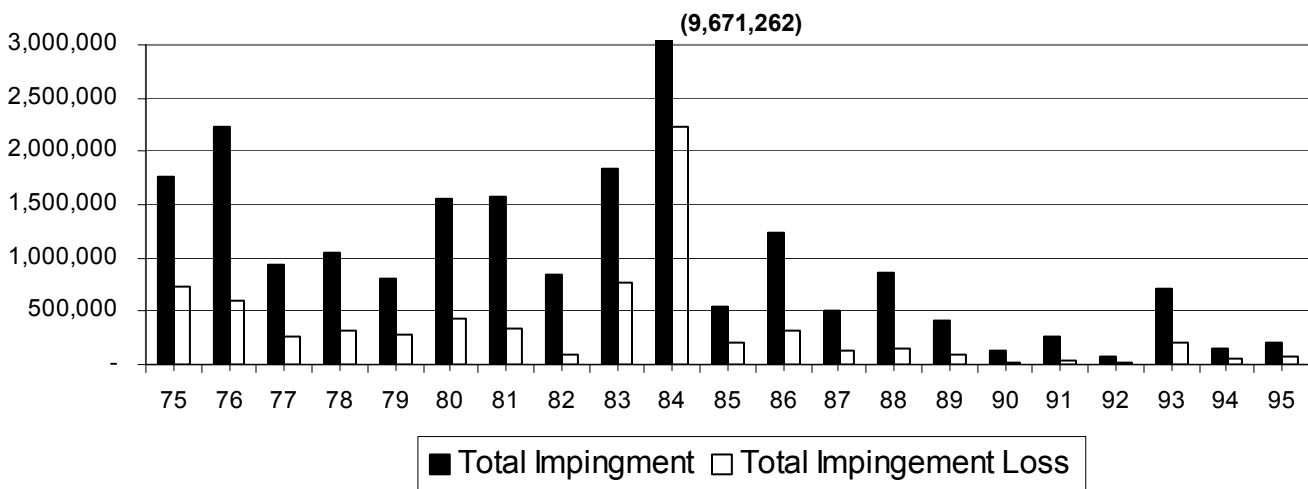
*Species-specific impingement mortality rates* - While large numbers of organisms were being impinged on the 9.6 mm mesh intake screens, those organisms were regularly washed from the screens and returned to the Bay, with many organisms appearing to be alive and viable. The real impact of impingement is a consequence of organisms that suffer mortality, and thus it was important to establish the level of mortality experienced by the impinged organisms. To quantify the survival rates, BGE used holding tanks along the screen wash trough into which organisms removed from the troughs could be maintained for 48 hours to determine immediate and chronic mortality rates. Over the course of these studies conducted from 1975 to 1981, 57 species and over 100,000 individual organisms were examined (Ringger 2000). Most mortality occurred within the first 16 to 24 hours after impingement. Table 1 from Ringger (2000) presents the 48-hour survival rates of 14 species that were among the five most numerous impinged fish species in any single year. Eleven of these 14 fish species demonstrated survival rates of 50% or greater, with 5 exhibiting greater than 90% survival. Blue crabs, which were also studied, had overall survival of 99.5%. These studies also showed that survival with continuous screen rotation, which would have reduced the time that organisms were trapped on the screens, was not significantly different from survival with normal screen wash operations, with screens being rotated for 10 minutes and stationary for 50 minutes of each hour. Thus, the study documented the efficacy of different screen operations procedures for minimizing impingement impacts. The survival rates established from BGE’s extensive studies were then applied by PPRP to total impingement rates in order to quantify the numbers of organisms actually being lost to the Chesapeake Bay ecosystem as a result of impingement at Calvert Cliffs.

**Table 1. Average percent survival of the fourteen fish species that were among the five most numerous impinged fish species in any single study year; survival was based on fish condition in holding pools 48 hours post impingement (from Ringger 2000)**

<i>Most Common Species</i>	<b>Percent survival</b>
Blueback herring	47
Bay anchovy	68
Atlantic menhaden	52
Weakfish	38
Threespine stickleback	91
Skilletfish	93
Spot	84
Atlantic silverside	54
Atlantic croaker	19
Summer flounder	90
Northern searobin	50
Winter flounder	93
Northern pipefish	85
Hogchoker	99

*Assessment of an alternative intake screening* – While the mortality studies showed that consequences of impingement were not as great as implied by numbers of organisms impinged, impingement rates were high and remained a concern to PPRP. BGE undertook a number of investigations of alternative screening technologies to determine if such technologies could help reduce impingement. Among the screening technologies tested was Royce “Smooth-Text” screens, finer mesh screens that offered the possibility of reducing entrainment of smaller species such as bay anchovy. These screens were installed in place of several of the existing traveling screens, but resulted in substantially higher impingement than existing screens at other intakes in the embayment. As a result, the technology was rejected for further study. This illustrates the iterative process that must often be followed in establishing whether a particular technology will be effective at a specific plant, and which of a number of technologies is the most effective means of achieving fish protection objectives. Maryland has addressed impingement and entrainment issues on a site-specific basis in this manner.

*Assessment of factors contributing to impingement* – In addition to evaluating alternative screen operations and alternative screening technologies, BGE and PPRP consulted on additional means of reducing impingement. The relatively high impingement rates during the early years of plant operation peaked in 1984 (Figure 5), when over 9 million fish were impinged (Ringger 2000). During a single major impingement episode, 46 thousand fish, primarily Atlantic menhaden, were impinged in a single hour at one unit in 1984. Episodes of this magnitude sometimes resulted in screen failure and plant shutdown, and it was thus of great economic value to BGE to reduce or eliminate the factors responsible for such episodes. A detailed evaluation of environmental conditions occurring during major impingement episodes revealed that they were associated with low dissolved oxygen conditions in the intake embayment. The curtain wall of the embayment, extending down to 8.5 m below the surface, was intended to have the plant draw cooler, bottom waters from the Bay. These deeper waters frequently exhibit low dissolved oxygen levels as well as low temperatures. When low dissolved oxygen events occurred, oxygen levels in the embayment dropped to lethal levels, and fish aggregated in the embayment were incapacitated and impinged in great numbers. A number of simple and inexpensive solutions were found to correct for these contributing factors. During periods when low dissolved oxygen conditions were most likely to occur, several curtain wall panels were removed, thus providing an oxygenated route for fish to move out of the embayment into open Bay waters. In addition, aerators were installed in the embayment to enhance surface oxygen levels. These simple measures resulted in a significant decline in impingement that has been maintained since they were implemented. Figure 5 illustrates the reduction in both numbers of fish impinged but also in mortality rates of those impinged fish. It should be noted that these reductions in impact were achieved with no change in screen technology or operation.



**Figure 5.** Annual fish impingement and fish lost to impingement at the Calvert Cliffs nuclear power plant (data from Ringger 2000)

### **Morgantown Steam Electric Station**

The Morgantown SES, located on the estuarine portion of the Potomac River in Charles County, is owned by Mirant Energy (formerly PEPCO). It has a total generating capacity of 1,411 MW, and utilizes a once-through cooling system with a capacity of 1M gpm. As with all other power plants in Maryland, Morgantown was the subject of intensive PPRP study and evaluation, as is summarized in Bongers et al. (1975). One CWIS issue of particular concern at Morgantown was the fact that organisms impinged on intake screens were transported in the screen wash trough to the cooling system discharge canal. The consequence of this fish handling system was that organisms that may have already been stressed due to impingement were then exposed to abrupt and significant temperature increases and thermal stress. Predictive assessments suggested that these combinations of stressors could result in survival rates considerably lower than were being documented at facilities such as Calvert Cliffs, where impinged organisms were discharged directly into the source water body. As a result of these concerns, PPRP requested that PEPCO investigate alternative fish return configurations and technologies. PEPCO's consultants identified and evaluated a number of different alternatives for reducing fish impingement losses, including a variety of diversion devices (e.g., louvers, revolving drum screens), behavioral barriers (e.g., bubble screens, lights, sound), fish collection devices (e.g., fish pumps), physical barriers (e.g., wedge-wire screens, barrier nets) and alteration of plant operations (Stone and Webster Engineering, 1981). This evaluation included an assessment of engineering feasibility and cost, as well as potential for reductions in impingement mortalities. In subsequent negotiations between the State and the plant owner, the diversion of screen wash from the discharge canal into the Potomac River main stem was determined to be the least cost means of achieving a substantial reduction in impingement mortality at this facility. That modification of CWIS was then considered to be BTA at this plant. In this instance, PPRP raised the issue with the plant owner, consulted on the work to be performed by the plant's contractor, and reviewed and utilized the study findings in making its NPDES CWIS recommendations to MDE.

### **Conclusions**

This brief overview provides several diverse examples of the process employed by Maryland in making power plant BTA determinations under Maryland's CWIS regulations. The major points I wish to convey include:

- ▶ Impingement and entrainment impacts can be significantly reduced by a wide variety of changes in intake structure operation, fish handling, external structure design, etc.; no single operational or technological change will have the same effects or benefits at all facilities
- ▶ Site-specific results of implementation of CWIS impact reduction measures cannot be accurately predicted, so site specific studies and evaluation are critical to successful, cost-effective reductions of CWIS impacts, and
- ▶ Cooperative efforts between regulators and permittees are the most timely and cost-effective way of ensuring that CWIS impacts are minimized

### **Acknowledgements**

I would like to acknowledge the contributions of William Richkus, Ward Slacum, Steve Schreiner and Sherian George, of Versar, Inc., in the preparation of this paper, as well as the symposium presentation on which this paper is based.

### **References**

Bongers, L. H. et al., 1975. The Impact of the Morgantown Power Plant on the Potomac Estuary: An Interpretive Summary of the 1972-1973 Investigations, Environmental Technology Center, Martin Marietta Corporation, PPSP-MP-15, December 1975. NTIS No. PB-296203.

Cadman, L.R. and Holland, A. F., 1986. Evaluation of auxiliary tempering pump effectiveness at Chalk Point Steam Electric Station. Prepared by Martin Marietta Environmental Systems, Columbia, MD. Prepared for Maryland Department of Natural Resources, Power Plant Siting Program, Annapolis, MD.

Loos, J. J., 1987. Chalk Point Station intake liability values computed after deployment of a second barrier net at the mouth of the intake canal and after discontinuation of auxiliary tempering pump usage. Potomac Electric Power Company, Washington, DC.

MMC, 1980. Summary of Findings: Calvert Cliffs Nuclear Power Plant Aquatic Monitoring Program. Prepared by Environmental Center, Martin Marietta Corporation, Baltimore, MD. Prepared for Maryland Department of Natural Resources Power Plant Siting Program, Annapolis, MD.

MMES, 1985. Impact assessment report: Chalk Point Steam Electric Stations Aquatic Monitoring Program. Prepared for the Maryland Department of Natural Resources, Power Plant Research Program, Annapolis, MD. CPC-85-1.

Ringger, T. G., 2000. Investigations of impingement of aquatic organisms at the Calvert Cliffs Nuclear Power Plant, 1975-1995. *Environmental Science & Policy* (2000): S262-S273.

Stone and Webster Engineering, 1981. Alternative intake designs for reducing fish impingement losses, Morgantown Steam Electric Station, Potomac Electric Power Company.

Weisberg, S.B., Burton, W. H., Jacobs, F. and Ross, E., 1987. Reductions in ichthyoplankton entrainment with fine-mesh, wedge-wire screens. *North American Journal of Fisheries Management* 7:386-393.

---

#### *New York*

*Edward W. Radle (retired) and Michael J. Calaban, New York State Department of Environmental Conservation, Steam Electric Unit*

#### **BIOSKETCHES**

Mr. Ed Radle is the now-retired, former Steam-Electric Unit Leader for the New York State Department of Environmental Conservation, Division of Fish, Wildlife, and Marine Resources. Mr. Radle has an Associates Degree in Chemical Engineering from Keystone College in Pennsylvania, a B.S. in Biology from Fairleigh Dickinson U. in New Jersey, and a M.S. in Marine Fisheries from the University of Delaware. Mr. Radle has spent the past 25 years with the NY DEC, initially as an Aquatic and Terrestrial Ecologist, then as the Hudson River Program Coordinator, and finally as the Steam-Electric Unit Leader. The Unit's primary work involves specifying monitoring programs, and where necessary, working with permittees and interested parties to mitigate aquatic impacts at water intakes as part of the state's SPDES permit program.

Mr. Michael Calaban works as a biologist for the New York State Department of Environmental Conservation (DEC). Mr. Calaban received his B.S. and M.S. in Biology from the State University of New York College at Brockport. After graduation he worked as a technician for an environmental testing laboratory in Hackensack, NJ, and for the Department of Neurology at Albany Medical Center. He has worked for the State of New York for 18 years, for both the Department of Health's Bureau of Toxic Substance Assessment, and the DEC Division's of Permits, and Fish, Wildlife and Marine Resources. For the past 13 years he has worked on energy issues for the Division of Fish, Wildlife and Marine Resources. His work is primarily focused on mitigating adverse aquatic impacts from the operation of large cooling water intake systems.

#### **Technical Paper**

##### **Abstract**

This paper highlights NYSDEC's efforts over the last 25 years to advance intake mitigation technology in New York State and briefly reviews their effectiveness and application. The flurry of activity in exploring technologies and operational modes to reduce the impacts of withdrawing cooling water from natural systems that characterized the mid-1970s through the early 1980s across the country continues to this day in New York State. Efforts to further



develop intake mitigative technologies is based on the realization that the requirement to install best technology available (BTA) to minimize adverse impacts is an empty promise absent efforts to advance the existing state of the art. The requirement to install a particular mitigative technology at a cooling water intake, however, must also pass a reasonableness test, and we have interpreted that to mean that the cost of mitigation should not be wholly disproportionate to the benefits to be realized.

Installation of closed cycle condenser cooling, with its attending reduction in water use, minimizes both impingement and entrainment of fish. However, the expense of retrofitting this technology at existing facilities frequently does not pass the wholly disproportionate test. Other than reducing cooling water use, the only other technology we believe to have the potential to be effective in mitigating the entrainment of early life stages of fish is an aquatic filter barrier (AFB), an emerging technology in New York State. Past efforts to apply cost effective reductions in impacts at cooling water intakes have led to our work with traveling intake screen modifications, fish return systems, passive wedge wire intake screens, barrier nets and behavioral devices.

### **Introduction**

The New York State Department of Environmental Conservation (NYSDEC) has been working to mitigate cooling water intake impacts at steam-electric power plants since shortly after the National Pollution Discharge Elimination System program was delegated to New York State in 1975. Steam-electric power plants impinge many millions of juvenile and adult fish and entrain billions of fish eggs and larvae from New York State waters each year. The NYSDEC Division of Fish, Wildlife and Marine Resources (DFWMR) addresses the biological impacts resulting from the operation of cooling water intake systems and thermal discharges.

Similar to Section 316(b) of the Clean Water Act [33 U.S.C. Section 1326(b)], New York State established regulations for the withdrawal of water from natural waterbodies for cooling purposes. 6NYCRR 704.5 requires: "The location, design, construction and capacity of cooling water intake structures, in connection with point source thermal discharges, shall reflect the best technology available for minimizing adverse environmental impact.". Adverse environmental impact has been generally defined by the NYSDEC as mortality or injurious or harmful effects, including those effects on individual organisms. Mitigation is aimed at minimizing any mortality or injury, but not at a cost that is wholly disproportionate to the environmental benefit to be gained.

The NYSDEC is at the national forefront in the development and application of state of the art technologies to achieve BTA at cooling water intakes. Staff have nurtured productive working relationships with industry and the environmental community to help advance the state of cooling water intake mitigation technology and have made significant accomplishments. This paper provides an overview of the efforts and technologies applied to minimize fish mortality at cooling water intakes in New York State over the past 25 years.

### **Overview of Technologies used at Cooling Water Intakes**

#### Low Technology Solutions

##### *Direct Return of Fish and Debris*

For many years, the standard practice for the handling of fish and debris screened from condenser cooling water was to collect the material for upland disposal. The NYSDEC recognized that a return of this material to the waterbody could be a low cost benefit to both the environment (through survival of at least some fish), and industry (through reduced operational and disposal costs). By the 1980s, improvements in water quality under the Clean Water Act had resulted in screen wash debris containing more fish and less trash, making the return of this material all the more important. Returning fish and debris to the waterbody became a common requirement placed into discharge permits issued for steam-electric power plants. This usually required constructing some conveyance between the screenhouse and point of discharge. In the case of the Albany Steam Generating Station, located on the Hudson River, an inground sluice was built to transfer fish to the thermal discharge canal, thus allowing the 300,000 fish impinged on average each year to be returned to the Hudson River. At the Ravenswood Station located in New York City along

the East River, screen washings at each of three units were collected in a wire basket suspended within a 10 foot deep concrete pit. To return fish to the East River, they must be safely transported through the debris pit with a minimum of stress. The utility accomplished this by installing aluminum and plastic spiral sluices, modeled after playground slides, to smoothly convey fish and debris to a discharge pipe located at the bottom of each pit. The sluices eliminated debris and odor problems. The cost of materials and labor was under \$3,000 per unit. In most cases, these requirements were considered to be interim measures, to be in use until the station's impact could be addressed in full. Although success of these installations has not been quantified by post-operational monitoring, they have operated well, and many fish that would have otherwise been carted to landfills have been returned safely to the water. Those fish that do suffer mortality become a food source for scavengers such as American eels, crayfish and blue crabs rather than contributing to landfill problems.

#### *Management of Cooling Water Flow*

The volume of cooling water withdrawn can be an important determinant of the magnitude of impacts to fish at a cooling water intake. Some flow management alternatives used for a number of years in New York State, such as reduced winter pumping, offer a simple approach to seasonally reducing cooling water use and protecting resources, while reducing operational costs to generators. Pumping less cooling water during periods of low ambient water temperatures can reduce energy consumption, increase plant thermal efficiency, and reduce plant maintenance and internal wear to items such as condenser tubes.

At the Dunkirk Steam Station, located along the southeast shore of Lake Erie, NYSDEC approved the utility's request to shut down one or more circulating water pumps when ambient intake water is below 50 degrees F. During the winter period (generally November through March), it was estimated that cooling water withdrawal could be reduced by 40 %. Winter is a period of high impingement for species such as rainbow smelt at the Dunkirk Station and this operation is expected to provide a cost effective reduction in fish mortality (Beak Consultants, Inc. 1988).

As a consequence of reducing cooling water volume, Dunkirk Station's intake-discharge temperature differential ( $\Delta T$ ) was permitted to increase from 16 to 28 degrees F during this period. Some concern existed over an expected increase in the thermal discharge plume's near field temperatures (although no increase in total heat rejection occurred), and the subsequent attraction to fish and potential for cold shock. Therefore, additional provisions were placed in the facility's State Discharge Elimination System (SPDES) permit to prevent a rapid shutdown of the Plant's thermal discharge and lessen any potential for cold shock induced mortality to fish acclimated to the thermal plume. The program has been in place since 1994, and no rapid plant shutdowns have occurred.

The Somerset Power Station, located along Lake Ontario in Niagara County also reduces cooling water flow during the winter period. In 1987, the station studied the effects of using two rather than three circulating water pumps when intake temperatures were 50 degrees F or less. Results showed that with the condenser in a clean condition, circulating cooling water could be reduced by 22.6% when operating with two circulating pumps (NYSEG et.al., 1988). Improvements in both heat rate and unit reliability were noted under two pump operation, as well as cost savings due to running one less circulating water pump. An economic analysis indicated a savings of more than \$3 million (1987 dollars) over a 30 year life cycle.

Impingement of fish has been monitored since the Somerset Station began commercial operation in 1984. Table 1 shows impingement for all species between 1985 and 1993 during periods of the year which include reduced pump operation. In years when reduced winter pumping was in effect (1988 and later), impingement is substantially reduced in all but one year.

**Table 1.** Impingement at the Somerset Station

Month	1985	1986	1987	1988*	1989*	1990*	1991*	1992*	1993*
April	18,060	486	44,925	372	155	2,492	67,918	424	11,412
May	2,764	4,624	409	558	2,369	1,061	308	3,256	324
June	5,468	2,931	360	635	10,800	460	237	2,869	6,743
July	9,586	24,008	572	3,681	23,369	413	1,151	689	3,175
Nov.	22,726	196,862	3,145	1,222	5,446	5,195	218	1,771	417
Dec.	52,364	39,023	8,110	1,900	1,056	1,129	10,322	1,976	0
<b>Total</b>	<b>110,968</b>	<b>267,934</b>	<b>57,521</b>	<b>8,368</b>	<b>43,195</b>	<b>10,750</b>	<b>80,154</b>	<b>11,012</b>	<b>22,071</b>

Estimated monthly impingement at the Somerset Station (all species) from 1985 to 1993. Years with two-pump winter operation are denoted with an asterisk. From Beak Consultants (1993).

Traveling Intake Screen Modifications

*Through Flow Traveling Intake Screens*

Standard traveling intake screens, designed to keep debris from plugging the plant’s condenser tubes, are not fish friendly. Numerous studies have shown that only the hardier species of fish have high rates of impingement survival off standard intake screens. A large part of our effort has been to help advance protective intake screen technology and apply it where necessary. The most common type of traveling intake screen in New York State is the through flow screen, which is a rotating belt of screens facing perpendicular to flow. An early advance made to this type of screen was to fit a bucket or fish rail on the bottom of each screen panel to maintain impinged fish within a water filled trough as they are lifted from the surface for transfer to the fish return sluice. A reconfiguring of the rail to reduce turbulence and create a sheltered zone within the rail was an important achievement developed by Ian Fletcher in his work at the Indian Point Nuclear Generating Station (NGS) (Figure 1). (Fletcher 1990). The turbulence, or a secondary flow that swirls the fish around inside the rail, is thought to be a major source of injury during the impingement process. Other important features of the modified through flow or “Ristroph” screens are the smooth textured mesh panels, free slide screen panel articulation that allows fish to slide into the water filled return trough, and low pressure fish sprays. These design features have worked to markedly reduce injury and improve impingement survival for nearly all species of fish studied. Fletcher (1990) reported the results of a 1986 study at the Indian Point Station, where 8,882 fish, representing 34 taxa were collected and held for post-impingement survival from modified Ristroph screens, and more than 45,000 fish were collected for testing from standard (unmodified) screens. Because the screen types were tested during different seasons, the species compositions from the two screen types differed considerably. For the six species collected in greatest abundance and common to both screen types (more than 10,000 fish), the 8 hour post-impingement survival (all species combined) was 84.5% from the modified screen as compared to 37.6% from the standard screen. Ristroph type modified screens are installed and operating at the Indian Point NGS (DEIS for Bowline, Indian Point 2 & 3, and Roseton Steam Electric Generating Stations, 1993).

At the Huntley Generating Station located along the Niagara River, modification of the through flow traveling screens and a dedicated fish return system were determined to be BTA to mitigate the 1 to 2 million fish estimated to be impinged each year. The fish protection technology was further developed by the Station owners at Utah State University’s Water Research Laboratory (personal observation). The design of the fish bucket or rail was optimized through computer analysis and verified in the laboratory’s test flume. An additional feature was added inside the rail to enhance the stalled fluid zone within. Smooth top mesh, low pressure fish sprays and wide water filled collection trough system were also part of the design. The screens were installed in 1998 and tested in the fall and winter of 1999. Nearly 10,000 fish were collected and held for 24 hour post-impingement survival tests to verify the screens performance. The overall survival rate was 78.1%, which included large numbers of delicate species such as alewife, rainbow smelt and gizzard shad that typically do not survive the impingement process well (Beak Consultants, Inc. 2000). The cost for new screens was approximately \$1.6 million dollars.

### *Dual Flow Traveling Intake Screens*

Dual flow screens are also rotating screen belts, but with the screen panels oriented parallel to the intake channel flow. Unlike through flow screens, both sides of the dual flow screens (ascending and descending) are used for filtering water (Figure 2). Because they virtually eliminate debris carryover (a significant problem with through flow screens), they can be attractive for use in high debris load situations. In addition, it was thought by the industry that the greater screen filtration area (through use of both screen sides for filtering) allows for lower through screen velocities and lower stress on impinging organisms. However, soon after their use in New York State, it was noted that flow across dual flow screens was very non uniform, raising concern over areas of high velocity and increased stress to impinging fish. Figure 3 shows that as cooling water turns to enter each side of the dual flow screen, a separation in flow occurs whereby the flow becomes concentrated at the back of the screen, creating an eddy current of backward flow out through the front of the screen. Therefore, only part of the screen is actually filtering water. This effect was evident at the Dunkirk Station, where only the rear half of the dual flow screens were collecting debris (personal observation). In flume tests, flow velocities of 30 and 45 cm/s measured at the face of conventional through flow screens increased to 90 and 140 cm/s over sections of dual flow screens, due to flow separation (Fletcher, 1994). These fluid "hot spots" are a likely cause of post impingement fish injury as evidenced by low survival rates recorded from standard dual flow screens in both laboratory studies and in the field.

The velocity problem to a large extent has been solved through use of an elliptical shaped nose cone or fairing device, developed by Ian Fletcher (Figure 4). Installed on the front wall of the screens, the nose cone allows for a more gradual turning of the water as it enters the screen face and a more even distribution of flow across the screens. At the Arthur Kill Generating Station, 24 hour impingement viability was assessed on both standard dual flow screens and those modified with a fairing plus the full compliment of Ristroph enhancements (improved fish rail, smooth top mesh, low pressure fish sprays and free slide panel design). A total of 16,427 fish representing 59 species were tested from 1994-1995 (Con Edison 1996). Post-impingement survival (all species combined) from the standard dual flow screen (1/8 inch square mesh) was 15.2%. Survival, and increased to 78.9% on the modified screen equipped with 1/8 X 1/2 inch smooth mesh and to 92.4% on the modified screen equipped with 1/8 X 1/4 inch smooth mesh. The modified dual flow screens were judged to perform as well as modified through flow screens. The improved survival from the larger mesh screen was thought to be a function of its selection for older and hardier individuals (Con Edison 1996).

The Dunkirk Steam Station, located along Lake Erie, has imposed the largest impingement impact in New York State. In 1987, nearly 28 million fish, primarily emerald shiner, rainbow smelt and gizzard shad, were estimated to have been impinged at the plant. A single dual flow screen was modified with Ristroph type enhancements further developed at Utah State University's Water Research Laboratory (similar to those installed at the Huntley station). In addition, a rectangular design front wall fairing was developed and modifications made to the fish rail (a vortex suppressing ledge), and in the screenwell upstream of the screens to more uniformly distribute flow across the full width of each dual flow screen. Post impingement survival from the prototype screen was assessed over a one year period (1998-99). Table 2 summarizes survival results for seven species common to the standard dual flow screens study in 1987, and for the prototype Ristroph modified dual flow screen study in 1998-99 (Beak Consultants, Inc. 2000). Post-impingement survival of the more than 20,000 fish tested was similar to results obtained from the Indian Point and Arthur Kill modified screen studies. The remaining six screens at the station were modified in 2000, and together with an offshore fish return system, are now returning millions of fish to Lake Erie with a high rate of survival. Cost for new modified screens and additional flow straightening work performed in screenhouse 2 was approximately \$1.5 million dollars.

**Table 2.** Dual Flow Screen Impingement Survival Studies (Beak Consultants, Inc. 2000)

Target Species	Standard Screens (1987)		Modified Screen (1998-99)	
	S (%)	N	S (%)	N
alewife	4.1	73	29.6	879
emerald shiner	82.7	891	97.3	12,420
gizzard shad	48.3	1,013	92.5	4,058
rainbow smelt	51.7	1,217	74.3	1,453
white bass	73.6	424	98.1	155
white perch	55.5	279	100.0	69
yellow perch	95.0	139	98.8	259

Comparison of 24-hr. impingement survival rates (S) of target fish species, and number of fish (N) at the Dunkirk Steam Station from standard dual flow screens in 1987, and a modified prototype dual flow screen in 1998-99.

**Flow Management - Use of Variable/Multiple Speed Pumps**

Variable and multiple speed pumps can be used to reduce cooling water flow on both a seasonal and daily basis, and can therefore be used to help minimize the abundance of organisms impinged and entrained at steam-electric power plants. In New York State, variable or multiple speed circulating water pumps are in use at the Indian Point Nuclear Generating Station and at the C.A. Poletti Power Project located on the East River (New York Power Authority, personal communication). In addition, assessments of this technology have been conducted at several other power plants located along the Hudson River Estuary and New York Harbor.

This technology can benefit plant operations as well as the environment. Electric power is produced most efficiently when the cooling water flow rate is at a minimum needed to condense exhaust steam from the turbine. Cooling water use in excess of this minimum is undesirable because the condensed steam may be cooled below saturation temperature, requiring more energy to re-heat it. At stations whose generating loads follow seasonal and/or daily demand patterns, modulation of the cooling water flow to maintain a high thermal efficiency can result in large reductions in cooling water use and the number of organisms entrained. An engineering analysis of the theoretically achievable flow reductions through the use of variable speed pumps at the Arthur Kill Generating Station, located in New York City along the Arthur Kill tidal straight, concluded that the annual flow could be reduced at the Station's two units by 43% and 59% respectfully (LMS, 1999). Depending upon the relative timing of flow reductions and abundances of ichthyoplankton subject to entrainment, reductions in the entrainment of passive organisms like ichthyoplankton could be substantial. Plant heat rate effects, discharge temperature limits, temperature related mortality to entrained fish, and potential entrainment reductions all need to be carefully assessed so that the maximum benefits to both the environment and station operation are obtained.

**Fish Return Systems**

As discussed, low tech systems to return fish to the waterbody, often through the station's thermal discharge, have been constructed as interim measures at a number of plants. For facilities that have optimized fish survival from their traveling intake screens, a dedicated fish return system is necessary to complete the BTA process. Return pipes are constructed with smooth interior surfaces, wide angle bends for gradual transitions in direction and elevation, and discharge points well below the water's surface. Fish pumps are only used if necessary to maintain adequate flow.

The cost and complexity of fish return systems can vary greatly. For the Huntley Steam Station, returning fish from the newly modified screens was a relatively simple matter. The fish and debris sluices discharge first into a steel pipe, then into an 18 inch diameter high density polyethylene (HDPE) pipe which leaves the screenhouse and is suspended along the sheet pile wall along the Station's river front. The end of the return structure is located up stream and out of the influence of the Station's thermal discharge, and was designed for smooth entry of fish into the river. The return system is gravity operated, and therefore avoids added stress to fish through operation of a fish pump. The cost of the return system was approximately \$ 400,000 dollars (Niagara Mohawk Corporation, personal communication).

At the Dunkirk Steam Station, the fish return system was actually constructed before the screens were modified, and was a much more challenging project. Because of local opposition existed to discharging the large quantities of fish and debris typically impinged at the Station back to Dunkirk Harbor, the only other option available was to construct a return line to the Lake proper. Directional drilling was used to construct a tunnel underneath a federal navigation channel, terminating at a discharge point approximately 1250 feet offshore and lakeward of a harbor breakwall. Fish and debris washed from the screens in each screenhouse are joined into a 24 inch diameter HDPE pipe before traveling under the lake bottom. Because of insufficient hydraulic head, a pumped system consisting of a 28 inch variable speed, screw type impeller Hydrostal Pump was installed. The pump operates at low rpm's (i.e. 200 to 350) to minimize damage to aquatic organisms, and is capable of passing up to a 9 ½ inch diameter, 36 inch long solid. Station personal have been pleased with the return system's operation, which has nearly eliminated the debris load problems of the past. The total cost of the fish return system was \$3.25 million dollars. The company estimated that they save approximately \$30,000 dollars per year in operating and disposal costs (Niagara Mohawk Corporation, personal communication).

New intake traveling screens to mitigate impingement impacts were included as part of the negotiated agreement that settled a NPDES permit disagreement at the Indian Point NGS. The Hudson River in the area of Indian Point is an estuary, with nearly equal ebb and flood tidal flows. As a consequence, simply releasing impinged fish downstream of the intakes raised concerns about possible recirculation of the fish back into the plant. The Hudson River Utilities were raising and stocking striped bass at the time. Each released fish was marked with a coded magnetic tag inserted into the cheek muscle so that the contribution of stocked fish to the existing population could be evaluated. In excess of 25,000 of these fish were released at numerous locations in the area of the plant with each release location having a specific tag code. An impingement census provided information on the percent of recirculation of these marked striped bass from each of the release locations. The southernmost unit, (Unit 3) had a suitable location at the distal end of the shoreline bulkhead diffuser, so a simple pipe carrying the screen washing and fish to that area was acceptable. The most practical location for Unit 2 resulting in approximately 3% recirculation was 240 feet offshore of the intake and in 40 feet of water.

The shoreline intake of Indian Point is 28 feet deep, and therefore releasing fish into water 12 feet deeper than their maximum pre-impingement depth exposure raised concerns about stress and possible subsequent mortality. Moreover, there is a substantial debris load in the river at times, and there was a question of the need to keep the fish return trough separate from the debris return to avoid further stress to returned fish. Separate return systems for both fish and debris would greatly increase the cost of the project.

In addition to strong tidal currents, the Hudson River in this area is quite turbid and has considerable ship traffic from large vessels. There was little expectation that an evaluation of the effects of the fish return terminus depth, and combining fish and debris in the same pipe could be done *in situ*. However, a nearby quarry provided ideal test conditions, and so a complete replica of the Indian Point screen wash and fish/debris return systems were constructed at the quarry. Test results indicated that fish could be returned with a large amount of debris in the same pipe with no apparent stress. Fish acclimated to surface pressure, however, did show signs of stress on a video monitor when confined to the rectangular test cage at 40 foot depths. When the rectangular cage was replaced with a cylindrical unit that allowed access to the full water column, test fish would quickly move up in the water column to a depth where they did not appear to be under stress.

### **Wedge Wire Intake Screens**

Wedge wire intake screens have been approved as BTA for a number of cooling water intake systems in New York State, such as the Westchester and Oswego Resource Recovery Facilities, the Brooklyn Navy Yard Cogeneration Plant, Cornell University's Lake Source Cooling System, and for several small cogeneration facilities. Wedge wire screens will be used in conjunction with other fish protection features such as the aquatic filter barrier (AFB) to filter cooling tower make-up water at two state approved repowering projects, the Bethlehem Energy Center (750 MW), and the Astoria Generating Station (1816 MW). These screens generally require little maintenance (no moving parts),

and their placement within the waterbody allows for easy debris removal via the air backwash cleaning system, as long as sufficient current exists to carry the dislodged material away. Because of these features, wedge wire screens can be an attractive option for power plant operators. However, because of the low through flow velocity design (0.5 feet per second (fps) or less) and need for relatively large screen surface area, their use has been mainly limited to facilities with lower cooling water requirements in New York State (personal observation).

Laboratory studies of wedge wire screens at the more narrow slot widths (<2.0 mm) have been shown to be effective at reducing the entrainment of early life stages of fish, and the impingement of older fish is virtually eliminated (Weisburg, et. al., 1987; EPRI 2003). The protective features of the screens are due to: 1) physical exclusion of organisms by the narrow screen slot widths (0.5 - 11.5 mm slot widths are available), 2) low through slot withdrawal velocities of 0.5 feet per second or less, 3) rapid dissipation of the through flow velocity as you move away from the surface of cylindrical shaped screens, which allows organisms with weak swimming abilities (e.g. fish larvae) an increased chance for escape, and 4) the placement of the screens within the waterbody which provides organisms with numerous escape routes from the screens.

Wedge wire screens with 2.0 mm slot widths are most commonly used in New York State. This slot width is narrow enough to provide a high degree of protection in most cases, while also allowing for relative operational ease. Entrainment studies conducted at the Brooklyn Navy Yard Cogeneration facility, and at other plants have shown that 2.0 mm slot wedge wire screens utilizing through slot withdrawal velocities of 0.5 fps or less, exclude well over 90% of the larvae of several species of fish (e.g. bay anchovy, winter flounder, gobies, grubby sculpin) that are greater than 15 mm total length (EA 1998). However, a 2.0 mm wedge wire provides less protection for eggs and smaller larvae (Weisburg et. al., 1987).

### **Barrier Nets**

Since 1976, an impingement barrier net has been deployed around the cooling water intake structure to mitigate fish impingement at the Bowline Point Generating Station. This facility consists of two 600 MW generating units located on the west shore of the Hudson River. A design cooling water flow of 912 MGD is withdrawn from a small bay, named Bowline Pond. The barrier net is deployed within the pond, extending the full depth of the water column, and is approximately 560 feet in length. The net is constructed of 0.38 inch multi-filament nylon mesh and is equipped with float lines, anchor attachments, a de-icing bubbler and debris boom. Annual deployment of the net occurs during historic peak impingement season at the Station, usually from early fall (October-November) through spring (May-June), and has proven to be effective in reducing impingement of fish at the Station. An impingement monitoring program, in effect since 1974, is used to evaluate the nets performance. Figure 5 shows the annual estimated impingement abundance (all species) from 1974 to 1999. Following deployment of the barrier net in 1976 and its refinement in 1977, the abundance of fish impinged has been reduced from more than 600,000 fish per year to an average of about 30,000 fish per year. Species such as white perch have benefited in particular, as they are typically impinged in greatest numbers during the colder months when the barrier net is in place (Normandeau 2001).

Occasional problems have occurred that affected net efficiency. A buildup of algae in 1981, and large amounts of detritus and leaf litter in 1982, 1987 and 1988, each caused the net to lift off the bottom and allow fish to enter the Station's intake thereby increasing impingement. In December 1999, the net was damaged by a submerged tree, leading to a high impingement episode over the first few days of the month. A regular inspection and maintenance program and impingement monitoring is important for ensuring that the barrier net remains intact and continues to keep fish out of the plant.

The barrier net at Bowline turned out to be a win-win situation for the environment and the station operators. The heavy debris load that often occurs in Bowline Pond frequently required station personnel to spend hours raking debris from the trash bar racks. The debris boom and the barrier net effectively eliminated this problem.

### **Behavioral Deterrent Systems - High frequency sound**

The J.A. Fitzpatrick NGS is an 821 MW facility, located on the south shore of Lake Ontario. The Station has an offshore intake and historically impinges several hundred thousand fish per year, of which approximately 70% are alewife. The alewife is a delicate species that does not survive the mechanical stresses of impingement well - even from modified traveling intake screens. Because the alewife is the major species impinged at Lake Ontario power plants, technologies that avoid impingement can provide superior impingement mitigation at this and other Lake Ontario power plants.

A number of behavioral deterrent systems (e.g. fish hammers, hanging chains, bubble curtains, strobe and mercury lights, etc.) have been studied by utilities in New York State for reducing impingement impacts. High frequency sound is the only behavioral deterrent technology shown to be effective and currently in use as an impingement mitigation technology in New York State. The technology is in use at the J. A. Fitzpatrick NGS and has effectively reduced the impingement of alewife at the Station. The fish deterrent system, known by the trademark "Fish Startle System", emits a high frequency broadband sound (122 - 128 KHz) at a source level of 190 decibels. The system has three major components: the integrated projector assemblies (IPAs), the power source taken from the heated bar rack supply and the computerized control panel. The IPAs contain the signal generators and transducers that emit at high frequency broadband sound which members of the herring family avoid. (Ross et. al. 1996).

In 1989, the New York Power Authority, who owned and operated the Fitzpatrick NGS, started developing the mitigation system after learning that high frequency sound evoked a strong avoidance effect in some species of herring. Laboratory testing was successfully conducted on alewife, then a temporary acoustic deterrent system was developed and tested in Lake Ontario in 1991. Preliminary results showed that the number of fish in front of the Fitzpatrick intake was reduced by 81 to 87% when the system was operated. Between April and July 1993, a second full scale test was conducted. Paired impingement samples were collected with the system on/off and compared against impingement samples collected at the nearby Nile Mile Point Unit 1 NGS (control facility). The Nile Mile Point Station is a similar sized NGS, with a similar off shore velocity-cap type intake structure. Ross et. al. (1996) reported the overall effectiveness of the system to be 84% (i.e. an 84 % reduction in impingement as compared to the control facility).

In 1995, the NYSDEC determined the acoustic deterrent system to be BTA for minimizing adverse environmental impact at the Fitzpatrick NGS, and the acoustic deterrent system has been in use since that time. Because high frequency sound has only been shown to be effective for certain clupeid species (alewife, blueback herring and American shad), the technology has limited application. The preliminary cost of a permanent fish deterrent system at the Fitzpatrick NGS was estimated to be about \$775,000 dollars (1993 dollars). The system was later reconfigured to eliminate unnecessary transducers, reducing the cost to \$525,000 dollars. Operational costs are about \$120,000 dollars per year (Dunning and Ross 1998).

### **Aquatic Filter Barrier (AFB) Systems**

An emerging technology for protecting aquatic organisms of almost all sizes from cooling water intakes is the aquatic filter barrier (AFB) system. Designed by the Gunderboom Company as a sediment barrier and oil boom, it has been modified and developed for placement around cooling water intakes for impingement and entrainment mitigation. The AFB system is a full depth curtain barrier, constructed of polyester fibers pressed into a water permeable fabric mat. Additional components of the AFB include anchors, flotation billets, an air back wash cleaning system and electronic monitoring equipment. The original fabric tested had a nominal pore space of 20 microns (0.02 mm) which is capable of excluding all life stages of fish. The original AFB was designed for a flow rate of approximately 5 gallons per minute per square foot (0.01 feet per second) (Gunderboom Inc., personal communication). The fabric can be made with perforations to increase filtration rate and facilitate cleaning, without compromising its effectiveness in excluding fish eggs and larvae. More recently, experiments with various fiber diameters, curtain thickness and perforation sizes and density have been conducted in order to optimize the AFB design.



Between 1995 and 2000, the technology was developed at the Lovett Generating Station, located on the west bank of the Hudson River Estuary. The station has a once through cooling system with a design capacity of 491 MGD. A series of studies were conducted to evaluate impingement, entrainment, operational reliability and the influence of biological growth on the fabric. Samples of eggs and larvae were collected at both Unit 3 (protected with an AFB) and at Unit 4 (unprotected) in 1995, 1998 and 2000. Despite some early operational problems, the studies indicate that the boom reduced the entrainment of eggs and larvae by approximately 80% (LMS 2001). Additional laboratory studies have found that American shad eggs and day-old larvae in contact with the fabric at design flows were not adversely affected (NYSDEC, unpublished data). The AFB was determined to be BTA for the Lovett Generating Station in early 2003.

The Arthur Kill Station is a 713 MGD facility located in Staten Island, along the Arthur Kill tidal straight. This facility in the past has impinged more than 10 million fish per year. Conceptual engineering plans for an AFB are currently being developed for the Station's entire cooling water flow. A preliminary cost estimate for a 3,000 foot long AFB (66,000 square foot filter area) at the Arthur Kill Station was \$10.6 million dollars. This cost includes 55,000 cubic yards of dredging and disposal costs of \$2.75 million dollars. Operation and maintenance costs were estimated to be between \$310 to \$500,000 dollars per year (LMS 2002).

The technology is also planned for use at several new combined cycle facilities to be located along the Hudson River such as the Bowline Unit 3, Bethlehem Energy Center and the Empire State Newsprint Project. For these facilities, which will use closed cycle cooling, a smaller AFB will be required, and is expected to virtually eliminate impingement and entrainment impacts.

### **Conclusion**

This paper has presented a wide range of alternatives that the NYSDEC has implemented over the last 25+ years to achieve BTA for minimizing adverse environmental impacts from the operation of cooling water intake systems. These alternatives have ranged from relatively simple fixes to substantially complex and expensive mitigation projects, depending upon the magnitude of impingement and entrainment, site specific considerations and cost of mitigation. Consistent with other environmental protection programs, an evolution of increased protection at cooling water intakes has taken place over this period. This is most evident in the NYSDEC's increased focus on minimizing the entrainment of early life stages of fish. For Hudson River species, more than a quarter century of data collection and modeling of losses to juvenile fish populations indicates that the entrainment of early life stages is a major aquatic impact resulting from power plant operation. Entrainment mitigation alternatives are more limited, and generally much more costly than impingement mitigation, and therefore they present added difficulties. However, protecting all life stages of fish at cooling water intakes will continue to be the NYSDEC's goal, and this work will no doubt continue to be challenging.

### **References**

Beak Consultants, Inc. 1988. Dunkirk Station Biological Studies. Final Report. January – December 1987. Prepared for Niagara Mohawk Power Corp. by Beak Consultants Incorporated, March 1988.

Beak Consultants, Inc. 1993. Aquatic Monitoring Program: Allen E. Kintigh Station. Prepared for New York Electric and Gas Corp., March 1993.

Beak Consultants, Inc. 2000. Post-Impingement Fish Survival: Dunkirk Steam Station. Winter, Spring, Summer and Fall 1998-1999. Prepared for NRG Dunkirk Power L.L.C.

Beak Consultants, Inc. 2000. Post-Impingement Fish Survival at Huntley Steam Station: Winter and Fall 1999. Final Report. Prepared for Niagara Mohawk Corporation.

Boreman, J. 1977. Impacts of Power Plant Intake Velocities on Fish. Office of Biological Sciences, Fish and Wildlife Service, U.S. Department of Interior, FWS/OBS-76/20.1. March 1977.

Con Ed. 1996. Arthur Kill Generating Station Diagnostic Study and Post-Impingement Viability Substudy Report. Prepared by Consolidated Edison Company of New York, Inc. Pursuant to the December 23, 1993 Order on Consent in DEC File No. R2-2985-90-04, January 31, 1996.

DEIS for Bowline, Indian Point 2 & 3, and Roseton Steam Electric Generating Stations, 1993. Prepared for Central Hudson Gas and Electric Corp., Consolidated Edison Company of New York, Inc., New York Power Authority, and Orange and Rockland Utilities, Inc. June 1993.

Dunning, D.J. and Q.E. Ross. 1998. Effectiveness of a Reconfigured Fish Deterrence System at the James A. FitzPatrick Nuclear Power Plant. Submitted in compliance of Additional Requirement 9.a.iii of SPDES Permit No. NY0020109. April 1998.

EA Engineering, Science and Technology, 1998. Brooklyn Navy Yard Cogeneration Facility. Ichthyoplankton Entrainment Monitoring Study. Prepared for Brooklyn Navy Yard Cogeneration Facility, L.P./Palmark. February 1998.

EPRI (Electric Power Research Institute). 2003. Laboratory Evaluation of Cylindrical V-Wire Screens for Fish Protection at Cooling Water Intake Structures. EPRI Report 1005339, Palo Alto, California, May 2003.

Fletcher, R. I. 1990. Flow Dynamics and Fish Recovery Experiments: Water Intake Systems. Transactions of the American Fisheries Society, 119:393-415.

Fletcher, R. I. 1994. Flows and Fish Behavior: Large Double-Entry Screening Systems. Transactions of the American Fisheries Society, 123:866-885.

LMS. 1999. Arthur Kill Generating Station: Final Action Plan. Lawler, Matusky and Skelly Engineers, LLP. Prepared Pursuant to the December 23, 1993 Order on Consent Issued to Con Edison Company of New York, Inc. NYSDEC File No. R2-2985-90-04, December 1999.

LMS. 2001. Lovett Generating Station, Gunterboom Deployment Program 2000. Lawler, Matusky and Skelly Engineers, LLP. for Mirant of New York, Inc., April 2001.

LMS 2002. Arthur Kill Generating Station. Feasibility Assessment Report. Prepared for Arthur Kill Power, LLC. February 2002.

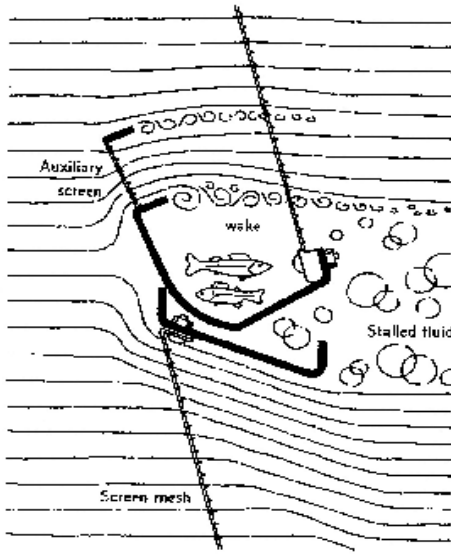
New York State Electric and Gas Corporation (NYSEG), Stone & Webster Engineering Corporation, Auld Environmental Associates. 1988. Somerset Station - 1988 Winter Operation Study. Prepared for New York State Electric and Gas Corporation, September 1988.

Normandeau Associates. 2001. Bowline Point Generating Station - 1999 Impingement Studies. Prepared for Mirant, New York, December 2001.

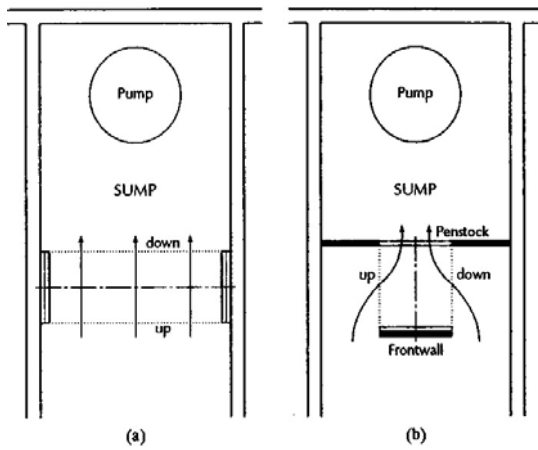
Ross, Q. E., D. J. Dunning, J. K. Menezes, M. J. Kenna, Jr., and G. Tiller. 1996. Reducing Impingement of Alewives with High-Frequency Sound at a Power Plant Intake on Lake Ontario. North American Journal of Fisheries Management, 16:548-559.

Weisburg, S. B., Burton, W. H., Jacobs, F., and E. A. Ross. 1987. Reductions in Ichthyoplankton Entrainment with Fine Mesh, Wedge Wire Screens. North American Journal of Fisheries Management, 7: 386-393.

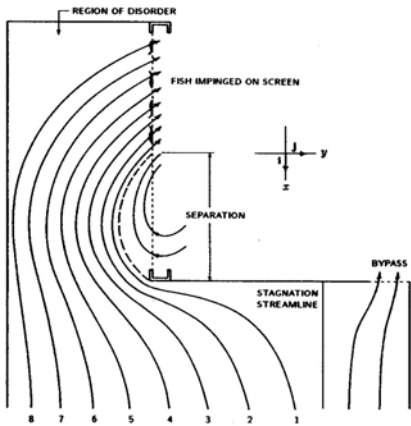
Figures



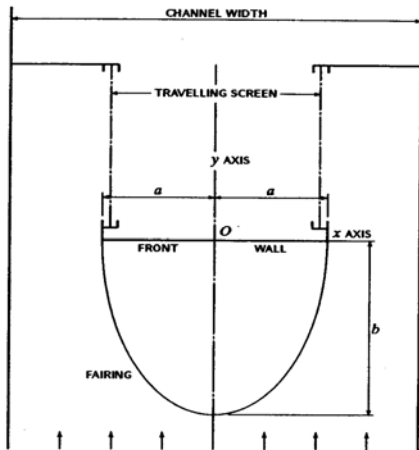
**Figure 1.** Cross section of screen panel showing modified screen rail, flow pattern and sheltered region created within rail. From Fletcher (1990).



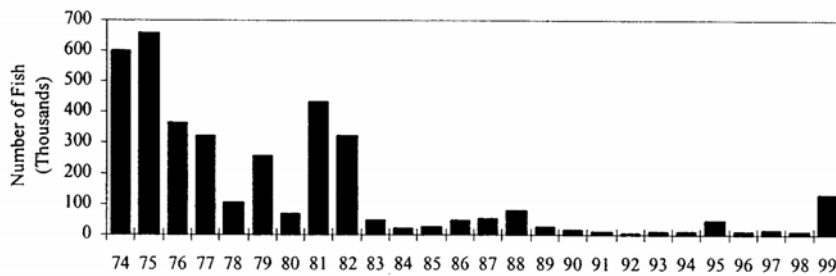
**Figure 2.** Plan of intake channel equipped with a through flow screen (a) and dual flow screen (b). From Fletcher (1994).



**Figure 3.** Plot of flow trajectories for dual flow screen model at 45 cm/s, showing corner flow separation. From Fletcher (1994).



**Figure 4.** Top view of an elliptical fairing for a dual flow intake screen. Arrows show the direction of flow before turning into screen face. From Fletcher (1994).



**Figure 5.** Estimated impingement abundance at Bowline Point Generating Station, 1974-1999. Barrier net was in first deployed in 1976. From Normandeau Associates (2001).

## California

Richard L. Wantuck, NOAA Fisheries, Santa Rosa, California

### BIOSKETCH

Mr. Wantuck is currently Chief of Fisheries Bioengineering for NOAA Fisheries, Southwest Region of the U.S. Department of Commerce in Santa Rosa, CA. Mr. Wantuck was educated at the University of the State of New York and Cornell University, receiving (2) Bachelor of Science degrees and a Masters degree in the fields of Sociology and Government, Environmental Science and Technology, and Aquacultural Engineering. Mr. Wantuck was a former small business owner in the water treatment field- servicing water resource and water quality needs of commercial, residential, and industrial clients. Mr. Wantuck is a U.S. Navy Veteran, who served honorably for 6 years in the Navy Nuclear Propulsion Engineering Program. Mr. Wantuck has more than 20 years experience in various aspects of water resources and hydraulic engineering, as well as natural resource and aquatic species protection.

### TECHNICAL PAPER

#### Introduction

Cooling Water Intake Structures at power plants are required to meet certain standards of fish protection as mandated by the Clean Water Act 316(b) Final Rule (2003), as well as other regulatory statutes in various areas across the nation. These standards are based on the idea of protecting sensitive fisheries populations, and the ecosystem as a whole, from serious and irreversible decline. Natural resource agencies seek to prevent entrainment, impingement, and predation of aquatic species at the point of diversion via proven technologies. On the West Coast, the conventional method of achieving these goals is through the use of positive barrier fish screens. In recent times, however, a number of new technologies have been promoted as a more cost effective means of achieving the required level of fish protection. Recognizing this technology question, the National Oceanic and Atmospheric Administration's Fisheries Office (NOAA Fisheries) promulgated a set of Agency guidelines entitled: ***Experimental Fish Guidance Devices (1994)***, to govern the development, implementation, and evaluation procedures used to assess the efficacy of any given technology in California. The American Fisheries Society (AFS) Bio-Engineering Section also produced: ***Guidelines for Evaluating Fish Passage Technologies (2000)***. These two documents are resources for researchers and professionals in the fish passage and fish protection field.

#### Discussion

NOAA Fisheries, a branch of the U.S. Department of Commerce, has been involved with fish passage technology development on the west coast for more than forty years. The Endangered Species Act, Federal Power Act, Fish & Wildlife Coordination Act, and other federal statutes mandate protection of fisheries resources from impacts created by water withdrawals and other human activities. In recent years, the most common applications in California have been directed at preventing harm to juvenile salmonids (plus other riverine, estuarine, and marine species) at agricultural, municipal, and power plant intakes. Conventional technologies such as positive barrier fish screens are well understood through years of operations and evaluation. They are the standard technology for salmon protection in the western states because of the physical barrier they provide. A physical barrier offers the highest assurance for entrainment prevention for all target species. However, these systems are often very expensive to design and construct for large scale water diversions. Thus, innovative new technologies have been developed which have the potential of providing some degree of fish protection in a more cost-effective manner.

Due to seriously declining fish population trends over the past fifty years, and subsequent natural resource agency decisions to list numerous Pacific salmon stocks under the federal Endangered Species Act, NOAA Fisheries adopted a stringent standard for fish protection at water diversions and hydropower intakes.

The standard is based on equaling or exceeding the protection efficiency offered by the best available technology- positive barrier fish screens. If a particular alternative technology can demonstrate that it matches or exceeds this level of performance, then NOAA Fisheries is likely to accept it. However, no new technologies have been able to meet the scientific threshold for success. Therefore, West Coast natural resource agencies have been reluctant to approve these systems for widespread use where *endangered* or *threatened* species are concerned.

Over the past quarter century, the NOAA Fisheries western regions closely monitored several field prototypes which featured Abehavioral barrier technologies. These demonstration projects applied a number of devices which sought to elicit an Aavoidance behavior from fish in the vicinity of large water diversions. Typical systems included the use of sound-emitting equipment and underwater electrical fields which were intended to provide an Ainvisible barrier between fish and the water intake. Unfortunately, the results of these experiments were inconclusive, and they did not prove as effective as conventional positive barriers.<sup>1</sup>

The inconclusive outcomes of field prototype testing over many years led NOAA Fisheries, and later the AFS Bioengineering Section, to publish formal guidelines to ensure that laboratory and field experiments are conducted in a scientific and statistically valid fashion. The objective is to offer a standard testing protocol that all technology development efforts can follow. In this way, natural resource agencies, which have the responsibility of conserving the nation's fisheries resources can be assured that the technology development process is scientifically objective, and consistent among all applicants.

NOAA Fisheries Southwest Region published *Experimental Fish Guidance Devices (1994)* to assist consultants, industries, and manufacturers in following a logical, stepwise process for technology development where fish facilities are needed in California (see appendix A).<sup>2</sup> The process includes five discrete steps:

- 1) Consider earlier research
- 2) Develop a Study Plan
- 3) Conduct Laboratory Research
- 4) Evaluate Prototype Units
- 5) Study Results

Seeking to refine the technology development process further, the AFS Bioengineering Section published a document titled: *Guidelines for Evaluation of Fish Passage Technologies (2000)* (see Appendix B)<sup>3</sup>. This work provides additional background information such as- technology definitions, controversial issues, existing guidelines and recommendations, and guideline implementation. It describes a Aphased process for technology development:

- Phase 1 - Conceptual Development
- Phase 2 - Laboratory Evaluation
- Phase 3 - Prototype Evaluation
- Phase 4 - Technology Selection and Application

The relationship between these two sets of guidelines is a complementary one in many respects. The NOAA Fisheries guidelines are specific to salmon protection in the western United States; though they serve as a good template to follow elsewhere, and for other species. These rules serve as a basis for government regulatory procedures within the jurisdiction of the Agency. The AFS Bioengineering guidelines represent a broader set of informative material. They deal with technical and scientific details to a greater degree. It should be noted that both documents contain a

---

<sup>1</sup> e.g.- Reclamation Districts 108 and 1004, Sacramento River, CA (1994-1996). Georgiana Slough acoustic testing, San Francisco Delta (1996)

<sup>2</sup> NOAA Fisheries Northwest Region produced a similar document for use in the northwest states, nearly identical to the Southwest Region.

Internet websites: Southwest Region- <http://swr.nmfs.noaa.gov/habitat.htm>

Northwest Region: [http://www.nwr.noaa.gov/1hydrop/exp\\_tech1.htm](http://www.nwr.noaa.gov/1hydrop/exp_tech1.htm)

<sup>3</sup> Internet website: [http://www.afsbioengineering.org/fish\\_pass\\_comm.htm](http://www.afsbioengineering.org/fish_pass_comm.htm)

common theme: development of new technologies for fish protection must be validated with a deliberate, scientific approach before they can be accepted as Amain-stream solutions for widespread use in the United States.

### **Conclusion**

Fisheries resources all over the world have come under intense pressure in the modern era due to human activities. Water diversions represent a threat to viable fish habitats unless their impacts can be effectively mitigated. New technologies show promise for minimizing the damages in a cost-effective way. However, it is not in the interest of natural resource agencies representing the federal (and state) government, or the AFS, to allow unproven technologies to proliferate without considerable proof that they work *in the field*, as advertised. This is why it is important for consultants, manufacturers, and industries to observe the guidelines that have been set forth. Working in unison, toward common goals, there is every reason to anticipate that new technologies will become an increasingly important and effective tool for the protection of our nation's living aquatic resources.

Appendix A

EXPERIMENTAL FISH GUIDANCE DEVICES

Position Statement of  
National Marine Fisheries Service  
**Southwest Region**

January 1994

NMFS Southwest Region Position Paper on Experimental Technology  
**for Managing Downstream Salmonid Passage**

INTRODUCTION

Numerous stocks of salmon and steelhead trout in California streams are at low levels and many stocks continue to decline. The Sacramento River winter-run chinook salmon is listed as "endangered" under the Federal Endangered Species Act. Petitions for additional listings are pending. It is essential to provide maximum protection for juveniles to halt and reverse these declines.

The injury or death of juvenile fish at water diversion intakes have long been identified as a major source of fish mortality [Spencer 1928, Hatton 1939, Hallock and Woert 1959, Hallock 1987]. Fish diverted into power turbines experience up to 40 percent mortality as well as injury, disorientation, and delay of migration [Bell, 1991], while those entrained into agricultural and municipal water diversions experience 100 percent mortality. Diversion mortality is the major cause of decline in some fish populations.

Positive barrier screens have long been tested and used to prevent or reduce the loss of fish. Recent decades have seen an increase in the use and effectiveness of these screens and bypass systems; they take advantage of carefully designed hydraulic conditions and known fish behavior. These positive systems are successful at moving juvenile salmonids past intakes with a minimum of delay, loss or injury.

The past few decades have also seen much effort in developing "startle" systems to elicit a taxis (response) by the fish with an ultimate goal of reducing entrainment. This Position Statement addresses research designed to prevent fish losses at diversions and presents a tiered process for studying, reviewing, and implementing future fish protection measures.

JUVENILES AT INTAKES

The three main causes of delay, injury, and loss of fish at water intakes are entrainment, impingement, and predation. Entrainment occurs when the fish is pulled into the diversion and passes into a canal or turbine. Impingement is where a fish comes in contact with a screen, a trashrack, or debris at the intake. This causes bruising, descaling, and other injuries. Impingement, if prolonged, repeated, or occurs at high velocities also causes direct mortality. Predation also occurs. Intakes increase predation by stressing or disorienting fish and/or by providing habitat for fish and bird predators.

A. Positive Barriers

Positive barrier screen systems and criteria for their design have been developed, tested, and proved to minimize harm caused at diversions. Positive barriers do not rely on active fish behavior; they prevent physical entrainment with a physical barrier. Screens with small openings and good seals are designed to work with hydraulic conditions at the site, providing low velocities normal to the screen face and sufficient sweeping velocities to move fish past the screen. These screens are very effective at preventing entrainment [Pearce and Lee 1991]. Carefully designed bypass



systems minimize fish exposure to screens and provide hydraulic conditions that return fish to the river, preventing both entrainment and impingement [Rainey 1985]. The positive screen and fish bypass systems are designed to minimize predation, and to reduce mortality, stress, and delay from the point of diversion, through the bypass facility, and back the river.

Carefully designed positive barrier screen and bypass systems have been installed and evaluated at numerous facilities [Abernethy et al 1989, 1990, Rainey, 1990, Johnson, 1988]. A variety of screen types (e.g. flat plate, chevron, drum) and screen materials (e.g. woven cloth, perforated plate, profile wire), have proved effective, taking into consideration their appropriateness for each site. Well-designed facilities consistently result in a guidance efficiency of over 95 percent [Hosey, 1990, Neitzel, 1985, 1986, 1990 a,b,c,d, Neitzel, 1991].

The main drawback to positive barrier screens is cost. At diversions of several hundred cubic feet per second or greater, the low velocity requirement and structural complexity can drive the cost for fish protection and the associated civil works over a million dollars. At the headwork, the need to clean the screen, remove trash, and provide regular maintenance (e.g. seasonal installation, replacing seals, etc.) also increase costs.

## B. Behavioral Devices

Due to higher costs of positive barrier screens, there has been much experimentation since 1960 to develop behavioral devices as a substitute for barrier screens [EPRI, 1986]. A behavioral device, as opposed to a positive (physical) barrier, requires a volitional taxis on the part of the fish to avoid entrainment. Early efforts were designed to either attract or repel fish. These studies focused on soliciting a behavioral response from the fish, usually noticeable agitation. Using these startle investigations to develop effective fish guidance systems has not been effective. Experiments show that there is a large response variation between individual fish of the same size and species. Therefore, it cannot be predicted that a fish will always move toward or away from a certain stimulus. Even when such a movement is desired by a fish, it often cannot discern the source or direction of the signal and choose a safe escape route.

Many behavioral devices do not incorporate and use a controlled set of hydraulic conditions to assure fish guidance, as does the positive screen/bypass system. The devices can actually encourage fish movement that actually contrasts with the expected rheotactic response. Thus, the fish gets mixed signals about what direction to move. Another concern is repeated exposure; a fish may no longer react to a signal that initially was an attractant or repellent. In addition to the vagaries in the response of an individual fish, behavior variations are expected due to size, species, life stage, and water quality conditions.

In strong or accelerating water velocity fields, the swimming ability of a fish may prevent it from responding to a stimulus even if it attempts to do so. Other environmental cues (e.g., pursuing prey, avoiding predators, or attractive habitat) may cause a fish to ignore the signal.

A main motivation for opting to install behavioral devices is cost-savings. However, much of the cost in conventional systems is for the physical structure needed to provide proper hydraulic conditions. Paradoxically, complementing a behavioral device with its own structural requirements may lessen much of its cost advantage.

Present skepticism over behavioral devices is supported by the fact that few are currently being used in the field and those that have been installed and evaluated seldom exhibit consistent guidance efficiencies above 60 percent [Vogel, 1988, EPRI, 1986]. The louver system is an example of a behavioral device with a poor success record. In this case, even with the use of favorable hydraulics, performance is poor especially for smaller fish. Entrainment can be high, particularly when operated over a wide range of hydraulic conditions [Vogel, 1988, Cramer, 1982, Bates, 1961]. Due to their poor performance, some of these systems are already replaced by positive barriers.

## EXPERIMENTATION PROCESS

However, there is potential for developing new positive screens as well as behavioral guidance devices for the future. Nonetheless, experimental technology must achieve, over the foreseeable range of adverse conditions, a consistent level of success that equals or exceeds that of best available technology. It should be a deliberate, logical process. NMFS will not discourage research and development on experimental fish protection devices if the following tiered study process is incorporated:

- (1) Consider earlier research. A thorough review should be performed of past methods similar to that proposed. Reasons for substandard performances of these earlier methods should be clearly identified.
- (2) Study plan. A study plan should be developed and presented to NMFS for review and concurrence. It is essential that tests occur over a full range of possible hydraulic, biological, and ecological conditions that the device is expected to experience.
- (3) Laboratory research. Controlled laboratory experiments should be developed using species, size, and life stages intended to be protected (or acceptable surrogate species). For behavioral devices, special attention must be directed at providing favorable hydraulic conditions and demonstrating that the device clearly causes the planned behavioral response. Studies should be repeated with the same test fish to examine any habituation to the stimulus.
- (4) Prototype units. Once laboratory tests show high potential to equal or exceed success rates of state-of-the-art screening, it is appropriate to further examine the new device as a prototype under real field conditions. Field sites must be fully appropriate to (1) demonstrate all operational and natural variables expected to influence the device performance, (2) evaluate the species, or an acceptable surrogate, that would be exposed to the device under full operation, and (3) avoid unacceptable risk to resources at the prototype locations.
- (5) Study results. Results of both laboratory tests and prototype devices examined in the field must demonstrate a level of performance equal to or exceeding that of conventional, established technology before NMFS will support further installations.

## CONCLUSIONS

In the course of the past few decades, we have seen increased demand for water diversions. This trend is likely to continue. Accompanying this demand is a corresponding decline of fisheries. Therefore, prudence dictates that fish protection facilities be held to the highest practicable level of performance.

A major effort was made to examine experimental guidance systems over several decades by a variety of funding agencies. The results were generally poor or inconclusive, with low guidance efficiencies attributable to the particular device used. Often results were based on a small sample size or varied with operational conditions. In addition, unforeseen operational and maintenance problems, including safety hazards, sometimes developed.

Nevertheless, some of these experiments show potential. To further improve fish protection technology, NMFS will not oppose tests that proceed in the tiered process outlined above. Further, to ensure no further detriment to fish, experimental field testing should be done with the simultaneous design of a positive barrier and bypass system for that site. This conventional system should be scheduled for installation immediately, if the experimental guidance system, once again, does not prove to be as effective as a conventional system.

## REFERENCES

- Abernethy, C.S., D.A. Neitzel, and E.W. Lusty. 1989. Velocity Measurements at Six Fish Screening Facilities in the Yakima Basin, Washington, Summer 1988. Annual report to the Bonneville Power Administration.
- Abernethy, C.S., D.D. Neitzel, and E.W. Lusty. 1990. Velocity Measurements at Three Fish Screening Facilities in the Yakima River Basin, Summer 1989. U.S. Department of Energy Bonneville Power Administration Division of Fish and Wildlife.
- Bates, D.W. and S.G. Jewett, Jr. 1961. Louver Efficiency in Deflecting Downstream Migrant Steelhead Transaction of the American Fisheries Society, Vo. 90., No. 3, p. 336-337.
- Bell, Milo C., 1991. "Revised Compendium on the Success of Passage of Small Fish Through Turbines." Report for U.S. Army Corps of Engineers, North Pacific Division, Contract No. DACW-57-88-C-0070. Portland, OR.
- Cramer, D.P. 1982. Evaluation of Downstream Migrant Bypass System - T.W. Sullivan Plant, Willamette Falls (Progress Report for Fall 1981 and Spring 1982 dtd October 11, 1982) PGE.
- EPRI (Electric Power Research Institute). 1986. Assessment of Downstream Migrant Fish Protection technologies for hydroelectric application. EPRI, Palo Alto, CA.
- Hallock, R.J. 1977. A Description of the California Department of Fish and Game Management Program and Goals for the Sacramento River System Salmon Resource. California Fish and Game, Anadromous Fisheries Branch Administrative Report. 16 pp.
- Hallock, R.J., and W.F. Van Woert. October 1959. A Survey of Anadromous Fish Losses in Irrigation Diversions from the Sacramento and San Joaquin Rivers. California Fish and Game. Vol. 45, No. 4, pp. 227-266.
- Hatton, S. 1940. Progress Report on Central Valley Fish, 1939. California Fish and Game, 26(3) pp. 334-373.
- Hosey and Associates and Fish Management Consultants. 1990. Evaluation of the Chandler, Columbia, Roza and Easton Screening Facilities. Completion Report for the Bureau of Reclamation.
- Johnson, P.L. 1988. Hydraulic Design of Angled Drum Fish Screens. In: Proceedings of the Electric Power Research Institute Conference on Fish Protection at Steam and Hydro Plants, San Francisco, CA., Oct. 28-30, 1987. EPRI CS/EA/AP-5663-SR.
- Neitzel, D.A., C.S. Abernethy, E.W. Lusty, and S.A. Prohammer. 1985. A Fisheries Evaluation of the Sunnyside Canal Fish Screening Facilities, Spring 1985. Annual Report to the Bonneville Power Administration.
- Neitzel, D.A., C.S. Abernethy, and W.W. Lusty. 1986. A Fisheries Evaluation of the Richland and Toppenish/Satus Canal Fish Screening Facilities, Spring 1986. Annual Report to the Bonneville Power Administration.
- Neitzel, D.A., t.J. Clune, and C.S. Abernethy. 1990a. Evaluation of Rotary Drum Screens Used to Project Juvenile Salmonids in the Yakima River Basin. In: Proceedings of the International Symposium on Fishways '90. Gifu, Japan.
- Neitzel, D.A., C.S. Abernethy, and E.W. Lusty. 1990b. A Fisheries Evaluation of the Westside Ditch and Wapato Canal Fish Screening Facilities, Spring 1989. Annual Report to the Bonneville Power Administration.

Neitzel, D.A., C.S. Abernethy, and E.W. Lusty. 1990c. A Fisheries Evaluation of the Wapato, Sunnyside and Toppenish Creek Canal Fish Screening Facilities, Spring 1988.

Neitzel, D.A., C.S. Abernethy, and G.A. Martenson. 1990d. A Fisheries Evaluation of the Westside Ditch and Town Canal Fish Screening Facilities, Spring 1990. Annual Report to the Bonneville Power Administration.

Neitzel, D.A., C.S. Abernethy, and E.W. Lusty. 1991. Evaluating of Rotating Drum Screen Facilities in the Yakima River Basin, South-Central Washington State. In: Fisheries Bioengineering Symposium. American Fisheries Society Symposium 10. Bethesda, MD.

Pearce, R.O., and R.T. Lee. 1991. Some Design Considerations for Approach Velocities at Juvenile Salmonid Screening Facilities. In: Fisheries Bioengineering Symposium. American Fisheries Society Symposium 10. Bethesda, MD.

Rainey, W.S. 1990. Cylindrical Drum Screen Designs for Juvenile Fish Protection at Two Large Diversions. In: Proceedings of the International Symposium on Fishways '90 in Gifu. Gifu, Japan.

Rainey, W.S. 1985. Considerations in the Design of Juvenile Bypass Systems. In: F.W. Olson, R.G. White and R.H. Hamre, Proceedings of the Symposium on Small Hydropower and Fisheries, Aurora.

Skinner, J.E. 1974. A Functional Evaluation of a Large Louver Screen Installation and Fish Facilities Research on California Water Diversion Projects. In: Proceedings of the Second Workshop on Entrainment and Intake Screening. Johns Hopkins University, Baltimore, MD., February 5-9, 1973.

Spencer, John. 1928. Fish Screens in California Irrigation Ditches. California Fish and Game, Vol. 14, No. 3, p. 208-210.

Vogel, D.A., K.R. Marine and J.G. Smith. 1990 or 1988. A Summary of Upstream and Downstream Anadromous Salmonid Passage at Red Bluff Diversion Dam on the Sacramento River, California, U.S.A.. In: Proceedings of the International Symposium on Fishways '90 in Gifu. Gifu, Japan.

Appendix B

**GUIDELINES FOR EVALUATING FISH PASSAGE TECHNOLOGIES**  
(Initiative 2: Fish Passage Technologies Research Development Process)

Prepared by the  
American Fisheries Society Bioengineering Section

Committee Members:

Ned Taft (Chairman)

Ken Bates

Tim Brush

Joan Harn

Al Solonsky

Marcin Whitman

Ed Zapel

January 2000

**TABLE OF CONTENTS**

<b><u>SECTION</u></b>	<b><u>TITLE</u></b>
<b>1</b>	<b>INTRODUCTION</b>
<b>2</b>	<b>BACKGROUND INFORMATION</b> 2.1 Technologies Defined 2.2 Controversial Issues 2.3 Existing Guidelines and Recommendations 2.4 Guideline Implementation
<b>3</b>	<b>PHASE 1 - CONCEPTUAL DEVELOPMENT</b>
<b>4</b>	<b>PHASE 2 - “LABORATORY” EVALUATION</b>
<b>5</b>	<b>PHASE 3 - PROTOTYPE EVALUATION</b>
<b>6</b>	<b>PHASE 4 - TECHNOLOGY SELECTION AND APPLICATION</b> 6.1 Site Assessment 6.2 Review of Alternative Fish Protection and Passage Technologies 6.3 Design, Operation, and Post-Installation Evaluation
<b>7</b>	<b>LITERATURE CITED</b>

## **SECTION 1**

### **INTRODUCTION**

Losses of fish at hydroelectric projects and water intakes for steam electric plant cooling, irrigation diversions and other municipal and industrial uses have led to the development of numerous alternative fish protection and passage technologies that mitigate this problem. Only a relatively small number of technologies are currently considered by the industry to be highly effective and/or are acceptable to the various agencies that are charged with protecting the resource. Fishery managers and other industry professionals typically greet new approaches to safe fish passage and diversion at water intakes with caution. There are multiple reasons for this caution, which include:

- ▶ The results of evaluations of some technologies have been equivocal, with inconsistencies in biological effectiveness both between different test sites and between test years at individual sites;
- ▶ Many of the studies conducted in the past have been reported in client reports and conference proceedings that are considered to represent “gray” literature; many professionals are reluctant to accept test results that are not presented in a peer-reviewed document;
- ▶ Inventors, manufacturers and/or sales representatives have a vested interest in the sale or use of their technology and may be considered biased in their claims of product effectiveness;
- ▶ Due to increasingly stringent requirements for biological effectiveness that have evolved over the last few decades, especially for listed species, “structural” technologies that physically exclude fish (e.g.- diversion screens) are generally favored over behavioral barriers which may not be as effective in protecting a variety of fish under variable conditions.

Equivocal results in past studies have resulted from improper applications of technologies and differences in experimental design employed by different researchers with varying levels of experience in the conduct of fishery investigations. Variations in site conditions and fish species and sizes may also give different results. The reporting of results in gray literature, where original data are often lacking and data analyses are not clearly presented, also has added to the confusion over the biological effectiveness of certain technologies and contributed to the skeptical attitude that study results often are overstated. This is particularly true when results are presented or reported by parties with a vested interest in the success of a technology. However, it should be recognized that peer-reviewed documents are often not feasible due to time constraints. For example, license requirements may dictate a reporting schedule that will not provide adequate time for the peer review process. Therefore, gray literature will continue to be a source of information on which decisions will be based. This guideline attempts to address this issue by providing for a type of peer review throughout the process of developing a technology. In this way, even those with a vested interest in a technology, who deserve support for their inventiveness and enthusiasm, can expect to have their invention or product receive a fair and unbiased evaluation.

There is clearly a need for improving the process of evaluating fish passage and protection technologies such that there is greater consistency in experimental design and results and that the evaluation process is scientific and objective. The process also must provide evaluations that are relevant to regional and/or local fishery management objectives. As stated previously, there are still only a small number of technologies that are in common use and that are not considered experimental, despite decades of research and development efforts with a wide variety of technologies. Given the decline in fish stocks in some rivers, and the inability to restore historic runs in others, it is in the interest of all parties involved in fishery management and technology development to develop a process that will lead to improved experimental design, increased communication, and, eventually, general consensus on the biological effectiveness (or ineffectiveness) of a technology. This process should replace the “trial-and-error” approach that often has been employed during past studies. The need for standardized guidelines is supported by a government report on fish passage technologies [Office of Technology Assessment (OTA) 1995] that identified a critical need for

accepted scientific methods and independent evaluations for the successful development of new fish passage technologies.

At the 1997 Annual Meeting of the American Fisheries Society in Monterey, California, the Bioengineering Section met to discuss this issue. As a result of that meeting, a committee was formed to develop a guideline for improving the process by which fish passage and protection technologies are evaluated. The Committee comprised resource agency and industry professionals. This guideline is the product of the Committee's efforts. The guideline document is intended to provide standardized procedures for the development, evaluation, and application of technologies that will facilitate fish passage and/or protection through the development of sound scientific evidence. Subsequently, the guidelines are designed to assist technology developers, researchers and fishery managers and regulators in gaining approval of new technologies by providing general development and evaluation steps that have been peer-reviewed by agency and industry biologists and engineers. The proposed approach provides for an ongoing peer review process during technology development and testing that will permit further development and application of effective new technologies more reliably and consistently. Also, having a panel of experts involved from the beginning of technology development should aid in securing funding sources to support the development and evaluation process.

Naturally, while standardized procedures are desirable, any guideline must have a degree of flexibility that recognizes the diversity and varying complexity of fish passage and protection technologies and the methodologies available for evaluating them. Attempts have been made to build such flexibility into this Guideline. The Guideline is intended to serve as a tool for bringing new technologies into practical application. It is not a specific prescription for how new technologies should be evaluated and does not address the issue of what constitutes an aquatic impact and when fish passage or protection technologies are warranted to alleviate any such impacts.

## **SECTION 2 BACKGROUND INFORMATION**

In developing the guidelines, it was considered important to address the following questions:

- What are the definitions of new, experimental, and existing technologies?
- What are the controversies and their causes regarding technology effectiveness?

Can previously developed guidelines be incorporated into this guideline?

Answers to these three questions were explored to provide an understanding of the current problems with technology evaluations and to derive baseline information that would be helpful in producing a comprehensive scope for the guidelines. Having investigated the above questions, the following objectives were defined for the development of the actual guidelines and their subsequent application:

- ▶ Define a process for the development, evaluation, and acceptance of new technologies.
- ▶ Define specific procedures for evaluating new technologies.
- ▶ Provide information that will help guide those who need to evaluate and compare new technologies for possible application at a site.

Using the guidelines, researchers should be able to meet procedural criteria that will allow fishery managers to assess the potential for a technology to be successfully applied at specific sites based on rigorous and well-defined scientific evaluations. However, use of the guidelines is not intended to be a way of gaining unqualified acceptance of any given device. Every technology has ranges of effectiveness that are related to design, operational, biological, and environmental factors. Constraints or limitations associated with these factors need to be determined and addressed in any application of fish protection and passage technologies. Also, it should be recognized that effectiveness requirements vary by jurisdiction (i.e., between local, state, regional and federal agencies). These differences are due to differences in species, regional societal values, robustness of local stocks, fish management strategies, and regional histories of specific technologies. Therefore, it is possible that a given technology might meet acceptance criteria at



one site or in a region but not at another site or another region. It is not within the purview of the guideline document to assess the reasonableness of existing effectiveness requirements. Rather, the document is intended to guide researchers in the conduct of studies that will determine the effectiveness of a technology with reasonable precision and accuracy, regardless of the effectiveness goal.

## 2.1 Technologies Defined

Fish protection and passage technologies that are candidates for evaluations conducted under the scope of these guidelines may be new, experimental, or variations of existing technologies. The introduction of *new technologies* in recent years has been rare. Examples include infrasound generators, Eicher and modular inclined screens and fish-friendly turbines (EPRI 1994,1999; Knudsen *et al.* 1992, 1994; Cook *et al.* 1997; Franke, *et al.* 1997 ). *Experimental technologies* include devices or systems that have demonstrated some potential for protecting or passing fish, but for which adequate scientific evidence has not been collected to verify effectiveness and gain agency acceptance or to be considered for general application. Behavioral fish protection devices, such as louvers, strobe lights and sound systems, are considered to be experimental by some resource agencies (NMFS 1994) but are accepted by others (Odeh and Orvis 1997). *Existing technologies* (e.g., diversion screens and fish ladders) often are modified to improve effectiveness or to meet site- or species-specific criteria. Modifications to existing technologies should be assessed to ensure that they meet required performance standards. These guidelines might be used to advance a given technology from a new or experimental status to an accepted status in a specific region and/or for specific species or age classes of fish.

These guidelines are intended to be general so they can be used with a wide range of devices. For the purposes of developing the guidelines, fish protection and passage technologies were divided into the following broad classifications and sub-categories:

### *Downstream Fish Protection and Passage Technologies*

- Behavioral devices
- Physical barriers
- Fish collection systems
- Diversion devices
- Bypasses
- Fish pumps
- Spillways/sluices
- Turbines
- Trap and transport

### *Upstream Fish Passage Technologies*

- Fish ladders
- Fish lifts (locks and elevators)
- Fish trap and transport
- Fish pumps
- Bypass channels

### *Tailrace Barriers/Adult Guidance*

- Diffuser barriers
- Physical barriers
- Behavioral barriers
- Electrical barriers

Downstream fish protection and passage technologies encompass devices that are designed to reduce entrainment and possible mortality of fish at water intakes. This group of technologies includes devices that are used at hydro projects for downstream passage of fish and devices used at other types of water intakes (e.g., pumped storage, cooling water

and irrigation diversions) to minimize entrainment and/or mortality. Upstream fish passage technologies include fish lifts and ladders and associated facilities. Tailrace barriers include devices that are used to improve upstream fish passage efficiency by diverting upstream migrants to passage facilities or bypass reaches, or to block access to tailrace areas (e.g., draft tubes) where fish can be injured or migrations delayed.

## **2.2 Controversial Issues**

Many controversies with the application of fish protection and passage technologies have been associated with systems and devices that are used to repel or divert fish from water intakes or pass fish through turbines. Upstream fish passage technologies are better understood for applications with many species, although considerable developmental work is currently ongoing with additional species (e.g., sturgeon), small fishways and culvert passage; controversial issues generally have been related to site-specific designs. Tailrace barriers, although important at sites where there is a need, are required less often than upstream or downstream facilities, and the question of their need is usually more controversial than the technology selected for application.

Controversy associated with the evaluation and application of fish protection and passage technologies have been related to all aspects of evaluations as presented in Table 2-1. In general, controversies arise when industry, consultant, or vendor representatives conclude that a technology is effective and should be considered for general application when the responsible resource agencies or NGOs have concluded otherwise or do not have sufficient information to draw conclusions. Controversies can be associated with site-specific applications of a technology, or with the general application of a device to any given site. Most disagreements center on the issues listed above.

## **2.3 Existing Guidelines and Recommendations**

There have been no formal guidelines published for evaluating fish passage and protection technologies similar to the guidelines presented in this document. There is literature available that presents general information on, as well as specific design and operating criteria for selected technologies (e.g., angled, fixed fish diversion screens); pertinent publications are presented in the List of References. However, standardized evaluation processes have not been developed to provide investigators and resource agencies with data derived from a rigorous scientific evaluation on which they can base judgements on the biological effectiveness of a technology and its potential for further application. The National Marine Fisheries Service Southwest Region (1994) and Northwest Region (1995) have issued Position Statements on the use of experimental fish guidance devices (refer to List of References). While these Position Statements address these devices relative to regional fishery issues, they also (1) reflect the philosophy of a key resource agency and (2) present guidance that is of general importance. Therefore, these Statements (and any others that might be developed by other agencies in the future) should be reviewed by any individual planning to conduct or sponsor a study of an experimental technology.

## **2.4 Guideline Implementation**

Fish protection and passage technologies need to be evaluated and applied in a step-wise manner that will allow investigators and fishery managers to make application decisions using data and information from rigorous scientific assessments. An outline of an evaluation process that will improve the potential for industry and agency acceptance is presented in Table 2-2. A four-phase process is recommended for the development, evaluation and acceptance of a technology:

*Phase 1 - Conceptual Development.* Establishment of an Expert Review Panel and development of a study plan that outlines the biological and engineering basis of operation and expected effectiveness and presents an approach to initial evaluation. All alternative study methods that meet the objectives of the evaluation should be reviewed and considered.

*Phase 2 - "Laboratory" Evaluation.* Initial evaluation of the technology at a reasonably small scale in a location where operational and environmental conditions can be controlled.

*Phase 3 - Prototype Evaluation.* Large-scale field evaluation where the sometimes subtle, yet critical, implications of real-world operational and environmental conditions can be fully understood.

*Phase 4 - Application and Evaluation.* The Expert Review Panel verifies, based on Phase 2 and 3, the conclusions of the evaluations relative to the degree or range of effective protection provided by the technology. The Panel should also verify that the stated conditions under which further applications can be considered (e.g., species, life stage, and hydraulic and environmental conditions) are valid and that any limitations of the technology are clearly defined.

Each phase is discussed individually in the following sections. It should be pointed out that this process may be an iterative one in which researchers may have to repeat earlier phases during the development of a technology. For example, problems discovered in a Phase 3 prototype study may best be resolved by returning to the laboratory.

### **SECTION 3 PHASE 1 – CONCEPTUAL DEVELOPMENT**

The first step in the evaluation process involves the development of basic information regarding the intended design, operation, and biological basis of a technology that can be reviewed and commented upon by industry and agency experts. This step will act to ensure that the technology is based on reasonable engineering and biological principles and expectations, thereby improving the potential for acceptance following subsequent laboratory and/or field evaluations, as described in Section 4. The following presents the key elements of the technology development process.

*Expert Review Panel.* It is recommended that an expert review panel be assembled during the initial stages of a technology's development. The review panel should consist of a diverse group of professionals (e.g., fishery managers, engineers, research scientists) representing groups directly associated with the development of the technology (funding organizations/companies, consultants, regional resource agencies) as well as groups not directly associated with a technology's development but knowledgeable in the area of evaluating technologies (research universities, consultants, or resource agencies). The review panel should be consulted throughout the development and evaluation of a technology and be involved in assessing study plans, data analyses, and progress and final reports.

*Literature Review.* A thorough literature review should be conducted during a technology's development. Literature to be reviewed should include all publications that provide information on biological, environmental, and site parameters that are important to the design and operation of a technology. To the extent possible, the developer of a technology should provide information on the evolutionary, physiological and/or behavioral basis on which the developer believes that the technology will be effective. The literature review should address:

- (1) whether the technology is targeted at certain species of fish,
- (2) if its effectiveness is expected to be influenced by the behavior, physiology, swimming abilities, age, lifestage and size of the target species, and
- (3) if its effectiveness is expected to be influenced by physical conditions such as water temperature, turbidity, salinity, velocity, etc.

All past evaluations and applications of similar devices, including successes and failures, will be important to presenting the concept of a new or modified technology and for providing justification for testing or application of an existing technology. Past failures or shortcomings of the technology and identifying reasons for these shortcomings should be fully disclosed. Lack of transparency on this issue has often generated controversy in the past.

*Design and Operation.* It is important that individuals who will be asked to support the use of a technology understand its basic design and operation, particularly as these factors may affect product reliability and maintenance costs. Any experience with operation and maintenance problems should be fully disclosed. An evaluation of the reliability of a technology should be an integral part of the study plan. If the technology is proprietary (e.g., the inventors plan to file for a patent), a confidentiality agreement or other form of legal protection should be prepared to allow the disclosure of the design on a “need to know” basis. Many stakeholders are very skeptical of “black boxes” that are accompanied with unsubstantiated claims of potential effectiveness.

*General Plan of Study.* A general plan of study should be prepared by the developer of the technology (or a qualified Contractor) and reviewed by the Expert Review Panel. The general plan should describe the approach to be taken in the next phase of development, namely laboratory and/or field studies. The plan should include recommendations for test methods, possible test locations, test species and life stages, physical, environmental and hydraulic conditions, and data recording and analysis procedures. In essence, the general plan of study is a proposal for conducting an evaluation of a technology. Who will perform the study and how it will be financed are issues outside the purview of this Guideline Committee.

Depending on the technology, it may be appropriate to use physical or mathematical model studies to develop a concept prior to laboratory and/or field testing with live fish (e.g., a screen model to ensure that the design configuration chosen will meet established hydraulic criteria for safe fish passage). In the past, most modeling involved scaled physical models. Recently, computational fluid dynamic (CFD) techniques have been used in developing fish protection and passage technologies, as well as in addressing site-specific application issues. CFD allows for thorough analyses of flow dynamics using standard hydraulic principles and available flow and design data from a site and for the technology being assessed. CFD analyses can be conducted in lieu of physical model studies, or to provide additional information either prior to or after model studies have been completed.

*Independent Review and Comment.* All biological and engineering data from the technology development effort described above should be summarized in a comprehensive technology development report. The report should include the general plan of study and should be submitted to the Expert Review Panel for review and input. Input from the Panel could lead to improvements in the technology or allow for potential problems with design and operation to be identified early in the evaluation process.

## **SECTION 4**

### **PHASE 2 - “LABORATORY” EVALUATION**

The next step in the evaluation of a technology should be to conduct the laboratory and/or field studies discussed in the previous section of this Guideline. In the context of this Guideline, the term “laboratory” is not intended to describe a physical research laboratory facility *per se*. Rather, while the term encompasses such facilities, it also includes small-scale test facilities, such as test cages, land-based tanks and flumes that can be constructed or deployed at or near a potential site of application. The key distinction of “laboratory” studies is that they are conducted under a set of tightly controlled conditions.

Laboratory studies have been successful in the past in the development of various fish diversion screens that are now in full-scale use. For behavioral fish protection systems, laboratory studies allow researchers to determine the basic fish response to a stimulus under controlled conditions without interference from the many uncontrolled variables that occur in nature. On the other hand, laboratory studies are sometimes considered to be too controlled and unrepresentative of real world conditions. Therefore, the various advantages or disadvantages of laboratory versus field studies must be carefully weighed when deciding the location for the first evaluation of a technology. The decision on whether to begin with studies in the laboratory or to proceed directly to the field can be addressed by answering the following questions:

- ▶ Is the technology new or is it a variation of an existing technology (i.e., are data available from the existing technology that may be sufficient to obviate the need for laboratory testing)?
- ▶ Does the technology have numerous alternative configurations and/or operating conditions which need to be evaluated in order to identify optimum engineering design criteria and hydraulic performance prior to testing with live fish?
- ▶ Can the technology be “scaled” to a level where meaningful results can be obtained with live fish of the proper species and life stages in a laboratory test facility? (“scaled” refers to a small version of the technology rather than a true scaled model)?
- ▶ Will laboratory experiments serve to isolate the behavioral characteristic (e.g., phototaxis) responsible for the observed fish response to the technology (something that is difficult to isolate in the field)?
- ▶ Is the technology of such a design that it can be easily deployed on a small-scale basis at a field site?
- ▶ As a corollary, does a field test site exist that can provide (1) appropriate physical and hydraulic conditions, (2) target or representative species in sufficient abundance and duration to provide statistically meaningful results, (3) features that will permit the proper deployment of performance monitoring equipment (e.g., traps, nets, bypasses, hydroacoustics, telemetry), and (4) will allow testing without causing unacceptable impacts due to installation (e.g., riparian/upland destruction) or operation (e.g., entrainment of ESA listed species)?

These questions are addressed in the following discussions of laboratory and field evaluations.

Laboratory studies can provide a vital step in evaluating the effectiveness and future applicability of fish protection and passage technologies by providing a rigid scientific framework within which a technology can be studied under reasonably controlled conditions. Such studies are particularly useful in evaluating technologies that can have wide variation in design and operational parameters. For example, fish diversion screens can incorporate a range of screen angles and flow velocities that influence hydraulic conditions. In a hydraulic model, many variations can be evaluated quickly and inexpensively to determine which combination of parameters yields the optimal hydraulic conditions for effective fish diversion with minimal stress or injury. Similarly, laboratory test flumes are effective in evaluating the effectiveness of diversion devices (e.g., screens and louvers) with multiple species over a range of operating conditions in a short time frame.

The primary goal of laboratory investigations should be to collect data that will support the basic biological and engineering principle governing the potential effectiveness of a technology and provide clear evidence that future testing of a prototype at a field site is warranted. It should be clearly understood by all study participants that the results of the laboratory studies may indicate that a technology does not perform as expected and (1) that future testing is not warranted or (2) that major modifications in design or operation are needed. It is natural to expect that the first evaluation of a new technology may not produce the desired results. In such cases, researchers should review the results, make appropriate changes and re-evaluate the technology in the laboratory. In the past, market forces or the desire to proceed to the next level of testing have resulted in inappropriate applications of new technologies in field applications that have led to equivocal results. This approach has heightened the skepticism of many toward new technologies. The following discussion presents the key factors that need to be addressed in planning and conducting laboratory studies.

*Goals and Objectives.* It is critical to any research project that reasonable goals and objectives of the project are clearly defined and reviewed *a priori* by the Expert Review Panel, the researchers performing the study, and the inventor/supplier/manufacturer (vendors) of the technology. Poorly developed or understood study objectives can leave the door open to various and biased interpretations of study results. Properly worded goals and objectives also minimize the potential for false expectations among participants. The goals and objectives should pertain to the

laboratory phase only. At this point in the development process, goals and objectives should not be related to site-specific needs that might arise in the future when the technology might be applied to meet a specific fishery management program objective or to conform to a regional biological effectiveness requirement.

*Study Participants.* The primary participants will be the researchers conducting the study. However, the Expert Review Panel and the vendor of the technology (if any) should be involved in a review capacity, providing input into the Plan of Study, any changes to the proposed testing protocols that may become necessary during the evaluation, the test results and the study report.

*Test Facility.* If the test facility is intended to develop optimum design and hydraulic performance parameters for a technology, it may be appropriate to use a scaled model for the evaluation. As mentioned, such models have been used successfully for the development of a variety of fish passage facilities. If testing with live fish is intended, the facility should be of suitable size that “natural” behavioral responses can be expected. For example, a fish diversion screen test flume should be wide enough that the test fish are not unnaturally crowded and should include a sufficient length of screen to ensure that fish have actively guided on the screen and have not merely passed directly into the fish bypass. Studies of repelling behavioral devices should be conducted in facilities that have adequate escape routes. Particular care must be taken when studying the effects of sound on fish to ensure realistic propagation of the sound signal without reverberation and large boundary layer effects. It should also be kept in mind that evaluations of some technologies on a “laboratory” scale might not be appropriate under any circumstance, requiring researchers to proceed directly to field studies.

If live fish are being tested, adequate fish holding facilities must be provided. Appropriate methods for handling and holding fish should be used at all times to minimize injury and stress to the test fish. Past studies of technologies have occasionally been negatively impacted by the inability of the researchers to maintain test fish in a reasonably healthy state. Unfortunately, the lack of effectiveness of a device has sometimes been attributed to “the poor condition of the test fish.” Such statements have not helped to quell the skepticism of regulatory agencies asked to review the study data. If the test fish are in poor condition, it is recommended that they not be used. Rather, healthy fish should be used and, when the evaluation of a technology includes latent survival, control groups of fish should be held such that treatment and control survival rates can be calculated. In many cases, if control survival is reasonably high (e.g., greater than 80 percent), treatment survival can be adjusted for control mortality.

Holding facility design requirements and fish handling procedures vary by species and are not within the scope of this guideline. However, such information is widely available and can be obtained in other publications (EPRI 1997).

*Quality Assurance Plan.* A Quality Assurance Plan should be developed to describe and define objectives, experimental design, methods, personnel training requirements, data quality objectives and acceptability criteria, data reduction and analysis methods, and standard operating procedures for all aspects of the evaluation.

*Test Species.* Selection of appropriate test species and life stages (and related size) is one of the most critical components of a technology evaluation. If the technology development phase has been performed properly (see Section 3), it should be a straightforward task to select species/life stages on the basis of one or both of the following criteria:

- ▶ The species and life stages are of great enough importance at enough sites that might employ the technology (if effective) that they are appropriate for evaluation.
- ▶ There is an evolutionary, physiological and/or behavioral basis to expect that the selected species will adequately represent the performance of the technology for another species/life stage of interest.

To the extent possible, the species and life stages should be ones that are in need of protection. While it may be appropriate to use one species as a surrogate for another species, both species should be of importance and the

surrogate should reasonably represent an important, known attribute of the other species (e.g., swimming capability, body shape, behavior). Also, it may be appropriate to use surrogate species in preliminary trials; however, detailed evaluation with target species must eventually be completed.

*Test Conditions and Procedures.* To the extent possible, tests should be conducted under the full range of (1) operating conditions of a technology (e.g., device settings, such as screen angle or sound amplitude) and (2) environmental conditions (e.g., water quality, lighting).

*Data Analysis.* Appropriate and adequate analyses of data are very important aspects of any scientific evaluation and will be vital in gaining acceptance of study results. Use of inappropriate statistical models can lead to erroneous conclusions. Consideration should be given to involving a professional statistician for assistance in developing the experimental design for laboratory studies, as well as in the analysis of data. It is incumbent upon reviewers to have an understanding of the analysis techniques or to consult an authority on the specific statistical approach employed. Due to the natural vagaries in biological response, data often can be widely scattered, requiring a large number of replicates to produce statistically reliable results. The inclusion of a statistician on the Expert Review Panel is recommended. A well-defined plan for data collection and analysis can avoid the problem of “false positives” and “false negatives” that have occurred in past studies. A well-defined Quality Control/Quality Assurance plan should also be developed.

*Reporting.* Laboratory study reports should present all methods, collected data, statistical analysis results, and conclusions in a comprehensive and logical manner. A description of methods should include test facilities, equipment, procedures, and data analysis methods. Data summaries, trends, and statistical results should be presented in tabular and graphical formats in the body of a report and, to the extent possible, all raw data should be included in appendices. A lack of information pertaining to how a study was conducted, how data were analyzed, why some data may have been discarded, and thorough justification of all conclusions and recommendations often leads to controversy. Test data and information included in a report should be adequate to allow reviewers to independently replicate analyses and assess the validity of any conclusions or recommendations. The report should also include a summary of previous studies (if any) related to the technology and provide a complete bibliography.

*Acceptance of Results, Recommendations, and Conclusions.* The Expert Review Panel should review laboratory study results, conclusions, and recommendations and verify that the conclusions drawn are supported by the available data. The review panel would be responsible for submitting comments on draft reports and for confirming that the study was conducted according to the Plan of Study developed in Phase 1. Verification of the results is not an endorsement of the technology but rather a statement that (1) the methods used to evaluate the technology were appropriate and (2) the conclusions drawn are consistent with the results obtained. General considerations for accepting results of fish protection and passage technology evaluations are summarized in Table 4-1.

## **SECTION 5**

### **PHASE 3 - PROTOTYPE EVALUATION**

Prototype field studies represent the next logical step in evaluating technologies that have been shown in the laboratory to have the potential to protect or pass fish. Field studies should be designed to be a rigid scientific evaluation of a technology’s ability to meet desired effectiveness levels at a specific site or at a site that is considered representative of expected applications.

A primary goal of prototype studies should be to collect data that will allow researchers and fishery managers to determine if a technology can be considered a viable option for general application at appropriate sites. As with laboratory studies, it should be clearly understood by all study participants that the study results may indicate that a technology does not perform as expected and (1) that future testing is not warranted or (2) that major modifications in design or operation are needed.

*Study Participants.* Generally, the participants will be the same as in the laboratory with the possible exception of the researchers. Field studies require different skills and are best performed by experienced field organizations. At this stage, resource agencies may be expected to have a greater role in defining acceptance standards.

*Site Selection.* Site selection criteria should be developed for identifying an appropriate site for field studies of a technology. The criteria will vary depending on the type of technology being evaluated, but general factors to be considered in the site selection process include the following:

- ▶ **Species Availability:** The species of interest must occur at the site in sufficient numbers and for long enough periods to provide statistically meaningful results. It should be demonstrated that the evaluation of a technology at a given site will not cause unacceptable injury or losses to the fish or other sensitive species involved.
- ▶ **Site Representativeness:** The site should be reasonably representative of other sites of intended future use of the technology relative to fish species and life stage present, site layout and operating conditions.
- ▶ **Hydraulic Conditions:** The existence of appropriate hydraulic conditions is one of the most critical requirements for site evaluations of technologies. Velocities that are appropriate for the species/life stages being evaluated are essential. If the technology's effectiveness is considered to be sensitive to hydraulic conditions such as non-uniform velocities, turbulence, and effects of debris loads, these factors need to be specifically included or avoided, depending on the objective of the field evaluation.
- ▶ **Existing Features:** Some technologies have specific power requirements, installation specifications and/or operational needs that cannot be met at all sites. If a site has existing design and operating features that can support these needs, considerable cost savings can be realized.
- ▶ **Past Experience:** Sites at which previous studies of fish protection or passage technologies have occurred offer two advantages - (1) many of the "unknowns" of a new site have been previously identified and (2) sampling equipment with proven capabilities might be available for use and may allow for side-by-side comparison.
- ▶ **Ability to Modify Project Operations:** Evaluations of some technologies require periodic modifications to normal operations at a test site (e.g., shutting down hydro units to permit sampling equipment installation or preferential operation of a unit). The need to modify operations should be identified prior to the site selection process and be made known to potential site operators.
- ▶ **Access and Safety:** Reasonable access to test and sampling equipment should be available to permit researchers to conduct the study in a safe manner.

*Scale of Prototype Field Facilities.* Many of the past studies that have produced equivocal or controversial results suffered from the selection of an inappropriate scale for the first field trial of a new technology. There has been a tendency to evaluate new technologies on too large a scale, which can make monitoring of performance difficult and expensive. During the site selection process, attempts should be made to identify sites, or areas within sites, where the technology can be installed for testing under appropriate physical and hydraulic conditions, and at a scale that is large enough to produce data that is representative of results that would be expected at larger scales. A common approach to prototype testing is to install a technology on one unit of an operating plant; if the technology is effective, it can be "scaled up" by installing it at the other units.

*Test Conditions.* Test conditions include the operation of a technology (e.g., device settings, such as screen angle or sound amplitude), operation of site facilities (e.g., hydraulic conditions, turbine operation, diversion intakes), and environmental conditions (e.g., water quality, debris load, lighting conditions). To the extent possible, all important variables and combinations of variables (both controlled and uncontrolled) should be evaluated. A phased approach



to testing is recommended in which a wide range of test conditions is sequentially narrowed down to a few optimum performance conditions. Where possible, a bracketing approach to testing is recommended (e.g., starting at extremes in the ranges of particular variables). This approach could substantially reduce testing and analyses costs in some cases.

It should be recognized that natural variables outside of human control can confound test results or, in extreme cases, cause the loss of data. For example, high flow conditions at a hydroelectric project during the fish migration period of interest might result in the planned test fish bypassing the test facility (e.g., by passing through opened spill gates). Although such events are a fact of life, it is incumbent on planners and reviewers to adequately consider the potential for these events. Every effort should be made to minimize the likelihood that such events will occur or to minimize the impacts of the events on the data if they are unavoidable. When data are lost due to them, the loss should be acknowledged and subsequent analyses, if any are possible, should clearly state the limitations of the data and take those limitations into account.

*Target Species.* The species selection process for field evaluations is similar to that for the laboratory. Target species may include specific species for which a technology is designed, or representative species if a device is designed for application with many different types of fish. Target life stages (i.e.-size classes) also will be important to the evaluation of most technologies. In some cases, interactions with predatory species may be important in prototype evaluations.

*Quality Assurance Plan.* A Quality Assurance Plan should be developed to describe and define objectives, experimental design, methods, personnel training requirements, data quality objectives and acceptability criteria, data reduction and analysis methods, and standard operating procedures for all aspects of the prototype evaluation.

*Data Analysis.* Appropriate and adequate analyses of data are very important aspects of any scientific evaluation and will be vital in gaining agreement on conclusions based on field study results. With more uncontrolled variables in the field than in the laboratory, the analytical techniques to be used should be developed *a priori* by individuals knowledgeable in the design and operation of test site features. As with the laboratory evaluations, consideration should be given to involving a professional statistician for assistance. It is incumbent upon reviewers to have an understanding of the analytical techniques used or to consult an authority on the particular approach employed. The inclusion of a statistician on the Expert Review Panel also is recommended.

*Reporting.* Study reports should present all methods, collected data, statistical analysis results, and conclusions in a comprehensive and logical manner. A description of methods should include site design, test facilities, equipment, procedures, and data analysis methods. Data summaries, trends, and statistical results should be presented in tabular and graphical formats in the body of a report and, to the extent possible, all raw data should be included in appendices. A lack of information on how a study was conducted, how data were analyzed, and why some data may have been discarded, coupled with an incomplete justification of all conclusions and recommendations, has led to most of the controversies that have been experienced in past evaluations and application of new and experimental technologies. Test data and information included in a report should be adequate to allow reviewers to independently replicate analyses and assess the validity of any conclusions or recommendations.

*Acceptance of Results, Recommendations, and Conclusions.* The Expert Review Panel should review study results, conclusions, and recommendations and verify that the conclusions drawn are supported by the available information. The review panel would be responsible for submitting comments on draft reports and for confirming that the study was conducted according to the guideline criteria. Acceptance of the results is not an endorsement of the technology but rather a statement that (1) the methods used to evaluate the technology were appropriate and (2) the conclusions drawn are consistent with the results obtained. General considerations for accepting results of fish protection and passage technology evaluations have been summarized previously in Table 4-1.

It may be determined that the technology is limited in application to certain species, site-specific physical and hydraulic conditions, and other factors. Such limitations should be clearly identified in the report. If the limitations can be potentially removed through further study, the types of study efforts should be generally defined.

## **SECTION 6**

### **PHASE 4 - APPLICATION AND EVALUATION**

If results from Phase 2 and 3 laboratory and field tests have been verified by the Expert Review Panel and all study participants, and these results indicate that a technology has potential for effective application, then the technology should be considered as a candidate for application at appropriate sites and with species for which the device has been designed and successfully evaluated. Therefore, the types of sites, species, environmental conditions, etc. that are considered “appropriate” should be defined.

#### **6.1 Site Assessment**

When the application of a fish protection or passage technology is being planned for a given site, there are many issues related to biological, environmental, and engineering parameters that need to be addressed. The selection of an appropriate site is paramount to the “proof of concept” that is hoped to be achieved in the first full-scale application of a technology. Some past studies of experimental technologies have suffered from the selection of sites that have too many environmental, physical and/or hydraulic variables that confound the data and lead to equivocal results. It is recommended that the Expert Review Panel be involved in the site selection process and the studies that follow.

#### **6.2 Review of Alternative Fish Protection and Passage Technologies**

When a site owner is required to evaluate fish protection or passage technologies for a given site, it is advisable to objectively review the status of available alternatives. Available technologies should be assessed for applicability to a site using criteria that address biological, environmental, engineering, and cost considerations. The owner should understand from the outset whether the technology is considered experimental, how the resource agencies view the technology, and whether its experimental status will impact its potential for acceptance by the agencies if it is applied at a given site. Agency requirements vary by region and may change over time. Therefore, it is considered essential to involve the appropriate agencies in the process of selecting a technology, particularly if it is considered experimental.

#### **6.3 Design, Operation, and Post-Installation Evaluation**

After a technology is selected for application, site-specific design and operation criteria must be established and a study plan for a post-installation evaluation should be prepared. The Plan of Study should clearly identify specific fish passage/protection goals that can lead to ultimate acceptance of the installation. The Plan should also include a quality assurance program that describes and defines objectives, experimental design, methods, personnel training requirements, data quality objectives and acceptability criteria, data reduction and analysis methods, and standard operating procedures for all aspects of the post-installation evaluation.

Post-installation studies are typically necessary to determine site-specific performance and guide modifications if performance criteria are not met. The necessary rigor of a given post-installation evaluation will depend on many factors, such as the adequacy of the data from evaluations conducted during the developmental phases to predict effectiveness at a site and regional agency requirements for effectiveness. These studies can be especially important if major site-specific biological, environmental, design or operational differences exist relative to the prototype that was evaluated during field studies.

**Table 2-1**  
Controversial Issues Associated with Technology Evaluations

<b>STUDY PARAMETER</b>	<b>ISSUE</b>
Study scale	Has the appropriate scale been selected for the current level of development of the technology (laboratory, prototype, full-scale)?
Site selection	Is the site appropriate (physical, hydraulic, water quality, etc. conditions representative without unusual, confounding factors)?
Technology deployment	Has the system or device been configured and deployed in an appropriate manner that will maximize biological effectiveness?
Study design	Have appropriate protocols been developed to adequately address the goals and objectives of the study in a reasonable and cost-effective manner?
Data collection	Has the data been collected in a scientific manner by experienced and objective fishery scientists?
Species tested	Are the species tested the actual target species; if surrogate species are tested, are they representative of target species?
Test fish	Are the test fish of the appropriate age, size, condition (e.g., smolted vs. non-smolted)?
Conditions tested	Have a reasonable range of environmental conditions of proposed application been included (e.g., day vs. night, temperature, light, turbidity)?
Statistical analyses	Have appropriate techniques been selected to allow determinations of statistical significance with a measure of variance?
Reporting	Do results support conclusions?

**Table 2-2**  
Process of Evaluation and Acceptance

**Phase 1 - Technology Development**

- Establish an expert review panel
- Review literature for information supporting the technology concept
- Describe design, operation, and intended effects (e.g., avoidance, attraction)
- Develop a general plan of study for laboratory and/or field evaluations
- Prepare a technology development report (include literature review, design and operation, and general plan of study)
- Submit draft final report for review and comment
- Submit copy of final report to AFS Bioengineering Section

**Phase 2 - “Laboratory” Evaluation**

- Prepare draft study plan
- Submit draft study plan for review and comment
- Finalize study plan
- Conduct studies
- Submit progress reports
- Prepare summary draft report
- Submit draft final report for review and comment
- Revise draft report and publish

### **Phase 3 - Prototype Evaluation**

- Prepare draft study plan
- Submit draft study plan for review and comment
- Finalize study plan
- Conduct studies
- Submit progress reports
- Prepare draft final report
- Submit draft final report for review and comment
- Revise final report and publish

### **Phase 4 - Technology Selection and Application**

- Site assessment
- Technology selection
- Review by Expert Review Panel
- Conduct post-installation evaluation
- Perform long-term evaluation with annual reports

**Table 4-1**

Considerations for Accepting the Results of Fish Protection and Passage Technology Evaluations

#### **1. Test Facilities**

Test facilities that are used during a laboratory or field study should meet design criteria that allow for precise or accurate and reliable testing of all proposed conditions and scenarios. Test facilities should be assessed for conditions that may introduce error or bias in data during an evaluation.

#### **2. Test Equipment**

Test equipment to be used during laboratory and field testing should be adequate to meet all study objectives related to device operation, conditions tested, and type and accuracy of data collected. The type and quality of test equipment should be assessed to verify that each item is appropriate for its intended purpose.

#### **3. Testing Procedures**

Testing procedures used for technology evaluations should be designed to collect data in a standardized, logical manner that minimizes the potential for error and bias. Testing procedures should be reviewed for inconsistencies and potential for influencing the outcome or study results (i.e., observed results that are an artifact of testing methods).

#### **4. Experimental Design and Data Analysis Methods**

Experimental design of technology evaluations should be based on study objectives, hypotheses to be tested, and the type of data to be collected (e.g., diversion or survival rates, time fish take to ascend a ladder). Data analysis methods should be appropriate for the type of test conducted and data collected. Statistical tests and models should be robust with respect to assumption violations. A full discussion of the validity of each assumption should be provided in study reports. Where possible, assumptions should be tested. Experimental design and data analysis methods should be assessed for their appropriateness, adequacy, and robustness to determine the strength of the data, statistical results, and subsequent study conclusions and recommendations.

## 5. Reporting

Study reports should present all relevant data and information that was generated during an evaluation. Reviewers should be able to replicate all analyses with the information and data that are provided in a report. Unexpected or poor results should be reported and, if possible, causes should be identified.

## 6. Study Conclusions and Recommendations

Study conclusions and recommendations must be consistent with collected data and statistical analysis results. Researchers should avoid drawing conclusions that are speculative or based on ambiguous results.

## LIST OF REFERENCES

### A.) *Fish Protection and Passage Technologies*

- American Society of Civil Engineers. 1995. Design of Intakes for Hydroelectric Plants. ISBN 0-7844-0073-3, 1995.
- American Society of Civil Engineers. 1982. Design of Intakes with Fish Handling Capability. ISBN 0-87262-291-6, 1982.
- California Department of Fish and Game. 1993. "General Fish Screening Criteria." Sacramento, CA, February 1993.
- Cook, T. C., G. E. Hecker, H. B. Faulkner. 1997. Development of a More Fish Tolerant Turbine Runner. Advanced Hydropower Turbine Project. U. S. Department of Energy Contract No. DE-AC07-95ID13383.
- Electric Power Research Institute (EPRI). 1986. Assessment of Downstream Migrant Fish Protection Technologies for Hydroelectric Application. EPRI AP-4711.
- EPRI. 1994. Research Update on Fish Protection Technologies for Water Intakes. EPRI TR-104122.
- EPRI. 1997. Guidelines for Hydro Turbine Fish Entrainment and Survival Studies. EPRI TR-10729.
- EPRI. 1999. Fish Protection at Cooling Water Intakes. EPRI TR-114013.
- Franke, G. F., D. R. Webb, R. K. Fischer, D. Mathur, P. N. Hopping, P. A. March, M. R. Headrick, I. T. Laczó, Y. Ventikos, and F. Sotiropoulis. 1997. Development of Environmentally Advanced Hydropower Turbine System Design Concepts. U. S. Department of Energy Contract No. DE-AC07-94ID13223. Idaho National Engineering and Environmental Laboratory Report No. INEEL/EXT-97-00639.
- Knudsen, F. R., P. S. Enger, and O. Sand. 1992. Awareness Reactions and Avoidance Responses to Sound in Juvenile Atlantic Salmon, *Salmo salar* L. *Journal of Fish Biology* 40:523-534.
- Knudsen, F. R., P. S. Enger, and O. Sand. 1994. Avoidance Responses To Low Frequency Sound In Downstream Migrating Atlantic Salmon Smolt, *Salmo salar* L. *Journal of Fish Biology*.
- Odeh, M. and C. Orvis. 1997. "Status of Downstream Fish Passage at Hydroelectric Projects in the Northeast, U.S.A.. In: D. J. Mahoney, ed., Proceedings of the International Conference on Hydropower (Waterpower '97), Vol. 1: 645-654. American Society of Civil Engineers, New York, NY.
- U. S. Congress, Office of Technology Assessment (OTA). 1995. Fish Passage Technologies: Protection at Hydroelectric Facilities, OTA-ENV-641 (Washington, DC: U. S. Government Printing Office, September 1995).

U. S. Department of Commerce, National Marine Fisheries Service. 1992. "Fish Screening Criteria for Anadromous Salmonids, National Marine Fisheries Service, Southwest Region." April 1992.

U. S. Department of Commerce, National Marine Fisheries Service (NMFS). 1990. "Fish passage facilities functional design criteria and supplemental criteria." November 16, 1990.

### ***B.) Upstream Fish Passage Technologies***

Clay, C. H. 1995. Design of Fishways and Other Fish Facilities. CRC Press, Inc. ISBN 1-56670-111-2.

### ***C.) Tailrace Barriers***

Federal Energy Regulatory Commission. 1995. "Impacts of Hydroelectric Plant Tailraces on Fish Passage: A Report on Effects of Tailraces on Migratory Fish and Use of Barriers, Modified Project Operations, and Spills for Reducing Impacts. Paper No. DPR-9, June 1995.

### ***D.) Agency Position Statements***

U. S. Department of Commerce, National Marine Fisheries Service (NMFS). 1994. Experimental fish Guidance Devices: Position Statement of the National Marine Fisheries Service, Southwest Region. Santa Rosa, CA, January, 1994.

U. S. Department of Commerce, National Marine Fisheries Service (NMFS). 1995. Experimental fish Guidance Devices: Position Statement of the National Marine Fisheries Service, Northwest Region. Portland, OR, January, 1995.

---

## **Session A Questions and Answers**

- Q: Karen Patterson, Tetra Tech NUS, asked whether the state agencies have given thought to their ability to be involved, given resource restrictions.
- A. Edward Radle, retired, New York State Department of Environmental Conservation (NYSDEC) – Steam Electric Unit, answered that New York State intends to be fully engaged in the effort. Michael Calaban, New York State Department of Environmental Conservation – Steam Electric Unit, added that the two positions vacated at NYSDEC by retirement have been filled. Mr. McLean indicated that, for Maryland, the Department of Natural Resources, Power Plant Research Program (Maryland DNR – PPRP) is funded outside of state funds, so they will have the resources to address the issues.

## V. Session B: Flow Reduction

### *Retrofit of Closed-Cycle Cooling with Unit-Specific Mechanical Draft Wet Cooling Towers with By-Pass Capability: A Case Study*

*Reed Super, Riverkeeper, Inc. and John Torgan, Save the Bay – People for Narragansett Bay*

#### **BIOSKETCHES**

Mr. Reed Super received his JD and MBA degrees from the University of Virginia. He has practiced environmental law since 1992, and since 1994 has been working on clean water issues with Waterkeeper Alliance programs. Since 2000, Mr. Super has directed Riverkeeper's National Fisheries and Power Plant Program. He is the author with David Gordon of *Minimizing Adverse Environmental Impact: How Murky the Waters?* and teaches Preservation Law as an adjunct professor at Hofstra University School of Law.

Mr. John Torgan serves as Narragansett BayKeeper, an advocacy program of Save The Bay, Southeastern New England's largest non-profit environmental group dedicated to protection and restoration of Narragansett Bay. He has been with Save The Bay since 1993. Mr. Torgan holds a B.S. in Environmental Studies/Biology from Union College in NY. He is a master's candidate at the University of Rhode Island Department of Marine Affairs. Before joining Save The Bay, John worked for Ichthyological Associates in NY and Michigan conducting habitat assessments related to power plant permitting. He has served on a number of national committees, mostly related to the environmental aspects of marine transportation, and presently serves on the National Academy of Science/Transportation Research Board committee on Marine Transportation Systems.

#### **ABSTRACT** (*Technical Paper Not Available*)

Direct-cooled, steam-electric power plants can withdraw up to several billion gallons of cooling water per day, resulting in the entrainment of more than a billion fish, eggs and larvae per year, and the discharge of substantial thermal pollution.

Closed-cycle recirculating cooling systems cut cooling water usage by approximately 70-96 percent (depending on the salinity of source waters and local water quality standards) compared to once-through cooling systems, thereby reducing impingement and entrainment and other aquatic impacts by a similar percentage. According to the USEPA, 100 percent of the combined-cycle power plants with a cooling water intake capacity greater than 2 MGD built in the last twenty years and 88 percent of the 2+ MGD coal-fired facilities built in the last 10 years have a closed-cycle recirculating cooling system.

Retrofits of cooling towers on existing facilities are less frequent, but have been completed at a variety of facilities, including a gas-fired plant on a west coast estuary, a nuclear plant on a Great Lake, and coal-fired plants on eastern seaboard rivers. Retrofits are also currently planned at several other US facilities, including 100 percent cooling towers at the McDonough and Yates plants on the Chattahoochee River. Several different retrofit options have been evaluated for some or all of the four units at the Brayton Point Power Station in Somerset, Massachusetts, including unit-specific and/or multi-mode cooling towers.

The paper will focus on the retrofit of mechanical draft wet cooling towers with or without by-pass capability as a case study of one closed-cycle retrofit technology option. It will address environmental advantages and any disadvantages, costs, feasibility and retrofit considerations.

*Proposed Innovative Cooling System for Heat and Flow Reduction at the Brayton Point Power Station*  
 Thomas Englert, Lawler, Matusky and Skelly Engineers, LLP

**BIOSKETCH**

Dr. Thomas Englert is a partner in Lawler, Matusky & Skelly Engineers and Manager of the Environmental Modeling and Analysis Group. Dr. Englert has a PhD in Chemical Engineering from Princeton University. For the past thirty years he has conducted and supervised modeling studies and data analyses as part of 316 evaluations regarding the effects of power plants operations on fish populations. This has included evaluation of intake effects (impingement and entrainment) as well as the effects of thermal discharges. These evaluations have also addressed the costs and benefits of alternative intake technologies and cooling systems. His current research interests include the effects of the proposed 316(b) regulations for existing facilities on power plant operations.

**TECHNICAL PAPER**

**Abstract**

Brayton Point Station, a 1600-megawatt (MW) four-unit fossil-fuel electrical generating station located in Somerset, Massachusetts, uses Mount Hope Bay for withdrawal and discharge of condenser cooling and service water. As part of the NPDES permit renewal application and 316(a) and (b) Demonstration, the Station designed an innovative cooling-water system to reduce the amount of intake flow from, and heat discharged to, Mount Hope Bay. Referred to as the enhanced multi-mode (EMM) system, the innovative technology consists of a 20-cell mechanical-draft counter-flow cooling tower linked to the warmest generating units via a unique piping configuration. The piping permits rapid switching of the cooling tower to capture and remove heat from the warmest condenser-heated water under any Station operating scenario. Further, the absence of “hard piping” characteristic of conventional closed-cycle systems avoids the need to shut down a generating unit when the cooling tower to which it is piped must be shut down. Compared to the Station’s current cooling-water system, the EMM system would yield a 33% reduction in cooling water withdrawal and heat load. Associated reductions in entrainment and impingement of commercially and recreationally fished species and their prey would trim equivalent adult losses by 40 percent. Finally, biothermal effects on a series of life-cycle functions, already negligible under current Station operation, would be reduced further under the new technology. While significant costs would arise in constructing, operating, and maintaining the EMM system, economic analyses suggest that, among three alternative cooling-water technologies evaluated by the Station, the EMM system is the most cost-effective and provides the greatest net benefits. The EMM system is highly specific to Brayton Point Station. Nonetheless, the concept of a dynamically configurable cooling-water system is potentially applicable across a variety of power plant installations.

**Introduction**

Brayton Point Station occupies approximately 250 acres on Brayton Point, a peninsula formed by the confluence of the Lee and Taunton rivers in Mount Hope Bay, which comprises the northeast corner of the greater Narragansett Bay complex. Operating 24 hours a day, 7 days a week, the Station produces the equivalent of 20% of the electrical power for Massachusetts or 150% of the electrical power for Rhode Island. Table 1 presents generating capacity and heat and flow data for the Station’s four generating units.

**Table 1.** Brayton Point Station Operating Data

Component	MW Capacity	Condenser Duty (mBTU/hr)	Flow (gal/min)	Max Design Temperature Change ( °F)	Commercial Start-up
Unit 1	250	1,098	180,000	12.2	Aug 1963
Unit 2	250	1,098	180,000	12.2	July 1964
Unit 3	650	2,590	280,000	18.5	July 1969
Unit 4	450	2,340	260,000	18.0	Dec 1974
Service Water	-	232.7	31,000	15.0	-
Combined	1,600	7,359	931,000	15.8	-

Currently water to cool the condensers for Units 1, 2, and 3 is withdrawn from the Taunton River, while cooling water for Unit 4 is withdrawn from the Lee River. After passing through the condensers, cooling water from Units 1, 2, and



3 mixes with cooling water from Unit 4 and then exits to Mount Hope Bay via a 3,200-foot-long discharge canal. The canal terminates at the southern tip of the Station at a venturi that causes the exiting discharge to mix rapidly with the cooler water of the bay. The Taunton and Lee River intakes and the discharge canal are identified in Figure 1, which presents an aerial view of Brayton Point Station.

Figures 2 and 3 illustrate the two cooling-water system configurations currently in use at the Station. From June through September (Figure 2), the maximum flow rate at the Station is 1,299 million gallons per day (MGD). From October through May (Figure 3), the maximum flow rate drops to 925 MGD. During this reduced-flow period—which spans the spawning season of winter flounder, a species sought locally in both the commercial and recreational fisheries—the Station operates in “piggyback” mode. In this mode, the Unit 4 intake is closed, and the cooling water discharge from Units 1, 2, and 3 is reused as cooling water for Unit 4.

In evaluating alternative cooling-water systems as part of the process of applying for renewal of its NPDES operating permit, Brayton Point Station designed an enhanced multi-mode (EMM) cooling-water system. The EMM system is comprised of a cooling tower connected to the Station’s four generating units via a unique, dynamically configurable piping system. The piping allows the cooling tower to capture and cool the warmest water from the Station, resulting in significant performance improvements over a comparably sized fixed-piping system. This paper describes the basic engineering and operation of the EMM system. It also compares the biological benefits of the EMM system to those under the Station’s current once-through/piggyback cooling-water system and two alternative systems: closed-cycle cooling for Unit 3 and closed-cycle cooling for all four units. Finally, the paper presents the results of cost-effectiveness and cost-benefit analyses of the foregoing alternatives.

### **EMM Engineering And Operation**

The EMM system involves installation of a mechanical-draft counter-flow cooling tower comprised of 20 cells arranged in two rows of 10 cells each on a common foundation. Overall plan dimensions of the tower structure are 540 by 108 feet, with an above-grade height of 67 feet.<sup>1</sup> The design situates the tower to minimize the lengths of large-diameter pipe required to connect the structure to generating-unit intakes, condensers, and the discharge canal.

In a tower-driven counter-flow cooling-water system, heated water exiting a generating-unit condenser is pumped to the tower, where upward-flowing air is used to dissipate the heat. In the system evaluated for Brayton Point Station, heated water enters the tower at an elevation of about 8 feet above the tower air inlet. Within each cell, the water is distributed evenly and dispersed over the top of a heat transfer section. It then falls by gravity through that section and into a concrete basin at ground level, from which it is recirculated by gravity to one or more condenser inlets or routed to the discharge channel. As the heated water flows downward into the 10-12 ft thick heat transfer fill section, which consists of layers of low-fouling polyvinyl chloride, it is cooled by ambient air induced to flow upward by a large-diameter fan located at the top of the cell. After passage through the heat transfer section, the upward-flowing air moves through highly efficient drift eliminators. These devices remove almost all of the entrained water droplets, which are then returned to the concrete basin at the bottom of the cell.

The key innovation of the EMM system is a unique piping system that ties the tower to all four generating units. A series of gate and butterfly valves allows the system to be dynamically configured while the Station is in operation, permitting heated water from different units or combinations of units to be directed to the cooling tower. The EMM cooling tower is sized to always enable cooling of the warmest water produced by the Station.<sup>2</sup>

---

<sup>1</sup> The design basis for the cooling tower includes a water inlet temperature of 107°F, a water outlet temperature of 85°F, and a wet-bulb temperature of 77°F.

<sup>2</sup> As shown in Table 1, Units 4 and 3 produce the warmest water (essentially equivalent temperature increases of 18 and 18.5 °F, respectively, and respective mBTU/hr ratings of 2,340 and 2,590). The tower is sized to accommodate all of Unit 4’s condenser water heat when that unit operates closed-cycle, or essentially all of Unit 3’s heat during Unit-3-closed-cycle operation. (During some periods of the year, efficiency losses will be experienced when Unit 3 operates closed-cycle.) Annually, the tower will remove 14 tBTU of heat, inclusive of scheduled maintenance and other periods when the Station operates at less than full capacity.

The ability to accommodate a variety of Station operating scenarios affords operational flexibility and reliability not possible in a “hard-piped” arrangement. The piping system accommodates the following operating modes:

- ▶ Effectively closed cycle on Unit 4 (Figure 4)  
Whenever Unit 4 operates at full capacity, it is cooled by water recirculated from the cooling tower. Note: In the EMM design, Unit 4—unlike Units 1, 2, and 3—does not have its own dedicated circulating water intake pumps. Instead, its former circulating water pumps are used to circulate water to the tower. Therefore, when the tower is on and Unit 4 operates at full capacity, it always operates effectively closed-cycle.
- ▶ Effectively closed cycle on Unit 3 (Figure 5)  
When Unit 4 is not operating, both of Unit 3’s circulating water intake pumps are shut down, and tower-cooled water is recirculated to Unit 3’s condenser.
- ▶ Effectively closed cycle on Unit 4 and partially closed cycle on Unit 3 (Figure 6)  
When Unit 4 operates at less than full capacity, tower-cooled water is recirculated to both Units 4 and 3. In this configuration, Unit 3 operates *partially* closed-cycle because one of its two circulating water intake pumps is turned off, while the other continues to operate.
- ▶ Helper cooling on Units 1 and 2 (Figure 7)  
When both Units 4 and 3 are shut down, heated water from the Unit 1 and 2 condensers enters the discharge canal and is then routed to the tower. The water is cooled by the tower and then returned to the discharge canal, from which it exits to the bay.
- ▶ Piggyback operation on Unit 4 when the cooling tower is shut down  
The ability to operate in the piggyback mode affords the EMM system a degree of reliability not possible in conventional closed-cycle systems. Brayton Point Station is located near a major interstate highway. When certain weather conditions prevail, the tower’s plume of humid air could cause fogging or icing of nearby roads. For safety reasons, the tower would be shut down to avoid these hazards. In conventional closed-cycle systems, in which towers are permanently hard-piped to condenser inlets, tower shutdown forces shutdown of the associated generating unit. In the EMM system, tower shutdown—whether due to safety concerns or for maintenance—does not prevent any generating unit from operating. Unit 4, for example, could continue to run by switching the EMM system to piggyback mode, in which heated water from Units 1, 2, and 3 cools as it mixes and travels through the discharge canal and then recirculates to Unit 4’s condenser inlet (essentially in the same manner as shown in Figure 3, which depicts piggyback operation currently in effect from October through May). Piggyback operation will enable the EMM system to continue to reduce flow from and to Mount Hope Bay while providing a reliable supply of energy.

### **Flow and Heat Reductions**

On an annual basis, the EMM system would remove the full heat equivalent of Unit 4 and approximately 50% of the heat equivalent of Unit 3. Compared to current once-through/piggyback operation, this yields the following reductions in flow and heat load:

- ▶ A 33% reduction in Station average annual flow from Mount Hope Bay: from 977 to 650 MGD
- ▶ A 33% reduction in annual heat load to the bay: from 42 to 28 tBTU.

Important biological benefits would accrue from such large reductions in flow and heat load. These are discussed later in this paper in the section entitled “Evaluation of Biological Benefits.”

### **Additional EMM Components**

Additional Station modifications are included in the EMM implementation:

- ▶ Installation of variable-speed drives (VSDs) on the Unit 1 and 2 circulating water intake pump motors. Currently the Unit 1 and 2 circulating water intake pumps operate in two positions: on and off. Thus when Unit 1 or 2 operates at less than full load, there is no means to reduce flow into the condenser inlet, and thus no means to reduce organism loss or damage associated with incoming flow. The VSDs would allow reductions in cooling water flow.
- ▶ Installation of fish buckets on the Unit 1, 2, and 3 traveling screens to increase survival of impinged fish. Currently the Unit 1, 2, and 3 intake screens have a screen lip that acts to carry fish to a sluiceway, from which they are subsequently returned to the bay. Fish buckets, which carry both water and fish to the sluiceway, have been found to be more effective than the screen lip configuration in reducing mortality of organisms impinged on intake screens (Fletcher 1990).
- ▶ Extension of the condenser discharge pipe on Units 1 and 2 to effectively direct the warmest discharge waters (from Units 3 and 4) to the cooling tower. Currently the Unit 1, 2 and 3 condensers discharge at the same location in the discharge canal. Extending the Unit 1 and 2 condenser discharge pipes further down the discharge canal, slightly beyond the cooling tower inlet, would effectively direct the warmest water through the tower at all times.

### **Construction Schedule**

Implementation of the EMM system at Brayton Point Station is projected to take approximately 31 months and require no long-term lapses in electrical generation. This schedule assumes that one year would be required for permitting and that engineering would start seven months into the permitting cycle. Start of construction would occur 15 months into the schedule.

The following outages are anticipated during implementation of the EMM system:

- ▶ One Unit 4 outage of approximately 4 months' duration starting 27 months into the schedule
- ▶ Shorter outages (2 to 3 weeks) for Units 1 and 2 at 19 months into the schedule and for Unit 3 at 24 months into the schedule.

This schedule includes modification of the traveling intake screens on Units 1, 2, and 3.

### **Costs: Capital, Operation and Maintenance, and Lost Annual Generation**

The estimated capital cost for implementing the EMM cooling system with a 20-cell cooling tower, VSDs on the Unit 1 and 2 circulating water pumps, and modified traveling screens on Units 1, 2 and 3 is \$57.4 million (2001 US \$). This estimate includes a 10% allowance for indeterminants and a 10% contingency allowance.<sup>3</sup> Annual maintenance costs associated with the EMM system include fan maintenance, cooling tower basin cleaning, cooling tower fill cleaning and maintenance, and pump maintenance. The latter includes an estimated normal annual maintenance cost plus the cost of a pump overhaul once every 10 years for each pump. (Estimated pump maintenance plus overhaul costs over a 10-year period are averaged to determine an estimated annual cost.) The estimated annual combined maintenance cost for the EMM cooling system is \$240,000 per year.

The combined lost annual power generation is estimated at 97,900 MW-hr/yr. This value is comprised of 72,600 MW-hr/year of additional auxiliary power consumption required to run the system and 25,300 MW-hr/year of steam turbine operating penalties.

---

<sup>3</sup> Capital costs for closed-cycle cooling for Unit 3 and closed-cycle cooling for all four units are \$56.4 and \$177 million (2001 US \$), respectively. Detailed cost estimates for the three alternative technologies are included in Volume IV of USGen (2001).

### **Evaluation of Biological Benefits**

The potential biological benefits associated with alternative cooling-water technologies accrue from two primary sources: reductions in cooling-water intake flows and reductions in the amount of heat released to the host water body. In connection with its Section 316(b) demonstration, Brayton Point Station conducted detailed evaluations of the biological benefits anticipated from both flow and heat reductions for each of the four technologies considered here: the once-through/piggyback operation currently in effect, EMM, Unit-3-closed-cycle, and all-units-closed-cycle.

Biological benefits associated with intake flow reductions were determined through a two-step process:

1. The total numbers of organisms lost to entrainment and impingement were calculated.<sup>4</sup>
2. The entrainment and impingement losses were converted into equivalent adult losses. (As discussed in the “Economic Evaluation” section later in this paper, the anticipated dollar value of additions to the fishery due to reduced entrainment and impingement losses has been used in ranking three alternative cooling-water technologies with respect to cost-benefit ratios.)

Biological benefits associated with reduced heat loads were determined by assessing effects of the Station’s thermal plume on biological functions of an EPA-approved set of aquatic organisms.

### **Reductions in Intake Flow**

The number of organisms entrained or impinged annually depends on two primary factors:

- ▶ Total intake flows  
In general, the more water that is withdrawn, the higher are the numbers of organisms entrained or impinged.
- ▶ Seasonality of water withdrawal  
During some periods of the year, more fish at life stages that make them susceptible to impingement or entrainment may be present. This is why, since 1997, Brayton Point Station has operated in piggyback mode from October through May, when winter flounder spawn. Reduced intake flows during these months have resulted in lower annual winter flounder entrainment and impingement losses compared to pre-piggyback operations.

In determining how intake flows under the current and three alternative cooling-water technologies affect entrainment and impingement losses, flow-based entrainment and impingement data collected at Brayton Point Station from 1973–1985 were used as benchmarks. For one species, winter flounder, 1993–1999 data were available, and these were used for the evaluation. (It should be noted that documented survival rates for impinged organisms were used, but that for entrained organisms—even though records demonstrate some entrainment survival—100% mortality was assumed for all species except winter flounder.<sup>5</sup>) From these historical data and data resulting from hourly Station cooling-flow simulations made for each of the three alternative cooling-water technologies, technology-dependent entrainment and impingement losses were calculated. For each alternative technology, the associated losses were then used to calculate equivalent adult losses of entrained or impinged finfish species that are part of a commercial or

---

<sup>4</sup> Aquatic organisms entering a power plant through its intake structures can become damaged or succumb due to entrainment (passage through an intake screen’s wire mesh and then through the plant’s cooling-water or service-water system) or impingement (entrapment against or in the structure’s intake screens). With respect to fish species, entrainment usually involves only the early life stages, that is, eggs, larvae, and small juveniles. Susceptibility to impingement depends primarily on an organism’s size relative to the intake screen’s mesh size, and on its life-stage mobility when it enters the intake channel.

<sup>5</sup> For winter flounder, entrainment survival data were incorporated in the evaluation. Compared to the assumption of 100% entrainment mortality, the survival data resulted in a 9% reduction in the estimate of winter flounder equivalent adult losses under current operations.

recreational fishery.<sup>6</sup> These losses, expressed in pounds, represent the cumulative weight of the lost fish at the age at which they would have entered the fishery.

Two intermediate metrics were used in deriving total equivalent adult losses of fished species:

- ▶ **Direct losses**  
These losses were calculated by converting the numbers of entrained and impinged organisms into the numbers of fish that can be expected to have survived to the age at which they would enter the fishery.
- ▶ **Indirect losses**  
Indirect losses reflect pounds of fished species biomass lost because the prey upon which the species forage were entrained or impinged. These losses were determined through a two-step process:
  1. Calculation of production foregone. This is the total prey biomass that would have been produced over the prey's natural life span had they not been entrained or impinged.
  2. Conversion of production foregone into fished species biomass. This was done using a 10% trophic conversion efficiency factor (PSE&G, 1999). That is, it was assumed that for every 10 pounds of prey biomass foregone, one pound of equivalent adult fished species biomass was lost. Additionally, the prey biomass was apportioned to the fished predator species based on known predator-prey relationships as well as the relative abundance of the fished predators.

Table 2 presents annual equivalent adult losses that would occur due to entrainment and impingement at Brayton Point Station under the current and three alternative cooling-water technologies evaluated. For brevity, species-specific data are presented only for the three finfish with the highest losses—namely, winter flounder, tautog, and weakfish. Composite data are presented for all other fished species evaluated and for all fished species evaluated. Table 2 also includes the percentage of the combined Rhode Island/Massachusetts commercial and recreational fishery harvest represented by equivalent adult losses.

Table 3 presents the biological benefit of reduced flow rates—expressed as the percent reduction in equivalent adult losses—that would occur under each alternative cooling-system scenario compared to current once-through/piggyback Station operation. As shown, the EMM system would reduce the pounds of fished species lost due to entrainment and impingement by 40%. This value is not significantly different from the percent reduction estimated under Unit-3-closed-cycle operation (43%). The all-units-closed-cycle alternative would, not surprisingly, produce a higher reduction in equivalent adult losses (93%), although, as discussed in the “Economic Evaluation” section of this paper, it would do so at nearly five times the cost. It should also be noted that, although the 93% reduction in equivalent adult losses appears large compared to the EMM's 40% reduction, equivalent adult losses under EMM are themselves very small compared to the combined effects of other stresses on the fished populations. For example, winter flounder and weakfish losses under EMM represent only 0.1% and 2.0%, respectively, of the Rhode Island/Massachusetts harvest. Finally, it should be noted that, relative to current operations, the biological benefits of reduced flow rates under EMM (40%) would exceed, on a percentage basis, the overall anticipated flow reduction (33%). This is explained by the seasonality of water withdrawal mentioned earlier. For example, lower volumes of water are used by the Station during periods when some key species, such as winter flounder and tautog, are most vulnerable to entrainment.

#### Reductions in Heat Discharges

To determine the benefit of reductions in the Brayton Point Station thermal discharge under the cooling system technologies studied, a biothermal assessment of nine fish species and one invertebrate species (quahog) was performed.<sup>7</sup>

---

<sup>6</sup> The fished species included in this analysis account for greater than 97% of the organisms entrained and impinged at Brayton Point Station.

Predictions of the temporal and spatial location of the Station's thermal plume under current operation and the three alternative cooling-water scenarios were provided by Applied Science Associates, Inc, which performed hydrothermal modeling of Mount Hope Bay. The year modeled was 1999, which was selected as the reasonable worst-case warm-water year.<sup>8</sup>

The biothermal assessment was performed for every day of the year for the following biological functions:

- ▶ Growth—Depending on the species and the specific combination of environmental circumstances in effect, a thermal discharge could shift temperature toward or away from the temperature range for growth.
- ▶ Reproduction—Bay-water temperature is important to the survival of eggs after spawning.
- ▶ Avoidance—A thermal avoidance response occurs when mobile species evade high temperatures.

---

<sup>7</sup> The nine fish species were winter flounder, weakfish, bay anchovy, bluefish, Atlantic menhaden, Atlantic silverside, alewife, striped bass, and white perch.

<sup>8</sup> In a 40-year period for which ambient (i.e., no Station) water temperatures were simulated, 1999 ranked as the second warmest year. In the same 40-year period, it ranked as the fifth warmest year with respect to air temperatures recorded at an airport located 12 miles from Brayton Point Station.

**Table 2.** Annual Equivalent Adult Losses of Fished Species Due to Entrainment and Impingement under Brayton Point Station Current Operation and Three Alternative Cooling-Water Scenarios

Species	Type of Loss	Direct Losses (lbs)				Indirect Losses Due to Losses of Prey (lbs)				Total Losses (lbs)				Total Losses as a Percent of Fishery Harvest				
		Current Operation	EMM	Unit 3 Closed Cycle	All Units Closed Cycle	Current Operation	EMM	Unit 3 Closed Cycle	All Units Closed Cycle	Current Operation	EMM	Unit 3 Closed Cycle	All Units Closed Cycle	MA/RI Fishery Harvest (lbs)*	Current Operation	EMM	Unit 3 Closed Cycle	All Units Closed Cycle
Winter Flounder	Entrainment	21,231	11,922	9,451	1,891	0	0	0	0	21,231	11,922	9,451	1,891	9,092,816	0.2%	0.1%	0.1%	0.0%
	Impingement	45	30	32	3	0	0	0	0	45	30	32	3					
	Total E&I	21,276	11,952	9,483	1,894	0	0	0	0	21,276	11,952	9,483	1,894					
Tautog	Entrainment	20,942	12,006	12,736	1,200	0	0	0	0	20,942	12,006	12,736	1,200	1,628,000	1.3%	0.7%	0.8%	0.1%
	Impingement	7	5	5	1	0	0	0	0	7	5	5	1					
	Total E&I	20,949	12,011	12,741	1,201	0	0	0	0	20,949	12,011	12,741	1,201					
Weakfish	Entrainment	335	202	214	20	9,549	6,720	6,676	631	9,884	6,922	6,890	651	351,000	2.8%	2.0%	2.0%	0.2%
	Impingement	0	0	0	0	7	5	5	1	7	5	5	1					
	Total E&I	335	202	214	20	9,556	6,725	6,681	632	9,891	6,927	6,895	652					
Remaining Fished Species	Entrainment	1,750	1,021	1,082	108	3,086	2,130	2,152	222	4,836	3,151	3,234	330	-	-	-	-	-
	Impingement	142	100	105	11	17	12	13	1	159	112	118	12					
	Total E&I	1,892	1,121	1,187	119	3,103	2,142	2,165	223	4,995	3,263	3,352	342					
All Fished Species	Entrainment	44,258	25,151	23,483	3,219	12,635	8,850	8,828	853	56,893	34,001	32,311	4,072	-	-	-	-	-
	Impingement	194	135	142	15	24	17	18	2	218	152	160	17					
	Total E&I	44,452	25,286	23,625	3,234	12,659	8,867	8,846	855	57,111	34,153	32,471	4,089					

\* Entrainment sampling for species other than winter flounder ended in 1985. Hence, tautog and weakfish annual harvests listed here are the average of 1973–1985 harvests to correspond with the time frame of the most recent entrainment data (1973–1985). Similarly, winter flounder annual harvest listed here is the average of 1993–1999 harvests to correspond with the most recent winter flounder entrainment data (1993–1999).

**Table 3.** Biological Benefit of Three Alternative Cooling-Water Scenarios—  
Reductions in Equivalent Adult Losses Compared to Current Levels

Species	EMM	Unit 3 Closed Cycle	All Units Closed Cycle
Winter Flounder	44%	55%	91%
Tautog	43%	39%	94%
Weakfish	30%	30%	93%
Remaining Fished Species	35%	33%	93%
All Fished Species	40%	43%	93%

- ▶ Migratory blockage—Depending on water temperature, the “door” at each bay tributary mouth is open (fish can pass through) or closed (thermally blocked)
- ▶ Chronic thermal mortality (72-hour exposure)—This metric was assessed for quahog and for winter flounder (which sometimes burrows in the substrate to avoid elevated temperatures rather than fleeing the area)

For each species evaluated, a polygon was developed that made it possible to predict effects as a function of the relationship between acclimation temperature (defined for the assessment as the average temperature of a given location for seven days prior to the day of exposure) and exposure temperature.<sup>9</sup> The polygons depicted how the key thermal tolerances varied with acclimation temperatures of the affected organisms. In conjunction with the results of plume modeling, the polygons permitted quantitative evaluation of the effects of the Station’s thermal discharge on the species evaluated.

For all four operating scenarios evaluated—current operation, EMM, Unit-3-closed-cycle, and all-units-closed-cycle—the effects of the Station’s discharge on the biological functions studied were found to be negligible. Table 4 summarizes effects for winter flounder, the most thermally sensitive of the 10 species studied. When the EMM data are compared to those predicted under Unit-3-closed-cycle operation, which produces a slightly lower annual heat load, the effects of Station operation on growth, reproduction, avoidance, migratory blockage, and thermal mortality are almost indistinguishable under the two operating scenarios. Retrofit of the entire Station to closed-cycle cooling would of course reduce heat load the most, and therefore yield the greatest reduction in biological effects. But the biological benefits of such a reduction are trivial, because they represent a reduction of effects that are already negligible under current operations and that would remain so (although with some improvement) under EMM operation. It should also be remembered that, as noted earlier, the all-units-closed-cycle configuration is nearly five times more costly to implement than the EMM technology.

---

<sup>9</sup> Acclimation temperature is the temperature to which a fish has been exposed for a period of time sufficient to allow adjustment of physiological processes, e.g., metabolic rates (Brett 1956; Coutant 1972). The basic reason acclimation occurs is that fish lack the physiological mechanisms to control tissue temperature, and thus their peripheral body temperature is essentially the same as the surrounding water. Therefore, as water temperature and thus fish body temperature change, corresponding changes occur in thermal preference, avoidance, and mortality thresholds.



**Table 4.** Winter Flounder Assessment—Summary of Biothermal Effects Found

Biothermal Metric	Life Stage	<u>No-Plant Effect*</u>	<u>Incremental Effect of Station Operation</u>			
			Current	EMM	Unit 3 Closed Cycle	<u>All Units Closed Cycle</u>
Critical Growth (% Critical Growth Days Lost)	Juveniles	0.6	3.9	2.7	3.6	0
	Adults	None predicted				
Reproduction (% Thermal Egg Mortality)	Eggs	2.5	2.7	2.3	1.9	0
Avoidance (% of Habitat Avoided)	Juveniles	1.9	1.1	0.9	1.0	0.1
Potential for Blockage at the Entrances of the Mount Hope Bay Tributaries	Juveniles	None predicted				
Chronic Mortality (% Mortality from a 72-Hour Exposure)	Juveniles	1.5	3.2	2.2	2.7	0.1

\* Ambient bay-water temperatures (i.e., those that would occur in the absence of plant operation) vary due to natural environmental conditions. Over the course of the year, natural temperatures can swing dramatically, and in some cases such variations explain the no-plant effect observed. The effect is also likely due to the fact that 1999 was a very warm year. In less warm years (i.e., lower ambient bay-water temperatures), the no-plant effect would be less—as would plant effects, since they are the product of Station heat load on top of ambient bay-water temperatures.

**Economic Evaluation**

As part of the NPDES permit renewal process, Brayton Point Station supplied EPA with detailed analyses of the cost-effectiveness of nine alternative cooling-water technologies (Volume III, Appendix G, USGen, 2001). The analyses were performed by Professor Robert N. Stavins— Albert Pratt Professor of Business and Government and Chairman of the Environment and Natural Resources Faculty Group, John F. Kennedy School of Government, Harvard University—with assistance from Analysis Group of Cambridge, Massachusetts. In July 2002, EPA issued its NPDES draft permit determination for Brayton Point Station. In the determination document, EPA focused particularly on the EMM, Unit-3-closed-cycle, and all-units-closed-cycle alternatives. In keeping with the EPA’s emphasis, Dr. Stavins performed a follow-up cost-to-benefit analysis of these three alternatives in October 2002 (Stavins, 2002).

In addition to analyzing the economic merits of alternative cooling-water technologies for Brayton Point Station, Dr. Stavins evaluated the costs and benefits associated with the alternatives studied in order to determine whether they satisfy the EPA standard that system costs must not be “wholly disproportionate” to predicted environmental and social benefits. Rankings of cost-effectiveness and cost-to-benefit ratios are presented in Tables 5 and 6, respectively.

The following sections summarize Dr. Stavins’ methodology and the results of his October 2002 cost-effectiveness analysis and cost-benefit analysis.

**A Dynamic Cost Analysis**

A decision made today to implement a particular cooling-water technology would result in a stream of costs and benefits likely to continue for decades. Because of this, a static evaluation of costs, or of costs and benefits, in a given year cannot provide an effective basis for comparing the economics of alternative technologies. A dynamic analysis assesses the future cost/benefit stream by taking into account all the anticipated costs and benefits over the useful life of each alternative, as well as the time at which each element of costs or benefits will occur. This is accomplished by:

- ▶ Estimating the future time path of all categories of costs and benefits
- ▶ Identifying significant annual differences in cost and benefit time paths  
For example, annual costs typically are greatest in the first year of construction, while annual benefits tend to reach their peak several years into the life of the technology.

- ▶ Assigning present discounted values to each future year's costs and benefits<sup>10</sup> and then summing all yearly costs and benefits to arrive at an estimate of net benefits in present-value terms.
- ▶ Note that, in the case of determining cost-effectiveness, an additional step was taken: the net present value of the technology's cost was converted into an annualized value, taking into account its lifetime, in order to estimate annualized (annuity) cost-effectiveness values.
- ▶ Comparing net present values of costs and benefits to obtain estimates of net benefits and cost-to-benefit ratios.

Professor Stavins performed this type of dynamic cost and cost/benefit analysis for each of the options under consideration. In calculating costs and benefits of the EMM, Unit-3-closed-cycle, and all-units-closed-cycle alternatives, a 20-year life cycle was assumed. Technology installation time frames were treated as three years for either EMM or Unit-3-closed-cycle and four years for all-units-closed-cycle. Therefore, the time horizons used in the analyses were 23 years for EMM and Unit-3-closed-cycle and 24 years for all-units-closed-cycle. For the purpose of assigning baseline cost and benefit values, installation startup was assumed to occur in mid-2002.

### **Cost-Effectiveness in Reducing Flow**

The cost-effectiveness of each alternative in reducing flow is the ratio of the annuity (annualized) cost to the amount of flow reduction achieved. Cost, expressed in 2002 U.S. dollars, represents estimated expenditures associated with construction, operation, and maintenance of the system. Flow reduction is expressed in million gallons per day (MGD).

Table 5 summarizes results of the flow reduction cost-effectiveness analysis. As can be seen, the EMM system is the most cost-effective alternative—with a cost per unit of flow reduction that is half that of the Unit-3-closed-cycle system and 39% lower than the all-units-closed-cycle system. It should be noted that the EMM's ranking remained the same across a range of reasonable variations in model inputs. For example, under any of the three alternatives considered, actual operation might necessitate the addition of tower plume abatement technology to minimize potentially hazardous fog plumes sometimes experienced with cooling tower operation. When such technology was included as a model input, the EMM system remained the most cost-effective of the three alternatives.

Note that flow reduction was used in measuring cost-effectiveness because, assuming 100% mortality for entrained organisms, entrainment and impingement losses are essentially proportional to flow.<sup>11</sup> A similar cost-to-benefit calculation was done for heat reduction. However, under current once-through/piggyback operation, the biothermal effects of Station heat load on Mount Hope Bay are modest (averaging less than 4% above the no-plant effect across a range of organism life-cycle functions). Therefore, differences in the extent of reduction of these effects under the three alternatives were also considered to be modest. Thus, only the flow reduction analysis is presented here.

---

<sup>10</sup> An annual cost-of-capital discount of 15 % was assigned. The discount accounts for the fact that costs incurred over the project's life span are estimated at present dollar values, whereas had those dollars been invested instead of "spent," they would have grown over time by a given amount (in this case, estimated at 15%).

<sup>11</sup> A byproduct of reduced flow is increases in the amount of temperature change (delta T) as cooling water passes through the plant. For cases in which some organisms survive cooling-water entrainment, the increased delta Ts might reduce through-plant survival due to thermal shock. In these cases, the beneficial effect of flow reduction could be partially or completely offset by the increased heat-related mortality.

**Table 5.**

Annualized Cost-Effectiveness of Three Cooling-System Alternatives in Reducing Flow— Cost per Unit (MGD) of Flow Reduction

Cooling-System Alternative	Cost (Millions of 2002 U.S. \$)	Units of Flow Reduction (MGD)	Cost per MGD of Flow Reduction (Thousands of 2002 U.S. \$)
EMM	6.9	327	21.1
Unit 3 Closed Cycle	13.0	323	40.1
All Units Closed Cycle	31.9	921	34.6

**Cost-Effectiveness in Reducing Fishery Losses**

As discussed earlier, entrainment and impingement losses can be converted to equivalent adult losses, which can in turn be converted to value lost to the fishery. In Dr. Stavins’ October 2002 analysis of the EMM, Unit-3-closed-cycle, and all-units-closed-cycle cooling-system alternatives, he developed cost-to-benefit ratios that express the relationship between system construction, operation, and maintenance expenses and the use benefit that would derive from additional commercial and recreational fish catch attributable to reductions in entrainment and impingement. These ratios are presented in Table 6, which expresses, for each cooling-system alternative, the amount of 2002 U.S. dollars required in costs to Brayton Point Station to produce \$1 of benefit to the commercial and recreational fishery.

As can be seen in Table 6, the EMM system is the most cost-effective in achieving a fishery benefit—with a cost per dollar of fishery benefits that is nearly 40% lower than Unit-3-closed-cycle and more than 50% lower than all-units-closed-cycle. It should be noted that, here again, overall rankings of the three alternatives remain unchanged under reasonable sensitivity analyses of the calculations. For example, the calculations reflect price increases over time for unprocessed fish (i.e., at-the-dock prices). When variations in the rate of price increase were input to the model, changes in net benefit were negligible, and the overall rankings thus remained unchanged.

**Table 6.**

Life-Cycle Net Benefits of Three Cooling-System Alternatives (Millions of 2002 U.S. Dollars<sup>1</sup>)

Cooling-System Alternative	Fishery Benefit <sup>2</sup>	Technology Cost <sup>3</sup>	Net Benefit	Cost-to-Benefit Ratio
EMM	0.20	50.69	-50.49	253
Unit 3 Closed Cycle	0.23	95.31	-95.08	412
All Units Closed Cycle	0.44	236.02	-235.58	537

<sup>1</sup> Present discounted value

<sup>2</sup> Fishery benefit is the dollar value of additional commercial and recreational catch (based on price/pound values obtained from the National Marine Fisheries Service) that would be available if the alternative technology were implemented instead of proceeding under current cooling-system operation. Catch pounds were calculated via a multi-step analysis that considered an array of factors, including species survival rates for fish that would not be entrained or impinged under the alternative and therefore grow to fishable weights, and reduced losses of forage species that are consumed by fished species.

<sup>3</sup> Technology cost includes Initial costs (capital costs, cost of construction outages) and annual operating costs (maintenance, auxiliary power consumption, efficiency losses and generating unit outages necessary to prevent icing and fogging on a nearby bridge and highway costs and energy value savings).

**Application of the “Wholly Disproportionate” Standard to System Cost-to-Benefit Ratios**

As can be seen in Table 6, none of the three cooling-system alternatives has a benefit value that exceeds cost. That is, the net benefits for each of the alternatives are less than zero. Indeed, a dollar of benefit comes at a cost of \$253 for EMM and a high of \$537 for the all-units-closed-cycle option.

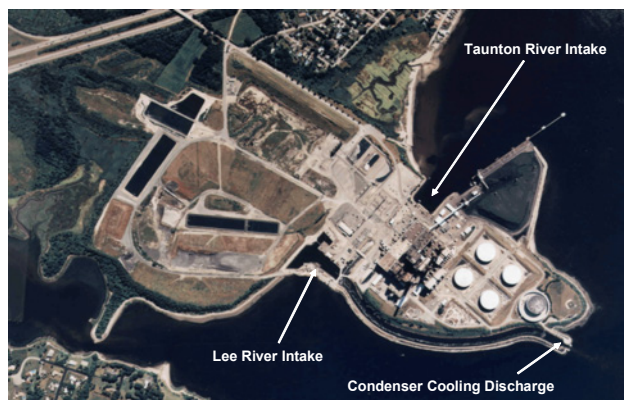
Based on the results of Dr. Stavins’ economic analyses, it is clear that all the alternatives proposed for reducing entrainment and impingement from current levels would impose costs “wholly disproportionate” to their associated benefits. Nonetheless, the cost-effectiveness of producing flow reductions and their concomitant benefit on the fishery clearly is plainly greatest for the EMM technology compared to the Unit-3-closed-cycle and all-units-closed-cycle alternatives.

## Summary

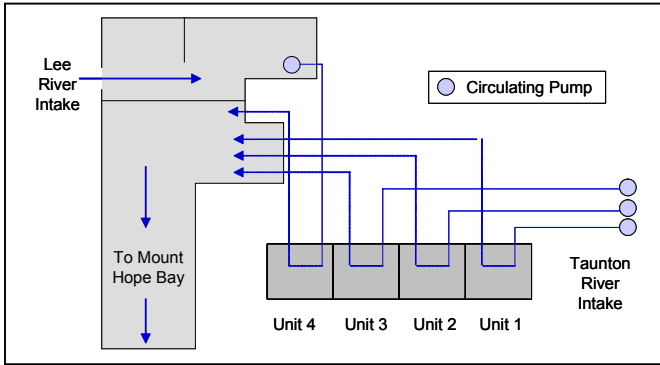
The EMM system includes a mechanical-draft cooling tower tied to four generating units via a configurable piping arrangement. In contrast to integrating the tower with any one specific generating unit, the innovative piping system enables tower operation in an effectively closed-cycle configuration for Units 3 and 4 and a helper cooling configuration for Units 1 and 2. Although the system described was designed specifically for Brayton Point Station, the concept has potential application to other generating stations, depending on their configuration. The EMM system is an improvement over more conventional tower cooling systems in meeting a totality of key performance criteria related to engineering, costs of construction and ongoing operation and maintenance, operational flexibility and reliability, biological benefits, fishery benefits, and overall cost-effectiveness. Although an economic analysis identifies the EMM—as well as the two other cooling-system alternatives evaluated in this paper—as imposing costs “wholly disproportionate” to the resulting environmental benefits, the EMM system is clearly the most cost-effective compared to the conventional closed-cycle options examined here. The EMM system would significantly reduce the Station’s flow and heat impacts. On an annual basis, the amount of cooling water withdrawn from Mount Hope Bay would be reduced by 33%, and current heat load to the bay would also be reduced by 33%. Reductions in heat load would yield reductions in biothermal effects on the 10 species examined, although such reductions would be small since biothermal effects under current Station operation are already negligible. Reductions in flow would also yield reductions in entrainment and impingement losses of approximately 40% (USGen, 2001).

## References

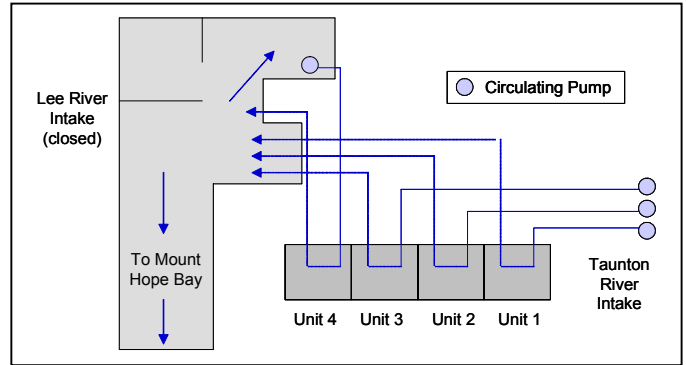
- Brett, J.R. 1956. Some principles in the thermal requirements of fishes. *Quart. Rev. Biol.* 31(2): 72-87.
- Coutant, C.C. 1972. Biological aspects of thermal pollution. Vol. I: entrainment and discharge canal effects. *CRC Critical Rev. in Environ. Cont.* 3:341-381.
- Fletcher, R.I. 1990. Flow dynamics and fish recovery experiments: water intake systems. *Transaction of the American Fisheries Society* 119:393-415.
- PSE&G (Public Service Electric and Gas) 1999. Biological modeling of fish protection alternatives. PSE&G Renewal Application, Salem Generating Station, March 1999.
- Stavins, R.N. October 4, 2002 Memorandum to USEPA: Appendix A to review of economic analysis supporting NPDES permitting determination for Brayton Point Station (Permit No. MA 0003654): Dynamic benefit-cost analysis of heat and flow reduction technologies for Brayton Point Station.
- USGen 2001. Brayton Point Station 316(a) and (b) demonstration in support of NPDES permit renewal application, November 2001.



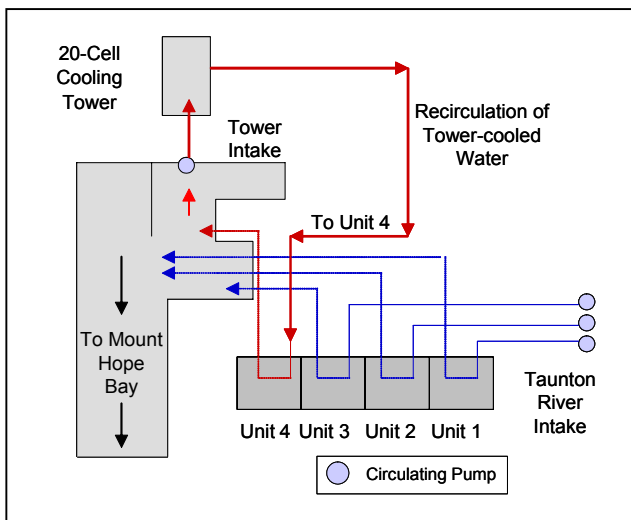
**Figure 1.** Aerial View of Brayton Point Station



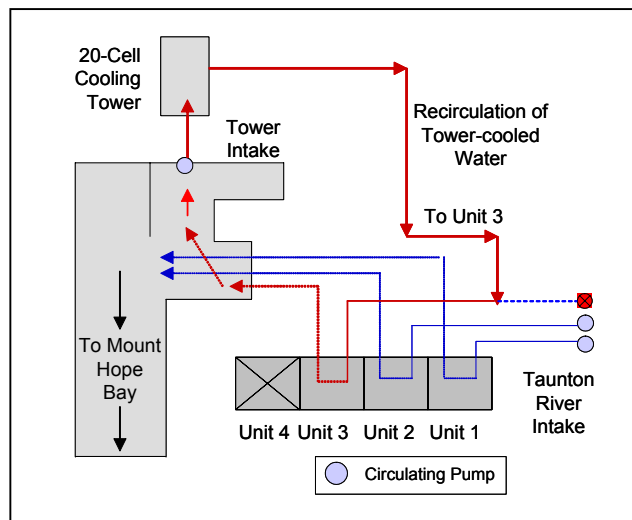
**Figure 2.** Existing Cooling System—  
Summer Operation (June–September)



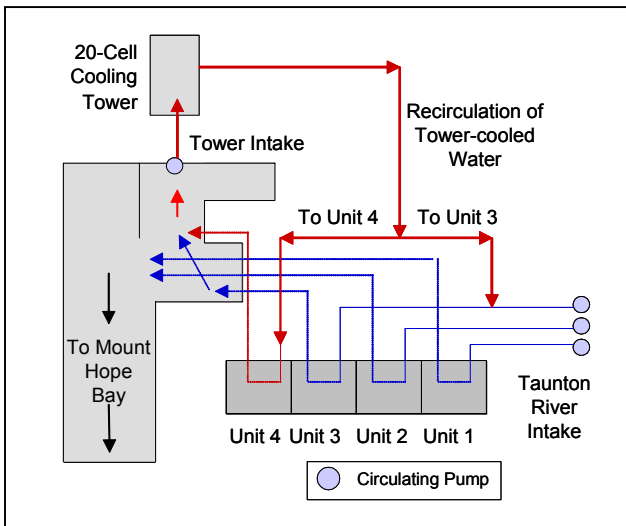
**Figure 3.** Existing Cooling System—  
Winter (Piggyback) Operation (October–May)



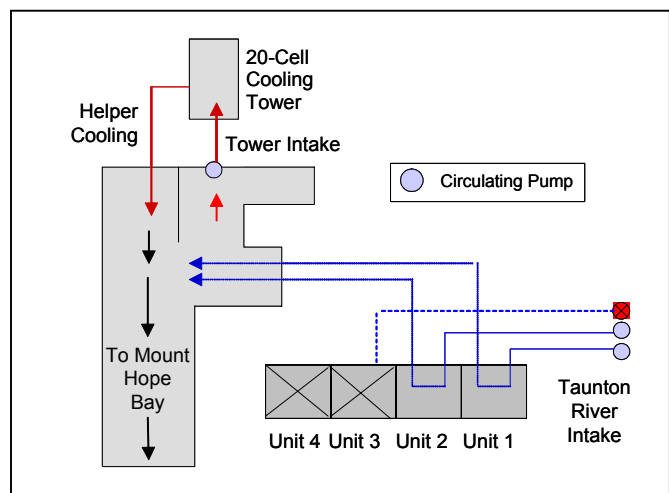
**Figure 4.** EMM—Unit 4 “Closed Cycle”



**Figure 5.** EMM—Unit 3 “Closed Cycle”



**Figure 6.** EMM—Unit 4 “Closed Cycle” and  
Unit 3 “Partial Closed Cycle”



**Figure 7.** EMM—Units 1 and 2 “Helper” Cooling

*Design and Performance of Optimized Air-Cooled Condenser at Crockett Cogeneration Plant*  
*Bill Powers, Bill Powers, P.E., Consulting Engineer*

**BIOSKETCH**

Mr. Bill Powers is the principal of Powers Engineering, an air quality consulting engineering firm established in San Diego in 1994. Mr. Powers has a bachelor's degree in mechanical engineering from Duke University and a master's degree in environmental science from the University of North Carolina – Chapel Hill, and is a registered mechanical engineer in California. His project work focuses on air emission control technology assessments for new power projects and existing industrial sources. Recent projects include: 1) co-authorship of two Electric Power Research Institute gas turbine power plant siting documents, 2) preparation of air permit applications for five 49 MW ultra-low NO<sub>x</sub> simple-cycle gas turbine peaking plants in California, 3) development of draft air emission standards for power generation plants, petroleum refineries, and oil production facilities for the Ministry of Energy and Mines in Peru, and 4) evaluation of effectiveness of US-Mexico binational agreement to minimize SO<sub>2</sub> emissions from border copper smelters.

Mr. Powers was the organizer of the Dry Cooling Symposium held in San Diego on May 31 – June 1, 2002. He is also chair of the Border Power Plant Working Group, formed in May 2001 to promote the establishment of a binational sustainable development policy for power plants constructed in the border region. The border region is currently experiencing an unprecedented “boom” in power plant construction. The three primary components of the proposed power plant policy are: 1) “net zero” air emissions, 2) use of dry cooling systems to eliminate cooling tower PM<sub>10</sub> emissions and conserve water, and 3) use of zero liquid discharge systems.

**TECHNICAL PAPER**

**Abstract**

This paper addresses the design and performance of the air-cooled 240 MW Crockett Cogeneration Plant (Crockett Cogen) and “lessons-learned” that could be applicable to larger combined-cycle plants. Crockett Cogen came on-line in 1996 and is located on San Francisco Bay. The plant is composed of a single GE PG7241 FA power block. The power block consists of one GE Frame 7FA gas turbine, one Vogt heat recovery steam generator, 260 MMBtu/hr (LHV) duct firing capacity, and a single steam turbine. The plant is located on a 2.4 acre site between the bay and a sugar processing plant. The air-cooled condenser (ACC) is located on the roof of the powerhouse due to the space restrictions at the site.

The Crockett Cogen ACC design was optimized for height, noise, footprint and performance. The overall height of the powerhouse and ACC is 130 feet. The net height of the ACC from the powerhouse roofline to the top of the ACC is 70 feet. Ultralow noise fans are utilized due to the proximity of a residential neighborhood (less than 300 feet from the ACC). A significant portion of plant steam production is typically used by the sugar processing plant. However, the ACC is designed to provide sufficient cooling to achieve a steam turbine power output of approximately 80 MW at the maximum site temperature of 96 oF. The capital equipment cost of the ACC is comparable to that of groundlevel ACCs of similar size, although the rooflevel construction and relative lack of site accessibility resulted in significant additional construction-related costs.

The ACC has performed well during over six years of continuous operation. At no time has the plant failed to meet the 240 MW plant design output on peak hot days due to ACC cooling capacity limitations. The plant meets the noise design target of 56 dBA at 113 feet from the edge of the ACC. Periodic washdown of the tube bundles at annual or greater intervals is necessary. Principal issues are: 1) condensation of sugar compounds from the nearby sugar processing plant on the ACC tube bundles, and 2) insect buildup. Inleakage of ambient air at the north steam turbine/ACC duct interface has been an ongoing minor maintenance issue. Relatively little maintenance has been required on the ACC or ACC fans and motors since initial startup in 1996.

The transferability of the optimized height, noise, and performance characteristics of the Crockett Cogen ACC to larger combined-cycle plants is also addressed by the authors.

### **Introduction**

Crockett Cogen came on-line in 1996 and is located on San Francisco Bay. The plant is composed of a single GE PG7241 FA power block. The power block consists of one GE Frame 7FA gas turbine, one Vogt heat recovery steam generator, 260 MMBtu/hr (LHV) duct firing capacity, and a single steam turbine. The plant is located on a 2.4-acre site between the bay and a sugar mill. An air-cooled condenser (ACC) was selected for the site to avoid the permitting delays that would have occurred if once-through cooling had been proposed. Figure 1 is a photograph of the Crockett Cogen ACC. The ACC is located on the roof of the powerhouse due to the space restrictions at the site.

Fifteen (15) ACC cells are located on the Crockett Cogen roof. Twelve (12) cells are dedicated to steam cycle heat rejection, while the remaining three cells are used for auxiliary cooling needs at the site. A schematic of basic ACC operation is provided in Figure 2.

The Crockett Cogen ACC design is optimized for height, noise, footprint and performance. The overall height of the powerhouse and ACC is 130 feet. The net height of the ACC from the powerhouse roofline to the top of the ACC is 70 feet. Ultralow noise fans are utilized due to the proximity of a residential neighborhood less than 300 feet from the ACC. A significant portion of plant steam production is typically used by the sugar processing plant. However, the ACC is designed to provide sufficient cooling to achieve a steam turbine power output of approximately 80 MW at the maximum site temperature of 96 oF with no steam directed to the sugar mill. The capital equipment cost of the Crockett Cogen ACC is comparable to that of groundlevel ACCs of similar size, although the rooflevel construction and relative lack of site accessibility resulted in significant additional construction-related costs.

### **Site Layout**

Crockett Cogen is located on a very restricted 2.4 acre site measuring approximately 140 feet by 740 feet. Water bounds the site to the north and east. An active rail corridor forms the southern boundary, with a residential area located immediately south of the rail corridor. The sugar mill is located to the west. The site is classified as a seismic zone 4. There was no option other than to locate the ACC on the roof of the powerhouse. Figure 3 is an arial photo of the site that clearly indicates the Crockett Cogen site characteristics. A similar facility, Ravenswood Cogen in New York City, is expected to come on-line in late 2003. Figure 4 is a photo-simulation of the rooftop ACC at Ravenswood.

### **Design and Performance Specifications**

Cogen Plant Design and Performance Parameters: Crockett Cogen has a rated output of 240 MW at 96 oF, the “typical year” maximum site temperature. The plant consists of a single GE Frame 7FA turbine and a Vogt heat recovery steam generator (HRSG). The duct burner is rated at 260 MMBtu/hr. Up to 750,000 pounds per hour (lb/hr) of high pressure steam can be produced in the HRSG at full duct firing. The local steam host, C&H Sugar, requires 260,000 lb/hr steam on average, though steam demand varies from 70,000 to 400,000 lb/hr.

ACC Design and Performance Parameters: The ACC consists of twelve (12) cells, each equipped with a 29-foot diameter fan. Ultralow noise two-speed Alpina fans are used, driven by 150 hp motors. The ACC is designed to reject 519 MMBtu/hr at 65 oF.

Overall ACC height of 70.5 feet. Three (3) additional ACC cells, which form the western border of the 15-cell rooftop array, are used to reject the plant’s auxiliary cooling load.

ACC Hot Day Performance: Crockett Cogen is fully dispatchable from 120 to 240 MW. This means the plant is contractually obligated to provide 240 MW whenever it is needed. However, the plant is allowed 16 hr/yr of forced outage without penalty. This is equal to 3,840 MW/yr (16 hr/yr x 240 MW).

Worst case cooling demand conditions, meaning 96°F, dry heat, and C&H Sugar in forced outage (meaning 0 lb/hr steam demand), occurred less than 10 hours in 2002.

Crockett can be limited to 235 to 238 MW during these worst case conditions. This slight output reduction is accomplished by reducing duct firing. The typical MW-hr/yr penalty attributable to the ACC is less than 20 MW-hr/yr.

ACC Noise Reduction Measures: The Crockett Cogen ACC was required to meet a 56 dBa noise limit at 113 ft from the southern edge of ACC. A number of noise reduction techniques were employed to achieve this objective, including: 1) ultralow noise fans, 2) fan motor enclosures, 3) perimeter siding to the top of the steam header, 4) acoustically insulated ducting to mitigate bypass operation noise, and 5) a steam duct riser chase. A photograph of the Alpina ultralow noise fan used at the site is shown in Figure 5.

ACC Height Minimization: Height minimization is important issue in populated areas. The minimum height that is readily achievable for the “inverted A-frame” ACC design used at Crockett Cogen is in the range of 70 to 75 feet (to top of ACC steam duct). Low height is achieved by limiting the width of the ACC to three cells or less. A 3-cell by 5-cell configuration is used on the Crockett Cogen roof. ACCs for large plants must be split into blocks of cells separated by 60 to 80 feet of open space if minimum height is a primary objective.

The HRSG(s) are generally the most visually dominant structure at a combined-cycle power plant, due to the height, length, and solid mass of the HRSG. The exhaust stack(s) is taller than the HRSG(s), though the stacks have very little visual bulk. The height of the HRSG to the top of the steam drum is often 90 to 100 feet or more. A height optimized ACC would typically be 20 to 30 feet lower than the HRSG(s).

The evaporative wet cooling alternative to the ACC in populated areas is the plume abatement wet tower. Plume abatement is necessary to minimize the negative visual impacts of the large vapor plumes generated by conventional wet towers under certain atmospheric conditions. The plume abatement tower height is approximately 65 feet, significantly taller than a conventional wet tower with no plume abatement component. Maximum visible plume height above the tower can be guaranteed to as little as 40 feet. It would be difficult to make a credible case that a 70- to 75-foot high ACC with at least 30 vertical feet of open area at its base and no vapor plume at any time is significantly more visually intrusive than a 65-foot high plume abated-cooling tower with a 40-foot plume under certain atmospheric conditions.

### **ACC Operating Experience**

Crockett Cogen ACC has performed well over seven year operating history. Relatively little maintenance has been required on ACC, ACC fans, or fan motors. Periodic washdown of tube bundles necessary, due to insect buildup and condensation of sugar compounds on tubes. Inleakage of ambient air at north ACC takeoff duct interface with steam turbine has been ongoing minor maintenance issue.

ACC Heat Rate Penalty: Crockett Cogen considers heat rate data proprietary. However, the ACC is designed to maintain a steam turbine backpressure of 2.0 to 2.5 inches Hg at average annual daytime temperature of 65 °F and typical C&H Sugar steam load of 260,000 lb/hr. A once-through system would typically maintain backpressure at 1.5 to 2.0 inches Hg at average site conditions. The annual thermal efficiency penalty of ACC is estimated at 1 percent or less, as there is little difference in heat rate under average operating conditions between the actual air-cooled system and a hypothetical once-through cooled system.

### **ACC Cost**

Marley Cooling Technologies, Inc. (formerly Blacke-Durr), the manufacturer of the Crockett Cogen ACC, indicates the equipment cost for the 15-cell ACC with ultralow noise, 29-foot fans was in the \$8 million to \$8.5 million range. This cost is mitigated to a degree by the lower steam turbine cost, estimated at approximately \$1 million less than a standard (wet-cooled) steam turbine due to a shorter last stage turbine bucket. The ACC manufacturer was not

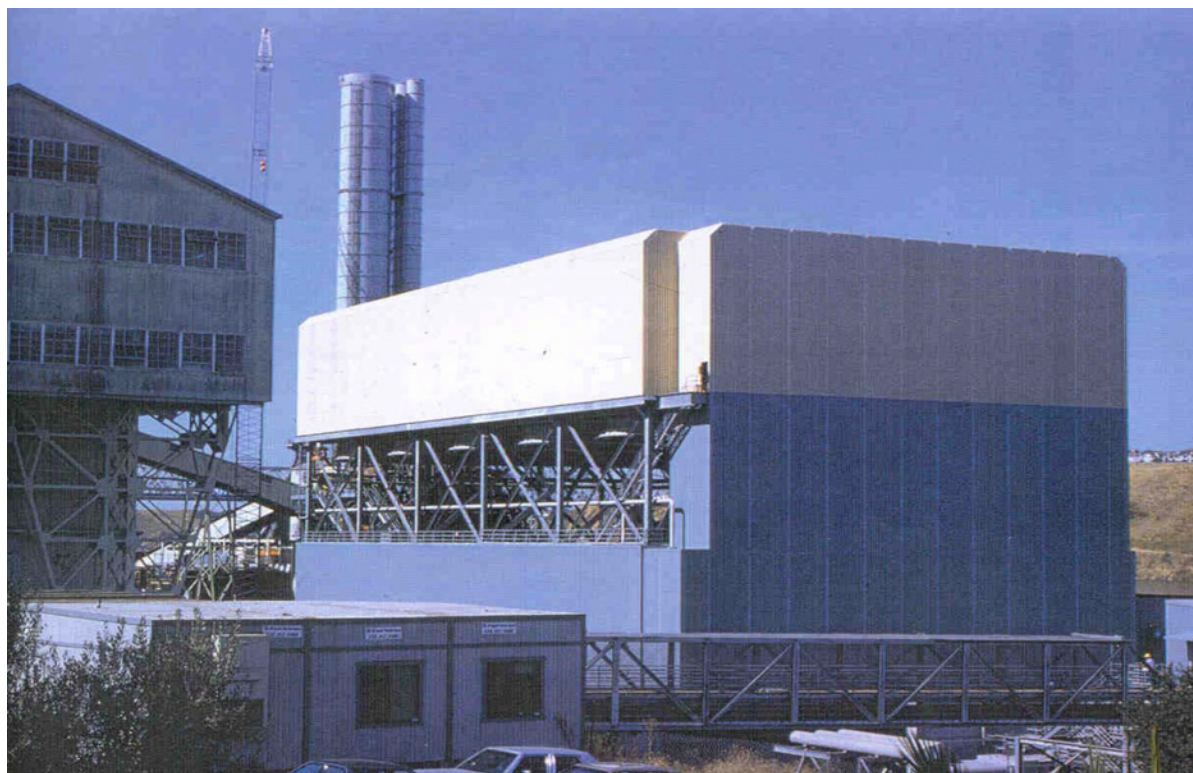


responsible for ACC installation at Crockett Cogen and does not have the installed cost figures for the project. However, the installation costs were higher than typical greenfield projects due to the rooftop location and relative lack of access to the site. The estimated ACC installation cost (by Marley Cooling Technologies) for a hypothetical 15-cell greenfield, groundlevel site are \$3.8 million non-union, \$4.5 million union.

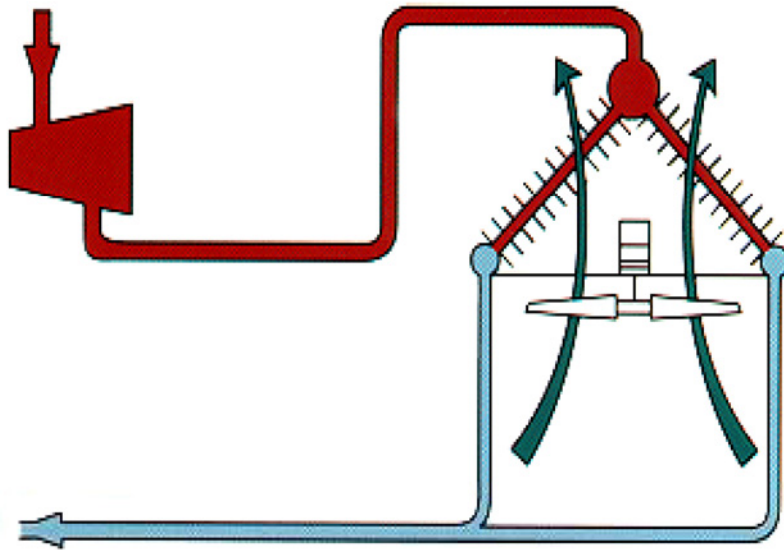
### **Transferability of Crockett Experience to Larger Combined-Cycle Plants**

The 170 MW GE Frame 7FA used at Crockett Cogen is the basic building block of most utility-scale combined-cycle power plants. There are no significant scale-up issues related to use of an optimized ACC at Crockett Cogen and use of an optimized ACC at much larger combined-cycle plants. The Crockett Cogen rooftop ACC location actually underscores the versatility of ACC technology, and demonstrates that ACC may be a preferable alternative at even the most constrained sites. The ACC noise optimization features used at Crockett Cogen are readily transferrable to any ACC located in urban or suburban areas where minimum noise is a primary design objective. Optimizing ACC height to the 70 to 75 feet range is also readily transferable and would minimize concerns of negative visual impact relative to available cooling alternatives. In most circumstances a plume-abated wet tower would be the competition for an ACC at a plant sited in an urban or suburban environment. Plume-abated wet towers are typically in the range of 65 feet high and generate a short visible plume under certain atmospheric conditions. Use of a height-optimized ACC for urban and suburban sites would minimize or eliminate the primary basis for the perception that ACCs are more visually intrusive than wet towers.

The Crockett Cogen ACC is sized to avoid any significant steam cycle MW derate under “hottest hour” conditions, even when the steam host is completely shut down and Crockett Cogen is operating in a pure combined-cycle mode. This is an appropriate design standard for large combined-cycle plants as well, and ensures that: 1) rated steam cycle MW output is maintained on the hottest days, 2) the annual fuel efficiency penalty is modest relative to closed-cycle wet cooling or a once-through cooling system.



**Figure 1.** Crockett Cogen with Rooftop ACC. Photo courtesy of Marley Cooling Technologies.



**Figure 2.** Crockett Cogen with Rooftop ACC. Sketch courtesy of GEA Power Cooling Systems.



**View of the Ravenswood Cogeneration Facility, facing Southwest**

**Figure 3.** Ravenswood Cogen with Rooftop ACC. Photo-simulation courtesy of New York Department of Environmental Conservation.



Figure 4. Crockett Cogen and Surrounding Area



**Figure 5.** Ultralow Noise Alpina Fan. Photo courtesy of Marley Cooling Technologies.

---

*Evaluation of Variable Pumping Rates as a Means to Reduce Entrainment Mortalities*  
John Young, ASA Analysis & Communications, Inc.

**BIOSKETCH**

Dr. John Young is a Senior Scientist with ASA Analysis & Communication, Inc. Dr. Young received his B.A. in Biology from Washington University, M.S. degrees from Pennsylvania State University and Union College, and a Ph.D. in Ecology from the City University of New York. He has studied the effects of entrainment and impingement for the last 27 years, as a consultant and while in the environmental affairs department of a major utility. His experience encompasses in-plant sampling programs to assess entrainment and impingement abundance and survival, as well as long-term source water body monitoring to determine population and community impacts

**TECHNICAL PAPER**

**Abstract**

We evaluated the potential of a load-based flow strategy (vary flows with generating load to use minimum flow sufficient to meet specified thermal characteristics) to meet the USEPA proposed entrainment reduction targets (60% to 90%) for the Roseton Generating Station. Actual generating loads from 1999-2001 were used as the operation schedule. Operating rules that would minimize flows while keeping discharge temperatures below a maximum of 20° to 40° C and  $\Delta T$  below 15° to 30° C were used to predict cooling water use. These strategies would have reduced cooling water use by 63% to 70% from the full withdrawal capacity of the station. Striped bass entrainment numbers would be reduced from 71% to 75% from a full-flow full-operation baseline condition. When expected entrainment survival at the Roseton Station was factored into the analysis, potential reductions of striped bass losses increased to 89% to 91%. For facilities that vary the generating loads to meet peak loads, a load-based flow strategy appears to be a viable option to approach or meet the reduction targets of the proposed new regulations. The achievable reductions were not highly sensitive to the thermal design criteria, which should allow plant operators to find a set of thermal criteria that reduce entrainment and still allow efficient operation of the facility. The ultimate utility of load-based flow strategies to achieve compliance with entrainment reduction targets will depend on the final definition of

“baseline” conditions. If baseline is defined as the full capacity of a station to entrain fish (full flow and full generation) then a load-based flow strategy can be an important component to achieving compliance. However, if baseline becomes defined by past operating levels and practices, then it is unlikely that a load-based flow strategy could achieve the additional reductions required, especially for facilities that already operate at reduced flows as a matter of practice. Stations in this situation would be left to choose between closed cycle systems, or application for site-specific conditions.

## **Introduction**

The new regulations that the United States Environmental Protection Agency (USEPA) has proposed for §316(b) of the Clean Water Act will pose distinct challenges to operators of electric generating facilities to meet criteria for reducing entrainment and impingement mortality. A number of technologies are currently available that can either reduce the numbers of fish that are impinged, by keeping them away from the screens through physical exclusion or behavioral means, and/or to improve the survival rates of fish that have been impinged. However, for entrainment mortality, there are far fewer options. Physical exclusion systems, such as the Marine Life Exclusion System, are currently being tested, but even if exclusion systems are successful in some locations, their applicability may not be universal. Behavioral exclusion is not effective because most entrainable stages do not have swimming capabilities or a behavioral repertoire sufficient to escape the flow into a power plant intake. Thus, reducing the cooling water flow is the primary means for reducing entrainment. We explored the potential of variable speed pumping as a means to meet entrainment reduction goals at an existing power station on a tidal river.

The Roseton Generating Station is situated on the west shore of the Hudson River near Newburgh, NY, 105 km upstream from the Battery, a setting that, according to the proposed Phase II regulations, would require a reduction of entrainment between 60% and 90% of baseline levels. The station, which began commercial operation in 1974, has two 600-MW oil/gas-fired generating units that use Hudson River water for condenser cooling. The single intake structure contains four circulating water pumps that draw through 8 intake bays. Six of the bays are fitted with conventional 9-mm mesh traveling screens, and two have dual-flow screens. The four pumps feed cooling water into a single inlet conduit that serves both units. Depending upon generating loads and river water temperatures, the plant may be operated with 2 pumps (1,584 m<sup>3</sup>/min), 3 pumps (2,124 m<sup>3</sup>/min), or 4 pumps (2,424 m<sup>3</sup>/min). Under full generation and full flow, the design  $\Delta T$  for the station is 9.8°C.

Although the Roseton Generating Station was originally constructed as a base-load facility, its recent use has been to follow the daily and seasonal demand patterns. In this mode its generating loads can vary substantially between peak and off-peak periods. We hypothesize that if cooling water use could be matched closely to the generating load, then entrainment numbers could be reduced. Because a substantial base of entrainment abundance information exists for the Roseton Station, it is possible to quantitatively assess the potential of a variable flow strategy to approach or achieve the USEPA’s target reduction levels. In addition, the Roseton Station also has a large amount of data on entrainment survival rates for key taxa, therefore it is possible to assess the contribution entrainment survival provides towards meeting USEPA’s target reduction levels. Availability of site specific entrainment abundance and survival data provides a reasonable and defensible basis for the design of prudent operating rules that would guarantee that flow reductions do not actually exacerbate entrainment mortality.

## **Methods**

The Roseton Generating Station is an excellent site for evaluation of variable pumping rates due to the amount of information available. Although an evaluation could be conducted on a theoretical basis using hypothetical abundance patterns and entrainment survival rates, the Roseton Station possess a large base of empirical information which makes the evaluation process highly relevant and establishes the groundwork for additional evaluation that could ultimately lead to renewed discharge permits. The available data included:

### *Seasonal and daily operating pattern*

In the post-deregulation electric generating industry, it is very difficult to predict future operating patterns. Plant operations are no longer determined by demand patterns within a utility’s service territory, which are relatively

predictable in the short term, but are now determined by the market. Rather than attempt to predict future operations of the Roseton Station, we used the 1999-2001 actual operation patterns as examples of how the station operates, and might be expected to operate in the future. The Roseton Station varies its generation to match seasonal and daily load changes, thus hourly information on the intake temperature, cooling water flows, and generating load for each unit were used to establish the operating pattern for evaluation (Figure 1).

#### *Density of entrainable life stages*

Entrainment densities were sampled from May through July from 1983-1987 using a net-in-barrel pumped sampling system with a 0.5 mm mesh net at a rate of approximately 1 m<sup>3</sup>/min. (Figure 2). Sampling location was in the discharge seal well just prior to the point where the conduit entered the river. Sampling was conducted on a variable frequency, from 1 to 7 days per week. On each sampling event, 24 samples, each of 1 hour duration, were collected and analyzed. During laboratory analysis, ichthyoplankton were identified to species where possible, and subsamples of key taxa were measured to the nearest 0.1 mm. The data were used to estimate the density (number of organisms per m<sup>3</sup>) of each 1-mm length interval during each hour of each day sampled. The densities on unsampled days were interpolated between sampled days on an hour and length interval basis. The final expected density pattern was then developed from the average density over the 1983-1987 annual patterns (Figure 3). For this evaluation only data on striped bass were used, but similar results would be expected for other taxa whose temporal pattern is similar to that of striped bass.

#### *Mortality of entrained organisms*

Entrainment mortality studies were conducted from 1976-1980. Sampling was conducted with pumped larval flumes, and rear-draw and pumpless systems (EPRI 2000). Samples were collected from the intake to establish the level of sampling mortality, and simultaneously from the discharge.

Initial survival in samples was used to estimate a logistic regression equation (Sokal and Rohlf 1995) to predict survival as a function of length of organism and discharge temperature range. For this evaluation, only the data for 1980 were used because the most advanced sampling techniques were used in that year and the sample size was relatively large (1252 individuals). The predicted logistic regression curves for discharge samples collected at temperatures < 30°C, and the intake samples (Figure 4) were used to estimate the mechanical component of entrainment mortality according to Abbott's formula:

$$\text{Mechanical mortality} = 1 - (\text{Survival in discharge samples}) / (\text{Survival in intake samples})$$

Because few larvae were collected under higher discharge temperatures, laboratory thermal tolerance data were used to estimate the thermal mortality component based on lower and upper temperature thresholds. If the predicted exposure temperature was below the lower threshold (T<sub>L</sub>) then thermal mortality was 0. Temperatures above the upper threshold (T<sub>U</sub>) were assumed to result in 100% mortality. Between T<sub>L</sub> and T<sub>U</sub>, mortality rate was linearly related to temperature. The T<sub>L</sub> and T<sub>U</sub> values were estimated as functions of ambient temperature, exposure temperature, and transit time (Central Hudson et al 1999).

The mechanical and thermal components of mortality were assumed to be independent:

$$\text{Entrainment Mortality} = 1 - (1 - \text{Mechanical Mortality})(1 - \text{Thermal Mortality})$$

#### *Evaluation Process*

There were five distinct steps in the evaluation process;

- 1) Set hourly generating load and inlet temperatures. The actual 1999-2001 data were used to establish these values. Use of past operating data essentially makes the evaluation an analysis of the theoretical entrainment levels in these years if the flow reduction strategy had been followed. The calculation baseline for comparison was 365-day per year operation at full flow (2,424 m<sup>3</sup>/min), with an assumed 100% mortality of entrained organisms.

- 2) Use operating rules to establish cooling water flow and discharge temperatures. The basic procedure of the load-based flow strategy is to use the minimum cooling water flow required to maintain discharge temperature and  $\Delta T$  within specified bounds. We examined a range of maximum discharge temperatures from 20° to 40° C in increments of 5°C, and  $\Delta T$  from 15° to 30°C in increments of 5°C. The analysis was conducted as if the station operators would, on at least an hourly basis, adjust cooling water flows to match the current generation load. The  $\Delta T$  for a given generating load, and transit time through the cooling system, are inversely proportional to cooling water flow. Analysis was conducted for full-flow full-generation, and for actual generation and rule-based flows.
- 3) Estimate numbers of organisms entrained. Entrainment numbers were estimated as the product of the estimated hourly densities and the hourly cooling water flows. The goal to reduce entrainment was aided, for some later life stages, by the offset in daily generation load and entrainment density (Figure 5) in which highest entrainment densities occurred at night when generating load and cooling water flow requirements were lowest.
- 4) Calculate mortality component. The numbers dying in each hourly interval was calculated by adjusting the total number entrained by the hourly projected mortality rate. The mortality rate is the combined effect of mechanical and thermal mortality calculated for each length interval.
- 5) Estimate percentage reduction from baseline. The hourly estimates of numbers entrained and number killed were summed for each year. The totals from the load-based flow strategy were compared to the full-flow full-generation baseline. Estimates based on actual flows were also calculated for comparison. Percent reductions were calculated as:

$$\% \text{ Reduction} = 100 \times (\text{Baseline Number Killed} - \text{Strategy Number Killed}) / \text{Baseline Number Killed}$$

For the baseline number killed, 100% entrainment mortality was assumed. For the strategy number killed, both the empirically-based estimates, and a 100% mortality assumption were used.

## Results

The load-based flow strategy, if implemented during 1999-2001, had the potential to reduce flows substantially from baseline levels (Figure 6). Over all sets of operating rules, flows would have been reduced from 63% to 70%, with higher reductions occurring at higher  $\Delta T$ s and lower maximum discharge temperatures.

For striped bass, a load-based flow strategy would have resulted in substantial reductions in entrainment and entrainment mortality at the Roseton Generating Station. For numbers entrained, the average annual reduction was on the order of 75% from the full-flow full-generation baseline (Figure 7). This reduction was higher than the reduction in flows due to the additional protection resulting from the diel pattern in entrainment. Striped bass densities in the vicinity of the intake are at their lowest at the time when generation, and need for cooling water, is highest. The percentage reduction was relatively insensitive to the maximum discharge temperature or maximum  $\Delta T$ . The range of reduction in entrainment was approximately 71% to 75% under all combinations of maximum discharge temperature and maximum  $\Delta T$ . Reductions were near the high end of the range at the highest  $\Delta T$ s and extreme values of maximum discharge temperature (20° or 40°C). The wide range of conditions that produced relatively similar reductions in entrainment provides considerable latitude in finding plant operation schemes that will allow reasonably efficient operation and also decrease entrainment.

When entrainment survival estimates for striped bass were factored into the analysis, the reduction from baseline levels of entrainment mortality (which are based on an assumption of no survival) reached approximately 90% (Figure 8). As with numbers entrained, the percent reduction was relatively insensitive to the operating rules, ranging from about 89% to 91% across all combinations of maximum discharge temperature and maximum  $\Delta T$ . In contrast to the pattern for numbers entrained, the percent reductions of numbers killed was highest at intermediate values of maximum discharge temperature.

## Discussion

The analysis shows that, for plants such as Roseton that have highly variable operations, a load-based flow strategy could approach or achieve the reductions of entrainment required under the USEPA's proposed regulations. The actual reductions achieved for any taxon would depend upon the timing of the presence of entrainable life stages relative to the generating demand on a seasonal, and perhaps daily, basis. Particularly for taxa whose peak densities occur outside the seasonal generating peaks, load-based flows could be sufficient to achieve compliance.

For taxa that could be expected to exhibit moderate to high levels of entrainment survival, such as striped bass, a strong base of entrainment survival information would provide a safety margin for potential compliance, or could bring the reduction levels closer to or within the required levels for compliance. Thus stations that entrain relatively hardy taxa, but have no site-specific information on survival, might consider conducting carefully designed and executed entrainment survival studies in order to be able to include survival in the assessment process.

This evaluation entailed only the biological potential for load-based flows to reduce entrainment, i.e. does entrainment occur at a time when flow could be reduced below maximum levels, and could flow be reduced enough to achieve compliance with the reduction targets. The modeled results were encouraging in that a wide range of operating rules (use minimum flow to stay below a maximum discharge temperature and maximum  $\Delta T$ ) would meet the target levels of entrainment reduction. However, significant additional evaluation is necessary before a load-based flow strategy could be considered for implementation. The operating rules must still be evaluated for operational feasibility and economic implications on a site-specific basis. To the extent that these rules would cause departures from a facility's design operating state, there may be reduced generating efficiency, or additional risks of equipment failure. Existing pumps, or pump control equipment may need to be replaced, therefore the costs and engineering implications must be factored into the evaluation. In addition, the facility's compliance with §316(a) standards or thermal water quality criteria also must be considered.

USEPA's final definition of "baseline" conditions will be crucial to determining whether a load-based flow strategy will be a viable means to achieve the required percent reductions of entrainment. If, as suggested in USEPA's original proposal (USEPA 2002), "baseline" is interpreted as the full potential of a power station to entrain and kill fish, then a load-based flow strategy may allow many non-baseload stations to achieve compliance, even without considering the issue of entrainment survival. However, if baseline is interpreted as past operating practices, as has been recently suggested by USEPA (USEPA 2003) and advocated by some parties (Super 2003), then a load-based flow strategy will likely not be sufficient to achieve compliance at stations that already operate at reduced flows on a seasonal basis. This interpretation would essentially penalize stations like Roseton by requiring them to reduce entrainment 60% to 90% below their already-reduced levels, a reduction possibly achievable only with closed-cycle cooling, while stations that historically operate at full flow year-round, regardless of generating load, would have their full entrainment potential as the yardstick for measuring percent reductions. One way that USEPA can apply its reduction criteria fairly and equitably to all stations would be to establish full-flow, full-generation, 100% mortality as the baseline for all facilities. Then any design features, operating practices, or technology innovations that reduce the numbers entrained and/or demonstrably increase their survival rates would be part of the overall compliance package for the facility. If USEPA takes a load-based flow strategy out of the compliance options by improperly defining, in the opinion of the authors, the calculation baseline, the only options available to many stations will be either closed-cycle cooling or a site-specific determination of Best Technology Available. Given only these two choices, existing facilities that operate well below maximum capacity are likely to seek a site-specific determination far more often than USEPA may have anticipated.

## Literature Cited

EA Engineering, Science & Technology (EA). 1984. Roseton and Danskammer Point Generating Stations Entrainment Abundance Studies 1983 Report. Prepared for Central Hudson Gas & Electric Corporation, Poughkeepsie, NY.



Electric Power Research Institute (EPRI). 2000. Review of Entrainment Survival Studies: 1970-2000. Palo Alto, CA.

Central Hudson Gas & Electric Corporation, Consolidated Edison Company of New York, Inc., New York Power Authority, and Orange & Rockland Utilities, Inc. 1999. Draft Environmental Impact Statement for the Renewal of State Pollutant Discharge Elimination System Permits for Bowline Point 1 & 2, Indian Point 2 & 3, and Roseton 1 & 2 Steam Electric Generating Stations. Poughkeepsie, NY.

Sokal, R.R. and F.J. Rohlf. 1995. Biometry. Third Edition. W. H. Freeman and Company. New York. 887 p.

Super, R. 2003. An Overview of Flow Reduction Technologies for Reducing Aquatic Impacts at Cooling Water Intake Structures. Presentation at "A Symposium on Cooling Water Intake Technologies to Protect Aquatic Organisms." May 6-7, 2003. Arlington, VA.

United States Environmental Protection Agency (USEPA). 2002. National Pollutant Discharge Elimination System--Proposed Regulations to Establish Requirements for Cooling Water Intake Structures at Phase II Existing Facilities. Federal Register April 9, 2002 (Volume 67, Number 68), pp 17121-17170.

USEPA. 2003. National Pollutant Discharge Elimination System--Proposed Regulations To Establish Requirements for Cooling Water Intake Structures at Phase II Existing Facilities; Notice of Data Availability. Federal Register: March 19, 2003 (Volume 68, Number 53), pp 13521-13587.

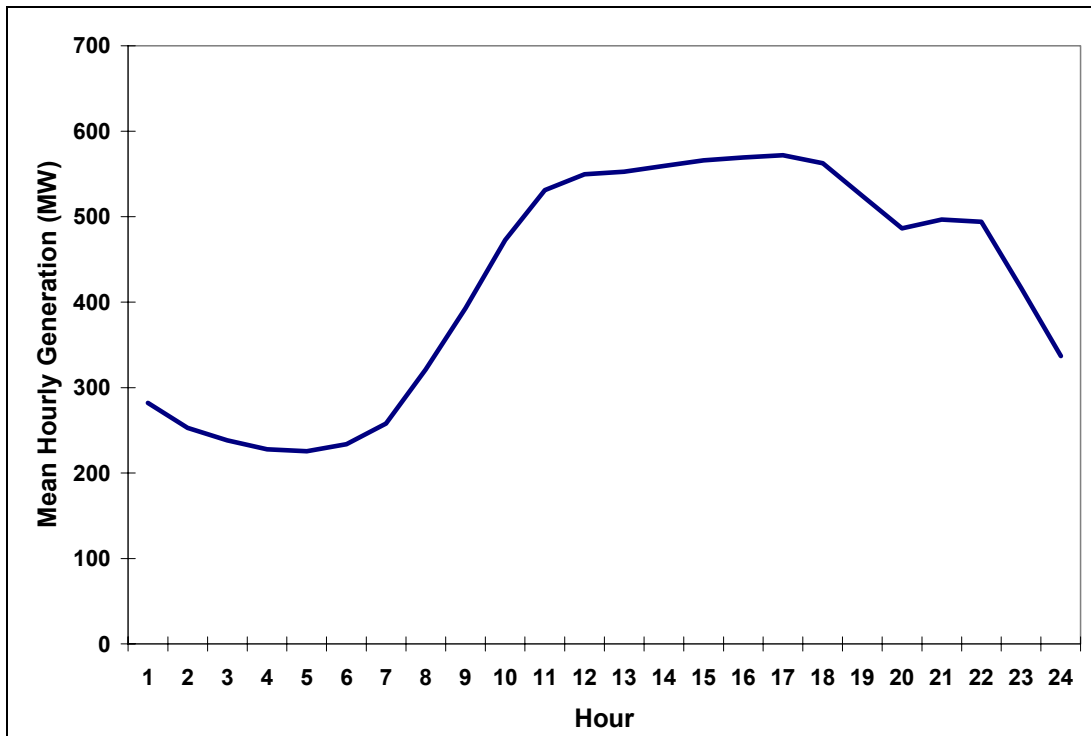


Figure 1 Typical diel generating load at the Roseton Generating Station during May-July.

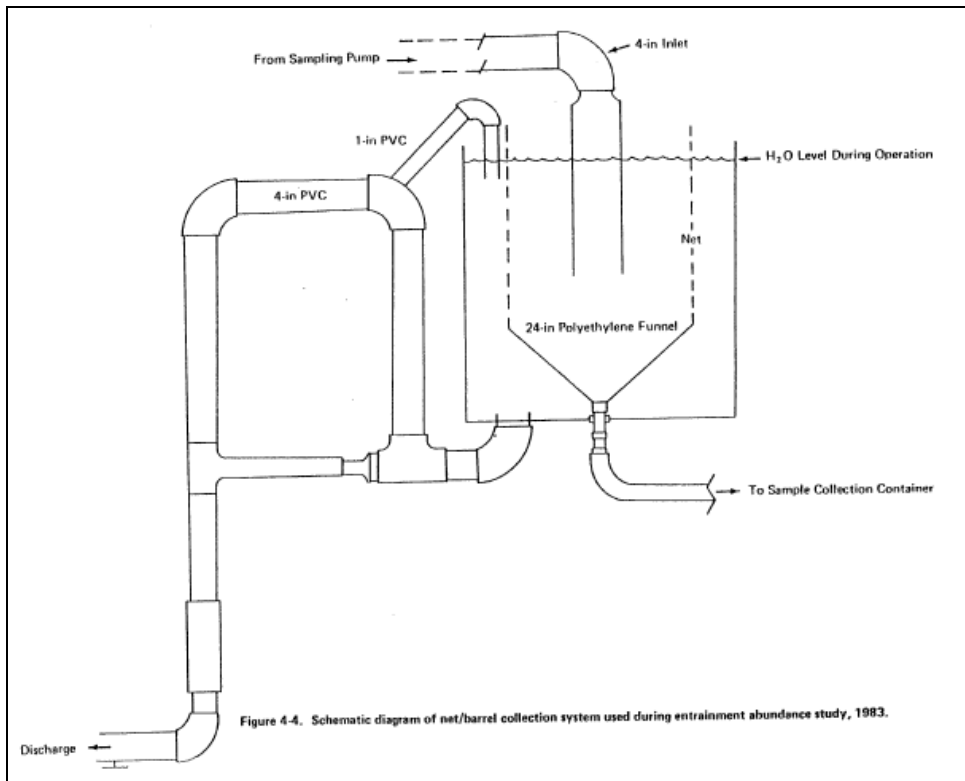


Figure 2 Net-in-barrel collection system used for entrainment abundance sampling. (From EA 1984)

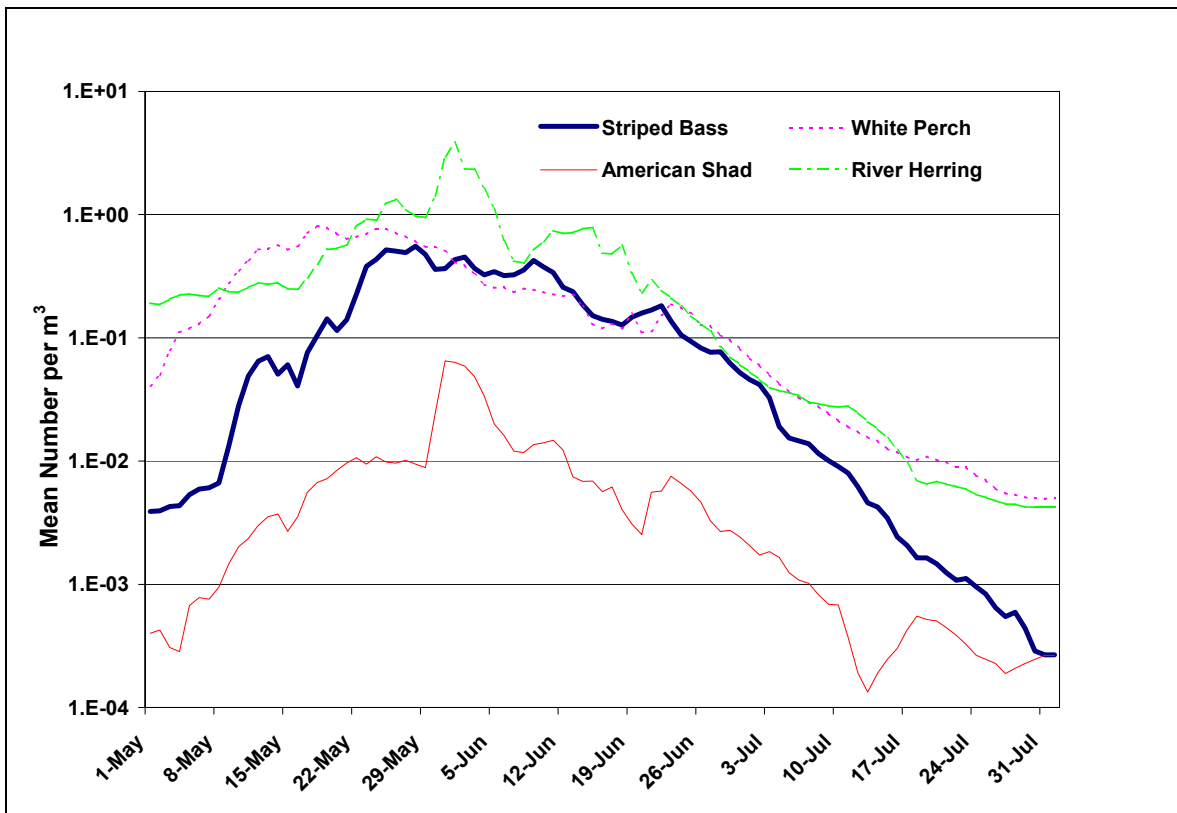
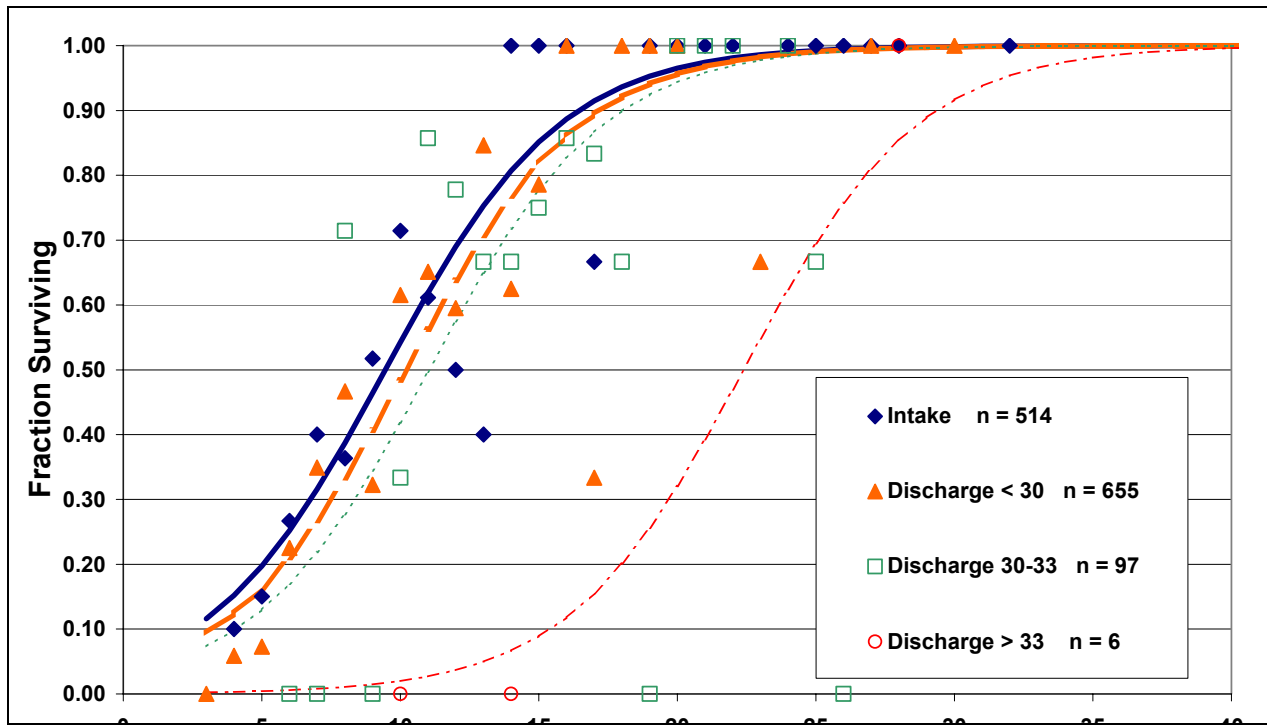
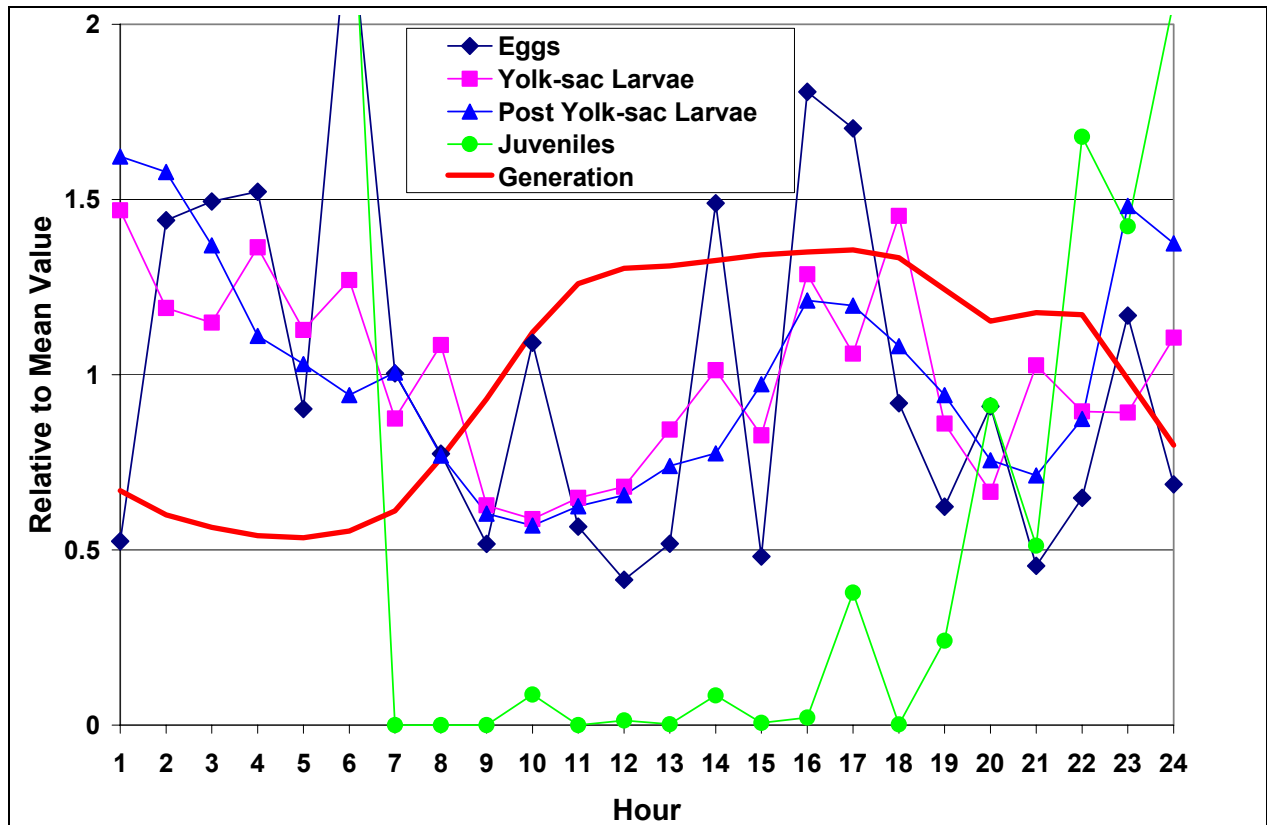


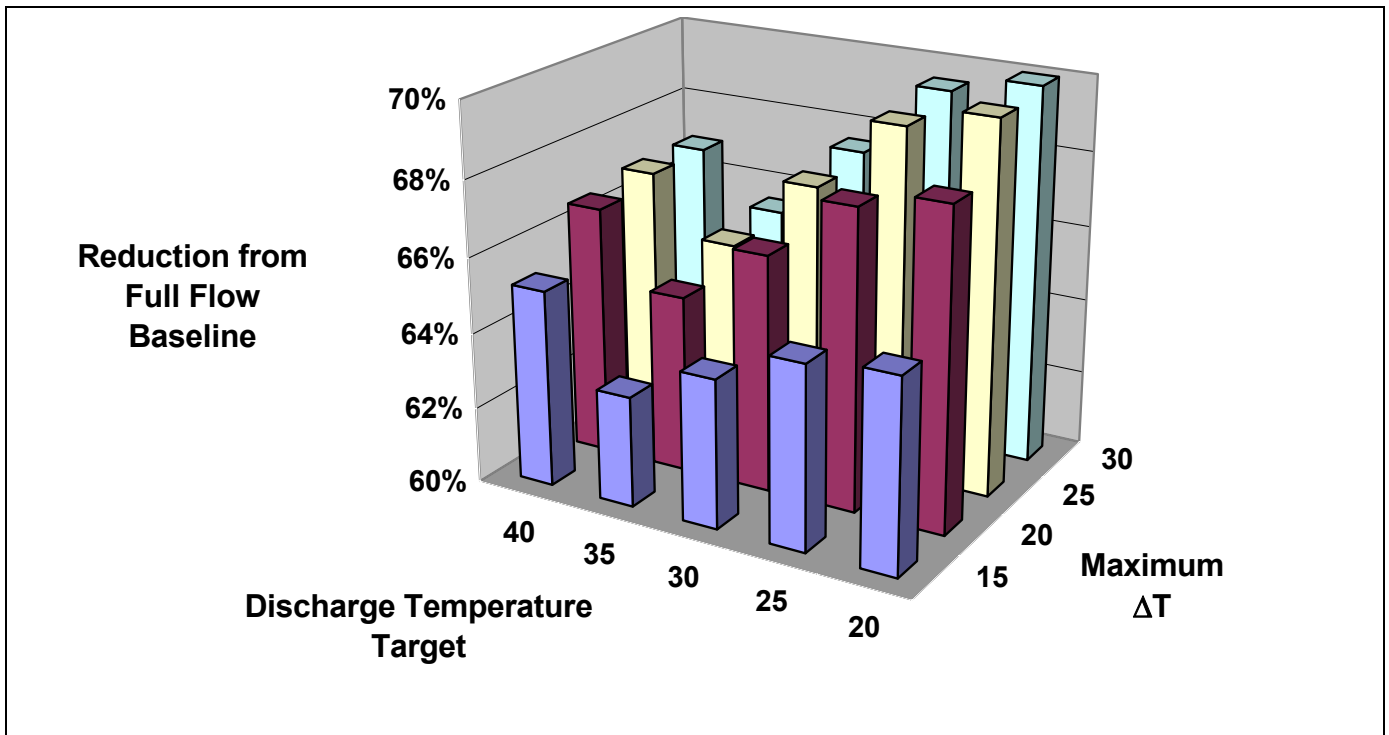
Figure 3 Seasonal pattern of entrainment density (# per m<sup>3</sup>) of striped bass, white perch, American shad, and river herring (all life stages combined) at the Roseton Generating Station based on 1983-1987 data.



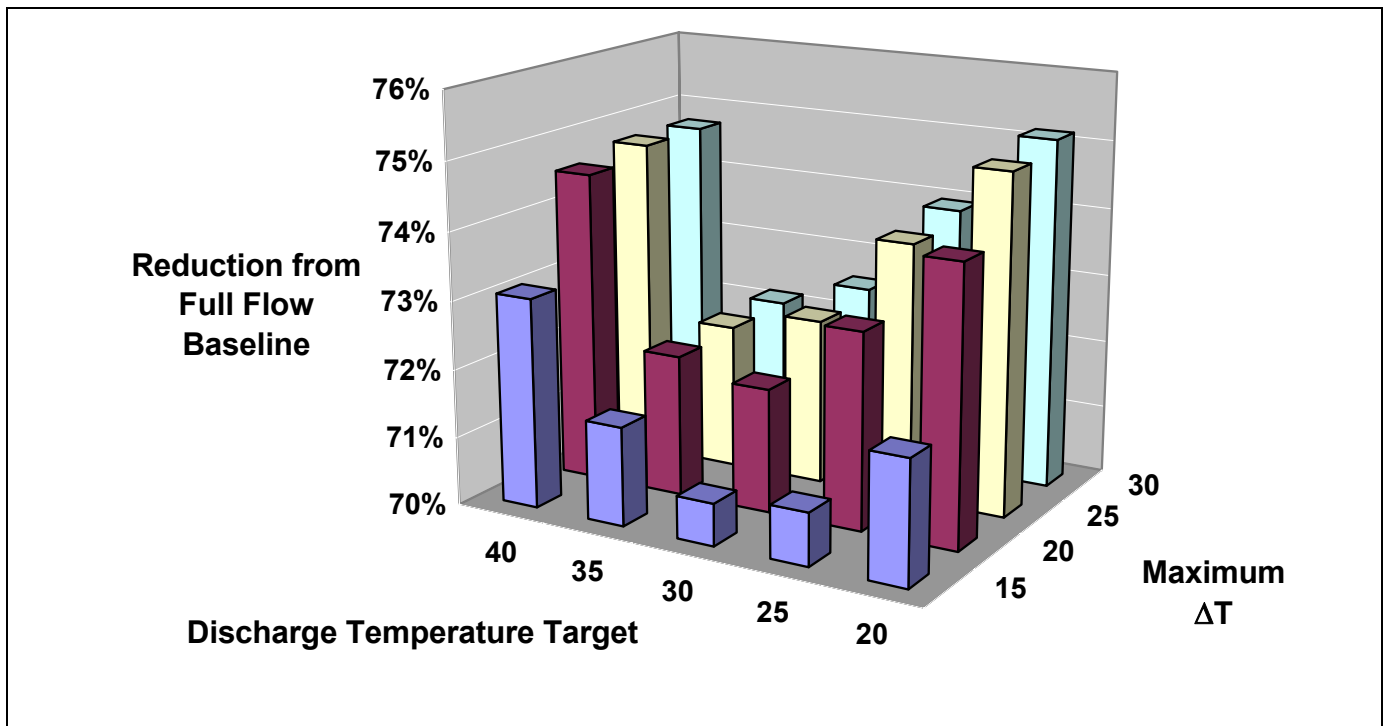
**Figure 4** Initial survival as a function of length from entrainment samples collected at the intake, and at the discharge sampling locations at temperatures < 30°C, 30°-33°C, and > 33°C at the Roseton Generating Station, 1980.



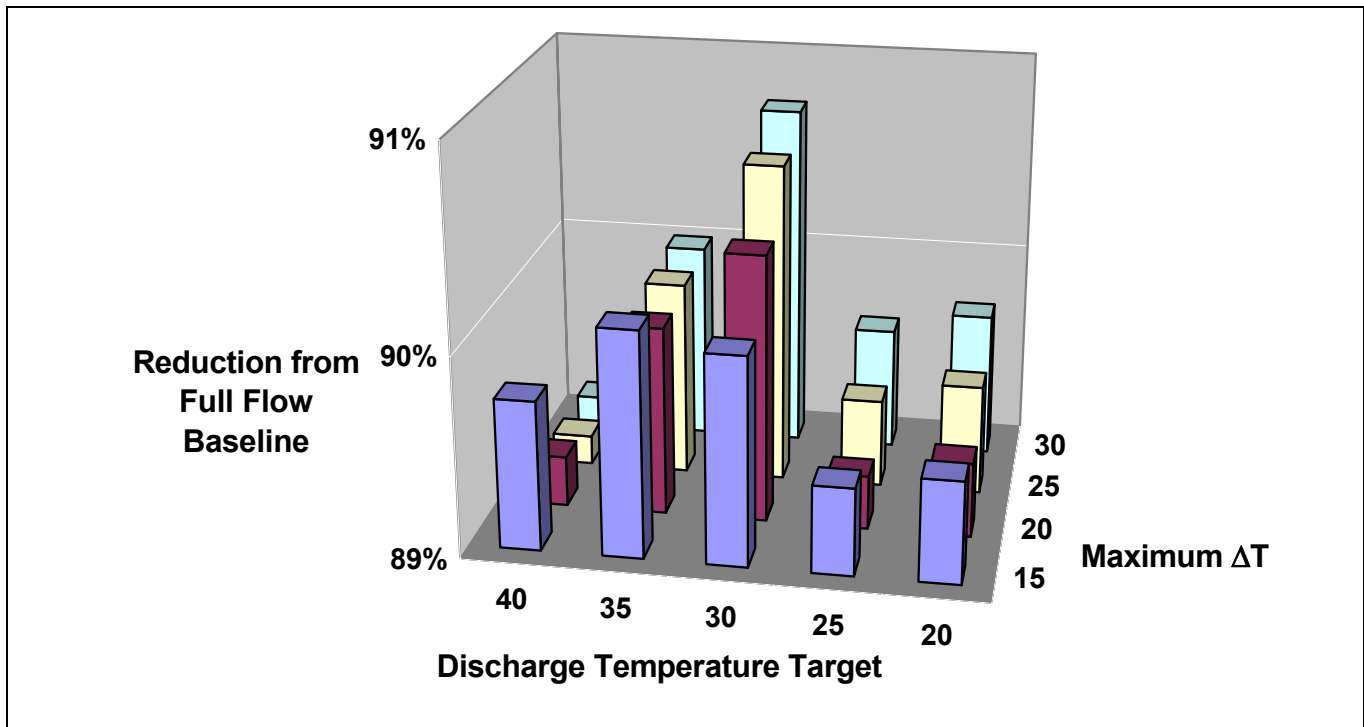
**Figure 5** Daily variation in density of entrainable striped bass life stages and generation load at the Roseton Generating Station. (Relative density values above 2 were cut off in order to improve resolution in 0-2 range.)



**Figure 6** Percent reduction from full-flow baseline of total cooling water flow under 1999-2001 operations at the Roseton Generating Station due to a load-based flow strategy. Maximum discharge temperatures range from 20° to 40°C and maximum  $\Delta T$  from 15° to 30°C.



**Figure 7** Percent reduction from full-flow baseline of numbers entrained under 1999-2001 operations at the Roseton Generating Station due to a load-based flow strategy. Maximum discharge temperatures range from 20° to 40°C and maximum  $\Delta T$  from 15° to 30°C.



**Figure 8** Percent reduction from full-flow baseline of numbers killed under 1999-2001 operations at the Roseton Generating Station due to a load-based flow strategy. Maximum discharge temperatures range from 20° to 40°C and maximum ΔT from 15° to 30°C.

### Session B Questions and Answers

- Q. Steve Dixon, PG&E, asked Mr. Super about his implication about reduced flows from all plants, and how costs can be addressed in the case of merchant plants.
- A. Mr. Super replied that flow reduction would be useful in almost every situation. If the rules are equal, and everyone has to meet them, then the costs would be the same.
- Q. Debra Littleton, USDOE, pointed out that 3 out of 4 new wet towers have plume abatement. She referenced the USDOE studies on retrofit of wet towers. She asked Bill Powers, Bill Powers, P.E., if he was convinced that you could not retrofit to air-cooled condensers because of the 8-inch backpressure limits.
- A. Mr. Powers said no, that there were ways to address this issue, but it has not been done. You could retrofit the turbine to bring in higher backpressure limits.
- Q. Mr. Super asked John Young, ASA Analysis & Communications, Inc. whether his evaluation was based on the lower capacity rates assumed for that plant. What would happen if the market changed to require higher capacity?
- A. Yes, you would get higher capacity factors.
- Q. John Veil, Argonne National Laboratory, asked Mr. Powers about entrainment of insects on air-cooled condensers.
- A. Mr. Super said that tube spacing is designed to pass most insects. Riverkeeper is about to release a study by Pisces on insect entrainment that does not show it to be an issue.

- Q. Denny Smith, USDOE, asked Mr. Powers about the footprint of dry cooling towers vs. the footprint of wet cooling (in particular, size requirements and restraints). In light of the ratio, what would it mean for a typical 300-500 MW unit? Mr. Smith added that the cost for a new dry system unit would be equivalent to \$50/KW. How would this impact retrofits?
- A. Mr. Powers cited another case where the air-cooled condenser was not as long as the wet tower, and in this case footprint was not an issue. He mentioned that you would need to take into account which impact you were trying to minimize: height or length.

## VI. Session C: Costs Associated with Flow Reduction

### *Cooling System Retrofit Costs*

*John Maulbetsch, Maulbetsch Consulting*

#### **BIOSKETCH**

Dr. John S. Maulbetsch is currently a consultant to government and industry in the areas of energy and environment, advanced power system technologies and global sustainability. His focus in the past two years has been on water conserving alternative cooling technologies for electric power generation. From 1975 through 1998, he held a number of senior technical positions at EPRI (formerly the Electric Power Research Institute). His activities during that time included developing energy technology strategies for global sustainability, authoring “Electrification and Global Sustainability” portion of EPRI’s Electricity Technology Strategy Roadmap, developing and coordinating EPRI’s central exploratory research effort and leading several major programs in the Environmental Control Systems area. Before joining EPRI, Dr. Maulbetsch was with Dynatech Corporation in Cambridge, Massachusetts for seven years. He was Director of the Energy Technology Center for the company. From 1965 to 1968, Dr. Maulbetsch was an Assistant Professor of Mechanical Engineering and Ford Post-Doctoral Fellow of Engineering at the Massachusetts Institute of Technology. Dr. Maulbetsch is a Fellow of the American Society of Mechanical Engineers and was a member of the Council of the American Association for the Advancement of Science representing the Engineering Section. He is the author of numerous articles on heat transfer in boiling and two-phase flow, water conservation, waste management, air quality control and global energy strategy. Dr. Maulbetsch received his S.B., S.M. and Ph.D. degrees from M.I.T. in 1960, 1962 and 1965 respectively.

#### **TECHNICAL PAPER**

##### **Abstract**

This paper presents estimates of the costs and environmental trade-offs of retrofitting recirculating cooling systems using mechanical draft cooling towers onto electric power generating plants designed for and operating on once-through cooling systems. The estimates and conclusions are based on retrofit studies at individual plants obtained from utility sources and on independent cost studies by three separate A&E firms.

The conclusions were:

1. Retrofit costs are highly variable from plant to plant.
2. This variability cannot be well accounted for by correlating factors such as \$/kW or \$/gpm of circulating water flow often found to be satisfactory for new plant cost correlations.
3. Differences in individual plant costs cannot be accounted for by differences in plant type (fossil vs. nuclear) nor by cooling water source type (fresh, brackish, saline).
4. The variability results from site-specific factors associated with difficulties related to carrying out major construction activities at existing sites.
5. Plant retrofits can be roughly assigned a “degree of difficulty” classification. Costs range from ~ \$125/gpm (“easy”), to \$200/gpm +/-20% (“average”) to \$250 to \$300/gpm (“difficult”) with a few as high as \$700 to \$900/gpm
6. Significant costs, in addition to the initial capital costs, include
  - i. additional power requirements for cooling system operation in the range of 1.0 to 1.5% of plant capacity,
  - ii. additional maintenance costs in the range of 1 to 3% of system capital costs annually and
  - iii. additional fuel costs resulting from efficiency reductions imposed on the plant by the inherent limitations of closed-cycle cooling systems in the range of 1% on an annual average basis.
7. Closed-cycle cooling, while reducing water withdrawals has environmental impacts that once-through cooling does not. These include higher evaporation losses, discharge of blowdown, discharge and disposal of wastewater and solid waste, drift, visible plumes, additional air emissions from increased fuel consumption and noise.

## Introduction

The focus of this study is on the capital costs of retrofitting once-through cooling to recirculated cooling using cooling towers at existing plants meeting criteria set forth by EPA in the April 9, 2002 Federal Register (1). Information from a variety of sources has been collected and organized to provide a reliable estimate of these costs. The information is of two types. The first derives from two independent studies (2, 3) which used generalized cost algorithms and plausible scaling rules from which costs for all units potentially subject to the proposed EPA rulemaking were calculated. The details of the methods used are described later in the report.

The second is information on 50 individual plants. Most of the estimates were provided to the Utility Water Act Group for use in this analysis. The cost estimates for a few of the plants were obtained from open literature reports. (4, 5, 6). Four plants were studied and discussed in a report for the U.S. DOE's National Energy Technology Laboratory by Parsons Engineering (7). The cost estimates for these 50 plants differed from the estimates from the generalized studies cited above in that the costs were individually developed for the specific plant and accounted for all site-specific features deemed to be important by the estimators. A few items are noteworthy.

1. While the cost estimates for the individual plants are referred to in the text and figures as "data", they are not, in nearly all cases, recorded costs incurred in actual retrofit projects. Rather they are the results of cost estimating studies for the specific plant performed either by the utility's engineering department or by contractors such as A&E firms hired by the utility to develop the estimate.
2. The amount of supporting or explanatory material provided with the costs was highly variable. The information ranged from "single number estimates" for a named plant to a full-blown engineering study of several hundred pages. Most were brief descriptions of the scope of the estimate and some cost breakdown into material, equipment, labor, project management and "other" categories.
3. In many cases, the information was provided under condition of confidentiality. As a result the plants are not identified in the paper beyond the specification of "plant size" (in MW), plant type (fossil or nuclear) and source water type (fresh, brackish or saline). Therefore, no specific source citations for the cost "data" is provided for plants other than those available in the report literature cited above. (4, 5, 6, 7).

These cost estimates for existing plants were scaled up from the date of the study to reflect 2002 costs and correlated against several plant characteristics. The individual plant estimates were then compared with results from the independent, generalized studies (2, 3). The agreement, or lack thereof, is used to estimate the range of costs likely to be encountered, and these are compared to the EPA results.

Other costs including changes in the O&M costs, an increase in the plant heat rate and a reduction in the plant output capacity, particularly during the warmest and most humid days of the year, are briefly considered. Finally, some of the environmental effects of closed-cycle cooling are discussed.

## Cooling System Descriptions

Figure 1 displays a simple once-through cooling system and typical design point values of flow rate, water temperatures and condenser backpressure. Figure 2 illustrates a retrofitted cooling tower, modified circulating water piping and typical new operating temperatures and backpressure.

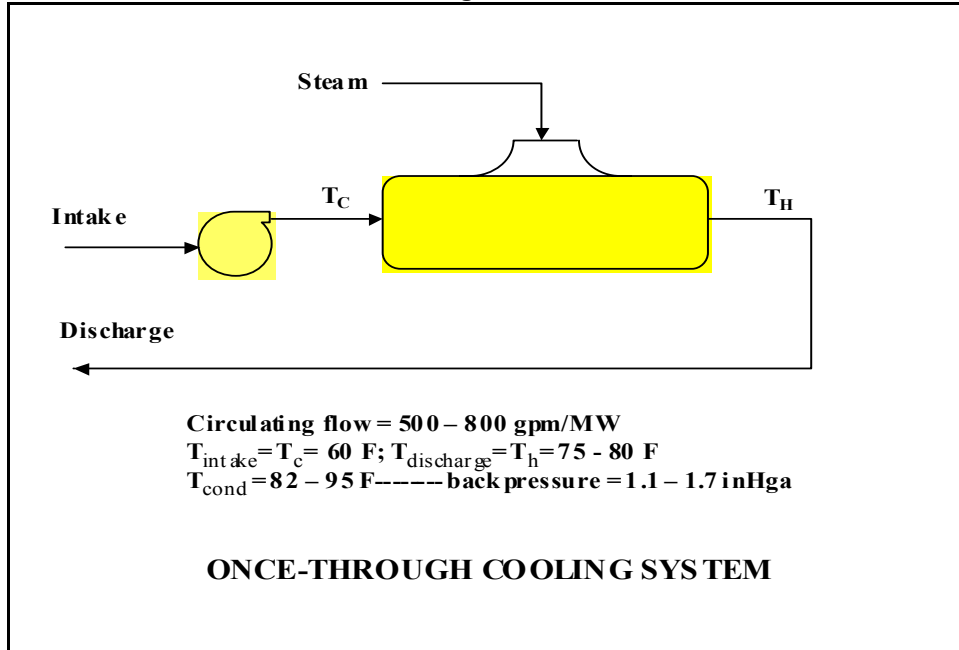
Several points are important.

- ▶ The likely choice of cooling tower is a counter-flow, mechanical draft tower of FRP (fiber-reinforced plastic) construction.
- ▶ Additional circulating water piping must be installed.
- ▶ In some cases an additional circulating water pump must be installed to return the flow from the cooling tower basin. In other cases, gravity return may be possible.

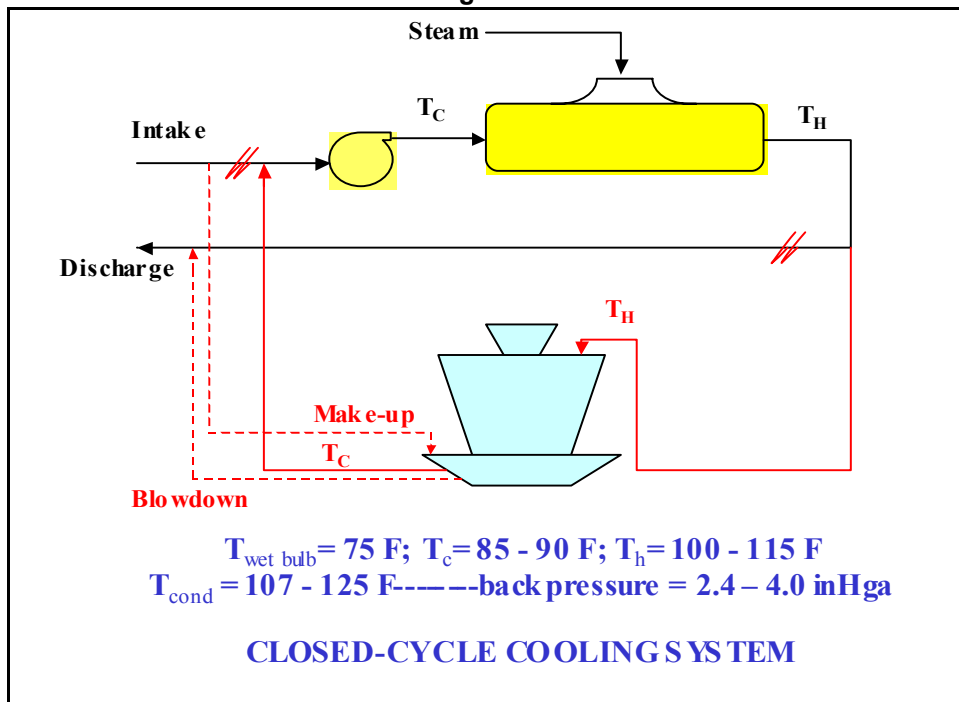


- ▶ The circulating water pump must now deliver a higher discharge head to pump water to the top of the tower. This may require a new or modified pump and, perhaps, reinforcement of the condenser water boxes and the circulating water piping.
- ▶ Additional make-up and blowdown lines and pumps must be provided. In some cases, it may be necessary to modify the intake and outfall structures. Water treatment facilities for in-plant use and discharge may be required depending on source water quality, cycles of concentration at which the tower is to be operated and discharge regulations.

**Figure 1**



**Figure 2**



In addition, the condensing water temperature and backpressure will probably increase with a corresponding increase in plant heat rate and a possible limitation on plant output.

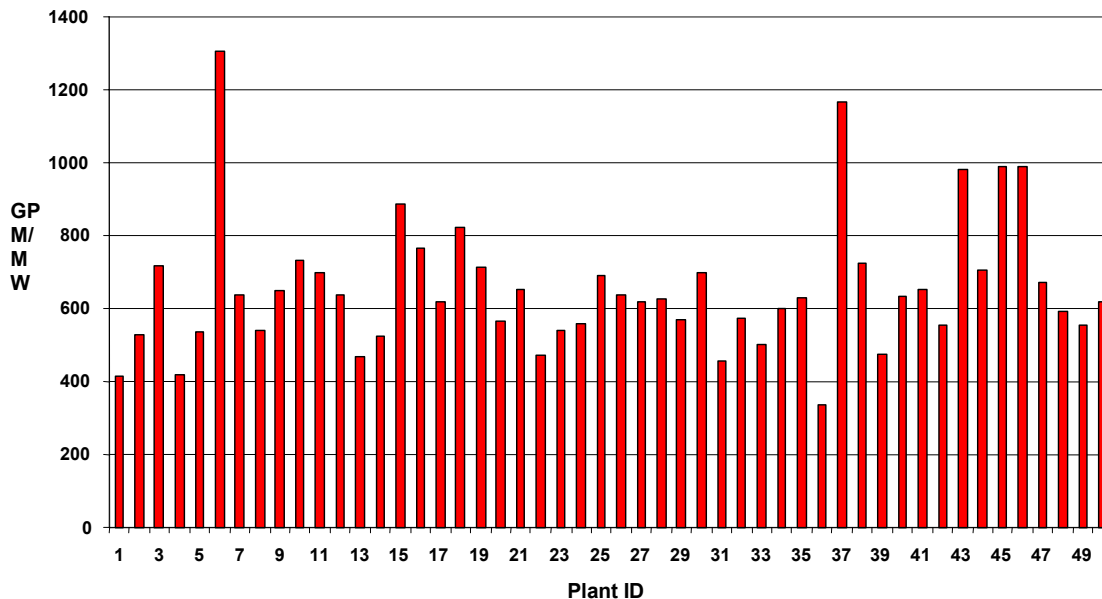
- ▶ The cold water temperature will now be set by the ambient wet bulb temperature and the cooling tower performance.
- ▶ Towers sized for a 10 F approach at the 1% wet bulb condition and with the “pre-retrofit” condenser water temperature rise and terminal temperature difference will impose a 32 F to 40 F temperature difference between the ambient wet bulb temperature and the condensing temperature. For the example illustrated in the captions of Figures 1 and 2, this results in a 1.3 to 2.3 in Hga increase in turbine backpressure.

**Other Retrofit Considerations**

The issue of whether the circulating water flow and condenser configuration are kept the same in a retrofit is an important one. Systems originally designed for and operated on once-through cooling typically have a higher condenser flow rate than do systems designed originally for closed cycle cooling with cooling towers for the following reasons:

1. The circulating water loop head requirements are substantially lower for once-through systems where the major pressure drop occurs across the tube side of the condenser. In a closed-cycle system, the head rise needed to lift the water to the spray deck at the top of the cooling tower is added to the condenser pressure drop increasing the required pumping power by a factor of two or three if the flow rate is the same.
2. For a given heat load, the temperature rise of the cooling water as it flows through the condenser is inversely proportional to the flow rate. Therefore, for a given condensing temperature, the mean temperature difference across the condenser is greater for a lower water temperature rise (higher flow) allowing for a smaller condenser. Typically, once-through systems optimize at flow rates corresponding to a temperature rise of 10 to 15 F with a circulating water flow rate of 400 to 700 gpm/MW as shown in Figure 3 for the 50 plants for which cost information was obtained.
3. On the other hand, cooling towers operate more effectively at higher cooling water temperatures and lower water flow rates. Therefore, compared to a once-through system, an optimized tower system normally has higher temperature rises across the condenser, lower circulating flow rates resulting in lower pumping power, a smaller and less expensive tower, but with larger condenser area.

**Figure 3: Circulating Water Flow Rates**



Therefore, a retrofit strategy which leaves the circulating water flow and condenser unchanged results in a tower which is more costly and pumping requirements that are higher than an optimized closed-cycle system, but avoids the cost of retrofitting the condenser and minimizes the modifications required to the circulating water piping.

A retrofit strategy that re-optimizes the balance of the cooling system to accommodate the change to closed-cycle by cutting the circulating water flow rate by 40 to 60% will require major condenser tube-side modifications to keep the tube-side water velocities at sufficiently high levels. This typically requires a change from a one-pass to a two-pass tube side, rearrangement of the water boxes, and rerouting of the inlet and outlet piping. These modifications may require substantial time and effort to gain access to the condenser through the turbine hall walls, and to rearrange massive piping in the area below the turbine exhaust.

The approach which re-optimizes the cooling water system as part of the retrofit typically incurs higher costs for the retrofit itself but results in more efficient operation with lower heat rates and lower operating energy requirements over the remaining life of the plant. Therefore, this strategy would be preferentially applied to large, base-loaded (low heat rate plants) with long remaining life. EPA has not made this distinction in their analysis. However, as will be noted later, nearly all the case studies done at individual plants by the owners themselves or by A&E firms adopted a similar strategy so virtually no data exist to confirm estimated differences in either capital cost or lifetime operating costs definitively.

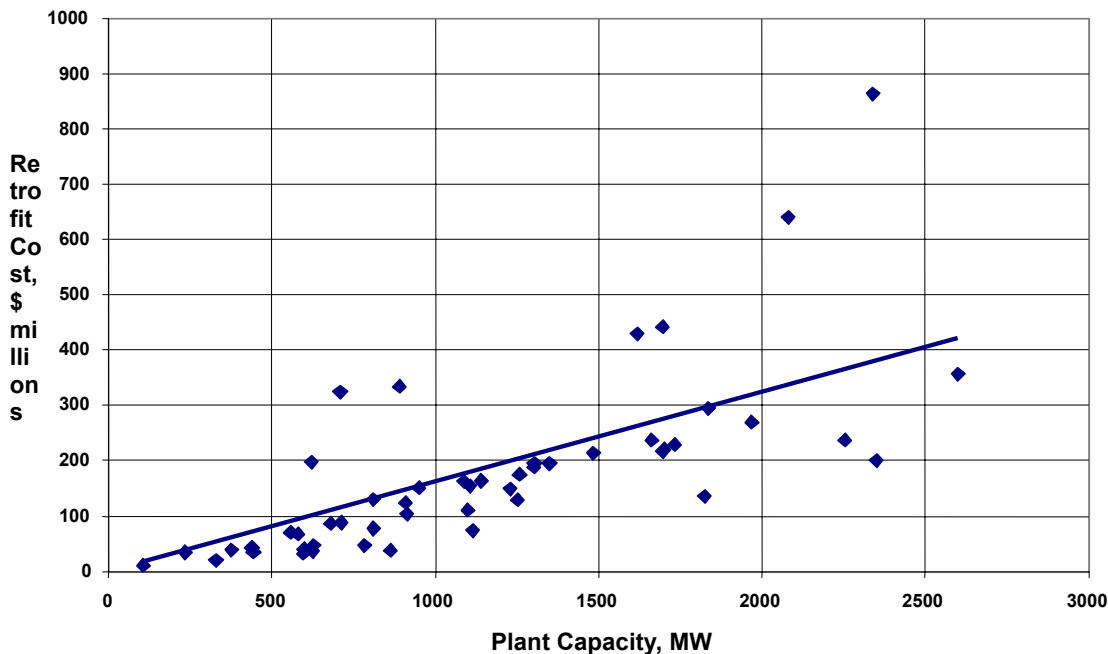
### **Costs: Individual Plant Studies**

Cost estimates for retrofitting once-through cooling systems to closed-cycle systems were solicited from many utilities including EPRI and Utility Water Act Group (UWAG) member companies. In addition, a brief literature search was conducted for published studies. Cost information was obtained for 50 plants. The sample included nuclear and fossil plants, a range of plant sizes, and fresh, brackish and saline source waters.

The source information came in varying forms and adjustments were often required to put them on a common basis. The costs were scaled from the year of the estimate to \$2002 using standard references (8). Ancillary costs include construction management, engineering and an allowance for contingency. When these were not included in the original estimates, 37% of the direct costs were added to account for them.

These adjusted costs for each of the 50 plants is shown in Figure 4 plotted against plant size in megawatts. While the cost is roughly proportional to plant size, the correlation is poor. Correlation was attempted vs. circulating water flow rate on the basis that the size of the cooling system components might be more closely related to the amount of water being circulated and cooled than to the heat load being rejected. As shown in Figure 3, the circulating water flow per MW of plant capacity varies considerably. However, the correlation against circulating water flow rate, while improved, is still poor, with many outliers. Sub-categorization by plant type or source water also fails to substantially improve the correlation against either plant size or flow rate.

**Figure 4: Plant Retrofit Cost Data vs. Plant Capacity**



The overall conclusion is that neither size nor flow rate scaling, or differences associated with fuel or service water type account adequately for the site-specific differences in retrofit costs. This is clear from a detailed look at some of the individual case study documents.

For example, in a study of nine individual plants at a single utility, the site-specific elements at each plant were factored from an in-depth study at one of the plants. The cost of retrofit was broken into 15 separate elements. The scale factors for many of the major elements varied from 1.0 to 3.3 across the other plants. At one of the plants, 2/3 of the cost of retrofit was for items that were completely absent at all the others. Clearly the retrofit costs at each of the plants were dominated by site-specific adjustments rather than by simple scale factors based on size or flow rate. In a survey of EPRI and UWAG members, utilities were asked to assess the seriousness of eight potential site-specific issues which might make retrofit more difficult and costly at their plants.

The specific issues raised were

1. Availability of land at the site to place a cooling tower
2. Distance of a preferred site from the turbine/condenser
3. Likelihood of interferences to installation of new circulating water piping
4. Unacceptable site geology or topography for tower support
5. Drift or plume problems
6. Noise problems
7. Aqueous discharge constraints on blowdown
8. Need to re-optimize condenser or reinforce condenser for increased pressure

Responses were received for a total of 56 plants. Each of the issues was identified at least 1/3 of the plants with some at nearly all. The most common concerns were the difficulty of finding a site near the turbine/condenser and the difficulty of installing circulating water piping in the midst of existing underground interferences.

**Costs: Generalized Studies**

Three independent studies have been conducted recently to estimate the cost of retrofitting existing facilities from once-through cooling to closed-cycle cooling. These studies were done by Stone & Webster Engineering Corporation (SWEC) (2), the Washington Group, Incorporated (WGI) (3) and the National Energy Technology Laboratory (NETL) (7). A brief review of the methodology used in each study and a comparison of the results to the individual plant data follows.

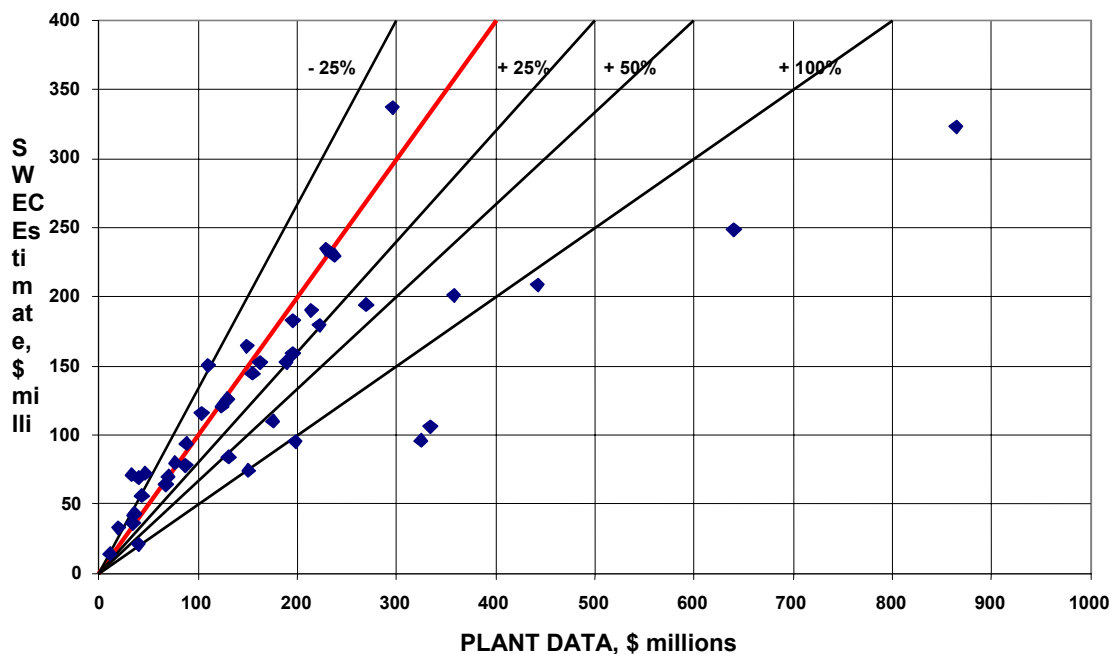
SWEC Study

The SWEC study developed a retrofit cost estimate for each of 1041 units currently using once-through cooling. The cost for each was scaled from one of six reference plants for which detailed cost estimates of a cooling system retrofit had previously been conducted. These six plants include fossil (coal and oil) and nuclear plants, fresh, brackish and saline source waters and plant sizes from 82 to 1137 MW. The total cost was built up from estimates of equipment, materials, labor and indirect costs.

For each unit, the most representative of the six reference plants was selected. The costs were then scaled from the reference plant costs on the basis of regional differences in labor cost and productivity and circulating water flow rate. The circulating water flow rate for the retrofitted plant was assumed equal to the original once-through system. No adjustment for “degree of difficulty” or site-specific issues was made.

Figure 5 displays the comparison with individual plant costs. These estimates give excellent (+/- 25%) agreement against approximately 2/3 of the individual plant data and reasonable agreement (-25%/+50%) for all but about 20% of the cases. A few points are substantial outliers exceeding the estimates by a factor of x2 or more. There is no particular improvement in the degree of correlation when the data are segregated by plant type or source water.

**Figure 5: Comparison with SWEC Estimates**



It is noteworthy that most of the deviation is in the direction of underestimating the individual plant costs rather than overestimating. In fact, the data cluster itself has a reasonably well-defined lower bound while discontinuities and outliers characterize the high cost boundary. This is consistent with the notion of a reasonably well-defined “minimum cost retrofit” (such as might be represented by new facility construction) modified by site-specific differences that lead to a range of high-end costs that are not predictable on the basis of simple scaling laws.

Washington Group Study (WGI)

The Washington Group conducted another study conducted to estimate the costs of cooling system retrofit (3). The approach taken in this study was quite different. For each unit in the population of units eligible for retrofit, information was obtained from an industry database on the power generation thermal cycle, steam conditions and unit size. The reject heat load to the condenser was then calculated based on heat balance equations chosen as appropriate for each grouping. A constant cooling water temperature rise across the condenser of 12 F was chosen for each unit. From this, a cooling water flow rate was calculated and a cooling water flow per unit plant output was determined.

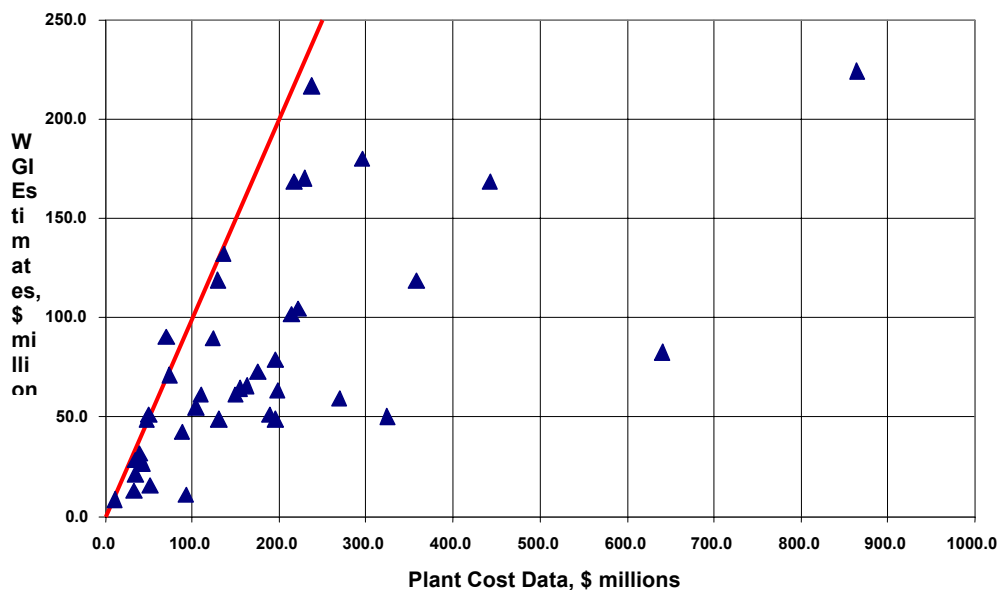
Costs for closed-cycle cooling systems were determined from vendor estimates and contractor experience for fresh and salt water cooling systems for a range of cooling tower sizes. In addition to the cooling tower structure, costs were added for the cooling tower basin, circulating water pumps, circulating water pipe costs, make-up water treatment system, circulating water chemical treatment system, make water pump, electrical equipment and connections, and additional multipliers for engineering, construction management, interest during construction, startup, contingency and fees. All the costs were then normalized on a cost per circulating water flow rate (\$/gpm) and applied to the unit groupings developed for the different thermal cycles and associated heat rates.

Retrofit issues were addressed in a limited fashion. The circulating water lines were calculated on the basis of 1000 foot length (implying a 500 foot distance between the condenser and the tower) for each case. This was felt to be longer than would normally be the case in new plant construction and chosen to account for difficulty in finding a closer location for the tower at an existing site. New circulating water pumps were included to account for the increased head rise required to pump the water to the top of the tower. Beyond these two items, the cost elements were essentially new facility costs.

A comparison of the results of this analysis to the individual plant costs is presented in Figure 6. The WGI estimates are consistent with the lower bound of the individual plant data as might be expected for estimates which are consistent with new facility costs and which do not reflect issues related to retrofit conditions.

The costs developed in this manner range from \$70 to \$95 per gpm for fresh water units and from \$95 to \$125 per gpm for salt water units. This compares to the SWEC scale factors based on site-specific studies of projects carried out under retrofit conditions of \$140 to \$212 per gpm. This comparison further demonstrates the potentially large difference between “greenfield” and retrofit costs.

Figure 6: WGI Estimates vs. Utility Data



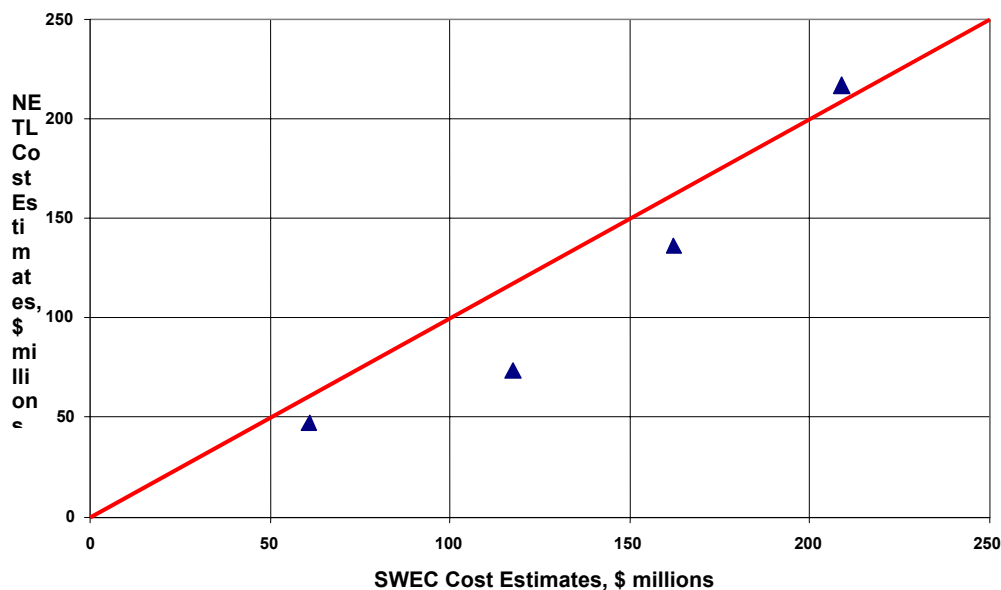
National Energy Technology Laboratory (NETL)

A brief study of retrofit costs at four sites was conducted by NETL. The sites were

- a 1700 MW (2 units) nuclear plant on brackish water
- a 1100 MW (2 units) fossil (gas and coal) plant on brackish water
- a 700 MW (2 units) fossil (gas) plant on brackish water, and
- a 1850 MW (4 units) fossil (coal) plant on saline water.

The exact methodology and scope is not known, and none of the plants were in the set of 50 plants for which owner-supplied estimates of plant-specific retrofit costs were available. Therefore, a simple comparison was made with estimates for the corresponding plants from the SWEC study in Figure 7. The agreement is reasonable with three of the four cases within 20% and the fourth within about 40%. While the results of such a limited sample may be fortuitous, this generally good agreement between two sets of estimates, both of which factored in site-specific retrofit issues {either through specific site studies (NETL) or implicitly through the use of reference plants for which site-specific studies had been carried out (SWEC)}, gives further support to the contention that a simple scaling from new facility estimates is inadequate to account for retrofit costs.

**Figure 7: SWEC vs. NETL Comparison**



**Comparisons with EPA Estimates**

A comparison of EPA cost estimates with either the individual plant cost data or the results of the three independent cost studies is difficult. EPA does not report plant-by-plant estimates. Also they include a number of cost adjustment factors and add-ons in the cost tables and example calculations which make it difficult to generalize or average across the population of plants.

As an alternative for comparison purposes, a likely upper-bound of the EPA cost estimates can be established. The costs are based on new facility costs reported in Economic and Engineering Analyses of the Proposed §316(b) New Facility Rule (9). Table A.5 of that document provides costs for a range of flows for five different materials of tower construction. For cooling water flows greater than 10,000 gpm, the highest cost per gpm is for a concrete tower with a flow rate of 11,000 gpm and equals \$76/gpm. Excluding Alaska and Hawaii, the highest regional cost factor is for New Jersey and equals 1.099, bringing the adjusted cost to \$83.2/gpm.

In the example calculations given in Technical Development Document for Proposed Section 316(b) Phase II Existing Facility Rule (10), the capital cost of the installed cooling system alone was increased by additional costs for intake

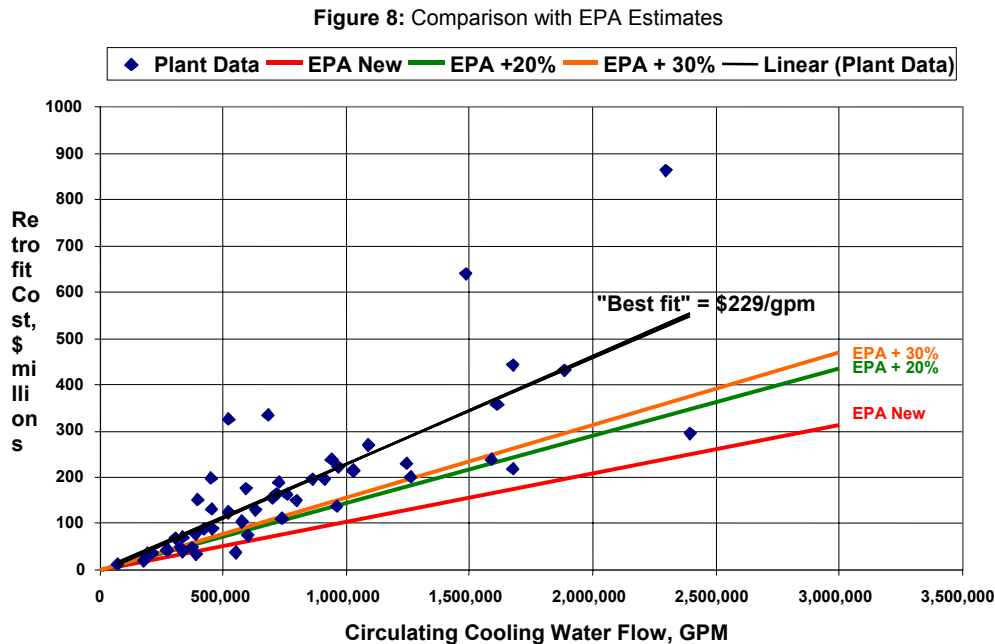
and discharge piping modification capital costs, cooling water intake technology retrofit capital costs and condenser upgrade capital costs.

These items added over \$12.5 million to a base cooling system costs of \$53,550,000 or an increase of about 25%. While these costs are apparently not applied in all cases, they suggest a potential increase in \$/gpm factor of 25% bringing the system cost to \$104/gpm for new facility costs.

The retrofit costs are then developed by adding a 20% retrofit factor (30% for some elements of the system), a 10% “contingency factor” and a 5% factor “to account for uncertainties inherent in intake modifications at existing facilities.” This would result in retrofit costs of \$145 to \$156/gpm depending on whether a 20% or a 30% retrofit factor is applied.

Figure 8 displays the individual plant retrofit costs plotted against circulating water flow along with the correlation lines for EPA new facilities, and the adjusted EPA retrofit costs using both a 20% and a 30% retrofit factor.

As was suggested earlier, the “new facility” costs appear to give a reasonable approximation to the lower boundary of the cluster of 50 data points obtained from individual plant studies. This is consistent with the contention that the minimum cost of retrofit is close to the cost for cooling system installation at a new facility. The adjustment factors are seen to account for the additional costs associated with retrofit factors in only a fraction of the cases. The “best fit” linearization of the data points exceeds the EPA new facility costs by a factor of about x 2.3.

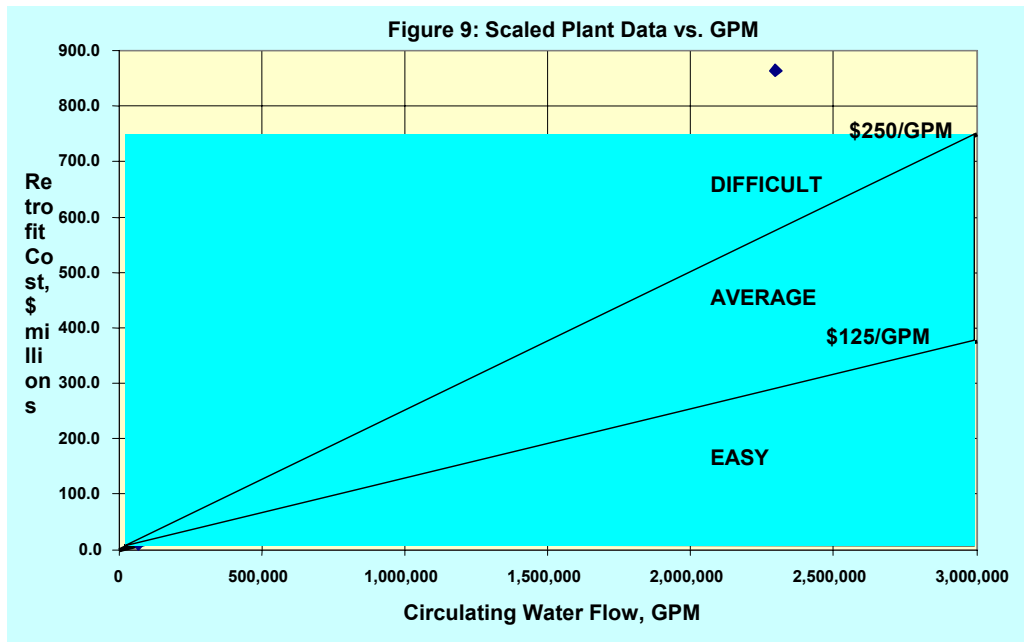


**General Conclusions**

No general scaling laws, such as \$/MW or \$/gpm, which are often used for rough estimates of component costs at new plants, give satisfactory correlations. Sub-categorization to account for the effect of plant type or source water type provides little improvement.

In general, the lower bound of the data points from the 50 plants is in reasonable agreement with what are essentially new plant estimates by WGI and EPA. A rough clustering of data into three groupings designated as “easy”, “average” and “difficult” retrofits illustrates the site-specific nature of retrofit costs.





### Other Costs

The retrofitting of a plant designed for and operating on once-through cooling imposes a number of continuing costs on future operations of the plant in addition to the one-time capital cost of retrofit. The most important of these are

- ▶ Closed loop cooling systems will have higher power requirements as compared to once-through systems for the increased head rise required of the circulating water pumps and for the fans to draw air through the tower. This is estimated to amount to 1.0 to 1.25% of plant output.
- ▶ Closed cycle systems have additional equipment that requires maintenance labor and specialty chemical costs for water treatment systems for both the make-up and the blowdown. Factored annual allowances of 1.5 to 3.0% of the cooling system capital cost are typical.
- ▶ Plants equipped with closed-cycle cooling systems incur efficiency losses compared with once-through cooled systems due to the higher turbine backpressures imposed on the plant by limitations of the cooling system. While highly dependent on the climate at the site, an increase in plant fuel requirement of 1.0% is consistent with a 1 inch Hga increase in turbine backpressure from a 10 F variation in site wet bulb temperature.
- ▶ To the extent that closed-cycle cooling system may not be able to maintain turbine backpressure below warranty limits during the hottest and most humid hours of the year, the plant maybe forced to reduce output to protect the turbine. While this would be expected only rarely, capacity limitations may occur in some locations during the summer.

### Environmental Issues

Brief mention will be made of issues to be considered in comparing the environmental effects of closed-cycle and once-through cooling systems.

#### Intake losses

Retrofitting once-through cooling to recirculated cooling can provide a twenty- to fifty-fold reduction in the water taken into the system. However, it may not represent a similar reduction in the degree to which “fish, shellfish and other aquatic life are killed or injured”. The survival rate of organisms entrained or impinged in once-through systems has been studied and debated extensively but is not normally assumed to be zero. It is, however, unlikely that entrained organisms will survive passage through a recirculated cooling system with a cooling tower.

### Water consumption

A recirculated cooling system is designed to cool by evaporating a portion of the circulating water flow in order to cool the remainder. A typical evaporation rate for mechanical draft cooling towers is 10 gpm/MW representing 50 to 80% of the intake flow, depending on the cycles of concentration. This loss of water to the source waterbody will likely exceed losses associated with increased evaporation rate from the receiving waters of a once-through cooling system.

### Water and waste discharge and disposal

Recirculated cooling systems require the discharge of cooling tower blowdown, which, while regulated, may result in some water quality impact. If blowdown treatment is required, the disposal of solid waste, such as basin sludge or water treatment system sludges from evaporation ponds, brine concentrators, side-stream softeners or other blowdown reduction processes must be considered.

### Plumes and Drift

On cold days, wet towers can produce a large visible plume as the warm saturated air leaving the tower mixes with the cold ambient air and water vapor condenses. In some locations, these plumes may obscure visibility, creating dangerous conditions on roadways or lead to local icing on neighboring roads or structures.

Drift rates from modern, well-designed cooling towers can be held to quite low levels. New installations have been quoted at less than 0.0005% of the circulating water flow rate. However, even that low rate will result in a total drift of nearly 2000 gallons per day from a 500 MW steam plant circulating 250,000 gpm. The environmental issues normally raised in connection with cooling tower drift are PM10 emissions, bacterial or pathogenic emissions and damage to local crops.

### Air emissions

The primary air emissions from fossil plants are, of course, from the combustion of the fuel. As has been noted, the choice of cooling system can reduce the overall plant efficiency and capacity. Therefore, to meet a given total system load, more fuel must be burned with a corresponding increase in emissions of NO<sub>x</sub>, particulate matter, SO<sub>2</sub> and CO<sub>2</sub> in amounts and proportions which depend on where and in what equipment the additional fuel is used.

For retrofits to recirculated cooling systems in most locations, the effect is small. On the other hand, for site-specific situations, a case-by-case analysis of these emissions would be needed to determine what the local environmental impact of each cooling option would be.

### Noise

Cooling tower operation is noisier than once-through cooling operation. The primary noise from cooling facilities is fan noise and "fill" noise caused by the flow of water down over the tower fill. While fan noise can be reduced through the choice of low noise fans, the water noise is less amenable to reduction, and some sort of sound barrier may be required to comply with local ordinances. Here again, the issue may simply add to the difficulty of obtaining a permit and the cost and duration of the project, and warrant consideration in the larger context of balancing the overall benefits to the environment and society of a given decision affecting the choice of cooling systems at power plants.

These issues are noted not to suggest the presence or potential of serious environmental harm from recirculated cooling systems but to note that environmental impacts are associated with such system that do not occur with once-through cooling and that should be balanced against the benefits to be derived from reducing the cooling water intake flow. It is certainly the case that these issues are subject of concern to the public in some instances and can prolong permitting processes seeking approval for retrofit, adding to the duration and cost of the project.

## Conclusions

The conclusions of the analysis were:

1. Retrofit costs are highly variable from plant to plant.
2. This variability cannot be well accounted for by correlating factors such as \$/kW or \$/gpm of circulating water flow normally found to be satisfactory for new plant cost correlations.
3. Differences in individual plant costs cannot be accounted for by differences in plant type (fossil vs. nuclear) or by cooling water source type (fresh, brackish, saline).
4. The variability is the result of site-specific factors associated with difficulties particularly related to the fact that retrofits present special constraints to on-site construction projects.
5. Plant retrofits can be roughly assigned a “degree of difficulty classification” as “easy”, “average” or “difficult” retrofits.
  - i. The costs for the easiest of the projects (lower bound of the individual plant data) are roughly consistent with the costs estimated for cooling system construction at new facilities and fall in the range of \$125/gpm
  - ii. The average difficulty projects costs cluster around \$200/gpm +/- 20%
  - iii. The more difficult projects range from \$250 to \$300/gpm with a few ranging as high as \$700 to \$900/gpm
6. Significant costs, in addition to the initial capital costs, result from cooling system retrofits including:
  - i. Additional requirements for operating power in the range of 1.0 to 1.5% of plant capacity
  - ii. Additional maintenance costs, primarily associated with water treatment requirements, in the range of 1 to 3% of system capital costs annually.
  - iii. Additional fuel costs resulting from efficiency reductions imposed on the plant by the inherent limitations of closed-cycle cooling systems in the range of 1% on an annual average basis.
7. Recirculated cooling, while reducing water withdrawals for natural waterbodies relative to once-through cooling, has environmental impacts which once-through cooling does not associated with evaporation losses, discharge of blowdown, discharge and disposal of wastewater and solid waste, emissions of drift, visible plumes, additional air emissions from increased fuel consumption and noise.

## References

National Pollutant Discharge Elimination System--Proposed Regulations to Establish Requirements for Cooling Water Intake Structures at Phase II Existing Facilities, Federal Register, April 9, 2002. pp. 17121-17170  
Prepublication Copy of Reference 1, February 28, 2002

Yasi, D. E. and T. A. Adams, Jr., Engineering Cost Estimate for Retrofitting Closed-Cycle Cooling Systems at Existing Facilities, Stone & Webster Report to Hunton & Williams, July 3, 2002.

Estimated Cost of Compliance with EPA Proposed Rule 316(b) of the Clean Water Act; Washington Group International, December, 2001.

Millstone Power Station : An Evaluation of Cooling Water System Alternatives, Submitted by Dominion Nuclear Connecticut, Inc. to Connecticut Department of Environmental Protection, August, 2001.

Burns, J. M. *et al.*, The Impacts of Retrofitting Cooling Towers at a Large Power Station, EPRI-TR-104867, February, 1995.

Veil, J. A. *et al.*, Impact on the Steam Electric Power Industry of Deleting Section 316(a) of the Clean Water Act: Energy and Environmental Impacts, Argonne National Laboratory, ANL/EA/S-5, January, 1993.

An Investigation of Site-Specific Considerations for Retrofitting Recirculating Cooling Towers at Existing Power Plants—A Four-Site Case Study, Parsons Infrastructure and Technology Group, Inc. and the National Energy Technology Laboratory, May, 2002.

R. S. Means Cost Works, 2001 (Available through [www.rsmeans.com](http://www.rsmeans.com)).

Economic and Engineering Analyses of the Proposed Section 316(b) New Facility Rule, EPA 821-R-00-019, August, 2000.

Technical Development Document for the Final Regulations Addressing Cooling Water Intake Structures for New Facilities (EPA-821-R-01-036) November 2001.

---

*Estimating Energy Penalties for Wet and Dry Cooling Systems at New Power Plants*  
Wayne Micheletti, Wayne C. Micheletti, Inc.

**BIOSKETCH**

Mr. Wayne Micheletti is founder and president of Wayne C. Micheletti, Inc., an independent water and wastewater management-consulting firm. Mr. Micheletti received his B.S. and M.S. in Chemical Engineering from the University of Texas at Austin. He worked as a Senior Engineer and Group Leader of the Water Processes Group at Radian Corporation for 6½ years, directing field and laboratory studies, software development and technology assessments. He then became a Senior Project Manager for the Electric Power Research Institute where he guided EPRI research for 8 years in the areas of cooling water systems, ash handling systems, wastewater treatment, and low volume waste management. Since 1991, he has been an independent consultant. He specializes in all aspects of water and wastewater management, from intake to discharge, and has worked with a wide variety of industrial, commercial, institutional and governmental clients.

**TECHNICAL PAPER**

**Abstract**

One means for reducing the impingement and entrainment of aquatic organisms at new power plant cooling water intakes is to reduce the total volume of water withdrawn from the surface water source. A wet recirculated cooling system (cooling tower) withdraws about 10% as much water as a wet once-through cooling system. A dry cooling system (air-cooled condenser or ACC) has a still lower withdrawal rate. While the choice between a wet cooling tower and an ACC for a new power plant will depend upon a number of site-specific factors, economics is always an important consideration. And the total life-cycle cost for a new cooling system can be significantly influenced by the system's ability to continuously operate at design efficiency during widely varying climatic conditions throughout the year. A decline in cooling system efficiency can result in a decline in power generating efficiency due to insufficient cooling of the turbine exhaust steam and an increase in turbine backpressure. The associated loss of generating capacity is frequently referred to as an "energy penalty". Although this "penalty" is normally associated with steam turbine-generator operation, in some circumstances the combustion turbines in a combined-cycle power plant also can be affected. Therefore, anyone involved in the specification, evaluation, selection or approval of new power plant cooling systems should understand the subtle, but critical economic consequences of estimating energy penalties. This paper will explain the energy penalty concept in detail by describing the data that are needed, explaining the implications of key assumptions and showing how these data and assumptions can influence subsequent estimates.

After an extended period of general inactivity, new power plant construction in the United States has been relatively dynamic over the past five to seven years. Some of this construction has been due to the rapid growth in demand for electrical power in certain areas of the country, notably the southwest. Other construction has been in response to steadily dwindling reserve margins throughout the U.S. But almost all of the recent new power plant construction has occurred under the revised economics associated with industry deregulation in which unit dispatch is not guaranteed for any single producer but is increasingly determined by the best available generation cost from multiple producers.

In an evolving competitive industry, power producers know generating units that are unable to meet consumers' demands for electricity at the lowest price will slowly, but inevitably, be excluded from the market. So the renewed emphases in recent power plant design and operation have been reliable, low-cost performance and unit availability.

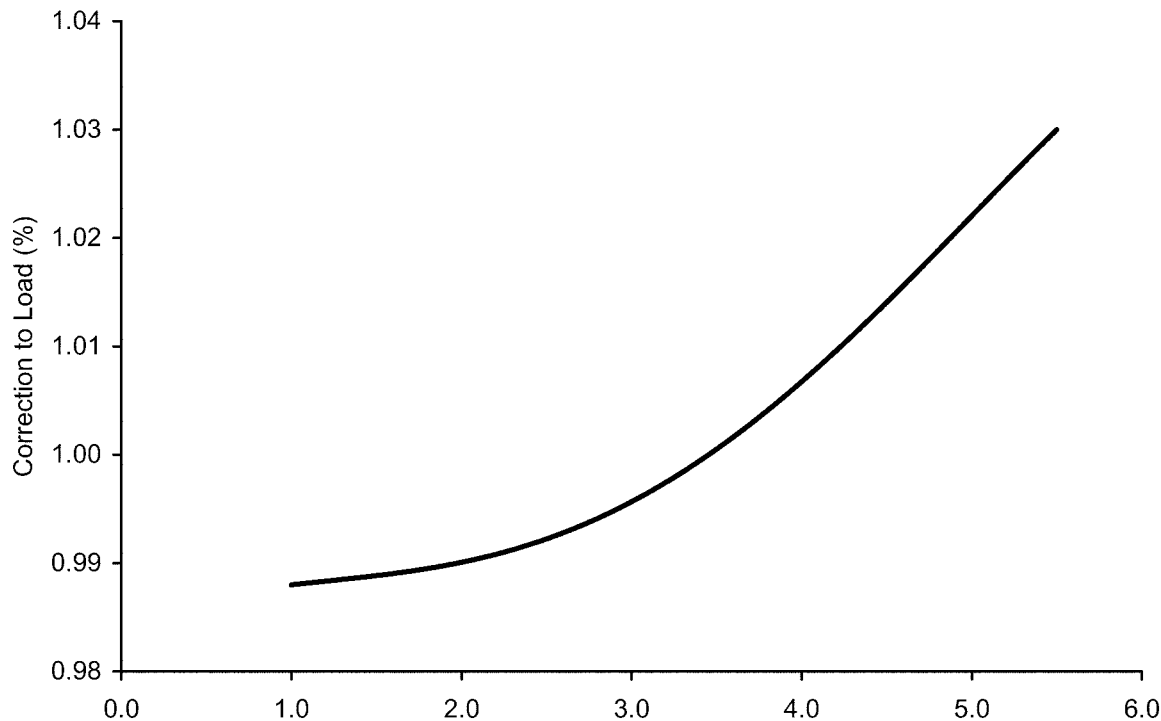
The majority of new plants built since 1995 are based on the combined-cycle process for power generation. With short construction schedules, high generating efficiencies and good operating flexibility, combined cycle units have many economic benefits important in the deregulated utility market. In the most common 2-on-1 arrangement, electricity is produced by two combustion turbine-generators with the hot exhaust gas from these turbines used to produce steam in a heat recovery steam generator (HRSG) for a single steam turbine-generator. This represents a significant shift in the traditional use of fossil fuels for electricity production via 100% steam turbine-generators. It also represents a substantial change in power plant raw water needs. Since the combustion turbines produce roughly two-thirds of the overall electrical power and have no steam condensation step, a 2-on-1 combined-cycle plant requires only about one-third the amount of cooling needed by a conventional fossil fuel steam-electric plant of equivalent capacity. This is an important consideration because: 1) makeup to a recirculated cooling system typically represents 75% or more of the raw water needed in a conventional fossil-fuel steam-electric plant, and 2) securing access to adequate raw water supplies and obtaining the necessary intake and discharge permits can be time-consuming and expensive aspects of siting a new power plant. In addition, the reduced cooling requirement for a combined-cycle plant means that other cooling approaches (such as dry cooling or combination wet/dry cooling systems) may offer benefits not apparent for the larger cooling requirements of conventional fossil-fuel steam-electric plants.

Proponents of different cooling systems can usually provide a list of advantages favoring a given cooling technique. However, assigning a monetary value to those perceived advantages is more difficult, primarily because the economics of power plant cooling systems are complex. This complexity results from the complicated relationships of three key costs: installed equipment capital cost, annual operating and maintenance or O&M cost, and energy penalty cost. For most industrial processes, the first two costs can be fairly well defined and, to a certain extent, contractually guaranteed by the vendor/ supplier. But the energy penalty cost is somewhat unique to power plant cooling systems because it reflects a direct performance link between the cooling system and the low-pressure steam turbine-generator. Consequently, the potential for and the magnitude of an energy penalty cost dictate cooling system design and operating changes that directly affect the capital and O&M costs. So in a competitive market, generating power in the most cost-effective manner depends upon a company's ability to balance all three key costs by optimizing the design of the cooling system and steam turbine-generator over the range of anticipated operating conditions.

### **Cooling System and Low-Pressure Steam Turbine-Generator Performance**

The function of a steam turbine-generator is to convert the thermal energy of steam into electrical energy. This change is accomplished in a two-step process. First, the thermal energy is converted to mechanical energy by expanding steam through numerous stages in the turbine, causing the turbine rotor to turn the generator rotor. Because the generator rotor is magnetized, its rotation converts the mechanical energy to electrical energy in the generator stator.

**Figure 1**  
 Typical Load Correction for Conventional LP Steam Turbine-Generator



A very important part of this process is the condensation of exhaust steam from the final, low-pressure (LP) turbine. When the steam condenses, the rapid decrease in vapor-to-liquid specific volumes creates a vacuum at the turbine outlet (monitored as turbine backpressure) that increases power generation efficiency. As shown in Figure 1, the conventional LP steam turbine-generator can operate over a modest backpressure range (typically 1.0 to 5.0 or 5.5 in. Hga), but the design point for optimum efficiency is usually at the lower end of this range (2.0 to 3.5 in. Hga). Operating at backpressures lower than the design point will increase generating efficiency slightly until a minimum “choke” point is reached where any reduction in exhaust pressure no longer produces further increases in last-stage work. Operating at backpressures greater than the design point will decrease generation efficiency until at a maximum limit (usually specified in the manufacturer’s warranty) damage to last-stage blades can occur. For these reasons, backpressure is the most frequently used means for monitoring steam turbine-generator operation and performance.

Because lower turbine backpressures are achieved when the steam condensate temperatures are lower, designing and operating a cooling system that can remove the heat of condensation at those low temperatures is essential. Therefore, for any power plant cooling system, performance is determined by the system’s ability to continuously and consistently reject the heat load needed to achieve the steam condensate temperature corresponding to the optimum (i.e., minimal) turbine backpressure compatible with the operating conditions at that time. In doing so, the cooling system must be designed not only to transfer the maximum heat load, but also to operate over a broad range of anticipated environmental conditions. This is because the “waste” heat removed by the cooling system during the steam condensation step must ultimately be transferred to the surrounding environment. Failure to meet either of these design considerations usually means higher steam condensate temperatures (higher turbine backpressures) and lower power generation efficiency.

For wet cooling systems with a given condenser design (steam flow and cooling water flow), the temperature of the cold water entering the condenser is a driving determinant of the steam condensate temperature. As a result, the cold water temperature is a key design and operating parameter. For a once through cooling system, plant operators have no control over inlet cold-water temperatures. But with adequate historic source water data, once-through systems

usually can be designed to provide cold-water temperatures suitable for maintaining turbine operation at the optimum design point throughout the year. Assuming some typical values for condenser temperature rise (the increase in cooling water temperature entering and exiting the condenser) and a condenser terminal temperature difference or TTD (the temperature difference between the condensing steam and the hot water leaving the condenser), it is possible to calculate the condensing steam temperature and the corresponding turbine backpressure for a once through cooling system as shown in the first column of Table 1. For this example, Atlanta, Georgia has been chosen as the power plant site.

**Table 1**  
 Steam Condensate Temperatures and Turbine Backpressures for Typical Cooling System Design Values

	Once-through Wet Cooling	Recirculated Wet Cooling	Direct Dry Cooling (ACC)
Surface water temperature <sup>A</sup>	79 °F		
Condenser temperature rise	20 °F		
Ambient wet-bulb temperature <sup>A</sup>		79 °F	
Ambient dry-bulb temperature <sup>A</sup>			95 °F
Correction for plume recirculation		2 °F	3 °F
Approach to wet-bulb temperature		8 °F	
Cooling tower range		24 °F	
Condenser TTD	6 °F	6 °F	
Condenser ITD <sup>B</sup>			20 °F
Steam condensate temperature	2.3 in. Hga	3.3 in. Hga	3.3 in. Hga

- A - Maximum surface water temperature and 1% ambient wet-bulb and dry-bulb data are for Atlanta, GA
- B - A 20 °F ITD was selected only to achieve a steam condensate temperature comparable to the recirculated system and to ensure adequate performance at the 1% ambient dry-bulb temperature. This value is not “typical” of most ACC designs; a more typical, cost-effective ACC would have an ITD in the 35-55 °F range.

For a recirculated system, the cooling tower is designed to produce a specified cold-water temperature based on the anticipated climatic conditions. Because evaporation is the dominant means of heat transfer in a cooling tower, the ambient air wet-bulb temperature is the controlling factor. The lower the inlet air wet-bulb temperature (indicating colder air and/or lower humidity), the colder a tower can make the cooling water going to the condenser. As a matter of physics, the cold-water temperature can never be lower than the inlet air wet-bulb temperature. The difference in cold-water and inlet air wet-bulb temperatures is known as the “cooling approach”. Over the years, cooling towers have been designed with approaches between 5 and 12 °F; for power plant cooling towers, the approach is generally 8 °F.

To assure adequate cooling tower performance virtually all of the time, a “worst case” ambient wet-bulb temperature is selected for design purposes. Based on historic climatic data, the design value most frequently used is an ambient wet-bulb temperature that would not be exceeded for more than 29 hours during the months of June through September (approximately 1 percent of the total time for that period). Again, assuming some typical values for a power plant cooling tower range (the temperature difference between the hot water entering and the cold water leaving an evaporative cooling tower) and plume recirculation and interference (the estimated artificial increase in inlet air wet-bulb temperature over the actual ambient value), it is possible to calculate the condensing steam temperature and the corresponding turbine backpressure as shown in the second column of Table 1.

For direct dry cooling systems (air-cooled condensers or ACCs), sensible heat transfer is the only form of heat rejection, so performance depends upon the ambient air dry-bulb temperature instead of the wet-bulb temperature. Because ambient dry-bulb temperatures are usually higher and tend to experience more dramatic daily and seasonal fluctuations than ambient wet-bulb temperatures, designing and operating dry cooling systems to obtain the consistent

and continuous performance historically provided by wet cooling systems is possibly the greatest obstacle to the increased use of dry cooling in power plants. One way to overcome this obstacle is to increase the size of the air-cooled condenser (i.e., when the rate of sensible heat transfer declines due to an increase in the ambient dry-bulb temperature, a larger ACC will still have adequate heat transfer area to reject the design heat load at the design backpressure). This can be accomplished in the design phase by specifying a smaller initial temperature difference or ITD (the temperature difference between the condensing steam and the ACC inlet air dry-bulb temperature). Assuming a fairly low design ITD (20 °F) and a typical plume recirculation (the estimated increase in inlet air dry-bulb temperature due to ACC plume recirculation), it is possible to calculate the condensing steam temperature and the corresponding turbine backpressure as shown in the last column of Table 1.

The results presented in Table 1 indicate that, theoretically, all three types of cooling systems can be designed to provide acceptable performance (operating turbine backpressures in the range of 2.0-3.5 in. Hga) for environmental conditions that might occur approximately 99.44% of the year. Therefore, performance need not be a limiting factor in the selection and/or use of any of these systems for power plant cooling. However, a cooling system design based either on inadequate or inaccurate environmental data and/or on low installed capital costs for undersized equipment can adversely affect cooling system performance, which, in turn, reduces steam turbine-generator performance.

### **Understanding Energy Penalties**

For power plant cooling systems, an energy penalty is defined as the decline in electrical generating output that occurs when the cooling system is unable to reject the heat load necessary to achieve a steam condensate temperature corresponding to the optimum design turbine backpressure. In general, two types of energy penalties are associated with an increase in steam condensate temperature:

1. Loss of efficiency – for a given fuel input, the turbine-generator output is lower (i.e., an increase in fuel consumption would restore the turbine-generator output, albeit at a higher heat rate), and
2. Loss of capability – for a given maximum backpressure limit, the turbine-generator cannot operate at the rated full-load capacity (i.e., the steam flow (heat input) to the turbine-generator must be reduced to maintain the backpressure at a value no greater than the maximum limit established by the manufacturer, thereby limiting the output).

Note that in actual practice many operating factors (such as condenser tube cleanliness or air blanketing, poor water or air distribution in the cooling tower, etc.) can influence the performance of a cooling system and result in energy penalties. However, for the purposes of this discussion, the cooling system design for a new power plant is the focus, so these operating factors, which are site-specific and unpredictable, are ignored. Note also that cooling system energy “requirements” (such as electrical power for pumps and fans) are frequently included in the calculation of energy “penalties”. But again, for the purposes of this discussion, these energy “requirements” are considered to be operating costs that would be more appropriately included in an annual O&M cost analysis.

### **Wet Cooling Systems**

The concept of power plant cooling system energy penalties is not new. Initially, once-through cooling was the favored approach for rejecting steam condensate heat from the power production process. The large size of the surface water sources guaranteed cold-water temperatures with almost no daily variation and usually very modest seasonal variation. However, in the early 1970's, new steam-electric power plants began using recirculated cooling water systems in the start of a trend that continues today. At that time, the use of cooling towers was seen as a potential conflict between national environmental and energy objectives. Therefore, several analyses were completed to calculate annual energy penalties for wet evaporative cooling towers. The results showed that the estimated annual energy penalties for towers designed for a 5% worst case scenario ranged from 0.1 to 1.4 percent in generating output for fossil-fuel plants operating at 70% capacity (Christianson, 1975). Subsequent experience with power plant cooling towers and optimization of the steam turbine-generator/cooling system combination have shown that the 1% worst-case scenario described earlier is a more cost-effective design basis and would ideally eliminate the energy penalty in a well maintained recirculated cooling system.



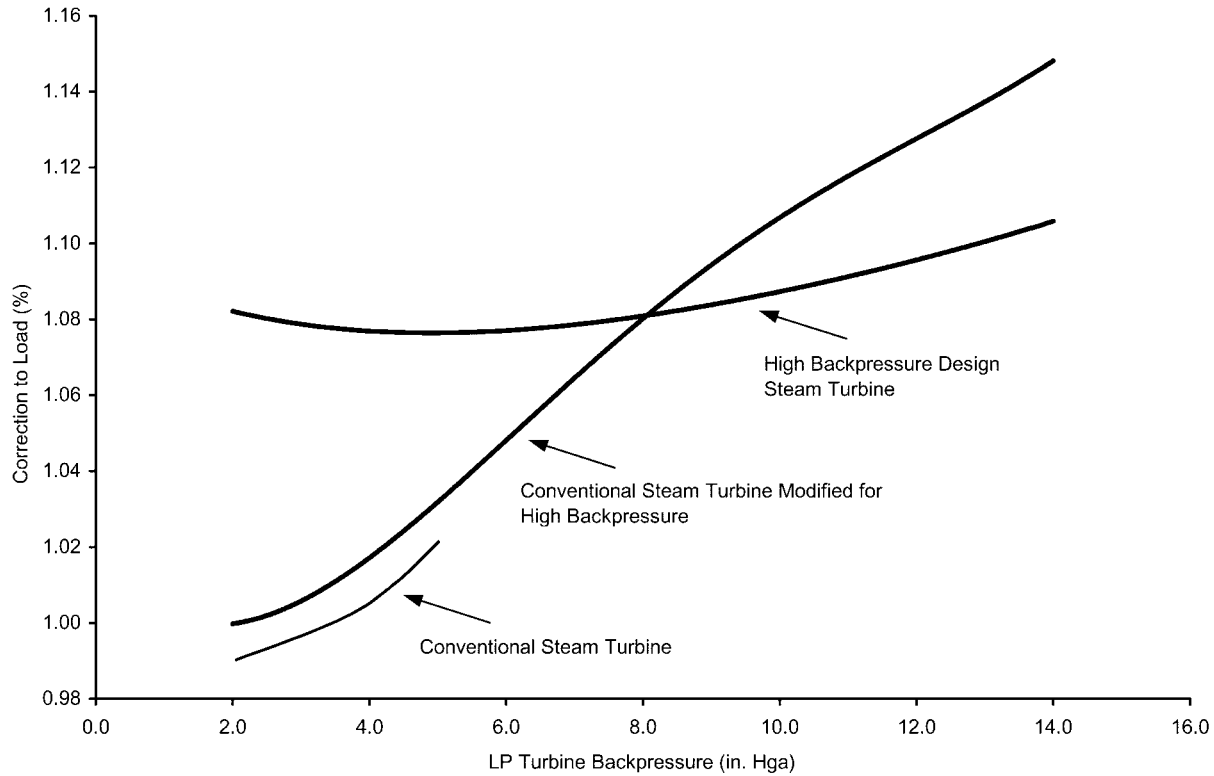
### Dry Cooling Systems

For direct dry cooling systems, the U.S. power plant experiential database is extremely small. Although some sources cite as many as 600 power plants using dry cooling systems worldwide, in the U.S. most dry cooling systems are associated with units that have generating capacities less than 100 MW. During the ten-year period 1990-1999, dry cooling was used at ten new U.S. power plants with a capacity greater than 50 MW; only one of these plants had a generating capacity greater than 200 MW. Hence, the actual opportunities for optimizing a steam turbine-generator/dry cooling system combination have been limited and any actual energy penalties encountered when using dry cooling systems operated over a range of environmental conditions are not well documented. But this lack of first-hand experience does not mean that reasonable and meaningful estimates of potential energy penalties cannot be calculated and used in the overall life cycle cost analysis for a new power plant. It simply means that great care must be taken in defining the values for critical parameters that influence potential energy penalties, and in consistently using these same values when estimating the installed equipment capital cost and the annual O&M cost to determine the overall plant economics.

As mentioned previously, dry cooling system performance depends upon ambient air dry-bulb temperatures, which can be fairly high ( $> 95$  °F) at the 1% design point for many parts of the U.S. For a conventional LP steam turbine-generator, any capability energy penalty can be eliminated by building an ACC large enough to provide adequate heat transfer area for the worst-case scenario. Then, the only potential energy penalty would be limited to about a 3% loss of efficiency experienced when the turbine backpressure rises to the 5.0 in. Hga level during extremely hot periods. The larger ACC is accomplished by selecting a very low ITD as part of the cooling system design (20 °F for the example presented in Table 1). Unfortunately, the capability energy penalty costs avoided with this approach are offset by a significantly higher installed equipment capital cost and a much greater O&M cost than would normally be the case for a more typical ITD design value (35-55 °F). The obvious dilemma is finding the design ITD for the optimum balance between estimated annual energy penalty costs and installed equipment capital costs. One recent study suggests the ideal design ITD may range from 37 to 49 °F, depending upon the market price for electrical power (EPRI, 2002). But for reasons that are discussed later, this study may not adequately account for all of the energy penalties in a manner necessary to support this conclusion.

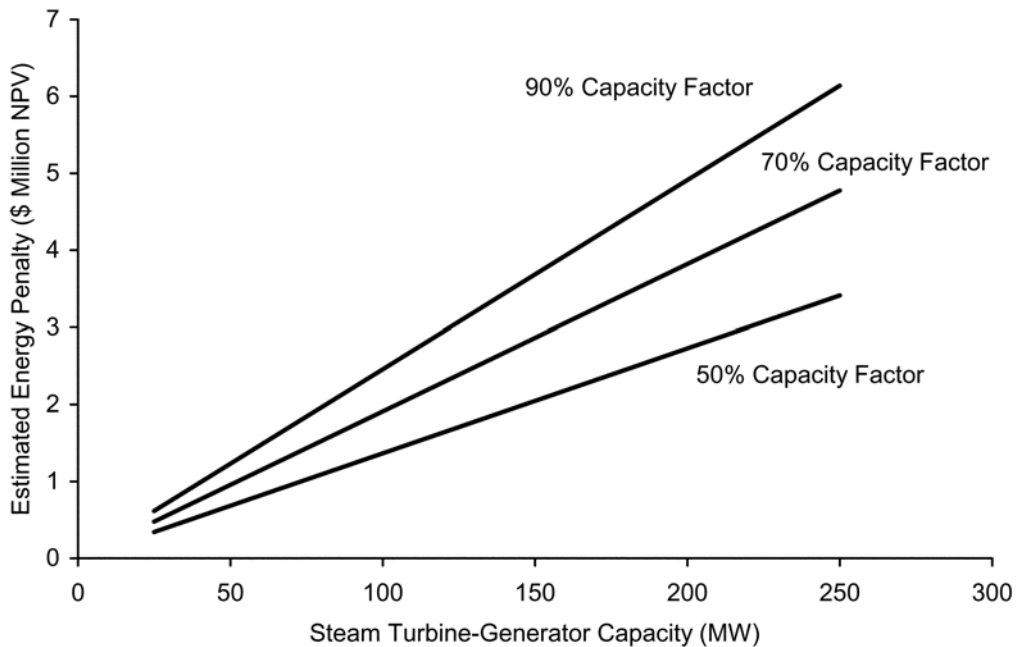
Another approach to eliminating any capability energy penalty is to replace the conventional LP steam turbine that has a maximum operating backpressure of 5.0-5.5 in. Hga with a turbine having a much higher backpressure limit. This could be done by modifying the existing conventional LP turbine designs or by developing an entirely new LP turbine (Rossie & Cecil, 1970). One suggested modification involved removing the last row of blades or the final stage and introducing steam downstream of the initial stage during periods of high ambient dry-bulb temperatures. In addition, the steam flow area of both the high pressure and intermediate-pressure turbines would be enlarged. A different modification would retain the last row of blades, but adjust the lengths and increase the structural strength of blades in the last several rows; no changes would be made to the high or intermediate-pressure turbines. In either case, these changes could increase the maximum operating backpressure limit to 12-14 in. Hga as shown in Figure 2. However, these changes would also reduce the modified LP turbine efficiency by approximately 1.0% relative to the conventional LP turbine when operating in the typical backpressure range of 2.0-5.0 in. Hga.

**Figure 2**  
 Estimated Load Correction for Different LP Steam Turbine-Generator Designs  
 (Rossie and Cecil, 1970 and EPRI, 1989)



The cost of a 1.0% efficiency energy penalty is not insignificant, especially when this penalty is unavoidable (i.e., is incurred whenever the LP steam turbine-generator operates). Depending upon the steam turbine generator design output, the unit capacity factor and the retail price of electricity, Figure 3 demonstrates that this energy penalty can be over \$6 million (net present value) for a 20-year period.

**Figure 3**  
 Estimated Energy Penalty Cost for Modified Conventional LP Steam Turbine-Generator  
 (Assumes 1% efficiency energy penalty, \$25/MW-hr, 5% discount rate, and 20-year time period)



At least one major steam turbine-generator manufacturer recognized the importance of the 1% energy penalty associated with proposed modifications to the conventional LP turbine design and studied other options to reduce this inherent loss of efficiency (Silvestri, 1981). The published results claimed that certain modifications to the last-stage blade tip geometry could increase the LP turbine maximum backpressure limit to as high as 8.0-12.0 in. Hga and produce a “higher efficiency than the predecessor conventional design”. But the resulting impacts on turbine-generator design capacity and installed capital cost were unclear and the commercial use of this design is unknown.

A more radical approach than modifying the existing conventional turbine would be the design of a completely new turbine. More than thirty years ago, one study suggested that by shortening the last-stage blades, strengthening all of the stages to pass more steam flow and extensively altering the exhaust structure, a turbine could be designed to operate at backpressures ranging from 2.0 to 14.0 in. Hga (Rossie and Cecil, 1970). While such a design might be 7-9% less efficient than a conventional low-pressure turbine over the low-end operating range (2.0-5.5 in. Hga), the efficiency would be relatively constant across the entire range of backpressures (see Figure 2). This type of turbine could favor systems specifically designed to operate at higher backpressures (> 8.0 in. Hga). So a complete economic analysis must consider not only the efficiency energy penalty, but also the tradeoff between larger steam supply systems and smaller cooling systems, and the corresponding installed equipment capital costs and annual O&M costs.

### **Special Considerations for Combined-Cycle Units**

Department of Energy projections indicate that new combined-cycle units will account for an additional 135 GW of generating capacity in the U.S. during the period 2000-2020. If correct, by 2020, combined-cycle units will represent a significant portion (16%) of the projected overall U.S. generating capacity, compared with only 2.6% in 1998 (EIA, 1999). The popularity of combined-cycle units can be attributed to a number of benefits, one of which is operating flexibility. In a deregulated market where the price of power fluctuates with consumer demand on an hourly basis, combined-cycle units have the ability to operate efficiently during periods of non-peak demand (providing low-cost power at times of competitive pricing) and to maximize capacity during periods of peak demand (providing abundant power at times of escalated pricing).

But this operating flexibility relies on a bottoming cycle (HRSG/steam turbine) that is always capable of utilizing the thermal energy available in the exhaust gases from the topping cycle (combustion turbines). When a cooling system cannot provide adequate heat rejection, then steam flow from the HRSG through the turbines to the condenser may need to be reduced. Since the exhaust gases from the combustion turbines must pass through the HRSG, a limit on the boiler's steam production would also make it necessary to reduce the flow and/or temperature of the exhaust gases by “trimming” operation of the combustion turbines. Through this domino effect, reduced cooling system performance can have capacity energy penalty implications for the steam and combustion turbines in a combined-cycle power plant.

The two most important factors contributing to this pair of capacity energy penalties are reduced cooling system performance and peak power demand. Unfortunately, both factors generally occur at the same time – during the warmest parts of the day and year. Even a marginal cooling system under most operating conditions (one performing close to, but without a capacity energy penalty) may fail to perform adequately when different power enhancement techniques are used to meet the temporary demand for more electricity production.

According to one study, most power enhancement opportunities in the combined-cycle process are associated with the combustion turbine-generator (Jones and Jacobs, 2000). While these performance enhancements (such as combustion turbine inlet air cooling, water or steam injection, and peak firing) are intended to increase power production from the topping cycle, they will also increase the combustion turbine exhaust energy, causing a corresponding increase in high-pressure steam production and steam turbine-generator performance. On the other hand, duct-firing within the HRSG is the only notable power enhancement option that is specific to the steam turbine-generator. But it can have a tremendous impact on peak power production. Depending on unit design and operating conditions, HRSG duct-firing

can increase high-pressure steam production by as much as 45% compared to the average design basis (assuming that operation of the LP steam turbine-generator is not limited by cooling system performance).

So, during periods of peak demand, it is quite possible that a cooling system capacity energy penalty may have two components: one for the LP steam turbine-generator and another for the combustion turbine generators. It is also likely that both of these two capacity energy penalty components can be further divided into two parts: one associated with the actual loss of power at standard operating conditions and another associated with the potential loss of power from various generation enhancement options. These are important considerations that can impose significant limitations on the operating flexibility expected with new combined-cycle plants and should not be overlooked when estimating energy penalties for these units.

**Calculating Energy Penalties**

Power plant cooling system energy penalties are generally calculated for one reason – to help determine the most cost-effective means for generating electricity. As previously stated, the potential for and the magnitude of an energy penalty can dictate cooling system design and operating changes that directly affect the plant capital and O&M costs. Hence, any effort to economically optimize and compare cooling system design alternatives must incorporate energy penalty estimates that are as meaningful and reliable as the corresponding capital and O&M cost estimates. This means that energy penalty calculations must:

1. Use the same assumptions and basis as the other options intended for comparison, and
2. Closely reflect anticipated operating conditions.

Although these two requirements seem simple and self-evident, they are frequently overlooked or disregarded, resulting in energy penalty estimates that are mistaken and/or misleading.

**Consistent Assumptions and Bases**

New power plants are usually designed in several phases, proceeding from fairly conceptual (maximum design flexibility) to very detailed (limited design flexibility). With each step in the process, the plant becomes more fully defined and the estimated costs (including energy penalties) become more accurate. Table 2 is a brief summary of how the design process progresses.

**Table 2**  
Typical Phases in Power Plant Design  
(adapted from Dysert, 2001)

Design Phase	Purpose	Project Definition (Percent Completion)	Estimate Accuracy (Variation in low and high range)
1	Screening	0-2	Lo: -20 to -50% / Hi: 30 to 100%
2	Feasibility	1-15	Lo: -15 to -30% / Hi: 20 to 50%
3	Budget Authorization or Cost Control	10-40	Lo: -10 to -20% / Hi: 10 to 30%
4	Bid Control or Tender	30-70	Lo: -5 to -15% / Hi: 5 to 20%
5	Check of Estimate, Bid or Tender	50-100	Lo: -3 to -10% / Hi: 3 to 15%

For comparing cooling system designs, it is critical that the underlying assumptions and bases be identical to avoid unfairly favoring or penalizing any particular design option. In the early design phases, the five key parameters are total unit generating capacity, LP steam turbine-generator capacity (or HRSG steam production), 1% worst-case environmental conditions (ambient wet-bulb and dry-bulb temperatures), access to adequate space (land) for wet or dry cooling tower structure, and the availability of water (for recirculated cooling systems). Note that the type of LP steam turbine-generator is not specified, only the required capacity. This means that energy penalty estimates for a wet recirculated cooling system could be based on the conventional LP steam turbine, while a dry cooling system could be evaluated with another LP turbine capable of operating at higher backpressures. Any differences in steam turbine size, construction and efficiency will be reflected in the resulting energy penalty estimates (as well as the

associated capital cost and O&M cost estimates). But for comparison purposes, both turbines should have the same maximum design power output. Otherwise, the bases for comparison are inherently unequal.

New combined-cycle units can complicate the process in the early design phases by introducing a variety of power enhancement options. Although this may increase the total number of energy penalty estimates that need to be calculated by changing the total unit generating capacity and the LP steam turbine-generator capacity from single-value to multi-value parameters, it does not change the need to maintain a uniform basis for comparison purposes.

### **Anticipated Operating Conditions**

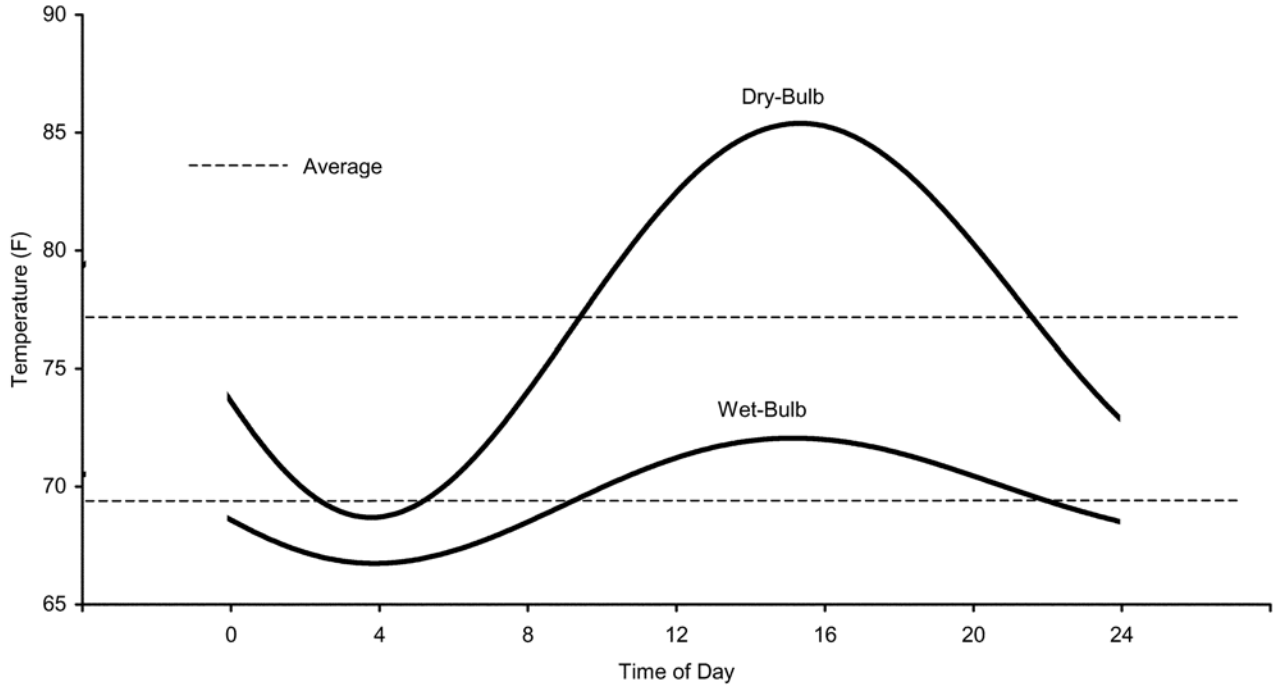
Energy penalty estimates should only be calculated by using the best available data for the anticipated operating conditions specific to the given site and equipment. Extrapolating from “similar” power plants for “similar” operating conditions is only suitable for developing a sense of which cooling system designs may merit consideration in an initial screening effort. As a basis for estimating energy penalties, this approach is completely impractical.

Even when abundant site-specific data are available, attempts to simplify the calculation can still produce erroneous energy penalty estimates. Using daily, weekly or monthly temperature averages in place of hourly values is the best example of this mistake. Figure 4 shows the daily variation in ambient wet-bulb and dry-bulb temperatures for Atlanta during the month of June. As expected, both temperature profiles have peaks that occur between 9:00 am and 10:00 pm, coinciding with the hottest times of the day and the periods of greatest power demand. The variation in dry-bulb temperature is about 17 °F (from 69 to 86 °F); at 5 °F (from 67 to 72 °F), the variation in wet-bulb temperature is considerably less. Frequently, energy penalty calculations are simplified by using a single daily average instead of summing a series of hourly values. But the daily-average approach dampens the effect of the diurnal temperature variations (more so for the dry-bulb temperature than the wet-bulb temperature). As a result, the daily-average approach may not account for capacity energy penalties that might occur briefly during the hottest times of the day, substantially understating the true energy penalty.

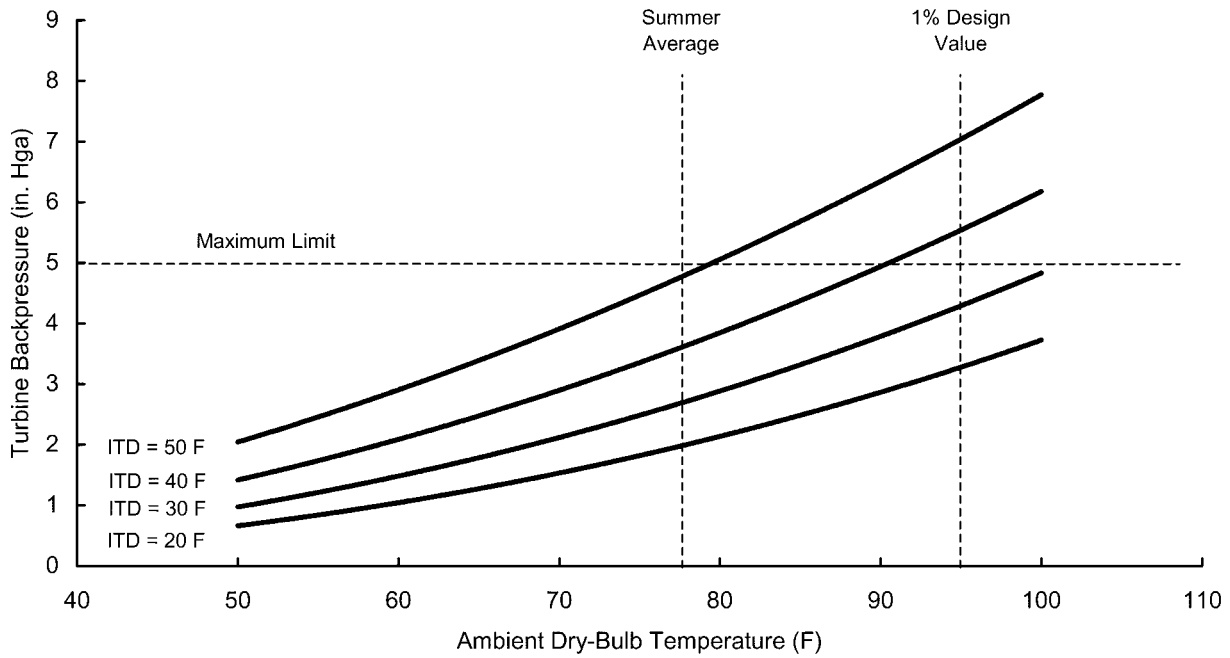
Continuing with the example presented earlier in Table 1 and Figure 4, Figure 5 shows the change in backpressure for a conventional LP steam turbine as a function of ambient dry-bulb temperature for four different ACC designs (ITD values). For an ITD of 50 °F and the average daily dry-bulb temperature for Atlanta during the summer (77.3 °F), the corresponding backpressure for a conventional LP steam turbine would be 4.75 in. Hga. Assuming a maximum backpressure limit of 5.0 in. Hga (including a slight operating margin), estimates based on the average daily dry-bulb temperature would predict an average daily efficiency energy penalty of about 1.83% (see Figure 1) and no capacity energy penalty. However, this would be incorrect because at certain times of the day (10:30 am to 8:30 pm) the average hourly ambient dry-bulb temperatures are high enough (> 78.5 °F) to produce a turbine backpressure greater than the 5.0 in Hga operating limit. So using an average daily temperature completely misses the ten-hour capacity energy penalty that would be identified if average hourly temperatures were used instead. Table 3 shows that using hourly temperature data more accurately reflects both efficiency and capacity energy penalties.

Table 3 also shows that using time-dependent power price data is equally important in calculating energy penalty costs. Since the retail price for electric power increases with consumer demand, and both consumer demand and energy penalties follow similar trends, any calculation that minimizes the effect of these dual peaks will significantly underestimate the actual energy penalty costs. For example, in Table 3, a daily variation in the retail price for electric power generated during the summer has been assumed to range from \$25/MW-hr to \$175/MW-hr. Normalized over the entire 24-hr day, the average daily retail power price would be \$68.75/MW-hr. So, using the average daily efficiency energy penalty (1.83%) based on the average daily dry-bulb temperature (77.3 °F), the total average energy penalty cost for a 100-MW unit could be estimated as low as \$126/day. Repeating the same calculation with a “normalized” daily energy penalty (5.18%) based on the contributions of individual hourly efficiency and capacity energy penalties, increases the energy penalty cost estimate for a 100-MW unit to \$356/day. However, using the hourly energy penalties and the corresponding hourly power prices, the estimated energy penalty cost for a 100-MW unit jumps to \$15,495/day, more than 120 times the amount estimated by using daily averages for the dry-bulb temperature and the retail price of power.

**Figure 4**  
 Typical Variation in Ambient Dry-Bulb and Wet-Bulb Temperatures (June in Atlanta, GA)  
 (Albright, 1939)



**Figure 5**  
 Ambient Dry-Bulb Temperature vs Turbine Backpressure



**TABLE 3**  
 Estimated Energy Penalties and Associated Costs for Dry Cooling System  
 (Assumes typical dry-bulb temperatures for Atlanta, GA in June, ACC ITD = 50°F, and a conventional LP steam turbine with maximum backpressure limit of 5.0 in. Hga)

Time of Day	Dry-bulb Temperature (°F)	LP Turbine Backpressure (in. Hga)	Efficiency Energy Penalty (%)	Capacity Energy Penalty (%)	Retail Power Price (\$/MW-hr)	Daily Energy Penalty Cost (\$/100 MW)
Midnight	73.70	4.33	1.15		25	29
1:00	71.50	4.10	0.83		25	21
2:00	69.80	3.90	0.55		25	14
3:00	68.80	3.80	0.42		25	11
4:00	68.75	3.80	0.42		25	11
5:00	69.30	3.85	0.47		25	12
6:00	70.40	3.95	0.62		25	16
7:00	72.00	4.13	0.83		25	21
8:00	74.00	4.35	1.20		25	30
9:00	76.30	4.60	1.57		50	79
10:00	78.50	5.00	2.20		75	165
11:00	80.70	5.10	2.20	1.74	100	390
Noon	82.50	5.35	2.20	6.30	125	1,046
1:00	84.00	5.55	2.20	10.26	150	1,836
2:00	84.90	5.70	2.20	13.38	175	2,676
3:00	85.40	5.75	2.20	14.52	175	2,871
4:00	85.20	5.75	2.20	14.45	150	2,450
5:00	84.70	5.68	2.20	12.93	125	1,856
6:00	83.60	5.50	2.20	9.24	100	1,124
7:00	82.00	5.30	2.20	5.32	75	555
8:00	80.30	5.07	2.20	1.20	50	169
9:00	78.20	4.83	1.90		25	47
10:00	76.30	4.60	1.57		25	39
11:00	74.50	4.40	1.25		25	31
						<u>15,495</u>

While the results summarized in Table 3 demonstrate the critical importance of using hourly data to calculate both the energy penalties and the associated costs, they are still subject to some limitations that may cause estimates to be understated. For instance the 1% dry-bulb design value is 95 °F, approximately 10 °F greater than the highest average hourly summer temperature. While this 95 °F value is reached only a very limited time, all actual temperatures in the 10-degree range between 85 °F and 95 °F would never be accounted for by using average hourly values as done in Table 3. Not including the capacity losses associated with these higher temperatures would mean a much lower estimated energy penalty cost than would actually occur. As shown in Table 3, most of the energy penalty costs are associated with capacity losses during times of high ambient dry-bulb temperatures and high retail power prices.

**Conclusions**

For new plant construction in a deregulated power market, meaningful energy penalty estimates are an essential element in economically optimizing and comparing possible cooling system design alternatives. The electric utility industry’s extensive history with wet recirculated cooling systems (i.e., cooling towers) suggests that energy penalties can be cost-effectively minimized, if not eliminated, by designing for the 1% worst-case environmental conditions. However, this is almost certainly not the case when considering dry cooling systems (i.e., air-cooled condensers or ACCs), which have greater performance sensitivity to ambient conditions. Designing dry cooling systems for the 1% worst-case scenario would result in enormous, cost-prohibitive installations. But relying on smaller dry cooling systems would lead to substantial energy penalties, particularly during the hottest times of the year when consumer demand and power prices are greatest.

The performance issues and associated energy penalties for dry cooling systems can be addressed in several ways. One approach involves replacement of the conventional low-pressure steam turbine-generator with one that has either been modified or completely redesigned to operate at higher backpressure limits. Other approaches (not discussed in

this paper) include conditioning (i.e., cooling) of the inlet air to the dry cooling tower or combining wet and dry towers in a hybrid wet/dry system sometimes referred to as a parallel condensing system (Akhtar, 2000). Choosing among these options means fairly evaluating all of the life cycle costs, including the energy penalties.

When calculating energy penalties, it is important that all cooling system options intended for comparison: 1) use the same assumptions and basis, and 2) reflect actual (not average) site-specific operating conditions. In addition, for a combined-cycle unit, estimates should not ignore the energy penalties that might occur when power enhancement options cannot be implemented in either the topping or bottoming cycle during periods of peak demand because of cooling system performance limitations.

The economics of deregulation have placed a renewed emphasis on low-cost performance during periods of non-peak demand and unit availability during periods of peak demand. Well designed and operated cooling systems that avoid efficiency energy penalties during periods of non-peak demand and/or capability energy penalties during periods of peak demand can provide a significant cost advantage in a competitive generating market. Therefore, the successful utility will recognize that energy penalties are an important part of the life cycle economic optimization that should be completed for new power plants.

### References

Akhtar, S.Z., October 2000. "Parallel Condensing Systems Getting Fresh Look", *Power Engineering*, Vol. 104, No. 1, pp. 63-68.

Albright, J.C., 1939. *Summer Weather Data*, First Edition, the Marley Company, Kansas City, KS.

Christianson, A.G., and B.A. Tichenor, 1975. "Energy Penalties – Wet Closed-Cycle Cooling" in Cooling Towers Volume 2, a CEP technical manual published by the American Institute of Chemical Engineers, New York, NY, pp 1-5.

Dysert, Larry, October 2001. "Sharpen Your Capital-Cost Estimation Skills", *Chemical Engineering*, Vol. 108, No. 5, pp. 70-81.

Electric Power Research Institute, March 1989. "Survey of Water-Conserving Heat Rejection Systems", GS-2652, EPRI, Palo Alto, CA.

Electric Power Research Institute, June 2001. "Comparison of Alternative Cooling Technologies for California Applications", EPRI, Palo Alto, CA.

Energy Information Administration, December 1999. "Annual Energy Outlook 2000 With Projections to 2020", Report DOE/EIA-0383 (2000), U.S. Department of Energy, Office of Integrated Analysis and Forecasting, Washington, DC.

Jones, C., and J.A. Jacobs, III, October 2000. "Economic and Technical Considerations for Combined-Cycle Performance Enhancement Options", GER-4200, GE Power Systems, Schenectady, NY.

Rossie, J.P., and E.A. Cecil, November 1970. "Research on Dry-Type Cooling Towers for Thermal Electric Generation: Part I", Water Quality Office of the United States Environmental Protection Agency, Project # 16130 EES, Contract # 14-12-823, FWQA R&D Report # 16130EES11/70.

Silvestri, G.J., August 1981. "High Efficiency and High Turbine Exhaust Pressure: Now You Can Have Both", *Power Engineering*, Vol. 85, No. 8, pp. 66-69.



*A Tool for Budgetary Estimation of Cooling Towers Unit Costs Based on Flow*  
Faysal Bekdash and Michael Moe, SAIC

**BIOSKETCHES**

Dr. Faysal Bekdash is a section manager and senior engineer at Science Applications International Corporation (SAIC). Dr. Bekdash has a Ph.D. from University of Maryland, College Park, Diplôme de Spécialisation Post-Universitaire, from IAM, Italy, Diploma of Ingénieur Agricole, AUB, and B.Sc. from AUB. Dr. Bekdash has 22 years of extensive experience in development projects. He served as a juror on the Army Corps of Engineers Chief of Engineers Design and Environmental Award Program for the year 2002. He served on DOE and NOAA research proposals review panels (2002) (Bioremediation and Biotechnology). Co-author of a white paper submitted to DOE (2002) on research needs in the area of water use by power plants. The U.S. Environmental Protection Agency (EPA) Office of Water presented him with the Tribute of Appreciation award in 1991. Dr. Bekdash is a lead technical-person in charge of evaluating and costing standard and emerging technologies in areas related to power plants and water/wastewater treatment plants. He is the work assignment manager (WAM) for SPARRC (Software to Ascertain Radionuclides Residuals Concentrations). He served as an expert witness, for the State of California, on wastewater treatment compliance costs and technologies= efficacy and feasibility. He served as an instructor, for a course on hazardous waste and hazardous material management (in Italian) to local personnel at Camp Darby base (US army, Italy). Dr. Bekdash has national and international experiences in development projects. As a consultant to SAIC, he provided technical support for two forecast energy-related economic studies (the Middle East and beyond and the ex-Soviet central Asian States plus Iran). The studies looked into the feasibility of various regional development scenarios, available and needed resources, political systems, points of conflict and resolution mechanisms.

Mr. Michael Moe is a senior engineer and project manager with the Environmental and Health Sciences Group of Science Applications International Corporation (SAIC). Mr. Moe received his B.S. in Chemical Engineering from Rice University and his M.S. in Chemical Engineering from the University of Texas at Austin. He set up and ran an analytical laboratory for four years at Wilson Oxygen & Supply Co. in Austin, Texas. He then joined the Oklahoma Department of Environmental Quality, where he worked in the Industrial NPDES Permit Unit for six-and-a-half years, the last two of which he served as Permit Unit Supervisor. His responsibilities included overseeing the drafting and issuance of industrial discharge permits, as well as maintaining and updating the State's Continuing Planning Process document, which addressed the State's procedures for watershed management. For the last four years at SAIC, Mr. Moe has led SAIC's support to EPA for development of NPDES permits and NPDES regulations for cooling water intake structures and for concentrated animal feeding operations (CAFOs).

**TECHNICAL PAPER**

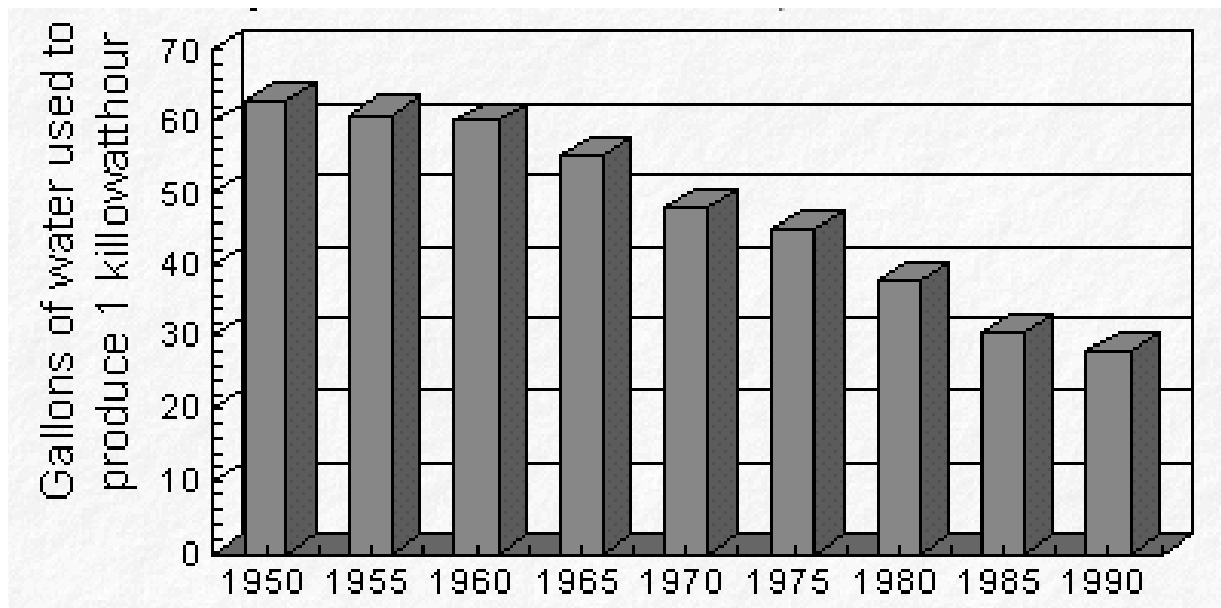
**Abstract**

A parametric model for estimating cooling tower costs was developed based on recirculating cooling water flow (\$/gpm or \$/L/min). Given the complexity and diversity of cooling towers, a parametric model based on flow appears to be the most practical method for developing budgetary unit cost estimates. Estimating costs of various environmental regulations at the unit technology level can be very challenging for engineers. Cooling tower costs are so site-specific that cost estimates for an individual facility or a few specific facilities would not be appropriate for developing budgetary or regulatory estimates on a national basis. Therefore, the cost estimator has to develop unit costs that are representative of costs that might be incurred by power plants and other industries across the different regions of the United States. The new cost model is applicable for budgetary and compliance purposes and should not be used as a pricing tool for a specific site. This paper presents the method used in the development and the validation of the parametric model. It also presents ideas for research in areas of reducing dependency on water as a medium for cooling in power plants and other industries.

**Introduction**

Electrical power generation from fossil fuels, especially from coal, is dependent on the use of water and represents one of the largest uses of water in the United States. On average, approximately 28-33 gallons of water are required for each kilowatt-hour (kWh) of power produced from coal. To produce power (excluding hydroelectric power), about 70 trillion gallons of water are consumed or impacted annually in the United States (USGS 2000).

Figure 1 shows the trend in the amount of water used to produce 1 kWh of thermoelectric power since 1950. The figure illustrates that less water is used today to produce more electricity. For example, in 1950 it took about 63 gallons of water to produce 1 kWh of electricity. By 1990, this number had dropped to about 28 gallons per kWh. Thus, in the last 50 years there has been a more than 50% reduction in the water requirement per unit power production. This reduced water requirement is due in part to the increased use of cooling towers. Factors such as regulatory and technological issues related to intake and disposal of water and increasing concern about the availability of clean water will contribute to increasing use of cooling towers in electrical power generation into the future. Thus, there is a need for a robust model for developing budgetary and regulatory cooling tower cost estimates at the regional and national level. This paper describes the development and validation of such a model.



**Figure 1.** Amount of Water Used to Produce Thermoelectric Power in United States, 1950-1990. Source: <http://www.wga.usgs.gov/edu/graphics/htmjl/ptratioyears.html>.

#### **Indirect Engineering-Based Cost Method (Parametric Method)**

To develop budgetary and regulatory cooling tower cost estimates at the regional and national level, the Indirect Engineering-Based Cost Method (Parametric Method) was used. As the name implies, these types of estimates are based on certain parameters that reflect the size and scope of a project. Such cost models are constructed based on a given set of relations and operators that connects a technology with defined specifications to a cost assumed to represent the national average. The sources and basis for costing in these models vary from textbooks, peer-reviewed and gray literature, vendors and manufacturers' quotes, results of some surveys, to best professional judgment. Costing models have a large number of variables, parameters and approximations. Therefore, a model user needs to keep in mind that parameters are nothing but a lump sum of known and unknown factors that may change because of the changing nature of the technology, including regulatory, engineering, and construction environments.

Parametric estimates are relatively quick to develop and are usually more accurate than order of magnitude costs because the project can be broken down into more detail. In this type of estimate, specific technology design characteristics (such as flow, square footage, unit of power, pressure requirement, etc.) and major cost components are assumed or determined. Based on these design parameters, cost curves or cost equations are used to estimate the cost of the project or cost of major components. The cost curves or cost equations are based on the collection of similar projects and the combination of several available cost data. There are various levels of cost detail associated with the curves, depending on available data. To obtain the total cost, the individual costs from the cost curves or cost

equations are added. Percentage multipliers or cost factors may then be added or applied to account for indirect and overhead costs. A widely used parametric costing method is the building cost per square foot estimation method.

The indirect engineering-based cost method (parametric method) best fits the purpose of developing a quick budgetary cost estimate for a cooling tower unit. The parametric model is easy to use, does not require many input variables and does not consume as much time, effort and resources as the other methods.

### **Use of Cooling Towers in Industry**

Facilities (e.g., steam electric power generation facilities, chemical and allied products manufacturers, pulp and paper plants) using cooling water can have either once-through or recirculating cooling systems. In a once-through system, the cooling water that is drawn in from a waterbody travels through the cooling system once to provide cooling and is then discharged, typically back to the waterbody from which it was withdrawn. In a recirculating system, the cooling water is used to cool equipment and steam. The cooling water absorbs process heat, then gets cooled (generally in either a cooling tower or a cooling lake/pond), after which it is recirculated to the beginning of the system to be used again for cooling. Cooling towers are the most common type of recirculating systems.

There are two general types of cooling towers, wet and dry. Wet cooling tower systems, which are the far more common type, use cooling water to absorb heat from the steam in a condenser. The cooling water, now warm from the heat exchange in the condenser, then flows to the cooling tower where heat is transferred to the atmosphere. Part of the cooling water evaporates through this process, thereby having a cooling effect on the rest of the water. This water then exits the cooling tower at a temperature approaching the wet bulb temperature of the air, and is recirculated to the condenser (recirculating tower) or discharged (helper tower). Wet cooling towers consume about 5 percent of the flow used by comparable once-through systems. The 5-percent consumed water is lost to evaporation, drift and blowdown.

For dry cooling towers, air going through the tower flows along the outside of the pipe walls and absorbs heat from the pipe walls, which absorb heat from the steam in the pipes and cause the steam to condense. Dry cooling towers tend to be much larger and more costly than wet towers, since the dry cooling process is less efficient. The temperature of the condensate is warmer than the condensate of a comparable wet tower since it only approaches the dry bulb temperature of the air (not the cooler wet bulb temperature). Dry cooling systems consume practically no water in the cooling process. However, the plant will still need a water source for the boiler make-up water and to satisfy other water service needs, such as jet cleaning the fins of the dry cooling tower that can easily get clogged with insects.

Hybrid wet-dry towers, which combine dry heat exchange surfaces with standard wet cooling towers, are plume abatement towers. These towers tend to be used most where local authorities require plume abatement. Technologies for achieving low noise and low drift can be fitted to all types of towers.

Typically, the capital cost of the cooling tower project is determined based on many factors. These factors include type of equipment to be cooled (e.g., coal-fired equipment, oil or natural gas-powered equipment), location of the water intake (on a river, lake, or seashore), amount of power to be generated (e.g., 50 Megawatt vs. 200 Megawatt), and volume of water needed. The volume of water needed for cooling depends on many critical parameters, such as make of equipment to be used (e.g., GE turbine vs. ABB turbine, turbine with heat recovery system and turbine without heat recovery system), water temperature, discharge permit limits, and water quality (particularly for wet cooling towers). Finally, the capital cost of a wet cooling tower is driven by the type of tower (i.e., whether it is natural draft or mechanical draft) and construction material (e.g., wood, concrete, steel or fiberglass).

To estimate costs specifically for installing and operating a particular cooling tower, important factors include:

- ▶ Condenser heat load and wet bulb temperature (or approach to wet bulb temperature): Largely determine the size of tower needed. For example, the size of a cooling tower with an approach of 7°F is larger, by a

factor of two, than the size of a cooling tower with a 15°F approach (Marley, 1985). Size is also affected by climate conditions.

- ▶ Plant fuel type and age/efficiency: Condenser discharge heat load per Megawatt varies greatly by plant type. Nuclear thermal efficiency is about 33 to 35 percent, while newer oil-fired plants can have nearly 40-percent thermal efficiency, and newer coal-fired plants can have nearly 38-percent thermal efficiency; combined cycle plant efficiency can be as high as 60 percent.<sup>1</sup> Older plants typically have lower thermal efficiency than new plants.
- ▶ Topography: May affect tower height and/or shape, and may increase construction costs due to subsurface conditions. For example, sites requiring significant blasting, use of piles or a remote tower location will typically have greater installation/ construction cost. The presence of existing structures at a site may also affect tower size, shape and location.
- ▶ Material used for tower construction: Wood towers tend to be the least expensive, followed by fiberglass-reinforced plastic, steel, and concrete. However, some industry sources claim that Redwood cooling tower capital costs might be much higher compared to other wood cooling towers, particularly in the Northwest U.S., because Redwood trees are a protected species. Factors that affect the material used include chemical and mineral composition of the cooling water, cost, aesthetics, and local/regional availability of materials. There is also somewhat of a trade-off between capital and O&M costs. Table 1 shows relative trends in capital, operation, and maintenance costs for cooling towers by construction material type. On the maintenance side fiberglass cooling towers require less maintenance than other types of cooling towers. In addition to the cost driver factors listed here, the selection of which type of cooling tower is suitable for a particular site depends to a great extent on available water quality.
- ▶ Pollution control requirements: Air pollution control facilities require electricity to operate. Local requirements to control drift, plume, fog, and noise and to consider aesthetics can also increase costs for a given site (e.g., different design specifications may be required).

**Table 1.** Relative Trends in Capital, Operation, and Maintenance Costs for Cooling Towers by Construction Material Type

Capital	Operation	Maintenance	Useful Life (Yrs)	Cost Increase
Concrete	Douglas Fir	Douglas Fir	30 (Douglas Fir)	↑
Steel	Redwood	Redwood	40 (Redwood)	
Redwood	Steel	Steel	17 (Steel)	
Fiberglass	Fiberglass	Concrete	50 (Concrete)	
Douglas Fir	Concrete	Fiberglass	30 (RFG)	

**Model Development**

In the first step, we contacted two cooling tower industry managers with extensive experience in selling and installing cooling towers to power plants and manufacturing industries. These experienced managers provided information on how they estimate budget capital costs associated with wet cooling towers. The rule of thumb they use is about \$8/L/min (\$30/gpm) for an approach delta of 10 °F<sup>2</sup> and \$13.2/L/min (\$50/gpm) for an approach delta of 5 °F. For purposes of model development, the 10 °F approach delta rule of thumb was used, since 10 °F represents a median delta value for recently installed cooling towers at a variety of geographic locations and plant sizes. The 10 °F approach value was validated using data on more than 40 cooling towers constructed in the US between 1997 and 2000 (Mirsky 2001). The data showed that the mode and the median were 10 °F while the average was 10.4 °F. (We

<sup>1</sup>With a 33-percent efficiency, one-third of the heat is converted to electric energy and two-thirds goes to waste heat in the cooling water and the atmosphere.

<sup>2</sup>The approach delta is the difference between the cold water (tower effluent) temperature and the tower wet bulb temperature. This is also referred to as the design approach. For example, at design conditions with a delta or design approach of 5 degrees, the tower effluent would be 5 degrees warmer than the wet bulb temperature. A smaller delta (or lower tower effluent temperature) requires a larger cooling tower to transfer and dissipate the heat, and thus is more expensive.

investigated the use of MW as a parameter for costing cooling towers and found, based on the available data, that a correlation between the nameplate MW or MW produced and cooling tower costs could not be established.) As stated above the smaller the approach delta, the larger the size of the needed cooling tower. Therefore, for a tower with lower approach delta the cost of the tower is expected to be higher than the base tower (10°F approach) cost.

This unit cost is for a small tower (flow less than 37.854 m<sup>3</sup>/min or 10,000 gpm) and equipment associated with the basic tower, and does not include installation. Above 37.854 m<sup>3</sup>/min (10,000 gpm), to account for economy of scale, the unit cost was lowered by \$1.32/L/min (\$5/gpm) over the flow range up to 772.22 m<sup>3</sup>/min (204,000 gpm). For flows greater than 772.22 m<sup>3</sup>/min or 204,000 gpm, a facility may either deploy additional towers or a custom design with little or no savings due to economy of scale.

The next step in developing the cost model was combining the size factor with the variability in costs among various cooling tower types and features. Table 2 presents relative capital and operation cost factors for various cooling tower types and features in comparison to the conventional, basic Douglas Fir cooling tower as a standard.

**Table 2.** Relative Cost Factors for Various Cooling Tower Types and Features<sup>1</sup>

Tower Type	Capital Cost Factor (%)	Operation Cost Factor (%)
Douglas Fir	100	100
Redwood	112 <sup>2</sup>	100
Concrete	140	90
Steel	135	98
Fiberglass Reinforced Plastic	110	98
Splash Fill	120	150
Non-Fouling Film Fill	110	102
Mechanical draft	100	100
Natural draft (concrete)	175	35
Hybrid [Plume abatement [32DBT]]	250-300	125-150
Dry/wet	375	175
Air condenser (steel)	250-325	175-225
Noise reduction (10dBA)	130	107

Sources: Mirsky et al. (1992), Mirsky and Bauthier (1997), and Mirsky (2000).

<sup>1</sup>Percent estimates are relative to the Douglas Fir cooling tower.

<sup>2</sup>Redwood cooling tower costs may be higher because redwood trees are a protected species, particularly in the Northwest.

Using the cost factors in Table 2, the capital costs of cooling towers constructed of various materials and with various additional features were calculated for flows ranging between 37.854 m<sup>3</sup>/min (10,000 gpm) and 772.22 m<sup>3</sup>/min (204,000gpm).

The resulting capital costs include costs for all installation components, such as site preparation and clearing, support foundation, electrical wiring and controls, basin and sump, circulating piping, blowdown water treatment system, and recirculating pump and housing costs. These costs do not include make-up and blowdown piping, intake pumps, intake structure and screening technologies.

To account for the auxiliary costs of installing the cooling tower system, we obtained estimates from industry representatives for installation costs as an inflation percentage of the equipment costs. Based on discussions with industry representatives, installation costs were estimated as 80 percent of cooling tower equipment costs, which the industry representatives described as the average installation inflation factor.

Using the resulting calculated capital costs, best-fit curves and equations were developed. Figure 2 provides cost curves and equations for the capital costs of basic cooling towers with various construction materials. Figure 3 provides cost curves and equations for the capital costs of fiberglass towers with various features. Similar cost curves

and equations were developed for towers constructed of other materials and with various features. All costs are in 1999 dollars.

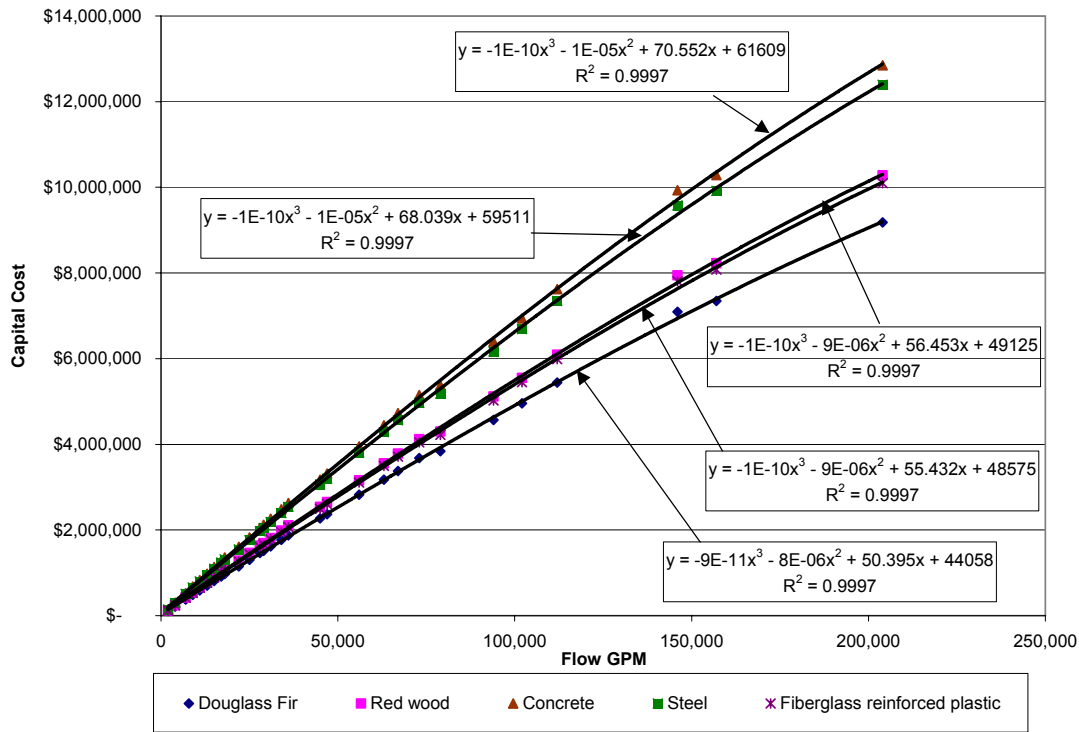


Figure 2. Capital Costs of Basic Cooling Towers with Various Construction Materials (Approach 10 Degrees)

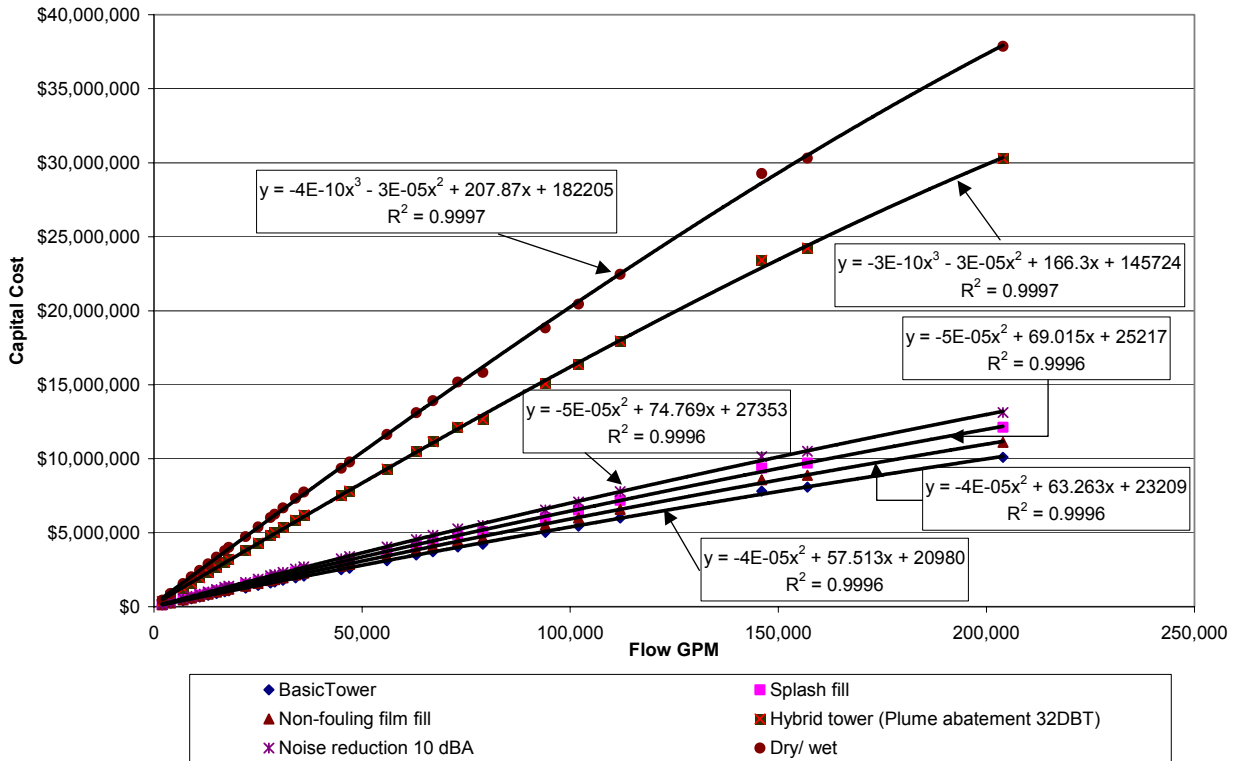


Figure 3. Capital Costs for Fiberglass Cooling Tower with Various Features (Approach Delta 10 Degrees)

As stated above, the cost estimates developed for various cooling towers are for budgetary estimates and are intended to represent a typical average cost estimate. The cost estimates should not be used as a project-pricing tool as they cannot account for all the site-specific conditions for a particular project. There are some especially site-specific costs associated with the construction of cooling towers and water intake structures that represent potential additional expenditures a facility may incur to get a technology in place and operational. These costs can be considerable in some cases and in such cases, they need to be added to cost estimates. These potential site-specific costs<sup>3</sup> include:

- ▶ Permits
- ▶ Pilot studies
- ▶ Land acquisition
- ▶ Interest
- ▶ Legal, fiscal, and administrative expenses
- ▶ Sales tax, and
- ▶ Geotechnical conditions

However, the parametric model cost estimates can be used for budgetary estimates once these site-specific conditions are accounted for.

### **Model Validation**

To validate the developed parametric model cost estimates, we compared the costs predicted by the model to information obtained from vendors regarding actual project costs and project bid prices for the construction of both wet and dry cooling towers. In some cases, the project costs did not include certain components such as pumps or basins. Where this was the case, we adjusted the project costs as follows:

- ▶ Where project costs did not include pumps, we added, based on preliminary cost estimates of large flows pumping installations, \$10/gpm to the project costs to account for pumps (USEPA, 2000).
- ▶ Where project costs did not include pumps and basins, based on discussions with cooling towers manufacturers, we doubled the project costs to account for pumps and basins.

Table 3 (wet cooling towers) and Table 4 (dry cooling towers) compare these project cost data with the comparable estimates that would be obtained using the developed parametric model cost curves. Figure 4 (wet cooling towers) and Figure 5 (dry cooling towers) present the developed parametric cost curves and equations and actual projects costs, with 25 percent error bars around the cost curve predicted values. These tables and figures show that, in almost all cases, the model cost curves provide conservative cost estimates (erring on the high side). This holds true even for projects with unusual site-specific factors that increased project costs (e.g., custom-built towers, difficult construction conditions, accelerated schedules).

For wet cooling towers, the model cost curves are almost always within 25 percent of actual project costs. In those few cases where the cost curve predictions are not within 25 percent of the actual costs, the difference can generally be attributed to the fact that the constructed cooling towers were designed for temperature deltas different than the 10 °F use in the parametric model. For dry cooling towers, the model cost curves are almost always greater than 25 percent higher than the actual costs, indicating that the parametric model may be overly conservative for dry cooling towers.

---

<sup>3</sup>Because these costs are so site-specific, an individual cost estimate of one site should not be used as a yardstick to estimate the costs of other towers across the nation. In addition, costs do vary substantially by region. For example, weighted unit cost averages for 689 cities range from 0.653 to 1.352, with a 30-city average index of 1.0 (R.S. Means, 1997). City indices are available on the Internet on various sites and provide a tool for adjusting estimated costs to be more reflective of potential costs in specific geographic locations.

Adjusting the cost model to reflect regional cost factors, or the year 2003 can be easily done using city indices and Construction Cost index. Such adjustments for budgetary estimation purposes may become necessary when the state of the economy changes drastically (inflation or deflation for few consecutive years) and costs of material, labor and services exceed or fall short of the  $\pm 25\%$  allowed margin of cost estimate error.

**Table 3.** Comparison of Actual Wet Cooling Towers Project Costs and Comparable Estimates Based on the Parametric Model

Description	Circulating Cooling Water Flow (gpm)	Project Cost (1999 \$)	Adjusted Project Cost (1999 \$)/gpm	Comparable Cost Estimate Based on Model (1999 \$)
Douglas Fir tower built by Marley Cooling Tower Co. in Arizona (with range of 19 °F and approach of 12.4 °F)	42,000	\$608,350 (\$15/gpm)	\$ 29	\$2.89 million (\$69/gpm)
Douglas Fir tower built by Marley Cooling Tower Co. in Virginia (with range of 19 °F and approach of 8 °F)	55,000	\$1.3 million (\$24/gpm)	\$ 47	\$3.74 million (\$68/gpm)
Fiberglass tower built by Marley Cooling Tower Co. in Alabama (with range of 13.2 °F and approach of 10 °F)	85,000	\$3.3 million (\$39/gpm)	\$ 78	\$5.64 million (\$66/gpm)
Douglas Fir tower built by Marley Cooling Tower Co. in Virginia (with range of 21 °F and approach 10 °F)	110,000	\$2.55 million (\$23/gpm)	\$ 46	\$7.15 million (\$65/gpm)
Custom-made (built onsite) redwood/fiberglass tower built by American Thermal Design, Inc.	112,000	\$6 million (\$54/gpm)	\$ 54	\$7.27 million (\$65/gpm)
Douglas Fir tower built by Marley Cooling Tower Co. in Missouri (with range of 25 °F and approach of 14.8 °F)	123,000	\$1.5 million (\$12/gpm)	\$ 24	\$7.91 million (\$64/gpm)
Redwood tower built by American Thermal Design, Inc.	132,000	\$8.5 million (\$64/gpm)	\$ 64	\$8.43 million (\$64/gpm)
750 MW capacity fiberglass tower built by Burger & Associates (with range of 24 °F and approach of 8.4 °F)	156,200	\$4 million (\$26/gpm)	\$ 51	\$9.78 million (\$63/gpm)
Douglas Fir tower built by Marley Cooling Tower Co. in Nevada (with range of 15 °F and approach of 8 °F)	169,100	\$2.7 million (\$16/gpm)	\$ 32	\$10.48 million (\$62/gpm)
Rebuild of tower with range of 21 °F and approach of 19.5 °F by Marley Cooling Tower Co.	630,000	\$28 million (\$44/gpm)	\$ 54	\$37.92 million (\$60/gpm)
Helper tower retrofit for nuclear power plant built by Marley Cooling Tower Co. <sup>1</sup>	630,400	\$36 million (\$57/gpm)	\$ 57	\$37.95 million (\$60/gpm)

<sup>1</sup>Cost is for a turnkey job that includes the construction of an intake structure carved in bedrock and an intake pumping station (Marley estimates the cost of both items at \$24 million), all completed in a 6-month period.



**Table 4.** Comparison of Actual Dry Cooling Tower Project Costs and Comparable Estimates Developed Using the Parametric Cost Mode

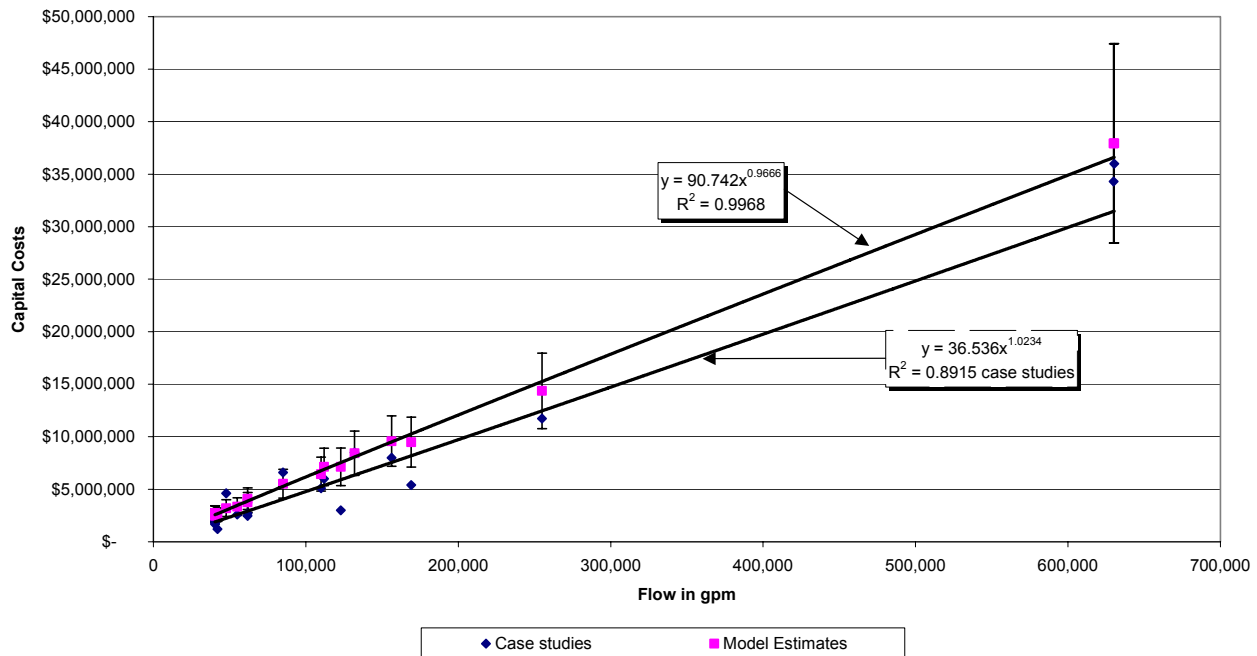
Description	Equivalent Wet Tower Cooling Water Flow (gpm) <sup>1</sup>	Project Cost (1999 \$)	Comparable Cost Estimate Based on Model (1999 \$)
500 MW capacity tower built in Nevada	153,500	\$20 million (\$130/gpm)	\$32 million (\$209/gpm)
500 MW capacity tower built in Colorado with noise reduction component	287,000	\$23.7 million (\$83/gpm)	\$61.6 million (\$215/gpm)
1000 MW capacity combined cycle (1/3 steam turbine) tower built in New York with noise reduction component	169,950	\$29.5 million (\$174/gpm)	\$35.5 million (\$209/gpm)
248 MW capacity tower built in Washington with two cooling processes: dry for winter and wet for summer	153,500	\$9 million (\$59/gpm)	\$32 million (\$209/gpm)
50 MW capacity tower built in Canada	63,000	\$1.76 million (\$28/gpm)	\$13.1 million (\$209/gpm)

Source for project costs: Brian Phelan, GEA Power Cooling Systems, Inc., 2001. GEA Power Cooling Systems, Inc. is one of the largest builders of dry cooling towers in the United States.

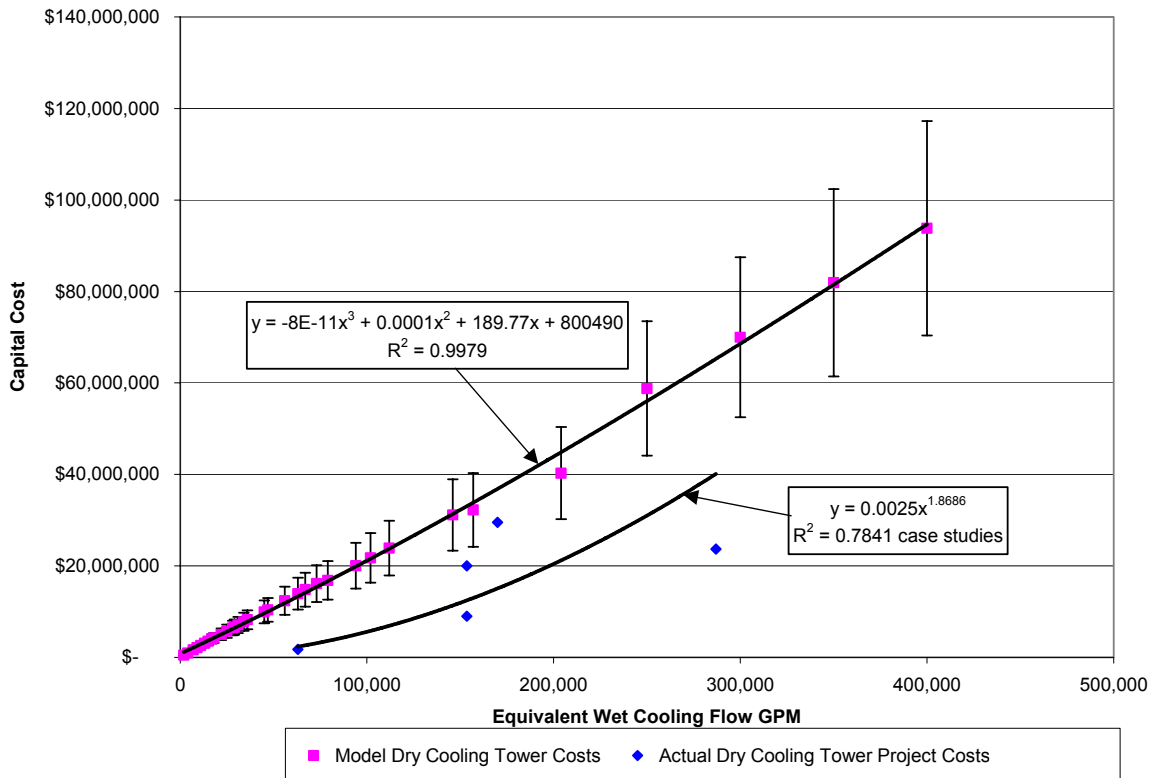
<sup>1</sup>Dry cooling towers do not require a circulating flow. For comparative purposes, we estimated the flow required for a wet cooling tower that is functionally equivalent to the dry cooling tower by converting each plant's steam tons/hour into flow in gpm, using the following equations:

$$\begin{aligned}
 &(\text{steam tons/hr}) \times 2,000 \times 1,000 = \text{BTUs/hr (1,000 BTUs/\# steam)} \\
 &(\text{BTUs/hr})/12,000 = \text{Tons of Ice (12,000 BTUs/hr/ton)} \\
 &(\text{Tons of Ice}) \times 3 = \text{flow (gpm) (3 gpm/ton of ice)}
 \end{aligned}$$

The equivalent wet cooling tower flow was then used to develop the comparable cost estimate based on the parametric model.



**Figure 4.** Actual Capital Costs for Wet Cooling Tower Projects and Comparable Estimates Developed Using the Parametric Cost Model



**Figure 5.** Actual Capital Costs of Dry Cooling Tower Projects and Comparable Estimates Developed Using the Parametric Cost Model

As can be seen from the graphical presentation in Figures 4 and 5, the cooling towers cost model fits are higher than the curve fits of the cooling towers costs case studies. The fit equations in Figure 4 show that the slopes of the case study curve and model fit curve are close and that two case study data points are outside the  $\pm 25\%$  boundary around the model fit. The model case study curves presented in Figure 5 for dry cooling tower show that when compared to the best-fit curve for the case studies, the model overestimates costs by a factor of 8 times at the low end of the small size towers to a factor of about 1.7 times at the high end of the large size cooling towers. Because of the limited available data on actual cost studies, the dry cooling tower cost model was not adjusted.

### Conclusions

There is no single appropriate cost method for developing budgetary cost estimates. Selecting the appropriate method depends greatly on the availability of data and the desired level of accuracy, particularly when the variables and cost drivers are plentiful. Keys to a good technology cost estimation tool that can be applied for budgetary purposes at a national level are its applicability to different sites, its major cost driver elements, and the availability of information and knowledge about how well the technology is established and standardized.

For both wet and dry cooling towers, the parametric model described above yields cost estimates that are conservative (i.e., erring on the high side) compared to actual project costs. Given the complexity and diversity of cooling towers, a parametric model based on flow appears to be the most cost-effective way for estimating unit costs for budgetary purposes. Cooling tower parametric cost estimation model costs are based on the flow rate, approach temperature delta, and the type of cooling tower.

Some industry representatives provided information on how they conduct preliminary cost estimates for cooling towers. This is considered to be the “rule of thumb” in costing cooling towers [i.e., \$/L/min or \$/gallons per minute (gpm)]. Rule of thumb cost estimates include many cost items, such as design/engineering, process equipment, and installation, that are clearly part of getting a structure or cooling tower in place and operational. The user of these

developed parametric models needs to know the required cooling flow in gpm and plug in that value in the set equations. The user needs to keep in mind that these models were developed for a range of 20°F and a delta approach of 10°F. Therefore when calculating the flow required from a heat rejection value (Btus/hr\*8.34\*20/60) for a range other than 20°F, the user may want to adjust his cost from the model-generated base tower cost for that flow down by a factor of about 10% for every 20% increase in range temperature (i.e., °F) value. The model user may also need to account for regional variations, because regional variations in costs do exist. For example, the costs of cooling towers in New England (union labor) are generally more than for comparable cooling towers in the Mid Atlantic and Southeast parts of the country. Thus, it may be desirable to use regional cost factors to adjust the parametric model cost estimates to account for such variations.

### **Future Directions and Research Needs**

Power plants and cooling towers have been around for more than a century. The fundamentals that govern power production and the cooling systems associated remain almost the same. The time to look for real solutions to reduce thermal discharges, water use, and improving power production efficiency is now.

Reducing water use requirements may be achieved by developing technologies that yield:

- ▶ New power generation and cooling media
- ▶ Improved wet cooling system efficiency
- ▶ Improved dry cooling system efficiency
- ▶ Improved water recycling processes
- ▶ Improved boilers to use low quality water
- ▶ Reduced cooling tower evaporative losses

Reducing water use by power plants and other industries also may be achieved by improving power generation with the same or reduced amounts of used water through:

- ▶ Improved turbine efficiency
- ▶ Improved process control
- ▶ Combined power generating cycles
- ▶ Advanced steam power plant design
- ▶ Systems to utilize evaporated water energy and exhaust gases energy
- ▶ Improved treatment of water used for steam generation and cooling.

A new vision for power generation is warranted; with all the advances and improvements in power generation efficiency, the basis for power generation has not changed much over the last century. This situation is very much similar to the status of the internal combustion engine. Compared to the existing engines of 100 years ago, the internal combustion engine in any modern car is by far more efficient and powerful. However, can we imagine the status of aviation if we kept relying on such engines rather than jet engines to fly travel or war planes?

### **References**

Marley Cooling Tower Company (Marley), 1985. Cooling Tower Fundamentals, 2<sup>nd</sup> Edition. The Marley Cooling Tower Company (Mission, Kansas).

Mirsky, G.L., et al., 1992. The Latest Worldwide Technology in Environmentally Designed Cooling Towers. Cooling Tower Institute 1992 Annual Meeting Technical Paper Number TP92-02.

Mirsky, G. and J. Bautier, 1997. Designs for Cooling Towers and Air Cooled Steam Condensers that Meet Today's Stringent Environmental Requirements. Presented at the EPRI 1997 Cooling Tower Conference (St. Petersburg, Florida) and ASME 1997 Joint Power Conference (Denver, Colorado).

Mirsky, G. 2000. Personal communication between Gary Mirsky, Hamon Cooling Towers, and Faysal Bekdash, SAIC. Email dated 3/27/00.

Mirsky, G. 2001. Personal communication between Gary Mirsky, Hamon Cooling Towers, and Faysal Bekdash, SAIC.

R.S. Means Company, Inc. (R.S. Means), 1997. Heavy Construction Cost Data 1998, 12<sup>th</sup> Annual Edition.

U.S. EPA (2000). Design and Cost Estimates for Advanced Water Treatment Technologies. Final Draft. U.S. EPA, Office of Research and Development, National Risk Management Research Laboratory, Cincinnati, OH.

USGS 2000. <http://www.ga.usgs.gov/edu/graphicshtml/ptratioyears.html> last modified Feb3 2000.

---

### ***Power Plant Repowering as a Strategy for Reducing Water Consumption at Existing Electric Generating Facilities***

*David Schlissel, Synapse Energy Economics, Inc.*

#### **BIOSKETCH**

Mr. David Schlissel is a Senior Consultant at Synapse Energy Economics. Mr. Schlissel received a B.S. from M.I.T. and an M.S. from Stanford. Both degrees were in Aeronautical and Astronautical Engineering. He also received a Juris Doctor Degree from Stanford Law School. In addition, he has studied Nuclear Engineering and Project Management at M.I.T. Prior to joining Synapse in November 2000, Mr. Schlissel was the president of Schlissel Technical Consulting, Inc. and its predecessor, Schlissel Engineering Associates. He has over 29 years of experience in energy and environmental work. Mr. Schlissel's recent projects have included analyses related to power plant cooling system design issues, the repowering of older electric generating facilities, electric transmission and distribution system reliability, and the environmental benefits that would be provided by proposed electric generating and transmission facilities.

#### **ABSTRACT** *(Technical Paper Not Available)*

The "repowering" of a power plant involves replacing the older, inefficient equipment in the plant with new equipment, usually combined-cycle technology. Repowering also can result in the creation of additional generating capacity as part of the "repowered" facility. This study examines the environmental and economic impacts of using repowering as a strategy to reduce adverse water impacts at electric generating facilities.

First, the study examines the experience to date with repowering, reviewing the publicly available information concerning the cost of repowerings and the reductions in water consumption that have been achieved at repowered facilities. Second, we examine as case studies several recent repowerings. Cases are explored in terms of expected changes in plant performance, forecast reductions in water and air impacts, and projected costs. Finally, we compare the costs and benefits of repowering to other possible options for reducing water usage at existing power plants.

Key findings will include the following:

- ▶ A repowered electric generating facility can produce additional revenues through increased sales because (1) it can generate electricity at lower cost than older, less efficient units and (2) it can add new generating capacity as part of the repowering process. These additional revenues will offset the costs of transitioning to a closed-cycle cooling system.
- ▶ Repowering can make retrofitting an existing power plant to a closed-cycle cooling system a more attractive option.
- ▶ Repowering also can achieve secondary effect reductions in water usage at other power plants in the region, where generation decreases as a result of the operation of the new, more efficient repowered plant.

## Session C Questions and Answers

- Q. Gordon Hart, Performance Contracting, asked John Maulbetsch, Maulbetsch Consulting, questions regarding the graphs used in his presentation. In particular, he requested an estimate of the net present value (millions per year) for energy efficiency costs for dry cooling.
- A. Mr. Maulbetsch answered that the assumed energy efficiency penalty was 1 percent and the basis for the 20-year net present value was a 5 percent discount rate at a \$25/MW cost at a 100-MW facility— a fairly low cost.
- Q. Mr. Hart pointed out that one of the benefits of dry cooling is that you get a steam turbine credit—which makes it significantly cheaper with dry-cooled than with a conventional unit. The graph implies that the dry-cooling turbine would be designed for a 5.5-inch with a conventional turbine. With such a configuration, Mr. Hart anticipated constantly tripping the turbine. With a dry-cooled system, Mr. Hart said that you would not be designing it with a conventional turbine, but rather with a modified unit.
- A. Mr. Maulbetsch agreed that the option was available. First you would probably look at the conventional turbine simply because that's what has usually been purchased. You could use other turbines (such as the high-backpressure turbine, which to date has only been theorized). You do need to look at the total cost relative to the lifetime of the plant, and include energy penalty costs. It's a complex calculation.
- Q. John Kelly, Entergy Nuclear Operations, asked whether anyone could address the additional hotel load: the additional usage of systems that would have to be installed for backfitting a plant. For example, the cost of running fans and the pumping needs of going to a higher head.
- A. Mr. Maulbetsch said that he did have that data in his presentation but breezed over it because of time. He said that he would not normally include fans and pumping under the term "hotel load." He explained that if you go from once-through cooling to a closed-cycle system, and keep the flow rate the same, you add to the system pressure because of having to pump to the top of the tower (20-45 feet). This can double the pressure drop in the loop, and adding the fans can get you to 1.5- 2.5 percent energy use, which is significant over a long period of time. As pertains to the issue of re-optimizing the flow, if you do it, it will raise the going-in costs of the retrofit. If you don't do it, you will have higher costs over the lifetime of the plant, and this is a choice you will have to make.

## VII. Session D-1: Screening and Other Fish Diversion/Deterrent Technologies

### *Fish Return System Efficacy and Monitoring Studies for JEA's Northside Generating Station* *Isabel C. Johnson, Golder Associates, Inc.*

#### **BIOSKETCH**

Ms. Isabel Johnson is the Environmental Toxicology Practice Leader for Golder Associates, Inc. Ms. Johnson also serves on the Board of Directors for Golder Associates Inc. and has a Courtesy Scientist appointment at the University of Florida's College of veterinary medicine, Center for Environmental and Human Toxicology. Ms. Johnson holds a Bachelor of Science degree in Zoology from the University of Florida and a Master of Science degree specializing in Marine Biology from the University of West Florida. Ms. Johnson is responsible for management of multidisciplinary projects for the power and manufacturing industry, marine and freshwater aquatic studies, and ecological risk assessments. Her efforts in these studies include thermal assessments, development and implementation of aquatic biological programs, evaluations of industrial effluent impacts, and NPDES compliance.

#### **TECHNICAL PAPER**

##### **Introduction**

The JEA Northside Generating Station (Station) is located north of Jacksonville, Florida, and is adjacent to San Carlos Creek, a tributary to the St. Johns River. The plant is approximately 10 river miles from the Atlantic Ocean, and the plant's once-through cooling water intake flume draws water from a tidal river, the St. Johns River. The Station discharges its cooling water back to the St. Johns River. The intake structures at the plant consist of: trash racks, intake cannals, concrete-lined bays approximately 30 feet deep; a set of continuous-belt traveling screens; and electrically driven impeller pumps for circulating the cooling water.

The water used at the Station for condenser cooling is withdrawn from the Blount Island Channel (Channel) of the St. Johns River. The Channel was the original course of the St. Johns River until 1947 when Fulton Dame Point was constructed. The Channel conveys approximately 30 to 50 percent of the total river flow. This region of the St. Johns River is tidal, and the salinity in the Channel varies from 12 to 35 parts per thousand (ppt). The plant's NPDES permit allows for 827 million gallons per day to be withdrawn from the St. Johns River.

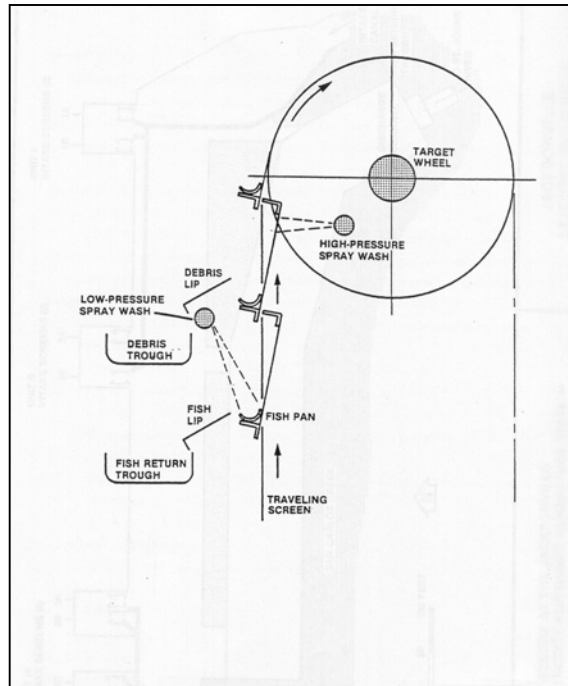
The Station's fish return system (FRS) is an array of trays, wash sprays, and sluice channels (troughs) designed to remove impinged organisms from the traveling screens and return them to the aquatic system. Each FRS has a rotating traveling screen (0.5-inch mesh) with collection pans attached approximately every four feet. As the traveling screens rotate, low pressure sprays rinse the biota from the screens into the fish trays; the biota are then flushed with the water over a rubber lip into the fish return troughs. Troughs join two main sluice channels that return impinged biota to the San Carlos Creek at two locations. The traveling screens are then back-flushed with a high pressure spray wash to remove debris. Debris is discarded through the debris troughs into the plant discharge.

Impingement monitoring studies have been conducted by JEA to evaluate the Station's impact on the aquatic environment and the efficacy of its FRS. These studies included:

- original Section 316(b) demonstration;
- impingement survival verification studies required by the plant's NPDES permit; and
- traveling screen schedule optimization.

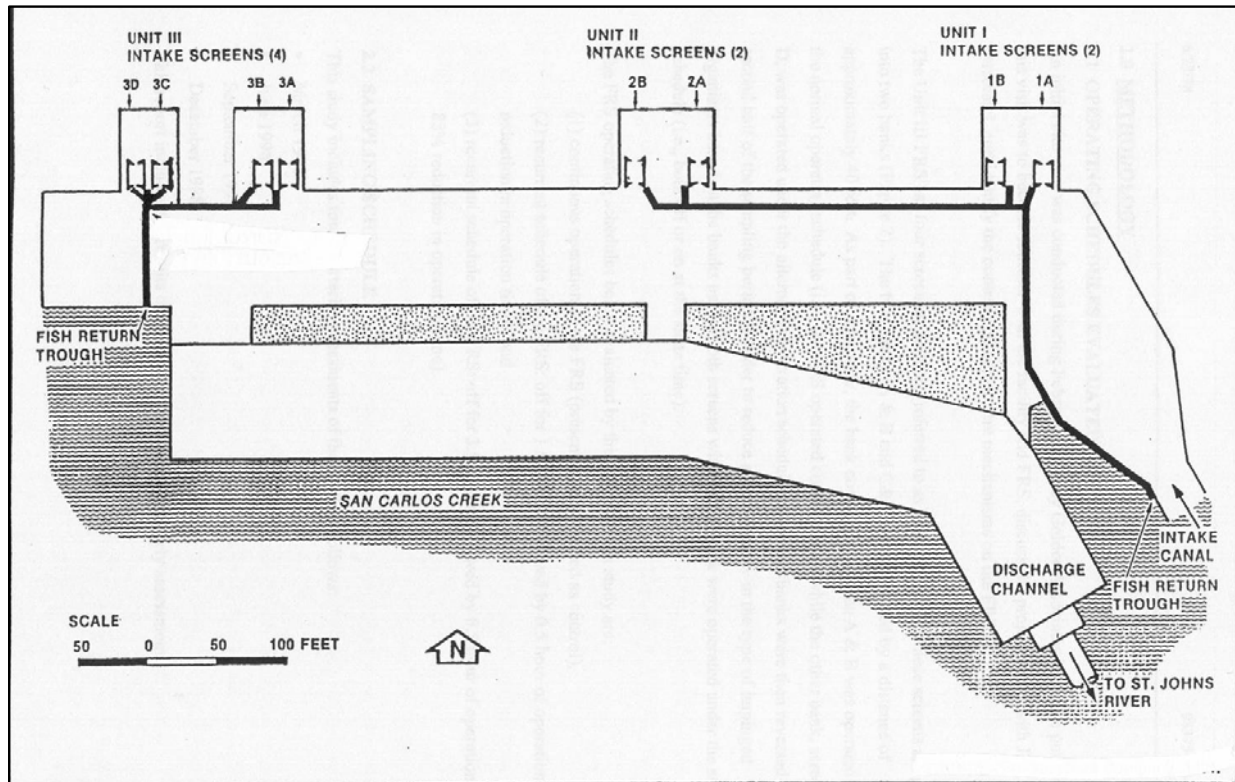
#### **FRS**

Each FRS (Figure 1) consists of five major components: a traveling screen, a low-pressure wash system, a fish return trough, a high pressure wash system, and a debris return trough. The traveling screens have a square mesh size of 0.5 inches (in) with fish pans attached approximately every four feet. As the screen rotates, impinged organisms are lifted from the intake canal by the screens and fish pans, which in turn are flushed by the low-pressure wash system into the fish return troughs. The troughs serve as conduits to return impinged organisms to San Carlos Creek.



**Figure 1.** Fish Return System (FRS) Traveling Screen and Wash System (ESE, 1985)

The high pressure wash system is the final phase of the FRS and serves to clean the traveling screens of any debris not previously cleared by the low-pressure wash system. Organisms and debris cleared by the high-pressure wash system are discharged via the debris trough to the discharge canal. The Station has three FRS units (Figure 2). Units I and II have two traveling screens each, and utilize the same fish return trough system. Unit III has four traveling screens and its own fish return trough system. Both trough systems return the impinged organisms to the San Carlos Creek.



**Figure 2** Diagrammatic representation of FRS at JEA's Northside Generating Station (ESE, 1985)

### Section 316(b) Demonstration Study

In 1976 JEA completed its Section 316 demonstration for the Station, and this included extensive physical, chemical and biological studies (including a 1-year impingement study) [Reynolds, Smith and Hills (RS&H), 1976]. These studies were conducted to determine, among other factors, the effect of the Station upon the aquatic environment, the nature of the aquatic environment of the St. Johns River system, and the alternative cooling water systems and impingement technologies which would meet the requirements of Section 316(a) and (b) of the Clean Water Act. Section 316 (b) required that the cooling water intake structure of the Station reflect the best technology available for minimizing adverse environmental impact. The 1976 demonstration concluded that the Blount Island Channel was not a primary spawning ground for any species of importance to the St. Johns River ecosystem and that the proposed FRS would significantly reduce the mortality of impinged fish and shellfish. The report concluded that the FRS would minimize the adverse environmental impact of the once-through cooling system and would represent the best technology in this application, thus satisfying Section 316(b) of the Clean Water Act. Each FRS was scheduled to run continuously when the associated power plant Unit was operating.

### Section 316(b) Demonstration Study Methods

The RS&H (1976) 316(b) demonstration included a one year, monthly impingement study at the Station. The impingement study was conducted by Battelle (1975); the original report for the impingement study was not available, so the methodology was not reviewed. From the 316(b) demonstration report it appears that impinged organisms were collected from the rotating screens at the intake of the Units, enumerated and identified to the lowest taxonomic level. The length of each sampling event was not specified, but it appears to be 24 hours.

### Section 316(b) Demonstration Study Results

Table 1 summarizes the total number of fish impinged, and the distribution of the seven most abundant fish species.

**Table 1.** Monthly counts of total fish impinged on the screens at JEA’s Northside Generating Station (August 1973 to August 1974). Seven most abundant fish species listed. Species key: 1. *Micropogon undulatus*, 2. *Stellifer lanceolatus*, 3. *Cynoscion regalis*, 4. *Anchoa mitchilli*, 5. *Cynoscion nothus*, 6. *Symphurus plagiusa*, 7. *Opisthonema oglinum*.

Month	Total Fish Impinged	Sp. 1	Sp. 2	Sp. 3	Sp. 4	Sp. 5	Sp. 6	Sp. 7
August	1,799	1,196	297	0	1	96	0	0
October	389	3	270	3	4	15	3	0
November	47	2	28	0	0	3	0	0
December	12	0	1	0	0	1	0	0
January	321	44	43	22	0	32	0	0
February	798	666	61	0	30	0	14	0
March	66	36	0	0	4	0	6	0
March	12	10	0	0	0	0	0	0
April	19	13	0	0	0	0	0	0
May	503	8	4	15	130	254	10	0
June	469	41	52	98	41	0	8	0
July	3,199	647	193	661	297	0	286	730
August	2,278	1,646	218	70	118	0	18	0
<b>Total</b>	<b>9,912</b>	<b>4,312</b>	<b>1,167</b>	<b>869</b>	<b>625</b>	<b>401</b>	<b>345</b>	<b>730</b>

During the one-year impingement study at the Station, 78 species of fish were impinged on the rotating screens (RS&H, 1976). Seven species accounted for over 85 percent of all impinged fish. Listed in order of decreasing abundance they were: Atlantic croaker (*Micropogon undulatus*), star drum (*Stellifer lanceolatus*), weakfish (*Cynoscion regalis*), silver sea trout (*Cynoscion nothus*), Atlantic thread herring (*Opisthonema oglinum*), bay anchovy (*Anchoa mitchilli*), and (*Symphurus plagiusa*). Of the seven fish species, *M. undulatus* accounted for 43.5 percent of the fish.



Twenty-two species of invertebrates were impinged during the one-year impingement study. Of the 22 species, four were considered of commercial or sport fishery importance: three commercial shrimp species (*Panaeus setiferus*, *Panaeus aztecus* and *Panaeus duorarum*) and the blue crab (*Callinectes sapidus*). Table 2 summarizes the distribution of these four species over the monthly impingement study conducted during 1973-1974.

**Table 2.** Monthly counts of commercial shrimp and crab species impinged on the screens at JEA’s Northside Generating Station (August 1973 to August 1974). Collection time: 24 hours.

Month	<i>P. setiferus</i>	<i>P. aztecus</i>	<i>P. durarum</i>	Total Number of Shrimp Collected	<i>C. sapidus</i>
August	393	0	0	393	77
October	425	129	0	554	115
November	32	21	0	53	26
December	14	16	0	30	31
January	43	9	0	52	108
February	26	11	0	37	64
March	3	3	2	8	4
March	0	6	2	8	28
April	18	9	0	27	61
May	55	87	1	143	61
June	30	165	0	195	106
July	666	670	0	1,336	176
August	1,642	50	13	1,705	163
<b>Total</b>	<b>3,347</b>	<b>1,176</b>	<b>18</b>	<b>4,541</b>	<b>1,020</b>

Section 316(b) Demonstration Study Conclusions

The 316(b) demonstration concluded that the Station withdrew approximately ten percent of the average flow of the Blount Island Channel, and that the Channel represented less than 50 percent of the river flow. Biological field studies documented that the Channel was not a primary spawning ground for any species of ecological importance, however, the lower portions of the St. Johns River were found to serve as an access route to the upper estuary areas of the St. Johns River.

During the one-year impingement study, 78 species of fish were impinged on the Station’s screens, and seven species accounted for 85 percent of all impinged fish. These species were: Atlantic croaker (*Micropogon undulatus*), star drum (*Stellifer lanceolatus*), weakfish (*Cynoscion regalis*), silver sea trout (*Cynoscion nothus*), Atlantic thread herring (*Opistonema oglinum*), bay anchovy (*Anchoa mitchilli*), and (*Symphurus plaqiasa*). Of the seven fish species, *M. undulatus* accounted for 43.5 percent. July and August data showed the highest fish impingement rates in this study, and December, March and April had the lowest impingement rates.

Twenty-two species of invertebrates were impinged during the one-year impingement study. Of the 22 species, four were considered of commercial or sport fishery importance: three species of the commercial shrimp (*Panaeus setiferus*, *Panaeus aztecus* and *Panaeus duorarum*) and the blue crab (*Callinectes sapidus*). Of the commercial shrimp, *P. setiferus* was the dominant species, with daily impingement rates ranging from 0 in March 1973 to 1,642 in August 1974. Blue crab daily impingement ranged from 4 per day in March 1973 to 176 crabs per day in August 1974.

The impinged fish and shellfish data developed to support the 316(b) demonstration showed that impingement rates at the Station were relatively low. The demonstration concluded that these low total numbers (12 to 3,199 per 24 hours) in conjunction with the fish return system proposed would significantly reduce the impingement of fish and shellfish, and would minimize adverse environmental impact and represent the best technology in this application.

**FRS Efficacy Study**

In 1984-1985, JEA conducted an assessment of the FRS during the summer and winter conditions as part of the Station’s National Pollutant Discharge Elimination System (NPDES) permit requirements (ESE, 1985). The purpose of this assessment was to determine the effectiveness of the FRS; that is to define what types of organisms were

impinged as well as their physical condition after passing through the FRS. Survivability studies and impingement rate studies were conducted to evaluate the FRS. These studies were conducted during the anticipated periods of peak impingement identified in the Battelle (1975) report.

Unit III was used for the summer studies and Units I and II during the winter studies; all three FRS units are comparable. Standard EPA guidance documents were not available for the evaluation of the efficacy of the FRS; therefore a plan of study was developed and submitted to EPA for approval. These studies consisted of assessments of percentage of animals returned and their longer term survivability (96 hours) after passage through the FRS.

### FRS Efficacy Study Methods

#### **Survivability Studies**

These studies were designed to assess the effectiveness of the FRS by determining the survival rates of various impinged organisms. The organisms studied were divided into three categories:

1. Vulnerable or sensitive species that are likely to be harmed or die after entrapment, impingement, and return to the natural ecosystem by the FRS, such as spotted sea trout (*Cynoscion* spp), anchovy (*Anchoa* spp), silversides (*Menidia* spp), and menhaden (*Brevoortia* spp).
2. Species of intermediate tolerance, such as Atlantic croaker (*Micropogonias undulatus*), spot (*Leiostomus xanthurus*), mullet (*Mugil cephalus*), and star drum (*Stellifer lanceolatus*).
3. Tolerant or hardy species that are likely to pass through the FRS unharmed, such as commercial shrimp (*Penaeus* spp), blue crab (*Callinectes sapidus*), hogchoker (*Trinectes maculatus*), and hardhead catfish (*Arius felis*).

One representative genus or species of fish or invertebrate was selected from each of the three categories for survival evaluation. Species selection depended on their availability from the FRS, as well as impingement rates.

Test organism collection was accomplished by using a net at the point of convergence of the fish return troughs (Figure 2). A minimum of 19 individuals of each genera, from each sensitivity category, were monitored for survival using flow-through San Carlos Creek water in 20-gallon aquaria over a 96-hour period. Control organisms were collected by seining in San Carlos Creek and the St. Johns River. Mortality and physical parameters were monitored at collection and every 24 hours thereafter. Average weight and lengths of all animals tested were also recorded. Percent survival for each category was estimated following passage through the FRS.

#### **Impingement Return Rate Assessment**

These studies were designed to compare the total number of organisms impinged with the number of organisms returned to San Carlos Creek via the FRS. Organisms were collected over two 4-hour periods; one collection period starting prior to high tide and the other prior to low tide. Data collected included: total number of organisms returned via the FRS, species or genus of species returned, and number of organisms returned via the debris system. From these data the total number of organisms impinged and the percent returned to the San Carlos Creek were calculated.

#### **FRS Efficacy Study Results**

As required by the Station's NPDES permit, the survivability and impingement rates were assessed for the continuously operating FRS. These studies were conducted during August and September 1984 and January 1985 (ESE, 1985).

#### Survivability Studies

The summer survivability study was initially attempted by collecting all organisms impinged over an 8-hour period in August 1984. Due to the low impingement rates (total of 77 fish and invertebrates), only the survivability of the sensitive species (sea trout, *Cynoscion nebulosus*) was assessed. All of these fish died within the first hour after passage through the FRS.

Based on the Battelle (1975) study and personal observations by JEA Station personnel, higher impingement rates were anticipated during the night. Collection was again initiated during September 1984. Species collected and tested for survivability were from the intermediate and tolerant sensitivity ranges; no sensitive species were impinged during this collection period. The following species were tested:

1. intermediate tolerance species: spot (*L. xanthurus*), Atlantic croaker (*M. undulatus*), and star drum (*S. lanceolatus*), and
2. tolerant species: commercial shrimp (*Penaeus* spp).

Organisms collected from the estuary near the plant, were used as controls. The control organisms used were:

1. sensitive species: menhaden (*Brevoortia* spp), only sensitive category species collected
2. intermediate tolerance species: spot (*L. xanthurus*) and Atlantic croaker (*M. undulatus*), and
3. tolerant species: commercial shrimp (*Penaeus* spp).

The summer conditions resulted in control survival at 96 hours of 95 percent or higher for all species tested. For the species collected from the FRS, the survival rates were: spotted sea trout had no surviving organisms after 1 hour; spot/croaker 80 percent, and star drum 80 percent; and penaeid shrimp 90 percent survival. The salinity varied from 19 to 31 ppt over this 4-day period; this was due to the tides. The water temperature was  $27 \pm 2^\circ\text{C}$ .

The winter survivability study was initiated in January 1985, and the following species were tested:

- sensitive species: Atlantic menhaden (*Brevoortia tyrannus*),
- intermediate tolerance species: star drum (*S. lanceolatus*), and
- tolerant species: hardhead catfish (*Arius felis*).

Organisms collected from the estuary near the plant, were used as controls. The control organisms used were:

- sensitive species: inland silverside (*Menidia beryllina*),
- intermediate tolerance species: striped mullet (*Mugil cephalus*), and
- tolerant species: hardhead catfish (*A. felis*).

The winter conditions resulted in 100 percent control survival at 96 hours for the silversides and mullet; 75 percent survival in the catfish. For the species collected from the FRS, the survival rates were: menhaden 5 percent; star drum 10 percent; and catfish 90 percent. The salinity varied from 17 to 22 ppt over this 4-day period. The water temperature range was 9.5 to 12.5 °C.

Impingement Return Rate Assessment

Impingement rates at the Station were relatively low for the summer and winter conditions. During each event, sampling was conducted for 4 hours prior to low tide and 4 hours prior to high tide. Table 3 summarizes these data.

**Table 3.** FRS impingement return rate assessments conducted at JEA’s Northside Generating Station during summer and winter conditions (1984-1985). Collection time: 8 hours.

Season	Tide	Total Number of Fish Collected	Total Number of Invertebrates Collected	Dominant Species	Number
Summer	Low (night)	7	103	Commercial shrimp Blue crab	79 20
	High (night)	2	31	Commercial shrimp	27
Winter	Low (afternoon)	32	5	Star drum	10
	High (night)	859	9	Hardhead catfish Star drum	463 357

Table 4 summarizes the number of organisms returned through the debris trough. These organisms are discharged through the outfall to the St. Johns River (Blount Island Channel).

**Table 4.** Impinged organisms disposed through the debris troughs at JEA's Northside Generating Station during summer and winter conditions (1984-1985). Collection time: 8 hours.

Season	Tide	Total Number of Fish Collected	Total Number of Invertebrates Collected	Dominant Species	Number
Summer	Low (night)	2	38	Commercial shrimp	35
	High (night)	0	9	Commercial shrimp	7
Winter	Low (afternoon)	31	7	Hardhead catfish Star drum	11 6
	High (night)	662	7	Hardhead catfish Star drum	274 363

During summer conditions, at low tide, night collections from the FRS resulted in 150 organisms being impinged over 4 hours, of these, 110 were returned to the San Carlos Creek via the FRS. The calculated FRS return rate was 73 percent. Commercial shrimp accounted for 76 percent and blue crabs for 14 percent of the total impinged. At high tide (night collection) 42 organisms were impinged, again commercial shrimp was the primary species collected accounting for 81 percent. The calculated FRS return rate was 79 percent.

During winter conditions, at low tide, afternoon collections from the FRS resulted in 75 organisms being impinged over 4 hours, of these, 37 were returned to the San Carlos Creek via the FRS. The calculated FRS return rate was 49 percent. Star drum accounted for 21 percent of the total impinged. At high tide (night collection) 1,537 organisms were impinged, hardhead catfish and star drum were the dominant species accounting for 48 percent and 47 percent of the organisms impinged, respectively. The calculated FRS return rate was 56.5 percent.

FRS return rates for this study are summarized in Table 5.

**Table 5.** FRS return rate at JEA's Northside Generating Station during summer and winter conditions (1984-1985).

Season	Tide	FRS Return Rate (percent)
Summer	Low (night)	73
	High (night)	79
Winter	Low (afternoon)	49
	High (night)	56.5

FRS Efficacy Study Conclusions

The FRS Efficacy study conducted in 1984 and 1985 documented that impingement rates were low at the Station during the summer and winter months. The winter impingement numbers, as compared to the summer, were found to be higher at night than in the daytime. During the summer, commercial shrimp and blue crabs were the primary impinged organisms, representing 76 and 14 percent of the impinged organisms, with very few fish impinged. During the winter fish were the primary species impinged, with hardhead catfish and star drum as the primary species collected and representing 48 and 47 percent of the impinged organisms.

The FRS return rates were evaluated at low tide and high tide and the results were: 73 and 79 percent return efficiency in the summer and 49 and 56.5 return efficiency in the winter.

The results of the summer longer term survivability tests indicated that the sensitive species did not survive after passage through the FRS during the summer conditions evaluated; 95 percent control survival was observed for the sensitive species. The intermediate and tolerant species had greater than 80 percent survival after passage through the FRS.

The winter evaluation showed low survival of the sensitive and intermediate sensitivity species (menhaden, 5 percent survival; star drum, 10 percent survival), as compared to the controls with 100 percent survival for these 2 categories. In all cases, the tolerant species (commercial shrimp and catfish) had excellent survival.

### **Optimization Study**

The standard operating procedure at the Station was to operate the FRS continuously, unless the power plant Unit associated with the FRS was not being used. These quarterly studies were conducted to evaluate different operating schedules, and their impact on the survival of impinged organisms and the return rate efficiency of the FRS.

A quarterly study was conducted at the Station in 1998 and 1999 to determine if immediate survival, longer-term survival, and return rate efficiency were significantly altered as a result of reducing the operational time of the FRS units (Golder, 1999). The objective of these quarterly studies was to determine if the plant could reduce the hours of operation of the FRS without significantly increasing the mortality rate of impinged and entrained organisms.

#### Optimization Study Methods

This study compared the continuous operation of the FRS to two alternative schedules: 1.5 hours off: 0.5 hour on, and 3.5 hours off: 0.5 hour on. Monitoring was conducted during the day and night.

Immediate survival was quantified for impinged organisms immediately after passing through the FRS; longer-term survival was assessed by holding groups of organisms in aquaria for 3 to 4 days following collection from the FRS. All impinged organisms were identified to the lowest taxonomic level possible. The return rate efficiency was defined as the number of organisms returned to the San Carlos Creek divided by the total number of organisms impinged (total number impinged was quantified by collecting all organisms from the FRS troughs as well as the debris troughs for a pre-determined period of time).

The Station's Unit III FRS has four rotating screen assemblies referred to as A, B, C and D (Figure 2). These screen assemblies are grouped into 2 banks (A&B and C&D) and are separated by a distance of approximately 40 feet. For these studies the bank containing screen assemblies A&B was operated continuously, while the other bank (C&D) was operated under the alternative operating schedules. The FRS operating schedules were then reversed for the second half of the sampling period in order to reduce variability in the data. Both screen assemblies within the same bank were operated under the same schedule (*i.e.*, both off or on at the same time).

Following preliminary trials, the final FRS operating schedules evaluated were:

1. continuous operation of the FRS (current schedule, used as Control), and
2. intermittent operation of the FRS: off for 1.5 hours, followed by 0.5 hour of operation (alternate schedule).

The Control FRS (continuously operating screens) was sampled for approximately 16 hours over two days. Half of the sampling was conducted during daytime and half during nighttime. For the FRS operating under the alternate schedule (1.5 hours off: 0.5 hour on), the collection period was for the 0.5 hour that the FRS operated. Four sampling events per quarterly assessment were conducted, two during the day and two at night (within a 24-hour period) concurrent with the continuously operating screens.

### **Survivability Studies**

Aquatic organisms impinged on the screens and returned by the FRS were evaluated for the two operating schedules by collecting organisms from the fish return troughs and determining their survivability. This was done in two ways:

1. Immediate survivability – Impinged organisms were collected over a pre-determined period of time, counted and categorized as dead or alive.
2. Longer term survivability – Three species, representing three sensitivity categories (as defined in the FRS efficacy study), were collected from the fish return troughs and maintained under flow-through conditions for 72 to 96 hours to evaluate longer term survivability.

Impinged organisms were collected by placing nets in the fish return troughs. The nets were replaced every five to seven minutes, immediate survivability and taxonomic identification of each organism was determined. Nets were also placed in the debris troughs and were replaced every half hour. All organisms collected were classified to the lowest taxonomic level possible.

In order to determine longer term survivability, three species selected representing three sensitivity categories were held for 72 to 96 hours in 30-gallon flow-through chambers. If an insufficient number of organisms from one of the sensitivity categories were collected, a mixture of two species from the same category were used. Survival was determined in each chamber daily and at the end of the holding period. Water quality was monitored in each chamber every 24 hours. Weight and length of each surviving animal in the holding chambers were measured at holding period termination.

**Impingement Return Rate Assessment**

The FRS was also evaluated by comparing the total number of organisms impinged with the number of organisms returned to the San Carlos Creek via the FRS. This was done by counting the total number of organism returned via the FRS and the total number disposed by the debris system.

**Optimization Study Results**

Following the first quarterly study, the 3.5 hour off: 0.5 hour on schedule was discontinued due to significant reduction in the survival of impinged organisms passing through the FRS.

Immediate Survival

Immediate survival was the most useful end point measured to compare the alternative FRS operating schedules. As summarized in Table 6, immediate survival among fish exposed to a 3.5-hour screen stoppage was significantly reduced (49.5 percent immediate survival versus 85.8 percent in the continuous operation group) during the March 1998 monitoring period. This group was dismissed from further study; the remainder of this discussion examines the effect of a 1.5-hour stoppage of the FRS on survival of biota in comparison to continually operating the FRS.

**Table 6.** Immediate survival of organisms returned by the FRS under different operating schedules, JEA's Northside Generating Station (1998-1999). N/A, not applicable, this schedule was discontinued after the first quarter due to low survival.

Quarter	Schedule and Immediate Survival (percent)		
	Continuous	1.5 hours off: 0.5 hour on	3.5 hours off: 0.5 hour on
March	85.8	86.3	49.5
June	93.0	72.3	N/A
September	95.4	82.3	N/A
January	90.6	91.9	N/A

During the March 1998 and January 1999 quarterly monitoring periods, the immediate survival of the 1.5 hours off: 0.5 hour on group (referred to hereafter as the treatment group) was similar to that of the continuously-operating group (referred to hereafter as the control group). The immediate survival values for the control and treatment groups were: 85.8 and 86.3 percent (March 1998); and 90.6 and 91.9 percent (January 1999), respectively.

During the June and September 1998 quarterly monitoring periods, the immediate survival of the treatment group in comparison to the control group was significantly reduced. The immediate survival values were 93.0 percent versus 72.3 percent (June 1998) and 95.4 percent versus 82.3 percent (September 1998), for the control and treatment groups, respectively. These values translate to a treatment mortality rate that is approximately 4 times greater than the control mortality rate (Table 6).

It is important to note that the values presented in the preceding paragraphs include all impinged organisms. The drum family (Sciaenidae), which includes spotted and gray sea trout, spot, silver perch, red drum, star drum, and Atlantic croaker, was the numerically dominant family of fish collected (70 percent) from the FRS during all sampling events. When the data for this family were examined separately, a similar trend in immediate survival was observed, but with greater magnitude. The immediate survival in the treatment group was again similar to that in the control group for the March period (83.9 percent versus 81.5 percent, respectively) and the January period

(100 percent survival in both groups). However, the immediate survival values for the control and treatment groups were 95.8 percent versus 66.7 percent, respectively, for June and 89.1 percent versus 21.7 percent, respectively, for September. These values translate to treatment mortality rates that are approximately 7 to 8 times greater than the control mortality rates (Table 7).

**Table 7.** Percent immediate survival of Sciaenid fish species following passage through the FRS at JEA’s Northside Generating Station (1998-1999).

Quarter	Schedule and Immediate Survival (percent)		Total Number Collected
	Continuous	1.5 hours off: 0.5 hour on	
March	81.5%	83.9%	1,312
June	95.8%	66.7%	497
September	89.1%	21.7%	257
January	100%	100%	8

Immediate survival of crustaceans, which comprised approximately half of the organisms collected, was excellent regardless of season. Control group survival ranged from 87.5 percent to 100 percent and treatment group survival ranged from 88.0 percent to 97.4 percent.

Longer-term Survival

The results of the longer-term were difficult to interpret due to the low numbers of sensitive species impinged. When statistical analyses could be employed to analyze the longer term survival data, no significant reductions in the treatment group (alternate FRS schedule) survival were detected, as compared to the controls (continuous FRS schedule) (Table 8). But, survivability was relatively low for the controls and treatments in June and September 1998 for the sensitive and intermediate species.

**Table 8.** Long-term survival data for impinged organisms following passage through the FRS at JEA’s Northside Generating Station. Data shown includes controls (continuous operation of FRS) and treatment (1.5 hours off and 0.5 hour on). \* High turbidity in flow-through water may have affected their survival.

Quarter		Long-Term Survival (percent)		
		Sensitive	Intermediate	Tolerant
March 1998	Control	Not available	100	37*
	Treatment	Not available	90	100
June 1998	Control	25	53	90
	Treatment	11	39	90
September 1998	Control	Not available	17	100
	Treatment	Not available	7	100
January 1999	Control	Not available	100	93
	Treatment	Not available	75	100

Impingement Return Rate Assessment

During the March sampling event, approximately two-thirds of the impinged organisms collected was during the day, while the remainder was collected during the evening hours. For the other three quarterly monitoring periods, very few organisms (35 out of 2,402 or <1.5 percent of the total) were collected during daytime hours.

Species composition over the four quarterly monitoring periods revealed a population of impinged organisms that was 57 percent fish and 43 percent crustacean. Fish from the family Sciaenidae comprised 70 percent of impinged fish, which is equivalent to approximately 40 percent of impinged organisms. The remaining 30 percent of the fish population was comprised of many families.

Return rate of the FRS units was very high regardless of FRS operating schedule (Table 9). The return rate was 87.9 percent, or higher, and no significant reduction in return rate was detected for any monitoring period. Usually,

crustaceans rather than fish were found in the debris chute nets, as these organisms have the ability to hang on to the mesh screen until dislodged by the high-pressure wash spray.

**Table 9.** FRS return rates for the 1998-1999 evaluation of continuous (control) and treatment (1.5 hours off: 0.5 hour on) operation schedules at JEA's Northside Generating Station. Control collection time: 16 hours; treatment collection time: 8 hours.

Quarter		Total Number Impinged	Total Number Returned by FRS	FRS Return Rate (percent)
March 1998	Control	1196	1167	97.6
	Treatment	456	446	97.8
June 1998	Control	497	487	98.0
	Treatment	398	375	94.2
September 1998	Control	983	947	96.3
	Treatment	596	524	87.9
January 1999	Control	32	32	100
	Treatment	38	37	97.4

### Optimization Study Conclusions

An Optimization Study was conducted in 1998 and 1999 to evaluate the FRS and to assess alternative operating schedules. Prior to the initiation of the optimization study, each FRS was evaluated and the system optimized in its operation (such as direction of the low spray wash, water pressure, and water flow in the troughs). Of the 2 alternative schedules originally planned, only the “1.5 hours off: 0.5 hour on” was assessed for four quarters; the “3.5 hour off: 0.5 hour on” alternative resulted in high mortality immediately following passage through the FRS, and was discontinued. The continuous operation schedule was considered the control for comparison.

The return rate efficiency of the FRS units was high, between 96.3 and 100 percent during continuous operation and 87.9 and 97.8 using the alternate schedule. The return rates were not significantly affected by the alternate operation schedule.

Immediate survival was considered the most useful endpoint measured to compare the alternate operation schedules. The “1.5 hours off: 0.5 hour on” schedule resulted in similar survival to the continuous operation during the March and January monitoring periods (March control immediate survival of 85.8 percent and alternate schedule immediate survival of 86.3 percent; January control immediate survival of 90.6 percent and alternate immediate survival of 91.0 percent).

During the warmer months (June and September), the immediate survival under the alternate schedule as compared to the control schedule was significantly reduced (June control immediate survival of 93 percent and alternate schedule immediate survival of 72.3 percent; September control immediate survival of 95.4 and alternate schedule immediate survival of 82.3 percent). The family Scianidae comprised the majority of the juvenile fish impinged on the FRS screens during all sampling events. When the immediate survivability of this group was evaluated for the alternate schedule and the continuous schedule, a significant reduction in survival of this group of fish was observed using the alternate schedule as compared to the controls. Immediate survival of crustaceans was excellent regardless of season or schedule. Control group immediate survival ranged from 87.5 to 100 percent and alternate schedule survival from 88 to 97.4 percent.

The longer term (96-hour) survivability assessments were inconclusive due to the fact that very few sensitive species were impinged during the sampling events, and both the control and alternate schedule assessments showed low survival for the intermediate species during the warmer months. The tolerant species showed excellent survival (>93 percent) regardless of season, with one exception, the commercial shrimp control (continuous operation) during March showed low survival (37 percent) and the alternative schedule had 100 percent survival.



Species composition over the four quarterly monitoring periods showed a population of impinged organisms that was 57 percent fish and 43 percent crustaceans. Fish from the family Sciaenidae comprised 70 percent of the impinged fish, which is equivalent to 40 percent of the impinged organisms.

The Optimization report concluded that the use of the alternate schedule (1.5 hours off : 0.5 hour on) during the cool season months in north Florida would not significantly decrease the FRS return efficiency, the immediate, or the longer-term survivability of impinged fish and crustaceans. The report also stated that during the warmer months, this alternate schedule could also be used during the day (due to the low impingement rates observed), but that the FRS would have to run continuously during the night. The report suggested that the FRS schedule should be determined by water temperature, and proposed that once water temperature reached 20°C, the warm season schedule could be implemented.

### **Conclusions**

Based on observations made during the ESE (1985) study and the Golder (1999) study, sufficient water flow in the fish return troughs and appropriate pressure of the FRS nozzles were of greatest importance in the proper function of the FRS and resulted in improved FRS return efficiency and high survival of impinged organisms. Predation by birds from the fish return troughs was not quantified, but observed during both studies. Both studies recommended that the fish return troughs should be covered and long enough so that during low tide the fish are not dropped into the aquatic system.

### **References**

Battelle Laboratories, 1975. Biological Assessment of Water and Marsh Areas of the St. Johns River. Prepared for Reynolds, Smith and Hills. January 1975.

ESE, 1985. An Assessment of the Fish Return System at the Jacksonville Electric Authority Northside Generating Station, Jacksonville, Florida. Prepared for Jacksonville Electric Authority. April 1985.

Golder Associates Inc., 1999. Fish Return System Optimization Study: Summary of Results and Discussion, Considerations, and Recommendations. Prepared for Jacksonville Electric Authority, October 1999.

Reynolds, Smith and Hills, 1976. Northside Generating Station 316 Demonstration. Prepared for Jacksonville Electric Authority. March 1976.

---

### ***Effectiveness, Operation and Maintenance, and Costs of a Barrier Net System for Impingement Reduction at the Chalk Point Generating Station***

*David Bailey, Mirant*

### **BIOSKETCH**

Mr. Bailey is currently Group Leader, Water and Land Management Services for Mirant Mid-Atlantic. His responsibilities include tracking new environmental regulatory developments, providing environmental permitting and compliance support services and management of Mirant Mid-Atlantic's environmental stewardship programs. Mr. Bailey has over 30 yrs. experience working on environmental issues in the electric power generation industry. This includes 25 yrs. of experience working on 316(a) and (b) issues. Mr. Bailey currently serves as Chair of the Utility Water Act Group's Cooling Systems Committee, which has played a lead role in representing the Industry during the 316(b) rulemaking. Mr. Bailey also serves as Co-Chair of the Electric Power Supply Association 316(b) workgroup and serves as an advisory to EPRI on 316(b). Mr. Bailey has also served as Chair of the Environment Section for Southeastern Electric Exchange and has served as President of the Alliance for the Chesapeake Bay.

## TECHNICAL PAPER

### Abstract

Barrier nets at the Chalk Point Generating Station on the Patuxent River Estuary are deployed to reduce environmental and operational impacts of fish and blue crab impingement. A temporary prototype net was deployed in 1981; a single permanent net, in 1982; and a second (additional) permanent net, in September 1984. The current nets are constructed of woven mesh netting (0.75-in. and 1.25-in stretch mesh width on the inner and outer nets, respectively) suspended on 40-ft pilings at the mouth of the station intake canal that has a maximum depth of 15 feet. The barrier nets cost \$100,000 to install and \$75,000 to \$88,000 for annual operation and maintenance. After deployment of the second net, impingement liability was evaluated based on size and number of organisms impinged as specified in the Code of Maryland Regulations. Prior to the analysis presented in this paper, there was no estimation of overall percent reduction in impingement.

In the current evaluation, percent reduction was estimated by comparing numbers impinged in a 12-month period in 1984 and 1985 (after the second barrier net was deployed) with baseline numbers during an 18-month period in 1976 and 1977 (before deployment of any of the nets). There were 78% and 18% reductions in the impingement of fish and blue crab, respectively. However, these estimates were confounded by changes in river populations. To alleviate this bias, the estimated reductions were adjusted where this could be supported by finding good correlations ( $R$ -square  $> 0.4$ ) between impingement and relative abundance for those individual species representing more than 1% of the impingement totals during both evaluation periods. Of the seven species meeting the 1% criteria, the relationship was judged sufficient for Atlantic menhaden, spot, white perch, hogchoker and blue crab and insufficient for bay anchovy and Atlantic silverside. Proportionally adjusted estimates of reduction for the five species meeting the criteria ranged from 82 to 98%.

### Introduction

The Chalk Point Generating Station (Chalk Point) is currently owned and operated by Mirant Chalk Point, LLC. A barrier net was first deployed at Chalk Point in the summer of 1981, in response to operational problems. The station was experiencing frequent outages during a period of peak energy demand due to condenser blockages by juvenile blue crabs (*Callinectes sapidus*). Subsequently, the barrier net was used to satisfy requirements for Best Technology Available for impingement under Maryland's State 316(b) regulations (Loos, 1986 and 1987, Bailey et. al., 1998). There has also been a retrospective evaluation of decisions related to reducing and mitigating entrainment and impingement impacts at Chalk Point (Bailey et. al, 2000).

This paper will describe the barrier net system development in terms of its design and operation and associated capital and operation and maintenance (O&M) costs. The paper will then discuss the effectiveness of the net and its ability to satisfy the performance standards proposed by the United States Environmental Protection Agency (EPA) in the proposed Phase II existing facilities regulations issued on April 9, 2002 (EPA 2002). Two approaches are used in the evaluation. The first method involves calculating percent reductions for the major fish species (all fish species combined and blue crabs) by comparing impingement levels before and after the installation of the barrier net system. The second method uses relative abundance data from long-term seining and trawling studies to adjust performance estimates for the most commonly impinged species based on their inter-year relative abundance.

### Design, Operation and Maintenance

Chalk Point is located at the confluence of the Patuxent River, a tidal estuary, and Swanson's Creek (Figure 1). Units 1 and 2 of the station use once-through cooling water for condenser cooling. Each unit has two 125,000 gpm circulating water pumps such that the station uses a total of 500,000 gpm with all pumps in operation. Each pump draws water through four traveling screens equipped with 0.375-in sq wire mesh panels.

The first barrier net of the current net system was deployed at the entrance to the intake canal in Swanson's Creek in April of 1982 (a prototype was temporarily installed on hand placed gill net poles from August – October of 1981). It is currently made up of two 275-ft long by 27-ft deep panels supported on forty 10-in pilings. The woven netting mesh width is 0.75-in stretch. A second barrier net, located approximately 100 ft south of the first net, was deployed

in September of 1984 to relieve pressure on the inner net. This outer net currently consists of three panels, 275-ft long. The net is approximately 700-ft long when deployed by 27-ft deep, supported by fifty 10-in pilings. The woven netting mesh width is 1.25-in stretch. Both sets of pilings now have a 4-ft skirt attached along the bottom in the deepest part of the channel to help ensure a good seal during times when there is a lot of pressure on the nets. The skirt is made up of 0.75-in stretch mesh. There is 0.5-in wire mesh fencing located on supports between the shore and the first pilings. The top of each net panel is hung from hooks attached to the support pilings such that there is always several feet of net above the waterline at mean high tide. Each net panel has a chain of 0.19-in galvanized steel to hold the net on the bottom.

The net is located in an area of the Patuxent River where several biofouling organisms are found. The dominant species during peak fouling season are a colonial hydroid (*Garvia franciscana*) and a bryozoan (*Victorella pavidia*). In addition, debris (primarily leaves in the fall) and jellyfish (in the summer) can accumulate on the outer net. To control fouling growth and remove debris and jellyfish, the barrier net panels are changed on a regular basis. All net panels are changed once every two weeks, except in the summer when net changes can take place once or even twice per week at the peak of the biofouling season. The net is changed in a manner such that as panels are unhooked from pilings and peeled away with one boat, another boat comes behind with the replacement net. This minimizes the opportunity for fish or crabs to by-pass the net. The nets have a line of floats attached to the top line which keeps them buoyant during this process. The new net is deployed about 15-ft in front of the pilings and relies on the current to carry it against the pilings. About 6 to 8 ft of net lies on the substrate in front of the pilings to ensure a good seal. It takes approximately 40 minutes to complete a change of the inner net. After the change, divers inspect and adjust the bottom of the nets to insure there is a good seal with the river substrate.

Each fall around mid-November the barrier nets are removed for ten days to two weeks. This is done to prevent impingement of menhaden in the fall. It is believed that small juvenile or late larval stage menhaden go through the net in the spring or early summer and take advantage of the continuous flow of cooling water and associated food supply in the intake canal. They grow quickly, reaching a size of 4 to 6-in by the fall, and are too large to pass back through the net in order to migrate downstream in the fall. Small impingement incidents can occur in late November if the nets are not removed and the fish allowed to escape.

Based on 1984 observations of barrier net performance, significant changes were made to the barrier net system in September of 1984. Inspections in 1984 determined that in eleven of nineteen post deployment dive inspections (conducted a day or so after the net was changed) the barrier net was off the bottom at one or more pilings. To alleviate this problem, a 380-ft skirt of 0.75-in stretch mesh was added along the bottom of the inner pilings. It was further determined that small juvenile crabs could pass through the single 1.25-in stretch mesh net. In September 1984, the mesh size of the net was reduced to 0.75-in stretch (Figure 2) and an outer net of 1.25-in stretch mesh was added. The mesh size of the inner net was now slightly smaller than the 0.375-in stainless steel sq mesh of the traveling screens. The method of net deployment was also changed. The net was deployed 15-ft in front of the pilings and allowed to float back against the pilings, which allowed the bottom of the net to lay on the substrate several feet in front of the pilings and form a good seal. Prior to this, the net was simply dropped directly in front of the pilings, which resulted in gaps under the net in areas where depressions occurred in the substrate. An analysis of performance was conducted following these design and operational improvements. This analysis focused on benthic species like blue crab, hogchoker (*Trinectes maculatus*) and white perch (*Morone americana*) that could have gone under the net or through the larger mesh size in 1984 (Table 2).

Up until 1996 the barrier nets were removed in early December and kept out through late February, due to concern over ice damage. In the late fall of 1996 however, instead of removing both nets, the inner net was left deployed through the winter with the top of the net submerged several feet below the water for a period of six weeks, or as long as there was a threat of the river freezing.

## Costs

The primary capital cost of the barrier net system was installation of the barrier-net support pilings. The 40-ft long pilings were hydraulically sunk into the sediment to a depth of 10-ft leaving 3 to 5-ft of piling above water at mean high tide. The capital cost to install the 90 pilings that make up the barrier net system was \$100,000. The 40 inner net pilings were deployed in 1982 and the 50 outer net pilings were deployed in 1984.

One set of nets (2 inner panels and 3 outer panels) cost approximately \$13,000 and each year one set of replacement nets is purchased, as the life of the nets is about three years. A local contractor performs the barrier net changes and diving inspections. The annual cost of this contract ranges between \$75,000-88,000.

Costs of barrier net systems may vary considerably due to site-specific circumstances. Wisconsin Energy Corporation reports that the barrier net used at its Pine Hydroelectric Facility in northeastern Wisconsin is almost never changed and associated O&M costs are minimal. In addition, since the nets are replaced less frequently, the ultraviolet damage due to exposure to sunlight during the drying process (to remove fouling) is eliminated (Dave Michaud, personal communication). In contrast, the Detroit Edison Company reports significantly higher costs at the Ludington Pumped Storage Plant (jointly owned with Consumers Energy Company) located on Lake Michigan. In this case, a 2.5-mi long barrier net is deployed seasonally from April through October and requires frequent maintenance by divers. The capital cost of this net was \$1.5 million and annual O&M costs are \$1.3 million (Robert Reider, personal communication).

## Effectiveness Evaluation

### Methods

#### 1. Impingement Monitoring Methods

##### *1976-1977 Pre-Barrier Net Impingement Study*

Between June 1976 and November 1977 impingement monitoring was conducted to estimate impingement of fish and blue crab. Two 0.5-h collections, 3 hours apart, were made on each of 6 consecutive days in order to determine diel impingement rates. These samples were followed by a 2 or 3 day period during which no sampling was done and then a new 6-d series began. The time schedule for the collection of the first sample of each in the 6-d series was: 0000 h, 0400 h, 0800 h, 1200 h, 1600 h and 2000 h. After the sixth sampling series, the start time would go back to 0000 h. Unit 1 was sampled first, immediately followed by Unit 2. This procedure was followed for 18 months.

Prior to sampling, the screens were run for 20 to 30 minutes to clean them of debris and impinged organisms. After the initial cleaning, impinged organisms were collected by placing a dip net in the screenwash discharge sluiceway for 0.5-h. The dip net was made of 0.5-in stretch mesh nylon attached to a steel frame made to fit precisely in the discharge trough.

All collected organisms were counted and weighed by species. In addition, up to 50 individuals of each fish species was measured for total length.

##### *1984-85 Post Barrier Net Deployment Impingement Study*

Between March 1, 1984 and September 6, 1985 two methods were used to monitor fish impingement. The first method involved conducting a complete count of all organisms impinged throughout the entire sampling period. The complete count method was an attempt to more accurately determine impingement numbers, specifically for blue crab. Although fish data were also collected, there was concern that, due to screen predation by crabs or deterioration in hot weather, fish counts could be skewed. Therefore, the fish data collected using this method were only used during the period when crabs were less active and the temperatures were below 14 °C. (from November through March). The other method involved sampling one day a week, twice a day, for 0.5 h to monitor impingement rates in a way that could compare current impingement levels to the pre-barrier net levels of the 1976/1977 study.

The complete count was generally conducted by collecting daily samples throughout the study period. Some variances in the sampling regime occurred from March 1 to April 13, 1984 and September 17, 1984 to May 24, 1985 when weekends were included in Monday counts. Also, between June 16 and July 24, 1984, sampling was done twice a day to help evaluate potential losses due to consumption of impinged organisms by blue crab. As in the pre-barrier net study, these samples were collected by deploying a net in the screenwash sluiceways of Units 1 and 2. The collection nets remained deployed however, to insure that, in the event that plant personnel rotated the screens for operational purposes, any fish or crabs washed from the screens would be collected and included in the count. The frame size of these sampling nets was 17-in wide by 27-in high, and the mesh was 0.25-in square.

For impingement rate estimates, 0.5-h daytime and nighttime samples were collected once per week. Collections were scheduled so that there would be complete diel coverage each month. The methods used to collect these samples were the same as those used in the complete counts, except that the screens were rotated for 30 minutes prior to taking the sample in order to clean them of accumulated debris and organisms. This material was still collected and included in the complete count numbers (as were the samples themselves).

#### *1989-1999 Barrier Net Performance Monitoring*

From June 1989 through 1999 qualitative sampling was conducted to monitor barrier net performance. Twenty-four hour samples were collected from the screenwash sluiceway troughs. These samples were collected weekly from Units 1 and 2 until 1991 when sampling was reduced to once every other week. Sampling was further reduced in 1992 to Unit 1 only. The screens would be run to clean them of debris and fish and the final screen would be marked in order to insure that the screens had not been rotated during the 24-h sample period by plant personnel when biologists returned to collect the sample the next day.

## 2. Long-term Relative Abundance Monitoring Methods

Two sources of fish and crab data were used to evaluate barrier net effectiveness in the context of inter-year relative abundance changes: (1) Maryland Department of Natural Resources (MD DNR) juvenile index data for the Choptank and Nanticoke Rivers, the closest permanent juvenile index locations to Chalk Point (Figure 1), and (2) the Chalk Point Patuxent River benthic trawl catch. The MD DNR index is based on 2 seine hauls with a 100-ft bagless seine with 0.25-in bar mesh. Collections are made monthly from July to September. The index value used in the analysis is the geometric mean over 8 stations. The MD DNR data and a more detailed description of methods are available at <http://www.dnr.state.md.us/fisheries/juvindex/index.html>.

The Patuxent River trawl catch data are the mean numbers of fish per minute of trawling over 23 stations for fish and 24 stations for crabs. The trawl was a 16-ft otter trawl with 1.25-in stretch mesh in the body and 0.5-in stretch mesh in the bag. Sampling frequency varied from weekly to monthly from 1982 to 2003 (Loos and Perry, 2001).

## 3. Analytical Methods

The yearly estimates of impingement from 0.5-h samples in the 1976/1977 period were calculated using the formula:

$$\text{Impingement Estimate} = \text{mean \# fish per 0.5 hour} * 2 \text{ units} * 48 \text{ half-hours/day} * 365 \text{ days/yr.}^{(1)}$$

These estimates are for the hypothetical case of full operation of both units year round. In the 1984/1985 period, 0.5-h samples were weighted by the duration of day and night periods. In other words, estimates for day and night periods were computed separately by multiplying by the number of fish and crabs impinged per hour by the number of hours in each diel period and then summing over the diel period. This was not necessary in the 1976/1977 period because the number of samples in each period was proportional to the duration.

More realistic estimates based on actual plant operation and census estimates of impingement were also made for the 1984/1985 period. The census data were considered to provide more reliable estimates because they did not require making the assumption that impingement on a freshly cleaned screen is representative of normal operation. However, the data were used selectively, due to concerns about bias that could result from predation of impinged fish by crabs and from deterioration in hot weather. For purposes of computing annual impingement estimates, the census data were used during the period when crabs were less active and the temperatures were below 14 °C (from November through March). Crab census data were used year round. The composite of 30-m impingement estimates and census estimates were made by summing monthly estimates of impingement over the period that each method was used.

For the purpose of comparing fish impingement relative to barrier net deployment, estimates for individual fish species were computed only for those species that made up more than 1% of impingement levels in the 1976/1977 and 1984/1985 study periods. The blue crab and six fish species met this criterion.

We considered the change in number impinged before and after the net system deployment as the most logical comparison for evaluating the effectiveness of the net system because it allows a direct estimate of percent reduction. However, for that to be a fair comparison, the number of fish and crabs in the river had to be comparable for the before and after periods. That was not the case. Examination of the annual MD DNR juvenile index values for major species with available data showed substantial differences. Therefore we elected to make adjustments in the estimates based on changes in population abundances.

Adjusted estimates of percent reduction were done in two steps. First, an expected impingement in the 1984/1985 period was computed based on fish abundance using the following equation:

$$\text{Expected Impingement in 1984/1985} = \text{Impingement in 1976/1977} * (\text{Juvenile Index in 1984/} \\ \text{Juvenile Index in 1976})^{(2)}$$

Second, the percent reduction was computed using expected and actual impingement in 1984/1985 using this equation:

$$\text{Percent Reduction} = (\text{Expected Impingement} - \text{Actual Impingement}) / \text{Expected Impingement} * 100^{(3)}$$

Population abundance adjustments were made using the MD DNR juvenile index data where it could be shown that there was a reasonably close relationship between impingement and the index. This was judged using R-square values of approximately 0.4 or higher for the Impingement – Juvenile Index regression for log transformed data. The two most abundant fish species in 1976/1977 met this criterion.

The MD DNR juvenile index data were not useful for making adjustments for some species because index data were not available or because there was little or no relationship between the index and impingement data. Therefore, for those species, trawl data were evaluated for inter-year relative abundance adjustments. Blue crab weekly census data for impingement were correlated with weekly trawl catches, while annual impingement for two fish species were correlated with mean trawl catches from May to September.

A limitation of the trawl data is that they were not available for the 1976/1977 study period. Therefore, data from 1984 and 1985 were used to compute percent reduction, since many improvements were made prior to the 1985 crab season. As noted in the description of barrier net deployment, there were many improvements in design and operation of the net that would be expected to reduce impingement between 1984 and 1985, especially for benthic oriented species like blue crab, hogchoker and white perch. The equations used to compute percent reduction were similar to those used for the juvenile index except that the ratio of mean trawl catch in 1985 over mean trawl catch in 1984 was used to compute the expected impingement in 1985. The census data collected between April and August in 1984 and 1985 were used for the impingement numbers.

This analysis would not take into account periods when the barrier net was not deployed. For blue crab, however, there was almost no impingement during this period (winter). For the other species, there could be some overestimate but this can be reduced since the net is now deployed year-round.

## Results

Table 2 provides a summary comparison of the 1976/1977 and 1984/1985 impingement studies. Blue crab were the most commonly impinged organism making up 45.1% of the total impingement in 1976/1977 and 75.3% in 1984/1985 (38.1% using the census data in 1984/1985). Atlantic menhaden (*Brevoortia tyrannus*) were the most commonly impinged fish species making up 56.9% of total fish impingement in 1976/1977 and 36.5% in 1984/1985 (54.1% using the census data in 1984/1985). These two species made up 76.4% of the total impingement prior to and 84.2% (71.6%) of total impingement after deployment of the double barrier net system.

In 1976/1977, spot (*Leiostomus xanthurus*) were the next most abundant fish making up 27.3 percent of total fish, followed by hogchoker (8.1%), white perch (1.8%), bay anchovy (*Anchoa mitchilli*) (1.4%), gizzard shad (*Dorosoma cepedianum*) (1.3%) and Atlantic silversides (*Menidia menidia*) (1.3%). Fish species making up more than 1% of fish impingement in 1984/1985 included hogchoker (21.9%), Atlantic silverside (14.9%), weakfish (*Cynoscion regalis*) (5.5%), spot (3.7%), skillettfish (*Gobiesox strumosus*) (3.3), white perch (2.9), bay anchovy (2.3%) and winter flounder (*Pleuronectes americanus*) (1.7%).

Comparisons of blue crab and fish species that made up more than 1% of fish impingement both before and after the barrier net system was deployment are shown in Figure 3. Based on a simple comparison of impingement samples collected before (1976/1977) and after (1984/1985) the barrier net system was deployed, there was an overall 78% reduction for total fish. There were reductions of 86% for menhaden and 97% for spot, which accounted for 84.2% of fish impingement prior to the barrier net system deployment. Hogchoker, white perch and bay anchovy had reductions of 40%, 64% and 62% respectively. These three species made up 11.3% of fish impingement prior to the net system deployment. Atlantic silversides, however, showed a 162% increase in impingement after the net system deployment and blue crabs, the most commonly impinged organism had a reduction of only 18%.

Table 3 shows the results of correlation analysis conducted to determine if impingement levels of the commonly impinged species could be correlated with either the MD DNR juvenile index or Patuxent River trawl catch. Results of this analysis showed that for Atlantic menhaden and spot there were good and weak correlations, respectively, between the MD DNR juvenile index survey and numbers of fish impinged. Lower or no correlations were found between impingement and the juvenile indices for white perch, bay anchovy and Atlantic silverside. The survey does not include data for blue crab and hogchoker. Applying the adjustment, the barrier net system reduction for Atlantic menhaden was decreased to 85% and for spot increased to 98% (Table 4).

Another method to evaluate the barrier net system performance in the context of inter-year species abundance variability of commonly impinged species was to correlate results with the 1984 and 1985 benthic trawl survey. As indicated earlier in this paper, a single barrier net of 1.25-in stretch mesh was deployed in the summer of 1984. The use of a single net, combined with poor deployment methods frequently resulted in the net having gaps along the bottom which allowed benthic species (in particular) to pass under the net. It is these species that are collected in greatest abundance in benthic trawl surveys. In this analysis, the more accurate complete census impingement data were used for correlation with the benthic trawl data. A good correlation was found for blue crab (Figures 6 and 7) and weaker correlations were found for hogchoker and white perch (Figure 5). The results of estimates of barrier net performance based on adjustments for inter-year relative abundance are shown in Table 4. For all three species the relative abundance was higher in 1985 than in 1984. Figure 7 shows the results of barrier net system performance for the blue crab based on a comparison of 1984 and 1985 weekly impingement census data, versus expected 1985 weekly impingement adjusting for relative abundance using the weekly benthic trawl data. This comparison indicates the barrier net system resulted in an estimated 82% reduction in blue crab impingement. Similar analyses (i.e. based on annual impingement and trawl data rather than weekly data) for hogchoker and white perch indicated reductions of 83% and 95%, respectively (Table 4).

Atlantic silverside impingement numbers could not be correlated with the MD DNR juvenile index and they were not effectively collected in benthic trawl samples. However, it is important to note that in 1984/1985 the barrier net system was deployed on a seasonal basis; being removed in December and re-deployed in late February or early March due to concern over ice damage. Analysis of impingement samples on a weekly basis determined that 95% of the Atlantic silverside impingement occurred in the winter during the period of net system removal. The Atlantic silverside 1984 and 1985 complete census data were compared to evaluate the benefit of the double barrier net system during the periods when the net was deployed in those years. There were 58% fewer of this species impinged in 1985 after the double barrier net system was deployed.

Bay anchovy impingement samples also could not be correlated with either MD DNR juvenile index or trawling samples. A comparison of the 1984 and 1985 census data showed a 55% reduction in observed impingement.

### **Discussion**

Based on impingement reductions reported, the barrier net was determined to satisfy 316(b) requirements under Maryland State regulations (Loos 1987). The Maryland impingement reduction regulations are based on American Fisheries Society replacement value costs rather than a numeric reduction in impingement. In addition to providing a fish and shellfish protection benefit, Chalk Point personnel have reported that the technology has been beneficial in terms of preventing outages due to condenser blockage by aquatic organisms or debris that by-passes the traveling screens (Loos 1986).

The primary cost component of the operation and maintenance of this technology is the cost for barrier net changes to control biofouling and debris. This cost runs approximately \$75,000 to \$88,000 per year at Chalk Point and[but] can be substantially higher or lower depending on site-specific circumstances.

It is important to consider the barrier net system performance in the context of the current EPA rulemaking. EPA proposed Phase II regulations for existing generating stations on April 9, 2002 (US EPA 2002). The regulations propose performance standards that require reducing impingement by 80-95% for all generating stations that use more than 50 mgd and use greater than 25% of their water for cooling and do not employ wet closed-cycle cooling. Facilities on oceans, tidal estuaries and the Great Lakes as well as facilities on non tidal rivers that use more than 5% of the mean annual flow of the source water are also required to reduce entrainment by 60-90%.

EPA identified the barrier net as a technology for meeting the impingement performance standard in both the Phase II proposal and the Notice of Data Availability (NODA) issued March 19, 2003 (US EPA 2003). The results of the Chalk Point barrier net system provide support that the technology can satisfy the performance standard. However, application of the technology should be evaluated on a site-specific basis. Success of the barrier net system at Chalk Point required modifications based on site-specific conditions and impinged species specific to that river system. The Chalk Point barrier net system continues to be evaluated as to improvements that will reduce cost and/or improve effectiveness.

EPA's proposed impingement performance standard is based on requiring a reduction in impingement mortality rather than a reduction in impingement numbers. The Academy of Natural Sciences of Philadelphia (ANSP), which conducted the 1976/1977 impingement studies at Chalk Point, used impingement survival studies conducted at the Calvert Cliffs Nuclear Generating Station, located on the main-stem Chesapeake Bay, to make observations of impingement survival for Chalk Point. In addition, some effort was made to estimate impingement survival of blue crab during studies conducted by Pepco at Chalk Point. The blue crab was not only the primary organism impinged, but it also accounted for the major economic value of impingement losses under Maryland's 316(b) regulations. Studies showed a 5% immediate impingement mortality for blue crab with an estimated overall mortality of approximately 15% (ANSP 1983). This was seemingly due to thermal exposure (and possibly exposure to biocide) as a result of returning impinged crabs to the heated discharge canal; therefore, mortality beyond the immediate losses was considered a function of discharge temperature and biocide use. The hogchoker also had a very high



impingement immediate survival rate, estimated to be in the range of 99%, although mortality in the discharge canal was not estimated.

The Chalk Point barrier net system study results point out several issues related to impingement monitoring relative to EPA's proposed rule and the NODA. The first is the importance of being able to relate pre and post barrier net deployment impingement figures to the inter-year variability of the most commonly impinged species. Failure to account for inter-year variability of the major species impinged could significantly under or over estimate the technology's performance in the context of the proposed performance standard. This is especially true in estuarine environments, such as the tidal Patuxent River where Chalk Point is located, due to salinity changes that affect species composition, in addition to normal fluctuations in fish and crab populations. In the case of Chalk Point, there would have been a significant underestimate of performance for the most commonly impinged species (blue crab), as well as hogchoker and white perch, if the performance evaluation had simply been limited to a comparison of impingement numbers before and after the net system was deployed.

A second point is that it is simply not practical to evaluate barrier net effectiveness in terms of the performance standard for each impinged species. Skilletfish, for example, were not collected in the 1976/1977 study, but in the post barrier net system deployment sampling they ranked sixth in terms of the most frequently impinged fish. Similarly, gizzard shad ranked sixth in terms of the most frequently impinged fish with an estimated 31,000 impinged in 1976/1977. However, so few were impinged in 1984/1985, the reduction would be estimated to be well over 99% (probably an overestimate). In both instances, precise quantitative conclusions would be unwarranted due to increased uncertainty in years of low relative abundance.

A third point is the importance of proper selection of the methods used to quantify impingement levels. As noted in Table 2, the estimation samples significantly overestimated impingement compared to the census method samples. This phenomenon is discussed in more detail by Bailey et al (1998). The use of the estimation method would be appropriate if the screens at a facility were rotated on a continuous basis. However, this method will lead to an overestimate of impingement at facilities such as Chalk Point, where screens tend to be rotated only once per day.

Ideas are being considered to further improve the performance of the barrier net at Chalk Point. One idea is to use 0.75-in stretch mesh for both the inner and outer nets to provide additional protection for small crabs and fish. It might be possible to even further reduce the mesh size to provide protection to larger entrainable organisms. A barrier net cannot achieve protection for all life stages, but protection for larger entrainable organisms combined with other technologies or measures, could be a viable compliance strategy under EPA's proposed Phase II rules. Another idea being considered for the Chalk Point barrier net system is to devise an escape mechanism for trapped menhaden that would eliminate the need for temporary net removal in the fall. The fall is a time when leaves make up a large component of the screenwash, even with the barrier nets deployed. When the nets are out, leaf impingement can become so heavy that there is carry over behind the screens or backpressure created by screen blockages (Chalk doesn't rotate their traveling screens continuously). By not pulling the net, even for the week or 10 days that is required for menhaden migration out of the canal, the plant could alleviate the operational issues that arise with such heavy impingement episodes.

Finally, it is important to note that site-specific circumstances may preclude use of barrier nets. An attempt was made to deploy a barrier net at the Morgantown Station on the lower Potomac River where there is a curtain wall in front of the facility's intake. Delivery of fuel by barge precluded deployment of a barrier net outside the curtain wall, while the currents inside the curtain wall prevented successful deployment of a barrier net there. At other locations, proximity of the intake to navigation channels or deployment in areas with rapid currents or high debris loads could prevent their use.

### **Summary and Conclusions**

In summary, the barrier net, depending on site-specific circumstances, can be a cost effective technology to meet EPA's proposed impingement performance standards or as a component of an overall compliance strategy to satisfy

requirements for facilities subject to both impingement and entrainment performance standards. When using a barrier net it is important to establish the calculation baseline prior to net deployment and collect inter-year variability data on the most commonly impinged species in order to evaluate performance in the context of source water body population fluctuations. It is also important to recognize that the barrier net system is likely to require modifications on a site-specific basis to provide protection for the species of concern.

**References**

ANSP, 1983. Impingement. In: Chalk Point Station 316 demonstration. Technical reports. Vol. III, pp 123-196. Prepared by Academy of Natural Sciences of Philadelphia, Benedict Estuarine Research Laboratory, Benedict, MD.

Bailey D. E., J. J. Loos, and E. S. Perry, 1998. Studies of Cooling Water Intake Structure Effects at Potomac River Generating Stations. EPRI Clean Water Act Section 316(b) Technical Workshop. Coolfont Conference Center, Berkely Springs, WV. Sept. 1998

Bailey D. E., J. J. Loos, E. S. Perry, R. J. Wood. 2000. A retrospective evaluation of 316(b) mitigation options using a decision analysis framework. Environmental Science and Policy, 3 (Supplement 1): S1-S36

Loos, J. 1986. Evaluation of Benefits to Pepco of Improvements in the Barrier Net and Intake Screens at Chalk Point Station between 1984 and 1985. Environmental Affairs Group, Potomac Electric Power Company, Washington DC. June 1986.

Loos, J.J. 1987. Chalk Point Station intake liability values computed after deployment of a second barrier net at the mouth of the intake canal and after discontinuation of auxiliary tempering pump usage. Environmental Affairs Group, Potomac Electric Power Company, Washington DC.

Loos, J. J. and E. S. Perry, 2001. Chalk Point Station. Analysis of fish distribution relative to the Unit 1 and 2 thermal discharge 1991 – 2001. Environmental Compliance Support, Mirant Mid-Atlantic, LLC, Upper Marlboro MD. March 2001.

US EPA, 2002. National Pollutant Discharge Elimination System - Proposed Regulations to Establish Requirements for Cooling Water Intake Structures at Phase II Existing Facilities; Proposed Rule Federal Register 67(68): 17122-17225.

US EPA, 2003. National Pollutant Discharge Elimination System – Proposed Regulations to Establish Requirements for Cooling Water Intake Structures at Phase II Existing Facilities; Notice of Data Availability; Proposed Rule, Federal Register 68(53): 13522-13587.

Tables

**Table 1.** Primary changes in barrier net deployment from 1982 to 2002.

Change	Before Sept. 1984	After Sept. 1984	1996 to 2002
# Barrier Nets	One Net	Two Nets	Same as 1985
Mesh Size	1.25-in Stretch Mesh	<b>Outer net - 1.25-in stretch mesh</b> Inner net - 0.75-in stretch mesh	Same as 1985
Sealing Skirt	None	Inner net only	Inner net and outer net
Sealing Net Deployment	None	Net deployed 15 ft in front of pilings. 6-8 ft drape on substrate	Same as 1985
Seasonal Deployment	Removed in winter	Removed in winter	Year round deployment

**Table 2.** Estimated numbers of fish and crabs impinged before barrier net deployment (1976/1977) compared with estimated numbers after net deployment (1984/85). In the 1984/1985 period there were two estimation methods: The 0.5-h sample estimate was based on the same methods used in the 1976/1977 period; the combination estimate was based on a combination of 0.5-h sample estimates from April to October for fish, census estimates from November to March for fish and census methods year round for crabs. The sample estimate is based on assumed full unit operation. The combination estimate is based on actual operation.<sup>a</sup>

1976/1977 Sample Estimate			1984/1985 Sample Estimate			1984/1985 Combination Estimate		
Dominate Species <sup>b</sup>	#s	% <sup>c</sup>	Dominate Species <sup>b</sup>	#s	% <sup>c</sup>	Dominate Species <sup>b</sup>	#s	% <sup>c</sup>
<b>Blue Crab</b>	1,948,132	45.1	<b>Blue Crab</b>	1,599,762	75.3	<b>Blue Crab</b>	164,738	38.1
<b>Fish:</b>			<b>Fish:</b>			<b>Fish:</b>		
1. <b>Atlantic menhaden</b>	1,347,490	56.9	1. <b>Atlantic menhaden</b>	191,753	36.5	1. <b>Atlantic menhaden</b>	144,558	54.1
2. <b>Spot</b>	647,016	27.3	2. <b>Hogchoker</b>	115,205	21.9	2. <b>Hogchoker</b>	19,019	7.1
3. <b>Hogchoker</b>	191,926	8.1	3. <b>Atlantic silverside</b>	78,472	14.9	3. Weakfish	17,336	6.5
4. <b>White perch</b>	41,910	1.8	4. Weakfish	28,707	5.5	4. <b>Atlantic silverside</b>	14,195	5.3
5. <b>Bay anchovy</b>	32,206	1.4	5. <b>Spot</b>	19,531	3.7	5. Skilletfish	12,129	4.5
6. Gizzard shad	31,026	1.3	6. Skilletfish	17,326	3.3	6. <b>White perch</b>	10,459	3.9
7. <b>Atlantic silverside</b>	29,908	1.3	7. <b>White perch</b>	15,210	2.9	7. <b>Bay anchovy</b>	10,327	3.9
			8. <b>Bay anchovy</b>	12,192	2.3	8. <b>Spot</b>	9,170	3.4
			9. Winter flounder	8,914	1.7	9. Winter flounder	8,794	3.3
						10. Naked goby	7,534	2.8
						11. Mummichog	6,888	2.6
Fish >1% of total fish	2,321,482	98.0		487,310	92.5		260,409	97.4
32 other fish species	46,842	2.0	37 other fish species	38,149	7.3	40 other fish species	6,959	2.6
Total fish	2,368,324	54.9		525,459	24.7		267,368	61.9
Total organisms	4,316,456			2,125,221			432,106	

<sup>a</sup> The combination estimate was submitted to Maryland regulators as the best estimate of actual impingement. There was no comparable estimate for the baseline period in 1976/1977, so no overall percent reduction was computed.

<sup>b</sup> Fish species with impingement greater than 1% of total fish impingement are included. Species listed in bold font were greater than 1% of total in both sampling periods.

<sup>c</sup> For blue crab and total fish, percent impingement is based on total organism impingement. For individual fish species, percent impingement is based on total fish impingement.

**Table 3.** Results of regression analysis of impingement vs. measures of river population abundance.

Species	Years	Dependent Variable	Independent Variable	Parameter Value	P-Value	R <sup>2</sup>
Atlantic Menhaden	1985-1999	Imp. Sample <sup>a</sup>	Juvenile. Index <sup>a</sup>	1.382	0.0001	0.68
Bay Anchovy	"	"	"	-0.765	0.0106	0.36
Atlantic Silverside	"	"	"	0.055	0.8879	0
White Perch	"	"	"	0.184	0.1122	0.18
Spot	"	"	"	0.829	0.0037	0.49
Atlantic Menhaden	1985-1999	Imp. Sample <sup>1</sup>	Trawl Catch <sup>1</sup>	0.660	0.6721	0.02
Bay Anchovy	"	"	"	-0.622	0.0554	0.27
Atlantic Silverside	"	"	"	-0.616	0.7995	0
White Perch	"	"	"	0.340	0.0088	0.42
Spot	"	"	"	0.318	0.0064	0.45
Hogchoker	"	"	"	0.402	0.0026	0.52
Blue Crab	1984/1985	Weekly Imp. Census (x 1000)	WeeklyTrawlCatch Year 1984=1; 1985=2 TrawlCatch*Year	1.8684 15.554 -0.917	<0.0001 0.0246 <0.0001	0.79

<sup>a</sup> Log<sub>10</sub> Transformed

**Table 4.** Unadjusted and adjusted estimates of percent reduction in impingement following barrier net deployment.

Species	Impingement Reduction Based on Raw Data	Impingement Reduction Adjusted for Inter-Year Relative Abundance
<i>Blue crab</i>	18%	82%
<i>Atlantic menhaden</i>	86%	85%
<i>Spot</i>	97%	98% <sup>a</sup>
<i>Hogchoker</i>	40%	83%
<i>White perch</i>	64%	95% <sup>a</sup>

<sup>a</sup> R square less for impingement vs. abundance regression less than 0.5 (0.45 for spot and 0.42 for white perch).

**Figure Captions**

Figure 1. Map showing location of Chalk Point Generating Station and River Population Monitoring Stations

Figure 2. Barrier net system as deployed in 1985.

Figure 3. Impingement before (1976/1977) and after (1984/1985) barrier net deployment reduction and unadjusted (raw) percent reduction after deployment.

Figure 4. Plot of impingement vs. Maryland Juvenile Index for Atlantic menhaden and spot. Trace indicates predicted value from regression analysis.

Figure 5. Plot of impingement vs. benthic trawl for white perch and hogchoker. Trace indicates predicted value from regression analysis.

Figure 6. Plot of weekly impingement vs. mean weekly trawl catch for blue crab. Trace indicates predicted value from regression analysis.

Figure 7. Observed weekly impingement in 1984 and observed and predicted weekly impingement in 1985 with predicted impingement based on river population abundance

Figures

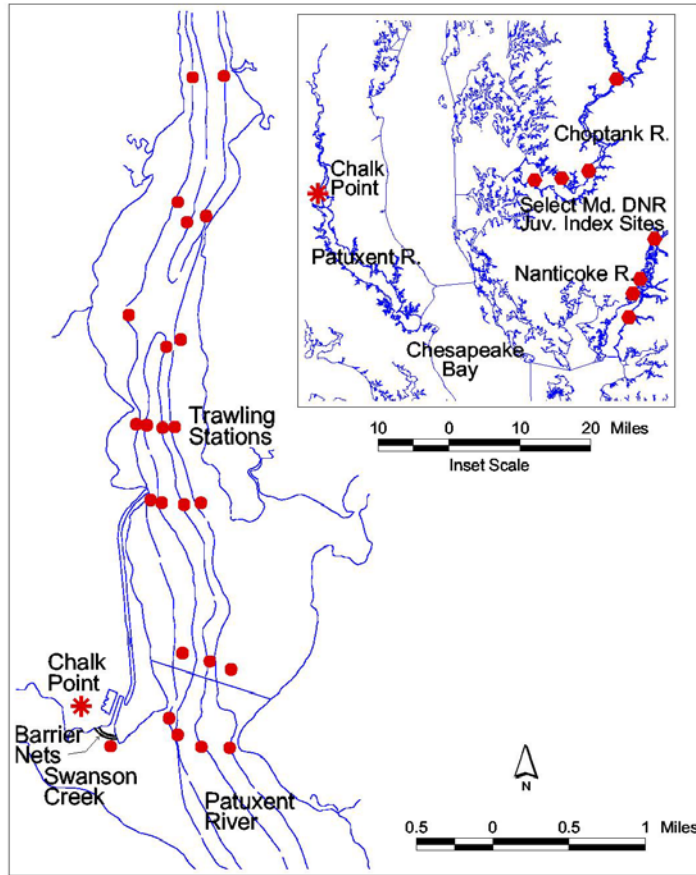


Figure 1. Map showing location of Chalk Point Generating Station and River Population Monitoring Stations

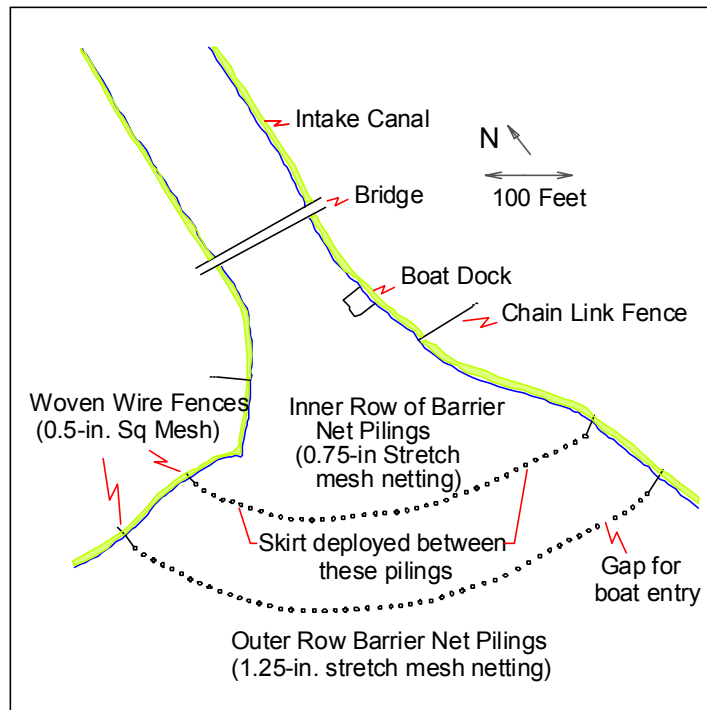
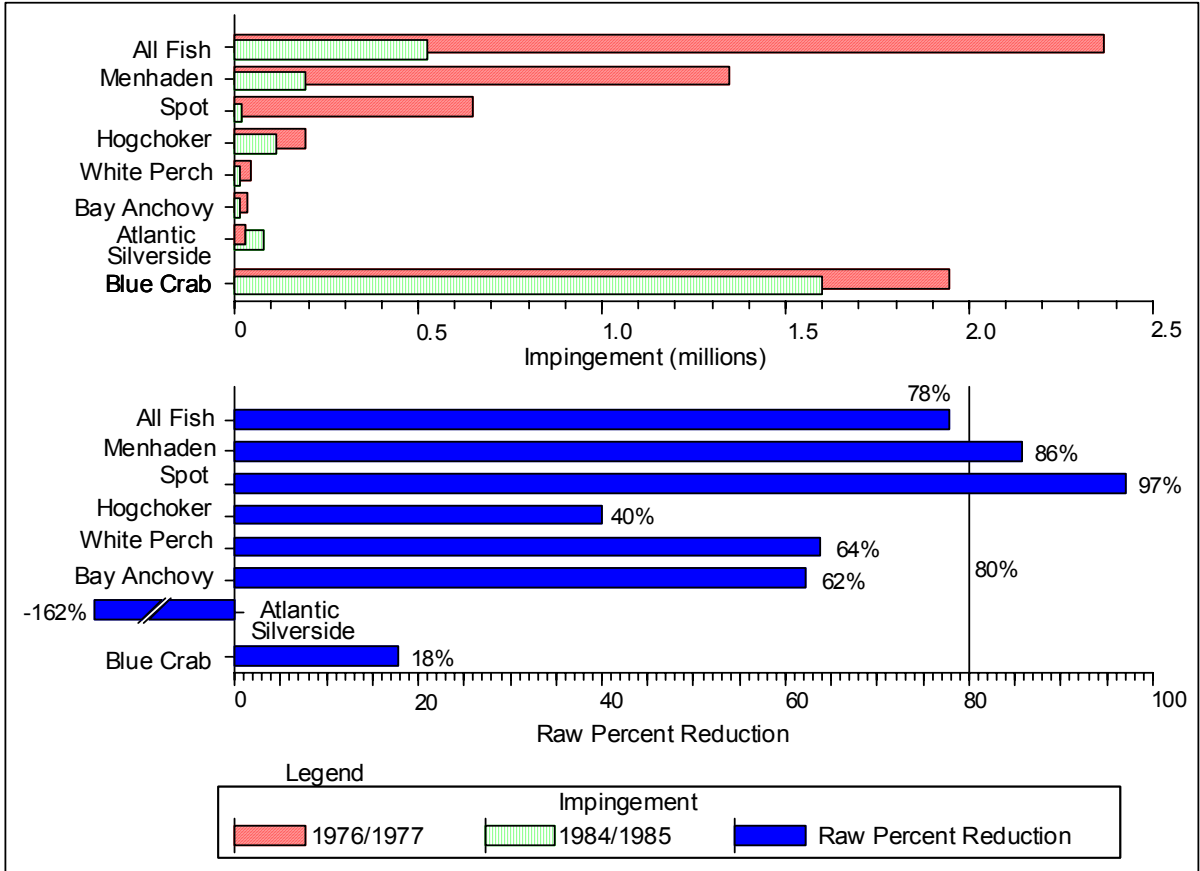
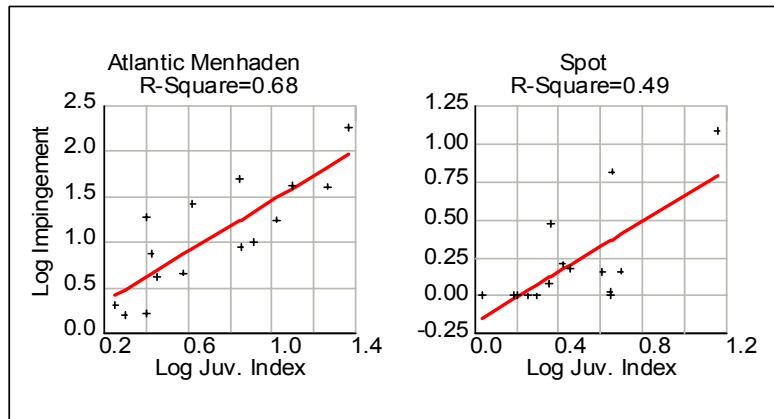


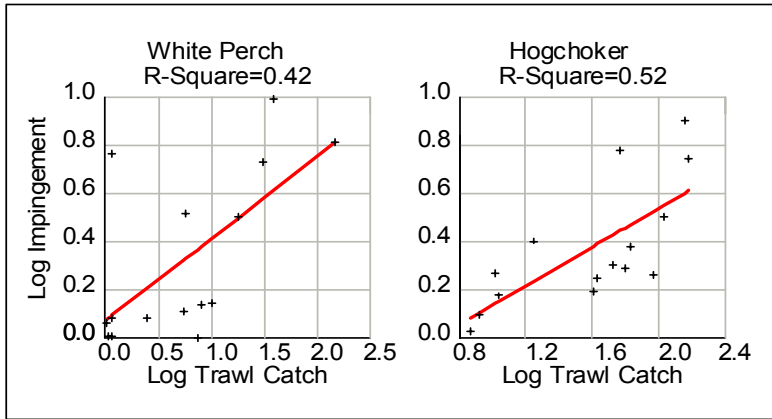
Figure 2. Barrier net system as deployed in 1985.



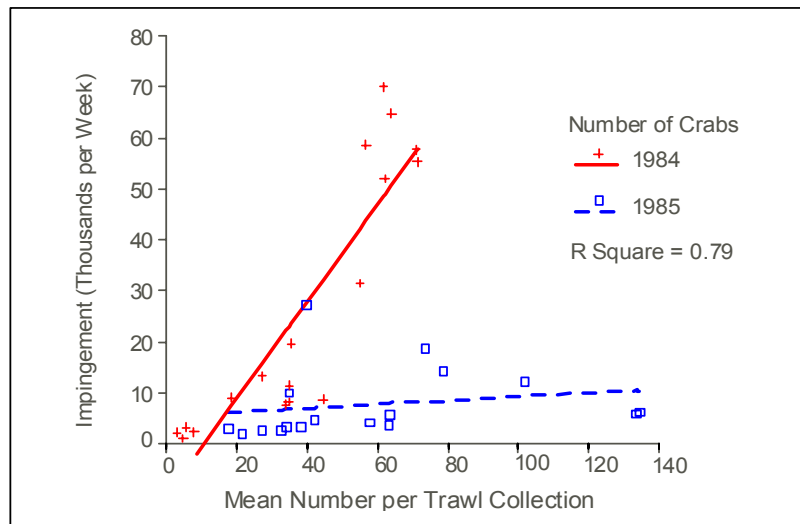
**Figure 3.** Impingement before (1976/1977) and after (1984/1985) barrier net deployment reduction and unadjusted (raw) percent reduction after deployment.



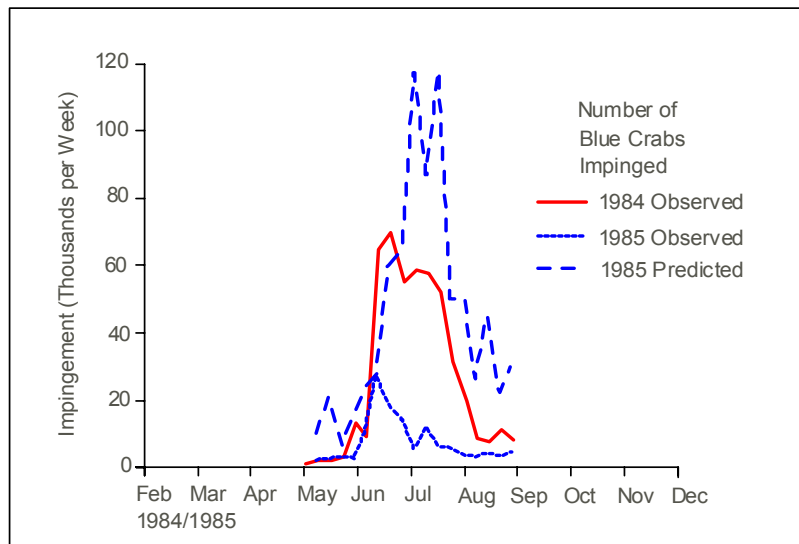
**Figure 4.** Plot of impingement vs. Maryland Juvenile Index for Atlantic menhaden and spot. Trace indicates predicted value from regression analysis.



**Figure 5.** Plot of impingement vs. benthic trawl for white perch and hogchoker. Trace indicates predicted value from regression analysis.



**Figure 6.** Plot of weekly impingement vs. mean weekly trawl catch for blue crab. Trace indicates predicted value from regression analysis.



**Figure 7.** Observed weekly impingement in 1984 and observed and predicted weekly impingement in 1985 with predicted impingement based on river population abundance

*Reductions in Impingement Mortality Resulting from Enhancements to Ristroph Traveling Screens at an Estuarine Cooling Water Intake Structure  
Kenneth Strait, PSEG Services Corporation*

**BIOSKETCH**

Mr. Kenneth Strait is the Project Manager for the Public Service Enterprise Group Estuary Enhancement Program and is responsible for the ongoing cooling water intake studies, wetland restoration efforts, fish ladder installations, and biological monitoring programs associated with PSEG's Salem Generating Station. Ken received his B.S. and M.S. in Wildlife Resources from West Virginia University and is pursuing his Ph.D. in Ecology at Rutgers University. He has been involved in cooling water intake, Section 316(b), and related fisheries research for 20 years. The Estuary Enhancement Program (EEP) is the largest privately funded wetland restoration program in the country. It includes a combination of environmental and technological enhancements designed to reduce and offset potential adverse environmental impacts of the Salem Generating Station cooling water intake.

**TECHNICAL PAPER**

**Abstract**

In 1995, the Public Service Enterprise Group (PSEG), PSEG Nuclear LLC, initiated several improvements to the Ristroph traveling screens at its cooling water intake structure (CWIS) for the two-unit Salem Generating Station (Salem) in New Jersey. The facility is located on the Delaware Estuary. CWIS modifications included a redesigned fish bucket to prevent escapement, a smooth woven screen mesh with rectangular pore openings and improved fish return troughs. Improvements were completed for Unit 2 in July of 1995 and for Unit 1 in February of 1997.

Impingement mortality associated with the modified traveling screens was monitored by collecting impinged fish and holding them for 48 h to evaluate latent impingement mortality (LIM). The effectiveness of the modified screens for reducing impingement mortality was generally high, but dependent on species and months. For striped bass, white perch and spot, overall impingement mortality was low with an average annual mortality of less than 10% (4.7%, 6.3%, and 6.7%, respectively). For other species, such as Atlantic croaker and blueback herring, annual mortality estimates were higher at 22.6%, and 27.4%, respectively. Weakfish and bay anchovy annual impingement mortality estimates (47.8% and 58.0%, respectively) while higher, have improved from historical values.

In 2001, studies were initiated to identify components of the CWIS fish return system, independent of the traveling screens, which could contribute to impingement mortality. Two potential stressors, the fish collection and counting pool, and the terminus of the fish return discharge pipe, were evaluated using computational fluid dynamics ("CFD") modeling, live fish testing in a scale model, and live fish testing at the Salem CWIS. Results indicated that these components of the fish return system were not significant contributors to overall mortality.

**Introduction**

The Salem Generating Station (Salem) is located on a peninsula known as Artificial Island on the eastern shore of the Delaware Estuary, 50 miles northwest of the mouth of the Delaware Bay and 30 miles southwest of Philadelphia, PA. Artificial Island is bordered by the Delaware River on two sides and by extensive marshes and uplands on the other side. Salem Units 1 and 2 are identical pressurized water reactors, each with a net-rated electrical output of 1,162 Mwe. Units 1 and 2 began commercial operation in 1977 and 1981, respectively.

The station was sited to take advantage of the large volume of relatively low temperature cooling water. The rated flow for both units with all twelve pumps operating is 3,168 million gallons per day (mgd). Under its New Jersey Pollution Discharge Elimination System (NJPDES) Permit, Salem is limited to a monthly average rate not to exceed 3,024 mgd. Water is withdrawn from the Delaware River through a shoreline intake structure divided into 12 intake bays. Each bay is 11.5 ft wide at the entrance with a designed water depth ranging from 31 to 50 ft depending on tide



(and factors influencing tides). This configuration results in an average intake bay entrance design approach velocity of 0.87 feet per second (fps) at mean high tide and 1.0 fps at mean low tide.

There are 12 traveling screens (one per intake bay) in the CWIS. The screens rotate continuously to minimize the time during which organisms may be impinged. Each screen basket base is fitted with a lip, which creates a water-filled bucket. Estuarine organisms are captured in the buckets that are emptied into an upper fish return sluiceway (part of the fish return system) behind the screens. The transfer of fish from the screens to the sluiceway is assisted by internal and external spray wash nozzles. Debris remaining on the traveling screen is removed into a separate, lower debris removal sluiceway equipped with a high pressure spray wash. Fish and debris trough spray wash pressures are maintained at 15 - 20 psi and 100 psi, respectively. The upper (fish) and lower (debris) sluiceways join outside the CWIS and the combined trough returns fish to the estuary. The fish return points are located approximately 50 ft north of the CWIS intake on flood tide and approximately 50 ft south of the CWIS on ebb tide, to minimize the potential for re-impingement. The re-impingement rate is estimated at 10% based historical studies using preserved, dyed fish.

In July of 1995, PSEG, in compliance with the 1994 NJPDES permit for Salem, completed the installation of six newly modified traveling screens at the Unit 2 intake. Modification of the Unit 1 traveling screens was completed by February 1997, following operational and biological testing of the modified Unit 2 screens. Composite material was used in place of the existing stainless steel for the construction of the fish buckets. This significantly reduced the weight of each screen panel. The lighter weight enabled the maximum speed of the traveling screens to double from 17.5 to 35 feet per minute (fpm). The leading edge of the bucket is also formed into a hydrodynamic inward-bending shape that eliminated turbulence in the bucket, which could damage fish.

New screen mesh was installed with a flat smooth mesh face and 0.25 in x 0.5 in openings (vs. 0.375 in x 0.375 in for the old screens). The size of the mesh wire was reduced, increasing the open area by approximately 25%. Eight spray nozzles were added to the inside spray wash headers to provide a more efficient and even spray pattern. Debris shields were added above the spray nozzles to keep them free of debris. Flap seals separating the fish and debris troughs were redesigned to maintain a closer fit to the traveling screens. All of these modifications were designed to improve fish survival after exposure to the traveling screens (Ronafalvy et al., 2000).

To assess the effectiveness of the modified screens for increasing fish survival, estimates of impingement mortality for the modified screens were compared to estimates of impingement mortality with the original screens. This assessment approach relied on empirical observations of the mortality of fish impinged on the traveling screens. The effectiveness of the modified intake screens was evaluated in terms of the percent change in impingement mortality.

## **Methods**

### 1995 Direct Comparison Study

The 1995 Direct Comparison Study was a side-by-side study, with the six original Ristroph screens on Unit 1 and the modified screens on Unit 2. Samples were collected concurrently from both units. Impingement survival samples were collected on 19 separate dates between June 20 and August 24, 1995. Each sampling period began 2 h before high slack water and ended 2 h after low slack water in order to encompass the entire ebb tide, during which impingement was historically the highest. Fish were collected and placed in holding tanks to determine latent impingement mortality (LIM). Targeted species for this study were weakfish, bay anchovy (*Anchoa mitchilli*), and spot (*Leiostomus xanthurus*).

Combined fish trough and debris trough wash water from each unit was diverted to the respective collecting pools, typically for four to six minutes. Stop-gates were closed in both the fish and debris troughs between the two units so that the combined screen wash from the original intake screens discharged to the north collecting pool and the combined wash from the modified screens discharged to the south collecting pool. Samples were taken from the pools for both units simultaneously.

At the time of collection, investigators classified fish by condition category (i.e., live, damaged, or dead), and after approximately 12, 24 and 48 h of holding, mortality was assessed. Fish initially classified as “damaged” were included in the investigation of latent mortality. Mortality studies were conducted at the station in three 100 gal tanks filled with filtered river water from the wash-water return trough. The tanks were equipped with filters, heaters, and aeration. Water temperature, salinity, and dissolved oxygen concentration were measured daily.

1997 – 2000 Studies

Studies conducted from 1997 through 2000 provided estimates of impingement mortality with the modified screens installed on both units. These estimates were compared with the estimates obtained between 1978 and 1982 when both units had the original screens. This study expanded the targeted species beyond weakfish, bay anchovy, and spot, to develop pooled, new screen LIM estimates for other Representative Important Species (RIS) for Salem. The additional RIS evaluated were alewife (*Alosa pseudoharengus*), blueback herring (*A. aestivalis*), American shad (*A. sapidissima*), white perch (*Morone americana*), striped bass (*M. saxatalis*) and Atlantic croaker (*Micropogonias undulatus*).

As in the 1995 study, test fish that were not dead upon collection were moved into tanks for observation. The number of dead fish in the tanks was counted at approximately 24 and 48 h, and fish lengths were measured at mortality or at the termination of the test at 48 h. Temperature, salinity and ammonia concentration were measured at 24 and 48 h.

**Results**

1995 Direct Comparison Study

In 1995 a total of 2,641 juvenile weakfish was collected from the pools, 1,082 from the north pool (original screens) and 1,559 from the south pool (modified screens). In samples collected from the original screens, 50 juvenile weakfish were dead initially, and 228 and 157 were found dead at 24 and 48 h, respectively. Fifty-one fish were not accounted for at the termination of the mortality experiments. These fish may have been missing due to miscounts, predation by cats, cannibalism, escape from the tanks, and/or other unknown causes. A total of 1,031 fish was the basis for mortality estimates for the original screens. In samples from the modified screens, 70 weakfish were dead initially, and 145 and 88 were found dead at 24 and 48 h, respectively. At the termination of the tests, 97 fish had not been accounted for, leaving a total of 1,462 fish on which to base mortality estimates. Only weakfish were collected in sufficient numbers for reliable estimates of impingement mortality.

Weakfish estimates for the modified screens ranged from 17% in June to 25% in August. For the original screens, the weakfish estimates ranged from 31% in July to 51% in August (**Table 1**).

**Table 1** – Summary of results from the 1995 Direct Comparison Study – Original Screens versus Modified Screens

MONTH	Original Screens		Modified Screens	
	Number of fish examined	Impingement Mortality Rate	Number of fish examined	Impingement Mortality Rate
June	111	33%	366	17%
July	367	31%	473	18%
August	553	51%	623	25%
<b>TOTAL</b>	1031	42%	1462	21%

1997 - 2000 Study

The 1997 - 2000 estimates of impingement mortality are based on a total of 103,956 fish examined during the experiments: 10,235 bay anchovy; 4,741 alosids (blueback herring, alewife and American shad combined); 132 spot; 25,757 white perch; 1,505 striped bass; 26,400 weakfish; and 35,186 Atlantic croaker. Mortality rates for the nine RIS impinged at Salem are presented in Table 2. The monthly impingement mortality estimates for the most abundant species collected ranged from 1% to 34% for white perch, 10% to 65% for weakfish, 27% to 84% for bay anchovy and, 4 % to 45% for Atlantic croaker.

**Table 2** - Mortality Rate Ranking (Lowest to Highest) for RIS Species Based on 1997 through 2000 Data

RANK	SPECIES	ANNUAL MORTALITY* (%)	MINIMUM (%)	MAXIMUM (%)	TOTAL NUMBER SAMPLED
1	Striped Bass	4.66	2.10	6.87	1,505
2	White Perch	6.29	0.95	33.63	25,757
3	Spot	6.67	--	--	132
4	Atlantic Croaker	22.64	3.86	44.86	35,186
5	American Shad	23.95	--	--	40
6	Blueback Herring	27.39	14.11	43.38	4,150
7	Alewife	39.15	17.41	43.01	551
8	Weakfish	47.77	10.28	65.25	26,400
9	Bay Anchovy	58.02	27.48	83.97	10,235

\* Calculated from abundance-weighted monthly mortality estimates.

The estimate for spot was 7% (only one month had a sufficient number of spot collected). Insufficient numbers of blueback herring, alewife, and American shad were collected for monthly species-specific estimates. Collections of these three species were pooled to produce generic monthly mortality rate estimates that ranged from 14% to 43% .

Abundance-weighted annual mortality rates for striped bass, white perch, and spot were relatively low (4.7%, 6.3%, and 6.7%, respectively). With the exception of bay anchovy, the abundance weighted annual mortality rates for the remaining RIS were lower than 50% (Atlantic croaker – 22.6%, American shad – 24.0%, blueback herring – 27.4%, alewife – 39.2%, weakfish – 47.8%). Annual mortality for the bay anchovy was 58.0%.

The aggregated results from the 1995 and the 1997 - 2000 impingement mortality analyses for the modified screens and the 1978 – 1982 mortality estimates for *Alosids*, Atlantic croaker, bay anchovy, spot, weakfish, and white perch are presented in Figures 1 through 6, respectively.<sup>1</sup> Each figure depicts: 1) the 1995 - 2000 impingement monthly mortality estimates for the modified (new) screens in months with sufficient data for *month-specific* estimates, 2) the 1978 - 1982 impingement mortality estimates for the original (old) screens in months with sufficient data for month-specific estimates, and 3) the average monthly impingement density (i.e., number of fish per volume of water withdrawn by the station), on a relative scale, to indicate the months of higher and lower impingement densities.

### Evaluation of Fish Return System

Despite improvement to fish survival with the installation of the modified screens, PSEG investigated potential sources of fish mortality within the CWIS fish return system. The 2001 NJPDES Permit for Salem required investigation of possible enhancements to the intake or fish return system to further reduce fish mortality. In late 2001, studies were initiated to identify components of the CWIS fish return system, independent of the traveling screens, which could contribute to impingement mortality. The fish return system was examined with the intention to quantify stressors documented to have deleterious effects on fish. These stressors included turbulence, shear, impact, pressure change, and abrasion.

Two areas of the Salem fish return system, the fish collection and counting pool and the terminus of the fish return discharge pipe, were identified as potential sources of significant stress. These system components were first evaluated using computational fluid dynamics (CFD) modeling to quantify probable levels of shear and turbulence. In addition, live fish testing with alewife in a scale model and live fish testing with alewife and weakfish at the Salem CWIS were conducted to assess the effects of stressors associated with these system components.

<sup>1</sup> Because of historically low abundance and the absence of mortality data for the period 1978 – 1982, a figure illustrating relative mortality rates for striped bass is not presented.

The existing end-of-pipe configuration (40 in diameter round pipe, sub-surface discharge, normal flow = 13cfs) and alternatives to the existing end-of-pipe discharge configuration were tested to determine if a freefall discharge could improve survival. In addition, the fish counting pool was modeled under various flow regimes and with varying amounts of cushion water (25 cm and 50 cm) to determine if a component of reported LIM estimates was due to collection stress. Results of the live fish testing indicate that these components of the fish return system are not significant contributors to overall mortality (i.e. survival approaches 100% for the 48 h LIM observation period). The results of the live fish testing to evaluate the “end-of-pipe” and fish collection pool mortality are summarized in Tables 3 and 4.

**Table 3** - Estimates of survival from the pooled replicates by treatment, 1 h, 24 h, and 48 h post-collection for the end-of-pipe experiment. Standard errors are in parentheses.

<b>Treatment</b>	<b>Immediate</b>	<b>1 Hour</b>	<b>24 Hours</b>	<b>48 Hours</b>
Existing Configuration	0.9965 (0.0035)	0.9965 (0.0035)	0.9965 (0.0035)	0.9964 (0.0059)
1.3-ft Freefall	1.0 (N/A)	1.0 (N/A)	1.0103 (0.0060)	1.0140 (0.0098)
6-ft Freefall	1.0 (N/A)	1.0 (N/A)	1.0 (N/A)	1.0034 (0.0034)

\* Note: Values greater than 1.0 (100%) indicate survival of the test fish (i.e. those subjected to treatment) was higher than control fish (i.e. not subjected to treatment).

**Table 4** - Estimates of survival from the pooled replicates by treatment, 1 h, 24 h, and 48 h post-collection for the on-site fish collection pool experiment. Standard errors are in parentheses.

<b>Treatment</b>	<b>Immediate</b>	<b>1 Hour</b>	<b>24 Hours</b>	<b>48 Hours</b>
3 cfs / 25 cm of cushion water	1.0034* (0.0058)	1.0034 (0.0058)	1.0034 (0.0058)	1.0034 (0.0058)
3 cfs / 50 cm of cushion water	1.0067 (0.0047)	1.0067 (0.0047)	1.0067 (0.0047)	1.0067 (0.0047)
13 cfs / 25 cm of cushion water	0.9966 (0.0034)	0.9966 (0.0034)	0.9966 (0.0034)	0.9966 (0.0034)

\* Note: Values greater than 1.0 (100%) indicate survival of the test fish (i.e. those subjected to treatment) was higher than control fish (i.e. not subjected to treatment).

## Discussion

Based on measured mortality rates for the Salem RIS, the modifications to the Ristroph screens that were initiated in 1995 were highly effective at reducing impingement mortality. Abundance weighted impingement mortality estimates, calculated by multiplying month-specific abundance estimates by month-specific mortality rates, for the modified screens are approximately one-half of those for the original screens.

As indicated by monitoring of impingement survival at Salem Station, impingement mortality rates vary by species and life stage/length class. Variables such as condition factor, temperature, and salinity may also affect impingement survival. In spite of these factors, properly designed traveling water screens and fish return systems can effectively reduce impingement mortality rates for many estuarine species. Fish collection and handling facilities probably need to be evaluated on a site-specific basis, but properly designed systems are not significant contributors to the overall mortality.

## References

Ronafalvy, J. P., Cheesman, R.R., Matejek, W. M., 2000. Circulating water traveling screen modifications to improve impinged fish survival and debris handling at Salem Generating Station. *Environmental Science & Policy*, 3(1):377–382.

BLUEBACK HERRING AND ALEWIFE

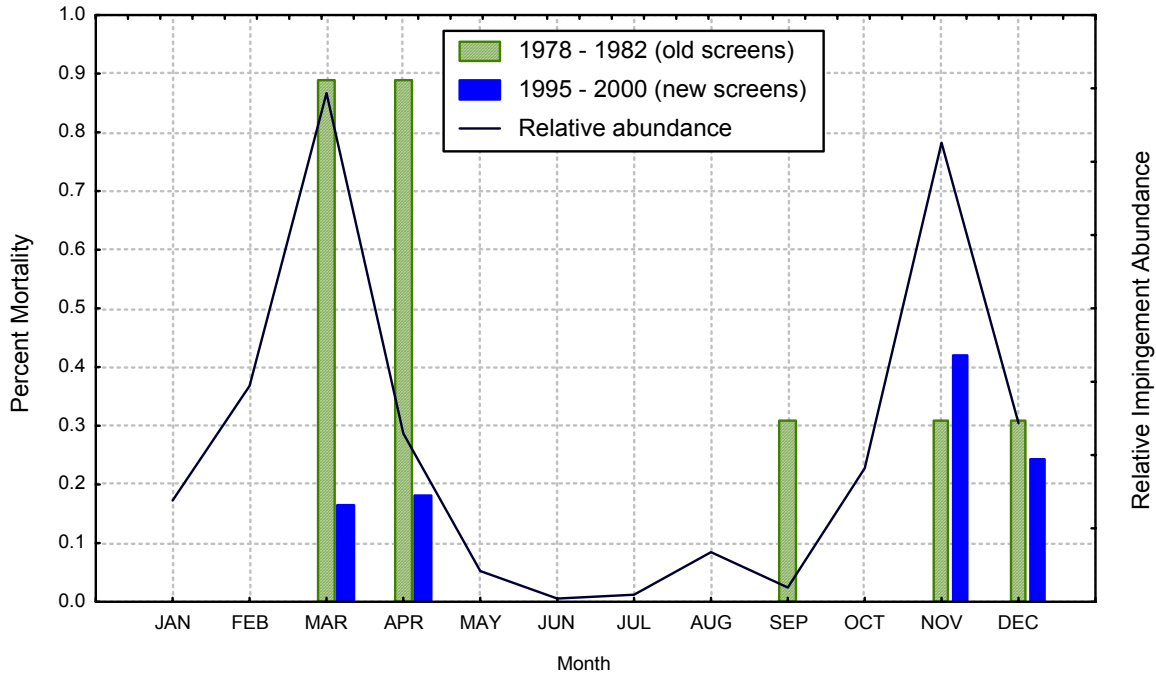


Figure 1 – Mean monthly mortality on new and old screens and relative abundance for *Alosids*

ATLANTIC CROAKER

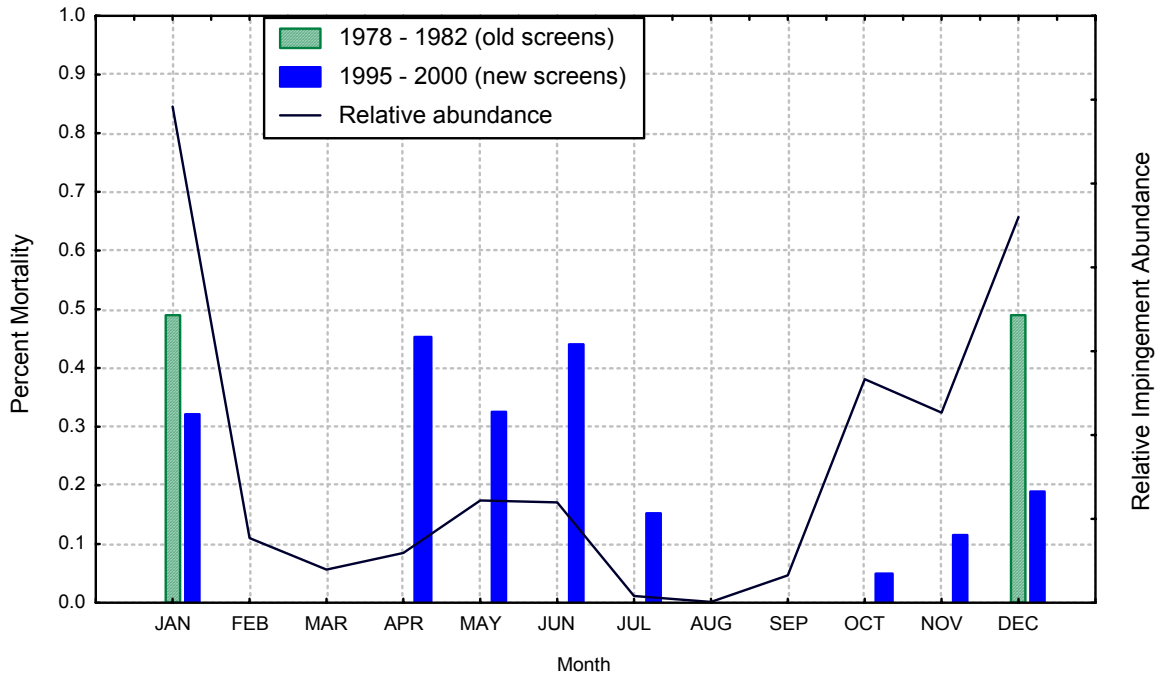


Figure 2 – Mean monthly mortality on new and old screens and relative abundance for Atlantic croaker

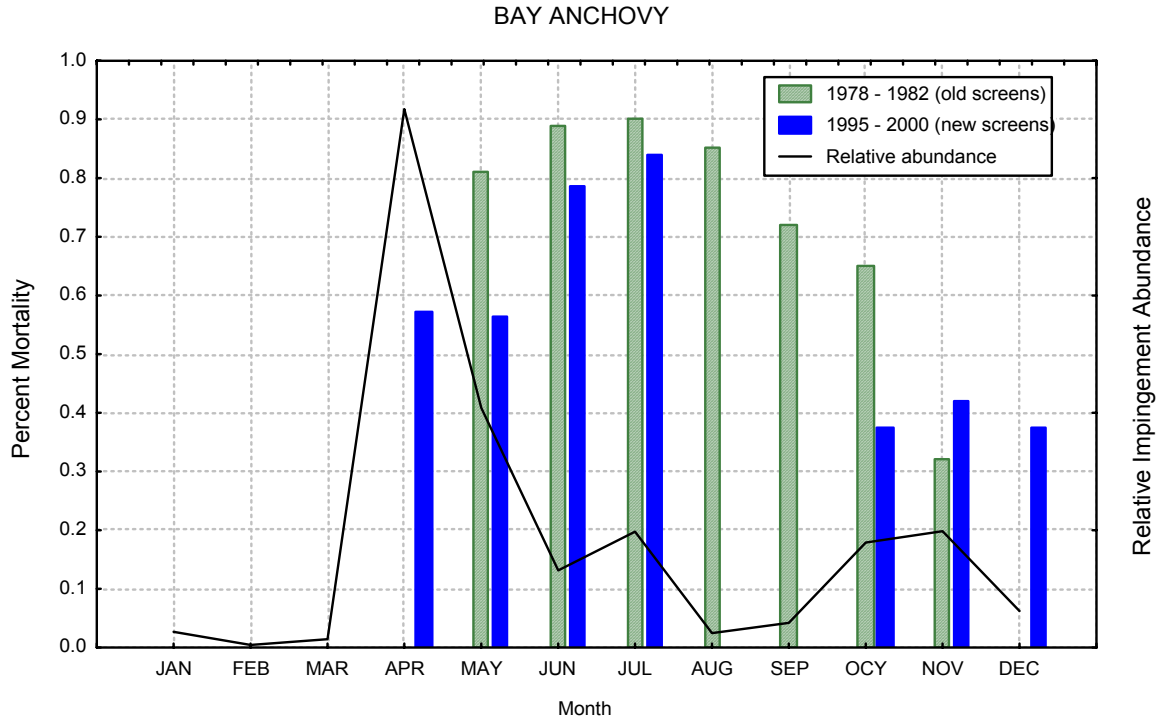


Figure 3 – Mean monthly mortality on new and old screens and relative abundance for bay anchovy

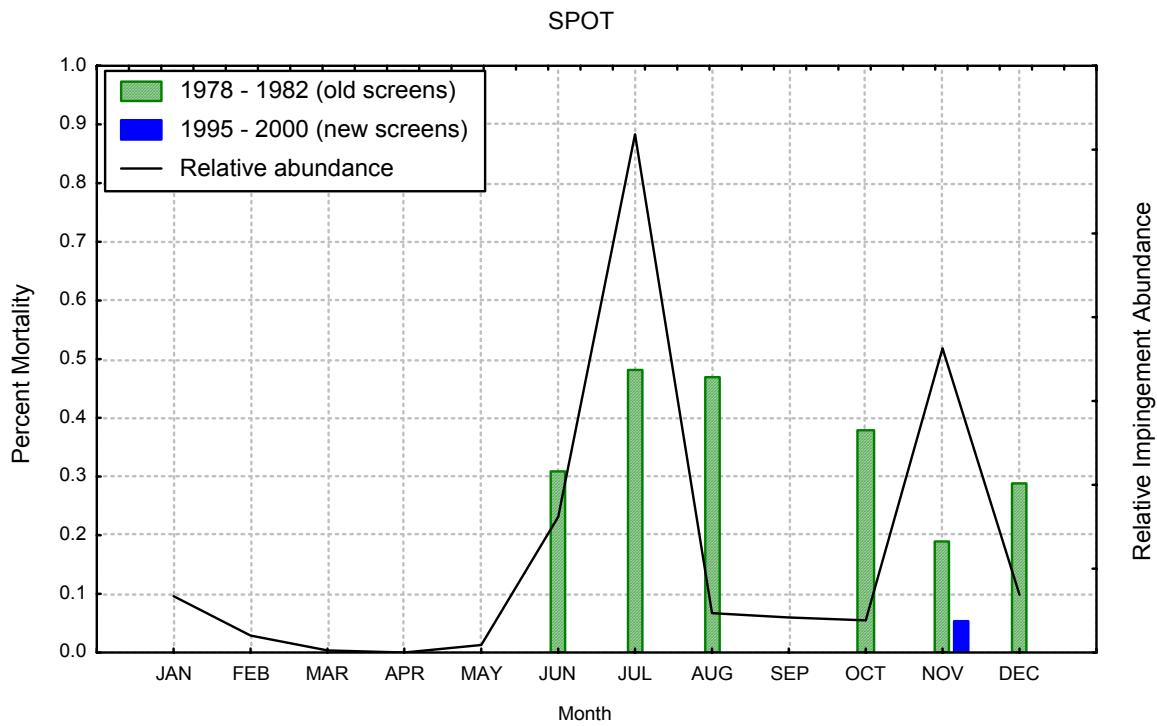
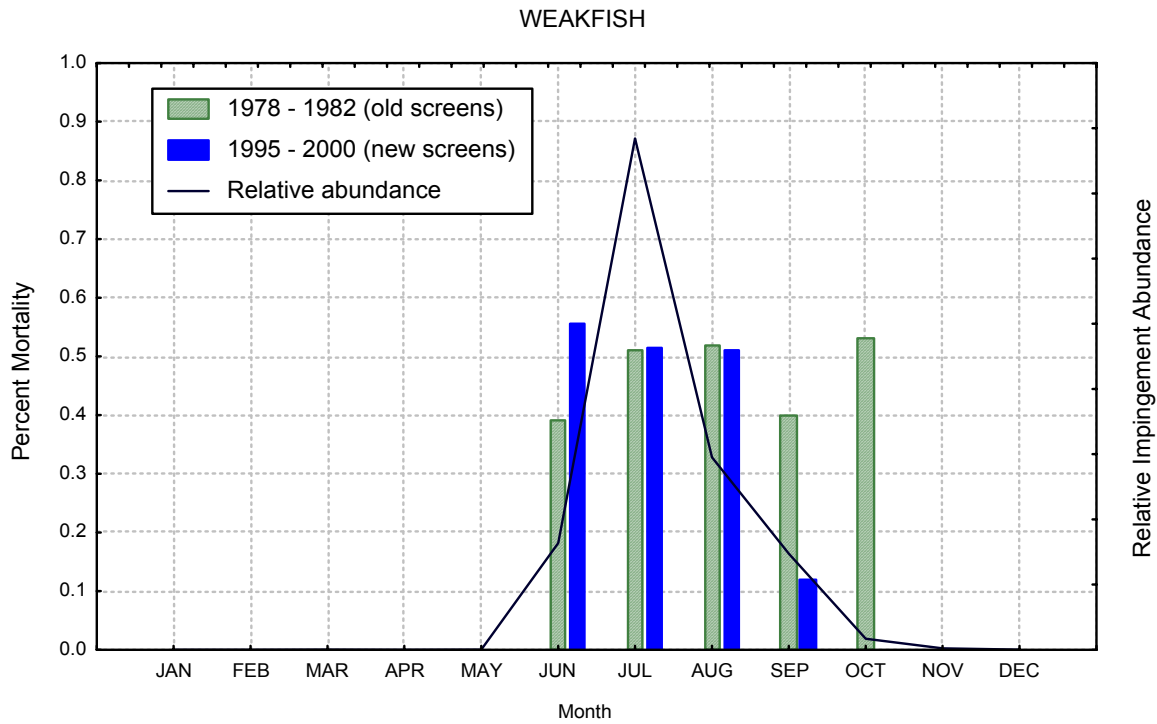
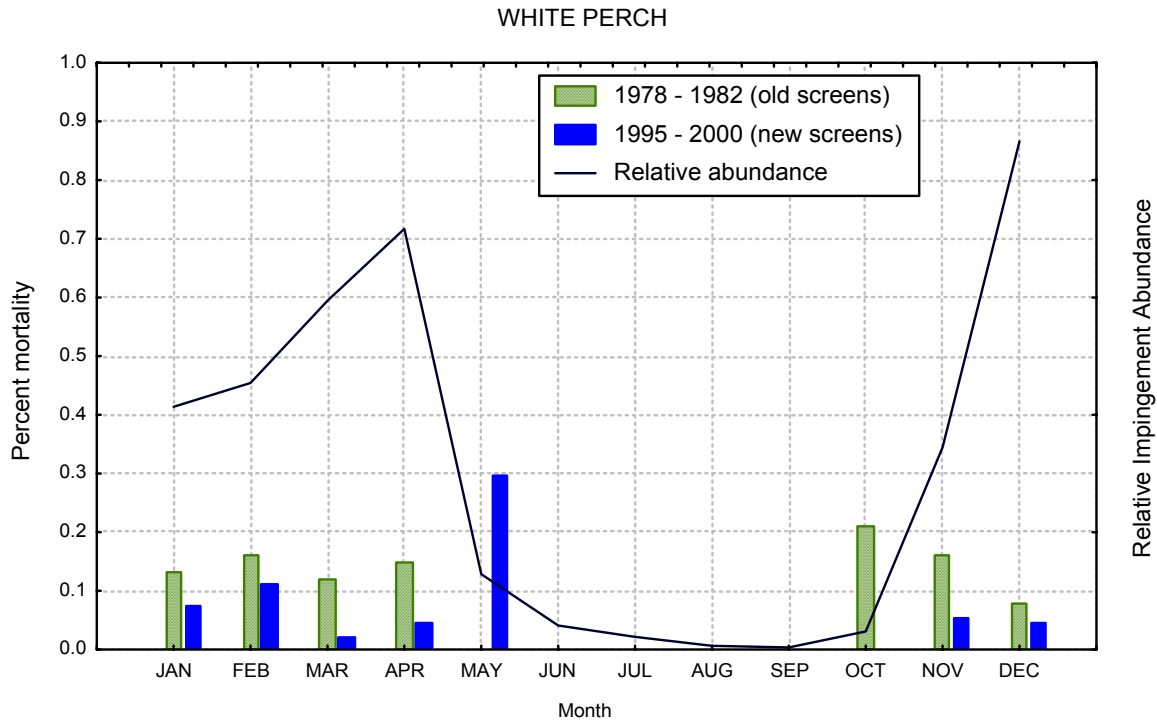


Figure 4 – Mean monthly mortality on new and old screens and relative abundance for spot



**Figure 5** – Mean monthly mortality on new and old screens and relative abundance for weakfish



**Figure 6** – Mean monthly mortality on new and old screens and relative abundance for white perch

## Session D-1 Questions and Answers

Comment. Dave Michaud, WE Energies, talked about a barrier net installation that they have had good success with. He reinforced statements by Dave Bailey (Mirant) regarding barrier nets, adding that in freshwater systems (hydropower plants, specifically, with ~600 cubic feet per second (cfs) flow), barrier nets (1) have been found to require bottom sealing and (2) generally do not have a problem with biofouling in freshwater, although the barrier nets he's familiar with are removed in winter conditions. Their original net is still in service after approximately 10 years, and with excellent results. Its useful life was expected to be only about 2 years. Operations and Maintenance costs typically run under \$1,000 per year.

Q. Deborah Littleton, USDOE, asked Mr. Bailey to explain the preferred options in the proposal, particularly options for the calculation baseline. For example, at Chalk Point, what would they do to meet the performance standards?

A. Mr. Bailey said that Chalk Point has some before and after data for baseline projections. They could remove the net (to simulate a calculation baseline), but this would be counterproductive. He felt that they should use the data developed as the facility was deployed, rather than introducing error associated with trying to calculate a hypothetical baseline.

Comment. Ken Strait, PSEG, added that Salem also has a lot of data to use. The question becomes how to apply the percent reductions, as the facility needs to retain maximum flexibility as to which method to use. They might prefer using a method with RIS.

Q. Greg Seegert, EA Engineering, pointed out that there are a lot of difficulties associated with the establishment baseline. He referred to Mr. Bailey's data on blue crabs as evidence that population fluctuations can cause problems assessing effectiveness. He added that the hypothetical shoreline intake would be difficult to measure. For Mr. Bailey: How would one measure the calculation baseline? It doesn't include a measure of "at risk" population changes, such as the blue crabs near Chalk Point mentioned earlier. Generally, one could only tell by doing extra sampling (indexing). Also, Chalk Point has more data than most facilities. How would one compare data without access to ample data, such as state surveys or other index data? If you do not have the indexing data sets that Mr. Bailey had, how could you evaluate population variation?

A. Mr. Bailey said that one would need some sort of baseline for relative abundance. You would have to do your own before/after studies to measure relative abundance. The other option may be to modify half the screens and do a side-by-side comparison. One would have to consider the data in the mindset of before and after prior to installing a given technology. For example, the barrier net has to take into account relative abundance, whereas other technologies (such as screens) may be able to compare percent reduction values. This certainly needs to be considered further.

Q. Tim Connor, USEPA, mentioned to Mr. Bailey that the barrier net costs in today's presentations were much lower than the costs mentioned in yesterday's presentation by Mr. Taft.

A. Mr. Bailey explained that these were 1981-1984 costs, so they would be higher in present value. It is unclear what site-specific factors may drive up costs at some locations.

Q. Bart Ruiters, Dupont, asked Mr. Bailey what the follow-up monitoring costs are for these barrier nets.

A. Mr. Bailey answered that he was not sure. Some are at no cost, because the state performs these index surveys. Also, the trawling studies were part of an overall 316(a) study, so the specific costs are not clear.

Comment. Ken Strait, PSEG, added that Salem spends approximately \$80,000 per year for impingement and entrainment monitoring.

Comment. Isabel Johnson, Golder Associates, Ltd., added that in 1996-9 dollars, costs were approximately \$60,000 per year.

Comment. Robert Rieder, Detroit Edison Company, added that the barrier net at Luddington is approximately 2.5 miles long. Capital costs were \$1.5 million and the nets are replaced every 4-5 years. Operations and



Maintenance costs are about \$1.3 million, because divers perform clean-in-place operations. Algae and zebra mussels are problematic at the site. Approximately \$100,000 per year is spent on monitoring.

Q. Doug Dixon, EPRI, asked with respect to Ristroph screens, could they meet the 80 percent impingement standards for reducing the number of fish impinged? Given that the most frequently impinged fish are often sensitive species, would it be sufficient?

A. Ken Strait, PSEG: It depends on the method of calculation. For example, there may be no survival data for non-RIS fish. The screens would likely meet the standard for biomass, but maybe not for number of fish. It would depend upon how the guidance is written and how they want to assess it.

Q. Randy Lewis, Cinergy, asked whether there has been any monitoring of the response of fish communities or populations after installing a technology.

A. Mr. Bailey replied that no extensive AEI studies have been done, but he would guess there would be no discernible response in either direction. They have spent \$7 million on 316(b) demonstration studies, and not seen any discernable impacts.

Comment. Ken Strait, PSEG, said that no indications of long-term effect in either direction have been noted. He indicated that only one species is declining and it is all along the eastern coast.

Comment. Isabel Johnson, Golder Associates, Ltd., added that they haven't done any population level studies since the 1980s.

Q. Gordon Hart, Performance Contracting, asked with respect to screen blockages at Salem and the potential for plant shutdowns, what plans are there to avoid those circumstances?

A. Ken Strait, PSEG, replied that Salem has had the highest debris loadings on record for the Delaware River and the screens are handling the loads well. The primary problem for Salem right now is related to "carryover," where debris ends up in the condenser.

## VIII: Session D-2: Screening and other Fish Diversion/Deterrent Technologies (cont'd)

### *Development and Operation of Acoustic Fish Deterrent Systems at Estuarine Power Stations*

*Andy Turnpenny and Jeremy Nedwell, Fish Guidance Systems, Inc.*

#### **BIOSKETCHES**

Dr. Andy Turnpenny is a fish biologist and is currently Managing Director of Fawley Aquatic Research Laboratories and Fisheries Director of Fish Guidance Systems Ltd, both located in Southampton England. Andy spent 15 years as an environmental research scientist with the UK power industry and was formerly head of aquatic research for National Power PLC. He has specialized in fish entrainment and fish screening and passage issues.

Dr Jeremy Nedwell is an engineer in underwater acoustics and previously headed the underwater acoustics laboratory at Southampton University, England. He is Managing Director of the UK underwater acoustics consultancy Subacoustech Ltd and Engineering Director of Fish Guidance Systems Ltd. Jeremy has specialized in environmental acoustics.

#### **TECHNICAL PAPER**

##### **Abstract**

Sound-projector-array- (SPA-) based acoustic fish deterrent (AFD) systems were developed initially in the early 1990's in response to fish mortality issues at UK estuarine and coastal generation stations and for potential tidal power applications. Early systems suffered technical problems but were sufficiently successful to encourage further development, allowing the key problems to be overcome. SPA AFD systems have been trialled or permanently installed at five UK estuarine power stations and one Belgian plant. Regulatory approvals have been obtained to install others.

The paper outlines the operating principles of SPA AFD systems, reviews operating experience over ten years of use at estuarine sites and presents results of scientific trials.

##### **Introduction**

The cooling water (CW) requirements of thermal power plants have led to the siting of many of the UK's larger electricity generating stations on estuaries or the open coast. The water demand may range from a few cubic metres per second for a modern combined-cycle gas turbine or tower-cooled plant, to several hundred cubic metres per second for the largest coastal nuclear complexes. A side effect of this process is the entrapment of fish, shrimps and other organisms that happen to be present at the point of withdrawal. Those not small enough to pass through the cooling system become impinged upon CW filter screens (band-screens or drum screens) and are removed from the flow to prevent blockage of the power plant condenser systems. In most cases they are collected, along with a mixture of weed and other debris and are removed to landfill; at some more modern stations, fish-friendly handling systems have been used with some success to return the more robust demersal species to the wild. Quantities of fish impinged at stations in Britain and northern Europe range from a few tonnes to a few hundred tonnes per annum; although these quantities may not be considered large when viewed in the context of commercial landings, they are a potential nuisance to plant operators, sometimes causing blockage of cooling systems, and detract from efforts to improve the environmental performance of power stations (Turnpenny and Coughlan, 2003).

The modern development of acoustic fish deterrent (AFD) systems began about ten years ago, although early unsuccessful attempts within the British power industry go back as far as the 1970s. The idea of using underwater noise to repel fish from water intakes, similar to the bird-scarer concept, presents an attractive alternative for plant operators to the more conventional method of mechanical screening using metal grid-type fish screens. Not only does it eliminate the risk of blockage and hydraulic starvation, it also removes the likelihood of fish becoming injured by mechanical contact. Such screens, which are common at river intakes, are in any case unworkable in an estuarine environment, where quantities of loose weed and attached biofouling become problematical. The difficulty with AFDs has been in developing systems that are effective for a wide range of species and that will last in a hostile marine or estuarine environment. In North America, there has been some success with systems that operate in the

ultrasound region (>100 kHz) but these so far have been found to be effective only with certain species of the clupeid family, which are thought to have developed ultrasound sensitivity as a means of evading cetacean predators (Mann *et al.*, 1997; Carlsson, 1998). Infrasonics (<20 Hz) has also been shown to have some potential for repelling salmonid fish (Knudsen *et al.*, 1997) but, owing to the large volumetric displacements required of the underwater transducers, reliable systems based purely on infrasonics have been difficult to achieve.

The experiments reported here were based on AFD systems designed to emit sounds in the 20 Hz-1 kHz band, i.e. spanning the infrasonic band and lower part of human audible spectra. Most fish species have been found to have optimum sensitivity to sound pressures and vibrations in the sub-1 kHz waveband (Hawkins, 1981). Initial laboratory and field experiments to develop suitable sound signals were conducted by the Fawley Marine Biology Unit when it operated as part of the UK power industry's in-house research department (Turnpenny *et al.*, 1993). In the present paper, we trace the progress of the technology pioneered through four developmental stages, which has now culminated in its widespread use for fish protection at estuarine and other power station sites, as well as at other types of water intakes. The power plant test locations include three sites in Britain (Oldbury and Hinkley Point, Severn Estuary; Hartlepool, Tees Estuary) and one in Belgium (Doel, Zeeschelde). In each case, AFD systems were deployed at the CW intakes and test programmes were conducted by comparing the fish impingement catches for some alternating sound-on/sound-off test pattern. The Oldbury trial was a preliminary experiment, designed to take the concept one step beyond the laboratory. The other three trials were full-scale trials over weeks, months or years and show improving results as the technology has matured.

## Study Sites

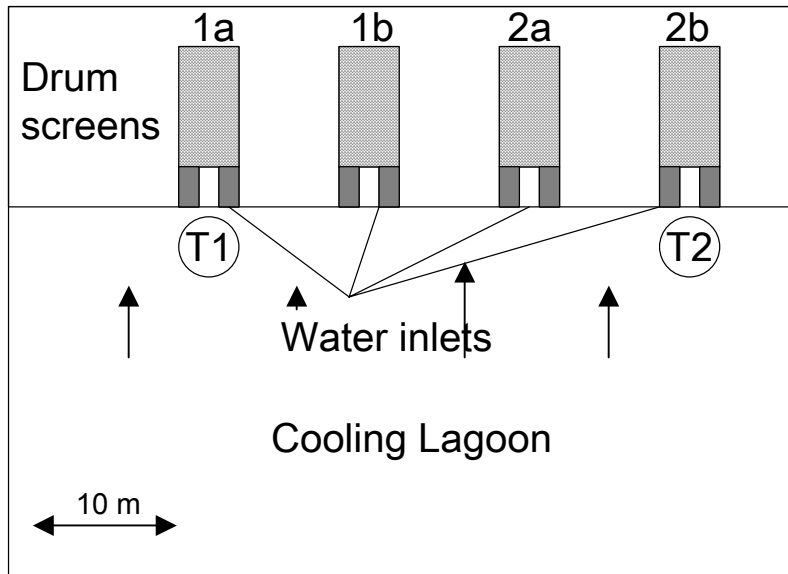
### Oldbury on Severn

Oldbury nuclear power station is situated on the southern bank of the Severn Estuary. The estuary is 1.2 km wide at this point with considerable intertidal areas. Water for cooling purposes is pumped from a tidal reservoir (soft mud substrate), which draws down towards low water and is replenished on the flood. The total cooling water (CW) demand is  $25.5 \text{ m}^3 \text{ s}^{-1}$  via four CW pumps but during the study only three pumps were operating, with a combined flow of  $19.1 \text{ m}^3 \text{ s}^{-1}$ . The water passes through a set of four submerged trash racks (~15 cm spacing) and then through one of four drum screens fitted with 10 mm-square mesh filters. These are numbered 1a, 1b, 2a and 2b. The layout is shown in Figure 1. Velocities measured at mid-trash rack depth with a propeller current meter placed 2 m upstream of the bars averaged  $40.5 \text{ cm s}^{-1}$  (standard deviation = 9.8, n=8).

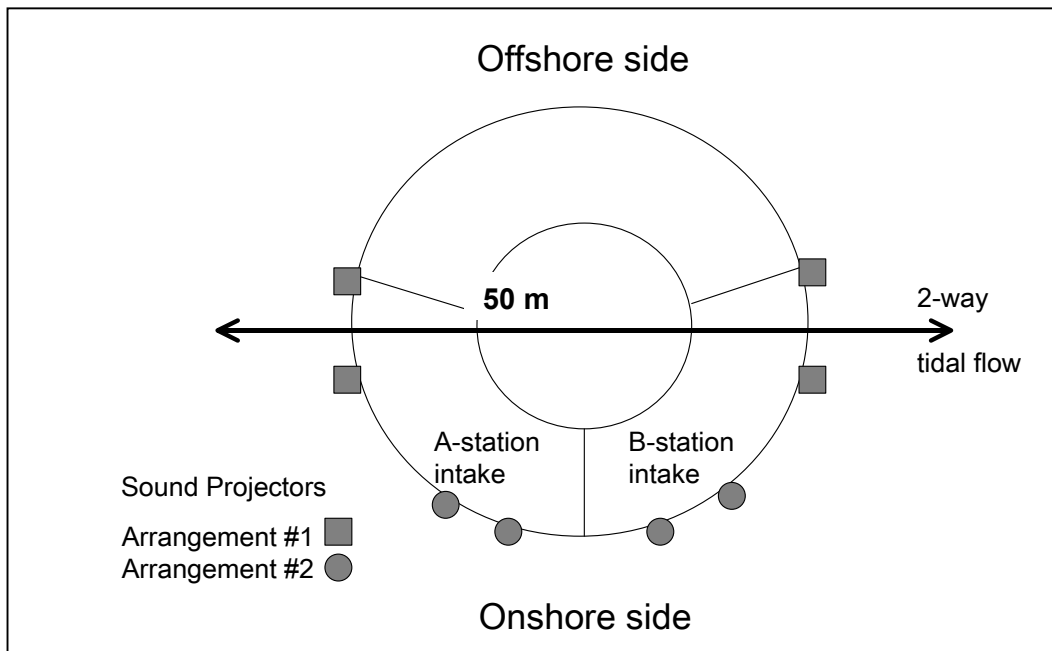
### Hinkley Point

The CW intake at Hinkley Point nuclear plant comprises a single circular caisson structure, located 500 m offshore, which is shared by the 'A' and 'B' power stations. These have maximum CW demands of 44 and  $31 \text{ m}^3 \text{ s}^{-1}$  respectively. Figure 2 shows the location of the intake caisson with respect to the adjacent shoreline, and the relative positions of the 'A' and 'B' station intake ports, both of which are biased towards the southern (shoreline) side of the structure. The openings are at seabed level and are 1.6 m high. The periphery of the structure is surrounded by retractable coarse screens of ~20 cm bar spacing.

Water from the intakes feeds back to the plant via a pair of tunnels serving the 'A' and 'B' stations, respectively. Within the plant, fine screening (10 mm mesh) is provided by band screens ('A') or drum screens ('B'), with backwash facilities and trash baskets.



**Figure 1** Schematic plan of cooling water intakes at Oldbury. Four drum screens, denoted 1a, 1b, 2a, & 2b open onto the tidal cooling water lagoon. Sound projectors (T1 & T2) placed in front of intakes 1a and 2b were operated alternately to avoid bias. When T1 was operated, catches in screen 1a & 1b (control) were compared. For T2, catches in 2a (control) & 2 b were compared. Vertical arrows show direction of water flow.

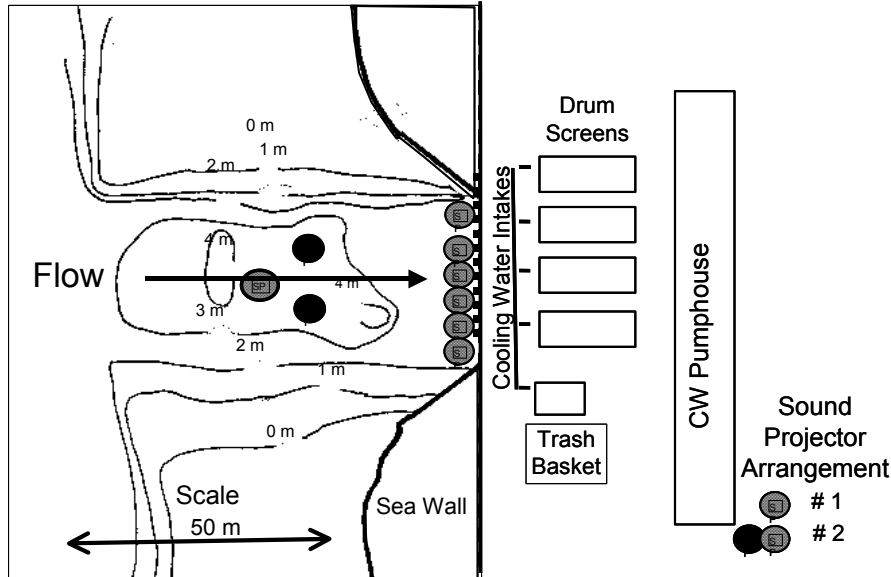


**Figure 2** Schematic of intake caisson at Hinkley Point, showing positions of sound projectors in Arrangements #1 & #2. The Intake is located some 500 m off a rocky shore in 1 15 m tidal range. The caisson is 39m in diameter.

### Hartlepool

Hartlepool nuclear power station is located on the north side of the Tees Estuary in Cleveland, on the north-east coast of England. The CW intakes draw water from the Seaton Channel, which lies within the Seal Sands SSSI. The intake opens onto a short, dredged channel, some 70 m in length (Figure 3); depth in the middle of the channel was estimated at -4 m Chart Datum (CD). Four CW pumps of nominal discharge  $8.5 \text{ m}^3 \text{ s}^{-1}$  each have paired openings along a concrete sea wall, which forms the boundary of the power station. Normally, no more than three CW pumps are operated simultaneously, giving a combined flow of  $25.5 \text{ m}^3 \text{ s}^{-1}$ . Water entering the CW intakes passes through

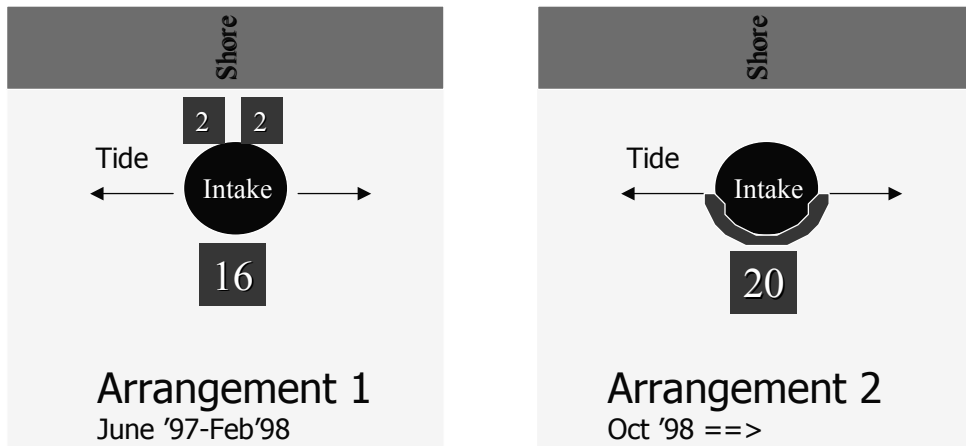
coarse grids (~15 cm spacing) and is filtered by drum screens fitted with 10 mm square mesh. No measurements of intake velocity were made but the maximum value at the grids was calculated to be  $\sim 1 \text{ m s}^{-1}$ .



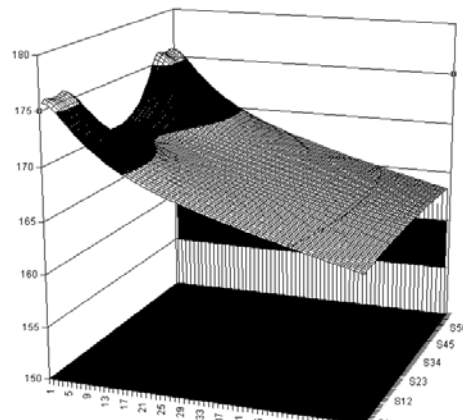
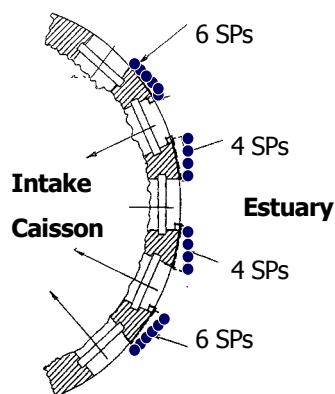
**Figure 3** Plan view of the cooling water intake channel at Hartlepool, which draws from a shallow creek on the Seaton Channel (Tees Estuary). The two sound projector arrangements tested are shown. Arrangement #2 includes all the sound projectors used in Arrangement #1 plus two others. Depths are in metres Chart Datum.

Doel

The Doel nuclear power plant (Units 3/4) is located on the left bank of the brackish water part of the Zeeschelde estuary (Belgium) at a water depth of about 5 m (Figure 4). Its CW intake is formed by an offshore concrete caisson opening 2 m above the bottom, withdrawing  $25.1 \text{ m}^3 \text{ s}^{-1}$  through five apertures measuring  $4 \times 2.4 \text{ m}^2$  each. This gives a nominal velocity of  $52 \text{ cm s}^{-1}$  through the openings. Water is brought ashore via a 540 m long tunnel, then entering a forebay area with coarse trash racks, followed by band screens fitted with 4 mm meshes. During the trials, fish and other debris were backwashed into a collecting basket.



**Figure 4** Doel Units 3/4 Upper: sound projector positions around the offshore intake caisson in Arrangements #1 & #2. Lower: the detail to the left shows in plan section how the 20 sound projectors were positioned with respect to the intake ports in Arrangement #2. The graphic on the right is an extract from the PrISM model for Doel (Arrangements #2) showing the predicted smooth gradient of sound pressure (Y-axis: dB re  $1 \mu\text{Pa}$ ) relative to distance from the intake (10 m grid); the two maxima towards the top-left indicate the positions of two sound projector clusters. In the lower two figures, the shoreline lies to the left of the diagrams.



## Methods

### Experimental designs

Table 1 gives details of the sampling patterns and times used in each of the four trials.

**Table 1** Details of experimental trial dates, durations and experimental patterns.

Site	Experimental Pattern	Days of Testing	Dates of Trial
Oldbury	Alternate 24 h periods with sound 'on' and 'off', sampling for last 6 hours only	14	Nov. 1991-Jan. 1992
Hinkley Point	Alternate 24 h periods with sound 'on' and 'off', sampling for last 6 hours only	42	Nov. 1993-Feb. 1994
Hartlepool	Alternate 24 h periods with sound 'on' and 'off', sampling for full 24 hours	44	Mar.-April 1995
Doel	Alternate 24 h periods with sound 'on' and 'off', sampling for full 24 hours	44	Sept. 1997-Oct. 2001

The basic experimental plan used at all of the sites involved collection of the fish backwashed from the drum or band screens and comparing catches for alternate days with the AFD system turned 'off' (control) then 'on' (experimental). It was necessary to estimate the residence time of fish within the CW system between the intake and the fine screens to ensure that significant quantities of fish were not carried over between control and experimental periods. At Hinkley Point and Doel, which have offshore intakes with lengthy tunnels, this was done by releasing batches of live fish at the inlet and recording the times taken to recover them from the screens. Rainbow trout (*Oncorhynchus mykiss*) ( $L_s = 10\text{-}20\text{ cm}$ ,  $n=50$ ) were used at Hinkley Point and goldfish (*Carassius auratus*,  $L_s = 7\text{-}23\text{ cm}$ ,  $n=246$ ) at Doel. These species are non-indigenous and are therefore easily recognisable without the need for marking. The recapture rate was estimated at 80% per hour for Doel. At Hinkley Point 70% (64-76% for two batches) were re-caught in 5 hours but the remainder were unaccounted for and were presumed to have swum out of the intake. Further analysis using sprat catch data from the power station indicated a clearance rate of 60% of fish per hour or 95% in five hours (Turnpenny *et al.*, 1994). Residence of fish within the intakes at Hartlepool and Oldbury power stations was considered not to be an issue, as both have their screen wells opening directly onto the water, and both were being dosed with toxic levels of chlorine during the trials; residence time is likely to have been less than one hour. In the first two trials (Oldbury and Hinkley Point), sampling was in any case limited to the last six hours of a 24-h 'on' or 'off' period of the AFD.

The acoustic signals used in the field tests were developed in earlier laboratory tests by trial and error from a wide range of candidate signals (Turnpenny *et al.*, 1993). The two main criteria for signals to be selected for field use were:

- (i) that in laboratory trials they would cause a strong avoidance response in the majority of species tested (these included cod, *Gadus morhua*, whiting, *Merlangius merlangius*, bass, *Dicentrarchus labrax*, salmon, *Salmo salar*, brown trout, *S. trutta*, eel, *Anguilla anguilla* and Twaite shad, *Alosa fallax*);
- (ii) that the fish should not readily habituate to the sounds (the trials investigated responses over ten repeat exposures of the fish over a 1-2 day period).

The signals used throughout comprised low-frequency sweeps in the 20 Hz-600Hz waveband; these varied somewhat from test to test as described below, mainly on account of the varied ability of the sound projectors used to handle the low frequency components.

### AFD Equipment

A generalized schematic diagram showing the main system components of the AFD systems used and their interconnections is shown in Figure 5. The variations in this format used at the individual sites are shown in Table 2, along with the particular equipment specifications.

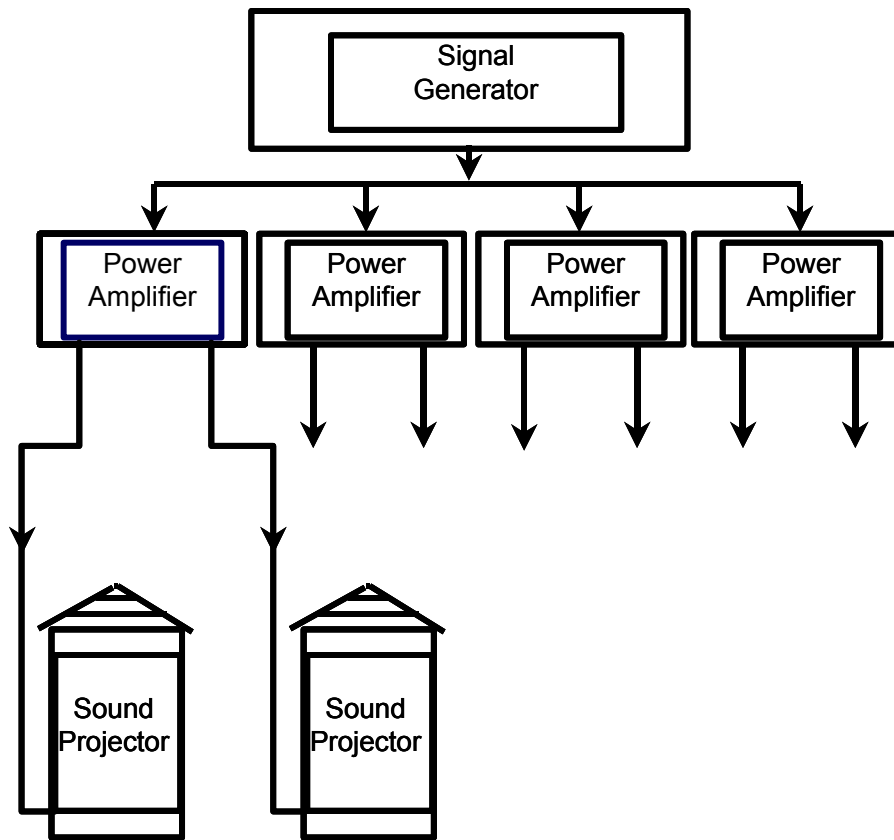
**Table 2** Details of the AFD hardware used for the power plant trials.

Site	Signal Source	Amplifiers	Sound Projectors	Nominal Signal Sound Pressure Levels and Ambient Noise Levels
Oldbury	Hewlett-Packard 8111a function generator/ Kema VBF/8 filter	RS Components 303-236 power amplifier (30W rms) (1 no.)	Argotec 214 (40W rms, 60Hz-6kHz) (1 no.), Gearing & Watson UW60 (50 W rms, 160 Hz-7kHz) (1 no.)	158±3 dB re 1µPa @1 m 150Hz-1kHz (measured <i>in situ</i> ). Ambient: 110 dB re 1µPa
Hinkley Pt	Argotec 215 control unit (synthesized digital signal on EPROM)	Techron 3550 power amplifiers (2 x 800W rms ea.) (8 no.)	Argotec 215 (40W rms, 120 Hz-6kHz) (8 no.)	172 dB re 1µPa @1 m 120Hz-600Hz. Ambient: 90-105 dB re 1µPa
Hartlepool	FGS 1-08 signal control unit (synthesized digital signal on EPROM)	FGS 400 Amplifier/Monitors (450W rms ea.) (9 no.)	FGS Model 30-300 Mk I (600W rms, 10-600Hz) (9 no.)	172 dB re 1µPa @1 m 100Hz-600Hz; frequency range 20 Hz-600 Hz for period #2. Ambient: 105 dB re 1µPa.
Doel	FGS 1-08 signal control unit (synthesized digital signal on EPROM)	FGS 400 Amplifier/Monitors (450W rms ea.) (20 no.)	FGS Model 30-300 Mk I (600W rms, 10-600Hz) (20 no.)	172 dB re 1µPa @1 m 20Hz-600Hz. Ambient: 110 dB re 1µPa

The AFD system layout is similar to that of a domestic audio system. The deterrent signal is produced by a programmable signal source: either a function generator, or a digitally recorded source (EPROM). The signal is then sent to one or more audio amplifiers and then to one or more underwater sound projectors (analogous to loudspeakers). The sound projectors, which are air-filled devices, use some form of pressure compensation system to equalise the internal and external pressures. This avoids the problem of the diaphragm being forced inwards towards its end-stop as the external pressure increases, e.g. due to rising tides. The ambient noise levels shown are typical of inshore waters where wave noise, shipping activity and industrial noise all play a part.

### Oldbury

The AFD system used at Oldbury was primitive and used generic ‘off-the-shelf’ components. The Gearing and Watson sound projector, for example, was a low-powered device used for applications such as underwater music in swimming pools.



**Figure 5** Schematic of AFD sound generating system. Each amplifier feeds one or more sound projectors. The schematic shown is the simple arrangement used in power plant trials. Additional signal and condition-monitoring equipment is present e.g. on the permanent installation at Doel, which transmits information to the plant control room.

The deterrent sound signal used comprised frequencies in the 100-1,000 Hz band. Owing to limitations of the sound projectors, the lowest frequency effectively generated was 150 Hz. The configuration adopted was also simple (Figure 1). No attempt was made to exclude fish from the entire power station, as the available hardware was capable of raising signals levels above the background noise level only over a distance of a few metres. A more realistic objective of deflecting fish from the entrance to a single screen to that of its nearest neighbour was therefore chosen. This meant moving the fish over a distance of no more than 10 m. To avoid the results being biased by the choice of intake with possible inherent differences in fish entrapment rate, two adjacent intakes were fitted with sound projectors systems and these were used alternately. In this case, the screen with the sound projector switched off was used as the 'control'.

### Hinkley Point

The experiment at Hinkley Point was a large-scale test using a more elaborate sound system designed to repel fish from the offshore intake structure supplying both 'A' and 'B' nuclear plants at Hinkley (44 and 31 m<sup>3</sup>s<sup>-1</sup> CW flow respectively). The equipment used (Table 2) was developed originally for military use and not for fish deflection. The trials met with considerable technical difficulties owing to the frequent failure of the sound projectors during the first part of the project. Failures occurred daily as a result of the extreme tidal range (14.5 m) which overstretched the pressure compensation system and because they were unsuited to handling the low frequency part of the deterrent signal. The original signal used frequencies in the range 50-600 Hz; this subsequently was modified to a 120 -600 Hz range to reduce low-frequency stress on the sound projectors. An active pressure compensation system was introduced for the second phase of the testing (Arrangement #2). This continuously monitored the internal pressures of the sound projectors and fed or released compressed air to balance the internal and external pressure. This worked satisfactorily.



The sound projectors were deployed radially around the offshore CW intake structure at positions shown in Figure 2, and were lowered into position on carriages that ran down the legs of the intake superstructure, placing them level with the middle of the intake openings. The offshore structure was accessible by a pedestrian tunnel and was supplied with electrical power, while the system electronics were located on the intake head within a protective housing.

### Hartlepool

Owing to difficulties experienced with the AFD equipment used at Hinkley Point, the system used at Hartlepool was designed and constructed specifically for the purpose of the project by Fish Guidance System Ltd (FGS) of Southampton, UK. The sound projectors had similar power handling capacity to the Argotec units used at Hinkley Point but a larger diaphragm area (700 cm<sup>2</sup> versus 80 cm<sup>2</sup>). Consequently, a much reduced diaphragm throw was required to achieve the same displacement for a given frequency and amplitude of operation. This allowed frequencies down to 20 Hz to be generated, enabling signals developed in the laboratory to be used without curtailment of the low-frequency component. The amplifiers and signal generators were also designed and built for the project (Table 2).

The system was deployed in two configurations as shown in Figure 3. The first (Arrangement #1) used 6 sound projectors located at each of the intake openings (at mid-intake level) and a single unit placed out in the middle of the dredged approach channel, some 40 m upstream of the intake openings. The second configuration (Arrangement #2) used two extra sound projectors placed in the mid-channel position. The purpose of the mid-channel sound projectors was to improve the performance of the system at low tidal levels when high velocities close to the screens could have trapped fish. It was therefore necessary to repel them further out into the channel where velocities were low.

A further change made between Arrangements #1 & #2 relates to the sound signal used. During the first test period, the signal comprised a sweep of frequencies from 100-600 Hz; for test phase #2, the lower frequency point was reduced to 20 Hz.

### Doel

The system used at Doel was a later development of the FGS equipment used at Hartlepool, but with 20 sound projectors and 20 amplifiers. The initial configuration (Arrangement #1, Figure 4) was installed in early 1997 and comprised one cluster of 16 sound projectors located on the seabed on the mid-estuary side of the intake caisson, and two pairs of projectors placed on the inshore side. This was superseded in autumn 1998 by Arrangement #2, in which the 20 sound projectors were attached directly to the intake caisson between the inlet ports (Figure 4).

### **Acoustic Modelling**

The use of acoustic modelling techniques was an important element in the design of the AFD installations at Hinkley Point, Hartlepool and Doel. The behaviour of sound in water is highly reactive compared to that found in air, and the resultant sound field is more strongly influenced by features of the environment. The most important ones are the water depth (which varies tidally), the substrate type, the presence of hard structures (e.g. the concrete intake structure) and the background noise level (due e.g. to wave action, pump machinery and shipping). The proprietary acoustic model PrISM (Subacoustech Ltd) allows the acoustic field to be predicted in terms of sound pressure level (units of dB re 1µPa) versus receiver (in this case fish) position for any given geometry of sound sources, taking account of the environmental conditions. The model was used to optimise the sound field by varying the numbers and positions of sound projectors used. A 'good' sound field was considered to be one in which there was a smooth gradient of sound pressure, increasing towards the water inlets (Figure 4); conversely, a 'bad' sound field was one in which the interactions between the sound waves caused distinct areas of constructive and destructive interference which might confuse and disorientate the fish.

### **Fish Sampling**

At all four sites, fish and other estuarine fauna caught on the screens were intercepted using baskets or nets placed under the backwash channels serving the screens. Collections were made hourly, except during the night when bulked

overnight samples were used; the bulked sample data only are presented here. Numbers and weights of each species were recorded. Length data (fish standard length) were recorded for subsamples of fish.

## Results

### Effect of AFD System on Fish Catch

#### *Oldbury*

A total of 5,106 fish representing 36 species was captured during 14 days of trials at Oldbury. The most abundant was sprat (*Sprattus sprattus*), followed by whiting, sand goby (*Pomatoschistus minutus*), sea snail (*Liparis liparis*) and bass. Most fish were juveniles and 95% of the catch was below 20 cm standard length.

**Table 3** Summary of results for main fish groups in trial of primitive AFD trial at Oldbury power plant.

	All Fish	Pelagic & Demersal	Bass	Whiting	Sprat
Sound Off	2,696	1,809	235	527	950
Sound On	2,410	1,547	145	497	842
% Change, sound on	-11	-14	-39	-6	-11
Significance	P>0.05 (NS)	P>0.05 (NS)	P<0.02	P>0.05 (NS)	P>0.05 (NS)
% Change in catch with Sound On	+50.6%		+33.1%	+74.2%	-15.6%

The effect of operating the AFD system is seen from Table 3. The total number of fish was slightly lower (-11%, n= 5,106, P>0.05) when the sound system was operating but the difference was non-significant. Teleost species possessing a functional swimbladder have been shown to be more sensitive to sound pressure than those without a swimbladder (e.g. flatfishes and other benthic fish) (Hawkins, 1986). Taking the combined data for all pelagic and demersal fish but excluding benthic species the difference was slightly higher but remained non-significant (-14%, n= 3,356, P>0.05). Individual comparisons were made of the three commonest swimbladder species: bass (n=380), whiting (n=1,024) and sprat (n=1,792). Of these, the largest percentage change was found in bass (-39%, P<0.02), the only species for which the recorded difference was statistically significant; significance was measured in these cases by applying a paired-sample t-test to hourly catch data from one control day with data from the corresponding hours in the following experimental day.

#### *Hinkley Point*

The system was operated over 42 days (19 days with sound on, 23 control ‘sound-off’ days) at Hinkley Point (November 1993- February, 1994), during which 18,416 fish of 49 species were recorded during the six-hours-per-day sampling. The bulk of the catch was made up of the clupeoids (sprat: 64.9% by number) and gadoids (whiting, *Merlangius merlangus*: 27.8%; poor cod, *Trisopterus minutus*: 2.9%); various flatfishes accounted for 4.4% numerically.

Table 4 compares the catches for the sound-on versus sound-off (control) days. Unlike at Oldbury, the significant changes in catch with the AFD system operating were increases rather than decreases. Fish catches were on average 50.6% higher when the AFD system was switched on; the greatest difference was found for clupeoids, catches of which were 74.2% higher than for control periods.

**Table 4** Hinkley Point Trials: Summary of catches for sound-on versus sound-off days over a 42 day test period (November 1993- February, 1994).

	All Fish	Gadoids	Clupeoids	Other Fish
Sound Off	7,349	2,487	4,230	315
Sound On	11,067	3,310	7,371	267
Paired sample t-value	4.16	6.19	3.59	-0.75
Significance	P<0.01	P<0.01	P<0.01	P>0.05 (NS)
% Change in catch with Sound On	+50.6%	+33.1%	+74.2%	-15.6%

The possible cause of the increased catch was investigated (Turnpenny *et al.* 1994) and was thought to be a result of fish diving in response to the sound, a commonly reported reaction in the literature. This would have caused fish to concentrate in a layer near the seabed where the intake openings were located, increasing the probability of entrainment. It was also hypothesised that the reaction range was possibly too close to the intake, so that by the time fish were close enough to the sources to be repelled, they were already beyond the point-of-no-return owing to locally high water velocities. More powerful sound sources would have been required to remedy this problem.

Although not the target response, the observed significant reaction of some species fish to the AFD sound was sufficiently encouraging to pursue further power station trials. The further testing was moved to Hartlepool power station, which at the time was suffering a particular problem of clupeoid ingress.

**Hartlepool**

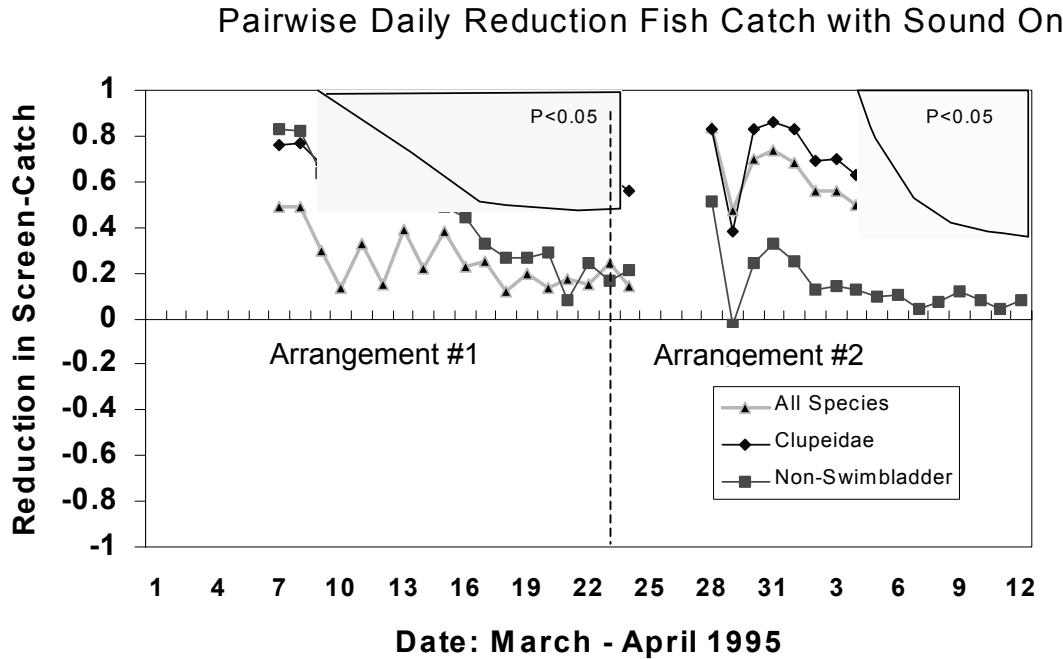
The AFD system was tested over 42 days during March–April, 1995. During this period, a total of 111,630 fish were caught, representing 48 species. The clupeoids sprat and herring (*Clupea harengus*) were the dominant species, being 43.6% and 41.2% respectively of the fish numbers caught. The gadoid, whiting, was next most abundant species (7.7%) while the remaining species accounted for only 7.5% of the total.

Table 5 gives a breakdown for the three dominant species, as well as for all species combined and for non-swimbladder species. As for Hinkley Point, the data have been treated as consecutive pairs of days and the results show the percentage change in mean daily fish catch rate with the AFD system switched on. The results are split into two periods, the first corresponding to sound projector Arrangement #1 (100-600Hz signal) and the second to Arrangement #2 (20-600Hz signal). This change in test conditions had a marked effect on fish catch. During period #1 (March 1-24, 1995), only herring showed any significant catch reduction with the AFD operating (-38.5%, P<0.05); for other species there was no detectable effect. With the modified arrangement, the overall effect was to reduce the combined catch of all species by over half (-55.9%, P<0.05). Most affected were the clupeoid species (sprat: -60.1%, P<0.05; herring: -79.6%, P<0.05), with no significant effect being evident for the bottom-living non-swimbladder species. Owing to the short winter-spring season when fish are impinged in large numbers at Hartlepool, it was not possible to investigate separately the effects of the two sound projector arrangements and the signal frequency spectra, and so it is not clear which change was primarily responsible for the improvement in performance in test period #2 (March 25-April 12, 1995).

**Table 5** Hartlepool Trials: Estimated change in mean daily fish catch rate with the AFD system operating for the two sound projector arrangements and test periods.

Species	Sound Projector Arrangement #1 (March 1-24, 1995)	Sound Projector Arrangement #2 (March 25-April 12, 1995)
All species combined	-2.1% (P>0.05: ns)	-55.9% (P<0.05)
Sprat	+33.1% (P>0.05: ns)	-60.1% (P<0.05)
Herring	-38.5% (P<0.05)	-79.6% (P<0.05)
Whiting	+19.8% (P>0.05: ns)	-53.5% (P<0.05)
Non-swim-bladder species	+25.9% (P>0.05: ns)	-15.6% (P>0.05: ns)

The time-series of catch reduction due to the AFD system over the two test periods is displayed in Figure 6. A feature over both periods was the progressive reduction in fish deflection efficiency. Initially it was thought to be due to fish becoming habituated to the sound signal. However, upon removing the sound projectors at the end of the trial, it was found that they had suffered a gradual loss of compensation-air pressure, via the spaces between the copper cores of the signal conductors. The result of this was that the transducer diaphragms were gradually forced inwards towards their limit of travel, thereby reducing the sound pressure level emitted. Gradually reducing sound output was therefore hypothesised to be cause of deteriorating performance.



**Figure 6** Hartlepool: time series showing reduction in fish catch with the AFD operating for Sound Projector Arrangements #1 & #2. Shaded areas to top right of data show where percentage reductions differ significantly from zero, based on a pair-wise t-test for sound-on versus sound-off day pairs.

*Doel*

The Doel AFD system was initially installed on Units 3 & 4 in early 1997 and has been the subject of ongoing performance monitoring by the Laboratory of Aquatic Biology at Leuven University, Belgium (Maes *et al*, 2002). Prior to the introduction of the system, Units 3 & 4 caused the destruction of about 100 tonnes per year of fish, shrimp and crabs. Following the introduction of the AFD system, the annual catch biomass was reduced overall by 88%.

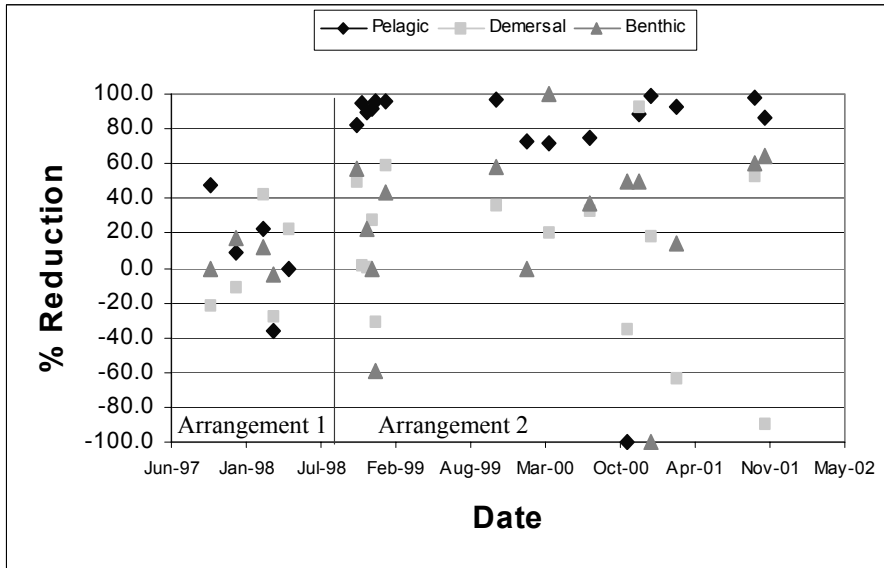
The AFD system has been progressively modified and improved as a result of feedback from the plant operators and from experience at Hartlepool. New, more robust sound projectors were developed, in which air loss along the power cables was eliminated by introduction of a sealed connector system. The change to sound projector Arrangement #2 was made after disappointing early results with Arrangement #1. This was thought to be due to the placement of sound projectors several metres away from the intake structure rather than directly on it. The revised arrangement concentrated the sound field around the inlet ports. The AFD signal was a 20-600 Hz sweep, as used in Hartlepool sound projector Arrangement #2.

**Table 6** Doel Unit 3/4 Trials: Estimated change in mean daily fish catch rate with the AFD system operating for the two sound projector arrangements and test period (ns= not significant).

Species	Sound Projector Arrangement #1 (March 1-24, 1995)	Sound Projector Arrangement #2 (March 25-April 12, 1995)
Pelagic fish	-29.2% (P>0.05: ns)	-80.3% (P<0.01)
Demersal fish	-10.3% (P>0.05: ns)	-21.7% (P<0.02)
Benthic fish	+47.8% (P>0.05: ns)	-24.1% (P>0.05: ns)

For the purposes of data analysis, the fish have been divided into just three groups: pelagic, demersal and benthic. These comprise 18 marine/estuarine species and 10 freshwater or migratory species. More details on the individual species may be found in Maes *et al.*, (2002). Dominant species in the pelagic component were sprat (11.7% of total fish number) and herring (11.9%). Demersal fish comprised small quantities of several fish species but accounted for <5% of all fish. Gobies (*Pomatoschistus* spp.) dominated the benthic catch (70.7%).

Results with Sound Projector Arrangement #1 were poor compared with the previous results at Hartlepool, showing only a 29.2% reduction of pelagic catch and a 10.7% reduction in demersal fish (Table 6). The revised arrangement (#2), however, showed an immediate improvement, which was maintained thereafter (Figure 7). The mean daily catch of pelagic fish fell by 80.3% ( $P < 0.01$ ) with the AFD in operation. The value for demersal fish, at 21.7% was lower than seen e.g. for gadoids at Hartlepool, but in this case, the demersal fish comprised small numbers of several species (presumably of varying auditory sensitivity), whereas at Hartlepool, large numbers of one species (whiting) were involved.



**Figure 7** Doel Units 3/4: percentage reduction in fish catch with AFD system operating Sound Projector Arrangements #1 & #2: June 1997- May 2002

Figure 7 shows that the initially high reduction in fish impingement rates for sound projector Arrangement #2, particularly for pelagic fish, has been maintained, unlike the pattern seen at Hartlepool. This supports the view that the cause of the problem was related to pressure-loss in the sound projectors at Hartlepool, rather than habituation of the fish to the AFD signal.

## Discussion

### Performance of the AFD Systems

The bulk of the impinged fish catch at most UK and European estuarine power plant sites comprises pelagic species, predominantly clupeoids and these are the target species for acoustic deterrents in most applications. Sprat invasions have forced shutdowns of some coastal power stations (Turnpenny and Coughlan, 2003), although the motivation for reducing impingement is predominantly environmental these days. Current diversion efficiencies for these species using the AFD's of the type described here for Doel are in excess of 80% and may reach 95% (Maes *et al.*, 2002). Many of these species are 'hearing specialists', i.e. they have anatomical specialisations that increase auditory sensitivity (Hawkins, 1981). These species are usually very delicate, with deciduous scales, and are not amenable to rescue once they have contacted the band- or drum-screening plant. Demersal species possessing a swimbladder but without such specialisations are of intermediate sensitivity, and AFD systems have rather more variable success with these species (22-54% reduction for Doel and Hartlepool respectively). Fortunately, most fish in this category are relatively robust significant proportion can usually be returned in viable condition to the wild using fish-friendly screens and dedicated return lines (Turnpenny and Coughlan, 2003). Lastly, the benthic species are more insensitive to sound and generally respond little to AFD stimuli. These are toughest of all and most amenable to successful return to the wild.

As attention in these studies has been primarily focused towards the pelagic species, no attempt has been made to improve performance for the other groups. However, if auditory sensitivity is the key factor, then simply increasing the acoustic emission of the system may be a way of achieving improved performance for these species. This issue is addressed in another paper in this Symposium (Nedwell & Turnpenny). It should be borne in mind however that increasing the acoustic output may have other consequences: for example it should be ensured that the longer-range propagation of the signal cannot interfere with diadromous fish movements. Such a problem can be avoided with careful planning and design, using acoustic models such as PrISM.

#### Technical issues

Many technical issues have been overcome during the ten years' development of AFD systems for coastal and estuarine plants. The sound projectors developed for the projects described here are better suited than other 'off-the-shelf' transducers and initial problems associated with pressure compensation for tidal waters have been overcome. The larger (300 mm diameter) diaphragm sizes are also more appropriate for handling the necessary low-frequency components of the signal. Other problems that have had to be solved include: corrosion in some estuarine waters, sediment accumulation within the sound projector bodies, robustness of signal cabling and overheating of amplifiers when placed within waterproof housings. All of these problems have been overcome and it is now possible to run AFD systems in hostile marine and estuarine environments with maintenance intervals of up to one year. Nevertheless, this is not a 'fit-and-forget' technology. An important requirement when installing systems is to provide an easy method of retrieving the underwater sound projectors for servicing, without the need for divers. Generally, every site requires a different approach. A very positive aspect of AFD systems is that they can be retrofitted to almost any existing plant intake configuration with minimal civil engineering.

#### Future of AFD's for Estuarine plant

In addition to the sites described above, AFD systems have been fitted to other UK direct-cooled estuarine power plants, including Fawley (Hampshire: 500 MW oil-fired), Shoreham (West Sussex: 400 MW CCGT) and Great Yarmouth (Norfolk: 800 MW CCGT). In each case, the combination of an AFD system and a fish return system have been selected by the UK Environment Agency as the most appropriate technology for fish protection. This combined approach has also been adopted at Doel. The retrofitting of AFDs at several other estuarine stations is also presently under consideration. Already AFD systems are commonplace at UK and European freshwater locations, with around 60 systems operating to date.

#### **References**

- Carlson, T. J., 1995. Use of sound for fish protection at power production facilities: a historical perspective of the state of the art. Phase 1 Final Report: Evaluation of the use of sound to modify the behavior of fish., No. DOE/BP-62611-4, July 1995. Bonneville Power Administration, Public Information Center - CKPS-1, PO Box 3621, Portland, OR 97208, USA.
- Hawkins, A.D., 1981. The hearing abilities of fish. In: Hearing and Sound Communication in Fishes. Springer-Verlag, New York: 109-133.
- Knudsen, F.R., Schreck, C.B., Knapp, S.M, Enger, P.S. and O. Sand, (1997). Infrasound produces flight and avoidance responses in Pacific juvenile salmonids. *Journal of Fish Biology*, 51: 824-829.
- Mann, D.A., Lu, Z. and A.N. Popper, 1997. A clupeid fish can detect ultrasound. *Nature*, 389, 25 September 1997: p. 341.
- Turnpenny, A.W.H. and J. Coughlan, 2003. Using Water Well: Studies of Power Stations and the Aquatic Environment. Monograph prepared for the Joint Environmental Programme, Innogy plc, Windmill Hill Business Park, Whitehill Way, Swindon, SN5 6PB. ISBN 095171726X: 142 pp.
- Turnpenny, A.W.H., Fleming, J.M., Thatcher, K.P. and R. Wood, 1995. Trials of an acoustic fish deterrent system at Hartlepool power Station. FAWLEY aquatic research laboratories Ltd. Client Research Report to Nuclear Electric plc, No. FCR 163/95.

Turnpenny, A.W.H., Thatcher, K.P., Wood, R. and P.H. Loeffelman, 1993. Experiments on the use of sound as a fish deterrent. Fawley Aquatic Research Laboratories Ltd, Report to the Energy Technology Support Unit (ETSU), Harwell, Didcot, Oxfordshire OX11-ORA, Contractors Report No. ETSU T/04/00171/REP.

Turnpenny, A.W.H., Wood, R. and K.P. Thatcher, 1994. Fish deterrent trials at Hinkley Point Power Station, Somerset, 1993-1994. Fawley Aquatic Research Laboratories Ltd, Report to the Energy Technology Support Unit (ETSU), Harwell, Didcot, Oxfordshire OX11-ORA, Contractors Report No. ETSU T/04/00198/REP.

---

### ***Objective Design Of Acoustic Fish Deterrent Systems***

*Jeremy Nedwell, Andy Turnpenny, and David Lambert, Fish Guidance Systems Ltd.*

#### **BIOSKETCHES**

Dr Jeremy Nedwell is an engineer in underwater acoustics and previously headed the underwater acoustics laboratory at Southampton University, England. He is Managing Director of the UK underwater acoustics consultancy Subacoustech Ltd and Engineering Director of Fish Guidance Systems Ltd. Jeremy has specialized in environmental acoustics.

Dr. Andy Turnpenny is a fish biologist and is currently Managing Director of Fawley Aquatic Research Laboratories and Fisheries Director of Fish Guidance Systems Ltd, both located in Southampton England. Andy spent 15 years as an environmental research scientist with the UK power industry and was formerly head of aquatic research for National Power PLC. He has specialized in fish entrainment and fish screening and passage issues.

#### **TECHNICAL PAPER**

##### **Abstract**

Behavioural systems such as bubble barriers, artificial lighting arrays and underwater acoustic systems use an aversive stimulus to deflect fish away from intakes. They have the advantage of having minimal engineering constraints, and no visual impact. Yet, the latest low-frequency acoustic systems are efficient in diverting a wide variety of species.

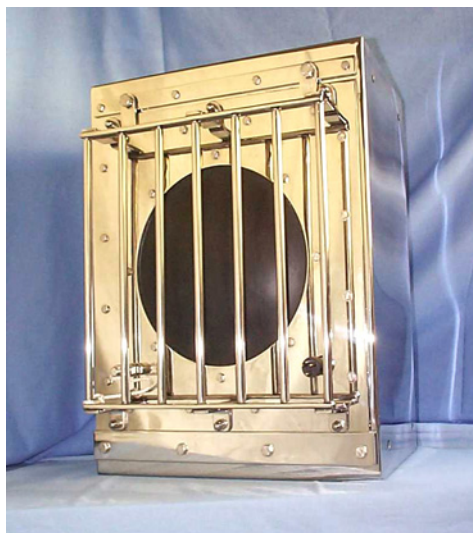
For efficient operation, the sound has to be sufficiently “loud” to cause an avoidance reaction, the sound field has to give a clear guidance cue to the fish, and the system has to be designed so that the fish will react in a way that leads to the desired consequence for the fish. Of these, the most difficult requirement to specify is the level of sound that is required to achieve avoidance. The paper outlines a scale developed by the authors which, given a specified efficiency, allows the sound amplitude required for engineering an effective fish deterrent system.

##### **Introduction**

Behavioural barriers (i.e. barriers based on the reaction of fish to some behavioural cue or cues) will generally reduce the operating costs and operational “outages” due to the entrainment of aquatic organisms and subsequent impingement on intake screens and have no visual impact, but the fish diversion efficiency has historically been lower than for mechanical systems. Consequently much effort has been focused on improving the diversion efficiency of behavioural systems. Behavioural systems may also be the only practical option in some high-flow, high-debris situations where physical screening is neither practical nor cost-effective.

A variety of behavioural systems have been developed including bubble barriers, artificial lighting arrays and underwater acoustic systems (Carlson, 1995). Of the three options, neither bubble curtains nor lighting systems appear to work efficiently enough to replace screens on salmonid rivers (Solomon, 1992), although light systems work well with some species and may have a role in conjunction with other behavioural methods. Low frequency acoustic systems, on the other hand, are now efficient in diverting a wide variety of species (e.g. Knudsen, 1997). The systems are simple in principle; a set of underwater sound projectors are used to generate high levels of low-frequency noise in the vicinity of the inlet, which guides the fish away along an amplitude gradient. The electrical

signals that feed the transducers are generated by a signal generator and set of amplifiers; a typical low-frequency transducer capable of generating underwater sound from 20 Hz to 500 Hz is illustrated in figure 1.



**Figure 1.** A typical transducer used in a acoustic fish deflection system (FGS Type 30/600). The active area of the transducer (the black disk) is 300 mmm diameter.

### **Fundamental Criteria For Successful Operation**

The fact that fish can hear is well established, and measurements of the hearing efficiency of fish at different sound frequencies have been taken for many species (e.g. Hawkins, 1981). Sound at a sufficiently high level will cause an avoidance reaction by the fish, and this may be used to modify its behaviour in a way that is advantageous to the user of the system.

In general, for an acoustic fish deflection (AFD) system to function effectively, the sound that it generates has to meet three essential design aims related to the behaviour of the fish; these are reaction, guidance, and delivery.

Achieving a reaction by the fish to the sound requires careful acoustical design of the AFD system. The sound has to have the right characteristics for the fish to respond. Pure tones for instance are ineffective in deterring fish except at very high levels; sounds that rapidly vary in level and frequency tend to have greater effect. The sound must also be sufficiently loud to cause an avoidance reaction. In order to design an AFD system from a sound engineering standpoint, it is necessary to be able to specify the level of sound that will be required to cause this reaction. However, the specification of this level of sound will depend on the species' sensitivity to sound and its hearing range of frequencies. In practice this has proved to be the most difficult feature of the AFD system; the dB<sub>ht</sub> scale described herein provides that objective engineering specification.

Guidance is achieved by ensuring that the sound field gives a clear directional cue to the fish, causing it to swim in a direction that enables it to avoid the inlet. The sound field must be of consistently high level in the areas where an avoidance reaction by the fish is required. Normally, the system is engineered to develop a sound field that increases rapidly in level as the fish approach the intake. Finally, the result of the behavioural reaction must be to lead to the desired consequence for the fish of delivery to safety. In the simplest case, for an inlet situated in a large expanse of water, the required reaction is for the fish to avoid the inlet area. If the preceding two criteria are satisfied, this requirement will readily be achieved. For a hydro plant, the more likely requirement is to divert the fish to a bypass entrance, in which case a barrier angled to the flow and leading into the bypass is used. Upon reaching the end of the guidance array, the fish must enter the bypass. Conditions here are always critical to the success of the project. Important characteristics include the opening depth and width, the attraction flow and the visual appearance of the structure (Turnpenny et al., 1998). It has been found for other types of behavioral barrier, such as the louver screen,



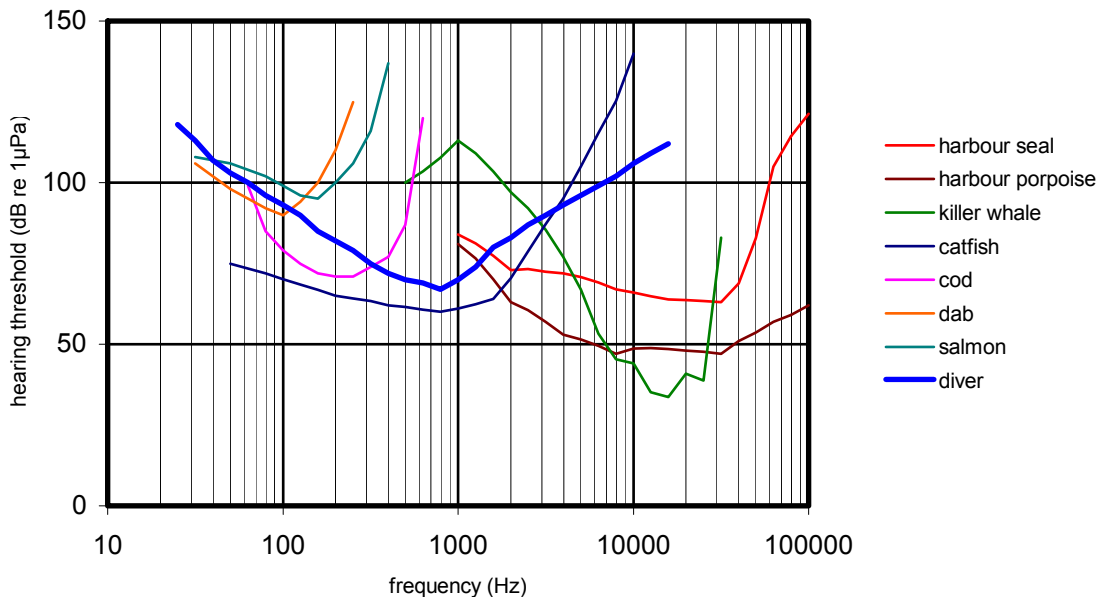
that attraction is greatest when water accelerates into the bypass entrance; the rate of acceleration of the water also affects the time taken for fish to enter the bypass (Haro et al., 1998).

In conclusion, failure in any one of these three requirements results in partial or complete failure of the entire system. The efficient operation of such barriers requires a systematic engineering approach to design in which all three requirements are investigated.

**Loudness And Reaction: The  $dB_{ht}$  (Species).**

To work, the sound generated by an acoustical guidance system must be “sufficiently loud to cause a reaction”. But what level of sound is sufficient to satisfy this requirement? Intuitively, it is obvious that it must be much higher amplitude for salmonids, which have relatively poor hearing, than for cyprinids, whose hearing is acute. The question is pertinent when undertaking feasibility studies concerning the use of AFD systems because the more sensitive the species is to the sound, the lower the cost of achieving efficient deflection.

To answer these questions, the authors have found it beneficial to express the sound levels on a scale termed the  $dB_{ht}$  (Species). This scale involves the acuity and frequency range of the species’ hearing, and is a measure of how much the sound is above the species’ threshold of hearing. It may be considered to be a measure of the relative “loudness” of a sound for a given species. The suffix  $_{ht}$  relates to the fact that the sound is expressed in dBs which are referenced to the hearing threshold of the species. The  $dB_{ht}$  (Species) level is estimated by passing the sound through a Finite Impulse Response (FIR) filter that mimics the hearing ability of the species, and measuring the peak level of sound after the filter; the level expressed in this scale is different for each species and corresponds to the *perception* or *loudness* of the sound by the species. Typical audiograms of fish, marine mammals and a human diver are shown in figure 2.



**Figure 2.** Typical audiograms of fish, marine mammals and a human diver

Let  $W(\omega)$  be the threshold sound pressure of the species' hearing at frequency  $\omega$  expressed in any unit of pressure. The weighted version of a sound  $P(t)$ , expressed in the same units, which might be termed the perception filtered sound, is given by

$$P_{ht} = \int_0^{\infty} \frac{1}{W(\omega)} e^{-i\omega t} \int_0^{\infty} P(t) \delta t \delta \omega \quad (1)$$

The units of the resulting quantity are pressure, divided by pressure at threshold, and hence are non-dimensional. The consequent level may be expressed as the  $\text{dB}_{ht}(\text{Species})$  level, where

$$\text{dB}_{ht}(\text{Species}) = 20 \log \langle P_{ht} \rangle$$

where the chevrons denote the RMS value of  $P_{ht}$ .

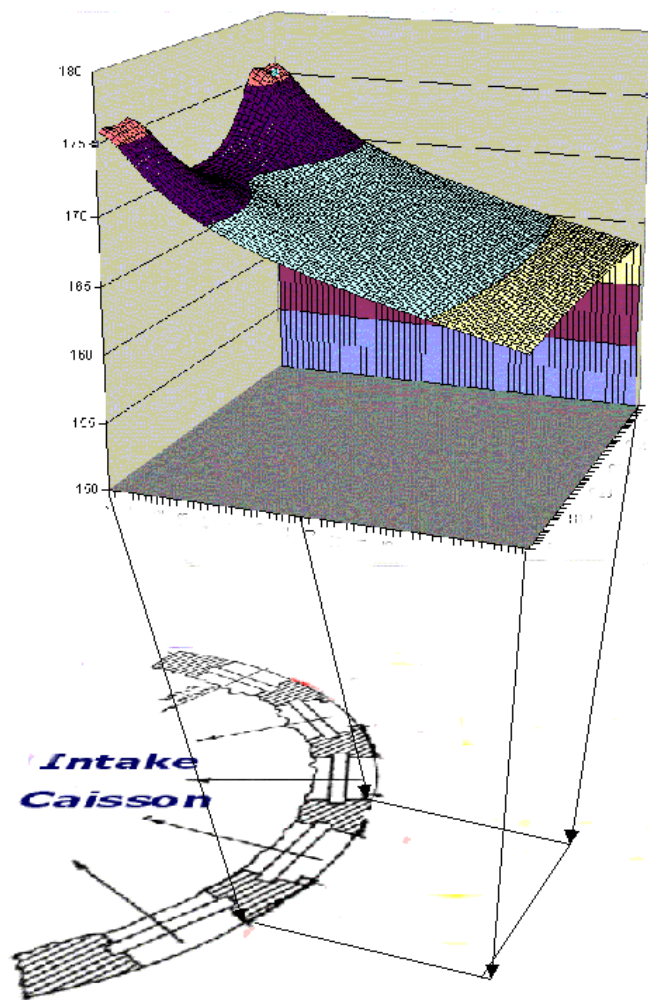
Level of sound to cause a avoidance. Human hearing has a dynamic range, from the threshold of hearing, to the threshold of pain, of about 130 dB. The range is determined by physical constraints; at the lower end, hearing is limited by natural background noise, and at the upper end, by displacements of the sensory structures associated with hearing to a degree that causes traumatic damage. When the sound exceeds about 90 dB above the threshold level, it is likely to cause significant behavioural effects and in particular avoidance. It may be proposed that since these limits are set by physical constraints, the dynamic ranges available to other species may be similar.

#### **Field Observations Of $\text{dB}_{ht}(\text{Species})$ Required For Avoidance**

In 1997, Fish Guidance Systems Ltd (FGS) installed a large infrasonic SPA-AFD system at Electrabel's Nuclear Power Station at Doel in Belgium. The power station draws cooling water from the Schelde estuary, and the system is designed to reduce fish ingress (mainly clupeids) into the offshore cooling water intake. Fish catches were monitored by biologists from Leuven University [6].

The intake structure is a 30-metre diameter hollow concrete caisson, from the bottom of which flow is drawn via a tunnel. Water enters through five rectangular ports 2.4 metres wide, 4 metres high and 1.75 metres apart, giving a mean inflow velocity of  $0.5 \text{ ms}^{-1}$ . The SPA-AFD system uses 20 FGS MkII 30-600 sound projectors, 20 FGS Model 400 amplifiers and 1 FGS Model 1-08 signal generator. Four transducers are mounted on each buttress between windows, and two transducers are mounted at each end. Each transducer generates a Source Level of about 155 dB re  $1 \mu\text{Pa}$  @ 1 metre in the frequency range from 20 to 500 Hz, swept over a 0.2 second period. A typical calculation of unweighted sound pressure level using PrISM is illustrated in figure 3.

The average sound level in  $\text{dB}_{ht}(\text{Species})$  at the inlet has been calculated for three species (pelagic, demersal and benthic, respectively) (table 1). Also given are the results from the Leuven University evaluation of the system from fish catches. Since there were no statistically significant individual results for either dab or cod (owing to low numbers), the results for the categories into which they fall in the Leuven results (flatfish and roundfish respectively) have been used. Results are also listed from a SPA-AFD installation at the Hartlepool nuclear station on the Tees Estuary (Turnpenny 1995). As the  $\text{dB}_{ht}(\text{Species})$  levels generated by the AFD system were not measured or modelled they are not included, but the system was similar to the preceding system, and hence it may be assumed that the sound levels are of similar order to those at Doel.



**Figure 3.** A typical calculation of sound pressure level using PrISM

It should be commented that in general it is preferable to directly measure actual levels of sound, rather than estimating them using an acoustic model. In practice however, it is difficult to measure sound levels at inlets due to the high flow and the consequent difficulty in locating the hydrophone used to measure the sound at an accurate position in front of the inlet.

**Table 1.** The estimated average level at the inlet vs the system efficiency

<b>Modelled dB<sub>ht</sub>(Species) level for Doel system</b>	<b>Doel system efficiency</b>	<b>Hartlepool system efficiency</b>
76 dB <sub>ht</sub> ( <i>Limanda limanda</i> )	21% (flatfish results)	16% (flatfish results)
90 dB <sub>ht</sub> ( <i>Gadus morhua</i> )	50% (roundfish results)	54% (whiting results)
98 dB <sub>ht</sub> ( <i>Clupea harengus</i> )	80%	80%

## Discussion

First, it should be noted that the analysis presented is not ideal. Despite there being estimates of efficiency from Doel for a wide range of species, the number for which a  $dB_{ht}(\textit{Species})$  analysis could be undertaken was very limited due to the lack of information on their hearing. Second, it is common that levels of sound estimated from acoustical models differ significantly from measured levels. While it would be possible to measure the sound level accurately at Doel, this was not possible within the timescales and budget of this project.

Nevertheless, the analysis indicates that the varying results for effectiveness of the system are consistent with the effects of the sound depending primarily on its “loudness” or level above the species’ threshold, that is, the  $dB_{ht}(\textit{Species})$  level. The varying effectiveness of the system can be explained in terms of the differing sensitivities of the species to sound; the less sensitive species are little affected by the system whereas the most sensitive species are efficiently deterred from entering the cooling water offtake.

In terms of objective measures of sound which could be used to engineer AFD systems, the results indicate that at a level of 90  $dB_{ht}(\textit{Species})$ , a strong avoidance reaction occurs, and at 98  $dB_{ht}(\textit{Species})$ , the majority of fish avoid the inlet (It may be commented that the most recent results from Doel indicate >90% deflection efficiency for the target fish species). In principle, adequate efficiencies could be achieved for any species given a large enough acoustic system and, hence, a high enough level of sound. However, in the case of very insensitive species the cost of such a system might be prohibitive.

It is interesting to note however that the species that are least sensitive to sound are often well suited to a physical fish return system. Consequently, a system aiming for Best Available Technology may combine an AFD system with a physical screen with fish return system. Acoustically sensitive but delicate species may be deterred by the AFD system from entering the vicinity of the inlet. The acoustically insensitive and robust species however may be returned from the screens with low mortality. This is the basis of the system which is now used at Doel.

## References

- Carlson, T. J., 1995. Use of sound for fish protection at power production facilities: a historical perspective of the state of the art. Phase 1 Final Report: Evaluation of the use of sound to modify the behavior of fish., No. DOE/BP-62611-4, July 1995. Bonneville Power Administration, Public Information Center - CKPS-1, PO Box 3621, Portland, OR 97208, USA.
- Haro, A., Odeh, M., Noreika, J. and Castro-Santos, T., 1998. Effects of water acceleration on downstream migratory behaviour and passage of Atlantic salmon smolts and juvenile American shad at surface bypasses. *Trans. Am. Fish. Soc.*, **127** (1): 118-127.
- Hawkins, A.D., 1981. The hearing abilities of fish. In: *Hearing and Sound Communication in Fishes*. Springer-Verlag, New York: 109-133.
- Knudsen, F.R., Schreck, C.B., Knapp, S.M, Enger, P.S. and Sand O., (1997). Infrasound produces flight and avoidance responses in Pacific juvenile salmonids. *Journal of Fish Biology*, 51: 824-829.
- Maes, J., Turnpenny, A.; Lambert, D., Nedwell, J., Parmentier, A. & Ollevier, F. 2002. The impact of cooling water abstraction on fish at the Electrabel Power Plant Doel (Belgium) after installation of a fish guidance sound system. *Tribune de l* **55**: 75-78.
- Solomon D.J., 1992. Diversion and entrapment of fish at water intakes and outfalls. R & D Report No. 1, National Rivers Authority, Bristol: 51 pp.

Turnpenny, A.W.H., Struthers, G. and Hanson, K.P., 1998. A UK Guide to Intake Fish-Screening Regulations, Policy and Best Practice. Final Report, ETSU Contract No. H/06/00052/00/00. Energy Technology Support Unit, Harwell, Oxon., OX11 0RA, UK.

Turnpenny, A.W.H., Fleming, J.M., Thatcher, K.P. and Wood R., 1995. Trials of an acoustic fish deterrent system at Hartlepool power Station. FAWLEY aquatic research laboratories Ltd. Client Research Report to Nuclear Electric plc, No. FCR 163/95.

---

*Induced Sweeping Flows at CWIS for Reducing Fish Impingement*  
*Charles C. Coutant*

**BIOSKETCH**

Dr. Charles Coutant is Distinguished Research Ecologist in the Environmental Sciences Division of Oak Ridge National Laboratory. Dr. Coutant received his B.A., M.S., and Ph.D. in biology (ecology) from Lehigh University. He conducted field and laboratory studies on Pacific salmon in relation to nuclear power stations on the Columbia River for 5 years at the Atomic Energy Commission's Pacific Northwest Laboratory. He led a program on power station effects on aquatic systems at Oak Ridge National Laboratory (Tennessee) in the 1970s and early 1980s, and has held various research and administrative positions there for 33 years. He was active in developing guidelines for, and implementing, 316(a) and 316(b) demonstrations. Since 1989 he has served as an independent advisor for the salmon restoration programs in the Columbia River basin. His main interests are temperature effects, fish behavior and habitat selection, and research and analysis for minimizing the impacts of thermal-electric and hydropower generation on aquatic systems.

**TECHNICAL PAPER**

**Abstract**

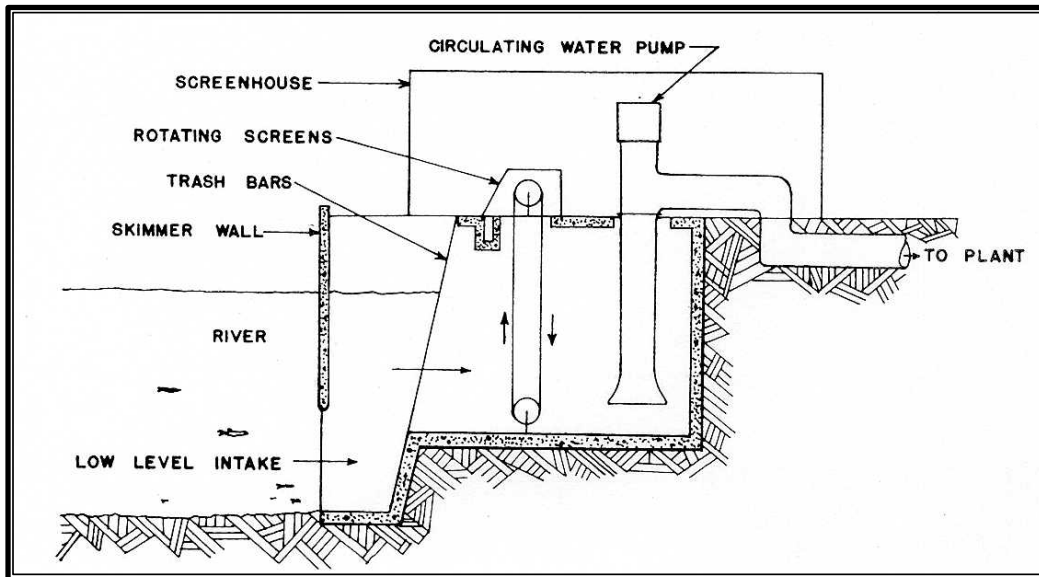
We propose induction of an angled sweeping flow at cooling-water intakes (CWIS) as an innovative technology to reduce impingement by guiding fish to a screen bypass that returns fish to the waterbody. The concept arises from specification of a "sweeping velocity" by several state and federal agencies to protect fish from being impinged at water intake screens, primarily angled fish screens at irrigation water diversions in the Pacific Northwest. A sweeping velocity is the velocity component parallel to the angled screen face in contrast to the velocity perpendicular to the screen face. Although there is disagreement over whether the sweeping velocity is anything other than a theoretical vector, screens that are angled according to the calculations for meeting the sweeping velocity criteria are generally effective in diverting fish to bypasses. Most existing CWIS intake screens are not angled and were not constructed to provide a sweeping velocity to a bypass. The typical CWIS has vertical traveling screens mounted perpendicular to the overall intake flow, often in an intake canal. Some perpendicular intake screens are mounted very close to the flow of a river, nearly flush with the riverbank, with a design (containing a sweeping flow in the direction of river flow) that is recognized as having generally low rates of impingement. Replacing existing screens with angled screens designed to steer fish toward a bypass may be cost prohibitive for existing facilities. Alternately, we propose that an angled sweeping flow induced (by pumps or baffles) upstream of existing screens could effectively guide fish away from impingement on the screens and into a bypass. If proven effective, such a hydraulic barrier would not require extensive structural modifications of existing screens other than provision of a bypass to the source water body. This paper reviews the existing regulatory criteria for sweeping flows, presents a possible layout for inducing sweeping flows at a CWIS, predicts fish behavior based on previous studies, and outlines proposed studies to test the hypothesis in laboratory flumes and at an existing CWIS.

**Introduction**

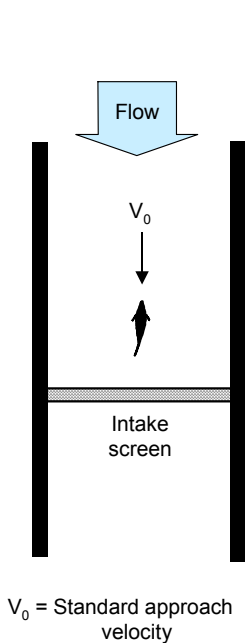
The purpose of this paper is to present a conceptual plan and initial research strategy for simulating "sweeping velocities," which are mandated by regulations for angled screens, at existing cooling-water intake structures (CWIS) having screens perpendicular to the water flow. This would be done so that fish otherwise destined for impingement are swept laterally to a safe bypass. The concept is proposed specifically to offer a possible solution for retrofitting existing power stations that have limited ability to make major structural changes in present intakes.

Impingement of fish on intake screens of cooling-water systems is a major regulatory issue for electric power generators and other water users. It has been of concern and subject to considerable study since the early 1970s (EPA, 1973; Jensen, 1974). This environmental issue has drawn a large amount of attention recently as a result of decisions from 1995 litigation that obligated more strict enforcement of Section 316(b) provisions of the 1972 Clean Water Act. The US Environmental Protection Agency is currently involved in rulemaking as a result of a consent decree resulting from that litigation (Nagle and Morgan 2000). This rulemaking has stimulated reevaluation of (in the wording of the Clean Water Act) “adverse environmental impacts” caused by CWIS (Dixon et al., 2003) such as the impingement of fish and shellfish on intake screens and the “best technology available” for minimizing those impacts (the subject of this symposium). In 2002, EPA’s proposed Phase II rule for existing facilities (Federal Register 67: 17122; reiterated in Federal Register 68:13522) established an impingement mortality reduction standard of 80-95% for all existing power plants in the U.S., although a lesser standard could be obtained based on proposed variance tests (cost-cost and cost-benefit tests).

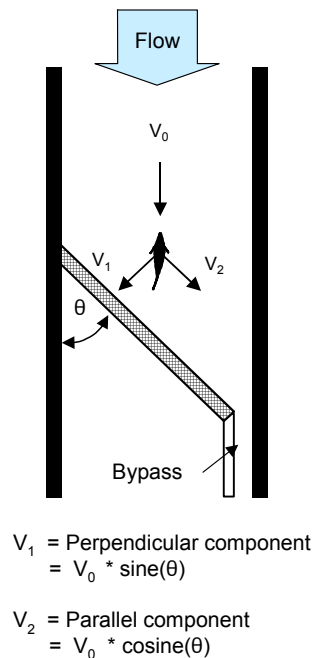
Several reviews of fish protection at CWIS have concluded that most present technologies have not been proven effective for greatly lowering the numbers of fish impinged or entrained (EPRI, 1998, 1999). Most CWIS in the United States use vertical travelling screens set perpendicular to the flow of water moving into the pump well (Figures 1, 2). Impingement of fish can result when fish are trapped in intake canals by high water velocities and long distances to slower waters, become exhausted from swimming against the flow, and fall back onto screens as their only option (Figure 2).



**Figure 1.** Typical power station cooling-water intake system, side view. From Lifton and Storr, 1978.



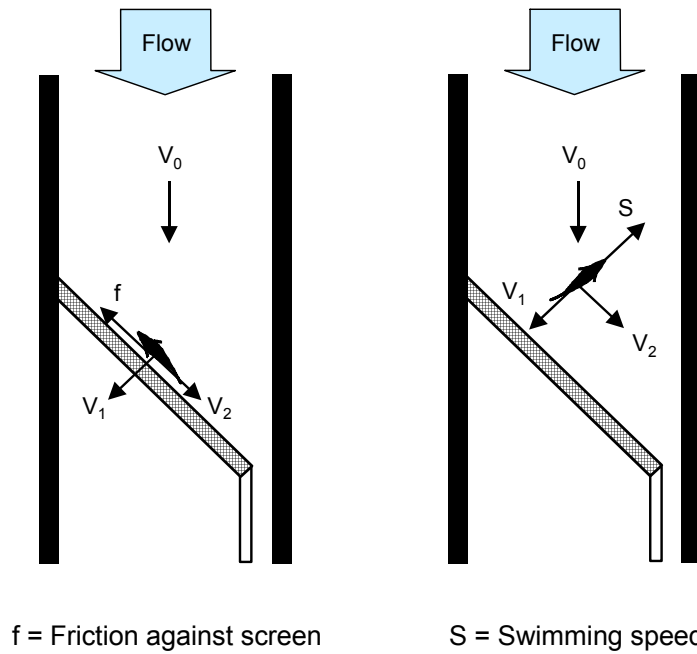
**Figure 2.** Velocity vector affecting fish that approach screens perpendicular to flow. From EPRI, 2000.



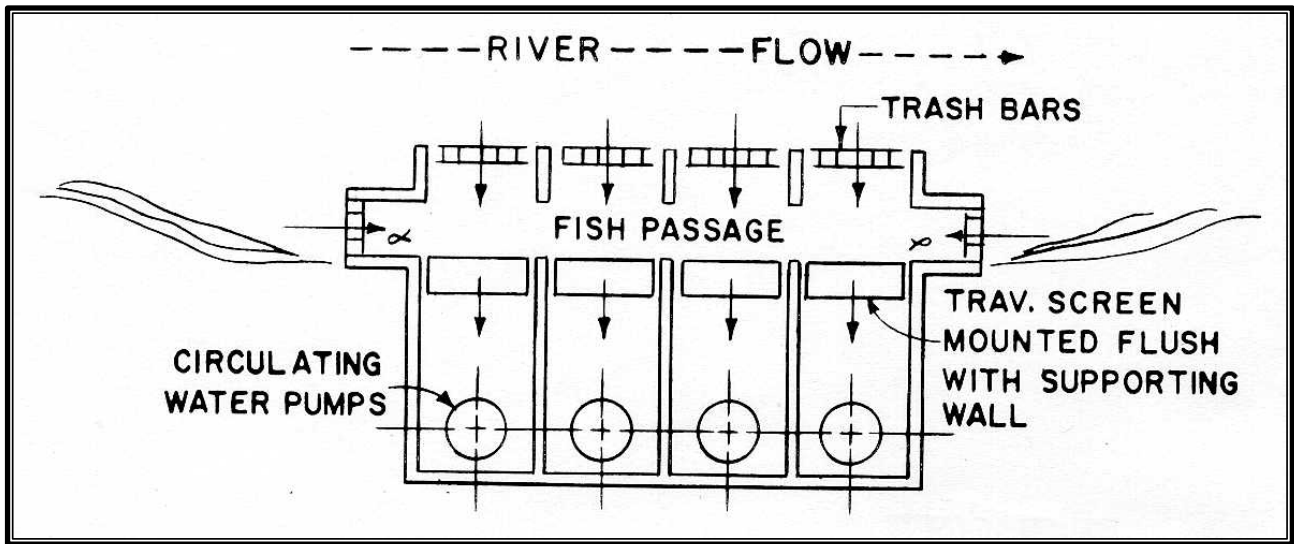
**Figure 3.** Theoretical velocity vectors affecting fish that approach a screen angled to the incoming flow (but see Fletcher 1984 for a detailed analysis). From EPRI, 2000.

This arrangement differs from currently accepted guidelines for fish protection at water intakes used for other purposes (e.g., irrigation systems in the western U.S.), in which angled screens are the norm (NMFS, 1995, 1997; EPRI, 2000). A main rationale for angled screens is that fish that might otherwise be impinged on a screen perpendicular to flow (Figure 2) are swept laterally along the screen to a bypass by a flow vector called the “sweeping velocity,” which is the parallel component,  $V_2$ , of the velocity vectors affecting a fish at an angled screen (Figure 3). Although a sweeping velocity is perhaps more theoretical than real (see analysis by Fletcher, 1985), the angle of such a screen has proven effective in moving fish laterally. Even if fish are impinged, they are facilitated in their escape by a lateral component of movement from burst swimming, which progressively moves a fish along the face of the screen to the bypass (Figure 4). Power station intakes located along river shorelines, with screens nearly flush with the shore, have a built-in sweeping flow in the form of the river current (Figure 5). Such shoreline intakes generally have low impingement rates, because fish can easily bypass the screens through access ports at the sides.

New intakes with angled screens might be constructed to minimize impingement (Figure 6). However, full re-engineering and rebuilding of existing CWIS to provide for angled screens and fish bypasses has not been considered economically feasible or physically possible due to space limitations on many existing plant sites. Therefore, we have sought an alternative technology, particularly one that has its roots in systems that have been proven effective.

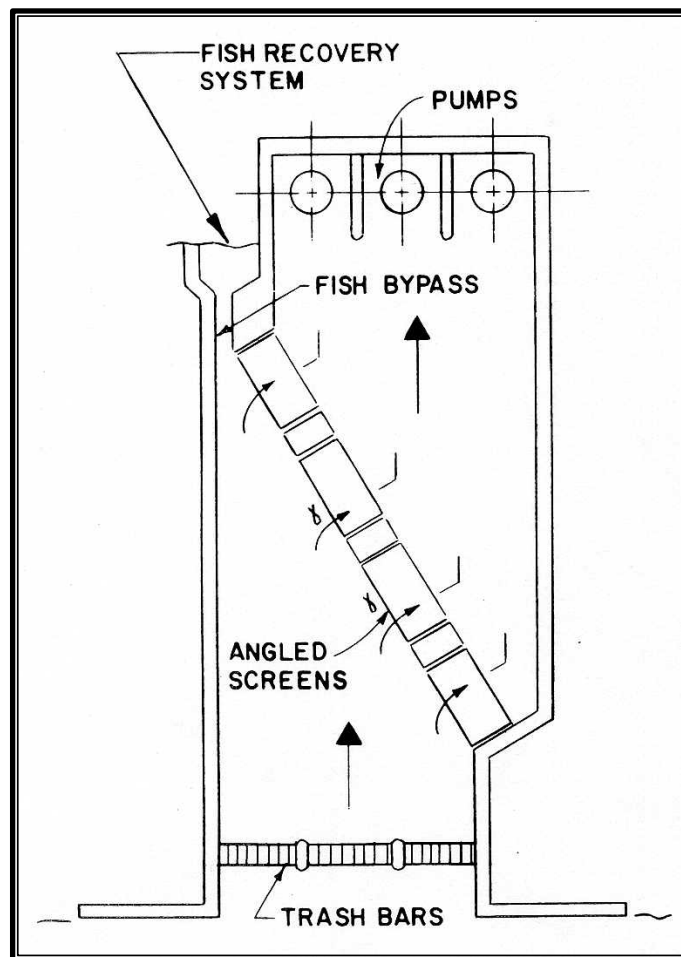


**Figure 4.** Escape from impingement on an angled screen by sliding along screen or burst swimming away from a screen. From EPRI, 2000.



**Figure 5.** A CWIS located flush along a river shoreline already has a sweeping flow in the form of the river flow. From Richards, 1978.

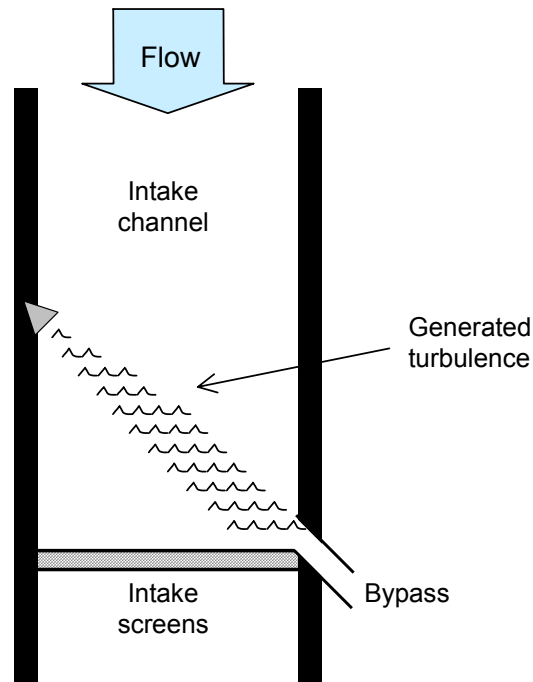




**Figure 6.** Simplified CWIS with angled screens. From Richards, 1978.

We believe it should be possible to simulate an angled screen’s theoretical “sweeping velocity” with an induced flow, without re-engineering an intake to accommodate actual angled screens. Rather than relying on a presumed lateral (parallel) vector of the intake flow along an angled screen, actual flows would be induced by pumps, propellers, or vanes across a perpendicular screen face (Figure 7). Fish would thus be concentrated at one side of the screening system, from which they could be diverted to a bypass. An induced flow could be established most effectively at a point upstream of the screen to divert fish toward a bypass or back to the source water body. The flow might be an attractant in the sense of turbulent attraction flows proposed by Coutant (1998; 2001) or simply a cross velocity that moves fish laterally as they use burst swimming to avoid contacting either the screen, as suggested in EPRI (2000), or the turbulent cross flow. Fish guidance by hydraulic patterns, natural and induced, is currently being studied and evaluated by the authors and commercial firms (e.g., Natural Solutions, Helena, MT and Current Solutions, Boston MA).

This paper reviews the existing regulatory criteria for sweeping flows, presents an alternative layout for inducing sweeping flows at a CWIS, predicts fish behavior based on previous studies, and outlines proposed studies to test the hypothesis in laboratory flumes and at an existing CWIS.



**Figure 7.** Induced sweeping flows. The general pattern of a turbulent plume angled across an intake channel upstream of an intake screen, top view.

### State and Federal Criteria for Sweeping Flows

Several state and federal agencies have developed intake screen criteria that include sweeping velocities to protect fish from being impinged (Table 1). The National Marine Fisheries Service (NMFS; now referred to as NOAA Fisheries) has established criteria for protection of anadromous species (NMFS, 1995). NMFS based its criteria on those established by the state of Washington in 1988 (Bates, 1988), which were developed primarily for angled fish diversion screens. The Washington criteria were guided largely by studies on salmonid swimming stamina by Smith and Carpenter (1987). The NMFS criteria apply to intakes on lakes, reservoirs, tidal areas, as well as rivers and streams. Several states in the Pacific Northwest have adopted criteria that are similar to those developed by NMFS.

The details of particular velocity vectors at screens and their use in existing or proposed regulations can be difficult to fathom. Terminology often is inconsistent. Fletcher (1985) provided a detailed technical analysis of flows at angled screens based on laboratory and power-plant experiments, which showed that many analyses were erroneous. For our purposes, we follow the terminology in EPRI (2000), simplistic as it may be, shown in Figure 3. Our particular interest is  $V_2$ , the presumed velocity vector that is angled laterally with regard to the main component of water flow entering the intake,  $V_0$ . This is what is called the “sweeping velocity” in federal and state regulations. EPRI (2000) compared several alternative uses of velocity as a regulatory criterion, but most do not concern us here.

Although the regulatory concept of a sweeping velocity at angled screens was developed for salmonids and was tied to specific perpendicular velocity criteria (Table 1), we adopt the concept in its more general sense. That is, as a flow of some definable strength suitable for diverting fish to one side of the intake where they may be selectively removed from risk of impingement.

**Table 1.** Federal and state agency criteria for sweeping velocity. Compiled in EPRI (2000) from several sources.

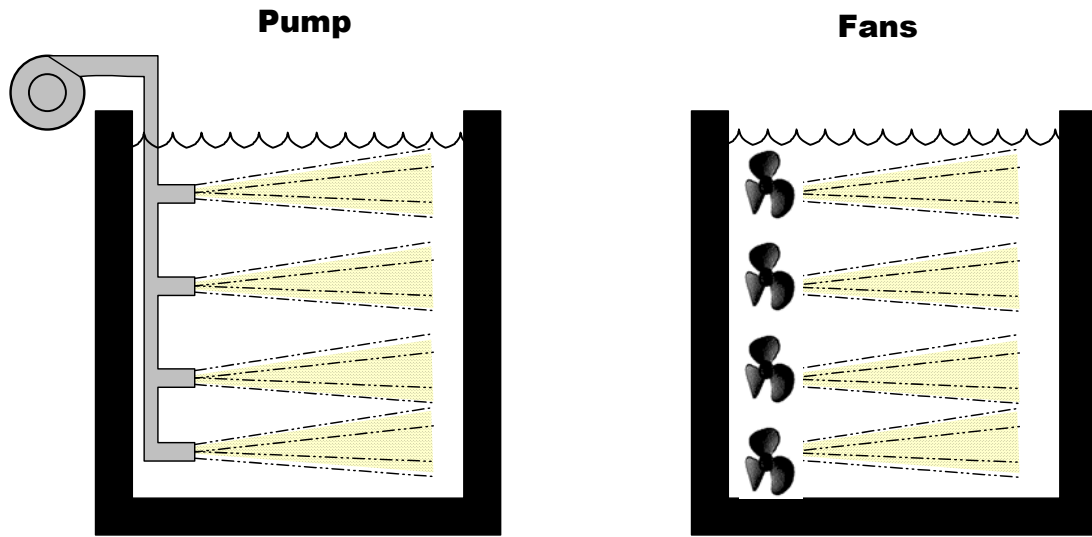
Agency	Perpendicular approach velocity (f/s)		Sweeping velocity (Parallel velocity vector)
	Fry (<60 mm)	Juv. (<60 mm)	
NMFS-Northwest Region	0.4	0.8	> approach velocity
NMFS-Southwest Region	0.33-0.4	0.8	> approach velocity
California DFG/USFWS	0.2 <sup>3</sup>	Same as fry	At least 2X approach velocity
Oregon DFW	0.5	1.0	≥ approach velocity
Washington DFW	0.4	--	≥ approach velocity
Idaho DFG	0.5	Same as fry	Sufficient to avoid physical injury to fish

### Induced Sweeping Velocity

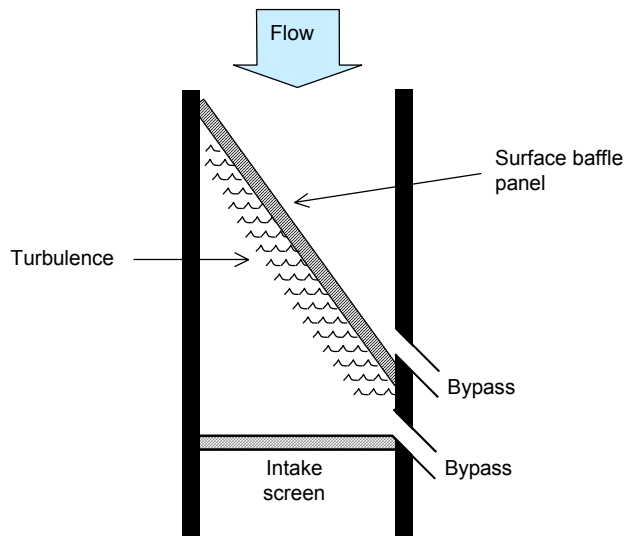
Following the geometry of Figure 2, which shows a screen perpendicular to the intake flow in a canal, we envision a sweeping flow being induced at an angle upstream of the screen (Figure 7). Depending on the shape of the canal, the flow could be induced in several ways. A series of sewage mixers (propellers or fans), as first used by Lakeside Engineering, Inc. (1997), could be placed in a vertical array on one side of the canal, directing flow toward the other side (Figure 8). Such mixers have been effective in guiding salmon smolts at a hydropower intake (Darland et al., 2001). Alternatively, a single onshore pump could supply water to a vertical manifold of water jets (Figure 8). Recent studies at an intake canal in Michigan by the authors indicated that an angled baffle panel at the surface (a trash boom) would provide a turbulent plume that guides many surface-oriented fish to one side of the canal (Coutant and Bevelhimer, in review a; Figure 9). Some fish would follow the upstream side of the baffle whereas others would follow the turbulent plume on the downstream side.

Whatever the means for inducing the sweeping velocity, we expect many fish to be diverted laterally. Some fish may sense the turbulent zone as a barrier and attempt to pass around it, thus actively swimming toward the side of the canal that is downstream relative to the turbulent zone. Other fish may be entrained in the induced flow and follow it to the side. Such entrainment would include cold-stressed fish like threadfin shad in a cold coma, a condition that causes large episodes of impingement at many power stations (Griffith and Tomljanovich, 1975; Griffith, 1978; Loar et al., 1978). This displacement may be enhanced for fish that have tired from swimming against the flow in the intake canal. Because fish species most sensitive to handling stress tend to be the most often impinged, it is a valuable feature that induced sweeping flow involves guidance without physical handling. For each design option, however, a fish bypass would need to be provided from the side of the canal downstream of the induced flow in order to return fish to the source water body (below).

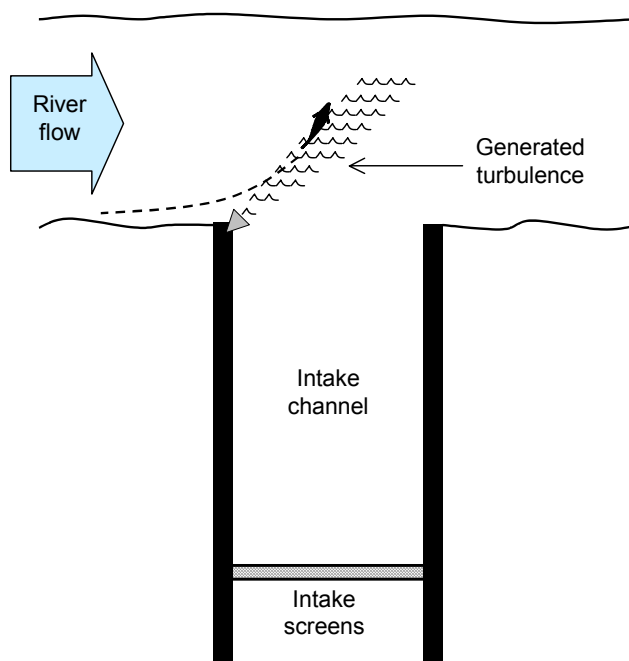
We also envision an application outside an intake canal on a lake or estuary (Figure 10). This situation would mimic an intake screen that is nearly flush with the river shore, where the river flow provides the sweeping velocity. Flow would be induced at the mouth of the intake canal, oriented away from the shore. Fish moving along the shoreline, as they often do, would be diverted outward and away from the water entering the intake canal. In this case, the water body itself provides the “bypass.”



**Figure 8.** Cross sections of an intake canal with a vertical array of jets from a single pump source located onshore (left) and a vertical array of fans or propellers (sewage mixers) aimed across the canal (right).



**Figure 9.** A turbulent plume from a surface baffle panel.



**Figure 10.** A sweeping flow located at the entrance of an intake canal to divert fish before they enter the canal (for simplicity, induced flow is shown on only one side of the entrance whereas both sides may be necessary).

### Fish Bypass

Except for induced flow at a canal entrance, a CWIS would need to provide a fish bypass at the side of the intake screen system where fish are induced to congregate. The type of bypass would depend greatly on the configuration of the particular CWIS. The principal design constraint is the lower water level in the intake well than in the source water body (created by pumping of the cooling water). This usually would prevent using a direct pipe or channel because inflowing velocities could be so high as to prevent fish use.

Several types of existing and proven fish bypasses may be appropriate. A fish lift might be suitable. Induced flow could guide fish into a cage in front of the most lateral intake screen. The cage would need to be constructed so that water velocities are slowed and fish do not impinge on the sides of the cage. It would also need to have a lower portion that would hold water when the cage is lifted. The cage would be raised periodically by an amount sufficient to allow discharge to a pipe or channel above water level that would allow flow by gravity to the source water. Fish lifts are commonly used at hydropower facilities and a number of effective designs are available (Clay, 1995). Two large Archimedes lifts and a large Hidrostal pump have proven effective at the U.S. Bureau of Reclamation's experimental pumping plant at Red Bluff on the Sacramento River (McNabb et al., 2003). Also, aquaculture facilities have developed fish friendly pumps for transferring cultured stock between ponds and holding tanks.

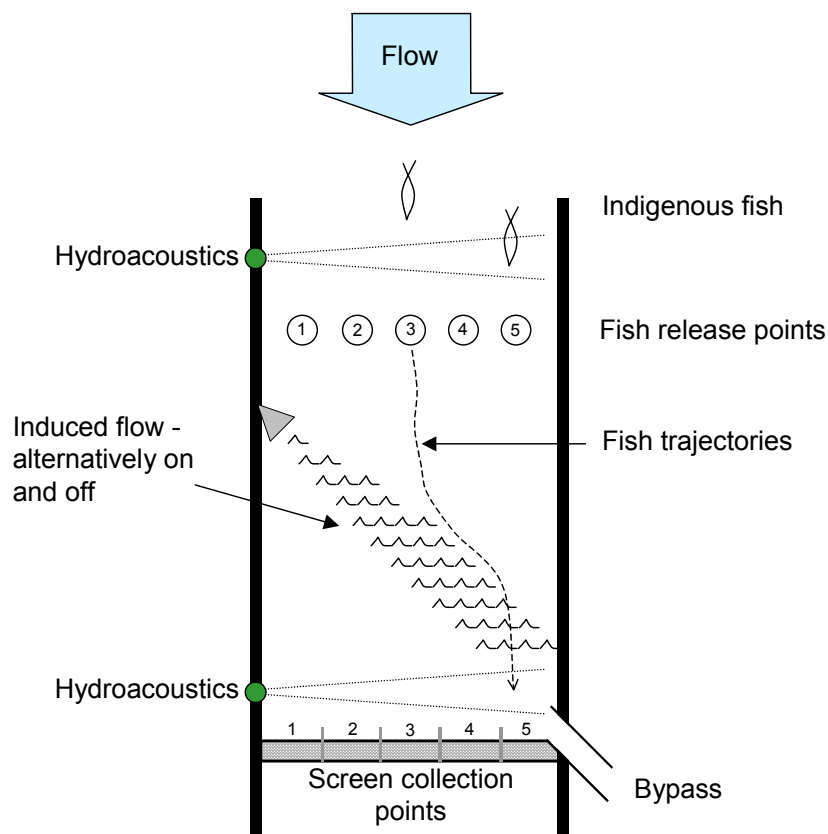
### Testing and Evaluation

Multidisciplinary studies among structural engineers, hydraulic engineers, and biologists will be needed to test the effectiveness of these concepts for meeting EPA's impingement-reduction goals at existing CWIS. This research would entail several steps:

1. Examine the impingement history of potential study sites and the species of fish and invertebrates that occur there and tend to be impinged. It is essential to know what the problem actually is and to understand the

species involved and their vulnerabilities. An understanding of fish behavior is essential, especially how the species and life stages respond to the physical features of the site and the water velocities and directions that are created by the CWIS; i.e., one needs to learn to “think like a fish” (Coutant, 1999).

2. Develop conceptual designs for inducing sweeping velocities at a variety of existing intake types. Power plants are usually designed uniquely to fit the terrain of the site. Thus, existing facilities are diverse and one design will likely not suffice for all situations.
3. Conduct numerical modeling of the hydraulic patterns likely to be produced by flow induction devices. Computational fluid dynamics (CFD) models are increasingly capable of simulating water velocities and directions in turbulent flows. Such models could provide numerical “experiments” to test alternative flow-induction devices and placement strategies.
4. Develop research strategies for testing the effectiveness of such induced velocities for guiding fish at test sites (Figure 11). Strategies should be developed for configurations discussed above. One strategy would involve naturally occurring fish, with an alternating “on-off” experiment in which impingement at each individual screen in a multi-screen CWIS is monitored to see if induced flow guides fish to the side intended (where a bypass could later be located). Hydroacoustic techniques could also be used to compare lateral fish distributions upstream and downstream of the induced flow. Another strategy would be to release test fish upstream of the induced flow and follow their trajectories, either by following movements of tagged fish or by sampling final locations as impingement on screens. A statistical design would involve comparing initial lateral distribution of released fish with the final lateral distribution.
5. Conduct experimental flume tests, where such facilities are available. Experimental flumes would allow small-scale testing away from constraints of size and logistics of an operating power plant and a natural water body. Water of high clarity can be assured to facilitate visual observations of both water and fish. Experimental strategies would use introduced fish and prototype-scale devices for inducing sweeping flows in a configuration that could be easily modified as hydraulic and fish-behavior data are produced. Adaptive changes are not so quickly and easily made in actual operating systems. Fletcher (1985) describes flume tests with angled screens.
6. Conduct actual field testing, beginning with fairly simple systems. A site with water of high clarity should be used initially if trajectories of introduced fish are to be determined. We have had good experience in the field with following fish tagged with inexpensive light tags, using visual observation enhanced by video recording and analysis (Coutant and Bevelhimer, in review b). We have also had good experience with hydroacoustic techniques when there are abundant indigenous fish (Coutant and Bevelhimer, in review a).
7. Evaluate effectiveness of induced flows for guiding fish compared to objectives for impingement reduction. An 80-95% reduction from prior impingement levels is a draft goal of EPA.
8. Estimate costs of an operating system (installation and operation) as well as associated costs of fish bypass facilities and other features to be changed. Compare these costs to costs of other technologies that might be used at the site.



**Figure 11.** Diagrammatic experimental designs for testing effectiveness of induced sweeping flows for diverting fish to a bypass in test flumes or intake canals. An induced flow is alternately on and off. Ambient fish are either counted on individual intake screens during on and off periods or located and counted laterally with hydroacoustics both upstream and downstream of the induced flow. Captive fish can be released at known locations laterally and recaptured at individual intake screens. Fish can be tagged for observation of trajectories through the zone of induced flow during times on and off. Statistical tests are used to evaluate significance of differences in fish locations.

### Conclusion

We believe a technology using induced sweeping flows would provide a potentially effective and relatively inexpensive remedial measure for retrofitting existing cooling-water intake systems to reduce impingement. The concept is based generally on (1) the proven effectiveness of angled screens in the Northwest designed to meet federal and state criteria for sweeping velocities and fish bypasses, and (2) low impingement at river shoreline water intakes. The concept of induced sweeping flows, although untested at cooling-water intakes, seems to have sufficient promise to justify further analysis and initiation of testing in laboratory flumes and field power station intakes.

### Acknowledgments

This paper is based on research sponsored jointly by the U.S. Department of Energy's Hydropower Program and EPRI performed at Oak Ridge National Laboratory (ORNL). ORNL is managed by UT-Battelle, LLC, for the U. S. Department of Energy under contract DE-AC05-00OR22725.

### References

Bates, K., 1988. Screen criteria for juvenile salmon. Habitat Management Division, Washington State Department of Fisheries, Olympia.

Clay, C. H., 1995. Design of fishways and other fish facilities, Second edition. Lewis Publishers, Boca Raton, Florida.

Coutant, C. C., 1998. Turbulent attraction flows for juvenile salmonid passage at dams, ORNL/TM-13608, Oak Ridge National Laboratory, Oak Ridge, Tennessee.

Coutant, C. C., 1999. Think like a fish! Emphasizing the 'behavior' in behavioral guidance systems, *Hydro Review*, 18(3):18-25.

Coutant, C. C., 2001. Turbulent attraction flows for guiding juvenile salmonids at dams, *American Fisheries Society Symposium*, 26:57-77.

Coutant, C. C., and M. S. Bevelhimer. In review a. Fish guidance at Buchanan Hydropower Plant, 2002. Oak Ridge National Laboratory, Oak Ridge, Tennessee.

Coutant, C. C., and M. S. Bevelhimer. In review b. Light tags for observing behavior of migrating salmonids. Oak Ridge National Laboratory, Oak Ridge, Tennessee.

Darland, T. J., and seven co-authors, 2001. Test of concept to improve fish guidance using induced water currents at Cowlitz Falls Dam, Washington. Annual Report for 1999, U.S. Army Corps of Engineers, Walla Walla District, Walla Walla, Washington.

Dixon, D. A., J. A. Veil, and J. Wisniewski, editors. 2003. Defining and assessing adverse environmental impact from power plant impingement and entrainment of aquatic organisms. A. A. Balkema Publishers, Lisse, The Netherlands

EPA (U. S. Environmental Protection Agency), 1973. Development document for proposed best technology available for minimizing adverse environmental impact of cooling water intake structures. EPA 440/1-74/015, Washington, DC.

EPRI (Electric Power Research Institute), 1998. Review of downstream fish passage and protection technology. Evaluations and effectiveness. EPRI Report No. 111517. EPRI, Palo Alto, California.

EPRI, 1999. Status report on fish protection at cooling water intakes, EPRI Report No. TR-114013, Palo Alto, California.

EPRI, 2000. Technical Evaluation of the utility of intake approach velocity as an indicator of potential adverse environmental impact under CWA §316(b), EPRI Report No. 100731. EPRI, Palo Alto, California.

Fletcher, R. I., 1985. Risk analysis for fish diversion experiments: Pumped intake systems. *Transactions of the American Fisheries Society*, 114:652-694.

Griffith, J. S., 1978. Effects of low temperature on the survival and behavior of threadfin shad, *Dorosoma petenense*. *Transactions of the American Fisheries Society*, 107:63-69.

Griffith, J. S., and D. A. Tomljanovich, 1975. Susceptibility of threadfin shad to impingement. Annual Conference, Southeastern Association of Game and Fish Commissioners 29:223-234.

Jensen, L. D. (editor), 1974. Second National Workshop on Entrainment and Impingement. Ecological Analysts, Inc., Melville, New York.

Lakeside Engineering, Inc., 1997. Current inducer/downstream fish bypass system at Penacook Upper Falls. Lakeside Engineering, Inc., Mirror Lake, New Hampshire.



- Loar et al., 1978. An analysis of factors influencing the impingement of threadfin shad at power plants in the southeastern United States. Pages 245-255, in L. D. Jensen, editor, Fourth National Workshop on Entrainment and Impingement. EA Communications, Melville, New York.
- Lifton, W. S., and J. F. Storr, 1978. The effect of environmental variables on fish impingement, Pages 299-311, in L. D. Jensen, editor. Fourth National Workshop on Entrainment and Impingement. EA Communications, Melville, N.Y.
- McNabb, C. D., Liston, C. R., and S. M. Borthwick, 2003. Passage of juvenile chinook salmon and other fish species through Archimedes lifts and a Hidrostral pump at Red Bluff, California. Transactions of the American Fisheries Society 132:326-334.
- Nagle, D. G., and J. T. Morgan, Jr. 2000. A draft regulatory framework for analyzing potential adverse environmental impact from cooling water intake structures. Pages IX-XIV in D. A. Dixon, D. E. Bailey, C. Jordan, J. Wisniewski, J. R. Wright, Jr., and K. D. Zammit, editors. Power Plants & Aquatic Resources: Issues and Assessment. Environmental Science & Policy 3(Supplement 1).
- NMFS (National Marine Fisheries Service), 1995. Fish screening criteria for anadromous salmonids. NMFS Northwest Region, Portland, Oregon.
- NMFS, 1997. Fish screening criteria for anadromous salmonids, NMFS Southwest Region. Santa Rosa, California.
- Richards, R. T, 1978. Present engineering limitations to the protection of fish at water intakes, Pages 415-424 in L. D. Jensen, editor, Fourth National Workshop on Entrainment and Impingement. EA Communications, Melville, N.Y.
- Smith, L. S., and L. T. Carpenter, 1987. Salmonid fry swimming stamina data for diversion screen criteria. Fisheries Research Institute, University of Washington, Seattle.

---

*The Use of Angled Bar Racks and Louvers for Protecting Fish at Water Intakes*  
Stephen Amaral, Alden Research Laboratory, Inc.

**BIOSKETCH**

Dr. Steve Amaral is a Senior Fisheries Biologist with Alden Research Laboratory, Inc. Steve received his B.S. and M.S. degrees in Fisheries Biology from the University of Massachusetts. During the past 12 years, he has been heavily involved in the development and evaluation of fish passage and protection technologies for use at water intakes. Prior to joining Alden nine years ago, Steve worked on fish passage projects for the Massachusetts Cooperative Fish and Wildlife Research Unit and Stone and Webster Engineering. Working with his colleagues at Alden, he has conducted numerous laboratory and field studies with many different technologies and fish species. Recent studies have included biological evaluations of a fish-friendly hydro turbine, wedgewire screens, angled bar racks and louvers, and behavioral deterrents.

**Abstract** (*Technical Paper Not Available*)

Angled bar racks and louvers have been used to effectively guide fish away from water intakes. These technologies have been applied mainly at hydroelectric projects, with some installations occurring at irrigation diversions and one at a cooling water intake structure. Although guidance efficiency rates have varied among sites, available data suggest that angled bar rack and louver arrays can effectively guide a wide range of species and size classes. Successful application appears to be dependent on producing hydraulic conditions that have been shown to elicit avoidance responses from particular species and sizes classes. The performance of existing installations and results from recent studies indicate that angled bar rack and louver arrays have potential for effective application at cooling water intakes. Fish that are potentially vulnerable to impingement could be guided downstream past an intake or to a fish return sluice. Effective guidance will depend primarily on the behavior and swimming abilities of target species, physical design of a guidance system (e.g., angle of array to approaching flow, slat spacing), and the presence of hydraulic conditions (e.g., turbulence

near bar and louvers slats, approach velocity, bypass velocity) that elicit strong avoidance responses. Field and laboratory studies have demonstrated that guidance rates as high as 90 to 100% can be achieved depending on species, fish size, and guidance array design. The presentation will review the recent results of EPRI sponsored laboratory evaluations of bar racks/louvers and discuss potential application of bar racks and louvers for fish protection at CWIS.

---

### *A Review of Impingement Survival Studies at Steam-Electric Power Stations*

*Steven Jinks, ASA Analysis & Communications, Inc.*

#### **BIOSKETCH**

Dr. Steven Jinks is a senior scientist and president of ASA Analysis & Communication, Inc. Dr. Jinks received his B.S. in biology from Rutgers University in New Jersey, his M.S. in radiological health, and his Ph.D. in environmental science from New York University. He researched the environmental fate and human health effects of radionuclides for 4 years as an associate research scientist at New York University. He then conducted ecological risk, impact assessment, and water quality studies as a consulting scientist, most recently at ASA Analysis & Communication, the firm he founded in 1997. His work on aquatic impacts from power plant operation extends over the past 27 years.

#### **TECHNICAL PAPER**

##### **Abstract**

EPA has recently proposed draft §316(b) regulations for existing power producing facilities that contain performance requirements based, in part, on reducing fish and shellfish impingement mortality at the cooling water intake structure by 80% to 95% relative to a baseline consisting of a shoreline intake with no impingement controls. Analyses of the potential for focal species to survive impingement for both existing and alternative intake design and operation will be important for demonstrating compliance with this requirement. Recognizing this fact, the Electric Power Research Institute (EPRI) has recently sponsored a review of the historical studies on impingement survival. The majority of impingement survival studies were conducted between the mid-1970s and mid-1980s, as part of the initial surge of activity in response to the requirements of §316(b) of the Federal Water Pollution Control Act Amendments of 1972. The review included studies at 31 steam-electric plants located in 15 states and the province of Ontario, Canada, covering all four of the major waterbody types for which USEPA has proposed §316(b) performance requirements. Various biological, cooling water intake structure (CWIS), and water body factors have been shown to influence impingement survival rates, but no generally applicable mechanistic models for predicting impingement survival have been developed. Results of the review indicate that over half of the taxonomic families of fish and shellfish studied to date have the potential for impingement survival rates of 70-80% or higher with adequate screen design and operation. Reported data also indicate that modifying screenwash operation to a continuous mode is one of the most effective means for enhancing impingement survival. Uses and limitations of the historical studies and available summaries and a database of key information from the historical studies are discussed.

##### **Introduction**

In April 2002, USEPA proposed CWA §316(b) regulations for existing utility and non-utility power producing facilities with cooling water flows greater than 50 million gallons per day. These proposed regulations would establish national performance standards for best technology available (BTA) based, in part, on reducing fish and shellfish impingement mortality at the cooling water intake structure by 80% to 95% relative to a baseline consisting of a shoreline intake with no impingement controls. These required reductions could be achieved through a combination of intake system design and operational controls, implemented in whole or in part to reduce impingement mortality, or through environmental enhancements or restoration. However, a facility may also qualify for a site-specific determination of BTA if it can demonstrate that the costs to the specific facility are significantly greater than considered by USEPA in establishing the standard or if the costs to the facility of complying with the standard are significantly greater than the associated environmental benefits.

Impingement mortality is a function both of the number of organisms impinged and their rate of mortality from exposure to the impingement process (Text Box 1). Estimates of impingement mortality rates for the primary species impinged at

existing facilities will, therefore, be an important input for assessing compliance with the new regulations, whether that assessment is focused on demonstrating compliance with the performance requirements for reducing impingement mortality or on balancing risk reduction benefits versus costs of alternative fish protection measures.

The probability of death from impingement, or impingement mortality rate, has been studied at a number of existing steam-electric stations since the mid-1970's in response to the requirements of §316(b) of the Federal Water Pollution Control Act Amendments of 1972. The purpose of these studies was generally to: 1) document the actual impingement mortality rate at an existing intake so that estimates of impingement losses, and associated potential for adverse environmental impact (AEI), could be more accurately assessed; and/or 2) evaluate the reduction in impingement mortality rate, and impingement mortality, achieved by changes in screen design and operation<sup>1</sup>. Typically, these studies used the proportion of organisms surviving as the measure of organism response to the impingement stress<sup>2</sup>, and are therefore generally referred to as "impingement survival" studies.

Recognizing that existing information on impingement mortality would provide valuable background for planning and conducting future studies and assessments to address the new regulatory requirements, EPRI sponsored a review of prior impingement survival studies to serve as an information resource for a diversity of users involved in the regulatory process, including scientists, engineers, managers, and lawyers working for the utility industry, regulatory and resource management agencies, academic and private consultants, and environmental advocates. The specific purposes of this review were to:

1. Identify and summarize impingement survival studies conducted to date;
2. Facilitate access to impingement survival study reports;
3. Identify factors potentially influencing impingement survival; and
4. Discuss important considerations for using impingement survival data in BTA assessments.

Impingement survival study reports available for this review were identified and accessed from several sources including: 1) the EPRI Intake Systems Database maintained by Alden Research Laboratories; 2) the library of ASA Analysis & Communication; 3) a search of the open literature using the DIALOG system; 4) questionnaires soliciting impingement survival information that were sent by EPRI to its members; and 5) direct requests to several power companies thought to have completed impingement survival studies. The results of the review of these impingement survival reports are being published in full in *Evaluating the Effects of Power Plant Operations: Summary of Impingement Survival Studies*, EPRI Report 1007821 (EPRI 2003). This paper provides an overview of that report and summarizes some of the results of the review.

---

***Text Box 1. Definitions of Key Terms***

---

***Impingement Mortality Rate***—A measure of the sensitivity of the organisms to impingement exposure (i.e., probability of dying as a result of impingement). Typically measured in site studies as the proportion of organisms surviving impingement, or impingement survival rate (i.e., *Impingement Mortality Rate* =  $(1 - \text{Impingement Survival Rate})$ ).

***Impingement Mortality***—Impingement loss, or the number of organisms of each species killed by impingement. Impingement loss is a function of both the exposure (numbers impinged) and sensitivity (mortality rate as a result of impingement) of the organisms.

***Sensitivity***—An organism's tolerance or ability, when exposed to a stress, to resist effects or to maintain its physiological state within normal homeostatic bounds.

---

<sup>1</sup> The latter studies were often part of SPDES permitting agreements to test alternative intake screen technology.

<sup>2</sup> The impingement mortality rate is simply equal to (1-proportion surviving).

### **Summary of the Impingement Survival Studies**

Sixty-five impingement survival source documents were obtained for the review. The majority of these source documents are reports on studies funded or conducted by electric generating companies at steam-electric facilities. The review summarized the general methodology used in the impingement survival studies, the species, waterbodies, and screen designs covered by the studies, and the survival rate estimates obtained from the studies.

### **General Methodology Used in Prior Studies**

Debris and organisms in the cooling water withdrawn into steam-electric power plant intakes are usually filtered, first with fixed bar racks (typically about 8-10 cm spacing) and then with rotating traveling screens (typically 0.95 cm, but at some facilities as small as 0.5 mm spacing). A screen-wash spray system washes organisms and debris that impinge on the traveling screens into a sluiceway, which discharges the wash water to the source waterbody. Impingement survival studies monitor the post-impingement survival rate of fish and macroinvertebrates that are washed from the intake traveling screens. The detailed methods that have been used to conduct this monitoring vary somewhat among facilities and, sometimes, among years at a given facility. Variations in methods over time generally reflect attempts to refine and improve impingement survival estimates by reducing handling and holding stresses, or to accommodate testing of alternative intake screen technology (Muessig et al. 1988). Nevertheless, the large majority of studies have used similar methods that allow description of a general approach for monitoring impingement survival, which is provided below.

### **Data Collection**

For impingement survival study, impinged organisms generally were collected from the screenwash water using a dip-net or a basket type of device containing a mesh opening equal to, or slightly smaller than, that of the traveling screen panels. The collection location was either at a point along the sluiceway (often at a debris collection pit designed to allow removal of large pieces of debris before discharge to the waterbody) or at the point where the sluice water discharges to the waterbody (Figure 1). At some sites, modifications were made to the sluiceway system itself to bypass impinged organisms to collection pools or tanks for use in the impingement survival studies (ECSI and LMS 1996, Davis et al. 1988). Sampling gear consisted of metal mesh baskets, with or without net liners, floating live-pens, or angled screen flumes. Brief sampling intervals (e.g., 15-30 minutes) or continuous dip-netting from the sluiceway or collection device were often used to minimize damage from the collection process (e.g., Tatham et al. 1977; NUSC 1986). Most studies either focused sampling on peak periods of impingement or sampled seasonally to obtain data representative of the majority of impingement at the facility.

Immediately following collection, impinged organisms are categorized as live or dead, or as live, stunned,<sup>3</sup> or dead. Data on length or age classification is often also taken at the time of sample collection. These initial survival data have typically been taken on all fish species collected in the samples, as well as on important shellfish species. Most impingement survival studies have also collected data on delayed, or latent, mortality from impingement by transferring organisms initially alive to a holding facility and monitoring mortality (number dead) at pre-established intervals over an extended period of time. Typically, mortality observations are made at least once during each 24-hour period of the extended survival study to avoid data loss through decay, scavenging, etc. To optimize the use of holding facilities and monitoring efforts, these “extended” survival studies have often been limited to focal species that are frequently impinged and/or of commercial, recreational, or other importance in the waterbody. Holding facilities used for the extended survival studies have consisted either of land based flow-through tanks supplied with water by pumping from the source waterbody or floating live pens maintained in the source waterbody near the cooling water intake. However, at one facility, fish were also held in discharge water to investigate the potential for thermal effects since the screen wash sluiceway at this facility returned impinged fish to the discharge canal, rather than directly to the source waterbody (EA 1986). Extended survival observations have typically ranged from less

---

<sup>3</sup> In some studies, a “damaged” or “stressed” category was used instead. The distinction between these categories is apparently based on whether behavioral observation (e.g. non-equilibrium, struggling movements) or visual inspection for injuries was used to classify fish. The text uses the term “stunned” to mean any of these categories.

than 24 hours up to 108 hours, although at least one study monitored mortality of impinged fish for up to 204 hours (EA 1979a).

To distinguish impingement effects from the effects of sampling and holding, some studies have conducted survival tests on several fish species using controls collected by seining or box trapping in the source waterbody (Serven and Barbour 1981; Muessig et al. 1988; EA 1983). Field-collected fish were generally held for a day or more to allow recovery from collection stress prior to their use as controls, after which they were introduced to the collection device (collection controls) and/or directly into the holding facility (holding controls).

### **Data Analysis**

The majority of studies conducted to date have used the proportion of impinged organisms remaining alive as the principal statistic for survival analysis and the binomial distribution as the basis for calculating variance about the measured proportion surviving. The alternative approach has been to use failure analysis methods such as the Kaplan-Meier survivorship function (ECSI and LMS 1996). The definitions and formulae used to calculate impingement survival proportions and associated standard errors are reported in Muessig et al. (1988).

Initial survival is calculated for each species and age group studied by dividing the counts of living organisms (“alive” = “live” plus “stunned”) by the total numbers collected. The “stunned” category used in many studies has generally had two purposes. First, it provided a basis for representatively sub-sampling both undamaged and damaged fish for use in extended survival studies when too many organisms were collected to allow them all to be transferred to the holding facilities. Second, if no extended survival studies were conducted, it provided an indicator of the potential for delayed mortality. In effect, initial survival estimates calculated using counts of “live”, rather than the “live” plus “stunned”, in the numerator adjust survival for delayed mortality by assuming that all stunned organisms will die from damage caused by impingement.

Extended survival is the conditional probability of surviving both initially and during the extended-survival monitoring period, calculated by multiplying the initial survival proportion by the proportion of initially living organisms that survive to each extended observation interval (Table 2-1). While some of the prior impingement survival studies reported extended survival estimates for each observation interval used in the study, many chose not to report extended survival for intermediate observation intervals, and instead presented estimates of initial survival and extended survival determined at the last observation interval (e.g., 96-hr extended survival).

The observed survival resulting from impingement, collection, and holding can be adjusted for control survival (reflecting the effects of collection and holding) to obtain estimates of survival resulting from the effects of impingement alone. Control-adjusted impingement survival estimates are calculated by dividing the initial or extended survival proportion by the corresponding proportion of controls surviving. However, control-adjusted impingement survival estimates are available in relatively few studies and for only a few species, largely as a result of the difficulty of obtaining suitable control fish. Therefore, unadjusted extended survival is typically used as the best available estimate of impingement survival. To the extent that such estimates include mortality from collection and holding stresses, which they probably often do, they overestimate the mortality rate from impingement.

### **Coverage of the Studies**

The majority of the impingement survival studies were performed between the mid-1970s and mid-1980s, as part of the initial surge of activity in response to the requirements of §316(b) of the Federal Water Pollution Control Act Amendments of 1972. State Pollution Discharge Elimination System (SPDES) permit conditions that required testing of intake system alternatives for reducing impingement mortality provided the impetus for many of the studies, particularly during the 1980s and 1990s.

The source documents reported impingement survival studies at 31 power plants located near the Atlantic, Pacific, and Gulf coasts of the U.S., on the Great Lakes, and on the upper Mississippi and Columbia River basins. More than half of the studies have been at plants located in the mid-Atlantic and southern New England states (Figure 2).

Altogether, impingement survival has been studied for at least 31 steam-electric plants located in 15 states and the province of Ontario. The facilities at which studies were conducted are located on 22 different waterbodies covering all four of the major waterbody types for which USEPA has proposed §316(b) performance requirements (USEPA 2002), as follows:

- ▶ Freshwater streams and rivers—4 facilities located on 3 waterbodies;
- ▶ Great Lakes—5 facilities located on 2 waterbodies;
- ▶ Tidal rivers and estuaries—16 facilities located on 13 waterbodies; and
- ▶ Oceans—4 facilities located on 4 waterbodies.

Impingement survival data is available for three basic types of vertical traveling screens: angled, dual-flow, and through-flow, as follows:

- ▶ Angled screens—5 reports covering studies at 4 facilities;
- ▶ Dual-flow screens—6 reports covering studies at 5 facilities; and
- ▶ Through-flow screens—55 reports covering studies at 23 facilities

Three facilities, Danskammer Point, Oswego, and Roseton, have studied survival using single-flow and either dual-flow or angled screens. The majority of studies have tested some form of modification to screen design and/or operation intended to enhance impingement survival.

The historical studies report data for over 300 different taxa, most identified to the species level. Grouped by waterbody type there are 55 taxa represented from facilities on freshwater streams and rivers, 39 from facilities on the Great Lakes, 184 from facilities on tidal rivers and estuaries, and 85 from facilities located at coastal ocean sites, of course with some overlap of taxa among waterbody types. The majority of species were collected in relatively low numbers in these studies, mostly because only a portion of the resident species are highly susceptible to impingement at any given facility. For comparison, there were about 180 taxa where 10 or more organisms were collected in an individual study.

### **Information Summaries**

Source documents were reviewed for selected types of information, which, if available, was compiled in a hierarchical database (Figure 3). EPRI (2003) provides tables listing the facilities and dates of studies, waterbodies, screen designs, and taxa that are covered in previous impingement survival studies. The EPRI report also contains tables of impingement survival rate estimates by species and by screen design and operation. To provide the broadest reasonable amount of survival information, impingement survival rate estimates available in the source documents were included in the database, if those estimates were based on ten or more organisms collected. The database contains several types of survival rate estimates, including the initial proportion surviving ( $S_i = (\text{live} + \text{stunned}) / \text{total collected}$ ), initial proportion surviving assuming stunned are dead ( $S_{idd} = \text{live} / \text{total collected}$ ), and extended survival ( $S_e$ ) at the end of the latent effects holding period.

### **Factors Influencing Impingement Survival**

The survival of impinged organisms depends on the nature and magnitude of stresses imposed on them during impingement and on the tolerance of the organisms to those stresses. Theoretically, the magnitude of the various potential stresses of impingement, such as physical impact and abrasion, acidosis and neurological shock, suffocation, desiccation and thermal shock, depend on CWIS design and operation; while the sensitivities of impinged organisms vary depending on biological and waterbody characteristics. The impingement survival source documents were reviewed for information that would assist in characterizing the influence of theoretically important biological, CWIS, and waterbody factors on impingement survival rates. Examples of the information available from prior studies are provided below, and discussed more fully in EPRI (2003).

### **Biological Characteristics**

The biological variables that could affect impingement survival include species type, developmental stage and size, and physiological condition. Studies at operating power plants have shown that impingement survival is strongly influenced by the inherent sensitivity of species to impingement stresses. The morphological, physiological and behavioral characteristics of each species affect its sensitivity to impingement stress, although the relationships between these characteristics and impingement survival have not been quantitatively defined. In general, species types that are found to be hardy in terms of their resistance to collection and handling stress (e.g., crabs, killifish, catfish) are also tolerant of impingement stresses, while those that are difficult to collect and keep alive (e.g., herrings, anchovies, smelts) tend to be sensitive to impingement.

It may be helpful to qualitatively consider species characteristics in the context of each of the sources of impingement stress discussed above when evaluating the potential for species to survive impingement at a CWIS (e.g., for planning site studies). For example, species possessing heavier skeletal structure, thick scales or bony scutes, thick protective slimes, or hard exoskeletons would be more likely to resist physical injury and desiccation than would species that have light skeletons, and thin scales that shed easily. Similarly, species that are better adapted to low oxygen conditions or are able to extract some oxygen directly from the air are less likely to experience suffocation.

Behavioral characteristics of the species may also have important influences on impingement survival. Some species may be responsive to local hydraulic conditions and, in the case of pelagic species, may tend to maintain a position up in the water column in the intake flow upstream of the screens. Such prolonged swimming may lead to systemic stress from oxygen debt and acidosis (Powers 1977), and increased mortality when the fish become exhausted and are impinged. Prior studies provide little information on the specific relationship between various species characteristics and impingement survival. However, studies conducted at the Millstone Nuclear Power Station examined the aggregate effects of body type and habitat preference on impingement survival (NUSC 1986, 1987). Crustaceans and demersal fish species generally showed much higher impingement survival in these studies than either pelagic fish species or squid.

The variation in extended impingement survival rates among taxonomic families that has been observed in prior studies is illustrated in Figure 4, which shows the mean and standard deviation of extended survival rate estimates reported for 36 taxonomic families under continuous screenwash conditions. The mean and standard deviation of the survival rate estimates reported for each taxonomic family for all screenwash conditions are presented in Table 1. Within family and screenwash frequency groups, survival rate estimates vary, apparently due to differences among facilities and other study conditions such as length of the extended survival observation and season. However, the survival rate estimates appear to reflect the relative species tolerances to impingement that would be expected based on the nature of the impingement stresses and the biological characteristics of the species. For example, families with relatively high survival rates consist mostly of macroinvertebrates with hard exoskeletons, fish generally inhabiting shallow, turbid waters and known to be easily held in captivity such as killifish and minnows, demersal species and species tolerant of low dissolved oxygen levels such as flounders, catfishes and sunfishes, and species that are heavily scaled or armored, such as pipefishes and sculpins. Families with low survival rates are mostly characterized by soft-bodied pelagic forage species such as anchovies, herrings and smelts. Survival rate estimates for about two-thirds of the taxonomic families exceed 50 percent when screenwash is continuous. Twenty-eight out of the forty-seven families for which data have been reported, or about 60 percent, appear to have the potential, given adequate screenwash frequency, for impingement survival rates greater than about 70 to 80 percent.

Within a given species, changes in sensitivity to the physical stresses of impingement should be most evident during distinct developmental transitions that significantly alter physical characteristics and/or physiological mechanisms (e.g., osmoregulation). The source documents contained several examples of the potential influence of such transitions on impingement survival rate. For example, studies of impingement survival on fine-mesh intake screens show that the survival rate of fish increased sharply as larvae transition to the juvenile stage, possibly reflecting the additional protection afforded by scale and skeletal development at this stage (EA 1979b). Likewise, the absence of a hard exoskeleton during molting increased the sensitivity of decapod crustaceans to impingement, resulting in more

moderate survival rates of juveniles and adults during the molting season than at other times of the year (NUSC 1987; CP&L 1985; Tatham et al. 1978; Serven and Barbour 1981).

On the other hand, no consistent relationship between size or age of juvenile and older fish and impingement survival is apparent in the prior studies. Extended impingement survival rates have in some cases tended to increase (CP&L 1985; ECSI and LMS 1996) or decrease (ECSI and LMS 1996) with size of the fish. Other studies have found little consistent trend in extended impingement survival rates among size classes (Serven and Barbour 1981) or among age groups (Muessig et al. 1988) of several species. The ability to observe consistent trends in survival due solely to size or age may be confounded by other factors influencing survival, including seasonal differences in debris loadings or cooling system operation (e.g., cooling water flow rates), size-related differences in handling and holding mortality, and environmental factors influencing the physiological state of the organism prior to impingement. Environmental factors that affect the organism's physiology and condition are also likely to influence its sensitivity to impingement stresses. Nutrition, disease, and reproductive state (Con Ed 1986) may influence impingement survival rate, but relatively little information is available from prior studies regarding these factors.

### **CWIS Characteristics**

The impingement survival realized by each species and life stage may be greatly influenced by intake screen design and operating conditions. Physical stresses present during impingement are influenced by screenwash frequency, screen rotation speed, and screen modifications intended to reduce stress associated with fish separation and handling. A review of the biological effectiveness, engineering practicability, and costs of fish protection systems, including active screening systems, has been presented in detail in three EPRI reports (EPRI 1986, 1994, 1999a).

For vertical traveling screens there is generally a substantial increase in organism survival associated with decreased time between screen washes, with continuous screen rotation providing the highest survival (King et al. 1978; Tatham et al. 1978). When screens are stationary for long periods of time, impinged organisms may become moribund in repeated attempts to free themselves and may suffocate against the screen. In the studies that contained data for various screenwash frequencies, extended impingement survival rate for most species decreased, often very substantially, as time between screen washes increased (Figure 5). However, the survival rate for several hardier species (e.g., tessellated darter, three-spine stickleback, hogchoker) was very high, regardless of the length of interval between screen washes.

The duration of organism impingement on the traveling screens is also directly related to rotation time of the screen, or the in other words, the time of travel required before impinged fish reach the screenwash headers. This travel time is determined both by the speed of screen rotation and the elevation or height of the screen. Faster rotation and/or shorter screens would be expected to decrease stress. Screen elevation above the intake decking may also affect the length of the drop that fish experience from the screen to the screenwash sluiceway, which could potentially also impact impingement survival.

Several studies have examined the relationship between the speed of screen rotation and impingement survival. Studies at the Dunkirk, Mystic, and Brunswick generating stations indicated faster screen rotation speeds generally resulted in higher impingement survival rates (Table 2) (Beak 1988; SWEC 1981; CP&L 1985). Studies on Ristroph-modified dual-flow traveling screens at the Roseton generating station at screen speeds of 9.8 ft/min and 19.7 ft/min found no definitive trend in survival between the two screen speeds (Normandeau 1995). Six of ten fish species with 20 or more organisms collected had higher survival at the faster screen speeds, while 3 fish species and blue crab had higher survival at the slower screen speed.

A number of physical modifications to screen systems have been developed specifically to protect fish and other aquatic organisms. Screen systems employing fish buckets<sup>4</sup> (or troughs), continuous operation, and low pressure

---

<sup>4</sup> "Buckets" are essentially troughs mounted along the bottom edge of each screen panel that hold a few inches of water. Their purpose is to reduce escape and reimpingement of impinged fish and keep them immersed as they are lifted from the waterbody.



washes with fish returns to the waterbody are typically referred to as Ristroph screens, after the original developer of the modified screen. Because fish protection measures evolved or were added over the years, later versions of the modified screens are sometimes referred to as modified Ristroph screens.

One of the last modifications to the Ristroph design was to add a recurved lip to the screen fish buckets. Fletcher (1990) showed in laboratory studies that, in selected species, struggling behavior resulted in a downward movement along the screen mesh that directed them to the fish-lifting bucket attached to each of his experimental screen panels. Redesigning the bucket with a recurved edge creates a calm zone, where fish were found to seek shelter and remained in the bucket as the screen's rotation carried them upward to the water surface and a spray wash fish removal system.

The effectiveness of modified screen systems in reducing impingement mortality compared to conventional screens has been evaluated at the Oyster Creek (EA 1986), Salem (ECSI and LMS 1996, Heimbuch 1999, Ronalfalvy et al. 2000), Arthur Kill (Con Ed 1996), and Roseton (LMS 1991) generating stations. Both modified and unmodified screens were single-flow (or through-flow) at the first two stations, and dual-flow at the Arthur Kill station. The study at Roseton compared survival on dual-flow modified screens to that on single-flow conventional screens. At the Oyster Creek<sup>5</sup>, Arthur Kill, and Roseton stations, impingement survival rates measured on modified screens were compared to those from unmodified, conventional screens. Studies at the Salem station, evaluated the benefits of progressive improvements in the fish protection measures incorporated into existing Ristroph screens. Overall, the comparisons indicate that the Ristroph modifications are effective in improving the survival rates, especially of species that are sensitive or moderately tolerant of impingement stresses (Table 3). However, the incremental fish protection benefits of Ristroph modifications, versus continuously operated conventional screens, may vary widely among species and power plant sites.

Other CWIS factors, such as screen approach velocity, intake configuration, and the proximity of the screenwash discharge and fish return to the cooling water intake may influence impingement survival rates. However, the potential effect of these factors on survival rate has not been examined in any detail in the studies reviewed. Screen approach velocity and intake configuration could affect the behavior and energy expenditures of fish prior to encountering the screen surface, as well as the damage incurred during impingement. The proximity of the fish return to the cooling water intake, together with the hydrodynamics of the waterbody in the vicinity of the station, influences the magnitude of fish reimpingement after return to the waterbody. Multiple impingement exposures may tend to reduce survival as a result of cumulative stress and injury.

### **Water Body Characteristics**

Many of the impingement survival studies report survival rates separately for various time periods or seasons during the year, though only a portion of those studies have attempted to explicitly address the relationship of survival to season or to seasonal changes in environmental conditions (Tatham et al. 1978; Muessig et al. 1988; Con Ed 1986; Beak 1988; NUSC 1987; ECSI and LMS 1996; LMS 1991; EA 1986; Normandeau 1995; Reider 1984). A variety of water body characteristics that vary seasonally or over shorter time periods in response to weather conditions could potentially affect the mortality of impinged organisms. Such factors include: loadings of debris and other organisms that may damage fish; water temperature; dissolved oxygen and turbidity; and, in the case of estuarine sites, salinity.

Intake screen loadings of debris and organisms with hard exoskeletons (e.g., crabs) appear to cause an increase in injury and death, reducing survival of impinged fish (Landry and Strawn 1974). Occurrence of debris and its blockage of intake screens is a highly site-specific factor. Some researchers have noted lower survival of impinged fish species when large masses of jellyfish are present (NUSC 1987) or when the numbers and activity of crabs on the intake screens is high (Tatham et al. 1978). The potential for injury from physical contact with plant materials and man-made debris during impingement underlies the design of screens that include separate fish and debris spraywash removal troughs.

---

<sup>5</sup> The unmodified screens at Oyster Creek were operated intermittently (up to 2 hours between screenwashes). Unmodified screens at Arthur Kill and Roseton were apparently operated continuously, as were the Ristroph screens at all these plants.

A number of studies have examined the relationship between impingement survival and ambient water temperatures. Seasonal water temperatures near the upper or lower temperature tolerance limit of the species may increase their sensitivity to the subsequent stress of impingement, thereby lowering impingement survival relative to that observed at other times of the year. The elevation of metabolic rate as temperatures increase to their summer maximums may exacerbate the physiological stresses of impingement, including increasing the rate of oxygen starvation of tissues and suffocation. Very low temperatures have been observed to increase mortality due to handling and rearing stress as a result of increased osmoregulatory dysfunction (Wedemeyer 1972; Miles et al. 1974). In temperate zones, many species are unable to fully adapt physiologically to the wide changes in water temperatures that occur seasonally. Although many of these species adapt behaviorally by seasonal migration to habitats with more favorable temperatures, some portion of their populations often reside in waters quite close to the limits of their thermal tolerance. As a result, these organisms may be more susceptible to impingement mortality or may even be susceptible to natural seasonal mortality, especially in particularly cold winters or hot summers. For example, Lankford (1997) has shown that Atlantic croaker, which uses bays and estuaries during summer and fall months, can become highly stressed and more susceptible to impingement when water temperatures are lowest. Lajeone and Monzingo (2000) reported that the vast majority of fish (gizzard shad and freshwater drum) impinged in winter were either dead or moribund prior to their arrival on the Quad Cities generating station screens.

One may expect that the effect of water temperatures on impingement survival will vary among ecosystems and species, depending on the adaptations of species to their thermal environments. Variation in temperature relationships observed in field studies can also result from covarying factors that may affect survival, such as increasing fish size during the growth season and, in the case of estuaries, salinity. It is therefore not surprising that reported temperature relationships vary considerably among the impingement survival studies. However, the general pattern of effect on fish that emerges when these data are examined collectively is one of highest impingement survival over some intermediate ambient temperature range, with the potential, depending upon species, for decreasing survival at temperatures above and below this range<sup>6</sup> (Muessig et al. 1988; EA 1986; LMS 1991; NUSC 1987; Normandeau 1995).

The limited data available suggest that this intermediate temperature range may be relatively narrow for pelagic species more sensitive to impingement and relatively broad for demersal or littoral species more tolerant of impingement (EA 1986; NUSC 1987; Normandeau 1995; LMS 1991). For example, at the Roseton station, impingement survival of blueback herring, bay anchovy, and alewife steadily declined as temperature increased above about 16°C; from the 20 to 40 percent range below 16°C to near zero percent at 22 to 28°C (Normandeau 1995; LMS 1991). In contrast, impingement survival of brown bullhead decreased only slightly at temperatures up to 28°C. Most of the observations of reduced impingement survival at low water temperatures (less than about 4.5 to 7° C) suggest that the effect may be confined to temperatures near the low temperature tolerance limits of the species, with the increased impingement mortality caused by the thermally stressed condition of the organisms at the time of impingement.

Some impingement survival studies have not explicitly examined survival relationships to temperature, but have observed differences in extended impingement survival at various times of year (Tatham et al. 1978; Reider 1984; Beak 1988). Those observations that span warm and cold seasons, summarized below, are not inconsistent with the typical seasonal cycles of ambient water temperature in temperate zones of the U.S. and the temperature patterns discussed above. In general, impingement survival rates observed in these studies for a given species have been lowest in summer and highest in spring and fall, with intermediate survival rates in winter.

The reduced impingement survival rate at higher summer water temperatures that has been observed for some species may, in part, reflect the influence of seasonal changes in dissolved oxygen levels. The concentration of dissolved

---

<sup>6</sup> It should be noted that those studies that have explored the relationship between impingement survival and temperature have not found such a relationship for all species. This may be due to variation among species and/or to limitations of the data.

oxygen in water is determined by the interaction of several biological and physical processes, which typically results in a seasonal pattern of highest dissolved oxygen concentrations in the winter and lowest during the summer. The correlation of increasing water temperatures with decreasing dissolved oxygen levels makes it difficult to distinguish the independent effects of dissolved oxygen on impingement survival rate. One study used discriminant analysis to examine the importance of temperature, dissolved oxygen, and other factors on impingement survival (Normandeau 1995). Dissolved oxygen was identified as a primary factor influencing the impingement survival of blueback herring and a secondary factor influencing the survival of alewife. For both of these species, impingement survival rate was significantly higher at dissolved oxygen concentrations of 10-12 mg/l than it was at 7-8 mg/l.

Water salinity may be an important factor influencing impingement survival in the brackish water regions of estuaries, where salinity varies seasonally in response to changes in freshwater discharge and tidal height. Low to moderate levels of salinity reduce the energy input required for osmoregulation, and thereby act as a general stress ameliorator (Bowser and Buttner 1991; Kane et al. 1990; Palawski et al. 1985). Impingement survival studies in brackish water regions of the Hudson River suggest that the stress reducing effects of salt result in higher impingement survival of some species when brackish water is present than during freshwater periods (ORU 1977). For example, at the Bowline Point generating station, extended survival of white perch and striped bass increased in proportion to the logarithm of conductivity (Muessig et al. 1988). In studies at the Indian Point station, extended impingement survival of striped bass, white perch, weakfish, bay anchovy, and blueback herring was higher in August and September when water salinity was 6 to 8 ppt than it was later in the year, when salinity decreased to less than 1 ppt (Con Ed 1986).

### **Impingement Survival and §316(b) Compliance**

Compliance with the §316(b) regulations soon to be established for existing power plants will likely require NPDES permit applicants to assess the level of fish and shellfish protection provided by existing and alternative intake technologies and operational measures, and in some cases may also compel applicants to assess the ecological significance of entrainment and impingement at their generating facilities as part of a cost-benefit analysis. These assessments will typically require quantitative estimation of fish losses from impingement, and impingement mortality rates will be needed as one of the inputs for calculating those losses. Adequate characterization of impingement mortality rates for focal species impinged at the existing and alternative intakes is obviously important for the demonstrating compliance since the historical impingement survival data show that mortality rates are strongly influenced by biological and CWIS characteristics, but can be very low for many species, given adequate screen design and operation.

Estimates of impingement mortality rates for use in the compliance demonstration may be obtained from site-specific studies conducted at the facility concerned or from published reports on impingement survival studies previously conducted elsewhere. Existing impingement survival data may be useful in a variety of ways in the BTA determination, including:

- ▶ Screening of intake alternatives—as part of this screening, existing impingement survival studies can be used to identify intake alternatives that would have potential for reducing impingement losses and prioritize them for more detailed evaluation.
- ▶ Selection of focal (critical or representative) species—one criterion for selection is susceptibility to effects of the intake. Existing impingement survival data can be used to help assure that the focal species selected for assessment adequately represent a range of species' sensitivities to impingement.
- ▶ Detailed evaluations of fish protection benefits from intake alternatives—prospective analysis of potential benefits prior to selection and installation of alternatives, which necessarily requires impingement mortality rate estimates derived from prior survival studies at other facilities, is required to assure that economically justifiable and environmentally beneficial actions are taken.

- ▶ Detailed evaluations of fish protection benefits from the existing intake—evaluations of impingement losses for the existing intake using survival estimates appropriately selected from studies at other sites may help to identify facilities or species with low potential for impact and to evaluate whether feasible alternatives are likely to provide appreciable additional fish protection benefits.<sup>7</sup>
- ▶ Defining additional data needs—the prior studies provide background information that is valuable for selecting impingement mortality rate estimates appropriate for the species, CWIS and waterbody characteristics present at a facility and help to identify additional information needed for adequately demonstrating compliance with the BTA requirements.

During the planning stage of the §316(b) compliance assessment, available impingement survival information should be compiled and evaluated as part of the development of an analysis plan. This process may identify additional data needed for the assessment, and should result in an analysis plan that includes approaches for addressing uncertainties identified. Impingement mortality rate estimates used in the assessment should be based on survival data that is representative of the sensitivity of the impinged species, the design and operation of the existing CWIS and any alternatives under consideration, and the waterbody conditions during primary periods of impingement.

### **Relevance of Mortality Rate Estimates to Site Conditions**

Since the inherent stress tolerance of different species types is one of the greatest influences on impingement survival rate, impingement mortality rates for the specific focal species at issue should be used, when available. However, the level of uncertainty associated with using mortality rate estimates for congeneric species, or in some cases even species of the same taxonomic family, may be acceptable when species-specific data are unavailable.

Mortality rate estimates should be consistent with the screenwash frequency normally used at the existing facility, and with that planned for alternative technologies and operations, since screenwash frequency is one of the most important CWIS factors affecting impingement survival. Screen travel time may be an additional consideration for evaluating mortality of sensitive and moderately tolerant species during continuous screenwash, particularly when screen speed is relatively slow (e.g., 2 or 3 ft/min). Ristroph modifications appear to increase impingement survival rates for sensitive and moderately tolerant species. However, in comparing Ristroph screens to conventional screen alternatives, assessors should take care to use mortality rates that reasonably represent the incremental improvement of each alternative. For example, the incremental benefit of Ristroph screens over conventional screens operated intermittently at very slow rotation speeds ought to be greater than their incremental benefit over conventional screens operated continuously and at relatively high rotation speeds.

Many of the impingement survival studies report variations in survival at different times of year. The most substantial changes seem to be associated with high summer ambient temperatures, or very cold winter temperatures, which result in higher mortality rates. In estuaries, survival rates appear to be substantially higher when water is brackish than when it is fresh. Since prevailing environmental conditions may vary from year to year, inter-annual variation in survival rate may also be expected. No generally applicable mechanistic models have been developed for predicting changes in impingement survival rate based on environmental conditions. Therefore, assessors must select or collect data that are reasonably representative of conditions that occur during the primary periods of impingement of the focal species. For many species quantifying variations in impingement survival rates during all seasons or over all environmental conditions may be impractical and unnecessary, since the large majority of impingement occurs during only a portion of the year. Identification of these critical periods is therefore a key requirement for effectively managing impingement mortality.

### **Uncertainty in Impingement Survival Study Methods**

The methods used to collect impingement survival data and calculate mortality rates may introduce uncertainties in the assessment of impingement losses. Some of these uncertainties reflect inherent practical limitations that are not

---

<sup>7</sup> Later verification of the assumptions used in the evaluations, including impingement mortality rates, can still be required.

easily addressed by study design, and may either overestimate or underestimate actual impingement mortality rates, including:

- ▶ No correction for collection/holding mortality—relatively few studies have conducted control tests on the mortality due to stress of collection, handling, and holding for latent effects. As opposed to laboratory bioassays where standard test organisms are readily available for use in testing, obtaining control organisms from the wild for testing is difficult and often impractical for many species. For many species, the holding stresses alone are sufficient to cause mortality, even when holding protocols conform to standard bioassay practice. Mortality rate estimates that are unadjusted for control mortality may overestimate the actual mortality rate from impingement.
- ▶ Assumption of no interaction of handling/holding and impingement stresses—studies that adjust mortality rate estimates for control survival assume that the probability of mortality from impingement and collection/holding are independent stresses that do not interact. To the extent that these stresses are interactive, this assumption overestimates the impingement mortality rate.
- ▶ No accounting for fish mortality from stresses prior to impingement—impingement survival studies generally assume that all dead fish that are collected have been killed by impingement. To the extent that some portion of the impinged fish may have died from natural causes or other anthropogenic stresses, this assumption may potentially overestimate the impingement mortality rate. Such overestimation could be substantial in cases where large fish kills have occurred, such as from low winter temperatures or disease outbreaks. In such cases, the majority of impinged fish may be dead or moribund prior to their arrival on the power station screens (LaJeone and Monzingo 2000). Distinguishing other sources of mortality by recording the physical condition of dead impinged fish (e.g., eye opacity and decomposition) and documenting local or regional fish kills may be an important consideration for design of future studies.
- ▶ Screenwash efficiency—impingement survival studies should assure that all fish are being representatively sampled. Impingement mortality may be underestimated to the extent that fish are carried over the screen or are trapped within the return system. Proper design and maintenance of the screenwash system and monitoring of the fish transport pathways can minimize biases from low screenwash and collection efficiency.
- ▶ Potential for predation—increased susceptibility to predation is a potential source of impingement mortality that has not been measured by impingement survival studies. To the extent that predation effects occur, impingement mortality rates would be underestimated by these studies. The potential for predation may depend on screenwash system design factors that affect attraction and immediate access of predators, such as fish and birds (e.g., enclosed fish sluice, location and depth of return). Other factors to consider in the assessment are the seasonal patterns in abundance and feeding rates of predators in relation to the primary impingement season(s).

## References

- Beak Consultants, Inc. 1988. Dunkirk Station Biological Studies, Final Report, January-December 1987. Prepared for Niagara-Mohawk Corporation. Lancaster, NY.
- Bowser, P.R. and J.K. Buttner. 1991. General Fish Health Management. NRAC Bull. No. 111-1992. Northeastern Regional Aquaculture Center, University of Massachusetts, N. Dartmouth, MA.
- Carolina Power & Light Company - Biology Unit (CP&L). 1985. Brunswick Steam Electric Plant 1984 Biological Monitoring Report. New Hill, NC.

- Consolidated Edison Company of New York, Inc. (Con Ed). 1985. Biological Evaluation of a Ristroph Screen at Indian Point Unit 2. Consolidated Edison Company of New York, Inc. New York, NY.
- Con Ed. 1986. Survival of Fish Impinged on a Ristroph-type Traveling Screen at the Indian Point Generating Station, Summer and Fall, 1985. New York, NY.
- Con Ed. 1996. Arthur Kill Generating Station Diagnostic Study and Post-Impingement Viability Substudy Report. New York, NY.
- Davis, R.W., J.A. Matuousek, M.J. Skelly, and M.R. Anderson. 1988. Biological Evaluation of Brayton Point Station Unit 4 Angled Screen Intake. In: Proceedings: Fish Protection at Steam and Hydroelectric Power Plants, Electric Power Research Institute, Palo Alto, CA. EPRI CS/EA/AP-5663-SR.
- Ecological Analysts, Inc. (EA). 1979a. Bowline Point Impingement Survival Studies 1975-1978 Overview Report. Prepared for Orange & Rockland Utilities, Inc., Pearl River, NY.
- EA. 1979b. Evaluation of the Effectiveness of a Continuously Operating Fine Mesh Traveling Screen for Reducing Ichthyoplankton Entrainment at the Indian Point Generating Station. Prepared for Central Hudson Gas & Electric Corp., Consolidated Edison Company of New York, Inc., Orange and Rockland Utilities, Inc., Power Authority of the State of New York. Middletown, NY.
- EA. 1983. Moss Landing Power Plant Cooling Water Intake Structures 316(b) Demonstration. Prepared for Pacific Gas & Electric Company, San Francisco, CA.
- EA. 1986. Entrainment and Impingement Studies at Oyster Creek Nuclear Generating Station. Prepared for GPU Nuclear Corporation. Sparks, MD.
- Environmental Consulting Services, Inc and Lawler, Matusky, and Skelly, Inc. (ECSI and LMS). 1996. 1995 Supplemental Impingement Studies with an Assessment of Intake-Related Losses at Salem Generating Station. Prepared for Public Service Electric and Gas Company, Hancocks Bridge, NJ.
- Electric Power Research Institute (EPRI). 1986. Assessment of Downstream Migrant Fish Protection Technologies for Hydroelectric Application. EPRI Report No. AP-4711. Palo Alto, CA.
- EPRI. 1994. Research Update on Fish Protection Technologies for Water Intakes. EPRI Report No. TR-104122, Project No. 2694-01. Palo Alto, CA.
- EPRI. 1999a. Fish Protection at Cooling Water Intakes. EPRI Report No. TR-114013. Palo Alto, CA.
- EPRI. 2003. Evaluating the Effects of Power Plant Operations: Summary of Impingement Survival Studies. EPRI. Palo Alto, CA. Report 1007821
- Environmental Consulting Services, Inc and Lawler, Matusky, and Skelly, Inc. (ECSI and LMS). 1996. 1995 Supplemental Impingement Studies with an Assessment of Intake-Related Losses at Salem Generating Station. Prepared for Public Service Electric and Gas Company, Hancocks Bridge, NJ.
- Fletcher, I.R. 1990. Flow Dynamics and Fish Recovery Experiments: Water Intake Systems. Trans. Am. Fish. Soc. 119: 393-415.
- Kane, A.S., R.O. Bennett, and E.B. May. 1990. Effect of hardness and salinity on survival of striped bass larvae. N. Amer. J. Fish. Management 10:67-71.

- King, L.R., J.B. Hutchison, and T.G. Huggins. 1978. Impingement survival studies on white perch, striped bass, and Atlantic tomcod at three Hudson River power plants. In: Fourth National Workshop on Entrainment and Impingement (L. Jensen, ed.), Ecological Analysts, Inc., Melville, NY. Pp. 217-233.
- Heimbuch, D.G. 1999. Salem Generating Station Clean Water Act § 316(b) Demonstration; Appendix F and Appendix G. Prepared for Public Service Electric and Gas Company, Hancocks Bridge, NJ.
- LaJeone, L.J. and R.G. Monzingo. 2000. 316(b) and Quad Cities Station, Commonwealth Edison Company. *Envir. Sci. Policy* 3(Suppl. 1), S322.
- Landry, A.M. and K. Strawn. 1974. Number of individuals and injury rates of fishes caught on revolving screens at the P.H. Robinson Generating Station. In: Proceedings of the Second Entrainment and Intake Screening Workshop (L. Jensen, ed.), Electric Power Research Institute, Palo Alto, CA. Pp. 263-271.
- Lankford, T.E., Jr. 1997. Estuarine recruitment processes and stock structure in Atlantic croaker, *Micropogonias undulatus* (Linnaeus). Ph.D. dissertation. University of Delaware.
- Lawler, Matusky, and Skelly Engineers (LMS). 1991. Roseton Generating Station Intake Debris Screen Post-Impingement Survival Evaluation Study. Prepared for Central Hudson Gas and Electric Corporation, Poughkeepsie, NY.
- Miles, H.M., S.M. Loehner, D.T. Michaud, and S.L. Salivar. 1974. Physiological responses of hatchery reared muskellunge (*Esox masquinongy*) to handling. *Trans. Am. Fish. Soc.* 103:336-342.
- Muessig, P.H., J.B. Hutchison, Jr., L.R. King, R.J. Ligotino, and M Daley. 1988. Survival of fishes after impingement on traveling screens at Hudson River power plants. In: Science, Law, and Hudson River Power Plants: A Case Study in Environmental Impact Assessment. American Fisheries Society Monograph 4.
- Normandeau Associates, Inc. (NA). 1995. Roseton Generating Station 1994 Evaluation of Post Impingement Survival and Impingement Abundance. Prepared for Central Hudson Gas and Electric Corporation, Poughkeepsie, NY.
- Northeast Utilities Service Company (NUSC). 1986. The Effectiveness of the Millstone Unit 1 Sluiceway in Returning Impinged Organisms to Long Island Sound. Waterford, CT.
- NUSC. 1987. The Effectiveness of the Millstone Unit 3 Fish Return System. Waterford, CT.
- Orange and Rockland Utilities, Inc. (ORU). 1977. Bowline Point Generating Station Near-Field Effects of Once-Through Cooling System Operation on Hudson River Biota. Pearl River, NY.
- Palawski, D., J.B. Hunn, and F.J. Dwyer. 1985. Sensitivity of young striped bass to organic and inorganic contaminants in fresh and saline waters. *Trans. Am. Fish. Soc.* 114:748-753.
- Powers, D.A. 1977. Physiology of fish impingement: role of hemoglobin and its environmental modifiers. In: Third National Workshop on Entrainment and Impingement (L. Jensen, ed.), Ecological Analysts, Inc., Melville, NY. Pp. 241-254.
- Reider, R.H. 1984. Alternative Screen Wash Survival Study at the Monroe Power Plant April-September, 1983.

Ronalfalvy, J.P., R.R. Cheesman, and W.M. Matejek. 2000. Circulating Water Traveling Screen Modifications to Improve Impinged Fish Survival and Debris Handling at Salem Generating Station. *Environ. Sci. Policy* 3(Sup. 1) Pp. S377-S382.

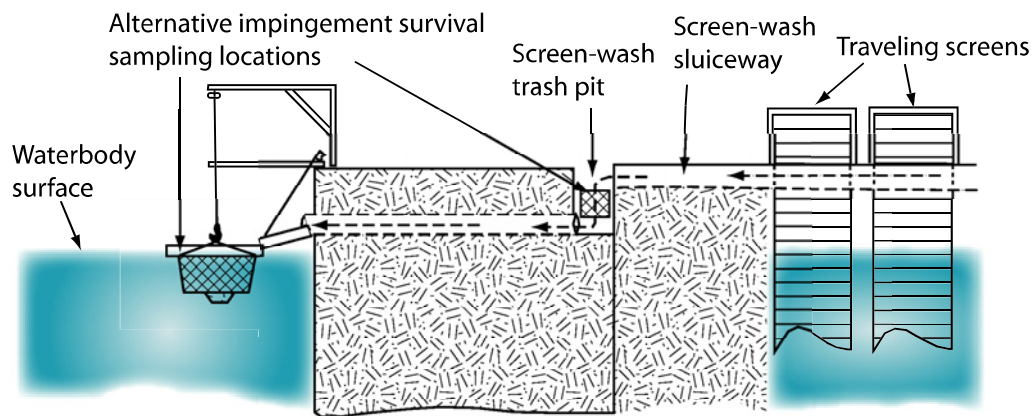
Serven, J.T. and M.T. Barbour. 1981. C.P. Crane Power Plant: Impingement Abundance and Viability Studies, Final Report January - December 1980. Prepared for Baltimore Gas and Electric Company, Baltimore, MD.

Stone & Webster Engineering Corporation (SWEC). 1981. Final Report, Biological Evaluation of a Modified Traveling Screen, Mystic Station - Unit No. 7. Prepared for Boston Edison Company.

Tatham, T.R., D.L. Thomas, and G.J. Miller. 1978. Survival of fishes and macroinvertebrates impinged at Oyster Creek Generating Station. In: Fourth National Workshop on Entrainment and Impingement (L. Jensen, ed.), Ecological Analysts, Inc., Melville, NY. Pp. 235-243.

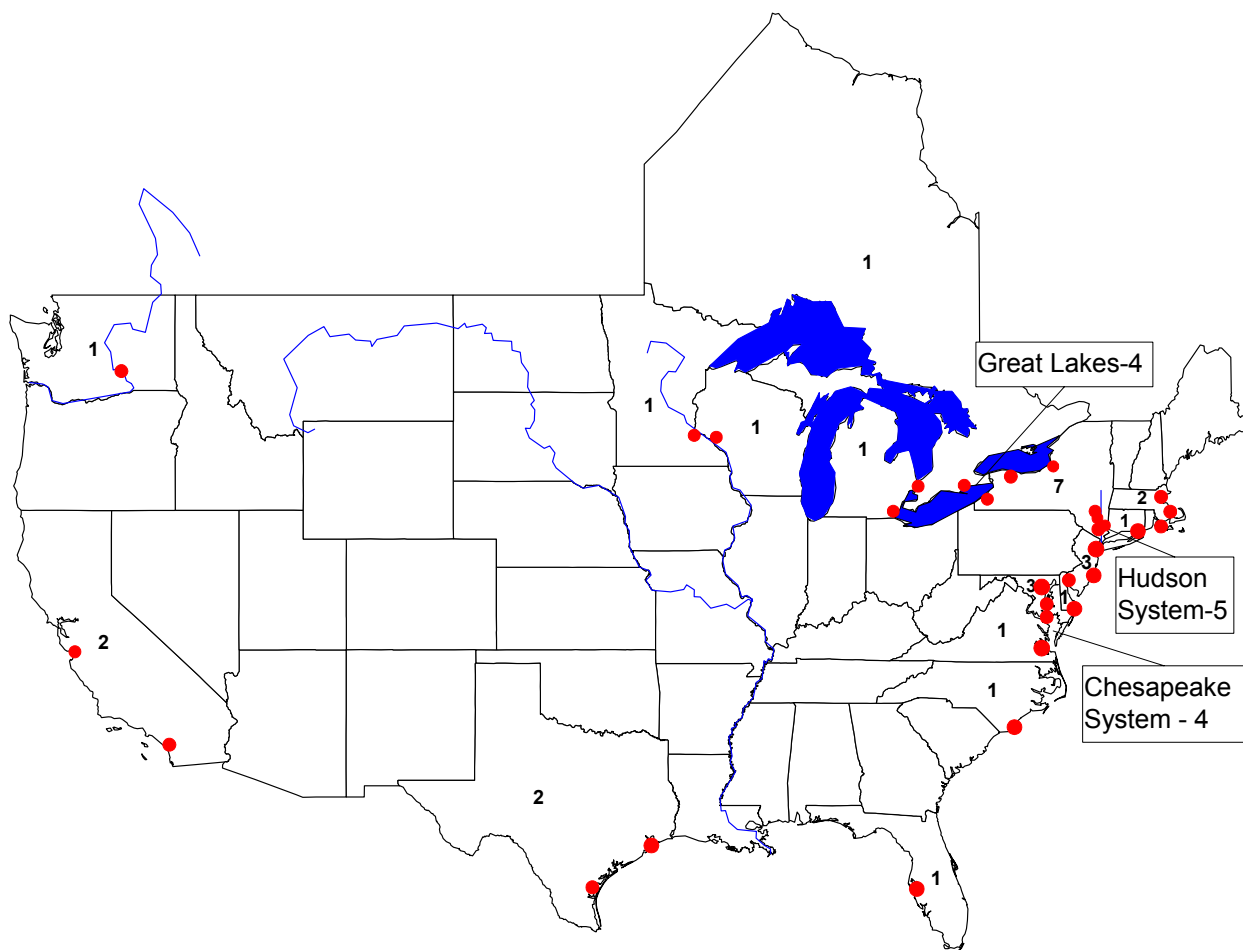
USEPA. 2002. National Pollutant Discharge Administration—Proposed Regulations to Establish Requirements for Cooling Water Intake Structures at Phase II Existing Facilities; Proposed Rule. 67 Fed. Reg. 17,122 (Apr. 9, 2002). Washington, D.C.

Wedemeyer, G. 1972. Some physiological consequences of handling stress in the juvenile coho salmon (*Onchorhynchus kisutch*) and steelhead trout (*Salmo gairdneri*). *J. Fish. Res. Board Can.* 29:1780-1783.



**Figure 1** Typical impingement survival study collection locations along the screenwash sluiceway system.





**Figure 2** Locations of Impingement Survival Studies (numerals indicate number of facilities studied in each state/province).

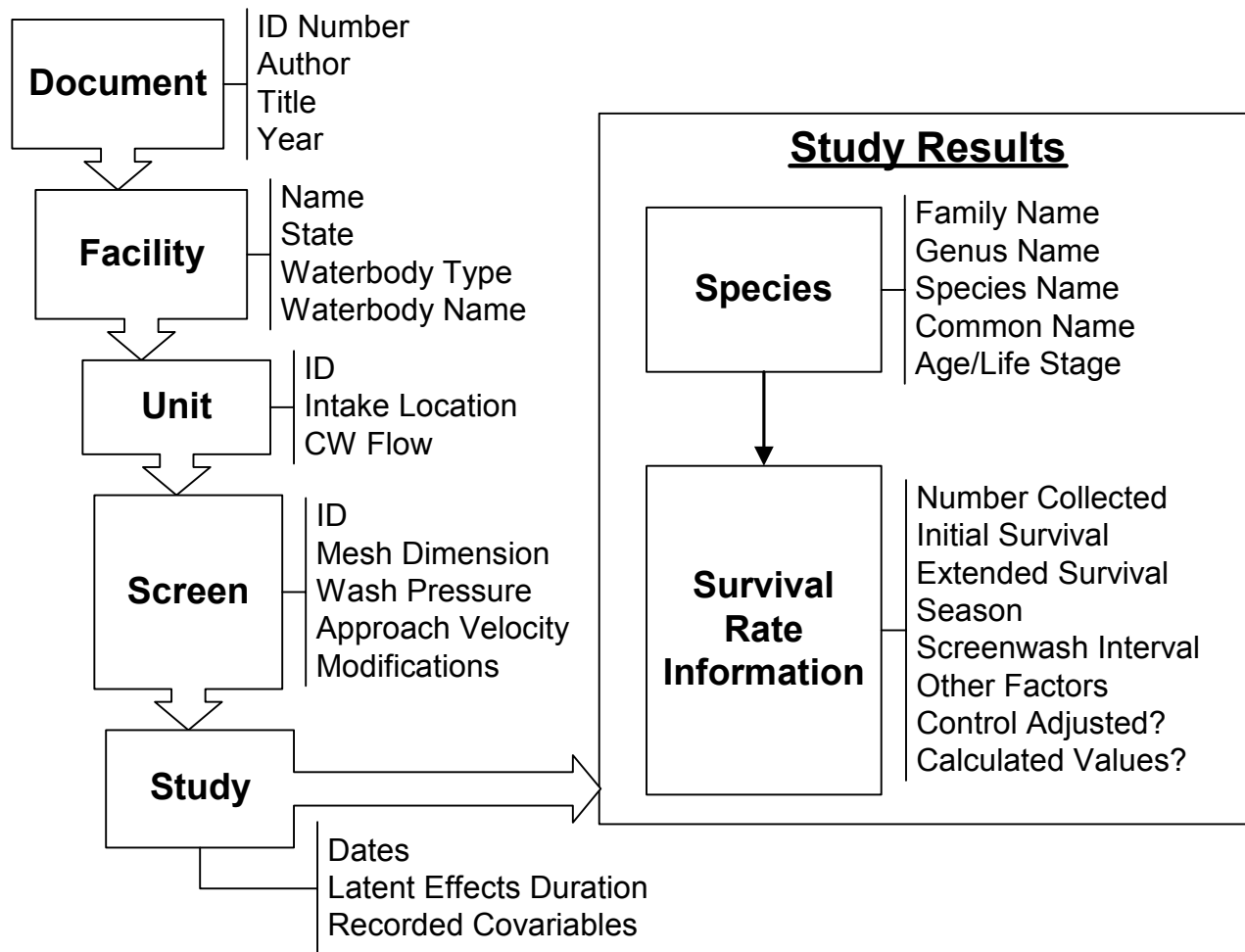
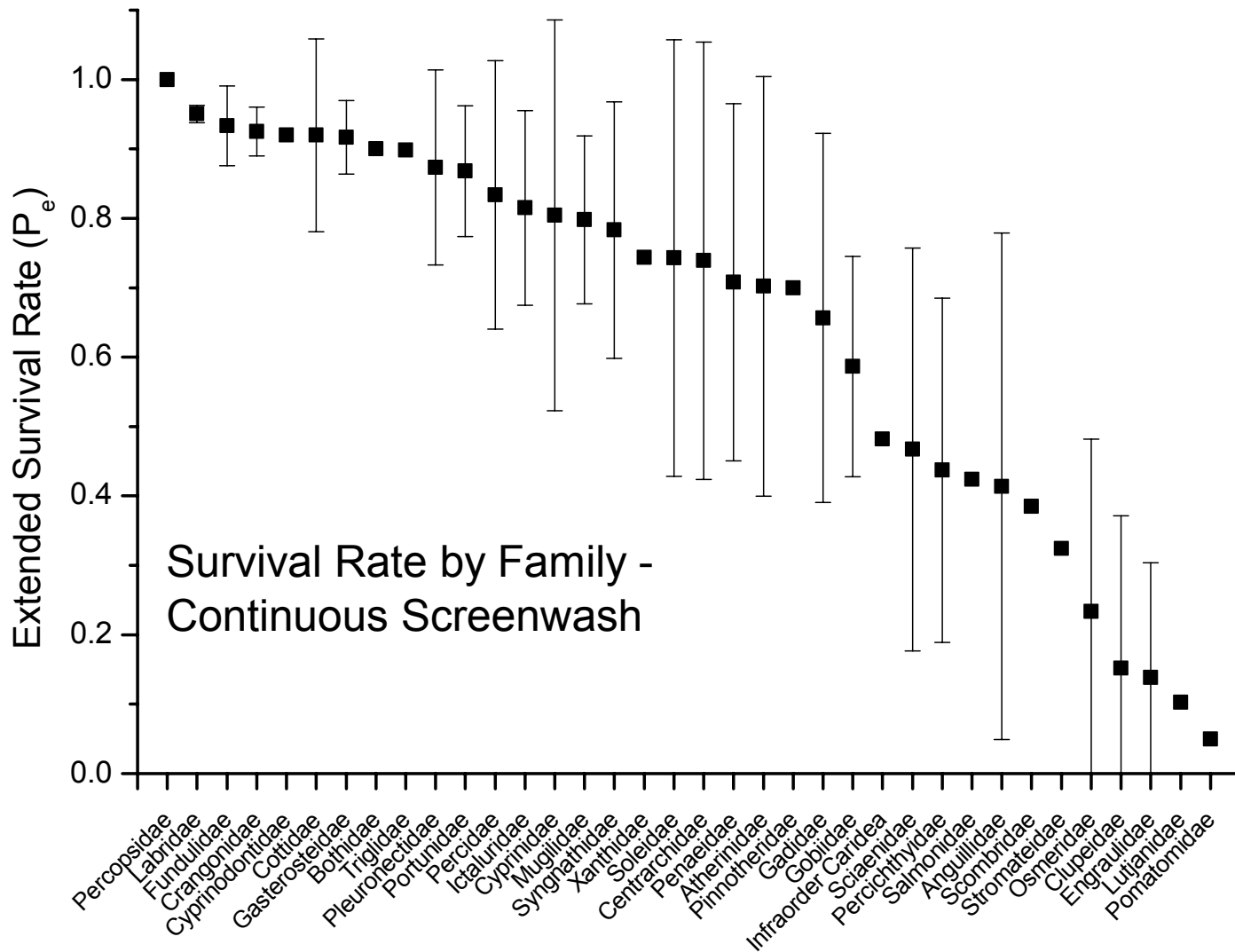
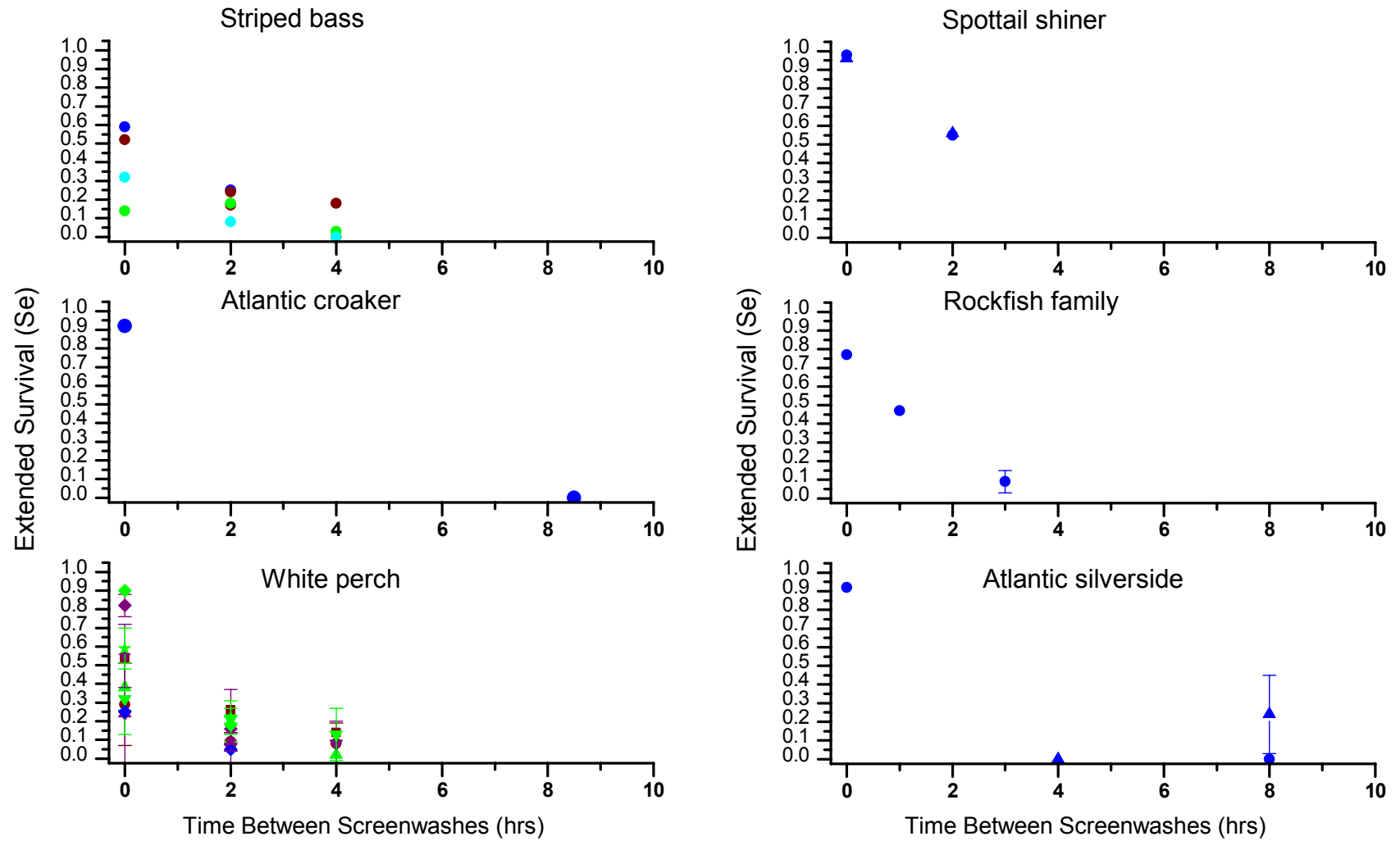


Figure 3 Structure of the impingement survival study descriptor database.



**Figure 4** Mean and standard error of extended (24-108 hr) impingement survival rate estimates reported in the source documents for each taxonomic family during continuous screenwash operation (no control adjustment for effects of handling/holding)



**Figure 5** Extended survival rates reported for various screenwash frequencies (only rockfish family adjusted for effects of handling/holding) (time 0 = continuous wash; numeric labels indicate study ID; blue=no season designated, green=spring, red=summer, brown=fall, cyan= winter)

**Table 1** Mean and Standard Deviation of Reported Extended Impingement Survival Rates by Taxonomic Family

	Screenwash Interval																	
	Continuous		1-hr		2-hr		3-hr		4-hr		6-hr		8-hr		8.5-hr		9-hr	
	P <sub>e</sub>	Stdv	P <sub>e</sub>	Stdv	P <sub>e</sub>	Stdv	P <sub>e</sub>	Stdv	P <sub>e</sub>	Stdv	P <sub>e</sub>	Stdv	P <sub>e</sub>	Stdv	P <sub>e</sub>	Stdv	P <sub>e</sub>	Stdv
Percopsidae	1.00																	
Homaridae					1.00		0.93	0.10										
Fundulidae	0.93	0.06											0.90					
Ophidiidae					0.93													
Cyprinodontidae	0.92																	
Inachidae							0.91	0.03										
Catostomidae									0.90									
Bothidae	0.90																	
Gasterosteidae	0.92	0.06			0.90		0.83	0.10					0.88	0.03				
Pleuronectidae	0.87	0.15			0.79	0.30	0.94						0.86					
Crangonidae	0.93	0.05			0.75													
Triglidae	0.90				0.80													
Cottidae	0.92	0.16			0.78		0.92	0.07					0.74		0.43			
Labridae	0.95	0.02			0.56	0.00	0.86											
Percidae	0.83	0.20			0.70	0.35			0.89	0.11	0.34	0.25	1.00		0.20	0.19		
Portunidae	0.86	0.10	0.32	0.26	0.76	0.19	0.80	0.08			0.36	0.23	0.72	0.13	0.40	0.24		
Ictaluridae	0.82	0.16			0.20				0.90	0.05								
Cyprinidae	0.80	0.29			0.52	0.38			0.80									
Mugilidae	0.80	0.17																
Syngnathidae	0.78	0.21			0.76	0.01	0.92	0.01					0.16					
Xanthidae	0.74				0.40		0.95											
Soleidae	0.74	0.33			0.05	0.06					0.28	0.48						0.00
Centrarchidae	0.74	0.33			0.54	0.51			0.59	0.28								
Penaeidae	0.71	0.29																
Atherinidae	0.70	0.35			0.27	0.09	0.00	0.00			0.00		0.00		0.16	0.17		
Pinnotheridae	0.70																	
Gadidae	0.66	0.27			0.76	0.09							0.27		0.60			
Gobiidae	0.59	0.22																
Tetraodontidae															0.62			
Cancriidae					0.58		0.87	0.06					0.92					
Rajidae													0.82					
Infraorder Caridea	0.48																	

	Screenwash Interval																	
	Continuous		1-hr		2-hr		3-hr		4-hr		6-hr		8-hr		8.5-hr		9-hr	
	P <sub>e</sub>	Stdv	P <sub>e</sub>	Stdv	P <sub>e</sub>	Stdv	P <sub>e</sub>	Stdv	P <sub>e</sub>	Stdv	P <sub>e</sub>	Stdv	P <sub>e</sub>	Stdv	P <sub>e</sub>	Stdv	P <sub>e</sub>	Stdv
Sciaenidae	0.47	0.30	0.18	0.25	0.25	0.40			0.12	0.17	0.06	0.13			0.05	0.08		
Percichthyidae	0.45	0.25			0.21	0.18			0.06		0.07	0.08			0.04			0.00
Salmonidae	0.42				0.88	0.14												
Anguillidae	0.41	0.42																
Scombridae	0.39																	
Stromateidae	0.32				0.03		0.01	0.02					0.00					
Osmeridae	0.23	0.25			0.33	0.27					0.02							
Clupeidae	0.15	0.22	0.08	0.12	0.11	0.23	0.00	0.00	0.00		0.00	0.00	0.00	0.00	0.00	0.00	0.00	0.00
Engraulidae	0.14	0.17			0.01	0.02	0.00				0.00		0.00	0.00	0.00	0.00		
Lutjanidae	0.10																	
Pomatomidae	0.05						0.00											
Cyclopteridae															0.30			
Loliginidae					0.17		0.03	0.04					0.00					
Portunidae <sup>8</sup>			0.97	0.02									0.94	0.08				
Batrachoididae <sup>1</sup>							0.95											
Cottidae <sup>1</sup>	0.96	0.02	0.91	0.13			0.75	0.31										
Gobiidae <sup>1</sup>							0.86	0.17										
Cyprinidae <sup>1</sup>	0.84	0.00																
Soleidae <sup>1</sup>			0.82	0.17									0.77	0.09				
Sebastes <sup>1</sup>	0.77		0.47				0.09	0.06										
Canacridae <sup>1</sup>	0.74		0.70				0.47											
Gadidae <sup>1</sup>	0.65	0.11																
Order Pleuronectiformes <sup>1</sup>							0.61	0.13										
Percichthyidae <sup>1</sup>	0.59	0.18	0.27	0.24									0.16	0.19				
Embiotocidae <sup>1</sup>	0.46	0.52	0.24	0.32			0.04	0.04										
Percidae <sup>1</sup>			0.43	0.50									0.39	0.38				
Sciaenidae <sup>1</sup>			0.55	0.43									0.22	0.19				
Clupeidae <sup>1</sup>	0.19	0.22	0.09	0.15									0.05	0.10				
Atherinidae <sup>1</sup>	0.07		0.04	0.06			0.02	0.03										
Engraulidae <sup>1</sup>	0.00	0.00	0.00	0.00			0.01	0.01										

P<sub>e</sub> = Extended survival rate

<sup>8</sup> For reported control-adjusted survival rate estimates.

**Table 2** Extended Survival of Fish by Screen Speed at the Dunkirk, Mystic, and Brunswick Power Plants

Power Plant (screen speeds)	Species	Size/Stage	Mean Percent Survival (96 hr) During Period of Peak Abundance		
			Low Speed	Medium Speed	High Speed
Dunkirk (18, 54 ft/min)	Emerald shiner	Juvenile	89		96
	Rainbow smelt	Adult	39		59
Mystic (2.5, 7.5-10, 15 ft/min)	Rainbow smelt	Large	11.0	31.3	40.0
	Rainbow smelt	Small	22.5	58.3	66.7
	Alosa spp.	Large	0.8	0	0.5
	Alosa spp.	Small	6.7	23.4	47.1
	Winter flounder	All	96.8	100	98.6
Brunswick (2.5, 6.5-10 ft/min)	Atlantic croaker	<25 mm	9.6		28.9
	Atlantic croaker	>25 mm	35.6		36.0
	Spot	<25 mm	7.6		31.0
	Bay anchovy	N/A	0		0

Source: Beak 1988; SWEC 1981; CP&L 1985

**Table 3** Summary of Mean Extended Impingement Survival Observed in Studies Comparing Conventional and Modified Screens

Station	Species	Extended Survival (Proportion)		
		Conventional Screens	Ristroph Screens	Modified-Ristroph Screens
Oyster Creek <sup>9</sup>	Bay anchovy	.06	.19	
	Atlantic silverside	.77	.80	
	Winter flounder	1.0	.93	
	Sand shrimp	.92	.95	
Salem <sup>10</sup>	Weakfish		.61	.82
	White perch		.87	.95
	Bay anchovy		.29	.45
	Atlantic croaker		.51	.85
	Spot		.81	.93
	Alosa sp.		.40	.80
Arthur Kill <sup>11</sup>	Alewife	.05		.95-.99 <sup>12</sup>
	Atlantic herring	.00		.22-.40
	Atlantic silverside	.51		.98-.99
	Bay anchovy	.00		.41-.52
	Blueback herring	.15		.79-.96
	Butterfish	.18		.72-.76
	Menhaden	.05		.71-.76
	Mummichog	.95		.80-.92
	Northern searobin	.82		.90-.97
	Seahorse	1.0		1.0-1.0
	Striped killifish	.91		.87-.96
	Three-spine stickleback	.99		1.0-1.0
	Weakfish	.42		.92-.97
	White perch	.63		.85-.90
Winter flounder	.41		.97-.97	
Roseton <sup>13</sup>	Alewife	.00		.00
	American shad	.00		.01
	Atlantic tomcod	.08		.20
	Bay anchovy	.00		.00
	Blue crab	.96		.96
	Bluegill	.83		.98
	Brown bullhead	.65		.84
	Gizzard shad	.05		.10
	Hogchoker	.92		.97
	Pumpkinseed	.73		.94
	Spottail shiner	.49		.68
	Striped bass	.24		.43
	White catfish	.75		.84
	White perch	.28		.46

<sup>9</sup> EA 1986

<sup>10</sup> ECSI and LMS 1996, Heimbuch 1999, Ronalvalvy et al. 2000

<sup>11</sup> Con Ed 1996

<sup>12</sup> Range for the two modified screens tested.

<sup>13</sup> LMS 1991



## Session D-2 Questions and Answers

- Q. Elicia Blumberg, Tetra Tech, asked Andy Turnpenny, Fawley Aquatic Research, and Jeremy Nedwell, with respect to noise deterrent systems, what impacts do they have on underwater noise pollution, especially on marine mammals?
- A. Mr. Turnpenny explained that the systems usually use low frequency sound and are well contained, often within 25 meters of the source. Mr. Hartlepool has a seal colony nearby, so this has always been a design consideration for sound deterrent systems.
- Q. Tom Englert, LMS, asked Chuck Coutant, Oak Ridge National Laboratory, whether he had some other results showing that the velocity vectors are still through the screen. With respect to angled screen flows, some papers have cast doubt on the existence of sweeping flows since the flow is still through the screen.
- A. Mr. Coutant answered that yes, even though the theory shows the flow going through the screen, the empirical data show they do work, possibly because the fish detects the screen.
- Q. Greg Seegert, EA Engineering, asked Steve Jinks, ASA Analysis & Communications, Inc. whether there are any studies on size-specific survival? These could impact biomass calculations for determining compliance.
- A. Mr. Jinks replied that this issue hasn't been talked about. Usually, the results are inconsistent. Smaller impinged individuals do often have a low survival rate.
- Q. Mr. Seegert: What about the same issue regarding numerical abundance and those species being more sensitive?
- A. Mr. Jinks: Intuitively, one would expect demersal and benthic species to be more tolerant, since they are more rigid, hard-bodied, and adapted for low dissolved oxygen. However, they did not study the numbers for that, but would expect that some facilities could expect problems with sensitive species.
- Comment. Mr. Coutant: Facilities with sensitive fish species can avoid handling them entirely with angled screens or other technologies—one can guide a fish to a return instead of using a screen to handle them.
- Q. Brad Wright, Constellation, for Steve Jinks: Are there any studies on entrainment survival?
- A. Steve Jinks, ASA Analysis & Communications, Inc.: EPRI has done a similar review for entrainment survival.

## IX. Session D-3: Screening and Other Fish Diversion/Deterrent Technologies (cont'd)

### *Optimal Slot-Width Selection for Wedge Wire Screens*

*William Dey, ASA Analysis & Communications, Inc.*

#### **BIOSKETCH**

Mr. William Dey is a Senior Scientist and Vice President of ASA Analysis & Communication, Inc. He has 28 years of experience conducting ecological risk assessments of man's activities on the aquatic environment. He has conducted ecological risk assessments of power plant cooling water intake systems to freshwater, marine, and estuarine habitats throughout much of the United States. Mr. Dey currently directs the development and implementations of mathematical models to assess the population-level consequences of large scale cooling water withdrawals and to evaluate the potential benefits of intake alternatives.

#### **TECHNICAL PAPER**

##### **Abstract**

Cylindrical wedgewire screens with proper slot widths have the potential to reduce the loss of aquatic organisms resulting from cooling water withdrawals. This is especially true in riverine and estuarine locations where ambient velocities far exceed velocities induced by the water withdrawal. However, the surface area and hence, size and cost, of a wedgewire intake system increases as the slot width gets smaller. Therefore data on the relative abundance of each length category of focal species in the vicinity of the intake is critically needed for optimally selecting the slot width of the wedgewire screens. This fact is illustrated for a hypothetical 500 MGD cooling water withdrawal using actual ichthyoplankton data from the Hudson River estuary. The focus of this assessment is on the marine species, bay anchovy, and anadromous species, striped bass and American shad. This analysis estimates the reduction in equivalent loss (i.e., biological benefit) that would occur at each of three locations along the estuary with a variety of wedgewire slot widths. The results demonstrate that the shape of the cost-benefit curve across slot widths varies depending on species and location. Consequently, it is imperative that site-specific biological data be considered when designing a wedgewire intake system that meets regulatory requirements at the lowest cost possible.

##### **Introduction**

Cylindrical wedgewire screens are a well-established intake screening technology that has a proven track record of successfully minimizing the loss of aquatic organisms at water intake structures, including those used for cooling purposes (USEPA 2001a, 2001b). These screens work especially well in source water bodies where there is a water current that can sweep potentially entrained or impingement organisms along the face of the intake screen, such as in a river or estuary.

Extensive laboratory and real-world experience with this type of screening technology has demonstrated that impingement of larger aquatic organisms (those greater than 1 inch long) is virtually eliminated (Veneziale 1992; Zeitoun et al 1981). Based on a review of existing information, the USEPA concluded that wedgewire screens are an effective means to substantially reduce the impingement of aquatic organisms with reductions of up to 99 percent over conventional intake screens (USEPA 2002).

In addition, studies have demonstrated that fine-mesh wedgewire screens can be effective in substantially reducing the entrainment of fish eggs and larvae at large scale water intake structure installations (Zeitoun et al. 1981; Ehler and Raifsnider 1999; EA 1986). Further, both laboratory studies (Heur and Tomljanovitch, 1978, EPRI 2003) as well as prototype field installations (Lifton 1979; Weisberg et al 1978; Hanson et al 1978) have all shown substantial reductions in entrainment. Many of these same studies have shown little, if any, impingement of organisms against the screen face (Hanson et al. 1978; EA 1986; Lifton 1979) and those few that do become entrapped exhibit very high survival rates (Hanson et al. 1978). In their review of intake technology, USEPA (2002) concluded that reductions in entrainment between 80 and 90 percent could be expected with installation of wedgewire screens. Based on an exhaustive review of all available information, Gowan et al. (1999) concluded that wedgewire screening "...is probably the best all-round screening material for protecting fish".

The results of these studies demonstrate that three factors are important in determining the site-specific performance of wedgewire screens:

- ▶ The slot width relative to the size of aquatic organisms that need to be protected;
- ▶ Through-slot velocity; and,
- ▶ Velocity of water currents sweeping across the face of the screen.

Generally, smaller slot widths, lower through-slot velocities, and higher sweep velocities will result in better screen performance. This paper focuses on the importance of the first factor: slot width. By using real-world data on the abundance and sizes of eggs and larvae of three target species of fish, we demonstrate that the optimal slot width can vary within the same waterbody depending on location and target species selected. Hence, we believe consideration of site-specific data on the abundance and size distribution of target species is critical for determining the wedgewire slot width that can meet entrainment and impingement reduction goals at the lowest possible construction and operating costs to the intake operator. In addition, this paper describes an evaluation process that can be used with site-specific data to conduct a cost-benefit assessment of various wedgewire slot width alternatives in an effort to select one most appropriate for any specific cooling water intake structure and type of fish species.

### Methods

Since 1974, extensive ichthyoplankton surveys of the Hudson River estuary have been conducted to meet permit requirements of three existing generating stations that use water from the Estuary for once-through cooling purposes. Each year approximately 200 samples, averaging 300 m<sup>3</sup> each, were collected weekly during the primary period of egg and larval abundance in the Estuary. Sampling was conducted following a stratified-random design resulting in the distribution of sampling effort throughout the 152-mile estuary (Figure 1). The specific design and sampling protocols for this survey are described by Boreman and Klauda (1988). The resulting database on egg and larval distribution and abundance of estuarine fishes provides an ideal dataset to evaluate the potential performance of wedgewire screens.

For this evaluation, hypothetical generating stations were sited at three different locations along the Estuary (Figure 1); each designated by the region number. Region 3 is located in the mesohaline portion of the Estuary whereas Regions 6 and 11 are located in the lower and upper tidal freshwater portions of the Estuary, respectively. Each power plant was assumed to be a base-loaded facility with once-through cooling requiring 500 million gallons per day of cooling water from the Estuary. Each intake was assumed to be protected by cylindrical wedgewire screens, located offshore and sized to result in a through-slot velocity of 0.25 fps. For this assessment, four difference wedgewire slot widths were assumed, 0.5 mm, 1.0 mm, 2.0 mm, and 3.0 mm.

The assessment focused on three common fish species, American shad, striped bass, and bay anchovy, each of which utilize the Estuary as spawning and/or larval nursery habitat. These three species were selected because they are each a common focus of power plant impact assessments and each has different spatial distribution patterns within the Estuary.

Using the available egg and larval dataset described above, weekly mean densities across each of the three hypothetical power plant regions were estimated for eggs and for the larval stages of each species by 1-mm length intervals. These weekly length-specific densities were calculated for each of three years, 1997-1999, in an effort to capture some of the natural year-to-year variability in egg and larval distribution and abundance. These mean densities were then assumed to be equal to the mean density in the vicinity of each intake location during each week.

All other factors being constant, the exclusion efficiency of wedgewire screens is highly dependent on the size of the organisms being potentially entrained (EPRI 2003). Eggs and larvae that are small relative to the slot width will mostly pass through the screens and become entrained. On the other hand, eggs and larvae that are much larger than the screen slot width are often excluded. Thus, it is important to determine the relationship between the size of the eggs and larvae and screen exclusion efficiency. For this assessment, we reviewed all available information and

developed functional relationships between length and screen exclusion efficiency based on best professional judgment for each of the four potential screen slot widths (Figure 2). These screen exclusion efficiencies were developed for two species groups: American shad and bay anchovy, which have a relatively slender larval form, and striped bass, which has a more robust larval form. Though we have no way of verifying the actual screen exclusion efficiencies that would be obtained at Hudson River wedge wire screen installations the estimates used in our analysis seem reasonable and sufficient for the illustrative purposes of this paper.

For each of the four slot widths, estimates of entrainment for the egg and the larval stages (by 1-mm length interval) were calculated for each year and species as follows:

$$E_{sjly} = \sum_{w=1}^n [D_{sjlyw} \times V \times (1 - SE_{sj})]$$

where:

- $E_{sjly}$  = Number entrained of species (s) and stage (j) in year (y) at intake location (l)
- $D_{sjlyw}$  = Density of species (s) and stage (j) in vicinity of intake during week (w) of year (y) at intake location (l)
- $V$  = Volume of cooling water withdrawn in any week = 13.25 million m<sup>3</sup>
- $SE_{sj}$  = Screen exclusion for species (s) and stage (j)
- $n$  = Number of weeks

To simplify the assessment, egg and larval entrainment mortality was assumed to be complete (100 percent) in all cases. Thus, estimates of the number of each life stage lost to entrainment are equal to the number of each life stage entrained.

Since these estimates of egg and larval loss are for a large number of discrete “life stages” and that the performance of the screens varies with the size of the life stage, there is no simple mechanism for directly comparing the performance of the screens among locations and slot widths. To overcome this difficulty, the estimates of entrainment loss for each life stage were then converted to an equivalent number of Age 1 individuals for each species and intake location using the Equivalent Adult Model (Horst 1975; Goodyear 1978) as follows:

$$NA_1 = \sum_{i=1}^{n_e} (NE_i \times S_{i \rightarrow A_1})$$

where:

- $NA_1$  = total number of equivalent Age 1 individuals
- $NE_i$  = number of life stage or age (i) entrained
- $S_{i \rightarrow A_1}$  = survival from life stage or age (i) to Age 1
- $n_e$  = total number of life stages or ages entrained.

For this assessment, all larvae entrained were assumed to be median-aged for that size interval. The median age of the yolk sac larval stage was estimated for each species as follows:

$$ma_i = \frac{\ln 2 - \ln(1 + e^{-Z_i t_i})}{Z_i}$$

where:

- $mai$  = median age of life stage/age (i)
- $t_i$  = duration of life stage/age (i)
- $Z_i$  = instantaneous mortality rate for life stage/age (i).

Estimates of the instantaneous mortality rate and duration for each species were obtained from PSEG (1999). These values were used to assess the effects of entrainment at the Salem Generating Station on Delaware Bay and were also used by the USEPA in their case studies for the proposed §316(b) regulations (USEPA 2002).

Estimates of the number of equivalent Age 1 individuals lost to entrainment were generated for each screen slot width alternative, as well as for a no screen alternative (baseline), for each year, intake location and species. These estimates of equivalent Age 1 individuals lost were then averaged across the three years for each slot width alternative, intake location and species. Percent reductions in the estimated number of Age 1 individuals lost for each alternative compared to baseline losses provides a measure of the effectiveness of that slot width for each species at each location.

## Results and Discussion

While the three species selected for this assessment all use the Hudson River Estuary as spawning and/or nursery habitat, these species each have a different spatial pattern of utilization. American shad primarily spawn in the extreme upper reaches of tidal freshwater areas of the Estuary. Upon hatch, the larvae are gradually transported downstream towards brackish areas. Striped bass, primarily spawn in lower and middle reaches of tidal freshwater areas, beginning immediately upstream of the saltwater/freshwater interface. Upon hatch, larvae are dispersed by tidal currents both upstream and downstream of spawning areas. In the late larvae and early juvenile stages, most of the population begins to move downstream towards brackish waters. Bay anchovy spawn principally in the higher salinity waters of the extreme lower Estuary and adjacent coastal waters. Larvae then move up into the lower salinity and freshwater areas of the Estuary which they utilize as nursery habitat.

These differing spatial utilization patterns results in differing abundance of eggs and size distributions of the larval stages across the three hypothetical intake locations. In Region 11, collections of the early life stages of American shad included a large number of eggs and a wide size range in the larval stages (Figure 3). In Region 6 in the mid-Estuary, collections of larvae also contained a wide size range although collections were dominated by early juveniles > 20 mm long. In the furthest downstream Region (3) very few shad larvae were collected. However, those that did occur there most commonly ranged from 9 to 15 mm long

For striped bass, collections of eggs were limited to freshwater areas of the Estuary (Regions 6 & 11) (Figure 4). In Region 11, collections included a wide size range of striped bass larvae and early juveniles. Region 6 (principal striped bass spawning and nursery area) collections were dominated by yolk-sac and early post-yolk sac larvae. Collections in Region 3 were principally of post yolk-sac larvae (6 – 12 mm long).

Bay anchovy larvae were restricted to Regions 3 and 6 and only a small number of eggs were collected in Region 11 (Figure 5). In Region 3, bay anchovy eggs were abundant and larval collections included a wide size range from newly hatched up to early juvenile stages. In Region 6, few eggs were collected and the larval size distribution was bimodal with one peak as post yolk-sac larvae 6 to 10 mm long and a second peak as juveniles 17 to 22 mm long.

Owing to their relatively large eggs, length at hatch, and rapid growth rates, all slot widths of wedgewire screens resulted in substantial reductions in the Age1 equivalent American shad lost to entrainment at each of the three hypothetical intake locations (Figure 6). Reductions increased from 87 to 99 percent with 3-mm slot width wedgewire screens to 99 to 100 percent reduction with 0.5-mm slot width screens. These results demonstrate that even the largest slot width tested (3 mm) provides a high degree of protection for American shad at all locations within the Hudson River estuary.

Striped bass exhibited greater variability in protection from entrainment across slot width and intake location (Figure 7). In Regions 3 and 6, reductions in entrainment increased from 26 to 39 percent at 3 mm slot width to 97 to 99 percent at 0.5 mm slot width. In Region 11, larval collection included many larger individuals. As a result, reductions in striped bass entrainment ranged from 78 percent with 3 mm slot width to 99 percent at 0.5 mm slot width.

Despite differences in length-frequency distributions, reductions in bay anchovy entrainment across slot widths were generally similar in Regions 3 and 6 (Figure 8). With 3 mm slot width screens, entrainment reductions averaged 56 to

60 percent and increased to 93 to 95 percent with 0.5 mm slot width screens. In Region 11 where only eggs were collected for bay anchovy, reductions in entrainment increased from 40 percent at 3 mm slot width to 90 percent at 0.5 mm slot width.

These estimates of wedgewire screen performance across a variety of slot width alternatives can be used to compare the relative costs of each alternative to the benefits that might accrue from their installation. Approximate construction and installation costs for wedgewire screens at these hypothetical intakes ranged from just under \$9 million for 3 mm slot-width screens to approximately \$13 million for 0.5 mm slot-width screens. Comparing these costs to reductions in entrainment loss for striped bass provides an example of a cost-benefit evaluation that could be conducted (Figure 9). In this example, the greatest increases in benefits relative to costs were in going from 3- to 2-mm slot width screens. Going to screens of < 2-mm slot width produced a lesser gain in benefits compared to increases in cost. It is important to recognize that the costs used in the example do not include routine operation and maintenance (O & M) costs. If O & M costs were included, it is likely that differences in the total costs across the slot-width sizes used in this example would be even greater, because screens with small slot widths generally would incur higher O & M costs than screens with large slot widths.

In summary, data on the early life stages of fish within the Hudson River estuary demonstrate that the size distribution of the eggs and larvae of any species varies considerably depending on location. The variability can be attributed to differences in how each species utilizes the Estuary as spawning and nursery habitat. Since it is well documented that the performance of wedgewire screens is dependent on the size of entrainable organisms relative to the slot width, it is clear that the performance of any specific slot width screen will vary depending on location as demonstrated herein. This paper provides a process that can be used to assess the relative benefits of various slot width wedgewire screens based on site-specific biological information. The results of this evaluation can then be used to select the optimal wedgewire slot width from a cost-benefit perspective.

## References

- Boreman, J. and R. J. Klauda. 1988. Distributions of early life stages of striped bass in the Hudson River Estuary, 1974-1979. *American Fisheries Society Monograph* 4:53-58.
- EA Science and Technology (EA). 1986. Results of entrainment and impingement monitoring studies at the Westchester RESCO facility Peekskill, New York.
- Ehrler, C. and C. Raifsnider. 1999. Evaluation of the Effectiveness of Intake Wedgewire Screens. In: *Power Impacts on Aquatic Resources Conference*, Atlanta, GA, April 12-15, 1999. Sponsored by the Electric Power Research Institute (EPRI).
- Electric Power Research Institute (EPRI). 2003. Laboratory Evaluation of Wedgewire Screens for Protecting Early Life Stages of Fish at Cooling Water Intakes. Palo Alto, CA. EPRI Report 1005339.
- Goodyear, C.P. 1978. Entrainment Impact Estimates Using the Equivalent Adult Approach. Report No. FWS/OBS-78/65. U.S. Fish and Wildlife Service, Washington, D.C.
- Gowan, C., G. Garman, and W. Shuart. 1999. Design Criteria for Fish Screens in Virginia: Recommendations Based on a Review of the Literature. Prepared for Virginia Department of Game and Inland Fisheries, Richmond, VA.
- Hanson, B. N., W. H. Bason, B. E. Beitz and K. E. Charles. 1978. A Practical Intake Screen which Substantially Reduces the Entrainment and Impingement of Early Life Stages of Fish. In: *Fourth National Workshop on Entrainment and Impingement*. December 5, 1977, Chicago, IL. L. D. Jenson (Ed.).
- Heuer, J. H. and D. A. Tomljanovich. 1978. A Study on the Protection of Fish Larvae at Water Intakes Using Wedge-Wire Screening. Tennessee Valley Authority Technical Note B26.
- Horst, T.J. 1975. The assessment of impact due to entrainment of ichthyoplankton, in: *Fisheries and Energy Production: A Symposium* (S.B. Saila, ed.), pp. 107-118. D.C. Heath, Lexington, MA.

Lifton, W. S. 1979. Biological Aspects of Screen Testing on the St. Johns River, Palatka, Florida. In: Fourth National Workshop on Entrainment and Impingement. December 5, 1977, Chicago, IL. L. D. Jenson (Ed.).

Public Service Electric and Gas Company (PSEG). 1999. Permit Renewal Application NJPDES Permit No. NJ0005622, Public Service Electric and Gas Company Salem Generating Station, March 4, 1999. PSE&G, Newark, New Jersey.

United States Environmental Protection Agency (USEPA). 2001a. Technical Development Document for the Final Regulations Addressing Cooling Water Intake Structures for New Facilities (EPA-821-R-01-036) November 2001.

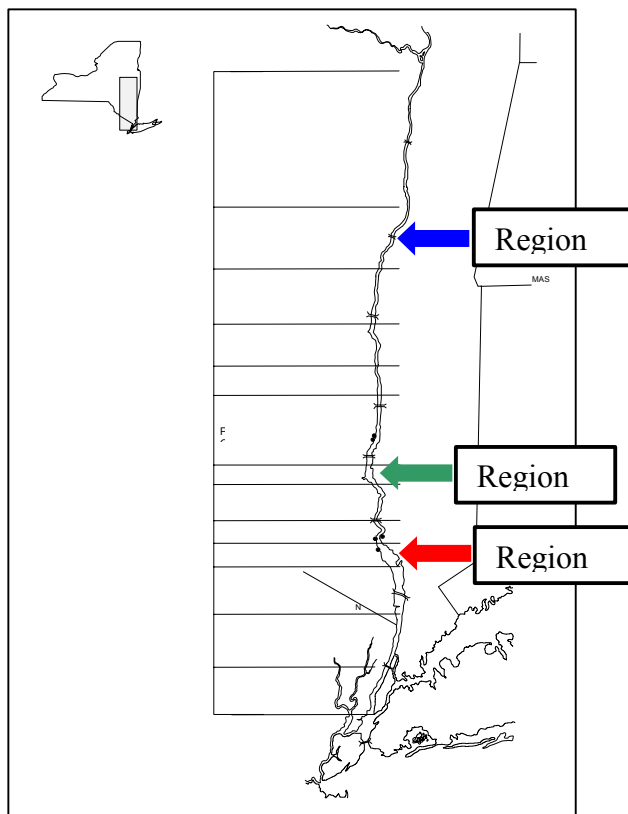
USEPA. 2001b. National Pollutant Discharge Elimination System: Regulations Addressing Cooling Water Intake Structures for New Facilities; Final Rule. Federal Register 66(243): 65256-65345. United States Environmental Protection Agency

USEPA. 2002. Case Study Analysis for the Proposed Section 316(b) Phase II Existing Facilities Rule. Office of Water. EPA-821-R-02-002. February.

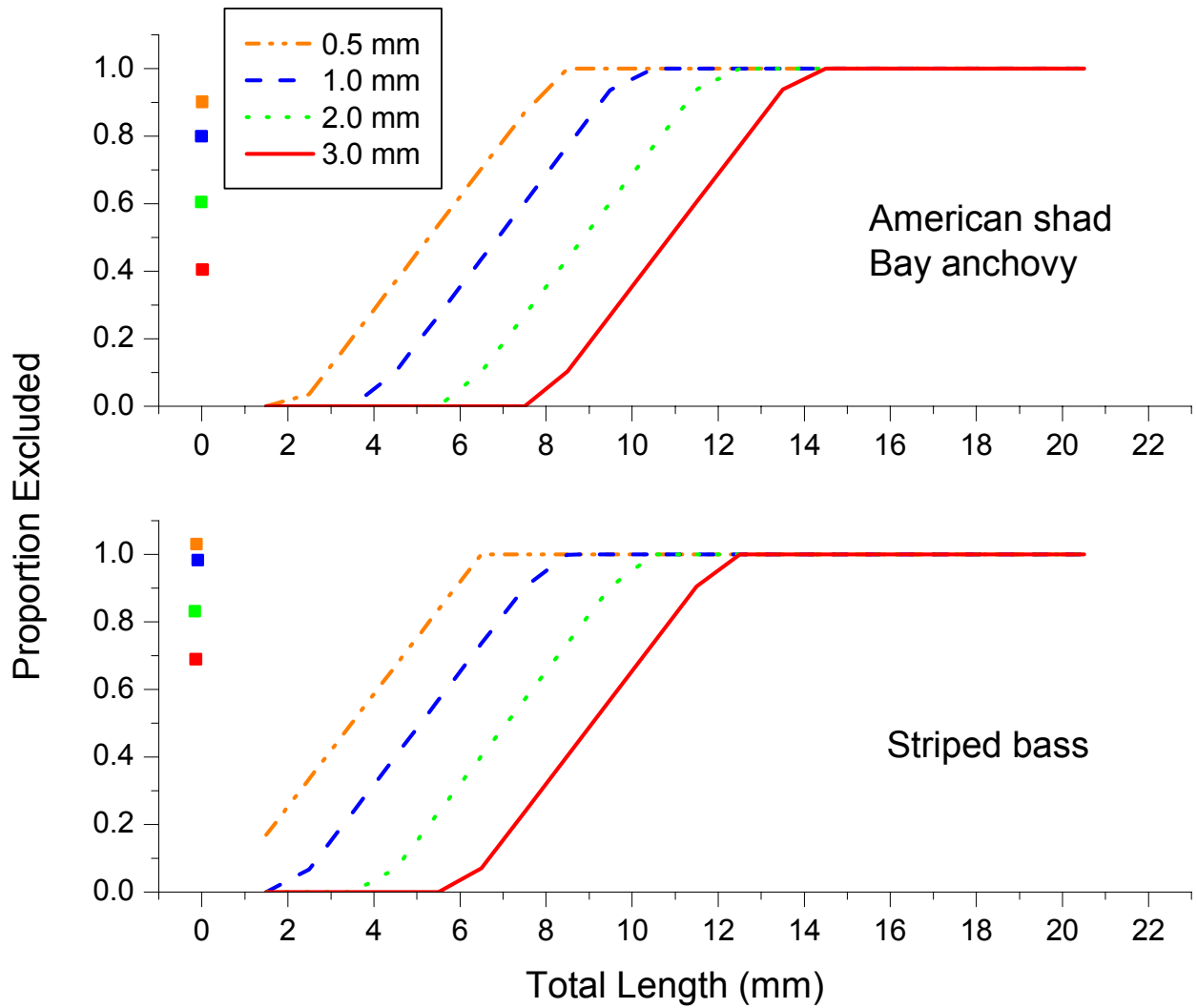
Veneziale, E. J. 1991. Design of Wedge Wire Screen Intake System to Replace Traveling Intake Screens at Eddystone Generating Station. Proceedings of the 53<sup>rd</sup> American Power Conference.

Weisberg, S. B., W. H. Burton, F. Jacobs, and E. A. Ross. 1987. Reductions in ichthyoplankton entrainment with fine-mesh wedge-wire screens. N. Am. J. of Fish. Manag. 7: 386-393.

Zeitoun, I. H., J. A. Gulvas, and D. B. Roarabaugh. 1981. Effectiveness of Fine Mesh Cylindrical Wedge-Wire Screens in Reducing Entrainment of Lake Michigan Ichthyoplankton. Canadian Journal of Fisheries and Aquatic Sciences 38: 120-125.

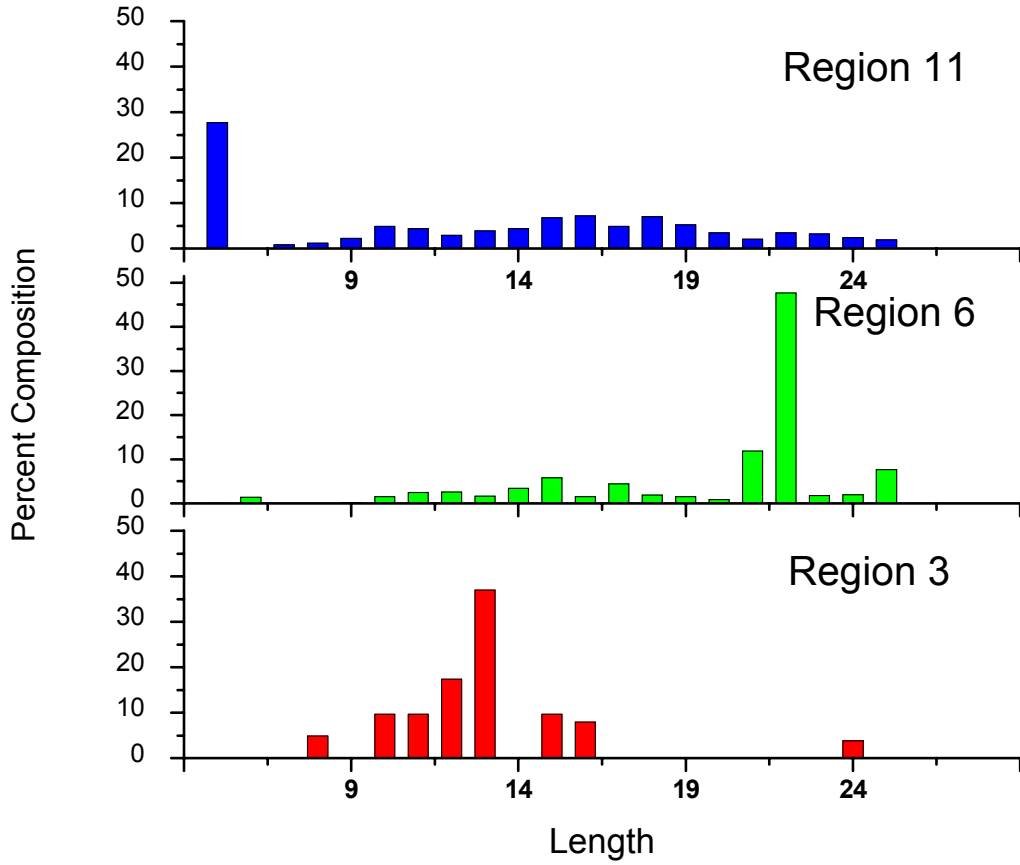


**Figure 1** Sampling regions used for egg and larval fish surveys of the Hudson River estuary and locations of three hypothetical cooling water intakes used in this assessment.

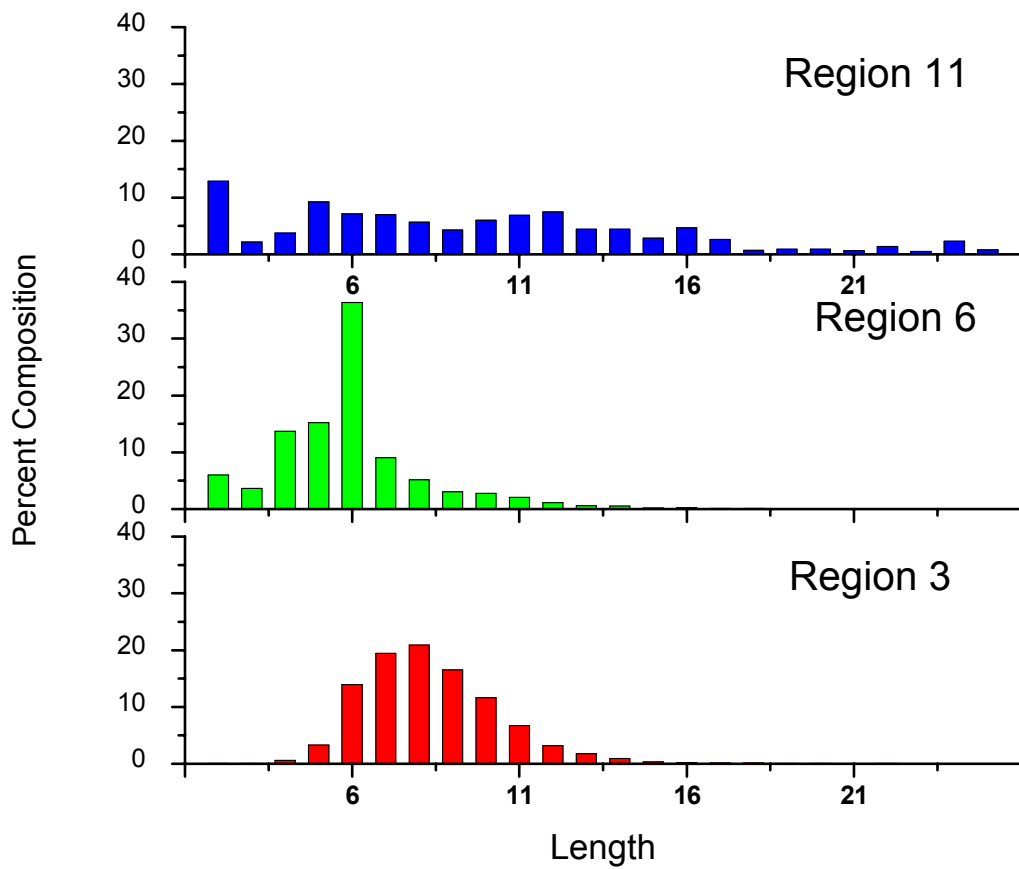


**Figure 2** Relationship between larval length and wedgewire screen efficiency used in the analysis. (Length =0 represents eggs).

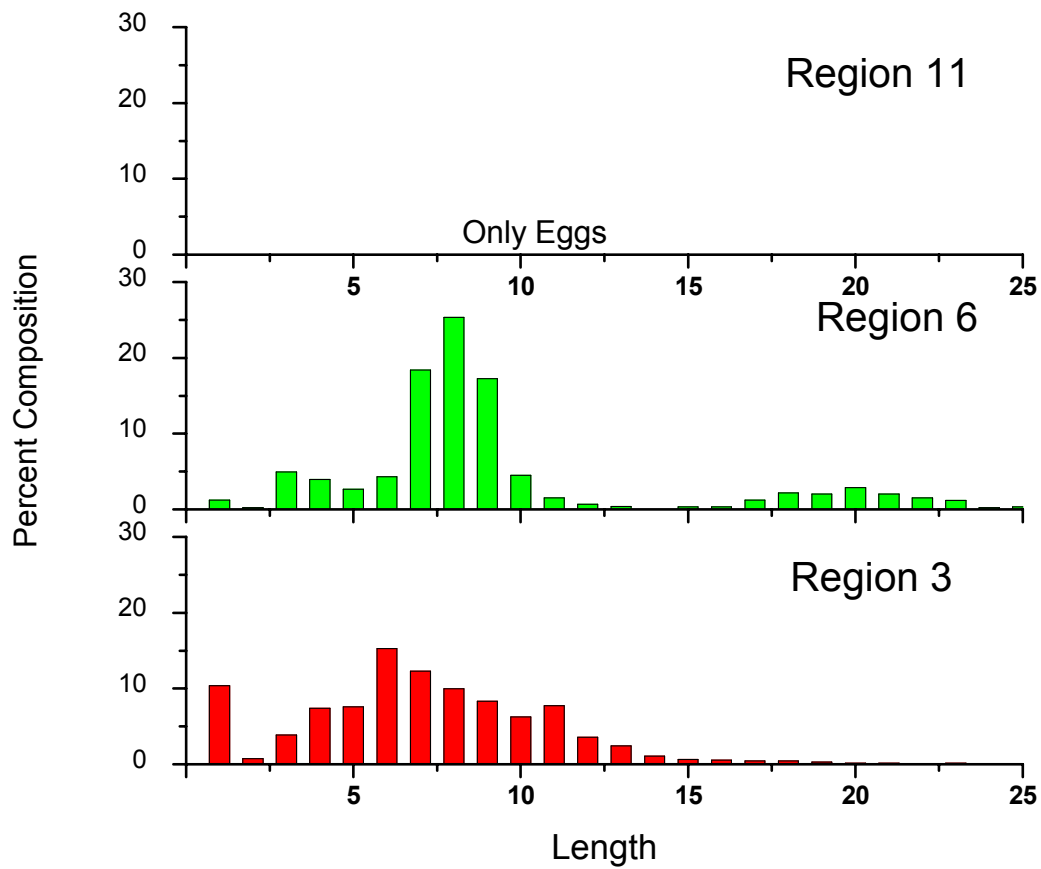




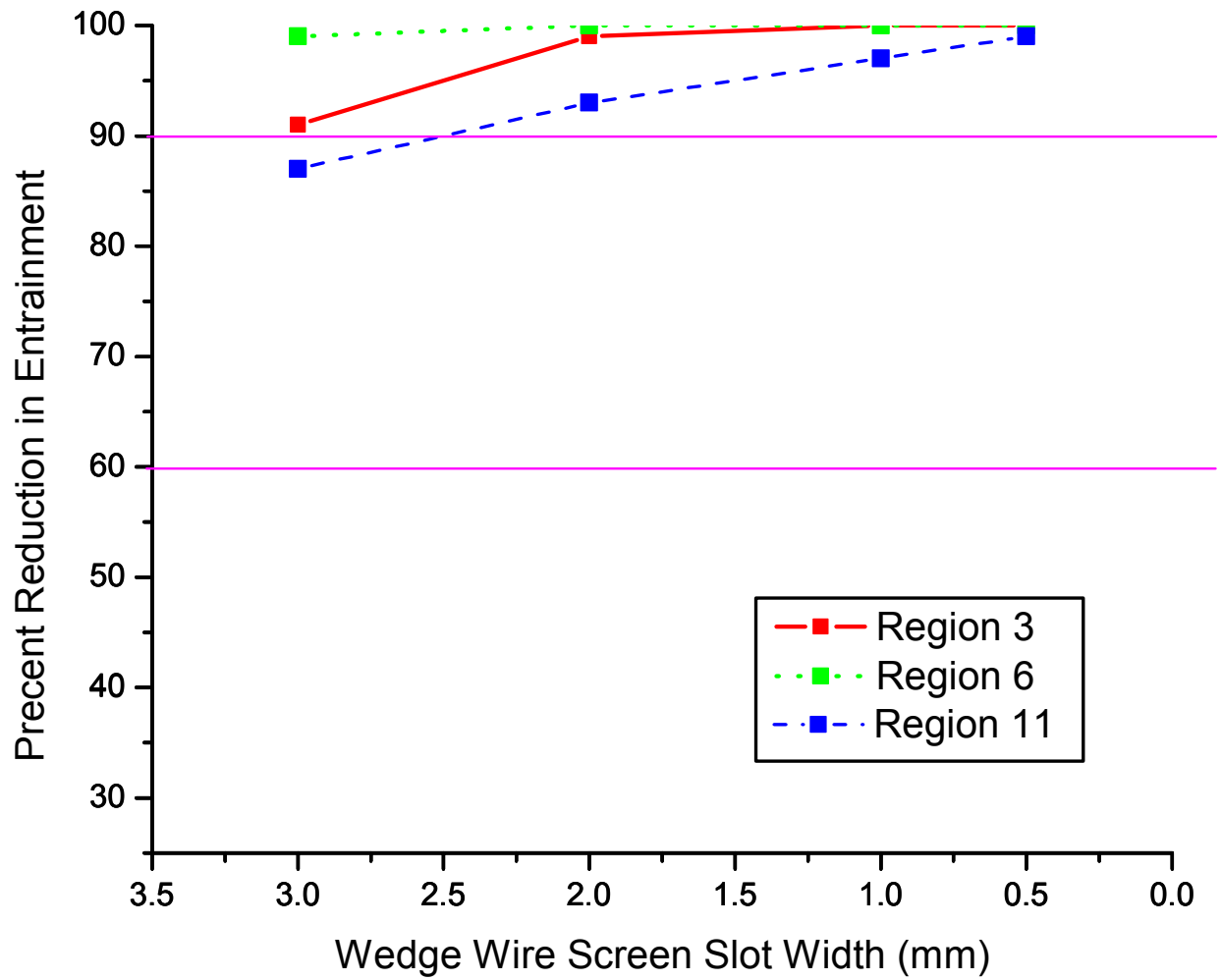
**Figure 3** Frequency distribution of egg and larval American shad at three hypothetical cooling water intake locations in Hudson River estuary, 1997 – 1999. (First bar represents eggs).



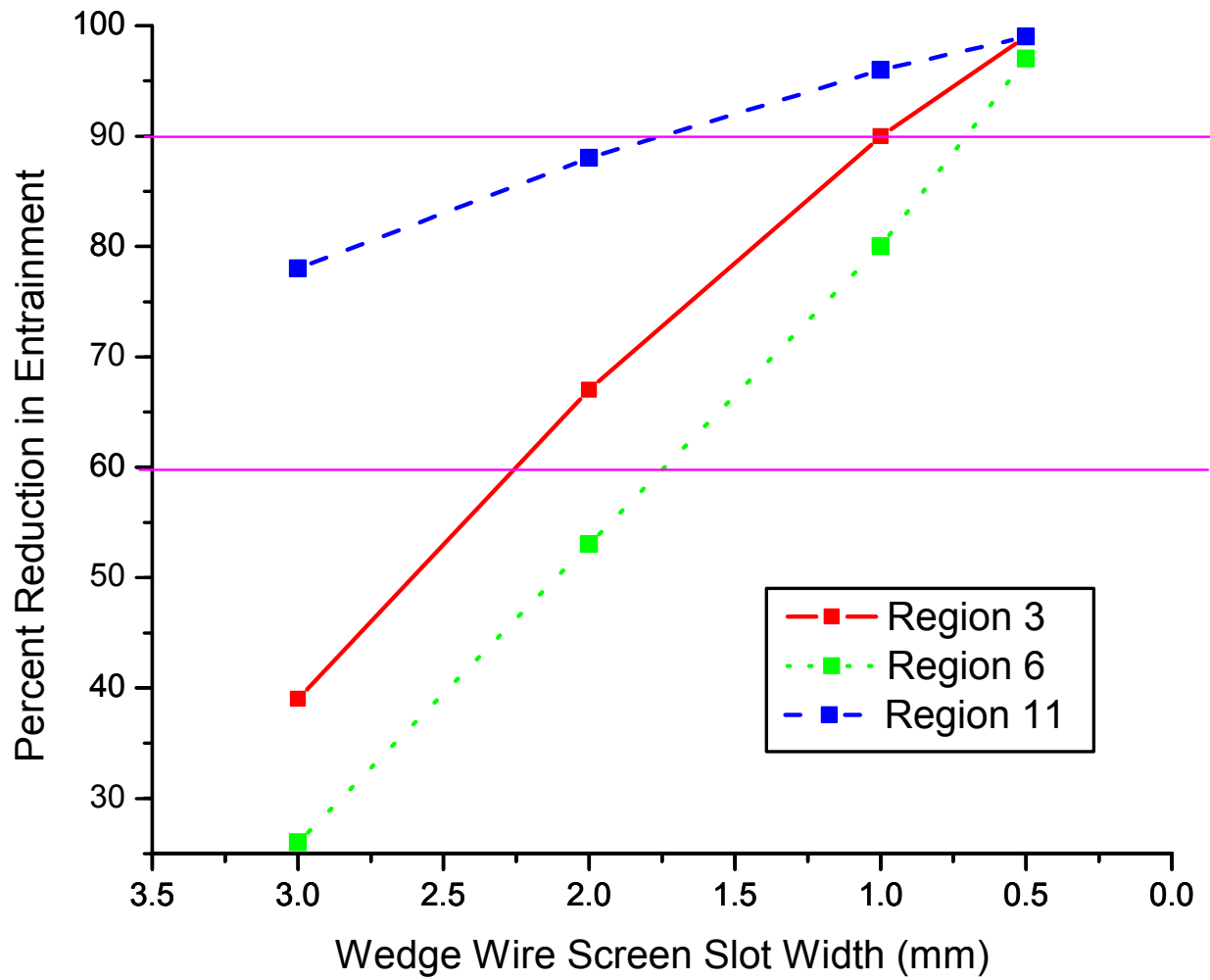
**Figure 4** Frequency distribution of egg and larval striped bass at three hypothetical cooling water intake locations in Hudson River estuary, 1997 – 1999. (First bar represents eggs).



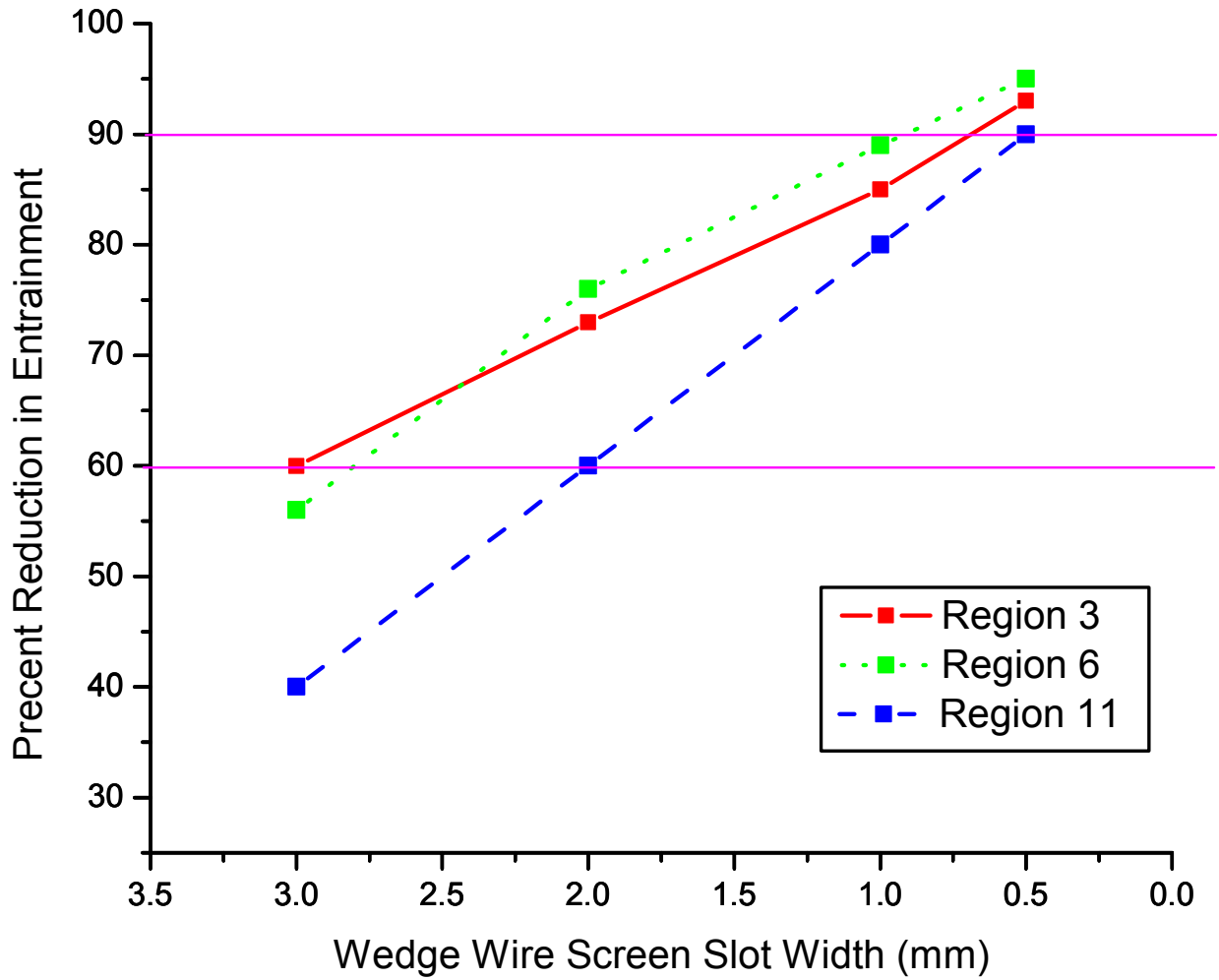
**Figure 5** Frequency distribution of egg and larval bay anchovy at three hypothetical cooling water intake locations in Hudson River estuary, 1997 – 1999. (First bar represents eggs).



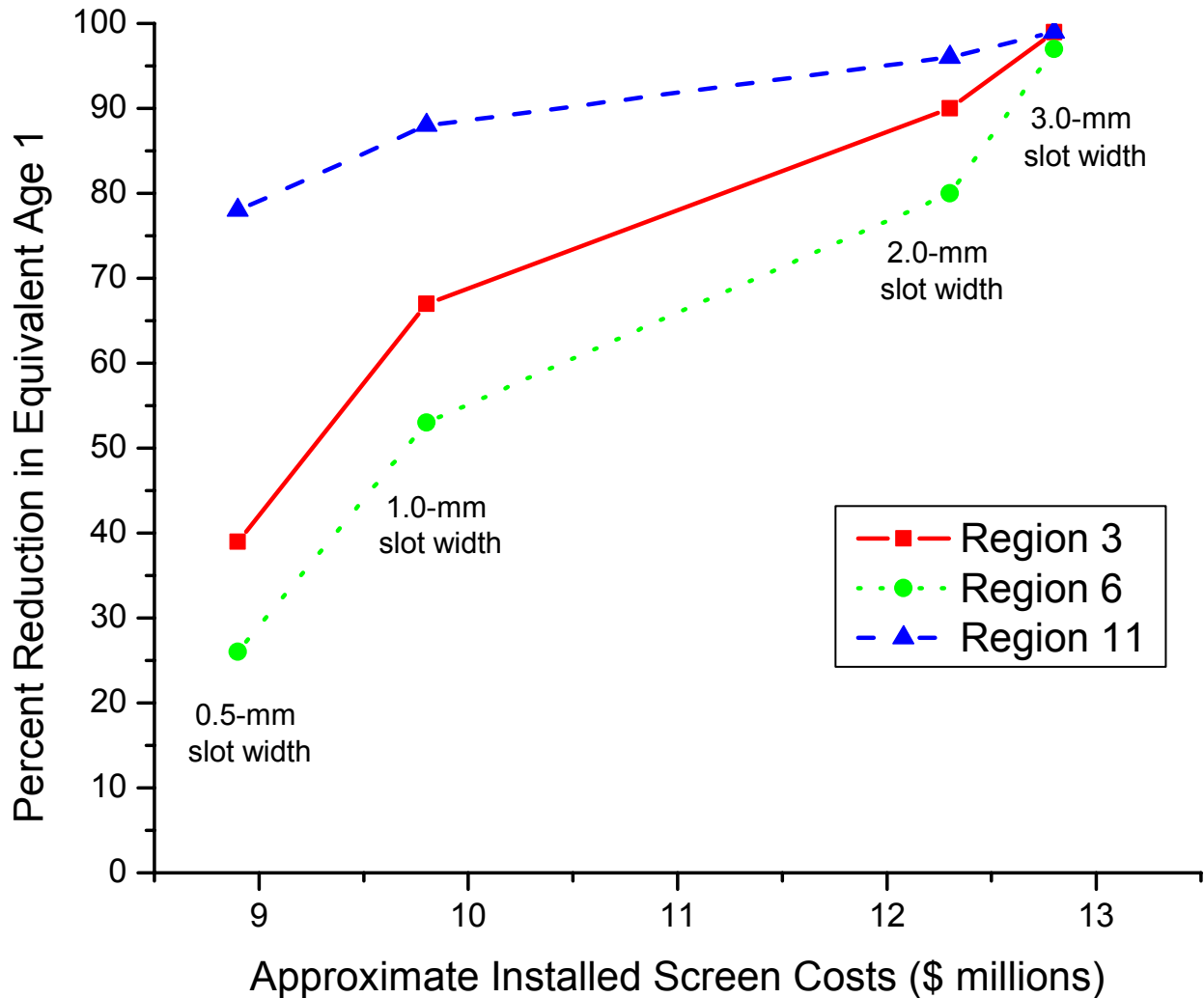
**Figure 6** Reductions in equivalent Age 1 individuals by slot width for American shad at three hypothetical cooling water intake locations within the Hudson River estuary.



**Figure 7** Reductions in equivalent Age 1 individuals by slot width for striped bass at three hypothetical cooling water intake locations within the Hudson River estuary.



**Figure 8** Reductions in equivalent Age 1 individuals by slot width for bay anchovy at three hypothetical power plant locations within the Hudson River estuary.



**Figure 9** Example of cost-benefit relationships for wedgewire screen slot widths at three hypothetical cooling water intake locations within the Hudson River estuary based on screen performance with striped bass.

*Development of Filter Fabric Technology to Reduce Aquatic Impacts at Water Intake Structures*  
 Matthew Raffenberg, Lawler, Matusky, and Skelly Engineers, LLP

**BIOSKETCH**

Mr. Matthew Raffenberg is a Senior Environmental Scientist for Lawler, Matusky and Skelly Engineers L.L.P (LMS) in Pearl River, New York. Mr. Raffenberg received a B.S. in Fisheries Management from The Ohio State University and a M.S. in Wildlife and Fisheries Biology from the University of Vermont. He worked for three years at the Illinois Natural History Survey studying fish recruitment in Southern Lake Michigan. With LMS, Mr. Raffenberg works on projects ranging from SPDES/NPDES permit renewal applications to determining the spatial and temporal occurrence of early life-stages and adult winter flounder in the New York-New Jersey Harbor. He also works with several power generating facilities to assess the feasibility of new technologies to reduce entrainment of fish.

## TECHNICAL PAPER

Section 316(b) of the Federal Clean Water Act requires that the location, design, construction, and capacity of cooling water intake structures reflect the BTA for minimizing adverse environmental impact. This determination is made on a case-by-case basis by the permitting agency that bears the ultimate burden of proof to support its decision. In New York State the National Pollutant Discharge Elimination System (NPDES) permit program is administered by the New York State Department of Environmental Conservation (NYSDEC).

In 1994, Orange and Rockland Utilities, Inc. (ORU), the then owners of the Lovett Steam Electric Generating Station (Lovett) began a research program to develop a technology to minimize entrainment at the Lovett cooling water intake. ORU and subsequent owners Southern Company and Mirant New York LLC focused on developing a physical barrier that would minimize entrainment while allowing the facility to withdraw the required volume of water for once-through cooling. An aquatic filter barrier (AFB), the Gunderboom<sup>®</sup> system, was selected as the primary technology for development. The Gunderboom system had been proven as a barrier at preventing sediment passage related to dredging operations.

In general, technologies that protect aquatic organisms from entrainment at cooling water intake structures can be grouped on the basis of their fundamental method of reducing biological impacts. The two major groups are those that prevent or lower the potential for entrainment into the cooling water system (exclusionary systems) and those that separate and remove entrapped organisms at some point within the system. The exclusionary group includes physical and behavioral barriers located at the interface between the intake structure and the source waterbody. The second group includes separation and removal systems located between the point of water withdrawal and the circulating water pumps, usually in the vicinity of existing apparatus that screens debris. Of the two basic intake protection systems, the exclusionary systems have the major advantage in that they eliminate stress related to organism contact with screening devices associated with collection and return systems. The Gunderboom<sup>®</sup> MLES<sup>™</sup> is a good example of an exclusionary system.

The primary objective of the Lovett research and development program was to maintain an effective filtering physical barrier in front of the facility. As a result, the initial annual research goals focused on the flow through capacity of the fabric, mooring and anchoring, cleaning the fabric, and maintenance and deployment. The annual research goals are listed below.

- 1994 – *In situ* feasibility test
- 1995 - Gunderboom System concept
- 1996 - Manual AirBurst<sup>™</sup> cleaning system / spud-type anchors (3-unit deployment)
- 1997 - Manual AirBurst<sup>™</sup> cleaning / dead-weight anchoring system
- 1998 - Automated AirBurst<sup>™</sup> cleaning / 500-micron perforations / monitoring equipment
- 1999 - Automatic AirBurst<sup>™</sup> cleaning / monitoring equipment 2000 - Improve field maintenance procedures, improve mooring hardware and test new zipper connections

## Site Description

The Lovett Generating Station is located on the west bank of the Hudson River at River Mile (RM) 42, in Tomkins Cove, Rockland County, New York (Figure 1). The station consists of three fossil-fueled, steam electric units (Units 3, 4 and 5), having net generating capacities ranging from 63 to 202 MWe for a total of 462 MWe for all units combined (Figure 2). The three-unit combined once-through condenser cooling system requires 391 MGD of non-contact cooling water at full capacity.

## Site Specific Considerations

The cooling water required to operate Lovett is drawn from the Hudson River, a large coastal river that empties into New York Harbor. The Hudson River in the vicinity of Lovett is approximately 1.2-km wide and has a maximum channel depth of 21 meters. The river experiences a 3-ft tidal range and has salinities ranging from 0-10 ppt depending on tides and freshwater flows. The river experiences periods of high total suspended solids (TSS) and



flows (160,000 cfs) as a result of seasonal rain events and snowmelt. The Hudson River physical and chemical characteristics that were considered in the development of the MLES™ at Lovett, included: tidal water level fluctuations, tidal currents, waves, waterborne sediments, substrate quality, floating debris, and potential fouling species (e.g. zebra mussels). Other site specific variables that were considered include the life history characteristics of the species targeted for protection and physical limitations of the site.

### **What is an Aquatic Filter Barrier?**

The aquatic filter barrier is a full-water-depth barrier that limits aquatic biota entering water intake structures. The fabric is a permeable fabric curtain consisting of polyester fibers and is constructed of two layers that are subdivided into vertical cells or pockets. A sufficient amount of filter fabric is designed into the boom to accommodate water level fluctuations up to the design high-water condition. A flotation hood, along the top of the entire length of the boom keeps the system afloat while maintaining complete coverage through the water column (Figure 3). The MLES™ is fixed in position by an anchoring and mooring system. A heavy skirt constructed of durable, impermeable, rubberized material is attached to the bottom of the filter fabric to create a seal with the substrate and prevent aquatic organisms from passing underneath.

### **Lovett Gunderboom® MLES™ Development**

The evaluation of (Gunderboom fabric or the Gunderboom system fabric) the Gunderboom fabric was initiated in 1994 with small-scale tests to obtain preliminary information on filtering capacity and the potential for fabric clogging. Based on the results of the preliminary tests, it was determined that sufficient filtering capability was recorded to warrant large scale tests at the cooling water intake.

The following year a Gunderboom barrier system was constructed utilizing a single-ply of filtering fabric and was deployed at the Lovett Unit 3 intake from 23 June to 25 August (Photo 1). The 1995 Gunderboom system was approximately 91m (300-ft long and was deployed at depths of 6-9m (20-30 ft). Based on past experience with passive system applications, Danforth type anchors were selected for the deployment.

During this initial deployment, the boom system was overtopped as a result of sediment build-up on the fabric, reducing filtering capacity. The length of the flotation that was overtopped gradually increased so that within several weeks of deployment it was estimated that the required flow for Unit 3 was passing over the top of the boom. Overtopping was a design characteristic of the initial system to relieve stress on the fabric and minimize the potential for fabric failure. Observations of the initial deployment showed that the fabric was rugged and did not develop holes or tears due to stress over the deployment period; however, sediment build-up was evident over the entire filtering area. Initially it was thought that the tidal action in the Hudson River, coupled with wave action, would resuspend any sediment on the boom. This was the first installation of a Gunderboom system at a facility that required unidirectional flow through the fabric. In addition, the stress of the sediment accumulating on the fabric caused the Danforth anchors to destabilize and move in the muddy bottom substrate of the Hudson River (Table 1).

In response to the clogging identified during the 1995 deployment, Gunderboom developed the AirBurst™ Technology cleaning system. The 1996 deployment tested the AirBurst™ Technology as well as spud-type anchors. For the AirBurst™ cleaning system to operate properly, two-ply of Gunderboom fabric were sewn together forming an internal pocket where the air was released (Photo 2). The AirBurst™ system consisted of a compressed air source connected to a diffuser located in the bottom of each cell. A timed burst of air into each cell provided cleaning by “shaking” the fabric material, by the diffusion of small bubbles through the pores of the fabric and by an induced upwelling of water around the boom created by the expanding air as it rises through the water column.

The 1996 Gunderboom system was fully deployed in front of Lovett’s three independent cooling water intake structures (Units 3, 4 and 5) on 5 September (LMS 1997) to test the AirBurst™ cleaning system. A few hours after deployment several anchors on the north end were dislodged, which resulted in the boom tearing loose from a rigid sheet-pile mooring at the northern end of the facility. The boom stabilized closer to the intake structures, which permitted limited testing of the air-burst cleaning system. Preliminary observations indicated that the AirBurst™

cleaning system had good potential at limiting sediment build-up on the Gunderboom fabric and maintaining fabric-filtering capacity. Gunderboom determined that the anchoring system (spud-type), based on the pre-deployment sediment geotechnical tests, was not appropriate for maintaining the boom position. In addition, it was determined that the northern terminal connection was not appropriate and that a gradual termination point, such as the mooring cell used in the 1995 system was the best attachment technique in a dynamic environment.

To maintain the boom in place a “dead weight” anchoring system was developed. The goal of the 1997 Gunderboom system evaluation was to deploy and test the “dead weight” anchors and to further test the AirBurst™ system. The boom deployed during 1996 was modified (cut down) to permit deployment around Unit 3 in 1997. The modified boom was deployed from 22 September to 6 October 1997 (LMS 1997). During the deployment, the dead weight anchors successfully maintained the position of the boom and the AirBurst™ system installation was determined to be effective at maintaining the fabric filtering capacity.

After the 1997 deployment, fabric improvements were evaluated that would increase filtering capacity while not compromising the fabric’s exclusion potential and maintaining the structural integrity of the Gunderboom system. Evaluation of a perforated filter fabric began in the winter of 1997-1998. This research determined that a perforated fabric could continually pass water at a minimum capacity of 5 gpm/ft<sup>2</sup> with regularly scheduled cleanings better than the fabric without perforations.

A two-ply boom system now called the Gunderboom MLEST™ (MLEST™) with perforations in the upstream and downstream fabric plies was tested at Lovett Unit 3 during 1998. Perforations or pores had an Apparent Opening Size (AOS) of 0.5 mm in diameter on 6.4-mm centers. The AOS is the industry standard test for measuring geotextile pore size. During MLEST™ manufacturing the pore alignment was offset between the two fabric layers. In addition, covered slits were placed in the downstream layer to permit sediment to pass through. The same dead weight anchors used in the 1997 deployment were used in 1998.

The 1998 MLEST™ was deployed from 11 June to 2 September at Lovett unit 3. During this deployment a manually operated AirBurst™ system effectively dislodged sediments from the MLEST™ (Photo 2). The AirBurst™ system was operated only during the daytime. A dive inspection in early August determined that an 2.5m (8 ft) to 3m (10 ft) section of the fabric had pulled free from the bottom; loosening a nylon support strap that had pulled on the flotation and operating the AirBurst™ system on a full-time basis essentially corrected the situation. Some algal growth was noted on the MLEST™ fabric; however, the growth was limited to the surface or photic zone area. The results of the deployment indicated that the biological growth did not adversely affect the filtering capacity of the MLEST™ fabric. The analysis of the 1998 program identified that the manual AirBurst™ system proved to be labor intensive and it was determined that an automated system needed to be designed and incorporated into future MLEST™ to make the technology effective.

A two-ply MLEST™ with an automated AirBurst™ cleaning system was deployed at Lovett Unit 3 during 1999 (LMS 2000). The automated system included strain and head differential gauges to continually monitor the system. The difference between inside and outside water levels (i.e. differential of hydraulic head) created a force that moved water through the fabric and provided a continuous measure of system performance. The second measurement was the load or strain on a subset of the mooring lines with the sensors located between the anchors and the fabric. Observations from the 1999 deployment showed that the system, incorporating perforated material, in conjunction with the automated AirBurst™ system, was effective at keeping the MLEST™ from clogging and overtopping due to sediment clogging/biological growth. The head differential and strain gauges accurately provided information on fabric loading. The refinements made to the 1999 MLEST™ and AirBurst™ systems confirmed that the MLEST™ filtering capacity could be maintained over extended time periods and that the automated cleaning system allowed the MLEST™ to operate unattended.

The same MLEST™ deployed at Lovett Unit 3 during 1999 was serviced and re-deployed at Lovett Unit 3 during two separate periods in 2000 (LMS 2001), the first period was from 10 May to 1 September, and the second period was

from 12 October to 15 December. The goals of these deployments were to refine in-field maintenance of the MLES™, test new mooring hardware, monitor operational effectiveness of a computerized and automated AirBurst™ cleaning system and test the effectiveness of zippers to join fabric sections. During both deployment periods, the automated AirBurst™ cleaning system maintained the filtering capacity of the MLES™, allowing operation to continue unattended around the clock. This deployment identified that integrating the Airburst™ system into facility operations and incorporating redundancies (i.e. alternate air sources) into the system are essential to long-term system operation. Results from the zipper test proved that sections of fabric could be separated during deployment, ultimately allowing for the maintenance or removal of panels without removing the entire MLES™ from the water.

### **Ichthyoplankton Monitoring**

Coupled with the physical performance monitoring of the MLES™ at Lovett, the effectiveness at limiting the passage of entrainable organisms was determined through ichthyoplankton sampling conducted during the 1995, 1998 and 2000 deployments. Effectiveness was measured by collecting simultaneous samples at a station located inside the MLES™ and at a station located outside the MLES™. The Unit 3 (protected by MLES™) and Unit 4 intakes (ambient conditions) were selected for sample collection as they are structurally similar and are located very close to each other. Ichthyoplankton sampling at these locations in 1997 - without the MLES™ in place - indicated that the Unit 4 and Unit 3 sampling locations were not significantly different, but as typical with ichthyoplankton there was considerable variability in the data (EA 1997).

Paired samples of approximately 30 minutes duration were collected at each intake sequentially at one depth in 1995 (mid-depth) and three depths (surface, mid-depth and bottom) during 1998 and 2000. Because each MLES™ deployment focused on improving different facets of the technology, deployment dates varied from year to year ultimately influencing the dates that ichthyoplankton monitoring was conducted (Table 2). During 1995, sampling was conducted over a 24-hr period, thereafter (i.e. 1998 and 2000) sampling was conducted between 1900 and 0700 hrs, historically the period of the highest ichthyoplankton abundance in the vicinity of the Lovett intake.

Sampling was conducted using a standard net/barrel, pumped ichthyoplankton sampling system. Water was pumped at 1.1 m<sup>3</sup>/min (300 gal/min), with the volume sampled monitored with inline flow meters. Water was filtered with a 505 µm mesh nylon plankton net, washed into a sample jar and preserved. In the lab, all fish eggs and larvae were separated from other materials, identified on morphometric and meristic characteristics and enumerated. Counts of eggs and larval in each sample were used to determine the total number of organisms collected in each sample. Effectiveness was calculated based on a ratio of total organisms inside (Unit 3) the Gunderboom fabric compared to total organisms outside (Unit 4) the Gunderboom fabric at the same sample volumes. Total numbers of organisms was used because the paired samples were collected over the same duration and at the same flow rate.

Variability in the annual ichthyoplankton monitoring results was influenced by the deployment schedule and specific events, as described in the previous section that occurred during each deployment. The ichthyoplankton results often tracked specific events or problems identified during each deployment. The results of the ichthyoplankton monitoring program were used to identify problem areas and ultimately improve the performance of the MLES™. The specific results of the ichthyoplankton monitoring program for each year are described below.

In 1995 a total of 5589 fish eggs and larvae were collected in 162 samples, with 725 (13.0%) collected at Unit 3 (inside MLES™ location) and 4864 fish eggs and larvae (87.0%) collected at Unit 4 (outside MLES™ location) (Figure 4). Bay anchovy were the dominant species collected, with a total of 3777 individuals representing 67.6% of the total. Of the 3777 bay anchovy identified in the samples, 536 individuals (14.2% of the total) were collected within the MLES™ and 3241 individuals (85.8% of the total) were collected outside the MLES™. Over the entire Gunderboom effectiveness monitoring period, inside ichthyoplankton concentrations (Unit 3 intake) compared to outside MLES™ ichthyoplankton concentrations (Unit 4 intake) indicated that the MLES™ was approximately 84% effective at limiting the passage of ichthyoplankton, even with surface water spillage during most of the evaluation period.

During ichthyoplankton monitoring in 1998, a total number of fish eggs and larvae collected at the Unit 3 intake was 2645, while ichthyoplankton numbers were 3698 at the Unit 4 intake. Bay anchovy again dominated (68%) catches ranged from 5-2000. Prior to loss of the bottom seal, the MLEST™ was 76% effective at reducing ichthyoplankton from entering the facility. The bottom seal loss resulted in 29% overall deployment period effectiveness. This experience resulted in the development of a heavy rubberized bottom skirt to maintain bottom seal integrity.

In 2000, a total of 40,404 individual fish eggs and larvae were collected, 8438 at the Unit 3 intake and 31,966 were collected at the Unit 4 intake (Figure 4). Striped bass dominated the catch (73.6%). Ichthyoplankton monitoring during the 2000 deployment showed that MLEST™ reduced the percentage of fish larvae (82%), yolk-sac larvae (87%) and post yolk-sac larvae (79%) (ASA 2000). The overall effectiveness of the MLEST™ was approximately 80% during the 2000 deployment.

### **Impingement Studies**

Studies were conducted using hatchery fish eggs and larvae to determine egg viability to impingement on the Gunderboom fabric and to determine impingement avoidance by larval fish. To determine egg viability, American shad (*Alosa sapidissima*) eggs were added to McDonald Jars (Photo 3) fitted with Gunderboom fabric. One hundred American shad eggs were introduced to the McDonald jars. Water was drawn through the fabric at 5 gpm/ft<sup>2</sup> of fabric for from one to four hours. Eggs were also exposed to the 5 gpm/ft<sup>2</sup> in “control” jars without Gunderboom fabric. At the completion of the test period, the fabric was removed from the test tank and the impinged eggs held for latent mortality observation for up to 24-hrs. At the completion of the 24-hr period the eggs were removed from the McDonald Jars, placed in Petri dishes under a microscope and checked for viability.

Eggs did not adhere to the Gunderboom fabric during the test period. The viability testing of the eggs identified that 1-2% mortality occurred, but this mortality was observed in the control jars and test jars suggesting that mortality was linked to causes unrelated to the fabric.

American shad larvae were used in raceway swimming studies to determine if larvae can avoid being impinged on the fabric at the through-fabric velocities (0.02 ft/sec) required at Lovett (Photo 4); and if fabric impingement occurred was there any resultant impact on viability. Gunderboom fabric was placed at the downstream end of a raceway so that all water exiting the raceway passed through the fabric at a flow rate of 5 gpm/ft<sup>2</sup> of fabric (Photo). Larvae were introduced to the raceway and observed. Overall it was noted that the 5 gpm/ft<sup>2</sup> flow rate was low enough that the larvae did not orient toward flow or impinge on the fabric, and there was no evidence of impingement stress. The results of these impingement studies identified that the 5 gpm/ft<sup>2</sup> of fabric flow rate targeted for Lovett did not affect American shad eggs or larvae because the through fabric flow rate was extremely low.

### **Conclusion**

The development of the MLEST™ required understanding site-specific characteristics at Lovett, the cooling water source, and the life-history of the target species. The MLEST™ development program resulted in a technology that was determined to be BTA for Lovett by the NYSDEC. The MLEST™ deployed at Lovett has been shown to be at least 80% effective at limiting the entrainment of ichthyoplankton. Although, this level of protection was periodically compromised, extensive improvements made since 1995 have advanced the effectiveness of the MLEST™ system. The improvements made to the MLEST™ include; increasing the flow through capacity of the fabric, strengthening the design, integrating an automated cleaning system, and designing an anchor system that can maintain the MLEST™ in the high currents of the Hudson River. These improvements have increased the longevity and durability of the MLEST™. The MLEST™ has also been proven to have minimal environmental or visual impact compared to other alternative technologies. These factors coupled with the high level of biological protection provided by the MLEST™ support this technology as BTA for the Lovett Generating Station.

The MLEST™ was recently specified as BTA at two proposed new power-generating facilities on the Hudson River. These new closed-loop cooling system facilities will require relatively low flow rates 13 to 18 cfs (6,000-8,000 gpm)

by incorporating hybrid wet cooling tower technology. The hybrid wet cooling tower technology in combination with the MLES™ is expected to achieve the equivalent of dry cooling tower impacts on aquatic life.

**Table 1.** Gunderboom® MLES™ development summary.

Year	Primary Testing	Significant Results or Accomplishments
1995	Gunderboom® System Concept	Ichthyoplankton monitoring identified that system was effective as skimmer weir to reduce ichthyoplankton entering the intake water. Improvements were required to remove sediment build-up and to replace the Danforth type anchors.
1996	Manual AirBurst™ cleaning system test	Successful test of 2-layered fabric system and positive initial results of the manually operated AirBurst™ system. Spud-type anchor system was not sufficient for this particular application
1997	Dead Weight Anchoring System	The dead weight anchors successfully maintained the Gunderboom position and the manual AirBurst™ provided promising results but was labor intensive.
1998	Automated AirBurst™	Small-scale system tests successful when the AirBurst™ was serviced by routine maintenance.
1999	Automatic AirBurst™ for extended periods, Design enhancements for longevity	Automated AirBurst™ allowed the system to operate for extended periods. Inner and outer skirts of rubberized material were added to the MLES™ base to help maintain the seal.
2000	Improve field maintenance procedures, improve mooring hardware and test new zipper connections	Additional design enhancements including, reuse of the 1999 MLES™, mooring point attachment hardware redesign, in-field repair and modification system, zipper connection successful to allow MLES™ to be fabricated, replaced in sections.

**Table 2.** Ichthyoplankton monitoring sampling characteristics.

Year	Sample Period	Sample Times	Sample Frequency	Duration (min.)	Average Volume
1995	25 June – 29 July	24 Hrs	Every 4 Hrs	30	34.07 m <sup>3</sup>
1998	11 June – 31 Aug	1900-0700	5 Per Date	20	23.2 m <sup>3</sup>
2000	11 May – 25 Aug	1900-0700	5 Per Date	20	21.87 m <sup>3</sup>

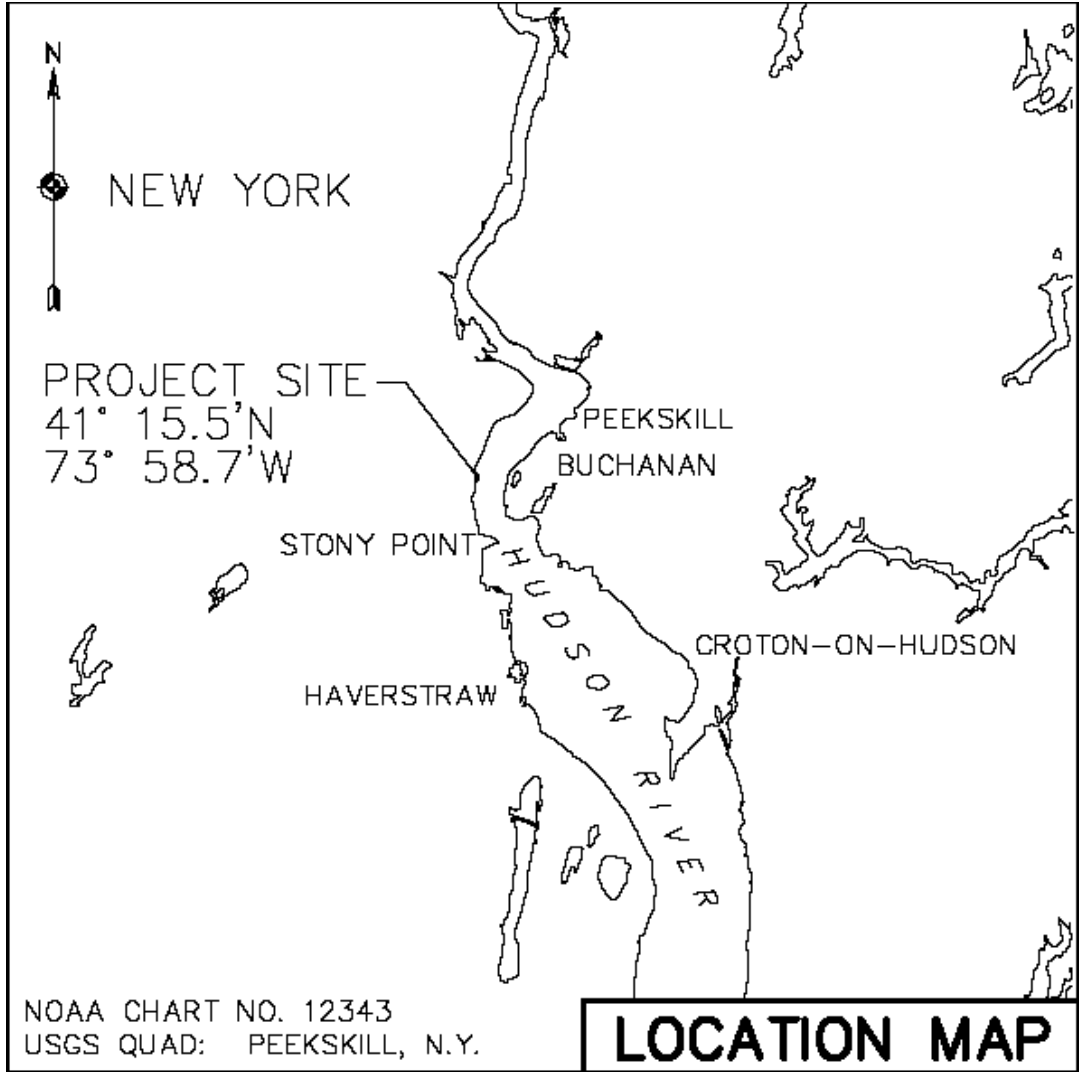


Figure 1. Location of the Lovett Generating Station

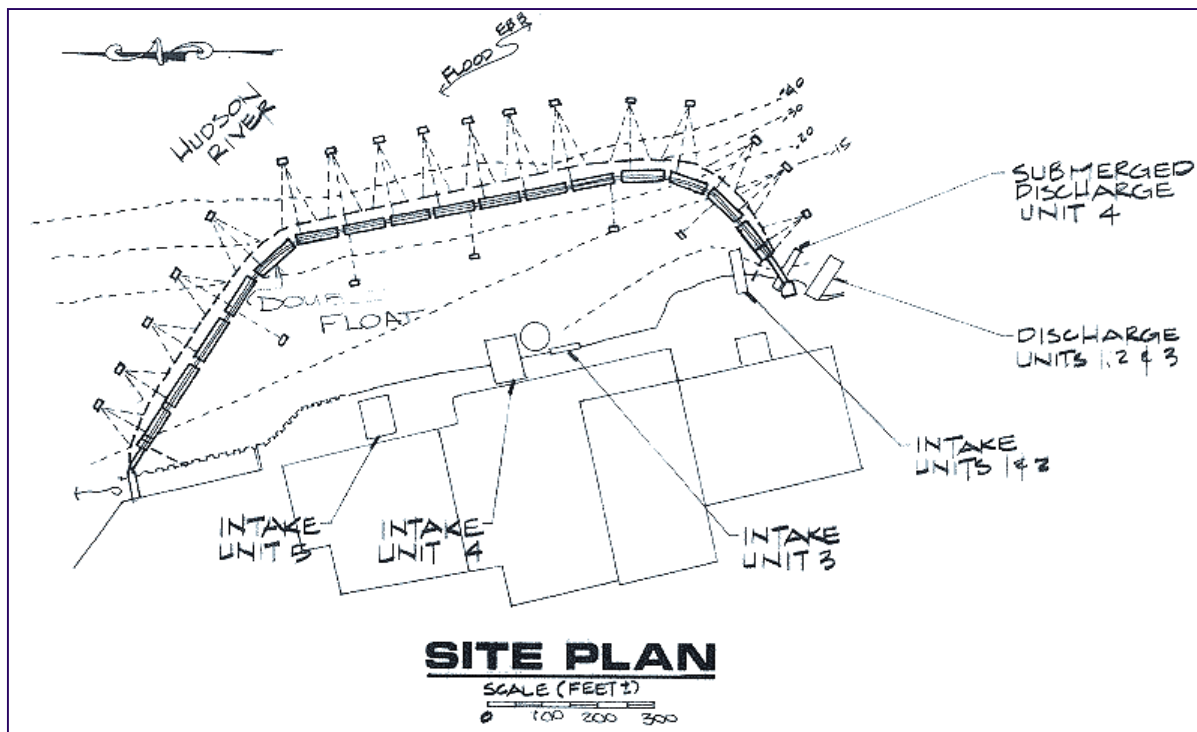


Figure 2. Lovett site plan

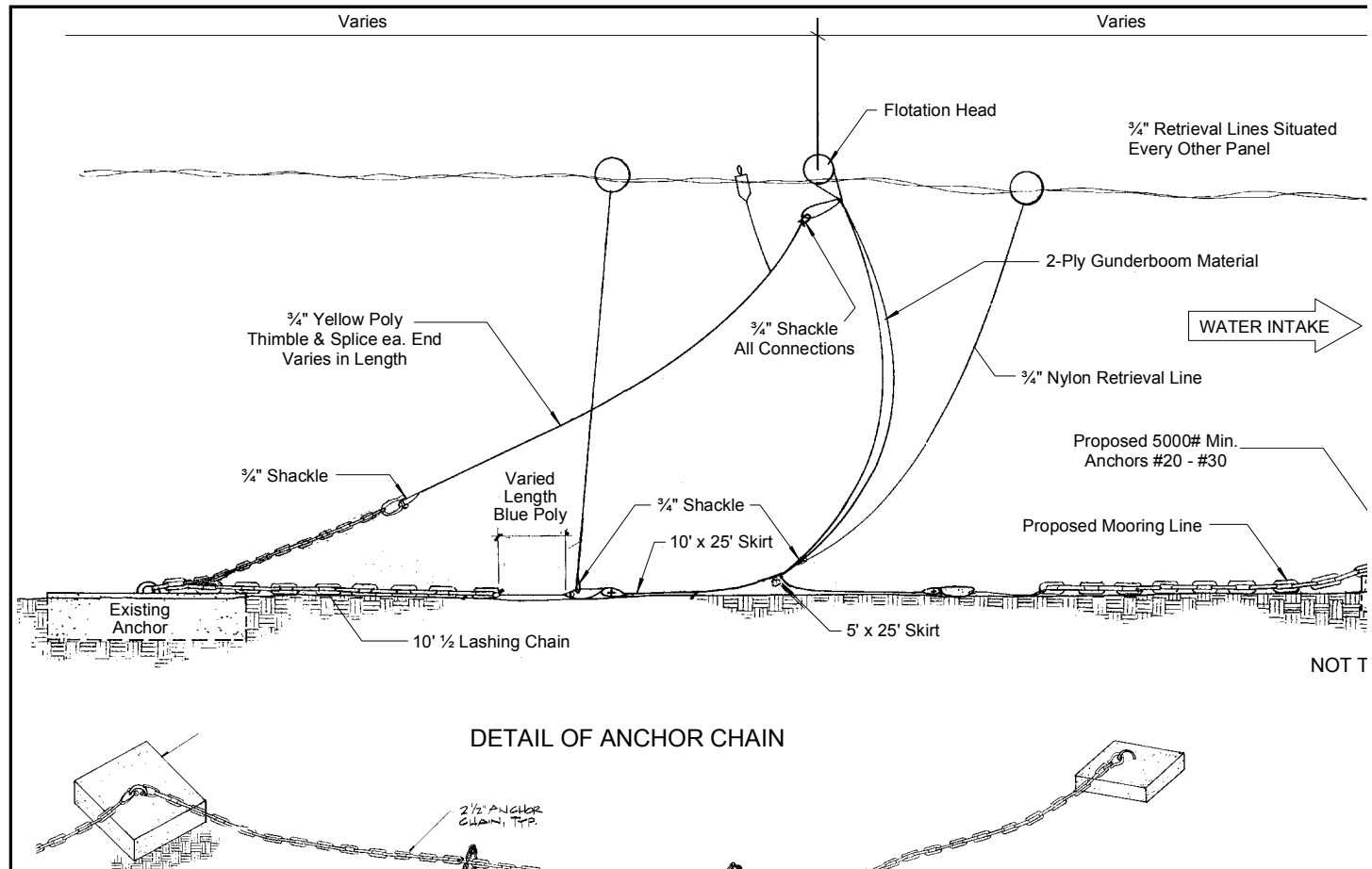
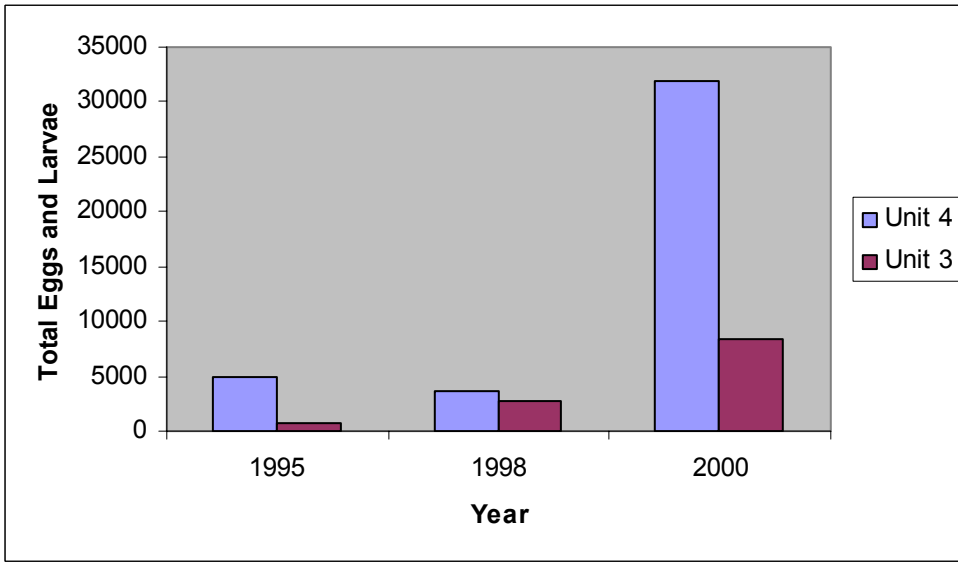


Figure 3. Three-dimensional depiction of the Gunderboom® MLES™





**Figure 4.** Total number of fish eggs and larvae collected outside (Unit 4) and inside (Unit 3) the MLES™ during annual ichthyoplankton monitoring.





**Photo 2.** Lovett 1998 Gunderboom<sup>®</sup> MLES<sup>™</sup> Deployment with AirBurst<sup>™</sup> Technology at the Lovett Generating Station, Tomkins Cove, NY.



**Photo 3.** McDonald jars used to test if American shad eggs are affected by being impinged on Gunderboom fabric.



**Photo 4.** Raceways used in swimming studies.

### References

Applied Sciences Associates, 1998. Ichthyoplankton Monitoring Study, Development of a Gunderboom system at Lovett Generating Station Unit 3. Prepared for Orange and Rockland Utilities, 17pp.

Applied Sciences Associates, 2000. Ichthyoplankton Monitoring Study, Development of a Gunderboom system at Lovett Generating Station Unit 3. Prepared for Mirant New York, Inc., 18pp.

Couch White, LLP (CW), 2001. Initial Brief of Mirant Bowline L.L.C. on SPDES Permit and Land Uses. Case 99-F-164, DEC No. 3-3922-0003/00015, SPDES No. 0264342.

EA, 1997. 1997 Ichthyoplankton entrainment monitoring study at Lovett Generating Station. Prepared for Orange and Rockland Utilities, Inc., 30 pp.

Lawler Matusky & Skelly Engineers, LLP, 1996. Lovett Generating Station, Gunderboom System Deployment Program, 1995. Prepared for Orange and Rockland Utilities, Inc., 20 pp.

Lawler Matusky & Skelly Engineers, LLP, 1997. Lovett Generating Station, Gunderboom System Evaluation Program, 1996. Prepared for Orange and Rockland Utilities, Inc. 20 pp.

Lawler Matusky & Skelly Engineers, LLP, 1998. Lovett Generating Station, Gunderboom System Evaluation Program, 1998. Prepared for Orange and Rockland Utilities, Inc., 22 pp.

Lawler Matusky & Skelly Engineers, LLP, 1999. Lovett Generating Station, Gunderboom System Evaluation Program, 2000. Prepared for Orange and Rockland Utilities, Inc., 32 pp.

Lawler Matusky & Skelly Engineers, LLP, 2000. Lovett Generating Station, Gunderboom System Deployment Program, 2001. Prepared for Mirant New York, Inc., 37pp.

### *Vulnerability of Biofouling of Filter Curtain Materials Used for Entrainment Reduction*

*Peter Henderson, Pisces Conservation Ltd. and University of Oxford and Richard Seaby, Pisces Conservation, Ltd.*

#### **BIOSKETCHES**

Dr. Peter Henderson is a director of Pisces Conservation Ltd and a Senior Research Associate of the Department of Zoology University of Oxford, England. Dr Henderson obtained both bachelors and doctoral degrees from Imperial College, London. He has worked for more than 25 years in ecological research, and lectures on population ecology and ecological methods at Oxford. He co-authored with Sir Richard Southwood the third edition of the textbook 'Ecological Methods', and subsequently recently wrote "Practical Methods in Ecology". His taxonomic specialty is freshwater ostracoda and he wrote the Linnean Society Synopsis of British species. He is a specialist in population dynamics and tropical and temperate crustacean and fish ecology and has worked extensively on the conservation of wetlands in Amazonia. He worked for many years with late Prof. W. D. Hamilton on the theory of evolution. Since first starting post-doctoral studies he has worked on the ecological effects of power stations and has been studying the fish and crustacean population dynamics in the Bristol Channel since 1980 using samples of animals impinged on cooling water intake screens.

Dr Richard Seaby is a director of Pisces Conservation Ltd. Dr Seaby obtained his bachelors degree from the University of London. His doctoral degree was from Liverpool University. He has worked for 10 years as an ecological consultant specializing in the aquatic environment. He has worked on impingement and entrainment issues in many different situations and has been involved in a long-term study into the population of fish and invertebrates in the Bristol Channel since graduation. He specializes the aquatic environmental impact of industrial and construction projects.

#### **TECHNICAL PAPER**

##### **Abstract**

The need to reduce the passage of planktonic aquatic life, particularly fish eggs and larvae, through the condenser cooling water circuits of direct-cooled power plants is widely acknowledged. While this could be achieved by the conversion to closed-cycle cooling it has been suggested that a more cost-effective approach would be to protect the intakes with fine-mesh filter curtains that would stop the entry of plankton. For a number of years a filter system designed by Gunderboom Inc. has been experimentally deployed at the Lovett Generating Station in the Hudson Estuary. A potential weakness with such filters is their vulnerability to biofouling, which would reduce permeability and damage the fabric. Tests for biofouling of the Gunderboom filter material were undertaken in Bowline Pond in the Hudson Estuary in summer 2001. These tests showed that the Gunderboom material was capable of becoming rapidly colonized by a community of bacteria, plants and animals. This fouling community developed steadily over a 30-day study period and would almost certainly have continued to develop further if the observations had been continued. Of particular significance was the colonisation and blockage of the 1 mm pores in the material by tube building crustaceans. A panel through which water was pumped and which was cleared of silt by airburst cleaning fouled more quickly than panels in static water without airburst cleaning. There was a highly significant reduction in permeability linked to biofouling, and a reduction of almost 97% was observed in the panel exposed to flowing water with air-burst cleaning. These simple observations show the potential vulnerability of fabric filter systems to fouling and indicate the need for testing in the vicinity of an intake before they can be considered as a viable technology for the reduction of entrainment.

##### **Introduction**

For a number of years, trials of a Gunderboom aquatic filter curtain system to stop planktonic organisms, particularly the eggs and larvae of fish, from entering the cooling water circuit of a direct-cooled power station, have been undertaken in the Hudson Estuary at the Lovett Generating Station (LMS 2000). A Gunderboom filter is a water-permeable filter made from two-layers of a perforated geotextile which is placed in front of a cooling water intake to exclude entrainment of planktonic organisms. Permeability was related to flows both through the body of the fabric and via the 1 mm holes. The Gunderboom Marine Life Exclusion System (Gunderboom MLES) is manufactured by Gunderboom Inc., Anchorage, AK. Following this initial development program Gunderboom Inc. are now

constructing a full-size filter curtain for the Lovett Generating Station situated in the Hudson Estuary, NY, and the use of filter curtains is under active consideration for a number of other power plants. For direct-cooled power plants these curtains are made from a geotextile matting that is hung from a large boom placed in the river in front of the cooling water intakes, and when correctly placed, stop planktonic animals from entering the cooling water circuit. For the smaller volume cooling water intakes at plant with closed cycle cooling, fixed panels of filter material are proposed.

A problem for the engineer is to maintain water permeability across the curtain given suspended sediments and biofouling. There are a number of potential problems linked to the biofouling of the fabric. The primary effect of fouling of the surface is a reduction in the area through which water can flow. This might lead to velocity 'hot spots' where delicate animals may be pinned onto the mesh. To reduce fouling, the Gunderboom MLES system includes an air-burst cleaning system. Interestingly, past experience has not found biofouling to be an appreciable problem for the Gunderboom MLES at Lovett (LMS 2000). However, there was some evidence of fouling by macro-algae, and the airburst system was not effective at removing algal growth from the boom (LMS 1998). But algal fouling was limited to the near surface photic zone.

A second effect of increased flow resistance is the tendency of water to force another path across or around the barrier. There are three alternative pathways available to the water.

- (i) The water may tunnel under the bottom/sides of the boom by displacing the sand or mud sediments;
- (ii) The boom may be pulled underwater, resulting in flow over the boom (overtopping);
- (iii) The material may rip, resulting in a flow via holes.

Overtopping, tunnelling and rips have been observed during testing. However, the diver surveys at Lovett in 2000 indicated that a good seal was maintained. The problem of water not flowing through the barrier is termed mesh avoidance.

A third major class of potential problem relates to the establishment of a predatory community feeding on any small animals drawn close to or onto the mesh. Many sessile fouling animals are filter feeders and will feed on any organic matter that they can catch. Within the fouling community, active mobile macroinvertebrate predators may also colonise. If water movement does not quickly carry away plankton from the surface of the material, planktonic animals may concentrate in front of the boom. This may then become a favoured hunting zone for their predators. Fish are frequently attracted to such structures, and it is possible to envisage a situation where they patrol along the boom picking off larval and juvenile organisms.

Only a short period in the spring and summer of 2001 was available for the biofouling studies reported here, and it was not possible to follow the full development of the fouling community. Experience at Lovett suggested that fouling was not a problem, but our experience in other waters suggested that this might not be transferable to other waters, or even other localities within the Hudson. Given the proposal to deploy a Gunderboom MLES at the Bowline 3 Generating Station, Riverkeeper Inc. asked for testing of the vulnerability of the proposed filter within Bowline Pond. It is the results of this test that are reported here.

A working Gunderboom MLES is designed with an air-burst cleaning system to remove dead, principally inorganic, sediment from the mesh. It can also be anticipated to affect the development of the biofouling community. For this investigation, the main series of fouling tests were carried out on static panels of Gunderboom material through which no water was pulled and which were not subject to air-burst cleaning. Static tests were undertaken because of logistical difficulties in testing working filter material. However, it is likely that static tests will give an indication of the vulnerability to fouling, as the Gunderboom is designed to work at low across-mesh velocities, and many fouling organisms once attached are very difficult to dislodge and are unlikely to be removed by air-burst cleaning. To ensure the relevance of the results, Gunderboom Inc. ran contemporaneously at the same locality a biofouling test rig which

used flow and air-burst cleaning (the FTA or Flow Test Apparatus). If this test material produced similar results to those obtained with the static pest panels, it would increase confidence that the fouling and permeability changes observed would be likely in an installed Gunderboom MLES.

## **Methods**

All biofouling tests were undertaken in Bowline Pond, a sheltered inlet on Haverstraw Bay, Hudson Estuary, NY. The Bay is weakly tidal with a maximum range of about 4 feet. Water temperatures vary seasonally from a minimum of about 32° F in winter to a maximum of about 80° F in July or August. Salinity in Haverstraw Bay typically ranges from 0.1 to 10 ppt. Oxygen levels are generally good with average dissolved oxygen concentrations of 6 to 8 mg/l in Haverstraw Bay. The field study was undertaken over a 29-day period from June 21<sup>st</sup> 2001, with biofouling examined on July 2<sup>nd</sup>, July 11<sup>th</sup> and July 20<sup>th</sup>.

### Construction and deployment of test equipment

The test material was standard Gunderboom MLES fabric drilled with 1-mm diameter pores to increase permeability as proposed for the Lovett trials. The pores were at approximately 4mm intervals, in rows 3-4mm apart, giving approximately 12 perforations per cm<sup>2</sup> of fabric, or 1280 per 5 inch by 4 inch exposed test section of material. The pieces of Gunderboom fabric, 6 inches by 5 inches, were fixed to stainless steel plates with a 5" by 4" hole cut in the centre. Spacers and bolts were used to attach the plates together in pairs to mimic the two-layer structure of a working Gunderboom. A neoprene sleeve was attached between the plates to prevent light penetration, which might increase the fouling on the inner surface. Six ropes were hung from the oil boom in front of the power station intakes in Bowline Pond. Three plates were positioned, vertically, on each rope at 3, 9 and 15 feet from the surface. The plates were attached to the ropes using cable ties, with an additional length of cord both as a precautionary measure in case of failure of the ties, and to ensure that the plates hung straight in the water. Three of the six ropes also had single control plates attached at each depth. The control panels were made of a coarse nylon mat commonly used for fouling studies and known to foul readily.

Plates were removed at 11, 20 and 29 days (2<sup>nd</sup>, 11<sup>th</sup> and 20<sup>th</sup> July 2001). On each occasion, two ropes were removed, containing a total of 6 Gunderboom plates (2 from each depth) and 3 control plates (1 from each depth). The plates were lifted gently to the surface of the water. Each plate was tied to the boat and the lower cable ties removed. While still in the water, a bag was dipped under the plate and both were lifted out of the water. The ropes were removed and the plates were double bagged and placed in a waterproof box. This procedure was adopted to minimise the disturbance of the sediment and animals on the Gunderboom.

### Analysis of test material

The sections of Gunderboom material were removed from the steel plates in the laboratory as each one was used for the analysis. One sheet was used for the permeability testing and biofouling inspections. The other sheet was halved and a 1cm<sup>2</sup> piece taken from the centre of each half sheet for use in the microbiology analyses. The rest of the sheet was preserved in formaldehyde to be investigated under an electron microscope in the UK.

Water from the plastic bags in which the plates had travelled to the lab was drained through a fine-meshed net and retained.

## **Permeability**

The permeability was measured using a piece of equipment designed based on the ISO 11058:1999 for testing geotextiles. A constant head apparatus was used, in which the head differential across the fabric is adjustable. Head loss was measured in mm using two transparent tubes, one from each side of the fabric, placed over a graduated scale. To allow for any head loss through the side of the fabric, the adjustable side of the apparatus was set so that no water flowed into the collection vessel. Ideally, with no flow there should be no head loss. In practice the head loss with no flow across clean fabric was 2 mm, and with fabric exposed for 29 days the head loss never exceeded 1 mm. Adjustments were made to the head to allow for this head loss. For example, to run the clean Gunderboom at a head differential of 10 mm required the apparatus to have a measured head of 12 mm.

Six sets of plates were used in total, each set consisting of three individual pieces of Gunderboom fabric, one from 3, 9 and 15 feet. Two sets of plates were removed on each visit.

In order to prevent drying out and gas bubble problems the fabric was kept in water at all times. Water temperatures used ranged from 20 to 21.9°C, with dissolved oxygen never getting above 7.75mg/l.

The panel was divided into 6 parts of similar area, two of which were randomly chosen for testing. The plates were placed on the permeability rig with the exposed outer surface of the fabric towards the flow, to reproduce conditions on the front surface in a working boom. This was assumed to be the best procedure, as most of the fouling was anticipated on the outer (river) surface of a working boom. Starting with the smallest head and working to the largest the permeability was measured twice with head differentials of 10, 20, 25 and 35 mm. For each determination the water passing across the fabric was collected in a measuring cylinder for 60 seconds. Control samples to measure the flow rates through clean, unexposed, Gunderboom were taken at regular intervals during each period of measurement.

The flow velocity across the test panel at 20 °C was calculated using the equation

$$f_{20} = \frac{VR}{At}$$

where :

- V was the measured water volume passing across the fabric (m<sup>3</sup>),
- R is a correction factor to a water temperature of 20 °C (not applied in this case as the temperature was always in the range 20-21 °C),
- A is the exposed specimen area (m<sup>2</sup>) and
- t is the time measured to achieve the volume V.

For each test panel the flow velocity was calculated for a head loss of 10, 20, 25 and 35 mm. The flow velocity for a head loss of 25 mm for each panel was then estimated by plotting the flow velocity against the head, fitting a line by linear regression and then obtaining the predicted value for a head of 25mm.

### **Biofouling inspections**

Different observations were made for each of the types of fouling that was discovered on the fabric. To estimate the number of holes blocked by tube-building amphipods, the number of holes blocked in 10 randomly picked rows of 25 holes were counted. In order to avoid edge effect errors where the Gunderboom had been in contact with the steel plate, only the area of the panels inside of the panel attachment points was used.

Descriptions of the general fouling community were made following a visual search of both sides of the panels at x 12 magnification. Both sides of the fabric were recorded and photographs taken. An estimate of the total proportion of the panel surface covered by fouling organisms was made.

The number of attached mussels on each side of the fabric was recorded. The water in the bags holding the panels was drained via a net and any animals present retained for examination.

### **Electron microscopy**

For subsequent electron microscope examination, the test fabric was fixed in 10% formaldehyde solution then placed in a sealed bag. These were then double bagged and placed in an airtight container and stored in 4% buffered formaldehyde. The fabric samples used for permeability testing and all other exposed panels were preserved.

Selected pieces of fabric were examined under a scanning electron microscope at the Southampton Oceanographic Centre on 26/7/01 using a Leo 1450 VP scanning electron microscope. A piece of fabric, approximately 1 cm<sup>2</sup>, was taken from the centre of one mid-water (9 feet deep) panel on days 11, 20 and 29. From the day 29 experiment

additional samples were taken from the top and bottom panels. A small number of additional samples were prepared to investigate unidentified objects of interest on the surface.

The samples were dehydrated, and splatter coated with gold for four minutes. Each piece of fabric was photographed under x450 magnification to give a general record of the amount of encrusted fouling present. Interesting observations were photographed under varying magnifications, particularly as aids to identification of the fouling present.

### **Microbiology**

Bacteria, general fungi and yeast levels in the mat were monitored using 'Easicult Combi' dip-slides; slides coated with multi-nutrient agar selective for bacteria on one side, and rose bengal agar the other side, selecting for yeasts and other fungi.

Two 1cm<sup>2</sup> pieces of Gunderboom fabric were removed from the centre of the panel to avoid any edge effects. One 1cm<sup>2</sup> piece was placed in a tube with 15ml of sterile water and shaken vigorously for 5 minutes. Any water then left in the square of fabric was drained into the tube and removed. A clean dip-slide was then placed into the water for 7 seconds, removed, drained and incubated at 25°C. The second 1cm<sup>2</sup> sample was treated in a similar way, but underwent a serial dilution to ensure the organism density was in the range of measurement of the dip-slide. The dip-slides were checked regularly for bacterial and fungal growth. Final readings were taken at 48 hrs for bacterial levels and 84 hrs for fungal and yeast levels.

Previous experiments had shown that a 1cm<sup>2</sup> block of Gunderboom holds an average of 0.295ml of water. Therefore, control dip-slide experiments were run, consisting of 0.295ml of river water diluted into 15ml of sterile water. These control dip-slides never showed more than two colonies, indicating that bacterial levels in the water were far lower than 10<sup>3</sup> bacterial cells per ml. This demonstrates that microbes extracted from the Gunderboom were not predominately from the river water held within the fabric, but were from bacteria attached to and living within the Gunderboom fabric.

Water remaining from the undiluted dip-slide tests was used for a live bacterial count using a haemocytometer. The number of rod-shaped bacteria was recorded for two slides with 15 squares counted per slide. The squares were selected using a random walk method, using a random number chart.

A staining method to count bacteria was also used. 0.1ml of water remaining from the undiluted dip-slide tests was placed onto a sterile microscope slide and allowed to air dry. Slides were fixed by passing through a Bunsen flame a few times, smear side up. The slide was flooded with 0.1% methyl blue and left to stain for 3-5 minutes. The stain was washed off and the slide was blotted dry using clean paper. The slides were examined under the microscope and a count of bacteria was made using an eyepiece graticule. For each slide, six fields of view were selected randomly and the same 5 squares were counted within each field of view. If the randomly selected field of view was at the edge of the drop, another field of view was randomly chosen to avoid any edge effect of the drop.

## **Results**

### Permeability

#### **Panels not exposed to flow or air-burst cleaning**

Analysis of Variance (ANOVA) showed that there was no significant difference in the flow across panels submerged at different depths. It was therefore possible to combine observations from all the individual test panels when analysing the change in permeability through time. Table 1 gives the flow rate in millimetres per second across all the tested panels. There was a large, statistically significant, decline in mean permeability through time. The rate of change of permeability was not constant and almost no change was observed between clean Gunderboom and that exposed for 11 days. Between 11 and 20 days exposure a reduction of almost 50% in flow was observed. Subsequently, the rate of decline was reduced.



**Table 1**

Flow velocity of Gunderboom material after different periods of submersion. The flow is given in mm/s at a standard head differential of 25 mm.

Replicate	Exposure time			
	Clean (0 days)	11 days	20 days	29 days
1	26.08	21.09	7.22	7.21
2	21.79	24.67	12.99	11.88
3	25.29	24.61	14.59	14.60
4	19.53	18.86	16.52	15.57
5	17.78	19.52	9.68	9.83
6	20.32	25.03	11.68	5.23
7	27.14	26.72	10.13	6.24
8	17.67	25.69	11.40	4.38
9		18.76	13.58	4.08
10		22.04	7.05	5.52
11		16.05	9.38	6.93
12		18.49	9.11	8.73
<b>Mean</b>	<b>21.95</b>	<b>21.79</b>	<b>11.11</b>	<b>8.35</b>
<b>SD</b>	<b>3.77</b>	<b>3.48</b>	<b>2.91</b>	<b>3.88</b>

**Panels with flow and air-burst cleaning**

Table 2 gives the measured flow at a standard 25 mm head difference across the test panels after 29 days of exposure. The front panel had an average flow of 0.86 mm/s, only 3.9 % of the flow through a clean panel. The back panel, which is not directly in contact with the river, had an average flow of 3.27 mm/s, 14.9 % of the flow through a clean panel (See Table 1). Some areas of these panels were so highly fouled that no flow at all occurred with a 10 mm head difference.

**Table 2**

Flow velocity of Gunderboom material exposed in the test rig (Flow Test Apparatus) where water was pumped through the material and air-blast cleaning was applied to simulate normal operating conditions. The flow is given in mm/s at a standard head differential of 25 mm. Results are given for both the front and back panels.

Replicate	Front	Back
1	0.26	2.86
2	0.67	2.34
3	0.57	2.56
4	0.29	3.48
5	2.01	4.20
6	1.35	4.20
<b>Mean</b>	<b>0.86</b>	<b>3.27</b>
<b>SD</b>	<b>0.69</b>	<b>0.81</b>

The development of the fouling community

The fouling community gradually developed over the 29 days of the study and there was a steady increase in macro-fouling on the surface and at a smaller scale in encrusted material on the fabric fibres. Plants were mostly filamentous algae and diatoms. Single-celled animals observed on the surface included mobile ciliates and attached forms such as *Vorticella*. Dominant multi-cellular animals within the community included bryozoans, hydroids, copepods, ostracods, *Corophium* species, *Gammarus* species, mussels and chironomids.

By day 11 the fabric had been colonised by *Corophium* and *Gammarus* spp. with about 5% of the surface showing evidence of colonisation. Tube-building *Corophium* spp had colonised the 1 mm holes in the fabric. Many holes were completely filled. Smaller *Corophium* used part of a hole as a base for building a tube.

By day 20 the fabric had started to be colonised by several additional organisms including mussels (probably zebra mussel *Dreissena polymorpha*), chironomids and small amounts of filamentous algae. Approximately 30% of the fabric surface showed evidence of colonisation. *Corophium* continued to colonise the 1mm holes and their tubes were also widely dispersed over the surface of the panels. These surface tubes were bound under the outer filaments of the fabric and the surface of the fabric was becoming looser. Some chironomid tubes were found. Copepods were observed moving across the surface of the fabric.

By day 29, obvious colonisation had increased to 70% of the available surface area. Many *Corophium* surface tubes were observed and most of the 1 mm holes in the fabric were occupied. Holes were now only occupied by large *Corophium*, which completely filled the holes with their tubes. A large number of chironomid tubes were present on the upper panels exposed at a depth of 3 feet. The community had increased in diversity to include several predatory organisms including ostracods and ciliates. Other groups included the vorticellids, hydroids and bryozoans.

### Number of holes blocked by *Corophium* tubes

The 1 mm holes through the fabric were used by the tube-building amphipod, *Corophium* sp. Table 3 gives a summary of the data and shows that the number of holes filled increases through time and that there was little difference in the percentage of blocked holes from panels exposed at 3, 9 and 15 feet. In the first sample, after 11 days, there were more tubes blocking holes in the lower panels than the top or middle panels. This might indicate that the initial colonisation was occurring from the bottom substrate. This difference had disappeared by the second and third samples. The average percentage of blocked holes for all panels, irrespective of depth ranged from 11% on day 11 to over 77% day 29 and increased greatly after day 20 (Table 3).

**Table 3**  
The percentage of blocked pores with depth after different exposure times

	Day 11	Day 20	Day 29
Top - 3 feet deep	9	30.2	86.4
Middle - 9 feet deep	9.2	25	72
Bottom - 15 feet deep	16.2	30	75.4

### The settlement of mussels

From day 20 onwards, young mussels (probably zebra mussels) were found attached to the fabric. The number of mussels was lowest near the surface. Table 4 shows the general increase in the number of attached mussels through time. The number increased rapidly between days 20 and 29. No significant difference in the number of mussels attaching to the Gunderboom and control fabrics was found.

**Table 4**  
Comparison of the average number of mussels found on a side of the Gunderboom and the fabric used on the control plates.

Days	0	11	20	29
Gunderboom fabric	0	0	2.83	11.92
Control fabric	0	0	2.67	11.67

### Microbial analysis

Four different methods were used to analyse the levels of bacteria in the Gunderboom material over time.

### Bacterial dip-slide results

After exposure for 11 days, the average abundance of bacteria extracted from the Gunderboom panels was  $7 \times 10^3$  bacterial cells per ml. This increased to  $2.2 \times 10^5$  cells per ml after 20 days and to  $2.02 \times 10^6$  cells after 29 days. While the bacterial dip-slide analysis showed an overall increase in bacterial numbers over the 29-day period, the bottom

panels showed a decrease from day 20 to day 29. The ANOVA performed on these data showed that this decrease was not significant (Depth  $F = 1.8$ ,  $p = 0.24$ ; Days  $F = 41.39$ ,  $P = 0.00021$ ,  $df = 2$ )

**Table 5**  
Number of bacterial cells indicated by the dip-slide method (cells/ml)

	Days of Exposure		
	11 Days	20 Days	29 Days
Top - 3 feet deep	10000	505000	5050000
Middle - 9 feet deep	5500	55000	1000000
Bottom - 15 feet deep	5500	100000	10000
Mean	7000	220000	2020000

Throughout the experiment the top panels gave higher bacterial counts than the middle and bottom panels.

An ANOVA showed a significant change in the number of bacteria found on the Gunderboom through time ( $F = 41.39$ ,  $P = 0.00021$ ,  $df = 2$ )

### Fungal dip-slide results

There were very few fungal colonies cultured from the Gunderboom panels. After 11 days there was light fungal growth from one of the bottom panels and after 20 days, light fungal growth was observed from one of the top panels. After 29 days, no fungal growth was visible. No trends were observed.

### Live count results

Table 6 shows the results of the live counts of rod-shaped bacteria extracted from the Gunderboom panels.

**Table 6**  
Number of rod-shaped bacteria found by the live count method (cells/ml)

	Days of Exposure		
	11 days	20 days	29 days
Top - 3 feet deep	5633	5133	9000
Middle - 9 feet deep	4700	3483	9717
Bottom - 15 feet deep	4083	3150	11300
Mean	4806	3922	10006

An ANOVA showed that the exposure time had a significant effect on the number of bacteria found. The effect of depth was again found to be non-significant (Depth  $F = 0.233$ ,  $p = 0.799$ ; Days  $F = 52.7$ ,  $p = 0.0001$ )

### Stained slide results

The average number of bacteria observed on the slides is given in Table 7. An ANOVA showed that the exposure time had a significant effect on the number of bacteria and depth of the panel was not significant (Depth,  $F = 1.97$ ,  $p = 0.22$ ; Days  $F = 15.95$ ,  $p = 0.0029$ ).

**Table 7**  
Number of bacterial cells observed per  $\text{mm}^2$  of slide

	Days of Exposure		
	11 days	20 days	29 days
Top - 3 feet deep	16373	59467	65947
Middle - 9 feet deep	14560	16987	64800
Bottom - 15 feet deep	8480	18080	52731
<b>Mean</b>	<b>13138</b>	<b>31511</b>	<b>61159</b>

## Discussion

Any surface exposed to natural fresh or saline waters provides an opportunity for the settlement and subsequent growth of organisms. The succession of an attached fouling community usually follows the same general order. When a surface is first placed in water it is immediately coated with a film of proteins, polypeptides, polysaccharides and lipids produced by aquatic organisms or by their breakdown products. Bacteria are the first group to colonise this film. Species that have a pellicle (a protective membrane) and produce slime as part of their metabolic function are usually first (Characklis, 1981). Within six hours bacteria will have consolidated their presence, as they exude polymeric fibrils from within the film. This bacterial film can reach a maximum thickness in less than 14 days in nutrient-rich waters. An important feature of this bacterial film is that it can anchor sediment from the water column. It can eventually develop into mats and offer keying points on the surface where other organisms can attach.

Once the biofilm has become established a succession occurs in which the original colonisers are progressively replaced or supplemented by new species. This is a complex process that is dependent on the geographical location of the site, the time of year and the substrate involved. Hydroids, fungi, and single-celled organisms are the next to colonise. These groups change the microhabitat enough to allow the invasion of larger organisms.

Non-attached organisms utilise the habitat at all stages in the colonisation process. For example, even at 11 days *Corophium* had started to colonise the holes in the material, and use the filaments on the surface of the fabric to attach their tubes.

During the fouling experiments in Bowline Pond the water was turbid, with little light penetration, due to large amounts of phytoplankton in the water. General observations around the pond indicated the presence of many fouling organisms. Algae, bacterial slime and barnacles were observed under the buoys that held the boom around the intake structure.

Measurements reported here clearly demonstrate that the permeability of the Gunderboom fabric exposed to the environment in Bowline Pond progressively declined, and that this decline is linked to the growth of a biological community on the surface. For the panels not exposed to air-burst and flow, permeability had declined after 29 days to an average of only 38% of that observed in the clean material.

An important question arising from this result is whether or not the permeability and fouling would get even worse if the experiment had continued for longer. All the evidence suggests that it would. First, the panel exposed to flow and air-burst was considerably more heavily fouled, and given sufficient time the static panels might have developed to this level. By the end of the experiment the encrustation on the individual fibres was still increasing and it seems inevitable that all the 1 mm holes would eventually have been blocked by *Corophium* tubes. Permeability was determined both by flows through both the body of the fabric and via the 1 mm holes. By day 29, with many of the holes blocked, much of the flow was probably via the fabric. If the individual fibres were to become ever more fouled, as seems likely, then permeability may have declined much further.

In panels with flow it is possible that encrusting of the material fibres would occur at an even higher rate. Sediments and other particles drawn into the fabric would be included in the mat formed by the bacteria and fungi. The SEM of the encrusted fabric shows inorganic debris amongst the diatoms, bacteria and other fouling organisms.

When the study was first proposed it was hypothesised that the static test panels would exaggerate the level of fouling and loss of permeability that would occur in material exposed to designed levels of flow and air-burst cleaning. Instead, air-burst and flow actually enhanced the level of fouling and resulted in an extremely severe reduction in permeability so that the flow after 29 days was less than 4% of that found in the clean material. We do not know why flow and air-burst increased fouling. The most likely explanation is that, even with flow, boundary layer effects offer a static or low-flow region close to the surface in which the community could attach while the flow allowed the delivery of oxygenated water and possibly food and nutrients. In any flowing medium there is a narrow layer of fluid close to the surface that is almost static. The thickness of this boundary layer is proportional to the surface roughness

and offers a region in which micro-organisms can attach and grow, even when there is a very rapid and powerful flow nearby. However, there need not be a static region for the community to establish. Most algae, bacteria and grazers are capable of attaching to substrates in flowing water and require the flow to obtain oxygen and food.

Once fouling is established on a surface, it is almost impossible to remove micro-organisms from the surface by mechanical means. For this reason biocides such as chlorine or antifouling paints are used in most situations where fouling is a concern. A fouling community, as it grows, extends the boundary layer outwards so that in a narrow orifice it can eventually completely block the flow, even when exposed to high forces.

Our experiments did not continue for sufficient time to observe if mussel fouling would develop into an important problem. However, mussels were found on both the FTA panels and the static panels. Once mussels become established it is unlikely that any air cleaning system will be effective in removing them. Holmes (1970) found that for mussels of about 25 cm, a force of over 1500 gm was needed to break the byssus thread that secures the mussel to substrates and that the strength of the byssus thread varied with size. The fact that the young mussels were found on the FTA panel suggests that the byssus thread of a newly settled mussel was already strong enough to resist being dislodged. Mussel spat (the planktonic early life stage) can settle in very high numbers. Densities of  $1 \times 10^5$  spat per  $m^2$  are regularly observed in natural populations of both *Mytilus edulis* and *Dreissena polymorpha* (Jenner *et al.* 1998). Mussel growth can also be very rapid in ideal conditions. The development of a sizeable mussel colony would have a significant impact on a filter curtain and our observations suggest that, in both marine and freshwater environments where mussels are abundant, a filter curtain needs to be carefully tested before full-scale deployment is contemplated.

As the colonisation progressed, there was a gradual increase in active, potentially predatory organisms on the Gunderboom material such as the ostracod, *Cypridopsis vidua* and gammarids. Gammarids became highly abundant; they moved rapidly over the surface of the fabric, entering any unblocked holes and tucking themselves under loose fibres. Such animals are potential predators of fish eggs and larvae that are drawn onto the surface. Other potential predators of plankton include large protozoans. At day 29 even a small catfish was caught living on one panel. Evidence of crab activity was also noted on a few of the panels. It is probable that swimming crabs had been grazing on the surface of the test panels during deployment. Most mobile animals would have escaped during this operation. The observed trends in the numbers of some organisms leave little doubt that only the early stages of colonisation and biofouling were observed.

Bacteria increased throughout the study. SEM images showed that, although some filaments were well encrusted with bacteria there was still a lot of space for bacterial colonies to form. As the surface of the fabric become looser due to the actions of macro-fouling organisms, the interstitial spaces may well develop large bacterial colonies. In other biofouling studies it has been shown that the fouling community develops over a far longer period. Chalmer (1982) examined the succession of fouling organisms on asbestos plates in seawater in Western Australia showing that the number of organisms on the plates rapidly increased for at least 150 days and, in some cases, continued to increase after 270 days. In the Damariscotta River Estuary studies on asbestos plates showed that fouling increased over the whole year (Field 1982). The nature of the substrate is also very important. (Kerr *et al.* 1999) found that the microscopic structure of a surface affects the rate at which fouling occurs; surfaces that are rough at a very small scale fouled significantly faster. The surface chemistry can affect the initial rate of settlement (Roberts *et al.* 1991). The disruption of the surface of the textile is likely to increase the speed and level of fouling as the complexity of the surface increases (Dean 1981). Collins (1968) lists several factors found to influence the development of fouling communities, the most important being the season at which the material is exposed. Many species have particular breeding or settling periods; although some are capable of settling throughout the year. Underwood and Anderson (1994), working in Australia, found that panels exposed in January (mid summer) were colonised by oysters. If the panel was exposed in October (spring) the surface was colonised by barnacles or algae.

In conclusion, geotextile filter curtains can foul and this fouling may impair permeability resulting in a failure of the system to stop entrainment. Fouling is dependent on local conditions and it seems prudent to always test for fouling at the proposed site before any large-scale deployment is considered.

## References

- Chalmer, P. N. (1982). "Settlement Patterns of species in a marine fouling community and some mechanisms of succession." *J. Exp. Mar. Biol. Ecol.* **58**: 73-85.
- Collins, T. M. (1968). A discussion on marine fouling and behaviour of cooling water culverts. Report Central Electricity Research Laboratories, Leatherhead, England. No 15.
- Dean, D. A. (1981). "Structural aspects of sessile invertebrates as organizing forces in an estuarine fouling community." *J. Exp. Mar. Biol. Ecol.* **53**: 163-180.
- Field, B. (1982). "Structural analysis of fouling community development in the Damariscotta River Estuary, Maine." *J. Exp. Mar. Biol. Ecol.* **57**: 25-33.
- Holmes, N. J. (1970). Mussel fouling in power stations: The attachment system of mussels, Report Central Electricity Research Laboratories, Leatherhead, England. No 10.
- Jenner, H. A., Whitehouse, J. W., Taylor, C. J. L. and Khalanski, M. (1998). Cooling water management in European power stations. Biology and control of fouling. In *Hydroecologie Appliquee*, Tome 10, Volume 1-2, 1998. pp 15-62.
- Kerr, A. Beveridge C. M., Cowling, M. J., Hodgkiess, T., Parr, A.C.S. & Smith, M. J. (1999). "Some physical factors affecting the accumulation of biofouling." *J. Mar. Biol. Ass. UK* **79**: 357-359.
- LMS (1998). Lovett Generating Station: Gunderboom System Evaluation Program 1997. New York, Lawler, Matusky and Skelly Engineers, Pearl River NY: 24pp.
- LMS (2000). Lovett Generating Station: Gunderboom Evaluation Program (1999). Lawler, Matusky and Skelly Engineers, Pearl River NY: 28pp.
- Roberts, D. Rittscof, D., Holm, E., Shmidt, A. R. (1991). "Factors influencing initial settlement: temporal, spatial and surface molecular components." *J. Exp. Mar. Biol. Ecol.* **150**: 203-211.
- Underwood, A. J. and Anderson, M. J. (1994). "Seasonal and temporal aspects of recruitment and succession in an intertidal estuarine fouling assemblage." *J. mar. biol. Ass. U.K.* **74**, 563-584.

---

## *Laboratory Evaluation of Wedge Wire Screens for Protecting Fish at Cooling Water Intakes* *Stephen Amaral, Alden Research Laboratory, Inc.*

### BIOSKETCH

Dr. Steve Amaral is a Senior Fisheries Biologist with Alden Research Laboratory, Inc. Steve received his B.S. and M.S. degrees in Fisheries Biology from the University of Massachusetts. During the past 12 years, he has been heavily involved in the development and evaluation of fish passage and protection technologies for use at water intakes. Prior to joining Alden nine years ago, Dr. Amaral worked on fish passage projects for the Massachusetts Cooperative Fish and Wildlife Research Unit and Stone and Webster Engineering. Working with his colleagues at Alden, he has conducted numerous laboratory and field studies with many different technologies and fish species. Recent studies have included biological evaluations of a fish-friendly hydro turbine, wedgewire screens, angled bar racks and louvers, and behavioral deterrents.

## **TECHNICAL PAPER**

### **Abstract**

Cylindrical wedgewire screens are considered a technology that has potential for minimizing entrainment and impingement of aquatic organisms at cooling water intakes. To assess this potential, a laboratory evaluation of cylindrical screens was conducted to determine hydraulic and design criteria that contribute to effective protection of fish larvae and eggs. Entrainment and impingement rates associated with various slot sizes, through-slot velocities, and channel velocities were estimated for early lifestages of eight species of fish. In general, entrainment increased with slot size and through-slot velocity and decreased with channel velocity and larval length. Impingement also increased with through-slot velocity and decreased with channel velocity, but, unlike entrainment, decreased with slot size. Interrelationships existed among the various test parameters (e.g., the effects of through-slot velocity were not uniform for all slot sizes evaluated and response of larvae to varying hydraulic conditions was related to fish size and swimming ability). The results of this study demonstrate that cylindrical wedgewire screens are capable of reducing entrainment and impingement rates to low levels for most species and lifestages of fish. However, optimum design criteria will differ depending on biological factors and hydraulic conditions. Future studies, whether conducted in the laboratory or field, should focus on a narrower range of screen design and hydraulic parameters in order to better define the relationships between the various parameters and effective protection of fish larvae and eggs.

### **Introduction**

Section 316(b) of the Clean Water Act (CWA) requires that the location, design, construction, and capacity of a cooling water intake structure (CWIS) reflect the best technology available (BTA) for minimizing adverse environmental impacts (AEI). Adverse environmental impacts from CWISs may occur as the result of entrainment of small aquatic organisms into the cooling water system and the impingement of larger life stages on traveling water screens. Cylindrical wedgewire screens have been identified as a technology that is capable of effectively reducing entrainment and impingement of aquatic organisms at CWIS (EPRI 1999).

Cylindrical wedgewire screens have a "V" or wedge-shaped, cross-section wire welded to a framing system that forms a slotted screening element (Figure 1). Conditions that are considered important for preventing or reducing entrainment and impingement of aquatic organisms that encounter wedgewire screens include (EPRI 1999): (1) a sufficiently small slot size to physically block passage of the smallest lifestages to be protected; (2) low through-slot velocity to minimize the hydraulic zone of influence in which passive or weak swimming organisms can become entrained; and (3) an adequate sweeping flow (i.e., ambient current or channel velocity) passing across a screen to carry organisms and debris along and away from the screen. When all of these factors exist, it is expected that the biological effectiveness of wedgewire screens will be high. However, past studies have not provided the necessary information to develop specific design and hydraulic criteria for this type of screen to be assessed for potential effectiveness at a wide range of intake types and for many of the species and life stages that are currently targeted for protection.

Consequently, the primary goal of this study was to determine the relative importance of various screen design parameters and hydraulic conditions in minimizing entrainment and impingement of selected species and life stages. Using this information, it may be possible to identify specific criteria that will be required for effectively employing cylindrical wedgewire screens in the future (or for modifying existing installations). To achieve this goal, biological testing was conducted with three slot widths, two through-slot velocities, and three channel velocities. Additionally, eight species of fish that commonly occur at CWIS and that represented a range of life histories and swimming capabilities were selected for testing.

## Methods

### Test Facility

The biological evaluation of cylindrical wedgewire screens was conducted in a flume that is specifically designed for evaluating fish passage and protection technologies. The section of the flume where testing was performed has a maximum depth and width of 2.1 m and 3.0 m, respectively. Channel velocities up to 0.9 m/sec can be maintained at full depth. Flow is re-circulated through the flume by a bow thruster that is driven by an electric motor. The wedgewire screen test facility consisted of a fish larvae and egg release system, the wedgewire screens, an entrainment collection system, and a downstream collection system (Figure 2). The location of the wedgewire screens was about 11.4 m downstream of where water is returned to the flume from the bow thruster (Figure 2). At this location, there is a plexiglass window on one side of the flume that allows for visual observations to be recorded during testing.

We used T-12 cylindrical wedgewire screens (30.5-cm diameter) supplied by Johnson Screen for the evaluation of entrainment and impingement. The T-12 screens have two 31-cm long sections through which water is withdrawn. Three screens constructed with different slot sizes (0.5, 1.0, and 2.0 mm) were evaluated individually under different channel and screen flow conditions. All three screens had 1.5-mm wide wedgewire bars. The porosities of the screens were 24.7% for the 0.5-mm slot screen, 39.6% for the 1.0-mm screen, and 56.8% for the 2.0-mm screen.

Eggs and larvae were introduced upstream of the screens using a release system designed to have a flow velocity similar to the channel velocity. The release system consisted of a small holding tank from which fish entered a tube that had an exit located upstream of the screens. The release system was positioned to deliver test organisms at the centerline of the screens, thereby maximizing their exposure to entrainment and impingement as they moved downstream with the channel flow. Organisms that were entrained through the screens entered a collection tank equipped with a 330-micron plankton net and located upstream of the screen pump. The plankton net was lifted from the collection tank using a pulley system and jars were attached to the net to collect entrained larvae and eggs.

### Test Species and Lifestages

Eight species were tested during the evaluation of entrainment and impingement rates: striped bass (*Morone saxatilis*), winter flounder (*Pleuronectes americanus*), yellow perch (*Perca flavescens*), rainbow smelt (*Osmerus mordax*), common carp (*Cyprinus carpio*), white sucker (*Catostomus commersoni*), alewife (*Alosa pseudoharengus*), and bluegill (*Lepomis macrochirus*). These species were selected primarily because they represent fishes that are most commonly entrained at cooling water intakes located in a variety of water body types (e.g., rivers, lakes, estuaries, and coastal areas). They also represent fishes with a range of body shapes and swimming capabilities. Life stages that were evaluated for each species tested included the following: striped bass and white sucker eggs and larvae; winter flounder stage 3 and 4 larvae; yellow perch, rainbow smelt, common carp, and bluegill larvae; and alewife eggs. Biological testing with striped bass larvae and surrogate eggs was conducted in 2001 and with the other seven species in 2002.

Striped bass was the only species for which a surrogate was used to represent live eggs. The surrogate eggs were gellan gum beads manufactured by Technology Flavors and Fragrances. These beads are about the same diameter and specific gravity as striped bass eggs and have been used in striped bass egg drift studies and sampling gear efficiency evaluations (Davin 1999; Will and Jennings 2001).

### Entrainment and Impingement Testing

The number of organisms entrained and impinged was estimated by releasing known numbers of larvae and eggs for a given set of test conditions (i.e., slot width, through-slot velocity, channel velocity). At the end of each trial, the number of larvae and/or eggs that were entrained and impinged were enumerated. The number of organisms entrained was estimated by a count of larvae and eggs captured in the entrainment collection net. The number impinged was estimated by visually scanning the screens through a plexiglass window and with an underwater video



camera that could be moved along the surface of the screens at very close proximity. The contrast between organisms and the screen surface was sufficient for effectively counting impinged eggs and larvae in this manner.

Entrainment net collection efficiency was estimated for most species and lifestages that were evaluated. Collection efficiency of the entrainment net was conducted by releasing known numbers of fish or eggs directly into the entrainment collection tank. After 10 minutes (i.e., the duration of an entrainment and impingement test), the net was raised and collected organisms were recovered and counted. When possible, entrainment collection efficiency tests for a given species/lifestage were conducted at the two through-slot velocities that were evaluated during entrainment and impingement testing. Attempts were made to conduct a minimum of 5 replicate trials per collection efficiency test condition, but limited numbers of fish and eggs resulted in fewer trials being conducted for some species and conditions.

The test parameters that were evaluated with each species and lifestage are presented in Table 1. For entrainment and impingement testing, three replicates were conducted with striped bass larvae and surrogate eggs for each set of test conditions (i.e., slot size, through-slot velocity, and channel velocity) during the first year of the study. Up to five replicates were conducted per test condition evaluated with species and lifestages evaluated during the second year. Individual tests were initiated by introducing fish into the flume upstream of the screens. A sample size of 50 to 100 larvae or eggs was used for each test. The number of organisms used per test depended on the number of fish or eggs available for testing, with a maximum target sample size of 100 for striped bass and 75 for the other species. Testing with each species was conducted separately. This was mainly due to differences in spawning periods and when certain species and lifestages were available from commercial suppliers.

The parameters that were estimated from the cylindrical wedgewire screen evaluation included the number and percent of fish and eggs impinged and entrained, and the total number and percent of organisms lost to impingement and entrainment combined. The number of fish and eggs entrained per unit flow was also estimated. The percent of fish lost to impingement and entrainment combined should not be interpreted as a percent mortality. In most field applications, entrainment and impingement survival rates are likely to be greater than zero. For example, impinged fish can be washed from screens alive during debris removal operations (e.g., air bursting or back washing) or when channel velocities increase (e.g., increasing tidal velocities after slack conditions). The percent lost, as used in this report, represents the number of organisms that were affected by the withdrawal of water through the screens in reference to the number that were exposed. The affected proportion of organisms (i.e., percent lost) indicates a risk to entrainment and impingement for larvae and eggs that pass in very close proximity to a screen's surface, and does not represent a any type of mortality risk. Impingement was estimated as the percent of fish released and entrainment was estimated by adjusting the number of fish recovered for collection efficiency. Entrainment estimates were standardized among test conditions (i.e., slot velocities and widths) by calculating the number of fish entrained per unit flow withdrawn (i.e., number of fish entrained divided by volume of water withdrawn during a test).

The general approach to analysis of the impingement, entrainment, and percent loss responses was to compare marginal means using a general linear model. This analysis was performed using a three-way factorial design of slot size, through-slot velocity, and channel velocity. Where appropriate, larval length was measured and introduced as a covariate to the response. The analytical model was a three (or four) factor analysis of covariance (ANCOVA) (Milliken and Johnson 1984). The model was implemented using the GLM procedure of the SAS software system (SAS Institute, Inc. 1989). The three responses were all recorded as percent or proportion of a total number of larvae or eggs released. The inverse sine of the square root of the proportion (Govindarajulu 2001) was used as a variance stabilizing transformation. The GLM assumption of homogeneity of variance was tested using Levene's test (Milliken and Johnson 1984). If the assumption of homogeneity of variance was violated, the source of the unequal variance was identified and the data were re-analyzed using the MIXED procedure of the SAS software system which is capable of modeling unequal variances (SAS Institute, Inc. 1996). Follow-up analysis to the ANCOVA was performed using the Student-Newman-Keuls test for marginal means or the LSD test for pair wise comparison of cell means (Milliken and Johnson 1984).

Simple linear regressions were used to evaluate the relationship between percent of organisms lost and the ratio of the channel to through-slot velocity. For this assessment, data from tests with all species and the three slot sizes were combined for each life stage (i.e., larvae and eggs).

## Results

### Entrainment Net Collection Efficiency

Entrainment collection efficiencies generally were high (> 90%) and did not vary considerably between slot velocities (Table 2). Collection efficiency of alewife eggs and rainbow smelt larvae were relatively low, most likely due to their small size, opaque color, and fragility. The entrainment collection efficiency estimate for white sucker eggs at a through-slot velocity of 0.15 m/s was used to adjust entrainment estimates for tests with this species and lifestage at the 0.3 m/s through-slot velocity. Given their similar size and shape, common carp entrainment rates for tests at a through-slot velocity of 0.3 m/s were adjusted with yellow perch collection efficiency estimates at the same velocity. Collection of surrogate striped bass eggs was facilitated by low entrainment rates (0% for many test conditions) and their relatively large size and bright color. These conditions produced entrainment net recovery rates of 100% for the surrogate eggs. Collection efficiency of entrained bluegill larvae was assumed to be 100% because of their large size.

### Entrainment and Impingement

Mean entrainment rates of fish larvae demonstrated several statistically significant relationships for the species and test parameters evaluated. Entrainment rates increased significantly with slot width and through-slot velocity for species that were evaluated with more than one slot width and velocity (Table 3). Entrainment of alewife eggs (mean diameter = 0.7 mm) also was significantly higher for tests with the 2.0-mm slot screen than with the 0.5-mm screen, whereas entrainment was 0.0% for all tests with striped bass surrogate eggs (mean diameter = 4.5 mm) and less than 0.5% for all tests with white sucker eggs (mean diameter 3.2 mm) (Table 4). Larval entrainment rates decreased significantly with increases in channel velocity for tests with yellow perch, rainbow smelt, common carp, and bluegill, but not for tests with striped bass, winter flounder, and white sucker (Table 3). Alewife egg entrainment rates were not statistically significant among the channel velocities evaluated, despite relatively large decreases from the lowest to highest channel velocity (Table 4). This likely was the result of highly variable entrainment estimates that prevented statistical differences from being detected.

Mean impingement rates of fish larvae were typically less than 10% for all species evaluated (Table 5), including 0% for all tests with striped bass. Consequently, there were no strong relationships evident among larval impingement rates and the various test parameters. This observation is also supported by a lack of statistically significant differences in impingement rates for the various test conditions evaluated with most species. Significant differences in impingement rates that were detected occurred between slot sizes and through-slot velocities during tests with winter flounder and among the three channel velocities evaluated with white sucker. In contrast to larvae, impingement rates of striped bass and white sucker eggs were significant with respect to slot size (striped bass only), through-slot velocity, and channel velocity. In general, egg impingement was lower for the smallest slot width, increased with increases in through-slot velocity, and decreased with increases in channel velocity (Table 4).

Mean percent of organisms lost to entrainment and impingement combined exhibited trends similar to entrainment for larvae and alewife eggs and similar to impingement for striped bass and white sucker eggs. The percent of larvae lost to entrainment and impingement combined generally declined with channel velocity for each slot size and through-slot velocity evaluated (Figures 3 through 5). However, during tests with the 1-mm slot screen at a through-slot velocity of 0.30 m/s, the mean percent of larvae lost was higher at a channel velocity of 0.15 m/s than it was at 0.08 m/s for all four species evaluated with under these conditions (Figure 4). This trend also was evident for winter flounder evaluated with the 0.5-mm screen (Figure 3). With the exception of rainbow smelt, very few larvae (< 10%) were lost to entrainment and impingement with the 0.5-mm screen at a through-slot velocity of 0.15 m/s, regardless of channel velocity (Figure 3).

Although testing with fish eggs was not as extensive as it was with larvae (i.e., number of species and conditions), the percent of fish eggs lost to entrainment and impingement demonstrated similar trends as observed for larvae with respect to channel and through-slot velocities. Specifically, the percent of eggs lost decreased with increases in channel velocity and increased at the higher slot velocities (Figure 6). The percent of eggs lost to entrainment and impingement was also lower for tests with the 0.5-mm slot screen than it was with the two larger slot sizes.

Relationships between larval fish length and entrainment and impingement rates were not detected for any of the species tested due to the relatively small length ranges over which they were each evaluated. However, when the data are combined across species, the potential influence of larval length on entrainment and impingement becomes evident for some of the test conditions. In particular, the mean percent of fish larvae lost to entrainment and impingement generally decreased with size (Figures 7 and 8). This relationship was most evident for tests with the 1-mm slot screen and at the higher through-slot velocity (i.e., 0.30 m/s) (Figure 8).

The percent of larvae and eggs lost to entrainment and impingement decreased with increases in the channel to slot velocity ratio (Figures 9 and 10). Depending on slot width, as much as 87% of the variability (as represented by the coefficient of determination,  $r^2$ ) in the mean percent of organisms lost was explained by this ratio (Figures 9 and 10). However, due to limited data (i.e., the number of channel to slot velocity combinations that were tested) and variability among species tested (including differences in larval length and egg diameter), the linear regressions calculated for each slot width were not statistically significant ( $P > 0.05$ ) for larvae or eggs.

The regression analyses of the channel to slot velocity ratio produced strong correlations between this parameter and the percent of larvae and eggs lost to entrainment and impingement (Figures 9 and 10). The high  $r^2$  values (i.e., coefficient of determination) that were calculated from these analyses indicate that entrainment and impingement may be highly dependent on the flow velocity ratio. However, despite the high  $r^2$  values, the regressions were not statistically significant due to considerable variability in entrainment and impingement rates among the species tested.

## Discussion

The biological evaluation of cylindrical wedgewire screens identified several important relationships associated with the various factors that affect impingement and entrainment of aquatic organisms. These relationships were not always straightforward or easily detectable due to interactions among the test variables and the inability to collect data for all species and life stages with all combinations of test conditions. As expected, impingement generally decreased and entrainment increased with increases in slot size. With respect to hydraulic conditions, entrainment and impingement typically increased with increases in through-slot velocities and decreased with increases in channel velocity. For most species and parameters evaluated, the importance of these relationships were demonstrated by statistically significant differences in entrainment and impingement rates.

These conclusions support the results of most previous studies that have demonstrated similar trends in entrainment and impingement rates with respect to biological and design parameters evaluated. These conclusions also are consistent with what would be predicted based on screen hydrodynamics described by a computational fluid dynamics (CFD) analysis of the test conditions (EPRI 2003), observations of larval swimming abilities, and physical constraints associated with the size of organisms in relation to slot width. The observed decreases in impingement can, in part, be attributed to greater susceptibility of organisms to entrainment as slot size increases. That is, most larvae and eggs were physically excluded from passing through the 0.5 mm slot screen, but not the 1 and 2 mm screens. Physical exclusion resulted in higher impingement or bypass rates depending on through-slot velocity and channel velocity. Greater slot velocities resulted in increases in impingement and entrainment and greater channel velocities resulted in decreases.

The entrainment and impingement of eggs during our study were related to the size of eggs and hydraulic conditions that influenced downstream movement of eggs along the screen surface. Alewife eggs, which averaged 0.7 mm in diameter, did not impinge on the 0.5 mm slot screen, but were entrained at rates of 10 to 20% for the two channel velocities evaluated. The entrainment rate at the lower channel velocity was nearly 50% greater than at the higher

velocity. In contrast to alewife, white sucker and surrogate striped bass eggs were not entrained, but were susceptible to impingement depending on the hydraulic conditions being evaluated. For both these species, egg impingement rates increased with through-slot velocity and decreased with channel velocity. An evaluation of cylindrical wedgewire screens installed at an intake on the Hudson River determined that striped bass egg impingement and entrainment rates were relatively low compared to other species (EA Science and Technology 1986). The screens evaluated in this study had a slot width of 0.5 mm, an intake velocity of 0.15 m/s, and were oriented parallel to channel flow. Such design features were all considered factors that contributed to reduced entrainment and impingement and are similar to the conditions that produced the best results with alewife, white sucker, and surrogate striped bass eggs during our laboratory evaluation.

The effects of fish size on impingement and entrainment rates have been shown to be associated with behavioral avoidance and physical exclusion (Hanson et al. 1978, 1981; Zeitoun et al. 1981a; Weisberg et al. 1987). Larger fish have a greater ability to actively avoid entraining flows and, depending on slot size, may be physically excluded from passing through screen slots. However, even though larger larvae may be less susceptible to entrainment as they grow, they may be more susceptible to impingement if they cannot avoid intake velocities and are too large to pass through slots. Previous studies suggest entrainment of fish between 5 and 10 mm in length can be low for screens with sufficiently small slot size (Hanson et al. 1978; Browne 1979; Weisburg 1987) and that fish greater than about 10 mm in length can be protected by slot sizes as large as 2 mm. These conclusions are supported by the results of our study, which demonstrated low entrainment rates for the 0.5-mm screen for fish less than 10 mm, particularly at a through-slot velocity of 0.15 m/s, and for larger bluegill larvae (> 15 mm in length) tested with the 2-mm screen.

Entrainment rates of species we evaluated with multiple slot sizes typically increased with slot width. The observed increases in entrainment at the larger slot sizes can be attributed to a lack of physical exclusion and behavioral avoidance for smaller fish (5-10 mm). Larger fish (>10 mm) also were entrained at the larger slot sizes (1 and 2 mm), but at lower rates than smaller larvae. Larger fish were capable of swimming along the screens, but when impinged, some were forced through the slots despite their physical size (body widths for all species evaluated averaged less than 2 mm, with exception of bluegill larvae which averaged 5.4 mm). Other studies also have identified a positive relationship between entrainment rates and slot size (Hanson et al. 1978; Heuer and Tomljanovich 1978; Browne 1979; Weisburg et al. 1984, 1987). A slot width of 0.5 mm has been shown to be capable of preventing entrainment of most larvae and eggs (Browne 1979), whereas screens with slot widths of 1 mm or greater have exhibited higher entrainment rates for fish less than 10 mm in length. Entrainment and impingement of fish greater than 10 mm in length have been effectively reduced for larger slots (1 mm or greater) (Hanson et al. 1978, 1981; Heuer and Tomljanovich 1979; Otto et al. 1981). Our results also support the ability of screens with larger slot sizes to minimize entrainment and impingement of fish greater than 10 mm, as well as afford protection to smaller fish in the presence of hydraulic conditions that are conducive to carrying fish downstream.

Through-slot velocity had a considerable effect on impingement and entrainment rates for most species that we evaluated. Impingement and entrainment increased with through-slot velocity and this relationship was statistically significant for several of the species evaluated. Most previous research with cylindrical screens has been conducted with a through-slot velocity of 0.15 m/s, which was the recommended intake approach velocity criteria for minimizing entrainment and impingement of fishes at screening facilities at the time many studies were performed (Boreman 1977). However, our results demonstrate that a through-slot velocity as high as 0.3 m/s may be biologically effective for reducing entrainment and impingement, depending on fish size, slot width, and approach flow velocity.

Channel velocity (also referred to as ambient, approach, or sweeping flow) has been cited in past studies as an important parameter for minimizing entrainment and impingement of aquatic organisms exposed to wedgewire screens (Hanson et al. 1978; Heuer and Tomljanovich 1978). At field sites, ambient currents produce a sweeping flow that carries aquatic organisms (and debris) along a screen until they are safely away from the influence of the intake flow. Our evaluation demonstrated that this sweeping flow can effectively carry larvae and eggs downstream even when they are extremely close to or contacting a screen's surface. The effectiveness of ambient currents or

channel flow to move fish and eggs past a screen will depend on several factors, including the distance of an organism from the screen surface, slot velocity and width, and the size and swimming ability of exposed organisms. The results of our study demonstrate that the ability of approaching flow to effectively carry fish and eggs that are in close contact with a screen decreased at higher slot velocities and larger slot widths and increased for larger fish and eggs.

Because increasing through-slot velocities typically results in greater entrainment and impingement rates and channel velocities have the opposite effect, optimizing the ratio of channel velocity to slot velocity should improve the biological effectiveness of wedgewire screens for any given slot size (i.e., larger ratios lead to greater protection). The results of the laboratory tests indicate that as this ratio increases, entrainment and impingement rates decrease. Optimum ratios of channel to slot velocity may need to be greater for smaller larvae (< 10 mm) and eggs and for larger slot sizes through which organisms are more likely to pass if a screen is contacted. A high channel velocity to slot velocity ratio has been cited previously as a means to reduce entrainment and impingement (Hanson et al. 1978).

Cylindrical wedgewire screens should be designed using hydraulic and biological criteria that will minimize impacts to the lifestages and species that are targeted for protection. One approach to this goal would be to address each screen design parameter separately (e.g., minimize slot velocity and width, maximize approach velocity). However, a more prudent approach would be to consider the interaction between design parameters as they relate to the species and lifestages that will be susceptible to entrainment and impingement. For example, a slot width that excludes all sizes of fish and eggs that will be exposed to a screen may not be required if sweeping velocities are sufficiently high and slot velocities sufficiently low that exposed organisms are carried away. Similarly, if a screen is located in an area where only larger fish are located, larger slot sizes or higher slot velocities may not contribute to greater rates of entrainment or impingement.

The results of our study represent a worst case scenario because larvae and eggs were released at a location that kept them within close proximity to the screens (i.e., within several centimeters of the screen surface) where the influence of intake flow velocity and direction on aquatic organisms is the greatest. The potential for intake velocity and flow direction to affect passing organisms appears to dissipate quickly over a relative short distance from the screen surface (about 0.3 to 0.5 m; EPRI 2003). Therefore, risk to entrainment and impingement also probably decreases rapidly for larvae and eggs as distance from the screen increases.

Based on the estimates of entrainment and impingement for larvae and eggs, protection of aquatic organisms using cylindrical wedgewire screens will be optimized by minimizing slot size and through-slot velocity and placing screens in locations with sufficient sweeping flows. Design and operation criteria that result in optimization of these parameters will be dependent on the target species and lifestages. Older and larger organisms will not require as stringent criteria as younger and smaller organisms that do not possess the size or swimming ability to avoid impingement and entrainment. Additionally, not all parameters may need to be optimized for effective protection of fish and eggs. Field studies indicate that intake location also will be important in determining design criteria (Zeitoun et al. 1981b). Specifically, using less conservative slot size and velocity criteria may be appropriate if wedgewire screens are located where species and lifestages that are potentially susceptible to entrainment and impingement are not abundant.

The data we gathered during the biological evaluation of cylindrical wedgewire screens demonstrate that this technology can effectively protect early lifestages of fish from entrainment and impingement when designed according to appropriate biological and hydraulic criteria. Future studies, whether conducted in the laboratory or field, should focus on interrelationships among a smaller set of design criteria or for specific species and lifestages. Such studies will provide more specific descriptions and a better understanding of the relationships between biological and engineering design parameters that maximize fish protection effectiveness. Future testing with a wider range of lengths also will provide valuable data which can be used to develop length-based entrainment and impingement curves. This information will help advance the use of wedgewire screens at sites where they can be effectively operated from both a biological and engineering standpoint.

## Reference

- Boreman, J. 1977. Impacts of Power Plant Intake Velocities on Fish. U.S. Fish & Wildlife Service FWS/OBS-76/20.1.
- Browne, M. E. 1979. Preliminary Engineering and Environmental Evaluation of Fine-Mesh Profile Wire as Powerplant Intake Screening. In Passive Intake Screen Workshop, Chicago, IL, December 1979.
- Davin, W. T., C. Ethridge, C. Babb, and S. Hilleman. 1999. Estimation of striped bass (*Morone saxatilis*) egg drift rate in the Lower Savannah River. Final Report, U.S. Army Corps of Engineers Savannah District, Savannah, Georgia, USA. 69 pp.
- EA Science and Technology. 1986. Results of Entrainment and Impingement Monitoring Study at the Westchester RESCO Facility, Peekskill, NY. RUS 41A
- EPRI (Electric Power Research Institute). 1999. Fish Protection at Cooling Water Intakes. Prepared by Alden Research Laboratory, Inc., EPRI Report No. TR-114013.
- EPRI (Electric Power Research Institute). Laboratory Evaluation of Wedgewire Screens for Protecting Early Life Stages of Fish at Cooling Water Intakes. Prepared by Alden Research Laboratory, Inc., EPRI Report No. 1005339.
- Govindarajulu, Z. 2001. Statistical Techniques in Bioassay. Second edition, Karger, New York.
- Hanson, B. N., W. H. Bason, B. E. Beitz, and K. E. Charles. 1978. A Practical Intake Screen which Substantially Reduces Entrainment. In: Fourth National Workshop on Entrainment and Impingement, Chicago, IL, December 5, 1977. Sponsored by Ecological Analysts. L. D. Johnson (Ed.)
- Hanson, B. N. 1981. Studies of Larval Striped Bass (*Morone saxatilis*) and Yellow Perch (*Perca flavescens*) Exposed to a 1 mm Slot Profile-Wire Screen Model Intake. In: Proceedings of the Workshop on Advanced Intake Technology, San Diego, CA, April 1981. P. B. Dorn and J. T. Larson (Eds.)
- Heuer, J. H. and D. A. Tomljanovich. 1978. A Study on the Protection of Fish Larvae at Water Intakes Using Wedge-Wire Screening. TVA Technical Note B26.
- Milliken, G. A. and D. E. Johnson. 1984. Analysis of Messy Data. Volume 1: Designed Experiments. Van Nostrand Reinhold, New York.
- Otto, R. G., T. I. Hiebert and V. R. Kranz. 1981. The Effectiveness of a Remote Profile-Wire Screen Intake Module in Reducing the Entrainment of Fish Eggs and Larvae. In: Proceedings of the Workshop on Advanced Intake Technology, San Diego, CA, April 1981. P. B. Dorn and J. T. Larson (Eds.).
- SAS Institute, Inc. 1989. SAS/STAT User's Guide, Version 6, Fourth Edition, Volume 2. SAS Institute, Cary, NC.
- SAS Institute, Inc. 1996. SAS/STAT Software: Changes and Enhancements through Release 6.11. SAS Institute, Cary, NC.
- Weisberg, S. B., W. H. Burton, F. Jacobs and E. A. Ross. 1987. Reductions in Ichthyoplankton Entrainment with Fine-Mesh, Wedge-Wire Screens. North American Journal of Fisheries Management 7: 386-393.
- Will, T. A., and C. A. Jennings. 2001. Assessment of Spawning Sites and Reproductive Status of Striped bass, *Morone saxatilis*, in the Savannah River Estuary. Prepared for the Georgia Ports Authority, Project 10-21-RR251-144.

Zeitoun, I. H., J. A. Gulvas, and D. B. Roarabaugh. 1981a. Effectiveness of Fine Mesh Cylindrical Wedge-Wire Screens in Reducing Entrainment of Lake Michigan Ichthyoplankton. *Canadian Journal of Fisheries and Aquatic Science* 38: 120-125.

Zeitoun, I. H., J. A. Gulvas and J. Z. Reynolds. 1981b. Effectiveness of Small Mesh Cylindrical Wedge-Wire Screens in Reducing Fish Larvae Entrainment at an Offshore and an Onshore Location of Lake Michigan. In: *Proceedings of the Workshop on Advanced Intake Technology*, San Diego, CA, April 1981. P. B. Dorn and J. T. Larson (Eds.).

**Table 1.** Test parameters evaluated with each species and lifestage (testing with larvae is indicated by an L and testing with eggs with an E). Species abbreviations are: STB, striped bass; WFL, winter flounder; YLP, yellow perch; CRP, common carp; WHS, white sucker; ALW, alewife; RBS, rainbow smelt; BLG, bluegill.

Slot Size (mm)	Slot Velocity (m/s)	Channel Velocity (m/s)	STB <sup>a</sup>	WFL	YLP	CRP	WHS	ALW	RBS	BLG
0.5	0.15	0.08	L/E	L	L	--	L/E	--	L	--
		0.15	L/E	L	L	--	L/E	--	L	--
		0.30	L/E	L	L	--	L/E	--	L	--
	0.30	0.08	L/E	L	L	--	E	E	--	L
		0.15	L/E	L	L	--	E	E	--	L
		0.30	L/E	L	L	--	E	--	--	--
1.0	0.15	0.08	L/E	L	--	L	L	--	--	--
		0.15	L/E	L	--	L	L	--	--	--
		0.30	L/E	L	--	L	L	--	--	--
	0.30	0.08	L/E	L	--	L	L	--	--	--
		0.15	L/E	L	--	L	L	--	--	--
		0.30	L/E	L	--	L	L	--	--	--
2.0	0.15	0.08	L/E	L	--	--	--	--	--	--
		0.15	L/E	L	--	--	--	--	--	--
		0.30	L/E	L	--	--	--	--	--	--
	0.30	0.08	--	--	--	--	--	--	E	L
		0.15	--	--	--	--	--	--	E	L
		0.30	--	--	--	--	--	--	E	L

<sup>a</sup> Striped bass egg tests were conducted with an artificial surrogate.

**Table 2.** Collection efficiency estimates for the various species, lifestages, and test conditions evaluated during wedgewire screen testing.

Species	Lifestage	Slot Size (mm)	Slot Velocity (m/s)	Number of Trials	Mean Collection Efficiency (SD) (%)
striped bass	larvae	0.5, 1.0, 2.0	0.5, 1.0	25	87.9 (4.6)
alewife	egg	0.5	0.15	5	59.6 (4.2)
common carp	larvae	1.0	0.15	5	99.2 (0.8)
rainbow smelt	larvae	0.5	0.15	1	80.0 (--)
winter flounder	larvae	0.5	0.15	5	98.0 (3.5)
			0.30	5	93.4 (8.6)
			1.0	3	98.3 (3.8)
white sucker	egg	0.5	0.30	2	100.0 (0.0)
			0.15	2	98.5 (1.5)
			0.15	1	97.0 (--)
yellow perch	larvae	0.5	0.15	5	87.8 (7.4)
			0.30	5	94.4 (4.0)



**Table 3.** Mean percent impingement of fish larvae. Species abbreviations are: STB, striped bass; WFL, winter flounder; YLP, yellow perch; CRP, common carp; WHS, white sucker; ALW, alewife; RBS, rainbow smelt; and BLG, bluegill. Average lengths of striped bass, winter flounder, yellow perch, common carp, and rainbow smelt were between 6.0 and 6.5 mm. White sucker and bluegill larvae averaged 13.9 and 18.5 mm in length, respectively.

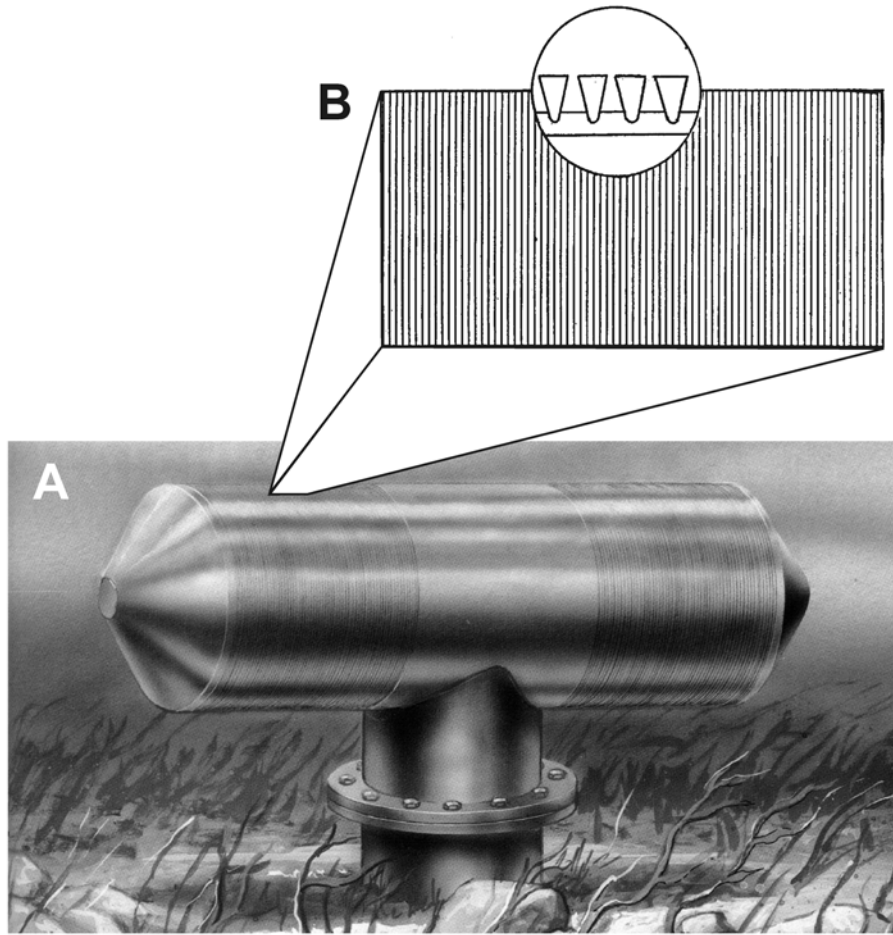
Slot Size (mm)	Slot Velocity (m/s)	Channel Velocity (m/s)	Mean Percent Entrainment (standard deviation in parentheses)						
			STB	WFL	YLP	CCP	RBS	WHS	BLG
0.5	0.15	0.08	3.4 (3.8)	0.8 (1.2)	0.0 (0.0)	--	75.0 (23.5)	0.0 (0.0)	--
		0.15	4.6 (7.6)	0.5 (0.7)	0.9 (1.4)	--	67.3 (28.4)	0.0 (0.0)	--
		0.30	2.7 (2.4)	2.5 (2.5)	0.0 (0.0)	--	25.3 (15.2)	0.3 (0.6)	--
	0.30	0.08	18.2 (6.3)	10.0 (11.0)	28.6 (15.8)	--	--	--	0.8 (0.8)
		0.15	27.2 (14.2)	11.1 (6.5)	26.3 (8.3)	--	--	--	0.0 (0.0)
		0.30	28.2 (20.5)	6.0 (3.7)	11.9 (6.0)	--	--	--	--
1.0	0.15	0.08	41.4 (10.3)	84.6 (5.9)	--	94.0 (7.8)	--	12.4 (12.4)	--
		0.15	27.0 (5.4)	72.4 (13.1)	--	81.9 (6.9)	--	8.3 (5.5)	--
		0.30	16.7 (3.5)	61.3 (3.8)	--	64.5 (5.5)	--	5.8 (2.3)	--
	0.30	0.08	21.3 (2.4)	64.5 (11.0)	--	89.6 (8.1)	--	36.4 (19.0)	--
		0.15	58.9 (27.1)	78.4 (20.8)	--	94.5 (4.9)	--	47.9 (10.9)	--
		0.30	39.1 (4.0)	74.1 (15.5)	--	89.8 (8.8)	--	23.6 (10.4)	--
2.0	0.15	0.08	61.1 (31.5)	82.7 (16.2)	--	--	--	--	--
		0.15	61.1 (7.6)	84.1 (8.5)	--	--	--	--	--
		0.30	45.9 (10.8)	73.3 (5.6)	--	--	--	--	--

**Table 4.** Mean percent impingement and entrainment of fish eggs. Mean egg diameters were 4.5 mm for of striped bass surrogate eggs, 3.2 mm for white sucker eggs, and 0.7 for alewife eggs.

Slot Size (mm)	Slot Velocity (m/s)	Channel Velocity (m/s)	Mean Percent Impingement and Entrainment (standard deviation in parentheses)					
			<u>Striped Bass</u>		<u>White Sucker</u>		<u>Alewife</u>	
			Imp	Ent	Imp	Ent	Imp	Ent
0.5	0.15	0.08	13.0 (10.6)	0.0(0.0)	0.5 (0.7)	0.0 (0.0)	--	--
		0.15	0.7 (1.2)	0.0(0.0)	1.1 (1.1)	0.0 (0.0)	--	--
		0.30	0.0 (0.0)	0.0(0.0)	0.0 (0.0)	0.0 (0.0)	--	--
	0.30	0.08	97.3 (2.3)	0.0(0.0)	59.8 (25.0)	0.3 (0.6)	0.0 (0.0)	19.7 (8.6)
		0.15	21.3 (16.7)	0.0(0.0)	4.8 (2.8)	0.0 (0.0)	0.0 (0.0)	10.1 (15.2)
		0.30	0.0 (0.0)	0.0(0.0)	0.5 (1.2)	0.0 (0.0)	0.0 (0.0)	--
1.0	0.15	0.08	91.0 (14.7)	0.0(0.0)	--	--	--	--
		0.15	0.3 (0.6)	0.0(0.0)	--	--	--	--
		0.30	0.0 (0.0)	0.0(0.0)	--	--	--	--
	0.30	0.08	98.7 (1.2)	0.0(0.0)	--	--	--	--
		0.15	88.7 (3.5)	0.0(0.0)	--	--	--	--
		0.30	0.0 (0.0)	0.0(0.0)	--	--	--	--
2.0	0.15	0.08	93.7 (4.9)	0.0(0.0)	--	--	--	--
		0.15	4.7 (3.2)	0.0(0.0)	--	--	--	--
		0.30	0.0 (0.0)	0.0(0.0)	--	--	--	--
	0.30	0.08	--	--	--	--	--	52.8 (31.6)
		0.15	--	--	--	--	--	29.5 (40.1)
		0.30	--	--	--	--	--	26.4 (11.3)

**Table 5.** Mean percent entrainment of fish larvae. Species abbreviations are: STB, striped bass; WFL, winter flounder; YLP, yellow perch; CRP, common carp; WHS, white sucker; ALW, alewife; RBS, rainbow smelt; and BLG, bluegill. Average lengths of striped bass, winter flounder, yellow perch, common carp, and rainbow smelt were between 6.0 and 6.5 mm. White sucker and bluegill larvae averaged 13.9 and 18.5 mm in length, respectively.

Slot Size (mm)	Slot Velocity (m/s)	Channel Velocity (m/s)	Mean Percent Impingement (standard deviation in parentheses)						
			STB	WFL	YLP	CCP	RBS	WHS	BLG
0.5	0.15	0.08	0.0 (0.0)	1.6 (2.2)	8.0 (5.3)	--	0.0 (0.0)	7.2 (5.5)	--
		0.15	0.0 (0.0)	8.8 (18.9)	6.7 (2.8)	--	0.3 (0.6)	5.9 (5.7)	--
		0.30	0.0 (0.0)	0.0 (0.0)	5.9 (2.5)	--	0.0 (0.0)	0.3 (0.6)	--
	0.30	0.08	0.0 (0.0)	6.7 (5.6)	9.7 (3.8)	--	--	--	4.0 (2.5)
		0.15	0.0 (0.0)	12.8 (7.9)	9.6 (5.5)	--	--	--	0.0 (0.0)
		0.30	0.0 (0.0)	8.7 (2.3)	11.2 (4.9)	--	--	--	--
1.0	0.15	0.08	0.0 (0.0)	1.1 (1.7)	--	5.2 (3.0)	--	10.8 (4.2)	--
		0.15	0.0 (0.0)	2.4 (1.1)	--	6.0 (3.7)	--	2.7 (3.1)	--
		0.30	0.0 (0.0)	1.3 (1.3)	--	4.8 (3.0)	--	4.0 (1.4)	--
	0.30	0.08	0.0 (0.0)	19.8 (6.5)	--	9.1 (5.6)	--	2.9 (3.3)	--
		0.15	0.0 (0.0)	7.2 (5.3)	--	7.6 (2.6)	--	8.8 (5.4)	--
		0.30	0.0 (0.0)	9.6 (3.9)	--	6.4 (2.2)	--	2.8 (5.2)	--
2.0	0.15	0.08	0.0 (0.0)	0.0 (0.0)	--	--	--	--	--
		0.15	0.0 (0.0)	0.0 (0.0)	--	--	--	--	--
		0.30	0.0 (0.0)	0.3 (0.6)	--	--	--	--	--



**Figure 2.** Depiction of a cylindrical wedgewire screen installation (A) and close-up view of slotted wedgewire screen elements (B) (Modified from Hanson et al. 1978 and EPRI 1999).

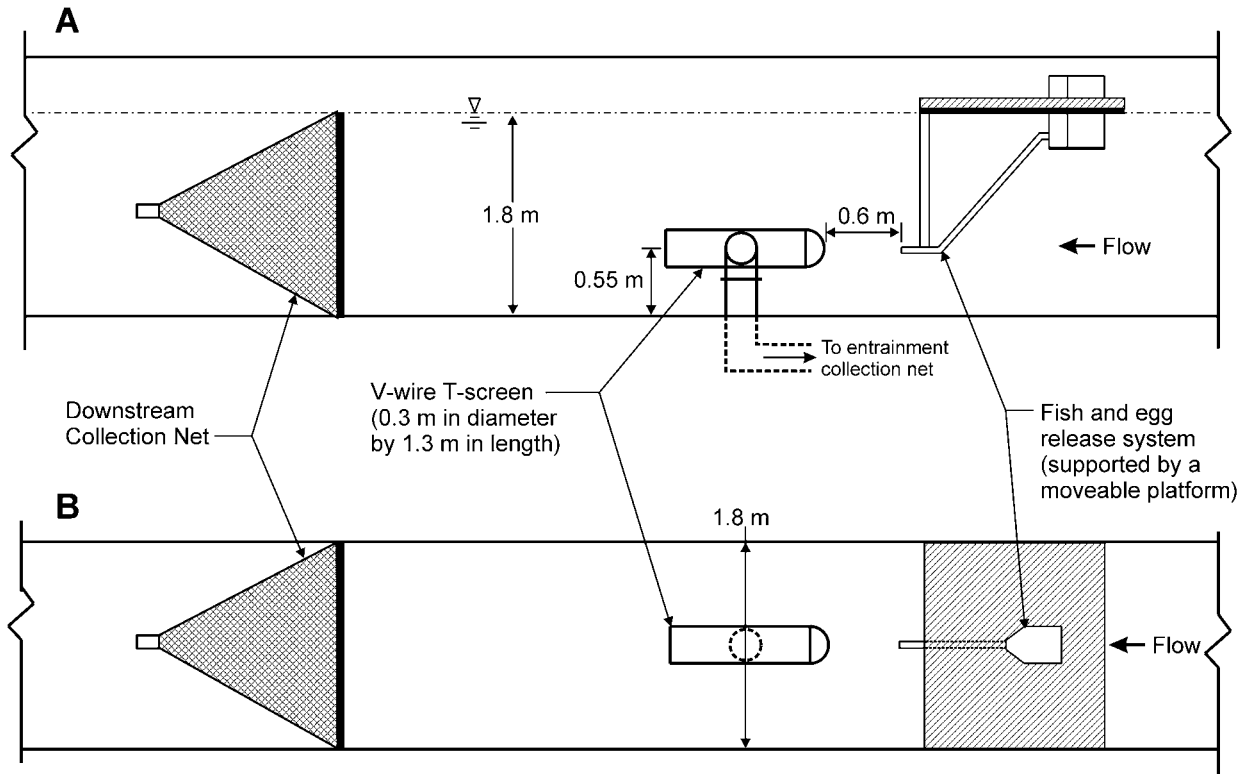
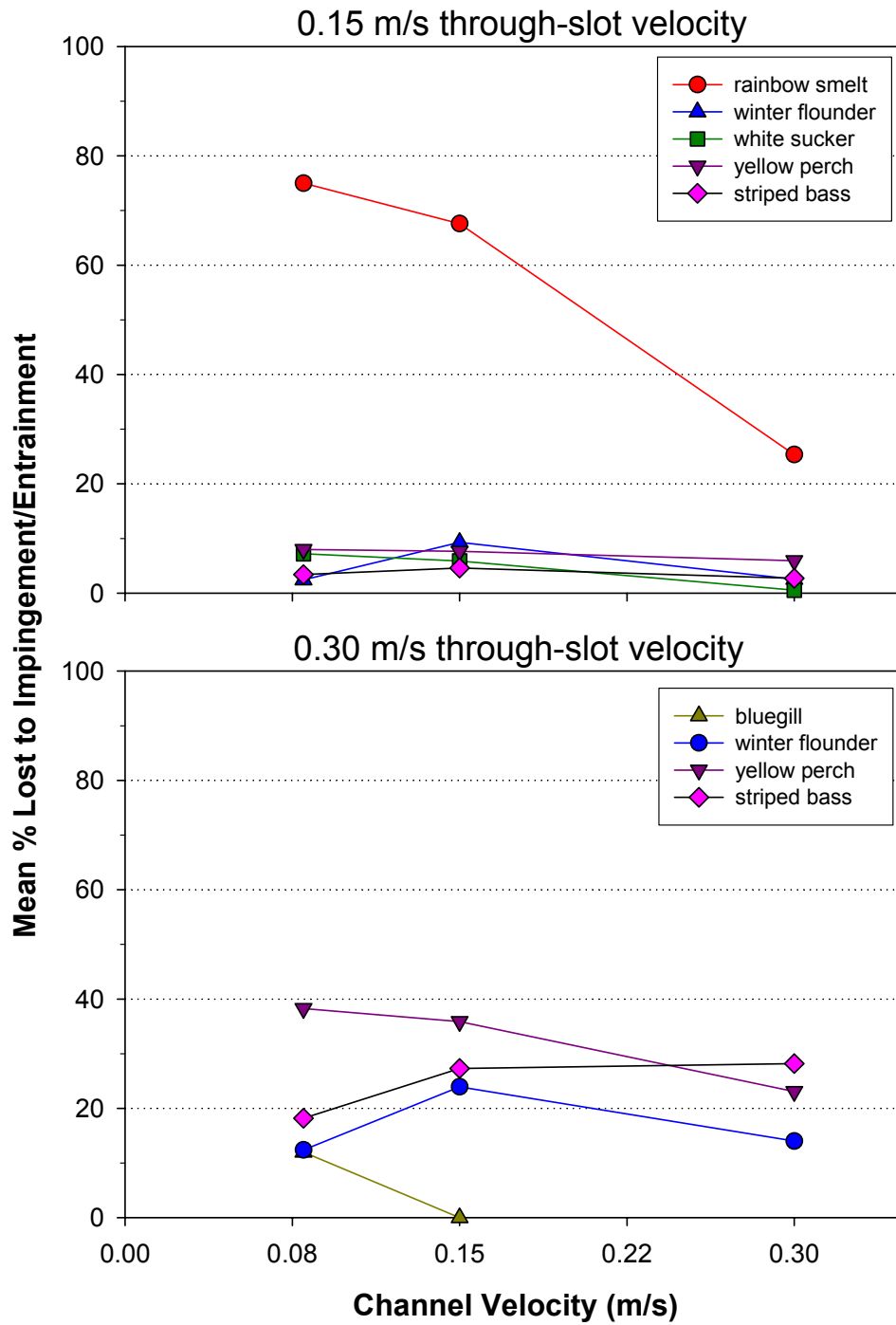
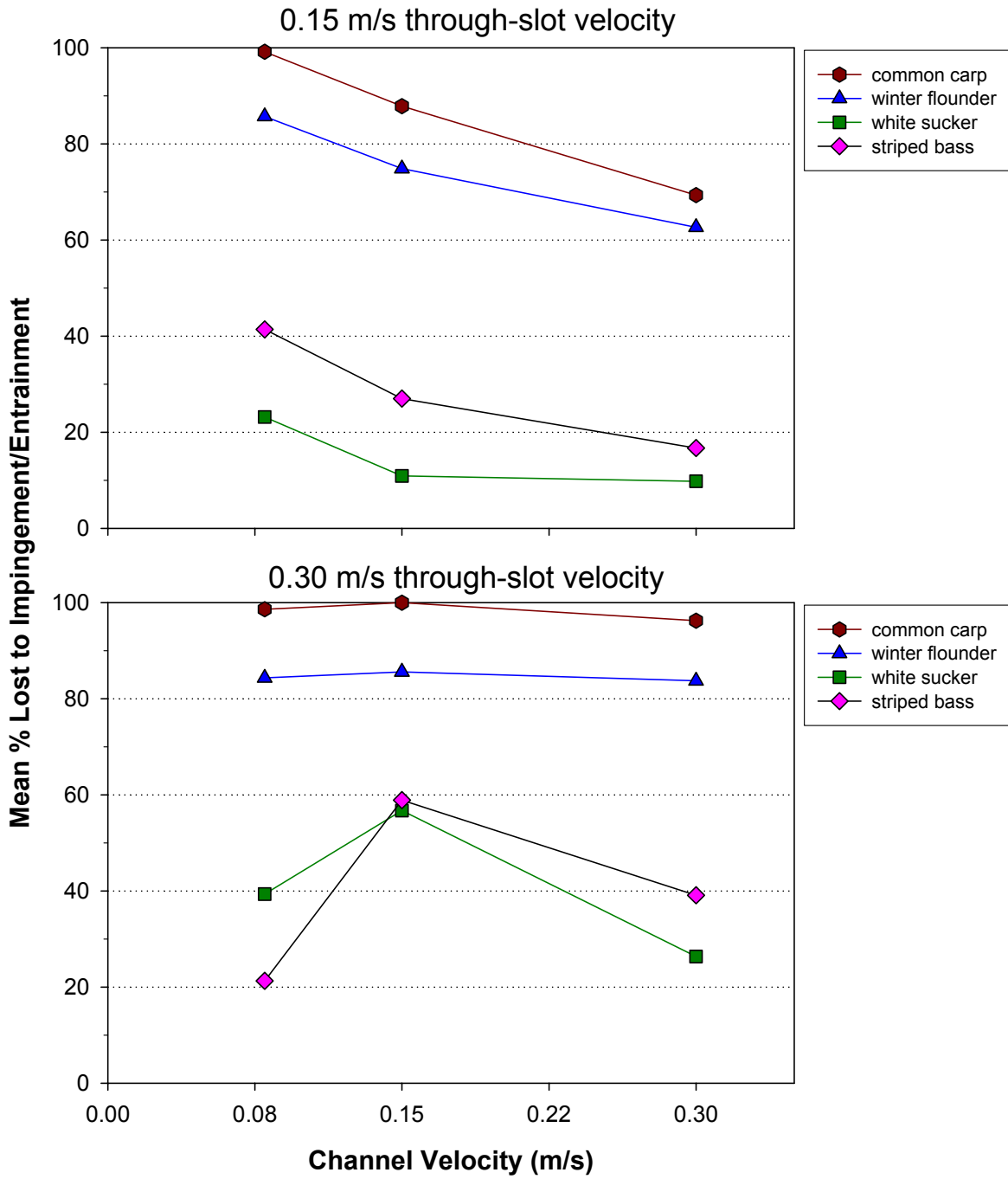


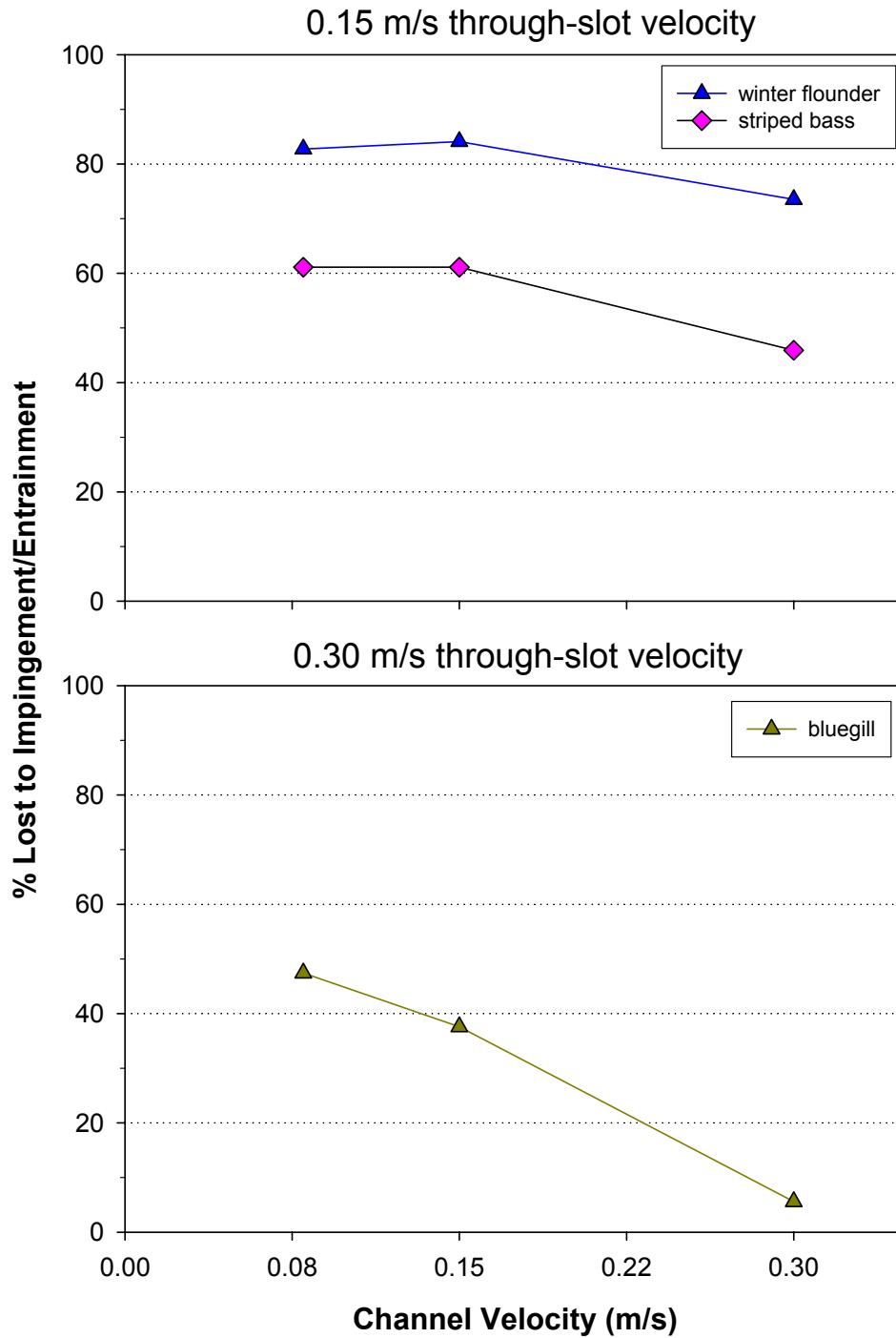
Figure 3. Schematic of wedgewire screen test facility.



**Figure 4.** Relationship between mean percent of fish larvae lost to entrainment and impingement (combined) and channel velocity for tests conducted at slot velocities of 0.15 and 0.30 m/s with the 0.5-mm slot screen.

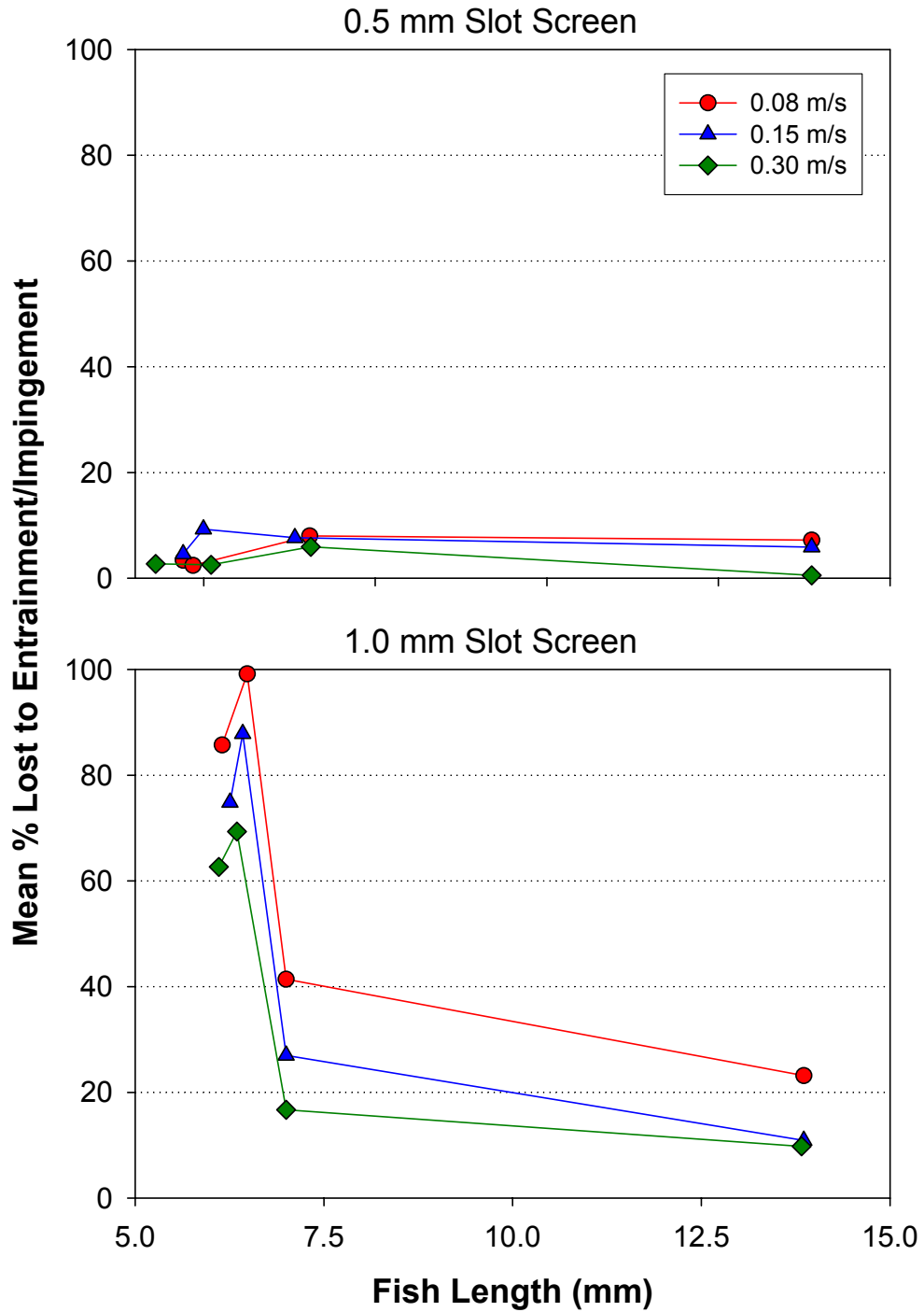


**Figure 5.** Relationship between mean percent of fish larvae lost to entrainment and impingement (combined) and channel velocity for tests conducted at slot velocities of 0.15 and 0.30 m/s with the 1.0-mm slot screen.

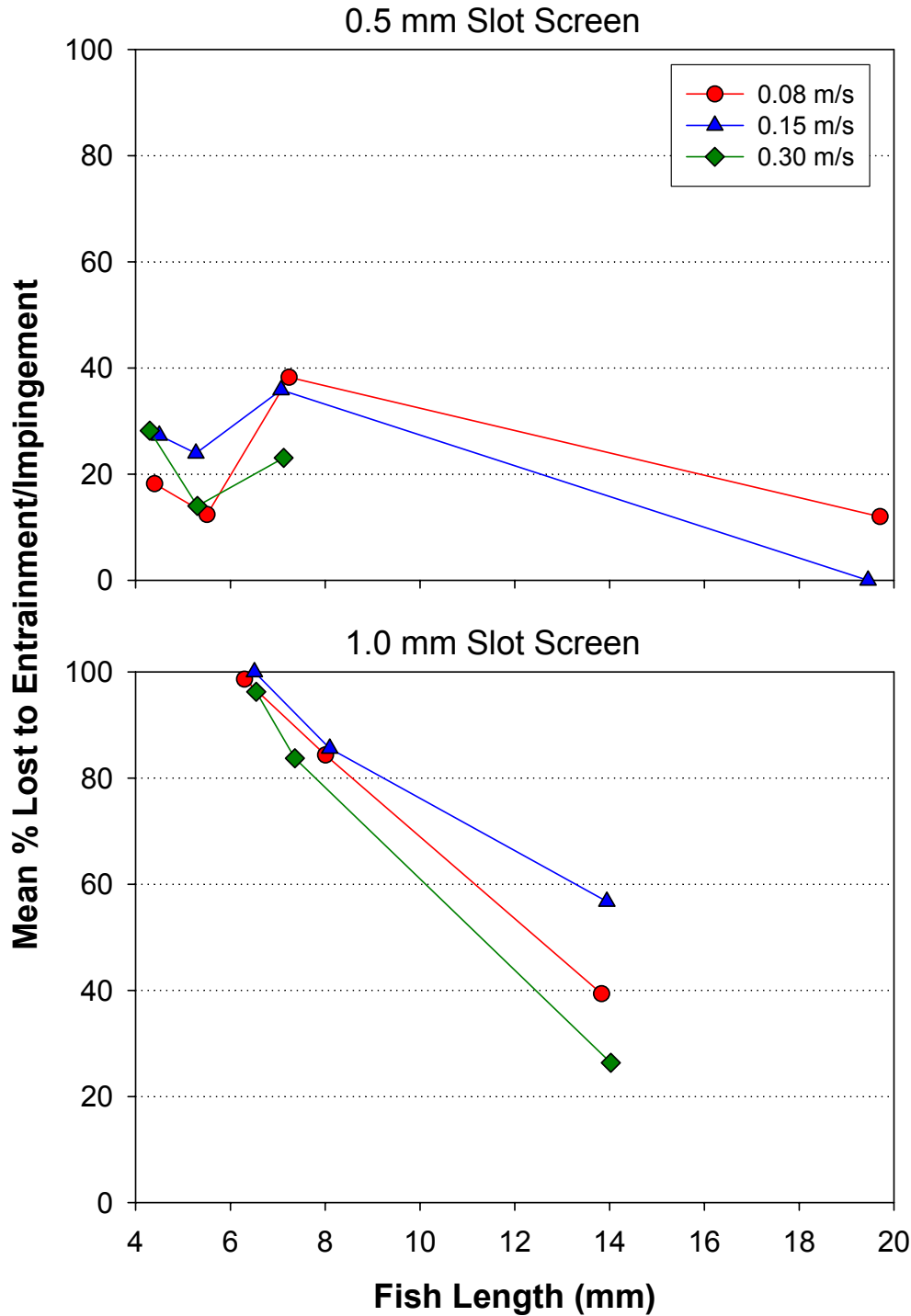


**Figure 6.** Relationship between mean percent of fish larvae lost to entrainment and impingement (combined) and channel velocity for tests conducted at at slot velocities of 0.15 and 0.30 m/s with the 2.0-mm slot screen.

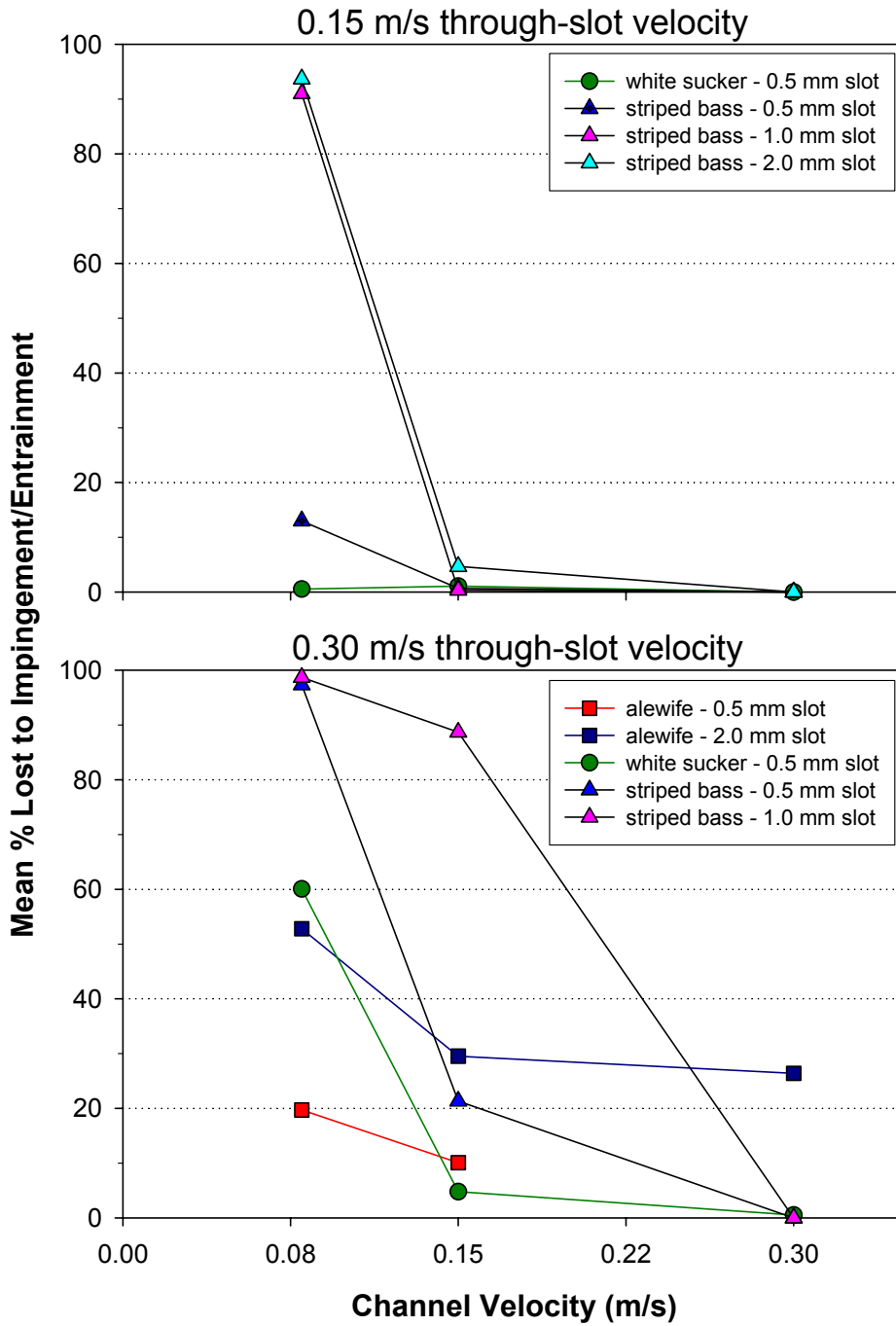




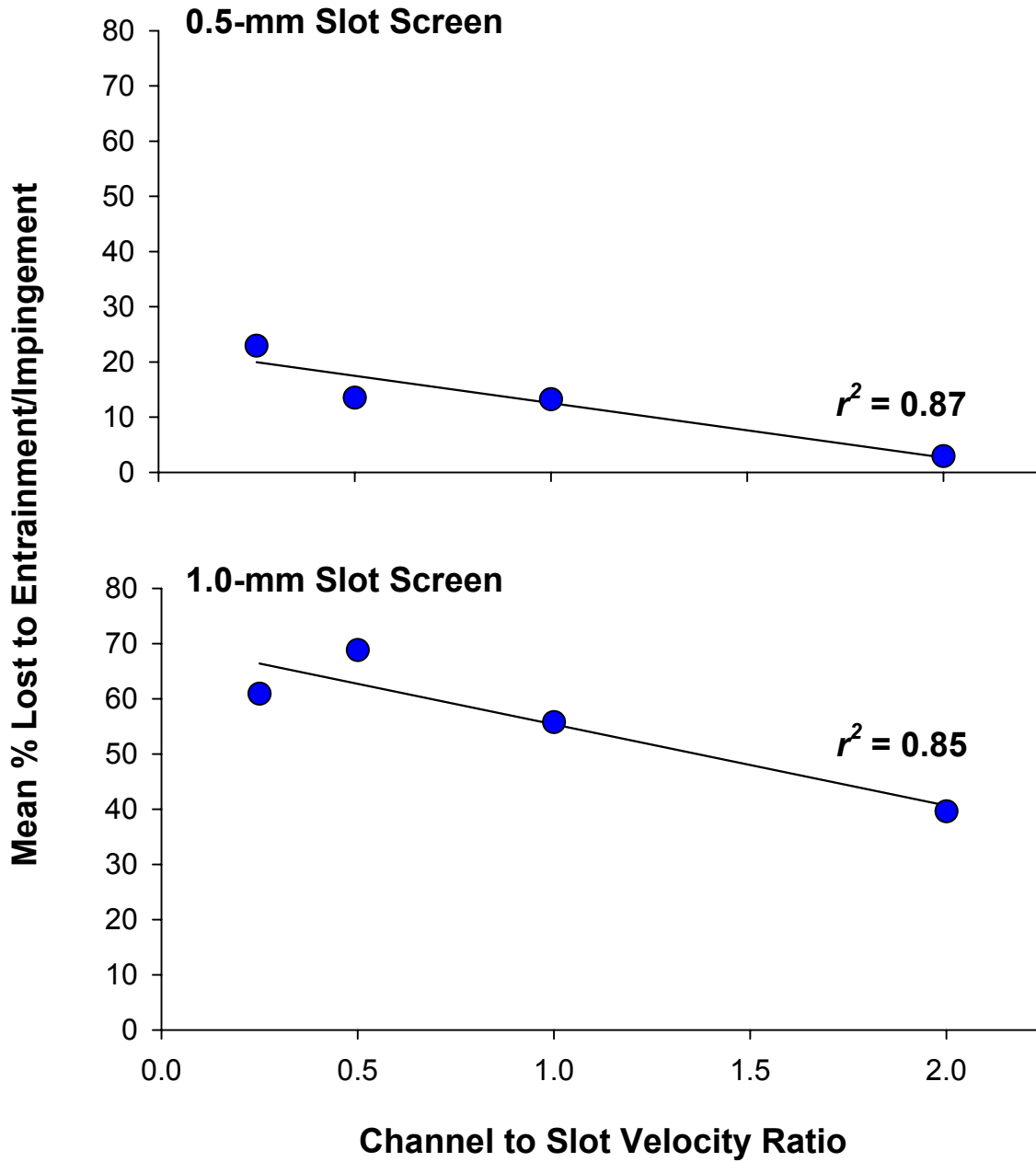
**Figure 7.** Relationship between mean percent of fish larvae lost to entrainment and impingement (combined) and fish length for tests conducted at a slot velocity of 0.15 m/s with the 0.5- and 1.0-mm slot screens. Data are presented for three channel velocities.



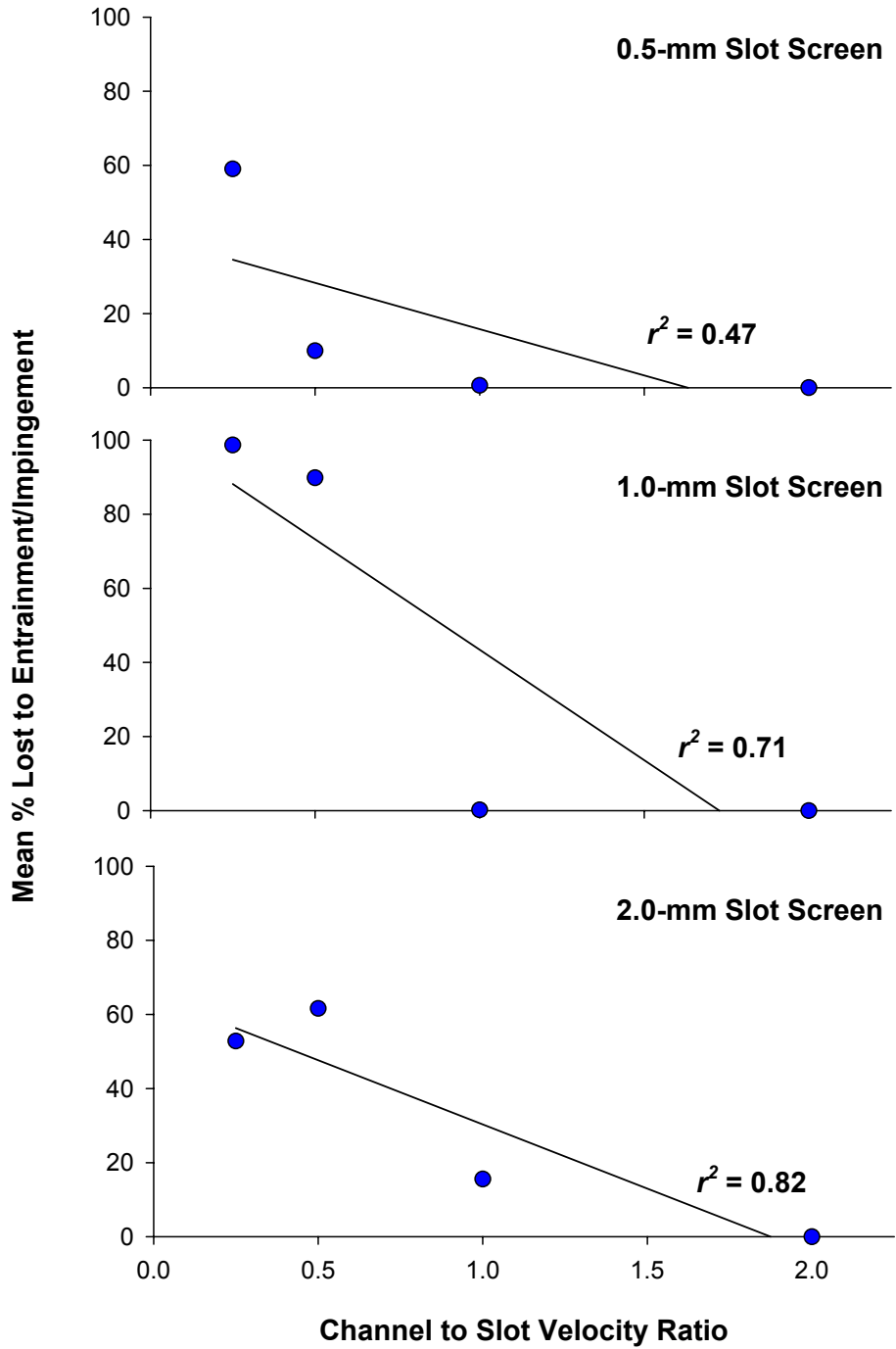
**Figure 8.** Relationship between mean percent of fish larvae lost to entrainment and impingement (combined) and fish length for tests conducted at a slot velocity of 0.30 m/s with the 0.5- and 1.0-mm slot screens. Data are presented for three channel velocities.



**Figure 9.** Relationship between mean percent of fish eggs lost to entrainment and impingement (combined) and channel velocity for tests conducted at at slot velocities of 0.15 and 0.30 m/s.



**Figure 10.** Simple linear regression for mean percent of fish larvae lost to entrainment and impingement combined versus the ratio of channel to slot velocity for tests conducted with the 0.5- and 1-mm slot screens.



**Figure 11.** Simple linear regression of mean percent of eggs lost to entrainment and impingement (combined) versus the ratio of channel to slot velocity evaluated with each slot size.

*Selection and Design of Wedgewire Screens and a Fixed-Panel Aquatic Filter Barrier System to Reduce Impingement and Entrainment at a Cooling Water Intake Structure on the Hudson River*

*Mark Strickland, PSEG Services Corporation and James Mudge, Ph.D., Civil and Environmental Consultants, Inc.*

**BIOSKETCHES**

Mr. Mark Strickland is the Corporate Environmental Issues Manager at PSEG Services Corporation serving the Public Service Enterprise Group family of companies. Mr. Strickland received his B.S. in Mechanical Engineering from Virginia Polytechnic Institute and State University and his M.B.A. in Industrial Management from Fairleigh Dickinson University in New Jersey. After starting his career in power plant engineering (nuclear and fossil steam supply systems, and air pollution control equipment), he moved into the environmental area 17 years ago where he has managed a variety of environmental programs and issues at a corporate level. His work has focused mainly on water issues and has included permitting, environmental studies and investigations, 316(a) and (b) demonstrations, regulatory affairs and issues management.

Dr. James Mudge is a Principal Environmental Scientist at Civil & Environmental Consultants, Inc. located in Pittsburgh, Pennsylvania. Dr Mudge received his B.S. in Biology from Mansfield University in Pennsylvania and his M.S. and Ph.D. in physiology from the Pennsylvania State University. He has thirty years of environmental monitoring, impact assessment, and permitting experience working both for electric utility and environmental consulting firms. He has designed and implemented 316b studies in Pennsylvania, New York, New Jersey, and Washington. His main interests are in assessing the effects of electric generating facilities on aquatic ecosystems and ecological risk assessment.

**TECHNICAL PAPER**

**Abstract**

In 2001, the New York Department of Environmental Conservation approved the retirement of the existing once-through cooling water system at the Albany Steam Generating Station (ASGS) and the construction of its replacement, the Bethlehem Energy Center (BEC), which includes a reconstructed cooling water intake structure. PSEG Power New York, Inc. (PSEGENY) evaluated various cooling system alternatives (i.e., once-through cooling, several closed-cycle technologies) and supplemental measures (aquatic filter barrier systems, and cooling water-holding tank). The alternative cooling systems study prepared by PSEGENY considered many factors such as the effects on aquatic organisms, system performance, noise, aesthetics, air emissions, and costs. This paper summarizes the analyses and conclusions contained in that study.

The alternative required by the State as the best technology available (BTA) for BEC consists of 2-mm wedgewire screens and a seasonally-deployed fixed-panel aquatic filter barrier system coupled with a hybrid cooling tower. This alternative is projected to virtually eliminate impingement and reduce entrainment by about 98 to 99% when compared to existing conditions at the ASGS.

**Introduction**

This paper describes the selection and design of the cooling system for the Bethlehem Energy Center (BEC), a 750-megawatt (MW), combined cycle power plant PSEG Power New York Inc. (PSEGENY) is building at the site of the existing 400 MW Albany Steam Generating Station (ASGS or the Station) located on the western shore of the Hudson River in Bethlehem, NY. The retirement of the existing Station and replacement with BEC will result in significant air and water environmental improvements. The wet tower closed-loop cooling system proposed by PSEGENY will withdraw 98-99% less water than ASGS, which will greatly reduce the entrainment and impingement of aquatic organisms.

The development of BEC provides a unique opportunity to retire an existing generation plant and redevelop the site with a state-of-the-art facility that is needed to provide clean, efficient, reliable new generation for New York while significantly reducing environmental impacts. Specifically, the BEC will:

- ▶ Provide 350 MW more electrical capacity while using less fuel.
- ▶ Provide significant environmental benefits that include a 97 - 98% reduction in emission rates of nitrogen oxides (NO<sub>x</sub>) and sulfur dioxide (SO<sub>2</sub>).
- ▶ Dramatically reduce use of Hudson River water (by 98-99%) for cooling resulting in significant environmental improvements (i.e., reduced negative effects on aquatic organisms).

An Alternative Cooling Systems Study (study) was performed to assess the quantitative and qualitative attributes of the proposed wet tower closed-loop cooling system to determine if any alternative provided additional protection of aquatic resources without creating significant undesirable effects or being wholly disproportionate in cost (PSEGNYS, 2001). This paper summarizes the analyses and conclusions contained in that study.

### **Project Background**

PSEGNYS acquired the existing Station with the intent to continue operation while exploring the possibility of continuing redevelopment plans initiated by the previous owner in 1998. The redevelopment of the site with the BEC utilizing the proposed wet tower cooling system provides a viable alternative to maintaining operation of the existing Station. PSEGNYS filed appropriate air and water permit applications for the new facility and a supplement to complete the Article X application for BEC submitted by the previous owner 1998. Upon the construction and commercial operation of the proposed BEC, PSEGNYS has committed to retire the 50-year-old ASGS.

The existing ASGS is a 400 MW facility located along Route 144 on the western bank of the Hudson River (the River) approximately 1.5 miles south of the Albany City boundary. The City of Rensselaer is located on the eastern bank of the River directly opposite ASGS. Portions of the Town of East Greenbush lie directly opposite and across the River from the plant site.

The ASGS includes four identical steam units. Plant construction started in 1950. Two units went into operation in 1952 and other two units went into operation in 1953 and 1954. The ASGS was originally designed to burn coal and has since been modified to burn residual oil (1970) and natural gas (1981).

The ASGS uses a once-through cooling system to cool and condense steam that drives the electric generating turbines. When the ASGS is operating, water is withdrawn from the River and circulated through condensers – large heat exchangers. Steam is exhausted into the condensers, is cooled and condensed back to water, which is then pumped back into the boilers to repeat the steam/electric generating process. Steam does not come in contact with River water circulated through the condensers.

Water is withdrawn from the River, circulated through the condensers, and discharged back into the River in a continual process. The water is discharged back into the River at slightly higher temperatures and the resulting thermal plume is quickly dispersed by currents. Previous studies conducted at the facility demonstrated that the thermal plume does not adversely impact the River aquatic community.

PSEGNYS's proposed BEC is a 750-MW, state-of-the-art combined cycle power plant that will use combustion turbines in conjunction with heat recovery steam generators and a new steam turbine. Natural gas will be the primary fuel, with low-sulfur distillate oil to be used as a secondary fuel. This approach employs the most efficient fossil-fueled electric generating technology currently available.

PSEGNYS's proposed design for BEC includes the use of a closed-loop cooling system with wet cooling towers. This system will reduce River water withdrawals by 98-99% and will be used in conjunction with state-of-the-art water intake technology employing wedgewire mesh screens. As documented in the SPDES permit application, this system will produce dramatic reductions in use of river water for cooling and substantially reduce the number of organisms entrained or impinged by the ASGS.

### **Alternative Cooling Systems Study**

The assessment of alternative cooling systems was conducted in response to a request for additional information on cooling system options made by various interested parties, including the New York State Department of Environmental Conservation (NYSDEC) and the New York State Department of Public Service (NYSDPS), and environmental organizations. The requests for additional information were submitted when the BEC was initially proposed by the previous plant owner. The assessment study examined the specific and relevant facts, impacts, and benefits associated with BEC to facilitate the necessary case-by-case review and BTA determination performed by NYSDEC in issuing the SPDES permit. PSEGNY made the study available and discussed its contents with regulators and interested individuals and organizations as part of the company's established commitment to stakeholders.

### **Alternatives Evaluated**

The study evaluated the proposed wet tower cooling system, various cooling system alternatives (i.e., once-through, wet/dry tower, and dry tower), and optional measures (i.e., aquatic filter barrier and a holding tank). The assessment of alternative technologies considered many factors including potential effects on system performance, air emissions, noise impacts, aesthetic impacts, aquatic impacts, and costs. In addition, quantifiable costs and benefits were compared in a cost/benefit analysis and a holistic evaluation was completed for quantifiable and non-quantifiable factors of the cooling system choices.

The four basic cooling system configurations that were evaluated included:

- ▶ **A once-through cooling system** similar to the one now in use at ASGS. In a once-through system, water is withdrawn directly from a sourcebody of water and pumped into heat exchangers (condensers), which condense steam exhausted from turbines back into water. Water is pumped into tubes in the condenser, absorbs heat from steam that flows over the condenser tubes, and then is discharged back into the source waterbody. The water is discharged at a higher temperature.
- ▶ **A closed loop system with wet cooling towers** as proposed by PSEGNY. In this system, water circulating through condenser tubes absorbs heat from steam and is circulated to mechanical draft cooling towers where the water is cooled through contact with ambient air. The water is then sent back to the condenser to repeat the process. With mechanical draft cooling towers, visible water vapor plumes are sometimes formed above the towers. These plumes dissipate as they mix with ambient air. This system reduces use of River water approximately 98-99% relative to the existing ASGS.
- ▶ **A closed loop system with wet/dry cooling towers.** These are mechanical draft cooling towers that incorporate features that, under specific ambient temperature and humidity conditions, can reduce the formation of water vapor plumes.
- ▶ **A closed loop system with dry cooling towers (air-cooled condenser).** This system uses finned-tubed steam/air heat exchangers directly to cool and condense steam and eliminates any significant evaporative water loss from the system minimizing the withdrawal of water. Dry cooling towers, however, require significant additional capital cost and the towers are considerably larger both in height and area than evaporative towers.

At the suggestion of the staffs of NYSDEC and NYSDPS, the study also included consideration of two modifications applicable to wet and wet/dry cooling tower systems to further reduce AEI. The suggested modifications include: (1) the use of an aquatic filter barrier (AFB) system consisting of a fabric filter designed to reduce the interaction of very small aquatic organisms with the cooling water intake, and (2) a water holding tank to allow daily sequenced pumping of river water to potentially reduce the entrainment of aquatic organisms. These modifications resulted in a total of seven alternatives to be considered for the proposed wet tower cooling system.



## Overview of Findings

After thoroughly considering all of the selected alternative cooling water intake technologies available to minimize potential adverse environmental impact, it was concluded that the wet tower cooling system constituted BTA given that the incremental costs of other practicable alternatives were wholly disproportionate to any environmental benefits which might be conferred by such measures. The wet tower cooling system represents a 98-99% reduction in losses of aquatic organisms as compared to the ASGS. Accordingly, any potential additional reductions in losses to aquatic organisms would likely be very small in comparison, and the effect of any such additional reductions would be very difficult to detect at a population level. Based on compounded conservative assumptions, the estimated Conditional Mortality Rates for target fish species (river herring, white perch, American shad, and striped bass) associated with wet tower cooling system range from a fraction of one percent to nearly zero.

The once through alternative compares less favorably to the wet tower cooling system from a BTA perspective since it provides considerably less environmental benefits at a higher capital construction cost. The once through cooling system alternative has a significantly higher flow and is not equipped with wedgewire screens. Consequently, impingement and entrainment estimates are significantly higher for a once-through system. The higher aquatic losses coupled with construction costs higher than that for the wet tower cooling system (because of the extensive underground piping required), make this alternative unattractive for this installation.

The wet towers with the holding tank alternative compares less favorably to the wet tower cooling system from a BTA perspective because the marginal additional reduction in aquatic effects is wholly disproportionate to the additional costs of this alternative. Moreover, the wet tower with holding tank alternative results in more incremental costs than the wet tower with Seasonal AFB alternative, but generates smaller incremental benefits. The actual effectiveness of the holding tank as a mitigation measure is not clear.

The wet/dry towers alternative compares less favorably to the wet tower cooling system from a BTA perspective because the marginal additional reduction in aquatic effects is likewise wholly disproportionate to the additional costs of this alternative. This alternative would require a slightly taller structure than the wet tower cooling system.

The wet/dry towers with holding tank alternative compares less favorably to the wet tower cooling system from a BTA perspective because the marginal additional reduction in aquatic effects is likewise wholly disproportionate to the additional costs of this alternative. The wet/dry towers with holding tank alternative results in more incremental costs than the wet/dry tower with seasonal AFB alternative, but generates smaller incremental benefits. In addition, the holding tank creates an additional visual impact. Moreover, as previously mentioned, the actual effectiveness of the holding tank as a mitigation measure is not clear.

The dry cooling towers alternative compares less favorably to the wet tower cooling system from a BTA perspective because the marginal additional reduction in aquatic effects is likewise wholly disproportionate to the substantial additional costs of this alternative. In addition, the large size of the structure is a significant negative visual impact. The dry cooling tower is also noisier than the wet tower cooling system. Moreover, this alternative is significantly less energy efficient, uses more fuel, and generates greater air emissions.

Based on the above assessments, the wet towers with seasonal AFB and wet/dry towers with seasonal AFB alternatives are superior to the once through, wet towers with holding tank, wet/dry towers, wet/dry towers with holding tank, and dry cooling tower alternatives, but compare less favorably to the wet tower cooling system. The wet towers with seasonal AFB alternative does not constitute BTA relative to the wet tower cooling system given that the marginal additional reduction in aquatic effects is wholly disproportionate to the additional costs of this alternative. Specifically, the incremental costs associated with this alternative as compared with the wet tower cooling system are 19 times the quantifiable incremental benefits associated with the reduced loss of fish. Moreover, the study's conclusions in this regard are predicated upon compounded conservative assumptions that overestimate the potential loss of aquatic organisms.

Likewise, the wet/dry towers with seasonal AFB alternative does not constitute BTA relative to the wet towers cooling system given that the marginal additional reduction in aquatic effects is wholly disproportionate to the additional costs of this alternative. Specifically, the incremental costs associated with this alternative as compared with the wet tower cooling system are 110 times the quantifiable incremental benefits associated with the reduced loss of fish. Moreover, the study's conclusions in this regard are predicated upon compounded conservative assumptions that overestimate the potential loss of aquatic organisms. In particular, the methodologies employed in the assessment do not take into account density dependent mechanisms (compensation) exhibited by fish populations.

On a qualitative basis, the wet tower cooling system compares favorably as a whole with all other alternatives. Specifically, the wet tower cooling system would provide less noise than every other alternative except once-through. With regard to aesthetics, the wet tower cooling system would create less visual impact than the existing structures or those associated with wet towers with holding tank or dry cooling towers. Any visual impact to nearby properties resulting from a cooling tower plume is expected to be slight when viewed within the context of the surrounding urban and industrial setting. Finally, from an energy conservation standpoint, the wet tower cooling system compares favorably with every other alternative, except once-through.

### **Public Participation Process**

The State of New York requires power plant siting applicants to implement a meaningful public involvement program. An applicant is expected to hold public meetings, offer presentations to individual groups and organizations, and establish a community presence to ensure that the concerns of all affected stakeholders are heard. PSEGNy established a website to provide up-to-date information on the project and notices of public meetings and other events. PSEGNy conducted public meetings in several locations in the vicinity of the plant and met numerous times with a number of individual groups and organizations.



**Figure 1 - Final Design**

### **Final Design of System**

The concerns identified in this process, as well as those of the regulatory agencies, were considered by NYSDEC and the New York State Board on Electric Generation Siting and the Environment in reaching their final decision on the cooling water system at BEC. The design required by NYSDEC and the Siting Board to comply with Administration policy consists of 2-mm wedgewire screens and a seasonally-deployed fixed-panel aquatic filter barrier system coupled with a hybrid (wt/dry) cooling tower to provide make-up water to the cooling tower and other service water needs. This design is more conservative than that recommended in PSEGNy's study, but was required to meet the administration's interpretation of BTA under the Clean Water Act, as well as the concerns of other stakeholders.

### **Fixed-Panel Aquatic Filter Barrier Configuration**

PSEGNy contracted Gunterboom to develop alternative AFB designs to minimize the structure's exposure at BEC to strong currents and floating and submerged debris (i.e., trees and tree branches) and to provide greater convenience for operation and maintenance. The result of these considerations led to the selection of a structural steel frame wall,

located immediately off the existing CWIS face, which will support fixed AFB panels. A pre-fabricated (H-pile and sheet pile) frame wall, approximately 146 feet in length, will be placed parallel to the existing bulkhead and accept a series of 12 framed panels. Two different framed panel sizes (7 “long panels” 9 ft x 40 ft and 5 “short panels” 9 ft x 30 ft) will be installed in the Fixed-Panel design. The panels are longer than needed to exceed the high water elevation (86 ft) providing additional freeboard to allow for rare extreme tides (usually due to storm surge) and waves. Because the Hudson River is influenced by tides near the BEC, the Fixed-Panel was designed to filter sufficient water to meet the NYSDEC required 5-gpm/ft<sup>2</sup> regardless of tidal stage. The fixed frame will have about 2,800-ft<sup>2</sup> (7 panels 9 ft x 30 ft and 5 panel 9 ft x 20 ft) total filtering area (2.1 gpm/ft<sup>2</sup> at 6000 gpm) at high tide and about 1,900- ft<sup>2</sup> (7 panels 9 ft x 22 ft and 5 panel 9 ft x12 ft) total filtering area (3.1 gpm/ft<sup>2</sup> at 6000 gpm) at low tide. Based on discussions with Gunderboom personnel, PSEGRY believed it was reasonable to oversize the filtering area in order to reduce the through-screen flow rates and associated velocities which will further minimize entrainment and impingement impacts and account for uncertainties in river flows in the Hudson River so overtopping does not occur.

The frames will be constructed with structural steel tubing that ensures structural integrity and rigidity while minimizing total weight. The fabric panels will be attached to the frames to ensure a positive seal around their perimeter. The overall structure would extend a minimum of 15 feet into the riverbed, and is seal-welded at each end to the existing intake structure wall to create a sealed enclosure. Openings in the wall (i.e., "panel slots") are framed on the bottom and two sides by steel channels, creating slots into which the aquatic filter panels slide. Each panel slot is slightly over 10 feet wide, and extends from above the high water line to within a few feet of the river bottom. When a panel is slipped into a slot, a thick rubber gasket on the bottom and sides of the panel creates a seal against the slot frame.

The steel pile wall segments will be installed using conventional pile-driving techniques. Shop fabrication will allow for very tight tolerances on panel and panel slot dimensions. Fit-up between panels and panel slots will be checked during fabrication to assure a good seal. Regular maintenance inspections will help ensure the integrity of the seals.

A compressed air cleaning system will be installed in each panel. The system will include two electric compressors: one compressor will act as the “lead” compressor and functions to keep the tanks at design pressure and the other or “lag” compressor will function if additional pressure is required or if the “lead” compressor fails. During the “break in” period the cleaning system will be set to cycle through the fixed panels on a fixed sequence to clean debris from the filter fabric. Cycle times will likely be adjusted for normal operation based on the information obtained during the break in period. Each panel is served by a pneumatic valve and air diffuser at the bottom of the filtration fabric in the panel. Controls will be mounted in the intake structure with system and warning readouts provided in the BEC control room.

The panels will be prepared for deployment on shore and deployed by an integrated overhead handling system or with a crane. Deployment will be scheduled at the end of March so all panels are installed by April 1. Panels will be removed for repairs or planned replacements when needed. After July 31, panels will be removed, examined, repaired if needed and stored for the winter. Replacement panels will be kept at BEC for rapid deployment should active panels experience any anomalies.

### **Monitoring**

BEC personnel on a frequent basis will visually monitor the AFB system during the deployment period. A video camera will be used to monitor the AFB panels and provided data to determine of whether anomalous conditions exist. In addition, diver inspections will be conducted upon initial deployment and then as needed based on trained station personnel reviewing the operation data. Future operation and monitoring will be adjusted based on observations during the first and subsequent years.

An entrainment monitoring program has been developed to coincide with the deployment of the AFB. The program will provide a measure of the effectiveness of the AFB in minimizing entrainment of aquatic organisms at BEC. During entrainment monitoring, samples will be collected inside and outside of the AFB. Sampling will be

conducted over 24-hour (hr) periods at weekly intervals from April through July. A sample period from April through July encompasses the peak period for the presence of ichthyoplankton in the Hudson River adjacent to the proposed BEC. Four, composite samples will be collected during each 24-hr period both in front of (outside) and behind (inside) the AFB panels.

Entrainment reports will be generated that summarize each annual sampling effort. Information on the species composition, relative abundance, and seasonal distribution of fish eggs, larvae, and juveniles, as appropriate, will be reported. Average weekly estimates for ichthyoplankton density (No/1000 m<sup>3</sup>) in front of and behind the AFB panels will be computed. The ratio of the ichthyoplankton density in front of (i.e., unprotected by) the fixed panels to the density behind the fixed panels will provide an index of how effective the AFB is in minimizing entrainment of fish eggs and larvae in the cooling water system at BEC.

The reports will present an evaluation of AFB effectiveness in minimizing entrainment and whether effectiveness is maintained during the proposed sampling period (i.e., April through July). In addition, physical indicator measurements (e.g., water level differentials, visual screen inspections) will be correlated with the biological effectiveness measurements to determine if one or more could be used in place of biological monitoring for future effectiveness/performance evaluations.

### **Summary**

The federal Clean Water Act (CWA), as implemented by New York State regulations, requires that the location, design, construction and capacity of cooling water intake structures (CWIS) reflect BTA for minimizing adverse environmental impact. New York regulators have noted that court decisions have established that the determination of what constitutes BTA is a site specific issue of fact which depends upon a variety of factors including the cost and age of the facility, impacts to aquatic populations, the additional energy, if any, needed to support improved technology, and other relevant concepts. Accordingly, New York regulators impose conditions on a “case by case basis”, consistent with the CWA.

In its alternatives study, PSEGENY presented site specific information regarding the location, design, construction and capacity of a cooling water intake structure to support a BTA decision. NYSDEC and the New York State Board on Electric Generation Siting and the Environment considered this site-specific information and concluded that a more conservative design was necessary to meet New York’s interpretation of best technology available. The more conservative design features include the addition of plume abatement on the cooling tower and a seasonally-deployed aquatic filter barrier system on the intake.

### **References**

PSEG Power New York Inc. (PSEGENY). 2001. Appendix M.2-Alternate Cooling System Study. In: Bethlehem Energy Center Supplement to Application for Certification of a Major Electric Generating Facility. Case 97-F-2162 under Article X of the New York State Public Service Law.

United States Environmental Protection Agency (EPA). 1976. Development Document for Best Technology Available for the location, Design, Construction and Capacity of Cooling Water Intake Structures for Minimizing Adverse Environmental Impact. EPA 440/1-76/015a. Washington, D.C.

---

### **Session D-3 Questions and Answers**

- Q. Dave Michaud, WE Energies, asked Peter Henderson, Pisces Conservation Ltd., and Mark Strickland, PSEG Services Corporation, about the light penetration at Lovett and Bowline. Is the water turbid or is there opportunity for light, and thereby for scavengers to colonize the material?
- A. Mr. Henderson stated that he thought light at Lovett doesn’t penetrate very far, so you won’t see much algal growth further down. The same conditions exist for Bowline, partly due to algal blooms on the surface.

Comment. Matthew Raffenberg, Lawler, Matusky, and Skelly Engineers, LLP, added that biological growth occurs only in the photic zone, and the waters are typically turbid at those plants.

Comment. Mr. Strickland, indicated the same conditions exist at Bethlehem.

Q. Gordon Hart, Performance Contracting, mentioned that William Dey, ASA Analysis & Communications, Inc., estimated through-screen velocity at 0.25 fps (feet per second), which is significantly less than the figure mentioned in a presentation by Steve Amaral, Alden Research Laboratory, Inc., this morning, which quoted 1-3 fps. Matthew Raffenberg's estimates, for the filter fabric barriers, according to my [back of the envelope] calculations were an order of magnitude lower than 0.25 fps. All of these estimates of velocities are very different. How are the areas selected to achieve these different velocities?

A. Mr. Dey said the velocity estimate of 0.25 fps was only important in terms of costing. Actually 0.5 fps is much closer to reality; 0.25 fps is very conservative for wedge wire. A. Mr. Amaral, Alden Research Laboratory, Inc., clarified that he had spoken about the louvers in the morning (in response to the 1-3 fps comment). Biologically, this is based on what the fish can avoid as per their swimming speeds (this varies by species and size classes, as well as among technologies). He stated that they observed low impingement and entrainment rates at the 0.5 fps velocity. The estimates differ for louvers and wedge wire screens. Even in the higher channel velocities (1 fps, for example), some eggs and larvae demonstrated low impingement and entrainment rates.

Comment. Mr. Raffenberg added that the selection of flow was initially based on what could pass the Gunderboom fabric. That's how they developed their estimate of 5 gallons per minute (gpm). Gunderboom is working to develop different fabric types and probably can elaborate further.

Comment. Ed Radle, NYSDEC, commented that when experimenting with fabric viability, they pasted the fabric to a barrel, sunk the barrel, and pumped water out of the barrel at different rates. At a very low rate the particles settled to the side and sloughed off. They developed the 5 gpm/square foot criteria based on observations that material impinged on the fabric filter cloth would slough off and no cleaning system would be required. He cautioned that the lesson learned is that laboratory experiments rarely mirror what happens in the field.

Q. Mr. Coutant, Oak Ridge National Laboratory, asked Peter Henderson: On biofouling tests that you mentioned in your presentation, was there flow? If it was static, at what point does the fabric itself become the impingement/entrainment problem?

A. Peter Henderson, Pisces Conservation Ltd. And Oxford University, replied that the example he gave was for static conditions where the only flow would be tidal movement. A contemporaneous study, done by Gunderboom using an airburst system, however, showed the same problems with colonization. There was appreciable growth. Mr. Henderson could not answer the second question; they are working on the issue of animals being pulled into the Gunderboom.

Q. Andy McCusker, Gunderboom Incorporated, stated that his background is in marine benthic biology. He found the Gunderboom results anomalous, as they have panels in place in the upper Hudson River, Sacramento River, and beaches in the Long Island Sound, which have been analyzed by third-party scientists, and have not demonstrated results similar to Mr. Henderson's. What they did find is an invasive species of hydroid. They would like to explain that the technology does not always demonstrate that level of biofouling.

Q. Kent Zammit, EPRI, asked Mr. McCusker, whether there is publicly available data for the panels that they tested at other sites. Second, are flows available as well for those panels? Third, can you comment on the effects of the backwashing system on minimizing biofouling in addition to the sedimentation?

A. Mr. McCusker explained that the panels at the other sites were static and did not have flows. Inspection results have not been made publicly available, but there are plans to do so.

A. Mr. Raffenberg explained, regarding the backwashing system described by Mr. McCusker, that the airburst system was in 4 feet of water and did not display the same kind of shaking of the fabric or expansion of the air bubbles that you get in 20-30 feet of water. Though it's site-specific, there is potential for the airburst system to reduce biofouling, particularly for Lovett.

Comment. Mr. McCusker explained that they observed a tube-building amphipod, *Corophium*, unsuccessfully attempt to perforate the airburst system.

Comment. Rick Wantuck, NOAA Fisheries in California, mentioned that there are presently four proposals in California for Gunderboom deployment. One has been formally permitted by his agency for a 5-year test program. All the questions that have been raised—biofouling in particular—are on Mr. Wantuck's mind, as are longevity and maintainability of the filter fabric. Other issues include debris impacts in flowing streams and anchoring in tidal environments. He concluded that this technology is worthy of more study and requires more evidence before it should be viewed as a panacea. In addition, it should be noted that the California proposals suggest year-round deployment, while New York based proposals are on a seasonal deployment basis.

Comment. Ed Radle, NYSDEC, stated that regarding maximum speed, the velocity at 5 gpm/ft<sup>2</sup> is equivalent to 0.01 fps, which is extremely slow. The limit would be driven by the swimming speed of the larvae in question, and there is little available literature on that. The experiment he did with shad showed that they did not orient to the flow at all. Mr. Radle read a section from the journal *Sea Technology*, the 2001 issue called *Aquaculture Beyond the Reef*. In summary, their research found that while biofouling was an issue during early deployment, the assemblage of herbivores around the technology rendered scrubbing unnecessary in time. The herbivores fed upon *Corophium* and other biofouling organisms. He said that this was a sales pitch for Gunderboom.

## Open Discussion: Identify Research Needs

The final session of the symposium provided participants with an open, informal forum to discuss intake technology research priorities. Participants geared their comments toward several topic areas that arose as central themes during the course of the symposium. Participants framed their comments around the outlined topics presented by the facilitator and developed an ideal research "wish list" for future research. Participants' discussions ranged from perceived data gaps to specific technology performance to long-term implementation issues. The following outline summarizes the comments made during this session:

### **I. LONG TERM VIEW**

- A. Permit Renewal Cycle
- B. Short-Term Permits for Study
- C. Recognition of Site Specifics
- D. Receptivity to Good Faith Efforts
- E. Implementation Workshops
- F. Potential for EPA Model Permits

### **II. RESEARCH PRIORITIES**

- A. Wedge Wire Screen Performance
- B. Aquatic Filter Barrier—full-scale study needed
- C. Ecosystem Impacts- review data collected over the years to examine population effects
- D. Advanced Cooling Concepts, such as
  1. Degraded Water Sources
  2. Dry Cooling
  3. Cooling with Other Fluids
- E. Optimizing Cooling Tower Retrofits
- F. Combinations of Technologies and/or Operational Measures, such as
  1. Physical with Behavioral
  2. Louvers with Fish Handling
  3. Ristroph Screens with Fine Mesh
  1. Gunderboom with Bypass System—are both needed?
- G. Biofouling Avoidance and Treatment—need better understanding of biofouling-induced pressure drops

### **III. WIRE SCREEN PERFORMANCE**

- A. Biofouling in Brackish and Marine Environments
- B. EPRI study on wedge wire screen laboratory study should be out by the end of the month

### **IV. AQUATIC FILTER BARRIER**

- A. Need additional research on survivability/durability

### **V. BIOFOULING AVOIDANCE AND TREATMENT**

- A. Increases flow resistance—is there information available on pressure losses due to biofouling?
- B. There is information available on zebra mussels worthy of review from international conferences worthy of review
- C. Additional information may be obtained from the following sources:
  - [www.waterscreen.com](http://www.waterscreen.com);
  - New York Sea Grant;
  - Florida Marine Research Institute

**VI. DATA GAPS AND COMMENTS**

- A. Concern was expressed regarding lack of time to work through biological testing
- B. Practical need for training program on identification of fish eggs and larvae
- C. More research on fine mesh traveling screens
- D. Need to investigate whether improvements in impingement and entrainment mitigation demonstrate positive impacts in the water body
- E. Difficult to “tease out” anthropogenic effects from natural variation
- F. Data is available for certain localities on population effects (for example, Hudson River, Salem studies) over long periods of time (lacking in others)
- G. Recent study on relationship between fish community and water withdrawal showed no relationship or increased productivity
- H. Need for continued study on population effects (multiple causes/ theories, such as density dependence theory, compensatory rebounding mechanisms)
- I. Focus on small-scale sites for long-term population/community studies
- J. Need for both broad research on aquatic ecosystems and specific field studies on existing technologies (performance, safety, long-term stability)
- K. Need additional benefits studies
- L. Need to prevent outages at key nuclear and fossil facilities
- M. Need to avoid physiological exhaustion in favor of gentler technologies; also need to prevent colonization by exotic species
- N. How to translate from site-specificity to broader applications (identify common elements)
- O. Focus on physical and chemical means to prevent impingement; specifically, a combination of physical barriers with chemical (non-toxic) control
- P. Need to consider impacts on sea turtles—what technologies are useful in preventing impingement and entrainment of turtles?
- Q. Link cooling water data with other data on populations and survival
- R. Need to address predation at Cooling Water Intakes
- S. Need to create a mechanism for sharing operational measures (tips, success stories, etc.)
- T. Given uneven nature of available data, need to investigate potential utility of “gray literature”



## **Appendices**

**Appendix A: Steering Committee Members**

**Appendix B: List of Symposium Attendees**

**Appendix C: Slide Presentations**

**Appendix D: Poster Abstracts**

**Appendix E: Vendor Displays**

## **Appendix A: Steering Committee Members**

## **Appendix A: Steering Committee Members**

### **Scott Minamyer, Chair of the Organizing Committee**

USEPA Office of Research and Development

minamyer.scott@epa.gov

### **Ashley Allen**

USEPA Office of Water

allen.ashley@epa.gov

### **David Bailey**

Mirant Corporation and Utility Water Act Group

david.e.bailey@mirant.com

### **Thomas Bigford**

NOAA, National Marine Fisheries Service

thomas.bigford@noaa.gov

### **Thomas Feeley**

DOE, National Energy Technology Laboratory

thomas.feeley@netl.doe.gov

### **Robert Gross**

DOE, National Energy Technology Laboratory

robert.gross@netl.doe.gov

### **Lisa Kline**

Atlantic States Marine Fisheries Commission

lkline@asmfc.org

### **Deborah Nagle**

USEPA Office of Water

nagle.deborah@epa.gov

### **Martha Segall**

USEPA Office of Water

segall.martha@epa.gov

### **Carrie Selberg**

Atlantic States Marine Fisheries Commission

cselberg@asmfc.org

### **Reed Super**

River Keeper, Inc.

rsuper@riverkeeper.org

### **Tom Wall**

USEPA Office of Water

wall.thomas@epa.gov

### **Kent Zammit**

Electric Power Research Institute

kezammit@epri.com

## **Appendix B: List of Symposium Attendees**

# Attendee List

## A Symposium on Cooling Water Intake Technologies to Protect Aquatic Organisms May 6-7, 2003 Arlington, VA

John Achenbach  
Kinectrics North America  
6942 Berkshire Drive  
Exponr, PA 15632  
Phone: 724-387-2959  
Fax: 724-387-2958  
E-mail: john.achenbach@kinectrics.com

Stephen Amaral  
Alden Research Laboratory, Inc.  
30 Shrewsbury Street  
Holden, MA 1520  
Phone: 508-829-6000  
Fax: 508-829-5939  
E-mail: amaral@aldenlab.com

David Bailey  
Mirant Mid-Atlantic  
8711 Westphalia Road  
Upper Marlboro, MD 20774  
Phone: 301-669-8019  
Fax: 301-669-8209  
E-mail: david.e.bailey@mirant.com

John Balletto  
Public Service Enterprise Group  
Environment, Health and Safety Department  
80 Park Plaza, T17-A  
Newark, NY 7101  
Phone: 973-430-8531  
Fax: 973-623-7758  
E-mail: john.balletto@pseg.com

Thomas Barron  
Pennsylvania Department of Environmental Protection  
Bureau of Water Supply & Wastewater Mgmt.  
400 Market Street, 11th Floor, RCSOB  
Harrisburg, PA 17105-8467  
Phone: 717-787-9614  
Fax: 717-772-3249  
E-mail: tbarron@state.pa.us

Dennis Baxter  
Tennessee Valley Authority  
Regulatory Affairs/Environmental Management  
400 W. Summit Hill Drive  
Knoxville, TN 37902-1499  
Phone: 423-632-8104  
Fax: 423-632-6855  
E-mail: dsbaxter@tva.gov

Ashley Allen  
U.S. Environmental Protection Agency  
Ariel Rios Building  
1200 Pennsylvania Avenue, NW, Mail Code: 4303T  
Washington, DC 20460  
Phone: 202-566-1012  
Fax: 202-566-1053  
E-mail: allen.ashley@epa.gov

Scott Arentsen  
Dayton Power & Light Company  
1065 Woodman Drive  
Dayton, OH 45432  
Phone: 937-259-7375  
Fax: 937-259-7178  
E-mail: scott.arentsen@dplinc.com

James Baker  
Tetra Tech EM Inc.  
3334 Richmond Avenue, Suite 200  
Houston, TX 77098  
Phone: 713-520-7667  
Fax: 713-524-9866  
E-mail: jim.baker@ttemi.com

David Barritt  
Smith-Root  
14014 NE Salmon Creek Avenue  
Vancouver, WA 98686  
Phone: 360-573-0202  
Fax: 360-573-2064  
E-mail: barritt@smith-root.com

Ellen Baum  
Clean Air Task Force  
269 White Road  
Bowdoinham, ME 4008  
Phone: 207-666-5676  
Fax: 207-666-8841  
E-mail: ebaum@catf.us

Faysal Bekdash  
SAIC  
11251 Roger Bacon Drive  
Reston, VA 20190  
Phone: 703-318-4793  
Fax: 703-736-0826  
E-mail: faysal.bekdash@saic.com

# Attendee List

## A Symposium on Cooling Water Intake Technologies to Protect Aquatic Organisms May 6-7, 2003 Arlington, VA

Mark Bell  
Bracket Green USA  
4235 South Victoria Circle  
New Berlin, WI 53151  
Phone: 262-853-4459  
E-mail: markbell@bgusa.com

Tom Bigford  
National Oceanic and Atmospheric Administration  
(NOAA) Fisheries  
1315 East-West Highway, Room 4100, F/HC2  
Silver Spring, MD 20910  
Phone: 301-713-4300  
Fax: 301-713-4305  
E-mail: Thomas.Bigford@noaa.gov

Craig Bleth  
Minnkota Power Cooperative, Inc.  
Box 127  
Center, ND 58530  
Phone: 701-794-7261  
Fax: 701-794-7258  
E-mail: cbleth@minnkota.com

Jason Bockel  
Montana-Dakota Utilities Company  
400 N. 4th Street  
Bismarck, ND 58501  
Phone: 701-222-7657  
Fax: 701-222-7845  
E-mail: jason.boeckel@mdu.com

Marilyn Booth  
Conectiv Energy  
P.O. Box 6066  
Newark, DE 19714  
Phone: 302-451-5013  
Fax: 302-451-5353  
E-mail: marilyn.booth@conectiv.com

Jack Bragg  
Intralox Corporation  
P.O. Box 183  
LaCrosse, FL 32658  
Phone: 386-462-5852  
Fax: 386-462-7323  
E-mail: jack.bragg@intralox.com

Peter Bestein  
Kleinschmidt Associates  
161 River Street  
Deep River, CT 6417  
Phone: 860-526-2358  
Fax: 860-526-2768  
E-mail: peter.bestein@kleinschmidtusa.com

Jonathan Black  
Alden Research Laboratory, Inc.  
30 Shrewsbury Street  
Holden, MA 01520-1843  
Phone: 508-829-6000  
Fax: 508-829-5939  
E-mail: jblack@aldenlab.com

Elicia Blumberg  
Tetra Tech, Inc.  
10306 Eaton Place, Suite 340  
Fairfax, VA 22030  
Phone: 703-385-6000  
Fax: 703-385-6007  
E-mail: elicia.blumberg@tetrattech-ffx.com

Raymond Bogardus  
BHE Environmental Inc.  
7041 Maynardville Highway  
Knoxville, TN 37918  
Phone: 865-922-3264  
Fax: 865-922-8495  
E-mail: rbogie@aol.com

Richard Bozek  
Edison Electric Institute  
701 Pennsylvania Avenue, NW  
Washington, DC 20004-2696  
Phone: 202-508-5641  
Fax: 202-508-5150  
E-mail: rbozek@eei.gov

Kevin Bromberg  
US Small Business Administration  
409 3rd Street, SW  
Washington, DC 20416  
Phone: 202-205-6964  
Fax: 202-205-6928  
E-mail: kevin.bromberg@sba.gov

# Attendee List

## A Symposium on Cooling Water Intake Technologies to Protect Aquatic Organisms May 6-7, 2003 Arlington, VA

Ron Brown  
Dielectric-Flash Technology  
323 Nichol Mill Lane  
Franklin, TN 37607  
Phone: 615-261-2000  
Fax: 615-261-2600  
E-mail: ron.e.brown@dielectric.spx.com

Kristy Bulleit  
Hunton & Williams  
1900 K Street, NW, Suite 1200  
Washington, DC 20006  
Phone: 202-955-1547  
Fax: 202-778-2201  
E-mail: kbulleit@hunton.com

Rayburn Butts  
Florida Power & Light Company  
700 Universe Blvd.  
Juno Beach, FL 33408  
Phone: 561-691-7040  
Fax: 561-691-7070  
E-mail: rbutts@fpl.com

Concepcion Cahanap  
U.S. Environmental Protection Agency  
Ariel Rios Building  
1200 Pennsylvania Avenue, NW, Mail Code: 4303T  
Washington, DC 20460  
Phone: 202-566-1382  
E-mail: cahanap.concepcion@epa.gov

Todd Callaghan  
Massachusetts Coastal Zone Management  
251 Causeway Street, Suite 900  
Boston, MA 2114  
Phone: 617-626-1233  
Fax: 617-626-1240  
E-mail: todd.callaghan@state.ma.us

John Carnright  
Dynergy Northeast Generation, Inc.  
992-994 River Road  
Newburgh, NY 12550  
Phone: 845-563-4965  
Fax: 845-563-4992  
E-mail: john.a.carnright@dynergy.com

John Chang-Chen  
U.S. Environmental Protection Agency, Region 2  
290 Broadway  
New York, NY 10278  
Phone: 212-637-3867  
Fax: 212-637-3887  
E-mail: chang-chen.john@epa.gov

Kevin Bryson  
Shaw Environmental & Infrastructure, Inc.  
3 Executive Campus  
Cherry Hill, NJ 8002  
Phone: 856-482-3677  
Fax: 856-482-3155  
E-mail: kevin.bryson@shawgrp.com

Thomas Burns  
Merck and Company  
Two Merck Drive, WS2W-16  
Whitehouse Station, NJ 8889  
Phone: 908-423-5215  
Fax: 908-735-1109  
E-mail: thomas\_burns@merck.com

Mark Buzel  
AES New York  
720 Riverside Drive  
Johnson City, NY 13790  
Phone: 607-729-6950  
Fax: 607-729-0540  
E-mail: mark.buzel@aes.com

Michael Calaban  
New York State Department of Environmental  
Conservation, Steam Electric Unit  
625 Broadway  
Albany, NY 12233-4756  
Phone: 518-402-8857  
Fax: 518-402-8925  
E-mail: mjcalaba@gw.dec.state.ny.us

Johan Carlsson  
Tech-X Corporation  
5541 Central Avenue, Suite 135  
Boulder, CO 80301  
Phone: 303-443-8824  
Fax: 303-448-7756  
E-mail: johan@txcorp.com

Jennifer Chan  
U.S. Environmental Protection Agency  
Ariel Rios Building  
1200 Pennsylvania Avenue, NW, Mail Code: 4303T  
Washington, DC 20460  
Phone: 202-566-1078  
E-mail: chan.jennifer@epa.gov

Terry Cheek  
GeoSyntec Consultants  
1100 Lake Hearn Drive, Suite 200  
Atlanta, GA 30342  
Phone: 404-236-7281  
Fax: 404-705-9400  
E-mail: tcheek@GeoSyntec.com

# Attendee List

## A Symposium on Cooling Water Intake Technologies to Protect Aquatic Organisms May 6-7, 2003 Arlington, VA

Ed Chrisp  
Nebraska Public Power District  
1414 15th Street  
Columbus, NE 68601  
Phone: 402-563-5687  
Fax: 402-563-5168  
E-mail: eychris@nppd.com

Richard Coniglio  
USFilter Envirex Products  
100 Highpoint Drive, Suite 101  
Chalfont, PA 18914  
Phone: 215-712-7063  
Fax: 215-996-1156  
E-mail: coniglior@usfilter.com

Ryan Cook  
Cook Legacy Coating Company, Inc.  
12454 Parliament Drive  
Baltimore, OH 43105  
Phone: 614-833-4745  
Fax: 614-833-4724  
E-mail: ryanacook15@hotmail.com

Ruby Cooper  
U.S. Environmental Protection Agency  
Water Permits Division  
1200 Pennsylvania Avenue, Mail Code: 4203M  
Washington, DC 20460  
Phone: 202-564-0757  
Fax: 202-564-6431  
E-mail: cooper.ruby@epa.gov

John Cruze  
ConocoPhillips  
600 North Dairy Ashford, MA 1054  
Houston, TX 77079-1175  
Phone: 281-293-2859  
Fax: 281-293-2774  
E-mail: john.a.cruze@conocophillips.com

Daniel Cunningham  
Con Edison Company of New York  
4 Irving Place, Room 817  
New York, NY 10003  
Phone: 212-460-2066  
Fax: 212-387-2142  
E-mail: cunninghamda@coned.com

Steve Cibiki  
ENSR International  
7041 Old Wake Forest Road, Suite 103  
Raleigh, NC 27616  
Phone: 919-872-6600  
Fax: 919-872-7996  
E-mail: scibik@ensr.com

Timothy Connor  
U.S. Environmental Protection Agency  
Ariel Rios Building  
1300 Pennsylvania Avenue, NW, Mail Code: 4303T  
Washington, DC 20460  
Phone: 202-566-1059  
Fax: 202-566-1054  
E-mail: connor.timothy@epa.gov

Thomas Cook  
Alden Research Laboratory, Inc.  
30 Shrewsbury Street  
Holden, MA 01520-1843  
Phone: 508-829-6000  
Fax: 508-829-5939  
E-mail: tcook@aldenlab.com

Charles Coutant  
Oak Ridge National Laboratory  
Environmental Sciences Division  
P.O. Box 2008  
Oak Ridge, TN 37831-6031  
Phone: 865-576-6830  
Fax: 423-576-3989  
E-mail: ccoutantcc@ornl.gov

Jon Cudworth  
Tetra Tech NUS  
900 Trail Ridge Road  
Aiken, SC 29803  
Phone: 803-649-7963  
Fax: 803-642-8454  
E-mail: cudworthj@ttnus.com

Richard D'Amato  
CH2M Hill  
4824 Parkway Plaza Blvd., Suite 200  
Charlotte, NC 28217  
Phone: 704-957-7823  
Fax: 704-329-0141  
E-mail: rdamato@ch2m.com



# Attendee List

## A Symposium on Cooling Water Intake Technologies to Protect Aquatic Organisms May 6-7, 2003 Arlington, VA

Susan Damron  
Los Angeles Department of Water and Power  
111 North Hope Street, Room 1213  
Los Angeles, CA 90012  
Phone: 213-367-0279  
Fax: 213-367-3377  
E-mail: susan.damron@water.ladwp.com

Leslie Darman  
U.S. Environmental Protection Agency  
Office of General Counsel  
1200 Pennsylvania Avenue, NW, Mail Code: 2355A  
Washington, DC 20460  
Phone: 202-564-5452  
Fax: 202-564-5477  
E-mail: darman.leslie@epa.gov

Adam Davis  
EPRI Solutions  
1299 Fourth Street, Suite 307  
San Rafael, CA 94901  
Phone: 415-454-8800  
Fax: 415-4548012  
E-mail: adavis@epriolutions.com

Sidina Dedah  
SAIC  
11251 Roger Bacon Drive  
Reston, VA 20190

Melissa DeSantis  
Tetra Tech, Inc.  
10306 Eaton Place, Suite 340  
Fairfax, VA 22030  
Phone: 703-385-6000  
Fax: 703-385-6007  
E-mail: desanme@tetratech-ffx.com

William Desvousges  
Triangle Economic Research  
2775 Meridian Parkway  
Durham, NC 27713  
Phone: 919-544-2244  
Fax: 919-544-3935  
E-mail: wdesvousges@ter.com

Lynn DeWald  
Entergy Nuclear Vermont Yankee  
320 Governor Hunt Road  
Vernon, VT 5354  
Phone: 802-258-5526  
Fax: 802-258-5509  
E-mail: ldewald@entergy.com

William Dey  
ASA Analysis & Communications, Inc.  
51 Old State Road  
Wappingers Falls, NY 12590  
Phone: 914-831-4365  
Fax: 914-832-4365  
E-mail: wdey@asaac.com

Douglas Dixon  
EPRI  
7905 Berkeley Drive  
Gloucester Point, VA 23062  
Phone: 804-642-1025  
Fax: 804-642-2211  
E-mail: ddixon@epri.com

Steve Dixon  
PG&E, National Energy Group  
7500 Old Georgetown Road  
Bethesda, MD 20814  
Phone: 301-280-6755  
Fax: 301-913-5850  
E-mail: stephen.dixon@neg.pge.com

Robert Domermuth  
PPL Generation, LLC  
2 North 9th Street, Mail Stop GENN5  
Allentown, PA 18101  
Phone: 610-774-4849  
Fax: 610-774-4759  
E-mail: rbdomermuth@pplweb.com

Mahendra Doshi  
GEA Integrated Cooling Technologies  
13717 Halliford Drive  
Tampa, FL 33624  
Phone: 813-908-2129  
Fax: 813-908-2130  
E-mail: modoshi@geaict.com

Jim Dougherty  
Conectiv Energy  
200 Hay Road  
Wilmington, DE 14805  
Phone: 302-761-7020  
Fax: 302-761-7850  
E-mail: jim.dougherty@conectiv.com

Bob Dove  
Gunderboom, Inc.  
9401 King Street, Suite A  
Anchorage, AK 99515  
Phone: 907-644-5000  
E-mail: wdove@gunderboom.com

# Attendee List

## A Symposium on Cooling Water Intake Technologies to Protect Aquatic Organisms May 6-7, 2003 Arlington, VA

John Downing  
Shaw Environmental & Infrastructure, Inc.  
Three Riverside Drive  
Andover, MA 1810  
Phone: 978-691-2189  
Fax: 978-691-2101  
E-mail: john.downing@shawgrp.com

John Dunn  
U.S. Environmental Protection Agency  
Water, Wetlands, & Pesticides Division  
901 North Fifth Street  
Kansas City, KS 66101  
Phone: 913-551-7594  
Fax: 913-551-7765  
E-mail: dunn.john@epa.gov

Julianne Duwel  
P.O. Box 5419  
Hagatna, GU 96932  
Phone: 671-734-1435  
Fax: 671-734-1437  
E-mail: jtduwel@earthlink.net

Mark Elliott  
Conectiv Energy  
200 Hay Road  
Wilmington, DE 19899  
Phone: 302-761-7016  
Fax: 302-761-7050  
E-mail: mark.elliott@conectiv.com

Thomas Englert  
Lawler, Matusky and Skelly Engineers, LLP  
One Blue Hill Plaza, 12th Floor  
Pearl River, NY 10965  
Phone: 845-735-8300  
Fax: 845-735-7466  
E-mail: tenglert@lmseng.com

David Evans  
Santee Cooper  
One Riverwood Drive, Mail Code A203  
Moncks Corner, SC 29461  
Phone: 843-761-8000  
Fax: 843-761-4114  
E-mail: dlevans@santecooper.com

Thomas Feeley  
Department of Energy  
National Energy Technology Laboratory  
P.O. Box 10940, 626 Cochrans Mill Road  
Pittsburgh, PA 15236  
Phone: 412-386-6134  
Fax: 412-386-4822  
E-mail: thomas.feeley@netl.doe.gov

Hal Dreyer  
Gunderboom, Inc.  
9401 King Street, Suite A  
Anchorage, AK 99515  
Phone: 907-644-5000  
E-mail: hdreyer@gunderboom.com

Gary Dupre  
Santee Cooper  
One Riverwood Drive, Mail Code A203  
Moncks Corner, SC 29461  
Phone: 843-761-8000  
Fax: 843-761-4114  
E-mail: mgdupre@santecooper.com

Jim Elder  
11328 Woodbrook Lane  
Reston, VA 20194  
Phone: 703-904-9528  
E-mail: elderjim@msn.com

William Elzinga  
MACTEC, Inc.  
3199 Riverport Tech Center Drive  
St. Louis, MO 63043  
Phone: 314-209-5957  
Fax: 314-209-5929  
E-mail: wjelzinga@mactec.com

Bill Evans  
GA Power Co.  
245 Ralph McGill Blvd.  
Atlanta, GA 30308  
Phone: 404-506-7031  
Fax: 404-506-1499  
E-mail: wrevans@southernco.com

Nancy Evans  
PPL Corporation  
Two North Ninth Street, Mail Stop A2-4  
Allentown, PA 18101  
Phone: 610-774-4309  
Fax: 610-774-5930  
E-mail: naevans@pplweb.com

Leslie Fishbeck  
Ecology and Environment, Inc.  
1700 N. Moore Street, Suite 1610  
Arlington, VA 22201  
Phone: 703-522-6065  
E-mail: lfishbeck@ene.com

# Attendee List

## A Symposium on Cooling Water Intake Technologies to Protect Aquatic Organisms May 6-7, 2003 Arlington, VA

Robert Fitzgerald  
Goodwin Procter LLP  
Exchange Place  
Boston, MA 2109  
Phone: 617-570-1343  
Fax: 617-227-8591  
E-mail: rfitzgerald@goodwinprocter.com

Bradley Foss  
Dairyland Power Cooperative  
3200 East Avenue South  
La Crosse, WI 54602-0817  
Phone: 608-787-1492  
Fax: 608-787-1490  
E-mail: bpf@dairynet.com

James French  
Collector Wells International, Inc.  
6360 Huntley Road  
Columbus, OH 43229  
Phone: 614-888-6263  
Fax: 614-888-9208  
E-mail: jafrench@collectorwellsint.com

Bill Garrett  
Alabama Power Company  
P.O. Box 2641, G.S.C. #8  
Birmingham, AL 35291  
Phone: 205-664-6168  
Fax: 205-664-6309  
E-mail: wegarret@southernco.com

Alan Gaulke  
American Electric Power  
Environmental Services Division  
P.O. Box 16631  
Columbus, OH 43216-6631  
Phone: 614-716-1242  
Fax: 614-716-1252  
E-mail: aegaulke@aep.com

Mark Gerath  
ENSR  
2 Technology Park Drive  
Westford, MA 1886  
Phone: 978-589-3189  
Fax: 978-589-3282  
E-mail: mgerath@ensr.com

William Gillespie  
NCASI  
Box 13318  
Research Triangle Park, NC 27709-3318  
Phone: 919-558-1990  
Fax: 919-558-1998  
E-mail: wgillespie@ncasi.org

Kari Fleming  
Wisconsin Department of Natural Resources  
101 S. Webster Street, P.O. Box 7921  
Madison, WI 53707-7921  
Phone: 608-267-7663  
Fax: 608-267-2800  
E-mail: kari.fleming@dnr.state.wi.us

Harold Frediani  
Tetra Tech FW, Inc.  
210 Hollyridge Drive  
Roswell, GA 30076  
Phone: 770-645-4721  
Fax: 770-645-0605  
E-mail: frediani@mindspring.com

Stephaen Friant  
Entrix, Inc.  
10 Corporate Commons  
New Castle, DE 19803  
Phone: 302-395-1919  
Fax: 302-395-1920  
E-mail: sfriant@entrrix.com

Robert Gatton  
CH2M Hill  
777 108th Avenue, NE  
Bellevue, WA 98004-5118  
Phone: 425-453-5000  
Fax: 423-468-3100  
E-mail: rgatton@ch2m.com

Paul Geoghegan  
Normandeau Associates, Inc.  
25 Nashua Road  
Bedford, NH 3110  
Phone: 603-472-5191  
Fax: 603-471-8007  
E-mail: pgeoghegan@normandeau.com

Nancy Gilbreath  
Southern Company Services, Inc.  
241 Ralph McGill Blvd., Suite 10221  
Atlanta, GA 30308  
Phone: 404-506-1309  
Fax: 404-506-1499  
E-mail: njgilbre@southernco.com

Gary Goeke  
Ecology and Environment, Inc.  
220 West Garden Street, Suite 404  
Pensacola, FL 32501  
Phone: 850-435-8925  
Fax: 850-435-9135  
E-mail: ggoeke@ene.com

# Attendee List

## A Symposium on Cooling Water Intake Technologies to Protect Aquatic Organisms May 6-7, 2003 Arlington, VA

Philip Goldstein  
Ross & Hardies  
65 East 55th Street  
New York, NY 10022  
Phone: 212-418-0615  
Fax: 212-715-2315  
E-mail: philip.goldstein@rosshardies.com

Shari Goodwin  
Tetra Tech, Inc.  
10306 Eaton Place, Suite 340  
Fairfax, VA 22030  
Phone: 703-385-6000  
Fax: 703-385-6007  
E-mail: shari.goodwin@tetrattech-ffx.com

Mick Greeson  
Progress Energy  
P.O. Box 1551, PEB 4A  
Raleigh, NC 27602-1551  
Phone: 919-546-5438  
Fax: 919-546-6153  
E-mail: mick.greeson@pgnmail.com

Robert Gross  
U.S. Department of Energy  
National Energy Technology Laboratory  
3532 Collins Ferry Road, P.O. Box 880  
Morgantown, WV 26507-0880  
Phone: 304-285-4374  
Fax: 304-285-1301  
E-mail: Robert.gross@netl.doe.gov

John Gulvas  
Consumers Energy Company  
Environmental Department  
1945 W. Parnall Road  
Jackson, MI 49201  
Phone: 517-788-1285  
Fax: 517-788-2329  
E-mail: jagulvas@cmsenergy.com

Paul Harmon  
Normandeau Associates, Inc.  
3450 Schuylkill Road  
Spring City, PA 19475  
Phone: 610-948-4700  
Fax: 610-948-4752  
E-mail: pharmon@normandeau.com

Ed Hartowicz  
Third Rock Consultants, LLC  
2514 Regency Road, Suite 104  
Lexington, KY 40503  
Phone: 859-977-2000  
Fax: 859-977-2001  
E-mail: ehartowicz@thirdrockconsultants.com

Charles Goodman  
Southern Company  
600 North 18th Street, P.O. Box 2641  
Birmingham, AL 35203  
Phone: 205-257-6325  
Fax: 205-257-7938  
E-mail: chgoodma@southernco.com

Darrel Graziani  
Tetra Tech FW, Inc.  
759 S. Federal Highway, Suite 100  
Stuart, FL 34994  
Phone: 772-718-3413  
Fax: 772-781-3411  
E-mail: dgraziani@fwenc.com

Christopher Gross  
KeySpan Energy  
175 E. Old Country Road  
Hicksville, NY 11801  
Phone: 516-545-2561  
Fax: 516-545-2582  
E-mail: agross@keyspanenergy.com

Benjamin Grumbles  
U.S. Environmental Protection Agency  
Office of Water  
1200 Pennsylvania Avenue, NW  
Washington, DC 20460  
Phone: 202-566-5700  
E-mail: grumbles.benjamin@epa.gov

Keith Hanson  
Minnesota Power  
30 W. Superior Street  
Duluth, MN 55802  
Phone: 218-722-5642  
Fax: 218-723-3916  
E-mail: khanson@mnpower.com

Gordon Hart  
Performance Contracting, Inc.  
4025 Bonner Industrial Drive  
Shawnee, KS 66226  
Phone: 913-441-0100  
Fax: 913-441-0953  
E-mail: Gordon.Hart@pcg.com

Laszlo Hary  
Mirant Corporation  
1155 Perimeter Center West  
Atlanta, GA 30338-5416  
Phone: 678-579-6620  
Fax: 678-579-6993  
E-mail: laszlo.hary@mirant.com

# Attendee List

## A Symposium on Cooling Water Intake Technologies to Protect Aquatic Organisms May 6-7, 2003 Arlington, VA

Tim Havey  
Tetra Tech, Inc.  
3775 Iris Avenue, Suite 404  
Boulder, CO 80301  
Phone: 720-406-9110  
Fax: 720-406-9114  
E-mail: tim.havey@tetratech-ffx.com

Peter Henderson  
Pisces Conservation Ltd.  
The Square  
Pennington, Lymington SO41 8GN UK  
Phone: 44 1590 676622  
E-mail: peter@irchouse.demon.co.uk

David Hibbs  
Barr Engineering  
450 South Wagner Road  
Ann Arbor, MI 48105  
Phone: 734-327-1200  
Fax: 734-327-1212  
E-mail: dhibbs@barr.com

Ron Hix  
Florida Power & Light Company  
700 Universe Blvd.  
Juno Beach, FL 33408  
Phone: 561-691-7641  
Fax: 561-691-7049  
E-mail: ron\_hix@fpl.com

Peter Hofmann  
CH2M Hill  
4350 W. Cypress Street, Suite 600  
Tampa, FL 33607  
Phone: 813-874-0777  
Fax: 813-874-3056  
E-mail: phofmann@ch2m.com

Jay Holbus  
Tetra Tech NUS  
20251 Century Blvd., Suite 200  
Germantown, MD 20855  
Phone: 301-528-3030  
Fax: 301-528-3000  
E-mail: holbusj@ttnus.com

John Holsapple  
Environmental Energy Alliance of New York  
1125 Broadway  
Albany, NY 12204  
Phone: 518-433-3306  
Fax: 518-433-3716  
E-mail: john.holsapple@us.ngrid.com

Douglas Heimbuch  
AKRF, Inc.  
7250 Parkway Drive, Suite 210  
Hanover, MD 21076  
Phone: 410-712-4848  
Fax: 410-712-4966  
E-mail: douglas\_heimbuch@akrf.com

Cheryl Hess  
Conectiv Energy  
P.O. Box 6066  
Newark, DE 19714  
Phone: 302-451-5081  
Fax: 302-451-5353  
E-mail: cheryl.hess@conectiv.com

Donna Hill  
Southern Company Services, Inc.  
Environmental Assessment Department  
608 N. 18th Street, Mail Bin 14N-8195  
Birmingham, AL 35291  
Phone: 205-257-5234  
Fax: 205-257-7294  
E-mail: dbhill@southernco.com

Britt Hodanger  
Intralox  
201 Laitram Lane  
Harahan, LA 70123  
Phone: 504-733-6739  
Fax: 504-734-0063  
E-mail: britt.hodanger@intralox.com

Timothy Hogan  
Alden Research Laboratory, Inc.  
30 Shrewsbury Street  
Holden, MA 1520  
Phone: 508-829-6000  
Fax: 508-829-5939  
E-mail: thogan@aldenlab.com

Bryan Holcomb  
Exelon Peach Bottom  
1848 Lay Road, Mail Stop S2-9  
Delta, PA 17314  
Phone: 717-456-3182  
Fax: 717-456-3633  
E-mail: bryan.holcomb@exeloncorp.com

Fred Holt  
Progress Energy  
P.O. Box 327  
New Hill, NC 27562  
Phone: 919-362-3558  
Fax: 919-362-3266  
E-mail: fred.holt@pgnmail.com

# Attendee List

## A Symposium on Cooling Water Intake Technologies to Protect Aquatic Organisms May 6-7, 2003 Arlington, VA

Albert Huang  
Environmental Health Coalition  
1717 Kettner Blvd., Suite 100  
San Diego, CA 92101  
Phone: 619-235-0281  
Fax: 619-232-3670  
E-mail: alberth@environmentalhealth.org

Rich Iovanna  
U.S. Environmental Protection Agency  
Ariel Rios Building  
1200 Pennsylvania Avenue, NW, Mail Code: 1809T  
Washington, DC 20460  
Phone: 202-566-2280  
Fax: 202-566-2373  
E-mail: iovanna.rich@epa.gov

Ashley Jansen  
Gulf Power Company  
One Energy Place  
Pensacola, FL 32520  
Phone: 850-444-6141  
Fax: 850-444-6217  
E-mail: adjansen@southernco.com

Steven Jinks  
ASA Analysis & Communications, Inc.  
291 County Road 62  
New Hampton, NY 10958  
Phone: 845-355-4749  
Fax: 845-355-4749  
E-mail: sjinks@asaac.com

Carey Johnston  
U.S. Environmental Protection Agency  
Office of Water  
1200 Pennsylvania Avenue, NW, Mail Code: 4303T  
Washington, DC 20460  
Phone: 202-566-1014  
Fax: 202-566-1053  
E-mail: johnston.carey@epa.gov

Russell Kiesling  
Reliant Energy  
12301 Kurland Drive, EDC A-274  
Houston, TX 77034  
Phone: 713-488-7432  
Fax: 713-488-7598  
E-mail: rkiesling@reliant.com

Betty Ann Hughes  
NYS Department of Environmental Conservation  
Division of Environmental Permits  
625 Broadway  
Albany, NY 12233-1750  
Phone: 518-402-9158  
Fax: 518-402-9168  
E-mail: bahughes@gw.dec.state.ny.us

Paul Jacobson  
Langhei Ecology, LLC  
14820 View Way Court  
Glenelg, MD 21737  
Phone: 410-489-3675  
Fax: 410-489-4523  
E-mail: pjacobson@langheiecolology.com

Heather Jennings  
URS  
5540 Falmouth Street, Suite 201  
Richmond, VA 23230  
Phone: 804-965-9000  
Fax: 804-965-9761  
E-mail: heather\_jennings@urscorp.com

Isabel Johnson  
Golder Associates, Ltd.  
6241 NW 23rd Street, Suite 500  
Gainesville, FL 32653  
Phone: 352-336-5600  
Fax: 352-336-6603  
E-mail: ijohnson@golder.com

John Kelly  
Entergy Nuclear Operations, Inc.  
440 Hamilton Avenue  
White Plains, NY 10601  
Phone: 914-272-3370  
Fax: 914-272-3382  
E-mail: jkelly7@entergy.com

John King  
U.S. Environmental Protection Agency  
New England Region  
1 Congress Street, Suite 1100 (CPE)  
Boston, MA 02114-2023  
Phone: 617-918-1295  
Fax: 617-918-1505  
E-mail: king.john@epa.gov

# Attendee List

## A Symposium on Cooling Water Intake Technologies to Protect Aquatic Organisms May 6-7, 2003 Arlington, VA

Peter Kinner  
Normandeau Associates, Inc.  
25 Nashua Road  
Bedford, NH 3110  
Phone: 603-472-5191  
Fax: 603-472-7052  
E-mail: [pkinner@normandeau.com](mailto:pkinner@normandeau.com)

Lisa Kline  
Atlantic States Marine Fisheries Commission  
1444 Eye Street, NW, 6th Floor  
Washington, DC 20005  
Phone: 202-289-6400  
Fax: 202-289-6051  
E-mail: [lkline@asmfc.org](mailto:lkline@asmfc.org)

Kathryn Krause  
Bard Center for Environmental Policy  
24 Mill Road  
Rhinebeck, NY 12572  
Phone: 845-876-2991  
E-mail: [kk239@bard.edu](mailto:kk239@bard.edu)

Richard Lacouture  
Academy of Natural Science Estuarine Research Center  
10545 Mackall Road  
St. Leonards, MD 20685  
Phone: 410-586-9721  
Fax: 410-586-9705  
E-mail: [lacouture@acnatsci.org](mailto:lacouture@acnatsci.org)

Joe Lapcevic  
Allegheny Energy Supply, LLC  
4350 Northern Pike  
Monroeville, PA 15146-2841  
Phone: 412-858-1671  
Fax: 412-856-2396  
E-mail: [jlapcev@alleghenyenergy.com](mailto:jlapcev@alleghenyenergy.com)

Steven Layman  
GeoSyntec  
1100 Lake Hearn Drive, Suite 200  
Atlanta, GA 30342  
Phone: 404-236-7383  
Fax: 404-705-9400  
E-mail: [slayman@geosyntec.com](mailto:slayman@geosyntec.com)

Randy Lewis  
Cinergy Corporation  
1000 East Main Street  
Plainfield, IN 46168  
Phone: 317-838-1723  
Fax: 317-838-2490  
E-mail: [randy.lewis@cinergy.com](mailto:randy.lewis@cinergy.com)

James Klickovich  
Conectiv Energy  
P.O. Box 6066  
Newark, DE 19714  
Phone: 302-451-5105  
Fax: 302-451-5353  
E-mail: [jim.klickovich@conectiv.com](mailto:jim.klickovich@conectiv.com)

Shawn Konary  
Mirant Corporation  
1099 Hingham Street  
Rockland, MA 2370  
Phone: 781-982-9370  
Fax: 781-982-3476  
E-mail: [shawn.konary@mirant.com](mailto:shawn.konary@mirant.com)

Andrew Labay  
PBS&J  
206 Wild Basin Road, Suite 300  
Austin, TX 78746  
Phone: 512-329-8342  
Fax: 512-327-2453  
E-mail: [aalabay@pbsj.com](mailto:aalabay@pbsj.com)

Sarah Lancaster  
Golder Associates, Ltd.  
2390 Argentia Road  
Mississauga, Ontario L5N 6Z7 Canada  
Phone: 905-567-4444  
Fax: 905-567-6561  
E-mail: [slancaster@golder.com](mailto:slancaster@golder.com)

Jim Laughlin  
CH2M Hill  
4824 Parkway Plaza Blvd., Suite 200  
Charlotte, NC 28217  
Phone: 704-329-0073  
Fax: 704-329-0141  
E-mail: [jlaughhli@ch2m.com](mailto:jlaughhli@ch2m.com)

Roger Lehman  
Weston Solutions, Inc.  
1400 Weston Way, Building 5-1  
West Chester, PA 19380  
Phone: 610-701-7400  
Fax: 610-701-7401  
E-mail: [roger.lehman@westonsolutions.com](mailto:roger.lehman@westonsolutions.com)

Ron Lewis  
Duke Energy  
P.O. Box 1006  
Charlotte, NC 28202  
Phone: 704-373-5710  
Fax: 704-382-9240  
E-mail: [relewis1@duke-energy.com](mailto:relewis1@duke-energy.com)

# Attendee List

## A Symposium on Cooling Water Intake Technologies to Protect Aquatic Organisms

May 6-7, 2003

Arlington, VA

Debra Littleton  
U.S. Department of Energy  
Office of Fossil Energy  
1000 Independence Avenue, SW, FE-4  
Washington, DC 20585  
Phone: 202-586-3033  
Fax: 202-586-7085  
E-mail: [debra.littleton@HQ.DOE.gov](mailto:debra.littleton@HQ.DOE.gov)

Carla Logan  
Constellation Energy Group  
2200 Defense Highway, Suite 405  
Crofton, MD 21114  
Phone: 410-793-3501  
Fax: 410-793-3441  
E-mail: [carla.logan@nuclearservices.com](mailto:carla.logan@nuclearservices.com)

Rees Madsen  
BP  
2815 Indianapolis Blvd., Mail Code 122  
Whiting, IN 46394  
Phone: 219-473-3074  
Fax: 219-473-5379  
E-mail: [madsenre@bp.com](mailto:madsenre@bp.com)

Eran Mahrer  
Pinnacle West  
400 North 5th Street  
Phoenix, AZ 85004  
Phone: 602-250-2154  
Fax: 602-250-3872  
E-mail: [eran.mahrer@pinnaclewest.com](mailto:eran.mahrer@pinnaclewest.com)

Joncile Martin  
Shell Oil Products US  
12700 Northborough Drive  
Houston, TX 77067  
Phone: 281-874-4748  
Fax: 281-874-7925  
E-mail: [jomartin@shellopus.com](mailto:jomartin@shellopus.com)

Richard Masaniello  
Mirant Mid-Atlantic, LLC  
8711 Westphalia Road  
Upper Marlboro, MD 20774  
Phone: 301-669-8120  
Fax: 301-669-8197  
E-mail: [richard.masaniello@mirant.com](mailto:richard.masaniello@mirant.com)

Tim Masty  
Cook Legacy Coating Company, Inc.  
2795 Greenrock Trail  
Atlanta, GA 30340  
Phone: 770-414-1861  
Fax: 770-414-0605  
E-mail: [clegacy@bellsouth.net](mailto:clegacy@bellsouth.net)

Joyce Livingstone  
Dominion  
5000 Dominion Blvd.  
Glen Allen, VA 23060  
Phone: 804-275-2985  
Fax: 804-273-3410  
E-mail: [Joyce\\_Livingston@dom.com](mailto:Joyce_Livingston@dom.com)

Jules Loos  
Mirant Mid-Atlantic  
8711 Westphalia Road  
Upper Marlboro, MD 20774  
Phone: 301-669-8018  
Fax: 301-669-8209  
E-mail: [jules.loos@mirant.com](mailto:jules.loos@mirant.com)

Steve Maghy  
AES Somerset, LLC  
690 N. Studebaker Road.  
Long Beach, CA 90803  
Phone: 562-493-7384  
Fax: 562-493-7320  
E-mail: [steven.maghy@aes.com](mailto:steven.maghy@aes.com)

Erik Martin  
Ecological Associates, Inc.  
P.O. Box 405  
Jensen Beach, FL 34958  
Phone: 772-334-3729  
Fax: 772-334-4925  
E-mail: [erikmartin@bellsouth.net](mailto:erikmartin@bellsouth.net)

Paul Martin  
TRC Environmental Inc.  
Boott Mills South  
Lowell, MA 1852  
Phone: 978-656-3631  
Fax: 978-453-1593  
E-mail: [pmartin@trcsolutions.com](mailto:pmartin@trcsolutions.com)

Michael Masnik  
U.S. Nuclear Regulatory Commission  
11555 Rockville Pike, O-11F1  
Rockville, MD 20852  
Phone: 301-415-1191  
Fax: 301-415-2002  
E-mail: [mtm2@nrc.gov](mailto:mtm2@nrc.gov)

John Matousek  
Lawler, Matusky and Skelly Engineers, LLP  
One Blue Hill Plaza, 12th Floor  
Pearl River, NY 10965  
Phone: 845-735-8300  
Fax: 845-735-7466  
E-mail: [jmatousek@lmseng.com](mailto:jmatousek@lmseng.com)



# Attendee List

## A Symposium on Cooling Water Intake Technologies to Protect Aquatic Organisms May 6-7, 2003 Arlington, VA

Alex Matthiesen  
Riverkeeper, Inc.  
25 Wing & Wing, P.O. Box 130  
Garrison, NY 10524  
Phone: 845-424-4149  
Fax: 845-424-4150  
E-mail: amathiessen@riverkeeper.org

John Maulbetsch  
Maulbetsch Consulting  
770 Menlo Avenue, Suite 211  
Menlo Park, CA 94025  
Phone: 650-327-7040  
Fax: 650-327-7045  
E-mail: maulbets@ix.netcom.com

David Mayhew  
EA Engineering, Science & Technology, Inc.  
15 Loveton Circle  
Sparks, MD 21152  
Phone: 410-329-5105  
Fax: 410-771-4204  
E-mail: dam@eaest.com

Andrew McCusker  
Gunderboom, Inc.  
2 White Sands Lane, Suite 316  
Portland, ME 4104  
Phone: 207-883-1777  
Fax: 207-883-3864  
E-mail: amccusker@mackworth.com

James McLaren  
36 Forest Stream Drive  
Williamsville, NY 14221  
Phone: 716-631-9975  
E-mail: jbmclaren@pce.net

Wesley McNegly  
Mirant Mid-Atlantic  
901 F Street, NW  
Washington, DC 20004  
Phone: 202-585-3700  
E-mail: wesley.mcnegly@mirant.com

David Michaud  
WE Energies  
333 W. Everett Street  
Milwaukee, WI 53203  
Phone: 414-221-2187  
Fax: 414-221-2169  
E-mail: dave.michaud@we-energies.com

Mark Mattson  
Normandeau Associates, Inc.  
25 Nashua Road  
Bedford, NH 03110-5500  
Phone: 603-472-5191  
Fax: 603-471-8007  
E-mail: mmattson@normandeau.com

David Mayer  
Tenera Environmental  
100 Bush Street  
San Francisco, CA 94104  
Phone: 415-445-3415  
Fax: 415-445-3652  
E-mail: dmayer@tenera.com

Robert McCormick  
US Filter  
1633 Main Street  
Trappe, PA 19426  
Phone: 610-489-9113  
Fax: 610-489-0650  
E-mail: mcquipco@aol.com

William McElroy  
Jacques Whitford Company, Inc.  
450 South Graves Road, Suite 105  
Plymouth Meeting, PA 19462  
Phone: 484-322-0301  
Fax: 484-322-0302  
E-mail: wmcclroy@jacqueswhitford.com

Richard McLean  
Maryland Department of Natural Resources  
Power Plant Research Program  
Tawes State Office Building, B3  
Annapolis, MD 21401  
Phone: 410-260-8662  
Fax: 410-260-8670  
E-mail: rmclean@dnr.state.md.us

Kelly Meadows  
Tetra Tech, Inc.  
10306 Eaton Place, Suite 340  
Fairfax, VA 22030  
Phone: 703-385-6000  
Fax: 703-385-6007  
E-mail: meadoke@tetratech-ffx.com

Wayne Micheletti  
Wayne Micheletti, Inc.  
977 Seminole Trail, #300  
Charlottesville, VA 22901-2824  
Phone: 434-977-8330  
Fax: 434-977-6117  
E-mail: wcminc@aol.com

# Attendee List

## A Symposium on Cooling Water Intake Technologies to Protect Aquatic Organisms May 6-7, 2003 Arlington, VA

Patrick Miglio  
Mirant Mid-Atlantic  
8711 Westphalia Road  
Upper Marlboro, MD 20774  
Phone: 301-669-8035  
Fax: 301-669-8209  
E-mail: patrick.miglio@mirant.com

Scott Minamyer  
U.S. Environmental Protection Agency  
26 West Martin Luther King, Mail Stop G75  
Cincinnati, OH 45268  
Phone: 513-569-7175  
Fax: 513-569-7585  
E-mail: minamyer.scott@epa.gov

Denise Molzahn  
Jacques Whitford Company, Inc.  
450 South Graves Road, Suite 105  
Plymouth Meeting, PA 19462  
Phone: 484-322-0301  
Fax: 484-322-0302  
E-mail: dmolzahn@jacqueswhitford.com

Blake Morrison  
Kinectrics North America  
124 Balch Springs Circle  
Lessburg, VA 20175

James Mudge  
Civil & Environmental Consultants, Inc.  
333 Baldwin Road  
Pittsburgh, PA 15205  
Phone: 412-429-2324  
Fax: 412-429-2114  
E-mail: jmudge@cecinc.com

Deborah Nagle  
U.S. Environmental Protection Agency  
Ariel Rios Building  
1200 Pennsylvania Avenue, NW, Mail Code: 4203M  
Washington, DC 20460  
Phone: 202-564-1185  
Fax: 202-564-6431  
E-mail: nagle.deborah@epa.gov

Joseph Neese  
Gulf Power Company  
One Energy Place  
Pensacola, FL 32520  
Phone: 850-444-6429  
Fax: 850-444-6217  
E-mail: jhneese@southernco.com

Edward Miller  
EBL Engineers  
8005 Harford Road  
Baltimore, MD 21234  
Phone: 410-668-8800  
Fax: 410-668-8801  
E-mail: emiller@eblengineers.com

Mike Moe  
SAIC  
11251 Roger Bacon Drive  
Reston, VA 20190  
Phone: 703-318-4666  
Fax: 703-318-4646  
E-mail: moem@saic.com

Richard Monzingo  
EA Engineering, Science & Technology, Inc.  
444 Lake Cook Road, Suite 18  
Deerfield, IL 60015  
Phone: 847-945-8010  
Fax: 847-945-0296  
E-mail: rmonzing@eaest.com

Manitia Moultrie  
Golder Associates, Ltd.  
5100 West Lemon Street, Suite 114  
Tampa, FL 33609  
Phone: 813-287-1717  
Fax: 813-287-1716  
E-mail: mmoultrie@golder.com

Bon Mui  
Alvord, Burdick & Howson  
20 N. Wacker Drive, Suite 1401  
Chicago, IL 60606  
Phone: 312-236-9147  
Fax: 312-236-0692  
E-mail: bmui@abhengineers.com

Jeremy Nedwell  
Fish Guidance Systems, Ltd.  
Marine & Freshwater Biology Unit  
Fawley, Southampton SO45 1TW UK  
Phone: 44 2380 89513  
Fax: 44 2380 24374  
E-mail: jeremy.nedwell@fish-guide.com

Hamid Nejad  
Los Angeles Department of Water and Power  
Power Supply Operations  
111 N. Hope Street, Room 1141  
Los Angeles, CA 90012  
Phone: 213-367-3009  
Fax: 213-367-3607  
E-mail: hamid.najed@ladwp.com

# Attendee List

## A Symposium on Cooling Water Intake Technologies to Protect Aquatic Organisms May 6-7, 2003 Arlington, VA

Nels Nelson  
Barr Engineering  
4700 W. 7th Street  
Minneapolis, MN 55435  
Phone: 952-832-2782  
Fax: 952-832-2601  
E-mail: nnelson@barr.com

Kit Ng  
Bechtel Corporation  
5275 Westview Drive  
Frederick, MD 21703  
Phone: 301-228-7652  
Fax: 301-682-6415  
E-mail: kyng@bechtel.com

Brenda Nuse  
Calvert Cliffs Nuclear Power Plant  
1650 Calvert Cliffs Parkway  
Lusby, MD 20657  
Phone: 410-495-4913  
Fax: 410-495-2618  
E-mail: brenda.d.nuse@ccnppi.com

Nathaniel Olken  
Alden Research Laboratory, Inc.  
30 Shrewsbury Street  
Holden, MA 1520  
Phone: 508-829-6000  
Fax: 508-829-5939  
E-mail: nolken@aldenlab.com

Dan Patel  
Southern Company Services, Inc.  
42 Inverness Center Parkway  
Birmingham, AL 35242  
Phone: 205-992-7697  
E-mail: dvpatel@southernco.com

Rena Ann Peck  
Golder Associates, Ltd.  
3730 Chamblee Tucker Road  
Atlanta, GA 30347  
Phone: 770-496-1893  
E-mail: rpeck@golder.com

Winifred Perkins  
Florida Power & Light Company  
Environmental Services Department  
P.O. Box 14000  
Juno Beach, FL 33408  
Phone: 561-691-7046  
Fax: 561-691-7070  
E-mail: winifred\_perkins@fpl.com

Steve Newbold  
U.S. Environmental Protection Agency  
Ariel Rios Building  
1200 Pennsylvania Avenue, NW, Mail Code: 1809T  
Washington, DC 20460  
Phone: 202-566-2293  
Fax:  
E-mail: newbold.steve@epa.gov

Keith Nichols  
C-K Associates, Inc.  
17170 Perkins Road  
Baton Rouge, LA 70810  
Phone: 225-755-1000  
Fax: 225-751-2010  
E-mail: keith.nichols@c-ka.com

Thomas O'Donnell  
The Academy of Natural Sciences  
1900 Benjamin Franklin Parkway  
Philadelphia, PA 19087  
Phone: 215-405-5097  
Fax: 215-299-1028  
E-mail: odonnell@acnatsci.org

Randal Oswald  
Wisconsin Public Service Corporation  
700 N. Adams Street, P.O. Box 19002  
Green Bay, WI 54307-9002  
Phone: 920-433-1395  
Fax: 920-433-1176  
E-mail: roswald@wpsr.com

Karen Patterson  
Tetra Tech NUS  
900 Trail Ridge Road, Suite 3  
Aiken, SC 29803  
Phone: 803-649-7963  
Fax: 803-642-8454  
E-mail: pattersonk@ttnus.com

Janet Pellegrini  
U.S. Environmental Protection Agency, Region 5  
77 West Jackson Blvd., WN-16J  
Chicago, IL 60604-3590  
Phone: 312-886-4298  
Fax: 312-886-4235  
E-mail: pellegrini.janet@epa.gov

Gail Peterson  
Lansing Board of Water & Light  
Environmental Services  
P.O. Box 13007  
Lansing, MI 48901  
Phone: 517-702-6366  
Fax: 517-702-6373  
E-mail: gfgp@lbwl.com

# Attendee List

## A Symposium on Cooling Water Intake Technologies to Protect Aquatic Organisms May 6-7, 2003 Arlington, VA

John Petro  
Exelon Nuclear Environmental Affairs  
4300 Winfield Road  
Warrenville, IL 60555  
Phone: 630-657-3209  
Fax: 630-657-4319  
E-mail: john.petro@exeloncorp.com

Glenn Piehler  
518 Gregory Avenue, A-302  
Weehawken, NJ 7086  
Phone: 201-865-5133  
E-mail: gpiehler@hotmail.com

Gregory Powell  
Golder Associates, Ltd.  
8933 Western Way, Suite 1200  
Jacksonville, FL 32256  
Phone: 904-363-3430  
Fax: 904-363-3445  
E-mail: gpowell@golder.com

John Pozzo  
Ameren  
1901 Chateau Avenue  
St. Louis, MO 63166-6149  
Phone: 314-554-2280  
Fax: 314-554-4182  
E-mail: jc Pozzo@ameren.com

Theresa Pugh  
American Public Power Association  
2301 M Street, Northwest, 3rd Floor  
Washington, DC  
Phone: 202-467-2943  
Fax: 202-467-2992  
E-mail: tpugh@appanet.org

Michael Quick  
US Filter  
1901 S. Prairie Avenue  
Waukesha, WI 53189  
Phone: 262-521-8332  
Fax: 262-547-4120  
E-mail: quickm@usfilter.com

Lisa Quiveors  
Exelon Power  
200 Exelon Way, KSA 1-E  
Kennett Square, PA 19348  
Phone: 610-765-5886  
Fax: 610-765-5561  
E-mail: lisa.quiveors@exeloncorp.com

Henry Petrovs  
USFilter  
Envirex Products  
1901 South Prairie Avenue, P.O. Box 1604  
Waukesha, WI 53187-1604  
Phone: 262-521-8414  
Fax: 262-521-8249  
E-mail: petrovsh@usfilter.com

John Popham  
Robinson Construction  
2411 Walters Lane  
Perryville, MO 63775  
Phone: 573-547-8397  
Fax: 573-547-8398  
E-mail: jpopham@robinsonconstruction.com

Bill Powers  
Powers Engineering  
4452 Park Blvd., Suite 209  
San Diego, CA 92116  
Phone: 619-295-2072  
Fax: 619-295-2073  
E-mail: bpowers@powersengineering.com

John Prill  
Rochester Gas and Electric Corporation  
89 East Avenue  
Rochester, NY 14649-0001  
Phone: 585-771-2711  
Fax: 585-724-8832  
E-mail: john\_prill@rge.com

Jeb Putnam  
MACTEC  
1606 Ownby Lane  
Richmond, VA 23320  
Phone: 804-358-7111  
Fax: 804-358-6646  
E-mail: jsputnam@mactec.com

Noel Quinnland  
Gunderboom, Inc.  
9401 King Street, Suite A  
Anchorage, AK 99515  
Phone: 907-644-5000  
E-mail: nquinnland@gunderboom.com

Ed Radle  
New York State Department of Environmental  
Conservation  
820 Millers Corners Road  
Amsterdam, NY 12010  
Phone: 518-843-3097  
E-mail: exradle@gw.dec.state.ny.us

# Attendee List

## A Symposium on Cooling Water Intake Technologies to Protect Aquatic Organisms May 6-7, 2003 Arlington, VA

Matthew Raffenberg  
Lawler, Matusky and Skelly Engineers, LLP  
One Blue Hill Plaza  
Pearl River, NY 10965  
Phone: 845-735-8300  
Fax: 845-735-7466  
E-mail: mraffenberg@lmseng.com

Jon Reimann  
AES Somerset, LLC  
7725 Lake Road  
Barker, NY 14012  
Phone: 716-795-9501  
Fax: 716-795-3654  
E-mail: jon.reimann@aes.com

John Richardson  
Alden Research Laboratory, Inc.  
30 Shrewsbury Street  
Holden, MA 01520-1843  
Phone: 508-829-6000  
Fax: 508-829-5939  
E-mail: jrichardson@aldenlab.com

Clement Riddle  
ClearWater Environmental Consultants  
300 North Main Street, Suite 202  
Hendersonville, NC 28792  
Phone: 828-698-9800  
Fax: 828-698-9003  
E-mail: criddle@cwenv.com

Barbara Rinaldi  
156 Cream Street  
Poughkeepsie, NY 12601  
Phone: 518-402-9171  
Fax: 518-402-9168  
E-mail: abcrinaldi@yahoo.com

Frank Robinson  
Robinson Construction  
2411 Walters Lane  
Perryville, MO 63775  
Phone: 573-547-8397  
Fax: 573-547-8397  
E-mail: frobinson@robinsonconstruction.com

Rafael Sanchez  
U.S. Environmental Protection Agency  
Ariel Rios Building  
1200 Pennsylvania Avenue, NW, Mail Code: 2223A  
Washington, DC 20460  
Phone: 202-564-7028  
E-mail: sanchez.rafael@epa.gov

Robert Reider  
Detroit Edison Company  
2000 Second Avenue, G55GO  
Detroit, MI 48226  
Phone: 313-235-7022  
Fax: 313-235-5018  
E-mail: reiderr@dteenergy.com

Bert Remley  
Third Rock Consultants, LLC  
2514 Regency Road, Suite 104  
Lexington, KY 40503  
Phone: 859-977-2000  
Fax: 859-977-2001  
E-mail: bremley@thirdrockconsultants.com

William Richkus  
Versar, Inc.  
9200 Rumsey Road  
Columbia, MD 21045  
Phone: 410-740-6078  
Fax: 410-964-5156  
E-mail: richkuswil@versar.com

Ron Rimelman  
Tetra Tech, Inc.  
3775 Iris Avenue, Suite 4  
Boulder, CO 80301  
Phone: 720-406-9110  
Fax: 720-406-9114  
E-mail: rrimelman@tetrattech-ffx.com

Ted Ringger  
Constellation Energy Group  
2200 Defense Highway, Suite 400  
Crofton, MD 21114  
Phone: 410-793-3492  
Fax: 410-793-3441  
E-mail: ted.ringger@nuclearservicesinc.com

Bart Ruitter  
DuPont Company  
1007 Market Street  
Wilmington, DE 19898  
Phone: 302-774-8076  
Fax: 302-774-8110  
E-mail: J-Bart.Ruitter@usa.dupont.com

Andre Sanderson  
Florida Power & Light Company  
700 Universe Blvd.  
Juno Beach, FL 33408  
E-mail: andre\_sanderson@fpl.com

# Attendee List

## A Symposium on Cooling Water Intake Technologies to Protect Aquatic Organisms May 6-7, 2003 Arlington, VA

Paul Sawyko  
Rochester Gas and Electric Corporation  
89 East Avenue  
Rochester, NY 14649-0001  
Phone: 585-771-2707  
Fax: 585-771-4916  
E-mail: paul\_sawyko@rge.com

David Schlissel  
Synapse Energy Economics, Inc.  
22 Pearl Street  
Cambridge, MA 2139  
Phone: 617-661-3248  
Fax: 617-661-0599  
E-mail: dschlissel@synapse-energy.com

Rob Scott  
Blasland, Bouck & Lee  
6723 Towpath Road  
Syracuse, NY 13214  
Phone: 315-446-2570  
E-mail: rscott@bbl-inc.com

Martha Segall  
U.S. Environmental Protection Agency  
Ariel Rios Building  
1200 Pennsylvania Avenue, NW, Mail Code: 4303T  
Washington, DC 20460  
Phone: 202-566-1041  
Fax: 202-566-1053  
E-mail: segall.martha@epa.gov

Kirti Shah  
ENSR International  
2005 Cabot Blvd.  
Langhorne, PA 19047  
Phone: 215-757-4900  
Fax: 215-757-3904  
E-mail: kshah@ensr.com

Ron Sher  
FPL Energy Seabrook Station  
P.O. Box 300  
Seabrook, NH 3862  
Phone: 603-773-7729  
Fax: 603-773-7740  
E-mail: ron\_sher@fpl.com

Robert Schaaf  
U.S. Nuclear Regulatory Commission  
Environmental Section, Nuclear Reactor Regulation  
Mail Stop O-11-F1  
Washington, DC 20555  
Phone: 301-415-1312  
Fax: 301-415-2002  
E-mail: rgs@nrc.gov

Steve Schreiner  
Versar, Inc.  
9200 Rumsey Road  
Columbia, MD 21045  
Phone: 410-740-6089  
Fax: 410-964-5156  
E-mail: schreinerste@versar.com

Greg Seegert  
EA Engineering, Science & Technology, Inc.  
444 Lake Cook Road, Suite 18  
Deerfield, IL 60015  
Phone: 847-945-8010  
Fax: 847-945-0296  
E-mail: gls@eaest.com

Carrie Selberg  
Atlantic States Marine Fisheries Commission  
1444 Eye Street, NW, 6th Floor  
Washington, DC 20005  
Phone: 202-289-6400  
Fax: 202-289-6051  
E-mail: cselberg@asmfc.org

Howard Shelnut  
Mirant Corporation  
1155 Perimeter Center West  
Atlanta, GA 30338-5416  
Phone: 678-579-7786  
Fax: 678-579-6993  
E-mail: howard.shelnutt@mirant.com

Tracy Siglin  
Exelon Nuclear Environmental Affairs  
200 Exelon Way, KSA3-N  
Kennett Square, PA 19348  
Phone: 610-765-5904  
Fax: 610-765-5765  
E-mail: tracy.siglin@exeloncorp.com

# Attendee List

## A Symposium on Cooling Water Intake Technologies to Protect Aquatic Organisms May 6-7, 2003 Arlington, VA

William Sim  
Alabama Power Company  
600 North 18th Street, P.O. Box 2641  
Birmingham, AL 35291  
Phone: 205-257-4136  
Fax: 205-257-4349  
E-mail: wasim@southernco.com

Mary Smith  
U.S. Environmental Protection Agency  
Ariel Rios Building  
1200 Pennsylvania Avenue, NW, Mail Code: 4303T  
Washington, DC 20460  
Phone: 202-566-1000  
Fax: 202-566-1053  
E-mail: smith.mary@epa.gov

Paul Snead  
Progress Energy  
P.O. Box 1551  
Raleigh, NC 27602  
Phone: 919-546-2836  
Fax: 919-546-7854  
E-mail: paul.snead@pgnmail.com

Kallie Speller  
Ecology and Environment, Inc.  
1700 N. Moore Street, Suite 1610  
Arlington, VA 22209  
Phone: 703-522-6065  
E-mail: kspeller@ene.com

Michael Stiefel  
U.S. Tennessee Valley Authority  
1101 Market Street, LP-5D  
Chattanooga, TN 37402  
Phone: 423-751-6844  
Fax: 423-751-7011  
E-mail: mbstiefel@tva.gov

James Stine  
NRECA  
4301 Wilson Blvd., EU11-249  
Arlington, VA 22203  
Phone: 703-907-5739  
Fax: 703-907-5599  
E-mail: james.stine@nreca.org

Dennis Smith  
U.S. Department of Energy  
Office of Fossil Energy  
1000 Independence Avenue, SW  
Washington, DC 20585  
Phone: 202-586-1822  
Fax: 202-586-1188

Garry Smythe  
Stantec Consulting Services  
140 Rotec Drive  
Lancaster, NY 14086  
Phone: 716-759-1200  
Fax: 716-759-1489  
E-mail: gsmythe@santec.com

Kenneth Snell  
Sargent & Lundy, LLC  
55 East Monroe, Mail Code: 22T70  
Chicago, IL 60603  
Phone: 312-269-2318  
Fax: 312-269-2499  
E-mail: kenneth.j.snell@sargentlundy.com

Thomas Steinke  
Johnson Screens  
1950 Old Highway 8 NW  
New Brighton, MN 55112  
Phone: 651-638-3297  
Fax: 651-638-3177  
E-mail: steinketj@johnsonscreens.com

Jim Stieritz  
Cinergy Corporation  
P.O. Box 960, Room 552A  
Cincinnati, OH 45201  
Phone: 513-287-2269  
Fax: 513-287-3499  
E-mail: jstieritz@cinergy.com

Kenneth Strait  
Public Service Electric & Gas Company (PSEG)  
Services Corporation  
Environment, Health and Safety Department  
130 Money Island Road  
Salem, NJ 8079  
Phone: 856-878-6929  
Fax: 856-878-1206  
E-mail: kenneth.strait@pseg.com

# Attendee List

## A Symposium on Cooling Water Intake Technologies to Protect Aquatic Organisms May 6-7, 2003 Arlington, VA

Mark Strickland  
Public Service Electric & Gas Company (PSEG)  
Services Corporation  
80 Park Plaza, 17E  
Newark, NJ 07102-4194  
Phone: 973-430-7911  
Fax: 973-565-0525  
E-mail: mark.strickland@pseg.com

Reed Super  
Riverkeeper, Inc.  
25 Wing & Wing  
Garrison, NY 10524  
Phone: 845-429-4149  
Fax: 845-424-4150  
E-mail: rsuper@riverkeeper.org

Melissa Teal  
Tetra Tech, Inc.  
10306 Eaton Place, Suite 340  
Fairfax, VA 22030  
Phone: 703-385-6000  
Fax: 703-385-6007  
E-mail: melissa.teal@tetrattech-ffx.com

Tom Thompson  
Progress Energy, HEEC  
3932 New Hill-Holleman Road  
New Hill, NC 27562-0327  
Phone: 919-362-3270  
Fax: 919-362-3391  
E-mail: thomas.thompson@pgnmail.com

Chris Tomichek  
Kleinschmidt Associates  
161 River Street  
Deep River, CT 6417  
Phone: 860-226-2358  
Fax: 860-526-2768  
E-mail: chris.tomichek@kleinschmidtusa.com

Jack Tramontano  
URS Corporation  
1400 Union Meeting Road, Suite 2002  
Blue Bell, PA 19422  
Phone: 215-619-4167  
Fax: 215-542-3888  
E-mail: jack\_tramontano@urscorp.com

Stephen Summer  
SCANA Corporation  
6248 Bush River Road  
Columbia, SC 29212  
Phone: 803-217-7357  
Fax: 803-217-7349  
E-mail: ssummer@scana.com

Edward Taft  
Alden Research Laboratory, Inc.  
30 Shrewsbury Street  
Holden, MA 01520-1843  
Phone: 508-829-6000  
Fax: 508-829-5939  
E-mail: ntaft@aldenlab.com

Dana Thomas  
U.S. Environmental Protection Agency  
Office of Water  
1200 Pennsylvania Avenue, NW, Mail Code: 4303T  
Washington, DC 20460  
Phone: 202-566-1046  
Fax: 202-566-1053  
E-mail: thomas.dana@epa.gov

Danielle Tillman  
U.S. Environmental Protection Agency  
Ariel Rios Building  
1200 Pennsylvania Avenue, NW, Mail Code: 8103R  
Washington, DC 20460  
Phone: 202-564-9839  
Fax: 202-564-2925  
E-mail: tillman.danielle@epa.gov

John Torgan  
Save the Bay  
People for Narragansett Bay  
434 Smith Street  
Providence, RI 2906  
Phone: 401-272-3540  
E-mail: jtorgan@savebay.org

Thomas Travers  
Progress Energy  
410 S. Willmington Street  
Raleigh, NC 27601  
Phone: 919-546-4589  
E-mail: thomas.travers@pgnmail.com



# Attendee List

## A Symposium on Cooling Water Intake Technologies to Protect Aquatic Organisms May 6-7, 2003 Arlington, VA

Rick Tripp  
AES Huntington Beach  
21730 Newland Street  
Huntington Beach, CA 92646  
Phone: 714-374-1409  
Fax: 714-374-1429  
E-mail: ricky.tripp@aes.com

Ed Tyberghein  
Alabama Power Company  
P.O. Box 2641, G.S.C. #8  
Birmingham, AL 35291  
Phone: 205-664-6056  
Fax: 205-664-6309  
E-mail: ejtyberg@southernco.com

Maureen Vaskis  
AKRF, Inc.  
117 East 29th Street  
New York, NY 10016  
Phone: 212-340-9752  
Fax: 212-447-9942  
E-mail: maureen\_vaskis@akrf.com

Thomas Wall  
U.S. Environmental Protection Agency  
Office of Water  
1200 Pennsylvania Avenue, NW, Mail Code: 4303T  
Washington, DC 20460  
Phone: 202-566-1060  
Fax: 202-566-1053  
E-mail: wall.tom@epa.gov

Brian Waters  
Framatome ANP  
2710 Gateway Oaks Drive, South, Suite 320  
Sacramento, CA 95833  
Phone: 916-561-4583  
Fax: 916-564-4203  
E-mail: brian.waters@framatome-anp.com

Jessica Webber  
ENTRIX, Inc.  
10 Corporate Circle, Suite 100  
New Castle, DE 19720  
Phone: 302-395-1919  
Fax: 302-395-1920  
E-mail: jwebber@entrix.com

Mary Willett  
ERG  
14555 Avion Parkway, Suite 200  
Chantilly, VA 20151  
Phone: 703-633-1615  
Fax: 703-263-7280  
E-mail: mary.willett@erg.com

Andy Turnpenny  
Fish Guidance Systems, Ltd.  
Marine & Freshwater Biology Unit  
Fawley, Southampton SO45 1TW UK  
Phone: 44 2380 89513  
Fax: 44 2380 24374  
E-mail: a.turnpenny@fawley-arl.co.uk

David Urban  
ENSR  
2 Technology Park Drive  
Westford, MA 1886  
Phone: 978-589-3087  
Fax: 978-589-3282  
E-mail: durban@ensr.com

John Veil  
Argonne National Laboratory  
955 L'Enfant Plaza North, SW, Suite 6000  
Washington, DC 20024  
Phone: 202-488-2450  
Fax: 202-488-2413  
E-mail: jveil@anl.gov

Richard Wantuck  
NOAA Fisheries  
777 Sonoma Avenue, Suite 325  
Santa Rosa, CA 95404  
Phone: 707-575-6063  
Fax: 707-578-3435  
E-mail: richard.wantuck@noaa.gov

Mark Watson  
Johnson Screens  
62 Westwood Drive  
Sturbridge, MA 1566  
Phone: 508-347-9309  
Fax: 508-347-0991  
E-mail: watsonme@johnsonscreens.com

LaJuana Wilcher  
English, Lucas, Priest & Owsley  
1101 College Street, P.O. Box 770  
Bowling Green, KY 42102-0770  
Phone: 270-781-6500  
Fax: 270-782-7782  
E-mail: lwilcher@elpolaw.com

Bradley Wright  
Calvert Cliffs Nuclear Power Plant  
1650 Calvert Cliffs Parkway  
Lusby, MD 20657  
Phone: 410-495-4005  
Fax: 410-495-4727  
E-mail: brad.r.wright@ccnppi.com

# Attendee List

## A Symposium on Cooling Water Intake Technologies to Protect Aquatic Organisms May 6-7, 2003 Arlington, VA

James Wright  
Tennessee Valley Authority  
Regulatory Affairs/Environmental Management  
400 W. Summit Hill Drive  
Knoxville, TN 37902-1499  
Phone: 423-632-8104  
Fax: 423-632-6855  
E-mail: jrwright@tva.gov

Kent Zammit  
EPRI  
3412 Hilview Avenue, P.O. Box 10412  
Palo Alto, CA 94304-1395  
Phone: 650-855-2097  
Fax: 650-855-2619  
E-mail: kezammit@epri.com

Ty Ziegler  
Duke Energy  
P.O. Box 1006, Mail Code: EC12A  
Charlotte, NC 28201-1006  
Phone: 704-373-7901  
Fax: 704-382-6240  
E-mail: tkziegle@duke-energy.com

John Young  
ASA Analysis & Communications, Inc.  
310 Goldfinch Drive  
State College, PA 16801  
Phone: 814-278-0482  
Fax: 814-278-0482  
E-mail: jyoung@asaac.com


Sharon Zaya  
U.S. Environmental Protection Agency, Region 1  
1 Congress Street, Suite 1100  
Boston, MA 02114-2023  
Phone: 617-918-1995  
E-mail: zaya.sharon@epa.gov

Omar Zubair  
Intralox, Inc.  
201 Laitram Lane  
Harahan, LA 70123  
Phone: 504-733-6739  
Fax: 504-734-5379  
E-mail: omair@intralox.com

## Appendix C: Slide Presentations

The Power Industry's Vision for Continuing Improvement in Fish Protection .....	C1
<i>Charles H. Goodman, Ph.D., Southern Company</i>	
Fish Protection Technologies for Existing Cooling Water Intake Structures and Their Costs .....	C2
<i>Edward Taft, Thomas Cook, Jon Black, and Nate Olken, Alden Research Laboratory</i>	
An Overview of Flow Reduction Technologies .....	C8
<i>Reed Super, Riverkeeper, Inc.</i>	
State of Maryland Perspectives on Cooling Water Intake Technologies to Protect Aquatic Organisms .....	C11
<i>Richard McLean, Maryland Department of Natural Resources</i>	
Implementation of CWA 316(b) in New York .....	C17
<i>Edward W. Radle (retired) and Michael J. Calaban, New York State Department of Environmental Conservation, Steam Electric Unit</i>	
Resource Agency Views of Technology Employed to Prevent Fish Mortality at Cooling Water Intakes .....	C24
<i>Richard L. Wantuck, NOAA Fisheries</i>	
Retrofit of Closed-Cycle Cooling Towers .....	C32
<i>Reed Super, Riverkeeper, Inc. and John Torgan, Save the Bay – People for Narragansett Bay</i>	
Innovative Cooling System for Heat and Flow Reduction at Brayton Point Station .....	C35
<i>Thomas L. Englert, Lawler, Matusky and Skelly Engineers, LLP</i>	
Design and Performance of Optimized Air-Cooled Condenser at Crockett Cogeneration Plants .....	C40
<i>Bill Powers, P.E., Powers Engineering</i>	
Evaluation of Variable Pumping Rates As A Means to Reduce Entrainment Mortalities.....	C44
<i>John Young, ASA Analysis &amp; Communications, Inc.</i>	
Cooling System Retrofit Costs .....	C48
<i>John Maulbetsch, Maulbetsch Consulting</i>	
A Tool for Budgetary Estimation of Cooling Tower Unit Costs Based on Flow .....	C54
<i>Faysal Bekdash and Mike Moe, SAIC</i>	
Power Plant Repowering as a Strategy for Reducing Cooling Water Consumption at Existing Electric Generating Facilities .....	C58
<i>David Schlissel, Synapse Energy Economics, Inc.</i>	
Fish Return System Efficacy and Monitoring Studies for JEA's Northside Generating Station .....	C61
<i>Isabel C. Johnson, Golder Associates, Inc.</i>	
Effectiveness, Operation and Maintenance, and Costs for a Barrier Net System for Impingement Reduction at the Chalk Point Station .....	C67
<i>David Bailey, Mirant Mid-Atlantic</i>	
Reductions in Impingement Mortality Resulting from Enhancements to Ristroph Traveling Screens at an Estuarine Cooling Water Intake Structure .....	C71
<i>Kenneth Strait, PSEG Services Corporation</i>	
Development and Operation of Acoustic Fish Deterrent Systems at Estuarine Power Stations .....	C75
<i>Andy Turnpenny and Jeremy Nedwell, Fish Guidance Systems, Ltd.</i>	
Interpretation of Recent Measurements of the Efficiency of an Acoustic Fish Deterrent System.....	C80
<i>Jeremy Nedwell, Andy Turnpenny, and David Lambert, Fish Guidance Systems Ltd.</i>	

Induced Sweeping Flows At CWIS for Reducing Fish Impingement .....	C83
<i>Charles C. Coutant, Oak Ridge National Laboratory</i>	
The Use of Angled Bar Racks and Louvers for Protecting Fish at Water Intakes .....	C86
<i>Stephen Amaral, Alden Research Laboratory, Inc.</i>	
Impingement Survival Review .....	C93
<i>Steven Jinks, ASA Analysis &amp; Communications, Inc.</i>	
Optimal Slot-Width Selection for Wedge Wire Screens .....	C97
<i>William Dey, ASA Analysis Communications, Inc.</i>	
Development of Filter Fabric Barrier to Reduce Aquatic Impacts at Water Intake Structures .....	C100
<i>Matthew J. Raffenberg, Lawler, Matusky and Skelly Engineers, LLP</i>	
Filter curtain materials, entrainment, biofouling and permeability .....	C105
<i>Peter Henderson, Pisces Conservation Ltd &amp; University of Oxford and Richard Seaby, Pisces Conservation, Ltd.</i>	
Biological Evaluation of Wedgewire Screens for Protecting Fish at Cooling Water Intakes .....	C108
<i>Stephen Amaral, Alden Research Laboratory, Inc.</i>	
Selection and Design of Wedge Wire Screens and a Fixed-Panel Aquatic Filter Barrier System to Reduce Impingement and Entrainment at a Cooling Water Intake Structure on the Hudson River .....	C113
<i>Mark Strickland, PSEG Service Corporation, and James E. Mudge, Ph.D., Civil and Environmental Consultants, Inc.</i>	



## The Power Industry's Vision for Continuing Improvement in Fish Protection


Charles H. Goodman, Ph.D.  
Senior Vice President  
Research and Environmental Affairs  
Southern Company  
Birmingham, Alabama  
May 6, 2003



## Balance Is Needed

- To minimize “adverse environmental impact” under 316(b) means balancing important interests, including:
  - Protecting the environment
  - Considering costs
  - Ensuring reliable electric power


2



## To Achieve Balance, We Should Use What We Have Learned

- The electric utility industry has done extensive studies of how cooling water intake structures affect aquatic organisms
  - Individual studies under State 316(b) programs
  - Industry-funded research by EPRI
- These studies provide information about fish biology and behavior that can be used to select the best solution for each site

3



## What Have We Learned?

- Past studies show:
  - Power facilities have not posed a significant risk to aquatic populations
  - Protecting fish populations and ecosystems depends on site-specific factors such as the species present at the site, the waterbody type, etc.
  - Protecting fish populations requires understanding of fish biology and behavior and how fish interact with intake structures
- A 316(b) rule based on understanding fish biology and site-specific biological assessments will protect fish populations and ecosystems


4



## The “Best” Solution Considers Environmental Costs and Benefits

- Different cooling water systems and intake technologies have different “adverse” effects
  - Canal dredging and other disruptions
  - Cooling tower impacts:
    - Use of land
    - Increased fuel use/reduced efficiency
    - Increased water consumption
  - Conversely, once-through cooling has benefits, especially where a thermal plume has created a warm water fishery
- Thus, a single uniform solution for every site would not necessarily minimize adverse environmental impact

5



## Conclusions

- A single, one-size-fits-all solution is not always the “best”
- Selecting the best solution requires balancing different interests
- This balancing requires attention to site-specific features
- The best solution is the one that maximizes net benefits

6

## Fish Protection Technologies for Existing Cooling Water Intake Structures and Their Costs

by  
Ned Taft, Tom Cook, Jon Black, and  
Nate Olken

Alden Research Laboratory

A Symposium on Cooling Water Intake Technologies  
to Protect Aquatic Organisms

May 6-7, 2003  
Hilton Crystal City at National Airport  
Arlington, VA

## Proposed Performance Standards

- Reduce impingement mortality by 80 to 95 percent
- Reduce entrainment by 60 to 90 percent

## Types of Site-Specific Factors

- Biology
- Hydraulic / Hydrodynamic
- Fouling
- Geotechnical
- Navigation and Space Requirements
- Climate

## Examples of Site-Specific Factors that Influence Cost

- organisms to be protected
- flow
- debris
- biofouling
- silt
- facility type (nuclear vs. fossil)
- ambient current
- waves
- icing
- waterbody type
- water depth
- navigation and space issues
- substrate

## Technology Categories

- Physical Barriers
- Collection Systems
- Diversion Systems
- Behavioral Barriers

## Technologies EPA Considers Having Potential for Meeting the Standards

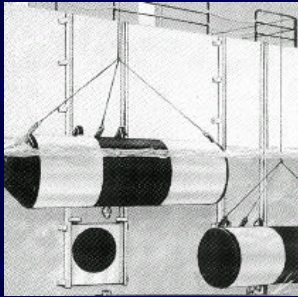
- Wedge Wire Screens
- Aquatic Filter Barrier (AFB)
- Modified Traveling Screens with Fish Return
- Barrier Nets
- Velocity Caps

## Physical Barriers

## Wedge Wire Screen



## Schematic of Wedge Wire Screens Eddystone Station



## 7-foot Diameter Wedge Wire Screen



Courtesy of Johnson Screen

## Status of Wedge Wire Screens

- Can be used to meet both the I and E standards
- Extensive existing performance data
- No large flow fine mesh installations

## Wedge Wire Costs

EPA Cost = \$0.2 – 23M  
Site-Specific Cost = \$3.5 – 144M

### Examples of Site-Specific Factors that Drive Cost

<u>Factor</u>	<u>Impacts</u>
species / lifestage	slot size
flow (slot size)	number of screens
space and water depth	amount of piping
current site config.	location
biofouling	screen material

### AFB – Deployed at Lovett



LMS 2001

### AFB - Perforations



### Status of Aquatic Filter Barrier (AFB)

- Can be used to meet both I & E performance standards
- Limited performance data
- Currently limited to 10 gpm/ft<sup>2</sup>
- Requires large surface area

### AFB Costs

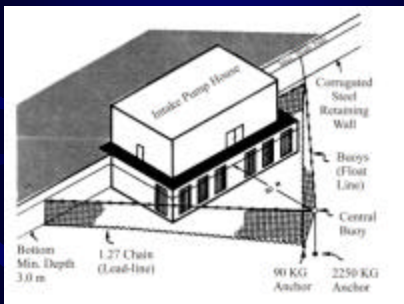
EPA Cost = \$0.8 – 3M

Site-Specific Cost = \$9 – 72M

#### Examples of Site-Specific Factors that Drive Cost

Factor	Impacts
species / lifestage	perforation size
flow (perf. size)	amount of material
currents and waves	support systems

### Bowline Barrier Net



### Brule Barrier Net



Courtesy of Dave Michaud



### Status of Barrier Nets

- Can be used to meet the I standard
- Performance data exists
- Species and lifestage dictates mesh size

### Barrier Net Costs

EPA Cost = \$0.013 – 0.063M  
Site-Specific Cost = \$0.1 – 14M

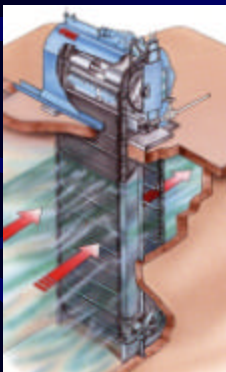
#### Examples of Site-Specific Factors that Drive Cost

<u>Factor</u>	<u>Impacts</u>
flow	net area
current and waves	support systems
extent of fouling	support systems

### Summary of Physical Barriers

- Wedge wire screens and AFB have the potential to meet the I & E performance standards
- Barrier nets are a viable alternative for meeting the I standard
- Site-specific factors affect applicability, biological effectiveness, and costs

### Collection Systems



### Modified Traveling Water Screens



Courtesy of USFilter



Prairie Island Fine Mesh (0.5 mm) Screens



Pilot Scale Fine Mesh Screens – Big Bend

### Status of Modified Traveling Screens

- Coarse mesh modified screens can be used to meet the I standard
- Fine mesh screens can be used to meet both the I & E standards
- Substantial data exists on effectiveness and costs
- E Survival ?

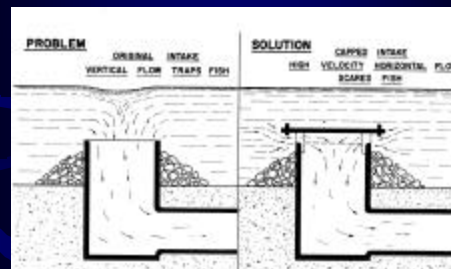
### Modified Traveling Screen Costs

EPA Cost = \$0.1 – 22M  
 Site-Specific Cost = \$0.3 – 44M

#### Examples of Site-Specific Factors that Drive Cost

Factor	Impacts
through-screen velocity	number of screens
current screen area	expand intake?

### Velocity Caps



Weight 1958

### Status of Velocity Caps

- Limited biological effectiveness data
- May have benefits associated with location
- No site-specific cost data

### Review of Site-Specific Factors that Influence Cost

- organisms to be protected
- flow
- debris
- biofouling
- silt
- facility type (nuclear vs. fossil)
- ambient current
- waves
- icing
- waterbody type
- water depth
- navigation and space issues
- substrate

## Comparison of Costs

<u>Technology</u>	<u>EPA Cost</u>	<u>Site-Specific Cost</u>
Wedge Wire Screens	\$0.2 – 23M	\$3.5 – 144M
AFB	\$0.8 – 3M	\$9 – 72M
Barrier Nets	\$0.013 – 0.063M	\$0.1 – 14M
Modified Screens	\$0.1 – 22M	\$0.3 – 44M

## Conclusions

- Several technologies are currently available to meet the I & E standards
- Site-specific factors will determine:
  - the applicability of a technology
  - the biological efficacy of a technology
  - the costs of installing and operating a technology

Questions?



EPA Cooling Water Intake Symposium  
Washington, DC May 6-7, 2003

## AN OVERVIEW OF FLOW REDUCTION TECHNOLOGIES

Presented by: Reed Super  
Senior Attorney, Riverkeeper, Inc., Garrison, NY 10524  
845-424-4149 [rsuper@riverkeeper.org](mailto:rsuper@riverkeeper.org) [www.riverkeeper.org](http://www.riverkeeper.org)

## Outline

- Why Reduce Flow?
- Flow Reduction Technologies
- Issues in Flow Reduction
- Cooling System/Flow/Impact Relationship
- Power Plant Examples and Illustrations
  - New Plant
  - Replacement Plant
  - Flow Reduction vs. AFB
  - Cooling Towers vs. Variable Speed Pumps

2

## Why Reduce Flow?

- Drastic reductions in I+E (~95%)
- Guaranteed reductions (no reliability issues)
- Facilitates lower velocity and better screens
- Reduces or eliminates thermal impacts
- Allows use of municipal H<sub>2</sub>O or effluent
- Allows siting away from wetlands, coasts

3

## Flow Reduction Technologies

- Once-Through to Closed-Cycle Wet (96%)
- Closed-Cycle Wet to Dry Cooling (97-100%)
- Repowering (add Combustion Turbine) (33%)
- Variable Speed Pumps (% varies; note baseline)
- Changing Source Water (100%)
- Seasonal Outages (% varies)
- Combination of the Above

4

## Issues in Flow Reduction

- Level of Reduction in Flow (and I+E)
- Relative Effectiveness
- Technical Feasibility
- Effect on Plant Efficiency (Energy Penalty)
- Cost to Plant Owner and Rate-Payer

5

## Flow/Impingement Relationship

Great Lakes:  $I = 1.7023V^{1.778}$

Pisces (2002) using data from Kelso (1979)

Other Fresh Water:  $I = 6 \times 10^{-8} V^{3.1444}$

Pisces (2002)

Ocean and Estuary:  $I = 0.1704V^{1.5943}$

Pisces (2002)

All Waters:  $I = 0.4719V^{1.8699}$

Pisces (2002)

I is # of fish impinged/yr

V is volume in cu/ft per sec

6

## Flow/Entrainment Relationship

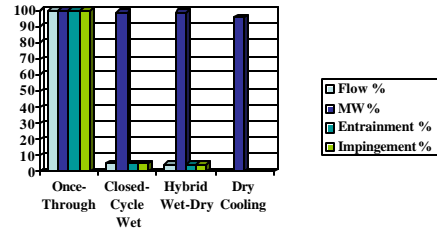
Fresh Water:  $En = 2E + 07V^{0.1924}$   
Pisces (2002)

Ocean and Estuary:  $En = 457475V^{1.1405}$   
Pisces (2002)

En is # of fish entrained/yr V is volume in cu/ft per sec

7

## Cooling Systems, Flow, and E+I



8

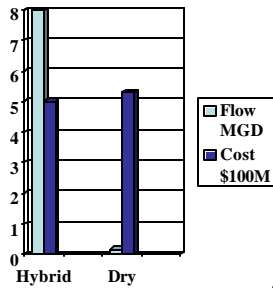
## Flow Reduction at New Plant Hybrid Cooling vs. Dry Cooling (Athens, NY)

### PROPOSED

- Hybrid Cooling
- 4.53-8 MGD

### APPROVED / BUILT

- Dry Cooling
- 0.18 MGD



9

## Flow Reduction at Replacement Plant (Morro Bay, CA)

Existing 1954 plant: 1000 MW, gas, 707 (387) MGD

### ONCE-THROUGH

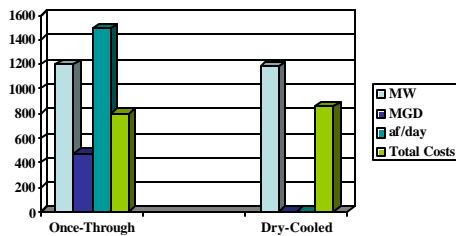
- 1200 MW
- 475 MGD
- 1489 af/day (62%)
- CMR 17-33% 20-37%
- Cost: \$800M

### DRY-COOLED

- 1200 MW
- 0 MGD (muni source)
- 0 af/day (0%)
- CMR 0%
- Cost: \$852M
- Energy Penalty: 1.5%

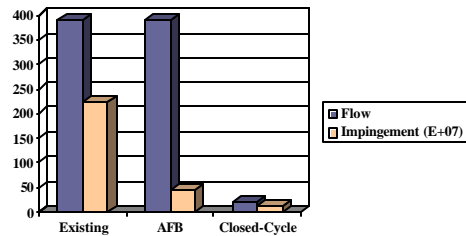
10

## Flow Reduction at Replacement Plant Once-Through vs. Dry Cooling (Morro Bay, CA)



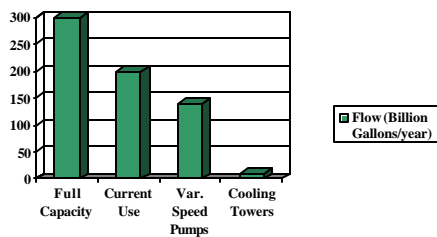
11

## Comparison of Technology Types Flow Reduction vs. Barrier Filters An Illustration



12

**Comparison of Flow Reduction Methods**  
**Variable Speed Pumps vs. Cooling Towers**  
**An Illustration (Current Use as Baseline)**



13

**A Symposium on Cooling  
Water Intake Technologies  
to Protect Aquatic  
Organisms**

14

## State of Maryland Perspectives on Cooling Water Intake Technologies to Protect Aquatic Organisms

Presented at  
Symposium on Technologies for Protecting  
Aquatic Organisms from Cooling Water  
Intake Structures, Arlington, VA,  
May 6-7, 2003

Richard McLean  
Senior Administrator  
Power Plant Research Program  
Maryland Department of Natural Resources



## What is the Power Plant Research Program (PPRP)?

- Created by state legislation in 1971
- Funded by an environmental surcharge on electricity use
- Small technical/administrative staff supported by integrator contractors



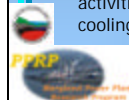
## What does PPRP do?

- Provides technical support to Maryland Public Service Commission with regard to licensing of new projects, including NPDES permitting and 316b compliance
- Provides technical support to Department of Environment, Maryland's permitting agency, for renewal of power plant NPDES permits and demonstrations and 316b compliance
- Conducts research relating to major impact issues of proposed and existing power plants



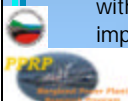
## How does PPRP perform its functions?

- As a result of review of applications, may recommend CWIS studies by applicant
- Conducts technical reviews of applicants' study plans and study results
- Develops cooperative CWIS studies with applicants
- May conduct independent CWIS studies
- Since inception of the program, have carried out such activities at all power plants in Maryland with regard to cooling water intake impacts and structures



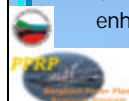
## Maryland View of CWIS Technologies and Impacts to Aquatic Biota

- CWIS "hardware" is only one factor in biological impacts
- Mode of operation of some CWIS and how impinged fish are handled are also major factors
- CWIS impacts must be viewed holistically, with the objective of minimizing losses of impinged and entrained organisms



## Overview of Maryland's Application of this View

- Presentation of types of studies done and actions taken to reduce CWIS impacts throughout Maryland over the past 30 years
- Provide examples to illustrate how the evolution of diverse actions taken at various power plants have resulted in significant CWIS impact reductions or resource enhancement



## Locations of power plants in Maryland



## Chalk Point Power Plant

- Owned by Mirant Energy (formerly PEPCO)
- Located on the estuarine portion of the Patuxent River in Prince George's County
- 2,415 MW (total generation)
- Units 1 & 2, once-thru system, 250,000 gal/min per unit; units 3 & 4, closed cycle cooling tower, 260,000 gal/min per unit
- Has both intake and discharge canals



## CWIS Impact Issues at Chalk Point Addressed by PPRP

- Effects of tempering pumps
- Significant impingement of fish and crabs
- Significant entrainment, particularly of bay anchovy



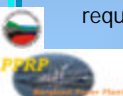
## Chalk Point Tempering Pumps

- Included in original plant design to manage delta T in discharge canal
- Shunt water from intake canal directly to discharge canal
- No screening
- Fish concentrated in intake canal
- High mortality of entrained fish and crabs (including early life stages, juveniles and adults) from mechanical injury




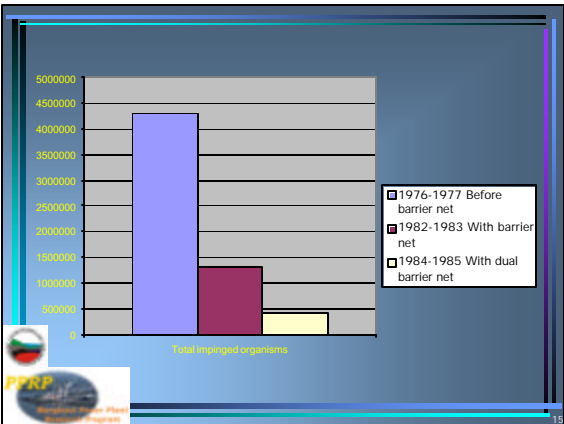
### Tempering Pump Issue Resolution

- Quantified and contrasted losses of organisms from thermal stress and entrainment
- Determined that cessation of operation of pumps would result in 50% decline in losses of fish and crabs
- Permit was modified to eliminate the requirement for augmenting discharge flow



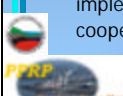
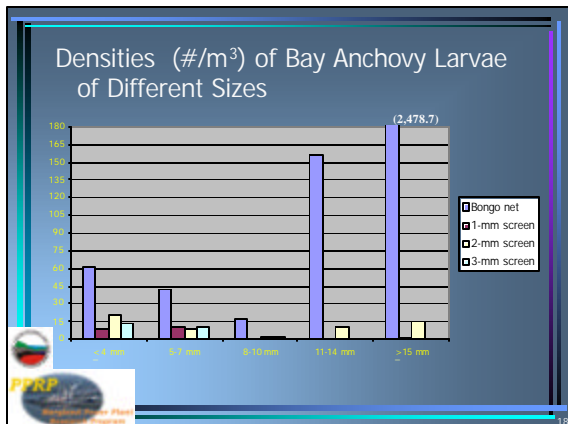
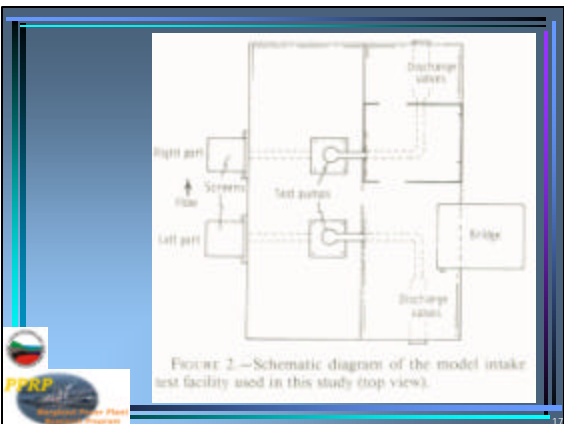
### Impingement Issue Resolution

- Annual impingement averaged about 2 million fish and 2 million crabs before any action
- Plant installed a single barrier net but substantial escapement of smaller fish and crabs through the net
- Negotiated installation of a second (double) barrier net
- About a 90% overall reduction in impingement


### Entrainment Issues

- PPRP estimated entrainment loss as high as 76 % of bay anchovy stock (disputed by PEPCO)
- Considered alternative CWIS, including wedge-wire screens, cooling towers and outages
- Because of lack of information on wedge-wire screen efficacy in estuarine waters, PPRP implemented feasibility studies at Chalk Point in cooperation with PEPCO

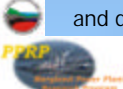
### Entrainment Issue Resolution

- PPRP and PEPSCO modeled estimates of entrainment varied widely
- Efficacy of wedge-wire screens at the site was uncertain, but cost would be high
- Negotiated out-of-kind mitigation, involving enhancement of important resource species in the Patuxent (American shad, yellow perch, striped bass)




### Calvert Cliffs Nuclear Generating Station

- Owned by Constellation Nuclear, a member of Constellation Power Source, Inc., (formerly BGE)
- Located on Chesapeake Bay mainstem in Calvert County
- 1,675 MW
- Once-through cooling, 2.5M gpm
- Shoreline intake embayment with curtain wall and dredged intake channel





### CWIS Impact Issues at Calvert Cliffs Addressed by PPRP

- Lethality of screen wash system initially not known
- Large impingement episodes, primarily menhaden in summer/fall




### Impingement Mortality Studies

- Holding pool constructed to receive screen wash
- Provided information on immediate and delayed mortality
- Allowed benefits of different screen wash procedures to be evaluated
- Provided high quality data on impingement mortality rates
- 11 of 14 most abundant species had survival rates >50%
- 5 species had survival rates >90%
- Blue crab survival rates were 99.5%




### Survival Rates of Impinged Fish at Calvert Cliffs

Most Common Species	Percent survival
Blueback herring	47
Bay anchovy	68
Atlantic menhaden	52
Weakfish	38
Theonopoe striatellata	91
Skullfish	93
Spot	84
Atlantic silverside	54
Atlantic croaker	19
Summer flounder	90
Northern sea robin	50
Blow napper	93
Northern bluefish	85
Shearwater	99



### Royce "Smooth Tex" Screen Studies

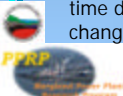
- Smaller mesh screens installed in portion of intake
- Anticipated reduction in entrainment of smaller organisms
- Result was very high impingement rates
- Technology rejected from further consideration



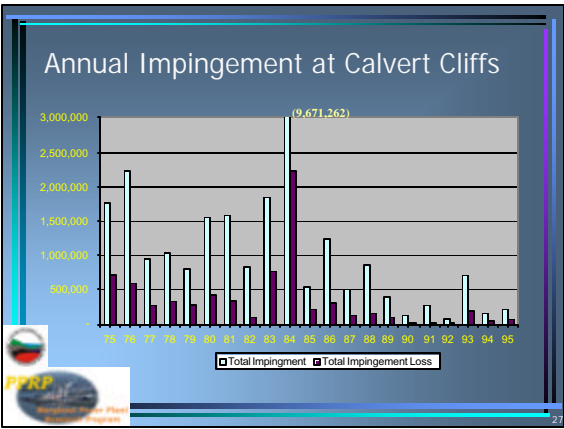
26

### Impingement Issue Resolution

- Studies indicated major impingement episodes were related to low DO conditions (e.g 146 thousand fish impinged in 1 hour at one unit in 1984)
- Curtain wall blocked oxygenated exit for fish concentrated in embayment
- Several curtain wall panels removed
- Eliminated major impingement episodes
- Impingement has shown major declines over time due to CWIS modifications and operational changes




27



### Morgantown Generating Station

- Mirant Energy (formerly PEPCO)
- Located on the Potomac River in Charles County
- 1,411 MW
- Once-through cooling, 1M gpm




28



### CWIS Impact Issues at Morgantown Addressed by PPRP


- Screen wash discharged into discharge canal
- Impinged organisms exposed to additional thermal stress



30

### Impingement Issue Resolution

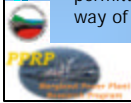
- Morgantown consultants identified several fish return alternatives
- PPRP negotiated redirecting of screen wash return from discharge canal into Potomac River



53

### Conclusions based on 30 years of PPRP Experience

- CWIS impacts can be significantly reduced by a wide variety of changes in intake structure operation, fish handling, external structure design, etc.
- Site-specific results of implementation of measures cannot be accurately predicted, so site specific studies and evaluation are critical
- Cooperative efforts between regulators and permittees are the most timely and cost-effective way of ensuring that CWIS impacts are minimized



53

## Implementation of CWA 316(b) in New York

Ed Radle, Steam-Electric Unit Leader  
(Retired)  
Mike Calaban, Steam-Electric Unit

## NY delegated NPDES program in 1975

- In NY, 316 implemented as a water quality standard.
- Department of Environmental Conservation includes Divisions of Water (water quality issues) and Fish, Wildlife, and Marine Resources (CWA 316) work cooperatively to issue permits

## Accomplished a lot – Things that helped:

- A long history of NY caring about the natural environment;
- The legacy of US EPA's efforts in the Hudson River Power Case;
- An engaged environmental community;
- Department support for the steam-electric program.

## Before getting started

- Define: Adverse environmental impact (any death or damage is adverse; the relevant question is what is a reasonable requirement to reduce or eliminate the impact?)
- Use Best Technology Available: an empty promise if no one is working to advance the state-of-the-art. Made a commitment; got lots of help! (Thanks.)

## Today's mission

- Provide an overview of the technologies that we have applied in NY.

## 316(a): Low-tech solution



Screen Washing = Plastic and..



“Debris elevator”



Enter CWA



Lots of Debris and Fish

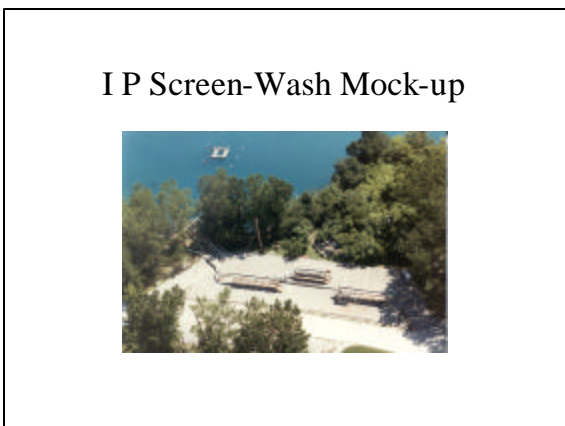
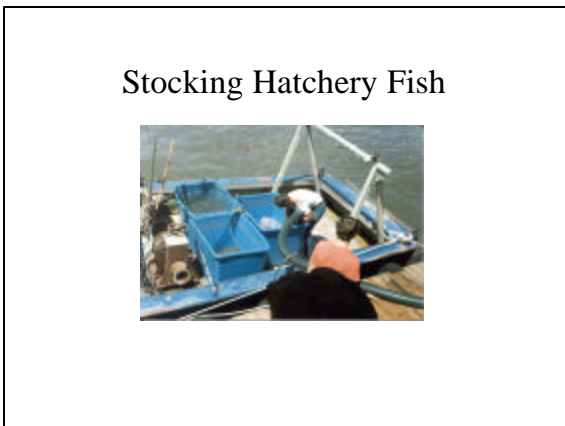
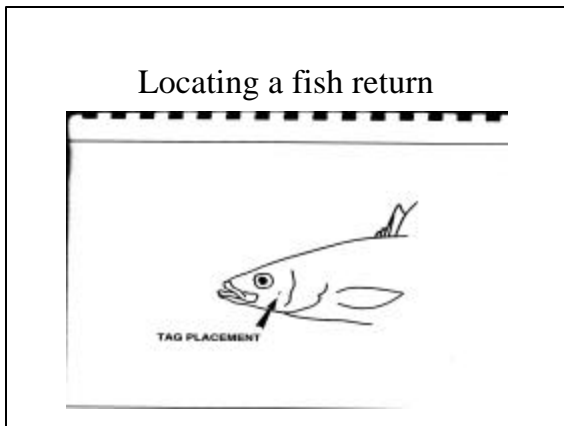
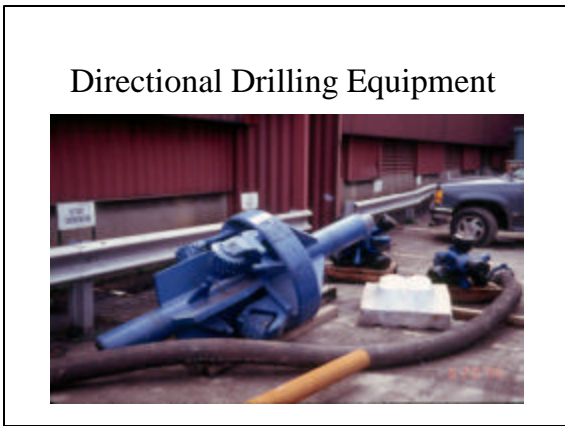


Lake Trout Anyone?



Fish Return via Micky D's





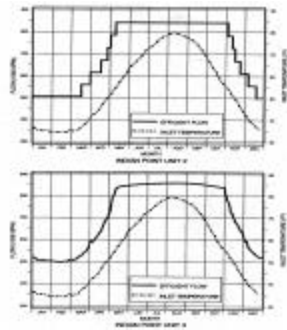
### I P Mock-up Fish Wash



### Release of Entrained Air



### Cooling Water Flow Modulation



### Winter Flow Reduction Study

TABLE 3.3.1-1  
THE FIVE MOST ABUNDANTLY SPAWING SPECIES DURING  
WINTER OPERATION AT JEROME STATION

Species	Year			
	1985-86	1986-87	1987-88	1988-89
Rock Bass	27,519(11)*	27,054(11)	25,329(11)	5,794(11)
Alewife	4,799(4)	5,379(5)	26,858(22)	528
Spottail Shiner	3,546(3)	16,312(3)	10,379(5)	3,392(2)
White Bass	4,155(5)	24,299(2)	13,309(4)	538
Clazzard Shad	689	4,184(3)	194,393(1)	254
White Perch	13,171(2)	3,951	1,417	1,195(3)
Rock Bass	1,800	2,288	818	406
Hottel'd Sculpin	1,144	846	1,167	1,813(3)
Lake Chub	1,428	802	462	779(3)

### A Tale of Two Screens

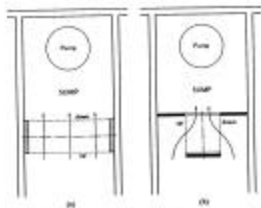


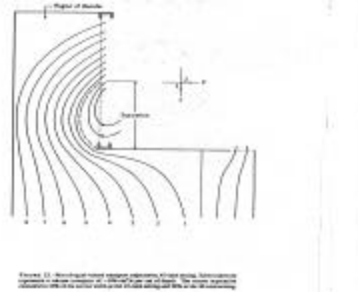
FIGURE 2-104 Plan of 24-inch screen shown equipped with a conventional mesh screen (a) in Fig. 2-103. Comparison of the water flow to a double-entry, single-entry screen.

### Dual Flow Screen Hydraulics

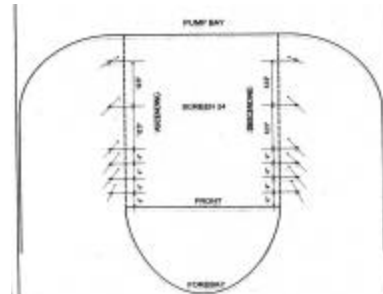




### Dual Flow Velocity Profiles



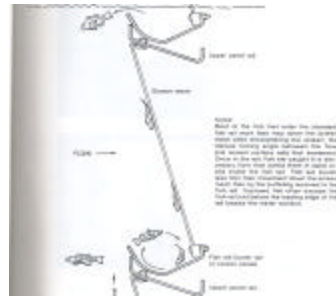
### Reordering Flow: Phase 1



### Reordering Flow: Phase 2



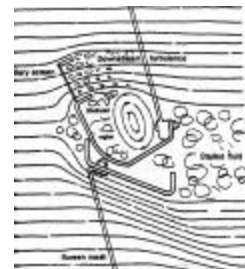
### Ristroph Screen Fish Rail



### Fish Rail Hydraulics



### Modified Fish Rail



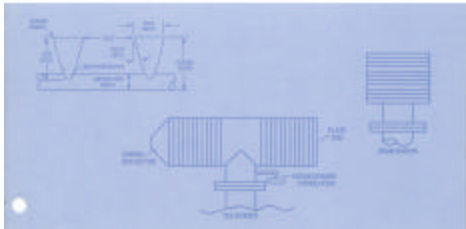
### Utah State Fish Rail Mod



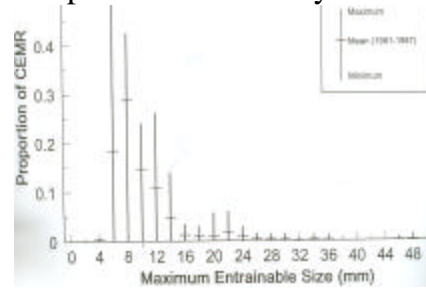
### Wedge-wire Screen



### Wedge-wire Screen Detail



### Striped bass CEMR by Size

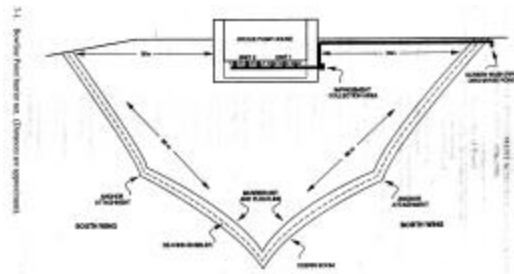


### Bowline Barrier Net

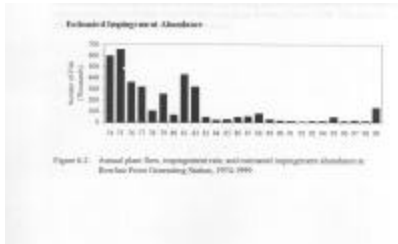


Bowline Point Generating Station

### Bowline Barrier Net Detail



## Bowline Impingement



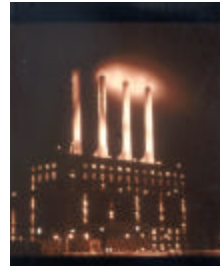
## Fish Startle System / IPA



## Gunderboom MLES



???



## Resource Agency Views of Technology Employed to Prevent Fish Mortality at Cooling Water Intakes

Presented by:



Richard L. Wantuck



NOAA Fisheries  
Southwest Region



Cooling Water Intake Symposium  
Arlington, VA  
May 6-7, 2003

## Overview

- Nature and scope of the problem
- Federal-state regulations
- Legal matters
- Some emphasis on West Coast perspective
- Considerate of the national "big-picture"
- General Considerations for Resource Protection Priorities
- Historical and Existing Standards for Fish Protection
- Guidelines for fish protection system
  - NMFS fish protection standards (west),
  - AFS Bioengineering
- Current CWIS projects in California
- Where do we go from here?

## Why are we here?

### Cooling Water Intake Structures - CWA Sec. 316(b)

EPA is developing regulations under section §316(b) of the Clean Water Act. Section §316(b) requires that the... *location, design, construction and capacity of cooling water intake structures reflect the best technology available for minimizing adverse environmental impact.*

More than 1,500 industrial intakes use large volumes of cooling water from lakes, rivers, estuaries or oceans to cool their plants, including steam electric power plants, pulp and paper makers, chemical manufacturers, petroleum refiners, and manufacturers of primary metals like iron and steel and aluminum.

Cooling water intake structures cause adverse environmental impact by pulling large numbers of fish and shellfish or their eggs into a power plant's or factory's cooling system. There, the organisms may be killed or injured by heat, physical stress, or by chemicals used to clean the cooling system. Larger organisms may be killed or injured when they are trapped against screens at the front of an intake structure.

Source: <http://www.epa.gov/waterscience/316b/>

## Riverkeeper Sues Again

<http://www.riverkeeper.org>

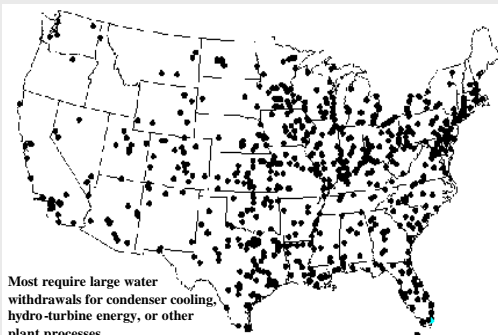
In January 2002, Hudson Riverkeeper led a coalition of environmental groups in a legal challenge to EPA's Phase I rule in the Second Circuit, U.S. Court of Appeals in New York City. ...a decision from the Court is expected in 2003

The new regulation is clearly superior to the...1976 regulation, and is a vast improvement over the 25-year period during which there were no federal regulations in this area. In particular, it acknowledges the technology-based nature of Section 316(b) regulations and mandates closed-cycle cooling as "best technology available." That alone can protect billions of aquatic organisms at each new power plant that uses closed-cycle cooling rather than once-through cooling. The regulation is also an improvement over the draft Phase I rule which would have allowed once-through cooling for offshore intakes in oceans, lakes and non-tidal rivers...

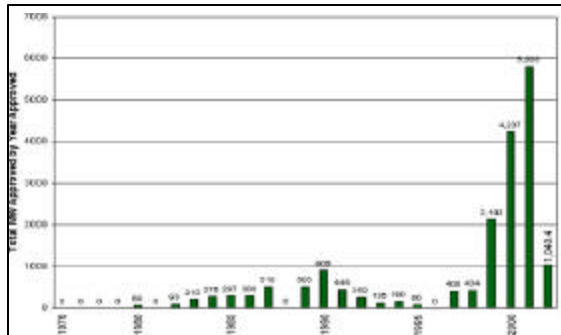
While it [is] a drastic improvement, the new regulation also contains "serious loopholes."

...applicants willing to conduct additional studies may be permitted to use once-through cooling either alone or in conjunction with other technologies...if they can demonstrate that these technologies will be 90% as effective as closed-cycle cooling...

## U.S. Power Plants



Most require large water withdrawals for condenser cooling, hydro-turbine energy, or other plant processes...



Megawatts Approved by Year in California

source: California Energy Commission

**Approaching the Problem**

*Fish Protection and Technology Standards for Water Intakes at U.S. Power Plants and Industries Must Be Viewed in the Context of:*

- 1) National, Regional, and State Overall Priorities
- 2) National, Regional, and State Natural Resource Conservation Priorities
- 3) National, Regional, and State statutes, codes, and regulations
- 4) Social and Economic Factors
- 5) An Understanding of Existing Standards and Historical Norms\*
- 6) Technological Capabilities and Results-Oriented Development\*

**Historical and Existing Standards for Fish Protection**

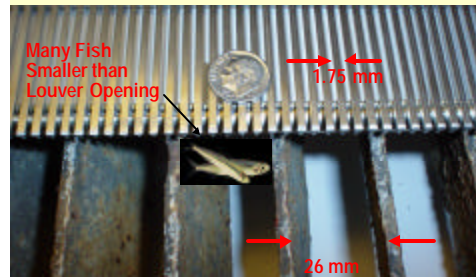
....Evolution from....

- **Trashracks ...**  
trash and debris- equipment concerns, structure may provide some fish deterrence, but poor hydraulics generally leads to entrainment /impingement
- **Louvers...**  
early 20th century behavioral technology, hydraulic behavioral guidance mechanism
- **Positive Barrier Fish Screens....**  
current west coast standard for Pacific salmon protection
- **Behavioral Fish Guidance Devices**  
“walls of light,” infrasound, underwater electric fields, chains, and “bubble curtains”

**TRASHRACKS**

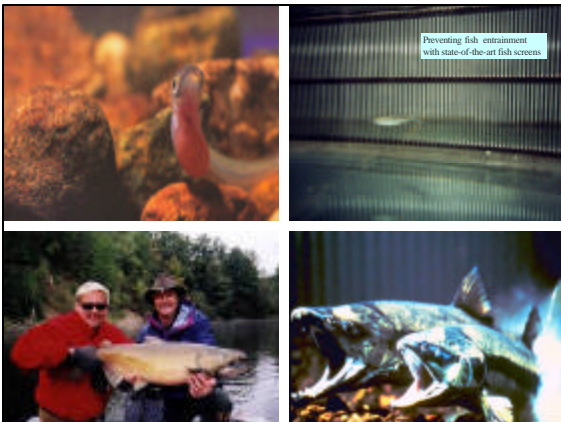


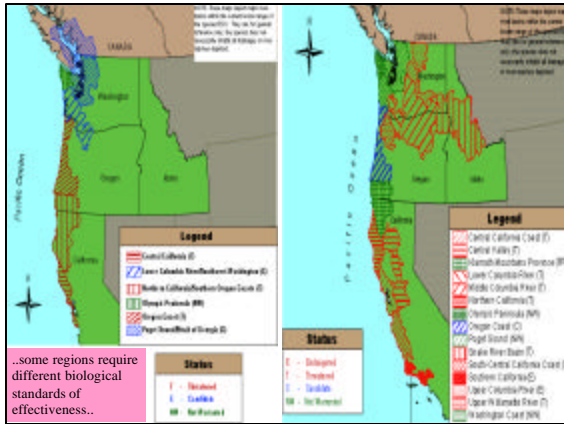
**Proposed Screen Opening will be 14 Times Smaller than Louvers!**



**Transition from Louvers to Positive Barrier Fish Screens**

Slide courtesy of Darryl Hayes, CH2MHill Sacramento, CA





### Approach to Assessing Technological Capabilities

Why?

- 1) Government Regulatory Responsibilities**
  - Clean Water Act
  - Endangered Species Act
  - Fish and Wildlife Coordination Act
  - Federal Power Act
  - State Fish and Game codes
  - NEPA, and other regulations
- 2) Industry Stewardship Responsibilities**
  - EPRI Initiatives, AFS Bioengineering Section, Industry sponsored research
- 3) Promote Scientific Advancement :**
  - Academic research
  - Promote Effective Technology Development using scientific methods
  - *Combined, cooperative efforts* of government, industry, academia, entrepreneurs, and fisheries professionals toward a *well-articulated common goal* will yield fastest, most effective results

### Experimental Fish Guidance Devices (1994)

<http://swr.nmfs.noaa.gov/habitat.htm>

- NOAA Fisheries Southwest Region position statement on Experimental Technology for Managing Downstream Salmonid Passage
- a *tiered process*...for studying, reviewing, and implementing future fish protection measures
- concerned with *effectively preventing or minimizing* the three main causes of delay, injury or mortality at water intakes: *entrainment, impingement, predation*
- NOAA Fisheries (west) currently considers *Positive Barrier Screens as Best Available Technology* for protection of juvenile salmonids and other marine species of fish *regardless of the classification of water diversion*...
  - ...i.e.- municipal, industrial, hydro- and non-hydro power generation, and agricultural water diversions are treated the same

### Experimental Fish Guidance Devices (1994)

<http://swr.nmfs.noaa.gov/habitat.htm>

The “tiered-procedure” for study, testing, and evaluation is:

- 1) **Consider Earlier Research**
- 2) **Study Plan**
- 3) **Laboratory Research**
- 4) **Prototype Units**
- 5) **Study Results**

### Experimental Fish Guidance Devices (1994)

<http://swr.nmfs.noaa.gov/habitat.htm>

#### Behavioral Fish Guidance Devices:

“Pros”

- Generally, *far less costly* than conventional positive barrier screens
- *Rapidly adaptable* as technology progresses
- Scientific research, technology innovations, and evaluations of field prototypes indicate *improved results* in recent years...
  - ...in some cases
- Useful in many situations as *interim improvements* or *long term enhancements* to existing fish protection technologies already in place...

### Experimental Fish Guidance Devices (1994)

<http://swr.nmfs.noaa.gov/habitat.htm>

#### Behavioral Fish Guidance Devices:

“Cons”

- requires a volitional taxis by fish to avoid entrainment... [resulting from a “startle” or avoidance response to a stimulus]
- in strong/accelerating water velocity field, the lack of swimming ability, or swimming fatigue, in a small fish may prevent it from responding to stimulus even if it attempts to do so
- providing a “safe hydraulic environment” for fish often requires physical structure. If behavioral devices require structural additions to modify hydraulics, the cost advantage may be substantially diminished
- other environmental conditions & cues [e.g.- predator/prey behavior, turbidity, etc.] may cause fish to be confused or ignore the signal. (competing stimulus theory)

**Experimental Fish Guidance Devices (1994)**

<http://swr.nmfs.noaa.gov/habitat.htm>

**Criticisms of the policy:**

- **Too rigid, inflexible**
- **No well-defined system to determine where a technology is in the process and how it can move to the next step with general acceptance by government regulators**
- **Takes too long to move serially from one step to another**
- **Regulators often are not up-to-date on technological progress as it happens as a result of simultaneous, and geographically, distant lab experiments and field prototype tests**
- **Stifles innovation by creating unreasonable “barriers to entry”**

**Experimental Fish Guidance Devices (1994)** <http://swr.nmfs.noaa.gov/habitat.htm>

On the other hand...using this approach, the NOAA Fisheries Southwest has seen the following results from experimental behavioral barriers field testing-

**1993-1996 - Reclamation District 108**

**Sacramento River, Agricultural Irrigation - 582 MGD or 900 cfs**

Field experiments failed to show efficacy using acoustics and electricity as barriers; first consultant's report used incorrect and misleading statistical methods, i.e. - "pseudo-replication" Second consultant improved the legitimacy of the science, but the results remained *inconsistent* and *ultimately unsatisfactory* for the protection of endangered winter-run chinook salmon fry.

**1994-1996 - Reclamation District 1004**

**Sacramento River, Agricultural Irrigation - 388 MGD or 600 cfs**

Field experiments failed to show efficacy using acoustic barrier. In addition, the installation was plagued by mechanical anchoring problems.

**1997 - Georgiana Slough Acoustic Guidance Experiment.**

**Sacramento River, water conveyance- 5000 cfs or 3232 MGD (estimate)**

Field experiments failed to show efficacy of acoustic barrier in guiding fish away from a channel which leads to California's Delta Water Export Pumping Plants. In addition, the installation was plagued by mechanical anchoring problems.

Recent History and Evolution of Technology Guidelines and Development:

- 1994- NOAA Fisheries Southwest Region develops Regional Guidelines to discourage proliferation of ineffective "black box fish protection systems" Northwest Region soon adopts a similar policy.
- 1993-97- NOAA Fisheries and California Dept. of Fish and Game evaluate unsuccessful field trials of acoustic and electric barriers
- 1995- **Fish Passage Technologies** published by Congressional Office of Technology Assessment
  - **Using Sound to Modify Fish Behavior**...Portland State workshop (see: Bonneville Power Administration Final Report)
- 1997- NOAA Fisheries Southwest Region modifies: "**Fish Screening Criteria for Anadromous Salmonids**" to include provisions for a "**Variance Procedure**" on a project-specific basis
- 1997 - **EPRI Fish Passage Workshop** in Milwaukee, WI
- 1998 - NOAA Fisheries Southwest Region promotes a proposal for an applied "Technology Development Facility" at the U.S. Bureau of Reclamation's fish salvage facility at Tracy, CA.

Recent History and Evolution of Technology, Guidelines, and Developments

- 1999 - **Innovations in Fish Passage Technology** - Odeh et al. American Fisheries Society
- 2000- **Guidelines for Evaluating Fish Passage Technologies**- American Fisheries Society Bioengineering Section
- 2000 - **Advances in Fish Passage Technology** - Odeh et al. American Fisheries Society Bioengineering Section
- 2001 - **EPA initiates CWA 316(b) rules for "Cooling Water Intakes"**
- 2001 - **Behavioral Technologies for Fish Guidance** - Coutant et al. American Fisheries Society
- 2002- NOAA Fisheries Sacramento area office accepts field prototype(s) and 5 year monitored test of "**Aquatic Filter Barrier**" at Mirant Corp's Pittsburg and Contra Costa Power Plants under ESA Section 7 consultation
- 2003- NOAA Fisheries Sacramento area office *considers a proposal* for "**combined behavioral technology**" (acoustics+bubble curtain) prototype experiment as a potential means to collect juvenile salmon above Oroville Dam on California's Feather River

**American Fisheries Society Bioengineering Section**  
**Guidelines for Evaluating Fish Passage Technologies (2000)**

[http://www.afsbioengineering.org/fish\\_pass\\_comm.htm](http://www.afsbioengineering.org/fish_pass_comm.htm)

- 1) Recognizes the **conflict between peer-reviewed science standards and timelines faced by industry** through regulatory processes
- 2) Acknowledges that **many field tests have proved equivocal, or not sufficiently scientific**...and that vendors of technology have **inherent financial interests and may occasionally be biased in claiming product effectiveness**.
- 3) Asserts that **some promising behavioral technology studies have been negatively received due to inadequate experimental design, lack of experienced personnel, and improper applications of specific technologies**
- 4) Acknowledges that lack of peer-reviewed science relegates test results to "**gray literature**" status in the minds of many scientists and regulators. Proposes to establish a "**peer-review system**" via AFS Bioengineering Section to help expedite evaluations of technology field trial performance

**American Fisheries Society Bioengineering Section**  
**Guidelines for Evaluating Fish Passage Technologies (2000)**

[http://www.afsbioengineering.org/fish\\_pass\\_comm.htm](http://www.afsbioengineering.org/fish_pass_comm.htm)

- 4) Clear need: **improving evaluating process [of fish protection technologies] providing... greater consistency in experimental design... scientific and objective evaluation process**
- 5) Replace: **Trial and Error Process**  
with: **improved experimental design, better communication,**  
leading to: **general consensus on biological effectiveness (or ineffectiveness)**
- 6) **...Tool for bringing new technologies into practical application**
- 7) offers... **standardized procedures** for development, evaluation, and application of technologies using "**sound science,**" but remaining **sufficiently flexible**.

**American Fisheries Society Bioengineering Section**  
**Guidelines for Evaluating Fish Passage Technologies (2000)**  
[http://www.afsbioengineering.org/fish\\_pass\\_comm.htm](http://www.afsbioengineering.org/fish_pass_comm.htm)

Effectiveness requirements may vary by jurisdiction due to:

- \* species distribution,
- \* regional histories of specific technologies
- \* robustness of local stocks,
- \* laws and statutes,
- \* fish management strategies,
- \* regional societal values...

**American Fisheries Society Bioengineering Section**  
**Guidelines for Evaluating Fish Passage Technologies (2000)**  
[http://www.afsbioengineering.org/fish\\_pass\\_comm.htm](http://www.afsbioengineering.org/fish_pass_comm.htm)

**Technologies Defined:**

**Existing Technologies-**

e.g.- positive barrier screens, fish ladders, other conventional hydro-mechanical systems... are subject to existing formal design and performance criteria in the western states NMFS, USFWS, state departments of Fish & Game

**Experimental Technologies-**

Devices or systems ... which have demonstrated some potential for protecting or passing fish, but .. adequate scientific evidence has not been collected to verify effectiveness...gain agency acceptance or ... considered for general application. Behavioral fish protection devices such as louvers, strobe lights and sound systems are considered experimental by some resource agencies (NMFS 1994), but are accepted by others ( Odeh and Orvis 1997).

**Guidelines for Evaluating Fish Passage Technologies (2000)**  
**American Fisheries Society Bioengineering Section**  
[http://www.afsbioengineering.org/fish\\_pass\\_comm.htm](http://www.afsbioengineering.org/fish_pass_comm.htm)

**Guideline Implementation... another step-wise process**

**Phase I- Conceptual Development**  
 ...establish an "Expert Review Panel" and study plan

**Phase II- Laboratory Evaluation**  
 ...controlled operational and environmental conditions

**Phase III- Prototype Evaluation**  
 ...large scale field evaluation in "real world conditions"

**Phase IV- Application and Evaluation**  
 ...Expert Review Panel verifies effectiveness  
 stating any conditions, limitations, or exceptions

**Current "CWIS"**  
**Evaluation and Certification Processes**  
**in**  
**California**

**POWER FACILITY LICENSING CASES CURRENTLY BEFORE THE COMMISSION**

**Projects Greater Than 300 Megawatts(4)**

- 1.Avenal Energy Project (01-AFC-20) Project Suspended until May 2003
- 2.Blythe Energy Project Phase II (02-AFC-1, 6 or 12-month AFC)
- 3.East Altamont Energy Center (01-AFC-4)
- 4.El Segundo Modernization Project (00-AFC-14)
- 5.Inland Empire Energy Center (01-AFC-17)
- 6.Morro Bay Power Plant Project (00-AFC-12)
- 7.Palomar Energy Project (01-AFC-24)
- 8.Potrero Power Plant Project (00-AFC-4)
- 9.San Joaquin Valley Energy Center (01-AFC-22, 6-month AFC)
- 10.SMUD Cosumnes Power Plant Project (01-AFC-19)
- 11.Tesla Power Plant Project (01-AFC-21)
- 12.United Golden Gate Power Plant, Phase II Project (01-AFC-3, 6-month AFC) - Project On Hold

**Projects Less Than 300 Megawatts**


- 13.City of Vernon Malburg Combined Cycle (01-AFC-25, 6-month AFC)
- 14.Los Banos Voltage Support Facility (01-AFC-23, 6-month AFC) - Project Suspended, 5/15/02
- 15.Modesto Irrigation District Electric Generating Station - Ripon (03-SPPE-1, Small Power Plant Exemption)
- 16.Pico Power Project (02-AFC-3)
- 17.Salton Sea Geothermal Power Project (02-AFC-2, 12-month AFC)
- 18.Turlock Irrigation District Walnut Energy Center (02-AFC-4, 12-month AFC)


**Notable California Power Plants currently in consultations under:**

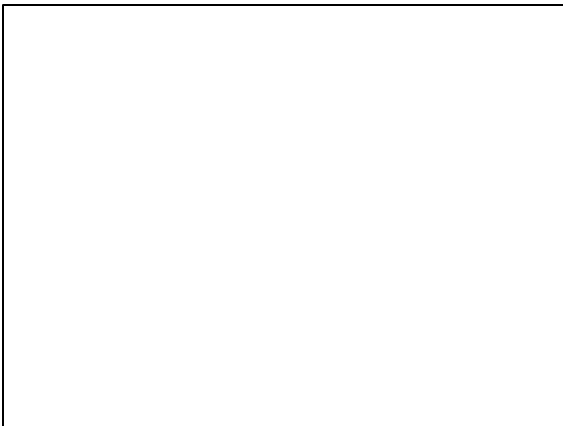
- California Energy Commission certification procedures,
- California Fish and Game Codes
- CWA 316(b) regulations,
- Endangered Species Act, and/or
- Essential Fish Habitat Consultations

- ▶ Pittsburg-Contra Costa Power Plants (2)- Mirant Corp.
- ▶ Potrero Power Plant- Mirant Corp.
- ▶ Morro Bay- Duke Energy
- ▶ Moss Landing - Duke Energy



<p><b>Contra Costa Power Plant</b> Mirant Corporation</p> <p>Total Output: 6,7, and 8 = 1,210 MW "once-through cooling system" water source - Sacramento River</p>  <p>Contra Costa Generating Plant</p>	<p><b>Pittsburg Power Plant</b> Mirant Corporation</p> <p>Total Output = 1,906 MW "once-through cooling system" water source - Sacramento River</p> <p><b>NMFS Biological Opinion 2002:</b></p> <ul style="list-style-type: none"> <li>• <b>Pittsburg-</b> <ul style="list-style-type: none"> <li>- 5-year field test of "AFB"</li> <li>- Formal monitoring and evaluation</li> <li>- Habitat enhancement measures</li> <li>- Off-site mitigation</li> </ul> </li> <li>• <b>Contra Costa-</b> <ul style="list-style-type: none"> <li>-cooling water conservation program</li> <li>-variable speed drive pumping (VSD)</li> <li>- Habitat enhancement measures</li> <li>- Off-site mitigation</li> </ul> </li> </ul>
---	---



<p><b>Potrero Power Plant</b> Mirant Corporation</p> <p>Proposed Total Power Output = 540 MW (units 4-7)</p> <p>"once-through cooling system" = 228 MGD water source = San Francisco Bay</p> <hr/> <p>NOAA Fisheries consultations in progress:</p> <p><b>ESA § 7</b> - considering conventional screening of intake, along with Habitat Enhancement and off-site mitigation</p> <p><b>EFH</b> - recommending consideration of Dry Cooling as best means of minimizing adverse impact to NOAA trust resources in SF Bay</p>	 <p>Other agencies forums and regulatory proceedings are simultaneously in progress</p>
---	--




**Moss Landing Power Plant told to review use of water for cooling**

...a Monterey County judge has ruled that **more expensive cooling methods must be studied for Duke Energy's huge power plant in Elkhorn Slough at Moss Landing.**

Superior Court Judge O'Farrell's decision *won't interrupt the flow of 2,550 megawatts of power* -- about 5 percent of California's total electricity use on a hot summer day . *[but ....it will force the Regional Water Quality Control Board to review its permit to make sure that the "best technology available" is being used to protect marine life* , as required by the Clean Water Act....  
San Jose Mercury News 10/03/02

**Aquatic Filter Barrier proposed for this site to prevent entrainment**

<p><b>Morro Bay Power Plant</b> Duke Energy</p> <p>Total Upgraded Output = 1,202 MW (enough to serve 1 million households)</p> <p>applicant proposes to use existing "once-through cooling system," but modernized plant will use 38% less cooling water</p> <p><b>Proposed Habitat Enhancement Measures</b></p> <ol style="list-style-type: none"> <li>1) Offset and minimize effects of entrainment with <i>modernized</i> plant</li> <li>2) Improve quality and quantity of aquatic habitat in Morro Bay</li> <li>3) Reduce sediment transport into Morro Bay</li> <li>4) Complement on-going Bay protection programs</li> <li>5) Conduct "Aquatic Filter Barrier" feasibility study</li> </ol>	
--	---

April 10, 2002...Letter from Duke Energy to CA. Regional Water Quality Control Board: citing independent review:

***Entrainment Mortality and the Morro Bay Power Plant Modernization Project: Technical Comments and Ecological Context ...* Dr. James Cowan, Jr.**

Selected and Paraphrased Excerpts

- ...mortality estimates should include all major taxa of entrained species
- ...known "mechanisms of compensatory mortality" effectively operate to maintain population levels commensurate with the carrying capacities of their respective habitats
- ...Dr. Cowan used a life history [model] to predict magnitude of compensation and to describe the first-order potential for compensation in Morro Bay fish species
- "...each of the species should be capable of either compensating for losses of early life stages, or to persist in the face of very high mortality rates of eggs and larvae
- ...losses of larvae do not translate *directly* into losses of adults if entrainment occurs before compensation...[and] arguments that infer that removal of larvae [from Morro Bay] at any level results in an equivalent decline in ecosystem productivity are not founded in sound ecological and fisheries theory.

**EPA 316(b) Legal Process:  
A New Standard for Protection of Aquatic Organisms?**

Traditionally, NOAA Fisheries west has been concerned with preventing entrainment of fry-size salmonids (20-30mm FL) with positive barrier fish screens

With current fish screen mesh sizes (1.75mm) and good hydraulic characteristics, high-efficiency exclusion of organisms as small as 4 mm has been observed.

However,

at least two major court cases are pending where environmentalists challenge the entrainment, impingement, and predation effects on **zooplankton and phytoplankton** communities sometimes referring to large water intakes as “**giant filter-feeders**” which adversely impact the aquatic ecosystem’s food web.

Other scientists counter that these small organisms reproduce rapidly and prolifically; and there is a “**density-dependent**” phenomena at work which allows populations to sustain themselves.

**NOAA Fisheries SWR Engineering Perspective of a Prospective  
“Phytoplankton Standard”**

**Questions**

- **What percentage of phytoplankton and zooplankton survive transport in “once-through cooling systems?”**
- **What is the biological cause(s) of mortality for organisms that die?**
- **Can small biota be salvaged and returned to the environment?**
- **Can plant cooling systems be re-engineered or retrofitted to maximize survival of very small aquatic species?**



**NOAA Fisheries SWR Engineering Perspective of a Prospective  
“Phytoplankton Standard”**

- **“Micromesh fabrics”**  
such as the Gunderboom Aquatic Filter Barrier are considered experimental technology and are undergoing analysis of laboratory research and field prototype testing. There is no guarantee that this is a long term solution until sufficient performance evaluations have been conducted in enough situations.  
**Durability, structural integrity** in hydraulic environments, and **maintenance** questions remain to be evaluated.
- **Non-physical Behavioral Guidance Systems**  
(e.g.- sound, light, electricity, bubbles, etc)  
**virtually no physical or biological effect on entrainment of extremely small organisms** (poor swimming or non-swimming), nor is there a hydraulic or biological rationale that would support a different expectation

**NOAA Fisheries SWR Engineering Perspective of a Prospective  
“Phytoplankton Standard”**

- Physical entrainment barriers using **micron size mesh** may present a **tremendous challenge to maintain the barrier material clean and undamaged on a consistent basis**, particularly in winter, or during stormy weather and spring freshets- where incipient **debris loading rate** can be very high in many locations
- If “**phytoplankton standard**” is upheld in courts for cooling water intakes, what does it mean for our existing, multi-billion dollar, national fish protection infrastructure (ie- positive barrier fish screens and louver systems) at hydro-, agricultural, municipal, and other industrial water intakes across the country ?
- Is **hybrid Wet or Dry-Cooling** the only acceptable answer, or is there room for compromise based on biological and economic priorities? What about other sectors where water withdrawal cannot be avoided, e.g.- agricultural irrigation or municipal water supply?

**Where do we go from here?**

- **Courts will likely decide how stringent or flexible technology standards can be for Cooling Water Intakes under EPA 316(b)**
- **There may be other laws and standards in effect, e.g.- Endangered Species Act listings in regional areas.**
- **NMFS-west generally defers to another standard if it requires a higher level of fish protection efficiency under an existing state, federal, or local laws**

**In the meantime,**

from a federal, regulatory point-of-view...

- continue working on ways to improve **effective fish protection** for the lowest possible cost
- support continued technological innovation for fish protection, but make sure it is based on good science
- support use of: **NMFS Experimental Fish Guidance Devices (1994)**  
**AFS Guidelines for Evaluating Fish Passage Technologies (2000)**  
as appropriate to the protection goals and standards of particular regions
- consider more streamlined, efficient evaluation and approval processes to allow more widespread testing of field prototypes...
- ...so long as there is a sufficient amount validity and integrity to the process of demonstrating “fish protection results” accurately and scientifically.

**THE END**

**Resource Agency Views of Technology Employed to Prevent Fish Mortality at Cooling Water Intakes**

Presented by:



**Richard L. Wantuck**



**NOAA Fisheries  
Southwest Region**



**Cooling Water Intake Symposium  
Arlington, VA  
May 6-7, 2003**



EPA Cooling Water Intake Symposium  
Washington, DC May 6-7, 2003

## RETROFIT OF CLOSED-CYCLE COOLING TOWERS

John Torgan, Narragansett Baykeeper  
Save the Bay®-People for Narragansett Bay

Reed Super, Senior Attorney  
Riverkeeper, Inc.

### Closed-Cycle Cooling at New Plants

- 100% of combined-cycle plants built in the last 20 years have a closed-cycle recirculating cooling system.
- 88% of the coal-fired facilities built in the last 10 years have closed-cycle cooling.

Source: U.S. EPA (66 Fed. Reg. at 28,855)

2

### Closed-Cycle Retrofits

- Palisades 821 MW nuclear (MI) 1974
- Pittsburg (Unit 7) 751 MW gas (CA) 1976
- Jefferies 346 MW coal (SC) 1985
- Canadys 490 MW coal (SC) 1972, 1992
- Wateree 772 MW coal (SC) 2003+
- Yates 1250 MW coal (GA) 2004 (proj)
- McDonough 520 MW coal (GA) 2008 (proj)
- Brayton Point 1500 MW coal/oil (MA/RI)

3

### Yates Plant Chattahoochee River

- Mechanical-draft counter flow cooling twrs
- 40 cells: 5 units, 8 cells each
- Length: 1000 ft
- Allows Routing to Different Cells
- 96% Flow Reduction (600 to 22 MGD)
- No Construction Outages
- Cost \$75-87M

4

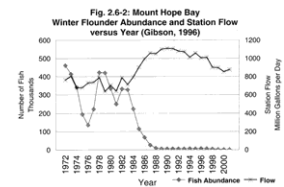
### Yates Plant Chattahoochee River

- 7 Units, 1250 MW total, coal-fired
  - Units 1-5, 1950s, 550 MW, once-through cooling
  - Units 6-7, 1970s, 700 MW, closed-cycle cooling
- Depowers Units 1-5 to 300 MW  
b/c thermal discharge, DO, fish kills
- Retrofitting Units 1-5

5

### Brayton Point Station -Aquatic Impacts of Once-Through Cooling-

- Thermal discharge 95° F
- Entrainment, including:
  - 251M winter flounder
  - 11.8M bay anchovy
  - 375M windowpane
  - 3.5 billion tautog
- 87% decline in finfish populations



6

**Brayton Point Station**  
-Cooling Tower Retrofit Options-

- Closed-Cycle Unit-Specific - Unit 3 (654 MGD)
- Enhanced Multi-Mode system (650 MGD)
- C/C Unit-Specific - Units 1 or 2&3 (350 MGD)
- C/C Unit-Specific - all 4 Units (with by-pass capability) (56 MGD)

7

**Brayton Point Station**  
- Cooling Tower Retrofit Options Specs-

**[Current Plant: Once-Through, 4 Units = 1.4 BGD]**

<u>Enhanced Multi-Mode</u>	<u>Unit-Specific Option</u>
<ul style="list-style-type: none"> <li>• Mechanical Draft</li> <li>• 20-cells, from canal</li> <li>• Not associated w/ units</li> <li>• 650 MGD (33%)</li> <li>• Allow bypass</li> </ul>	<ul style="list-style-type: none"> <li>• Mechanical Draft</li> <li>• All 4 units</li> <li>• 56 MGD (96%)</li> <li>• By-Pass Capability (6,847 MGy)</li> </ul>

8

**Mechanical Draft Unit-Specific Cooling Towers**  
-Summary of Aquatic Benefits-

- Reduce thermal discharge by 99%  
97 trillion to 0.8 trillion BTUs/yr)
- Reduce Max temperature from 95° F to 85° F
- Reduce water withdrawals by 96%  
(1.4 BGD to 56 MGD)
- Reduce losses to fishery (E+I) by 94%  
(e.g., 251M to 15M flounder larvae/yr)

9

**Reduction of Flow and Heat**  
-Comparison of Options-

Operating Scenario	Flow Rate (MGD)	Annual Heat Load Discharge (TBTU)
Current	1452	97
Closed-Cycle Unit 3	654	22.9
Enhanced Multi-Mode (20-cell cooling tower)	650 (annual) 750(summer)/ 600 (winter)	28
Closed-Cycle (Units 1 or 2 & 3)	350	14
Closed-Cycle Entire Station (Units 1, 2, 3 and 4)	56	0.8

10

**Brayton Point Station**  
**Total Annual Production Foregone in Pounds**

Tech Option	Impinge	Entrain
Current	4,926	121,968,640
Enhanced Multi-Mode	2,211	54,741,834
Closed-Cycle Unit 3	2,246	55,617,704
Closed-Cycle Full Plant	134	3,312,155

11

**Brayton Point Station**  
**Total Annual Production Foregone in Pounds**

12

**Annual Efficiency Losses (“Energy Penalty”)**

- Units 1, 2, 3: 0.29% Unit 4: 0.09%  
(100% capacity factor)
- Units 1, 2, 3: 0.75% Unit 4: 0.18%  
(100% capacity factor)

Current Capacity Factor (1, 2, 3): 80%

Source: SAIC Report (March 15, 2002)

13

**Annual Cost  
EPA/Abt Estimate (11.8% Disc. Rate)**

Technology Option	20 years	30 years
<u>Closed-Cycle 4 Units ( 0% plume abate)</u>		
Total After-Tax Cash Flow Cost, PV:	\$68.385 M	\$67.975 M
Annual Equivalent Cost:	\$9.041 M	\$8.314 M
<u>Closed-Cycle 4 Units (100% plume abate)</u>		
Total After-Tax Cash Flow Cost, PV:	\$83.269 M	\$85.803 M
Annual Equivalent Cost:	\$11.009 M	\$10.494 M

14

**Increased Cost to Rate-Payer  
-from production costs and reduced generation-**

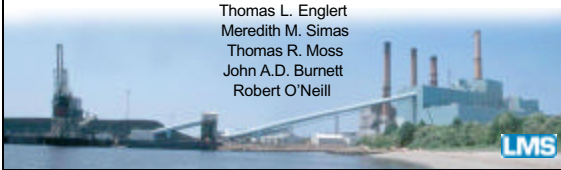
Long-term increase in electric rates  
for the average household  
(500 kWh per month consumer):

\$0.03-\$0.13 per month

15

## Innovative Cooling System for Heat and Flow Reduction at Brayton Point Station

Thomas L. Englert  
Meredith M. Simas  
Thomas R. Moss  
John A.D. Burnett  
Robert O'Neill



LMS

## An Innovative Cooling System

### Enhanced Multi-Mode Cooling (EMM)

Symposium on Protecting Aquatic Organisms from Cooling Water Intakes • 6-7 May 2003 LMS

## Presentation Overview

- Existing System
- Alternatives Evaluated
- Describe the EMM
- Biological Benefits
- Costs of technologies
- Cost/Benefit Comparison

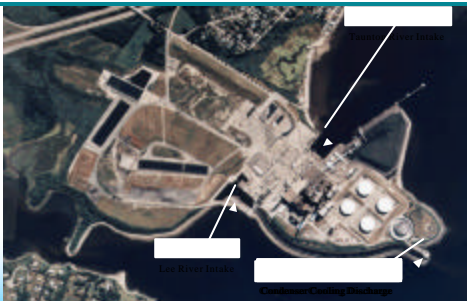
Symposium on Protecting Aquatic Organisms from Cooling Water Intakes • 6-7 May 2003 LMS

## Brayton Point Generating Station



Symposium on Protecting Aquatic Organisms from Cooling Water Intakes • 6-7 May 2003 LMS

## Brayton Point Station Aerial View



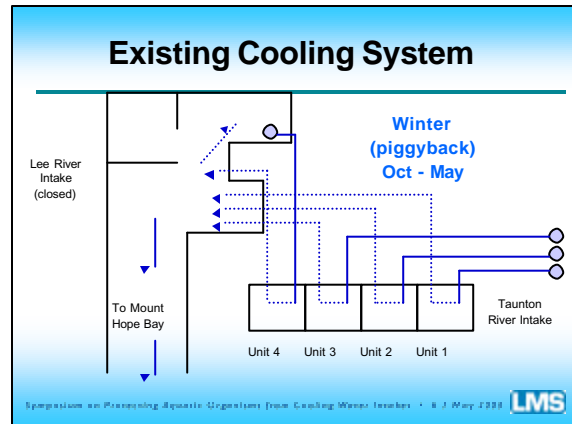
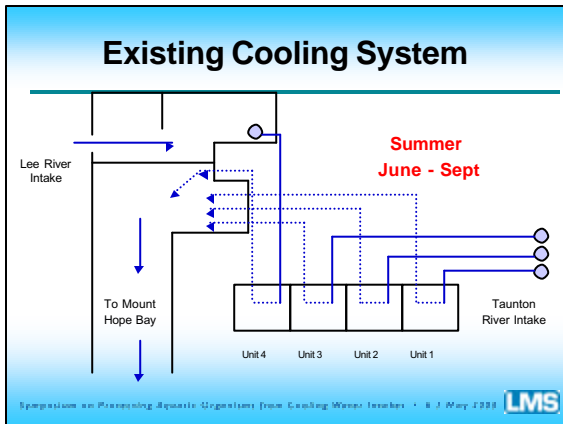
Symposium on Protecting Aquatic Organisms from Cooling Water Intakes • 6-7 May 2003 LMS

## Station Operations

	MW Capacity	Condenser Duty MBTU/hr	Flow (Gal/min)	Max Design Temperature Rise (°F)	Commercial Start-up
Unit 1	250	1,098	180,000	12.2	Aug 1963
Unit 2	250	1,098	180,000	12.2	July 1964
Unit 3	650	2,590	280,000	18.5	July 1969
Unit 4	450	2,340	260,000	18.0	Dec 1974
Service Water	-	232.7	31,000	15.0	-
Combined	1,600	7,360	931,000	15.8	-

- Units 1, 2 & 3 – Coal-fired
- Unit 4 – Gas/oil-fired
- Station produces equivalent of
  - 20% Massachusetts demand
  - 150% Rhode Island demand

Symposium on Protecting Aquatic Organisms from Cooling Water Intakes • 6-7 May 2003 LMS



- ### Current Conditions
- Winter flounder and other groundfish at historically low levels
  - Maximum intake flows & heat loads
    - Once-thru cooling (June thru September)
      - 1299 MGD
      - 13 TBTU
    - Piggyback cooling (October thru May – winter flounder spawning)
      - 925 MGD
      - 29 TBTU
  - NPDES Permit renewal pending
    - Draft Permit Determination issued July 2002
- Sperosium on Processing Aquatic Organisms from Cooling Water Intakes • 8 / 1 May 2008 **LMS**

- ### Cooling Alternatives Evaluated
- Existing once-thru with seasonal piggyback
  - Enhanced Multi-Mode (EMM)
  - Unit 3 closed cycle
  - All units closed cycle
  - Others
- Sperosium on Processing Aquatic Organisms from Cooling Water Intakes • 8 / 1 May 2008 **LMS**

- ### Enhanced Multi-Mode
- What are the goals of EMM?
  - How does EMM work?
  - What benefits are expected from EMM?
  - How do EMM costs and benefits compare with other alternatives?
- Sperosium on Processing Aquatic Organisms from Cooling Water Intakes • 8 / 1 May 2008 **LMS**

- ### EMM Goals
- Reduce impingement/entrainment losses
    - by reducing intake flows
  - Reduce already low discharge-related losses
    - by reducing heat load
- Sperosium on Processing Aquatic Organisms from Cooling Water Intakes • 8 / 1 May 2008 **LMS**

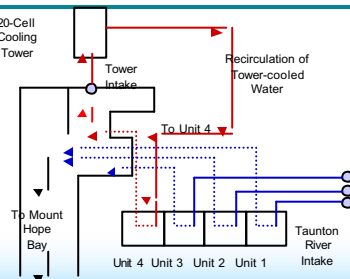


## EMM Design

- Wet cooling tower
  - 20 cells
  - Mechanical draft, counter-flowing
  - Plume abatement
  - 14 trillion BTU per year total heat reduction
  - 327 MGD average annual flow reduction
- Flexible piping configuration for optimal plant operation

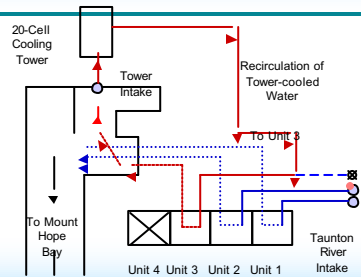
Spearsman on Peabody Aquatic Organisms from Cooling Water Intakes • 8 / May 2008 LMS

## EMM – Unit 4 “Closed Cycle”



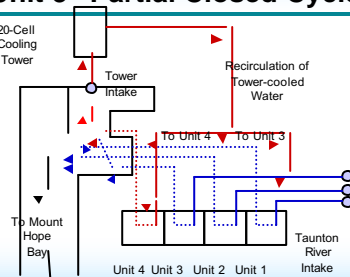
Spearsman on Peabody Aquatic Organisms from Cooling Water Intakes • 8 / May 2008 LMS

## EMM – Unit 3 “Closed Cycle”



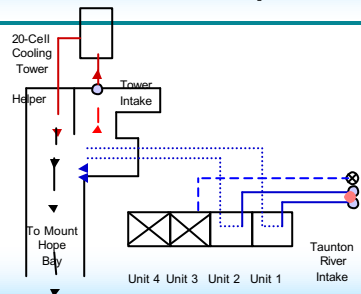
Spearsman on Peabody Aquatic Organisms from Cooling Water Intakes • 8 / May 2008 LMS

## EMM – Unit 4 “Closed Cycle” & Unit 3 “Partial Closed Cycle”



Spearsman on Peabody Aquatic Organisms from Cooling Water Intakes • 8 / May 2008 LMS

## EMM – Units 1 & 2 “Helper” Cooling



Spearsman on Peabody Aquatic Organisms from Cooling Water Intakes • 8 / May 2008 LMS

## Other EMM Components

- Variable-Speed Drives on Units 1 & 2 circulating water pumps
- Installation of fish buckets on Units 1, 2 & 3 traveling screens

Spearsman on Peabody Aquatic Organisms from Cooling Water Intakes • 8 / May 2008 LMS

## Flow & Heat Reductions

- Compared to existing once-thru with piggyback
  - 33% lower average annual flow
    - Existing – 977 MGD
    - EMM – 650 MGD
  - 33% lower annual heat load to Mount Hope Bay
    - Existing – 42 TBTU
    - EMM – 28 TBTU

Speersham on Preventing Aquatic Organisms from Cooling Water Intakes • 8 / 1 May 2008 LMS

## Biological Benefits – Reduced Intake Flow

Species	Cause of Loss	Fishable Biomass Lost (lbs)			
		Existing Operation	EMM	Unit 3 Closed Cycle	All Units Closed Cycle
Winter Flounder	Entrainment	21,231	11,922	9,451	1,891
	Impingement	45	30	32	3
	Total E&I	21,276	11,952	9,483	1,894
Other Fished Species	Entrainment	23,027	13,229	14,032	1,328
	Impingement	149	105	110	12
	Total E&I	23,176	13,334	14,142	1,340
All Fished Species	Entrainment	44,258	25,151	23,483	3,219
	Impingement	194	135	142	15
	Total E&I	44,452	25,286	23,625	3,234

Speersham on Preventing Aquatic Organisms from Cooling Water Intakes • 8 / 1 May 2008 LMS

## Biological Benefits – Reduced Intake Flow

- Reduction in impingement and entrainment

Species	Compared to Fishable Biomass Lost under Existing Operations		
	EMM	Unit 3 Closed Cycle	All Units Closed Cycle
Winter Flounder	44%	55%	91%
Other Fished Species	38%	36%	94%
All Fished Species	40%	43%	93%

Speersham on Preventing Aquatic Organisms from Cooling Water Intakes • 8 / 1 May 2008 LMS

## Biological Benefits – Reduced Heat Load

- Analysis based on “reasonable worst-case” hydrothermal modeling of Mount Hope Bay
- Biothermal assessment of
  - Critical growth
  - Reproduction
  - Avoidance
  - Migratory blockage
  - Chronic thermal mortality
- Effects are negligible for all four alternatives, including Existing Operation**

Speersham on Preventing Aquatic Organisms from Cooling Water Intakes • 8 / 1 May 2008 LMS

## Economic Evaluation

- Estimate future time path of costs & benefits
  - Identify significant differences in timing
- Express each year’s costs & benefits in 2002\$
- Compute cost-effectiveness ratio
- Compute cost-benefit ratio
- Apply EPA “wholly disproportionate” test

Speersham on Preventing Aquatic Organisms from Cooling Water Intakes • 8 / 1 May 2008 LMS

## Cost-Effectiveness

- Focus on Flow Reduction
- Annualized Costs
  - 20 years plus construction period
- EMM most cost-effective**

Cooling-System Alternative	Annualized Cost (Millions of 2002 U.S. \$)	Units of Flow Reduction (MGD)	Annualized Cost per MGD of Flow Reduction (Thousands of 2002 U.S. \$)
EMM	6.9	327	21.1
Unit 3 Closed Cycle	13.0	323	40.1
All Units Closed Cycle	31.9	921	34.6

Speersham on Preventing Aquatic Organisms from Cooling Water Intakes • 8 / 1 May 2008 LMS

## Cost-Benefit Ratio

- Total life-cycle costs and benefits
- Benefits due to:
  - Additional commercial fishery
  - Additional recreational fishery
- **EMM lowest cost-benefit ratio**

Cooling-System Alternative	Fishery Benefit (Millions of 2002 U.S. \$)	Technology Cost (Millions of 2002 U.S. \$)	Cost-Benefit Ratio
EMM	0.20	50.69	253
Unit 3 Closed Cycle	0.23	95.31	412
All Units Closed Cycle	0.44	236.02	537

Symposium on Protecting Aquatic Organisms from Cooling Water Intakes • 8-9 May 2003 

## “Wholly Disproportionate” Test

- **Guideline: Costs not more than 10 times benefits**
- **None of the alternatives evaluated passes**
  - Costs range between 253 and 537 times benefits
  - EMM has lowest cost/benefit ratio

Symposium on Protecting Aquatic Organisms from Cooling Water Intakes • 8-9 May 2003 

## Conclusions

- Costs “wholly disproportionate”
- EMM clearly best of alternatives considered
  - Most cost-effective
  - Best cost-benefit ratio
- EMM achieves reductions by flexible, optimal use of closed-cycle cooling
- EMM readily adaptable to similar facilities

Symposium on Protecting Aquatic Organisms from Cooling Water Intakes • 8-9 May 2003 

Symposium on  
Technologies for Protecting Aquatic Organisms from  
Cooling Water Intake Structures  
06-07 May 2003 | Arlington, Virginia

## Innovative Cooling System for Heat and Flow Reduction at Brayton Point Station

Contact:  
Thomas L. Englert, Ph.D., P.E.  
Lawler, Matusky & Skelly Engineers LLP  
845-735-8300  
tenglert@lmseng.com





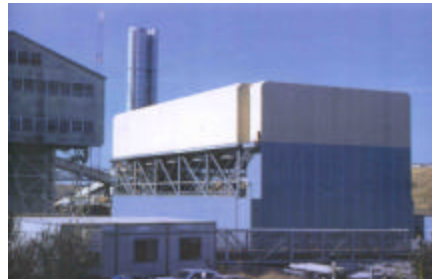
## Design and Performance of Optimized Air-Cooled Condenser at Crockett Cogeneration Plant

Bill Powers, P.E., Powers Engineering  
 Pat Morris, Crockett Cogeneration  
 Ralph Wyndrum, P.E., Marley Cooling Technologies, Inc.

1

## Roofmounted ACC, 12 cells

Courtesy of Marley Cooling Technologies, Inc.



2

## Ravenswood Cogen ACC

Courtesy of New York Department of Environmental Conservation

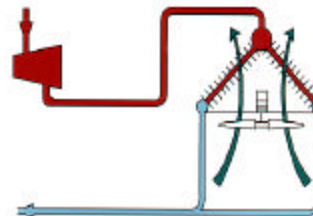


View of the Ravenswood Cogeneration Facility, facing Southwest

3

## ACC Operation

Courtesy of GEA Power Cooling Systems, Inc.



4

## Plant Plot Restrictions

- 2.4 acre site (140' x 740')
- Water to the north & east
- Railroad to the south
- Sugar mill to the west
- No room for ACC, except on power plant roof
- Seismic zone 4



5

## Plant Design and Performance Parameters

- Rated output of 240 MW at 96 °F
- Single GE Frame 7FA turbine
- Vogt heat recovery steam generator
- 260 MMBtu/hr duct burner system
- ~750,000 lb/hr HP steam maximum
- Local steam host (C&H Sugar) requires 260,000 lb/hr steam on average, varies from 70,000 to 400,000 lb/hr

6

## ACC Design and Performance Parameters

- 12 ACC cells
- Overall ACC height of 70.5 feet
- 519 MMBtu/hr rating
- 3,350,385 ft<sup>2</sup> of heat transfer surface
- 150 hp two-speed fans (63/32.5 rpm)
- ACC fan diameter of 29 feet
- 3 additional ACC cells for auxiliary cooling

7

## Thermal Design Parameters

	Case A	Case B	Case G
Air inlet temp., °F	85	65	96
Gross output, MW	262	248	248
Steam injection	on	off	on
Gas turbine, MW	175	158	172
Steam turbine, MW	87	69	79
Total steamflow, lb/h	733 k	510 k	688 k
ACC steamflow, lb/h	604 k	510 k	567 k
Backpressure, HgA	6.5	3.1	7.7

8

## ACC Hot Day Performance

Hotelling load only at C&H Sugar of 70,000 lb/hr steam

Date	Time	Temp., °F	kpph steam to ACC	" Hg vacuum
8/26/02	5:31 pm	89	670	8.0
8/26/02	6:41 pm	90	667	8.3
8/27/02	1:36 pm	81	676	7.0
8/27/02	4:26 pm	85	676	8.3
8/27/02	6:27 pm	87	656	7.5

9

## ACC and Steam Cycle Output

- Crockett is fully dispatchable from 120 to 240 MW
- Allowed 16 hr/yr of forced outage w/o penalty, equal to 16 hr/yr x 240 MW = 3,840 MW/yr
- Worst case conditions, 96 °F, dry heat, C&H Sugar in forced outage (0 lb/hr steam demand), occurred < 10 hr in 2002
- Crockett can be limited to 235 to 238 MW during worst case conditions (must reduce duct firing)
- Typical ACC MW-hr/yr penalty is  $\leq$  20 MW-hr/yr

10

## ACC Noise Requirements

- Three noise receptors
- Most stringent - Point A, 56 dBA at 113 ft from edge of ACC



11

## Noise Reduction Measures

Courtesy of Marley Cooling Technologies, Inc.

Ultra-low noise fans



Gear motor enclosures

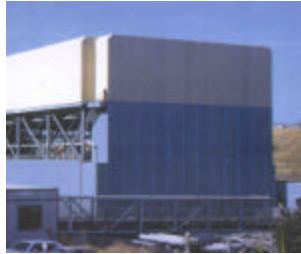


12

## Noise Reduction Measures

Courtesy of Marley Cooling Technologies, Inc.

- Steam duct riser chase
- Acoustically insulated ducting to mitigate by-pass operation noise
- Perimeter siding to top of steam header



13

## ACC Height Minimization

- Economical minimum height in range of 70 to 75 feet (to top of ACC steam duct)
- By comparison, HRSG height often 90 to 100 feet
- Height minimization is important issue in populated areas
- Evaporative wet cooling alternative in populated areas is plume abatement wet tower
- Plume abatement tower height ~ 65 feet, plume height is 40 feet or less (humid days)

14

## Plume Abatement Function

Courtesy of Marley Cooling Technologies, Inc.

- Two cells to right are operating in standard wet tower mode.
- Next two cells have damper 100% open (max. plume abate).
- Next three cells have dampers open 25%.



15

## ACC Height Minimization

Courtesy of GEA Power Cooling Systems, Inc.

### Samalayuca II 630 MW Combined Cycle Plant



16

## ACC Operating Experience

- Crockett Cogen ACC has performed well over seven year operating history
- Relatively little maintenance has been required on ACC, ACC fans, or fan motors
- Periodic washdown of tube bundles necessary, due to insect buildup and condensation of sugar compounds on tubes
- Inleakage of ambient air at north ACC takeoff duct interface with steam turbine has been ongoing minor maintenance issue

17

## ACC Heat Rate Penalty

- Facility considers heat rate data proprietary
- 2.0 - 2.5 "Hg backpressure at average annual daytime temperature of 65 °F and typical C&H Sugar steam load of 260 kpph
- Once-through system typically 1.5 -2.0 "Hg
- Annual thermal efficiency penalty of ACC estimated at 1 percent or less, little difference in heat rate under average operating conditions

18

### Crockett ACC Cost

- \$8MM to \$8.5MM equipment cost for 15 ACC cells with ultra-low noise, 29-foot fans
- Steam turbine ~\$1MM less expensive
- ACC manufacturer not responsible for installation at Crockett - install costs higher than typical due to rooftop location
- Estimated ACC installation costs (by Marley) for hypothetical greenfield, groundlevel location: \$3.8MM non-union, \$4.5MM union

19

### Transferability of Crockett Experience to Larger Combined-Cycle Plants

- 170 MW GE Frame 7FA or equivalent is basic building block of all utility scale combined-cycle plants
- ACC noise optimization features readily transferrable
- ACC height optimization to 70 - 75 feet readily transferable (Otay Mesa example)

20

### Transferability of Crockett Experience to Larger Combined-Cycle Plants

- Groundlevel installation necessary to take full advantage of optimized height and to minimize "visual bulk."
- ACC sized to avoid any significant MW derate under "hottest hour" conditions
- ACC sized to minimize heat rate penalty, estimated at  $\leq 1\%$  for Crockett (assuming average steamflow of 260 kpph to C&H)

21

## EVALUATION OF VARIABLE PUMPING RATES AS A MEANS TO REDUCE ENTRAINMENT MORTALITIES

John Young  
William Dey  
Steven Jinks

Martin Daley  
John Carnright

*AS&S* Analysis & Synthesis  
Environmental Science & Technology

DYNEGY

## Compliance Requirement of Proposed Regulations

- Existing Station
  - Tidal Estuary
    - Reduce Entrainment by 60%-90%
- Ancillary Issues
  - Calculation Baseline
  - Entrainment Survival

*AS&S* Analysis & Synthesis  
Environmental Science & Technology

DYNEGY

## Roseton Generating Station



*AS&S* Analysis & Synthesis  
Environmental Science & Technology

DYNEGY

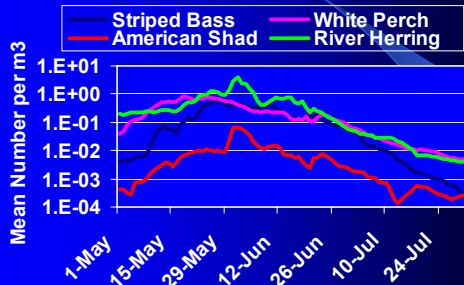
## Information Available

- Entrainment Abundance Data
  - 1983-1987; May-July
  - 1-7 days/week, 24 1-hour samples
  - Pump samples from discharge
- Entrainment Survival Data
  - 1976-1980
  - Evolving gear and methods
- Plant Operation Patterns
  - 1999-2001, hourly
  - MW, Flows, Temperatures

*AS&S* Analysis & Synthesis  
Environmental Science & Technology

DYNEGY

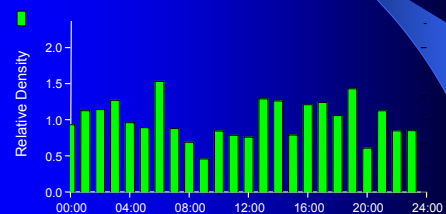
## Seasonal Pattern of Entrainment



*AS&S* Analysis & Synthesis  
Environmental Science & Technology

DYNEGY

## Daily Pattern of Entrainment Striped Bass YSL

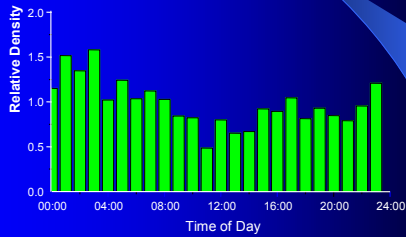


*AS&S* Analysis & Synthesis  
Environmental Science & Technology

DYNEGY



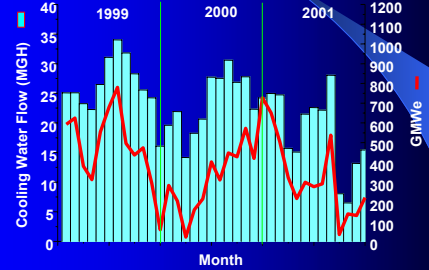
## Daily Pattern of Entrainment Striped Bass PYSL



ASST Advanced Systems & Technology  
Advanced Systems & Technology

DYNEGY

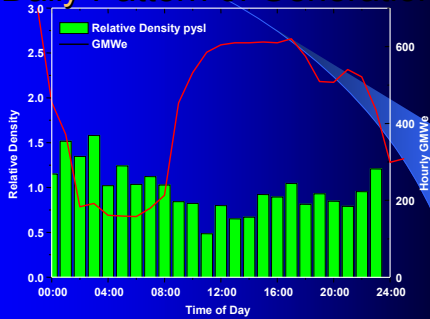
## Annual Patterns of Flow and Generation



ASST Advanced Systems & Technology  
Advanced Systems & Technology

DYNEGY

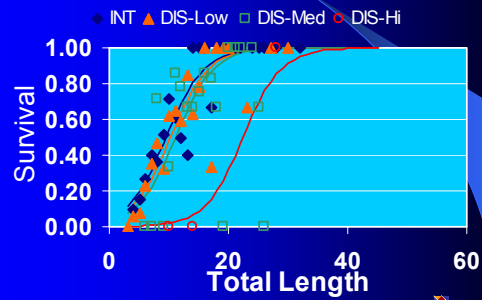
## Daily Pattern of Generation



ASST Advanced Systems & Technology  
Advanced Systems & Technology

DYNEGY

## Entrainment Survival



ASST Advanced Systems & Technology  
Advanced Systems & Technology

DYNEGY

## Strategy for Compliance: Match Flow to Generation on Hourly Time Scale

- Rapid response of plant operations to varying generation
- Capability for fine-scale flow control
  - Pump On-off
  - Variable-speed pumps
- Operational rules
  - Minimum flows
  - Maximum discharge temperatures
  - Maximum  $\Delta T$

ASST Advanced Systems & Technology  
Advanced Systems & Technology

DYNEGY

## Operating Rules

- Use minimum flow necessary to
  - Discharge temperature below target: 20-40C
  - $\Delta T$  below maximum: 15-30C
  - Flow at or above set minimum: 34% of Full
- If target discharge temperature exceeded
  - $\Delta T$  below maximum

ASST Advanced Systems & Technology  
Advanced Systems & Technology

DYNEGY

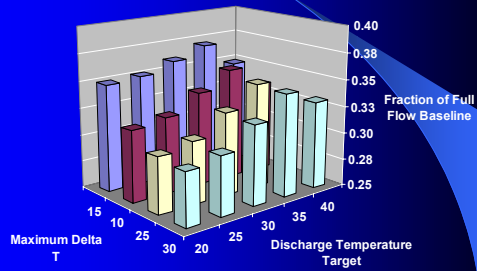
## Calculation Baseline

- Initial EPA Proposal
  - Full flow year-round
  - Full operation
  - 100% Mortality
- NODA
  - Past operational practices
    - Seasonally reduced flows
  - 100% Mortality

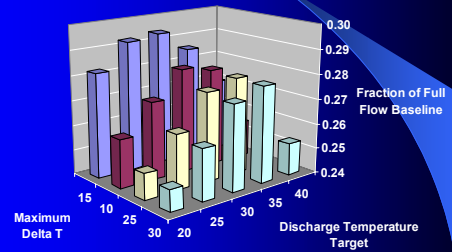
## Analysis Process

- Define hourly Flow and Discharge Temp
  - Historical generation, ambient temperature
  - Operating rules
- Determine numbers entrained
  - Flow and historical density pattern
- Determine numbers killed
  - Size, mechanical and thermal mortality
- Compare annual total numbers to baseline

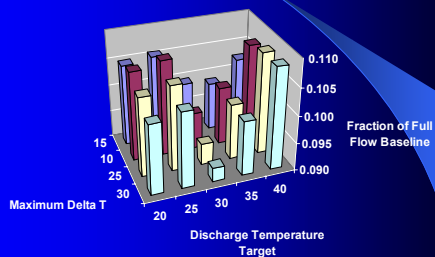
## Reduction in Flow



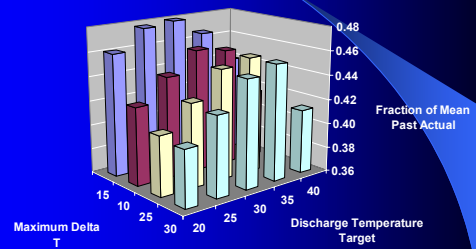
## Reduction of Number Entrained



## Reduction in Number Killed



## Effect of Alternate Baseline Number Entrained



## Conclusions

- Variable pumping rates can achieve significant entrainment reductions
  - Peaking plants
  - Diel abundance pattern counter to generation
  - Hardy species with demonstrable survival
- Wide range of Operating rules
  - Performance analysis necessary
  - Compliance of discharge with thermal criteria
- Critical Issues
  - Definition of Baseline
  - Entrainment Survival

## Cooling System Retrofit Costs

EPA Workshop on  
Cooling Water Intake Technologies  
Arlington, Virginia

May 6, 2003

John Maulbetsch, Maulbetsch Consulting  
Kent Zammit, EPRI

## Once-Through to Cooling Towers

- How much do retrofits cost?
  - What has to be done?
  - What cost information is available?
  - How do they compare?
  - How site-specific are the costs?
  - What are costs beyond capital costs?
  - What are some of the other issues?

## Starting with the Conclusions

**COSTS ARE VERY SITE-SPECIFIC**

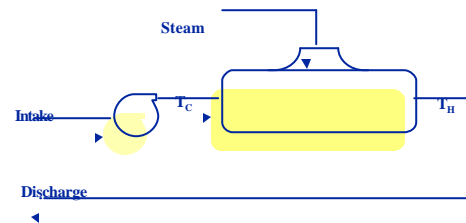
General correlations don't work  
Cost vary widely—x2 to x10  
Operating/penalty costs can be important  
Cooling towers have environmental effects too

## Once-Through to Cooling Towers

- How much do retrofits cost?
  - What has to be done?
  - What cost information is available?
  - How do they compare?
  - How site-specific are the costs?
  - What are costs beyond capital costs?
  - What are some of the other issues?

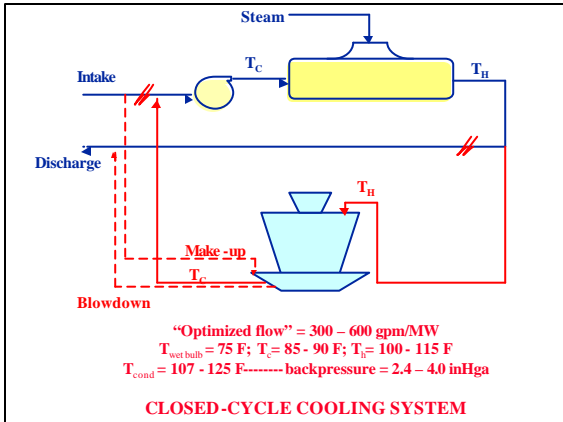
## What has to be done?

- Tower installation
- ✓ Circulating water piping and pumps
- Intake/discharge modifications
- Water treatment for use and for discharge
- ✓ Re-optimization of cooling system design



Circulating flow = 500 – 800 gpm/MW  
 $T_{\text{intake}} = T_c = 60 \text{ F}$ ;  $T_{\text{discharge}} = T_t = 75 - 80 \text{ F}$   
 $T_{\text{cond}} = 82 - 95 \text{ F}$ -----backpressure = 1.1 – 1.7 inHga

**ONCE-THROUGH COOLING SYSTEM**



### Re-optimization

- Once-through systems ---high flows; low range
- Closed cycle systems are off-optimum at once through conditions
- Reduce flow by 1/2
  - Major condenser modifications (one-pass to two-pass)
  - Turbine hall walls may have to be removed
  - Extended outage time

### Once-Through to Cooling Towers

- How much do retrofits cost?
  - What has to be done?
  - What cost information is available?
  - How do they compare?
  - How site-specific are the costs?
  - What are costs beyond capital costs?
  - What are some of the other issues?

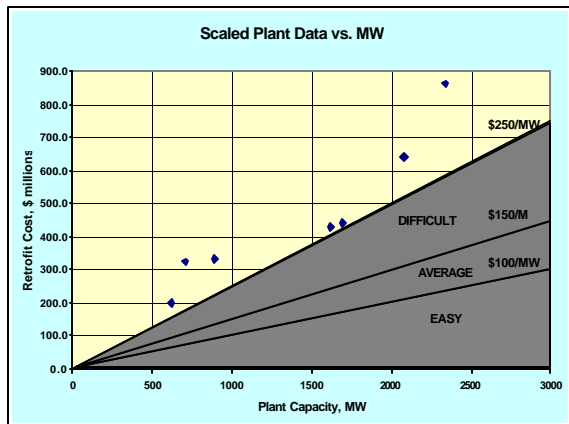
### INFORMATION SOURCES FOR COSTS

**Utility studies**

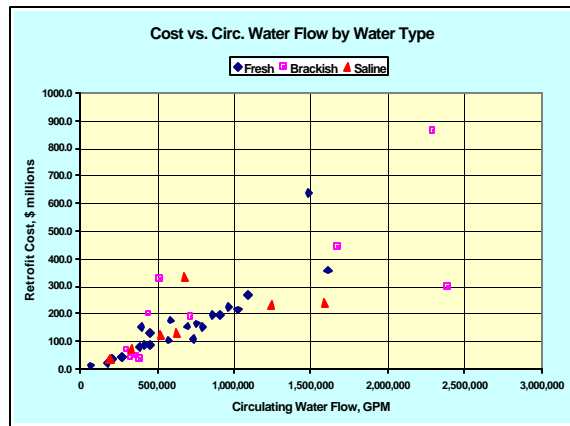
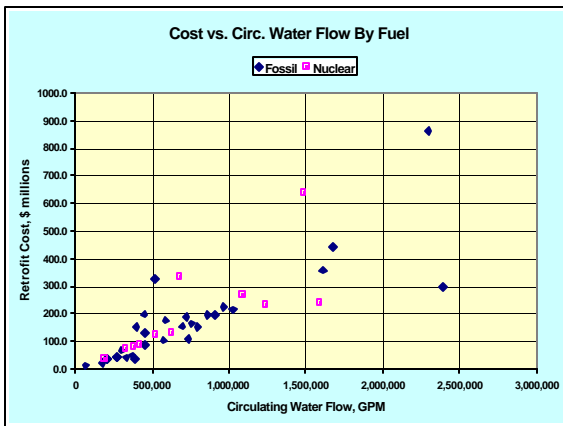
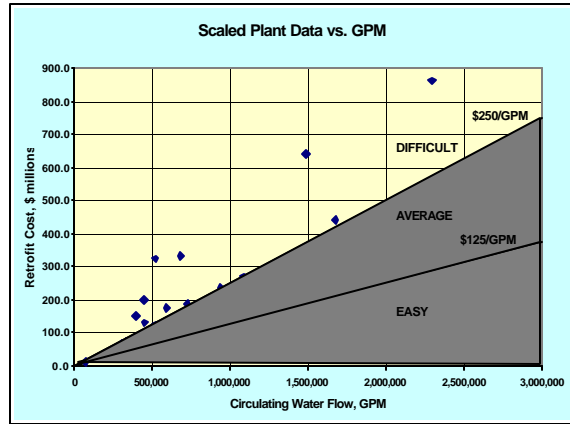
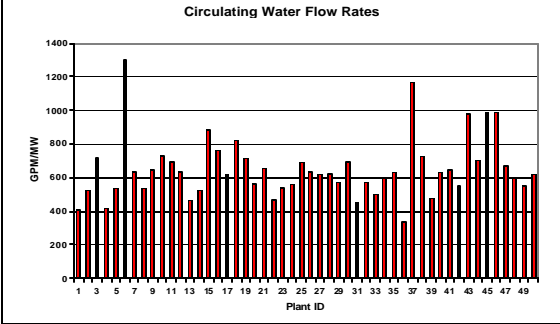
**A&E estimates**  
 Stone & Webster  
 The Washington Group  
 NETL/Parsons

**EPA estimates**

Distribution of Plants With Data (50)			
<b>NUCLEAR (15)</b>			
	Saline	Brackish	Fresh
> 500 MW (15)	5	5	5
< 500 MW (0)	0	0	0
<b>FOSSIL (35)</b>			
	Saline	Brackish	Fresh
> 500 MW (29)	2	8	19
< 500 MW (6)	1	1	4



## Cooling Water Flow vs. Plant Size



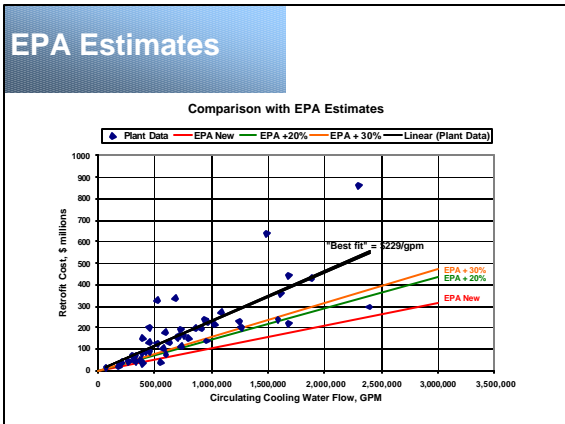
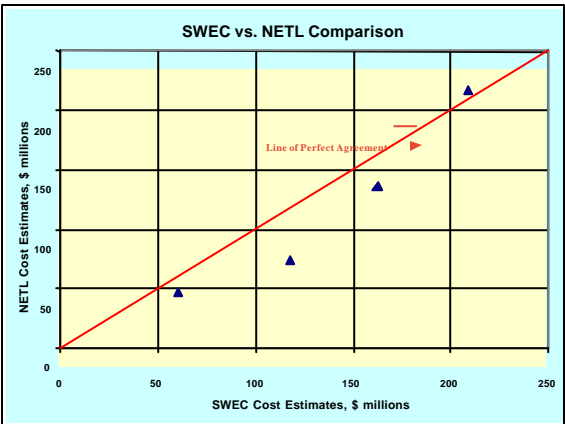
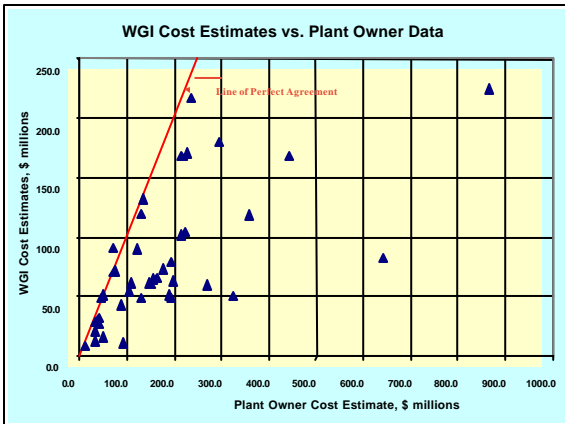
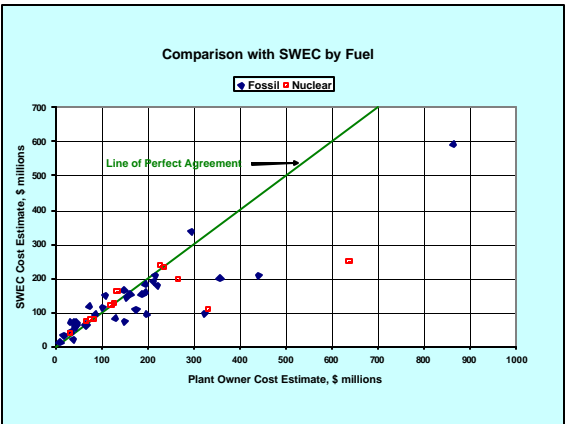
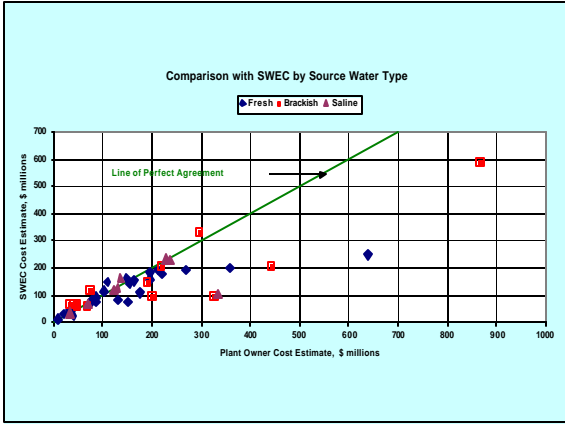
## Once-Through to Cooling Towers

- How much do retrofits cost?
  - What has to be done?
  - What cost information is available?
  - How do they compare?
  - How site-specific are the costs?
  - What are costs beyond capital costs?
  - What are some of the other issues?

## National Studies

- SWEC---
  - Compare to 6 base plants; scaled by flow
- Washington Group, Inc
  - Built up costs on component basis; scaled by flow
- NETL/Parsons
  - 4 site specific studies

SWEC REFERENCE PLANTS							
PLANT	Fuel	Water Source	CAPACITY MW	FLOW GPM	GPM/MW	COST \$	\$/GPM \$/kW
X1	Coal	Estuary	250	174,627	699	36,000,000	206.2 144.0
X2	Coal	Estuary	620	279,403	451	57,000,000	204.0 91.9
X3	Oil	Estuary	440	259,701	590	48,000,000	184.8 109.1
X4	Ur	Marine	863	570,448	661	121,000,000	212.1 140.2
X5	Ur	Marine	1137	895,522	788	126,000,000	140.7 110.8
X6	Coal	River	82	35,373	431	6,900,000	195.1 84.1



## Once-Through to Cooling Towers

- **How much do retrofits cost?**
  - What has to be done?
  - What cost information is available?
  - How do they compare?
  - How site-specific are the costs?
  - What are costs beyond capital costs?
  - What are some of the other issues?

## Retrofit Issues

### Tower

Source water quality  
Location on site  
Site geology  
Makeup/blowdown lines/pumps

### Circulating water loop

Circ. water loop—higher head  
Two sets of pumps  
New circ. water lines  
Condenser reinforcement

### PLANT REPLIES TO COST ANALYSES (based on replies from 56 plants)

ISSUES	PLANTS WITH SPECIAL CIRCUMSTANCES		%	
	ALL	44 of 56	ALL	44 of 56
Space	31	14	55	32
Separation Distance	46	35	82	80
Interferences	47	36	84	82
Site Geology	36	25	64	57
Plume/Drift	38	27	68	61
Noise	25	14	45	32
Aqueous Discharge	36	25	64	57
Condenser Modifications	22	11	39	25
Retirement	9	6	16	14

## Cost roll-ups

### SOURCE

### COST IN BILLIONS

WGI	22.1
SWEC	28.0
ANL/DOE	27.7 – 29.8

## Once-Through to Cooling Towers

- **How much do retrofits cost?**
  - What has to be done?
  - What cost information is available?
  - How do they compare?
  - How site-specific are the costs?
  - What are costs beyond capital costs?
  - What are some of the other issues?

## Other Costs

- Additional operating power
  - Pumping power > Once through pump power
  - Fan power
  - Net increase ~ 1.1 to 1.25%
- Additional maintenance
  - Tower is additional maintenance item
  - Water treatment for use & discharge
- Efficiency decrease
  - 10 F ~ 1 in Hg backpressure ~ 1% heat rate



## Once-Through to Cooling Towers

- **How much do retrofits cost?**
  - What has to be done?
  - What cost information is available?
  - How do they compare?
  - How site-specific are the costs?
  - What are costs beyond capital costs?
  - What are some of the other issues?

## Other Issues

### Environmental effects from cooling towers

Consumptive water use  
Makeup/blowdown treatment and discharge  
Visible plumes  
Drift/PM-10  
Noise

## CONCLUSIONS

- ✓ **RETROFIT COSTS VERY SITE-SPECIFIC**
- ✓ **INDIVIDUAL PLANT COSTS CAN BE VERY DIFFERENT FROM AVERAGE**
- ✓ **NATIONAL TOTALS REASONABLY CONSISTENT**

## CONCLUSIONS

- ✓ **O&M COSTS ARE IMPORTANT**
- ✓ **REOPTIMIZATION OF LARGE, NEW PLANTS IS VERY COSTLY**
- ✓ **NOT REOPTIMIZING IS ALSO VERY COSTLY**
- ✓ **A 20% RETROFIT FACTOR IS SIGNIFICANTLY LOW**

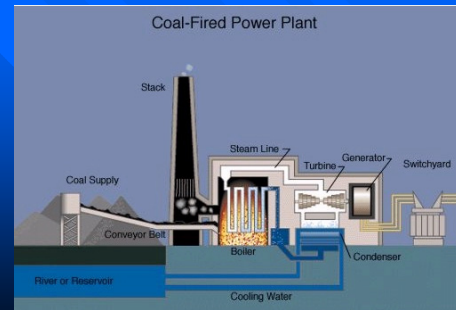
## A Tool for Budgetary Estimation of Cooling Tower Unit Costs Based on Flow

Faysal Bekdash, SAIC

Michael Moe, SAIC

Symposium on Cooling Water Intake  
Technologies to Protect Aquatic Organisms  
May 6, 2003

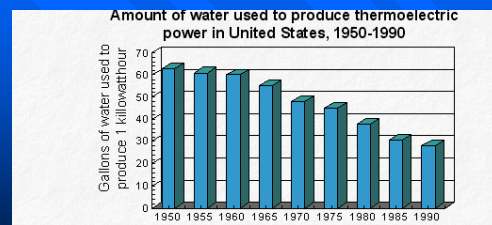
## Introduction



## Introduction (Continued)

- Power generated from fossil fuels, especially from coal, is dependent on water.
- On average, approximately 28-33 gallons of water are required for each kWh of power produced from coal.
- Around 70 trillion gallons of water are consumed or impacted annually in the United States to produce energy.

## Introduction (Continued)



■ Source: <http://www.ga.usgs.gov/edu/graphics/html/ptratioyears.html>

## Introduction (Continued)

- Why water use went down?
- Part of the answer is the use of cooling towers
- This presentation is about modeling cooling tower costs

## What Is a Model?

- Model: A fact-net founded on innate ideas and inputs
  - Fact-net: Set of relations and operators that interconnects inputs and innate ideas
  - Innate ideas: A priori knowledge, principles, or theoretical truths
  - Inputs: Experimental observations or data points

## Types of Models

- Leibnizian
  - Theory-directed, top-down
- Lockean
  - Data-directed, bottom-up
- Kantian
  - Theory- or data-directed, non-directional
- Hegelian
  - Dialectical Kantian

## Cost Estimation Methods

- Case study-based
  - Uses costs of actual project to estimate costs of similar project
- Indirect engineering-based (parametric method)
  - Uses parameters that reflect project size and scope to estimate costs
- Direct engineering-based
  - Uses engineering designs, drawings, schematics and specifications to estimate costs
- Survey-based
  - Uses surveys of actual projects to provide cost data

## Types of Cooling Systems

- Once-through
  - Cooling water makes single pass through condenser and is then discharged
- Recirculating
  - Cooling water passes through condenser, is cooled in cooling tower, and then recirculated to condenser

## Types of Cooling Towers

- Wet cooling tower
  - Most common type
  - Consumes roughly 5% flow of once-through
- Dry cooling tower
  - Less efficient, larger, more costly than wet towers
  - Consumes negligible water
- Hybrid tower
  - Combines dry heat exchange surfaces with standard wet towers
  - Mostly used where plume abatement required

## Factors Affecting Cooling Tower Costs

- Condenser heat load and wet bulb temperature
  - Determines size of tower needed
- Plant fuel type and age/efficiency
  - Thermal efficiency varies greatly by plant type
  - Older plants typically have lower thermal efficiencies
- Site topography
  - Can affect tower height, shape and location
  - Difficult subsurface conditions can significantly increase costs
- Material used for tower construction

## Relative Trends in Tower Costs by Material

Capital	Operation	Maintenance	Useful Life (yrs)	Cost Increase
Concrete	Douglas Fir	Douglas Fir	30 (Douglas Fir)	↑
Steel	Redwood	Redwood	40 (Redwood)	
Redwood	Steel	Steel	17 (Steel)	
Fiberglass	Fiberglass	Concrete	50 (Concrete)	
Douglas Fir	Concrete	Fiberglass	30 (Fiberglass)	

## Model Development

- Contacted cooling tower vendors
  - Costs as function of recirculating flow, delta
- Researched literature
  - Cost factors for various tower types, features
- Calculated costs for various flows, tower types, tower features
- Developed best-fit curves, equations for calculated costs

## Cost Factors for Tower Types, Features<sup>1</sup>

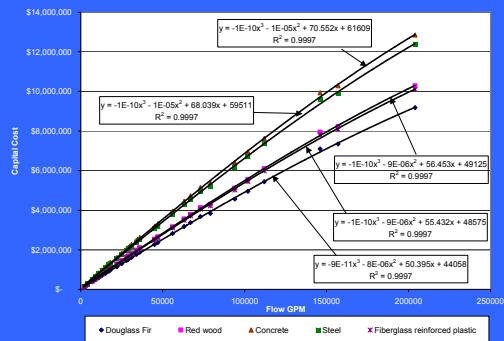
Tower Type	Capital Cost Factor (%)	Operation Cost Factor (%)
Douglas Fir	100	100
Redwood	112 <sup>2</sup>	100
Concrete	140	90
Steel	135	98
Fiberglass Reinforced Plastic	110	98
Splash Fill	120	150
Non-Fouling Film Fill	110	102
Natural Draft (Concrete)	175	35
Hybrid (Plume Abatement)	250-300	125-150
Dry/Wet	375	175
Air Condenser (Steel)	250-325	175-225
Noise Reduction (10dBA)	130	107

<sup>1</sup>Relative to Douglas Fir tower costs.

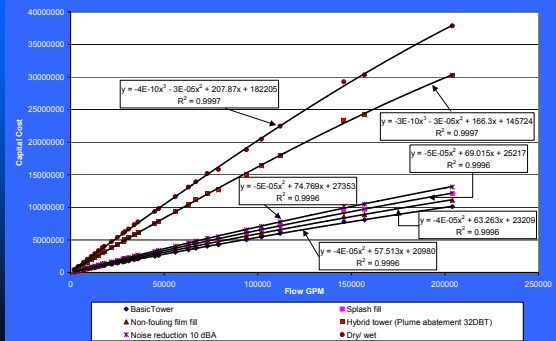
<sup>2</sup>Redwood costs may be higher because redwoods are protected species, particularly in NW.

Source: Mirsky et al. (1992), Mirsky and Bauthier (1997), and Mirsky (2000).

Capital Costs of Basic Cooling Towers with Various Building Material (Delta 10 Degrees)



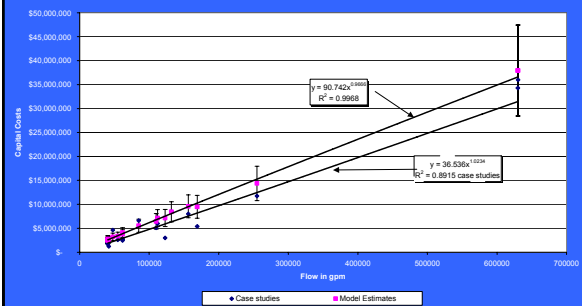
Fiberglass Cooling Tower Capital Costs with Various Features (Delta 10 Degrees)

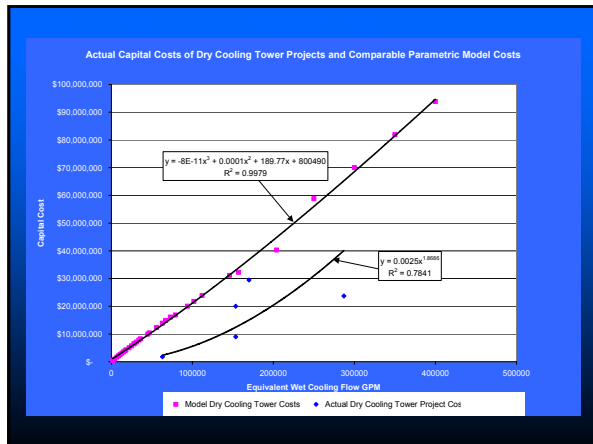


## Model Verification

- Contacted cooling tower vendors for case studies
  - Costs for actual projects
  - Prices for bid projects
  - 11 wet tower projects, 5 dry tower projects
- Case study costs lower than model costs
  - True even for projects with unusual site-specific factors (custom-built towers, difficult construction conditions, accelerated schedules)

Actual Capital Costs for Wet Cooling Tower Projects and Comparable Parametric Model Costs





## Conclusions

- Model gives tower cost estimates that are conservative on high side
  - Holds true even for projects with difficult site-specific factors

## Future Directions/Research Needs

- Reducing water use requirements
  - Improved wet cooling system efficiency
  - Improved dry cooling system efficiency
  - Improved water recycling processes
  - New generating and cooling media
  - Improved boilers to use low quality water
  - Technologies to reduce cooling tower evaporative losses

## Future Direction/Research Needs

- Improving power generation with same or reduced water use
  - Improved turbine efficiency
  - Improved process control
  - Combined power generating cycles
  - Advanced steam power plant design
  - Systems to utilize evaporated water energy and exhaust gases energy
  - Improved water treatment

---

---

## Power Plant Repowering as a Strategy for Reducing Cooling Water Consumption at Existing Electric Generating Facilities

---

David Schlissel, Geoff Keith and Michael Drunisc  
Synapse Energy Economics  
22 Pearl Street, Cambridge, MA 02139  
www.synapse-energy.com  
617-661-3248

Symposium on Cooling Water Intake Technologies to  
Protect Aquatic Organisms  
May 6, 2003

---

---

## The Issue

---

- Converting from a once-through to a closed-loop cooling system can produce significant reductions in water usage and provide environmental benefits.
  - However, this conversion also can have negative impacts on power plant performance and costs.
  - The actual cost and performance impacts of converting to a closed-loop cooling system depend on plant-specific equipment and design features.
  - The magnitude of these impacts also depend on whether the new closed-loop system will have wet, hybrid or dry cooling towers.
- 

---

## Potential Cost and Performance Impacts of a Conversion to a Closed-Cycle Cooling System

---

- Capital investment for adding a cooling tower and modifying pump, piping and, perhaps, the existing condenser.
  - Slightly higher O&M costs - closed-loop cooling systems have additional equipment that requires maintenance and specialty chemical costs for water treatment systems.
  - Lost plant output (both MW and MWh) because more power is needed on-site to operate pumps and the fans in mechanical draft cooling towers.
  - Additional fuel costs – plants with closed-loop cooling systems incur efficiency losses compared with once-through cooling systems.
  - The potential for lost plant output if capacity must be derated during hottest and most humid periods of the year.
- 

---

## A Possible Alternative to Avoid these Potential Negative Impacts

---

- Repower the existing power plant at the same time that the cooling system is converted to a closed-loop.
  - Repowering means replacing the plant's old, inefficient and polluting equipment with a newer combined cycle unit.
  - Repowering can be done in at least two ways.
    - by actually rebuilding and replacing part or all of an existing plant
    - by closing down an existing power plant, building a new unit next to it and reusing the existing transmission and fuel facilities.
- 

---

## Environmental Benefits of Repowering

---

- Repowering an older plant can include conversion from once-through to closed-cycle cooling. Cooling water intake and fish and aquatic organism impacts can be reduced by up to 98 percent.
  - Repowering an older plant also usually leads to large reductions in NO<sub>x</sub> and SO<sub>2</sub> emissions.
  - Repowering involves reuse of an existing industrial site instead of a new greenfield site.
- 

---

## Economic and Reliability Benefits of Repowering

---

- Lower plant operating and maintenance costs
  - Improved plant availability
  - Improved plant efficiency (e.g. heat rate reductions from 10,600 BTU/KWh to about 7,000 BTU/KWh)
  - Increased plant capacity and generation
  - Although more capital intensive, repowering can make conversion to a closed-cycle cooling system more attractive from an economic point-of-view
-

---

## Repowering is becoming a common practice around the U.S.

---

- Power plants have been repowered or are scheduled to be repowered in many states including Massachusetts, New Jersey, New York, Minnesota, Ohio, South Carolina, Kansas, Wisconsin, Oklahoma, Texas, and Illinois.

---

## Current Repowering Projects in New York State

---

- Bethlehem Energy Center on the Hudson River outside Albany
- East River Repowering Project on the East River in New York City
- Astoria Repowering Project on the East River in New York City
- Each of these projects is projected to have significantly lower heat rates (be more efficient) than the units being replaced and, consequently, will have substantially higher capacity factors. Each project also will have dramatically reduced water use and air emissions.

---

## Bethlehem Energy Center

---

- Will replace the existing 400 MW Albany Steam Station with a new 750 MW combined-cycle facility.
- The boilers, turbines and generators from the existing facility will be retired in place.
- New facility will employ closed-loop cooling system with hybrid mechanical draft cooling towers.
- Closed-loop system will reduce the intake of Hudson River water by 98 to 99 percent, compared to the existing Albany Steam Station -- from approximately 500 million gallons per day ("gpd") to an average of 4.72 million gpd, 8.53 million gpd maximum.

---

## East River Repowering Project

---

- Will add two combustion turbine generators and steam production equipment in unused space within the existing East River Generating Station. This will enable Con Edison to retire its existing Waterside plant.
- Will provide 360 MW of electric generating capacity, an increase of 200 MW over the existing Waterside plant.
- Steam will be sold into Con Edison's steam system.
- New facility will not draw water from the Hudson River.

---

## Astoria Repowering Project

---

- Would replace four existing boilers with six combined-cycle gas turbine assemblies.
- Would increase the Astoria Generating Station's capacity from 1,254 MW to 1,816 MW.
- Would include plume-abated mechanical draft wet cooling towers and a closed-loop circulating system.
- Would reduce the amount of water drawn from the East River by over 97%, from 865,000 gpm, at present, to 24,000 gpm, during periods of peak usage.

---

## Hypothetical Example for Illustrative Purposes

---

- Hypothetical repowering or retrofit of one of the existing units at the Bowline Station in the Hudson River Valley.
- In a repowering scenario, one of the existing 621 MW units at the facility would be replaced by a new 750 MW combined-cycle unit.
- Bowline Unit 1 used, on average, 99.5 billion gallons of river water each year during the period 1996-2000. Bowline Unit 2 used 48.6 billion gallons of river water each year.
- Either repowering or retrofitting one of the existing Bowline units to a closed-loop cooling system will reduce its water usage by 97 percent or more.

## Sources for Economic Assumptions

- Actual plant performance from 1996 through 2000
- The December 1999 Draft Environmental Impact Statement for the Renewal of the SPDES Permits for Roseton Units 1 and 2, Indian Point Units 2 and 3, and Bowline Point Units 1 and 2.
- New York Independent System Operator projections of future combined-cycle plant operating costs and performance.
- Synapse modeling of the New York State electric system.

## Key Assumptions

- Cost of converting one of the Bowline Units to a closed-loop cooling system - \$59 million.
- Increased O&M from the conversion – approximately \$350,000 per year.
- Lost output following conversion - 17 MW in summer, 9 MW in the winter.
- Cost of new 750 MW combined-cycle unit -- \$400 to \$500 million.
- Heat rate of existing unit – 10,600 BTU/KWh
- Heat rate of new combined cycle unit – 7,000 BTU/KWh.

## Results

- The average cost of operating a repowered Bowline Unit in 2008 (fuel and variable non-fuel O&M) would be about \$33/MWh.
- The average cost of operating a Bowline Unit in 2008 after retrofit to closed-loop cooling system (fuel and variable O&M) would be about \$36.50/MWh.
- Both of these average operating costs would be below projected peak and off-peak energy prices in the Hudson Valley and New York in 2008:
  - Hudson Valley – peak hours - \$47/MWh
  - Hudson Valley – non-peak hours - \$37.30/MWh
  - New York City – peak hours - \$57.17/MWh
  - New York City – non-peak hours - \$38.44/MWh

## Results

- Consequently, in repowering alternative sales of energy from the repowered Bowline Unit during both non-peak and peak hours not only cover fuel and variable non-fuel O&M costs but would include a substantial contribution to the recovery of and a return on invested capital.
- Additional revenues in both repowering and retrofit alternatives also would be earned from the sale of capacity and reserves from the unit in the New York State wholesale markets.
- The lower heat rate for the repowered unit would result in a significantly higher capacity factor – i.e., 60 to 85 percent, versus 30 percent for the retrofit unit. The repowered unit also would have 750 MW of capacity vs. the approximate 600-610 MW of capacity that would be available from the retrofit unit.

## Additional Flow Reduction Benefits

- Due to its significantly lower heat rate, the repowered unit would displace electricity that would otherwise be generated at older, less efficient power plants along the same or other waterways.
- For example, Reliant has projected that, when completed, its repowered Astoria facility will displace production from less-efficient, generating facilities in New York City, including the Ravenswood and Arthur Kill plants.
- By reducing the output from older, less efficient units, a repowering could reduce water usage at those units. But only if those facilities do not have fixed speed pumps.
- If the goal is to maximize the reduction in water usage at existing power plants, a strategy should be developed to encourage or require the installation of variable speed pumps at all facilities that are not being repowered or converted to closed-loop cooling systems.



## Benefits and Disadvantages of Repowering vs. Retrofitting to a Closed-Loop Cooling System

- Benefits
  - Lower operating costs (fuel and variable O&M)
  - Significantly lower heat rate
  - Additional plant capacity
  - Significantly higher generation (MWh)
  - Significantly lower air emissions
  - Potential economic benefits from sale of air emissions allowances allocated to the unit being repowered
  - Much longer remaining operating life (e.g., 50 years vs. 20 years for the retrofit unit)
- Disadvantages
  - Significantly higher initial capital investment



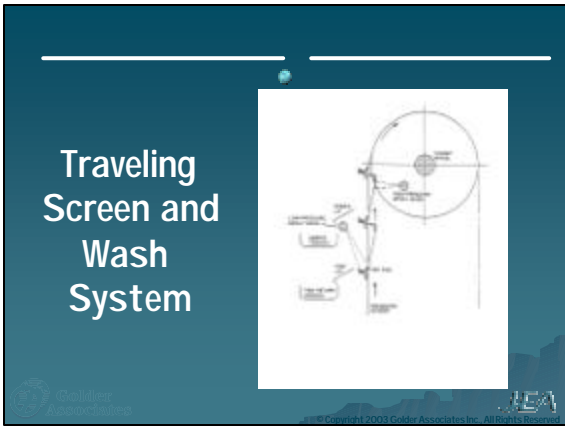
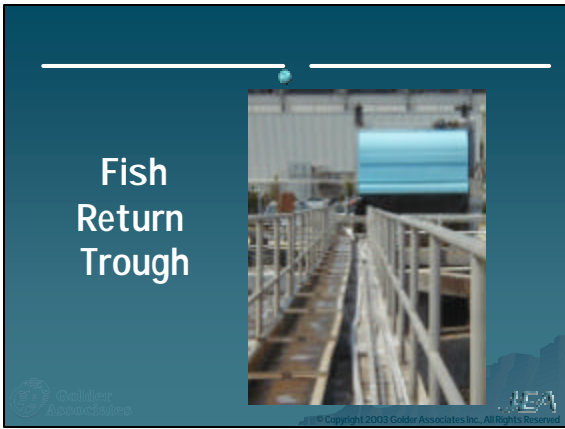
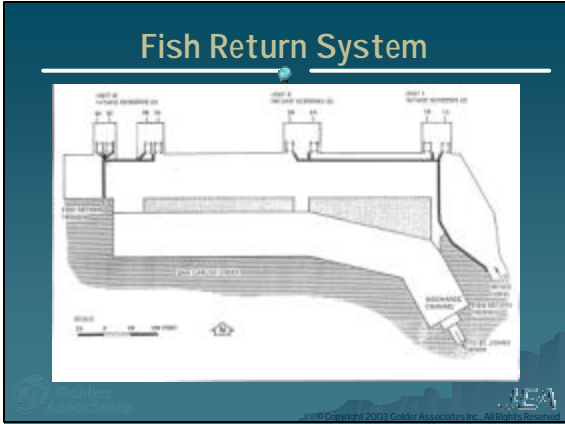
# Fish Return System Efficacy and Monitoring Studies for JEA's Northside Generating Station

Isabel C. Johnson  
Golder Associates, Inc.  
and  
Steve Moser  
JEA

© Copyright 2003 Golder Associates Inc. All Rights Reserved





## Studies

- ◆ 316 Demonstration (1976)
- ◆ Monitoring Study of Aquatic Communities (1980)
- ◆ Impingement/Survivability Study, continuous operation of FRS (1985)
- ◆ Fish Return Optimization Study, intermittent operation rate study (1999)



© Copyright 2003 Golder Associates Inc. All Rights Reserved



## Studies

- ◆ 316 Demonstration (1976)
- ◆ Monitoring Study of Aquatic Communities (1980)
- ◆ Impingement/Survivability Study (1985)
- ◆ Fish Return Optimization Study (1999)



© Copyright 2003 Golder Associates Inc. All Rights Reserved



## Impingement/Survivability Study

- ◆ NPDES permit requirement
- ◆ Study purpose was to determine the effectiveness of the FRS
  1. Define the types of organisms impinged
  2. Describe the physical condition of the aquatic organisms after passing through the FRS
  3. Quantify 4-day survivability post FRS



© Copyright 2003 Golder Associates Inc. All Rights Reserved



## Impingement/Survivability Study

- ◆ All FRS onsite were evaluated
- ◆ Summer and winter conditions
- ◆ Studies conducted during anticipated periods of peak impingement
- ◆ Scope of work approved by EPA



© Copyright 2003 Golder Associates Inc. All Rights Reserved



## Survivability Studies

- ◆ Assess the effectiveness of the FRS by determining the survival rates of three classes of impinged organisms
- ◆ Vulnerable or sensitive species likely to be harmed
- ◆ Species of intermediate tolerance
- ◆ Tolerant or hardy species likely to pass through the FRS unharmed



© Copyright 2003 Golder Associates Inc. All Rights Reserved



## Vulnerable Species

- ◆ Spotted seatrout
- ◆ Anchovy
- ◆ Silversides
- ◆ Menhaden



© Copyright 2003 Golder Associates Inc. All Rights Reserved



## Intermediate Tolerance

- ◆ Atlantic croaker
- ◆ Spot
- ◆ Mullet
- ◆ Star drum



© Copyright 2003 Golder Associates Inc. All Rights Reserved



## Tolerant or Hardy Species

- ◆ Commercial shrimp
- ◆ Blue crab
- ◆ Hogchoker
- ◆ Hardhead catfish



© Copyright 2003 Golder Associates Inc. All Rights Reserved



## Species Selection for Survivability Tests

- ◆ One representative genus or species was selected from each of the categories
- ◆ Species selection depended on their impingement rates and commercial importance
- ◆ All species tested were pre-approved by EPA Region IV



© Copyright 2003 Golder Associates Inc. All Rights Reserved



## Survivability Tests

- ◆ Approximately 20 individuals from each group were monitored for survival after passing through the FRS
- ◆ Test chambers were 20-gallon aquaria with flow-through water
- ◆ 10 individuals per aquarium
- ◆ Control organisms were collected from San Carlos Creek and St. Johns River, and handled similarly



© Copyright 2003 Golder Associates Inc. All Rights Reserved



## Survivability Results

### Summer conditions

- ◆ Control survival > 95 percent for all three classes of organism sensitivity
- ◆ No survival of sensitive species, spotted seatrout (all died within 1 hour of passage through FRS)
- ◆ 80 percent survival of intermediate species, spot and Atlantic croaker
- ◆ 90 percent survival of tolerant species, commercial shrimp



© Copyright 2003 Golder Associates Inc. All Rights Reserved



## Survivability Results

### Winter conditions (air temp. ~ 0 °C)

- ◆ Control survival 100 percent for sensitive and intermediate species; 75 percent survival of tolerant species (catfish)
- ◆ 5 percent survival of sensitive species, Atlantic menhaden (15 percent survival after 24 hours)
- ◆ 10 percent survival of intermediate species, Star drum
- ◆ 90 percent survival of tolerant species, catfish



© Copyright 2003 Golder Associates Inc. All Rights Reserved



## Survivability conclusions

- ◆ The sensitive species impinged and returned by the FRS had poor survival (<5 percent)
- ◆ The intermediate species impinged had good survival during summer conditions (80 percent), but poor survival under winter conditions (10 percent)
- ◆ The tolerant species (commercial shrimp and catfish) had good survival (>90 percent)

## FRS Return Rate Studies

- ◆ Comparison of total number of organisms impinged with number returned via FRS
- ◆ Organisms collected over two 4-hour periods, prior to high tide and prior to low tide
  - ◆ Summer and winter conditions
- ◆ Data collected: total number and species of organisms returned via FRS, and number disposed via debris system
  - ◆ Estimated total number impinged and percent returned

## FRS Return Rate

### Summer conditions

- ◆ Return rate was 73 percent for low-tide period (penaeid shrimp and blue crab accounted for 90 percent of the organisms impinged, total of 150 organisms)
- ◆ Return rate was 79 percent for high-tide period (pink shrimp accounted for 81 percent of organisms impinged, total of 42 organisms)

## FRS Return Rate

### Winter conditions

- ◆ Return rate was 49 percent for low-tide period
  - ◆ 8 fish species
  - ◆ 2 shrimp species
  - ◆ Total of 75 organisms
- ◆ Return rate was 56.5 percent for high-tide period
  - ◆ 13 fish species
  - ◆ 2 shrimp species
  - ◆ Catfish and star drum were most abundant
  - ◆ Total impinged 1,537

## Return Rate Conclusions

### Impingement study showed:

- ◆ Summer conditions, 74.5 percent of impinged organisms were returned
- ◆ Winter conditions, 56 percent of impinged organisms were returned
- ◆ Impingement rates were higher during the winter and at night

## Conclusions

- ◆ The sensitive species impinged and returned by the FRS had poor survival during summer and winter (<5 percent)
- ◆ Winter conditions resulted in poor survival of intermediate species (10 percent)
- ◆ Higher rates of impingement were observed in the winter and at night
- ◆ Winter conditions resulted in lower return rates, 56 percent vs. 74.5 percent

## FRS Optimization Study Conclusions

- ◆ Compared immediate survival post FRS, 96-hour survival, and return rate efficiency (quarterly)
- ◆ Continuous FRS operation, 1.5-hr off/0.5-hr on, and 3.5-hr off/0.5-hr on
- ◆ 3.5-hr off/0.5-hr on resulted in significant mortality
- ◆ 1.5-hr off/0.5-hr had similar results to continuous operation, except summer nights
- ◆ Intermittent schedule approved by FDEP (summer nights continuous operation)
- ◆ Resulted in 58 percent reduction in operation time for the FRS without affecting their performance

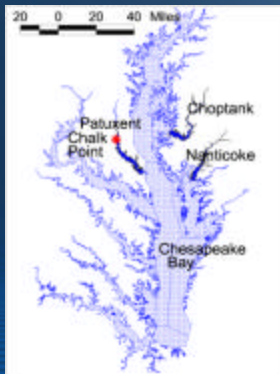
## Effectiveness, Operation and Maintenance, and Costs for a Barrier Net System for Impingement Reduction at the Chalk Point Station

David E. Bailey  
Jules J. Loos  
Dr. Elgin Perry  
Ann Wearmouth

## Topics Covered

Location and Design  
Operation and Maintenance  
Effectiveness  
Capital and O&M Costs

## Location of Chalk Point Station



## Chalk Point Generating Station



## Location of Chalk Point Generating Station

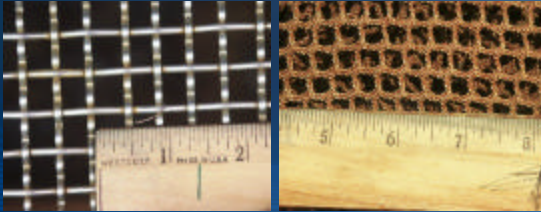
- 2 once through Units
- Units 1 & 2 are 330 MWe ea
- Two 125,000 gpm pumps/Unit
- 3 ft. avg. tide range
- Salinities ~5-7ppt winter/spring and ~15-17 ppt summer/fall



## Design and Construction

- **Double Barrier Net System**
  - Outer net is 671 ft., supported by 51 pilings and has a mesh size of 1.5 in. stretch mesh
  - Inner net is 533 ft., supported by 40 pilings and has 3/4in. stretch mesh. Inner net 100 ft. inside outer net
- Each barrier net is 300 ft. long and 27 ft. deep. Three nets used for outer net and two for inner net.
- Inner net has a 4 ft. 3/4in. stretch mesh skirt that is 380 ft long deployed in the center of the pilings

## Mesh Size Travelling Screen vs. Mesh Size Inner Barrier Net



DEB 428.03

7

## Current Operation and Maintenance Practices

- Net changed once to twice per week in summer and every other week the rest of the year
- Net located in a high fouling environment (primarily the colonial hydroid, *Garvia franciscana*)
- Jellyfish can accumulate on net in summer and leaves are heavy in the fall
- Net changes done by a local waterman and a diving inspection is performed to ensure the net is properly deployed on the bottom.
- Net removed for 2 weeks in fall to allow menhaden inside the net to escape.
- Top of nets submerged 3 ft below the water for 6 weeks in winter to prevent ice damage.

DEB 428.03

8

## Effectiveness Evaluation

### Baseline:

- Baseline sampling conducted June 1976 - September 1977
- 2 Samples taken every 28 hrs for 6 days followed by 2 or 3 days of no sampling, throughout the study period.
- Procedure involved rotation of the screens to clear them of any impinged organisms and taking .5 hr. sample from the screenwash sluiceway



DEB 428.03

9

## Chalk Point Baseline Impingement June 1976 to September 1977

Atlantic menhaden.....	1,347,490
Spot.....	647,016
Hogchoker.....	191,926
White perch.....	41,910
Bay anchovy.....	32,206
Gizzard shad.....	31,026
Atlantic Silverside.....	29,908
Atlantic Croaker.....	14,490
Weakfish.....	8,730
American eel.....	5,790
29 Other finfish species.....	17,832
<b>Total Finfish.....</b>	<b>2,368,324</b>
<b>Blue Crabs.....</b>	<b>1,948,132</b>

DEB 428.03

10

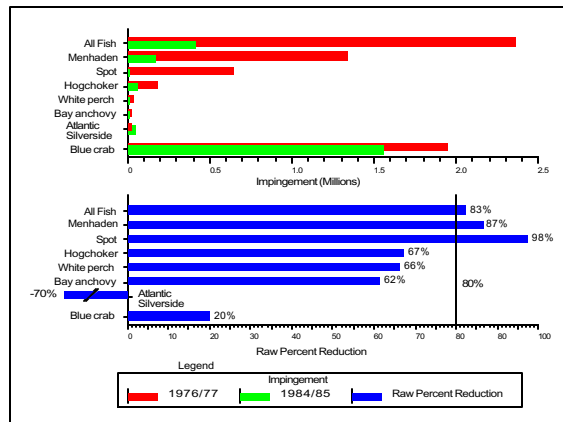
## Effectiveness Evaluation (cont.)

### Post Net Deployment Effectiveness Evaluation:

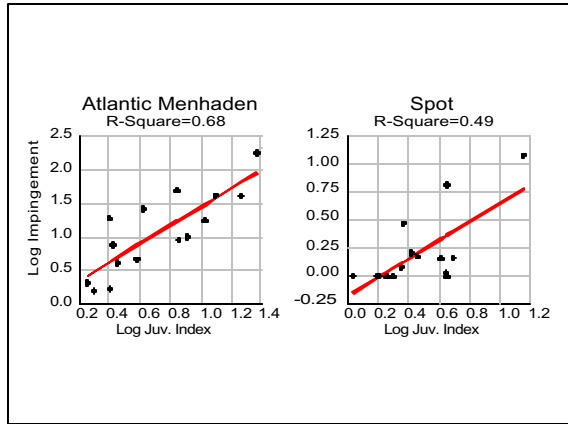
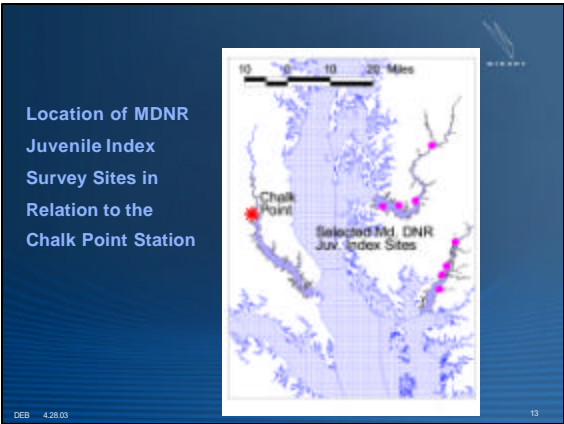
- Two Methods Used:
  1. Daily census - Screens rotated each day and all impinged organisms collected
  2. Once per week sample - Rotate and clear screens and collect two .5 hr sample while screens are rotating. One .5 hr sample collected during the day and one at night.
- For performance effectiveness evaluation the once per week sample used for comparison to 76/77

DEB 428.03

11







**Procedure for Adjusting Impingement Results Based on State Juvenile Index**

Example Adjustment Calculation for Atlantic menhaden

Step 1 - Estimate expected post barrier net impingement based on juvenile index:

$$\frac{1,347,490 \text{ (76 imp)}}{16,178 \text{ (ji 76)}} \times 15,588 \text{ (ji 84)} = 1,298,348 \text{ (exp 84 imp)}$$

Step 2 - Calculate % reduction of actual impingement from expected impingement:

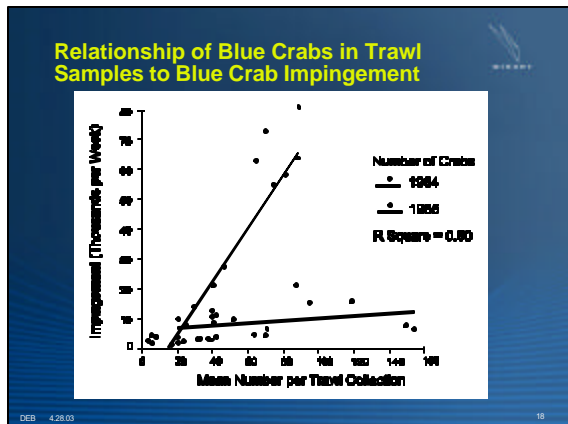
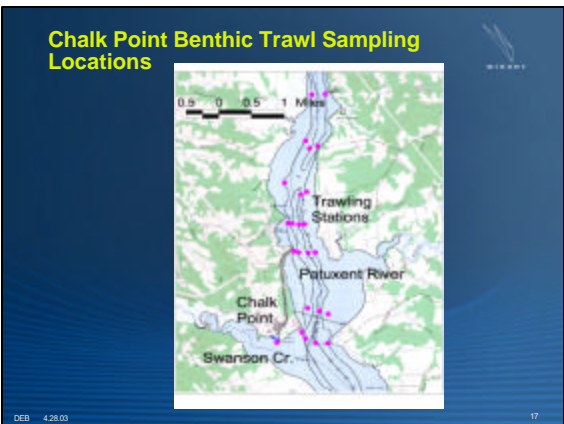
$$\frac{1,298,348 \text{ (exp 84 imp)} - 180,878 \text{ (act 84 imp)}}{1,298,348 \text{ (exp 84 imp)}} = 86\%$$

DEB 4/28/03 15

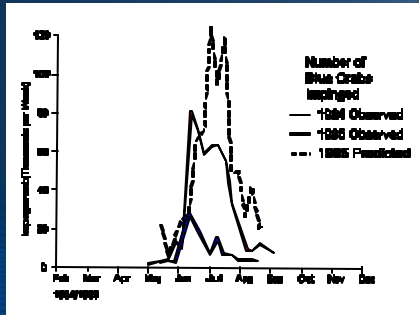
**Barrier Net Differences 1984 vs. 1985**

Change/Difference	1984	1985
# Barrier Nets	1	2
Mesh Size	1.5 in. Stretch Mesh	1.5 in. Stretch Mesh outer and 3/4in. stretch mesh inner
Sealing Skirt	None	380 ft. X 4 ft. 3/4in. stretch along bottom of inner net
Sealing Net Deployment	None	Net deployed 15ft. in front of pilings for 6-8 ft drape on substrate
Results of Diving Inspections	11 of 19 dives found gaps along bottom of net	3 of 29 dives found gaps of outer net only

DEB 4/28/03 16



### 82% Reduction in Blue Crabs from 84 to 85



DEB 4/28/03

19

### Barrier Net Effectiveness Adjusted for Inter-year Relative Abundance Variability

Species	Impingement Reduction Based on Raw Data	Impingement Reduction Adjusted for Inter-Year Relative Abundance
Blue Crab	20%	82%
Menhaden	87%	86%
Spot	98%	98%+ (*)
Hogchoker	67%	83%
White Perch	66%	95% (*)

\* R squared under .5

DEB 4/28/03

20

### Atlantic Silversides and Bay Anchovies

- Atlantic Silversides**
  - 91% of the impingement occurred in winter when barrier net was removed
  - 57% reduction 84 vs. 85 when barrier net in place
  - Barrier net now deployed year round
- Bay Anchovy**
  - 62% reduction 76/77 versus 84/85
  - 55% reduction 84 vs. 85

DEB 4/28/03

21

### Capital and O&M Costs for Chalk Point Barrier Net

- Capital Cost:**
  - Capital cost of barrier net deployment in 1981 ~\$100,000 (Primarily cost to install support pilings)
- Operation and Maintenance Costs:**
  - Net changing to control fouling & debris and post net change dive inspections \$75,000/yr
  - Net replacement panels 3 of 12/yr. \$12,000/yr

DEB 4/28/03

22

### Considerations for Use of a Barrier Net to Under EPA's Phase 2 Proposal

- Consider addition of an escape route for trapped fish
- Consider reducing the net mesh size to provide an entrainment benefit
- When determining the calculation baseline consider establishment of an index to account for inter-year variability of major impinged species
- Consider complete census impingement monitoring instead of estimating to prevent overestimates

DEB 4/28/03

23

## Reductions in Impingement Mortality Resulting from Enhancements to Ristroph Traveling Screens at an Estuarine Cooling Water Intake Structure

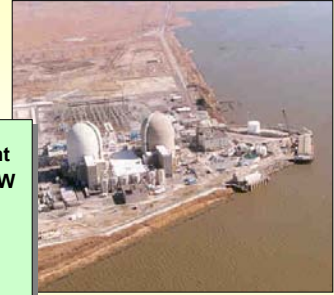
Kenneth A. Strait, John H. Balletto,  
L. Raymond Tuttle, Shawn L. Shotzberger

A Symposium on Cooling Water Intake Technologies to  
Protect Aquatic Organisms  
May 6-7, 2003



1

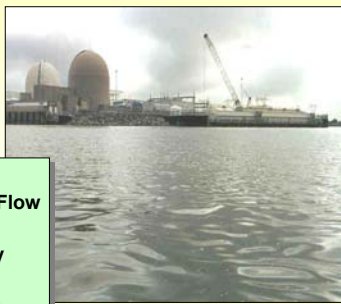
## Salem Generating Station



- Delaware Estuary Steam Electric Plant
- Approx. 30 miles SW of Philadelphia
- Each unit rated at 1,162 Mwe.
- Commercial Operation
  - Unit 1: 1977
  - Unit 2: 1981

2

## Cooling Water Intake Structure (CWIS)



- 12 Intake Bays
- Monthly Average Flow of 3,024 MGD
- Approach Velocity
  - 1.0 ft/s at low tide
  - 0.87 ft/s at high tide

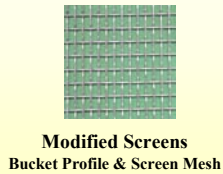
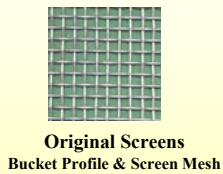
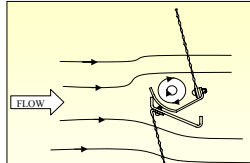
3

## CWIS Traveling Screens



- 12 screens (one per intake bay)
- Continuously rotating to remove detritus and marine life
- Modified in 1996 to improve efficacy:
  - Enhanced bucket profile
  - Lighter construction
  - Finer Smooth-Tex™ Mesh (0.25" x 0.5" vs. 0.375" x 0.375" with old screens)
  - Modified spray wash configuration

4



5

## Salem CWIS Fish Return System

Top Right: Fish spray and flap seals

Below: Fish and debris return troughs

Bottom Right: Fish return trough terminus



### Salem CWIS Fish Collection & Holding Facilities



**Impingement Abundance Sampling in North Fish Counting Pool**



**Temporary Latent Impingement Mortality (LIM) Holding Tank**

7

### 1995 Impingement Mortality Direct Comparison Study - Methods

- Unit 2 modified with improved Ristroph screens, Unit 1 retained original screens
- Discharge split to north (U1) and south (U2) pools in 4 to 6 minute samples for comparison
- LIM Samples collected on 19 dates between June 20 and August 24, 1995
- Sampled entire tidal cycle
- Weakfish, bay anchovy and spot targeted for study
- Fish held in six 100 gallon tanks
- Survival fraction observed after 12, 24, and 48 hours

8

### Summary of Results from the 1995 Direct Comparison Study - Weakfish

#### Original Screens versus Modified Screens

MONTH	Original Screens		Modified Screens	
	Number of fish examined	Impingement Mortality Rate	Number of fish examined	Impingement Mortality Rate
June	111	33%	366	17%
July	367	31%	473	18%
August	553	51%	623	25%
<b>TOTAL</b>	<b>1031</b>	<b>38%</b>	<b>1462</b>	<b>20%</b>

9

### 1997–2000 Impingement Mortality Study - Methods

- Modified Ristroph screen improvements completed for both units
- Discharge combined and directed in the direction of the tide
- Sampled entire tidal cycle
- Study targeted weakfish, bay anchovy, spot, alewife, blueback herring, American shad, striped bass, white perch and Atlantic croaker
- Fish held in six 100 gallon tanks
- Survival fraction observed after 12, 24, and 48 hours

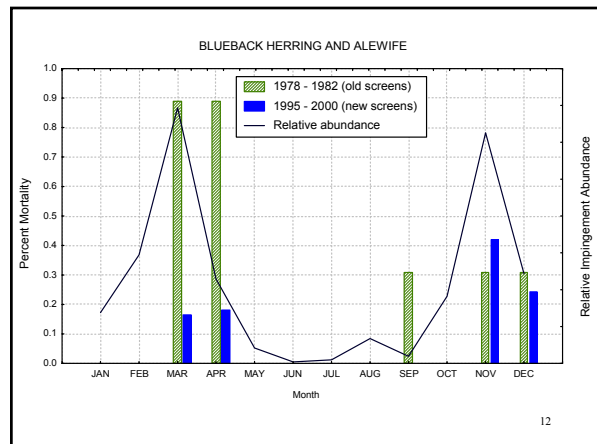
10

### Mortality Rate Ranking (Lowest to Highest) for RIS Species Based on 1997 through 2000 Data

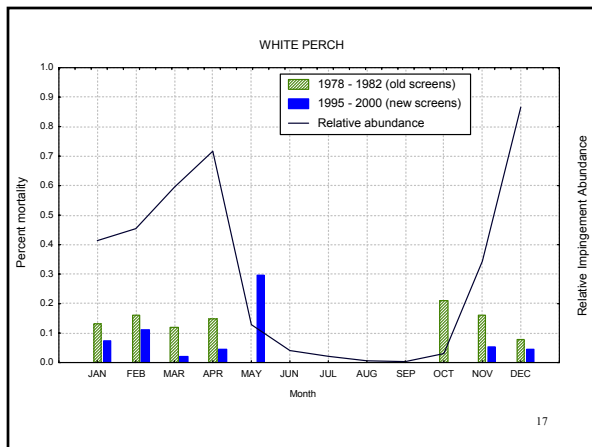
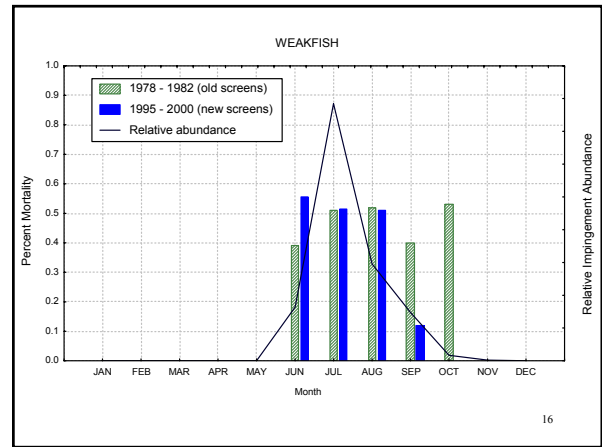
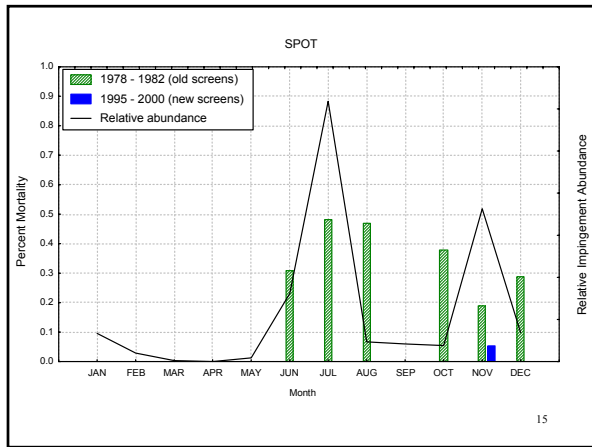
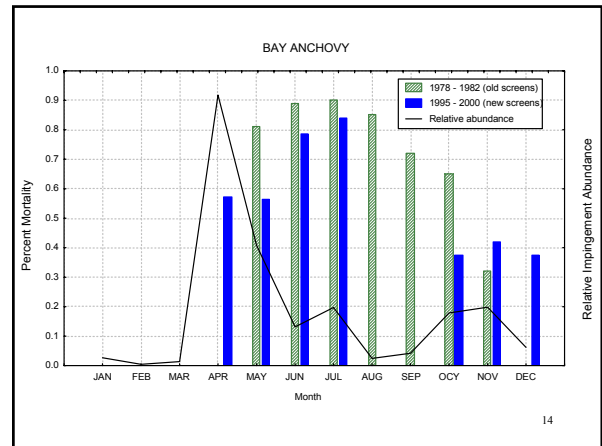
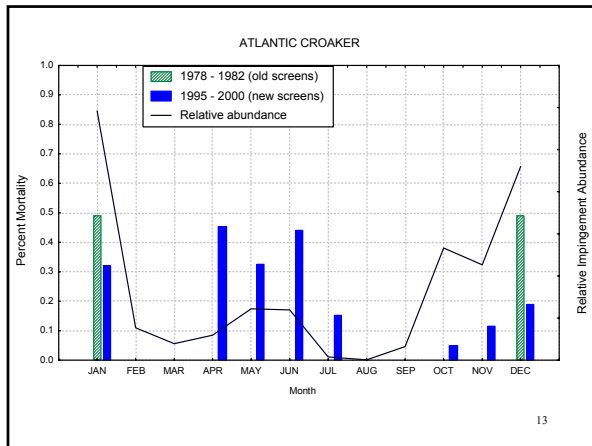
RANK	SPECIES	ANNUAL MORTALITY * (%)	MINIMUM (%)	MAXIMUM (%)	TOTAL NUMBER SAMPLED
1	Striped Bass	4.66	2.10	6.87	1,505
2	White Perch	6.29	0.95	33.63	25,757
3	Spot	6.67	--	--	132
4	Atlantic Croaker	22.64	3.86	44.86	35,186
5	American Shad	23.95	--	--	40
6	Blueback Herring	27.39	14.11	43.38	4,150
7	Alewife	39.15	17.41	43.01	551
8	Weakfish	47.77	10.28	65.25	26,400
9	Bay Anchovy	58.02	27.48	83.97	10,235

\* Calculated from abundance-weighted monthly mortality estimates.

11



12



### Fish Collection Pool and "End-of-Pipe" Evaluation Methods

- Fish collection pool and "End-of-Pipe" models constructed off-site
- Tests conducted with alewife and weakfish
- Testing performed in both models as well as in the Salem fish collection pools
- Marked control fish included in each replicate
- Survival fraction enumerated after 12, 24 and 48 hours

**“End-of-Pipe” Model  
6-foot drop configuration**



19

**Estimates of survival (standard error) from pooled replicates by treatment with alewife for the end-of-pipe experiment**

Treatment	Immediate	48 Hours
<b>Existing Configuration</b>	0.9965 (0.0035)	0.9964 (0.0059)
<b>1.3-ft Freefall</b>	1.0 (N/A)	1.0140 (0.0098)
<b>6-ft Freefall</b>	1.0 (N/A)	1.0034 (0.0034)

Note: Values > 1 indicate higher control mortality

20

**Fish Collection Pool Model**



21

**Estimates of survival (standard error) from pooled replicates by treatment for the fish collection pool experiment (Model)**

Treatment	Immediate	48 Hours
<b>3 cfs / 25 cm of cushion water</b>	1.0 (N/A)	1.16434 (0.0058)
<b>3 cfs / 50 cm of cushion water</b>	1.0 (N/A)	1.0315 (0.0379)

Note: Values > 1 indicate higher control mortality

22

**Estimates of survival (standard error) from pooled replicates by treatment for the fish collection pool experiment (Station)**

Treatment	Immediate	48 Hours
<b>3 cfs / 25 cm of cushion water</b>	1.0034 (0.0058)	1.0034 (0.0058)
<b>3 cfs / 50 cm of cushion water</b>	1.0067 (0.0047)	1.0067 (0.0047)
<b>13 cfs / 25 cm of cushion water</b>	0.9966 (0.0034)	0.9966 (0.0034)

Note: Values higher > 1 indicate higher control mortality

23

**Summary**


- Properly designed traveling water screen/fish return systems can effectively reduce impingement mortality rates
- Impingement mortality is variable & can be affected by fish distribution, condition factor, temperature and salinity
- Properly designed fish collection, counting and return systems do not contribute to reported impingement mortality rates

24




## Development and Operation of Acoustic Fish Deterrent Systems at Estuarine Power Stations

**Andy Turnpenny**, *Fish Guidance Systems Ltd, UK*  
**Jeremy Nedwell**, *Fish Guidance Systems, UK*  
 Joachim Maes, *University of Leuven University, Belgium*  
 Colin Taylor, *British Energy Ltd, UK*  
 David Lambert, *Fish Guidance Systems Ltd, UK*



## Overview



- The fish impingement issue
- Principles of acoustic guidance
- Implementation of acoustic barriers
- Power plant trials
- Required sound levels
- Conclusions




## Fish Impingement: Issues



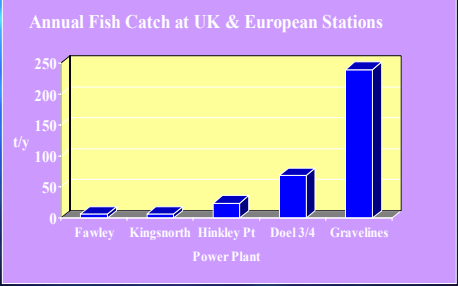

**Key Drivers**

- Conservation Laws
- 'Green' Image
- Plant Operation Issues



## Fish Impingement: Quantities

Annual Fish Catch at UK & European Stations




Power Plant	Annual Fish Catch (t/y)
Fawley	~10
Kingsnorth	~15
Hinkley Pt	~30
Doel3/4	~70
Gravelines	~250



## Fish Impingement: Composition

*-Mainly pelagics (herrings, smelts)*

## Principles of Acoustic Guidance

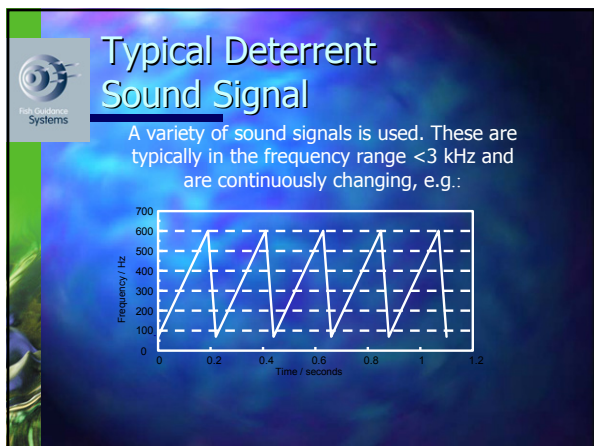
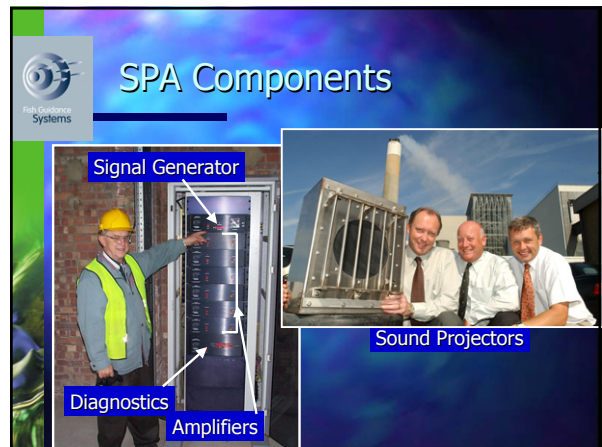
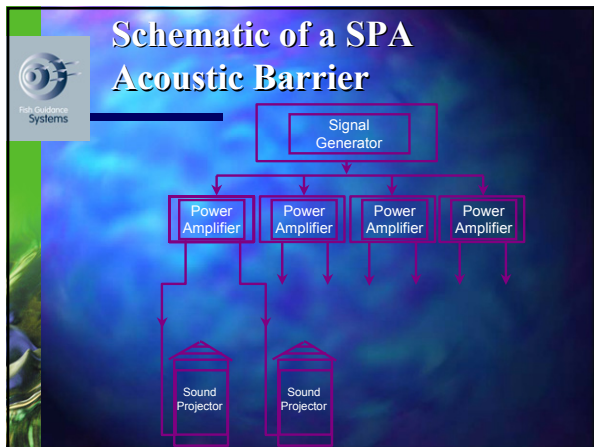
- Many fish species react to underwater sound (e.g. from trawlers, seismic surveys)
- Peak sensitivity mainly from a few Hz to 3kHz
- Repellent sounds can be produced using electrical or pneumatic transducers

## Requirements for Acoustic Guidance

- Signal must be in suitable frequency range
- It must be in a form & at a level above background sufficient to cause repulsion
- Hydraulic conditions must be suitable for fish escape (e.g. approach velocity)

## Sensitivity to Sound Pressure

- Presence/absence of swimbladder (e.g. poor in flatfish & other benthic spp.)
- Auditory specialisations (e.g. couplings from swimbladder to inner ear in clupeids, cyprinids, etc.)
- Hence reactions to sound expected to vary among spp.



## Power Plant Trials

<p><u>Hartlepool, UK</u></p> <ul style="list-style-type: none"> <li>■ Estuary: R. Tees</li> <li>■ CW flow: 34 m<sup>3</sup>s<sup>-1</sup></li> <li>■ Intake location: shoreline</li> <li>■ Catch rates: 85-15,427d<sup>-1</sup></li> <li>■ Main spp(&gt;90%): <i>Sprattus sprattus</i>, <i>Clupea harengus</i>, <i>Merlangius merlangus</i></li> </ul>	<p><u>Doel 3/4, Belgium</u></p> <ul style="list-style-type: none"> <li>■ Estuary: Zeeschelde</li> <li>■ CW flow: 25.1 m<sup>3</sup>s<sup>-1</sup></li> <li>■ Intake location: offshore</li> <li>■ Catch rates(x10<sup>3</sup>): 1,265-77,000d<sup>-1</sup></li> <li>■ Main spp(&gt;90%): <i>Sprattus sprattus</i>, <i>Clupea harengus</i>, <i>Stizostedion lucioperca</i></li> </ul>
--	--



## Test Programme

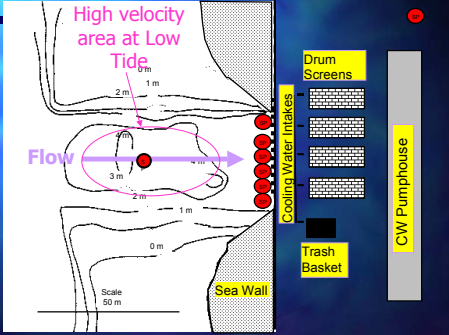
- Fish catch on screens compared for 24h sound 'on' vs. 'off'
- Comparisons repeated for at least 44 test-days (Hartlepool within 1 spring season; Doel, spread over 4 years)
- Transit time from intake checked with live fish: 60-80% < 1 h



## Hartlepool



### Hartlepool Layout – Plan View (Arrangement 1)



High velocity area at Low Tide

Flow

Drum Screens

Cooling Water Intakes

Trash Basket

CW Pumphouse

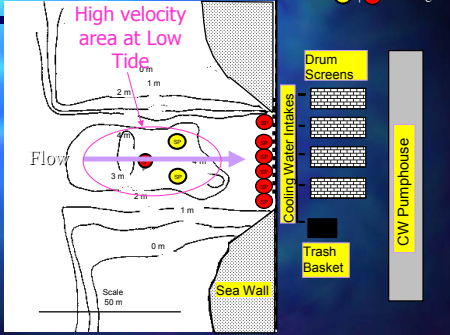
Sea Wall

Scale 50 m

Sound Projectors

- Arrangement 1

### Hartlepool Layout – Plan View (Arrangement 2)



High velocity area at Low Tide

Flow

Drum Screens

Cooling Water Intakes

Trash Basket

CW Pumphouse

Sea Wall

Scale 50 m

Sound Projectors

- Arrangement 1
- + Arrangement 2

### Hartlepool

Changes in Daily PG-Mean Catch with Sound 'On' (Student's t-test)

Species	Arrangement 1	
All spp.	-2.1%	(ns)
Sprat	+33.1%	(ns)
Herring	-38.5%	(P<0.05)
Whiting	+19.8%	(ns)
Non-swim-bladder spp	+25.9%	(ns)

### Hartlepool

Changes in Daily PG-Mean Catch with Sound 'On' (Student's t-test)

Species	Arrangement 1	Arrangement 2
All spp.	-2.1% (ns)	-55.9% (P<0.05)
Sprat	+33.1% (ns)	-60.1% (P<0.05)
Herring	-38.5% (P<0.05)	-79.6% (P<0.05)
Whiting	+19.8% (ns)	-53.5% (P<0.05)
Non-swim-bladder spp	+25.9% (ns)	-15.6% (ns)

**Hartlepool Summary**

- Significant reductions in impingement achieved using sound
- Response varied among different groups: **Pelagic** > **Demersal** > **Benthic**

**Doel Nuclear Plant, Belgium**

**Doel Units 3 /4 Trials**

Two sound projector arrangements used (20 amplifiers, 20 sound projectors):

Arrangement 1  
June '97-Feb'98

Arrangement 2  
Oct '98 ==>

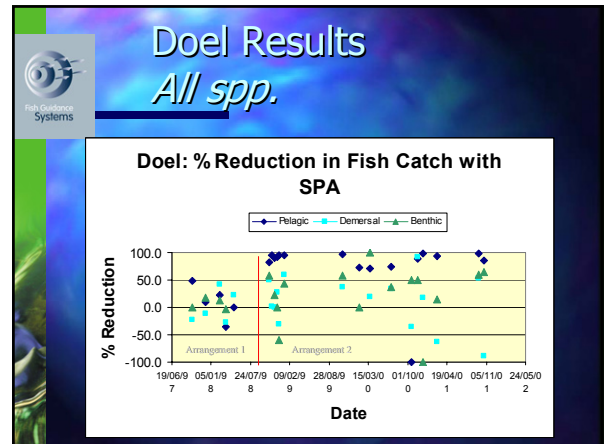
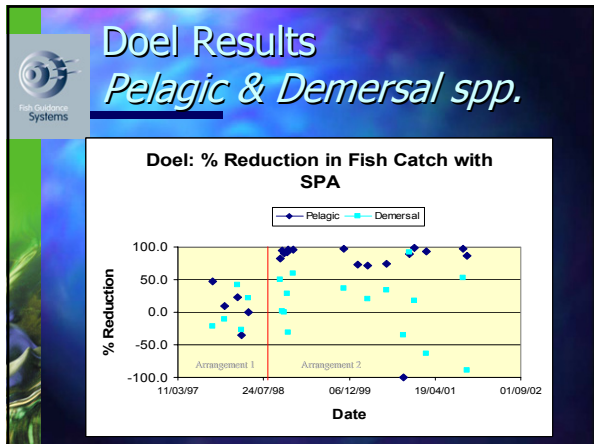
**Doel Sound Projector Layout- Arrangement 2**

**FGS 30-600 Mk 2 Sound Projectors used at Doel**



**Doel Results**  
*Pelagic spp.*

**Doel: % Reduction in Fish Catch with SPA**

Date	% Reduction
11/03/97	45
11/03/97	55
11/03/97	65
11/03/97	75
24/07/98	40
24/07/98	50
24/07/98	60
24/07/98	70
24/07/98	80
24/07/98	90
06/12/99	85
06/12/99	95
06/12/99	100
19/04/01	90
19/04/01	95
19/04/01	100
01/09/02	95
01/09/02	100




- ### Conclusions (1)
- SPA Acoustic deterrent systems using suitable low-frequency sound signals are effective in reducing fish impingement
  - Effectiveness depends on sensitivity to sound pressure (swimbladder)
  - Position of sound projectors is critical (interference, background noise)

- ### Conclusions (2)
- BAT* for Estuarine Plant? SPA + Fish Return System
- FGS SPA Systems have been fitted/tested at the following European estuarine power plants:
- Hartlepool (UK)
  - Great Yarmouth (UK)
  - Shoreham (UK)
  - Doel (Belgium)
- As well as at >30 freshwater sites.
- 
- 




## Interpretation of Recent Measurements of the Efficiency of an Acoustic Fish Deterrent System

Jeremy Nedwell  
Andy Turnpenny,  
*Fish Guidance Systems Ltd, UK*




## Subject of paper

- The Acoustic Fish Deterrent (AFD) system at Doel nuclear power station was a success
- Why?
- How is it possible to use the information from Doel to design other systems?




## Doel: Percentage Change in Fish Catch with SPA (Arr. 1)

Fish Habit	Arrangement 1	
Pelagic	-29.2 (ns)	
Demersal	-10.3 (ns)	
Benthic	47.8 (ns)	




## Doel: Percentage Change in Fish Catch with SPA (Arr. 1 & 2)

Fish Habit	Arrangement 1	Arrangement 2
Pelagic	-29.2 (ns)	-80.3 (P<0.01)
Demersal	-10.3 (ns)	-21.7 (P<0.02)
Benthic	47.8 (ns)	-24.1 (ns)




## Doel: Summary

- Moving SPA in close to intake improved effectiveness
- SPA system highly effective for clupeids (main target species)
- Latest results show consistently >90% for clupeids
- SPA, with fish return option, proved best solution for Doel.



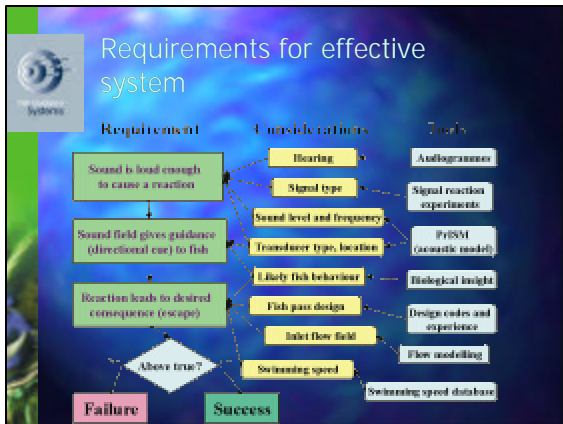
*Fish Return System*



## Questions raised by Doel

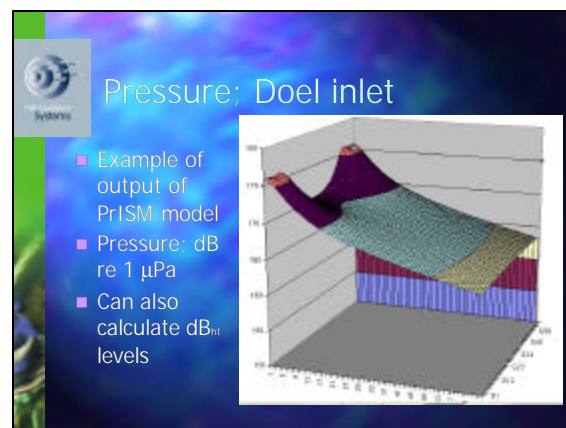
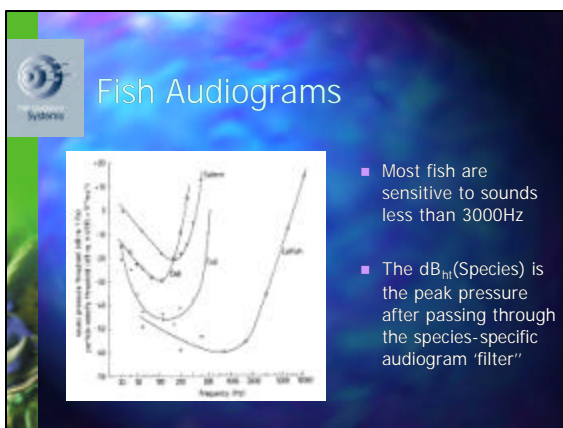
**For design to be engineering rather than an art:**

- can the differing efficiency for different species be accounted for?
- How is the percentage efficiency related to the level and frequency of the sound?
- Is it possible to design systems for a given efficiency?



### The $dB_{ht}(\text{Species})$

- $dB_{ht}(\text{Species})$ : frequency dependent filter is used to weight the sound.
- Suffix 'ht' relates to the fact that the sound is weighted by the hearing threshold of the species.
- For each species this is derived from the audiogram

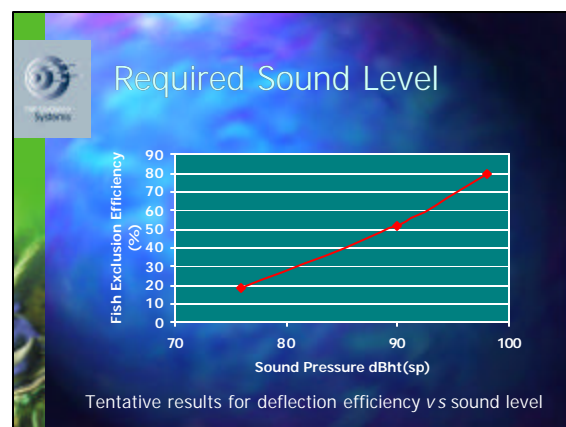


### Efficiency of Doel system vs $dB_{ht}(\text{Species})$ level

The  $dB_{ht}(\text{Species})$  levels shown here were calculated from sound pressure levels measured at Doel and processed using the species audiograms

Modelled $dB_{ht}(\text{Species})$ level for Doel system	Doel system efficiency	Hartlepool system efficiency
76 $dB_{ht}(\text{Limanda limanda})$	21% (flatfish results)	16% (flatfish results)
90 $dB_{ht}(\text{Gadus morhua})$	50% (roundfish results)	54% (whiting results)
98 $dB_{ht}(\text{Clupea harengus})$	80%	80%

Table 1: The estimated average level at the inlet vs the system efficiency





## Summary

- The differing efficiency of AFDs for different species can probably be accounted for in terms of their differing hearing sensitivity
- The percentage efficiency appears to be related to the level of sound perceived by the species
- Systems having a sound level of 90 dB<sub>ref</sub> for a given species are likely to generate effective deflection for that species

## INDUCED SWEEPING FLOWS AT CWIS FOR REDUCING FISH IMPINGEMENT

Charles C. Coutant  
Mark S. Bevelhimer

Environmental Sciences Division  
Oak Ridge National Laboratory  
Oak Ridge, Tennessee 37831

Symposium on  
Cooling Water Intake Technologies to Protect Aquatic Organisms  
May 6-7, 2003  
Arlington, Virginia

ORNL - NATIONAL LABORATORY  
E. S. BEVELHIMER & CHARLES C. COUTANT



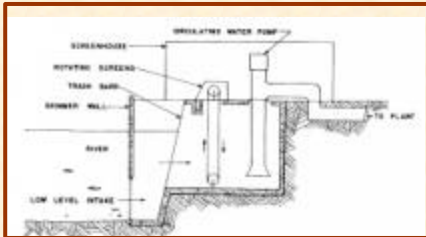
Purpose:

- To present: 1) Conceptual plan  
2) Research strategy

For simulating fish-protection "sweeping velocities" seen at angled screens at cooling-water intake structures (CWIS) having screens perpendicular with water inflow.

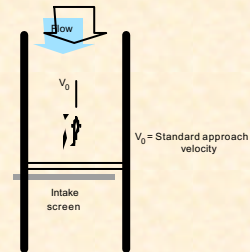
Most CWIS in U.S. use vertical traveling screens perpendicular to flow.

These can have impingement problems, except when screens are close to the river shore.



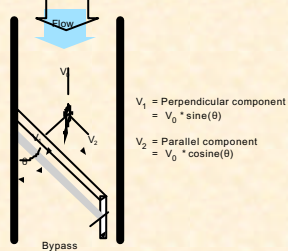
Impingement often results when fish:

- are trapped in intake canals by high velocities,
- become exhausted swimming against the flow,
- fall back onto screens as their only option.

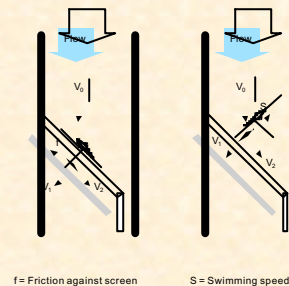


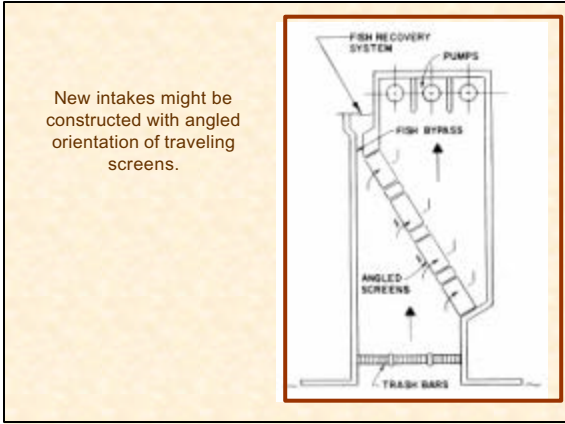
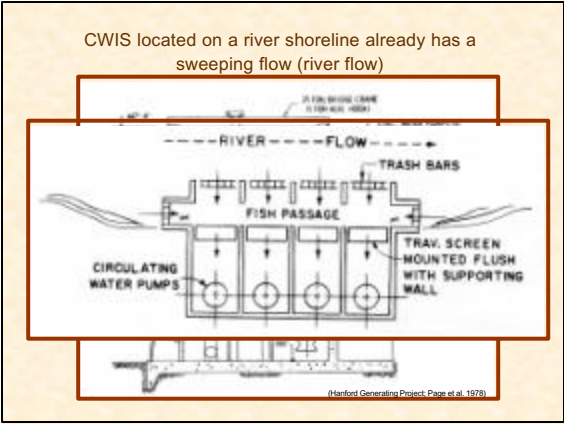
Angled screens are the norm in western U.S., e.g., for irrigation water withdrawals.

- NMFS and several states have regulatory criteria requiring angled screens.
- Rationale: Fish approaching a screen are swept laterally to a bypass by "sweeping velocity".



Any fish briefly impinged can also move laterally to a bypass.



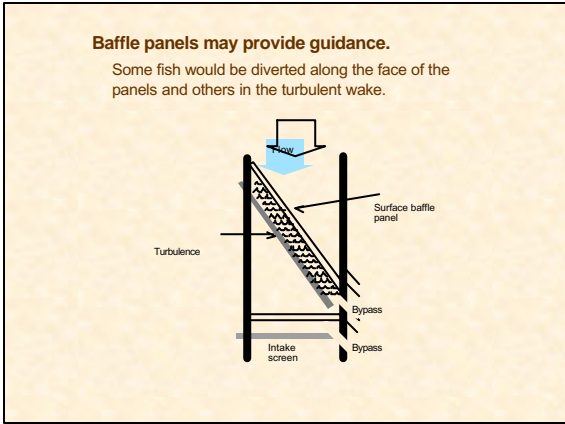
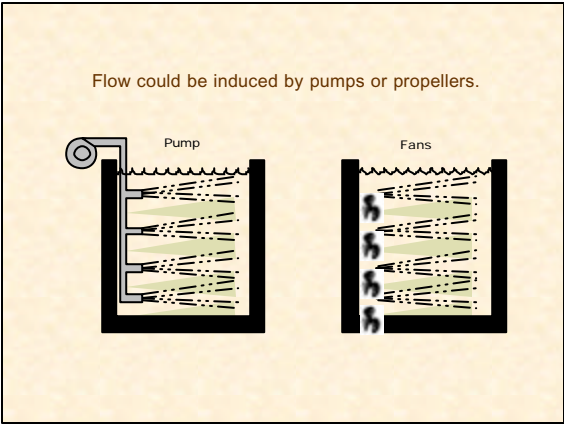
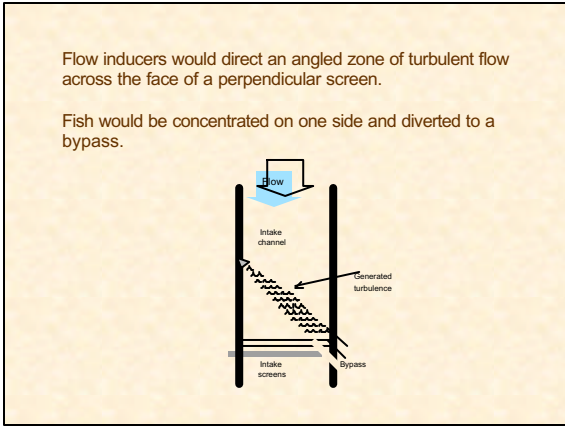


Rebuilding of existing CWIS for angled screens is likely not

- economically feasible
- physically possible

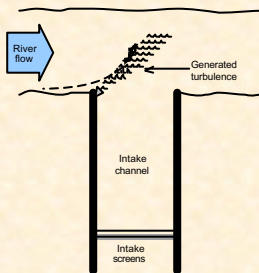
Therefore, we have sought an alternative technology for CWIS, with roots that have been proven effective.

Suggested solution: Simulate an angled screen's "sweeping velocity" with induced flow.





Induced turbulent flow can be installed at the entrance of an intake canal, to divert fish from the canal.

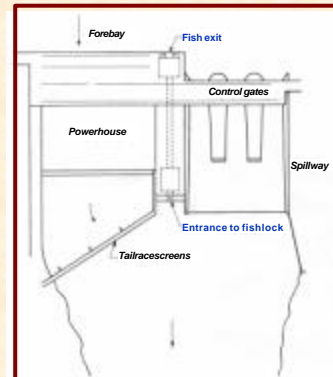


Fish bypasses

- Assorted proven technologies are available
- Fish lifts may be most feasible

Most often used at hydropower dams

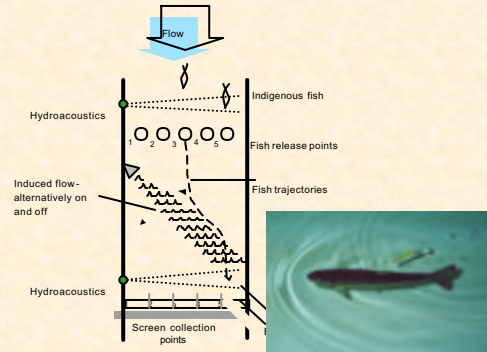
- Vertical lift
- Ramp lift
- Archimedes screw



### Testing and Evaluation

- Know the impingement history of sites and biology of impinged species
- Develop conceptual designs for inducing sweeping velocities
- Conduct CFD modeling of background and induced hydraulic patterns (numerical "experiments" to test alternative flow induction devices and placement strategies)
- Conduct flume tests
- Develop field experiments

### Elements of an experiment



### Conclusions

1. We believe a technology using induced sweeping flows would provide a potentially effective and relatively inexpensive remedial measure for retrofitting existing cooling-water intake systems to reduce impingement.
2. The concept is based generally on (1) the proven effectiveness of angled screens in the Northwest designed to meet federal and state criteria for sweeping velocities and fish bypasses, and (2) low impingement rates of river shoreline CWIS.
3. The concept of induced sweeping flow, although untested at CWIS, seems to have sufficient promise to justify further analysis and initiation of laboratory flume and field testing.

### Acknowledgements :



U.S. Department of Energy  
Energy Efficiency and Renewable Energy  
Wind & Hydropower Technologies Program

HAZARD OF NATIONAL LABORATORY  
U.S. DEPARTMENT OF ENERGY

## The Use of Angled Bar Racks and Louvers for Protecting Fish at Water Intakes



*A Symposium on Cooling Water Intake Technologies  
To Protect Aquatic Organisms*

Stephen Amaral and Edward Taft  
ALDEN Research Laboratory, Inc.

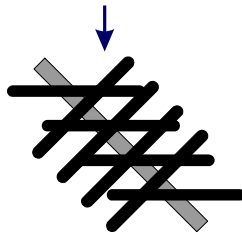
Douglas Dixon  
EPRI

## Angled Bar Racks and Louvers

- ◆ Field Installations and Evaluations
  - Hydro
  - Water Diversions
  - CWIS
- ◆ EPRI Bar Rack and Louver Study
- ◆ Potential for Angled Bar Racks and Louvers to be Applied at CWIS

## Bar Rack and Louver Design

APPROACH FLOW



Louver  
Bar Rack

## Angled Bar Racks

### *Guidance Mechanism and Important Considerations*

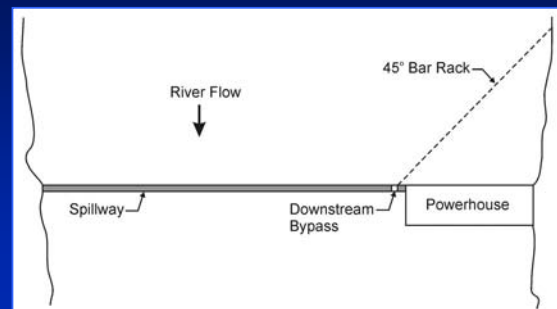
- ◆ Angled bar racks typically are designed to physically exclude fish and guide them to a bypass
- ◆ Most angled bar rack facilities have been installed at 45° to the flow and have bar spacings between 1 and 2 inches
- ◆ Important hydraulic parameters include approach and bypass velocity
- ◆ Important biological considerations include the species and size classes that are targeted for protection

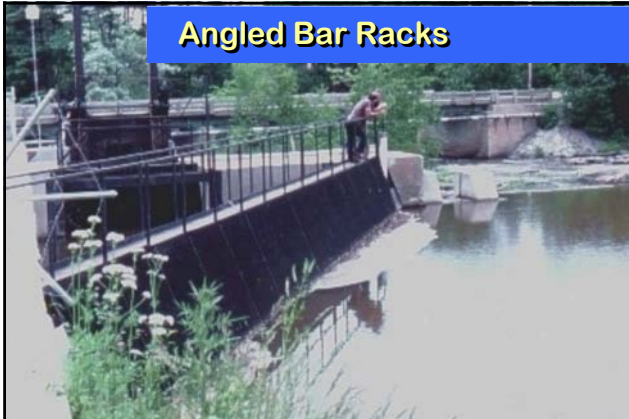
## Angled Bar Racks

### *Previous Applications and Existing Data*

- ◆ Narrow-spaced, angled bar racks have been prescribed for use at many hydroelectric projects in the Eastern U.S.
- ◆ Most bar rack installations and evaluations have focused on anadromous species (Atlantic salmon, juvenile shad and herring)
- ◆ Results have been mixed; effectiveness is dependent on fish behavior and hydraulics

## Angled Bar Racks





**Angled Bar Racks**

### Louvers

Guidance Mechanism and Important Considerations

- ◆ Louvers create hydraulic conditions that elicit behavioral avoidance reactions from approaching fish
- ◆ Important design parameters include structure angle (15-30 degrees), slat spacing (1 to 12 inches), and bypass design
- ◆ Important hydraulic parameters include approach and bypass velocity
- ◆ Important biological considerations include species and size classes that are targeted for protection

A photograph showing a close-up view of a louver system with fish swimming along the slats.

**Louvers**

Fish Guiding Along Louver System

### Louvers

Previous Applications and Existing Data

- ◆ Louvers have been effective at guiding anadromous species at several hydro sites
- ◆ Limited to no information for most freshwater, estuarine, and coastal species
- ◆ Limited use and evaluation at CWIS

A photograph of the Holyoke Canal Louver Facility with a table overlaid on the image.

**Holyoke Canal Louver Facility**

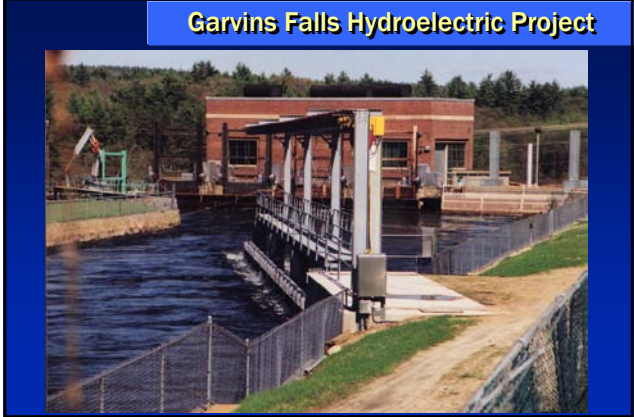
Slat Spacing	2 inches
Angle to Flow	15 degrees
Approach Velocity	1 – 3 ft/s
Target Species	Atlantic salmon juvenile <i>Alosa</i>
Size Range	75 – 200 mm
Effectiveness	80 - 95%



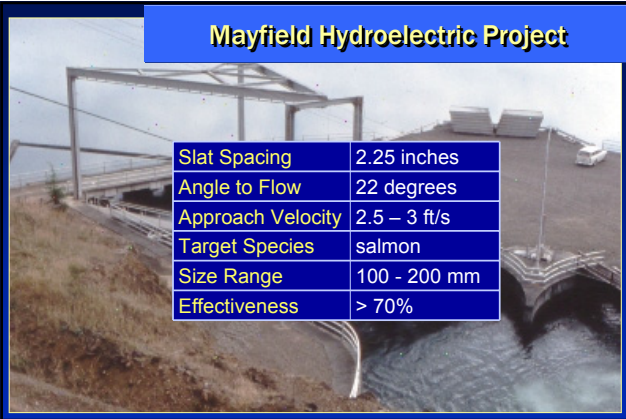
### Holyoke Canal Louver Facility



### Garvins Falls Hydroelectric Project

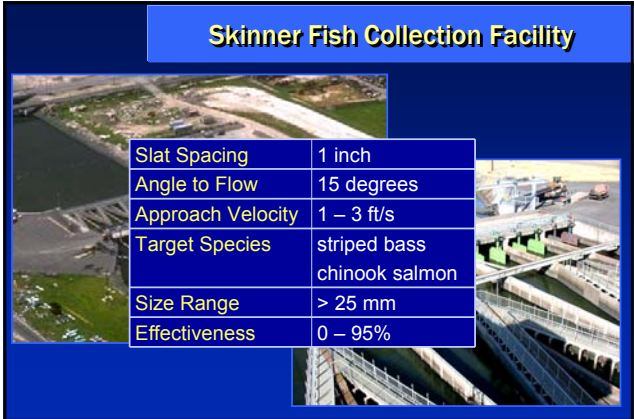


### Mayfield Hydroelectric Project



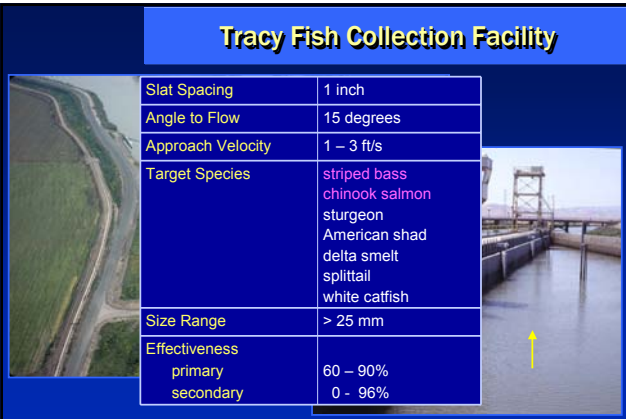
Slat Spacing	2.25 inches
Angle to Flow	22 degrees
Approach Velocity	2.5 – 3 ft/s
Target Species	salmon
Size Range	100 - 200 mm
Effectiveness	> 70%

### Skinner Fish Collection Facility



Slat Spacing	1 inch
Angle to Flow	15 degrees
Approach Velocity	1 – 3 ft/s
Target Species	striped bass chinook salmon
Size Range	> 25 mm
Effectiveness	0 – 95%

### Tracy Fish Collection Facility



Slat Spacing	1 inch
Angle to Flow	15 degrees
Approach Velocity	1 – 3 ft/s
Target Species	striped bass chinook salmon sturgeon American shad delta smelt splittail white catfish
Size Range	> 25 mm
Effectiveness	primary: 60 – 90% secondary: 0 - 96%

### San Onofre NGS

		Unit 2 Percent Returned	Unit 3 Percent Returned
San Onofre Nuclear Generating Station	Discharge		
	Intake		
	Intake		
	Discharge		
	Year		
	1984	96.5	95.4
	1985	88.3	60.1
	1986	75.0	69.9
	1987	65.0	67.8
	1988	80.0	68.5
1989	41.6	58.4	
1990	51.5	36.6	
1991	75.4	66.3	
1992	74.4	59.3	
1993	83.0	78.0	
1994	87.7	78.4	
1999	72.4	68.2	
Mean	74.2	67.2	

## EPRI Bar Rack/Louver Study

- ➔ Quantitatively evaluate the ability of selected fish species to guide along various configurations of bar racks and louvers
- ➔ Qualitatively evaluate fish behavior in the vicinity of the bar racks and louvers

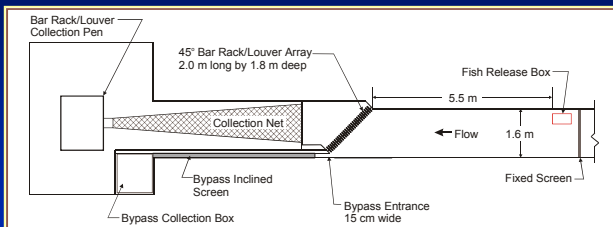
## METHODS

*Test Parameters*

Parameter	45 degrees		15 degrees	
	Bar Rack	Louver	Bar Rack	Louver
Spacing (mm)	25, 50	50	50	50
Velocity (ft/s)	1, 2, 3	1, 2, 2.5	1, 2, 3	1, 2, 3
Bypass depth	Full	Full	Full	Full
Fish release	Surface	Surface	Bottom	Bottom
Bottom overlay	No	No	Yes/No	Yes/No

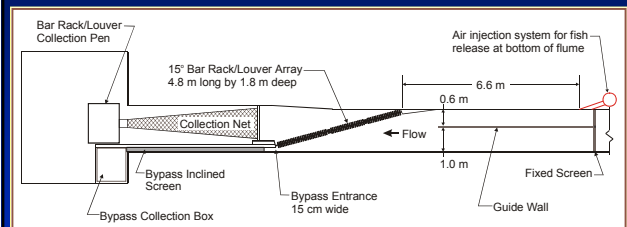
## METHODS *Fish Testing Facility*

### 45° Test Facility



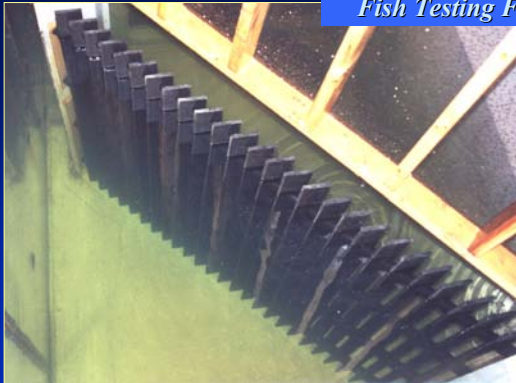
## METHODS *Fish Testing Facility*

### 15° Test Facility



## *Fish Testing Facility*

45°  
Louver



## *Fish Testing Facility*

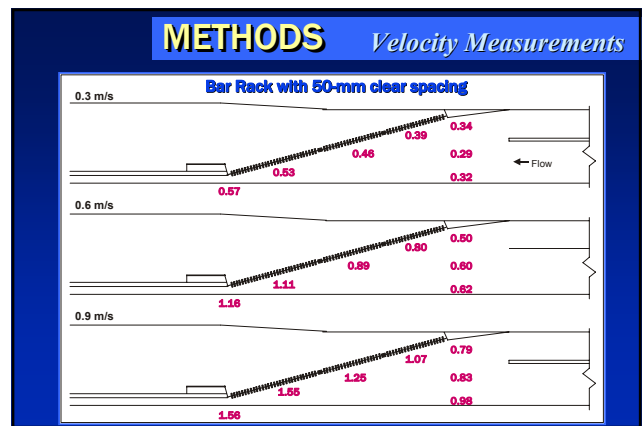
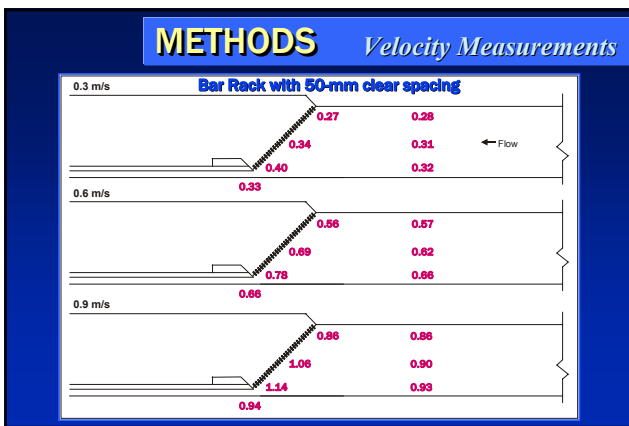
15° Bar Rack without  
Bottom Overlay



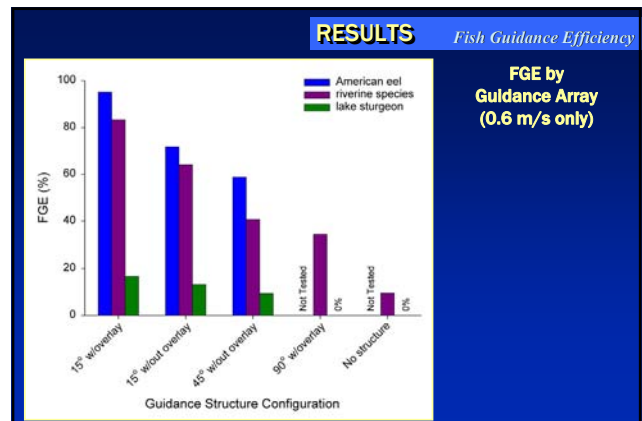


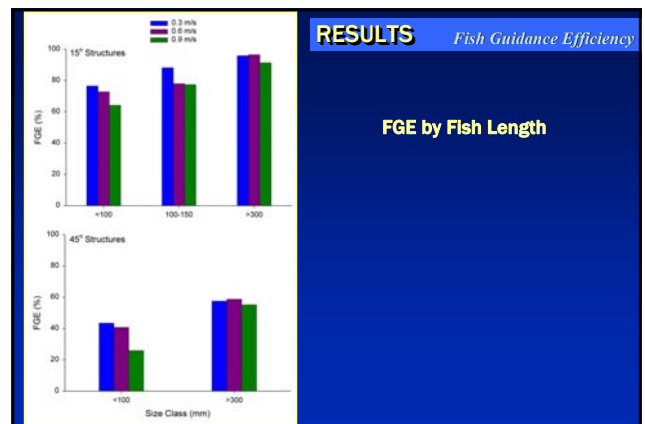
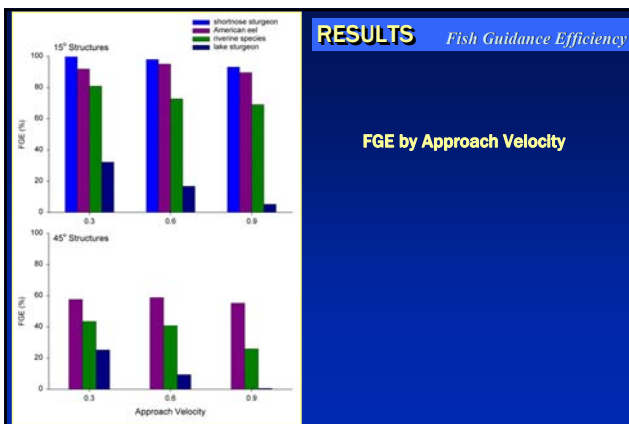
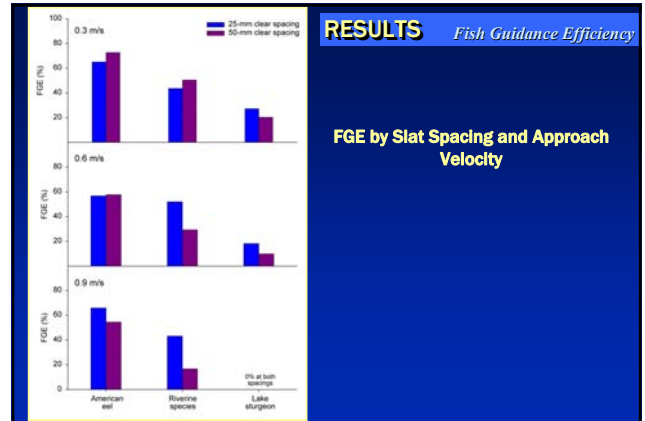
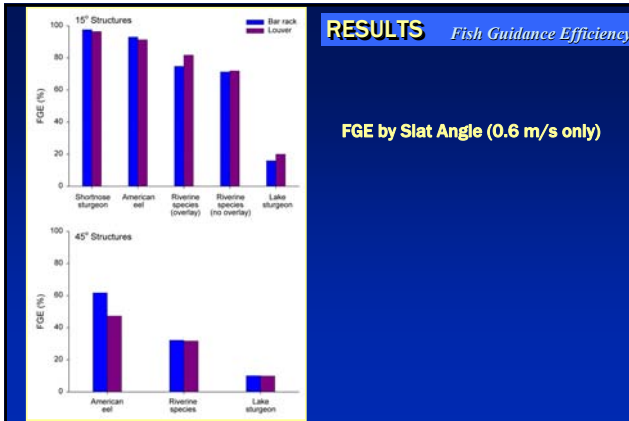
### METHODS Fish Species

<b>golden shiner</b> 79 mm	<b>American eel</b> 560 mm
<b>smallmouth bass</b> 59 - 117 mm	<b>lake sturgeon</b> 153, 332 mm
<b>channel catfish</b> 113 mm	<b>shortnose sturgeon</b> 319 mm
<b>largemouth bass</b> 73 mm	<b>walleye</b> 75 mm



Guidance Structure	Bottom Overlay	Vel (m/s)	Fish Guidance Efficiency (%)								
			SMB	WAL	LMB	CHA	GSH	LAS1	LAS2	SNS	EEL
45° bar rack (25 mm)	No	0.3	31.2	--	--	--	56.1	27.3	--	--	65.1
		0.6	51.4	--	--	--	52.6	18.3	--	--	56.8
		0.9	49.3	--	--	--	37.1	0.0	--	--	65.9
45° bar rack (50 mm)	No	0.3	49.6	--	--	--	51.3	20.4	--	--	72.7
		0.6	30.8	--	--	--	27.9	10.0	--	--	57.8
		0.9	20.3	--	--	--	13.1	0.0	--	--	54.5
15° bar rack (50 mm)	no	0.3	--	--	67.6	94.2	--	--	--	--	--
		0.6	69.7	57.1	58.3	75.6	--	10.4	--	--	83.3
		0.9	--	--	58.3	73.5	--	--	--	--	--
15° bar rack (50 mm)	yes	0.3	71.6	79.2	--	--	27.5	100.0	100.0	95.1	95.1
		0.6	80.4	78.2	--	--	17.4	95.2	100.0	95.0	95.0
		0.9	76.3	63.2	--	--	2.9	93.4	92.9	88.9	88.9
45° louver (50 mm)	no	0.3	43.0	--	--	--	29.5	28.0	--	--	34.9
		0.6	47.3	--	--	--	34.6	0.0	--	--	61.9
		0.9	13.7	--	--	--	22.1	1.7	--	--	45.1
15° louver (50 mm)	no	0.3	--	--	73.3	82.5	--	--	--	--	--
		0.6	56.7	51.3	71.5	73.4	--	16.2	--	--	80.0
		0.9	--	--	60.4	69.9	--	--	--	--	--
15° louver (50 mm)	yes	0.3	88.0	90.6	--	--	36.8	100.0	100.0	88.6	88.6
		0.6	84.9	75.4	87.3	93.8	--	15.9	94.8	95.0	95.1
		0.9	88.8	62.6	--	--	--	7.4	84.8	93.3	90.2
90° bar rack	yes	0.6	53.3	8.4	--	--	0.0	--	--	--	
no structure	--	0.6	--	29.1	0.0	--	--	--	--	--	





- EPRI Study Conclusions**
- ➔ FGE for the 45° bar rack with 25-mm spacing generally was higher than for the 45° bar rack with 50-mm spacing
  - ➔ There was no distinct difference in FGE between the bar rack and louver arrays
  - ➔ FGE at the 15° angle was higher than it was at the 45° angle, especially when the bottom overlay was used on the 15° arrays
  - ➔ FGE decreased with increasing velocity for most species and structure configurations evaluated
  - ➔ With the exception of lake sturgeon, FGE's for larger, bottom-oriented species were higher than for smaller fish that typically swam higher in the water column

- EPRI Study Conclusions**
- ➔ Tests with the 90° bar rack and with no structure in place demonstrated that fish were actively guiding along the angled bar racks and louvers to the bypass
  - ➔ 45° bar racks and louvers do not appear to have considerable potential as a means for guiding riverine species away from water intakes
  - ➔ 15° guidance structures do appear to have considerable potential for guiding riverine fishes and silver American eels away from water intakes
  - ➔ Design parameters (slat angle and spacing, approach velocity) that are important for successful guidance will depend on target species and size classes

## Conclusions

### *Application of Bar Racks and Louvers at CWIS*

- ➔ 45° angled bar racks have limited potential for application at CWIS based on the results from hydro and laboratory evaluations
- ➔ Depending on site design (e.g., canal intake), louvers have potential to effectively reduce impingement of fish at CWIS
- ➔ Targeted species and size classes will influence facility design and operation (e.g., slat spacing, angle to flow, approach velocities)
- ➔ Intake design, location, and hydraulic conditions also will influence guidance facility design and operation, as well as biological effectiveness

## Conclusions

### *Application of Bar Racks and Louvers at CWIS*

Species/Size	FGE
<b>Anadromous species</b>	
75 – 200 mm	> 80%
<b>Riverine Species</b>	
25 – 100 mm	60 - 90%
100 – 200 mm	70 – 95%
> 200 mm	80 – 100%
<b>Estuarine/Coastal</b>	
> 25 mm	> 60%

## Conclusions

### *Application of Bar Racks and Louvers at CWIS*

#### Optimum Louver Design Criteria

Slat Spacing	≤ 2 inches
Angle to Flow	≤ 30 degrees
Approach Velocity	≤ 3 ft/s
Bypass Velocity Ratio	≥ 1.5



## Impingement Survival Review

Steven Jinks, Nancy Decker, William Dey,  
John Young, Douglas Dixon

*ASA analysis & communication*

## Project Goals

- 1. Identify/summarize imp. survival studies
- 2. Facilitate access to reports/information
- 3. Identify factors influencing survival
- 4. Discuss use in BTA assessments

*ASA analysis & communication*

## 1. Summaries of the Studies

- 67 source documents identified/reviewed
- Summary of general methodology
- Summary of coverage
  - years, species, waterbodies, screen designs
- Summaries of impingement survival rates

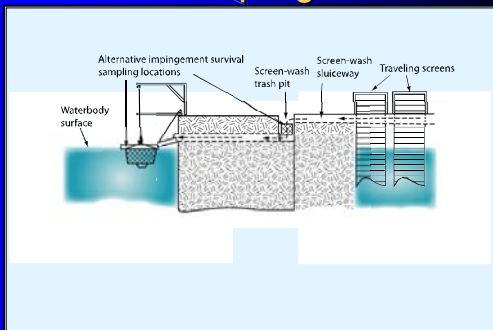
*ASA analysis & communication*

## General Methodology

- Collection from screenwash water system
- Sampling during peak or seasonal
- Initial enumeration - live, “stunned”, dead
- Latent mortality over 24-108 hrs
- Controls – some studies & species
- Survival rate = proportion remaining alive

*ASA analysis & communication*

## Survival Sampling Locations



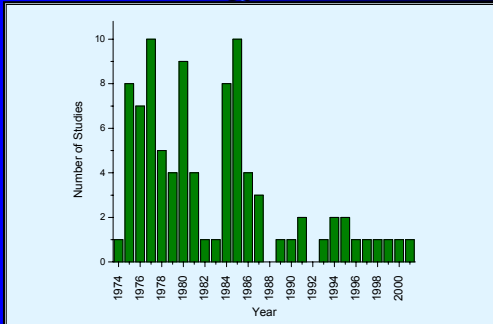
*ASA analysis & communication*

## Survival Rate Measures

- Initial Survival =  $P_i = A_i/N_T = L_i + St_i$
- Latent Effects Survival =  $P_\ell = A_{\ell(t)}/N_\ell$
- Extended Survival =  $P_e = P_i \times P_\ell$

*ASA analysis & communication*

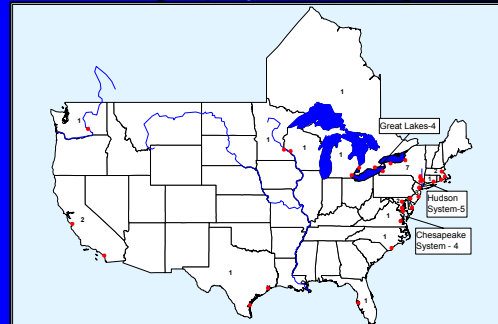
## Chronology of Studies



*ASCA analysis & communication*

7

## Geographic Coverage



*ASCA analysis & communication*

8

## Waterbody Coverage

Water Body Type	No. of Facilities	No. of Waterbodies
Freshwater stream or river	4	3
Great lake	5	2
Tidal river or estuary	16	13
Ocean	4	4

*ASCA analysis & communication*

9

## Screen Designs Studied

Traveling Screen Type	No. of Facilities
Single-Flow	23
Dual-Flow	5
Angled	4

*ASCA analysis & communication*

10

## Taxonomic Coverage

Water Body Type	Total No. of Taxa
Freshwater stream or river	55
Great lake	39
Tidal river or estuary	184
Ocean	85

*ASCA analysis & communication*

11

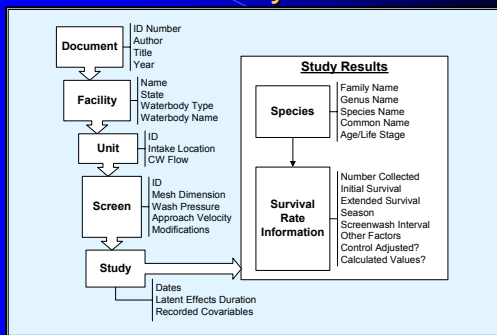
## 2. Facilitate Information Access

- Report tables
  - Descriptive information referenced to sources
  - Impingement survival rate estimates
- Database of key information
- Images of available documents on CD

*ASCA analysis & communication*

12

## Survival Study Database



*ASCA analysis & communication*

13

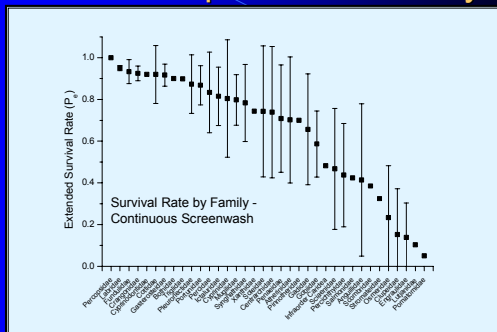
## 3. Factors Influencing Survival

- Factors affecting stresses
  - Screen wash frequency
  - Screen travel time
  - Modifications for fish handling
- Factors affecting sensitivity
  - Species type
  - Water temperature/season
  - Variable salinity in estuaries

*ASCA analysis & communication*

14

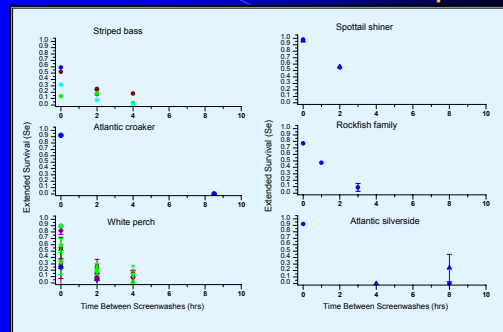
## Factors - Species Sensitivity



*ASCA analysis & communication*

15

## Factors – Screenwash Frequency



*ASCA analysis & communication*

16

## Other Intake Factors

- Screen rotation speed & height
- Fish handling (Ristroph) modifications

*ASCA analysis & communication*

17

## Waterbody Factors

- Loadings of debris and other organisms
- Ambient water temperature
- Salinity in estuaries

*ASCA analysis & communication*

18

## 4. Uses of Prior Studies

- Defining data needs for site/intake conditions
- Selection of focal species
- Screening intake alternatives
- Benefit calculations

## Potential Mortality Rate Biases

- Overestimate mortality rate
  - No correction for collection/holding effects
  - No accounting for pre-impingement mortality
- Underestimate mortality rate
  - Low screenwash collection efficiency
  - Increased susceptibility to predation

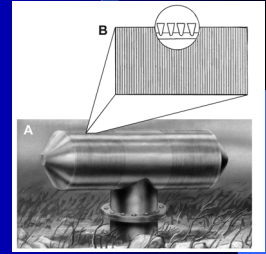
## Optimal Slot-Width Selection for Wedge Wire Screens

William Dey, John Young, Steven Jinks,  
Nancy Decker, Jon Black, and Stephen Amaral

*AS&A analysis & communication*

## Factors Affecting Screen Performance

- Slot width
- Through-slot velocity
- Sweep velocity



*AS&A analysis & communication*

## Purpose of Study

- To evaluate effects of slot width on screen performance at three hypothetical power plant locations on Hudson River estuary
- Address different response across three species:
  - American shad
  - Striped bass
  - Bay anchovy
- Performance measured in terms of equivalent Age 1 individuals

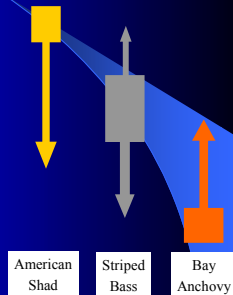
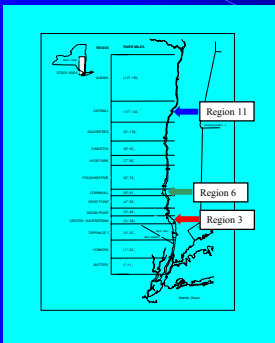
*AS&A analysis & communication*

## Hypothetical Plant

- 500 MGD cooling water requirement
- Base loaded
- Offshore intake with 0.5 mm, 1.0 mm, 2.0 mm, or 3.0 mm slot width wedge wire screens
- 0.25 fps through-slot velocity
- Three potential locations
  - Mesohaline
  - Lower Tidal Freshwater
  - Upper Tidal Freshwater

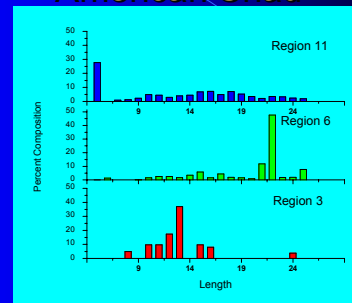
*AS&A analysis & communication*

## Hudson River Estuary

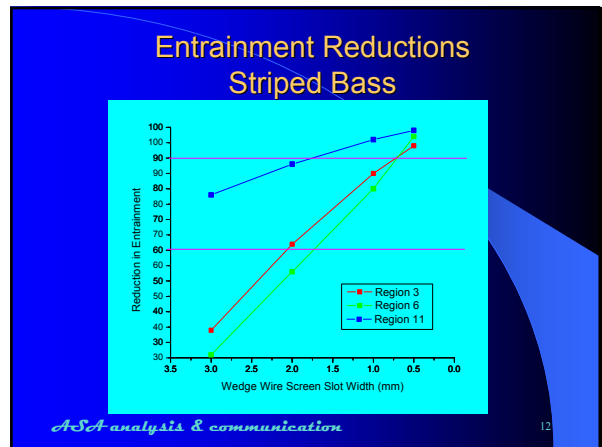
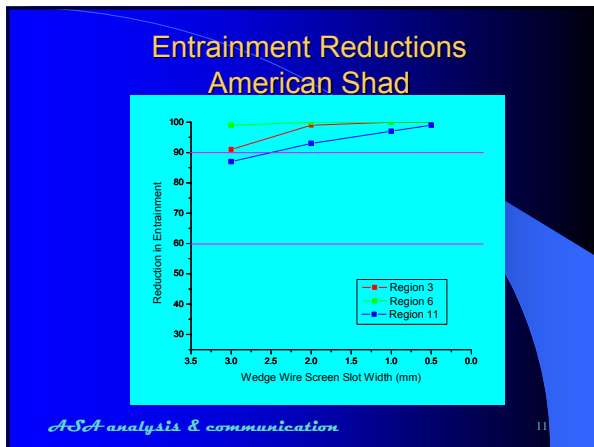
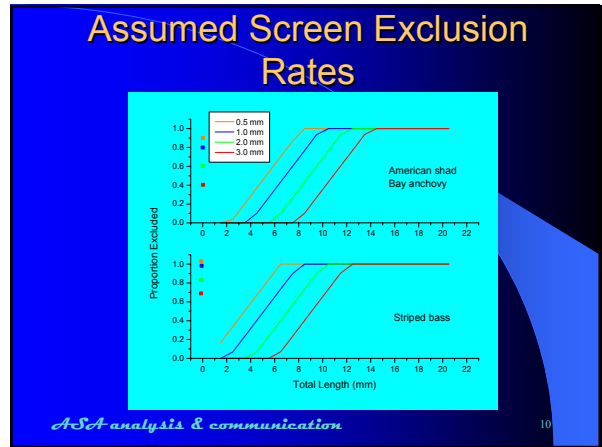
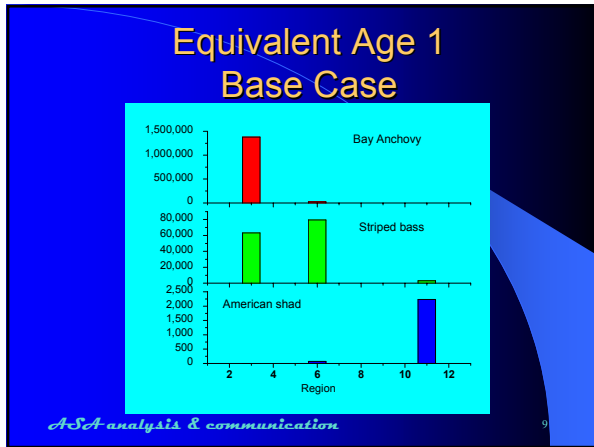
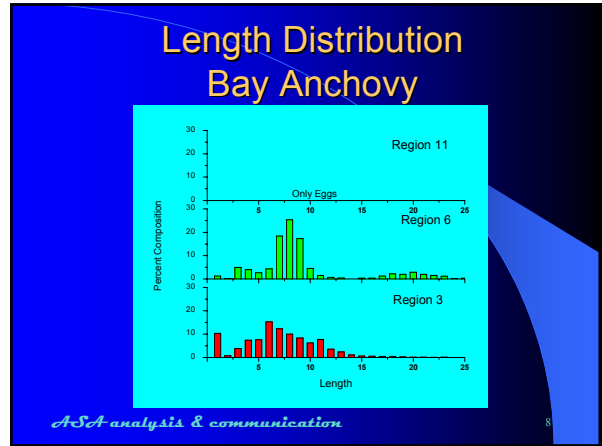
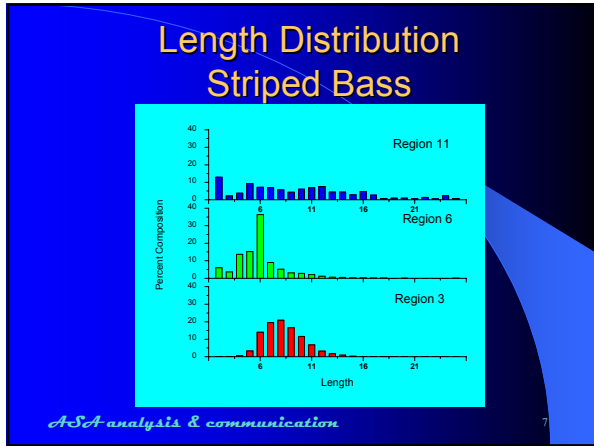


*AS&A analysis & communication*

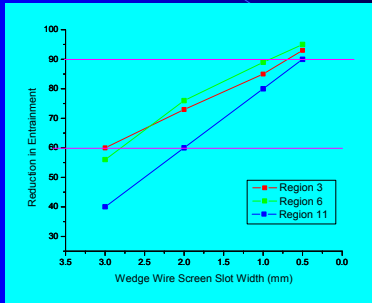
## Length Distribution American Shad



*AS&A analysis & communication*



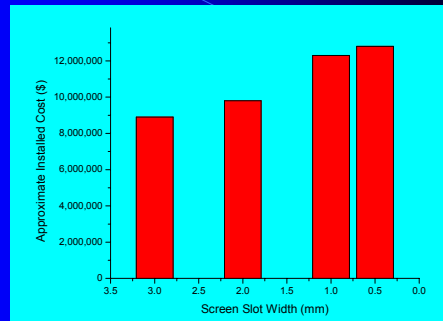
## Entrainment Reductions Bay Anchovy



ASCA analysis & communication

13

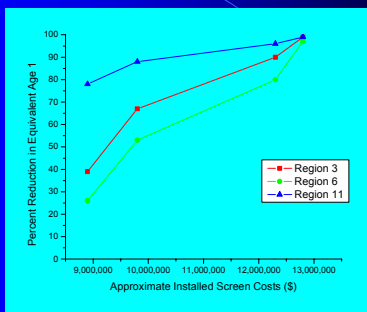
## Screen Installation Costs



ASCA analysis & communication

14

## Example Cost-Benefit Curve



ASCA analysis & communication

15

## Conclusions

- Wedge wire screens appear to be highly effective in reducing entrainment losses
- Site-specific length information is required for optimal slot-width selection
- For American shad, 3 mm screens provide a high degree of protection
- For striped bass and bay anchovy, 2 mm screens provide significant protection.

ASCA analysis & communication

16

## Development of Filter Fabric Barrier to Reduce Aquatic Impacts at Water Intake Structures

Mathew J. Raffenberg  
 John A. Matousek  
 William D. Saksen  
 Andrew J. McCusker  
 Edward W. Radle

## Filter Fabric Barrier Development

- A six-year research program to develop a technology to minimize adverse environmental impact at water intake structures
- Development of a permeable fabric that works as a physical barrier to exclude fish eggs and larvae from entering intake structures
- Resulting technology: Gunderboom Marine Life Exclusion System™ (MLES™)

## Gunderboom MLES™ as an Intake Technology

The Gunderboom MLES™ is currently incorporated in three NYSDEC SPDES permits

- Two closed-cycle facilities
  - Bethlehem Energy Center
  - Bowline Point Generating Station Unit 3
- One once-through facility
  - Lovett Generating Station

## Contributors to the Gunderboom Development

- Orange and Rockland Utilities Inc.
- Mirant Inc. (Southern Company)
- Gunderboom Inc.
- Lawler, Matusky and Skelly Engineers LLP (LMS)
- New York State Department of Environmental Conservation (NYSDEC)
- Hudson Riverkeeper: Pisces Conservation Ltd. / Carpenter Associates

## Lovett Generating Station

- Fossil fuel powered
- Three generating units
- 462-MW capacity
- Once-through cooling
- 391-MGD non-contact cooling water



## Facility Location



- Tomkins Cove, New York
- West Bank of the Hudson River
- 42 river miles upstream of New York City



## Hudson River Characteristics at Lovett

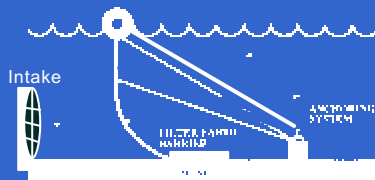


- 160,000 CFS / 3-5 FPS currents
- Tidal range 3 ft / Salinity 0-10 PPT
- Periods of high total suspended solids (TSS)
- 35-ft maintained navigation channel

## Site-Specific Considerations

- Select fabric to exclude the smallest size of target species
- Water withdrawal requirements and through-fabric flow rates
- Water level fluctuations, currents, waves
- Waterborne sediments, debris, ice, etc.
- Physical limitations of the site

## What is a Filter Fabric Barrier?



- Physical barrier made of permeable fabric
- Interstices of fabric have an Apparent Opening Size (AOS) of 20 - 200 microns

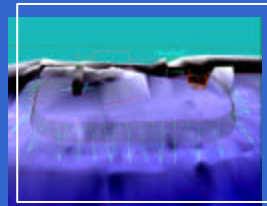
## Filter Fabric Perspective



Pre-deployment



Deployment



3-dimensional perspective

## Annual Development Goals

- 1995 - Gunderboom System concept
- 1996 - Manual AirBurst™ cleaning system / spud-type anchors (3-unit deployment)
- 1997 - Manual AirBurst™ cleaning / dead-weight anchoring system
- 1998 - Automated AirBurst™ cleaning / 500-micron perforations / monitoring equipment
- 1999 - Automatic AirBurst™ cleaning / monitoring equipment
- 2000 - Improve field maintenance procedures, improve mooring hardware and test new zipper connections

## 1995 Deployment



- Single-ply fabric
- Approximately 300 ft long
- 20-30 ft deep
- Danforth anchors

## Annual Development Goals

- 1995 - Gunderboom System concept
- 1996 - Manual AirBurst™ cleaning system / spud-type anchors (3-unit deployment)
- 1997 - Manual AirBurst™ cleaning / dead-weight anchoring system
- 1998 - Automated AirBurst™ cleaning / 500-micron perforations / monitoring equipment
- 1999 - Automatic AirBurst™ cleaning / monitoring equipment
- 2000 - Improve field maintenance procedures, improve mooring hardware and test new zipper connections

## Annual Development Goals

- 1995 - Gunderboom System concept
- 1996 - Manual AirBurst™ cleaning system / spud-type anchors (3-unit deployment)
- 1997 - Manual AirBurst™ cleaning / dead weight anchoring system
- 1998 - Automated AirBurst™ cleaning / 500-micron perforations / monitoring equipment
- 1999 - Automatic AirBurst™ cleaning / monitoring equipment
- 2000 - Improve field maintenance procedures, improve mooring hardware and test new zipper connections

## AirBurst™ System



- Two-ply panelized fabric
- Air hose extending to base of fabric



- Compressed air supplied to header
- Air released at depth
- Fabric billows and shakes to remove sediments

## AirBurst™ System

- Touch-screen control panel
- Strain Gauges
- Head differential monitors

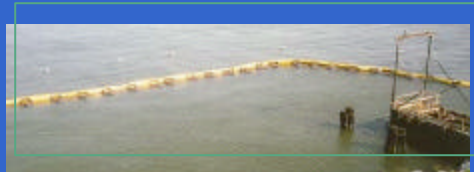


## Annual Development Goals

- 1995 - Gunderboom System concept
- 1996 - Manual AirBurst™ cleaning system / spud-type anchors (3-unit deployment)
- 1997 - Manual AirBurst™ cleaning / dead-weight anchoring system
- 1998 - Automated AirBurst™ cleaning / 500-micron perforations / monitoring equipment
- 1999 - Automatic AirBurst™ cleaning / monitoring equipment
- 2000 - Improve field maintenance procedures, improve mooring hardware and test new zipper connections

## 2000 Deployment

- Two-ply fabric with 500-micron perforations (8000/ft<sup>2</sup>)
- Approximately 500 ft long
- 20-30 ft deep
- Dead-weight anchors
- Automated airburst system with strain gauges and head differential monitors



## Zipper Test

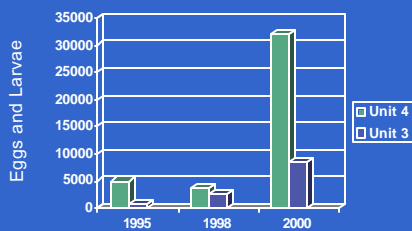


- Improve deployment, removal and maintenance
- Allow for damaged panels to be replaced

## Ichthyoplankton Monitoring

- Ichthyoplankton monitoring conducted inside and outside of the MLES™ during 1995, 1998, 2000 deployments
- Overall program resulted in an 80% reduction in ichthyoplankton entering the facility
- Periodic elevated densities inside were linked to breaches of the system

## Ichthyoplankton Program



Unit 4 – Unprotected / Unit 3 Protected by Gunderboom

## Impingement Experiment

- 24-hr impingement study conducted on American shad
  - 100 eggs added to McDonald Jars with Gunderboom fabric
  - 5 gpm/ft<sup>2</sup> flow rate
- Swimming studies with day-old American shad
  - Larvae added to flow-through tank with Gunderboom fabric
  - 5 gpm/ft<sup>2</sup> flow rate



## Impingement Experiment Results

- Eggs
  - Did not adhere to fabric
  - 1-2% mortality occurred
  - No difference between mortality in the control jars and mortality in the test jars
- Larvae
  - Did not orient toward flow
  - Did not impinge on fabric with through-fabric velocity of 5 gpm/ft<sup>2</sup>



## Program Observations

- Operated effectively under high river flows, debris conditions, and major storm events
- An effective physical barrier for fish eggs and larvae
- Minimal biological growth experienced; growth did not adversely affect operation
- System will perform best when integrated into facility operations



## Program Summary

- Minimize entrainment and impingement
- Maintain in dynamic river environment
- Less expensive than many alternative technologies
- BTA in three NYSDEC SPDES permits
- Being considered by NYSDEC at other selected sites

## Filter curtain materials, entrainment, biofouling and permeability.



Peter Henderson,  
Richard Seaby & Robin Some  
Pisces Conservation Ltd.  
www.irchouse.demon.co.uk  
pisces@irchouse.demon.co.uk

## Filter curtains and entrainment



- At Lovett, on the Hudson, a Gunderboom filter curtain has been tested experimentally in an attempt to reduce entrainment.
- Further installations are intended including at Bowline.

## Fouling is universal

- Any object in water will tend to be colonised by a range of organisms.



- Filter fabrics are unlikely to be an exception.

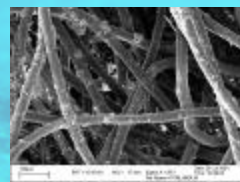
## Bowline pond

- A large Gunderboom filter curtain has been suggested for Bowline Pond on the Hudson River.
- Biofouling was thought to be a significant problem.
- An experiment was performed to investigate the rate and extent of biofouling.

## An experiment to investigate biofouling

- A series of pieces of gunderboom were exposed in Bowline Pond in June 2001.
- They were examined at regular intervals.
- Observations of the level of biofouling were made.

## After 11 Days



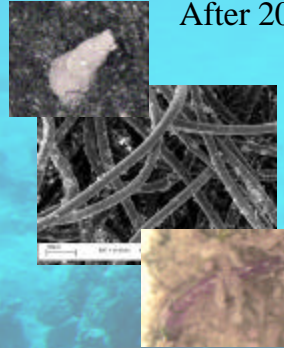
- Little fouling had occurred.
- Some macro-crustaceans had colonised the fabric.



### The fabric at 11 days



### After 20 Days



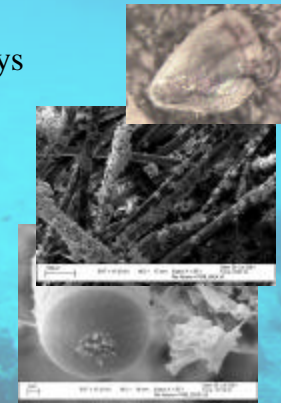
- Fouling was evident on the fibres.
- Many of the holes in the fabric had *Corophium* living in them.
- Other biofouling organisms were present.

### The fabric at 20 days



### After 30 Days

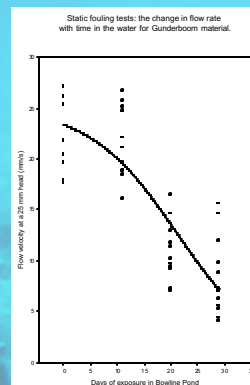
- Fouling continued.
- The community became ever more diverse.
- Burrowing animals were clearly loosening the surface.



### The fabric at 30 days

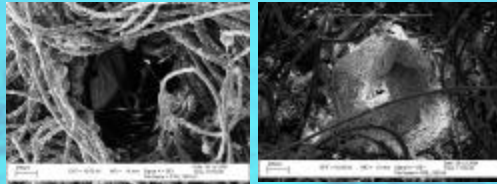


### Changes in permeability

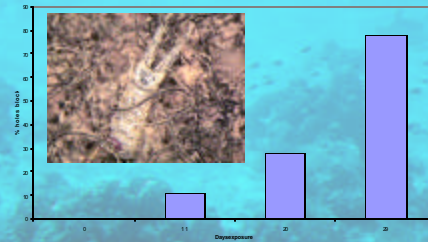


At regular intervals the permeability of the fabric was measured

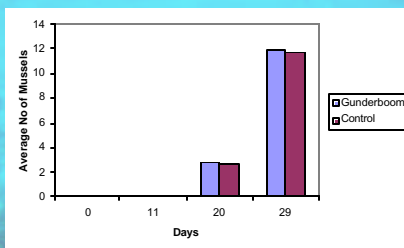
## Tube building in pores



## Increased colonisation of pores



## Zebra mussel fouling



## Fouling with flow and air burst

- The results reported so far have been with static panels.
- Tests on a panel through which water was drawn and air burst cleaning was applied showed even worse fouling.
- Fouling resulted in only 3.9% of the flow of clean filter at 25 mm head.



## Colonisation by fish predators

- Larval fish drawn onto the fabric are vulnerable to predation.
- Several predators were observed on the fouled fabric including ostracods, amphipods, crabs and young catfish.

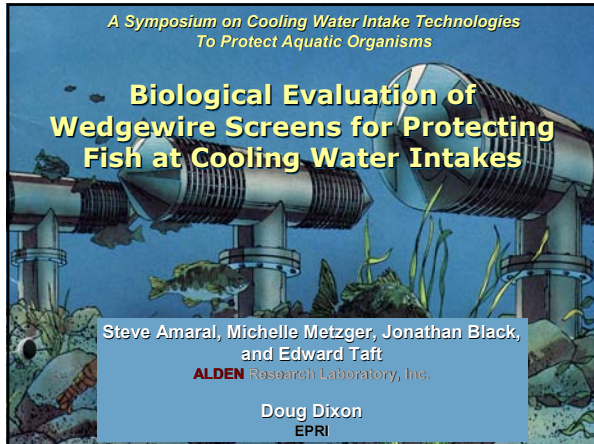


## Conclusions

- Problems with biofouling during the experimental deployment at Lovett have not been reported.
- However, we would anticipate that fouling would be a potentially serious problem in estuarine and marine waters.
- Our brief experiments demonstrated that filter material can be rapidly colonised and the permeability greatly reduced. Therefore care should be taken when assuming that the Lovett experience will be the case at other sites.
- Zebra mussels were colonising after 20 days – this may be a major problem in some freshwater and low salinity sites.
- The surface was colonised by predators such as small crustaceans that may feed upon fish larvae and eggs.

A Symposium on Cooling Water Intake Technologies  
To Protect Aquatic Organisms

## Biological Evaluation of Wedgewire Screens for Protecting Fish at Cooling Water Intakes



Steve Amaral, Michelle Metzger, Jonathan Black,  
and Edward Taft  
ALDEN Research Laboratory, Inc.

Doug Dixon  
EPRI

Laboratory Evaluation of Cylindrical Wedgewire Screens

## STUDY SPONSORS



**EPRI**

**EPA** United States Environmental Protection Agency

Laboratory Evaluation of Cylindrical Wedgewire Screens

## Biological Evaluation Objectives

Determine the relative influence of the following parameters on entrainment and impingement rates of selected species and life stages:

- Slot size
- Through-slot velocity
- Approach channel velocity









Laboratory Evaluation of Cylindrical Wedgewire Screens

## METHODS Test Conditions

Screen Orientation	Slot Size (mm)	Slot Velocity (m/s)	Channel Velocity (m/s)
0°	0.5	0.15	0.08
90°	1.0	0.30	0.15
	2.0		0.30

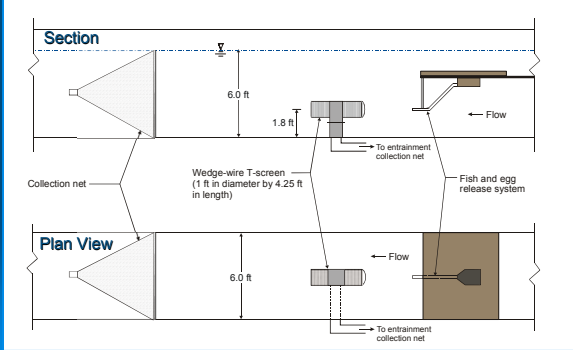
Laboratory Evaluation of Cylindrical Wedgewire Screens

## METHODS Test Fish

SPECIES	EGG DIA	LARVAL LENGTH
 striped bass ( <i>Morone saxatilis</i> )	4.5	4.3 - 8.8
 winter flounder ( <i>Pleuronectes americanus</i> )	--	5.0 - 7.9
 yellow perch ( <i>Perca flavescens</i> )	--	6.3 - 7.3
 common carp ( <i>Cyprinus carpio</i> )	--	6.4
 white sucker ( <i>Catostomus commersoni</i> )	3.2	13.9
 bluegill ( <i>Lepomis macrochirus</i> )	--	19.0
 alewife ( <i>Alosa pseudoharengus</i> )	0.7	--
 rainbow smelt ( <i>Osmerus mordax</i> )	--	6.2

Laboratory Evaluation of Cylindrical Wedgewire Screens

## METHODS Test Facility Design



**Section**

6.0 ft

1.8 ft

Wedge-wire T-screen (1 ft in diameter by 4.25 ft in length)

Collection net

To entrainment collection net

Flow

Fish and egg release system

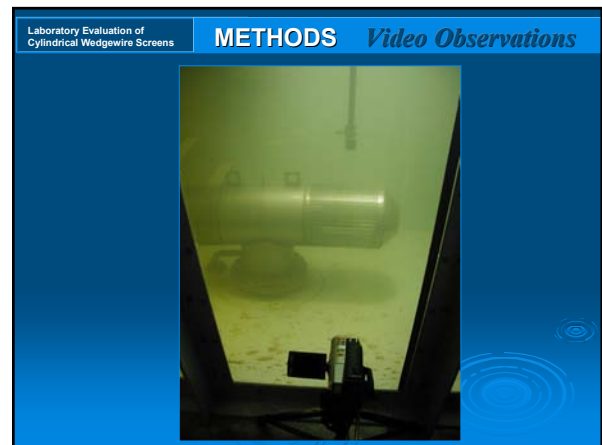
**Plan View**

6.0 ft

To entrainment collection net

Flow





Laboratory Evaluation of Cylindrical Wedgewire Screens

**METHODS** *Experimental Design*

For each set of test conditions (i.e., slot size, slot velocity, approach velocity, species):

- Conduct 3-5 trials
- Release 50 to 100 organisms per trial
- Estimate number entrained
- Estimate number impinged

Laboratory Evaluation of Cylindrical Wedgewire Screens

**METHODS** *Entrainment/Impingement*

$$\% \text{ Fish Lost to Impingement/Entrainment} = \left[ \frac{E_{\text{adj}} + I}{R} \right] \times 100$$

Laboratory Evaluation of Cylindrical Wedgewire Screens

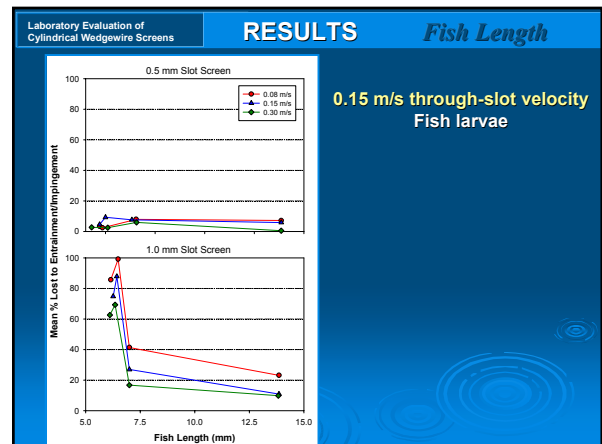
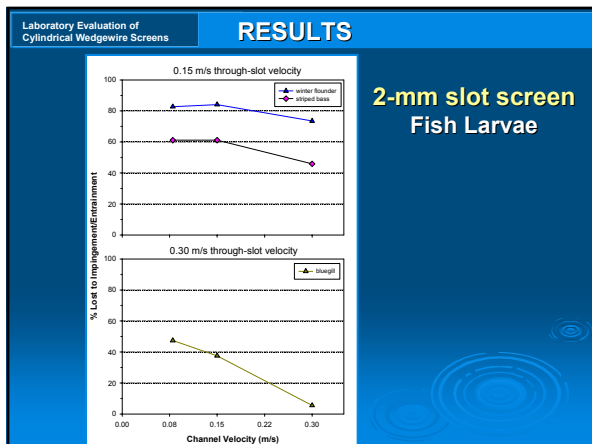
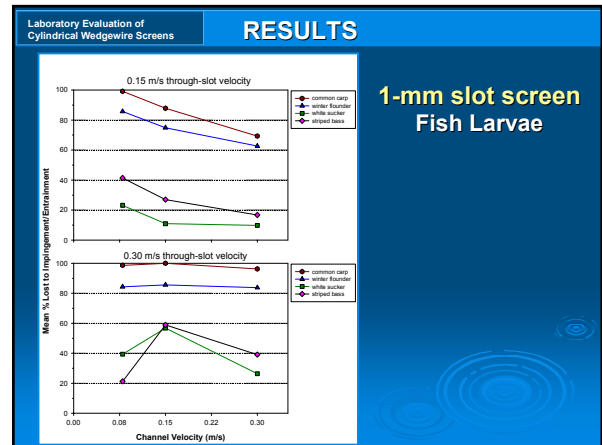
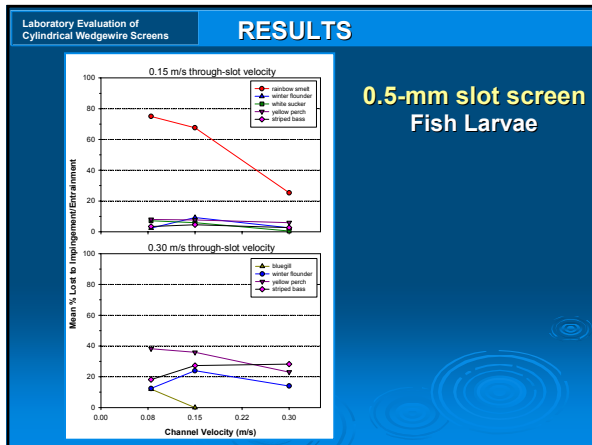
## METHODS *Data Analysis*

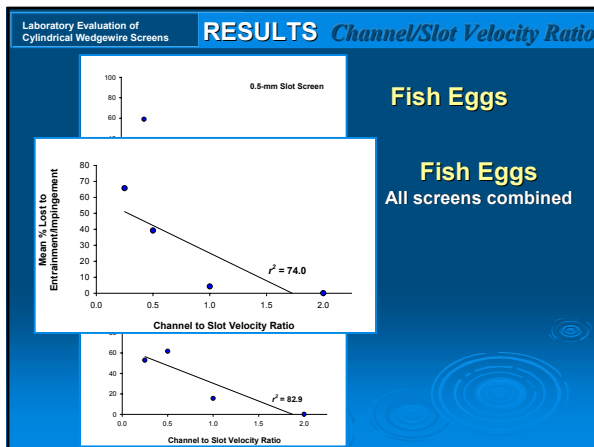
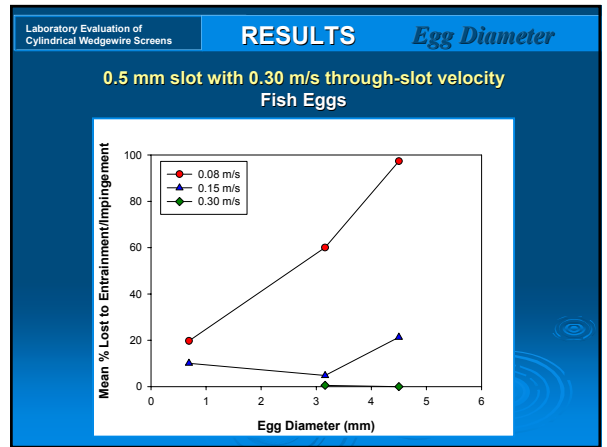
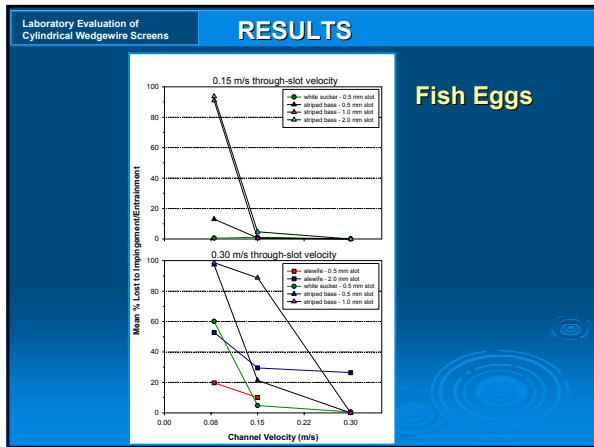
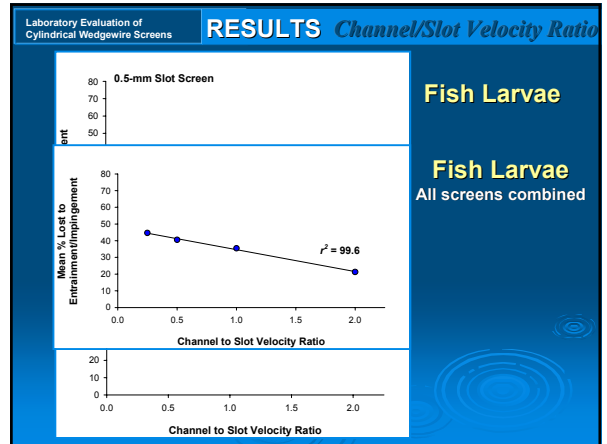
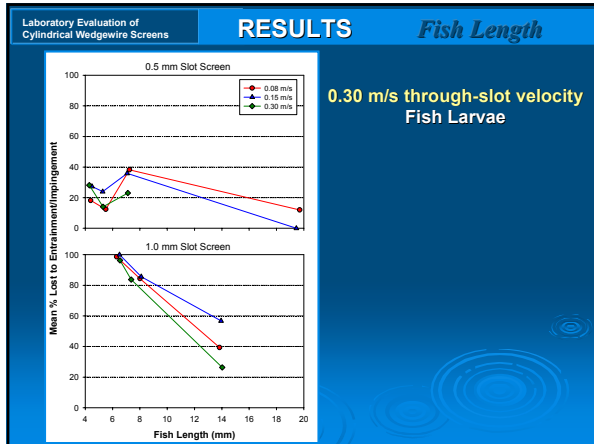
- Analyze entrainment and impingement data for statistical differences among test conditions (slot width, slot velocity, channel velocity, species)
- Explore potential interactions among the test conditions
- For larval data, examine fish length as a covariate

Laboratory Evaluation of Cylindrical Wedgewire Screens

## RESULTS

- Percent of organisms lost to entrainment and impingement by slot size
- Relationship between length/diameter and entrainment and impingement
- Effect of channel/slot velocity ratio on percent of organisms lost to entrainment and impingement





Laboratory Evaluation of Cylindrical Wedgewire Screens

## VIDEO OBSERVATIONS

Slot Width: 2.0 mm  
 Through-slot Velocity: 0.5 ft/s  
 Channel Velocity (ft/s): 0.6 ft/s



Laboratory Evaluation of Cylindrical Wedgewire Screens

## VIDEO OBSERVATIONS

Slot Width: 2.0 mm  
 Through-slot Velocity: 0.5 ft/s  
 Channel Velocity (ft/s): 1.0 ft/s



Laboratory Evaluation of Cylindrical Wedgewire Screens

## Conclusions

- Impingement decreased with increases in slot size
- Entrainment increased with increases in slot size
- Entrainment and impingement increased with increases in through-slot velocity
- Entrainment and impingement decreased with increases channel velocity
- For each species evaluated, larval length generally did not influence entrainment and impingement rates, most likely due to the narrow size ranges that were tested
- Among species, larval entrainment and impingement rates generally decreased with increasing fish length
- Percent of eggs lost to entrainment and impingement increased with diameter at the lower channel velocities
- The ratio of channel velocity to slot velocity was negatively correlated with entrainment/impingement rates

Laboratory Evaluation of Cylindrical Wedgewire Screens

## Conclusions

*General Effectiveness of Wedgewire Screens*

- Entrainment and impingement rates less than 10% can be achieved for eggs and larvae depending on organism size, screen design, and local hydraulics

*Considerations in Assessing Wedgewire Screen Effectiveness*

- The relative importance of each variable is dynamic
- More information is needed to fully understand the interactions among all variables that influence entrainment and impingement
- Effects of debris loading are unknown
- Entrainment and impingement rates will be lower when all organisms that are within the biological zone of influence are considered
- Conclusions from the laboratory study must be verified in the field

## Selection and Design of Wedge Wire Screens and a Fixed-Panel Aquatic Filter Barrier System to Reduce Impingement and Entrainment at a Cooling Water Intake Structure on the Hudson River

Mark F. Strickland, P.E., PSEG Services Corporation  
James E. Mudge, Ph.D., Civil and Environmental Consultants, Inc.

Symposium on Cooling Water Intake Technologies to Protect Aquatic Organisms

Arlington, Virginia  
May 6-7, 2003



## Outline

- Project Background
- Alternative Cooling Systems Study
  - Alternatives evaluated
  - Overview of findings
  - Public Participation Process
- Final Design
  - Configuration
  - Monitoring

## Albany Steam Station



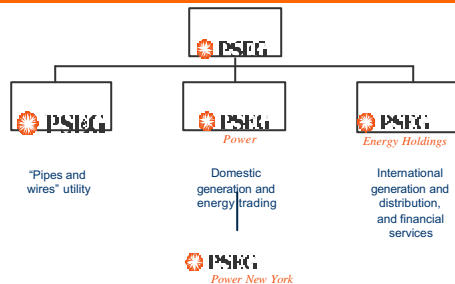
- PSEG Power New York LLC purchased from Niagara Mohawk in May 2000
- 400 Megawatts
- Natural gas and residual oil fired
- Constructed between 1952 and 1954

## Bethlehem Energy Center



- Efficient state-of-the-art technology**
- 750 Megawatts
  - 3 GE 7FA combustion turbines
  - New, efficient steam turbine
  - Natural gas as primary fuel
- Significant environmental improvements**
- SO<sub>2</sub> and NO<sub>x</sub> emission rates reduced 99% and 97%
  - Water usage reduced 98-99%
  - Redevelopment of existing industrial site
- Planned start-up in 2005**

## The PSEG Family of Companies



## PSEG Power



PSEG Power currently has more than 19,000 megawatts of generating capacity in operation, construction, or advanced development in six states

## Alternative Cooling Systems Study



- Selection of Best Technology Available is a site-specific process in New York
- An analysis of cooling system alternatives was prepared by PSEG Power New York Inc (PSEGN Y) to provide site-specific information for the evaluation of PSEGN Y's application for the Bethlehem Energy Center

## Cooling System Alternatives

- Alternatives evaluated:
  - Once-through cooling
  - Wet tower with 2-mm wedgewire screens
  - Wet/dry (plume abatement) tower with 2-mm wedgewire screens
  - Dry tower (air cooled condenser)
- Proposed alternative:
  - 2-mm wedgewire screens
  - Wet cooling tower
- Final design:
  - 2-mm wedgewire screens
  - Wet/dry (plume abatement) cooling tower
  - Seasonally-deployed aquatic filter barrier system

## The Evaluation

- Parameters Analyzed
  - Plant performance
  - Air emissions
  - Noise
  - Aesthetics
  - Aquatic impacts
  - Incremental costs and benefits

## Plant Performance

- The once-through cooling system alternative provides the best overall thermodynamic efficiency
- At 78°F, the efficiency of the dry tower alternative is projected to be 1.16% lower than that of the wet tower design
- At 94°F about 2.40% more fuel is needed to generate the same amount of electricity

## Air Emissions

- Modeled stack emissions associated with each of the main cooling system options:
  - Sulfur dioxide (SO<sub>2</sub>)
  - Nitrogen oxides (NO<sub>x</sub>)
  - Carbon monoxide (CO)
  - Particulate matter 10 microns or less in size (PM<sub>10</sub>)
  - Volatile organic compounds (VOC)
  - Ammonia (NH<sub>3</sub>)
  - Carbon dioxide (CO<sub>2</sub>)
- Wet and wet/dry tower alternatives were comparable
- Dry tower alternative produced about 1% more emissions annually

## Air Emissions

- Wet and wet/dry cooling tower emissions were modeled to estimate the annual ambient air quality concentrations
- Emissions of total solids (particulates) and other compounds from the wet and wet/dry cooling tower were estimated to be very small compared to health-based benchmark concentrations

## Noise

- Computer sound modeling was used to estimate ambient sound impacts at six sensitive receptor locations
- Sound goals could be achieved at each of the six sensitive receptor locations for the once-through, wet, and wet/dry cooling options
- Sound produced by the dry cooling option would marginally exceed the project goals

## Aesthetics

- Each cooling system alternative was evaluated with regard to the aesthetic impact on the visual setting
- An artist's rendering was produced for each alternative

## Existing Station



• Alternatives were compared to the aesthetic profile of the existing station and existing viewshed

## Once-Through Cooling Alternative



• No visual impacts associated with cooling tower structure or vapor plumes

## Wet Cooling Tower Alternative



• Visual impact of structures is similar to that of existing station  
• Visible plume consistent with character of existing viewshed

## Wet/Dry Tower Alternative



• Visual impact of structures is similar to that of existing station and wet tower alternative  
• Visible plume less frequent than from wet tower  
• Consistent with character of existing viewshed

## Dry Tower Alternative



- Nearfield visual impacts are greater because of the size and industrial character of the structure (taller than HRSG building)
- No vapor plumes
- Generally consistent with character of existing viewshed

## Dry Tower Alternative



- Dominant structure when viewed from road

## Aquatic Impacts

- Bethlehem Energy Center will use substantially less water than the existing station (98-99% less water withdrawn from the Hudson River)
- The approach velocity at the intake for the wet tower and wet/dry tower alternatives would be 90-95% less than at the existing station

## Primary Aquatic Populations

- Impingement
  - Total of 58 fish species identified from the Albany Station traveling screens
  - Blueback herring and white perch represent 45 and 19% of the estimated annual impingement
  - Other dominant species impinged were alewife, American shad, and spottail shiner
- Entrainment
  - Total of 24 fish taxa identified from ichthyoplankton sampling surveys near the Albany Station
  - River herring (43%), unidentified herring (17%), tessellated darters (13%), white perch (11%), and American shad (7%) dominated the 2001 entrainment monitoring program collections
  - 1983 entrainment collections dominated by river herring and white perch

## Impingement and Entrainment Reductions

- Wedgewire screens will virtually eliminate impingement
- Entrainment will be reduced by over 98% compared to existing station
- With the addition of an aquatic filter barrier system, entrainment will be reduced by over 99% compared to the existing station

## Cost/Benefit Analysis

- Included to provide a useful framework for organizing and evaluating the quantifiable, site-specific attributes of the alternatives
- The quantifiable incremental costs and benefits for each cooling system alternative were estimated and compared to the proposed alternative (wet tower with wedgewire screens)



## Public Participation

- Public participation is a critical component of power plant siting decisions in New York State
- An applicant must carry out a meaningful public involvement program
  - Public outreach through direct mailings, media coverage, newsletters, websites, etc
  - An applicant is expected to hold public meetings, offer presentations to individual groups and organizations, and establish a community presence
- PSEGRY actively engaged agencies, municipalities, commissions, non-profits and individual interested parties in the evaluation and approval process

## Final Design



Based on examination of site-specific information, and taking into account the interests of the agencies and other interested parties, NYSDEC and the New York State Board on Electric Generation Siting and the Environment required the following components in the final design for BEC:

- 2-mm wedgewire screens
- Wet/dry, plume abatement cooling tower
- Seasonally-deployed aquatic filter barrier system

## Wedgewire Screens



Johnson Screens™

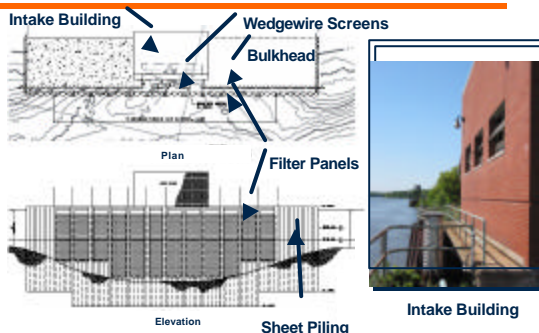
- 2-mm slots
- Cantilevered off face of existing intake structure
- Virtually eliminates impingement
- Passive cleaning and pressurized air backwash

## Wet/dry Cooling Tower



- Artist's rendering of estimated average visible plume
- Conservative design will reduce the occurrence of visible plumes by about 75% compared to a wet tower

## Aquatic Filter Barrier System



## Aquatic Filter Barrier System

- Required from April 1 through July 31
- 0.4mm pore size
- <5 gpm/ft<sup>2</sup>
- Currently working with Gunderboom Inc. to install Marine Life Exclusion System™ for 2005 start-up

## Proposed Monitoring Program

---

- Coincide with Aquatic Filter Barrier deployment
- Entrainment monitoring in front of and behind the Aquatic Filter Barrier
- Sampling over 24-hr periods at weekly intervals from April through July
- April through July encompasses peak period for the presence of ichthyoplankton in this reach of the Hudson River

## Monitoring Reports

---

- Annual entrainment monitoring reports
- Information will be collected on species composition, relative abundance, and temporal distribution of fish eggs, larvae, and juveniles

## Monitoring Reports

---

- The ratio of the weekly ichthyoplankton density in front of the Aquatic Filter Barrier to the density behind will provide an index of the effectiveness of the system for minimizing entrainment
- Physical indicator measurements (water level differentials, visual screen inspection) will be correlated with the biological effectiveness measurements

## **Appendix D: Poster Abstracts**

## Appendix D: Poster Abstracts

### **Improved Marine Life Recovery Technology for Circulating Water Traveling Band Screen Application**

Mark Bell, P.E. and Trent Gathright

*Primary Contact Information:*

Brackett Green USA

4235 South Victoria Circle

New Berlin, WI 53151

ph: (262) 853-4459

e-mail: markbell@bgusa.com

Introduction of EPA regulation 316b of the Clean Water Act is the latest effort by the Federal Government to minimize the impact of high mortality rates in aquatic life. The utilization of cooling water intake structures as the accepted practice of drawing water from lakes, rivers and oceans for both industrial and municipal applications has necessitated the creation of new, more efficient designs of fish handling and return systems for traveling band screens. This paper summarizes the various forms of fish protection systems as applied to Intake Traveling Band Screens at new and existing circulating water cooling intake structures. These proven technologies can be, and have been, applied at a vast cross section of electric utilities, industries and municipalities throughout North America. Areas of discussion will include: Entrance and exit velocity issues; marine life capture and return theory; separation of marine life from debris; hydraulic stabilization concerns; mesh opening size and configuration. Improvements in impingement survival rates as summarized in case studies from a power plant with fish protection traveling screens will be presented. Also included will be cost impact issues as they relate to the retrofitting of fish protection systems at new and existing intake structures.

### **Biological Evaluation of Aquatic Filter Barrier Material in the Laboratory**

Jonathan Black and Timothy Hogan

*Primary Contact Information:*

Alden Research Laboratory, Inc.

30 Shrewsbury Street

Holden, MA 01520-1843

ph: (508) 829-6000

e-mail: jblack@aldenlab.com

Aquatic Filter Barrier (AFB) is a permeable fabric material that can be considered for use as a method for reducing the entrainment of ichthyoplankton into cooling water intake structures (CWIS). We evaluated the retention and survival of the early lifestages of common carp (*Cyprinus carpio*), rainbow smelt (*Osmerus mordax*), white sucker (*Catostomus commersoni*), striped bass (*Morone saxatilis*), and bluegill (*Lepomis macrochirus*) exposed to AFB fabric in the laboratory. Twelve flow-through testing apparatus were used in a closed loop system to evaluate two flow rates ( $0.04 \text{ L}\cdot\text{min}^{-1}\cdot\text{cm}^{-2}$  [10 gpm/ft<sup>2</sup>]) and  $0.08 \text{ L}\cdot\text{min}^{-1}\cdot\text{cm}^{-2}$  [20 gpm/ft<sup>2</sup>]) and three sizes of fabric perforation (0.5, 1.0 and 1.5 mm) with each species. ANOVA results indicate that, with one exception (pair wise comparison of bluegill survival between 1.0 mm and 1.5 mm perforations;  $p = 0.0481$ ), survival of organisms was not significantly correlated ( $p \leq 0.05$ ) to either flow rate or perforation size. Retention of organisms appeared to decrease significantly with increasing flow rate for one species of fish (pair wise comparison of rainbow smelt between  $0.04$  and  $0.08 \text{ L}\cdot\text{min}^{-1}\cdot\text{cm}^{-2}$ ;  $p = 0.0084$ ). In addition, increasing perforation sizes appeared to significantly decrease retention of three species of fish tested (common carp, rainbow smelt, and striped bass; with each increase in perforation size;  $p \leq 0.05$ ), which potentially limits the effectiveness of larger perforation sizes in protecting the earliest lifestages of these species. Additional studies are planned for Spring of 2003 and the preliminary results from these may also be available for inclusion.

## **The Retrograde Monte Carlo Method – A Novel Computer Model of Aquatic Entrainment**

Johan Carlsson

*Primary Contact Information:*

Tech-X Corporation

5541 Central Avenue, Suite 135

Boulder, CO 80301

ph: (303) 443-8824

e-mail: johan@txcorp.com

Currently existing computer models of aquatic entrainment are far from optimal. We will introduce a new approach, the retrograde Monte Carlo method, that could be used for efficient, high-fidelity simulations of aquatic entrainment even for complicated geometries. Proposed intake structures and screening systems could thus be evaluated by computer simulations before being tested in situ. Computer modeling of aquatic entrainment requires the solution of two separate problems: calculating the background water flow and simulating the motion of the aquatic organisms, respectively. The retrograde Monte Carlo method is a better way to solve the latter problem. The traditional way of modeling the motion of the aquatic organisms would be to smooth them out into a density function governed by an advection-diffusion equation. Discretization in time and space converts the differential equation into a system of algebraic equations that can be solved using some standard technique such as Gaussian elimination. This approach has two disadvantages: it only allows for very simplistic motion of the aquatic organisms and it always produces a wasteful, global solution, i.e. the density function must be calculated everywhere even if only the entrainment rate at a single intake is of interest. A more direct way of modeling the motion of the aquatic organisms is provided by the conventional Monte Carlo (or Random Walk) method. In the Monte Carlo method a set of markers, each representing some known number of real aquatic organisms, is launched according to some initial condition. The markers are then advanced in time by periodically adding Monte Carlo kicks. The Monte Carlo random walk of the markers is a time-discretized approximation of the real motion. The sought solution, the entrainment rate at the intake, is then simply given by the rate at which the markers enter the intake. The fatal flaw of the conventional Monte Carlo is the fact that only very few of the markers find their way to the intake and contribute to the solution. The retrograde Monte Carlo method avoids this problem by launching the markers at the intake and pushing them backward in time. Markers that pass through a region where the initial condition was non-zero contribute to the solution. Because a much larger fraction of the markers contribute, the statistical noisiness of the solution is dramatically reduced. We will present simulation results (from a simple, model entrainment problem) that demonstrate the superiority of the retrograde method.

## **Innovative Design and New Technologies for Offshore & Onshore Cooling Water Intake Systems Aimed at the Preservation of Aquatic Life**

Moftah Elarbash

*Primary Contact Information:*

Elmosa

2180 Steeles Avenue, W, Suite 208

Concord, Ontario L4K 2Z5

Canada

ph: (905) 760-9039

e-mail: elmosa@imasar.com

The Elmosa offshore-onshore intake systems are different in design and performance from the open-channel seawater intake systems. The Elmosa offshore onshore intake system consists of two main parts:

- The offshore portion includes
  - the InvisiHead - an omni directional 360 degree passive intake head system,
  - and the submarine pipeline-the flow delivery duct system
- The onshore portion includes the NatSep separation basin at which debris are separated and removed.

The patented InvisiHead uses a natural approach in dealing with problems usually associated with water intake systems. Potential flow and gravity are the main forces driving water into the systems. The major sources of intake

troubles are Zebra Mussels, fish and fish larvae, seaweed, sand, trash, and oil spills. In the open channel intake systems these contaminants find their way into the intake channels where massive screening measures have to take place to filter these contaminants out. We utilize the powers of Mother Nature to drastically reduce any adverse impact caused by these sources of problems totally eliminating any possibility of oil flowing through into the intake system and jeopardizing the operation of the seawater users. The patented InvisiHead becomes hydraulically invisible to them, thus maximum protection is achieved and preservation of marine life is accomplished. The patented NatSep basin activates gravity to drive the flow in and separate sediments and debris from the water. The NatSep can be used also in the process of oil/water separation. This paper presents a new concept for an offshore and onshore seawater intake system with a uniquely engineered intake head to drastically reduce the inflow of seaweed, fish and larvae, and to keep zebra mussels from blocking the flow pathways and oil slicks from entraining into the raw water systems at exceptionally low initial costs especially that the system is self operating and self cleaning.

### **Using Large, Passive Suction Strainers to Reduce Water Approach Velocities of Intake Systems**

Gordon Hart

*Primary Contact Information:*

Performance Contracting, Inc.

4025 Bonner Industrial Drive

Shawnee, KS 66226

ph: (913) 441-0100

e-mail: Gordon.hart@pcg.com

With the recent release of standards for Rule 316(b) of the Clean Water Act by the US Environmental Protection Agency, designers of new industrial facilities will need practical and economical approaches to meet that regulation. One of the EPA's recommended approaches is to reduce the water velocity through the intake screens. Current intake structures typically have a water screen approach velocity of 2 to 2 ½ feet per second (fps) on average meaning some areas of the intake structure have local approach velocities that are greater than 2 ½ fps. One EPA recommended approach to addressing Rule 316(b) is to reduce the through-screen velocity to less than 0.5 fps (equivalent to an approach velocity less than about 0.2 fps). To meet both the spirit and intent of this approach, intake screens should not only achieve an average through-screen velocity equal to or less than 0.5 fps, but it should not exceed a local velocity of 0.5 fps at any point within the intake screens. This paper proposes to comply with Rule 316(b) by installing large, passive suction strainers, onto the intake pipes, that are sized to limit the through-screen velocity to 0.5 fps at all points of the screen. These strainers would be a modification of a strainer concept originally designed and installed at a number of Boiling Water Reactor nuclear power plants in the late 1990's. Their role was to enable the Emergency Core Cooling System (ECCS) suction pumps to continue long term operation, following a nuclear accident, while filtering out large quantities of debris and yet limiting pressure loss across the debris to a low value. To verify the strainer concepts' performance, a series of tests were performed at a hydraulic laboratory. For cooling water intakes, these strainers would be much larger and constructed in box shaped modules. The exterior surfaces would consist of mesh screening. The interior would have a suction flow control device consisting of a large core tube pipe with holes. The core tube holes would be designed and sized to provide uniform flow over the length of the core tube. This, in turn, would provide uniform water velocities over the surface of the strainer. With this modular design, additional strainers could be added in series, connecting to one another with flanges. The main constraint for the design engineer would be to size all the holes based on their relative position to the intake pipe and to properly select pumps of adequate flow and suction head. The paper addresses some typical strainer system designs for water intakes and estimated costs of fabrication. With this information, the paper shows that this proposed approach to addressing EPA Rule 316(b) can be both practical and cost effective.

## **Environmental and Engineering Considerations for the Use of Aquatic Filter Barrier Technology to Prevent Entrainment of Planktonic Organisms into Electric Generating Station Cooling Water Systems**

Andrew McCusker and H.B Dreyer

*Primary Contact Information:*

Vice President, Technical Services

Gunderboom, Inc

2 White Sands Lane

Scarborough, ME 04074

ph: (207) 883-1777

e-mail: amccusker@mackworth.com

Recent regulatory decisions have been made in New York that resulted in the approval by the State Board on Electric Generation that new generating facilities incorporate an aquatic filter barrier. The Gunderboom Marine Life Exclusion System™ (MLEST™) is a filter barrier that prevents fish eggs and larvae from being entrained in the cooling water to the plants. Filter barrier technology has also been specifically identified both in the recently-issued USEPA final regulations for cooling water system technology for new facilities and in the Proposed Rule for Existing Facilities as a viable means of achieving required minimization or reduction of impacts of a cooling water intake structure (CWIS). Not all facilities are candidates for effective use of the technology. The best technology available (BTA) to mitigate environmental impacts of CWIS's is influenced by a number site-specific variables, including water withdrawal volume, intake configuration, facility operation, source water characteristics, and economic considerations. These work alone or in concert. The factors that are important to the feasibility and design of an aquatic filter barrier are the following: target species or organisms for exclusion and their seasonality, water depths and bathymetry, water level fluctuation, currents and wave conditions, presence and degree of debris, ice, suspended solids, and location relative to shipping or other maritime uses of the nearby waters. To address these many environmental, regulatory and operational variables, engineers designing Gunderboom filter barrier systems have a number of design factors that can be varied. First, there is a choice of filter fabrics and the density of the fabric and the size of the perforations. Secondly, there is a range of physical designs for deploying the filter fabric material, including, an anchored floating filter barrier, a filter barrier secured to fixed pilings or sheet pile cells, a solid subtidal structure, bulkhead-mounted fixed frame panels, and cartridges. Configuration may be varied to include an accordion-like structure to increase filter area. An intake pipe or series of intakes may be buried under river or ocean floor and surface within an aquatic filter barrier-enclosed structure. This paper will present and explain the various factors affecting design and will review the various design approaches to address these considerations. It will conclude with an assessment of the range of applications and the probable approach and potential applicability of filter barrier technology to those applications.

### **Belle River Power Plant Angled Intake Structure**

Robert Reider

*Primary Contact Information:*

The Detroit Edison Company

2000 Second Avenue, G55GO

Detroit, MI 48226

ph: (313) 235-7022

e-mail: reiderr@dteenergy.com

The Belle River Power Plant is a 1260 MW, two-unit, once-through cooled facility located on the St. Clair River approximately 46 mi. north of Detroit, MI. The design of the intake structure incorporates several important features for reducing the entrapment potential for fish. The intake structure, both trash racks and traveling screens, are angled 20 degrees into the river flow to guide fish away from the plant's intake. The trash racks and traveling screens are also mounted flush with the support structures to eliminate embayments that are attractive to fish. Other features include a lateral escape way for fish in front of the traveling screens and low intake approach velocities. The plant minimizes the use of cooling water on a year round basis in order to optimize turbine cycle performance. Based on a one year impingement study, the total number of fish impinged was considerably less than what one would expect for this size

facility located on this water body. Also, most of the impinged fish were less than 3.9 in (100 mm) in length, indicating a possible reduced susceptibility of larger fish to impingement on the traveling screens.

### **Determination of Hydraulic Zone of Influence using 3-D Modeling Techniques**

John Richardson

*Primary Contact Information:*

Alden Research Laboratory, Inc.

30 Shrewsbury Street

Holden, MA 01520-1843

ph: (508) 829-6000

e-mail: jrichardson@aldenlab.com

The natural hydrology of the water body, and its relationship to plant hydraulics, is a key factor in evaluating the potential of a CWIS to impinge and entrain aquatic organisms. For an organism to become entrained, it must occur in the hydraulic zone of influence (HZI) of an intake. The probability that an organism will enter this area is controlled by complex hydrologic processes that extend into the far field and are influenced by a variety of other factors. Thus, while the proximity of a primary spawning and/or nursery area to a CWIS can be an important influence on the fraction of population potentially entrained for any individual species, other factors interact with proximity to determine actual susceptibility to entrainment. Extensive field data collection efforts can be used to identify the HZI, however, collecting data for a range of flow conditions is both time consuming and costly. The use of computational fluid dynamics (CFD) offers a state-of-the-art means for identifying the HZI using numerical models in a cost-effective manner. The primary advantages of using CFD is that variable flow conditions can be evaluated to determine the HZI under different plant and water body flow rates, as well as tidal and weather conditions. The capabilities of four modeling systems in defining the HZI at six CWIS on various water body types (i.e., reservoir, river, tidal river, estuary, Great Lake, and coastal CWIS) were evaluated: MIKE21, MIKE3, Fluent, and FLOW3D. Appropriate models for each water body type can probabilistically determine the fate of particles released from any given location within the flow field. Maps were created to probabilistically define the HZI, *i.e.* what is the probability that a non-motile, organism released from a given point in the flow field will be entrained by the cooling water intake. Graphic results of model studies will be presented showing the computed HZI for each power plant. The type of water body and flow conditions for which each model was best suited will be discussed. In addition, specific model limitations and suggestions will be discussed. Understanding and characterizing the HZI will be key to establishing power plant baseline impingement and entrainment impacts.

### **A Comparison of Young-of-the-Year Fish Impingement on 3/8" x 3/8" Mesh Traveling Screens with 3/16" x 1" Mesh Traveling Screens**

Paul Sawyko

*Primary Contact Information:*

Rochester Gas & Electric Corporation

89 East Avenue

Rochester, NY 14649-0001

ph: (585) 771-2707

e-mail: paul\_sawyko@rge.com

The original traveling screens were of the traditional design, consisting of woven wire mesh with 3/8 in. square openings. The screen replacement a project was initiated to replace the original screening material with a new stainless steel screening material which has a mesh of 3/16 in. x 1 in. and a crimped fit construction resulting in an overall smoother surface texture. One of the four traveling screens was completely replaced with the new screening material during 2000, and each subsequent year another screen has been replaced with the new material, resulting in three of the four screens being deployed with new screens by the fall of 2002.

During this period of screen replacement, impingement studies were conducted which differentiated between collections from each screen type (i.e., new or old). These studies were designed to provide information which can be used to (1) overall relate impingement findings from the old screens to the new screens, and (2) investigate the



relative impingement of smaller (typically young-of-the-year) fish by each screen mesh, thus determining the number of such individuals subject to the impacts of further entrainment. This analysis focuses upon the second of these two assessments, and is based upon information obtained from seven species collected during the study periods: alewife (*Alosa pseudoharengus*), rainbow smelt (*Osmerus mordax*), emerald shiner (*Notropis atherinoides*), spottail shiner (*Notropis hudsonius*), threespine stickleback (*Gasterosteus aculeatus*), yellow perch (*Perca flavescens*), slimy sculpin (*Cottus cognatus*). For five of these species (alewife, emerald shiner, spottail shiner, yellow perch, and slimy sculpin) a shift in length frequency distribution towards smaller sizes was apparent for the new screening. For one species, rainbow smelt, a length frequency distribution shift towards larger size was found for the new screening. Finally, screen type did not appear to effect length frequency distribution of threespine stickleback.

### **Effectiveness of 316(b) BTA at the Water Intake for a Midwestern Paper Mill**

Greg Seegert

*Primary Contact Information:*

EA Engineering, Science & Technology

444 Lake Cook Road, Suite 18

Deerfield, IL 60015

ph: (847) 945-8010

e-mail: gls@eaest.com

From March 1985 through April 1987, EA conducted fish studies to support a 316(b) demonstration for a paper mill located on the Menominee River in Michigan. The intake has a design capacity of 42 cfs, but normal operation requires only 26 cfs. Through-screen velocity is  $\leq 0.5$  ft/sec. The traveling screens are fine mesh, with a slot openings of 0.1 inch. Low impact backwashing returns impinged fish to the river. The mill's NPDES permit required that studies be conducted for at least one full year, and that annual loss estimates be developed for larval, juvenile, and adult fish. The permit required that the 90% confidence interval around these losses could not exceed  $\pm 10\%$  of the estimates. Prior to starting the study, we constructed hypothetical data sets, then used power analysis to determine how many samples would need to be collected to achieve the necessary precision.

The study had five major elements: adult fish monitoring, larval fish monitoring, entrainment collections, impingement collections, and population studies. Studies were done pre-operationally in 1985 and post-operationally in 1986-87. The pre- and post-operational adult fish studies resulted in the collection of more than 18,000 fish representing 33 species.

The in-river larval fish studies consisted of collecting about 600 samples each year during the spring and summer. Rock bass and smallmouth bass, which were abundant in the adult fish collections, were rare in the larval collections, indicating that adult fish data alone may be insufficient to predict entrainment risks. Impingement rates were low. Collections on 82 dates yielded only 337 fish. In terms of composition, the impingement catch was distinct from all other phases of the study. For example, white sucker, one of the most abundant species in the river, was represented by only nine individuals. Survival studies indicated that the intake's fish return system was operating effectively as about 90 percent of all fish impinged were returned to the river alive. Entrainment samples were collected on 62 dates from late April through early August 1986. Each of the samples was collected throughout a 24-hour period. The 62 collections yielded a total of nearly 14,000 larvae. From May through October 1986, adult white sucker, smallmouth bass, rock bass, walleye, and northern pike were marked and their populations estimated based on the number of marked fish recaptured.

Based on the numbers of fish entrained or impinged compared to the size of the at risk populations, we concluded that impacts to source waterbody fish communities would be minimal (i.e., there would not be an adverse environmental impact). Michigan DNR concurred with this assessment and no additional mitigative measures or design modifications were ever required for the mill.

## **Seabrook Station Offshore Cooling Water Intake System**

Ron Sher

*Primary Contact Information:*

FPL Energy Seabrook Station

P.O. Box 300

Seabrook, NH 03862

ph: (603) 773-7729

e-mail: ron\_sher@fpl.com

The Seabrook Station Nuclear Plant employs a submerged offshore cooling water intake structure (CWIS) design. This design was the original CWIS in operation when the power plant began generating electricity in 1990. This CWIS has resulted in lower impingement and entrainment impacts than those associated with shoreline intake structures.

Seabrook Station is a single-unit 1,160 megawatt nuclear plant in Seabrook, New Hampshire. The plant is located about two miles inland from the Atlantic Ocean. The plant's Cooling Water System employs a once-through submerged offshore ocean intake structure and discharge diffuser design. Between the power plant and the ocean is a saltwater estuary, harbor and barrier beach. The Cooling Water System was designed to avoid impact to this adjacent estuarine environment by installing deep underground cooling water tunnels to draw cooling water from and return it to the waters of the Atlantic Ocean. Nineteen-foot diameter intake and discharge tunnels extend about 7,000 and 5,500 feet offshore, respectively, to the intake and discharge location. Each tunnel is located in bedrock, about two hundred feet below sea level.

The Cooling Water System provides an average flow of about 580 million gallons per day of ocean cooling water. The ocean cooling water is drawn into three offshore intake structures that are located about 7,000 feet offshore and in water about 60 feet deep.

The three CWIS velocity intake caps are 30 feet in diameter with seven-foot tall horizontal openings and draw ocean water in at a relatively low speed of about 0.5 feet per second. The intakes were originally designed with vertical bars spaced 16 inches apart to prevent large debris from entering the intakes. In 1999 additional barrier panels were installed on the offshore intakes to reduce the spacing to about 5 inches to prevent the entrapment of seals. The installation of the barrier panels necessitated an increase in the frequency of the removal of biofouling organisms that grow on the intake structures. Since the barriers were installed fish impingement has been reduced. This decrease is likely the result of the removal of fouling material, which may have provided habitat to fish.

The operation of Seabrook Station has not impacted the balanced population of marine organisms near the power plant. This conclusion is based on an extensive ongoing environmental monitoring program that includes 12 years of monitoring since that plant went into operation in 1990 and dates back to the early 1970's during the initial permitting for the power plant.

Seabrook Station's NPDES Permit was renewed in April 2002. The Environmental Protection Agency stated in the renewed permit that it "has determined that the Cooling Water Intake System, as presently designed, employs the best technology available for minimizing adverse environmental impact." The EPA went on to state that "the present design shall be reviewed for conformity to regulations pursuant to Section 316(b) when such are promulgated."

## **Interpretation of Recent Measurements of the Efficiency of an Acoustic Fish Deterrent System**

Jeremy Nedwell and Andy Turnpenny

*Primary Contact Information:*

Fish Guidance Systems, Inc.

Marine & Freshwater Biology Unit

Fawley, Southampton SO45 4TW

United Kingdom

ph: 44 2380 2437

e-mail: [jeremy.nedwell@fish-guide.com](mailto:jeremy.nedwell@fish-guide.com)

Electrabel operate a Fish Guidance Systems infrasonic fish guidance system to keep fish out of the cooling water intake of the Nuclear Power Station at Doel in Belgium. The power station draws cooling water from the Schelde tidal estuary, and the system, installed in 1997, is on the off-shore intake for Reactors 3 & 4 which are each of 2,000 MW. The system has been evaluated for efficiency over several years by Leuven University, and the efficiency varies from 21 % for flat fish up to 98 % for herring, the target species.

The reason for these differences appears to lie in the differing hearing sensitivities of the different species, and hence the levels at which they will react to a sound stimulus. The results are addressed in the  $dB_{nl}(\textit{Species})$  scale, which enables fish behavior to sound stimuli to be related to objective and biologically meaningful measurements of sound level. The results when analyzed this way indicate a criterion that a level of sound about 90 dB above threshold within the species' frequency passband is required to cause efficient deflection.

The significance of this is discussed in the context of mixing fish screening and return technologies to achieve the greatest environmental benefit within a fixed budget.

## **Appendix E: Vendor Displays**

## Appendix E: Vendor Displays

### **Brackett Green USA, Inc.**

1335 Regents Park Drive, Suite 260  
Houston, TX 77058  
Phone: 281-480-7955  
Contact: Trent Gathright  
E-mail: trent@bgusa.com  
Website: www.bgusa.com

### **CH2M Hill**

115 Perimeter Center Place, NE, Suite 700  
Atlanta, GA 30346-1278  
Phone: 770-604-9182  
Contact: Tom Simpson  
E-mail: tsimpson@ch2m.com  
Website: www.ch2m.com

### **Collector Wells International**

6360 Huntley Road  
Columbus, OH 43068  
Phone: 614-888-6263  
Contact: Jim French  
E-mail: jafrench@collectorwellsint.com  
Website: www.collectorwellsint.com

### **Cook Legacy Coating Company**

2795 Greenrock Trail  
Atlanta, GA 30340  
Phone: 770-414-1861  
Contact: Ryan Cook  
E-mail: clegacy@bellsouth.com  
Website: www.waterscreen.com

### **Entrix**

10 Corporate Circle  
New Castle, DE 19720  
Phone: 302-395-1919  
Contact: Steve Friant  
E-mail: sfriant@entrix.com  
Website: www.entrix.com

### **Golder Associates**

3730 Chamblee Tucker Road  
Atlanta, GA 30347  
Phone: 770-496-1893  
Contact: Rena Peck  
E-mail: rpeck@golder.com  
Website: www.golder.com

### **Gunderboom**

2 White Sands Lane  
Scarborough, ME 04074  
Phone: 207-883-1777  
Contact: Andrew McCusker  
E-mail: amccusker@mackworth.com  
Website: www.gunderboom.com

### **Intralox, Inc.**

201 Laitram Lane  
Harahan, LA 70123  
Phone: 504-733-6739  
Contact: Britt Hodanger  
E-mail: britt.hodanger@intralox.com  
Website: www.intralox.com

### **Shaw Environmental**

3 Executive Campus  
Cherry Hill, NJ 08002  
Phone: 856-482-3677  
Contact: Kevin Bryson  
E-mail: kevin.bryson@shawgrp.com  
Website: www.shawgrp.com

### **Smith-Root, Inc.**

14014 NE Salem Creek Avenue  
Vancouver, WA 98686  
Phone: 360-573-0202  
Contact: David Barritt  
E-mail: Barritt@smith-root.com  
Website: www.smith-root.com

### **Tenera Environmental**

100 Bush Street, Suite 850  
San Francisco, CA 94104  
Phone: 415-445-3415  
Contact: Dave Mayer  
E-mail: dmayer@tenera.com  
Website: www.tenera.com

### **URS Corporation**

1400 Union Meeting Road  
Blue Bell, PA 19422  
Phone: 215-542-3800  
Contact: Jack Tramontano  
E-mail: jack\_tramontano@urscorp.com  
Website: www.urscorp.com

### **USFilter Envirex Products**

1901 S. Prairie Avenue  
Waukesha, WI 53189  
Phone: 262-547-0141  
Contact: Michael Quick  
E-mail: productinformation@usfilter.com  
Website: www.usfilter.com