

Forest Health Technology Enterprise Team

TECHNOLOGY
TRANSFER

*Biological
Control*

BIOLOGY AND BIOLOGICAL CONTROL OF KNAPWEED



LINDA M. WILSON AND CAROL BELL RANDALL

The Forest Health Technology Enterprise Team (FHTET) was created in 1995 by the Deputy Chief for State and Private Forestry, USDA, Forest Service, to develop and deliver technologies to protect and improve the health of American forests. This book was published by FHTET as part of the technology transfer series.

<http://www.fs.fed.us/foresthealth/technology/>

The U.S. Department of Agriculture (USDA) prohibits discrimination in all its programs and activities on the basis of race, color, national origin, sex, religion, age, disability, political beliefs, sexual orientation, or marital or family status. (Not all prohibited bases apply to all programs.) Persons with disabilities who require alternative means for communication of program information (Braille, large print, audiotape, etc.) should contact USDA's TARGET Center at 202-720-2600 (voice and TDD).

To file a complaint of discrimination, write USDA, Director, Office of Civil Rights, Room 326-W, Whitten Building, 1400 Independence Avenue, SW, Washington, D.C. 20250-9410 or call 202-720-5964 (voice and TDD). USDA is an equal opportunity provider and employer.

The use of trade, firm, or corporation names in this publication is for information only and does not constitute an endorsement by the U.S. Department of Agriculture.



Federal Recycling Program
Printed on recycled paper.

Biology and Biological Control of Knapweed

Linda M. Wilson¹
and
Carol Bell Randall²

¹ Department of Plant, Soil and Entomological Sciences, University of Idaho,
P.O. Box 442339, Moscow, ID 83844-2339

² Forest Health Protection, USDA Forest Service, 3815 Schreiber Way, Coeur d'Alene, ID 83815-8363

For additional copies of this publication, contact:

Carol Bell Randall
USDA Forest Service
Coeur d'Alene
Idaho
(208) 765-7343
crandall@fs.fed.us

Richard Reardon
FHTET, USDA Forest Service
Morgantown
West Virginia
(304) 285-1566
rreardon@fs.fed.us

ACKNOWLEDGMENTS

We thank Christina Kuykendall, Jim Story, Sandy Kegley, and Nancy Sturdevant for their contributions to this manual: Cindy Roché for contributing photographs and drawings; and Mark Riffe and Chuck Benedict of INTECS/Forest Health Technology Enterprise Team, USDA Forest Service, Fort Collins, Colorado, for editing, layout and graphics. We also thank J. McCaffrey, and J. Johnson for reviewing this manual. We would also like to thank Richard Reardon of the Forest Health Technology Enterprise Team, USDA Forest Service, Morgantown, West Virginia, for providing the funds needed to complete and publish this manual.

All photographs in this publication can be accessed and viewed on line. You'll find reference codes (UGA 0000000) in the captions for the figures in this publication. Point your browser at <http://www.forestryimages.org>, and enter the reference code at the search prompt.

Sources of Figures

Cover photos	University of Idaho, C. Roché and Nez Perce Biocontrol Center
Figures 1a, 4d-9d, 12, 21, 23, 26, 27, 44-47, 50, 52, 53, 58	University of Idaho
Figures 1b, 13, 14, 30	L. Wilson, University of Idaho
Figures 2, 4a-c, 5a-c, 6a-c, 7a-c, 8a-c, 9a-c, 18, 19, 34, 55	C. Roché, Medford, Oregon
Figure 3	http://pc65.frontier.osrhe.edu
Figures 5c, 29, 33, 35, 36, 43, 54, 57	Nez Perce BioControl Center, Lapwai, Idaho
Figures 4d, 5d, 6d, 8d, 9d	USDA-NRCS (http://plants.usda.gov)
Figures 10, 22	Biocontrol of Weeds in the West
Figures 11, 48, 49a, 51	K. Loeffelman, University of Idaho
Figures 15, 28, 40	J. Johnson, University of Idaho
Figures 16, 17	R. Gillespie, University of Idaho
Figures 20, 24, 25, 32, 37-39	USDA APHIS
Figures 31, 41	www.nysaes.cornell.edu:80/ent/biocontrol/weedfeeders
Figure 49b	BioQuip Catalog
Figure 56	S. Kegley, USDA Forest Service

Contents

INTRODUCTION	1
Overview	1
Biological Control of Weeds	2
About This Manual	4
CHAPTER 1: GETTING TO KNOW KNAPWEEDS	5
Plant Development	6
Key to the Knapweed Species (Adapted from Roché and Roché 1993)	7
Spotted Knapweed	8
Diffuse Knapweed	9
Squarrose Knapweed	10
Meadow Knapweed	11
Black Knapweed	12
Brown Knapweed	13
CHAPTER 2: BIOLOGY OF KNAPWEED BIOCONTROL AGENTS.....	15
Basic Insect Biology	15
Insects and Knapweed	17
Identifying Insects	19
Seedhead Feeders	21
Timeline of Attack	22
<i>Urophora affinis</i>	27
<i>Urophora quadrifasciata</i>	29
<i>Terellia virens</i>	31
<i>Chaetorellia acrolophi</i>	33
<i>Metzneria paucipunctella</i>	35
<i>Larinus minutus</i>	37
<i>Larinus obtusus</i>	39
<i>Bangasternus fausti</i>	41

Root Borers	43
<i>Agapeta zoegana</i>	44
<i>Pterolonche inspersa</i>	45
<i>Pelochrista medullana</i>	46
<i>Cyphocleonus achates</i>	47
<i>Sphenoptera jugoslavica</i>	49
CHAPTER 3: ELEMENTS OF A KNAPWEED BIOLOGICAL CONTROL PROGRAM	53
1. Selecting and Preparing Release Sites	55
Selecting the Site	55
Preparing the Site	56
2. Collecting Biocontrol Agents.....	57
General Collection Guidelines	57
Planning and Timing	59
3. Handling Biocontrol Agents	64
Transporting the Bioagents	64
Shipping the Bioagents	64
Summary: Care of the Bioagents	65
4. Releasing Biocontrol Agents	66
Timing the Release	67
Retaining Voucher Specimens	69
Frequency of Release.....	69
Releasing Multiple Bioagents	70
Suggestions for Optimal Establishment	70
5. Monitoring	71
Monitoring Bioagents	71
Monitoring Vegetation	73
Establishing a Photo Point	75
SELECTED REFERENCES	77
Insects	77
<i>Agapeta zoegana</i>	77
<i>Bangasternus fausti</i>	78
<i>Chaetorellia acrolophi</i>	78
<i>Cyphocleonus achates</i>	78
<i>Larinus minutus</i>	79
<i>Larinus obtusus</i>	79
<i>Metzneria paucipunctella</i>	79
<i>Pelochrista medullana</i>	80
<i>Pterolonche inspersa</i>	80
<i>Sphenoptera jugoslavica</i>	80
<i>Terellia virens</i>	81
<i>Urophora affinis</i> and <i>U. quadrifasciata</i>	81

Knapweed	83
General	84
GLOSSARY	87
APPENDICES	91
Appendix A: Troubleshooting Guide; When Things go Wrong	
Appendix B: Biological Control Agent Release Form	
Appendix C: Monitoring Plan Questionnaire	
Appendix D: Biological Control Monitoring Report	
Appendix E: Qualitative Monitoring Form	
Appendix F: Quadrat Density and Cover Data Form	
Appendix G: Macroplot Design for Measuring Density	

FIGURES

Figure 1. a) Spotted knapweed infestation in northern Idaho, b) knapweed rosette.	5
Figure 2. Knapweed capitulum showing placement of florets	6
Figure 3. Key tissues in the knapweed root.	6
Figure 4. Spotted knapweed.	8
Figure 5. Diffuse knapweed.	9
Figure 6. Squarrose knapweed.	10
Figure 7. Meadow knapweed.	11
Figure 8. Black knapweed.	12
Figure 9. Brown knapweed.	13
Figure 10. Diagram of insect body parts.	16
Figure 11. Insect lifecycle and complete metamorphosis.	16
Figure 12. Distribution of knapweed biocontrol agents.	18
Figure 13. Key for identifying fly, moth and beetle larvae.	19
Figure 14. Key for identifying fly, moth and beetle pupae.	20
Figure 15. Comparison of knapweed seedhead flies.	22
Figure 16. <i>Urophora affinis</i> ovipositing	22
Figure 17. Comparison of papery and woody <i>Urophora</i> galls.	22

Figure 18. Position of fly larvae inside the knapweed seedhead.	22
Figure 19. Position of beetle and moth larvae in knapweed seedhead.	22
Figure 20. <i>Urophora affinis</i> adult.	27
Figure 21. <i>Urophora affinis</i> larva in knapweed seedhead.	27
Figure 22. <i>Urophora quadrifasciata</i> adult.	29
Figure 23. <i>Urophora quadrifasciata</i> larva in knapweed seedhead.	29
Figure 24. <i>Terellia virens</i> adult.	31
Figure 25. <i>Chaetorellia acrolophi</i> adult.	33
Figure 26. <i>Metzneria paucipunctella</i> adult.	35
Figure 27. <i>Metzneria paucipunctella</i> larva in a knapweed seedhead.	35
Figure 28. <i>Larinus minutus</i> adult.	37
Figure 29. Defoliation of knapweed by <i>Larinus minutus</i> adult.	38
Figure 30. <i>Larinus minutus</i> emergence hole.	38
Figure 31. <i>Larinus obtusus</i> adult.	39
Figure 32. <i>Bangasternus fausti</i> adult.	41
Figure 33. <i>Bangasternus fausti</i> being released on spotted knapweed.	42
Figure 34. Distribution of knapweed root borers.	43
Figure 35. <i>Agapeta zoegana</i> adult.	44
Figure 36. <i>Agapeta zoegana</i> egg at the base of knapweed rosette leaf.	44
Figure 37. <i>Agapeta zoegana</i> larva in knapweed root.	44
Figure 38. <i>Pterolonche inspersa</i> adult.	45
Figure 39. <i>Pelochrista medullana</i> adult.	46
Figure 40. <i>Cyphocleonus achates</i> adult.	47
Figure 41. <i>Cyphocleonus achates</i> pupa in knapweed.	47
Figure 42. <i>Sphenoptera jugoslavica</i> adult.	49
Figure 43. <i>Sphenoptera jugoslavica</i> egg.	49
Figure 44. <i>Sphenoptera jugoslavica</i> larva in a knapweed root.	50
Figure 45. Spotted knapweed.	53
Figure 46. Spotted knapweed infestation suitable for biocontrol.	55
Figure 47. Sweep net.	59
Figure 48. Sweeping for insects.	61
Figure 49. Aspirators for collecting biocontrol agents.	61
Figure 50. Carton containing adult <i>Metzneria paucipunctella</i>	62
Figure 51. Insect rearing cage, or sleeve box.	63
Figure 52. Shipping box for biocontrol agent cartons.	65
Figure 53. Releasing knapweed bioagents on spotted knapweed.	67
Figure 54. Screen tent cage for knapweed bioagents.	69
Figure 55. Milk jug release cage for knapweed bioagents.	69
Figure 56. Pheromone trap for male <i>Agapeta zoegana</i> moths.	72
Figure 57. Emergence holes in spotted knapweed seedheads.	73
Figure 58. Measuring knapweed height at monitoring site.	74

TABLES

Table 1.	Knapweed bioagents in United States and knapweeds they attack.	17
Table 2.	List of seedhead feeding knapweed biocontrol agents.	23
Table 3.	Knapweed seedhead size and stage of development preferred by each of the eight seedhead feeding biocontrol agents.	23
Table 4.	Summary description of knapweed seedhead feeders.	24
Table 5.	Comparison of seedhead fly lifecycles by knapweed growth stage.	25
Table 6.	Comparison of knapweed seedhead moth and weevil lifecycles by knapweed growth stage.	26
Table 7.	Summary description of knapweed root borers.	51
Table 8.	Comparison of knapweed root borer lifecycles by knapweed growth stage.	52
Table 9.	Level of difficulty in collecting knapweed seedhead feeders.	58
Table 10.	Level of difficulty in collecting knapweed root borers.	58
Table 11.	Recommended timetable for collecting knapweed seedhead feeders for redistribution.	60
Table 12.	Recommended timetable for collecting knapweed root borers for redistribution.	60
Table 13.	Appropriate release method for each bioagent.	66
Table 14.	Recommended timetable for monitoring knapweed seedhead feeders.	67
Table 15.	Recommended timetable for monitoring knapweed root borers.	68

INTRODUCTION

Overview

The knapweeds comprise a diverse complex of species that predominantly infest rangelands in the western United States and Canada. This manual considers the biological control of six species of knapweeds: 1) spotted knapweed, 2) diffuse knapweed, 3) squarrose knapweed, 4) meadow knapweed, 5) black knapweed, and 6) brown knapweed. Spotted knapweed, *Centaurea stoebe*, is perhaps the most widespread species, followed in abundance by diffuse knapweed, *C. diffusa*. A third species, squarrose knapweed, *C. virgata* var. *squarrosa*, has a more limited distribution in the West. Three less widespread species, meadow (*C. pratensis*), brown (*C. jacea*) and black knapweed (*C. nigra*), are host to some of the same biocontrol agents and thus are included. Another well known species is Russian knapweed, *Acroptilon repens* (formerly known as *C. repens*). While a serious rangeland weed itself, Russian knapweed is not considered in this manual because it is sufficiently different from the other knapweeds to be considered separately and it has a unique complex of biocontrol agents.

In the United States, approximately 5 million acres are infested with knapweeds. A highly competitive and invasive group of weeds, knapweeds have adapted to a wide range of habitats and environmental conditions. Although some of the most common rangeland pests in the West, knapweeds also invade pastures and fields in the Midwest and Eastern states. Spotted knapweed, for example, is widespread throughout the United States and found in all but four states (see Chapter 1 for maps of knapweed distribution in the United States).

A large amount of information is available giving the land manager good tools to manage knapweed by a variety of strategic methods. Chemical, cultural and mechanical methods used to control weeds all apply when managing knapweed. However, most people recognize that knapweed management on a large scale over the landscape requires a well-planned, integrated program that maximizes the effective use of all weed management strategies in combination.

Among the myriad of weed control approaches to manage knapweed is biological control, a well-known and long-established tool in the United States and Canada. Biocontrol of knapweed is one of the earliest, and diverse biocontrol of weeds programs in North America. There is a lot of readily available information describing knapweed biocontrol in general terms. Lacking, however, is a publication that describes knapweeds and their many biocontrol agents, combined with a how-to, on-the-job reference that outlines, step-by-step, the process of establishing a biocontrol program, including selecting a suitable site, collecting and releasing the biocontrol agents, and follow-up monitoring of the agents and the knapweed.

This manual provides a practical reference for field workers and resource managers when implementing a biological control program for knapweed. It includes information on selecting a release site, collecting and releasing new agents, evaluating past releases, redistributing established biocontrol agents, and monitoring agents and vegetation after the release. The guidelines and timetables outlined in this manual are based on research and practical field experience, and can be used to maximize the success of your knapweed biological control program.

Biological Control of Weeds

Biological control is the deliberate use of naturally occurring organisms to limit the distribution and abundance of a target weed. These are *natural enemies* of the weed in its native range (i.e.: Europe) and include such organisms as insects, mites, nematodes, and fungi. Natural enemies are also referred to as biocontrol agents, bioagents, biological control organisms and weed herbivores. Plant-eating insects and other organisms may control weeds by killing the weed directly, by weakening or stressing the weed, and by destroying seeds, root, or stems - thereby weakening the weed and limiting its reproduction. Secondary infection from pathogens that invade feeding lesions is indirect damage.

There are a number of advantages to biological control of weeds. Biocontrol with carefully selected agents is not damaging to the environment: it provides long-term impacts on the target plant; it has limited side effects; it is directed to a specific weed or closely related group of weeds; it has nonrecurring costs, and biocontrol agents are self-perpetuating.

Historically, biological control works best on large infestations of a single weed species. It has been most successful on weeds that have been introduced into areas where their specialized natural enemies do not occur. In the United States, knapweed, leafy spurge, rush skeletonweed, tansy ragwort, purple loosestrife, thistles and St. Johnswort are a few examples of weeds with established biocontrol programs.

Knapweeds were introduced from Europe without the complex of organisms that regulate their population densities. In a system known as *Classical Biological Control*, these natural enemies are identified in knapweed's native land, rigorously tested to determine what plants they eat (their *host range*), and finally imported and released into the environment.

It's very important that the candidate insect and weed are in synchrony. When initiating a biological control program, natural enemies are collected from areas where the weed is native. Specific areas are chosen that are climatically similar to the area where the weed is to be controlled. Ecological and genetic studies are needed to ensure that the lifecycle of the potential biocontrol agent is the same as the lifecycle of the target weed. Potential biocontrol agents undergo 5 to 10 years of rigorous testing to ensure that they eat only the target weeds and will in fact die without the weed. This is known as *host-specificity* and is the ecological cornerstone of biocontrol of weeds.

These preliminary studies are important in order to:

- Have the best fit between bioagents and knapweed
- Preclude introduction of unapproved organisms
- Protect nontarget species, such as crop plants or rare and endangered plants
- Influence future assessments of risk
- Affect future evaluation processes

The USDA Animal and Plant Health Inspection Service (APHIS) is the governing agency responsible for authorizing the importation of an insect and other organisms into the US for biological control of weeds. Rigorous laws and regulations are in place to minimize risks associated with introducing foreign organisms. Biocontrol researchers work closely with APHIS to maximize safety in biocontrol programs.

While biocontrol is an effective and important weed management tool, it is not a panacea; it does not 'fix' the problem of knapweed. In the most effective programs, biological control is used along with other methods of weed control. In fact, many land managers, ranchers, and farmers use integrated weed management systems, which combine more than one method to manage weeds while keeping the desired plant community intact. The article listed in the Selected References section entitled, "*Biological Control of Weeds*," (McFadyen, 1998) provides a review, examples, and a discussion about the advantages and disadvantages of different approaches used to control weeds using biological methods.

About This Manual

This manual provides background information on each of the six knapweed species listed above, detailed descriptions of 13 knapweed biocontrol insects, and elements of a knapweed biocontrol program. The chapters are:

Chapter 1 provides detailed discussions of each of the knapweed species included in this manual. The species are identified by their scientific name, description of the leaves, stems, flowers, seeds, and habitat and occurrence in the United States. Photographs, drawings, and distribution maps are also provided.

Chapter 2 features knapweed biocontrol agents (flies, moths, and beetles) and their basic biology, including information on identification and lifecycle of each of the knapweed biocontrol agents. Information in this chapter is particularly useful in being able to identify each biocontrol agent in the field. Eight species of seedhead feeders and five root borers are described.

Chapter 3 includes detailed elements of a knapweed biocontrol program (planning, implementing, and evaluating). It encompasses techniques for all the agents. Included are guidelines for:

- Developing work schedules for field activities
- Selecting and preparing a release or nursery site
- Collecting, handling release, transporting and shipping biocontrol agents
- Monitoring agents and vegetation at the release site

Glossary defines technical terms essential in using and communicating about biological control effectively.

Selected References covers critical references from the comprehensive body of literature on knapweed biology, ecology, and biological control.

Appendices contains various insect release and monitoring forms, checklists, vegetation monitoring forms, and most important, a troubleshooting guide.

Appendix A: Troubleshooting Guide: When Things Go Wrong

Appendix B: Sample Biocontrol Agent Release Form

Appendix C: Monitoring Plan Questionnaire

Appendix D: Biocontrol Monitoring Report

Appendix E: Qualitative Monitoring Form

Appendix F: Quadrat Density and Cover Data Form

Appendix G: Macroplot Design for Measuring Density

CHAPTER 1: GETTING TO KNOW KNAPWEEDS

Knapweeds belong to the genus *Centaurea* and are members of the Sunflower family (Asteraceae). This is a very large and diverse family of plants that includes dandelions, sunflowers, and daisies. Most knapweeds are non-native to North America. They were brought to North America following the immigrant trail from Europe and Asia. Together, these Eurasian knapweeds form a large complex of invasive species that are found throughout the United States and Canada. All told, 25 species of knapweeds occur in the two countries, predominantly as noxious rangeland weeds in the West. Six species are considered in this manual. Among the most troublesome are diffuse, spotted, and squarrose knapweeds. Lesser-known knapweeds (meadow, brown, and black) are closely related to the others and are included in this manual because they share similar biology and some of the same biological control agents.

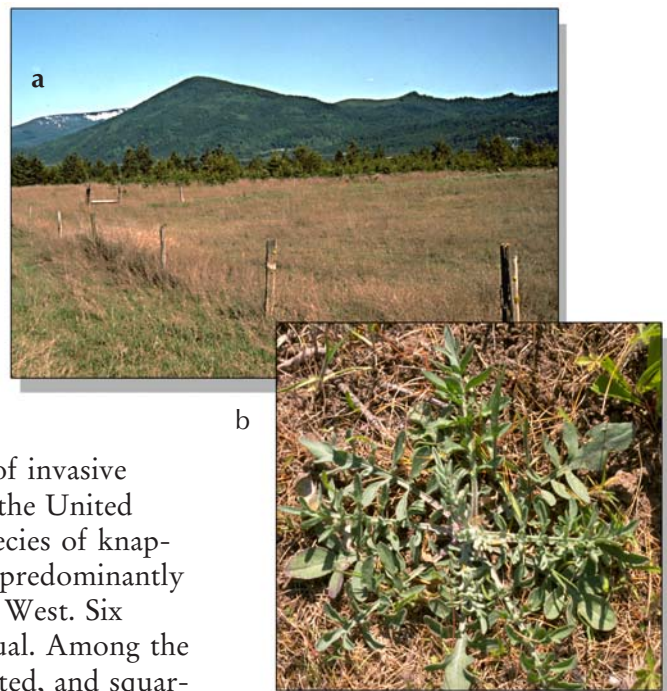

Figure 1. a. Spotted knapweed infestation in northern Idaho (UGA1350045). b. Spotted knapweed rosette (UGA1350046).

Knapweeds are highly invasive weeds that are capable of forming large infestations under favorable conditions (Fig. 1). Knapweeds are distinguished by their bract shape, flower color, leaf shape, roots, seeds and branching habit. The taxonomic key can be used to identify the six knapweed species described in this manual (see page 7). Sections following the key describe each of the species separately in greater detail to enable the user to identify each species in the field.

The list of references provides additional information about knapweed species discussed here (see page 81ff.).

Plant Development

All six knapweed species begin their lifecycle as seedlings that develop into prostrate rosettes of 5 to 12 lobed leaves (Fig. 1). Most species remain rosettes the first year. With the onset of warm, moist conditions the following spring, plants bloom on one to several branched, flowering stems. Plants have many seedheads that occur singly at the tips of branched stems.

Like other members of the sunflower family, the knapweed head, or *capitulum*, is an aggregation of small, individual flowers (Fig. 2). The individual flowers, or *florets*, are tightly clustered and anchored to a concave base, called the *receptacle*. The receptacle and florets are surrounded by an envelope of modified leaves, or *bracts*. Head size and bracts are important diagnostic characters for knapweeds.

As the head completes its development, the bracts separate to reveal the maturing florets, enabling pollination to occur. Seeds develop later in the season (knapweed seeds are also known as *achenes*). Seeds may have a tuft of whitish or tawny bristles at one end, called a *pappus*.

Insects used in knapweed biological control inflict damage to the plant in two places: the seedhead and the root. The plant is damaged by the larvae of these insects which feed in the head or root tissue, destroying it. Only the adult seedhead weevils eat foliage, otherwise adult insects generally don't damage the plant.

Seed-feeding biocontrol agents attack the plant at specific stages of development: some attack the plant early, in the bud stage, and others attack later, when plants are in early to full bloom. Larvae eat and destroy seeds and receptacle tissue.

Root-boring biocontrol agents can attack the plant as soon as the root is large enough for the insect to feed. The root is composed of two key tissues: the root cortex and the central vascular tissue (Fig. 3). Both tissues are nutritious: the cortex tissue stores nutrients and the vascular tissue contains the channels in which nutrients and water move up and down the plant.

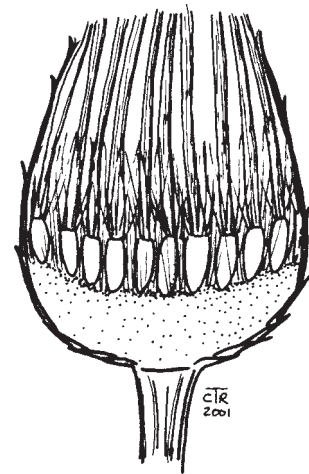

Figure 2. Knapweed capitulum showing placement of florets

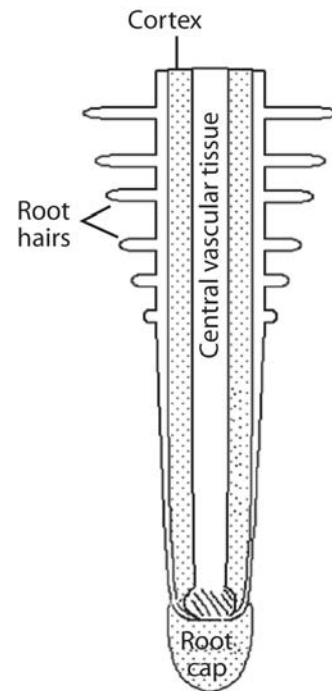

Figure 3. Key tissues in the knapweed root.

Key to the Knapweed Species

(Adapted from Roché and Roché 1993)

A1. Bracts that surround the flower head are spine-tipped, biennial or short-lived perennial

B1. Central, terminal bract bent backwards (curved)

Squarrose knapweed

(Centaurea virgata ssp. squarrosa)



B2. Central, terminal bract recurved

Diffuse knapweed

(Centaurea diffusa)

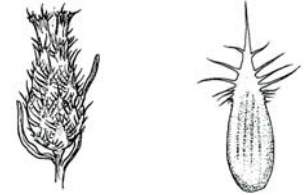

A2. Flower heads without spine-tipped bracts

C1. Edge of bract is comb-like fringe

D1. Fringes of bracts short, drawn out and rigid, bract with brown triangular tip

Spotted knapweed

(Centaurea stoebi)

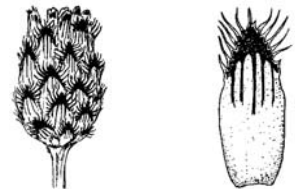

D2. Fringes on bracts as long or longer than the width of the bract, not rigid

E1. Fringe on bract black

Black knapweed

(Centaurea nigra)



E2. Fringe on bract tan to brown

Meadow knapweed

(Centaurea pratensis)

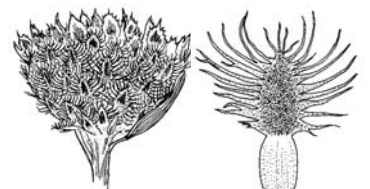

C2. Bracts without comblike fringe, having a brown, papery, translucent tip

Brown knapweed

(Centaurea jacea)

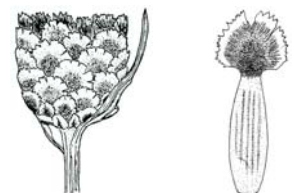

SPOTTED KNAPWEED

Scientific name: *Centaurea stoebe* L. ssp. *micranthos* (Gugler) Hay/synonym *C. biebersteinii* L., formerly *C. maculosa* Lam.

A winter-hardy, short-lived perennial with deep taproots (Fig. 4). Plants grow 6 to 24 inches (15 to 60 cm) in height and spread entirely by seeds. It is native to eastern Europe and Asia.

Leaves: The basal leaves are up to 8 inches (20 cm) long, deeply lobed, and arranged in a rosette. Stem leaves, arranged alternately, are smaller and not lobed. Uppermost leaves are bract-like.

Stems: The stems are upright, stiff, and branched. Small plants usually have an unbranched stem and one flower head; large plants have a stem with many branches and can have over 100 flower heads.

Flowers: Flowering occurs from June to October. The 0.2 to 0.4 inch (5 to 10 mm) long flower heads occur singly or in clusters at the branch tips. Each head bears stiff bracts, which are black-tipped, giving the plant its 'spotted' appearance. Heads contain from 30 to 50 pink or purple colored flowers.

Seeds: Seeds are 0.1 inch (2.5 mm) long, oval, black or brown with pale, vertical lines. Each seed has a short, bristly pappus about half the length of the seed. Plants can produce up to 600 seeds, some of which can remain dormant for many years.

Habitat and Occurrence: Spotted knapweed grows in a wide range of habitats, though mainly in grasslands and open forests. It has the widest distribution in the United States of all the knapweed species. A rapid colonizer of disturbed land, spotted knapweed can displace native vegetation in undisturbed areas. Heads persist on the stiff stems through the winter eventually breaking off when new rosette growth appears the following spring. Both diploid and tetraploid spotted knapweed types are known.

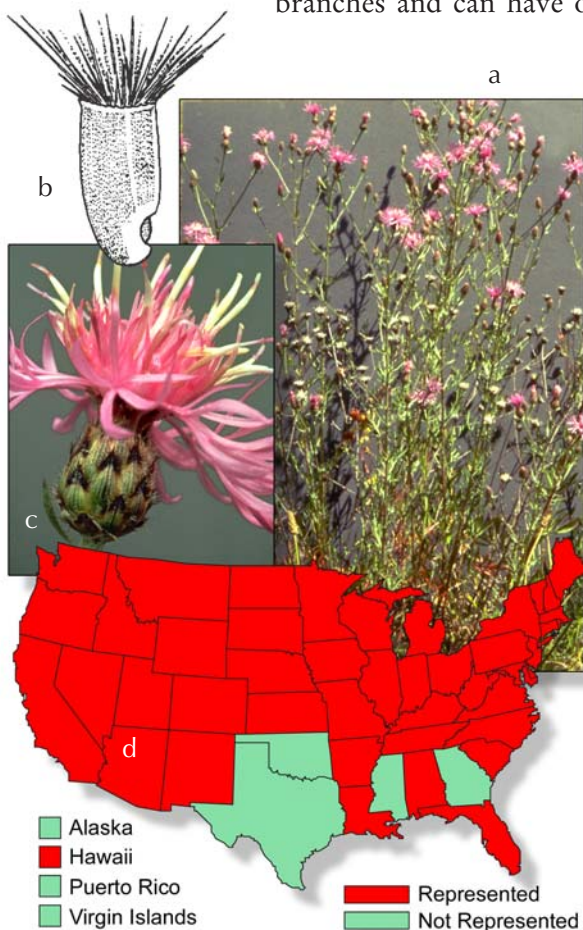

Figure 4. Spotted knapweed. a. Plant (UGA1350047). b. Seed. c. Seedhead (UGA1350048). d. US distribution.

DIFFUSE KNAPWEED

Scientific name: *Centaurea diffusa* Lam.

A winter-hardy biennial or short-lived, tap-rooted perennial that reproduces entirely by seeds. Diffuse knapweed (Fig. 5) is originally from the eastern Mediterranean.

Leaves: The deeply lobed basal leaves are up to 4 inches (10 cm) long and 1 inch (2.5 cm) wide and arranged in a low-lying rosette. Lower stem leaves are alternate and divided into many lobes, whereas upper stem leaves are much smaller and have only a few slender lobes.

Stems: The single upright stem grows 6 to 24 inches (15 to 60 cm) in height and has numerous branches mostly on the upper half.

Flowers: Flowers are predominantly white, occasionally pink-purple. Heads are 0.5 inch (1.3 cm) long and covered with small, narrow bracts ending in sharp, rigid spines. The terminal spine is distinctly longer than the lateral, spreading spines. Flowering occurs from June to October.

Seeds: Seeds are 1/8 inch (5 mm) long, oblong, and dark brown. Seeds may have a pappus of short, pale bristles.

Habitat and Occurrence: Diffuse knapweed is wide-ranging, although it prefers habitats in the shrub-steppe zones and dry forest habitats. Though predominately found in the Intermountain West, it is also found in the Midwest and the eastern U.S.

Comments: Like spotted knapweed, diffuse knapweed can displace native vegetation in undisturbed areas. Specialized chemicals give this weed a distinctive smell and an extremely bitter taste. Unlike other knapweeds, the heads of diffuse do not open to shed seeds. Instead, seeds are shed as the stiff, mature plants, tumble in the wind after the stiff central stalk breaks off. Seeds are also spread by vehicles, animals, and people.

A diploid, fertile hybrid between diffuse knapweed and spotted knapweed has been identified. It is known as *C. x psammogena*.

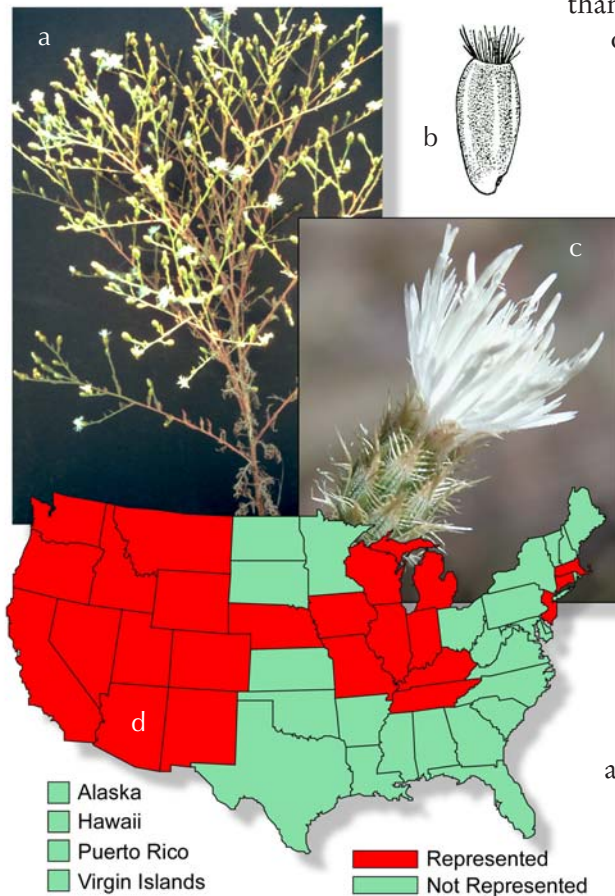

Figure 5. Diffuse knapweed. a. Plant (UGA1350049). b. Seed. c. Seedhead (UGA1350078). d. US distribution.

SQUARROSE KNAPWEED

Scientific name: *Centaurea virgata* Lam ssp. *squarrosa* Gigl.

Squarrose knapweed (Fig. 6) is a long-lived perennial with deep tap roots that reproduces only by seed. Squarrose knapweed came to the United States from the eastern Mediterranean.

Leaves: Rosettes of deeply lobed, gray-green leaves characterize squarrose knapweed.

Stems: The stems are upright, stiff, winged and branched. Small plants usually have an unbranched stem and one flower head; large plants have a stem with many branches and can have over 100 flower heads. Plants range in height from 6 to 24 inches (15 to 60 cm).

Flowers: Flowering occurs from July to September. Flower heads with 4 to 8 pink or purple flowers are borne singly or in pairs at the tips of branches. The seedheads are small and covered with spiny bracts having a long, recurved (backward pointing) terminal spine. The heads are deciduous, falling off the stems after the seeds mature.

Seeds: Squarrose knapweed seeds are pale to dark brown with pale vertical stripes and a short, white pappus. Only 3 to 4 seeds are produced per head, each measuring about 1/8 inch (5 mm) in length. Seeds are dispersed individually as they fall from the heads. Heads are transported when whole plants break off and tumble in the wind. Seeds disperse when whole heads break off from the stem and get lodged in the hair and fur of animals, much like cockleburs and burdock.

Habitat and Occurrence: Squarrose knapweed has a limited distribution in Utah, Oregon, California, Wyoming, and Michigan. It prefers dry, open rangeland with shallow soils.

Comments: Squarrose is similar to diffuse knapweed but has fewer flowers per head, recurved spines on the bracts, and is a true perennial.

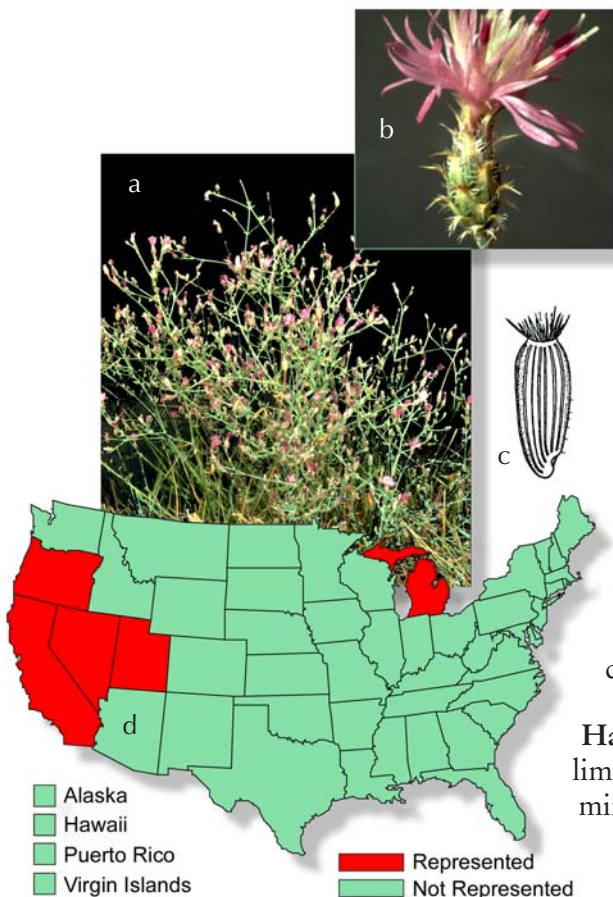

Figure 6. Squarrose knapweed. a. Plant (UGA1350050). b. Seedhead (UGA1350051). c. Seed. d. US distribution.

MEADOW KNAPWEED

Scientific name: *Centaurea pratensis* Thuill.

Meadow knapweed is a deep-rooted perennial, growing each year from a woody root crown. It is native to Europe (Fig. 7).

Leaves: Basal leaves are up to 6 inches (15.2 cm) long, tapering at both ends and having the broadest part above the middle of the leaf. Stem leaves are lance-shaped, shallowly-lobed and stalkless.

Stems: There are usually few to several stems with many branches. Mature plants reach 3.5 feet (1.04 m) tall.

Flowers: Flowers are generally rose-purple in color, although white flowers occasionally occur. Flowering occurs from July to September. The heads are solitary at the ends of the upper branches. They are broadly oval and almost globe-shaped, 0.5 inch (1.3 cm) long. The bracts of meadow knapweed are light to dark brown, with a fringed margin.

Seeds: Meadow knapweed seeds are pale tan in color, plumeless, 1/8 inch (2 cm) long.

Habitat and Occurrence:

Meadow knapweed prefers moister and cooler conditions than the other knapweeds. It occurs predominantly in coastal Washington and Oregon, but is also found in moister, cooler habitats of the interior, e.g. forest openings along rivers and streams.

Comments: Meadow knapweed is a fertile hybrid between black and brown knapweeds (see pages 12-13).

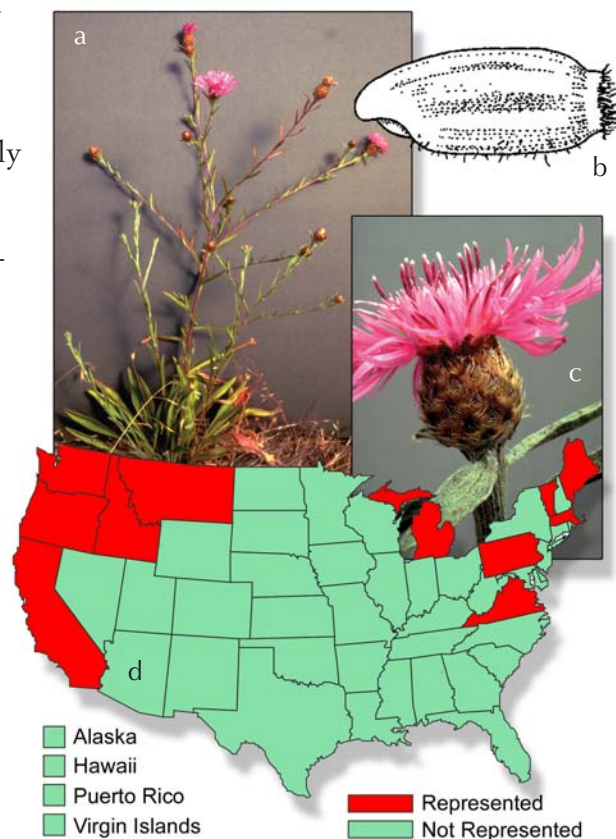

Figure 7. Meadow knapweed. a. Plant (UGA1350052). b. Seed c. Seedhead (UGA1350053). d. US distribution.

BLACK KNAPWEED

Scientific name: *Centaurea nigra* L.

Black knapweed is a perennial plant regrowing each year from a woody root crown (Fig. 8). It was introduced into the United States from the United Kingdom.

Leaves: Basal rosette leaves are broad, stalked, and shallowly lobed. Stem leaves are smaller and not lobed.

Stems: Stems are erect and branched near the middle, from 8 to 32 inches (20 to 80 cm) tall, the base of the stem is sometimes prostrate and rooting from the nodes.

Flowers: Flowering occurs from July to October. Flowers are rose colored. Heads occur solitary at the ends of the upper branches. They are broad and rounded, 0.5 inch (1.3 cm) tall and 1 inch (2.54 cm) wide. The bracts of black knapweed are dark brown to black, with a comb-like fringe on the margin.

Seeds: Black knapweed produces about 60 seeds per head. They are ivory with length-wise stripes, and have a pale, short pappus.

Habitat and Occurrence: Like meadow knapweed, black knapweed occurs predominantly in coastal Washington and Oregon, and in other cooler regions of the inland Northwest.



Figure 8. Black knapweed. a. Plant (UGA1350054). b. Seed. c. Seedhead (UGA1350055). d. US distribution.

BROWN KNAPWEED

Scientific name: *Centaurea jacea* L.

Brown knapweed (Fig. 9) is a perennial that reproduces only by seeds. It is native to Europe.

Leaves: Basal leaves are up to 6 inches (15.2 cm) long, tapering at both ends with the broadest part above the middle of the leaf. Stem leaves are lance-shaped, shallowly-lobed and stalkless.

Flowers: Flowers are rose-purple in color, rarely white. Flowering occurs from July to October. Heads are solitary at the ends of the upper branches. They are broadly oval. The bracts of brown knapweed are light to dark brown, with a papery, translucent margin.

Seeds: Brown knapweed seeds are light brown, plumeless, 1/8 inch (2 cm) long. Each head produces about twelve seeds.

Habitat and Occurrence: Like meadow knapweed, brown knapweed prefers moister, cooler conditions than the other knapweed species. It occurs predominantly in coastal Washington and Oregon, although it is distributed both in the West and the East. It also occurs in British Columbia.

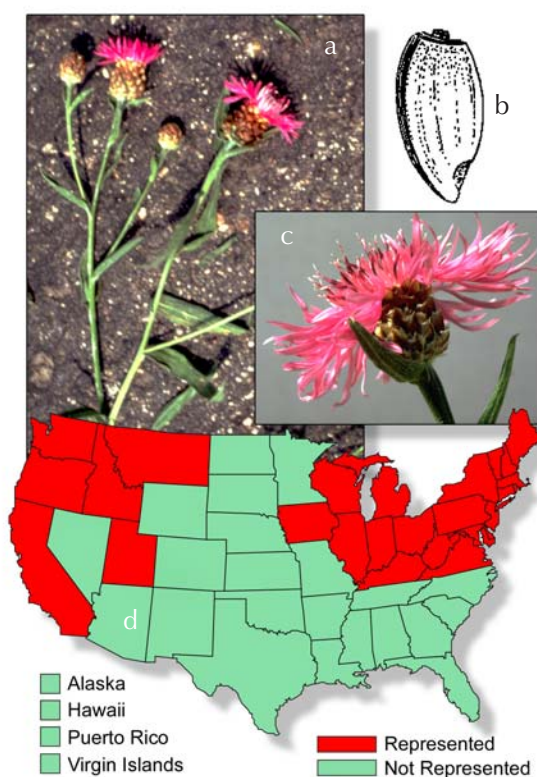

Figure 9. Brown knapweed. a. Plant (UGA1350056). b. Seed. c. Seedhead (UGA1350057). d. US distribution.

CHAPTER 2: BIOLOGY OF KNAPWEED BIOCONTROL AGENTS

Biological control of knapweeds is one of the oldest classical biocontrol programs in the United States and Canada. It began in the 1960's with the importation of two seedhead flies: the knapweed banded gall fly, *Urophora affinis*, and the UV knapweed seedhead fly, *U. quadrifasciata*. In all, 16 agents have been introduced; of these, 13 are insect species, two are fungi, and one is a mite (not released). Only the insects are emphasized in this manual because they are by far the most widespread, readily available and easy to work with. This chapter is organized into two sections: seedhead-feeding (seedhead feeders) and root-boring (root borers) insects.

Basic Insect Biology

Insects are a diverse and complicated group of animals. Basic knowledge of insect anatomy and lifecycles will help a great deal in recognizing knapweed bioagents in the field and understanding their impact on the weed. Adult insects possess unique characteristics: 1) an exoskeleton, 2) a segmented body consisting of three regions (head, thorax and abdomen), and 3) three pairs of legs (Fig. 10).

Insects grow and develop through a series of stages. The transformation from egg through juvenile stages to adult is called *metamorphosis*. This process can be incomplete or complete. All the insects used in biocontrol of knapweed undergo complete metamorphosis (having four distinct life stages): egg, larva (of which there can be three or more *instars*), pupa, and finally, adult.

The insect bioagent's lifecycle (Fig. 11) is closely matched, or *synchronized*, with knapweed's. In fact, in order to qualify as an acceptable biological control agent, the insect must show that it eats and develops only on knapweed and no other plants. Without knapweed, or a specific complex of knapweed, the insect will die. This highly specific, tightly regulated insect-plant relationship is the most critical issue in classical biological control of knapweeds.

Insect Body Parts

- A Head
- B Antenna
- C Thorax
- D Abdomen
- E Wing

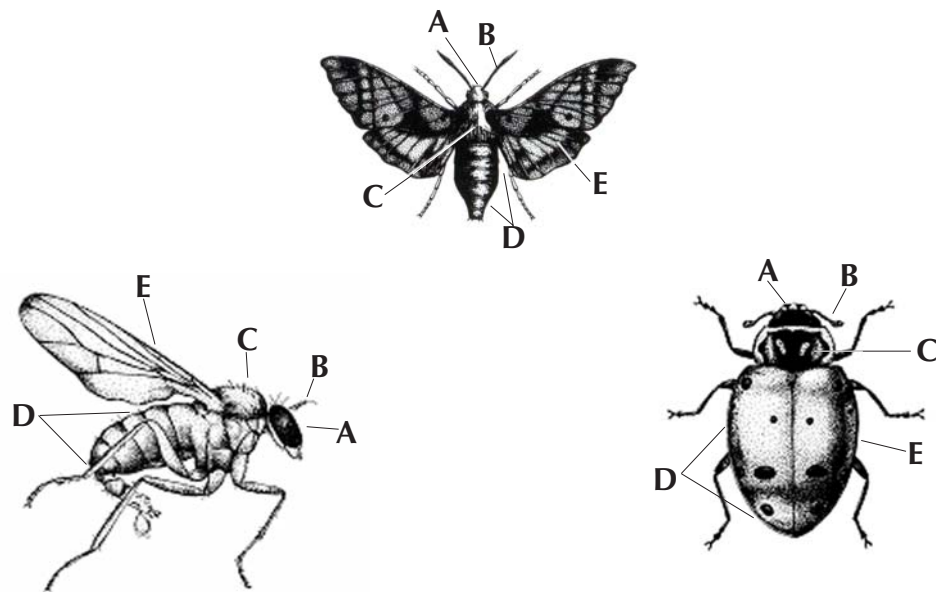

Figure 10. Diagram of insect body parts.

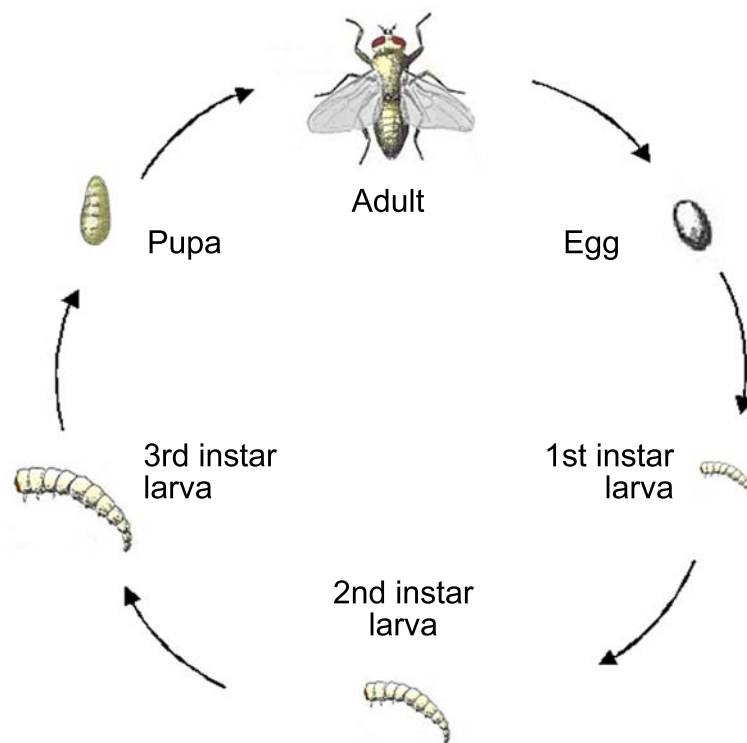

Figure 11. Example of an insect lifecycle showing complete metamorphosis.

Insects and Knapweed

Three types of insects are used in biocontrol of knapweed: flies, moths and beetles. In all, 13 species of insects, occurring in the seedheads or roots, are discussed in this manual (Table 1). All four fly species are ‘fruit flies’ (Family Tephritidae), in that they occur in the seedheads where the larvae eat developing flowers and seeds. One moth species and three weevil species complete the complex of eight seed-feeding bioagents on knapweed (Fig. 12). Among the root borers are three moth species and two beetle species. One beetle, *Cyphocleonus achates*, is a weevil, and the other beetle, *Sphenoptera jugoslavica*, is a metallic wood borer.

All of the insect bioagents damage knapweed plants as larvae by feeding internally in the seedheads or roots. In general, adults have little impact on the plant except for two of the seedhead weevils, *Larinus minutus* and *L. obtusus*. Adults of these weevils can significantly defoliate knapweed stems, further weakening the plant.

Table 1 lists the natural enemies of knapweeds in the United States and the species of knapweed they attack.

It is unlikely that any one of these species alone could successfully control knapweed. Most knapweed biocontrol programs use a combination of bioagents which together create multiple stresses on the plant and have a greater chance of contributing to the suppression of knapweed.

Table 1. Knapweed bioagents established in the United States and the species of knapweeds they attack.

Insects		Knapweeds					
Type	Species	Spotted	Diffuse	Squarrose	Meadow	Black	Brown
Seedhead Feeders	Flies	<i>Urophora affinis</i>	•	•	•		
		<i>Urophora quadrifasciata</i>	•	•	•	•	•
		<i>Terellia virens</i>	•	•			
		<i>Chaetorellia acrolophi</i>	•	•	•		
	Moth	<i>Metzneria paucipunctella</i>	•	•		•	
	Beetles	<i>Larinus minutus</i>	•	•	•	•	
		<i>Larinus obtusus</i>	•	•	•	•	
<i>Bangasternus fausti</i>		•	•	•	•		
Root Borers	Moths	<i>Agapeta zoegana</i>	•	•	•		
		<i>Pelochrista medullana</i>	•	•			
		<i>Pterolonche dispersa</i>	•	•			
	Beetles	<i>Cyphocleonus achates</i>	•	•			
		<i>Sphenoptera jugoslavica</i>	•	•			

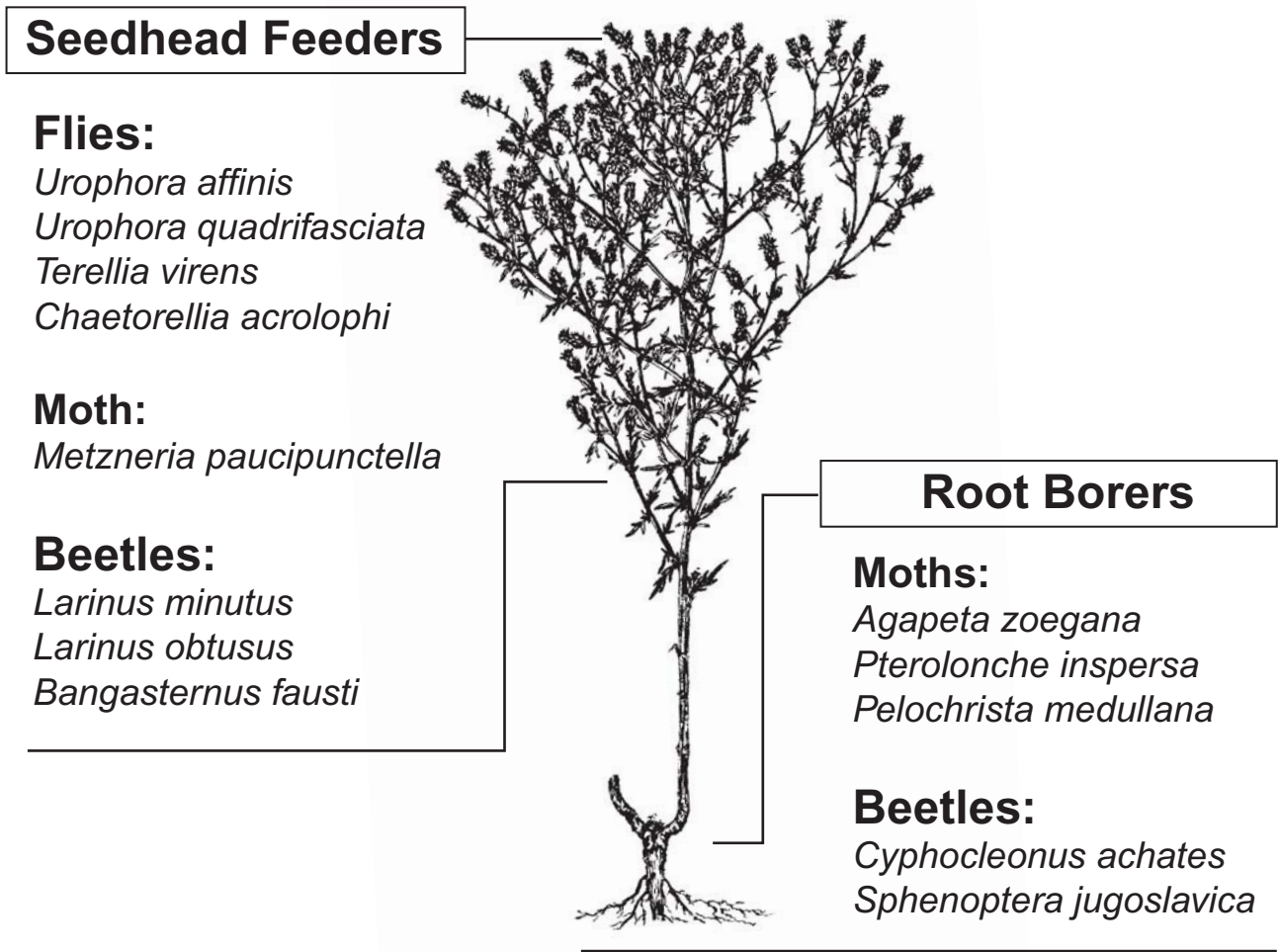

Figure 12. Distribution of knapweed biocontrol agents in a knapweed plant.

Identifying Insects

An important part of any successful biocontrol program is the ability to identify bioagents in the field. As adults, bioagents are relatively easy to identify with their variable size, color, and habits. Identifying the larvae is more challenging than the adults – and yet probably more important to know because it is in the larval stage that the bioagents: 1) do the most damage, 2) are often monitored in the field, and 3) provide conclusive evidence that the insects are established in the field.

Figure 13 is a key for identifying, in three easy steps, the larva of a fly, a moth and a beetle. This key is specific to knapweed insects, not insect larvae in general.

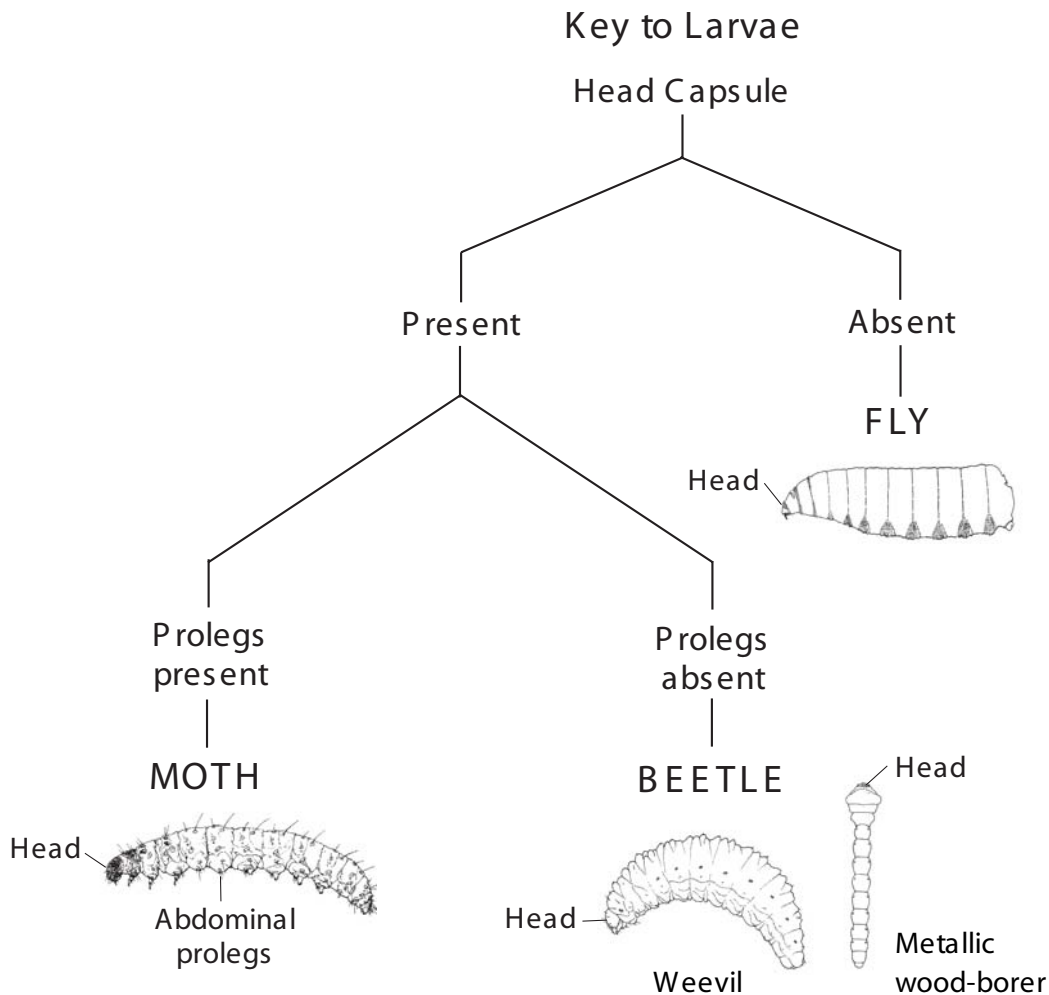

Figure 13. Key for identifying fly, moth and beetle larvae.

Fly larvae have no head capsules whereas beetle and moth larvae do. Fly larvae are sometimes confused with other larvae because they appear to have a broad, dark head. This is actually a dark, hardened anal plate anchoring the spiracles (breathing orifices).

Moth larvae have both head capsules and prolegs.

Beetle larvae are more variable. Weevil larvae (called grubs) are white, C-shaped, and have head capsules but no abdominal prolegs. Metallic wood boring larvae are narrow and tapering, with wide, somewhat flattened heads.

Figure 14 is a key for identifying the pupa of a beetle, a moth and a fly.

Beetle pupae have well-developed appendages that are obviously not fused to the pupal body.

Moth pupae have moderately well-developed appendages fused to the body.

Fly pupae are contained inside a barrel-shaped *puparium*.

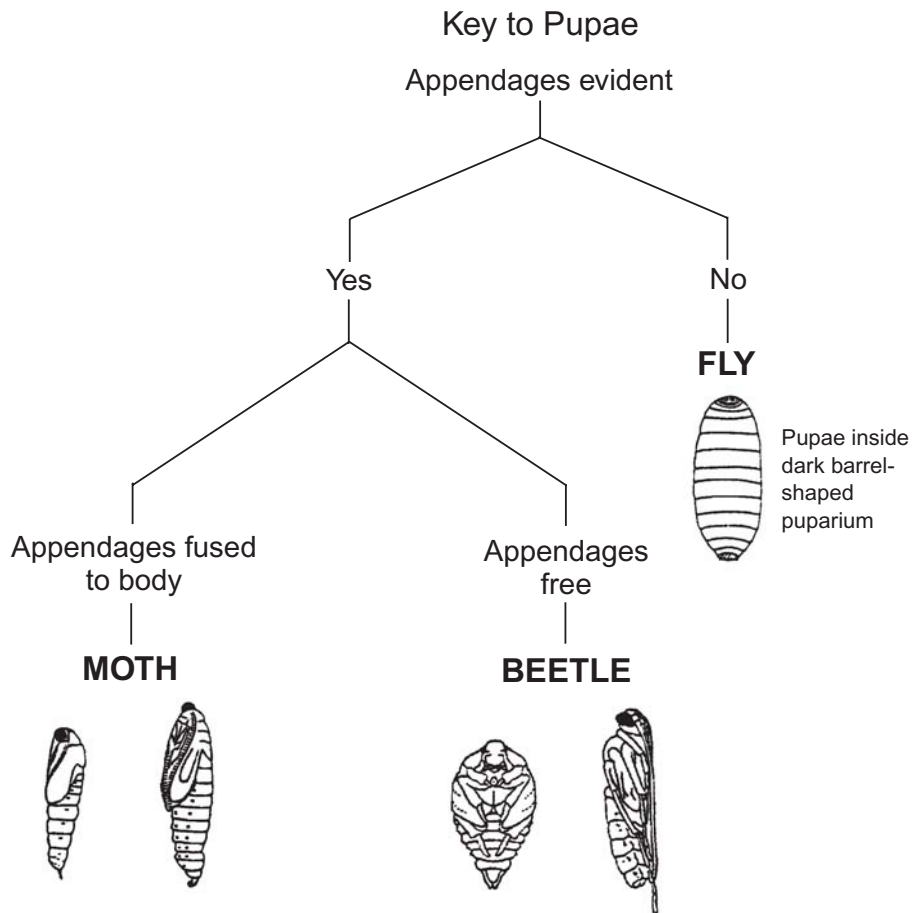

Figure 14. Key for identifying fly, moth and beetle pupae.

Seedhead Feeders

There are eight different seedhead-feeding insect species for controlling knapweeds that are established in the United States and Canada (Table 2, page 23). Among the seedhead-feeding insects are four fly, one moth, and three beetle species. The fly, *Urophora affinis*, was the first insect to be introduced into the United States and Canada for the biological control of diffuse and spotted knapweed. The second *Urophora* species, *U. quadrifasciata*, was not approved for release in the United States because of taxonomic concerns, but nevertheless migrated to the United States after being released in Canada. Two other flies are *Chaetorellia acrolophi* and *Terellia virens* (Fig. 15, page 22). Another seedhead feeder is the seedhead moth, *Metzneria paucipunctella*. Among the beetles are two closely related weevils, *Larinus minutus* and *L. obtusus*. The other seedhead weevil is *Bangasternus fausti*.

All of the seedhead-feeding insects damage the plant when larvae consume immature seeds and other tissues in the flower head, or *capitulum*. Feeding by the insects sometimes causes the plant to encase the insect larva in a hard or soft gall-like structure. In forming these galls, the insect is draining valuable nutrients away from normal plant growth (referred to as a *metabolic sink*), further depleting the plant's limited resources. Gall-forming insects are well adapted to plants like the knapweeds that produce a large number of small seedheads throughout the growing season.

Gall formers (the two *Urophora* flies) feed on actively dividing cells so they attack at the early stages of seedhead bud formation. The maximum number of gall-forming insect larvae in a seedhead is limited by the size of the seedhead, not the amount of food.

The impact that gall formers have on a plant is dictated by:

- Abundance of galls
- Power of galls as a metabolic sink
- Favorable weather conditions (i.e. drought, cold)

The other seedhead-feeding species either do not form a gall or construct a chamber in which to feed (Fig. 16). They inflict direct damage on developing seeds but do not create a metabolic sink.

Seedhead feeders are separated in time and space by such factors as:

- Type of knapweed patches insects will infest (isolated plants vs. dense stands)
- Larval feeding habits (e.g., feeding in the receptacle, florets, and seeds)
- Number of generations per year
- Number of larvae in the head
- Overwintering site (in or out of the seedhead)

Timeline of Attack

Knapweeds produce flower heads throughout the spring and summer, creating a constant supply of seedheads of different sizes and stages of development for the seedhead feeding insects to utilize.

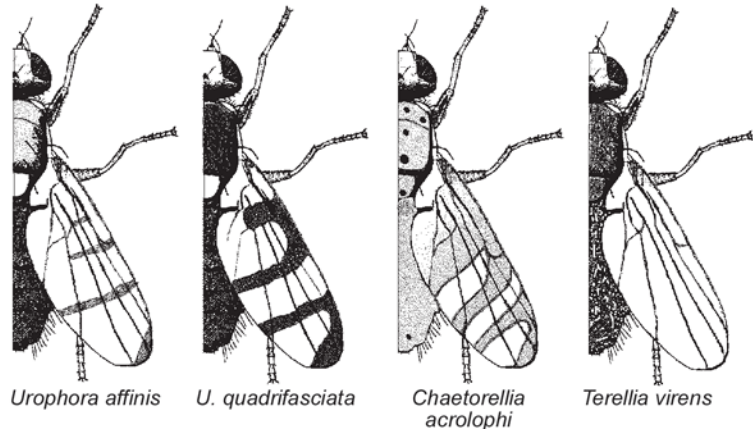

Figure 15. Comparison of knapweed seedhead flies.

Figure 15 is a comparison of adult *U. affinis*, *U. quadrifasciata*, *C. acrolophi* and *T. virens*.

Each seedhead-feeding insect prefers certain seedhead characteristics for oviposition (see Table 3, page 23). Figure 16 shows *U. affinis* ovipositing into knapweed flower bud and the position of its eggs. Figure 17 compares the galls of *U. affinis* and *U. quadrifasciata*. Figures 18 and 19 depict the position of fly, beetle and moth larvae inside the knapweed seedhead.

More than one bioagent can occupy a seedhead at one time. This coexistence is possible because of specialized adaptations.

Bioagents with a short adult life span attack fewer seedheads. Long-lived adults can attack many seedheads during their life span. Agents with more than one generation per year can attack seedheads during two distinct periods in the growing season.

Table 4 (page 24) is a summary description of knapweed seedhead feeders. Table 5 (page 25) compares the lifecycle of seedhead flies with the lifecycle of knapweed. Table 6 (page 26) compares the lifecycle of seedhead moths and beetles with the growth stages of knapweeds.



Figure 16. *Urophora affinis* ovipositing into a closed knapweed bud (left) and position of eggs amid the young florets in the head (right).

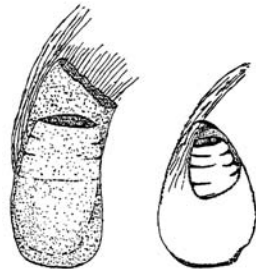

Figure 17. Comparison of *U. quadrifasciata* papery gall (left) and position of larva in the hard, woody gall of *U. affinis* (right).



Figure 18. Position of fly larvae inside the knapweed seedhead.



Figure 19. Position of beetle (left) and moth (right) larvae inside the knapweed seedhead.

Table 2. List of seedhead feeding knapweed biocontrol agents.

Type	Scientific Name	Common Name
Fly	<i>Urophora affinis</i> <i>Urophora quadrifasciata</i> <i>Terellia virens</i> <i>Chaetorellia acrolophi</i>	Banded knapweed gall fly UV knapweed seedhead fly Green clearwing fly, verdant seed fly Knapweed peacock fly
Moth	<i>Metzneria paucipunctella</i>	Spotted knapweed seedhead moth
Beetle	<i>Larinua minutus</i> <i>Larinus obtusus</i> <i>Bangasternus fausti</i>	Lesser knapweed flower weevil Blunt knapweed flower weevil Broad-nosed knapweed seedhead weevil

Table 3. Knapweed seedhead size and stage of development preferred by each of the eight seedhead feeding biocontrol agents.

Seedhead Development	Seedhead Feeder
Closed seedhead buds 0.12 inch (3mm) in diameter	<i>Urophora affinis</i> (spring only)
Seedhead buds 0.14 to 0.2 inch (4 to 5 mm) inch in diameter	<i>Bangasternus fausti</i> (spring only) <i>Chaetorellia acrolophi</i> (first generation spring; second generation summer)
Seedhead buds 0.2 to 0.3 inch (5 to 7 mm) in diameter	<i>Urophora quadrifasciata</i> (spring, non-obligatory second generation summer) <i>Chaetorellia acrolophi</i> (first generation spring; second generation summer)
Late seedhead bud to early bloom	<i>Metzneria paucipunctella</i> (spring only)
Full bloom	<i>Terellia virens</i> (spring flowers, if a second generation will affect attack later summer flowers)
Early seed formation	<i>Larinus minutus</i> and <i>L. obtusus</i> (adults persist for a number of weeks in the summer and lay eggs into susceptible seedheads as they become available)

Table 4. Summary description of knapweed seedhead feeders.

Agent	Flies				Moth	Beetles		
	<i>Urophora affinis</i>	<i>Urophora quadrifasciata</i>	<i>Terellia virens</i>	<i>Chaetorellia acolophi</i>	<i>Metzneria paucipunctella</i>	<i>Larinus minutus</i>	<i>Larinus obtusus</i>	<i>Bangasternus fausti</i>
Number of Generations	One, partial second	One or two	One, partial second	Two, rarely three	One	One	One	One
Adults	Black, faint horizontal bands on wings	Black, dark bands form a "UV" pattern on wings	Clear-winged with yellow or greenish bodies	Dark bodied with yellow bands on body and wings	Gray wings folded over back when at rest, dark spots on wings	Grayish black with large snout, reddish brown wings	Black, slightly mottled, bulbous snout, black legs	Grayish-black, with blunt snouts
Eggs	0.2" (5mm) long Cluster of 1-5 young inside unopened seedheads	0.2" (5mm) long Singly among developing florets	0.2" (5mm) long Multiple eggs laid inside the open flower head	0.2" (5mm) long Singly or in small clusters under bracts of flower bud	0.3" (7mm) long Singly on bracts at base of flower bud	0.2" (5mm) long Clusters are laid in the bud between pappus hairs	0.2-0.3" (5-7mm) long Singly into a newly opened head	0.2" (5mm) long Singly on bracts or stem leaves covered with a black egg cap
Larvae	Creamy white, barrel-shaped, retracted head, circular dark brown anal plate	Creamy white, barrel-shaped, retracted head, elliptical dark brown anal plate	Barrel-shaped white, turning yellow brown	Barrel-shaped, 1st gen. white, 2nd gen. yellow	White with dark brown head capsule, five pair of prolegs	White legless C-shaped grub with brown head capsule	White legless C-shaped grub with brown head capsule	White legless C-shaped grub with brown head capsule
Pupae	Inside woody gall, brown; 0.06" long	Inside papery gall, brown; 0.06" long	No gall, yellow-brown puparium; 0.06" long	No gall, white puparium covered in pappus hairs	Cocoon brown appendages fused to body	Long, white turning brown before emergence	Long, white turning brown before emergence	In a chamber in head, white (brown before emergence)
Overwinter	Larvae in seedhead	Larvae in seedhead	Larvae in seedhead	Larvae in seedhead	Larvae in seedhead	Adult in litter near root	Adult in litter near root	Adult in litter near root

Table 5. Comparison of seedhead fly lifecycles by knapweed growth stage.

Agent	<i>Urophora affinis</i>	<i>Urophora quadrifasciata</i>	<i>Terellia virens</i>	<i>Chaetorellia acrolophi</i>
Knapweeds Attacked	Spotted, Diffuse, Squarrose	Spotted, Diffuse, Brown, Black, Meadow, Squarrose	Spotted, Diffuse	Spotted, Diffuse, Squarrose
Seedling	Overwinters as larvae in previous year's seedheads	Overwinters as larvae or pupae in previous year's seedheads	Overwinters as mature larvae or pupae in previous year's seedheads	Overwinters as larvae in previous year's seedheads
Rosette				
Bolting	Late instar larvae and pupae	Late instar larvae and pupae	Adults emerge. Mating and egg laying begin with the onset of hot, sunny weather and continues for 4-6 weeks	Adults emerge and mate. Females lay eggs into flower buds.
Early Flower Buds	Adults emerge and mate. Females lay eggs on young flower buds.	Adults emerge and mate.		
Late Flower Buds	Larvae feed in developing seedheads. Feeding leads to development of hard, woody galls. Severely infested buds don't flower.	Egg laying between bracts of developing flower buds.	Eggs are laid in young, opening flowers. Eggs hatch in 3-5 days. Larvae feed for up to 14 days. Second generation may occur.	Larvae emerge from eggs and tunnel to center of flower bud. Larvae pupate 10-20 days after hatch, producing a second generation. A third generation is possible, but rare.
Flowering		Eggs hatch and only develop in pollinated seedheads or those attacked by <i>U. affinis</i> . Feeding leads to formation of thin, papery gall.		
Seed Formation				
Mature	10-33% of larvae pupate and emerge for a second generation in late-forming seedheads. Majority overwinter as larvae in seedheads.	If a second generation occurs, adults emerge and lay eggs in susceptible seedheads. Second generation overwinters as larvae in seedheads	First generation larvae overwinter as pupa, second generation larvae overwinter as prepupae; pupation occurs following spring.	Larvae from second (possible third) generation feed upon mature seed.
Senescence				

Table 6. Comparison of seedhead moth and weevil lifecycles by knapweed growth stage.

Agent	<i>Mezneria paucipunctella</i>	<i>Bangasternus fausti</i>	<i>Larinus minutus</i>	<i>Larinus obtusus</i>
Knapweeds Attacked	Spotted, Diffuse, Meadow	Spotted, Diffuse, Squarrose, Meadow	Spotted, Diffuse, Squarrose, Meadow	Spotted, Diffuse, Squarrose, Meadow
Seedling	Overwinters as larvae in previous year's seedheads.	Overwinters as adults in plant litter and soil surrounding plant.	Overwinters as adults in plant litter and soil surrounding plant.	Overwinters as adults in plant litter and soil surrounding plant.
Rosette				
Bolting	Mature larvae, and pupae	Adults begin to emerge.	Adults become active feeding on leaves, including seedlings and rosettes.	Adults become active feeding on leaves, including seedlings and rosettes.
Early Flower Buds		Adults feed on foliage, mate, lay eggs on bracts or on end of a stem.		
Late Flower Buds		Adults emerge and mate, lay eggs on bracts at base of young flower heads or on stem below flower head.		
Flowering	Eggs hatch and larvae enter opened flower head, feed on florets.	Larvae complete development from egg to adult in 32 days. Adults emerge from seedhead leaving a characteristic emergence hole. Overwinter in litter and soil surrounding plant.	Mating begins.	Mating begins.
Seed Formation	Larvae mine in flower base (receptacle) and feed on seeds. Overwinter as larvae in the seedhead.		Eggs laid between pappus hairs.	Eggs laid between pappus hairs.
Mature			Larvae hatch, feed on pappus hairs then move down to seeds and receptacle.	Larvae hatch, feed on pappus hairs then move down to seeds and receptacle.
Senescence			Pupate and emerge through exit holes; move to overwintering site.	Pupate and emerge through exit holes; move to overwintering site.

Urophora affinis

Order: Diptera
 Family: Tephritidae
 Common name: Banded knapweed gall fly

Weeds Attacked

Spotted, diffuse, and squarrose knapweeds

Description

Adult flies are about 0.2 inch (5 mm) long, black with faint horizontal bands on the wings (Fig. 20). Eggs are white when deposited, elongate and crescent-shaped. Larvae go through three larval stages or *instars*. Mature larvae are barrel-shaped, and creamy white, with heads that retract slightly into the thorax. A dark brown, circular anal plate develops by the end of the feeding period. The pupa is brown and 0.06 inch (3 mm) long.



Figure 20. *Urophora affinis* adult (UGA1350079).

Lifecycle

Urophora affinis usually has one only generation per year, although a small percentage of flies may undergo a second generation in late summer (August/ September). Overwintering as third instar larvae, flies pupate for about 14 days in the spring and emerge as adults at the time knapweed is in the bud stage. Emergence peaks when the largest seedhead buds are 0.12 inch (3 mm) long. Females can lay up to 120 eggs in groups of 1 to 5 among the immature florets inside the closed seedhead over a 3-week period. Seedheads are only susceptible to *U. affinis* oviposition for 2 to 3 days. After 3 to 4 days, larvae hatch from the eggs and tunnel into the base of the seedhead (receptacle). Larval feeding induces the formation of a hard woody gall, which surrounds the larva (Fig. 21). Between 10 and 25 percent of larvae pupate by 33 days and may emerge for a second generation.



Figure 21. *Urophora affinis* larva in knapweed (UGA1350058).

Impact

Larvae directly destroy seeds within the gall. Galls drain nutrients from other parts of the plant resulting in fewer seedheads and reduced vegetative growth. Between two and four galls in a single seedhead are common. The maximum number of galls that

can develop in a seedhead is a function of receptacle disc area. For example, more galls are generally produced in spotted knapweed versus diffuse knapweed which has a smaller diameter disc area. In spotted knapweed, the metabolic sinks created by *U. affinis* galls compete with root reserves so that fewer and smaller flowering stems are produced the following year. In diffuse knapweed, each *U. affinis* gall reduced seed production by approximately 13.7 seeds and an average of 1.1 galls per seedhead reduced the above ground dry weight of the plant by 71 percent as well as average seed weight.

The corolla (flower petals) is suppressed or absent in heavily-galled seedheads. Woody galls can be felt when heads are rolled between the fingertips.

Comments

This was the first insect introduced (1973) into the United States for knapweed control. *Urophora affinis* does not disperse as well as *U. quadrifasciata* and other seedhead-feeding agents. On sites with both *U. affinis* and *U. quadrifasciata* infesting knapweed, *U. affinis* tends to dominate.

In some areas the combination of *U. affinis* and *U. quadrifasciata* have reduced seed production by 95 percent in spotted knapweed. *U. affinis* has been found to complement the biological control activities of *U. quadrifasciata*, *Metzneria paucipunctella*, and *Larinus minutus* and other seedhead-feeding agents. Studies in Canada have shown that a combination of both *Urophora* flies and the root borer *Sphenoptera jugoslavica* can reduce diffuse knapweed seed production by 98 percent. Fly larvae are sometimes eaten by larvae of *Metzneria* and *Larinus*.

Urophora quadrifasciata

Order: Diptera
 Family: Tephritidae
 Common name: UV knapweed seedhead fly

Weeds Attacked

Spotted, diffuse, squarrose, meadow, black, and brown knapweeds

Description

Adult *U. quadrifasciata* flies are approximately 0.16 inch (4 mm) long, black, with black, UV pattern on the wings (Fig. 22), making this fly very easy to distinguish from *U. affinis*. Eggs are white when deposited, elongate and crescent shaped. Larvae go through three larval stages, or instars. Late instar larvae are creamy-white, barrel-shaped, with heads that are slightly retracted into the thorax. A dark brown, elliptical anal plate develops by the end of the feeding period (the anal plate of *U. affinis* is circular). Unlike *U. affinis*, larval feeding causes plants to form a thin, papery gall, which surrounds the larva and is the same color as the florets. Pupae are brown, and 0.12 inch (3 mm) long.



Figure 22. *Urophora quadrifasciata* adult (UGA1350080).



Figure 23. *Urophora quadrifasciata* larva in seedhead (UGA1350059).

Lifecycle

Urophora quadrifasciata has at least one generation per year with a certain percentage emerging for a non-obligatory second generation. Flies preferentially attack seedheads that measure 0.22 to 0.38 inch (5 to 8 mm) long with distinct seed embryos. Eggs are laid singly among developing florets and a seedhead may be attacked several times. Eggs hatch in 3 to 4 days and larvae bore down a floret to an ovary. Larvae will only develop in pollinated seedheads. Larval feeding induces plants to form a thin papery gall around the larvae (unlike the hard gall surrounding *U. affinis*) (Fig. 23). Larvae consume most of the gall tissue during their development.

Pupation lasts about 14 days. First generation flies pupate 20 to 25 days after oviposition, about the time that seed development is complete. Emerging second generation adults (August) attack later forming seedheads and emerge the following spring with the onset of knapweed seedhead buds. Otherwise, first generation overwinters in head.

Impact

Florets damaged by *U. quadrifasciata* are destroyed and adjacent florets abort (approximately two seeds destroyed for each *U. quadrifasciata*). There does not appear to be a decrease in the number of seedheads on plants attacked by *U. quadrifasciata*. The fly spreads rapidly, more so than *U. affinis*. The presence of *U. affinis* in the seedhead tends to discourage *U. quadrifasciata* attack, but the combination of both fly species enhances seed reduction.

Comments

Urophora quadrifasciata entered the US in 1980. This is the most widely distributed knapweed biocontrol agent. The importance of *U. quadrifasciata* will increase as knapweed densities decline because it is less dependent on dense populations of knapweed than *U. affinis*. *U. quadrifasciata* has been found to compliment the biological control activities of *U. affinis*, *Metzneria paucipunctella*, and *Larinus minutus*, and other seed head feeding agents.

On sites with both *U. affinis* and *U. quadrifasciata* infesting knapweed, *U. affinis* tends to dominate. In many areas the combination of *U. affinis* and *U. quadrifasciata* have reduced seed production by up to 95 percent in spotted knapweed. Studies in Canada have shown that a combination of both *Urophora* flies and the root borer *Sphenoptera jugoslavica* can reduce diffuse knapweed seed production by 98 percent. *U. quadrifasciata* larvae are eaten by *Metzneria* and *Larinus* larvae.

Terellia virens

Order: Diptera

Family: Tephritidae

Common name: Green knapweed clearwing fly, verdant knapweed seed fly

Weeds Attacked

Spotted knapweed primarily, diffuse knapweed secondarily.

Description

Terellia virens is a soft seed feeder like the *Larinus* species. This fly does not form galls. Adults are about 0.2 inch (5 mm) long, yellowish-green with clear wings (Fig. 24). Eggs are elongate, about 0.04 inch long (1 mm), and shiny white. Young larvae are white, but turn yellow-brown as they mature. Pupae are yellow-brown.



Figure 24. *Terellia virens* adult (UGA1350081).

Lifecycle

Weather conditions determine the number of generations (one or two). If there is only a single generation, flies spend the winter as pupae in the seed head oriented vertically above the receptacle in a loose cocoon of plant hairs. With two generations, flies spend the winter as mature larvae in cocoons partially embedded in the flower base (receptacle).

Adult *T. virens* begin to emerge in late May, about 4 weeks before spotted knapweed flowers. Mating and oviposition begin with the onset of warm weather and continues for the length of the adult's 48-day lifespan.

Females lay eggs in young, opening flowers heads from early June to early October. After laying one to several eggs into the flower heads between the flowers, the female marks the bracts of the head and upper stem leaves with a substance to discourage oviposition by other females. Each female will lay an average of 80 eggs that hatch within 3 to 5 days.

Larval development to pupation takes about 14 days. The barrel-shaped larvae spend their first two instars inside a single seed, feeding on ripening seed. Two to several *Terellia virens* larvae may infest a seedhead.

Impact

Terellia virens larvae cause considerable destruction of seeds; partial feeding damage on other seeds can reduce viability of the remaining seeds by up to 90 percent.

Comments

Terellia virens was introduced into the United States in 1992. It is now established in many states and is most successful in areas without *Larinus* species. The fly can co-exist in seedheads infested by *Chaetorellia acrolophi* and *Urophora* species but is a poor competitor in heads infested by *Larinus* species. Also, it appears to be severely hindered by high densities of *Urophora affinis*. *Terellia virens* prefers plants on south-facing slopes and dry locations.

Chaetorellia acrolophi

Order: Diptera
 Family: Tephritidae
 Common name: Knapweed peacock fly

Weeds Attacked

Spotted, squarrose and diffuse knapweeds.

Description

Chaetorellia acrolophi is an ovary feeder. Adults are small, 0.2 inch (5 mm) in size, yellow-brown flies with bright green eyes and light-brown wing bars (Fig. 25). Eggs are shiny white, elongate, and have a long filament thickened at one end. Larvae are white and develop through three instars. Pupae are contained within a white puparium.



Figure 25. *Chaetorellia acrolophi* adult (UGA1350082).

Lifecycle

Chaetorellia acrolophi generally has two generations a year; a third generation is possible but rare. Adults emerge in early June when knapweed plants are in the bud stage. Mating begins immediately and oviposition lasts for the remainder of the 17-day lifespan of the adult female. Eggs are laid singly or in batches of two to four underneath the bracts of unopened buds. A female will lay an average of 69 eggs in its lifetime. Larvae hatch 4 to 5 days later and migrate into the center of the flower buds where they feed on immature florets as they descend to the seeds. Second and third instar larvae feed on developing seeds, florets, and partially on the receptacle. Larvae pupate 10 to 15 days after hatching. First generation adults generally emerge in July, mate and lay eggs, which develop into the second generation.

First generation larvae and pupae are white and pupae are enclosed in a white pupal case covered in pappus hairs from the seeds. Second generation larvae and pupae are tan-colored, with pupae enclosed in a yellow puparium covered with pappus hairs from the seeds. Second generation larvae typically overwinter in the flower heads, then pupate the following spring.

Impact

This fly does not cause plants to form galls. Larval feeding can significantly reduce seed production; a single larva can destroy all of the seeds in a single seedhead.

Comments

Chaetorellia acrolophi prefers plants in moist habitats and is generally associated with scattered plants rather than in dense stands of spotted knapweed. This fly is not widely distributed but is established in Oregon and Montana. In Oregon, it is most successful in areas where *Larinus* species are not present. This fly should supplement the impact of *U. affinis* by attacking isolated knapweed plants; however, in Montana it appears to be hindered by high densities of *U. affinis*. It was introduced into the United States from Austria in 1992.

Metzneria paucipunctella

Order: Lepidoptera
 Family: Gelechiidae
 Common name: Knapweed seedhead moth

Weeds Attacked

Spotted knapweed preferred, will attack diffuse and meadow knapweed.

Description

Metzneria paucipunctella is a small moth, 0.32 inch (8 mm) long. Adults fly at dusk and are rarely seen. The adult's front wings are light gray with peppery spotting and dark at the tip, and when at rest, folded over the back (Fig. 26). The eggs are elongate, oval, and reddish-brown when first deposited but turn yellowish as they mature. Larvae are 0.16 to 0.20 inch (4 to 5 mm) long, white with dark brown head capsules and several pairs of prolegs. Pupae, enclosed in a cocoon, are brown with appendages fused to the body.



Figure 26. *Metzneria paucipunctella* adult (UGA1350060).

Lifecycle

Metzneria paucipunctella has one generation per year. The adults begin to emerge in late May and immediately begin mating. Female moths may lay from 60 to 100 eggs in a three-week period, beginning in June. Eggs are placed singly on the bracts at the base of the young flower heads, or on the stems just below the flower head.



Figure 27. *Metzneria paucipunctella* larva in a knapweed seedhead (UGA1350061).

Larvae hatch in 10 to 12 days as the flower heads are opening. Larvae enter the opened flower heads; first instar larvae feed on the florets while the second-instar larvae feed on the seeds. Third instar larvae mine into the flower base, which reduces the viability of uneaten seeds. Several young larvae can occupy a seedhead early in the season but only one larva survives beyond the third instar (Fig. 27). In the fall the moth larva moves from the receptacle to overwinter in the base of the seedhead. Pupation occurs in the spring and lasts for 3 to 4 weeks.

Impact

Larvae feed on developing seeds. Each larva can destroy on average of eight seeds and reduce the viability of others. Older larvae web seeds together preventing seeds from dispersing over long distances. Older larvae will eat *Urophora* larvae.

Comments

Metzneria paucipunctella was introduced in 1980. *M. paucipunctella* can suffer severe mortality during cold winters. Moth feeding compliments the biological control caused by *Urophora* species. *M. paucipunctella* larvae are aggressive and will kill one another or other knapweed seedhead-infesting larvae. White-footed deer mice are known to eat many of the larvae during the winter months.

Larinus minutus

Order: Coleoptera

Family: Curculionidae

Common name: Lesser knapweed flower weevil

Weeds Attacked

Diffuse and spotted knapweed; has become established on squarrose and meadow knapweed.

Description

Larinus minutus is a small, black weevil and a soft seed-feeder like *Terellia virens* and *Larinus obtusus*. Adults are 0.16 to 0.2 inch (4 to 5 mm) long, black and have a short robust snout (Fig. 28). Eggs are elongate, yellow and are often clustered in the seedhead between pappus hairs. Larvae are white, legless, C-shaped grubs with brown head capsules which go through three larval instars and reach a length of approximately 0.3 inch (8 mm) in length. Pupae are 0.24 inch (6 mm) long, and white, turning brown shortly before emergence and generally resemble the adult weevil.

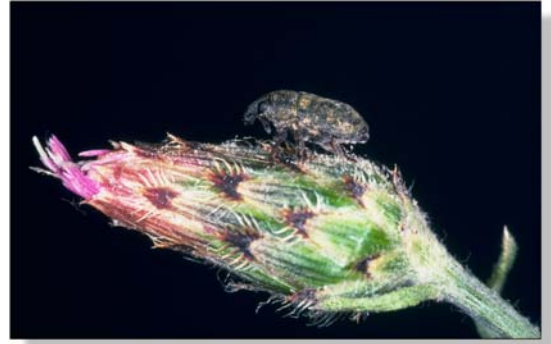

Figure 28. *Larinus minutus* adult (UGA1350062).

Lifecycle

Larinus minutus has one generation per year. Adults spend the winter in plant litter within the knapweed patch. Adults are active in the field from May or June until August. Mating occurs continuously during this 11-week period. Adults feed on the leaves (including rosette leaves in the spring), outer stem tissue and flowers prior to laying eggs. Eggs are deposited in the seedhead between the pappus hairs. Up to five eggs are clustered; the number of eggs laid per female ranges between 28 and 130. Eggs hatch three days later and the newly hatched larvae feed on the pappus hairs, then move downward to consume seeds and partially the receptacle. Feeding lasts about four weeks as larvae go through three instars. The number of *L. minutus* larvae a seedhead can support depends on the size of the seedhead and the knapweed species. The larva constructs a pupal chamber (partly from seed coats) attached to the flower base in which to house the pupa. New adults emerge and feed on foliage and flowers before moving to overwintering sites at the base of the plants.



Figure 29. Defoliation of knapweed by *Larinus minutus* adult (UGA1350083).

Impact

Adult feeding can severely defoliate plants (Fig. 29). Larval feeding reduces seed production; a single larva can destroy the contents of an entire diffuse knapweed seedhead.

Emerging adults make characteristic emergence holes in the center of affected seedheads similar to the emergence holes created by *B. fausti* and *L. obtusus* (Fig. 30).

Comments

Larinus minutus larvae are aggressive and will kill one another or other insects in the same seedhead.

Larinus minutus is established on squarrose knapweed in California.

Population increases of *L. minutus* on spotted knapweed have been slow; however, it still appears to be a very promising agent. The insect can have a significant impact on the plant growth and density across a wide range of habitats.

A study in Minnesota found that reduction in spotted knapweed infestation increased by 26.5 percent with the addition of *L. minutus* to existing *U. affinis* and *U. quadrifasciata* populations. The number of seeds destroyed in individual seedheads increased. *L. minutus* and the two *Urophora* species were found to successfully cohabit in spotted knapweed seedheads.

In addition to seed destruction by larvae, adults can do extensive damage by feeding on growing plants in the spring, which often results in the near total destruction of all growing diffuse knapweed plants in the vicinity of the original insect release. Diffuse knapweed plants under attack by *L. minutus* typically turn a characteristic blue-green color, have few leaves and often have distorted growth. Adult *L. minutus* can also destroy diffuse knapweed seedlings, resulting in suppressed recruitment of new plants. The insects develop large populations within 3 to 5 years and disperse rapidly to new areas.

Larinus minutus was introduced in 1991.



Figure 30. *Larinus minutus* emergence hole (UGA1350063).

Larinus obtusus

Order: Coleoptera
 Family: Curculionidae
 Common name: Blunt knapweed flower weevil

Weeds Attacked

Spotted is preferred and to a lesser extent diffuse knapweed.

Description

Larinus obtusus is a close relative of *L. minutus*. It is a small black weevil measuring 0.20 to 0.28 inch (5 to 7 mm) long; black with a somewhat mottled appearance caused by patches of white hair on their back, and a prominent, bulbous snout (Fig. 31). It too is a soft seed feeder. Eggs are yellowish, oval to round. Larvae are 0.3 inch (8 mm) long, white, legless, C-shaped grubs with brown head capsules. Pupae are 0.24 inch (5 mm) long, white turning brown shortly before emergence.



Figure 31. *Larinus obtusus* adult (UGA1350084).

Lifecycle

Larinus obtusus has one generation per year. Adults spend the winter in soil litter at or near the base of plants. Overwintering adults appear at the end of May and reach peak population levels during early July. Adults feed heavily on the foliage and flowers prior to mating and laying eggs. Females oviposit throughout their 5- to 6-month lifespan among the inner florets of newly opened flower heads. Occasionally adults may hibernate a second time and live a second season.

Eggs hatch in 3 to 6 days and larvae begin feeding on pappus hair and developing seeds. More than one larva can occupy a seedhead. Larvae develop through three instars over a 4- to 6-week period, pupating in chambers constructed from cemented seeds and pappus hairs. The pupal period generally lasts 9 days. Adults emerge late July and early August through holes chewed in the tops of the pupal chambers and vigorously feed on foliage before moving to overwintering sites in the soil.

Impact

One or two larvae can destroy most of the developing seeds in the head. Any seeds not eaten become part of the pupal chamber. Adult feeding on foliage can reduce photosynthetic capacity and plant vigor.

Emerging adults make characteristic holes in the center of affected seedheads, similar to the emergence holes created by *B. fausti* and *L. minutus*.

Comments

Larinus obtusus prefers moist sites in contrast to the other seedhead weevils for knapweed, which prefer and thrive in drier sites. It has not yet been established on knapweed species other than spotted in the United States. *L. obtusus* has been slow to build up significant populations in spotted knapweed in western Montana. *L. obtusus* is well established in Oregon, Idaho, Colorado, Washington and British Columbia. *Larinus obtusus* was introduced in 1993.

Bangasternus fausti

Order: Coleoptera

Family: Curculionidae

Common name: Broad-nosed knapweed seedhead weevil

Weeds Attacked

Spotted, diffuse, squarrose and meadow knapweed

Description

Bangasternus fausti is a small, gray-brown weevil measuring 0.16 inch (4 mm) with a short, blunt snout (Fig. 32). Eggs are oval, yellowish, and covered with a black egg-cap. Larvae are white, legless, C-shaped grubs with brown head capsules that reach a length of approximately 0.3 inch (8 mm). The white, 0.24 inch (5 mm) long pupae are found inside a cell in the seedhead.



Figure 32. *Bangasternus fausti* adult (UGA1350085).

Lifecycle

Bangasternus fausti has one generation per year. Adults spend the winter in plant litter and soil surrounding the plant (in warmer climates, adults overwinter in the seedheads). Adults become active in May and begin mating. They feed on knapweed foliage in the spring prior to egg laying. Eggs are laid individually on the seedhead bracts or on the end of the stem and leaflets from May to mid-August. Eggs are covered with masticated plant tissue which forms a black egg-cap and hatch in 8 to 12 days.

Depending on the placement of the egg, the new larva mines directly into the bud or into the stem and then tunnels to the bud where it feeds within the seedhead. Pupation occurs in the damaged head within a cell constructed by the larva of frass and fused seeds. It takes approximately 32 days for *B. fausti* to go from egg to adult. Adult *B. fausti* feed on knapweed foliage in the spring and on flowers in the summer.

Impact

Bangasternus fausti feeds in the flower base and destroys the flowers and ovules before they produce seeds. Weevils can consume 95 to 100 percent of the seed. In the fall, attacked seedheads have a characteristic emergence hole similar to emergence holes of *Larinus* species.

Comments

Bangasternus fausti was introduced into the United States in 1992, and has become well established on spotted knapweed. It is not known how *B. fausti* will interact with other seedhead- infesting biological control agents. Early concerns about the potential of *B. fausti* to displace *Urophora affinis* have yet to be realized. Under favorable conditions weevil density can increase dramatically allowing the collection of large numbers of weevils for collection and redistribution (Fig. 33).



Figure 33. *Bangasternus fausti* being released on spotted knapweed (UGA1350086).

Bangasternus fausti prefers hot dry sites. It attacks early buds and often occurs with *Larinus* spp. However populations of *B. fausti* are slower to build than *Larinus*.

Root Borers

There are five root boring insect species established in the United States and Canada for the control of diffuse, spotted and squarrose knapweeds. Three species are moths (sulfur knapweed root moth, *Agapeta zoegana*; gray-winged knapweed root moth, *Pelochrista medullana*, and brown-winged knapweed root moth, *Pterolonche inspersa*), and two are beetles (knapweed root weevil, *Cyphocleonus achates*, and bronze knapweed root borer, *Sphenoptera jugoslavica*). All these insects can be present in the root at the same time. Studies are underway to determine how these insects coexist and compete in knapweed roots.

All five root-feeding insects damage the plant in the larval stage by feeding on the central vascular tissue or the cortex of the root just below the epidermis, depending on species (Fig. 34). Eggs are laid on the stem, on the basal rosette leaves, on the soil surface, or on the root crown just below the soil surface. Upon emerging from the eggs, larvae immediately burrow into the root, where they feed and complete their development.

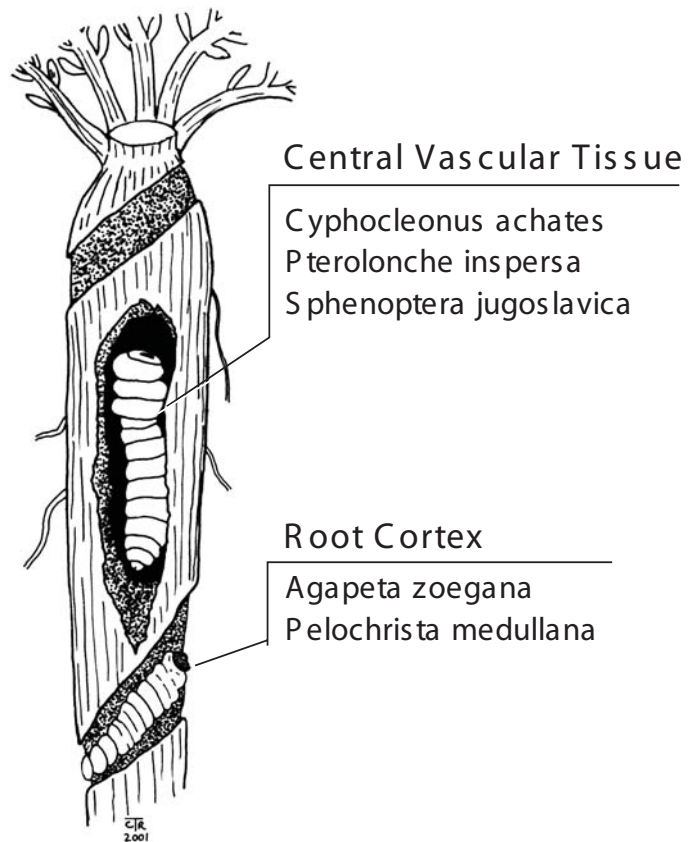

Figure 34. Distribution of knapweed root borers.

As larvae, insects mine the roots depleting the carbohydrate reserves of the plant that are important for growth and essential for overwintering. In addition to mining the roots, beetle larvae of *S. jugoslavica*, *C. achates* and *P. inspersa* cause root galls. Galls create a metabolic sink, meaning that the energy generated by the plants through photosynthesis is used to produce the gall rather than to meet critical plant needs.

All the insects are *univoltine*, which means they produce only one generation per year. Most larvae complete their development in a single root; however, larvae of the sulfur root moth, *Agapeta zoegana*, can migrate a short distance between roots during the growing season.

Agapeta zoegana

Order: Lepidoptera
 Family: Cochylidae
 Common name: Sulfur knapweed root moth

Weeds Attacked

Spotted knapweed primarily, diffuse and squarrose knapweeds secondarily.



Figure 36. *Agapeta zoegana* egg at the base of knapweed rosette leaf (UGA1350088).

Description

Agapeta zoegana is a small, bright-yellow moth, 0.44 inch (11 mm) long, with brown wing bands (Fig. 35). Adults may be found resting on the knapweed stems or under the leaves. Eggs are white, turning orange, round but somewhat flattened (Fig. 36). Larvae are white and have a brown head capsule and legs, and about 0.3 inch (7 mm) long (Fig. 37). Pupae are white.

Lifecycle

Adult moths emerge from overwintering as larvae in knapweed roots in early July through early September.

Mating takes place within 24 hours after emergence and the mated female begins ovipositing eggs the next day, laying eggs in the stem crevices and on the leaves of knapweed plants. Eggs are laid singly or in groups of 2 or 3. Adults live 11 to 14 days with each female laying from 21 to 78 eggs in her lifetime. The larvae hatch from the eggs in 7 to 10 days and move immediately to the root cortex. Larvae develop through six instars with mature larvae overwintering in the root and pupating early the next summer.

Impact

There can be multiple larvae in the roots. Larvae are mobile and can move a short distance to other plants. Larval feeding can kill young plants; larger plants often do not flower.

Comments

Agapeta zoegana was first released in the United States in 1984 and is now established in most western states. A pheromone (chemical attractant) system has been developed to monitor this moth (see page 71).



Figure 35. *Agapeta zoegana* adult (UGA1350087).



Figure 37. *Agapeta zoegana* larva in knapweed root (UGA1350089).

Pterolonche inspersa

Order: Lepidoptera
 Family: Pterolonchidae
 Common name: Brown-winged knapweed root moth

Weeds Attacked

Diffuse and spotted knapweed

Description

Pterolonche inspersa adult is a light-brown moth with a 0.8 inch (2 cm) wingspan and 0.3 inch (7 mm) body length. There are no distinct markings on the wings (Fig. 38). The eggs are oval and black.

Lifecycle

P. inspersa produces one generation per year. Adults emerge from June to early September, mate and lay eggs during their short, 15- to 20-day life span. Eggs are laid singly or in small groups on the under-surface of rosette leaves. Upon hatching, the larvae tunnel into the root crown and begin to feed on root tissue. As they reach the root cortex, they spin a silken tube and feed from within the tube. Mature larvae overwinter in the roots of the knapweed plants. In the spring they spin a silken tube 0.8 inch (2 mm) above the soil surface to pupate and provide an easy exit for the emerging adult.



Figure 38. *Pterolonche inspersa* adult (UGA1350090).

Impact

Infested diffuse knapweed plants can be recognized in the spring by the silken tubes around the crown of the rosette. *P. inspersa* larvae cause considerable root damage and as a result, plants attacked by the larvae are stunted and produce fewer flowers. The infested root becomes spongy and easy to pull from the ground. Feeding damage reduces root storage.

Comments

Pterolonche inspersa, a native moth of Europe, was released in 1988. *P. inspersa* larvae are known to eat the larvae of the bronze knapweed root beetle, *Sphenoptera jugoslavica*. This moth is now established in British Columbia and Idaho, approximately 10 years following its release.

Pelochrista medullana

Order: Lepidoptera

Family: Tortricidae

Common name: Gray-winged knapweed root moth

Weeds Attacked

Spotted and diffuse knapweed

Description

Pelochrista medullana is a tan to gray moth with mottled wings measuring 0.4 inch (10 mm) long (Fig. 39). Eggs are oval, flattened and ribbed.



Figure 39. *Pelochrista medullana* adult (UGA1350091).

Lifecycle

Pelochrista medullana produces one generation per year. Adults emerge mid-June to late July to mate (within 24 hours after emergence) and lay eggs. Adults live about 2 weeks. Eggs are laid primarily on the lower surface of rosette leaves. Females can lay up to 120 eggs in warm dry weather but this can be greatly reduced by cold, rainy weather.

Larvae hatch 7 to 9 days after oviposition and move to the center of the rosette and mine into the root crown. Larvae mine spiraling tunnels around the cortex of the root, just under the epidermis, similar to *Agapeta zoegana*. The tunnels are lined with a silken web. Larvae overwinter in the roots and complete development in the spring or early summer. Usually only one larva is found on an infested plant.

Impact

Damage to the roots is similar to that caused by *Agapeta zoegana*. Only third to sixth instar larvae cause measurable damage, reducing root storage capacity and exposing the plant to pathogens. Small plants, <0.4 inch (10 mm) root diameter, can be completely destroyed. Plants that survive insect attack are usually smaller and produce fewer flower heads than uninfested plants.

Comments

This moth was established in 1984. Limited numbers of *P. medullana* have been released in Idaho, Montana, Oregon and British Columbia. However, to date, there is no evidence of establishment of this agent in the United States or Canada.

Cyphocleonus achates

Order: Coleoptera
 Family: Curculionidae
 Common name: Knapweed root weevil

Weeds Attacked

Spotted knapweed preferentially, diffuse and squarrose knapweed secondarily.

Description

Cyphocleonus achates is a large, 0.5 to 0.6 in (13 to 15 mm) long, brown-gray mottled weevil with a short, thick snout (Fig. 40). Eggs are oval, cream-colored and noticeable on the plant. Larvae are white, C-shaped grubs with a brown head capsule, and about 0.5 inch (13 mm) long.



Figure 40. *Cyphocleonus achates* adult (UGA1350064).



Figure 41. *Cyphocleonus achates* pupa in knapweed. root (UGA1350092).

Lifecycle

This weevil has one generation per year. Adults emerge from mid-July to early September with peak emergence at about mid-August. Adults spend most or their life (about 10 weeks) on the root crown, just below the surface. They climb up to the tops of plants on sunny, warm days in search of a mate. Larvae hatch in 10 to 12 days and begin to tunnel into the root central vascular tissue where they will complete their development. Unlike other knapweed weevils, *C. achates* has four larval instars. By the fourth instar, larvae are large, white and obviously C-shaped. *Cyphocleonus achates* overwinters as larvae in the root. Mature larvae can cause a gall to form in the root giving the root a swollen appearance. Pupae are large and white (Fig 41). They pupate in the root gall with the onset of warmer spring temperatures. New adults appear after about two weeks of pupation by chewing their way out of

the root. Evidence of larval damage is a wide tunnel, abundant frass (insect excrement), and a swollen root gall (caused by the third and fourth instar).

Impact

Small plants can be killed as a direct result of larval feeding. Most damage is done when multiple larvae occupy a root or when the attacked roots are small. Older larvae cause a gall to form in the root, which acts as a metabolic sink. Plants are stunted and some survive only one season after being infested with *C. achates*. Tunneling in the root also exposes the plant to bacterial and fungal infection that can cause additional secondary injury.

Comments

This root-boring weevil was first released in the United States in 1988 and is now established in several states and provinces. *C. achates* is not a strong flyer and consequently has been slow to establish and spread. In hot weather adults can be seen on the tops of the plants. Its habit is to sit perfectly still and when disturbed, to drop to the ground and play dead. Up to 25 larvae have been recorded in the same root. This is probably the best knapweed root-boring bioagent available today. Techniques have been developed to mass-rear this insect for greater production and more rapid distribution.

Sphenoptera jugoslavica

Order: Coleoptera

Family: Buprestidae

Common name: Bronze knapweed root borer

Weeds Attacked

Diffuse primarily, spotted and squarrose secondarily.

Description

Sphenoptera jugoslavica adults are about 0.4 inch (10 mm) long, bronze-colored and somewhat flattened (Fig. 42). Eggs are flat and change color from white when first laid, to dark bluish – purple after about five days (Fig. 43). Larvae have an enlarged head and a long thin cylindrical body tapering at the end (Fig. 44, page 50). Pupae are initially white, but later darken.

Lifecycle

Sphenoptera jugoslavica has one generation per year. Adults emerge in mid to late July. They feed on knapweed leaves for two to three days before mating. Females lay multiple eggs during July and August between the base of rosette leaves. Larvae hatch from the eggs and begin to tunnel into the root's central vascular tissue where they will complete their development through three instars. *S. jugoslavica* overwinters as larvae in the root. Larvae pupate in the root gall with the onset of drier conditions and warm temperatures. There can be multiple larvae in the roots. Evidence of larval damage is a wide tunnel, abundant frass, and a root gall.



Figure 42. *Sphenoptera jugoslavica* adult (UGA1350066).



Figure 43. *Sphenoptera jugoslavica* egg (UGA1350093).

Impact

Larvae mining the roots can cause significant impact; adult feeding on the leaves is much less damaging. The larvae cause a gall-like swelling in the knapweed root near the crown. The depletion of root carbohydrates can kill the plant or retard rosette growth. Attacked plants are often stunted and produce fewer seeds the following season. This beetle prefers hot, dry sites typical of those infested with diffuse knapweed, but will also establish on drier spotted knapweed sites.

Comments

Sphenoptera jugoslavica was first released in the United States in 1979 and is now widely established in the western United States and Canada. It performs best in hot, dry diffuse knapweed sites with shallow, stony soil.



Figure 44. *Sphenoptera jugoslavica* larva in a knapweed root (UGA1350067).

Table 7. Summary description of knapweed root borers.

Agent	Moth			Beetle	
	<i>Agapeta zoegana</i>	<i>Pterolonche inspersa</i>	<i>Pelochrista medullana</i>	<i>Cyphocleonus achates</i>	<i>Sphenoptera jugoslavica</i>
Number of Generations	One	One	One	One	One
Adults	Bright yellow moth with brown wing bands	Light brown moth with tan-colored wings	Tan to gray with mottled wings	Large, mottled gray color	Bronze metallic-colored, elongate and flattened
	0.44: (11mm) long	0.8" (2cm) long	0.3" (8mm) long	0.4-0.6" (30-40mm) long	0.4" (10mm) long
Lifespan	11 to 14 days	About 15 days	2 weeks	10 weeks	12 weeks
Eggs	Eggs are white turning orange, round and ribbed, laid singly or in groups of 2-3 in stem and leaf crevices.	Eggs are oval and black, laid singly or in groups of 2-3 on underside of leaf.	Eggs are oval, white and flattened, and ribbed. Laid singly or in small batches on the underside of leaf surface.	Eggs are oval and cream-colored, laid in batches on the root crown, just below the soil surface.	Eggs are oval, flattened, white turning bluish-black, laid on the base of one rosette leaf petiole.
Larvae	Larvae are white and have brown head capsule and legs.	Larvae are elongate, pale and have head capsule and legs. Found in a silken cocoon.	Larvae are elongate, pale and have head capsule and legs. Found in a mined tunnel in silken web.	Larvae are large, C-shaped grubs located inside a gall in the center of the root. 0.1" (2.5mm) long.	Larvae are cylindrical, tapering at the tail end. 0.4" (10mm) long
Pupae	Large, white, appendages fused to body.	Large, white, appendages fused to body.	Large, white, appendages fused to body.	Large, white, with free appendages.	Large, cream colored with free appendages.
Overwinter	Mature larvae in the root.	Mature larvae in the root.	Mature larvae in the root.	Mature larvae in the root.	Mature larvae in the root.

Table 8. Comparison of knapweed root borer lifecycles by knapweed growth stage.

Agent	<i>Agapeta zoegana</i>	<i>Pterolonche inspersa</i>	<i>Pelochrista medullana</i>	<i>Cyphocleonus achates</i>	<i>Sphenoptera jugoslavica</i>
Knapweeds Attacked	Spotted, Diffuse, Squarrose	Spotted, Diffuse	Spotted, Diffuse	Spotted, Diffuse, Squarrose	Spotted, Diffuse, Squarrose
Seedling	Overwinters as larvae in previous year's roots.	Overwinters as larvae in previous year's roots.	Overwinters as larvae in previous year's roots.	Overwinters as larvae in previous year's roots.	Overwinters as larvae in previous year's roots.
Rosette					
Bolting	Larvae pupate and new adults emerge.	Larvae pupate and new adults emerge.	Larvae pupate and new adults emerge.	Larvae pupate and new adults emerge.	Larvae pupate and new adults emerge.
Early Flower Buds					
Late Flower Buds					
Flowering	Larvae hatch and chew into root cortex.	Adults mate and females lay eggs.	Adults mate and females lay eggs.	Adults mate and females lay eggs.	Adults mate and females lay eggs.
Seed Formation	May migrate to other nearby roots and continue development.	New larvae migrate to root vascular tissue.	New larvae migrate to root cortex.	Larvae burrow into root central vascular tissue, forming a gall in the root.	Larvae burrow into root central vascular tissue, forming a gall in the root.
Mature					
Dissemination	Overwinter	Overwinter	Overwinter	Overwinter	Overwinter

CHAPTER 3: ELEMENTS OF A KNAPWEED BIOLOGICAL CONTROL PROGRAM

This chapter discusses the elements necessary to successfully operate a knapweed biological control program. Biological control programs require years of continuous observations and a commitment to specific steps or processes.

To successfully establish a knapweed biological control program, follow these guidelines:

1. **Background information.** Read the information contained in this manual and become familiar with: a) general knowledge of biological control of weeds, b) knapweed species, and c) their biocontrol agents (also referred to as bioagents - species of flies, moths, and beetles, which are the natural enemies of knapweeds). An ability to identify knapweeds (Fig. 45) by appearance and growth stage, each of the biocontrol agents, and what they do to the weed, is essential.
2. **Select the release site.** Make note of the bioagents already present at the selected site.
3. **Schedule field activities.** Timing of the collection and release is crucial in the success or failure of a biocontrol program; thus, pay close attention to scheduling of field activities. For optimum results, follow the timetables suggested in this chapter as closely as possible.
4. **Obtain bioagents.** Obtain and release the natural enemies at the selected site.
5. **Monitor bioagents and vegetation.**



Figure 45. Spotted knapweed (UGA1350068).

A systematic process to establish a knapweed biological control program consists of the following elements:

1. Selecting and preparing study sites
2. Collecting biocontrol agents
3. Transporting biocontrol agents
4. Releasing biocontrol agents
5. Monitoring
 - a) Biocontrol agents
 - b) Vegetation (quantitative and qualitative)
 - c) Establishing photo points

Methods for carrying out each of these processes are discussed in separate sections in this chapter. (For solutions to common problems encountered when establishing a biocontrol program, see Appendix A.)

1. Selecting and Preparing Release Sites

Biocontrol sites are characterized in three ways: 1) study, 2) nursery, and 3) field release site.

Study site. A study site is a release site where the damage and impact is evaluated. Study sites can be used as demonstration areas for educational and training purposes, and can be monitored intensively to determine the effects of bioagents on knapweed over time. However, demonstration and monitoring activities at the study site should be planned carefully because frequent site visits can damage the site through disturbance and trampling of vegetation.

Nursery site. A nursery site, or field insectary, is used to grow large quantities of surplus bioagents for redistribution to other knapweed infested areas where bioagents have not been previously released or are of low density. Nursery sites should be left undisturbed for 3 to 5 years to allow the bioagent populations to increase. Careful monitoring will determine when the bioagent population is large enough to enable collection for redistribution. It is essential that nursery sites receive minimal disturbance.

Field Release. A field release site is simply an open site for general control purposes. Monitoring or redistribution efforts are not planned for these sites.



Figure 46. Spotted knapweed infestation suitable for a biocontrol program. (UGA1350069)

Selecting the Site

The type of site you select will depend on the objectives of your biocontrol program. Visit prospective field sites. Use the following guidelines and criteria to select a site (study, nursery, or field release).

Location. Consider accessibility, slope and cover (avoid shaded, forested sites).

Size of site. An area with at least 2 acres of knapweed infestation is minimal. However, a larger area of infestation is more desirable (Fig. 46).

Presence of bioagents. If bioagents you want to release are already present at the prospective site, move on and choose a different location.

Density of infestation. Choose a moderately dense area of infestation, an area containing three or more knapweed plants per square yard.

Landuse and disturbance factors. Select sites that are not cultivated, away from land development, and where no livestock are grazed.

Pesticides. Select sites which are pesticide-free (no herbicides and insecticides have been or will be applied to the area).

Landowner consent. The landowner/manager must be willing to have the release site available for visitations and monitoring over several to many years. Consent is particularly important when planning a study or nursery site. When getting permission to use a site, be sure to secure the following:

1. Written permission from the landowner or land manager allowing use of the area as a release site.
2. Written agreement by the landowner allowing access to the site for monitoring and collection for a period of at least six years (three years for establishment and buildup and at least three years for collections).
3. Permission to put a permanent location marker at the site.

Preparing the Site

Preparing the release site involves the following activities:

- **Determine the need.** Look for presence of bioagents before the release is made. Some knapweed bioagents are so common and widespread that it is no longer necessary to redistribute them; for example, it is likely that the two *Urophora* flies (*U. affinis* and *U. quadrifasciata*) are already present. If so, it will not be necessary to release these flies at this site.
- **Establish a permanent location marker.** After selecting a site, choose a dense, uniform patch of knapweed in which to place a marker. Use white wood or metal stakes to mark the exact location of the release site. Stakes must be tall (4 feet [1.2 m]) and highly visible so they can be found easily on future visits.
- **Set up a photo point.** A photo point is used to photographically record changes in knapweed infestation (decline or increase) over time following release of bioagents at a site (see page 75). Use a permanent feature in the background as a reference point.
- **Draw a map.** A map and written directions to the study site are essential for other people to locate the site. Note permanent roads, creeks, rivers, mile markers, etc. Include a legal description or latitude and longitude global positioning system (GPS) coordinates so that the site can be easily re-located.
- **Monitor baseline vegetation.** In study sites where vegetation will be monitored, baseline data are used for comparing knapweed infestation measurements before and after releasing bioagents in the area. It is always useful to collect baseline vegetation data even at nursery or field release sites (see page 73).

2. Collecting Biocontrol Agents

Planning and timing of collection is critical. The type of bioagent and the knapweed species will dictate the best time in the season to collect. Ensure that all necessary collection supplies are on hand. Also, accurate identification the bioagents is essential.

Whether collecting larvae or adults, follow these general guidelines.

General Collection Guidelines

Quantity. The minimum needed to optimize establishment is 200 bioagents per site, but more is better.

Containers. Use “breathable” containers at all times. Breathable containers allow air flow to the insects and will not form condensation. One of the best containers to use is a pint-sized, nonwaxed ice cream carton. These are sturdy and breathable. Paper bags can work as temporary containers if care is taken to keep the bag from getting wet or squashed. Do not use plastic bags as containers because they are airtight and will not release moisture. Put a small wad of paper toweling in the container to absorb moisture and to give the insects a crawling surface.

DO NOT USE PLASTIC BAGS AS CONTAINERS

Cooling. Keep bioagents shaded and cool at all times while collecting, sorting, counting and transporting. Bring a cooler with pre-frozen blue ice packs to the field. Secure an ice pack to the interior side of the cooler so that it does not roll around and crush the bioagents (see Fig. 52).

Sorting. Sorting is done after collecting to separate the insects from other organisms and debris, such as weed seeds, collected along with the insects. Empty the contents of the sweep net onto a tray and aspirate or hand-pick the insects out of the debris. For fast moving insects, keep them in the net and grip the top of the net at the rim. Slowly loosen your grip to open the top of the net and collect the insects as they attempt to escape (insects will always move toward the light). If the collected material is first chilled, the insects (especially beetles) move slower and are easier to collect.

Care. Exercise care in handling bioagents (see page 64). Difficulties that may be encountered when collecting bioagents are identified in Tables 9 and 10 (see also Appendix A).

KEEP INSECTS COOL AND SHADED WHILE COLLECTING SORTING, COUNTING OR TRANSPORTING THEM

Table 9. Level of difficulty in collecting knapweed seedhead feeders.

Insect	Life Stage	Method	Level of Difficulty ¹
<i>Urophora affinis</i> <i>U. quadrifasciata</i>	Larva/pupa	Collect seedheads	•
	Adult	Sweep net Rearing	••
<i>Metzneria paucipunctella</i>	Larva/pupa	Collect seedheads Rearing	•
<i>Larinus minutus</i> <i>L. obtusus</i>	Adult	Sweep net	••
<i>Bangasternus fausti</i>	Adult	Sweep net or tapping	••
<i>Terellia virens</i>	Larva/pupa	Collect seedheads Rearing	•
	Adult	Sweep net Rearing	••
<i>Chaetorellia acrolophi</i>	Larva/pupa	Collect seedheads	•
	Adult	Sweep net Rearing	••

¹Level of difficulty: • (easiest) to ••••• (most difficult)

Table 10. Level of difficulty in collecting knapweed root borers.

Insect	Life Stage	Method	Level of Difficulty ¹
<i>Sphenoptera jugoslavica</i>	Adult	Sweep net	••••
<i>Cyphocleonus achates</i>	Adult	Sweep net, hand pick	•••
<i>Agapeta zeogana</i>	Adult	Aspirating Black light	•• ••
	Larva	Rearing from roots	•••
<i>Pterolonche inspersa</i>	Adult	Sweep net	••
<i>Pelochrista medullana</i>	Adult	Sweep net	••

¹Level of difficulty: • (easiest) to ••••• (most difficult)

Planning and Timing

Planning and timing of bioagent collection is critical. It involves knowing where, when, how, and what to collect.

Where to collect

Collect from nursery sites or open field sites that have an abundance of insects. You may wish to consult with your county extension educator, university or state entomologist, or county weed superintendent for an appropriate site.

When to collect

Determine the collection and release date(s) using the recommended timetables for knapweed seedhead feeders and root borers (Tables 11 and 12) as guidelines.

- Due to varying emergence time for individual insects, adult weevils can be seen at other than the optimal emergence periods given in Tables 11 and 12. However, for the greatest success in collecting adult bioagents, collect them during the peak emergence period.
- When sweeping for insects, the best time to collect is during the heat of the day (between 1 and 6 p.m.) because bioagents are more active at that time. Exceptions are *Sphenoptera* adults, which are nocturnal; the best time to collect them is early on warm evenings.
- Wait for a good day. Do not collect in the rain. Flying insects will not be around during a rain; crawling beetles will hide in protected niches and become more difficult to find. Excess moisture problems also occur easily when both the collected bioagents and collection containers get very wet.

How to collect

Choose a collection method to use for the desired life stage (larvae or adults) of the insects (see Tables 11 and 12). The best collection method is the one that 1) produces the greatest number of insects in the least amount of time and effort, 2) produces insects in the best condition, and 3) requires the least handling and sorting (clean collection). The six typical collection methods are as follows: sweep net, aspirator, handpicking, tapping (stick and bucket), black light, and seedhead collecting.

- **Sweep net.** A sweep net is made of cotton or muslin on a hoop, 10 to 15 inches in diameter, attached to a handle 3 feet (0.9 m) long (Fig. 47). As its name implies, it is used to “sweep” insects off the knapweeds. The sweep net method is recommended for

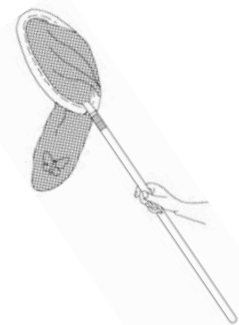

Figure 47. Sweep net.

Table 11. Recommended timetable for collecting knapweed seedhead feeders for redistribution.

Agent	Flies			Beetles		Moth
	<i>Urophora affinis</i>	<i>Urophora quadrifasciata</i>	<i>Terellia virens</i> <i>Chaetorellia acrolophi</i>	<i>Larinus minutus</i> <i>L. obtusus</i>	<i>Bangasternus fausti</i>	<i>Metzneria paucipunctella</i>
What to collect	Larvae or pupae in heads	Larvae or pupae in heads	Larvae or pupae in heads	Adults	Adults	Larvae or pupae in heads
Plant growth stage	Rosette	Rosette	Bolting	Flowering	Early to late bud	Rosette
When to collect	Fall to late winter	Fall to late winter	Fall to late winter	Late July	Mid-June	Fall or late winter
Collection method	Whole plant bouquets	Whole plant bouquets	Whole plant bouquets	Sweep net	Sweep net, tapping	Clip heads, bouquets

Table 12. Recommended timetable for collecting knapweed root borers for redistribution.

Agent	Beetles		Moths	
	<i>Sphenoptera jugoslavica</i>	<i>Cyphocleonus achates</i>	<i>Agapeta zeogana</i>	<i>Pterolonche inspersa</i> <i>Pelochrista medullana</i>
What to collect	Adults	Adults	Adults	Larvae in the roots or adults
Plant growth stage	Flowering (5-10% bloom)	Flowering	Late bud to flowering	Flowering
When to collect	Mid-July to mid-August during warm, calm evenings	Warm, calm, cloudless days during peak emergence in August	Mid-July to late August	Mid-August (adults), late winter (larvae)
Collection method	Sweep net	Hand pick from plants or sweep	Vacuum aspirate, handpick with blacklight	Vacuum aspirate, handpick, or sweep net

collecting adult beetles. It is relatively easy and efficient. It is best to alternate between sweeping insects off the knapweed and aspirating them out of the net. Sweep no more than 25 times before aspirating (Fig. 48). This reduces the potential harm that could result from knocking the bioagents around with debris or other insects inside the net (Tables 11 and 12). Flies are very delicate, thus collecting them with sweep nets can be harmful or fatal. For this reason, sweep-netting is not recommended for collecting flies. Sweep-netting delicate moths can also be harmful. When collecting adult moths, gently sweep the top half of the plants 7 to 10 times and immediately remove the moths from the net.



Figure 48. Sweeping for insects (UGA1350070).

- **Aspirator.** Use an aspirator (Fig. 49) to suck the insects from the knapweed or the sweep net. It is sanitary (no unwanted or unknown material is inadvertently collected and assures the identity and quantity of the agent being released). Aspirating can be done in the field or indoors. When aspirating indoors, cool the insects to make them inactive and easier to aspirate. Seal and label the carton with the species, number of bioagents, collection site and date. Do not use mouth aspirators for collecting adult moths because the scales from moth wings can break off during collection and get inhaled (by the collector).

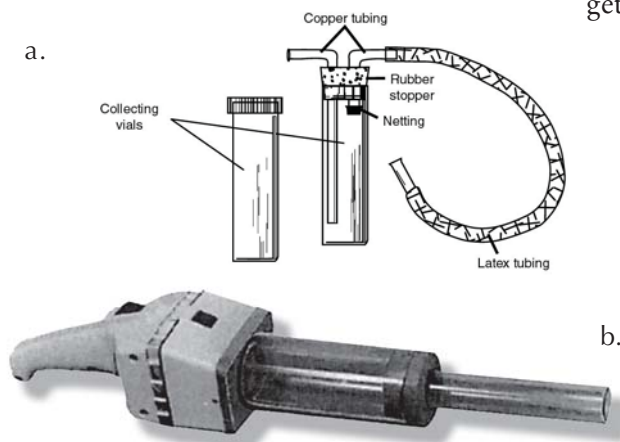

Figure 49. Aspirators for collecting biocontrol agents. a. Manual. b. Hand held vacuum, gasoline or battery powered.

A vacuum aspirator is another device for collecting insects, especially adult moths. It is faster and more sanitary than a mouth aspirator. However, vacuums are cumbersome and not as easy to transport and use as a sweep net and mouth aspirator.

- **Hand-picking.** Simply pick the insects from the knapweed by hand (with the aid of a pair of forceps, if desired). Hand-picking works best for stationary or slow-moving insects like the weevils *Bangasternus fausti* and *Cyphocleonus achates*. *Larinus* beetles can be hand-picked from plants on windy days as they cling tightly to the plants and resist the sweep net.

- **Tapping.** If a sweep net is not available, tapping is the easiest collection method to use for collecting weevils. Using a stick (a badminton racquet works well), gently tap the knapweed stems into a bucket to remove the weevils. Separate the weevils further from unwanted debris and other plant materials, then place them in a breathable container. Use a funnel to aid in

trapping the weevils into the bucket. To make a funnel, cut a plastic soda pop bottle in half, invert the small neck into the bottom and tape the two pieces together. Do not use funnels of this type for flies or moths.

- **Black light method.** Black ultraviolet (UV) lights attract moths at night. This method is used to monitor the nocturnal *Agapeta zoegana*. To use, suspend the black light from a post or set it up on top of a vehicle. Put a white sheet beneath the lights and on the ground to collect the moths that land on the sheet. Either hand-pick or use a vacuum aspirator to collect the moths and place them in a container.

What to collect

Biocontrol agents are collected as larvae, pupae and adults (see Tables 11 and 12 for the appropriate life stage in which to collect bioagents).

Collecting adults

Of the three types of knapweed insects (flies, moths and beetles), the beetles are best collected as adults. Fly and moth adults are more delicate than beetles and can be easily harmed or killed during collection. The ideal weather for collecting insects is a sunny, warm day with a slight breeze. It is best to collect bioagents when they are mating to collect both males and females and to ensure that eggs will be laid at the new site. If the insects are not mating and a collection is made too early or too late, the collection may be mostly one sex and the new population may not establish at the release site.

- **Beetles.** Adult beetles can be collected by hand or with a sweep net. Hand-picking is also a suitable, though slower, method for collecting adult weevils. They are generally slow and, in the case of *Cyphocleonus* usually flightless.
- **Moths.** Collect adult moths with a sweep net. Moths are more fragile than beetles thus greater care is needed during sweeping. Note that the black light method can be used to collect *Agapeta* moths. Carefully place adult moths in a container lined with tissue-paper or paper towel (Fig. 50).
- **Flies.** Sweeping adult seedhead flies is possible, but not recommended. Adult flies are fragile and can be damaged during collection. Gathering heads



Figure 50. Paper-towel lined carton containing adults of knapweed seedhead moth *Metzneria paucipunctella* (UGA1350071).

infested with larvae or pupae is the best way to collect and redistribute flies (see below).

Collecting larvae

- **Beetles.** Beetles are usually collected as adults, not larvae. Seedhead weevil larvae are not generally collected. Root beetle larvae may not survive if the root is collected (dug out); thus adult beetles are usually collected (see above).
- **Moths.** Larvae of the seedhead moth *M. paucipunctella* can be easily and successfully collected. Collect infested head in late winter or early spring. Root-boring moths (*Agapeta*, *Pterolonche* and *Pelochrista*) are best collected as adults although the moth *A. zoegana* can be collected as mature larvae in the root.
- **Flies.** Flies are best collected as larvae or pupae. Collect infested heads in late winter or early spring (they are overwintering in the heads). Heads can be taken indoors to rear out adults, or taken to the new site and left to emerge as adults under natural conditions (see page 68).

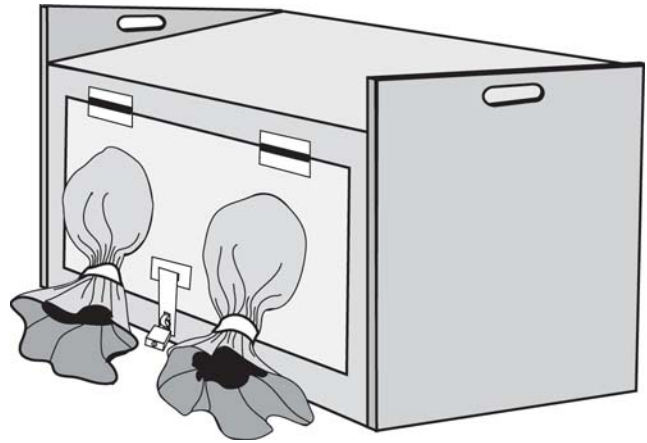

Figure 51. Insect rearing cage, or sleeve box.

Rearing flies indoors

Collect several hundred dry seedheads from last year's plants and put them in labeled paper bags. Once indoors, adults will likely emerge in a few weeks, so time the collection of heads carefully. You do not want adults to emerge too early and be out of synchrony with the knapweed plants, so collect heads a few weeks before flies would normally emerge outdoors. Empty infested seedheads from bag into a clear, breathable container such as a covered terrarium or in a rearing cage (Fig. 51). Leave the heads at room temperature. In 2-3 weeks, adult flies or moth will begin to emerge from the seedheads. Collect the adults that emerge, package and release them at the new site, or ship them to a cooperator.

3. Handling Biocontrol Agents

How the bioagents are handled after collection and transported to the release site can affect whether the bioagents will survive and multiply at the new site.

This section contains guidelines for transporting and shipping the bioagents.

Transporting the Bioagents

How the bioagents are handled and transported can greatly impact whether they become established. It is best to redistribute the bioagents immediately after they are collected to prevent injury to the specimens, within 24 hours if possible.

- **For immediate redistribution.** Store the insects in a breathable container with fresh knapweed foliage, crumpled tissue paper or paper towel.
- **For later redistribution.** Store the insects in a refrigerator. Bioagents can last up to three days in a refrigerator; however, only one day of refrigerated storage is recommended. For storage longer than one day, follow the guidelines for keeping bioagents alive during transportation, shipping or storage.
- **Seal and label the container.** Seal with tape and label the container with the name of the bioagent, the quantity collected, and collection date. Tape a blue ice pack to the bottom of the cooler to avoid physical damage. Put a barrier (e.g., newspaper) between the ice pack and the bioagents to protect the bioagents from excess moisture or cold.

Supplies Needed

- Breathable container
- Masking tape
- Paper towel or styrofoam (for transporting)
- Cooler
- Blue ice pack
- Cardboard box (for shipping)

DO NOT ALLOW CONTAINERS TO TOUCH THE BLUE ICE PACK

Shipping the Bioagents

To ship bioagents over a long distance, plan the route and timing of shipments to prevent undue delays and stress on the bioagents. Ship the agents by overnight courier and advise your cooperator as to when they are being shipped, when they can expect to receive them, and to release the insects immediately. Try to collect on Sunday or Monday and ship Tuesday so shipments can be received before the weekend. Avoid shipping late in the week, and be aware of holidays, etc, that can delay shipping. Overall, observe the following guidelines:



Figure 52. Styrofoam-lined shipping box containing blue ice pack and biocontrol agent cartons (UGA1350072).

- **Know the regulations.** Observe appropriate rules, restrictions and regulations pertaining to shipping bioagents to a cooperator or moving bioagents out of the county or state. For the current regulations, contact your local weed district, cooperative extension agent, the state Department of Agriculture, or the USDA Animal and Plant Health Inspection Service (APHIS).

- **Prepare the bioagents.** Sort the bioagents from all other unwanted material to avoid contamination at the receiving site. Put bioagents in shipping containers with enough space to allow the insects to move about within the container. Do the following:

- Provide the insects with a crawling surface by lining the container with crumpled tissue paper or paper towel.
- Do not put food or water in the container.
- Tape lids on the containers and make sure the bioagents do not get caught on the sticky part of the tape.
- Pack the shipping container with care. Tape the blue ice packs to the inner side of the chest and pack with a layer of paper to absorb condensation (Fig. 52). Keep the bioagents cool until they are shipped.

Summary: Care of the Bioagents

- Provide the bioagents with a crawling surface such as crumpled paper towel or tissue.
- Avoid physical damage to the bioagent by taping down potentially harmful objects, such as blue ice packs.
- Ensure that predators (i.e. spiders) are not trapped with the bioagent in the container by sorting bioagents before packaging them.
- Provide container with adequate ventilation. If necessary, punch holes in the lid with a pin.

Common Mistakes

- **Excess heat.** Do not expose bioagents to direct sunlight
- **Excess moisture.** Remove spilled or excess water in the container
- **Lack of air.** Provide adequate ventilation; use only breathable containers.

- Do not expose bioagents to heat above 80° F (26°C). Keep shipping containers in a cooler out of direct sunlight.
- If release or shipping is not immediate, store the bioagents in refrigerators no colder than 40° to 50° F (4°C) for a no longer than 2 days or keep them in an ice chest until the bioagents are ready to be shipped or transported. Longer storage decreases the bioagents’ chance for survival at the new site.

4. Releasing Biocontrol Agents

Timing of the bioagent release will determine whether the bioagents will survive and flourish at the new site. Follow these steps for releasing bioagents:

1. **Place the permanent location marker.** Release the insects at the location marker. This location will be later used to monitor activities.
2. **Make the release.** Consult Table 13 to determine the appropriate method to use for releasing each insect.
3. **Take pictures.** Take a series of photographs to record the release. A photo point will record the change in the site over time (see page 75).
4. **Collect baseline vegetation data.** Choose a monitoring method listed in Tables 14 and 15. Establish baseline data at the time of the release. Use the same monitoring method every year.

Table 13. Appropriate release method for each bioagent.

Agent	Release Method
<i>Urophora affinis</i>	Tie bouquets of infested seedheads to a fence post
<i>Urophora quadrifasciata</i>	Tie bouquets of infested seedheads to a fence post
<i>Terellia virens</i>	Release 200 adults within 24 hrs of emergence
<i>Chaetorellia acrolophi</i>	Release 200 adults within 24 hrs of emergence
<i>Metzneria paucipunctella</i>	Release 200 adults OR place infested seedheads
<i>Larinus minutus</i>	Release 200 adults
<i>Larinus obtusus</i>	Release 200 adults
<i>Bangasternus fausti</i>	Release 200 adults
<i>Agapeta zoegana</i>	Release 100-200 adults
<i>Pterolonche inspersa</i>	Release 200 adults
<i>Pelochrista medullana</i>	Release 200 adults
<i>Cyphocleonus achates</i>	Release 100-200 adults, depending on difficulty of collection
<i>Sphenoptera jugoslavica</i>	Release 100-200 adults, depending on difficulty of collection

Table 14. Recommended timetable for monitoring knapweed seedhead feeders.

Season	Spring		Summer		Fall		Winter	
	Early	Late	Early	Late	Early	Late	Early	Late
<i>Urophora affinis</i>	Dissect year-old seedheads for larvae and pupae		Collect adults by sweeping			Dissect year-old seedheads for larvae and pupae		
<i>Urophora quadrifasciata</i>	Dissect year-old seedheads for larvae and pupae		Collect adults by sweeping			Dissect year-old seedheads for larvae and pupae		
<i>Terellia virens</i>	Dissect year-old seedheads for larvae and pupae		Collect adults by sweeping			Dissect year-old seedheads for larvae and pupae		
<i>Chaetorellia acrolophi</i>	Dissect year-old seedheads for larvae and pupae		Collect adults by sweeping			Dissect year-old seedheads for larvae and pupae		
<i>Metzneria paucipunctella</i>	Dissect year-old seedheads for larvae and pupae		Collect adults by sweeping			Dissect year-old seedheads for larvae and pupae		
<i>Bangasternus fausti</i>		Sweep mating adults			Count exit holes in seedheads (see Fig. 57)			
<i>Larinus minutus</i>		Sweep mating adults			Count exit holes in seedheads (see Fig. 57)			
<i>Larinus obtusus</i>		Sweep mating adults			Count exit holes in seedheads (see Fig. 57)			

5. Fill out and submit a release form.

Complete the Biological Control Agent Release Form (see Appendix B). Submit the form to your county extension educator, university or state department of agriculture. Keep a copy for your records.

Timing the Release

Release bioagents (Fig. 53) at the appropriate growth stage of the knapweed or check with your county extension agent or county weed supervisor. If most knapweed plants are beyond the recommended stage, it is too late to release at that site.



Figure 53. Releasing knapweed bioagents on spotted knapweed (UGA1350073).

Table 15. Recommended timetable for monitoring knapweed root borers.

Season	Spring		Summer		Fall		Winter	
	Early	Late	Early	Late	Early	Late	Early	Late
<i>Agapeta zoegana</i>	Dissect roots for larvae			Trap males in pheromone traps				
				Aspirate adults from plants, visual counts, blacklight				
<i>Pelochrista medullana</i>	Dissect roots for larvae and pupae		Sweep adults, blacklight					
<i>Pterolonche inspersa</i>	Dissect roots for larvae and pupae		Sweep adults, blacklight		Sweep or hand-pick adults			
<i>Cyphocleonus achates</i>	Dissect roots for larvae and pupae			Sweep adults Visual counts				Dissect roots for larvae
<i>Sphenoptera jugoslavica</i>	Dissect roots for larvae and pupae			Sweep adults Visual counts				Dissect roots for larvae

Do not wait for good weather. If you must release in the rain, provide shelter for the bioagents until they can disperse on their own. One way to do this is to place a cardboard box on its side, place the container in the box and open the lid. The bioagents will disperse when weather conditions improve.

Methods of releasing bioagents are as follows:

- **Direct placement of fly-infested heads.** The easiest method for releasing flies and the seedhead moth is to place bouquets of infested plants at the new site. Collect last year’s plants in late winter, tie them into bouquets, take them to the new site and secure the bouquets to fence post or stake. Adults will emerge later in the spring as usual and colonize the new site. Retain 50 heads from the bouquet, put them in a labeled paper bag or dry container and allow the insects to emerge indoors, so that you know for sure which species you released at the new site. You can also estimate the number released based on how many adults emerge from the 50 heads.
- **Open-field release.** When releasing adult weevils, moths or flies, place the bioagents on the ground within a 3 foot radius of the permanent location marker under knapweed plants where they can continue to mate and disperse on their own.

- **Caged release.** An alternative to open-field release is to put the insects in a release cage or tent (Fig. 54). The bottomless tent, placed over a patch of knapweed, is very useful in keeping flying insects together while giving them “natural” conditions. Another simpler release cage is constructed from plastic milk jugs (Fig. 55) used for seedhead flies and moths. The cover over the jug keeps the seedheads dry; newly emerged adults can escape through the hole under the handle, and seeds are not released into the environment (the jug, with seeds, can be removed later).



Figure 54. Screen tent cage in which to release and contain knapweed bioagents (UGA1350041).

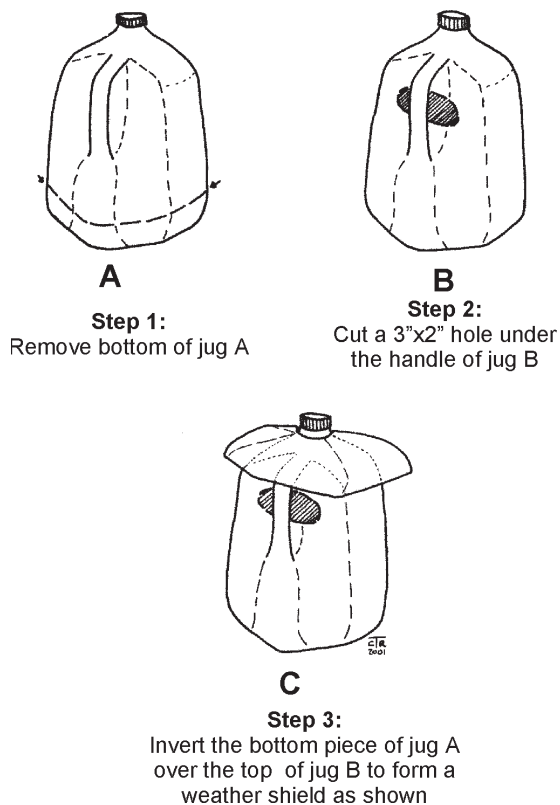

Figure 55. Milk jug release cage for knapweed bioagents.

Retaining Voucher Specimens

Retain 5 to 10 living or dead bioagents. Put the bioagents in a small vial with 70 percent ethyl alcohol for a voucher specimen. On a piece of white paper, in pencil (always use a pencil because alcohol will dissolve and bleed ink from pens and markers), write the name of the bioagent, source of the bioagent, the date of release, person or agency releasing, and release site. Put inside the vial. This identifies the bioagent released for future reference. Save several specimens for in-house records. Send the voucher specimens to your county extension educator or weed biocontrol expert.

Frequency of Release

Generally, if done correctly a single release will be sufficient to establish a bioagent population. More than one release might be needed if a prior release fails. It might take 2 years to determine if the release was successful.

Questions to Ask

- Are the bioagents already present at the site?
- Did the bioagents successfully establish following release?
- Are the bioagents found in high enough density to be collected and distributed?
- How far have bioagents dispersed from the initial release sites?
- Are the bioagents causing visible damage to the target weed?
- Are changes occurring within the plant community?

Answers to these questions will allow land managers to do the following:

- Determine the success of biological control efforts for target weed populations.
- Determine if a supplemental release is needed.
- Establish that biocontrol agents are impacting the target weed.
- Document changes in the plant community.

Releasing Multiple Bioagents

It is expected that bioagent populations will overlap and eventually sort themselves out naturally depending on the habitat, population density, and weed levels. As a rule, however, separate the species by at least 100 meters to allow your insect to establish without being impeded by another species.

Suggestions for Optimal Establishment

- A release of at least 200 bioagents.
- Releasing in the early morning hours between 6 and 10 a.m. or in the cooler evening hours between 7 and 8 p.m. is recommended. Bioagents are less likely to fly away immediately when released in cool temperatures.
- Avoid releasing bioagents during rainy or very hot weather for optimal establishment. However, sometimes it may be necessary to release in the rain.
- Releasing weevil bioagents at the bottom of a hill may encourage them to follow the phenological progression of the knapweed uphill, which may possibly increase the rate of spread; however, there is no data to support this observation.
- Common sense and care is a major factor in the survival and establishment of the insects.

5. Monitoring

Monitoring is an activity that tracks changes in the population that you are observing or measuring. In biocontrol, it involves monitoring bioagents (insects) or vegetation at the study site. Monitoring is conducted to: 1) ensure that the bioagents have established, 2) determine if the bioagents have spread from the release site, and 3) assess the impact of the bioagents on the target knapweed. Review the box, *Questions to Ask* (previous page), to determine your monitoring objectives.

Monitoring Bioagents

There are many methods used to monitor insects, including:

- Visual observations along a transect to count adults
- Sweep net sampling to count adults
- Using black light to capture and count nocturnal adult moths
- Use of pheromone traps to capture adult male *Agapeta zoegana* moths
- Dissecting roots and seedheads to observe larvae.

Outline your objectives before you begin monitoring (see Appendix C).

When to Begin Monitoring

Some bioagents may be detected as early as 1 year following release.

Some bioagents take 2 to 3 years to be detectable. Thus, if no bioagents are detected a year after the release, it does not mean that the insects failed to establish. Revisit the site for three years. If no evidence of insects is seen, either choose another site or make additional releases (see Appendix A). Consult with your county extension educator or local biocontrol of weeds expert.

Monitoring Methods

The monitoring method you choose depends on the:

- Life stage of the insect
- Amount of time available
- Expertise of the observer
- Availability of equipment
- Monitoring objective

For example, to merely determine if bioagents are established at the release site, observing any life stage is adequate. To determine the density of insects at the release site (i.e., number of insects per root), more detailed and intensive monitoring is

needed. Likewise, if you want to know how far the bioagents have spread from the release site, a more systematic monitoring method is needed.

Additional Monitoring Methods

It is usually necessary to collect bioagents in order to monitor their population and activity. Insect monitoring uses the same methods used to collect bioagents for release (see page 57). Additional monitoring methods including pheromone trapping, manual counting, and dissecting roots, are discussed below.

- **Pheromone Trap Method.** Sex pheromones are chemical attractants (odor) exuded by insects to attract the opposite sex. They are highly specific to one species of insect. Pheromones are used in many areas of insect pest management. The pheromone is artificially synthesized, packaged, placed in a trap and set out in the field. In the biocontrol of knapweed,



Figure 56. Pheromone trap used to monitor adult male *Agapeta zoegana* moths (UGA1350074).

this method is currently only available for the knapweed root moth, *Agapeta zoegana*. The pheromone trap, called a Delta trap (Fig. 56), is used to attract male moths. It is considered by some to be the best monitoring method for this insect.

- **Manual counting of adults.** This is an easy, fast and inexpensive way to monitor insects. Using six to ten transects, 60 feet (20 m) long, radiating away from the permanent location marker at the release site, count the number of adult insects you see on or near the plants in a circle with a diameter of 3 to 5 feet (0.9-1.6 m) every 20 feet (6.6 m) along the transect.

- **Dissecting roots for bioagent larvae.** This method is used to count larvae found in the knapweed roots. Using a transect of 30 feet (9.8m), dig a root (no smaller than $\frac{3}{4}$ inch (1.9 cm) diameter at the crown) every 3 feet (0.9 m). Roots can be examined on-site or taken back to the office or laboratory for dissection later. Cut the root longitudinally to expose the larva(e).

A Method for Sampling Plants to Evaluate Feeding Damage

Collect six plants along each of four lines in four cardinal directions (N, S, E, W) from the permanent location marker, for a total of 24 plants. Heads can be dissected indoors to see if they contain bioagent larvae or pupae. When sampling roots, dig one root at a time and slice it lengthwise to expose the center.

Label collection bags with site name, date and transect, and take the collected plants indoors for detailed examination later.

Count and record the total number of buds, flowers and mature seedheads collected from each plant. Dissect each bud carefully. Seedheads with weevils can be examined for damage by counting the number of exit holes on the plants (Fig. 57).

Fill out “Biocontrol Monitoring Report” (Appendix D).

Monitoring Vegetation

Vegetation monitoring is conducted to describe and measure changes in the knapweed population following the release of bioagents. It consists of taking multiple measurements of a variable, such as plant height, density or number of seedheads. Analysis is performed to determine if changes in the weed infestation have occurred. The type of vegetation monitoring to use depends on the type of site (e.g., study or nursery site), availability of resources, and your monitoring objective.

Monitoring can be as simple as before-and-after photos, or counting seeds left in seedheads, or as intensive as conducting field studies for accurate and detailed assessment over time. The level of intensity used in monitoring should be dictated by the questions you want to address and the level of precision you need in the answer. In general, the simpler the monitoring method, the greater the likelihood of obtaining consistent and useful information. Develop a plan for collecting data based on the monitoring objectives. Use the “Monitoring Plan Questionnaire” (see Appendix C) to determine the objective or purpose of monitoring.

Two types of monitoring are *qualitative* and *quantitative*.

Qualitative Monitoring

Qualitative monitoring uses descriptive elements about knapweed at the management site. It includes such general recording of presence or absence of bioagents, estimates of density, age and distribution classes, infestation mapping, and permanent photo points. Qualitative monitoring tends to be quick and inexpensive, and provides some insight into the status or change of the knapweed population. Its descriptive nature does not allow for detailed statistical analysis. Data obtained in qualitative monitoring may trigger more intensive monitoring later on. In addition, interpretations derived from this type of monitoring are often subjective.



Figure 57. Exit holes in spotted knapweed seedheads created by adult weevils (UGA1350075).

Quantitative Monitoring

The purpose of quantitative monitoring is to record and measure changes in the knapweed population after release of the bioagents. Quantitative monitoring can be as simple as counting the number of flowering knapweed plants in an area, or as detailed as measuring plant height (Fig. 58), seed production, rosette diameter and density, biomass, or plant community diversity. The data can be statistically analyzed and generally give precise information on population or community changes. In quantitative monitoring, sampling is more detailed than in qualitative monitoring (e.g., plant height, rosette diameter, number and size of seedheads, percent cover, species diversity). Quantitative monitoring takes more time to plan and implement, making it more expensive. It may also require specialized skills and training.



Figure 58. Measuring knapweed height at a quantitative monitoring site (UGA1350076).

Quantitative monitoring takes more time to plan and implement, making it more expensive. It may also require specialized skills and training.

A suggested format for qualitative and quantitative monitoring:

- **Choose location to monitor.** Begin monitoring where the bioagents were first released since this is where the highest density agents is likely to occur and therefore where changes to the knapweed are more likely to be detected.
- **Schedule monitoring activities.** Schedule monitoring activities at the same time each year to be consistent and compare year-to-year variation.
- **Determine a photo point.** Establish a permanent photo point in the monitoring area. The photo point is an area where estimated cover and/or density classes of the knapweed can be recorded. Be sure to label the photo point. Create a photo record beginning at the time of bioagent release and at 2-year intervals thereafter (called before-and-after photos). Trends and changes in the knapweed infestation and the plant community over time can be visually assessed with photographs.
- **Plan.** This step involves knowing what and how much data to collect before starting. Consult an experienced field technician, researcher or statistician for guidance on the design of your monitoring plan. The types of variables usually measured are one or more of the following:
 - **Visual estimates (qualitative).** Record visual estimates of canopy cover. Determine the density and distribution classes of knapweeds at the release site at 1- or 2-year intervals (distribution classes are seedlings, rosettes, bolted and mature). Fill out a qualitative monitoring report (see Appendix E). Personnel may have to be trained in estimating general vegetation attributes.

- **Counts** (*quantitative*). Count the number of seedlings, rosettes, seedheads, flowering knapweed plants within the quadrat. Seeds can be counted from a sub-sample of heads (about 30 heads) within the quadrat.
- **Measurements** (*quantitative*). Measure plant height, stem diameter, plant circumference, etc.
- **Choose a monitoring method.** Choice of a monitoring method depends on the amount of time available to conduct the work and the monitoring objectives. Two methods of quantitative monitoring are *transects* and *macroplots*.
 - **Transect.** A transect is a straight line measured on the ground along which vegetation is sampled. Transect lines can be as long as 300 feet (100 m) or as short as 30 feet (10 m). Vegetation along the transect is sampled or measured using a quadrat placed at regular intervals along the transect (i.e., every 10 feet (3.2 m)). While transects are a more systematic method of sampling vegetation, the location of the transect can be random. Transects are faster and easier to set up and use than macroplots (see Appendix F).
 - **Macroplot.** The purpose of the macroplot is to define a large area (e.g., 4 acres [1.6 hectares]) within which randomly placed small quadrats (1 sq. yd or 1 sq. m) are used to sample vegetation (see Appendix G). Although the macroplot is very useful and allows for sampling over a large area, it can cause considerable trampling by people at the site during sampling.

Supplies Needed

- Camera (35 mm or digital)
- Color film (if 35 mm)
- Notebook and forms
- Metal or wooden stake for camera point
- Bright spray paint
- Previous year's photo

Establishing a Photo Point

Photographs of the release site are a valuable assessment tool. Visual evidence of vegetation change over time is derived from comparing pictures of the same site taken from the same location, at the same time of year, with the same horizon, and taken over a period of years. Records consisting of photographs are a qualitative form of monitoring and can be used in conjunction with more intensive quantitative monitoring techniques (see page 74).

- **Take baseline photographs at the time of the release.** Choose the time of year to take the first set of pictures; flowering stages are ideal because of the contrasts with the surrounding vegetation. Once a year is sufficient but it is good practice to frequently take pictures of the site.

- **Locate a photo point.** The location of the photo point is determined at the time of establishing the release site. Note and document the location of the photo point marker in case of need to relocate it later. When photographing the site, point your camera so as to include the permanent marker location in the scene.
- **Close-up pictures.** Close up pictures are useful to show the amount of ground covered by vegetation and litter. A square frame, 3 feet x 3 feet, is recommended. Frames can be made of PVC pipe, steel rods, rebar, etc. Drive brightly painted angle iron stakes into the corners to permanently establish the plot. Repaint the stakes each time photos are taken. Put a plot identification label on the ground next to the frame. The camera point should be on the north side of the photo, so that pictures can be taken at any time of the day without a shadow.
- **General view pictures.** General view pictures give a broad view of the release site and the surrounding landscape.
 - Establish the point approximately 100 feet from the permanent location marker.
 - Choose an angle that will best show changes in the knapweed infestation over time.
 - Include a photo identification label, a general view of the site, some sky, and a reference point in the foreground (fence post, shrub, or person), and a distinct landmark on the skyline.
 - Use photos taken the previous year as reference for the following year's photos.

SELECTED REFERENCES

The following references were selected to give the reader a good overview of literature relevant to the biology and biological control of knapweed. For a more comprehensive list of references, see Story and Smith (2000).

Insects

Agapeta zoegana

- Bobylev, M. M., L. I. Bobyleva, and G. A. Strobel. 1996. Synthesis and bioactivity of analogs of maculosin, a host-specific phototoxin produced by *Alternaria alternata* on spotted knapweed (*Centaurea maculosa*). *J. Agric. and Food Chem.* 44: 3960-3964.
- Fitzpatrick, S. M. 1989. A potential collection method for *Agapeta zoegana* (Lepidoptera: Cochylidae), a knapweed-root-feeding moth. *J. Entomol. Soc. Brit. Columbia* 86: 55-62.
- Müller, H. and D. Schroeder. 1982. Investigations on *Agapeta zoegana* L. (Lep. Cochylidae), a possible biocontrol agent of spotted knapweed, *Centaurea maculosa* Lam. (Compositae) in Canada. Final Report, Commonw. Inst. Biol. Cont., Delemont
- Müller, H., D. Schroeder, and A. Gassmann. 1988. *Agapeta zoegana* (L.) (Lepidoptera: Cochylidae), a suitable prospect for biological control of spotted and diffuse knapweed, *Centaurea maculosa* Monnet de la Marck and *C. diffusa* Monnet de la Marck (Compositae) in North America. *Can. Entomol* 120: 109-124.
- Powell, G. W., B. M. Wikeem, and A. Sturko. 2000. Biology of *Agapeta zoegana* (Lepidoptera: Cochylidae), propagated for the biological control of knapweeds (Asteraceae). *Can. Entomol.* 132: 223-230.
- Story, J. M., K. W. Boggs, and W. R. Good. 1991. First report of the establishment of *Agapeta zoegana* L. (Lepidoptera: Cochylidae) on spotted knapweed, *Centaurea maculosa* Lamarck, in the United States. *Canadian Entomologist* 123(2): 411-412.
- Story, J. M., W. R. Good, and L.W. White. 1994. Propagation of *Agapeta zoegana* L. (Lepidoptera: Cochylidae) for biological control of spotted knapweed: procedures and cost. *Biological Control.* 4: 145-148.
- Story, J. M., W. R. Good, L. J. White, and L. Smith. 2000. Effects of the interaction of the biocontrol agent, *Agapeta zoegana* L. (Lepidoptera: Cochylidae), and grass competition on spotted knapweed. *Biological Control* 17: 182-190.

Sturdevant, N. J. and Kegley, S. J. 2000. How to select optimal sites for the establishment of *Agapeta zoegana* and *Cyphocleonus achates*, two root-feeding insects of spotted knapweed. USDA For. Serv. Northern Region Report R1-00-25.

Sturdevant, N. J. and Kegley, S. J. 2000. How to monitor knapweed biological control root-feeding insects: *Agapeta zoegana* and *Cyphocleonus achates*. USDA For. Serv. Northern Region Report R1-00-26.

Bangasternus fausti

Campobasso, G., R. Sobhian, L. Knutson, and G. Terragitti. 1998. Host specificity of *Bangasternus orientalis* Capiomont (Coleoptera: Curculionidae) introduced into the United States for biological control of yellow starthistle (*Centaurea solstitialis* L., Asteraceae: Carduae). Environ. Entomol. 27(6): 1525-1530.

Sobhian, R., G. Campobasso, and P. H. Dunn. 1992. Biology of *Bangasternus fausti* (Coleoptera: Curculionidae), a potential biological control agent of diffuse knapweed (*Centaurea diffusa*), and its effect on the host plant. Entomophaga 37(1): 50-58.

Sobhian, R., G. Campobasso, and P. H. Dunn. 1992. A contribution to the biology of *Bangasternus fausti* (Col.:Curculionidae), a potential biological control agent of diffuse knapweed, *Centaurea diffusa*, and its effect on the host plant. Entomophaga 37: 171-179.

Chaetorellia acrolophi

Groppe, K. and K. Marquardt. 1989. *Chaetorellia acrolophi* White and Marquardt (Diptera: Tephritidae), a suitable candidate for the biological control of diffuse and spotted knapweed in North America. CAB International Institute of Biological Control Report.

Cyphocleonus achates

Stinson, C. S. A. 1987. Investigations on *Cyphocleonus achates* (Fabr.) (Col.: Curculionidae), a potential biological control agent of spotted knapweed (*Centaurea maculosa* Lam.) and diffuse knapweed (*C. diffusa* Lam.) (Compositae) in North America. CAB International Institute of Biological Control, European Station, Report. 37 pp.

Stinson, C. S. A., D. Schroeder, and K. Marquardt. 1994. Investigations on *Cyphocleonus achates* (Fabr.) (Col., Curculionidae), a potential biological control agent of spotted knapweed (*Centaurea maculosa* Lam.) and diffuse knapweed (*C. diffusa* Lam.) (Compositae) in North America. J. Appl. Entomol. 117: 35-50.

- Story, J. M., W. R. Good, and L. J. White. 1997. First report of the establishment of *Cyphocleonus achates* (Fahraeus) (Coleoptera: Curculionidae) on spotted knapweed, *Centaurea maculosa* Lamarck, in the United States. Canadian Entomologist. 129(2): 373-374.
- Story, J. M., L. J. White, and W. R. Good. 1996. Propagation of *Cyphocleonus achates* (Fahraeus) (Coleoptera: Curculionidae) for biological control of spotted knapweed: procedures and cost. Biological Control. 7: 167-171.
- Wikeem, B. M. and G. W. Powell. 1999. Biology of *Cyphocleonus achates* (Coleoptera: Curculionidae), propagated for the biological control of knapweeds (Asteraceae). Can. Entomol. 131: 243-250.

Larinus minutus

- Groppe, K. 1990. *Larinus minutus* Gyll. (Coleoptera: Curculionidae), a suitable candidate for the biological control of diffuse and spotted knapweed in North America. Report. CAB International Institute of Biological Control, European Station, Delemont, Switzerland.
- Jordan, K. 1995. Host specificity of *Larinus minutus* Gyll. (Col., Curculionidae), and agent introduced for the biological control of diffuse and spotted knapweed in North America. J. Appl. Ent. 119: 689-693.
- Kashefi, J. M. and R. Sobhian. 1998. Notes on the biology of *Larinus minutus* Gyllenhal (Col., Curculionidae), an agent for biological control of diffuse and spotted knapweeds. J. Appl. Ent. 122: 547-549.
- Lang, R. F., J. M. Story, and G. L. Piper. 1996. Establishment of *Larinus minutus* Gyllenhal (Coleoptera: Curculionidae) for biological control of diffuse and spotted knapweed in the western United States. Pan-Pac. Entomol. 72: 209-212.

Larinus obtusus

- Groppe, K. 1992. *Larinus obtusus* Gyll. (Col: Curculionidae), a candidate for biological control of diffuse and spotted knapweed. CAB International Institute of Biological Control Final Report.

Metzneria paucipunctella

- Harris, P. and A. Muir. 1986. Biological control of spotted knapweed by *Metzneria paucipunctella* (Zeller). Canadex 641.613, Agric. Canada. 2 p.

Story, J. M., K. W. Boggs, W. R. Good and R. M. Nowierski. 1989. The seed moth, *Metzneria paucipunctella*: Its impact on spotted knapweed seed production and two seed head flies, *Urophora* spp, pp.172-174. In P.K. Fay and J.R. Lacey (editors), Proceedings of the 1989 Knapweed Symposium, April 4-5, 1989, Bozeman, Mt. Plant and Soil Department and Extension Service, Montana State University, Bozeman, Montana.

Story, J. M., K. W. Boggs, W. R. Good, P. Harris and R. M. Nowierski. 1991. *Metzneria paucipunctella* Zeller (Lepidoptera: Gelechiidae), a moth introduced against spotted knapweed: its feeding strategy and impact on two introduced *Urophora* spp. (Diptera: Tephritidae). Can. Entomol. 123: 1001-1007.

Pelochrista medullana

Gassmann, A., D. Schroeder, and H. Muller. 1982. Investigations on *Pelochrista medullana* (Stgr.) (Lep.: Tortricidae), a possible biocontrol agent of diffuse and spotted knapweed, *Centaurea diffusa* Lam., and *C. maculosa* Lam. (Compositae) in North America. Final Report, CAB, Delemont, Switzerland.

Pterolonche inspersa

Campobasso, G., R. Sobhian, L. Knutson, A. C. Pastorino, and P. H. Dunn. 1994. Biology of *Pterolonche inspersa* (Lep.: Pterolonchidae), a biological control agent for *Centaurea diffusa* and *C. maculosa* in the United States. Entomophaga 39: 377-384.

Dunn, P. and G. Campobasso. 1989. Host damage by *Pterolonche inspersa* (Lepidoptera: Pterolonchidae) and *Bangasternus fausti* (Coleoptera: Curculionidae) on diffuse knapweed (*Centaurea diffusa*), p. 171. In Delfosse, E. S. (ed.), Proc. VII. Int. Symp. Biol. Contr. Weeds, 6-11 March 1988, Rome, Italy.

Dunn, P. H., S. S. Rosenthal, G. Campobasso, and S. M. Tait. 1989. Host specificity of *Pterolonche inspersa* (Lep.: Pterolonchidae) and its potential as a biological control agent for *Centaurea diffusa*, diffuse knapweed and *C. maculosa*, spotted knapweed. Entomophaga 34: 435-446.

Sphenoptera jugoslavica

Lang, R. F., G. L. Piper, and E. M. Coombs. 1998. Establishment and redistribution of *Sphenoptera jugoslavica* Obenberger (Coleoptera: Buprestidae) for biological control of diffuse knapweed (*Centaurea diffusa* Lamarck) in the midwestern and western United States. Pan-Pacific Entomol. 74:27-31.

Powell, R. D. and P. Harris. 1986. Biological control of diffuse knapweed by *Sphenoptera jugoslavica* (Obenb.). Canadex 641-613. Agriculture Canada.

Powell, R. D. and J. H. Myers. 1988. The effect of *Sphenoptera jugoslavica* Obenb. (Col., Buprestidae) on its host plant *Centaurea diffusa* Lam. (Compositae). *Journal of Applied Entomology* 106: 25-45.

Terellia virens

Groppe, K. and K. Marquardt. 1989. *Terellia virens* (Loew) (Diptera: Tephritidae), a suitable candidate for the biological control of diffuse and spotted knapweed in North America. CAB International Institute of Biological Control Report.

Marquardt, K. 1988. *Terellia virens* (Loew.) and *Chaetorellia* spec. nov. (Dipt., Tephritidae), two new candidates for the biological control of *Centaurea maculosa* Lam. and *C. diffusa* Lam. (Compositae) in North America. *Mitteilungen der Deutschen Gesellschaft für Allgemeine und Angewandte Entomologie* 6(4-6): 306-310.

Urophora affinis* and *U. quadrifasciata

Berube, D. E. 1980. Interspecific competition between *Urophora affinis* and *U. quadrifasciata* (Diptera: Tephritidae) for ovipositional sites on diffuse knapweed (*Centaurea diffusa*: Compositae). *J. Appl. Entomol.* 90(3): 299-306.

Berube, D. E. and J. H. Myers. 1983. Reproductive isolation between *Urophora affinis* and *U. quadrifasciata* (Diptera: Tephritidae) in British Columbia. *Canadian Journal of Zoology* 61(4): 787-791.

Gillespie, R. L. 1983. Bionomics of *Urophora affinis* Fraunfeld, and *U. quadrifasciata* Meigen (Diptera: Tephritidae) in northern Idaho. M. S. thesis. Univ. of Idaho, Moscow. 90 pp.

Harris, P. 1986. Biological control of knapweed with *Urophora affinis* (Frfld.). Canadex 641.613. Agric. Canada. 2 p.

Harris, P. 1986. Biological control of knapweed with *Urophora quadrifasciata* Mg. Canadex 641.613. Agric. Canada. 2 p.

Mays, W. T. and L. T. Kok. 1996. Establishment and dispersal of *Urophora affinis* (Diptera: Tephritidae) and *Metzneria paucipunctella* (Lepidoptera: Gelechiidae) in southwestern Virginia. *Biological Control*. 6: 299-305.

McCaffrey, J. P. and R. H. Callihan. 1988. Compatibility of picloram and 2,4-D with *Urophora affinis* and *U. quadrifasciata* (Diptera: Tephritidae) for spotted knapweed control. *Environmental Entomology* 17(5): 785-788.

Meyers, J. H. and P. Harris. 1980. Distribution of *Urophora* galls in flower heads of diffuse and spotted knapweed in British Columbia. *J. Appl. Ecol.* 17: 359-367.

- Myers, J. H. and P. Harris. 1980. Distribution of *Urophora* galls in flower heads of diffuse and spotted knapweed in British Columbia. *J. Appl. Ecol.* 17:359-367.
- Shorthouse, J. D. 1977. Developmental morphology of *Urophora affinis* galls, p. 188-195. In Proc. Knapweed Symposium, Kamloops, British Columbia, October 6-7, 1977. Brit. Colum. Ministry of Agric., Victoria, B. C., Canada.
- Shorthouse, J. D. 1989. Modification of flowerheads of diffuse knapweed by the gall-inducers *Urophora affinis* and *Urophora quadrifasciata* (Diptera: Tephritidae), pp. 221-228. In Delfosse, E. S. (ed.), Proc. VII. Int. Symp. Biol. Contr. Weeds, 6-11 March 1988, Rome, Italy.
- Shorthouse, J. D. 1977. Developmental morphology of *Urophora quadrifasciata* galls, pp. 196-201. In Proc. Knapweed Symposium, Kamloops, British Columbia, October 6-7, 1977. Brit. Colum. Ministry of Agric., Victoria, B. C., Canada.
- Story, J. M. 1977. Effects of *Urophora affinis* on spotted knapweed seed production in Montana. pp. 208-209. In Proc. Knapweed Symposium, Kamloops, British Columbia, October 6-7, 1977. Brit. Colum. Ministry of Agric., Victoria, B.C., Canada.
- Story, J. M. 1977. Establishment, increase and dispersal of *Urophora affinis* in Montana, p. 202-205. In Proc. Knapweed Symposium, Kamloops, British Columbia, October 6-7, 1977. Brit. Colum. Ministry of Agric., Victoria, B.C., Canada.
- Story, J. M. 1984. Collection and redistribution of *Urophora affinis* and *U. quadrifasciata* for biological control of spotted knapweed. Montana Coop. Ext. Service. Circular No. 308. 9 p.
- Story, J. M. and N. L. Anderson. 1978. Release and establishment of *Urophora affinis* (Diptera: Tephritidae) on spotted knapweed in western Montana. *Environ. Entomol.* 7: 445-448.
- Story, J. M., K. W. Boggs, and W. R. Good. 1988. Optimal timing of 2,4-D applications for compatibility with *Urophora affinis* and *U. quadrifasciata* (Diptera: Tephritidae) for control of spotted knapweed. *Environ. Entomol.* 17: 911-914.
- Wheeler, A. G. 1995. *Urophora quadrifasciata* (Diptera: Tephritidae), an introduced seedhead fly new to midwestern North America. *The Great Lakes Entomologist* 28: 235-236.

Knapweed

- Baker, L. O. 1980. Competition from spotted knapweed (*Centaurea maculosa* Lam.) on Montana rangeland. Proceedings of the Western Society of Weed Science 33: 49-50.
- Callaway, R. M., T. H. Deluca, and W. M. Belliveau. 1999. Biological-control herbivores may increase competitive ability of the noxious weed *Centaurea maculosa*. Ecology 80: 1196-1201.
- Davis, E. S., P. K. Fay, T. K. Chicoine, and C. A. Lacey. 1993. Persistence of spotted knapweed (*Centaurea maculosa*) seed in soil. Weed Sci. 41: 57-61.
- Muller-Scharer, H. 1991. The impact of root herbivory as a function of plant density and competition: survival, growth and fecundity of *Centaurea maculosa* in field plots. J. Applied Ecol. 28:759-776.
- Muller-Scharer, H. and D. Schroeder. 1993. The biological control of *Centaurea* spp. in North America: Do insects solve the problem? Pestic. Sci. 37:343-353.
- Maddox, D. M. 1982. Biological control of diffuse knapweed (*Centaurea diffusa*) and spotted knapweed (*Centaurea maculosa*). Weed Sci. 30: 76-82.
- Nolan, D. O. and M. K. Upadhyaya. 1988. Primary seed dormancy in diffuse and spotted knapweed. Can. J. Plant Sci. 68:775-783.
- Roché, C. 1999. Squarrose knapweed, pp. 362-371. In R. Sheley and J Petroff (eds.); Biology and Management of Noxious Rangeland Weeds. Oregon State Univ. Press.
- Roché, B. F., Jr., G. L. Piper, and C. J. Talbott. 1986. Knapweeds of Washington, Washington State Cooperative Extension Service Bull. EB1393. 41 p.
- Roché, B. F., Jr. and C. T. Roché. 1991. Identification, introduction, distribution, ecology, and economics of *Centaurea* species, pp. 274-291. In L. F. James, J. O. Evans, M. H. Ralphs and R. D. Child (eds.), Noxious Range Weeds. Westview Press, Boulder, Colorado. Roche
- Roché, C. and L. C. Burrill. 1992. Squarrose knapweed *Centaurea virgata* Lam. ssp. *squarrosa* Gugl. Pacific Northwest Cooperative Extension Publication PNW422. Oregon State University Extension Service, Corvallis.
- Roché, C. T. and B. F. Roche, Jr. 1991. Meadow Knapweed Invasion in the Pacific Northwest, U.S.A., and British Columbia, Canada. Northwest Science 65(1): 53-61.

- Roché, B. F., Jr. and C. T. Roché. 1999. Diffuse knapweed, pp. 217-230. In R. Sheley and J. Petroff (eds.); *Biology and Management of Noxious Rangeland Weeds*. Oregon State Univ. Press.
- Rosenthal, S. S., G. Campobasso, L. Fornasari, R. Sobhian, and C. E. Turner. 1992. Biological control of *Centaurea* spp., pp. 292-302. In L. F. James, J. O. Evans, M. H. Ralphs, R. D. Child (eds), *Noxious Range Weeds*. Westview Press, Boulder, Colorado.
- Spears, B. M., S. T. Rose, and W. S. Belles. 1980. Effect of canopy cover, seedling depth, and soil moisture on emergence of *Centaurea maculosa* and *C. diffusa*. *Weed Res.* 20: 87-90
- Steinger, T. and H. Muller-Scharer. 1992. Physiological and growth responses of *Centaurea maculosa* (Asteraceae) to root herbivory under varying levels of interspecific plant competition and soil nitrogen availability. *Oecologia.* 91: 141-149.
- Sheley, R. L and J. S. Jacobs. 1997. Response of spotted knapweed and grass to picloram and fertilizer combinations. *J. Range Manage.* 50: 263-267.
- Sheley, R. L. and L. L. Larson. 1995. Interference between cheatgrass and yellow starthistle at 3 soil depths. *Journal of Range Management* 48(5): 392-397.
- Sheley, R. L., J. S. Jacobs and M. L. Carpinelli. 1999. Spotted knapweed, pp. 350-361 in R. Sheley and J. Petroff (eds.) *Biology and Management of Noxious Rangeland Weeds*. Oregon State Univ. Press.
- Story, J. M., and L. Smith. 2000. Bibliography of yellow starthistle, spotted knapweed, Russian knapweed and other weedy knapweeds. CD ROM, USDA-ARS.
- Story, J. M., K. W. Boggs, and D. R. Graham. 1989. Effects of nitrogen fertilization on spotted knapweed and competing vegetation in western Montana. *J. Range Management* 42(3): 222-225.
- Watson, A. K. and A. J. Renney. 1974. The biology of Canadian weeds, 6. *Centaurea diffusa* and *C. maculosa*. *Can. J. Plant Sci.* 54: 687-701.

General

- APHIS. 1994. Biological control of spotted and diffuse knapweeds. USDA, Animal Health Inspection Service. Program Aid No. 1529. 15 p.
- Berube, D. E. and J. H. Myers. 1982. Suppression of knapweed invasion by crested wheat grass in the dry interior of British Columbia. *Journal of Range Management* 35: 459-461

- Harris, P. 1989. Feeding Strategy, Coexistence and Impact of Insects in Spotted Knapweed *Capitula*, pp. 39-47. In Delfosse, E. S. (ed.), Proc. VII. Int. Symp. Biol. Contr. Weeds, 6-11 March 1988, Rome, Italy.
- Maddox, D. M. 1979. The knapweeds: Their economics and biological control in the western states, U.S.A. *Rangelands* 1(4): 139-143.
- McCaffrey, J. P., R. P. Wight, R. L. Stoltz, R. H. Callihan, and D. W. Kidder. 1988. Collection and redistribution of biological control agents of diffuse and spotted knapweed. Extension Bulletin 680, University of Idaho Cooperative Extension System, Moscow.
- McFadyen, R. E. C. 1998. Biological control of weeds. *Annu. Rev. Entomol.* 43:369-393.
- Müller, H. and D. Schroeder. 1989. The biological control of diffuse and spotted knapweed in North America: What did we learn?, pp. 151-169. In P. K. Fay and J. R. Lacey (eds), Proceedings of the 1989 Knapweed Symposium, April 4-5, 1989, Bozeman, Mt. Plant and Soil Department and Extension Service, Montana State University, Bozeman, Montana.
- Pearson, D. E., K. S. McKelvey, and L. F. Ruggiero. 2000. Non-target effects of an introduced biological control agent on deer mouse ecology. *Oecologia* 122: 121-128.
- Powell, R. D., C. Risley, and J. H. Myers. 1989. Plant size, seed production, and attack by biological control agents of knapweed in an area of reduced plant density following picloram spraying, pp. 58-66. In P.K. Fay and J.R. Lacey (editors), Proceedings of the 1989 Knapweed Symposium, April 4-5, 1989, Bozeman, Montana. Plant and Soil Department and Extension Service, Montana State University, Bozeman, Montana.
- Rees, N. E., P. C. Quimby, Jr., G. L. Piper, E. M. Coombs, C. E. Turner, N. R. Spencer and L. V. Knudson (eds.). 1996. *Biological Control of Weeds in the West*. West. Soc. Weed. Sci., Helena MT.
- Wilson, L. M. and J. P. McCaffrey. 1999. Biological Control of Noxious Rangeland Weeds, pp. 97-115. In R. Sheley and J. Petroff (eds.); *Biology and Management of Noxious Rangeland Weeds*, Oregon State Univ. Press.

GLOSSARY

achene	A small, one-seeded fruit that does not split at maturity
alternate	Leaves that are arranged singly along a stem; one leaf or bud at each node on alternate sides of the stem.
aspirator	An apparatus used to suck insects into a container. Can be as simple as in mouth-aspirator, or mechanical as in a gasoline- or battery-powered vacuum aspirator.
basal	At the base of a plant or plant part.
biennial	A plant which lives two years.
biological control	The intentional use of control a weed's natural enemies for control purposes. Also referred to as biocontrol.
bolting	Plant stage at which the flower stalk begins to grow.
bract	A small, leaf-like structure below a flower.
capitulum (pl. capitula)	Seedhead of plants in the sunflower family.
coordinate	Any of a set of numbers used to specify a point on a line or in a plot
cotyledon	First leaf-like structures that appear after germination; seed leaves.
density	Number of individuals per unit area.
dissemination	Dispersal. Can be applied to seeds or insects.
elytron (pl. elytra)	Hardened front wing of a beetle.
emergence	Act of adult insect leaving the pupal exoskeleton, or from winter or summer dormancy.
exoskeleton	External skeleton of the body of an insect.
floret	One of the small, closely clustered flowers forming the head of a composite flower in the sunflower family.
frass	Plant fragments, usually mixed with excrement, deposited by feeding insects.

gall	An abnormal growth on a plant, usually induced by an insect that lives within the gall.
grub	A soft, thick-bodied, C-shaped beetle larva.
head	A group of flowers borne tightly together.
host specificity	The highly-evolved, often obligatory association between an insect and its host (i.e., weed).
inflorescence	The flowering part of a plant.
instar	The phase of an insect's development between molts.
involucre	A circle of bracts under an inflorescence.
larva (pl. larvae)	Immature insect stage between the egg and pupa.
lobed	A leaf with shallow or deep, rounded segments, as in a knapweed rosette leaf.
metabolic sink	Site of the plant that receives photosynthate (food) produced by the plant, diverting the resource from the plant's normal use.
metamorphosis	A change in body form during insect development (e.g., change from caterpillar to moth).
molting	Process of insect development that involves shedding its exoskeleton and producing an exoskeleton for the next instar.
mottled	Surface having colored spots or blotches.
organdy	A fine transparent cloth.
oviposit	To lay or deposit eggs.
ovary	The part of the flower that contains the ovules or seeds.
pappus	A tuft of hairs, scales or bristles at the tip of an achene in flowers of the sunflower family.
perennial	A plant that lives more than two years.
pheromone	A substance given off by an insect used to communicate with other insects of the same species.
proleg	A fleshy, unsegmented, abdominal walking appendage of some insect larvae, common among caterpillars.

pubescence	Hairs covering a leaf, stem, or flower.
pupa (pl. pupae) (v. pupate)	Non-feeding, inactive stage between larvae and adult in insects.
puparium	The hardened, thickened skin of a mature larva within which the pupa and adult are formed.
quadrat	A specific area used to sample vegetation (e.g., 1 square meter).
qualitative	Measurement of descriptive elements (e.g., age class, distribution).
quantitative	Measurement of quantity - number or amount (e.g., seeds per capitula).
receptacle	Part of the stem to which the flower is attached.
rosette	A compact, circular, normally basal cluster of leaves.
senescence	Final stage in a plant's lifecycle.
snout	'Nose' of a weevil. The elongate head of a weevil with mouth parts at the tip (apex).
spine	A stiff, pointed plant part.
synchrony	Occurring at the same time (e.g., plant flowering and insect oviposition).
thorax	Body region of an insect behind the head and abdomen, bearing the legs and wings.
transect	A straight line of varying length along which plants are periodically sampled individually or in quadrants.
univoltine	Produce only one generation per year.
variable	A quantity that can have more than one of a set of values (e.g., plant height).
weevil	A type of plant-eating beetle; the adult has a snout, and the larva is a C-shaped grub (aka snout beetle).
x-axis	Horizontal axis or line in a coordinate system.
y-axis	Vertical axis or line in a coordinate system.

APPENDICES

Appendix A: Troubleshooting Guide: When Things Go Wrong

Appendix B: Sample Biocontrol Agent Release Form

Appendix C: Monitoring Plan Questionnaire

Appendix D: Biocontrol Monitoring Report

Appendix E: Qualitative Monitoring Form

Appendix F: Quadrat Density and Cover Data Form

Appendix G: Example of Macroplot Design for Measuring Density

Note: *Please make photocopies of these appendices and use them as worksheets.*

Appendix A: Troubleshooting Guide; When Things go Wrong

This guide is intended to assist those who encounter problems when establishing a biological control program. It identifies the probable cause of a typical problem and offers solutions.

Problem	Probable Cause	Solution
Bioagents unhealthy	Physical damage to agents	Prevent containers from colliding; use crush-proof containers.
	Drowning	Do not put water in containers. Prevent accumulation of excess moisture in the collection containers.
	Excess or prolonged heat or cold	Keep containers cool at all times; use coolers and blue ice packs; avoid exposure to direct sunlight while in transit.
	Starvation	Put knapweed foliage (no flowers, seeds, or roots) in containers.
	Redistribution time	Transport or ship agents immediately after collection. Release agents at new site immediately upon arrival or receipt of agent.
Number of eggs low	Parasitism and/or disease	Check source of agents. Ensure the insect population is disease-free when collecting or receiving shipment.
	Agents past reproductive stage	Collect at times of peak activity (i.e., insects are mating).
	Sex ratio: not enough males or females	Observe mating among bioagents before collecting; males often emerge earlier than females.
	Synchrony	Agents not synchronized with the knapweed growth stage; bioagents require knapweed to be at specific growth stage for optimal oviposition.

Appendix A: Troubleshooting Guide (*continued*)

Problem	Probable Cause	Solution
Few bioagents collected	Wrong method used	Refer to Tables 11 and 12 for recommended collection time and technique.
	Collection done at wrong time	Refer to Tables 11 and 12 for recommended collection time and technique.
	Collection technique	Bioagents can be killed during sweeping or aspirating. Use vacuum aspirator if aspirating by mouth is not working. Practice sweeping.
	Conditions at time of collection wrong	Refer to "Collecting Biocontrol Agents" and "Monitoring Biocontrol Agents" for guidelines on desirable weather conditions.
Agents not found after release	Site is unsuitable	Refer to "Collecting Biocontrol Agents."
	Site too small	Select a larger site with a dense, uniform stand of knapweed.
	Pesticide used in area	Select pesticide-free site.
Cannot locate release site	Permanent location marker not obvious	Use bright-colored wooden, metal, or plastic stake.
	Map poorly or incorrectly drawn	Check map; redraw with more detail or add landmarks.

Appendix B: Biological Control Agent Release Form

AGENT RELEASE			
Released By: _____	Release Date: ___/___/___ <small>(mm dd yy)</small>	County: _____	State: _____
Agent: _____	# Released: _____	Target Weed: _____	
Source of Agents: _____	Date Collected: ___/___/___ <small>(mm dd yy)</small>		
Life Stage (circle): Larvae Pupa ^e Adults Eggs Other (specify) _____			
Land Ownership (circle): Private County State USFS BLM COE BOR BIA/Tribe TNC Other (specify) _____			
Legal: T___ R___ Sec___ Q___ QQ___ (OR) Lat: Deg___ Min___ Sec___ Long: Deg___ Min___ Sec___			

ENVIRONMENT			
Temperature (°F): _____	Wind: Calm, Light, Moderate, Strong, Gusty	Wind Direction: N S E W	
Weather (circle): Clear, Ptly Cloudy, Cloudy, Rain, Snow	Release Time (military): _____		
Site Aspect (circle): N, NE, E, SE, S, SW, W, NW	Elevation: _____		
Site Slope: Flat (0-10%) _____ Gentle (10-30%) _____ Moderate (30-60%) _____ Steep (>60%) _____			
Topographic Position (circle): Valley Bottom Terrace Lower Slope Mid/Upper Slope Crest			
Disturbance: (check all that apply, circle most prevalent) Cultivation ___ Fire ___ Flood ___ Grazing ___ Logging ___ Roads ___ Mining ___ Recreation ___			
Directions to Site (include a map to the site on the back of this form): _____ _____			

SITE CHARACTERISTICS			
Site Name: _____	Size of Infestation (acres): _____	Weed Cover %: _____	
Weed Height: _____	Weed Density (# per meter sq.): _____	Dominant Plant: _____	
Distribution of Weed: Isolated ___ Scattered ___ Sc-Patchy ___ Patchy ___ Continuous ___ Linear ___			
Phenology: Seedling % ___ Rosette % ___ Bolt % ___ Bud % ___ Flowering % ___ Seed % ___ Dormant % ___			
Vegetation Type (check):		Estimate % Cover:	
Annual Grassland <input type="checkbox"/>		Tree _____	
Perennial Grassland <input type="checkbox"/>		Shrub _____	
Shrubland/Steppe <input type="checkbox"/>		Forb _____	
Dry Conifer <input type="checkbox"/>		Grass _____	
Mixed Conifer <input type="checkbox"/>		Litter _____	
Dry Meadow <input type="checkbox"/>		Bare Ground _____	
Moist Meadow <input type="checkbox"/>		Rock _____	
Soil Texture: (check) Sand ___ Silt ___ Clay ___ Gravel ___ Loam ___			

Comments (continue on reverse if necessary)

Appendix C: Monitoring Plan Questionnaire

The following is a list of questions to be answered and documented prior to collecting data. Use the questionnaire to outline a monitoring plan.

What is the management objective of the biocontrol release site? _____

What is the monitoring objective of the biocontrol release site? _____

What will be measured? _____

What equipment and supplies are needed? _____

What training is needed? _____

What is the cost of monitoring? _____

What is the time interval between monitoring? _____

Appendix E: Qualitative Monitoring Form

Name: _____ Date: _____ Time: _____ am/pm _____

Location: _____ Site #: _____

Insect: _____ Year of release: _____

Cover Class by Plant Type						
	0%	1-5%	6-20%	21-50%	51-75%	76-100%
Knapweed						
Annual Grasses						
Perennial Grasses						
Forbs						
Shrubs						
Trees						

Dominant Plants on Site:
Other Noxious Weeds:

Knapweed density class (check one)			
Flowering plants/meter sq)		Knapweed distribution	
0		Isolated	
1-25		Scattered	
26-50		Scattered-Patchy	
51-75		Patchy	
>75		Continuous	

Knapweed phenology Class at time of monitoring	
Knapweed Stage	Estimated percent
Seedling	
Rosette	
Bolting	
Flowering	
Senescent	

Comments/Observations _____

Appendix G: Macroplot Design for Measuring Density

Designed for a 1 x 2 ft. quadrat in a 22 x 22 ft. macroplot
 The X-axis is in 2 ft. increments; the Y-axis is in 1 ft. increments.

22											XX9	
21							XX5					
20												
19			XX2									
18												
17												
16												
15				XX3								
14												
13												
12	XX1									XX8		
11							XX4					
10												
9										XX7		
8												
7												
6												
5												
4										XX6		
3												
2												
1												XX10
	1	2	3	4	5	6	7	8	9	10	11	12
	0	2 ft	4 ft	6 ft	8 ft	10 ft	12 ft	14 ft	16 ft	18 ft	20 ft	22 ft

----- X-axis -----

Each square (cell) is a quadrat measuring 2 ft x 1 ft.

Vertical and horizontal numbers are the coordinates of the Y and X axes respectively

xx = randomly selected quadrat to be sampled

Examples: XX1 = coordinate (1,12); XX2 = coordinate (3,19); XX3 = coordinate (4,15);
 XX4 = coordinate (6,11); XX5 = coordinate (7,21); XX6 = coordinate (8,4);
 XX7 = coordinate (9,9); XX8 = coordinate (10,12); XX9 = coordinate (11,22);
 XX10 = coordinate (12,1)

Macroplot Instructions

Size: The sides of the macroplot need to be multiples of the sides of the quadrat. For example, a macroplot of 25 ft by 50 ft could be designed for a 1 x 2 ft quadrat.

A total of 500 (1X2 ft) non-overlapping quadrats could be placed within the macroplot.

Quadrats: Quadrats are small, measured areas that are used to sample vegetation. Rather than measure all of the vegetation in a large plot area (e.g., 0.5 acre plot), a smaller plot (e.g., 10 X 20 inch rectangle) is used. Placement of the quadrat can be completely random (e.g., close your eyes and throw it), can be placed along a measured transect (straight line), or can be precisely located within the macroplot by a set of randomly selected XYcoordinates. The random coordinates are generated from a random numbers table.

- Design the macroplot.
- Determine the quadrat shape and size.
- Randomly select the coordinates.
- Mark the selected quadrat on a macroplot layout to help locating the quadrats in the field.
- If a pair of coordinates repeats, drop the second set of coordinates, and select another set.
- Outline the macroplot at the field site. Place the Y-axis measuring tape perpendicular to the slope and upslope from the 0,0-ft mark. This is the Y-axis. Carefully mark the beginning and ending of the Y-axis. Place a second measuring tape along the slope perpendicular to the Y-axis. This is the X-axis. Where the two lines meet is the origin with a coordinate of 0,0. Other coordinates are measured from this point. The two numbers of a coordinate refer to X position then the Y position. For example, a coordinate of (15,8) means 15 feet across the X-axis and 8 feet up the Y-axis.
- Position the quadrat so that the long side is parallel to the X-axis, and placed adjacent and above the tape (upslope side of the tape) with the lower-left hand corner corresponding to the set of coordinates.
- Sample from 20 to 30 quadrats.

Sample Coordinate:

