

AQUATOX Training Workshop (Day 3)

Philadelphia, PA
October 24-26, 2006



Richard A. Park, Eco Modeling, Diamondhead MS
dickpark@CableOne.net

Jonathan S. Clough, Warren Pinnacle Consulting, Warren VT
jclough@warrenpinnacle.com

Marjorie Coombs Wellman, Office of Water, US EPA, Washington DC
wellman.marjorie@epamail.epa.gov

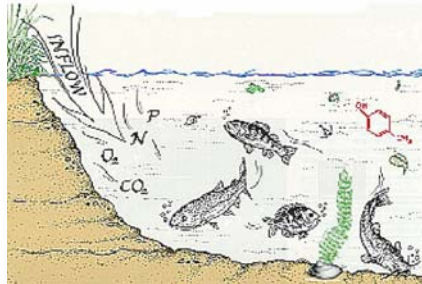

Modeling Fate, Bioaccumulation, and Toxicity of Organic Chemicals

- chemical fate
 - ionization
 - volatilization
 - hydrolysis
 - photolysis
 - sorption
 - microbial degradation
- biotransformation—can model daughter products
- bioaccumulation
- chronic and acute toxicity

The chemical fate module of AQUATOX predicts the partitioning of a compound between water, sediment, and biota, and estimates the rate of degradation of the compound. Microbial degradation, biotransformation, photolysis, hydrolysis, and volatilization are modeled in AQUATOX.

Microbial degradation is modeled by entering a maximum biodegradation rate for a particular organic toxicant, which is subsequently reduced to account for suboptimal temperature, pH, and dissolved oxygen. Biotransformation is represented by user-supplied first-order rate constants with the option of also modeling multiple daughter products. Photolysis is modeled by using a light screening factor (Schwarzenbach et al., 1993) and the near-surface, direct photolysis first-order rate constant for each pollutant. The light screening factor is a function of both the diffuse attenuation coefficient near the surface and the average diffuse attenuation coefficient for the whole water column. For those organic chemicals that undergo hydrolysis, neutral, acid-, and base-catalyzed reaction rates are entered into AQUATOX as applicable. Volatilization is modeled using a stagnant two-film model, with the air and water transfer velocities approximated by empirical equations based on reaeration of oxygen (Schwarzenbach et al., 1993).

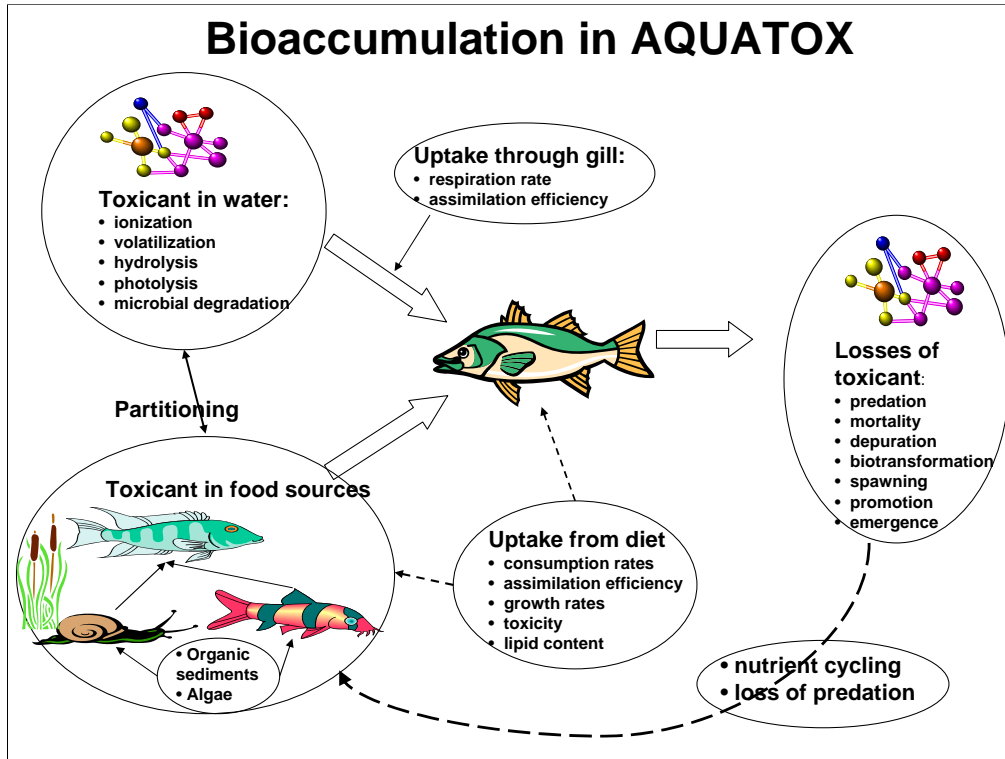

Nonequilibrium concentrations, as represented by kinetic equations, depend on sorption, desorption, and elimination as functions of the chemical and exposure through water and food as a function of bioenergetics of the organism.

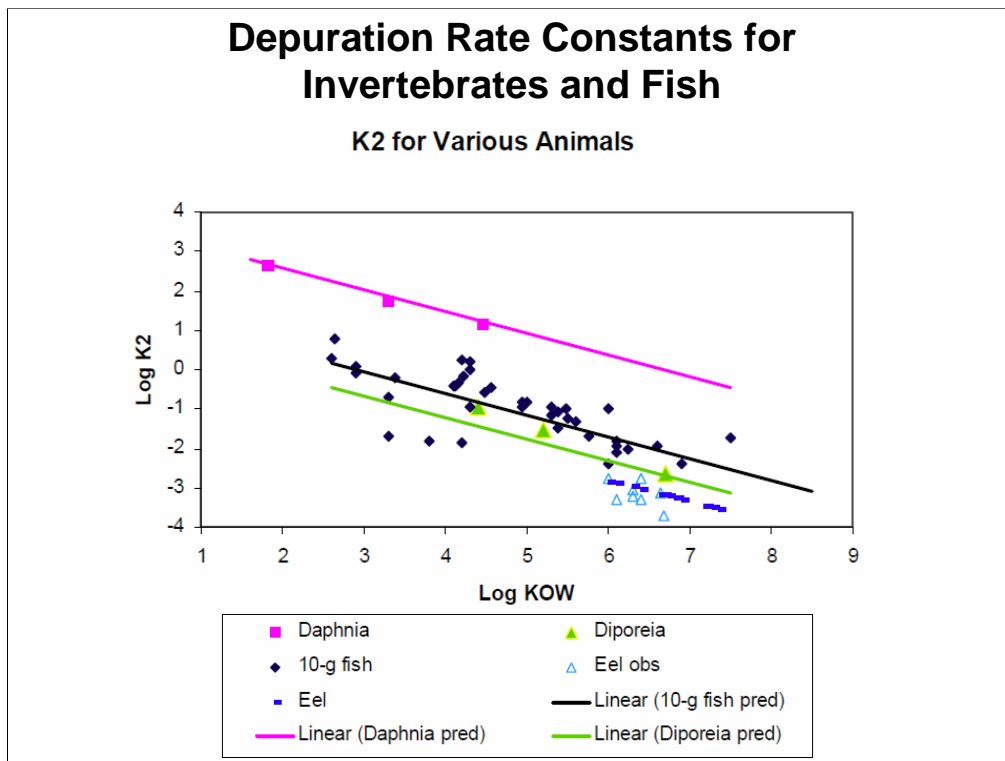

K2 can be estimated based on size, lipid content, and the LogKow of the chemical being modeled.

Chemical Fate Clarified Using Half-Lives and DT95

Time-to-loss Estimated Using Loss Rates at a given time

$$Loss_{Water} = \frac{Hydrolysis_{Water} + Photolysis + Microbial_{Water} + Washout + Volat. + Sorption}{Mass_{Water}}$$

$$Loss_{Sed} = \frac{Microbial_{Sed} + Hydrolysis_{Sed} + Desorption}{Mass_{Sed}}$$

For this Chlorpyrifos Study:

Half-life in Sediment of roughly
20 days
DT95 of roughly 75 days

Half-life in water of roughly 16
hours, DT95 in water is roughly
3 days

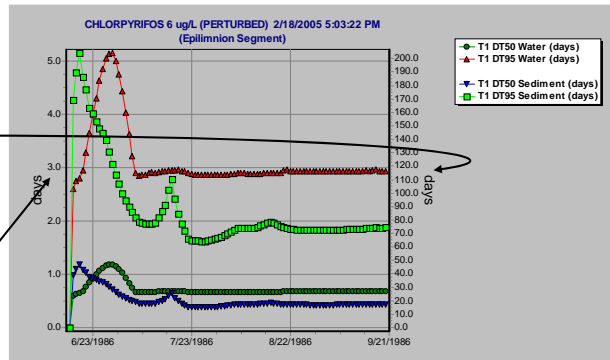

The half-life estimation capability with AQUATOX has been significantly upgraded since Release 2. AQUATOX now estimates half-lives (DT50s) and time to 95% chemical loss (DT95s) independently in bottom sediment and in the water column. Estimates are produced at each output time-step depending on the average loss rate during that time-step in that medium.

Chemical Rates May Be Tracked

In-situ Degradation Rates for Chlorpyrifos in Pond

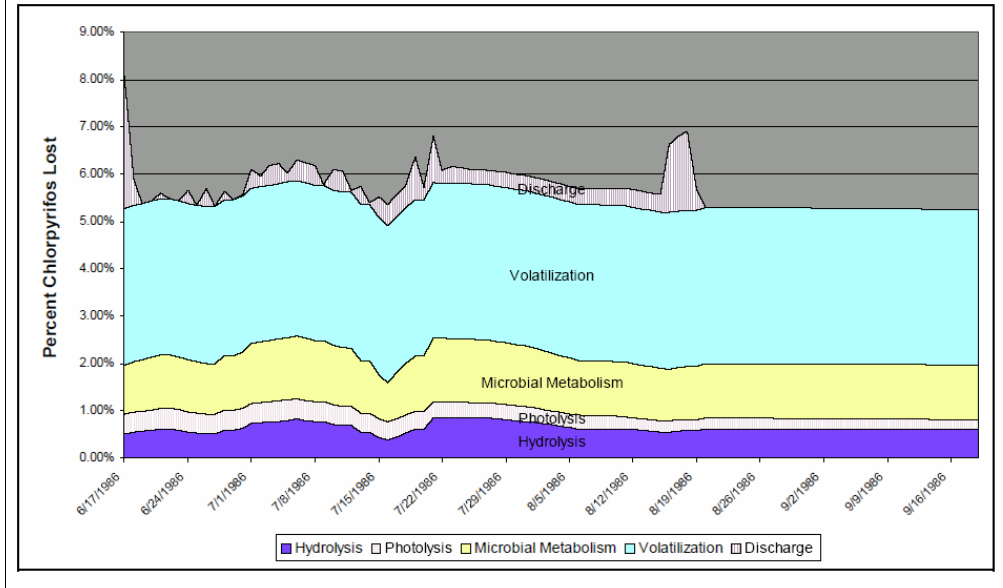

Chlorpyrifos is moderately persistent; however, according to the simulation about 3% per day is lost due to volatilization, about 1% due to microbial degradation, and another 1% due to hydrolysis and photolysis.

Chemical Derivatives Tend to be Complex

$$\begin{aligned} \frac{d\text{Toxicant}_{\text{Water}}}{dt} &= \text{Loading} + \sum_{\text{LabileDetr}} (\text{Decomposition}_{\text{LabileDetr}} \cdot \text{PPB}_{\text{LabileDetr}} \cdot 1e-6) \\ &+ \sum \text{Desorption}_{\text{DetrTox}} + \sum \text{Depuration}_{\text{Org}} - \sum \text{Sorption}_{\text{DetrTox}} \\ &- \sum \text{GillUptake} - \text{MacroUptake} - \sum \text{AlgalUptake}_{\text{Alga}} \\ &- \text{Hydrolysis} - \text{Photolysis} - \text{MicrobialDegrdn} + \text{Volatilization} \\ &- \text{Discharge} + \text{Biotransform}_{\text{Microb In}} \pm \text{TurbDiff} \\ \\ \frac{d\text{Toxicant}_{\text{Alga}}}{dt} &= \text{Loading} + \text{AlgalUptake} - \text{Depuration} \pm \text{TurbDiff} \\ &- (\text{Excretion} + \text{Washout} + \sum_{\text{Pred}} \text{Predation}_{\text{Pred, Alga}} + \text{Mortality} \\ &+ \text{Sink} \pm \text{SinkToHypo}) \cdot \text{PPB}_{\text{Alga}} \cdot 1e-6 \pm \text{Biotransform}_{\text{Alga}} \\ \\ \frac{d\text{Toxicant}_{\text{Animal}}}{dt} &= \text{Loading} + \text{GillUptake} + \sum_{\text{Prey}} \text{DietUptake} \pm \text{TurbDiff} \\ &- (\text{Depuration} + \sum_{\text{Pred}} \text{Predation}_{\text{Pred, Animal}} + \text{Mortality} + \text{Recruit} \\ &\pm \text{Promotion} + \text{GameteLoss} + \text{Drift} + \text{Migration} + \text{EmergeInsect}) \\ &\cdot \text{PPB}_{\text{Animal}} \cdot 1e-6 \pm \text{Biotransform}_{\text{Animal}} \end{aligned}$$

These are the differential equations for tracking toxicant in water, plants, and animals.

The change in mass of toxicant in the water includes explicit representations of mobilization of the toxicant from sediment to water as a result of decomposition of the labile sediment detritus compartment, sorption to and desorption from the detrital sediment compartments, uptake by algae and macrophytes, uptake across the gills of animals, depuration by organisms, and turbulent diffusion between epilimnion and hypolimnion

Chemical mass is balanced to machine accuracy.

Note that each process within an animal and plant has an effect on the toxicant that is contained within that organism.

Growth dilution is implicitly managed by tracking the mass of each chemical and the biomass of each organism separately.

See Chapter 7 of the Technical Documentation for further details.

Alternative Chemical Uptake Model

The user may enter two of the three factors defining uptake (BCF, K1, K2) and the third factor is calculated:

$$BCF \text{ (L/kg)} = \frac{K1 \text{ (L/kg} \cdot \text{d)}}{K2 \text{ (1/d)}}$$

Given these parameters, AQUATOX calculates uptake and depuration in plants and animals as kinetic processes.

Dietary uptake of chemicals by animals is not affected by this alternative parameterization.

When performing bioaccumulation calculations, the default behavior of the AQUATOX model is to allow the user to enter elimination rate constants (K2) for all plants and animals for a particular organic chemical. K2 values may also be estimated based on the LogK_{OW} of the chemical, as shown earlier. Uptake in plants and gill uptake in animals is a function of K_{OW} in plants and respiration to chemical uptake efficiency in animals. While the AQUATOX default model works well for a wide variety of organic chemicals, some chemicals with different physical characteristics are not effectively modeled using these relationships.

For this reason, an alternative uptake model based on equilibrium relationships among K1, K2, and BCF is provided to the user.

Modeling Toxicity of Chemicals

- Lethal and sublethal effects are represented
- Chronic and acute toxicity are both represented
- Effects based on total internal concentrations
- Uses the critical body residue approach (McCarty 1986, McCarty and Mackay 1993)

Sublethal effects include reduction in photosynthesis, ingestion, and reproduction, and increased egestion, drift, and sloughing of periphyton.

From Wikipedia, the free encyclopedia:

Chronic toxicity is a property of a substance that has [toxic](#) effects on a living organism, when that organism is exposed to the substance continuously or repeatedly.

Acute Toxicity is a property of a substance that has [toxic](#) effects on a living organism, when that organism is exposed to a [lethal dose](#) of a substance once. In other words, basically a short term version of chronic toxicity.

AQUATOX models time-varying toxicity—both chronic and acute.

McCarty, L.S., G.W. Ozburn, A.D. Smith, and D.G. Dixon. 1992. Toxicokinetic Modeling of Mixtures of Organic Chemicals. *Environmental Toxicology and Chemistry*, 11:1037-1047.

Mackay, D., H. Puig, and L.S. McCarty. 1992. An Equation Describing the Time Course and Variability in Uptake and Toxicity of Narcotic Chemicals to Fish. *Environmental Toxicology and Chemistry*, 11:941-951.

Toxicity Models within Bioaccumulation Models

Table 3.5. Toxicity Models

	AQUATOX Release 2	BASS v 2.1	Biotic Ligand 1.0.0	RAMAS Ecosystem
Domain of Toxicity Models				
Acute Toxicity	★	★	★	★
Chronic Toxicity	★	★	★	★
Sub-Lethal Effects	★	★	★	★
Toxicity Effects Feed Back to Bioconcentration Model	★	★	★	★
Toxicity Mechanisms				
Based on Total Internal Concentrations	★	★	★	★
Based on Concentrations in Organs	★	★	★	★
User Input Required				
LC50 values	★	★	★	★
EC50 values	★	★	★	★
Weibull Shape Parameter	★	★	★	★

Imhoff et al. 2004

Many bioaccumulation models do not include toxicity models, and of those, few include sub-lethal effects (such as toxicity-induced drift and periphyton sloughing).

Imhoff, John C., Jonathan S. Clough, Richard A. Park, and Andrew Stoddard. 2004. Evaluation Of Chemical Bioaccumulation Models of Aquatic Ecosystems: Final Report. Athens GA: U.S. Environmental Protection Agency.

Steps Taken to Estimate Toxicity

- Enter LC_{50} and EC_{50} values
 - LC_{50} estimators are available for species
- Compute internal LC_{50}
- Compute infinite LC_{50} (time-independent)
- Compute t-varying internal lethal concentration
- Compute cumulative mortality
- Compute biomass lost per day by disaggregating cumulative mortality
- Sublethal toxicity is related to lethal toxicity through an application factor
- Option has been added to use external concentration.

The details are covered in Chapter 8 of the *Technical Documentation*.

By entering both LC_{50} and EC_{50} values for a species the application factor can be computed.

Disaggregation of Cumulative Mortality

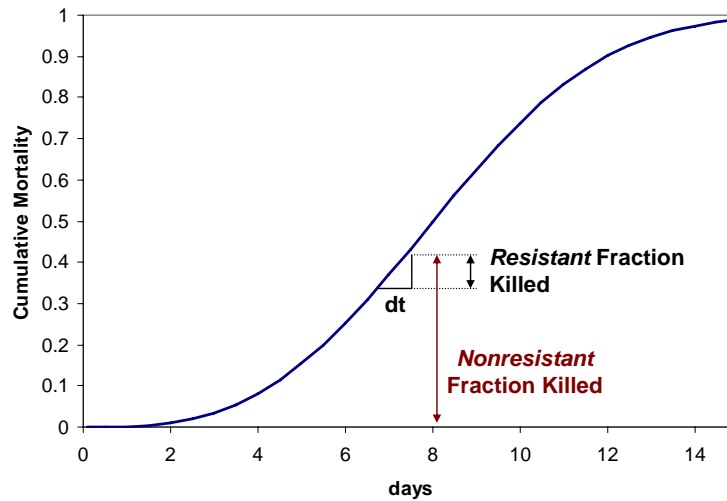

The biomass killed per day is computed by disaggregating the cumulative mortality. Think of the biomass at any given time as consisting of two types: biomass that has already been exposed to the toxicant previously, which is called *Resistant* because it represents the fraction that was not killed; and new biomass that has formed through growth, reproduction, and migration and has not been exposed to a given level of toxicant and therefore is referred to as *Nonresistant*.

New Option to Model with External Concentrations

Two-parameter Weibull distribution as in Christensen and Nyholm (1984)

$$CumFracKilled = 1 - \exp(-kz^\eta)$$

Two Required Parameters:

LC50 (or EC50)

“Slope Factor” = Slope at LC50 multiplied by LC50

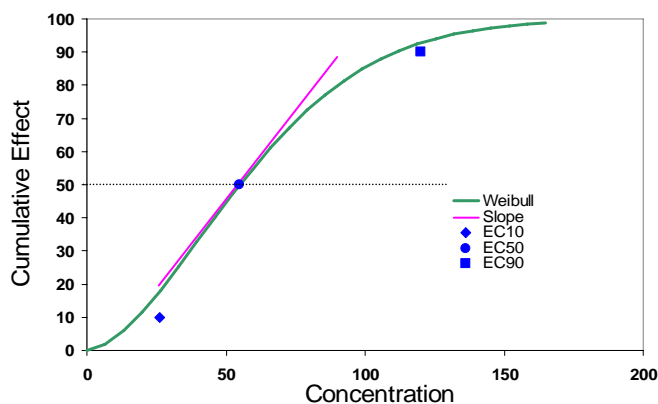

Rather than require the user to fit toxicological bioassay data to determine the parameters for k and η , these parameters are derived to fit the LC50 and the slope of the cumulative mortality curve at the LC50 (in the manner of the RAMAS Ecotoxicology model, Spencer and Ferson, 1997). (See *Technical Documentation Addendum*.)

AQUATOX assumes that each chemical's dose response curve has a distinct shape, relevant to all organisms modeled. In this manner, a single parameter describing the shape of the Weibull parameter can be entered in the chemical record rather than requiring the user to derive slope parameters for each organism modeled. However, as shown in the slide above, the slope of the curve at the LC50 is both a function of the shape of the Weibull distribution and also the magnitude of the LC50 in question. For this reason, rather than have a user enter “the slope at LC50” into the chemical record, AQUATOX asks that the user enter a “slope factor” defined as “the slope at LC50 multiplied by LC50.” In the above example, the user would enter a slope factor of 1.0 and then, given an LC50 of 1 or an LC50 of 100, the above two curves would be generated.

When modeling toxicity based on external concentrations, organisms are assumed to come to equilibrium with external concentrations (or the toxicity is assumed to be based on external effects to the organism).

Chemical Toxicity Screen

Chemical Toxicity Parameters -- PCB 1254

Animal Toxicity Data **Add an Animal Toxicity Record** **Print** To delete a record, press <Ctrl> Drift Threshold only relevant to zoobenthos

Animal name	LC50 (ug/L)	LC50 exp. time (h)	LC50 comment	K2 Elim. rate const (1/d)	K1 Uptake const (L/kg d)	BCF (L/kg)
Trout	142	96	Mayer & Ellersieck '85	6.504E-04		
Bluegill	2740	96	Mayer & Ellersieck '85 (lipid for smelt)	4.956E-03		
Bass	236.428	96	Regression on Trout	3.566E-03		
Calfish	1309.59	96	Regression on Trout (>200.Mayer & Ellersieck)	1.04E-03		
Minnnow	142	96	Hill & Napolitano, 1997, p. 451 ave.	1.333E-03		
Daphnia	31	96	Aquire	1.384E+00		
Chironomid	115.796	96	Regression on Daphnia	2.723E-01		
Stonelly	200	96	Mayer & Ellersieck '85, Ddonata	7.401E-02		
Ostracod	51.838	96	Regression on Daphnia	1.273E+00		
Amphipod	2400	96	Mayer & Ellersieck '85	1.273E+00		
Other	0	0		7.781E-03		

Enter or Estimate K2, Calculate K1 and BCF (default behavior)
 Enter K1 and K2, Calculate BCF
 Enter K1 and BCF, Calculate K2
 Enter K2 and BCF, Calculate K1

Plant Toxicity Data **Add a Plant Toxicity Record** **Print**

Plant name	EC50 photo (ug/L)	EC50 exp. time (h)	EC50 dislodge (ug/L)	EC50 comment	K2 Elim. rate const (1/d)	K1 Uptake
Greens	50	0	0	Hill & Napolitano, 1997, p. 451	10.4764	
Diatoms	50	0	0	Hill & Napolitano, 1997, p. 451	10.4764	
Bluegreens	0	0	0		2.0953	
Peri. Diatoms	50	10	0	ECOTOX	10.4764	
Peri. Greens	50	10	0	ECOTOX	10.4764	

Enter or Estimate K2, Calculate K1 and BCF (default behavior)
 Enter K1 and K2, Calculate BCF
 Enter K1 and BCF, Calculate K2
 Enter K2 and BCF, Calculate K1

This screen is where all of the important chemical toxicity parameters are located. To get to this screen go to Chemical Underlying Data and select the “Toxicity Data” button.

There are multiple options for entering uptake rate constant (k1), the elimination rate constant (k2) and the bioconcentration factor (BCF) or allowing the model to calculate these parameters ($BCF=k1/k2$)

Additionally, elimination rates may be estimated using the octanol water partition coefficient (Kow).

Fish and invertebrate regressions are available for a narrow range of organisms if the chemical has a narcotic mode of action and you only have data for a few species.

As explained previously, by entering both LC_{50} and EC_{50} values for a species the application factor can be computed. The user has the option of applying that same ratio to the rest of the species in the animal or plant toxicity screen using the buttons **Estimate animal LC50s...** and **Estimate plant EC50s...**

Rates can be output to an Excel file and graphed in a spreadsheet

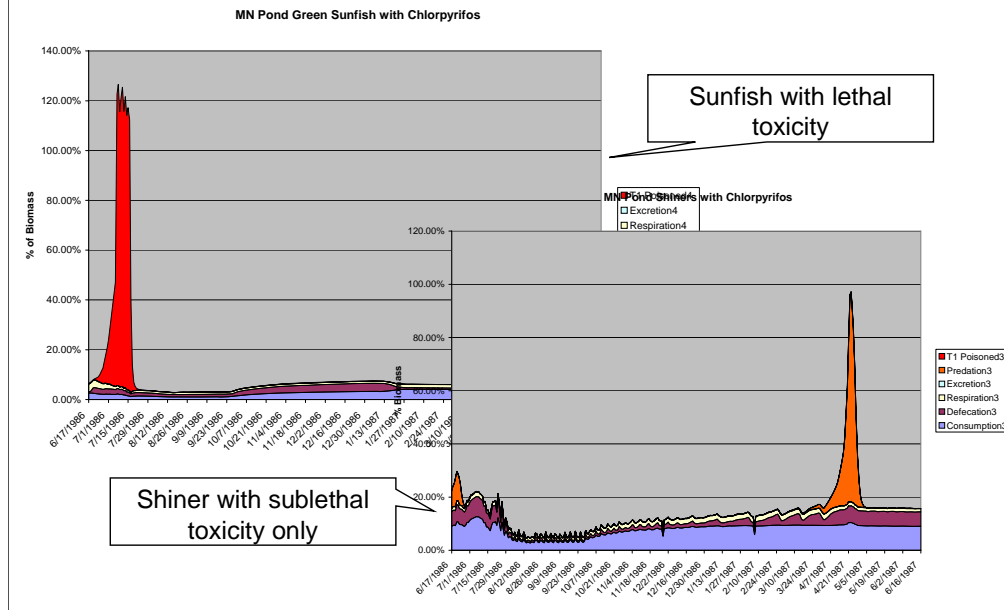

Sunfish have a low tolerance to chlorpyrifos, so bioaccumulation is followed by acute toxicity with gradual recovery. Shiners are tolerant of chlorpyrifos and exhibit no mortality with an initial dose of 6 ug/L chlorpyrifos; they do exhibit sublethal toxicity in the form of decreased consumption and assimilation; loss of forage is a predicted indirect effect. Predicted recovery of sunfish eventually leads to high predation of shinners.

% Difference Graph shows differences in how species respond to toxicant

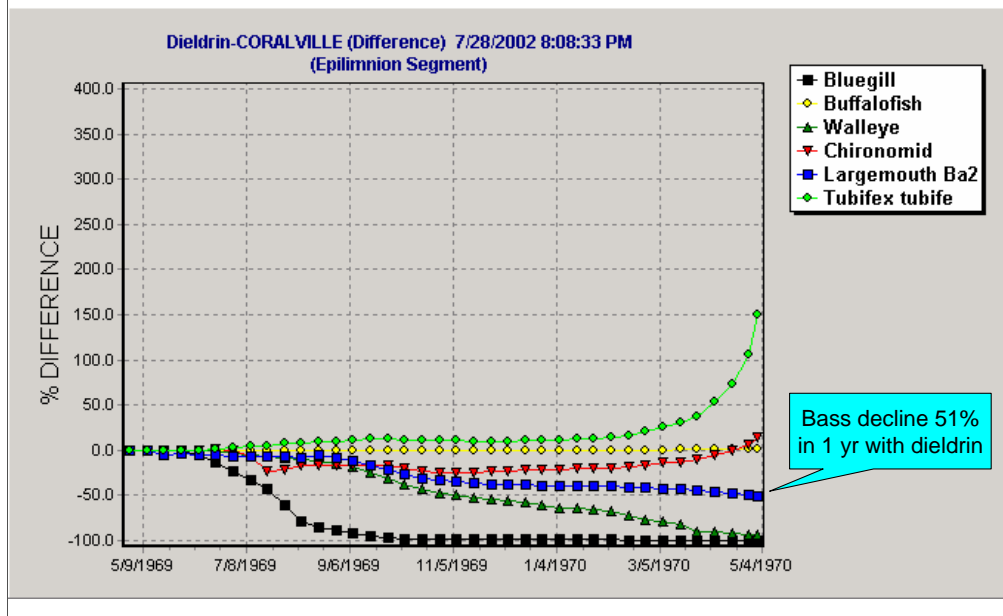

In a percent difference graph the perturbed simulation with dieldrin is compared with the control simulation without dieldrin. Bluegill decline and disappear within 5 months, bass decline 51% in the year, buffalofish are not affected, and tubifex increase.

Toxicant Parameters and Loadings are Subject to Uncertainty Analysis

The screenshot displays the 'AQUATOX - Uncertainty Setup' dialog box. It features a tree view on the left for parameter selection, a central distribution information panel, and control buttons at the bottom. The 'T1: Multiply Loading by' parameter is highlighted with a red arrow, and its distribution is shown as a normal curve with a mean of 1 and a standard deviation of 0.4.

By running uncertainty analysis with a normal distribution of multiplicative loadings of dieldrin we can easily see the probabilistic response to dieldrin. Let's reexamine this tool and its application to toxic response.

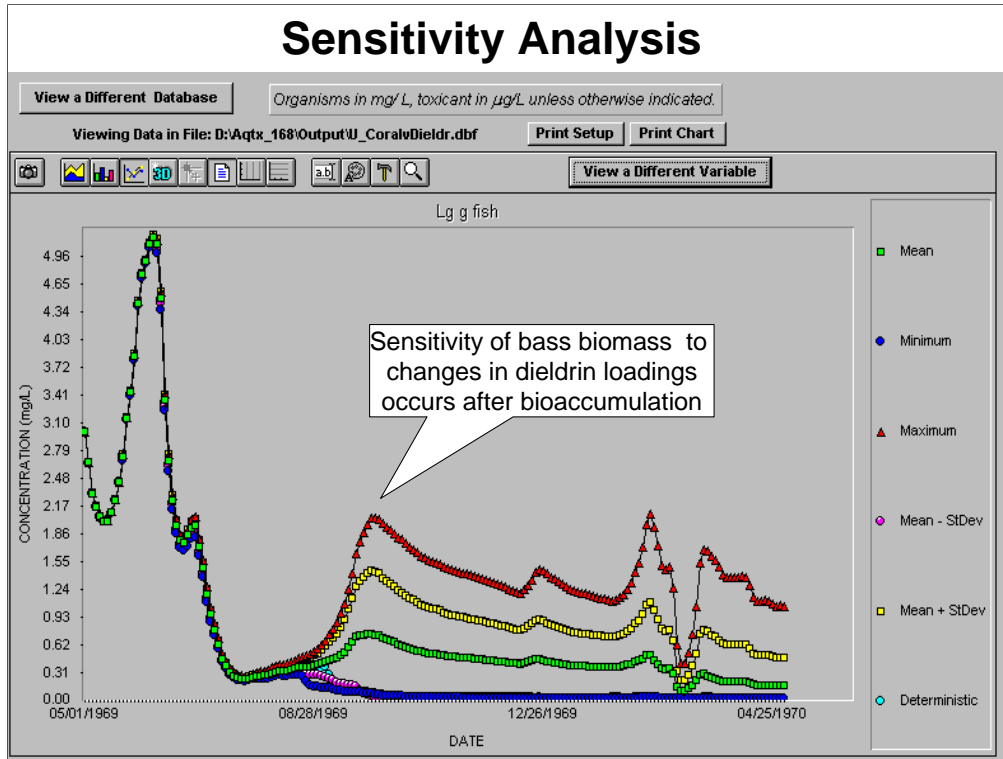

Because it takes a while for dieldrin to bioaccumulate to toxic levels, bass don't show a sensitivity to dieldrin until after two months. With the lowest levels of dieldrin they are able to sustain a reasonable fluctuating biomass.

The statistics are calculated for each time step; the values on a curve are not necessarily from the same simulation.

AQUATOX can estimate % probability of change in biomass

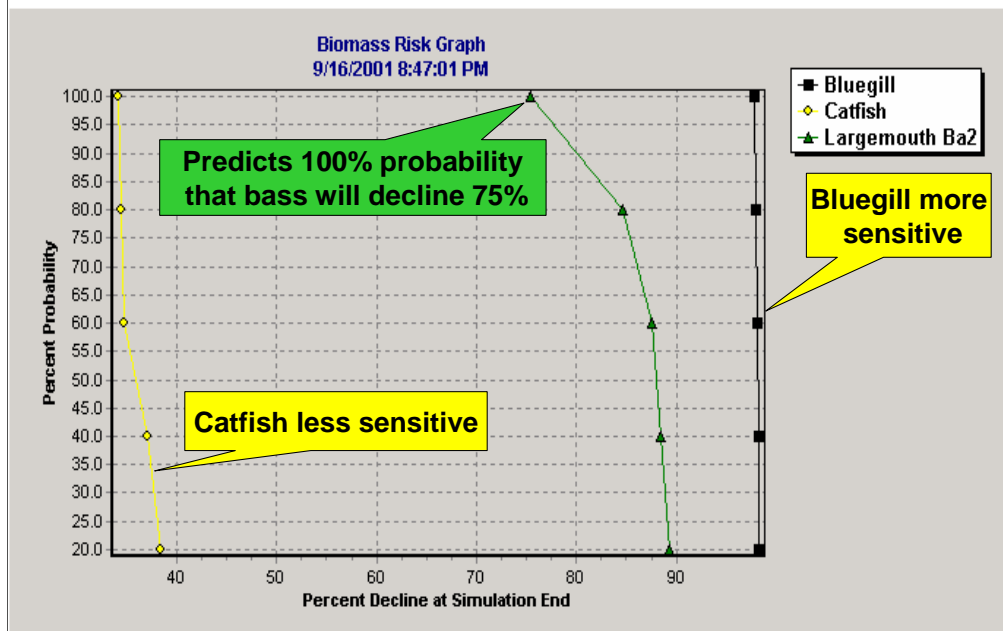

The sensitivity analysis can be expressed as a probability of decline, which is useful for risk assessment. In this example, we see that bluegill are the most sensitive to dieldrin and catfish are the least sensitive. (Buffalofish are even less sensitive, but we did not plot them.)

Bass are Very Sensitive to Dieldrin

Risk to Largemouth Bass from Dieldrin

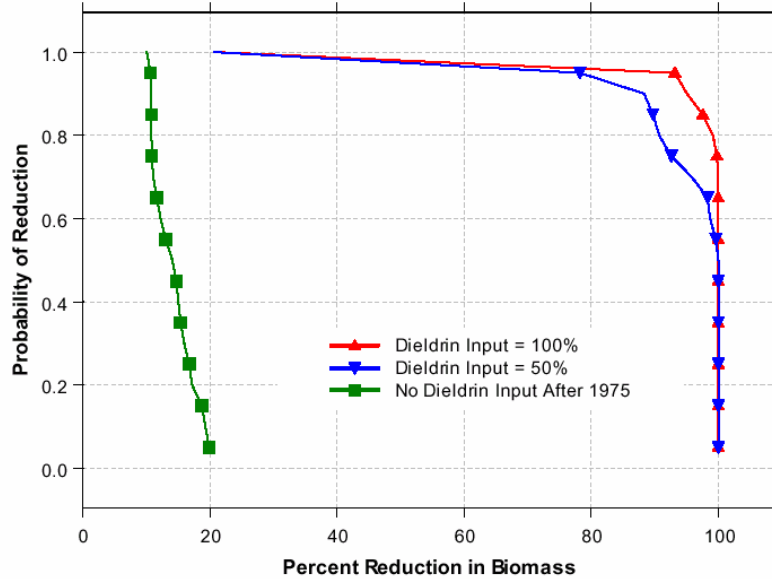

Probability of decline under different loading scenarios is plotted by saving the results from separate simulations.

Mauriello, D. A., and R. A. Park. 2002. An adaptive framework for ecological assessment and management. Pages 509-514 in A. E. Rizzoli and A. J. Jakeman, eds. *Integrated Assessment and Decision Support*. International Environmental Modeling and Software Society, Manno Switzerland.

Lab 9: Fate of Chemicals in a Tank and Pond

Objective: analyze chemical fate with model

- Tank:
 - open HCBTank.apr and run both perturbed and control (it's always a good idea to look at Setup, Control Setup to make sure they're different)
 - plot concentrations of HCB in plant and sediments
 - look at rate plots (having checked rates in Setup)
- Pond
 - open ChlorMed.apr
 - peruse site, biotic, and chemical files
 - run and plot concentrations of chlorpyrifos
 - look at rate plots

Hexachlorobenzene (HCB) is a waste product from the production of various industrial chemicals and pesticides. The tank or aquarium contains a macrophyte and HCB in solution; detritus is produced from the macrophyte.

Chlorpyrifos is a pesticide whose use was phased out in 2005. It was evaluated in a pond mesocosm by the Duluth EPA Laboratory.

HCB is taken up rapidly by macrophyte and by organic sediments

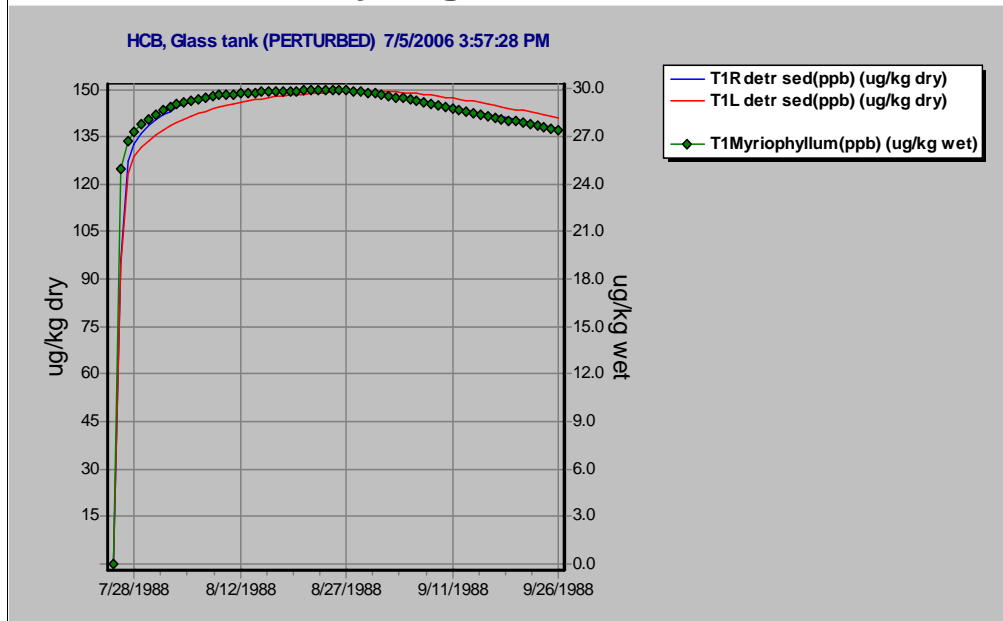

Given the differences in scales, hexachlorobenzene is taken up similarly by the macrophyte *Myriophyllum* and by sediments. In fact, with a wet:dry ratio of 5, the scales are comparable.

Loss rates can be saved and plotted in Excel

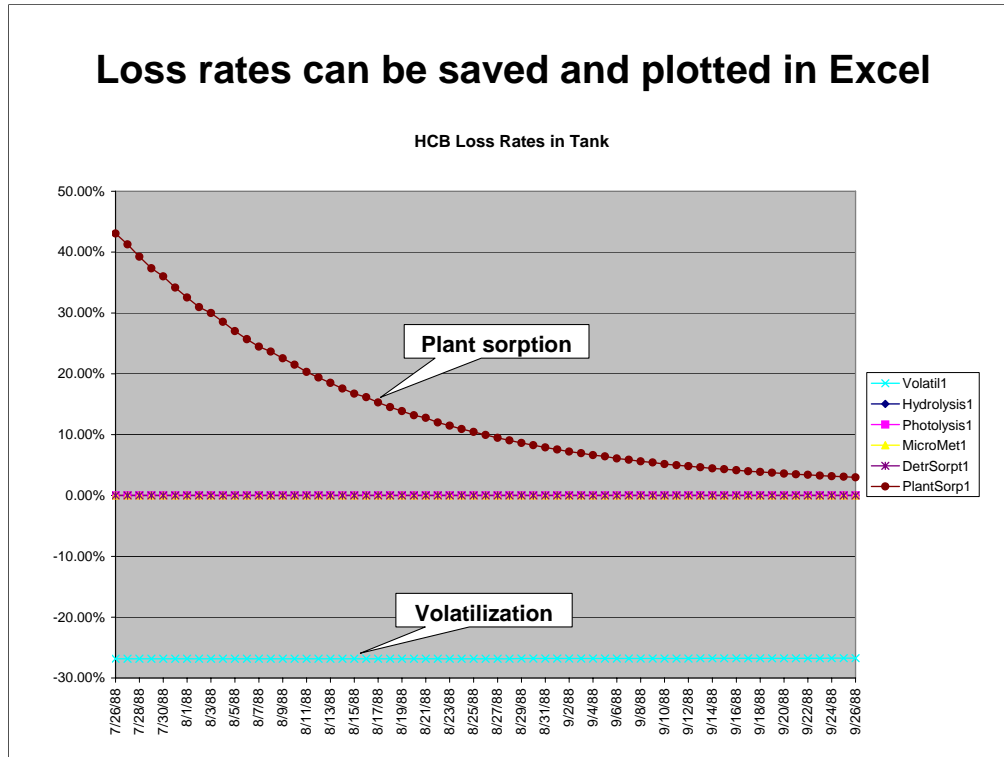

The rates plot indicate that the only significant processes in the tank are sorption by plants and volatilization. As we saw on the previous slide, the rate of sorption by detritus is almost the same as for plants; however the amount of detritus is so small that it accounts for only a fraction of a percent of the HCB in the water. The macrophytes, on the other hand, have a very large biomass in the tank, so much of the mass of HCB is taken up by the plants.

Note that volatilization is a negative when there is loss from the water into air (transfer through the water-air interface can be in either direction).

Fate of Chlorpyrifos in the Duluth MN Pond was Predicted Successfully

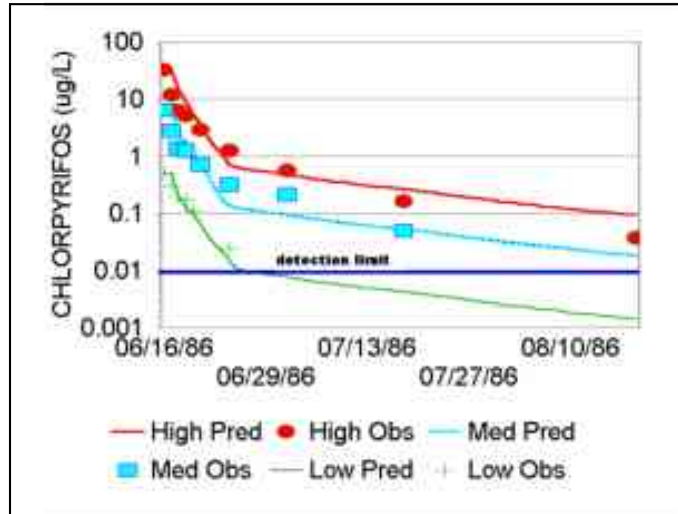

In a validation study several years ago, three levels of chlorpyrifos in a pond were predicted and compared to observed data.

Dissolved chlorpyrifos slowly declines while bioaccumulation proceeds at various rates

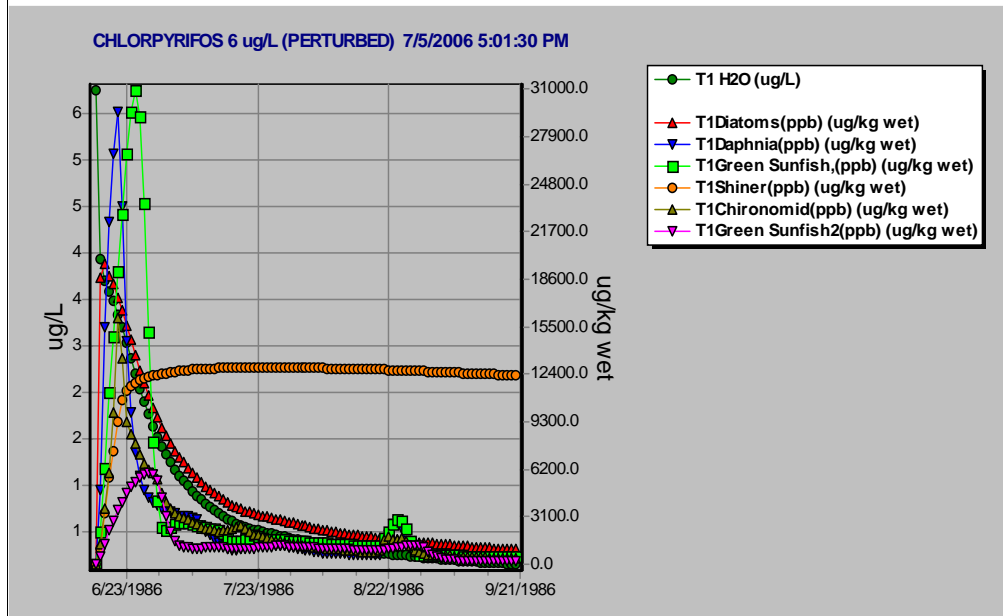

The fate depends in part on the effects: shiners (minnows) are tolerant of chlorpyrifos but sunfish aren't.

Note, save these results as we will be revisiting them in a future laboratory.

Loss rates can be saved and plotted in Excel

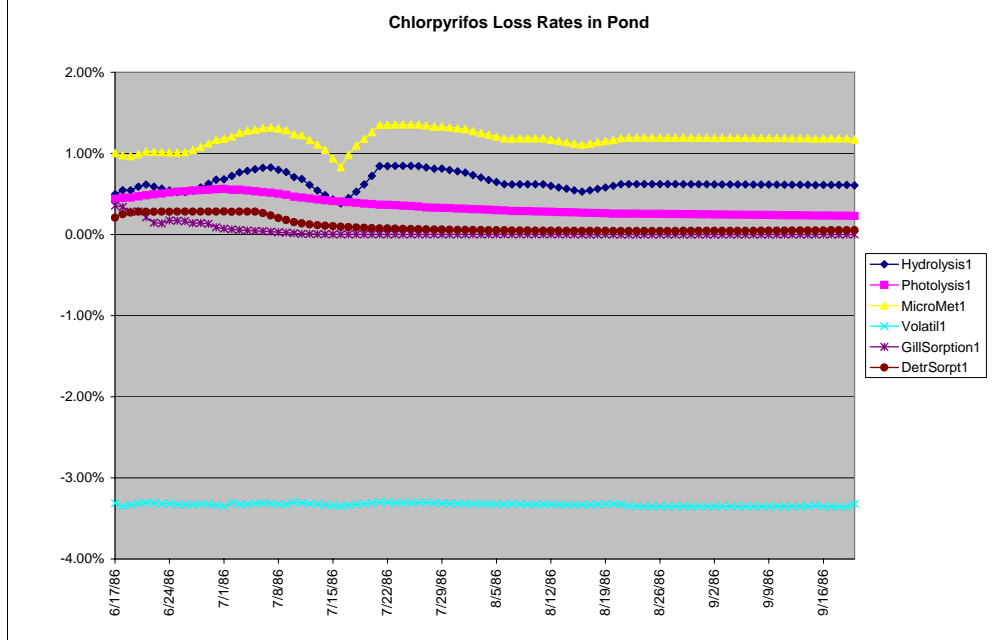

This is equivalent to the areagraph shown earlier.

Lab 10: Risk Assessment of Insecticide in Ohio Stream

Objective: analyze direct and indirect ecotoxicological effects with model

- Assessment of chlorpyrifos in a generic stream
 - small stream in corn belt
 - drain tiles
- Open Ohio Stream.aps,
- Add chlorpyrifos, save as Ohio Stream chlor.aps
- Run, plot, analyze control/perturbed/ %difference, plot loss rates (compare with pond rates)
- Revisit ChlorMed.aps results (control/perturbed)

We will use a constant level of 0.4 ug/L chlorpyrifos in a generic small stream for purposes of risk assessment. This concentration is based on the worst-case value chosen by US EPA for risk assessment of chlorpyrifos. We will start the simulation on May 1, the start of the growing season.

After you have explored the results for the stream you might return to the pond simulation with chlorpyrifos and look at the impacts predicted for that system.

Add chlorpyrifos

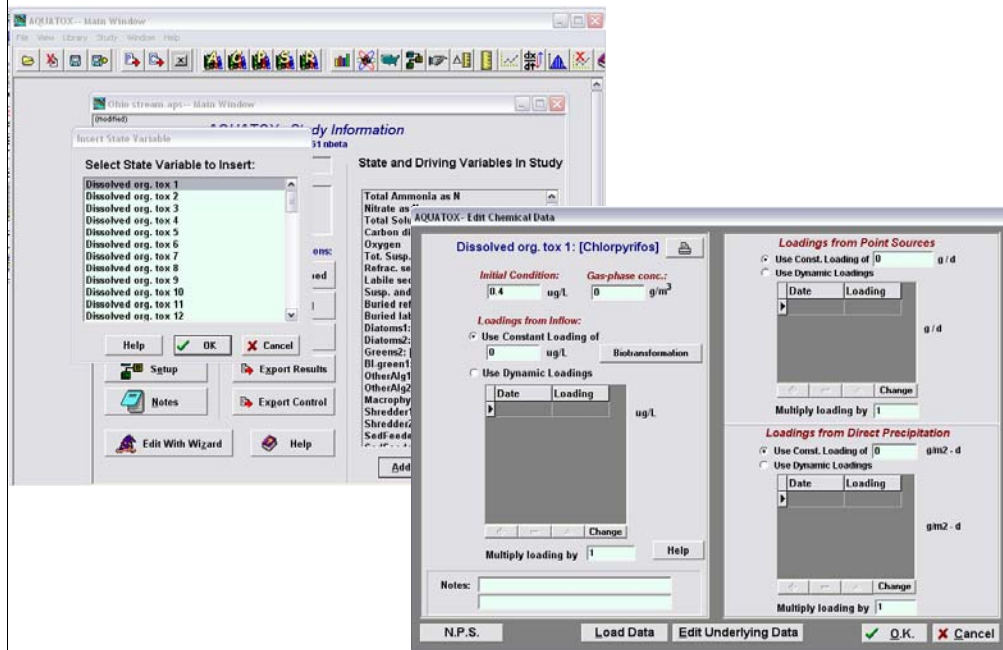

Add Dissolved org. tox 1 as statevariable

Choose **chlorpyrifos**

Double-click on **Dissolved org. tox 1 [chlorpyrifos]** in the state variable list

Set the initial condition to 0.4 ug/L

Click on **OK** to exit

Save as **Ohio stream chlorpyrifos.aps**

Set exposure to a constant in Study Setup and change Control Setup

The screenshot shows the 'Study Setup' dialog box with the following fields and options:

- First Day Of Simulation: 1/1/1997 (Callout: change to 5/1/1997)
- Last Day: 12/31/1997
- Data Storage Step: 1.00 day(s)
- Relative Error: 0.0007
- Min. Stepsize: 1E-10
- Keep Freely Dissolved Contaminant Constant (Callout: check box)
- Disable Dynamic Lipid Calculations
- Include Complexed Toxicant in BAF Calculations
- Write Hypolimnion Data When System not Stratified
- Show Integration Info Don't Show Integration
- When calculating toxicant uptake in organisms...
 - Calculate Normally (gill / dietary uptake and depuration)
 - Estimate Using BCF (will speed up Low Kow simulations)
- When calculating toxic effects...
 - Use Internal Concs
 - Use External Concentrations
- Save Biologic Rates Don't Save Rates
- Rate Specifications
- Buttons: Uncertainty Setup, Control Setup (Callout: control setup), Output Setup, Help, OK, Cancel

In Main Screen click on **Study Setup**

Check box **Keep Freely Dissolved Contaminant Constant**

Change start date to **5/1/1997** (to speed up simulation)

In **Control Setup** check **All Organic Toxicants** boxes (so Control will not have chlorpyrifos)

Error occurs when run Perturbed

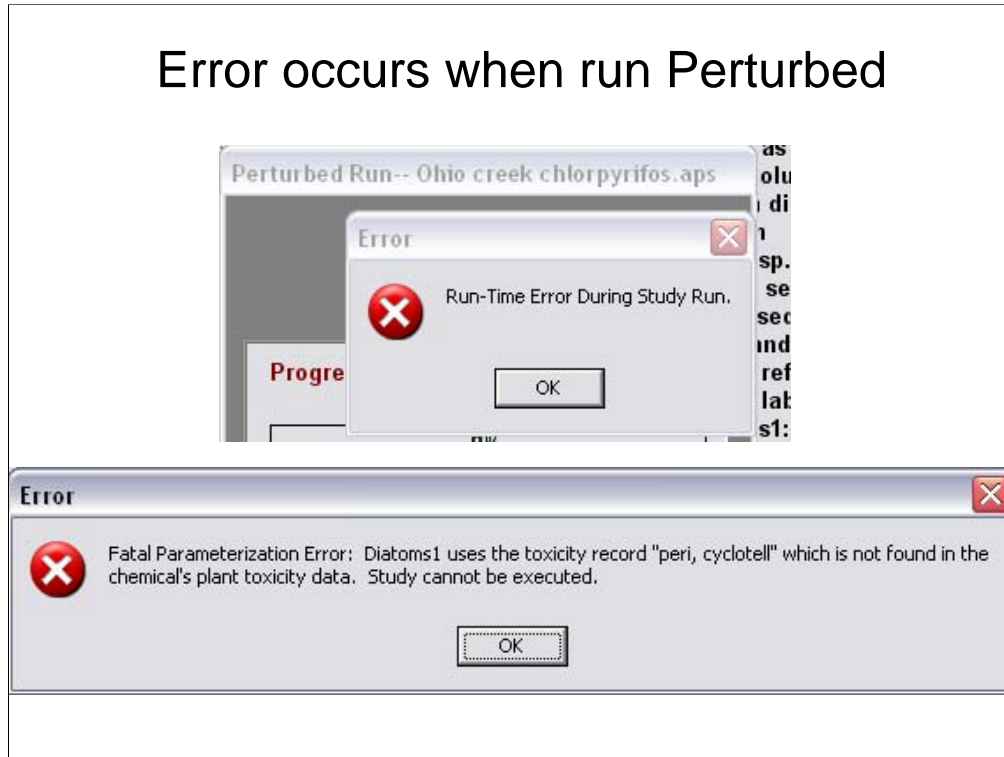

Run the perturbed simulation. We have purposefully included an error! Organisms must be linked to a valid toxicity record for the toxicant being modeled. The disconnect occurs when organisms are parameterized for one toxicant and then used for another toxicant with different available toxicity data.

Change the linkage to toxicity record

The screenshot shows the AQUATOX- Edit Plant window for 'Peri High-Nut Diatom'. The interface includes buttons for 'Load from Library', 'Save to Library', 'OK', and 'Print'. The 'Plant' dropdown is set to 'Peri High-Nut Diatom', and the 'Periphyton Linkage' tab is active. The 'Plant Type' is 'Periphyton' and the 'Taxonomic Group' is 'Diatoms'. The 'Toxicity Record' dropdown is currently set to 'Peri, Cyclotell', with an 'Edit All' button next to it. A callout box labeled 'Note' points to the 'Peri, Cyclotell' dropdown, and another callout box labeled 'change to Diatoms using pull-down menu' points to the 'Diatoms' option in the dropdown menu. Below these are sections for 'Plant Data' and 'References'.

Plant Data:		References:
Saturating Light	22.5 Ly/d	Hill, 1996 64 (22.5)
P Half-saturation	0.1 mg/L	Borchard;Collins & Wlosinski '83, p. 33 0
N Half-saturation	0.2 mg/L	Collins & Wlosinski '83, p. 36, EcoTox=0.
Inorg. C Half-saturation	0.054 mg/L	C & W '83, p. 39 (greens) = 0.054
Temp. Response Slope	1.8	
Optimum Temperature	20 °C	Collins & Wlosinski '83, p. 43 = 20
Maximum Temperature	35 °C	
Min Adaptation Temp.	2 °C	2

The pull-down menu for the Toxicity Record lists the available state-variable linkages for the toxicant. As you have seen, if you miss an assignment the program will return an error and tell you which state variable is unassigned.

If you need to make more than one toxicity assignment, click on **Edit All** next to the pull-down menu.

Can edit all toxicity linkages

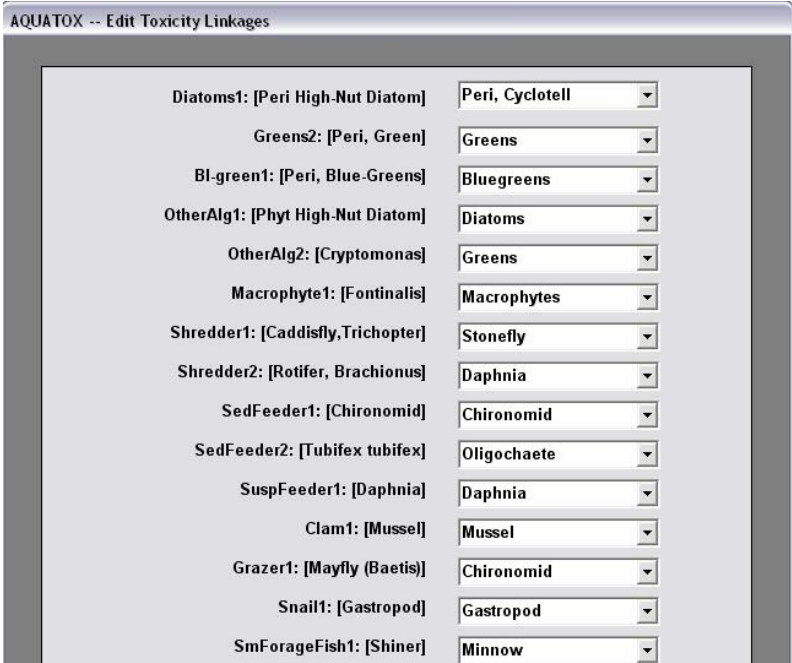

AQUATOX -- Edit Toxicity Linkages

Diatoms1: [Peri High-Nut Diatom]	Peri, Cyclotell
Greens2: [Peri, Green]	Greens
Bl-green1: [Peri, Blue-Greens]	Bluegreens
OtherAlg1: [Phyt High-Nut Diatom]	Diatoms
OtherAlg2: [Cryptomonas]	Greens
Macrophyte1: [Fontinalis]	Macrophytes
Shredder1: [Caddisfly, Trichopter]	Stonefly
Shredder2: [Rotifer, Brachionus]	Daphnia
SedFeeder1: [Chironomid]	Chironomid
SedFeeder2: [Tubifex tubifex]	Oligochaete
SuspFeeder1: [Daphnia]	Daphnia
Clam1: [Mussel]	Mussel
Grazer1: [Mayfly (Baetis)]	Chironomid
Snail1: [Gastropod]	Gastropod
SmForageFish1: [Shiner]	Minnow

By clicking on **Edit All** next to the toxicity assignment you can assign all linkages in one screen.

Run both the control and perturbed simulations.

Impacts of constant chlorpyrifos on animals are dramatic, algae increase

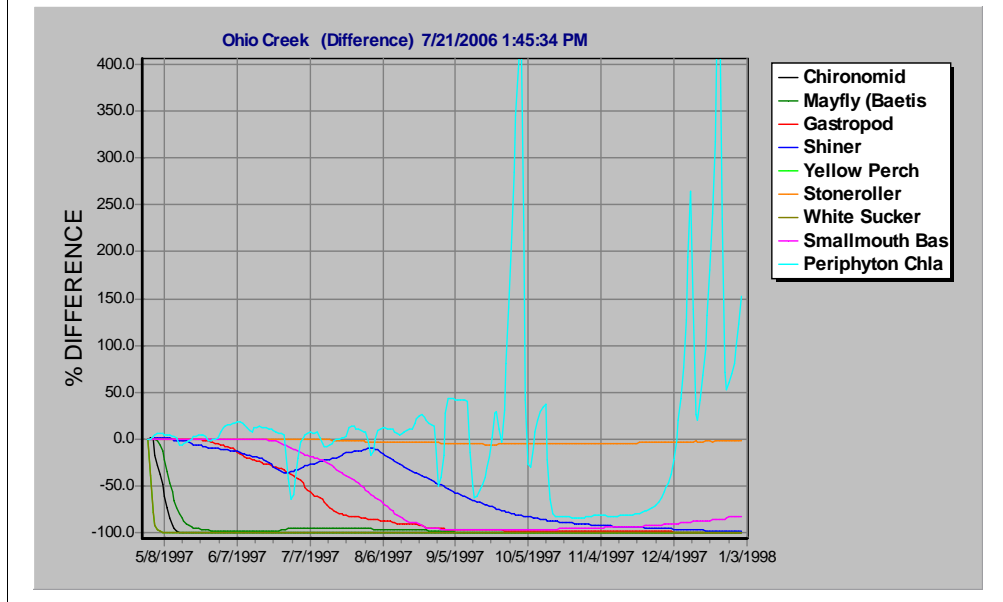

The best indication of the impacts are to be seen in a **Difference** graph that compares the perturbed with the control. To get this you have to run the simulations for the same period. Note that most of the invertebrates disappear quickly, followed by the fish. Shiners and stonerollers share the same toxicity record (Minnow), so the relative decline of shinners is due to loss of invertebrate food base and not direct toxicity whereas stonerollers, which graze periphyton, are unaffected.

What is the impact of an initial (rather than constant) exposure to 0.4 ug/L chlorpyrifos on May 1?

Plot of Steinhaus indices shows lasting impacts predicted by the model

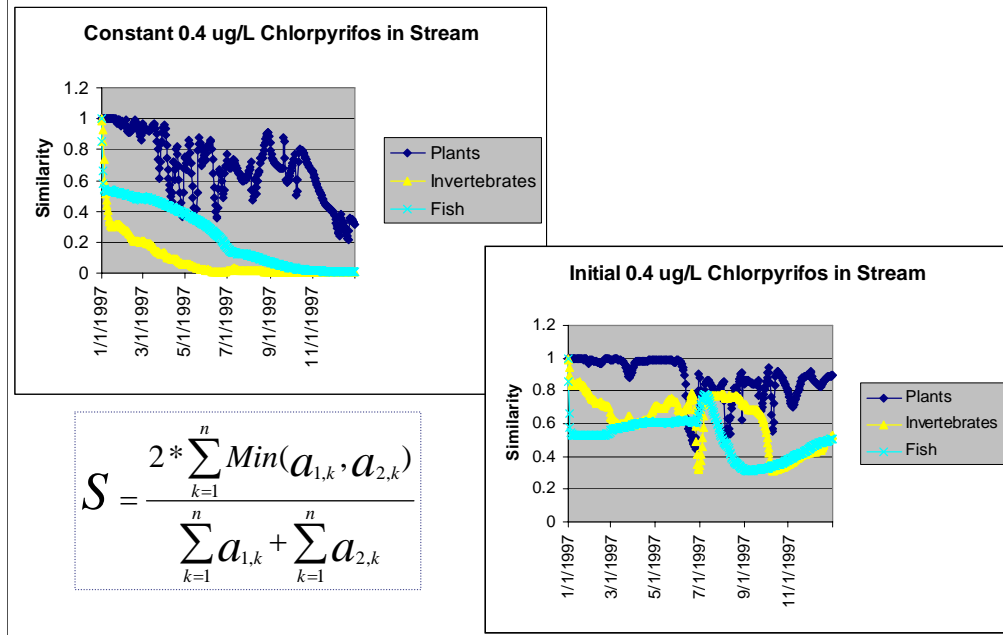

Coefficients of similarity are used to determine whether the composition of two communities is similar. The Steinhaus coefficient or similarity index (S) is based on the species abundances (in this case indicated by the species specific daily biomass) common to two communities, where $a_{i,k}$ is abundance of species k in sample i .

See Section 4.4 in the Addendum to the Technical Documentation for further details.

Initial 6 ug/L chlorpyrifos in pond has similar impact, with recovery of shiners

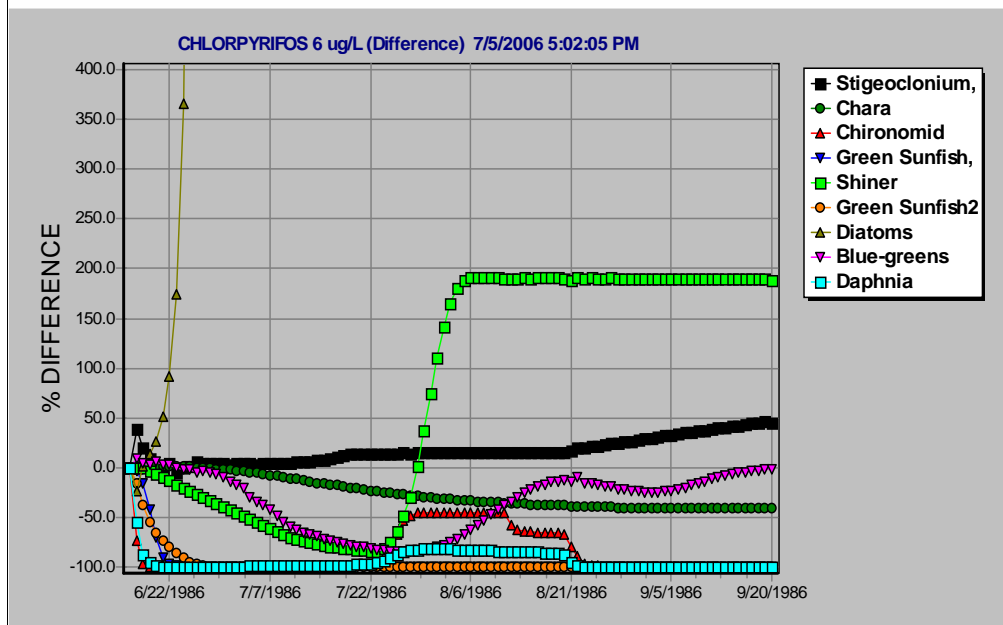

Revisiting the **Chlormed.aps** study results, we see that an initial 6 ug/L chlorpyrifos in the pond also has an immediate impact on the invertebrates and sunfish. Eventually, the shiners recovered and, in the absence of predation pressure from sunfish, increased.

Lab 11: Atrazine in Blue Earth River and Fluridone in Clear Lake

**Objective: additional ecotoxicological
analyses**

Atrazine runoff from agricultural land

- **Observed loadings**
- **Toxicity parameters**
- **Control and perturbed simulations**
- **Internal and external toxicity models**
- **Steinhaus index of community similarity**
- **Impacts on algal community**

Detailed Instructions

- We started with **BlueEarth54 Calibration.aps**. To save time, load **BlueEarth Atrazine Internal.aps**. (Details of the steps we took to modify the simulation are in the slide notes.)
- We already added Dissolved Org. Tox. 1
 - double-click on **Atrazine**
 - note that time series sequence is bracketed by 0's

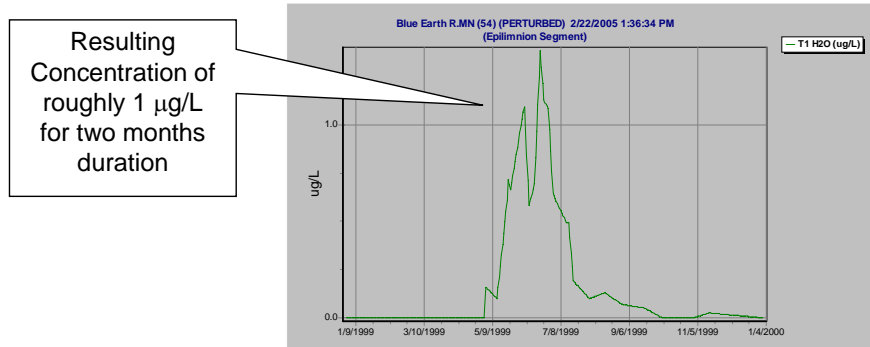

To convert **BlueEarth54 Calibration.aps** to the Atrazine Study we:

1. Loaded Dissolved Org. Tox 1 and loaded in Atrazine parameters (underlying data).
2. Loaded **BE Atrazine.xls** as a dynamic inflow loading of Atrazine. Bracketing a loading by 0's ensures that atrazine comes in as a pulse load or, in this case, does not interpolate to the next year.
3. Went to each animal in the simulation and assigned an appropriate toxicity record. A default toxicity record is assigned but we have considerable additional toxicity information for atrazine.
4. Went to the control setup screen and zeroed out all toxicants. The control simulation will therefore have no atrazine impact. Ran both control and perturbed simulations. (roughly 50 minute run-time on a 2.6Ghz PIV)

Pesticide data are available from the Minn. Department of Agriculture

GRABS and COMPOSITES ASSIGNED LO, MDA PEST Chemistry

Green shading indicates compound present assigned 1/2 the MRL

INSPNUM	STYPE	DATESAMPLE	Acetochlor	Atrazine ppb	DEAtrazine	DIAtazine
RD100007	Grab	05/02/00	0.140	0.160	ND@MRL	ND@MRL
RD100008	Grab	05/12/00	0.090	0.100	0.080	ND@MRL
RD100009	Composite	05/21/00	1.710	0.610	0.120	ND@MRL
RD100010	Composite	05/22/00	3.800	0.720	0.130	ND@MRL
RD100011	Composite	05/24/00	3.500	0.660	0.120	ND@MRL
RD100012	Composite	06/05/00	0.650	1.100	0.170	ND@MRL
RD100013	Composite	06/09/00	0.280	0.580	0.130	ND@MRL
RD100014	Composite	06/14/00	0.260	0.690	0.180	ND@MRL
RD100015	Composite	06/19/00	0.270	1.380	0.250	0.250
RD100016	Composite	06/22/00	0.170	1.120	0.240	0.250
RD100017	Composite	06/26/00	0.110	1.080	0.210	0.210
RD100018	Composite	06/30/00	0.100	0.640	0.150	ND@MRL
RD100019	Composite	07/12/00	0.100	0.490	0.210	ND@MRL

We will use a time series of observed values for atrazine collected at a station just downstream of the gage on the Blue Earth River near Rapidan MN. We will ignore the atrazine daughter products, although they could be modeled as well.

Edit Underlying Data: peruse physico-chemical parameters

AQUATOX - Edit Chemical

[Load from Library](#) [Save to Library](#) [OK](#) [Print](#) **Atrazine**

Chemical [Help](#)

Chemical Properties and Fate Data:

CAS Registry No.	<input type="text" value="1912-24-9"/>	Chemical is a Base <input type="checkbox"/>	Toxicity Data
Molecular Weight	<input type="text" value="215.69"/>	References:	
Dissociation Constant	<input type="text" value="2.68"/> pKa	<input type="text" value="Solomon; ARS Pest Properties Database, 1"/>	
Solubility	<input type="text" value="33"/> ppm	<input type="text" value="ARS Pesticide Properties Database"/>	
Henry's Law Constant	<input type="text" value="2.48E-9"/> atm. m ³ /mol	<input type="text" value="Solomon et al., 1995, p. 56"/>	
Vapor Pressure	<input type="text" value="3E-7"/> mm Hg	<input type="text" value="Versheuren '83"/>	
Octanol-Water Partition Coefficient	<input type="text" value="2.82"/> (log)	<input type="text" value="Draft Atrazine Criteria document (USEPA,2"/>	

Days to Reach Equilibrium: 1.62
(Calculated Using Octanol-Water Partition Coefficient)

Note in particular the Dissociation Constant indicating that this is an ionic compound. Log KOW is relatively low as well.

Edit Underlying Data: peruse physico-chemical parameters #2

Calculate Sed/Detritus Water Partition Coefficient dynamically using pH, pK_A and LogK_{OW}

at pH 7, K_{PSED} would be:

5.410E+1 L/kg OC

OR, Enter override value for K_{PSED}

11.446

L/kg OC

Calc. from Octanol Water Coeff

Activation Energy for Temperature

18000

cal/mol

default

Rate of Anaerobic Microbial Degradation

0.0011398

1/d

Solomon et al., 1995, p. 56, T_{1/2} = 608 d

Max. Rate of Aerobic Microbial Degradation

0.0047

1/d

Solomon et al., 1995, p. 56, T_{1/2} = 146 d

Uncatalyzed hydrolysis constant

0

1/d

stable, ARS Pesticide Properties Database

Acid catalyzed hydrolysis constant

0

1/mol · d

Base catalyzed hydrolysis constant

0

1/mol · d

Photolysis Rate

0.002

1/d

Solomon et al., 1995, p. 56, T_{1/2} = 335 d

Oxidation Rate Constant

0

1/mol · d

Weibull Shape Parameter

0.33

Mackay et al., 1992

We will explore the meaning of the Weibull Shape Parameter later in this lab.

Click on Toxicity Data to inspect toxicity records for animals and plants

Plant name	EC50 photo (ug/L)	EC50 exp. time (h)	EC50 dislodge (ug/L)	K2 Elim. rate const (1/h)	K1 Uptake Co
▶ Phyto, Navicula	60	120	0	1.2252	0
Cryptomonad	500	144	0	1.2252	0
Peri, Skeletone	69	72	0	1.2252	0
Peri, Cyclotell	430	48	0	1.2252	0
Peri, Chlorella	88	96	0	1.2252	0
Peri, Selenastr	120	72	0	1.2252	0
Peri, A. inaequ	173	24	0	1.2252	0
Peri, A. cylind	787	48	0	1.2252	0
Ceratophyllum	22	336	0	1.2252	0
Potamogeton	170	192	0	1.2252	0
Greens	70	24	0	1.2252	0
Diatoms	60	120	0	1.2252	0
Bluegreens	2300	96	0	1.2252	0
▶ Macrophytes	1104	672	0	0.6321	0

We can ignore the animals for now, noting only that the LC50s are large for most animals so that toxicity shouldn't be an issue. There are substantial toxicity data for plants; those without references were taken from an ongoing EPA study. In the Loading screen note that there is a button for **Biotransformation**; if we wanted to model transformation to daughter products (which do occur for atrazine) we would fill in the biotransformation table.

Check to make sure toxicity records have been properly linked for organisms

AQUATOX- Edit Plant

Load from Library Save to Library OK Print Peri High-Nut Diatom

Plant Peri High-Nut Diatom Periphyton Linkage Help

Plant Type: Periphyton Toxicity Record: Peri, Cyclotell Edit All

Taxonomic Group: Diatoms

Plant Data:

		References:
Saturating Light	22.5 Ly/d	Hill, 1996 64 (22.5)
P Half-saturation	0.055 mg/L	Borchard; Collins & Wlosinski '83, p. 33 0
N Half-saturation	0.117 mg/L	Collins & Wlosinski '83, p. 36, EcoTox=0.
Inorg. C Half-saturation	0.054 mg/L	C & W '83, p. 39 (greens) = 0.054
Temp. Response Slope	1.8	
Optimum Temperature	20 °C	Collins & Wlosinski '83, p. 43 = 20
Maximum Temperature	35 °C	
Min Adaptation Temp.	2 °C	2
Max. Photosynthetic Rate	2.06 1/d	Collins & Wlosinski '83; EcoTox 1-96 = 2.

toxicity linkage

The organisms in this study have been linked properly for the atrazine analysis. However, this can be tricky if you are analyzing a compound with limited toxicity data. You may be forced to decide which organism from the toxicity records is closest to the organism being modeled.

Results show essentially no difference

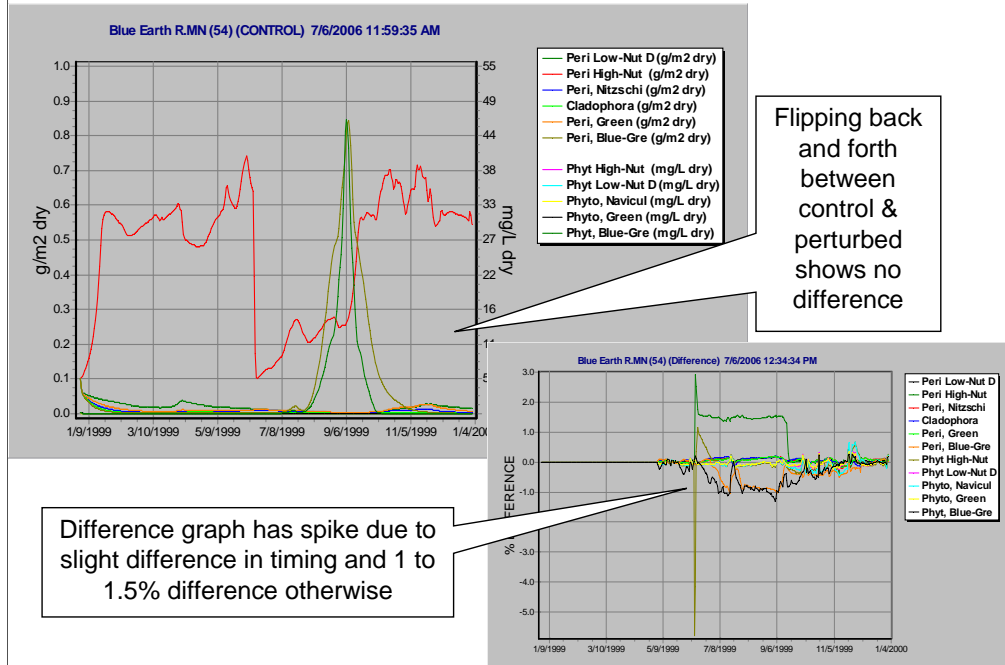

We ran the model with levels of atrazine observed in the Blue Earth River to be sure that the herbicide was not affecting our calibration for nutrients. It wasn't, so we proceeded with our calibration.

Convert to External Toxicity Model

- Input Weibull Slope Factor

Weibull Slope Factor
(slope at EC50 x EC50)
external model only

- Choose to use the External Concentrations Model and to Estimate Uptake using BCF

When calculating toxicant uptake in organisms...

Calculate Normally
(gill / dietary uptake and depuration)

Estimate Using BCF
(will speed up Low Kow simulations)

When calculating toxic effects...

Use Internal Concs

Use External Concentrations

- Run Perturbed

The run should take 10-15 minutes depending on processor speed. It is considerably faster than the 30-45 minutes for the internal model with Atrazine.

While the simulation runs... We will examine spreadsheet models

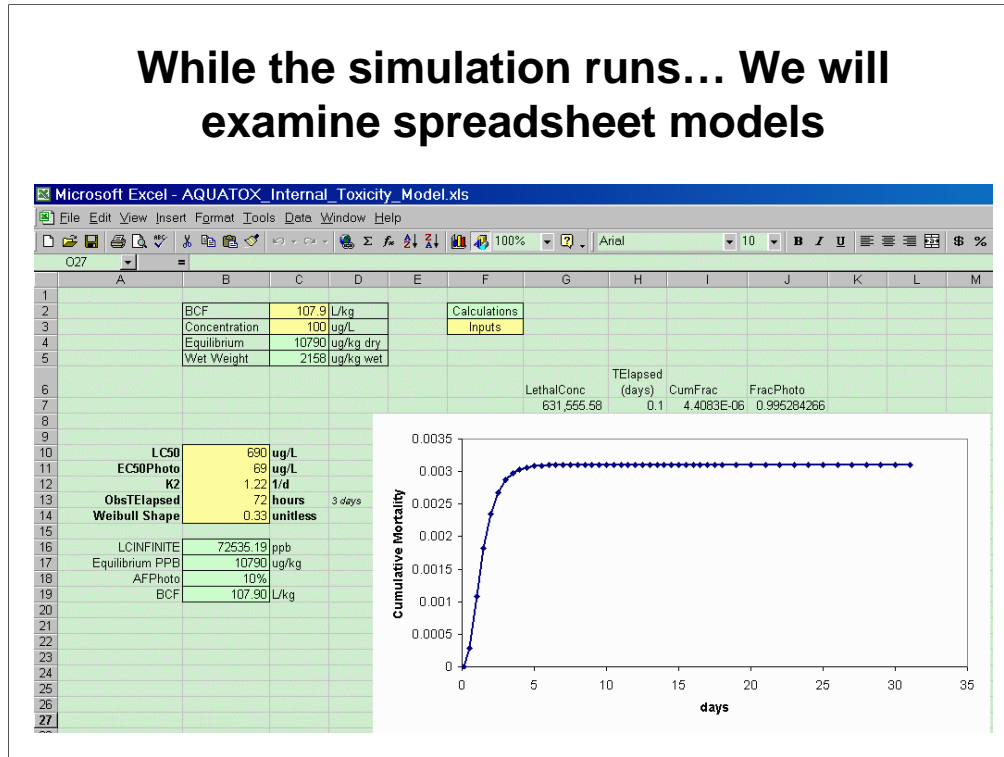

Load **AQUATOX_Internal_Toxicity_Model.xls** from the Data folder.

By changing the yellow inputs in this model, you can examine the effects on cumulative mortality and photosynthesis.

Note that the X axis in this case is days and the concentration is assumed to be constant in this spreadsheet model. In AQUATOX, of course, the concentration will be variable. This spreadsheet model also assumes that the organism has come to equilibrium with the toxicant. In AQUATOX, the concentration in the organism is determined through the kinetic processes of gill uptake, dietary uptake and depuration.

This spreadsheet model represents a significant simplification of the AQUATOX model. Still, it can be useful to examine the model that you are using and this simplified model can help you to interpret AQUATOX results. For example in this case, we see that a concentration of 100 ug/L will have little impact on acute mortality but significant impacts on photosynthesis.

External Toxicity Spreadsheet Model

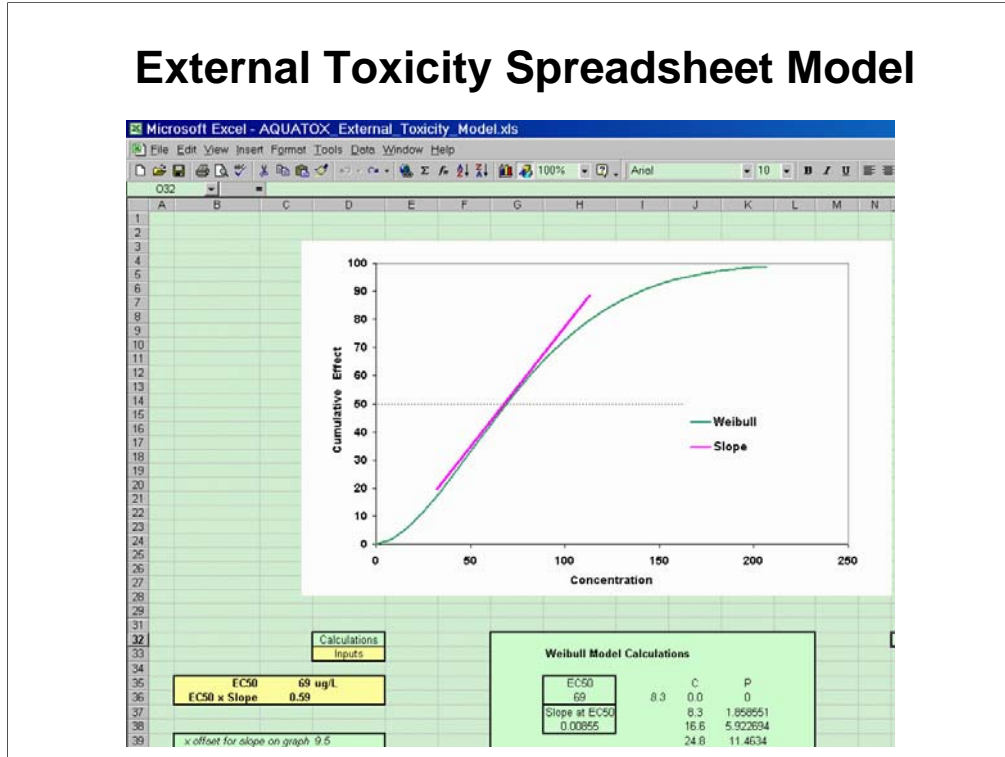

Load **AQUATOX_External_Toxicity_Model.xls** from the Data folder.

Again, by changing the yellow inputs in this model, you can look at the effects on cumulative mortality.

Note that the X axis in this case is the concentration and effects are assumed to be instantaneous.

The EC50 slope factor can be derived by fitting an equation to your toxicity data and then calculating the slope or by plotting the toxicity data on this graph and then playing with the slope until the fit seems to be appropriate. This slope parameter for Atrazine was determined by finding the best fit to an existing Probit model.

Results show even less difference

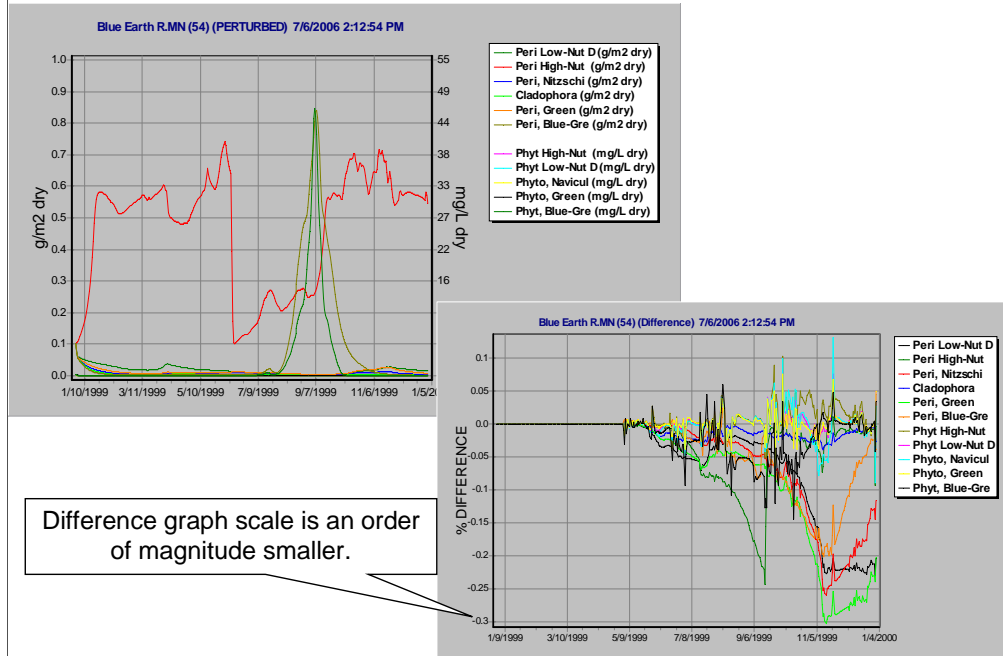

Differences in the external model are less significant than the internal model because time does not play a factor in this model. In the external model you either have the concentration to produce an effect instantaneously or the effect will not occur unless concentrations increase. In the internal model, effects can continue to occur the longer that an organism is exposed to the toxicant. These types of differences between the two models can become more intuitive as you play with the spreadsheet models.

Run the model with x100 observed Atrazine levels to force some effects

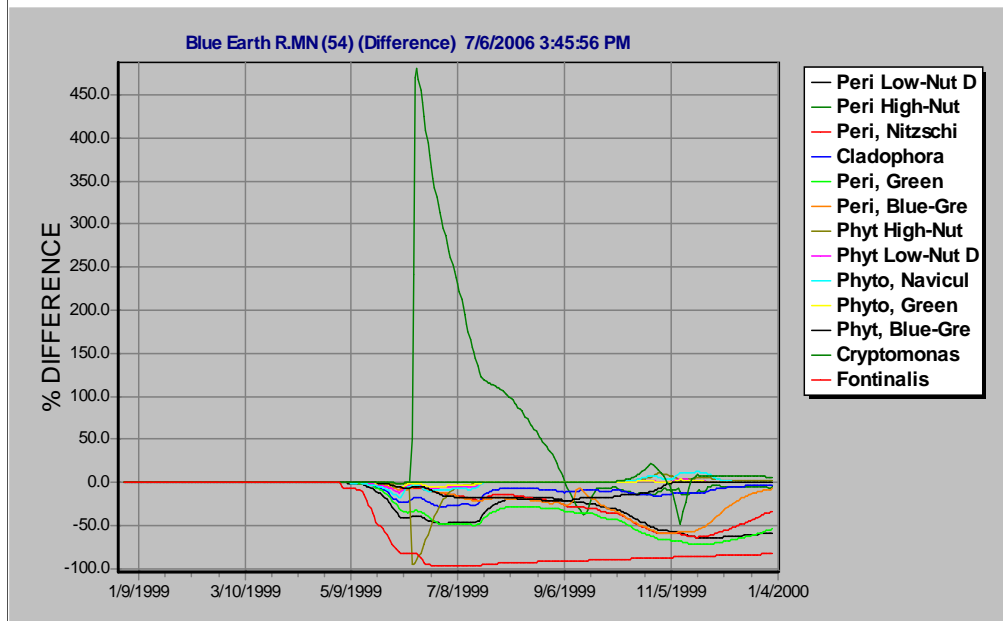

In order to get a sense of possible impacts, we will use a multiplier of 100. If we have time we can apply the multiplier and run the model. It is more likely going to be most efficient to load the results in **Blue Earth Atrazine x100 External.aps**

A percent difference graph emphasizes the differences. Moss disappears first, reflecting its low EC50. Several algal species decrease in biomass compared to the control simulation followed by an increase in high-nutrient diatoms due to reduced competition.

This difference graph has some meaningful differences over longer periods of time, not the spikes and very small differences that we saw previously.

Community indices can be computed

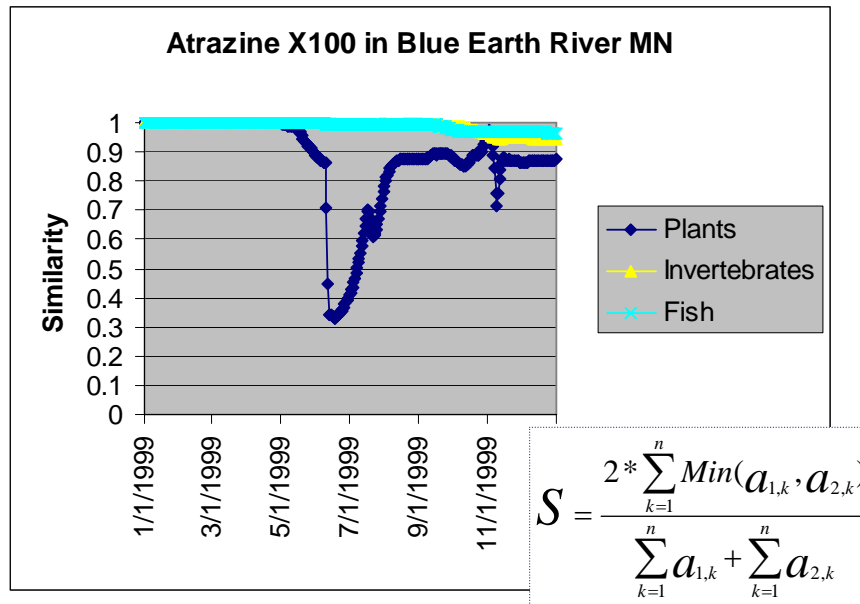

Click on **Write Steinhaus Indices** to save community indices to Excel for later plotting.

Here we see a dramatic dissimilarity between the perturbed and control simulations because of the unusually large levels of atrazine used in this “what if?” exercise. Note that even with levels of atrazine 100 times those measured, the community recovers toward the end of the year.

Loss rates for dissolved atrazine

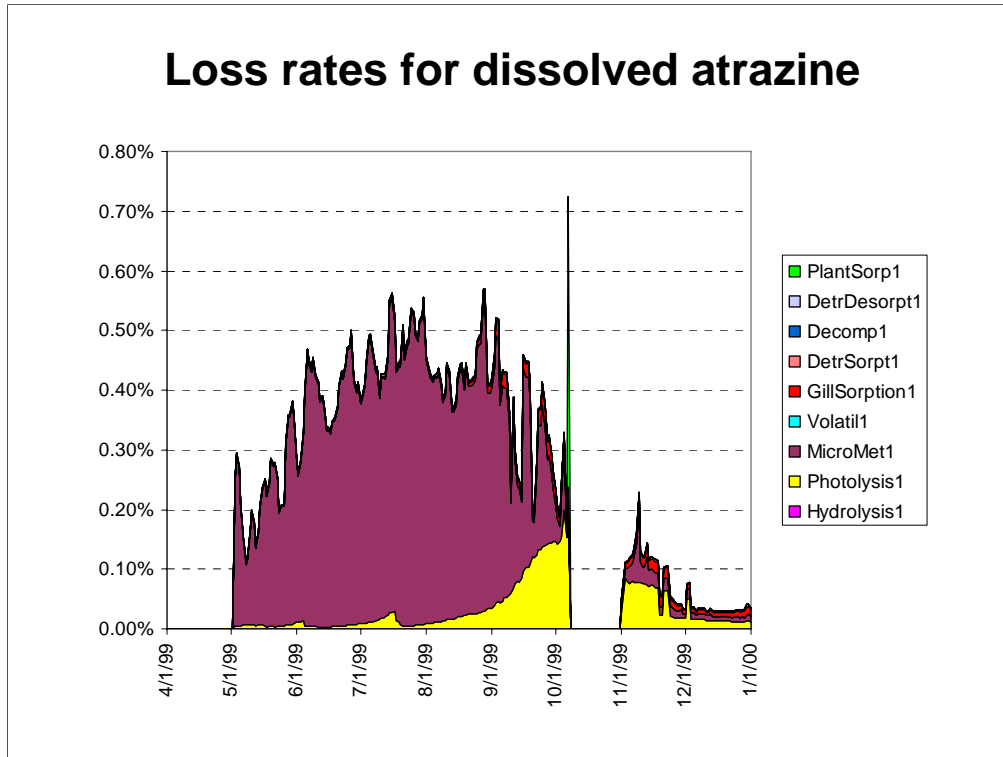

Note abrupt start of atrazine dependent on sampling, but determined by spring application to corn fields. The largest loss rate is by washout downstream; that was not plotted so that small chemical loss rates could be examined. Although readily dissolved, Atrazine is a very persistent chemical.

Fluridone (Sonar) used to eradicate *Hydrilla* in Clear Lake CA

- Open **Clear Lake CA fluridone.aps** and run
- Examine chemical loadings, properties, and toxicity
 - considering irrigation restrictions, why use 20 ppb dose?
 - why 6 doses?
 - what is impact on non-target organisms?
 - why does fluridone disappear so fast?
- What is recovery of Clear Lake ecosystem?
- Is there an impact on DO from sudden death of large *Hydrilla* biomass?
- Is this more informative than running with and without *Hydrilla* (Lab 8)?

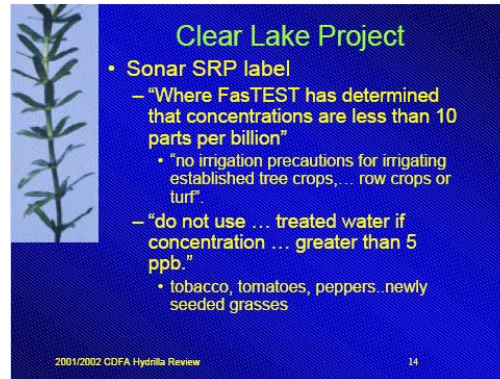

Clear Lake Project

- **Sonar SRP label**
 - “Where **FasTEST** has determined that concentrations are less than 10 parts per billion”
 - “no irrigation precautions for irrigating established tree crops, ... row crops or turf”
 - “do not use ... treated water if concentration ... greater than 5 ppb.”
 - tobacco, tomatoes, peppers, newly seeded grasses

2001/2002 GDFA Hydrilla Review 14

Sonar (fluridone) has been used successfully in Clear Lake to eradicate *Hydrilla*. Although *Hydrilla* did not appear until 1994, we will use the study set up with 1970-1971 data. Note that the fluridone loadings are for 1971 but without bracketing the simulation period with 0 loadings, the loadings are repeated in each of the three years. You can easily change this if you wish. Also note that we are modeling the entire lake for convenience; in reality, *Hydrilla* spread slowly, so only selected areas needed to be treated; our simulation is, therefore, a worst-case scenario.

This is a self-paced lab, so examine the results and be prepared to discuss the answers to the questions near the end of the exercise.

Addition of Fluridone causes dramatic response of Clear Lake ecosystem

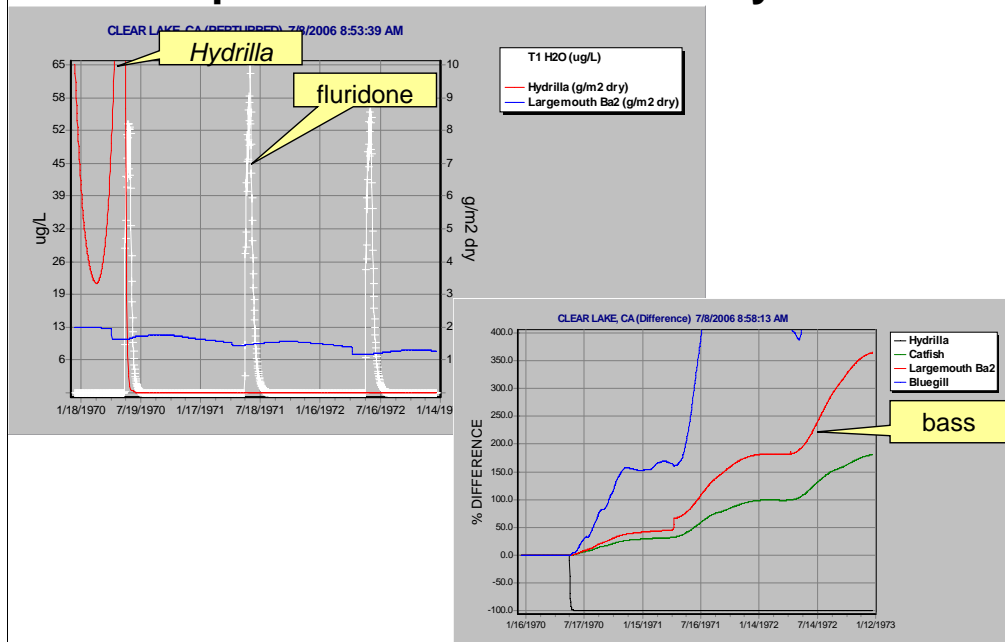

Modeling Inorganic Sediments (sand, silt, and clay)

- Stream simulations only
- Scour, deposition and transport of sediments
- River reach assumed short and well mixed
- Daily average flow regime determines shear stresses
- Feedback to biota through light limitation, sequestration of chemicals

The sediment transport component of AQUATOX simulates scour, deposition and transport of sediments and calculates the concentration of sediments in the water column and sediment bed within a river reach. For running waters, the sediment is divided into three categories according to the particle size: 1) sand, with particle sizes between 0.062 to 2.0 millimeters (mm), 2) silt (0.004 to 0.062 mm), and 3) clay (0.00024 to 0.004 mm). Wash load (primarily clay and silt) is deposited or eroded within the channel reach depending on the daily flow regime. Sand transport is also computed within the channel reach. At present, inorganic sediments in standing water are computed based on total suspended solids loadings.

Output variables resulting from the inclusion of sand/silt/clay include suspended sand, silt, and clay, bed shear, and bed depth.

Bed Shear Stress (Tau) Closely Related to Water Velocity

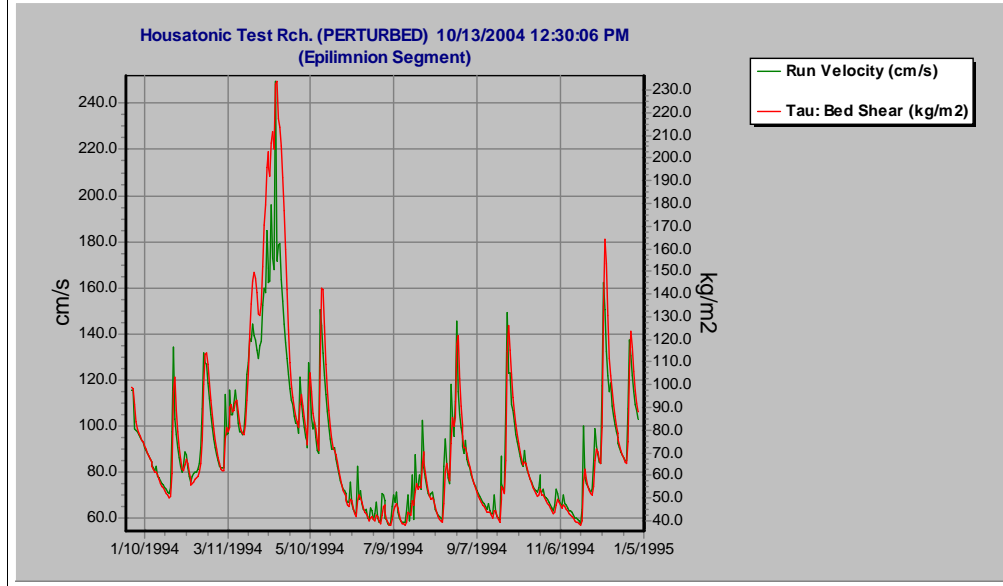

Tau is calculated as a function of channel slope and channel depth and width (hydraulic radius). This shear stress indicates whether deposition or erosion is taking place for silt and clay.

Critical Shear Stress for Erosion and Deposition Key Parameters

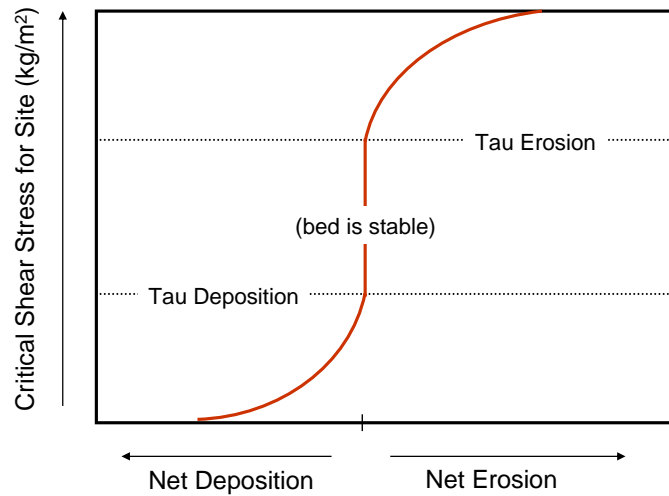

These two parameters are specified for silt and clay and can be found in the Stream section of the Site underlying data. This section of model is identical to HSPF. These parameters can be highly site specific and are usually used as calibration parameters when calibrating the HSPF inorganic sediment model.

The river reach is assumed to be short and well mixed so that concentration does not vary longitudinally. Flow routing is not performed within the river reach. The daily average flow regime determines the amount of scour, deposition and transport of sediment. Scour, deposition and transport quantities are also limited by the amount of solids available in the bed sediments and the water column.

When the inorganic sediments model is included in a stream simulation, particulate detritus moves to and from the bed to and from the water column along with the deposition and resuspension of the Cohesives compartment.

Sediment Model Parameters

Silt Parameters

Critical Shear Stress for Scour	<input type="text" value="0.7"/>	kg/m ²	References:
			<input type="text" value="default"/>
Critical Shear Stress for Deposition	<input type="text" value="0.1"/>	kg/m ²	<input type="text" value="default"/>
Fall Velocity	<input type="text" value="8.89E-5"/>	m/s	<input type="text" value="default"/>

Clay Parameters

Critical Shear Stress for Scour	<input type="text" value="0.6"/>	kg/m ²	References:
			<input type="text" value="default"/>
Critical Shear Stress for Deposition	<input type="text" value="0.07"/>	kg/m ²	<input type="text" value="default"/>
Fall Velocity	<input type="text" value="1.02E-5"/>	m/s	<input type="text" value="default"/>

Also important are channel slope and sediment depth that occur up higher on the “stream” screen. (Within Site Underlying Data)

The fall velocity affects the rate of deposition for silt and clay.

Sand Model

- No additional parameters / calibration required
- Potential concentration of sand in the water column is calculated as a function of water velocity and slope
- Uses Engelund and Hansen (1967) sediment transport relationships as presented by Brownlie (1981).

Scour, deposition and transport of sand are simulated using the Engelund and Hansen (1967) sediment transport relationships as presented by Brownlie (1981). This relationship was selected because of its simplicity and accuracy. Brownlie (1981) shows that this relationship gives good results when compared to 13 others using a field and laboratory data set of about 7,000 records.

Sediment Bed Depth May be Plotted

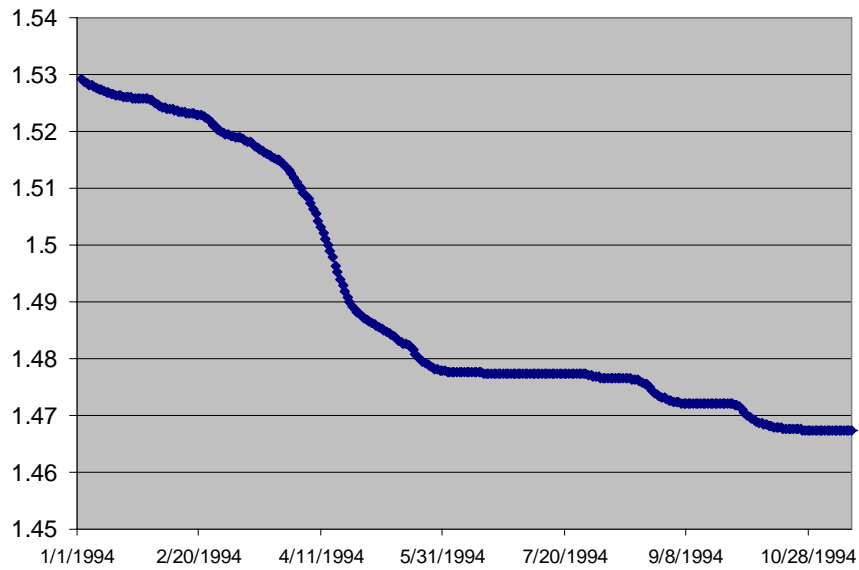

The sediment bed is assumed to be uniformly mixed and is composed of the three inorganic sediments, sedimented detritus, and toxins in sedimented detritus. Initial condition fractions of sand silt and clay in the sediment bed must be supplied by the user under the sand, silt, and clay state variable screens.

Suspended Sand, Silt, Clay may be Plotted

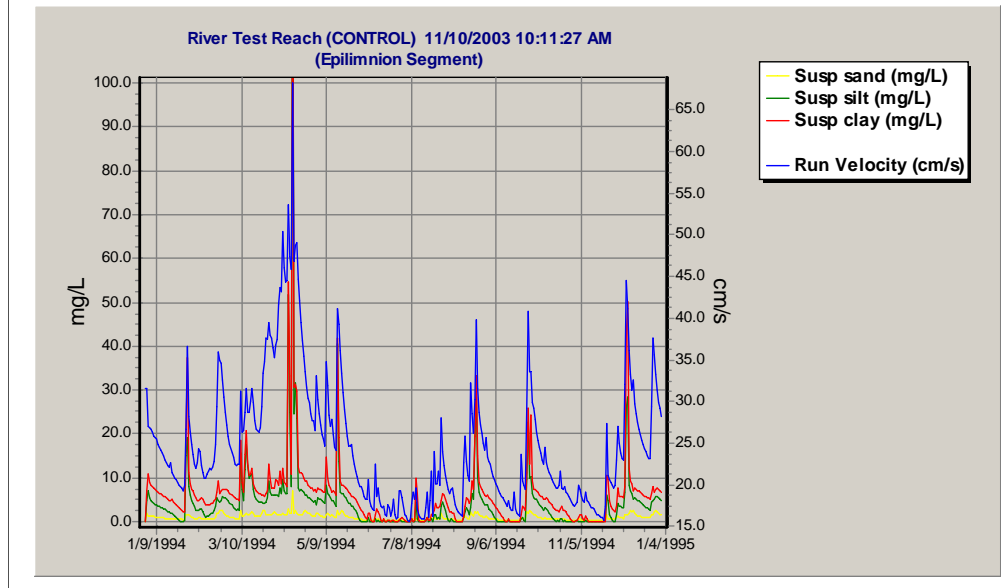

As was the case with the TSS inputs that we saw earlier, getting an appropriate accounting for inflows of sand / silt / and clay is vital for calculating appropriate concentrations in the water column.

Inorganic sediments are important to the functioning of natural and perturbed ecosystems for several reasons. When suspended, they increase light extinction and decrease photosynthesis. When sedimented, they can temporarily or permanently remove toxicants from the active ecosystem through deep burial. Scour can adversely affect periphyton and zoobenthos. All these processes are represented to a certain degree in AQUATOX.

In addition, rapid sedimentation also can adversely affect periphyton and some zoobenthos; and the ratio of inorganic to organic sediments can be used as an indicator of aerobic or anaerobic conditions in the bottom sediments. These are not simulated in the model at this time.

New, Consolidated Version of AQUATOX *(Release 3 beta)*

- PFA (*perfluorinated acids*) model
- Estuary version
- ICE (Interspecies Correlation Estimates)
- Linked segments
- Layered sediments
- Diel oxygen, light; Hourly time-step
- Low oxygen effects
- Toxicity due to ammonia

Additional capabilities are available in Release 3, which is in beta testing. These capabilities often require considerable additional data, but they do not have to be used unless the application calls for them. The basic data requirements are no greater than those of Release 2.2 but with the advantage of enhanced output.

The consolidated version is an integration of the three primary versions of AQUATOX that were diverging from one another. There was an estuarine version with a PFA model and shorebirds model, the basic version we have been working with during this workshop, and a multi-segment model that includes a complex sediment model.

As of July 2006, the consolidated version is still undergoing beta testing, technical documentation is still being written, and additional enhancements are being coded. It is available as a beta test version with limited support, but an EPA release is still in the future.

Perfluorinated Surfactants (PFAs)

- Originally developed as part of estuarine model
 - Sorption modeled using empirical approach
 - Animal Uptake/Depuration a function of chain length and PFA type (sulfonate/carboxylate)
 - Biotransformation can be modeled

The addition of code specifically developed for perfluorinated surfactants is an example of how AQUATOX can be modified to evaluate unusual chemicals.

EPA recently evaluated the bioaccumulation and effects of a group of chemicals known as perfluorinated surfactants. There are two major types of perfluorinated surfactants: perfluoroalkanesulfonates and perfluorocarboxylates. Perfluorooctane sulfonate (PFOS) belongs to the perfluoroalkanesulfonate group and Perfluorooctanoic acid (PFOA) belongs to the perfluorocarboxylate group. These persistent chemicals have been found in humans, fish, birds, marine and terrestrial animals throughout the world. PFOS has an especially high bioconcentration factor in fish. At present there is increasing public concern about PFOA, which is associated with the manufacture of Teflon (see, for example, an article in the August 8, 2004, NY Times).

Park, R. A., and J. S. Clough. 2003. AQUATOX for Windows: A Modular Fate and Effects Model for Aquatic Ecosystems: Perfluoroalkylated Surfactant and Estuarine Versions, Addendum to Release 2 Technical Documentation (Unpublished report). U.S. Environmental Protection Agency, Washington, D.C.

Uptake of carboxylates can be predicted by chain length

data from Martin et al., 2003

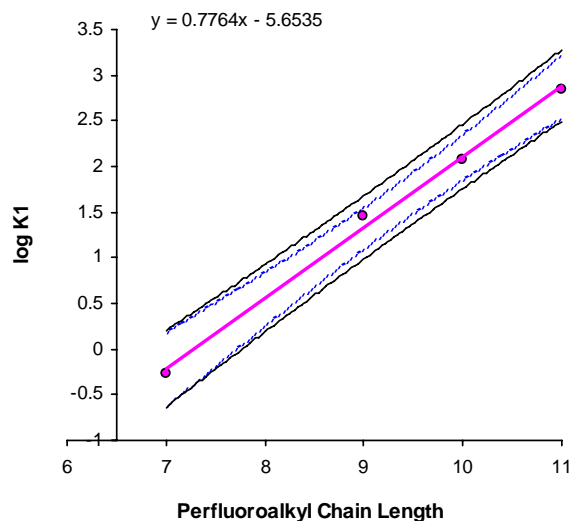

Because PFAs behave differently from most bioaccumulative compounds it was necessary to program estimation procedures for uptake and depuration specific to them. Fortunately, papers documenting such estimation procedures appeared just as we embarked on this project:

Martin, Jonathan W., Scott A. Mabury, Keith R. Solomon, and Derek C.G. Muir. 2003. Bioconcentration and Tissue Distribution of Perfluorinated Acids in Rainbow Trout (*Oncorhynchus mykiss*). *Environmental Toxicology and Chemistry* 22 (1):196-204.

Martin, Jonathan W., Scott A. Mabury, Keith R. Solomon, and Derek C.G. Muir. 2003. Dietary Accumulation of Perfluorinated Acids in Juvenile Rainbow Trout (*Oncorhynchus mykiss*). *Environmental Toxicology and Chemistry* 22 (1):189-195.

Depuration rate is also a function of chain length

data from Martin et al., 2003

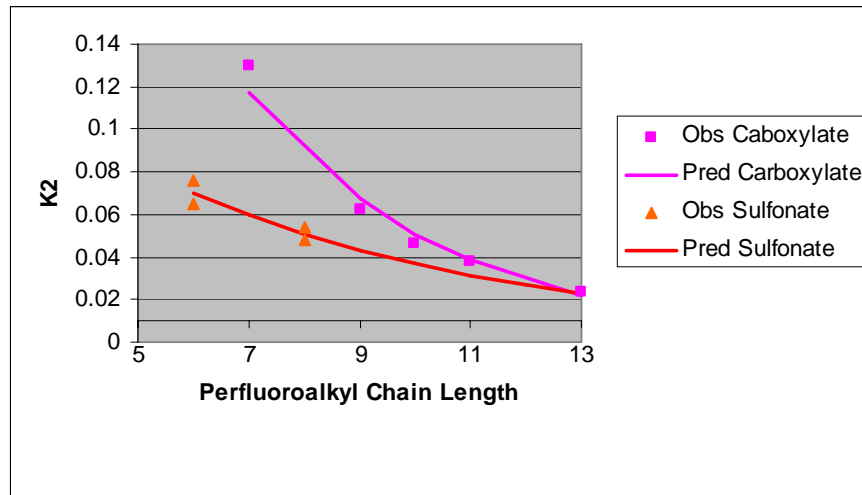

PFA Model Data Requirements

- Perflouralkyl Chain Length
- K_{OM} for sediments
- BCF for algae
- BCF for macrophytes
- Toxicity Data (LC50s)

(Parameters provided for PFOS, PFOA)

Modeling Estuarine Conditions

- Salt-balance submodel
- Estuarine species
- Shorebird bioaccumulation

Estuarine Features

- Stratification – salt wedge
- Water Balance – salt balance approach
- Entrainment Process – lower to upper layers

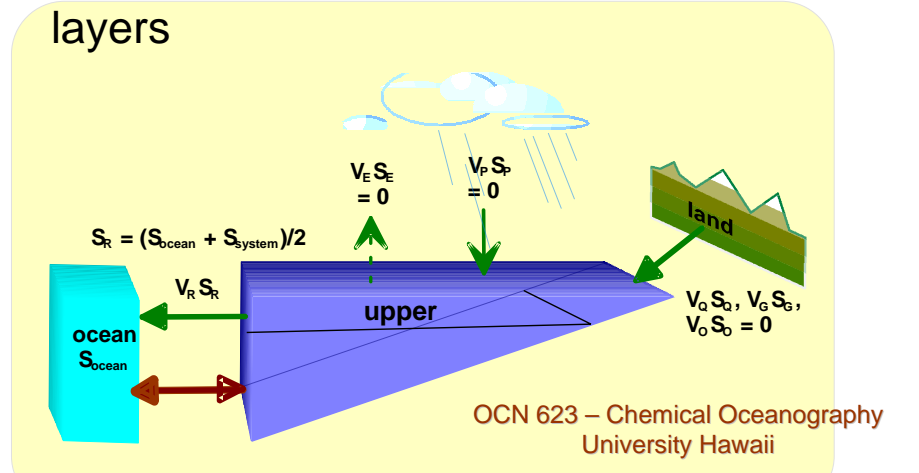

- Estuaries are considered to be permanently stratified, though at times the extent of turbulent diffusion will essentially mean that they are well mixed.
- Salt balance approach: salt water inflow and outflow at the estuary mouth is a function of salinity and residual flow.
- Entrainment, water movement from the lower level to the upper level, transports suspended and dissolved substances from one layer to the next.

Estuarine Features

- **Salinity Effects**
 - Mortality/gamete loss
 - Photosynthesis, respiration, ingestion
 - Sinking
 - Chemical volatilization
 - Reaeration

Estuarine version roughly calibrated for Galveston Bay, Texas, to evaluate toxicants



Photo Courtesy NASA Johnson Space Center

Galveston Bay was simulated as a point model representing average conditions for this large bay.

Galveston Bay, Texas, compartments

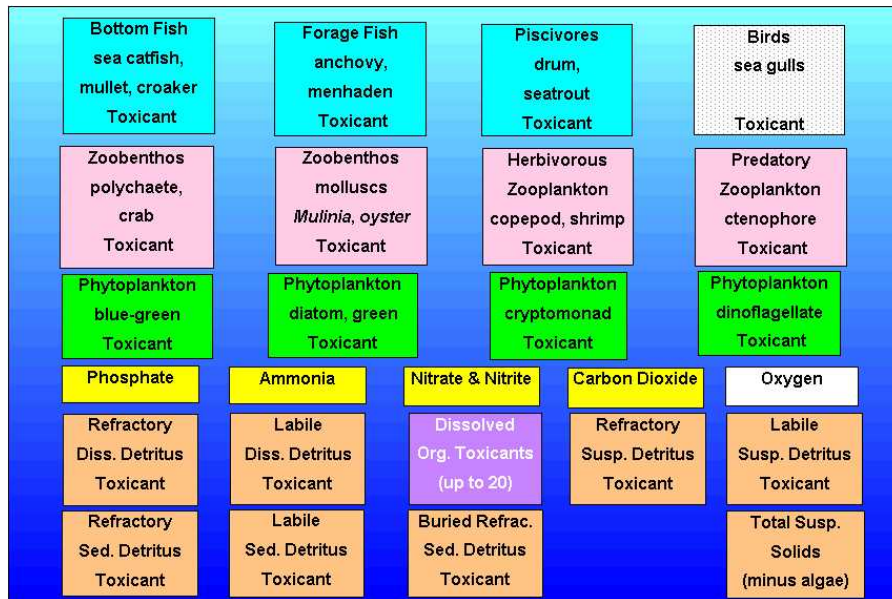

State variable include virtually every commercial species.

Can model biomass of commercial and other species in upper and lower layers

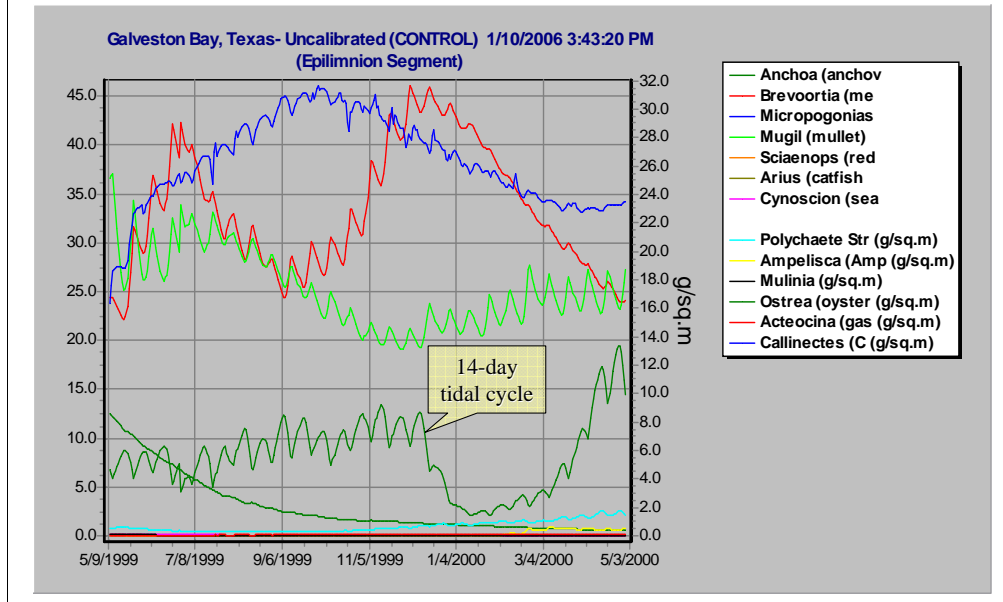

The ecosystem model has only been roughly calibrated for this highly productive system. The results have been compared to numerous data on the Bay, but only qualitatively.

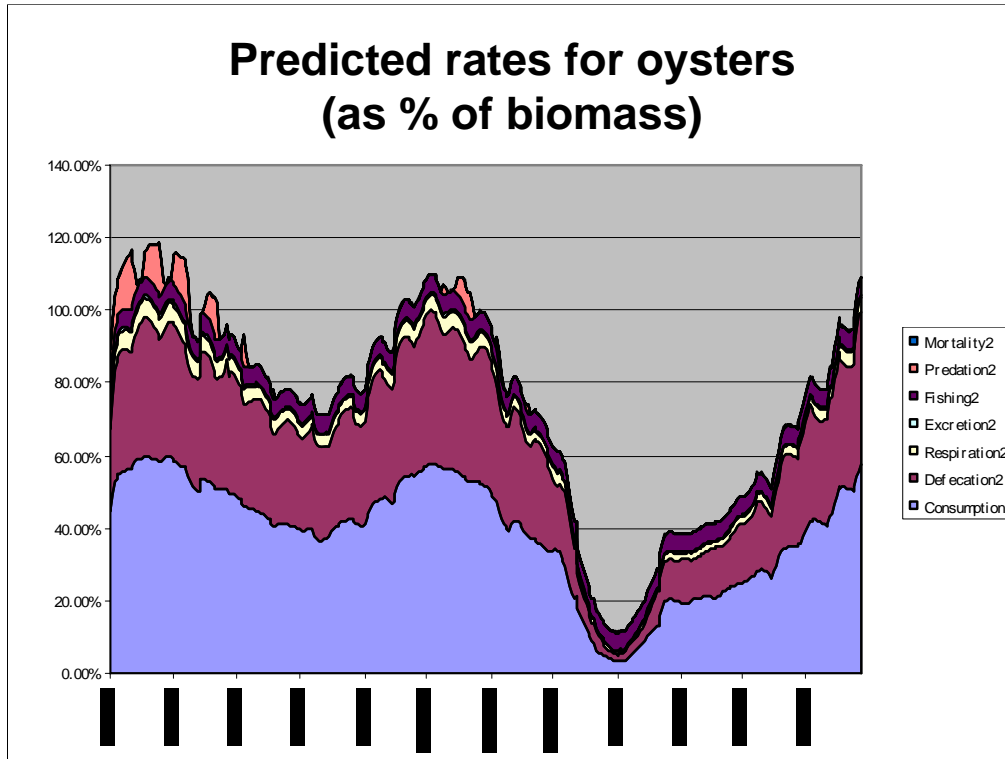

Loss rates for shellfish and finfish include fishing pressure—an important term that will be available for all sites in Release 3.

Validation: New Bedford Harbor MA, peak PCB values were comparable

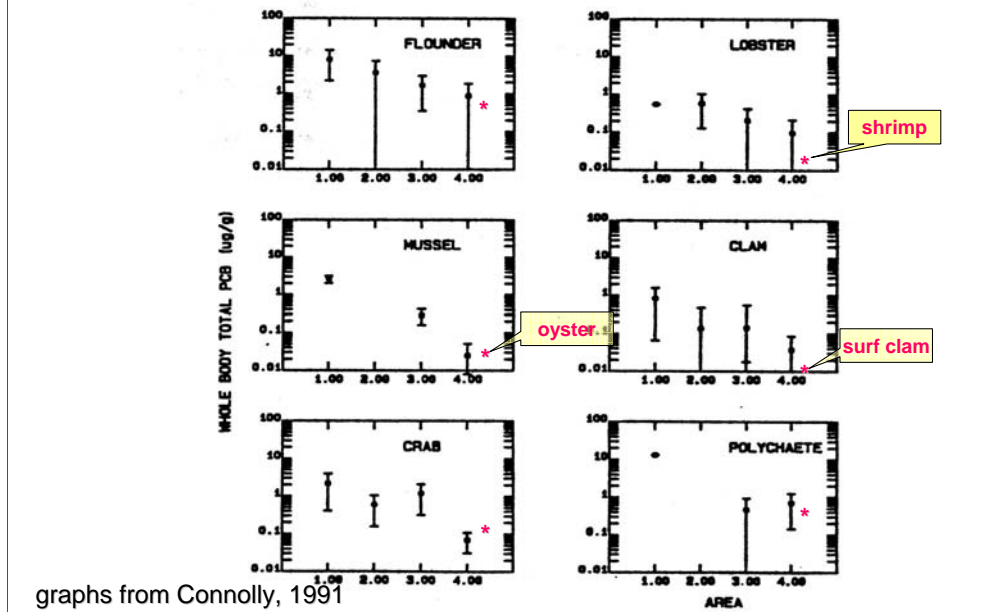

- Bioaccumulation was validated by using PCB water and sediment concentrations observed in Mass. harbor (Area 4) but with Galveston Bay simulation.
- Results were very close to observed concentrations in biota with the exception of greatly differing species (shrimp vs. lobster and dwarf surf clam vs. hard clam).
- Graph Y axes are “Whole Body Total PCB” in ug/g. X axes represent four different sampling sites in New Bedford Harbor. The relevant comparison is the right-most area (Area 4).

Park, R. A., and J. S. Clough. 2003. AQUATOX for Windows: A Modular Fate and Effects Model for Aquatic Ecosystems: Perfluoroalkylated Surfactant and Estuarine Versions, Addendum to Release 2 Technical Documentation (Unpublished report). U.S. Environmental Protection Agency, Washington, D.C.

Distribution of PFOS among major compartments at end of year

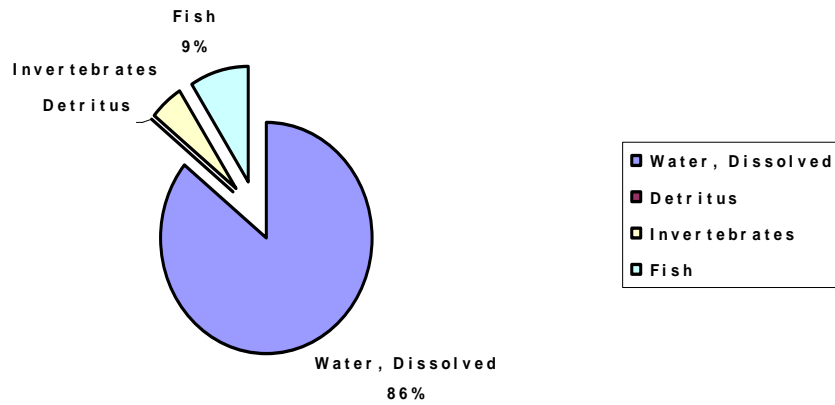

The estuarine version was used to predict the fate and bioaccumulation of PFOS and other PFAs in the nearshore environment.

Distribution of PFOS among biotic compartments at end of year

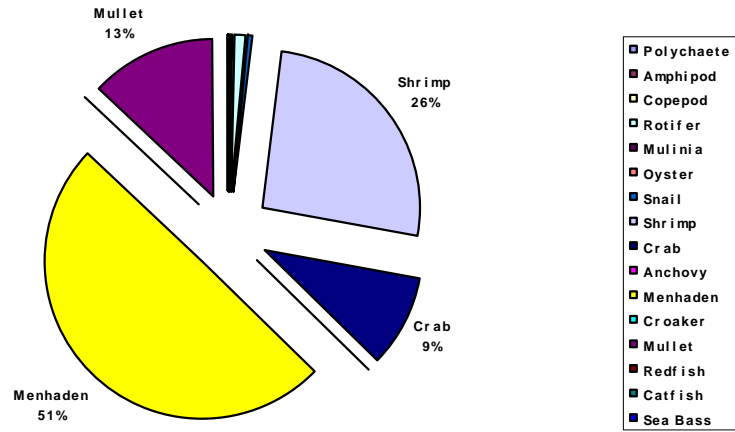

Of the PFOS in the biota at the end of the simulated year, half was predicted to be in menhaden, which are harvested for fish meal.

Estuary Model Data Requirements

- Time Series of “Upper Layer” and “Lower Layer” Salinities for Salt Wedge Model
- Tidal Range Model Parameters
 - “harmonic constants”, often available from NOAA website
- Estuary Site Width
- Loadings of Inflow Fresh Water

The website to load tide prediction parameters (harmonic constants) within the United States is:

<http://tidesandcurrents.noaa.gov/>

Shorebird Model

- Originally developed as part of estuarine model
- Inputs:
 - Shorebirds dietary preferences
 - BCFs
- Outputs:
 - Contaminant concentrations within shorebirds

Shorebirds have been added as a bioaccumulative endpoint—not as a dynamic variable but as a post-processed variable reflecting dietary exposure to a contaminant.

As pointed out by participants in a previous workshop, this endpoint can be used for any animal that feeds primarily on aquatic organisms and for which there are bioconcentration data. These could include bald eagles, mink, and otters.

Interspecies Correlation Estimates (ICE)

- Developed by
 - EPA OR&D
 - University of Missouri-Columbia
 - US Geological Survey
- 2786 regression models derived
- 130 aquatic species as “surrogates”
- Regressions on species, families, genus
- Goodness of fit information for regressions

Predictive toxicological models, including estimates of uncertainty, are necessary to address the trend towards probability-based ecological risk assessments. A method and software (ICE) were developed for estimating acute toxicity of chemicals to species where data are lacking. Interspecies correlation models for acute toxicity (2786) were derived for 95 aquatic and terrestrial organisms using Model II least squares regression, where both variables are independent and subject to measurement error ($\log X_2 = a + b[\log X_1]$). Toxicity of a chemical to one species could be predicted from toxicity to another species with known certainty. Correlations are best within a family, decreasing with increasing taxonomic distance. However, certain species (e.g., rainbow trout) are the most useful of all species for acute estimations among more than one family.

Testing of several species is required for protection of numerous species representing various habitats in aquatic environments. However, the number of species tested is limited by test procedure, species availability, time, and expense. To obviate this problem, interspecies correlations with selected organisms have been conducted relating acute toxicity of a chemical for one species to that of another (Mayer, et al. 2003). This approach integrates species sensitivity to chemicals with taxonomic similarities (physiology, biochemistry). The procedure allows for estimation of acute toxicity of a chemical to many species from toxicity values of only one or a few species. The software program Interspecies Correlation Estimation (ICE) expands the previous work of others (Bearden and Schultz 1998; Doherty 1983; Kenaga 1978, 1979; LeBlanc 1983; Maki 1979; Mayer and Ellersieck 1986; Mayer et al. 1987; Schultz 1997; Sinks and Schultz 2001; Suter and Vaughn 1985; and Thurston et al. 1985) for several species of aquatic and terrestrial organisms. ICE allows the user to estimate acute toxicity for a species or higher taxa (genus, family) having no data from a species having acute data.

Asfaw, A., M. R. Ellersieck, and F. L. Mayer. 2003. Interspecies Correlation Estimations (ICE) for Acute Toxicity to Aquatic Organisms and Wildlife. II. User Manual and Software. Pages 14. U.S. Environmental Protection Agency, National Health and Environmental Effects Research Laboratory, Gulf Ecology Division, Gulf Breeze, FL.

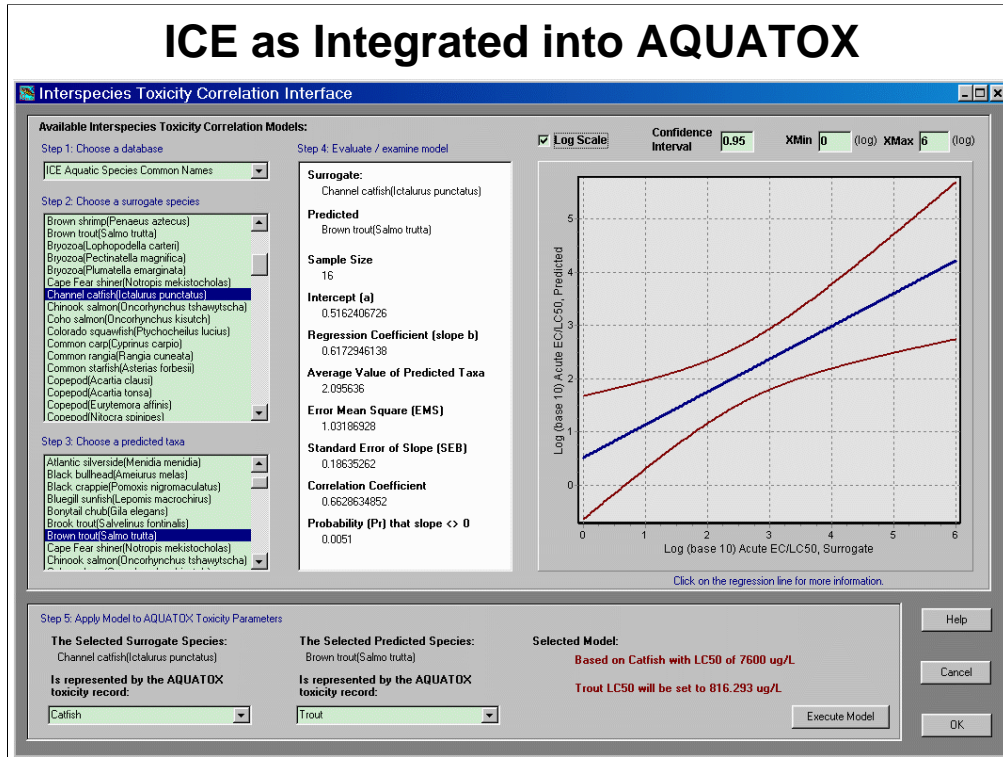

We will now see a demonstration of the use of the ICE model up on the screen.

Walk through the five steps of

1. Choosing a database
2. Selecting a surrogate species
3. Choosing a predicted taxon
4. Evaluating and examining the model
5. Applying the model to AQUATOX toxicity parameters

You will be warned if the correlation coefficient is “unacceptably” low for a given model. Final evaluation of the model is up to the user based on sample size and tightness of fit.

Linked Segment Version

- Developed as part of a Superfund project; now part of Release 3
- Allows the capability to model multiple linked segments--converting AQUATOX into a two dimensional model
- State variables move from one linked segment to the next through water flow, diffusion, and bed-load.

Segmented Version can Represent Dynamically Linked Multiple Segments

The screenshot displays the AQUATOX software interface in "Linked System Mode" for the "Housatonic.als" project. The window title is "AQUATOX - Linked System Mode: 'Housatonic.als'". The menu bar includes "File", "Library", "Segments", and "Help".

On the left side, there are two radio buttons: "Show Segment Data" (selected) and "Show Link Data". Below them is a list of segments:

- [4a]: East Branch
- [4b]: West Branch
- [5a]: Reach 5a
- [5b]: Reach 5b
- [5c]: Reach 5c
- [6a]: Deep Channel
- [6b]: Backwaters
- [6c-e]: Epi Deep Woods Pond
- [6c-h]: Hypo Deep Woods Pond
- [6d]: Shallow Woods Pond
- [6e]: Pond Outflow

Below the list are "Add", "Delete", and "Edit" buttons. Further down are two columns of buttons under "Data Operations" and "Program Operations":

- Data Operations:** Chemicals, Setup, Notes
- Program Operations:** Run, Control, Output, Export Results

On the right side, the "Linked System Name" is "Housatonic River, MA". Below it, status indicators show "Toxics Run: No Run Recorded" and "Control Run: No Ctrl. Run Recorded". A map view shows a topographic map with a river system overlaid in various colors (blue, green, yellow, red). Below the map are "Load Map" and "Clear Map" buttons.

At the bottom of the interface, a yellow highlighted box contains the text: "developed for Housatonic River MA project".

Linkage scheme is the same as used for WASP. In this example backwater areas and a multi-segment pond are linked with main channel reaches in a 10-mile stretch of the Housatonic River, MA.

Cascade & Feedback Linkages

Cascade Linkages:

One-way linkages with no backwards flow or diffusion across segment boundaries

Feedback Linkages:

Two-way linkages that allow for backwards flow and diffusion

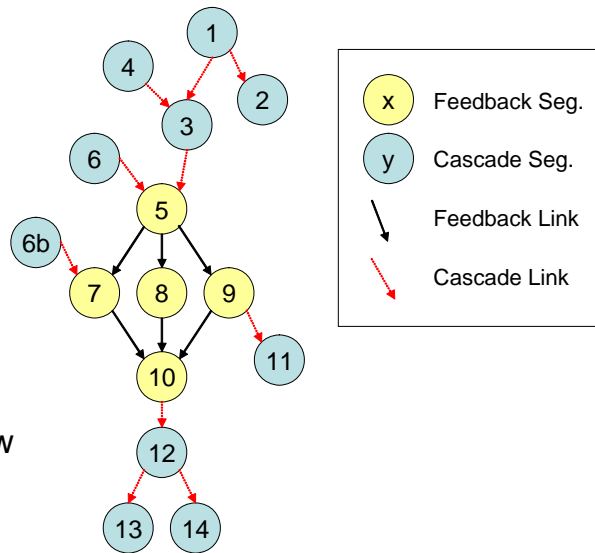

- After cascade and feedback linkages are defined, note that the purpose of this is to allow for slower running segments (i.e. segments with rapid water flow) to solve independently of other segments.
- In the diagram shown AQUATOX would first run the "upper cascade" segments. Those being 1, 2, 3, 4, 6, and 6b.
- AQUATOX would use the loadings from the "upper cascade" run to run the "feedback" segments. Those being 5, 7, 8, 9, and 10.
- Finally, AQUATOX would use the loadings from the feedback run to run the "lower cascade" segments. Those being 11, 12, 13, and 14.
- Mass balance of water, toxicants, nutrients, organisms is maintained through a complex system such as this one.

Linked Segment Model Data Requirements

- Water flows between segments
- Initial conditions for all state variables for each segment modeled
- Inflows, Point-sources and Non-point-source loadings for each segment

AQUATOX Multi-Layer Sediment Model

- **Based on IPX version 2.7.4**
- **Developed as part of a Superfund project; now part of Release 3**
- **Can model up to ten distinct sediment layers on top of non-reactive hardpan.**
- **Each sediment layer assumed to be perfectly mixed.**
- **“Pez-dispenser” action avoids common numerical problems.**

- For those who don't immediately recognize what “Pez” is, it's a candy composed of little tablets. When you take the top tablet from the pez dispenser the other tablets all move up.
- We cannot allow the layers to be defined by depth from the top and keep the active layer a constant thickness because this, combined with the assumption of perfect mixing in each layer, results in advection of chemicals in inappropriate ways.

Velleux, M., S. Westenbroek, J. Ruppel, M. Settles, and D. Endicott. 2000. A User's Guide to IPX, The In-Place Pollutant Export Water Quality Modeling Framework, Version 2.7.4. Pages 179. US Environmental Protection Agency, Grosse Ile, MI.

AQUATOX Sediment Modeling

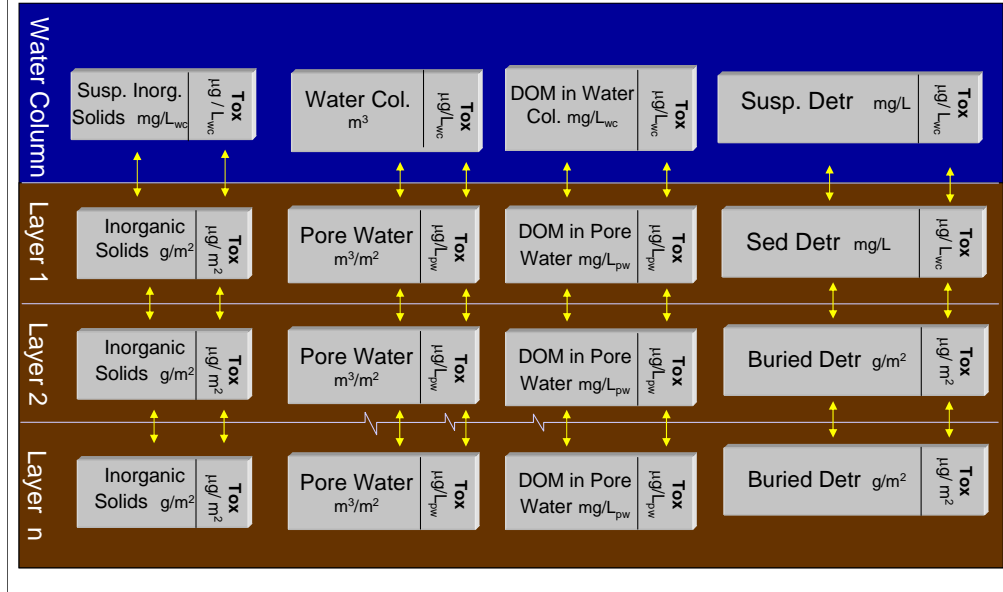

- From left to right each sediment layer is composed of inorganic solids, water, dissolved organic matter, and organic solids. Each category can have toxicant sorbed to it, or in the case of water, dissolved within it.
- In this case the top layer (Layer 1) is the active layer and interacts with the water column through scour, deposition and diffusion. This layer changes height and if it gets too big it is split into two layers; if it gets too small it is joined with the layer below it.
- Lower layers only interact through pore-water diffusion.

Representation of Inorganic Sediments:

- **Cohesives:** particle size smaller than 63 mg
(clay)
- **Non-Cohesives:** particle size from 63 to 250 mg
(silt)
- **Non-Cohesives2:** particle size greater than 250 mg
(sand)
- **Chemical sorption** to inorganic sediments may be modeled. (Multi-Layer sediment model only)

Composition of each Bed Layer

- Inorganic Sediments (and sorbed toxicants)
- Sedimented or Buried Detritus (and sorbed toxicants)
- Pore Waters (and dissolved toxicants)
- DOM in Pore Waters (and sorbed toxicants)

There are additional data requirements for this complex sediment model, but note that the simple “HSPF-like” sand-silt-clay model may also be run.

Sediment Model Data Requirements

- Densities of inorganic and organic sediments
- Sediment layer thicknesses
- Initial concentrations of each element and toxic exposure
- Each layer's porosity and density is calculated given densities and initial conditions
- Erosion/Deposition Velocities for inorganic sediments; alternatively erosion/deposition velocities may be internally calculated using HSPF-based model

Densities of inorganic and organic sediments are not assumed to change between layers.

Diel Oxygen, Light; Hourly time-step

Figure 4. Dissolved oxygen flux based on continuous measurement.

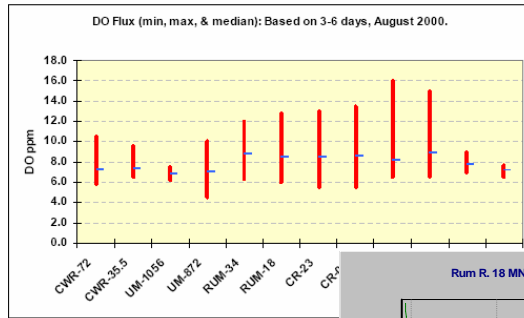

AQUATOX can now run with an hourly time-step including hourly light inputs. This results in a simulation of oxygen concentrations on an hourly basis

Monitoring data indicate that oxygen levels fluctuate daily

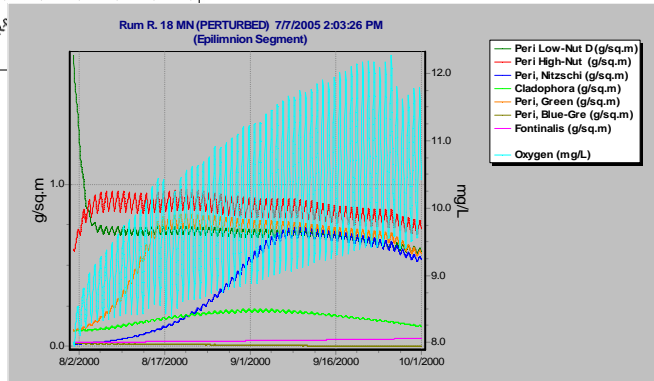

Photosynthesis is calculated on an hourly basis.

The Light Limitation calculation is modified during hourly simulation to remove the now irrelevant photoperiod.

Stress due to low light conditions remains calculated with an average daily light value.

Diel Oxygen, Light; Hourly time-step (2)

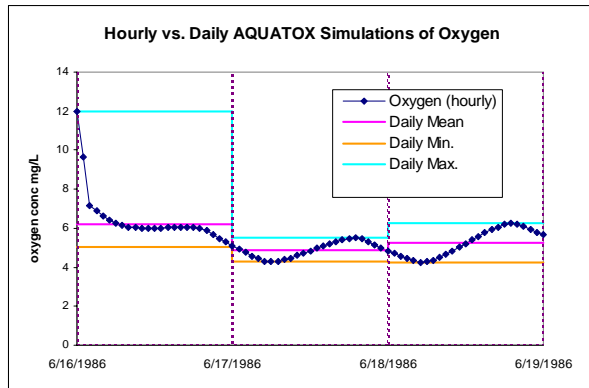

Oxygen output may be produced as minimum concentration per time-step and maximum concentration per time-step. (Mean concentration per time-step is the default for all AQUATOX output).

Average light per day is distributed during daylight hours in a semi-sinusoidal pattern based on photoperiod.

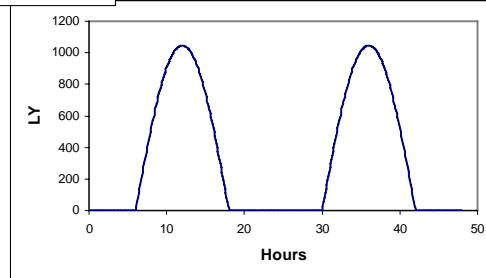

Low Oxygen Effects

Three dimensional model of effects is a function of exposure time and oxygen concentration.

Species specific $LC50_{24\text{-hour}}$ for O_2 is required

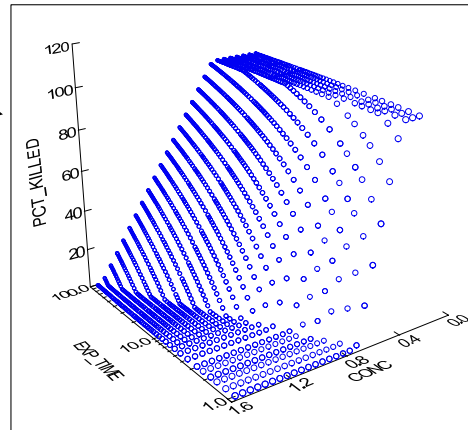
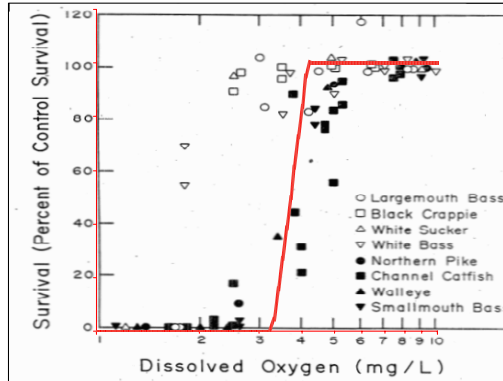

Steep slope for effects matches available data well.
(red line = model predictions with $LC50_{24\text{-hour}}$ of 3.5 mg/L)

Model is based on the U.S. EPA salt water criteria (U.S. Environmental Protection Agency 2000. *Ambient Aquatic Life Water Quality Criteria for Dissolved Oxygen in Saltwater*). <http://epa.gov/waterscience/criteria/dissolved/docrriteria.pdf>

Based on these data, for white bass and black crappie a lower $LC50$ than 3.5 mg/L would be appropriate.

Non-Lethal Low Oxygen Effects

EC50 reproduction and EC50 growth parameters affect timing

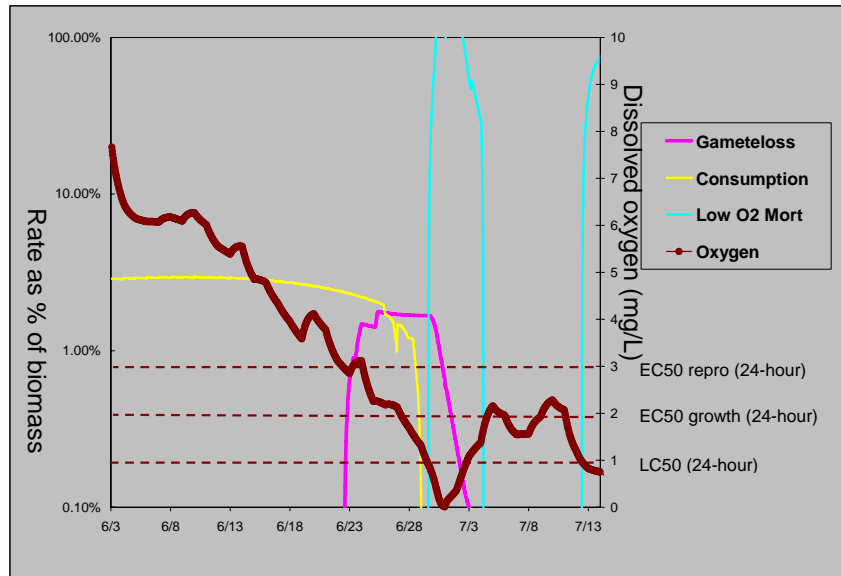

The same three dimensional model used for lethal effects is utilized to calculate non-lethal low oxygen effects (functions of exposure level and time.) In this case, EC50 reproduction affects the percent of gametes that are lost and EC50 growth affects consumption rates.

Low O₂ Affects Timing of Migration from Hypolimnion

EC50 growth parameter is key

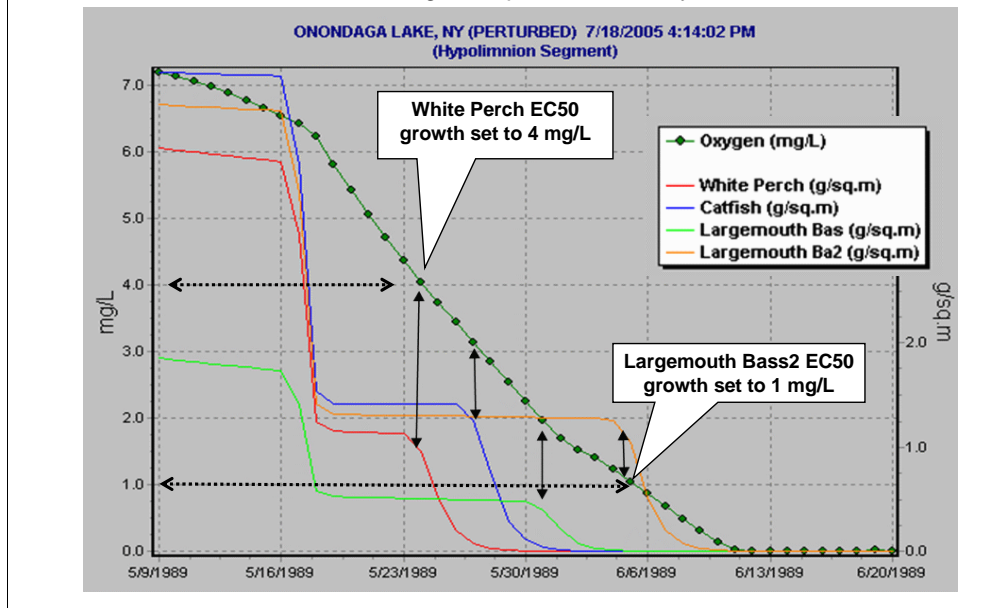

This is a graph of the Hypolimnion segment. The biomass in the hypolimnion drops to zero when migration takes place due to low oxygen concentrations.

In Release 2.2, vertical migration occurs when oxygen drops to 0.25 mg/L. Now that lethal and non-lethal oxygen effects are included (and usually at concentrations much higher than that) the 0.25 mg/L trigger doesn't work because all the animals would be dead before they could migrate.

We assume that EC50 growth is the best indicator of when the species has become so intolerant of the oxygen climate that it is going to migrate. This also allows more tolerant species to spend more time in the hypolimnion and less tolerant species to migrate earlier.

Toxicity Due to Ammonia

Animal Specific Input Parameter Required:

Ammonia Toxicity:

LC50, Total Ammonia (pH=8)	<input type="text" value="10"/> mg/L	<input type="text" value="Default"/>
----------------------------	--------------------------------------	--------------------------------------

LC50 un-ionized and LC50 ionized calculated from LC50 total as a function of pH

External Toxicity Model Utilized:

- Effects from un-ionized and ionized ammonia are additive
- Un-ionized ammonia fraction calculated as a function of site pH and temperature

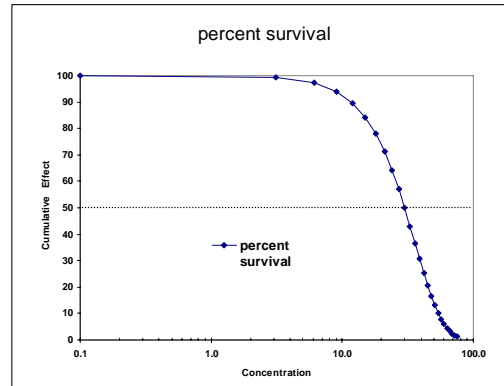

Model data and formulations based on U.S. EPA, 1999, *Update of Ambient Water Quality Criteria for Ammonia*, September 1999, U.S. EPA Office of Water, U.S. EPA Office of Science and Technology Washington, D.C.
<http://www.epa.gov/waterscience/criteria/ammonia/>

Species specific parameters are also available within this document.

Other Release 3 Notes

- Additional Output Categories
 - oxygen duration below a given threshold
 - minimum and maximum O₂
 - minimum and maximum un-ionized ammonia
- Chemical Mass Balance Testing
 - Tracks loadings of and fate of chemicals similar to nutrient mass balance covered earlier
- Trapezoidal Integration of Results
- Improved Graphing
 - specification of date ranges
 - can save and graph rates internally
- Same “core model” as Release 2.2
 - Most Imported Release 2.2 simulations will behave identically
- Beta test version:
www.warrenpinnacle.com/prof/AQUATOX/AQT_R3beta.exe

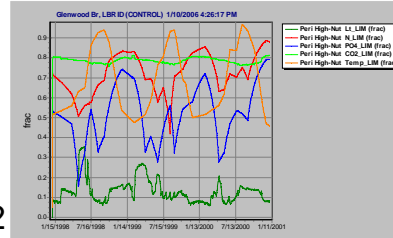

Significant testing has ensured that the functionality of Release 2.2 and Release 3.0 (single-segment mode) are identical.

However, as we continue to refine Release 3.0 we will not be upgrading Release 2.2.

For example, low oxygen and ammonia toxicity effects may make a Release 3.0 simulation behave differently if those effects are not turned off in Release 3.0.

Coming enhancements to Release 3.0 include

- effects of sediment on biota;
- the release of phosphorus from anaerobic sediments (sediment diagenesis);
- correlated inputs in an uncertainty analysis;
- the capability to compare model results to observed data within the AQUATOX output screen.

Release 3.0 will include an integrated technical document in which Release 2.0 documentation, Release 2.2 and Release 3.0 addenda are all combined into one (large) document. We also plan to develop an updated Users Manual.

Summary, Wrap-up

What we've tried to cover in this course:

- What AQUATOX can do
- A start on how to do it
- In what situations you would want to use it

Value added of AQUATOX

- **Process-based approach yields better understanding of ecosystem**
 - feedback loops, indirect effects, trophic cascades
 - Relative importance of multiple stressors
- **Leads to better management decisions**
 - Avoid unintended consequences
 - What stressor to control first
- **Get more bang from monitoring buck**
 - Fill in gaps between sampling periods
 - Identify monitoring needs

Challenges

- **It's hard!**
 - **Complex model reflects the complex ecosystem**
 - **Some processes omitted or imperfectly understood**
- **Calibration and parameterization are probably hardest tasks**
- **High data requirements**
 - **Many inputs and parameters**
 - **Continue to expand data libraries and utilities**
- **Undertaking structured sensitivity analysis**

Keep in touch!

- Applications help drive enhancements, example studies and data libraries
- Growing user community builds robustness and confidence
- Continued model and user support
 - One-on-one support
 - AQUATOX listserver (new!)
- Visit the AQUATOX web site
 - <http://epa.gov/ost/models/aquatox/>