



Marine Pollution Control 8631 West Jefferson Detroit, MI 48209

[www.marinepollutioncontrol.com](http://www.marinepollutioncontrol.com)



# ***OPA '90 After 10 Years of Regulatory Enforcement: Challenges Remain for the Great Lakes Region***



***Presented By: Michael Popa – Marine Pollution Control***

***Prepared By: William Hazel – Marine Pollution Control***



## Major Salvage & Pollution Response Operation



The Exxon Valdez incident required multiple response capabilities, including Lightering Pumps, Salvage Services, Emergency Towing and, of course, Oil Spill Removal Organizations (OSROS).



## **OPA '90 Requirements – Salvage-related Services**

- **Vessels that transport and facilities that store oil on or near U.S. navigable waters must maintain Response Plans that identify specific resources for:**

### **Emergency Lightering Equipment (Portable Pumps)**

### **Salvage Services**

### **Rescue Towing Capabilities**

### **Emergency Fire-Fighting Capabilities**

- **The Maritime Transportation Security Act has requirements for regulations that have delayed updates to the Salvage and Firefighting rules.**





## Specific Risks to the Great Lakes Environment



**Shipping** - According to a Canadian Shipowners' Association Study, there were over 4,006 annual transits through the St. Lawrence Seaway and the Great Lakes. This study included tank vessels (which are regulated by OPA '90), bulk carriers and cruise vessels (both non-regulated).



**Facilities** – A number of OPA'90 regulated and non-regulated facilities exist within potential reach of the Great Lakes. These include oil refineries/storage facilities, powerplants, manufacturing plants and other facilities which handle or store large quantities of oil or chemicals.



**Pipelines** – Numerous subsurface and shoreline pipelines are operating in and around Great Lakes waters.



## Salvage – Current OPA '90 Requirements

**“A salvage company with expertise and equipment ...must be capable of being deployed to the port nearest to the area in which the vessel operates within 24 hours of notification.”**

**As listed in:**

**33 CFR 155.1050**

**33 CFR 155.1052**

**33 CFR 155.2210**

**Etc.**



## Salvage – Proposed Changes to OPA '90 Req.

<u>Salvage Service</u>	<b>Inland Waters, Great Lakes, Rivers &amp; Canals &lt;math&gt;\leq 12&lt;/math&gt; miles</b>	<b>Ocean Environment 50 mile point</b>
<u>Assessment &amp; Survey</u>		
Remote assessment & consultation	<b>1</b>	<b>1</b>
Begin assessment of structural stability	<b>3</b>	<b>3</b>
On-site salvage assessment	<b>6</b>	<b>12</b>
Assessment of structural stability	<b>12</b>	<b>18</b>
Hull & bottom survey	<b>12</b>	<b>18</b>
<u>Stabilization</u>		
Salvage plan	<b>16</b>	<b>22</b>
Other refloating methods	<b>18</b>	<b>24</b>
Making temporary repairs	<b>18</b>	<b>24</b>
Diving services support	<b>18</b>	<b>24</b>
<u>Specialized Salvage Services</u>		
Special salvage operations plan	<b>18</b>	<b>24</b>
Heavy Lift	<b>72</b>	<b>84</b>
Subsurface product removal	<b>72</b>	<b>84</b>



## The Changing Dynamics of Marine Salvage

- Traditionally, Salvors work on the basis of a No Cure-No Pay contract format.
- Major emphasis of the salvage master was to concentrate on saving the ship and cargo.
- New laws emphasize pollution control and environmental damage control.
- Today, under the Incident Command System (ICS) a dedicated Project Manager remains onshore and works with the Unified Command to make sure that environmental concerns are relayed to, and addressed by, the Salvage Team onboard the Casualty.



## Innovations in Environmentally-Responsible Salvage

- Salvage Anchoring Systems – New mooring techniques reduce damage caused by drag and prevent damage to specific environmentally-safe areas.
- Better Towing Systems – The use of floating lines prevents unnecessary scouring of the bottom.
- Salvage Vessel Operations – Greater care is taken to avoid scouring through prop wash, tackle used instead of vessel pulls when possible.
- Tow Path and Modifications to Grounded Vessels – Care can be taken to tow a vessel through the same path it took when grounding. Propellers removed to minimize damage during the Tow.





## Salvage Resources

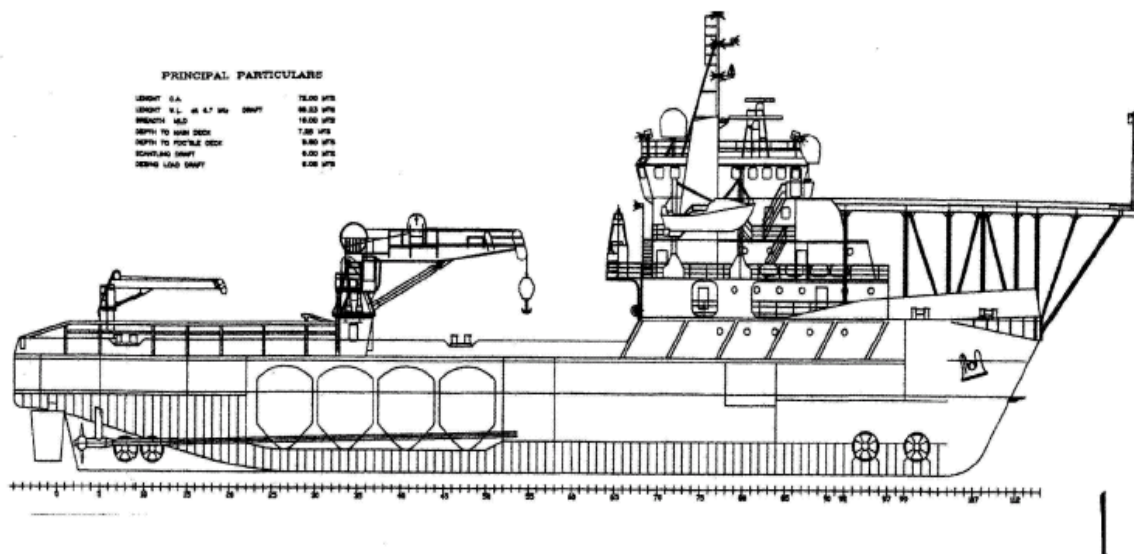

- Diving Support Vessel “Mystic Viking” – owned by Cal Dive, Inc. and generally operating out of the Gulf of Mexico.
- Kongsberg SIMRAD SDP 521 Dual Redundant Dynamic Positioning System – Can hold her position without mooring gear.
- Can accommodate 60 persons for 20-24 days continuous and features complete saturation dive system



# Salvage Resources



Stationed on the US West Coast

## American Salvor

213 Feet OAL

35-Ton Crane

Decompression Chamber

2 Breathing Air Systems

Helipad

Crew Quarters for 16

2 Firefighting Monitors

Underwater Color Video

4 Skagit Drum Winches

600' of 9" Nylon Line

Line Throwing Gun

6 Salvage Anchors (8-12,000lbs)

2 Workboats



## Salvage Resources



**Massive cranes mobilized to English Channel to support the salvage of the sunken RO/RO vessel Tricolor (2002-2003).**





## Salvage Resources



Photo courtesy of NOAA

### M/V New Carissa – Coos Bay, OR - 1999

The Carissa had stranded in front of a large sand bar, making it impossible for the towing vessel to get close to her. A special synthetic towing line had to be prepared and mobilized to the site from Europe to accomplish the difficult tow from her grounding point.



## Salvage Resources



**Heavy seas complicate all efforts at salvage and pollution response. During the New Carissa incident, salvage technicians are transported to the vessel by helicopter, a dangerous operation.**





## Salvage Resources



**The USCG can support the rescue, salvage and spill response operation with one of its C-130 aircraft, which carry a sophisticated array of electronic tracking systems.**



## Salvage Resources



### M/T Bow Mariner – Chincoteague, VA – 2004

An explosion and fire occur on the Singapore-flagged M/T Bow Mariner on Feb. 29, 2004. The vessel sinks 50 miles off the coast (her cargo of 3.5 million gallons of ethanol was completely lost). In this photo, the MSRC dedicated recovery vessel “Virginia Responder” is seen recovering oil over the wreck.



## Salvage and Pollution Prevention

**Note: 11 large tugs and 1 offshore supply vessel involved in response!**



**M/T Sea Empress - Milford Haven, 1996**

**58,000 tonnes (17 million gallons) of oil were offloaded during successful salvage operation**



## **Lightering – Current OPA'90 Requirements**

**“Portable pumps and ancillary equipment necessary to offload the vessel’s largest cargo tank in 24 hours of continuous operation.”**

**Prince William Sound – 6 Hours**

**Inland, nearshore and Great Lakes waters – 12 hours**

**Offshore waters, rivers and canals – 18 hours**

**Open Ocean waters – 36 hours**

**As listed in: 33 CFR 155.1050 - 33 CFR 155.1052**

**33 CFR 155.2210 - Etc.**



## Lightering – Proposed Changes to OPA '90 Req.

<u>Service</u>	<b>Inland Waters, Great Lakes, Rivers &amp; Canals &lt;math&gt;\leq 12&lt;/math&gt; miles</b>	<b>Ocean Environment 50 mile point</b>
External emergency transfer operations (i.e., tank-to-tank)	<b>18</b>	<b>24</b>
Emergency Lightering	<b>18</b>	<b>24</b>





# Lightering



## Evolution of Modern Pumps

Increased flow rates and reduction in weight and size



## Lightering

### Modern Pumping System Technical Specifications:

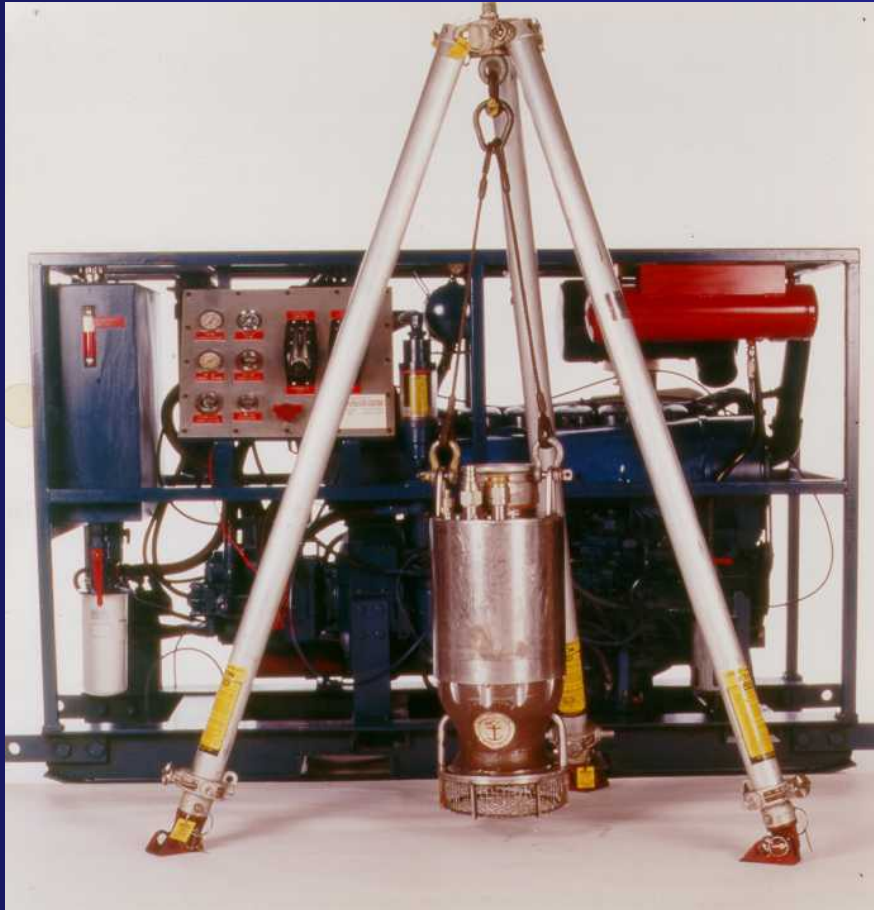

**135+ Horsepower diesel-hydraulic power unit – spark arrested for use in potentially hazardous atmospheres**

**2,400+ Gallons per minute –  
265+ feet Static Head (Hydraulic Submersible Pump - MPC Model KMA 333)**

**Heaviest component 2,850 lbs –  
Extremely portable system**

**250' “Layflat” 6” discharge hose  
with quick-connect fittings**





## Lightering – Oil Transfers



**Portable High-Capacity Pumping Systems are mobilized to the deck of Exxon Valdez by helicopter – 6 systems were used to remove the 40+ million gallons that remained on the ship**



## Lightering – Chemical Transfers



**Chemical Transfers - Tank-to-tank transfer of MTBE accomplished at sea with specialized stainless steel hose**



## Lightering – Specialty Transfers (Hot-Tapping)



Portable Hot-Tap system used to access the contents of tanks that are “open to the sea” – Tank contents removed using high-capacity pumps mounted on the installed valves



Ex-S/S Export Challenger - 1998





## Lightering – Marine Logistics



**A critical component of all salvage operations is the ability to move equipment and personnel to the site. The success of a lightering operation is contingent on the ability to have receiving vessels on site.**



## Lightering – Viscous Oil Transfers



### Viscous Oil Transfers – Risk Posed by Non-Tank Vessels (Bulk Carriers, Containerships and Passenger Vessels)

Joint private/public sector  
Viscous Oil Workgroup  
developing innovative  
techniques for the transfer of  
heavy oils

Continuing research into new  
technologies (improved  
discharge hoses, underwater  
recovery technologies, etc.)

Each pumping operation  
analyzed and lessons learned  
incorporated into program



## **Emergency Towing – Current OPA'90 Req.**

**Towing services with expertise and equipment must be capable of being deployed to the port nearest to the area in which the vessel operates within 24 hours of notification.**

**As listed in:**

**33 CFR 155.1050**

**33 CFR 155.1052**

**33 CFR 155.2210**

**Etc.**



## Emergency Towing – Proposed OPA'90 Req.

<u>Service</u>	Inland Waters, Great Lakes, Rivers & Canals $\leq$ 12 miles	Ocean Environment 50 mile point
Emergency towing  (Must identify towing vessels with the proper characteristics, horsepower and bollard pull to tow the vessel – must be capable of operating in environments where winds are up to 40 knots)	12	18





# Emergency Towing

## Evolution of Modern Towing Technologies



Invader Class Tug – Standard Propulsion System

OPA'90 required the use of escort tugs for laden tankers in the waters of Prince William Sound (Alaska) and Puget Sound (Washington)

These, and other requirements, lead to advances in tugboat technology and increased response capability nationwide





# Emergency Towing

## Prevention Response Tug (PRT) Class

140 Feet OAL

Twin controllable pitch 360° thruster  
Z drive propulsion units

43,000-gallon recovered oil storage  
capacity

300,000 lbs Bollard Pull

(compare at 27K to 100K available in  
Great Lakes)



“Attentive” dedicated to escort  
services in Prince William Sound

Class I Firefighting Equipment



# Emergency Towing

## Prince William Sound (PWS) Class



**153 Feet OAL**

**Twin 5,096 HP turbocharged engines  
with Voith Schneider propulsion  
units**

**70,000-gallon storage capacity and  
dispersant capabilities**

**210,000 lbs Bollard Pull**

**Class I Firefighting Equipment**

**“Tan’erliq” dedicated to escort  
services in Prince William Sound**



## Emergency Towing

Modern Propulsion Technology Increases Maneuverability and Response Capability

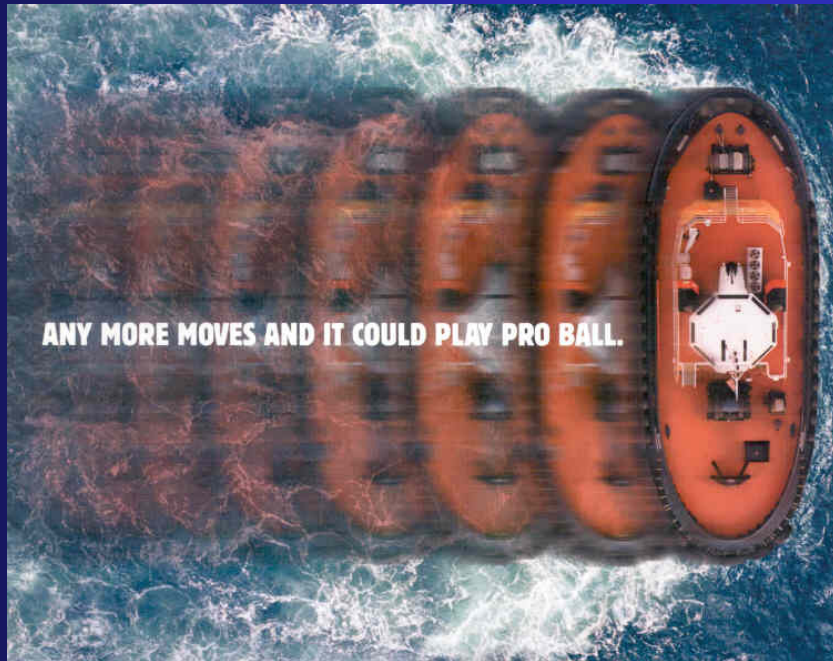

**Voith Schneider Cycloidal Drive**



**Ulstein-Aquamaster Model US 5001 Z-Drives with controllable pitch**





## Emergency Towing



### M/V Fortuna Reefer - Mona Island, Puerto Rico – 1997

Dry bulk carrier ran aground off environmentally-sensitive island.  
Salvage operation complicated by lack of tug with sufficient pull.  
Heavy fuel oil lightered off vessel using portable pumping system.





## **Fire-Fighting – Current OPA '90 Requirements**

**“A company with vessel firefighting capability that will respond to casualties in the area(s) in which the vessel will operate... within 24 hours of notification.”**

**As listed in:**

**33 CFR 155.1050**

**33 CFR 155.1052**

**33 CFR 155.2210**

**Etc.**



## Fire-Fighting – Proposed OPA'90 Requirements

<u>Service</u>	At Pier	Inland Waters, Great Lakes, Rivers & Canals <=/= 12 miles	Ocean Environment 50 mile point
<u>Assessment &amp; Planning</u>			
Remote assessment & consultation	1	1	1
On-site assessment	2	6	12
<u>Fire Suppression</u>			
External firefighting teams	4	8	12
External-vessel firefighting teams	4	12	18
(Must include proper type and amount of extinguishing agent – must pump 0.16 gallons per minute per square foot of deck area or equivalent for other spaces)			



## Fire-Fighting



Tampa Bay, 1993

**Marine firefighting is a highly specialized field. The OPA'90 requirements have increased our awareness of the capabilities of marine firefighters and the need for increased training.**

**Improvements in the escort and emergency towing tug fleet have bolstered marine firefighting capabilities (these vessels have FiFi systems installed)**



## Fire-Fighting Resources - Fireboats



**A well-equipped fire boat servicing the Seattle harbor.**

**Fireboats of this class feature multiple nozzles and pumping systems capable of deploying water and foam/water mixtures for distances beyond 500'**





# Fire-Fighting



## Portable Firefighting Systems

Portable firefighting units provide a rapidly deployable and multi-purpose system that can be delivered to the scene on a number of available work platforms

2,400 – 5,000+ gallons per minute capacity

Foam-Capable

500+ Foot Throw Distance





## Fire-Fighting



### HAZMAT Considerations of Firefighting Operations

A key element of marine firefighting is its HAZMAT component

The vapor release of the various chemicals that are involved pose an imminent and complex safety hazard during most shipboard fire responses

HAZCHEM specialists and Marine Chemists are an integral part of a marine firefighting operation



## Fire-Fighting



M/T Jupiter - Bay City, Michigan – 1990

Fire-Fighting teams deployed from Gulf Region.

Local resources included USCG Cutter Bristol Bay and MPC.

Fire suppression effort took 2-days, then lightering operation commenced.



## Fire-Fighting



### Cruise-Ship Ecstasy – Miami - 1998

- 54 people injured
- 4 tugboats equipped with fire monitors suppressed the fire in ~3 hours
- The Great Lakes is targeted for an increase in passenger ship traffic over the next few years







## Fire-Fighting



### F/V Ocean Pride – Seattle - 2001

- 200' Fishing vessel - 130,000 gallons diesel & 30,000 lbs anhydrous ammonia
- 160 firefighters, 40 pieces of apparatus, 2 local fireboats – 7 hour effort
- Fire started when welders torch sparked diesel-soaked foam insulation
- 6 minor injuries to firefighters during the response



## Facilities



Powell Duffryn Facility - Explosion - Savannah, Georgia – 1994

Explosion & fire released chemicals into nearby marshes, and then into the Savannah River.



## Facilities



Floating Roof Mechanical Failure - Bellingham, Washington - 2000



## Facilities

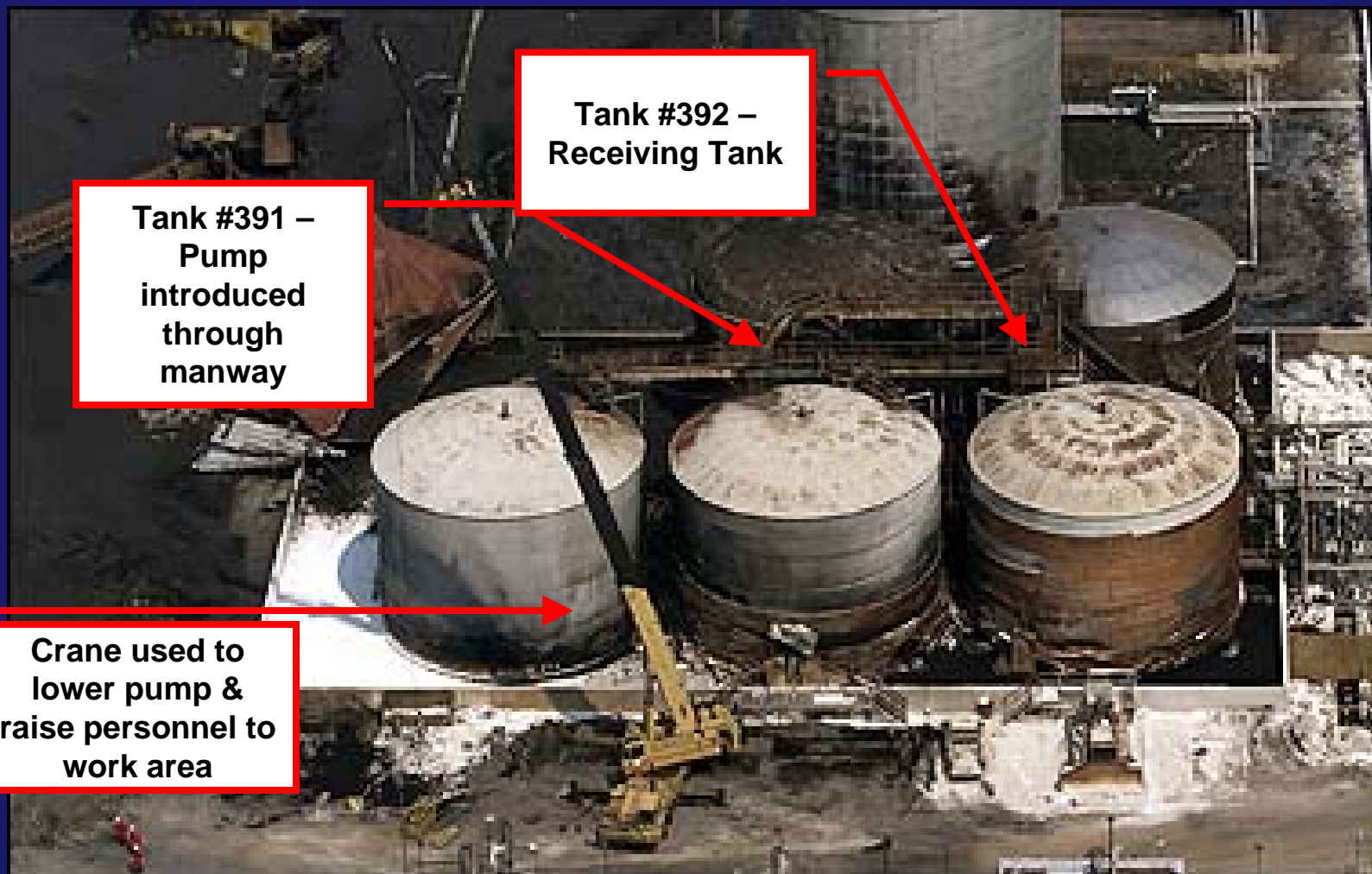

Motiva Enterprises – Industrial Accident - Delaware City, Delaware – 2000

Catastrophic fire at sulfuric acid tank farm resulted in breach of several tanks.





## Facilities



Motiva Enterprises – Industrial Accident - Delaware City, Delaware – 2000

Release of sulfuric into Delaware river resulted in a substantial fish kill.



## OPA '90 and the OSRO/Salvage Resource Market

- The nation's response capabilities remained geographically positioned near where, traditionally, they were able to sell their services (i.e., **high-volume ports industrial/oil ports**).
- Low-volume ports did not see a material increase in the amount of resources in their area (i.e., the upper Great Lakes).



# OPA '90 Resources & the Great Lakes Region

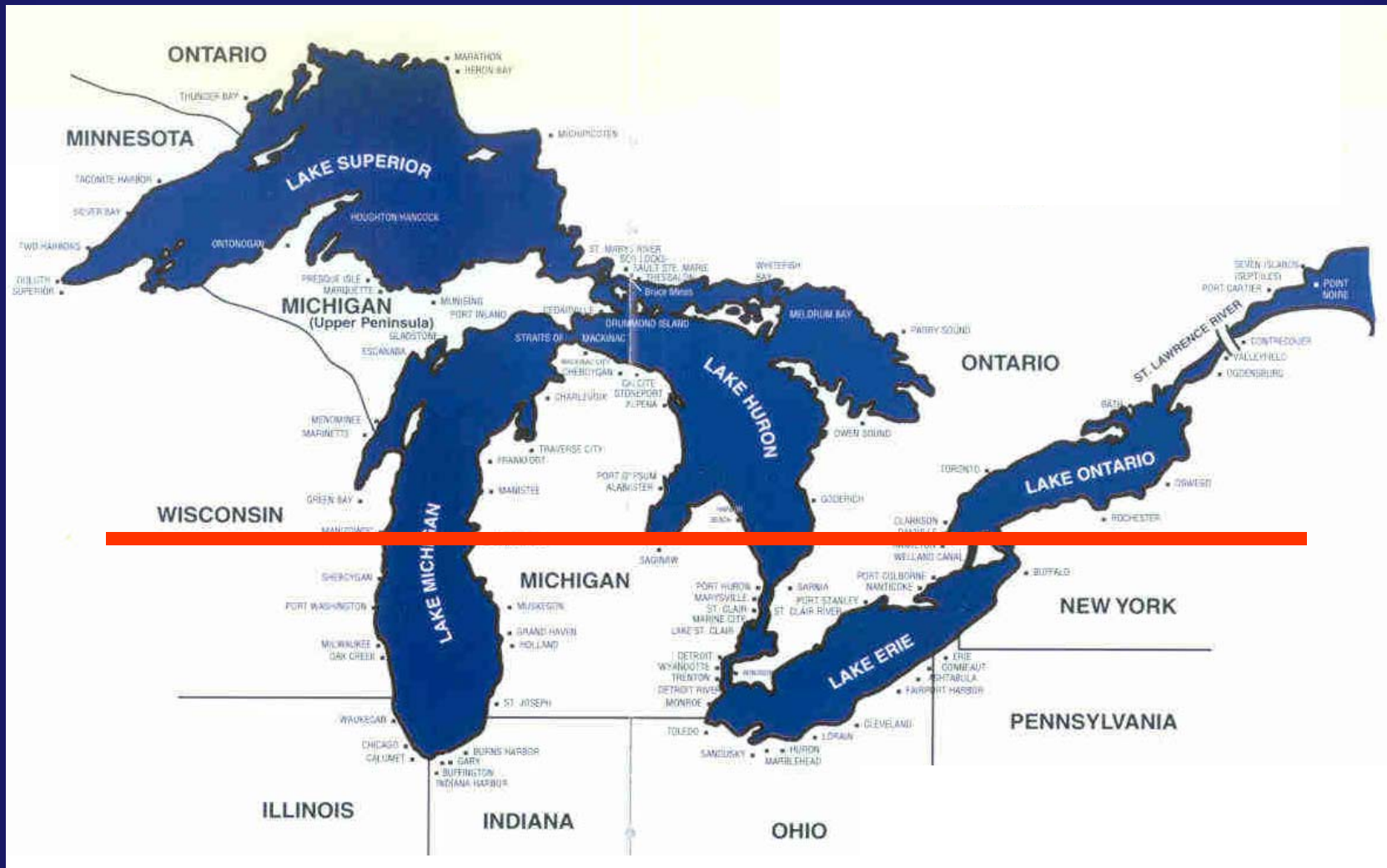



# Marine Response Alliance

## MARINE RESPONSE ALLIANCE U.S. EQUIPMENT LOCATIONS



The Marine Response Alliance LLC consists of four major Salvage companies:

**Marine Pollution Control** (Lightering)

**Titan Maritime** (Salvage)

**Marine Hazard Response** (FireFighting)

**Crowley Maritime** (Towing)





# American Salvage Association



American  
Salvage  
Association



Resolve  
Marine Group



T & T  
Marine Salvage

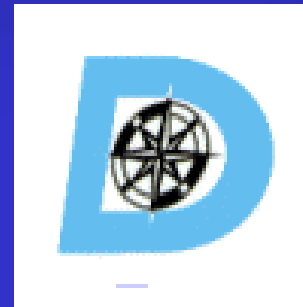

Donjon  
Marine

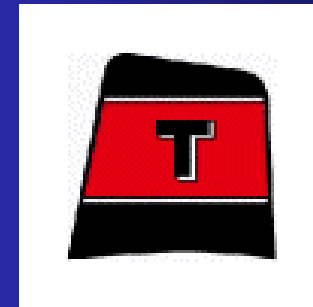

Titan  
Maritime



Smit  
Americas



Bisso  
Marine

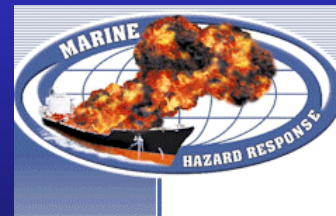

Marine  
Hazard Response



Marine  
Pollution  
Control



## Winter Weather and Great Lakes Response Operations



**The Great Lakes shipping season generally runs between late-March and early-January. Although the risk of a spill from a ship is reduced, these conditions also prevent the use of marine-based response assets during the winter months.**



## Suggestions and Recommendations

- **Identify areas where resources are low, and where logistics will be difficult.**
- **Identify environmentally-sensitive areas that are at risk and where resources are low.**
- **A good example is the case of Isle Royale (Lake Superior). Recognition of the lack of resources and logistic restraints has led to a unique private/public sector workgroup addressing the protection of the island's environment (NEBA analysis, etc.).**



## Suggestions and Recommendations

- **Area Contingency Plans – Constant and proactive updating of resource matrix through public/private sector networking. Keep up to date on new technologies.**
- **Continued and proactive networking and coordination with Canadian authorities to ensure that cross-border issues are resolved in advance of a response (i.e., CANUSLAK).**
- **Include Salvage-related issues in all OPA'90 and PREP program drills and exercises. A good example of this is the last USCG District 9 Area exercise, which, for its case study, involved locating salvage resources required for a collision between a bulk carrier and a cruise ship (*Special Note: This drill also involved a strong Homeland Security component*).**





## Suggestions and Recommendations

- **The ACPs need to take into account those resources that are lacking in their areas (specialized services such as Marine Firefighting) and determine where these services are located. Detailed logistic studies, including realistic response timelines, should be included in the plans.**
  
- **Additionally, these specialized services' logistic requirements must be included in Vessel and Facility Response Plans (to remain consistent with the ACPs). When conducting drills and exercises for the Plans, these timelines and logistic plans should be tested.**



*Thank You for Your Attention!*

*Questions?*