

### 3. HEALTH EFFECTS

#### 3.1 INTRODUCTION

The primary purpose of this chapter is to provide public health officials, physicians, toxicologists, and other interested individuals and groups with an overall perspective on the toxicology of dichloropropenes. It contains descriptions and evaluations of toxicological studies and epidemiological investigations and provides conclusions, where possible, on the relevance of toxicity and toxicokinetic data to public health.

A glossary and list of acronyms, abbreviations, and symbols can be found at the end of this profile.

The majority of toxicity and toxicokinetic information on dichloropropenes relates to the 1,3-dichloropropene isomer. 1,3-Dichloropropene is widely used as a preplanting soil fumigant for the control of nematodes, and it has been available for agricultural use in many formulations. Formulations, instead of pure 1,3-dichloropropene, were used in most of the studies discussed here. The trade names and components of these formulations are listed in Table 3-1.

In some studies, the investigation of the toxicity of 1,3-dichloropropene may have been confounded by other components in a formulation (e.g., chloropicrin and epichlorohydrin). This possibility is discussed in the appropriate sections of the text. The most recent toxicity studies have been conducted using Telone II<sup>®</sup>b (stabilized with 2% epoxidized soybean oil); recent dietary studies administered this material microencapsulated in a starch/sucrose matrix (80/20%) to avoid loss from evaporation and degradation in feed. Intermediate- and chronic-duration MRLs for 1,3-dichloropropene are based on studies that tested Telone II<sup>®</sup>b. Separate tables and figures for each formulation of 1,3-dichloropropene are not presented. Instead, the formulation used in each study is identified in the appropriate table; purity data and noteworthy impurities/additives are also provided as reported in the original studies. Further information on the formulations of 1,3-dichloropropene can be found in Chapter 5. Previously cited toxicity studies that examined formulations with a relatively low content of 1,3-dichloropropene, such as DD<sup>®</sup> (52% 1,3-dichloropropene; ≤29% 1,2-dichloropropane), have been removed from this profile because they have been superseded by studies on higher-purity formulations.

Little toxicity information, none for exposed humans, is available for other isomers of dichloropropene. No *in vivo* mammalian toxicity data are available for 1,1-dichloropropene, which is sometimes detected in

## 3. HEALTH EFFECTS

**Table 3-1. Trade Names and Components of Pure 1,3-Dichloropropene Formulations**

Formulation	Composition	Additives
Telone <sup>®</sup>	40.2% cis, 38.3% trans	Not otherwise specified
Telone C-17 <sup>®</sup>	40–41% cis, 38–39%trans	19–21% chloropicrin
Telone II <sup>®a</sup>	48–53% cis, 42–45% trans	1% epichlorohydrin, not otherwise specific
Telone II <sup>®b</sup>	48–53% cis, 42–45% trans	2% epoxidized soybean oil (ESO)
DD <sup>®</sup>	25–28% cis, 25–27% trans	25–29% 1,2-dichloropropene
DD-92 <sup>®</sup>	92% cis/trans	Not otherwise specified
DD-95 <sup>®</sup>	95% cis/trans	Not otherwise specified

<sup>a</sup>Also called M-3993

### 3. HEALTH EFFECTS

water systems, or 3,3-dichloropropene, which was present in some older pesticide formulations. A few acute-duration toxicity studies have been conducted on 1,2-dichloropropene, and both acute- and intermediate-duration studies have been conducted on 2,3-dichloropropene. An 11-day inhalation study on 2,3-dichloropropene was the basis for an acute-duration inhalation MRL (Zempel et al. 1987). NTP (1989) began a 13-week inhalation assay on 2,3-dichloropropene, but disbanded the postexposure data analysis when a new report indicated that production of the chemical in the United States had fallen below 100 kg/year (NTP 2006). The available records of that study are discussed in Chapter 3, since they provide some evidence for target-organ specificity of 2,3-dichloropropene following repeated exposure, but the data are not used for derivation of an intermediate-duration inhalation MRL. *In vivo* toxicokinetic studies have been conducted on 2,3-dichloropropene and one *in vitro* study has been conducted on 1,1-dichloropropene. All of the isomers except 3,3-dichloropropene have been investigated for genotoxicity.

#### 3.2 DISCUSSION OF HEALTH EFFECTS BY ROUTE OF EXPOSURE

To help public health professionals and others address the needs of persons living or working near hazardous waste sites, the information in this section is organized first by route of exposure (inhalation, oral, and dermal) and then by health effect (death, systemic, immunological, neurological, reproductive, developmental, genotoxic, and carcinogenic effects). These data are discussed in terms of three exposure periods: acute (14 days or less), intermediate (15–364 days), and chronic (365 days or more).

Levels of significant exposure for each route and duration are presented in tables and illustrated in figures. The points in the figures showing no-observed-adverse-effect levels (NOAELs) or lowest-observed-adverse-effect levels (LOAELs) reflect the actual doses (levels of exposure) used in the studies. LOAELs have been classified into "less serious" or "serious" effects. "Serious" effects are those that evoke failure in a biological system and can lead to morbidity or mortality (e.g., acute respiratory distress or death). "Less serious" effects are those that are not expected to cause significant dysfunction or death, or those whose significance to the organism is not entirely clear. ATSDR acknowledges that a considerable amount of judgment may be required in establishing whether an end point should be classified as a NOAEL, "less serious" LOAEL, or "serious" LOAEL, and that in some cases, there will be insufficient data to decide whether the effect is indicative of significant dysfunction. However, the Agency has established guidelines and policies that are used to classify these end points. ATSDR believes that there is sufficient merit in this approach to warrant an attempt at distinguishing between "less serious" and "serious" effects. The distinction between "less serious" effects and "serious" effects is considered to be important because it helps the users of the profiles to identify levels of exposure at which

### 3. HEALTH EFFECTS

major health effects start to appear. LOAELs or NOAELs should also help in determining whether or not the effects vary with dose and/or duration, and place into perspective the possible significance of these effects to human health.

The significance of the exposure levels shown in the Levels of Significant Exposure (LSE) tables and figures may differ depending on the user's perspective. Public health officials and others concerned with appropriate actions to take at hazardous waste sites may want information on levels of exposure associated with more subtle effects in humans or animals (LOAELs) or exposure levels below which no adverse effects (NOAELs) have been observed. Estimates of levels posing minimal risk to humans (Minimal Risk Levels or MRLs) may be of interest to health professionals and citizens alike. MRLs derived for dichloropropenes are summarized in Table 2-1, briefly described in Section 2.3 and described in detail in Appendix A.

Levels of exposure associated with carcinogenic effects (Cancer Effect Levels, CELs) of 1,3-dichloropropene are indicated in Tables 3-2 and 3-4 and Figures 3-1 and 3-3. Because cancer effects could occur at lower exposure levels, Figures 3-1 and 3-3 also show ranges for the upper bound of estimated excess risks, ranging from a risk of 1 in 10,000 to 1 in 10,000,000 ( $10^{-4}$  to  $10^{-7}$ ), as developed by EPA. Carcinogenicity studies were not available for other isomers of dichloropropene.

A User's Guide has been provided at the end of this profile (see Appendix B). This guide should aid in the interpretation of the tables and figures for Levels of Significant Exposure and the MRLs.

In Section 3.2, data for individual isomers (1,3-, 2,3-, and 1,2-dichloropropene) are presented under italicized subheadings under each end point. No subheading was created for an isomer if no data were located for that end point.

#### **3.2.1 Inhalation Exposure**

Reliable inhalation toxicity data are available for 1,3-dichloropropene and, to a lesser extent, for 2,3-dichloropropene. The highest NOAEL and all reliable LOAEL values after inhalation exposure to 1,3- and 2,3-dichloropropene are recorded in Tables 3-2 and 3-3, respectively, and plotted in Figures 3-1 and 3-2, respectively. Median lethal concentrations and other reliable mortality data are recorded as serious LOAELs in these tables and figures.

Table 3-2 Levels of Significant Exposure to 1,3-dichloropropene - Inhalation

Key to Figure <sup>a</sup>	Species (Strain)	Exposure/Duration/Frequency (Route)	System	NOAEL (ppm)	LOAEL		Reference Chemical Form	Comments
					Less Serious (ppm)	Serious (ppm)		
<b>ACUTE EXPOSURE</b>								
<b>Death</b>								
1	Rat (Wistar)	1 d 4 hr/d				675 (6/10 died)	Cracknell et al. 1987 T IIa	Purity: 98.4% 1,3-DCP.
2	Rat (Fischer- 344)	1 d 1 hr/d				253 (LC50)	Streeter and Lomax 1988 T C-17	Purity: 78.9% 1,3-DCP; 21.1% chloropicrin.
3	Rat (Fischer- 344)	1 d 4 hr/d				904 (LC50 females)	Streeter et al. 1987 T IIa	Purity: 97.5% 1,3-DCP.
4	Rabbit (New Zealand)	13 d Gd 6-18 6 hr/d				300 F (6/7 died)	Kloes et al. 1983 T IIa	Purity: 92.1% 1,3-DCP; 1% epichlorohydrin.
<b>Systemic</b>								
5	Rat (Wistar)	1 d 4 hr/d	Resp	581 M		594 M (lung edema)	Cracknell et al. 1987 T IIa	Purity: 98.4% 1,3-DCP.
			Endocr	594	675 (adrenal congestion in decedents)			
			Bd Wt		356 M (final body weight 10% lower than controls)			
6	Rat (Fischer- 344)	1 d 1 hr/d	Resp			206 (atelectasis, multifocal)	Streeter and Lomax 1988 T C-17	Purity: 78.9% 1,3-DCP; 21.1% chloropicrin.
			Ocular		206 (eye irritation)			

\*\*\*DRAFT FOR PUBLIC COMMENT\*\*\*

DICHLOROPROPENES

3. HEALTH EFFECTS

Table 3-2 Levels of Significant Exposure to 1,3-dichloropropene - Inhalation

(continued)

Key to Figure <sup>a</sup>	Species (Strain)	Exposure/Duration/Frequency (Route)	System	NOAEL (ppm)	LOAEL		Reference Chemical Form	Comments	
					Less Serious (ppm)	Serious (ppm)			
7	Rat (Fischer- 344)	1 d 4 hr/d	Resp			1035	(lung hemorrhage)	Streeter et al. 1987 T IIa	Purity: 97.5% 1,3-DCP.
			Ocular		775	(eye irritation)			
8	Rat (Sprague-Dawley)	1 d 1 hr/d	Ocular			1146	(eye irritation)	Yakel and Kociba 1977 T IIa	Purity: 92% 1,3-DCP.
<b>Neurological</b>									
9	Rabbit (New Zealand)	13 d 6 hr/d		150 F		300 F	(ataxia)	Kloes et al. 1983 T IIa	Purity: 92.1% 1,3-DCP; 1% epichlorohydrin.
<b>Developmental</b>									
10	Rat	Gd 6-15 6 hr/d		120				Hanley et al. 1987 T IIa	1,3-DCP: 47.7% cis; 42.4% trans.
11	Rat (Fischer- 344)	10 d Gd 6-15 6 hr/d		150 F		300 F	(decreased litter size)	Kloes et al. 1983 T IIa	Purity: 92.1% 1,3-DCP; 1% epichlorohydrin.
12	Rabbit (New Zealand)	13 d Gd 6-18 6 hr/d		150 F				Kloes et al. 1983 T	Purity: 92.1% 1,3-DCP; 1% epichlorohydrin.
<b>INTERMEDIATE EXPOSURE</b>									
<b>Systemic</b>									
13	Human	117 d 521 min/d (Occup)	Hepatic	0.59 M				Verplanke et al. 2000 cis	
			Renal	0.59 M					

\*\*\*DRAFT FOR PUBLIC COMMENT\*\*\*

DICHLOROPROPENES

3. HEALTH EFFECTS

Table 3-2 Levels of Significant Exposure to 1,3-dichloropropene - Inhalation

(continued)

Key to Figure	Species (Strain)	Exposure/ Duration/ Frequency (Route)	System	NOAEL (ppm)	LOAEL		Reference Chemical Form	Comments
					Less Serious (ppm)	Serious (ppm)		
14	Rat (Fischer- 344)	180 d 5-7 d/wk 6 hr/d	Resp	30	90	(nasal lesions)	Breslin et al. 1989 T IIb	Purity: 92% 1,3-DCP; 2% ESO.
			Gastro	90				
			Hepatic	90				
			Renal	90				
15	Rat (Fischer- 344)	13 wk 5 d/wk 6 hr/d	Resp	10	30	(decreased cytoplasm, disorganization of nuclei in epithelium of dorsal nasal turbinates)	Coate 1979a T IIa	Purity not reported.
			Cardio	90				
			Hepatic	90				
			Renal	90				
16	Rat	4 wk 5 d/wk 6 hr/d	Resp	30			Coate 1979b T IIa	No purity data.
			Cardio	30				
			Hepatic	30				
			Renal	30				

\*\*\*DRAFT FOR PUBLIC COMMENT\*\*\*

Table 3-2 Levels of Significant Exposure to 1,3-dichloropropene - Inhalation

(continued)

Key to Figure	Species <sup>a</sup> (Strain)	Exposure/Duration/Frequency (Route)	System	NOAEL (ppm)	LOAEL		Reference Chemical Form	Comments
					Less Serious (ppm)	Serious (ppm)		
17	Rat (Fischer- 344)	13 wk 5 d/wk 6 hr/d	Resp	30	90	(nasal hyperplasia)	Stott et al. 1988 T IIa	Purity: 90.9% 1,3-DCP; 1.2% epichlorohydrin.
			Cardio	150				
			Gastro	150				
			Hemato	150				
			Musc/skel	150				
			Hepatic	150				
			Renal	150				
			Dermal	150				
18	Rat	6 mo 5 d/wk 7 hr/d	Resp	3			Torkelson and Oyen 1977 T IIa	Purity: 99% 1,3-DCP; 1% epichlorohydrin.
			Cardio	3				
			Hemato	3				
			Hepatic	3				
19	Mouse (CD-1)	13 wk 5 d/wk 6 hr/d	Resp		90	(decreased epithelial cytoplasm of dorsal nasal turbinates)	Coate 1979a T IIa	Purity not reported.
			Cardio	90				
			Hepatic	90				
			Renal	90				

\*\*\*DRAFT FOR PUBLIC COMMENT\*\*\*

DICHLOROPROPENES

3. HEALTH EFFECTS



Table 3-2 Levels of Significant Exposure to 1,3-dichloropropene - Inhalation

(continued)

Key to Figure	Species <sup>a</sup> (Strain)	Exposure/Duration/Frequency (Route)	System	NOAEL (ppm)	LOAEL		Reference Chemical Form	Comments
					Less Serious (ppm)	Serious (ppm)		
20	Mouse (B6C3F1)	6 mo 5 d/wk 6 hr/d	Resp	20	60 <sup>b</sup>	(hyperplasia/hypertrophy of nasal respiratory epithelium)	Lomax et al. 1989 T IIb	Purity: 92.1% 1,3-DCP; 2% ESO.
			Cardio	60				
			Gastro	60				
			Hemato	60				
			Musc/skel	60				
			Hepatic	60				
			Renal	20	60 F	(bladder hyperplasia)		
Dermal	60							
21	Mouse (B6C3F1)	13 wk 5 d/wk 6 hr/d	Resp	30	90	(nasal hyperplasia)	Stott et al. 1988 T IIa	Purity: 90.9% 1,3-DCP; 1.2% epichlorohydrin.
			Cardio	150				
			Gastro	150				
			Hemato	150				
			Musc/skel	150				
			Hepatic	150				
Renal	30	90	(bladder hyperplasia)					

\*\*\*DRAFT FOR PUBLIC COMMENT\*\*\*

DICHLOROPROPENES

3. HEALTH EFFECTS

Table 3-2 Levels of Significant Exposure to 1,3-dichloropropene - Inhalation

(continued)

Key to Figure <sup>a</sup>	Species (Strain)	Exposure/Duration/Frequency (Route)	System	NOAEL (ppm)	LOAEL		Reference Chemical Form	Comments
					Less Serious (ppm)	Serious (ppm)		
22	Gn Pig	6 mo 5 d/wk .5-4 hr/d	Resp	3			Torkelson and Oyen 1977 T IIa	Purity: 99% 1,3-DCP; 1% epichlorohydrin.
			Cardio	3				
			Hemato	3				
			Hepatic	3				
			Renal	3				
23	Dog	6 mo 5 d/wk .5-4 hr/d	Resp	3			Torkelson and Oyen 1977 T IIa	Purity: 99% 1,3-DCP; 1% epichlorohydrin.
			Cardio	3				
			Gastro	3				
			Hemato	3				
			Musc/skel	3				
			Renal	3				
24	Rabbit	6 mo 5 d/wk .5-4 hr/d	Resp	3			Torkelson and Oyen 1977 T IIa	Purity: 99% 1,3-DCP; 1% epichlorohydrin.
			Cardio	3				
			Hemato	3				
			Hepatic	3				
			Renal	3				

\*\*\*DRAFT FOR PUBLIC COMMENT\*\*\*

DICHLOROPROPENES

3. HEALTH EFFECTS

Table 3-2 Levels of Significant Exposure to 1,3-dichloropropene - Inhalation

(continued)

Key to Figure <sup>a</sup>	Species (Strain)	Exposure/Duration/Frequency (Route)	System	NOAEL (ppm)	LOAEL		Reference Chemical Form	Comments
					Less Serious (ppm)	Serious (ppm)		
<b>Immuno/ Lymphoret</b>								
25	Rat (Fischer- 344)	6-12 mo 5 d/wk 6 hr/d		60			Lomax et al. 1989 T IIb	Purity: 92.1% 1,3-DCP.
26	Rat (Fischer- 344)	13 wk 5 d/wk 6 hr/d		150			Stott et al. 1988 T IIa	Purity: 90.9% 1,3-DCP; 1.2% epichlorohydrin.
27	Mouse (B6C3F1)	6-12 mo 5 d/wk 6 hr/d		60			Lomax et al. 1989 T IIb	Purity: 92.1% 1,3-DCP.
28	Mouse (B6C3F1)	13 wk 5 d/wk 6 hr/d		150			Stott et al. 1988 T IIa	Purity: 90.9% 1,3-DCP; 1.2% epichlorohydrin.
<b>Neurological</b>								
29	Rat (Fischer- 344)	6-12 mo 5 d/wk 6 hr/d		60			Lomax et al. 1989 T IIb	Purity: 92.1% 1,3-DCP.
30	Rat (Fischer- 344)	13 wk 5 d/wk 6 hr/d		150			Stott et al. 1988 T IIa	Purity: 90.9% 1,3-DCP; 1.2% epichlorohydrin.
31	Mouse (CD-1)	13 wk 5 d/wk 6 hr/d		90			Coate 1979a T IIa	Purity not reported.
32	Mouse (B6C3F1)	6-12 mo 5 d/wk 6 hr/d		60			Lomax et al. 1989 T IIb	Purity: 92.1% 1,3-DCP.

\*\*\*DRAFT FOR PUBLIC COMMENT\*\*\*

DICHLOROPROPENES

3. HEALTH EFFECTS

Table 3-2 Levels of Significant Exposure to 1,3-dichloropropene - Inhalation

(continued)

Key to Figure <sup>a</sup>	Species (Strain)	Exposure/Duration/Frequency (Route)	System	NOAEL (ppm)	LOAEL		Reference Chemical Form	Comments
					Less Serious (ppm)	Serious (ppm)		
33	Mouse (B6C3F1)	13 wk 5 d/wk 6 hr/d		150			Stott et al. 1988 T IIa	Purity: 90.9% 1,3-DCP; 1.2% epichlorohydrin.
34	Gn Pig	6 mo 5 d/wk .5-4 hr/d		3			Torkelson and Oyen 1977 T IIa	Purity: 99% 1,3-DCP; 1% epichlorohydrin.
35	Dog	6 mo 5 d/wk .5-4 hr/d		3			Torkelson and Oyen 1977 T IIa	Purity: 99% 1,3-DCP; 1% epichlorohydrin.
36	Rabbit	6 mo 5 d/wk .5-4 hr/d		3			Torkelson and Oyen 1977 T IIa	Purity: 99% 1,3-DCP; 1% epichlorohydrin.
<b>Reproductive</b>								
37	Rat (Fischer- 344)	180 d 5-7 d/wk 6 hr/d		90			Breslin et al. 1989 T IIb	Purity: 92% 1,3-DCP; 2% ESO.
38	Rat (Fischer- 344)	6-12 mo 5 d/wk 6 hr/d		60			Lomax et al. 1989 T IIb	Purity: 92.1% 1,3-DCP.
39	Rat (Fischer- 344)	13 wk 5 d/wk 6 hr/d		150			Stott et al. 1988 T IIa	Purity: 90.9% 1,3-DCP; 1.2% epichlorohydrin.
40	Mouse (B6C3F1)	6-12 mo 5 d/wk 6 hr/d		60			Lomax et al. 1989 T IIb	Purity: 92.1% 1,3-DCP.

\*\*\*DRAFT FOR PUBLIC COMMENT\*\*\*

DICHLOROPROPENES

3. HEALTH EFFECTS

50

Table 3-2 Levels of Significant Exposure to 1,3-dichloropropene - Inhalation

(continued)

Key to Figure <sup>a</sup>	Species (Strain)	Exposure/Duration/Frequency (Route)	System	NOAEL (ppm)	LOAEL		Reference Chemical Form	Comments
					Less Serious (ppm)	Serious (ppm)		
41	Mouse (B6C3F1)	13 wk 5 d/wk 6 hr/d		150			Stott et al. 1988 T IIa	Purity: 90.9% 1,3-DCP; 1.2% epichlorohydrin.
<b>Developmental</b>								
42	Rat (Fischer- 344)	180 d 5-7 d/wk 6 hr/d		90			Breslin et al. 1989 T IIb	Purity: 92% 1,3-DCP; 2% ESO.
<b>CHRONIC EXPOSURE</b>								
<b>Systemic</b>								
43	Rat (Fischer- 344)	2 yr 5 d/wk 6 hr/d	Resp	20	60	(epithelial degeneration)	Lomax et al. 1989 T IIb	Purity: 92.1% 1,3-DCP.
			Cardio	60				
			Gastro	60				
			Hemato	60				
			Musc/skel	60				
			Hepatic	60				
			Renal	60				
			Dermal	60				

\*\*\*DRAFT FOR PUBLIC COMMENT\*\*\*

Table 3-2 Levels of Significant Exposure to 1,3-dichloropropene - Inhalation

(continued)

Key to Figure <sup>a</sup>	Species (Strain)	Exposure/Duration/Frequency (Route)	System	NOAEL (ppm)	LOAEL		Reference Chemical Form	Comments
					Less Serious (ppm)	Serious (ppm)		
44	Mouse (B6C3F1)	2 yr 5 d/wk 6 hr/d	Resp	5 F	20 <sup>c</sup> F (hypertrophy/hyperplasia of nasal respiratory epithelium)		Lomax et al. 1989 T IIb	Purity: 92.1% 1,3-DCP.
			Cardio	60				
			Gastro	20 M	60 M (hyperplasia and hyperkeratosis of forestomach)			
			Hemato	60				
			Musc/skel	60				
			Hepatic	60				
			Renal	5 F	20 F (epithelial hyperplasia of urinary bladder)			
	Dermal	60						
<b>Immuno/ Lymphoret</b>								
45	Rat (Fischer- 344)	2 yr 5 d/wk 6 hr/d		60			Lomax et al. 1989 T IIb	Purity: 92.1% 1,3-DCP.
<b>Neurological</b>								
46	Rat (Fischer- 344)	2 yr 5 d/wk 6 hr/d		60			Lomax et al. 1989 T IIb	Purity: 92.1% 1,3-DCP.
47	Mouse (B6C3F1)	2 yr 5 d/wk 6 hr/d		60			Lomax et al. 1989 T IIb	Purity: 92.1% 1,3-DCP.

\*\*\*DRAFT FOR PUBLIC COMMENT\*\*\*

DICHLOROPROPENES

3. HEALTH EFFECTS

52

Table 3-2 Levels of Significant Exposure to 1,3-dichloropropene - Inhalation

(continued)

Key to Figure <sup>a</sup>	Species (Strain)	Exposure/Duration/Frequency (Route)	System	NOAEL (ppm)	LOAEL		Reference Chemical Form	Comments
					Less Serious (ppm)	Serious (ppm)		
<b>Reproductive</b>								
48	Rat (Fischer- 344)	2 yr 5 d/wk 6 hr/d		60			Lomax et al. 1989 T IIb	Purity: 92.1% 1,3-DCP.
49	Mouse (B6C3F1)	2 yr 5 d/wk 6 hr/d		60			Lomax et al. 1989 T IIb	Purity: 92.1% 1,3-DCP.
<b>Cancer</b>								
50	Mouse (B6C3F1)	2 yr 5 d/wk 6 hr/d				60 M (CEL: bronchioalveolar adenoma)	Lomax et al. 1989 T IIb	Purity: 92.1% 1,3-DCP.

a The number corresponds to entries in Figure 3-1.

b Study results used to derive an intermediate-duration inhalation minimal risk level (MRL) of 0.008 ppm for 1,3-dichloropropene, as described in detail in Appendix A. Benchmark dose analysis was performed using reported concentrations (adjusted for <100% purity and intermittent exposure) and incidences of hypertrophy/hyperplasia of the nasal respiratory epithelium in male and female mice to select a point of departure. The selected point of departure, based on nasal lesions in male mice, was adjusted to a human equivalent concentration, and then divided by an uncertainty factor of 30 (3 for extrapolation from animals to humans using dosimetric adjustment and 10 for human variability) (See Appendix A).

c Study results used to derive a chronic-duration inhalation minimal risk level (MRL) of 0.007 ppm for 1,3-dichloropropene, as described in detail in Appendix A. Benchmark dose analysis was performed using reported concentrations (adjusted for <100% purity and intermittent exposure) and incidences of hypertrophy/hyperplasia of the nasal respiratory epithelium in female mice to select a point of departure, which was adjusted to a human equivalent concentration, and then divided by an uncertainty factor of 30 (3 for extrapolation from animals to humans using dosimetric adjustment and 10 for human variability) (See Appendix A).

Bd Wt = body weight; ESO = epoxidized soybean oil; Cardio = cardiovascular; CEL = cancer effect level; d = day(s); F = female; Gastro = gastrointestinal; Gd = gestational day; Gn pig = guinea pig; hemato = hematological; hr = hour(s); Immuno/Lymphoret = immunological/lymphoretic; LC50 = lethal concentration, 50% kill; LOAEL = lowest-observed-adverse-effect level; M = male; mo = month(s); Musc/skel = musculoskeletal; NOAEL = no-observed-adverse-effect level; Resp = respiratory; wk = week(s); yr = year(s)

\*\*\*DRAFT FOR PUBLIC COMMENT\*\*\*

Figure 3-1 Levels of Significant Exposure to 1,3-dichloropropene - Inhalation  
Acute (≤14 days)

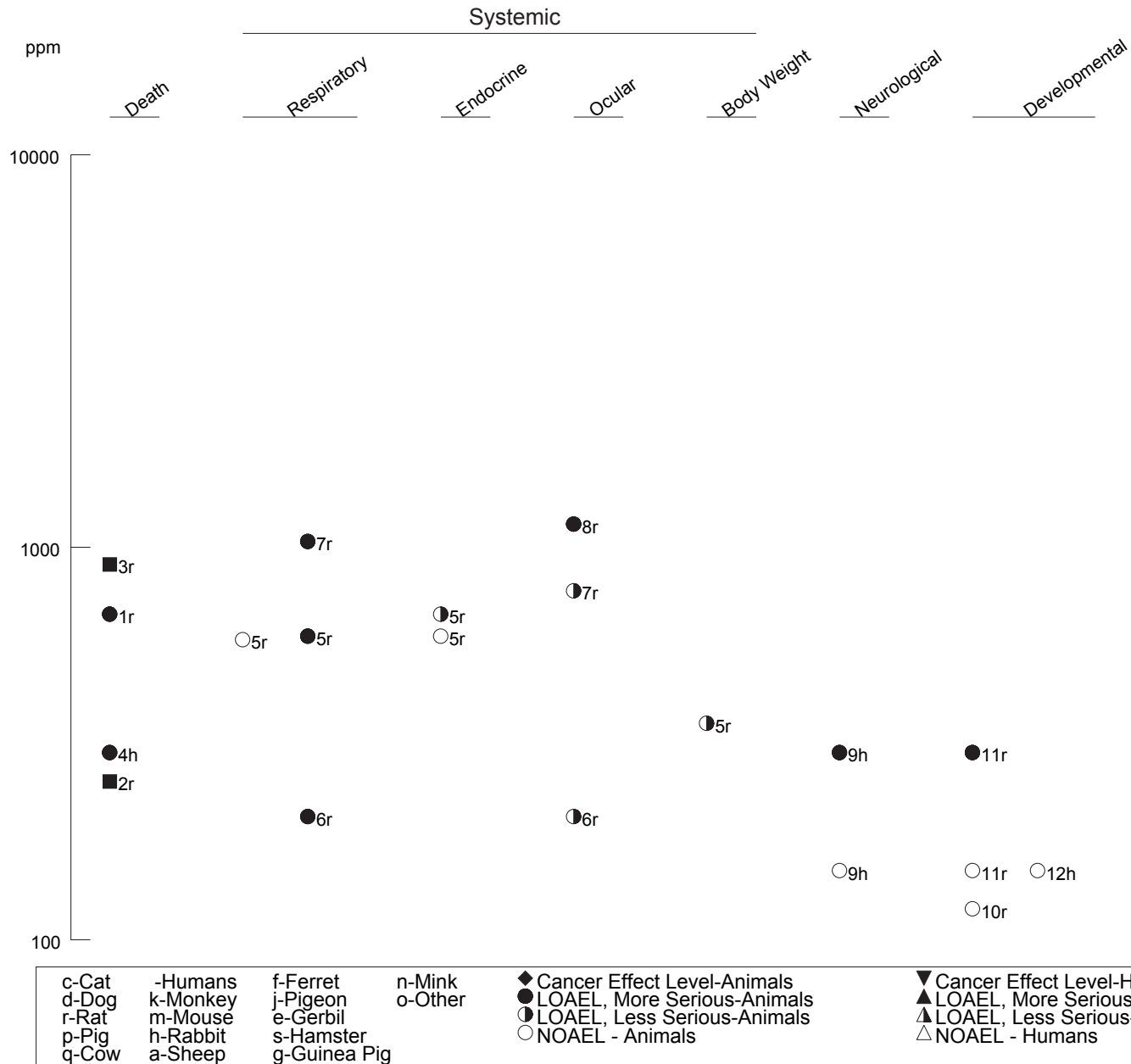

\*\*\*DRAFT FOR PUBLIC COMMENT\*\*\*



Figure 3-1 Levels of Significant Exposure to 1,3-dichloropropene - Inhalation (Continued)

Intermediate (15-364 days)

Systemic

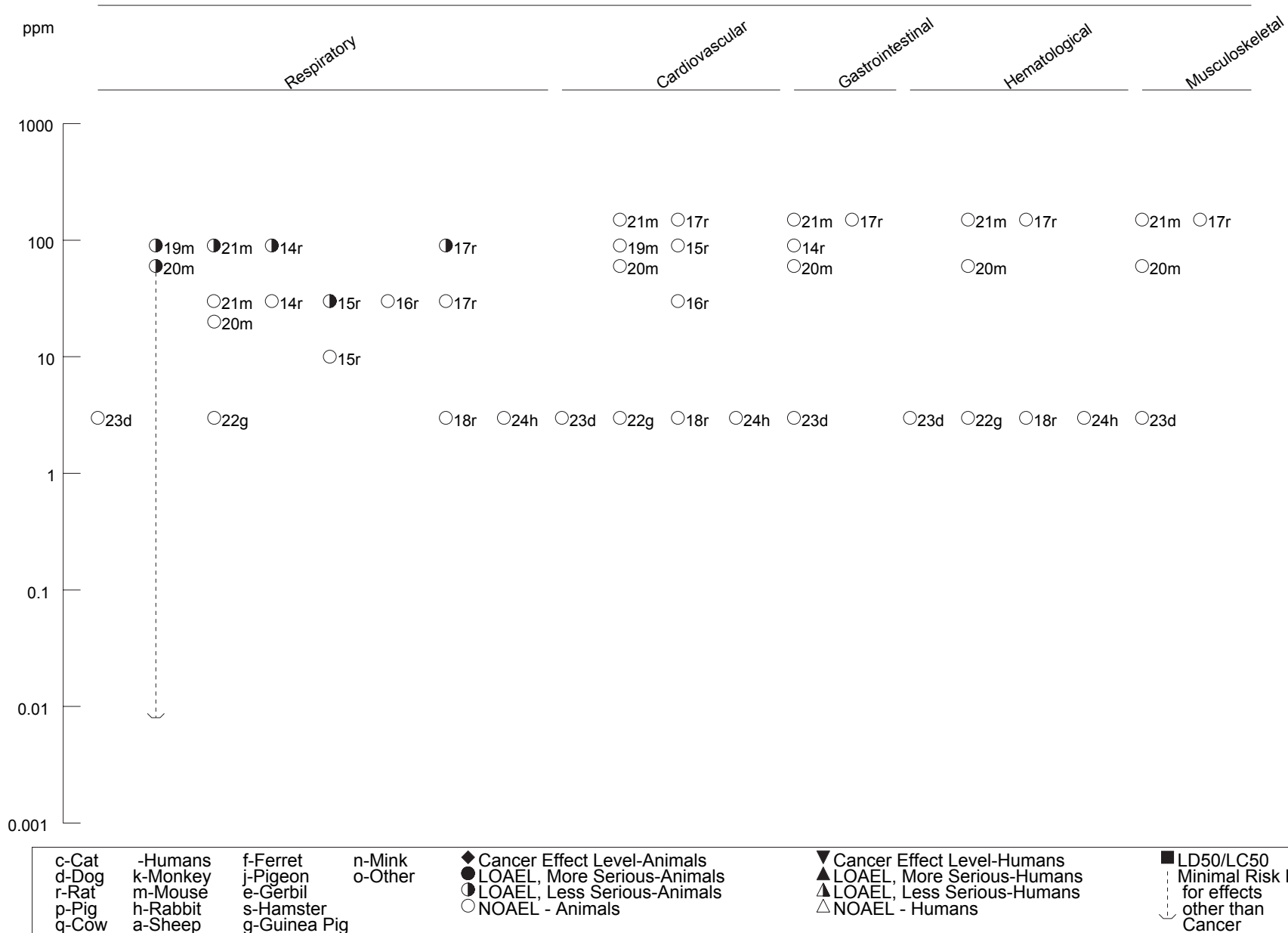

\*\*\*DRAFT FOR PUBLIC COMMENT\*\*\*

Figure 3-1 Levels of Significant Exposure to 1,3-dichloropropene - Inhalation (Continued)

Intermediate (15-364 days)

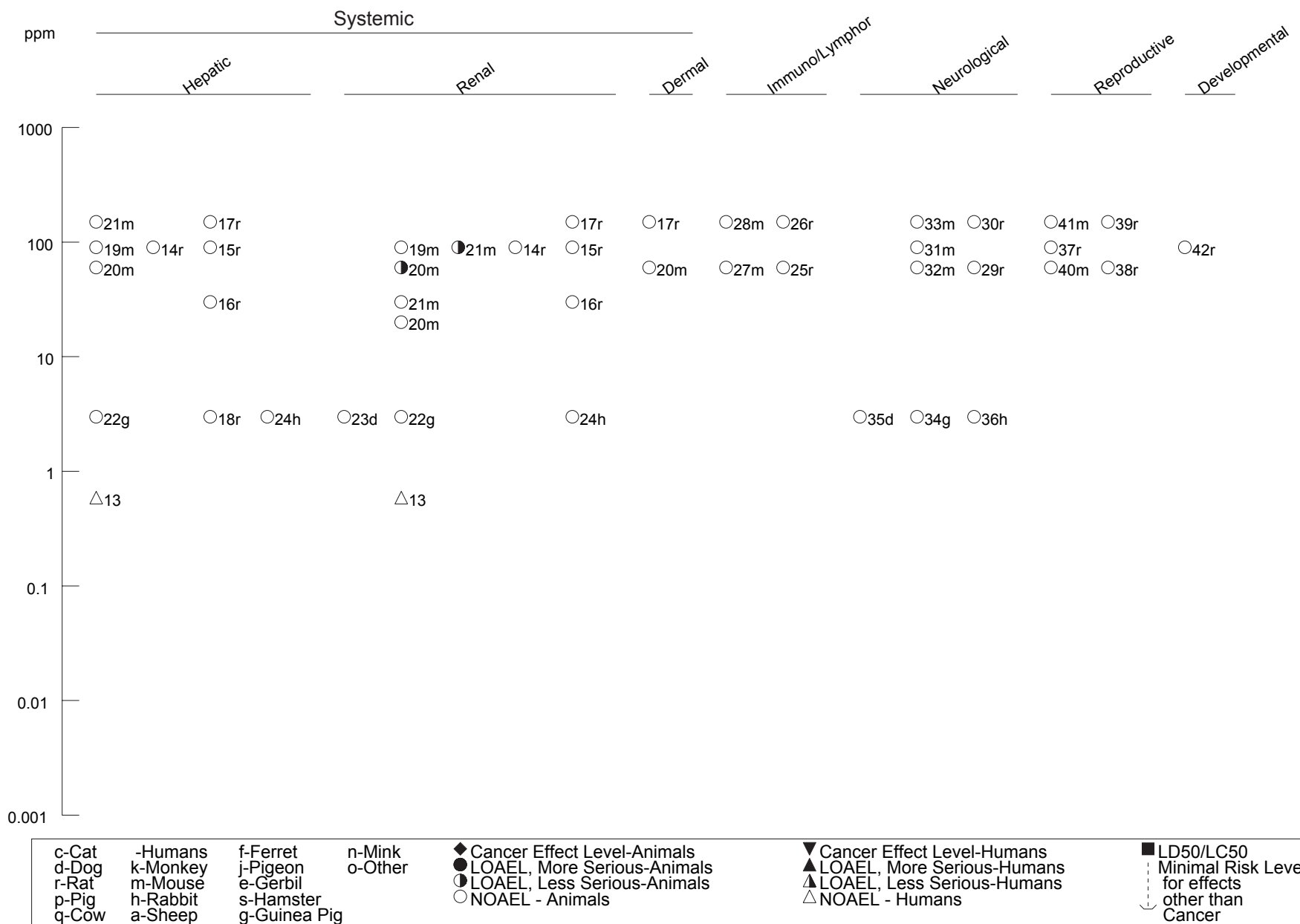

\*\*\*DRAFT FOR PUBLIC COMMENT\*\*\*



Figure 3-1 Levels of Significant Exposure to 1,3-dichloropropene - Inhalation (Continued)  
Chronic (≥365 days)

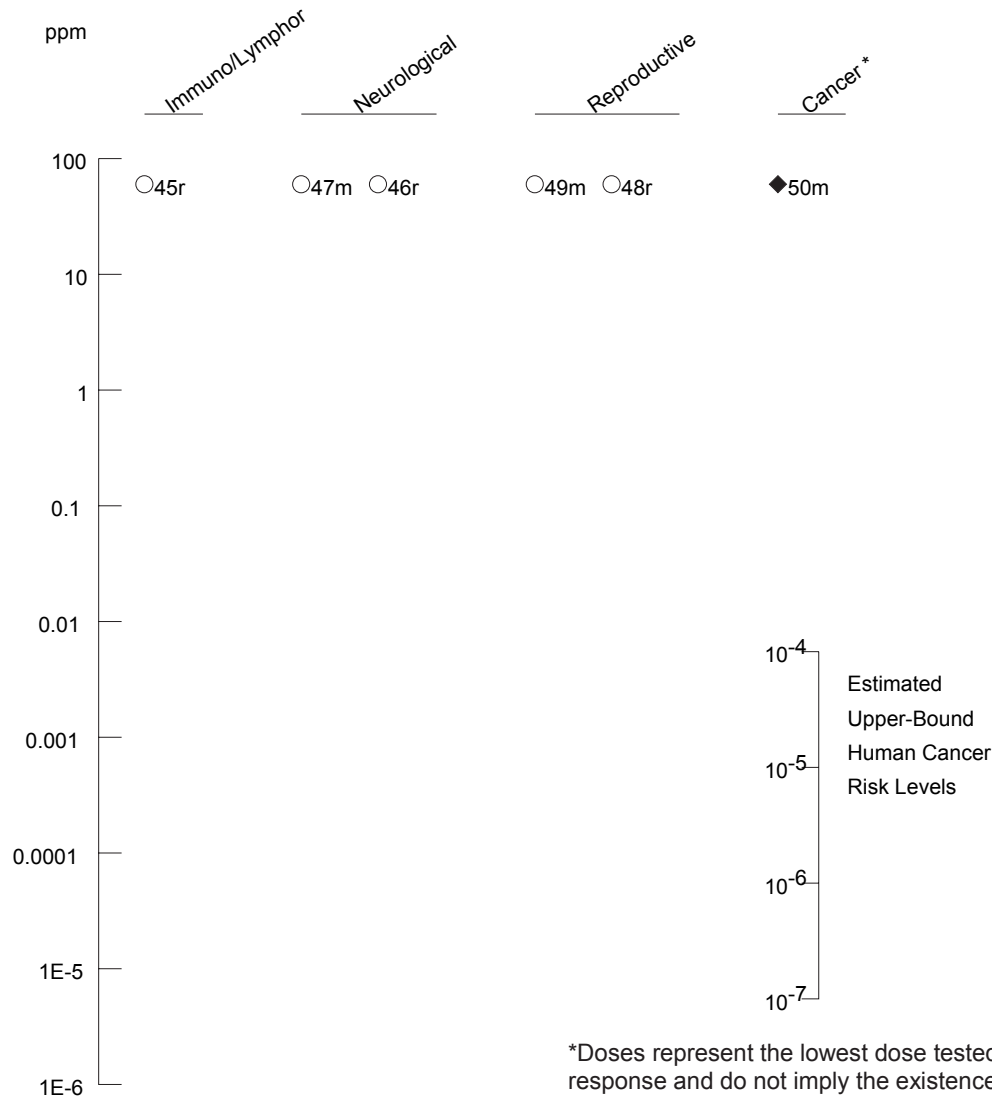

\*\*\*DRAFT FOR PUBLIC COMMENT\*\*\*

c-Cat	-Humans	f-Ferret	n-Mink	◆ Cancer Effect Level-Animals	▼ Cancer Effect Level-Humans	■ LD50/LC50
d-Dog	k-Monkey	j-Pigeon	o-Other	● LOAEL, More Serious-Animals	▲ LOAEL, More Serious-Humans	⋮ Minimal Risk Level
r-Rat	m-Mouse	e-Gerbil		◐ LOAEL, Less Serious-Animals	△ LOAEL, Less Serious-Humans	⋮ for effects
p-Pig	h-Rabbit	s-Hamster		○ NOAEL - Animals	△ NOAEL - Humans	other than
q-Cow	a-Sheep	g-Guinea Pig				Cancer

Table 3-3 Levels of Significant Exposure to 2,3-dichloropropene - Inhalation

Key to Figure <sup>a</sup>	Species (Strain)	Exposure/ Duration/ Frequency (Route)	System	NOAEL (ppm)	LOAEL		Reference Chemical Form	Comments
					Less Serious (ppm)	Serious (ppm)		
<b>ACUTE EXPOSURE</b>								
<b>Death</b>								
1	Rat (Fischer- 344)	once 1 hr				1331 F (1-hour LC50)	Dietz et al. 1985b 2,3-dichloropropene	Purity: >98%.
2	Rat (Wistar)	once 4 hr				500 (3/6 rats died)	Smyth et al. 1962; Union Carbide Corp 1958 2,3-dichloropropene	Purity not reported.
<b>Systemic</b>								
3	Rat (Fischer- 344)	9 d/11 d 6 hr/d	Resp		<sup>b</sup> 5	(very slight hyperplasia of nasal respiratory epithelium in 9/10)	Zempel et al. 1987 2,3-dichloropropene	Purity: >99%; NOAELs based on histological examination.
			Cardio	75				
			Gastro	75				
			Hemato	75				
			Musc/skel	75				
			Hepatic	75				
			Endocr	75				
			Dermal	75				
			Ocular	75				
			Bd Wt	75				

\*\*\*DRAFT FOR PUBLIC COMMENT\*\*\*

DICHLOROPROPENES

3. HEALTH EFFECTS

Table 3-3 Levels of Significant Exposure to 2,3-dichloropropene - Inhalation

(continued)

Key to Figure <sup>a</sup>	Species (Strain)	Exposure/Duration/Frequency (Route)	System	NOAEL (ppm)	LOAEL		Reference Chemical Form	Comments
					Less Serious (ppm)	Serious (ppm)		
4	Mouse (B6C3F1)	9 d/11 d 6 hr/d	Resp		5	(very slight hyperplasia of nasal respiratory epithelium in 7/10; slight diffuse degeneration of bronchial/bronchiolar epithelium in 10/10)	Zempel et al. 1987 2,3-dichloropropene	Purity: >99%; NOAELs based on histological examination.
			Cardio	75				
			Gastro	75				
			Hepatic	75				
			Renal	75				
			Endocr	75				
			Ocular	75				
Bd Wt	5	25	(final bd wt 12% lower in males and 16% lower in females compared to controls)					
<b>Neurological</b>								
5	Rat (Fischer- 344)	9 d/11 d 6 hr/d		75			Zempel et al. 1987 2,3-dichloropropene	Purity: >99%; NOAELs based on histological examination.

\*\*\*DRAFT FOR PUBLIC COMMENT\*\*\*

DICHLOROPROPENES

3. HEALTH EFFECTS

Table 3-3 Levels of Significant Exposure to 2,3-dichloropropene - Inhalation

(continued)

Key to Figure	Species <sup>a</sup> (Strain)	Exposure/Duration/Frequency (Route)	System	NOAEL (ppm)	LOAEL		Reference Chemical Form	Comments
					Less Serious (ppm)	Serious (ppm)		
6	Mouse (B6C3F1)	9 d/11 d 6 hr/d		75			Zempel et al. 1987 2,3-dichloropropene	Purity: >99%; NOAELs based on histological examination.
<b>INTERMEDIATE EXPOSURE</b>								
<b>Systemic</b>								
7	Rat (Sprague-Dawley)	13 wk 5 d/wk 6 hr/d	Cardio	15			Johannsen et al. 1991 2,3-dichloropropene	Purity: >99%; nasal turbinates were not examined for histopathology; NOAELs based on histological examination.
			Hemato	15				
			Musc/skel	15				
			Hepatic	15				
			Renal	15				
			Bd Wt	15				

\*\*\*DRAFT FOR PUBLIC COMMENT\*\*\*

DICHLOROPROPENES

3. HEALTH EFFECTS

Table 3-3 Levels of Significant Exposure to 2,3-dichloropropene - Inhalation

(continued)

Key to Figure	Species (Strain)	Exposure/Duration/Frequency (Route)	System	NOAEL (ppm)	LOAEL		Reference Chemical Form	Comments
					Less Serious (ppm)	Serious (ppm)		
8	Rat (Fischer- 344)	13 wk 5 d/wk 6 hr/d	Hemato	80			NTP 1989, 2006 2,3-dichloropropene	Purity: 99.4% 2,3-DCP; incomplete, abandoned study; no histopathology data.
			Hepatic	40 F	80 F (absolute and relative liver weights increased >30%)			
			Renal	20 F	40 F (urine volume doubled)			
			Bd Wt	20 M	40 M (terminal body weight 13% lower than control)			
				80 F				
9	Mouse (B6C3F1)	13 wk 5 d/wk 6 hr/d	Resp		5 F (absolute lung weight increased 29% and relative lung weight increased 25% in females compared to control)		NTP 1989, 2006 2,3-dichloropropene	Purity: 99.4% 2,3-DCP; incomplete, abandoned study; no histopathology data.
			Hemato	80 M				
			Hepatic	20 F	40 F (3-fold increases in serum ALT and SDH)			
<b>Reproductive</b>								
10	Rat (Sprague-Dawley)	13 wk 5 d/wk 6 hr/d		5			Johannsen et al. 1991 2,3-dichloropropene	Purity: >99%; nasal turbinates were not examined for histopathology.

\*\*\*DRAFT FOR PUBLIC COMMENT\*\*\*

DICHLOROPROPENES

3. HEALTH EFFECTS



Table 3-3 Levels of Significant Exposure to 2,3-dichloropropene - Inhalation

(continued)

Key to Figure	Species (Strain)	Exposure/Duration/Frequency (Route)	System	NOAEL (ppm)	LOAEL		Reference Chemical Form	Comments
					Less Serious (ppm)	Serious (ppm)		
11	Rat (Fischer- 344)	13 wk 5 d/wk 6 hr/d		80			NTP 1989, 2006 2,3-dichloropropene	Purity: 99.4% 2,3-DCP; incomplete, abandoned study.
12	Mouse (B6C3F1)	13 wk 5 d/wk 6 hr/d		20			NTP 1989, 2006 2,3-dichloropropene	Purity: 99.4% 2,3-DCP; incomplete, abandoned study.

a The number corresponds to entries in Figure 3-2.

b. The minimal LOAEL was used to derive an acute-duration inhalation minimal risk level (MRL) of 0.002 ppm for 2,3-dichloropropene, as described in detail in Appendix A. The minimal LOAEL was adjusted for intermittent exposure [multiplied by (6 hours/24 hours)] and multiplied by the regional gas dose ratio for extrathoracic effects in female rats (0.1143) to obtain the human equivalent concentration of 0.14 ppm. This was divided by uncertainty factor of 90 (3 for use of a minimal LOAEL, 3 for extrapolation from animal to human using dosimetric adjustment, and 10 for human variability) to derive the MRL (See Appendix A).

ALT = alanine aminotransferase; Bd Wt = body weight; Cardio = cardiovascular; d = day(s); Endocr = endocrine; F = Female; Gastro = gastrointestinal; Hemato = hematological; hr = hour(s); LC50 = lethal concentration, 50% kill, LOAEL = lowest-observed-adverse-effect level; Musc/skel = musculoskeletal; NOAEL = no-observed-adverse-effect level; Resp = respiratory; SDH = sorbitol dehydrogenase

\*\*\*DRAFT FOR PUBLIC COMMENT\*\*\*

Figure 3-2 Levels of Significant Exposure to 2,3-dichloropropene - Inhalation

Acute (≤14 days)

Systemic

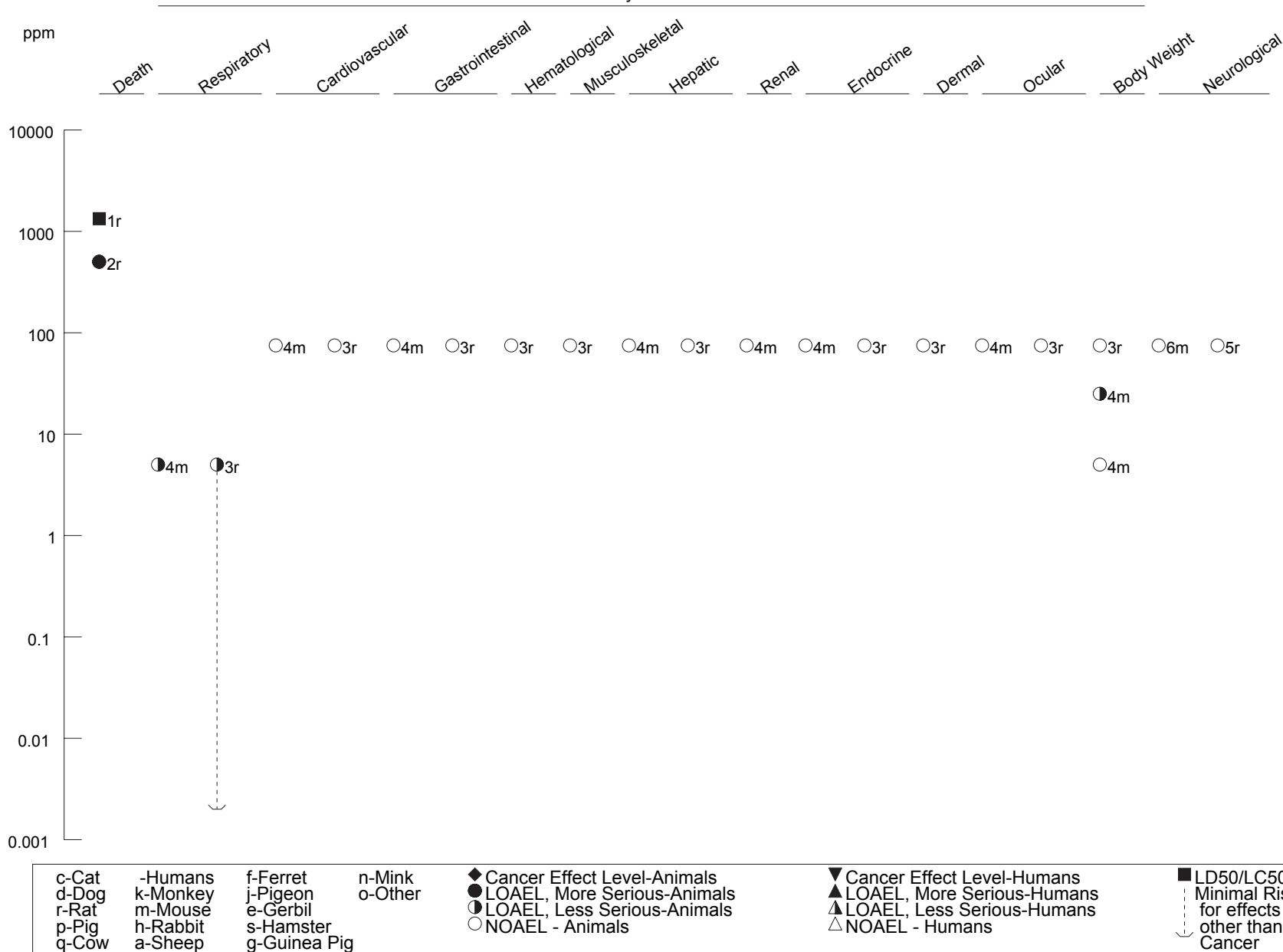

\*\*\*DRAFT FOR PUBLIC COMMENT\*\*\*

Figure 3-2 Levels of Significant Exposure to 2,3-dichloropropene - Inhalation (Continued)  
Intermediate (15-364 days)

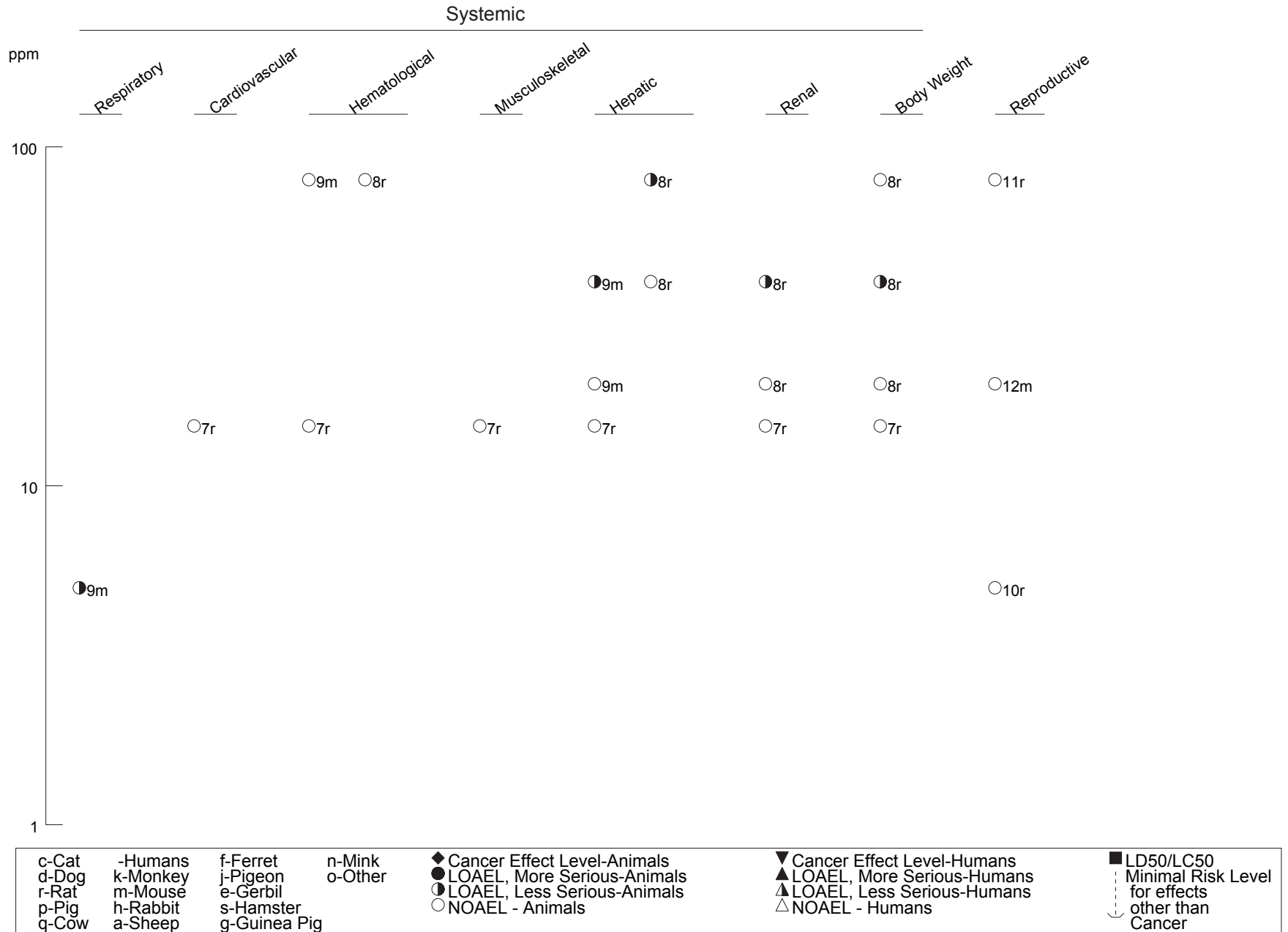

\*\*\*DRAFT FOR PUBLIC COMMENT\*\*\*

## 3. HEALTH EFFECTS

**3.2.1.1 Death**

**1,3-Dichloropropene.** No studies were located regarding death in humans after inhalation exposure to 1,3-dichloropropene.

LC<sub>50</sub> values for inhalation exposure to 1,3-dichloropropene have been determined in rats (Streeter and Lomax 1988; Streeter et al. 1987). The LC<sub>50</sub> for female rats exposed to Telone II<sup>®</sup>a for 4 hours was 904 ppm (95% confidence interval [CI]=846–990 ppm) (Streeter et al. 1987). The LC<sub>50</sub> for male rats could not be determined in this study, but fell in the range of 855–1,035 ppm 1,3-dichloropropene. Telone C-17<sup>®</sup> appears to be more toxic than Telone II<sup>®</sup>a; the LC<sub>50</sub> for rats after a 1-hour exposure to Telone C-17<sup>®</sup> was 253 ppm (no range reported) (Streeter and Lomax 1988). Telone C-17<sup>®</sup> contains a relatively high proportion of chloropicrin, which may account for the enhanced toxicity. Six of 10 rats died after a 4-hour exposure to 676 ppm Telone II<sup>®</sup>a. In the same study, no rats died after a 4-hour exposure to ≤595 ppm of Telone II<sup>®</sup>a (Cracknell et al. 1987).

Rabbits exposed to 300 ppm during gestation days 6–18 developed ataxia and died (Kloes et al. 1983). The cause of death was not determined, although lung congestion and edema were noted on necropsy.

Intermediate- or chronic-duration exposures of mice, rats, guinea pigs, rabbits, and dogs to Telone II<sup>®</sup>a or Telone II<sup>®</sup>b (1–150 ppm for 4 weeks to 2 years) had no effect on survival rates compared to control groups that were untreated or exposed to filtered room air (Coate 1979a, 1979b; Lomax et al. 1989; Stott et al. 1988; Torkelson and Oyen 1977).

**2,3-Dichloropropene.** No mortality data are available for humans exposed to 2,3-dichloropropene by inhalation.

Acute-duration animal studies indicate that single exposures at high concentrations may be fatal, possibly from suppression of the central nervous system. Exposure to 2,3-dichloropropene at high (unspecified) vapor concentrations was fatal to rats within 15–30 minutes (Monsanto 1967). As described in an incomplete report (even-numbered pages were missing), a 1-hour LC<sub>50</sub> of 1,331 ppm (1,250–1,406 ppm, 95% confidence interval [CI]) in males and 1,461 ppm (1,326–1,639 ppm) for females was reported for rats exposed to 2,3-dichloropropene vapor (Dietz et al. 1985b). After 4 hours of exposure to 500 ppm 2,3-dichloropropene vapor, three of six rats died within 2 weeks, whereas none exposed at 250 ppm died

### 3. HEALTH EFFECTS

(Smyth et al. 1962). No rats or mice died following exposure to  $\leq 75$  ppm 2,3-dichloropropene for 6 hours/day on 9 out of 11 days (Zempel et al. 1987).

No mortality was observed in rats exposed to 2,3-dichloropropene vapor at  $\leq 15$  ppm for 6 hours/day for 13 weeks (Johannsen et al. 1991). As indicated in the available records of an unfinished 13-week bioassay, no female mice exposed to 80 ppm for 6 hours/day, 5 days/week survived to termination (NTP 1989, 2006); no mortality records were available for female mice exposed to  $\leq 40$  ppm or male mice, male rats, or female rats exposed to  $\leq 80$  ppm in this study. Based on the available lung weight data, and results of the acute-duration study by Zempel et al. (1987), it is possible that toxicity of the respiratory tract from repeated irritation was a contributing factor to reduced survival in female mice.

***1,2-Dichloropropene.*** As described in a brief summary, exposure to a saturated atmosphere of 1,2-dichloropropene estimated at 63,764 ppm was fatal to all three rats exposed for 12 minutes and one of four rats exposed for 6 minutes (Dow 1962). It is likely that death was caused by suppression of the nervous system, since all exposed animals exhibited unconsciousness before the end of the exposure.

#### **3.2.1.2 Systemic Effects**

The systemic effects observed in humans or animals after inhalation exposure to 1,3-dichloropropene, 2,3-dichloropropene, or 1,2-dichloropropene are discussed below. The highest NOAEL values and all reliable LOAEL values for each systemic effect for each species and duration category are recorded in Table 3-2 and 3-3, respectively, and plotted in Figure 3-1 and 3-2, respectively, for the 1,3- and 2,3-dichloropropenes.

#### **Respiratory Effects.**

***1,3-Dichloropropene.*** Humans exposed to 1,3-dichloropropene (formulation unknown) after a tank truck spill complained of mucous membrane irritation, chest pain, cough, and breathing difficulties (Flessel et al. 1978; Markovitz and Crosby 1984).

Acute-duration exposures of rats to various formulations of 1,3-dichloropropene caused respiratory effects. Gross pathological examination revealed atelectasis, emphysema, and/or edema in rats exposed to 206 ppm of Telone C-17<sup>®</sup> for 1 hour. Atelectasis was still present in animals surviving the 2-week observation period (Streeter and Lomax 1988). As noted for death in Section 3.2.1.1, Telone C-17<sup>®</sup> also

## 3. HEALTH EFFECTS

appears to be more toxic than Telone II<sup>®</sup>a after acute-duration exposure. The presence of chloropicrin may enhance the toxicity of Telone C-17<sup>®</sup>. No respiratory effects were noted in rats after a 4-hour exposure to 581 ppm of Telone II<sup>®</sup>a, although swollen lungs were observed in 2 out of 10 rats after a 4-hour exposure to 594 ppm (Cracknell et al. 1987). In the same study, rats that died following exposure to 675 ppm of Telone II<sup>®</sup>a had lung congestion, tracheal congestion, and fluid in the thoracic cavity, but survivors had no respiratory lesions (Cracknell et al. 1987). Multifocal lung hemorrhage was observed in rats exposed for 4 hours to 1,035 ppm of Telone II<sup>®</sup>a (Streeter et al. 1987).

Intermediate-duration exposure studies indicate that effects on the upper respiratory tract appear to be concentration- and duration-related. Rats and mice had no respiratory lesions attributable to Telone II<sup>®</sup>a after exposure to  $\leq 30$  ppm for 4 weeks (Coate 1979b). No respiratory effects were observed in rats exposed to 10 ppm Telone II<sup>®</sup>a for 13 weeks (Coate 1979a). In contrast, rats exposed to  $\geq 30$  ppm Telone II<sup>®</sup>a for 13 weeks developed epithelial changes in the nasal turbinates that included loss of cytoplasm, nuclei disorganization, and occasional necrotic cells (Coate 1979a). No information was available as to the 1,3-dichloropropene concentration or the amount or types of impurities/additives present in the test material. The epithelial lesions were more severe in rats exposed to  $\geq 90$  ppm of Telone II<sup>®</sup>a or Telone II<sup>®</sup>b for  $\geq 13$  weeks and included hyperplasia and focal necrosis (Breslin et al. 1989; Coate 1979a; Stott et al. 1988). No significant respiratory effects were observed in rats exposed to 60 ppm Telone II<sup>®</sup>b, the highest concentration tested, for 6 months (Lomax et al. 1989). Mice also developed hyperplastic and/or degenerative lesions of the nasal epithelium after exposure to 90 ppm Telone II<sup>®</sup>a for 13 weeks (Stott et al. 1988) or to 60 ppm Telone II<sup>®</sup>b for 6 months (Lomax et al. 1989). Based on nasal lesion data in mice exposed for 6 months, an intermediate-duration inhalation MRL for 1,3-dichloropropene of 0.008 ppm was calculated using benchmark concentration modeling as described in Appendix A and the footnote to Table 3-2. No respiratory effects were noted on gross or histopathological examinations after an intermediate inhalation exposure of rats, guinea pigs, rabbits, or dogs to 3 ppm Telone II<sup>®</sup>a for 6 months (Torkelson and Oyen 1977). Higher concentrations were not tested in this study.

Exposure to 60 ppm of Telone II<sup>®</sup>b for 6–12 months did not result in respiratory effects in rats, but exposure to the same concentration for 2 years caused nasal olfactory epithelium degeneration (Lomax et al. 1989). A statistically significant increase in bronchioalveolar adenomas, benign lung tumors, was also noted in male rats exposed to 60 ppm for 2 years, but not in females. In mice exposed to 20 or 60 ppm Telone II<sup>®</sup>b, hypertrophy/hyperplasia of the nasal respiratory epithelium did not progress in severity between 6 and 24 months, but occurred in  $\geq 96\%$  of mice treated at 60 ppm. Degeneration of the

## 3. HEALTH EFFECTS

nasal olfactory epithelium, however, was noted in  $\geq 90\%$  of male and female mice exposed to 60 ppm, for 2 years (Lomax et al. 1989). Based on benchmark concentration modeling of the nasal lesion data in mice, a chronic inhalation MRL of 0.007 ppm was calculated as described in Appendix A and the footnote in Table 3-2.

These data indicate that acute exposure to 1,3-dichloropropene at high concentrations has effects on the lungs of rats, whereas intermediate or chronic inhalation exposure to 1,3-dichloropropene at lower concentrations produces hyperplastic lesions of the upper respiratory tract in rats and mice and degeneration of the olfactory epithelium in mice.

***2,3-Dichloropropene.*** No data are available for respiratory effects in humans exposed to 2,3-dichloropropene by inhalation.

Irritation of the respiratory tract is a major effect of inhalation exposure to 2,3-dichloropropene in animals. In acute lethality studies, respiratory effects included gasping, shallow respiration, labored breathing, hemorrhage of the lungs, and inflammation of nasal mucosae (Union Carbide Corp. 1958; Dietz et al. 1985b; Smyth et al. 1962; Younger 1967). Concentration-related increases in the incidence and severity of respiratory tract effects were observed in rats and mice exposed to 2,3-dichloropropene vapor 6 hours/day for 9 out of 11 days (Zempel et al. 1987). At  $\geq 5$  ppm, hyperplasia of the nasal respiratory epithelium occurred in 9/10 rats and 7/10 mice and diffuse degeneration occurred in the bronchial/bronchiolar epithelium of 10/10 mice. At  $\geq 25$  ppm, all rats and mice exhibited hyperplasia of the nasal olfactory epithelium and mice exhibited hyperplasia of the laryngeal epithelium. As described in Appendix A and the footnote to Table 3-3, an acute-duration inhalation exposure MRL of 0.002 ppm was derived for 2,3-dichloropropene based on the human equivalent to a minimal LOAEL of 5 ppm for very slight hyperplasia of the nasal respiratory epithelium in female rats (Zempel et al. 1987).

Studies in rodents indicate that the respiratory tract is vulnerable to irritant effects from repeated exposure to 2,3-dichloropropene. Red nasal discharge, an indicator of nasal irritation, was the only effect observed in rats exposed to 2,3-dichloropropene vapor at 15 ppm, 6 hours/day, 5 days/week for 13 weeks (Johannsen et al. 1991). Although the frequency was reported to increase during the course of the study, the nasal turbinates were not evaluated for histopathology. No lung histopathology was observed at  $\geq 15$  ppm in rats in this study, but because of the lack of histopathology data for the nasal turbinates, the likely target organ in rats, a NOAEL for the respiratory tract was not entered into the Table 3-3. The available records from an unfinished 13-week inhalation study indicate significant 25% increases in

## 3. HEALTH EFFECTS

absolute and relative lung weight in female mice exposed at 5 ppm and 13 and 22% increases, respectively, in absolute and relative lung weight in male mice exposed at 10 ppm (NTP 1989, 2006). Lung weight increases generally increased with concentration, the relative increase in male mice reaching 200% in the 80 ppm group compared with controls. Despite the lack of histological data for this study, it provides suggestive evidence that the respiratory tract is the most sensitive target of inhaled 2,3-dichloropropene. The NTP (1989) study is consistent with the acute-duration study by Zempel et al. (1987) in that lung effects were observed in mice, but not rats at low exposure levels.

***1,2-Dichloropropene.*** No information was available on respiratory effects in humans exposed to 1,2-dichloropropene.

As described in a brief summary, lethal exposure for 6–12 minutes to a saturated atmosphere of 1,2-dichloropropene estimated at 63,764 ppm resulted in unspecified lung damage in rats (Dow 1962).

**Cardiovascular Effects.**

***1,3-Dichloropropene.*** No studies were located regarding cardiovascular effects in humans after inhalation exposure to 1,3-dichloropropene.

No lesions attributable to Telone II<sup>®</sup>a were found upon histological evaluation of the heart and aorta from rats and mice exposed to  $\leq 150$  ppm for up to 13 weeks (Coate 1979a, 1979b; Stott et al. 1988), or rats and mice exposed to 60 ppm Telone II<sup>®</sup>b for 6, 12, or 24 months (Lomax et al. 1989).

Although other indices of cardiovascular toxicity were not examined, 1,3-dichloropropene does not appear to have cardiovascular effects.

***2,3-Dichloropropene.*** No data are available for cardiovascular effects in humans exposed to 2,3-dichloropropene by inhalation.

No cardiovascular histopathology was observed in rats or mice exposed to  $\leq 75$  ppm 2,3-dichloropropene vapor for 6 hours/day, for 9 out of 11 days (Zempel et al. 1987). No histopathology was observed in the heart of rats exposed to  $\leq 75$  ppm 2,3-dichloropropene vapor for 6 hours/day, 5 days/week for 13 weeks (Johannsen et al. 1991).



## 3. HEALTH EFFECTS

**Gastrointestinal Effects.**

*1,3-Dichloropropene.* No studies were located regarding gastrointestinal effects in humans after inhalation exposure to 1,3-dichloropropene.

No gastrointestinal effects were noted after gross and histologic examinations of the stomachs and intestines of rats or mice exposed to  $\leq 150$  ppm Telone II<sup>®</sup>a for 13 weeks (Stott et al. 1988), or rats or mice exposed to 60 ppm of Telone II<sup>®</sup>b for 6 or 12 months (Lomax et al. 1989). Similarly, no gastrointestinal lesions attributable to 1,3-dichloropropene were observed in rats exposed to 60 ppm of Telone II<sup>®</sup>b for 2 years (Lomax et al. 1989). In contrast, 8 of 50 male mice exposed to 60 ppm Telone II<sup>®</sup>b for 2 years had hyperplasia and hyperkeratosis of the forestomach. The NOAEL for this effect was 20 ppm in the male mice. Female mice did not develop hyperplasia or hyperkeratosis of the forestomach (Lomax et al. 1989).

*2,3-Dichloropropene.* No data are available for gastrointestinal effects in humans exposed to 2,3-dichloropropene by inhalation.

No gastrointestinal histopathology was observed in rats or mice exposed to  $\leq 75$  ppm 2,3-dichloropropene vapor for 6 hours/day, for 9 out of 11 days (Zempel et al. 1987). No histopathology was observed in the gastrointestinal tract of rats exposed to  $\leq 15$  ppm 2,3-dichloropropene vapor for 6 hours/day, 5 days/week for 13 weeks (Johannsen et al. 1991).

**Hematological Effects.**

*1,3-Dichloropropene.* No studies were located regarding hematological effects in humans after inhalation exposure to 1,3-dichloropropene.

Hematological parameters have been examined in many studies of intermediate or chronic duration in which several species were exposed by inhalation to formulations of 1,3-dichloropropene. No exposure-related hematological effects were observed in rats, guinea pigs, rabbits, or dogs exposed to 3 ppm Telone II<sup>®</sup>a for 6 months (Torkelson and Oyen 1977), in rats and mice exposed to 150 ppm Telone II<sup>®</sup>a for 13 weeks (Stott et al. 1988), or to 60 ppm Telone II<sup>®</sup>b for 6–24 months (Lomax et al. 1989).

## 3. HEALTH EFFECTS

Histological examination of bone marrow also did not reveal any adverse effects in either intermediate- or chronic-duration exposure studies (Lomax et al. 1989; Stott et al. 1988).

***2,3-Dichloropropene.*** No data are available for hematological effects in humans exposed to 2,3-dichloropropene by inhalation.

No hematological effects were observed in rats or mice exposed to  $\leq 75$  ppm 2,3-dichloropropene vapor for 6 hours/day, for 9 out of 11 days (Zempel et al. 1987). No hematological effects were observed in rats exposed to 2,3-dichloropropene vapor at  $\leq 15$  ppm for 6 hours/day, 5 days/week for 13 weeks (Johannsen et al. 1991). Available records from an unfinished 13-week study indicate that no hematological effects were observed in rats or mice exposed to  $\leq 80$  ppm 6 hours/day, 5 days/week (NTP 1989, 2006).

**Musculoskeletal Effects.**

***1,3-Dichloropropene.*** No studies were located regarding musculoskeletal effects in humans after inhalation exposure to 1,3-dichloropropene.

Gross and histopathological examination of bone and skeletal muscle did not reveal any differences between exposed and control groups of rats and mice exposed to  $\leq 150$  ppm Telone II<sup>®</sup>a for 13 weeks (Stott et al. 1988), or 60 ppm Telone II<sup>®</sup>b for 6–24 months (Lomax et al. 1989).

***2,3-Dichloropropene.*** No data are available for musculoskeletal effects in humans exposed to 2,3-dichloropropene by inhalation.

No musculoskeletal effects were observed in rats or mice exposed to  $\leq 75$  ppm 2,3-dichloropropene vapor for 6 hours/day, for 9 out of 11 days (Zempel et al. 1987). No musculoskeletal effects were observed in rats exposed to 2,3-dichloropropene vapor at  $\leq 15$  ppm for 6 hours/day, 5 days/week for 13 weeks (Johannsen et al. 1991).

**Hepatic Effects.**

***1,3-Dichloropropene.*** A few studies assessed hepatic toxicity in workers exposed to 1,3-dichloropropene, but found no differences in urinary or serum biomarkers between the exposed group and matched controls. Verplanke et al. (2000) measured hepatic effect variables in 13 commercial pesticide

## 3. HEALTH EFFECTS

application workers exposed to cis-1,3-dichloropropene at a (8-hour time-weighted average [TWA]) geometric mean exposure of 0.59 ppm (range 0.2–2.1 ppm) ( $2.7 \text{ mg/m}^3$ ; range,  $0.1\text{--}9.5 \text{ mg/m}^3$ ) for an average of 521 ( $\pm 230$ ) minutes/day for 117 days and 22 matched control workers. Based on results from urine and blood data collected before, during, and after fumigation, no significant difference in hepatic parameters was detected between the exposed and control group. Boogard et al. (1993) compared 73 male operators who had worked at an average of 8.2 years (0.5–23 years) in a chemical plant where they were exposed to 1,3-dichloropropene at geometric mean (8-hour TWA) concentrations between 0.03 and 0.31 ppm ( $0.14$  and  $1.39 \text{ mg/m}^3$ ) between 1981 and 1984 and 35 matched control male workers. Although no significant difference in hepatic biomarkers was observed between the exposed and control group, the study does not provide useful information about 1,3-dichloropropene since the exposures had ended 7 years prior to testing and exposures to other compounds were more recent.

Gross and histopathological examination of livers did not reveal any differences between exposed and control groups of rats and mice after inhalation exposure to  $\leq 150$  ppm of Telone II<sup>®a</sup> for  $\leq 13$  weeks (Coate 1979b; Stott et al. 1988), or to  $\leq 60$  ppm Telone II<sup>®b</sup> for  $\leq 24$  months (Lomax et al. 1989).

**2,3-Dichloropropene.** No data are available for hepatic effects in humans exposed to 2,3-dichloropropene by inhalation.

Hepatic effects in animals have been observed following exposure to relatively high exposure levels, but not consistently across studies. No effects on hepatic histology or serum parameters were observed in rats or mice exposed to  $\leq 75$  ppm 2,3-dichloropropene vapor for 6 hours/day, for 9 out of 11 days (Zempel et al. 1987). No effects on hepatic histology or serum parameters were observed in rats exposed to 2,3-dichloropropene vapor at  $\leq 15$  ppm for 6 hours/day, 5 days/week for 13 weeks (Johannsen et al. 1991). Available records from an unfinished 13-week inhalation bioassay indicate that hepatic toxicity increases in female, but not male rats exposed at higher concentrations 6 hours/day, 5 days/week (NTP 1989, 2006). Three-fold and higher increases in serum ALT and SDH occurred in female mice at 40–80 ppm and a 60% increase in alkaline phosphatase and a six-fold increase in total bile acids were observed at 80 ppm (NTP 1989, 2006). In female rats at 80 ppm, absolute liver weights were increased by 33% and relative liver weights by 37% compared to controls (NTP 1989, 2006). Hepatic LOAELs and NOAELs were entered into Table 3-3, although the lack of histopathology data was noted.

**1,2-Dichloropropene.** No information was available on hepatic effects in humans exposed to 1,2-dichloropropene.

## 3. HEALTH EFFECTS

As described in a brief summary, lethal exposure for 6–12 minutes to a saturated atmosphere of 1,2-dichloropropene estimated at 63,764 ppm resulted in unspecified liver damage in rats (Dow 1962).

**Renal Effects.**

**1,3-Dichloropropene.** A few studies assessed renal toxicity in workers exposed to 1,3-dichloropropene, but found no differences in urinary or serum biomarkers between the exposed group and matched controls. Verplanke et al. (2000) measured renal effect variables in 13 commercial pesticide application workers exposed to cis-1,3-dichloropropene at a (8-hour TWA) geometric mean exposure of 0.59 ppm (range 0.2–2.1 ppm (2.7 mg/m<sup>3</sup>; range, 0.1–9.5 mg/m<sup>3</sup>) for an average of 521 (±230) minutes/day for 117 days and 22 matched control workers. Based on results from urine and blood data collected before, during, and after fumigation, no significant difference in renal parameters was detected between the exposed and control group. Boogard et al. (1993) compared 73 male operators who had worked at an average of 8.2 years (0.5–23 years) in a chemical plant where they were exposed to 1,3-dichloropropene at geometric mean (8-hour TWA) concentrations between 0.03 and 0.31 ppm (0.14 and 1.39 mg/m<sup>3</sup>) between 1981 and 1984 and 35 matched control male workers. Although no significant difference in renal biomarkers was observed between the exposed and control group, the study does not provide useful information about 1,3-dichloropropene since the exposures had ended 7 years prior to testing and exposures to other compounds were more recent.

Other studies showed an association between exposure to 1,3-dichloropropene and the urinary excretion of enzymes possibly indicative of damage to renal tubules (Osterloh and Feldman 1993; Osterloh et al. 1989). Fumigation workers were exposed to Telone<sup>®</sup> (formulation not specified) at a mean concentration of 0.6 ppm (range 0.06–2.1 ppm) 2–7 hours/day for 5 days and urine samples were collected at intervals. The studies did not include unexposed groups or urinary measurements >24 hours after exposure. Urinalysis showed a correlation between exposure (concentration x duration) and cumulative 24-hour excretion of the metabolite N-acetyl-S-(cis-3-chloroprop-2-enyl)-cysteine (3CNAC) and excretion of the enzymes N-acetylglucosaminidase (NAG, indicative of damage to renal tubules) and retinol binding protein (RBP, indicative of impaired tubular reabsorption of filtered protein). The RBP data were based on urine that had been stored at -70°C for several years (Osterloh and Feldman 1993). For daily urine excretions of 3CNAC in excess of 1.5 mg/day (7 workers), mean amounts of NAG and RBP excreted over 24 hours were slightly, but significantly increased 2-fold compared to values for 3CNAC <1.5 mg/day (7 workers). These results were considered evidence of possible low-level subclinical

## 3. HEALTH EFFECTS

(nonadverse) renal tissue damage but demonstrate that the enzymes could be employed as biomarkers for renal toxicity. These studies are not included in Table 3-2 because the exposure levels were expressed in terms of excretion of 3CNAC and cannot be directly compared to atmospheric concentrations of 1,3-dichloropropene.

Male and female rats exposed to 3 ppm Telone II<sup>®</sup>a for 6 months developed reversible cloudy swelling of the renal tubular epithelium (Torkelson and Oyen 1977). No adverse renal effects were observed in rats allowed to recover for 3 months following the last exposure. The cloudy swelling observed in these rats was not confirmed in more recent studies, even at longer durations and/or higher concentrations. Exposure to 1 ppm in this study had no renal effects in the rats. Guinea pigs, rabbits, and dogs exposed to 3 ppm suffered no renal effects under the same exposure protocol (Torkelson and Oyen 1977).

Gross and histological examination of the kidneys from rats and mice exposed to up to  $\leq 150$  ppm Telone II<sup>®</sup>a for 4–13 weeks (Coate 1979b; Stott et al. 1988) revealed no differences in the incidence of renal lesions between exposed and control groups. Urinalysis also revealed no differences between exposed and control groups of rats and mice (Lomax et al. 1989; Stott et al. 1988).

Moderate hyperplasia of the transitional epithelium of the urinary bladder was found in female mice exposed to 90 or 150 ppm Telone II<sup>®</sup>a for 13 weeks (Stott et al. 1988). Mice exposed to 30 ppm did not show hyperplasia of the urinary bladder. Rats exposed for 6–24 months and mice exposed for 6 months to  $\leq 60$  ppm Telone II<sup>®</sup>b did not show hyperplasia of the urinary bladder (Lomax et al. 1989). However, female mice exposed to Telone II<sup>®</sup>b for 1 year at 60 ppm or 2 years at 20 or 60 ppm showed an increase in epithelial hyperplasia and inflammation of the urinary bladder (Lomax et al. 1989); epithelial hyperplasia of the urinary bladder occurred in male mice exposed at 60 ppm for 2 years.

**2,3-Dichloropropene.** No data are available for renal effects in humans exposed to 2,3-dichloropropene by inhalation.

Renal effects in animals have been observed at relatively high exposure levels. Slight mineralization of the corticomedullary junction was observed in 2/5 female rats following exposure to 5–75 ppm 2,3-dichloropropene vapor for 6 hours/day, for 9 out of 11 days (Zempel et al. 1987). The significance of this lesion is uncertain, given the small group size and the fact that neither the incidence nor severity showed concentration-related increases; because of this ambiguity, neither a NOAEL nor a LOAEL is specified for renal effects in rats in Table 3-3. No effects on renal histology in male rats or male or

## 3. HEALTH EFFECTS

female mice or urinalysis parameters in male rats were observed following exposure to  $\leq 75$  ppm in the same study. No effects on renal histology or urinalysis parameters were observed in rats exposed to 2,3-dichloropropene vapor at  $\leq 15$  ppm for 6 hours/day, 5 days/week for 13 weeks (Johannsen et al. 1991). Available records from an unfinished 13-week inhalation bioassay indicate that renal effects may occur in rats exposed at  $\geq 40$  ppm for 6 hours/day, 5 days/week (NTP 1989, 2006). Urine volumes compared to control values were increased 2- and 5-fold, respectively, in female rats at 40 and 80 ppm, but reduced by one third in male rats at 40–80 ppm. Urinary alkaline phosphatase was increased by 48–59% in male rats at 20–80 ppm, but the magnitudes of these increases are not biologically significant (NTP 1989, 2006). In female rats at 80 ppm, absolute kidney weights were increased by 17% and relative weights by 23% compared to controls (NTP 1989, 2006). NOAELs and LOAELs for kidney effects in rats were entered into Table 3-3, although the lack of histopathology data was noted.

***1,2-Dichloropropene.*** No information was available on renal effects in humans exposed by inhalation to 1,2-dichloropropene.

As described in a brief summary, lethal exposure for 6–12 minutes to a saturated atmosphere of 1,2-dichloropropene estimated at 63,764 ppm resulted in unspecified kidney damage in rats (Dow 1962).

**Dermal and Ocular Effects.**

***1,3-Dichloropropene.*** No studies were located regarding dermal or ocular effects in humans after inhalation exposure to 1,3-dichloropropene.

Gross and histological examination of the eyes and skin of rats and mice exposed to up to 150 ppm Telone II<sup>®</sup>a for 13 weeks (Stott et al. 1988) or to 60 ppm for 6–24 months (Lomax et al. 1989) revealed no differences between exposed and control groups.

**3.2.1.3 Immunological and Lymphoreticular Effects**

***1,3-Dichloropropene.*** No studies were located regarding immunological effects in humans after inhalation exposure to 1,3-dichloropropene.

Gross and histological examination of the thymus and lymph nodes of rats and mice exposed to  $\leq 150$  ppm of Telone II<sup>®</sup>a for 13 weeks (Stott et al. 1988), or to 60 ppm Telone II<sup>®</sup>b for 6–24 months (Lomax et al.

## 3. HEALTH EFFECTS

1989), revealed no lesions attributable to 1,3-dichloropropene exposure. However, more sensitive tests for immune system function were not used.

**3.2.1.4 Neurological Effects**

***1,3-Dichloropropene.*** No neurological effects were observed in humans occupationally exposed to 1,3-dichloropropene at levels high enough to require medical attention (Markovitz and Crosby 1984).

Ataxia of the hindlimbs and loss of the righting reflex was observed in six of seven pregnant rabbits exposed 6 hours/day to 300 ppm of Telone II<sup>®</sup>a during gestation days 6–18; the onset of ataxia was observed during gestation days 14–19 (Kloes et al. 1983). In the same study, no neurological signs of toxicity were observed in pregnant rabbits exposed to 50 or 150 ppm or in pregnant rats exposed to  $\leq 300$  ppm.

No gross clinical signs of neurotoxicity were observed in rats, guinea pigs, rabbits, or dogs after inhalation exposure to 3 ppm Telone II<sup>®</sup>a for 6 months (Torkelson and Oyen 1977), in rats or mice exposed to up to 150 ppm Telone II<sup>®</sup>a for 13 weeks (Coate 1979a; Stott et al. 1988), or to 60 ppm Telone II<sup>®</sup>b for 6–24 months (Lomax et al. 1989). The absence of clinical signs is supported by histological examinations of brain and spinal cords in rats and mice that revealed no lesions attributable to 1,3-dichloropropene exposure (Coate 1979a; Lomax et al. 1989; Stott et al. 1988). More sensitive tests for neurological effects, however, were not included in these studies.

***2,3-Dichloropropene.*** No data are available for neurological effects in humans exposed to 2,3-dichloropropene by inhalation.

Neurological effects in animals have been observed at relatively high exposure levels. Rats exposed to high vapor concentrations in acute lethality studies exhibited lethargy and hyperactivity (Dietz et al. 1985b). No histopathology of brain or spinal cord was observed in rats or mice exposed to  $\leq 75$  ppm 2,3-dichloropropene vapor for 6 hours/day, for 9 out of 11 days (Zempel et al. 1987). No histopathology was observed in the brain or spinal cord of rats or mice to 2,3-dichloropropene vapor at  $\leq 15$  ppm for 6 hours/day, 5 days/week for 13 weeks (Johannsen et al. 1991).

***1,2-Dichloropropene.*** No data were available for neurological effects in humans exposed by inhalation to 1,2-dichloropropene.

## 3. HEALTH EFFECTS

As mentioned in a brief summary, exposure to a saturated atmosphere of 1,2-dichloropropene estimated at 63,764 ppm resulted in signs of central nervous system depression (unconsciousness) in rats within 6 minutes of exposure (Dow 1962).

**3.2.1.5 Reproductive Effects**

**1,3-Dichloropropene.** No studies were located regarding reproductive effects in humans after inhalation exposure to 1,3-dichloropropene.

No adverse reproductive effects and no histological changes in reproductive organs were observed in parental groups or progeny of male and female rats exposed to up to 90 ppm Telone II<sup>®</sup>b for two generations (Breslin et al. 1989).

Gross and histological examination of reproductive organs and tissues of rats and mice exposed to  $\leq 150$  ppm of Telone II<sup>®</sup>a for 13 weeks (Stott et al. 1988) or  $\leq 60$  ppm Telone II<sup>®</sup>a for 6–24 months (Lomax et al. 1989) revealed no lesions attributable to 1,3-dichloropropene. More sensitive tests for reproductive effects, however, were not included in these studies.

**2,3-Dichloropropene.** No studies were located regarding reproductive effects in humans after inhalation exposure to 2,3-dichloropropene.

No significant adverse effects were observed in a one-generation reproductive assay in rats exposed to 2,3-dichloropropene vapor at  $\leq 5$  ppm for 6 hours/day, 5 days/week although there was a statistically insignificant reduction in mating in treated groups (Johannsen et al. 1991). Available reports from an incomplete study indicated that there were no adverse effects on estrus cycling or sperm parameters in rats or mice exposed to 2,3-dichloropropene vapor at  $\leq 80$  ppm for 6 hours/day, 5 days/week for 13 weeks (NTP 1989, 2006); no female mice exposed at 80 ppm survived for analysis of the estrus cycle, but no adverse effects were observed in those exposed at  $\leq 40$  ppm.



## 3. HEALTH EFFECTS

**3.2.1.6 Developmental Effects**

**1,3-Dichloropropene.** No studies were located regarding developmental effects in humans after inhalation exposure to 1,3-dichloropropene.

No developmental effects were found in groups of rats exposed to 50 or 150 ppm Telone II<sup>®</sup>a during gestation days 6–15 (Kloes et al. 1983). In contrast, rats exposed to 300 ppm Telone II<sup>®</sup>a during gestation days 6–15 had fewer fetuses per litter, an increase in the incidence of litters totally resorbed, and an increase in the number of litters with resorptions. Rats exposed to 300 ppm Telone II<sup>®</sup>a had urine and fecal staining, nasal exudate, a red crusty material around the eyes, and significantly decreased food and water consumption and body weight. These observations indicate serious maternal toxicity in rats exposed to 300 ppm, which could account for the decreased litter size, increased resorptions, and increased number of litters with resorptions. Rabbits were evaluated for developmental effects after exposure to up to 300 ppm Telone II<sup>®</sup>a during gestation days 6–18 (Kloes et al. 1983). No developmental effects attributable to 1,3-dichloropropene exposure were observed in the 50 and 150 ppm groups. In contrast, marked maternal toxicity in the 300 ppm group precluded evaluation of developmental effects; signs of maternal toxicity included ataxia, loss of the righting reflex, significantly decreased body weight, and the death of six of seven rabbits.

No developmental effects were observed in the progeny of groups of male and female rats exposed to ≤90 ppm Telone II<sup>®</sup>b for two generations (Breslin et al. 1989), or in pregnant rats exposed for 6 hours/day during gestation days 6–15 and rabbits exposed during gestation days 6–18 to ≤120 ppm 1,3-dichloropropene (90.1% purity) (Hanley et al. 1987). The parameters monitored included pup survival, pup body weight, pup crown-rump length, and gross pathology. Delayed ossification was noted in 14 rat pups of 21 litters exposed *in utero* to 120 ppm, but this may have been due to the decreased food and water consumption and body weight of the dams during the exposure period (Hanley et al. 1987).

**3.2.1.7 Cancer**

**1,3-Dichloropropene.** Few studies are available that link inhalation exposure to 1,3-dichloropropene with the development of cancer in humans.

Clary and Ritz (2003) conducted a case-control study using mortality odds ratios to compare deaths from pancreatic cancer (1989–1996) with a random sample of noncancer deaths in three agricultural counties in

### 3. HEALTH EFFECTS

California. A total of 1,002 cases in which pancreatic cancer was named as the cause of death (data from state records) were identified within 102 zip codes in the three-county area. About 10 controls (total 10,002) were selected for each case at random from all noncancer deaths in these counties. The state's pesticide use reporting (PUR) database was used to classify pesticide use within each zip code. The analysis showed an increased risk of death from pancreatic cancer for long-term residence (20 years) in the three-county area and residence at the time of death in zip codes showing the highest quartile of 1,3-dichloropropene application (107 cases, prevalence odds ratio of 1.89 [95% CI=1.13–3.15]). This study provides suggestive, but not definitive, evidence that exposure to 1,3-dichloropropene may be a risk factor for pancreatic cancer.

A clinical report describing three cases of neoplasms that developed after exposure to 1,3-dichloropropene provides other suggestive evidence that there may be an association between exposure and cancer (Markovitz and Crosby 1984). Nine firemen were exposed to 1,3-dichloropropene during cleanup of a tank truck spill. Six years later, two of the men developed histiocytic lymphomas that were refractory to treatment. Both men soon died. In addition, a 52-year-old farmer who had been in good health developed pain in the right ear, nasal mucosa, and pharynx after being exposed to 1,3-dichloropropene (not otherwise specified) from his tractor for 30 days. The hose carrying the 1,3-dichloropropene had a small leak that sprayed the chemical near the right side of the man's face. Over the next year, the man developed leukemia that was refractory to treatment. He died of pneumonia 5 weeks after hospital admission. None of these reports identified the formulation of 1,3-dichloropropene or stated whether the chemical included additives such as epichlorohydrin.

In the only study regarding the carcinogenic potential of 1,3-dichloropropene in animals after inhalation exposure, a statistically significant increase in the incidence of bronchioalveolar adenomas was observed in male mice exposed to 60 ppm Telone II<sup>®</sup>b for 24 months (Lomax et al. 1989). An increased incidence of this benign lung tumor, however, was not observed in female mice nor in male or female rats exposed to Telone II<sup>®</sup>b under the same protocol.

The cancer effect level (CEL) in male mice is recorded in Table 3-2 and plotted in Figure 3-1.

#### 3.2.2 Oral Exposure

Reliable oral toxicity data are available for 1,3-dichloropropene and for acute toxicity of 2,3-dichloropropene; a brief summary of an acute lethality study is available for 1,2-dichloropropene. The highest

## 3. HEALTH EFFECTS

NOAEL and all reliable LOAEL values after oral exposure to 1,3- and 2,3-dichloropropene are recorded in Tables 3-4 and 3-5, respectively, and plotted in Figures 3-3 and 3-4, respectively. Median lethal concentrations and other reliable mortality data are recorded as serious LOAELs in these tables and figures.

**3.2.2.1 Death**

*1,3-Dichloropropene.* A 27-year-old male died 40 hours after accidentally drinking 1,3-dichloropropene (mixed cis and trans isomers) (Hernandez et al. 1994). Upon recognizing his error, he vomited, but 2 hours later in an emergency room, he exhibited acute gastrointestinal distress, tachypnea, tachycardia, sweating, and hypovolemia; abdominal pain was evident at deep palpation. The level of 1,3-dichloropropene at this time was 1.13 micromol/L in blood and 0.20 micromol/L in urine. Subsequent effects included bloody diarrhea, metabolic acidosis, adult respiratory distress syndrome, and release of pancreatic enzymes into peritoneal fluid. Multiorgan failure preceded death.

Several studies were located that reported oral LD<sub>50</sub> values for 1,3-dichloropropene in various formulations (95% confidence limits are given in parentheses). The oral LD<sub>50</sub> for M-3993 was 713 mg/kg (no range calculable) in male rats and 470 (337–636) mg/kg in female rats (Lichy and Olson 1975). In a similar study, the oral LD<sub>50</sub> for Telone C-17<sup>®</sup> was 519 (305–1,009) mg/kg in male rats and 304 (147–516) mg/kg in female rats (Mizell et al. 1988b). These data indicate that female rats are more sensitive to 1,3-dichloropropene in its various formulations than male rats. Much lower LD<sub>50</sub> values of 150 (130–170) mg/kg was reported for Telone II<sup>®a</sup> in CFY-strain Sprague-Dawley rats (Jones and Collier 1986a) and 224 mg/kg for Telone II<sup>®a</sup> in female F344 rats (Jeffrey et al. 1987a). Similarly, the LD<sub>50</sub> value determined for the cis-isomer of 1,3-dichloropropene for male and female rats combined was 121 (107–137) mg/kg; for male rats only, 126 (108–148) mg/kg; and for female rats only, 117 (96–142) mg/kg (Jones 1988a). The variability in LD<sub>50</sub> values could result from different rat stocks or strains, or from differences in the 1,3-dichloropropene formulations used.

No deaths were reported among rats that received gavage doses up to 30 mg/kg/day of Telone<sup>®</sup> for 13 weeks (Til et al. 1973), rats or mice exposed to up to 50 or 100 mg/kg/day, respectively, Telone II<sup>®b</sup> in feed for 13 weeks (Haut et al. 1996), or dogs exposed to up to 41 mg/kg/day Telone II<sup>®b</sup> in feed for 13 weeks (Stebbins et al. 1999). No differences were observed in the survival rates of rats that received 0, 25, or 50 mg/kg, or of mice that received 0, 50, or 100 mg/kg Telone II<sup>®b</sup> by gavage in corn oil for 2 years (NTP 1985). No effects on survival were observed in dogs exposed to doses of Telone II<sup>®b</sup> in

Table 3-4 Levels of Significant Exposure to 1,3-dichloropropene - Oral

Key to Figure <sup>a</sup>	Species (Strain)	Exposure/ Duration/ Frequency (Route)	System	NOAEL (mg/kg/day)	LOAEL		Reference Chemical Form	Comments
					Less Serious (mg/kg/day)	Serious (mg/kg/day)		
<b>ACUTE EXPOSURE</b>								
<b>Death</b>								
1	Rat (Fischer- 344)	once (GO)				224 F (LD50)	Jeffrey et al. 1987a T IIa	Purity: 97.54% 1,3-DCP.
2	Rat (Sprague-Dawley)	1 d 1 x/d (GO)				121 (LD50)	Jones 1988a cis	Purity: 97.2% 1,3-DCP.
3	Rat (Sprague-Dawley)	1 d 1 x/d (GO)				150 (LD50)	Jones and Collier 1986a T IIa	Purity: 97.2% 1,3-DCP.
4	Rat (Sprague-Dawley)	1 d 1 x/d (G)				713 M (LD50) <sup>b</sup> 470 F (LD50)	Lichy and Olson 1975 M-3993	Purity: 92% 1,3-DCP.
5	Rat (Fischer- 344)	1 d 1 x/d (GO)				519 M (LD50) <sup>b</sup> 304 F (LD50)	Mizell et al. 1988a T C-17	Purity: 79% 1,3-DCP, 19% chloropicrin.
<b>Systemic</b>								
6	Rat (Sprague-Dawley)	1 d 1 x/d (GO)	Resp			110 (lung hemorrhage)	Jones 1988a cis	Purity: 97.2% 1,3-DCP.
			Gastro			110 (hemorrhage)		
			Hepatic			110 (intestinal hemorrhage, liver hemorrhage)		

\*\*\*DRAFT FOR PUBLIC COMMENT\*\*\*

DICHLOROPROPENES

3. HEALTH EFFECTS

Table 3-4 Levels of Significant Exposure to 1,3-dichloropropene - Oral

(continued)

Key to Figure	Species <sup>a</sup> (Strain)	Exposure/Duration/Frequency (Route)	System	NOAEL (mg/kg/day)	LOAEL		Reference Chemical Form	Comments
					Less Serious (mg/kg/day)	Serious (mg/kg/day)		
7	Rat (Sprague-Dawley)	1 d 1 x/d (GO)	Resp		75 (lung congestion)	250 (lung hemorrhage)	Jones and Collier 1986a T IIa	Purity: 97.2% 1,3-DCP.
			Gastro		75 M (hyperkeratosis of stomach)	170 M (stomach hemorrhage)		
			Hepatic	250				
			Renal	250				
8	Rat (Fischer-344)	1 d 1 x/d (GO)	Gastro		100 (hyperkeratosis)		Mizell et al. 1988a T C-17	Purity: 79% 1,3-DCP, 19% chloropicrin.
<b>Neurological</b>								
9	Rat (Sprague-Dawley)	1 d 1 x/d (GO)				75 (ataxia)	Jones 1988a cis	Purity: 97.2% 1,3-DCP.

\*\*\*DRAFT FOR PUBLIC COMMENT\*\*\*

DICHLOROPROPENES

3. HEALTH EFFECTS

Table 3-4 Levels of Significant Exposure to 1,3-dichloropropene - Oral

(continued)

Key to Figure	Species <sup>a</sup> (Strain)	Exposure/Duration/Frequency (Route)	System	NOAEL (mg/kg/day)	LOAEL		Reference Chemical Form	Comments
					Less Serious (mg/kg/day)	Serious (mg/kg/day)		
<b>INTERMEDIATE EXPOSURE</b>								
<b>Systemic</b>								
10	Rat (Fischer-344)	13 wk ad lib (F)	Resp	100 M			Haut et al. 1996 T IIb	Purity: 95.8% 1,3-DCP; 2% ESO; microencapsulated.
			Gastro	5 M	15 <sup>C</sup> M (basal cell hyperplasia of nonglandular stomach mucosa)			
			Hemato	100 M				
			Hepatic	100 M				
			Renal	100 M				
			Bd Wt	15 M	50 M (terminal weight 16% lower than control)			
11	Rat (Fischer-344)	9 mo 3 d/wk 1 x/d (GO)	Gastro	50			NTP 1985 T IIa	Purity: 89% 1,3-DCP; 1% epichlorohydrin.
			Hepatic	50				
			Renal	50				

\*\*\*DRAFT FOR PUBLIC COMMENT\*\*\*

DICHLOROPROPENES

3. HEALTH EFFECTS

Table 3-4 Levels of Significant Exposure to 1,3-dichloropropene - Oral

(continued)

Key to Figure	Species (Strain)	Exposure/Duration/Frequency (Route)	System	NOAEL (mg/kg/day)	LOAEL		Reference Chemical Form	Comments
					Less Serious (mg/kg/day)	Serious (mg/kg/day)		
12	Rat (Wistar)	13 wk 6 d/wk 1 x/d (GO)	Resp	30			Til et al. 1973 T	Purity: 78% 1,3-DCP.
			Cardio	30				
			Gastro	30				
			Hemato	30				
			Musc/skel	30				
			Hepatic	30				
			Renal	30				
Bd Wt	30							
13	Mouse (B6C3F1)	13 wk ad lib (F)	Resp	100			Haut et al. 1996 T IIb	Purity: 95.8% 1,3-DCP; 2% ESO; microencapsulated.
			Gastro	100				
			Hemato	100				
			Hepatic	100				
			Renal	100				
			Bd Wt	50	100	(terminal weight 11-12% lower than control)		

\*\*\*DRAFT FOR PUBLIC COMMENT\*\*\*

Table 3-4 Levels of Significant Exposure to 1,3-dichloropropene - Oral

(continued)

Key to Figure	Species <sup>a</sup> (Strain)	Exposure/Duration/Frequency (Route)	System	NOAEL (mg/kg/day)	LOAEL		Reference Chemical Form	Comments
					Less Serious (mg/kg/day)	Serious (mg/kg/day)		
14	Dog (Beagle)	13 wk ad lib (F)	Hemato	5	15	(19-29% reductions in hemoglobin and hematocrit)	Stebbins et al. 1999 T IIb	Purity: 95.8% 1,3-DCP; 2% ESO; microencapsulated.
			Hepatic	41				
			Renal	41				
			Bd Wt	5 F	15 F	(terminal weight 12% lower than control)		
<b>Neurological</b>								
15	Rat (Fischer- 344)	13 wk ad lib (F)		100			Haut et al. 1996 T IIb	Purity: 95.8% 1,3-DCP; 2% ESO; microencapsulated; brain weight and gross clinical signs were examined.
<b>Reproductive</b>								
16	Rat (Fischer- 344)	13 wk ad lib (F)		100			Haut et al. 1996 T IIb	Purity: 95.8% 1,3-DCP; 2% ESO; microencapsulated; testes and ovary weight and histopathology were examined.

\*\*\*DRAFT FOR PUBLIC COMMENT\*\*\*

DICHLOROPROPENES

3. HEALTH EFFECTS



Table 3-4 Levels of Significant Exposure to 1,3-dichloropropene - Oral

(continued)

Key to Figure <sup>a</sup>	Species (Strain)	Exposure/Duration/Frequency (Route)	System	NOAEL (mg/kg/day)	LOAEL		Reference Chemical Form	Comments
					Less Serious (mg/kg/day)	Serious (mg/kg/day)		
<b>CHRONIC EXPOSURE</b>								
<b>Systemic</b>								
17	Rat (Fischer- 344)	104 wk 3 d/wk 1 x/d (GO)	Resp	50			NTP 1985 T IIa	Purity: 89% 1,3-DCP; 1% epichlorohydrin.
			Cardio	50				
			Gastro		25	(basal cell hyperplasia in nonglandular stomach mucosa)		
			Hemato	50				
			Musc/skel	50				
			Hepatic	50				
			Renal		25	(nephropathy only in females)		
			Dermal	50				

\*\*\*DRAFT FOR PUBLIC COMMENT\*\*\*

Table 3-4 Levels of Significant Exposure to 1,3-dichloropropene - Oral

(continued)

Key to Figure <sup>a</sup>	Species (Strain)	Exposure/Duration/Frequency (Route)	System	NOAEL (mg/kg/day)	LOAEL		Reference Chemical Form	Comments
					Less Serious (mg/kg/day)	Serious (mg/kg/day)		
18	Rat (Fischer-344)	2 yr ad lib (F)	Resp	25			Stebbins et al. 2000 T IIb	Purity: 95.8% 1,3-DCP; 2% ESO; microencapsulated.
			Cardio	25				
			Gastro	2.5	12.5 <sup>d</sup>	(basal cell hyperplasia of nonglandular stomach mucosa)		
			Hemato	25				
			Musc/skel	25				
			Hepatic	25				
			Renal	25				
			Dermal	25				
			Ocular	25				
Bd Wt	12.5	25	(terminal weight 13-14% lower than control)					

\*\*\*DRAFT FOR PUBLIC COMMENT\*\*\*

DICHLOROPROPENES

3. HEALTH EFFECTS

Table 3-4 Levels of Significant Exposure to 1,3-dichloropropene - Oral

(continued)

Key to Figure	Species (Strain)	Exposure/Duration/Frequency (Route)	System	NOAEL (mg/kg/day)	LOAEL		Reference Chemical Form	Comments
					Less Serious (mg/kg/day)	Serious (mg/kg/day)		
19	Mouse (B6C3F1)	104 wk 3 d/wk 1 x/d (GO)	Resp	100			NTP 1985 T IIa	Purity: 89% 1,3-DCP; 1% epichlorohydrin.
			Cardio	100				
			Gastro		50 F (hyperplasia of nonglandular stomach)			
			Hemato	100				
			Musc/skel	100				
			Hepatic	100				
			Renal	50 F	100 F (hydronephrosis in females only)			
Dermal	100							

\*\*\*DRAFT FOR PUBLIC COMMENT\*\*\*

DICHLOROPROPENES

3. HEALTH EFFECTS

Table 3-4 Levels of Significant Exposure to 1,3-dichloropropene - Oral

(continued)

Key to Figure <sup>a</sup>	Species (Strain)	Exposure/Duration/Frequency (Route)	System	NOAEL (mg/kg/day)	LOAEL		Reference Chemical Form	Comments
					Less Serious (mg/kg/day)	Serious (mg/kg/day)		
20	Mouse (B6C3F1)	2 yr ad lib (F)	Resp	50			Stebbins et al. 2000 T IIb	Purity: 95.8% 1,3-DCP; 2% ESO; microencapsulated.
			Cardio	50				
			Gastro	50				
			Hemato	50				
			Musc/skel	50				
			Hepatic	50				
			Renal	50				
			Dermal	50				
			Ocular	50				
Bd Wt	2.5 M	25 M (terminal weight 15% lower than control)						

\*\*\*DRAFT FOR PUBLIC COMMENT\*\*\*

Table 3-4 Levels of Significant Exposure to 1,3-dichloropropene - Oral

(continued)

Key to Figure	Species (Strain)	Exposure/Duration/Frequency (Route)	System	NOAEL (mg/kg/day)	LOAEL		Reference Chemical Form	Comments
					Less Serious (mg/kg/day)	Serious (mg/kg/day)		
21	Dog (Beagle)	1 yr ad lib (F)	Resp	15			Stebbins et al. 1999 T IIb	Purity: 95.8% 1,3-DCP; 2% ESO; microencapsulated.
			Cardio	15				
			Gastro	15				
			Hemato	2.5	15	(microcytic anemia; increased extramedullary hematopoiesis in spleen)		
			Hepatic	15				
			Renal	15				
			Bd Wt	2.5	15	(terminal weight 13-19% lower than control)		
<b>Immuno/ Lymphoret</b>								
22	Rat (Fischer- 344)	2 yr 3 d/wk 1 x/d (GO)		50			NTP 1985 T IIa	Purity: 89% 1,3-DCP; 1% epichlorohydrin; immunological endpoints restricted to histological examination of spleen and thymus.

\*\*\*DRAFT FOR PUBLIC COMMENT\*\*\*

DICHLOROPROPENES

3. HEALTH EFFECTS

Table 3-4 Levels of Significant Exposure to 1,3-dichloropropene - Oral

(continued)

Key to Figure <sup>a</sup>	Species (Strain)	Exposure/Duration/Frequency (Route)	System	NOAEL (mg/kg/day)	LOAEL		Reference	Comments
					Less Serious (mg/kg/day)	Serious (mg/kg/day)		
23	Rat (Fischer-344)	2 yr ad lib (F)		25			Stebbins et al. 2000 T IIb	Purity: 95.8% 1,3-DCP; 2% ESO; microencapsulated; spleen, lymph nodes, and thymus were examined.
24	Mouse (B6C3F1)	2 yr 3 d/wk 1 x/d (GO)		100			NTP 1985 T IIa	Purity: 89% 1,3-DCP; 1% epichlorohydrin; immunological endpoints restricted to histological examination of spleen and thymus.
25	Mouse (B6C3F1)	2 yr ad lib (F)		50			Stebbins et al. 2000 T IIb	Purity: 95.8% 1,3-DCP; 2% ESO; microencapsulated; spleen, lymph nodes, and thymus were examined.
26	Dog (Beagle)	1 yr ad lib (F)		15			Stebbins et al. 1999 T IIb	Purity 95.8% 1,3-DCP; 2% ESO; microencapsulated; thymus and spleen weight and histopathology were examined.

\*\*\*DRAFT FOR PUBLIC COMMENT\*\*\*

Table 3-4 Levels of Significant Exposure to 1,3-dichloropropene - Oral

(continued)

Key to Figure <sup>a</sup>	Species (Strain)	Exposure/Duration/Frequency (Route)	System	NOAEL (mg/kg/day)	LOAEL		Reference Chemical Form	Comments
					Less Serious (mg/kg/day)	Serious (mg/kg/day)		
<b>Neurological</b>								
27	Rat (Fischer- 344)	2 yr 3 d/wk 1 x/d (GO)		50			NTP 1985 T IIa	Purity: 89% 1,3-DCP; 1% epichlorohydrin; histopathology of brain and spinal cord were examined.
28	Rat (Fischer- 344)	2 yr ad lib (F)		25			Stebbins et al. 2000 T IIb	Purity: 95.8% 1,3-DCP; 2% ESO; microencapsulated; examination included clinical signs and histopathology.
29	Mouse (B6C3F1)	2 yr 3 d/wk 1 x/d (GO)		100			NTP 1985 T IIa	Purity: 89% 1,3-DCP; 1% epichlorohydrin; brain and spinal cord were examined for histopathology.
30	Mouse (B6C3F1)	2 yr ad lib (F)		50			Stebbins et al. 2000 T IIb	Purity: 95.8% 1,3-DCP; 2% ESO; microencapsulated; examination included clinical signs and histopathology.

\*\*\*DRAFT FOR PUBLIC COMMENT\*\*\*

DICHLOROPROPENES

3. HEALTH EFFECTS

Table 3-4 Levels of Significant Exposure to 1,3-dichloropropene - Oral

(continued)

Key to Figure <sup>a</sup>	Species (Strain)	Exposure/ Duration/ Frequency (Route)	System	NOAEL (mg/kg/day)	LOAEL		Reference	Comments
					Less Serious (mg/kg/day)	Serious (mg/kg/day)		
31	Dog (Beagle)	1 yr ad lib (F)		15			Stebbins et al. 1999 T IIb	Purity 95.8% 1,3-DCP; 2% ESO; microencapsulated; brain weight and gross clinical signs were examined.
<b>Reproductive</b>								
32	Rat (Fischer- 344)	2 yr 3 d/wk 1 x/d (GO)		50			NTP 1985 T IIa	Purity: 89% 1,3-DCP; 1% epichlorohydrin; NOAELs based on histological examination of reproductive organs in males and females.
33	Rat (Fischer- 344)	2 yr ad lib (F)		25			Stebbins et al. 2000 T IIb	Purity: 95.8% 1,3-DCP; 2% ESO; microencapsulated; mammary gland, seminal vesicle, testes, uterus, ovaries and vagina were examined.
34	Mouse (B6C3F1)	2 yr 3 d/wk 1 x/d (GO)		100			NTP 1985 T IIa	Purity: 89% 1,3-DCP; 1% epichlorohydrin; NOAELs based on histological examination of reproductive organs in males and females.

\*\*\*DRAFT FOR PUBLIC COMMENT\*\*\*

DICHLOROPROPENES

3. HEALTH EFFECTS

94



Table 3-4 Levels of Significant Exposure to 1,3-dichloropropene - Oral

(continued)

Key to Figure <sup>a</sup>	Species (Strain)	Exposure/Duration/Frequency (Route)	System	NOAEL (mg/kg/day)	LOAEL		Reference Chemical Form	Comments
					Less Serious (mg/kg/day)	Serious (mg/kg/day)		
35	Mouse (B6C3F1)	2 yr ad lib (F)		50			Stebbins et al. 2000 T IIb	Purity: 95.8% 1,3-DCP; 2% ESO; microencapsulated; mammary gland, seminal vesicle, testes, uterus, ovaries and vagina were examined.
36	Dog (Beagle)	1 yr ad lib (F)		15			Stebbins et al. 1999 T IIb	Purity 95.8% 1,3-DCP; 2% ESO; microencapsulated; ovary and testes weight and histopathology were examined.
<b>Cancer</b>								
37	Rat (Fischer- 344)	104 wk 3 d/wk 1 x/d (GO)				25 (forestomach squamous cell tumors; neoplastic hepatic nodules)	NTP 1985 T IIa	Purity: 89% 1,3-DCP; 1% epichlorohydrin.
38	Rat (Fischer- 344)	2 yr ad lib (F)				25 M (CEL: hepatocellular adenoma in 9/50, carcinoma in 1/50)	Stebbins et al. 2000 T IIb	Purity: 95.8% 1,3-DCP, 2% ESO; microencapsulated.

\*\*\*DRAFT FOR PUBLIC COMMENT\*\*\*

Table 3-4 Levels of Significant Exposure to 1,3-dichloropropene - Oral

(continued)

Key to Figure	Species (Strain)	Exposure/ Duration/ Frequency (Route)	System	NOAEL (mg/kg/day)	LOAEL		Reference Chemical Form	Comments	
					Less Serious (mg/kg/day)	Serious (mg/kg/day)			
39	Mouse (B6C3F1)	2 yr 3 d/wk 1 x/d (GO)				50	(CEL: bronchioalveolar adenoma of lung; transitional cell carcinoma of urinary bladder; forestomach squamous cell tumors)	NTP 1985 T IIa	Purity: 89% 1,3-DCP; 1% epichlorohydrin.

a The number corresponds to entries in Figure 3-3.

b Differences in levels of health effects and cancer effects between male and females are not indicated in Figure 3-4. Where such differences exist, only the levels of effect for the most sensitive gender are presented.

c Study results used to derive an intermediate-duration oral minimal risk level (MRL) of 0.04 mg/kg/day for 1,3-dichloropropene, as described in detail in Appendix A. Benchmark dose analysis was performed for incidences of hyperplasia of the nonglandular stomach mucosa in male rats to select a point of departure, which was divided by an uncertainty factor of 100 (10 for extrapolation from animals to humans using dosimetric adjustment and 10 for human variability) (See Appendix A).

d Study results used to derive a chronic-duration oral minimal risk level (MRL) of 0.04 mg/kg/day for 1,3-dichloropropene, as described in detail in Appendix A. Benchmark dose analysis was performed for incidences of hyperplasia of the nonglandular stomach mucosa in male and female rats and for reduced hemoglobin concentrations in male and female dogs to select a point of departure. The selected point of departure, based on stomach hyperplasia in female rats, was divided by an uncertainty factor of 100 (10 for extrapolation from animals to humans using dosimetric adjustment and 10 for human variability) (See Appendix A).

ad lib = ad libitum; Bd Wt = body weight; Cardio = cardiovascular; CEL = cancer effect level; d = day(s); ESO = epoxidized soybean oil; (F) = feed; Gastro = gastrointestinal; (G)= gavage; (GO) = gavage in oil; hemato = hematological; LD50 = lethal dose, 50% kill; LOAEL = lowest-observed-adverse-effect level; mo = month(s); Musc/skel = musculoskeletal; NOAEL = no-observed-adverse-effect level; Resp = respiratory; x = time(s); wk = week(s); yr = year(s)

\*\*\*DRAFT FOR PUBLIC COMMENT\*\*\*

Figure 3-3 Levels of Significant Exposure to 1,3-dichloropropene - Oral  
Acute (≤14 days)

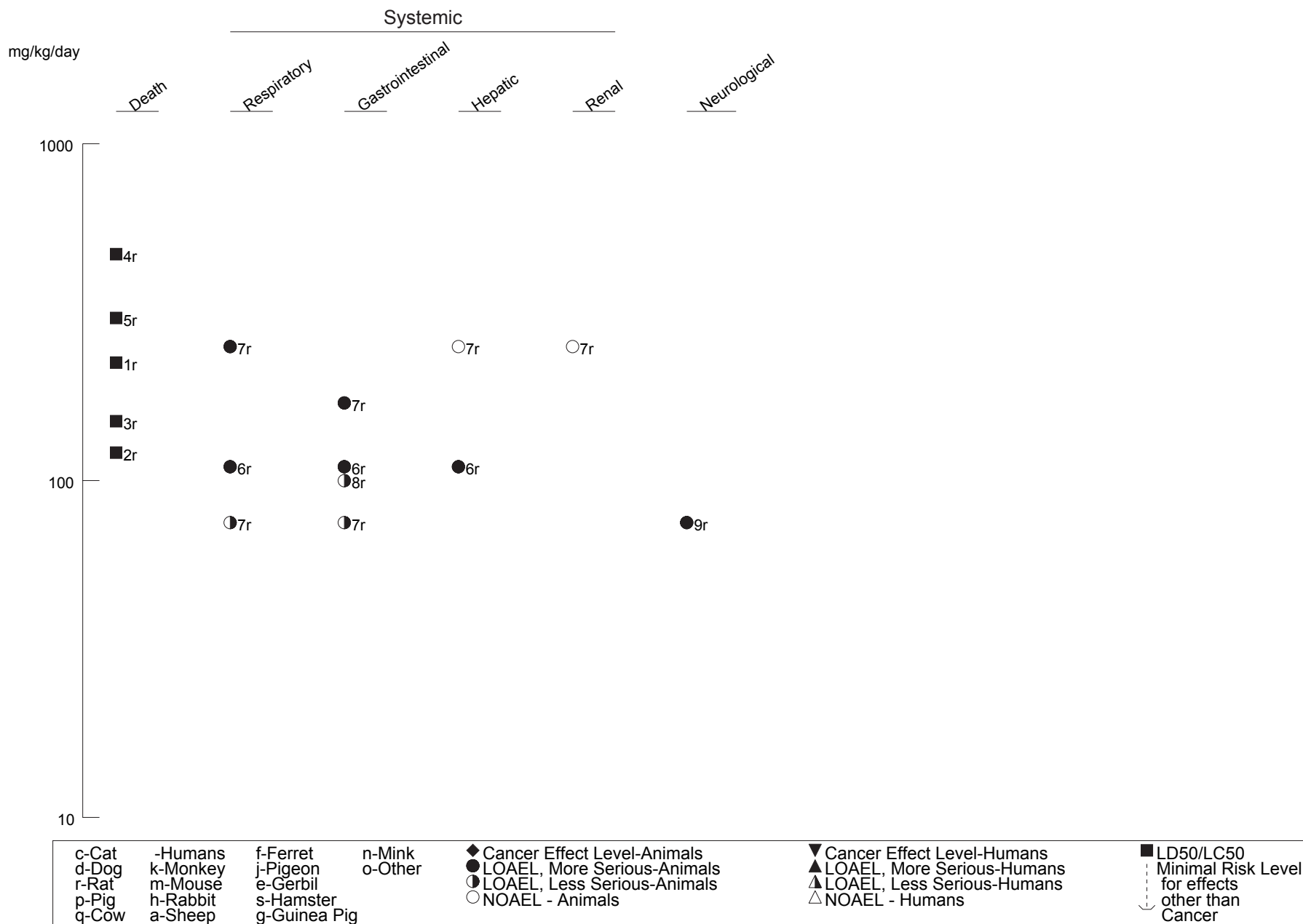

\*\*\*DRAFT FOR PUBLIC COMMENT\*\*\*

Figure 3-3 Levels of Significant Exposure to 1,3-dichloropropene - Oral (Continued)  
Intermediate (15-364 days)

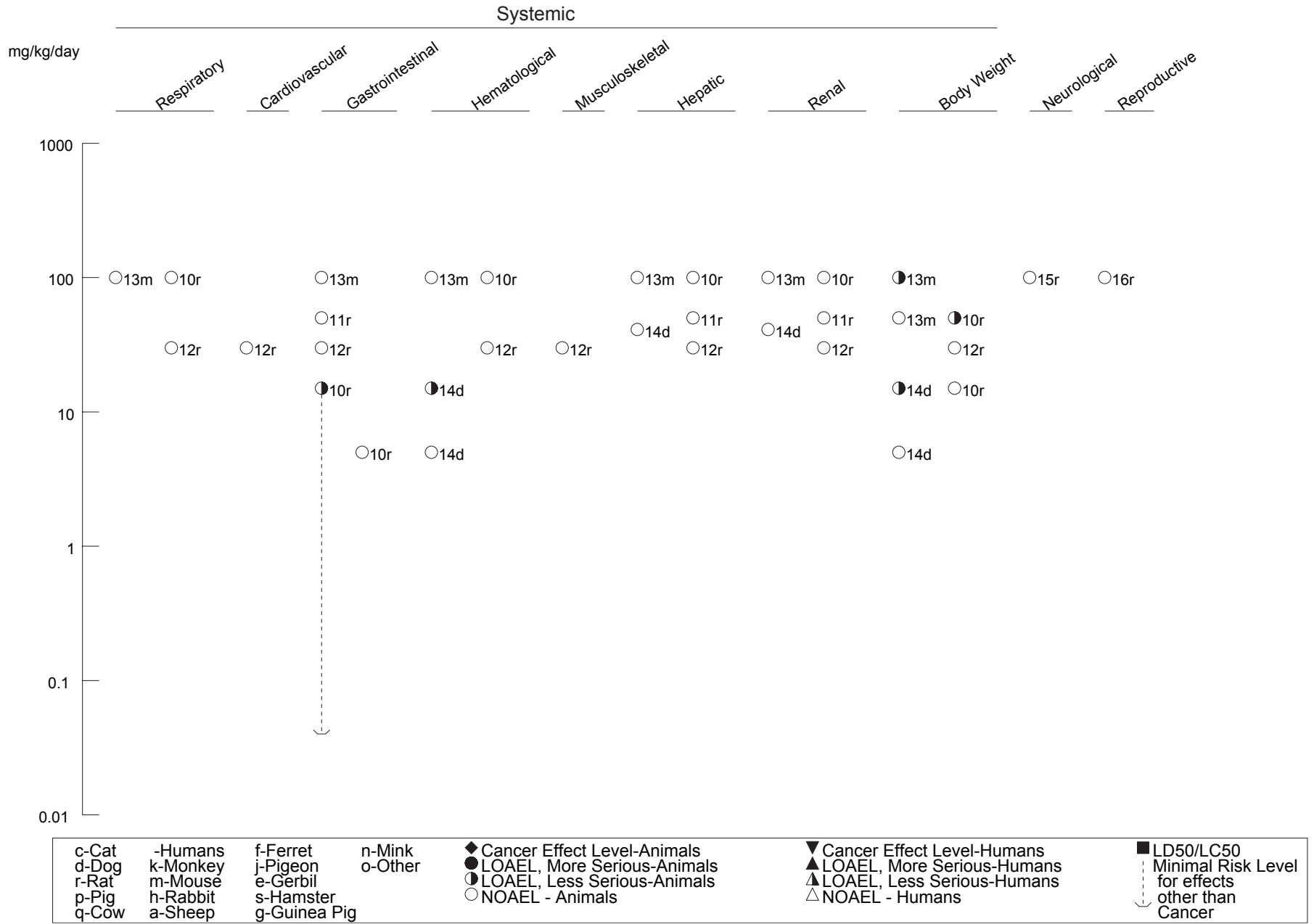

\*\*\*DRAFT FOR PUBLIC COMMENT\*\*\*

Figure 3-3 Levels of Significant Exposure to 1,3-dichloropropene - Oral (Continued)  
Chronic (≥365 days)

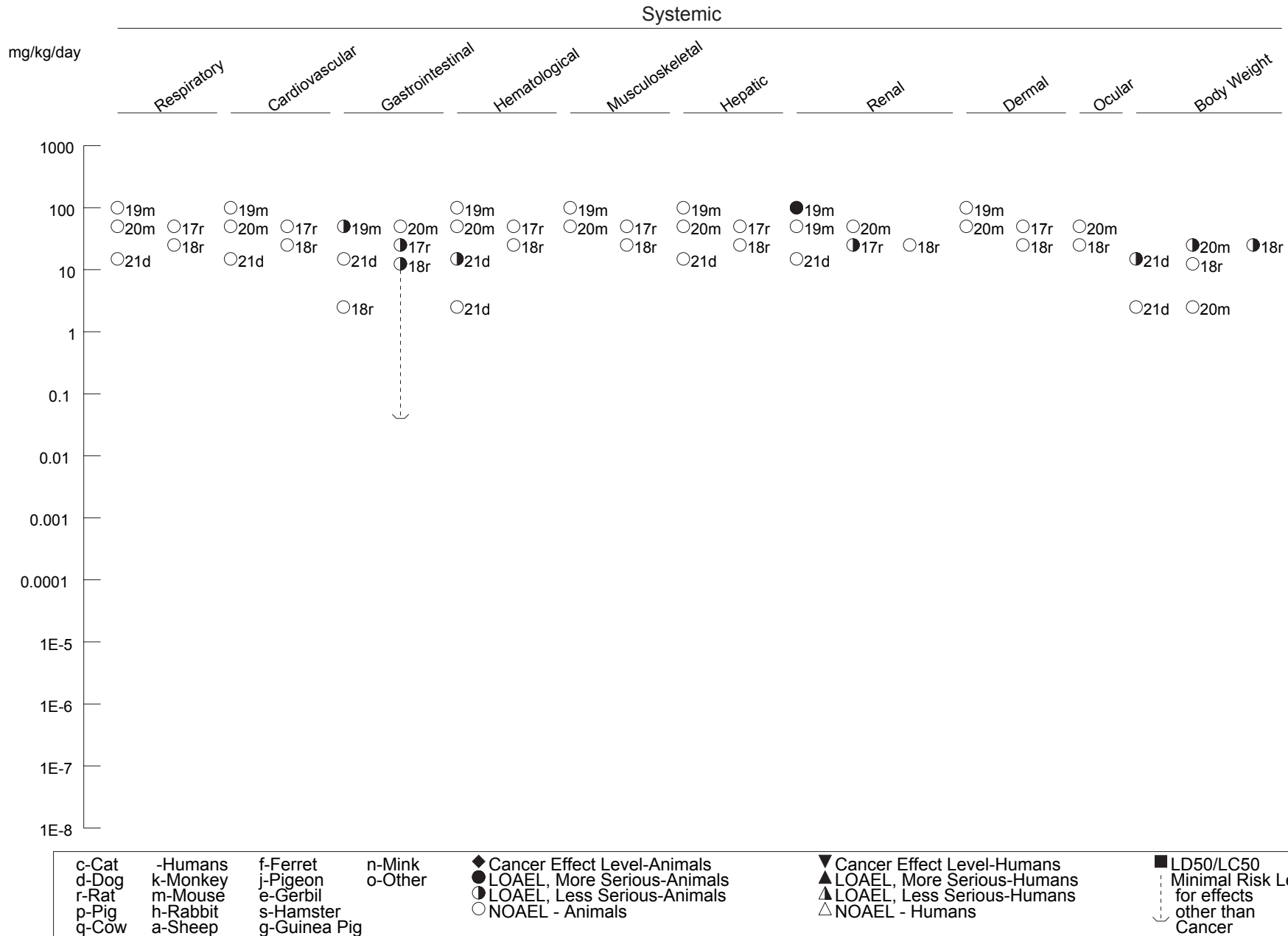

\*\*\*DRAFT FOR PUBLIC COMMENT\*\*\*

Figure 3-3 Levels of Significant Exposure to 1,3-dichloropropene - Oral (Continued)  
Chronic (≥365 days)

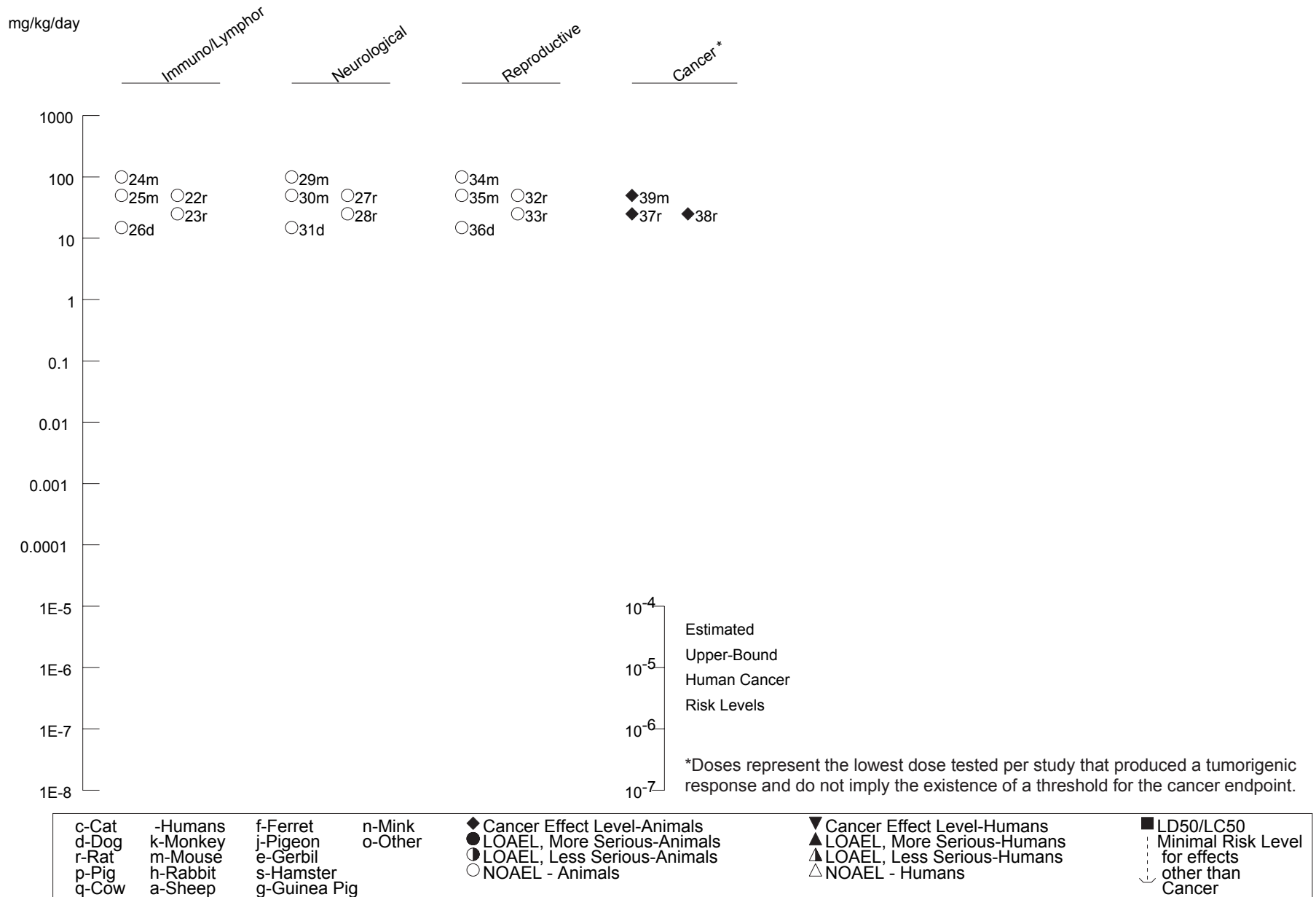

\*\*\*DRAFT FOR PUBLIC COMMENT\*\*\*

Table 3-5 Levels of Significant Exposure to 2,3-dichloropropene - Oral

Key to Figure <sup>a</sup>	Species (Strain)	Exposure/ Duration/ Frequency (Route)	System	NOAEL (mg/kg)	LOAEL		Reference Chemical Form	Comments
					Less Serious (mg/kg)	Serious (mg/kg)		
<b>ACUTE EXPOSURE</b>								
<b>Death</b>								
1	Rat (Sprague-Dawley)	once (G)				285 (LD50)	Monsanto 1967 2,3-dichloropropene	Purity not reported.
2	Rat (Wistar)	once (GO)				320 M (LD50)	Smyth et al. 1962; Union Carbide Corp 1958 2,3-dichloropropene	Purity not reported.

<sup>a</sup> The number corresponds to entries in Figure 3-4.

(G)= gavage; (GO) = gavage in oil; LD50 = lethal dose, 50% kill; LOAEL = lowest-observed-adverse-effect level; M = male; NOAEL = no-observed-adverse-effect level

\*\*\*DRAFT FOR PUBLIC COMMENT\*\*\*

Figure 3-4 Levels of Significant Exposure to 2,3-dichloropropene - Oral  
Acute ( $\leq 14$  days)

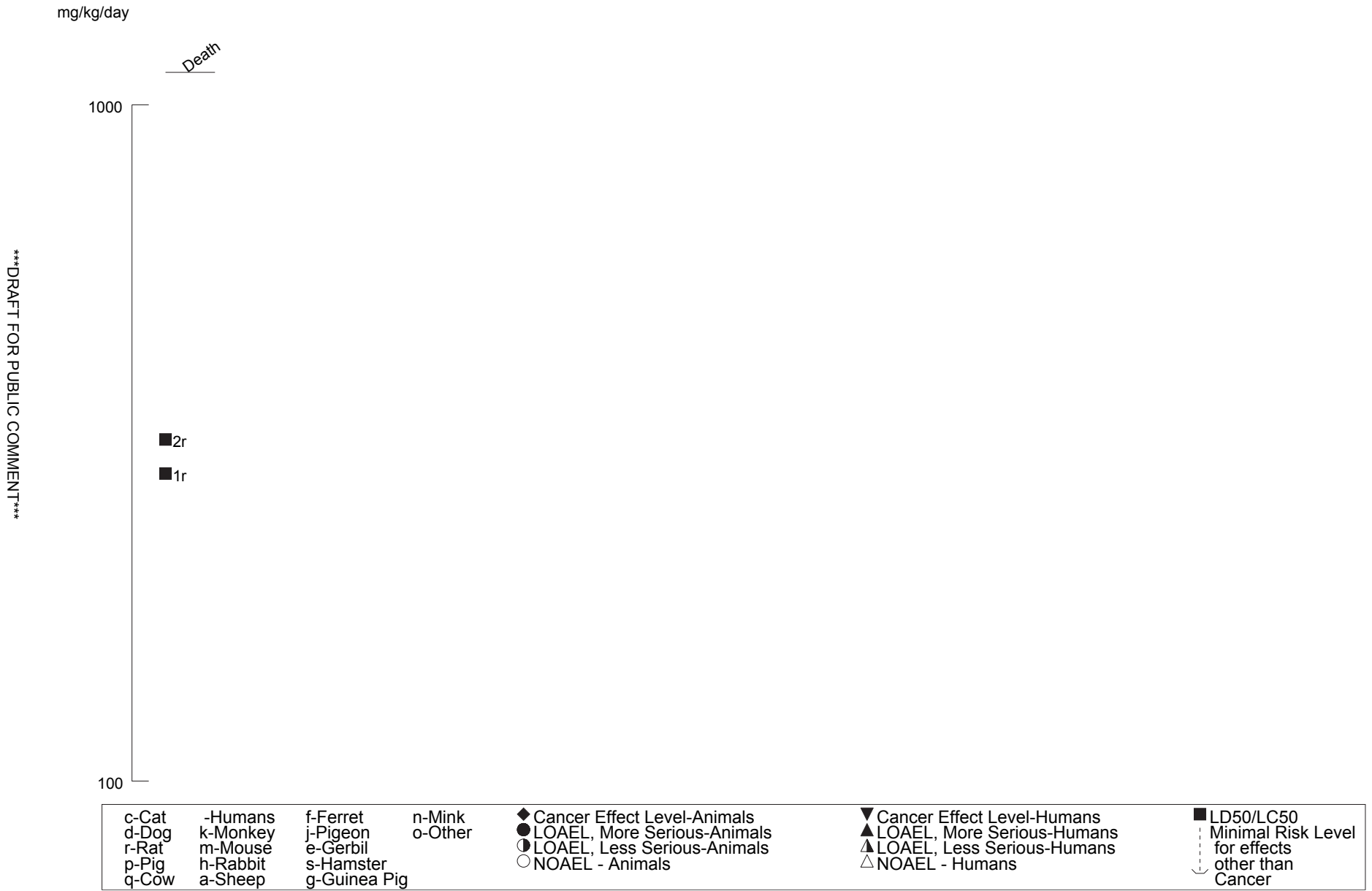



## 3. HEALTH EFFECTS

feed as high as 15 mg/kg/day for 1 year (Stebbins et al. 1999) or in rats or mice exposed to doses up to 25 or 50 mg/kg/day, respectively, for 2 years (Stebbins et al. 2000).

**2,3-Dichloropropene.** No mortality data were available for humans orally exposed to 2,3-dichloropropene.

The oral LD<sub>50</sub> for 2,3-dichloropropene in rats was 320 (260–400) mg/kg (Smyth et al. 1962).

**1,2-Dichloropropene.** No mortality data were available for humans orally exposed to 1,2-dichloropropene.

As mentioned in a brief summary, two rats survived that were given 2,000 mg/kg 1,2-dichloropropene by oral gavage (Dow 1962).

### 3.2.2.2 Systemic Effects

The systemic effects observed in humans or animals after oral exposure to 1,3-, 2,3-, or 1,2-dichloropropene are discussed below. The highest NOAELs and all reliable LOAELs for each systemic effect for each species and duration category are recorded in Tables 3-4 and 3-5, respectively, and plotted in Figures 3-3 and 3-4, respectively, for the 1,3- and 2,3-dichloropropenes.

#### Respiratory Effects.

**1,3-Dichloropropene.** In the 27-year-old male who died after accidentally ingesting 1,3-dichloropropene, tachypnea was an early sign of toxicity, and diffuse bilateral edema of the lungs consistent with adult respiratory distress syndrome developed several hours before death (Hernandez et al. 1994).

In a rat LD<sub>50</sub> study, a single oral administration of Telone II<sup>®</sup> a caused dose-related respiratory effects including lung congestion and lung hemorrhage (Jones and Collier 1986a). Abnormally red and hemorrhagic lungs were observed in rats that received a single oral dose of cis-1,3-dichloropropene in an LD<sub>50</sub> study (Jones 1988a).

Gross and microscopic examination revealed no respiratory effects in male and female rats exposed to ≤30 mg Telone<sup>®</sup>/kg/day by gavage for 13 weeks (Til et al. 1973), ≤50 mg Telone II<sup>®</sup> a/kg/day by gavage

## 3. HEALTH EFFECTS

for 9 months (NTP 1985), or  $\leq 100$  mg Telone II<sup>®</sup>b/kg/day in the feed for 13 weeks (Haut et al. 1996). Likewise, no exposure-related histologic lesions were found in the lungs of male and female mice exposed to doses  $\leq 100$  mg Telone II<sup>®</sup>b /kg/day in feed for 13 weeks (Haut et al. 1996).

Gross and histological examination revealed no neoplastic or nonneoplastic respiratory lesions in rats and no nonneoplastic respiratory lesions in mice receiving Telone II<sup>®</sup>a for 2 years at gavage doses of  $\leq 50$  mg/kg/day for rats or  $\leq 100$  mg/kg/day for mice (NTP 1985). In contrast, an increased incidence of bronchioalveolar adenomas was observed in female mice receiving Telone II<sup>®</sup>a for 2 years (Section 3.2.2.8). With dietary administration of microencapsulated Telone II<sup>®</sup>b in feed, no increased incidences of nonneoplastic respiratory lesions were found in rats or mice exposed to doses  $\leq 25$  or  $\leq 50$  mg/kg/day, respectively, for 2 years (Stebbins et al. 2000) or in dogs exposed to  $\leq 41$  mg/kg/day for 1 year (Stebbins et al. 1999).

**2,3-Dichloropropene.** No data were available for respiratory effects in humans orally exposed to 2,3-dichloropropene.

Congestion of the lungs was observed in rats that died in following ingestion of lethal doses of 2,3-dichloropropene (Smyth et al. 1962; Union Carbide Corp. 1958).

**Cardiovascular Effects.**

**1,3-Dichloropropene.** In the 27-year-old male who died after accidentally ingesting 1,3-dichloropropene, tachycardia was an early sign of toxicity and hypovolemia subsequently developed (Hernandez et al. 1994). At autopsy, there was evidence of hemorrhages in the stomach and brain.

Histological evaluation of the hearts revealed no exposure-related lesions in rats exposed to  $\leq 30$  mg/kg of Telone<sup>®</sup> by gavage for 13 weeks (Til et al. 1973).

Following chronic-duration exposure, gross and histological examination of hearts revealed no cardiovascular lesions in rats that received  $\leq 50$  mg/kg or in mice that received  $\leq 100$  mg Telone II<sup>®</sup>a/kg by gavage for 2 years (NTP 1985). Data in male mice were of limited value, because 25 of 50 vehicle controls died of myocarditis after 48–51 weeks. With dietary administration of microencapsulated Telone II<sup>®</sup>b in feed, no increased incidences of nonneoplastic cardiovascular lesions were found in rats or

## 3. HEALTH EFFECTS

mice exposed to doses  $\leq 25$  or  $\leq 50$  mg/kg/day, respectively, for 2 years (Stebbins et al. 2000) or in dogs exposed to  $\leq 41$  mg/kg/day for 1 year (Stebbins et al. 1999).

**Gastrointestinal Effects.**

*1,3-Dichloropropene.* The only information on gastrointestinal effects in humans following oral exposure to 1,3-dichloropropene comes from a fatal accidental poisoning case (Hernandez et al. 1994). Acute gastrointestinal distress and abdominal pain were among the initial symptoms in a 27-year-old male who died 40 hours after accidentally drinking 1,3-dichloropropene. Subsequent signs included bloody diarrhea and the presence of pancreatic enzymes in the peritoneal fluid; the study authors could not rule out the possibility of a preexisting pancreatic illness. Hemorrhagic exudate of the stomach was observed at autopsy. Histopathological analysis of the stomach revealed congestion of gastric mucosal vessels, autolysis, and mucosal erosions.

Rats that received a single oral dose of  $\geq 110$  mg cis-1,3-dichloropropene/kg developed ulcerations of the glandular stomach and hemorrhage of the small intestine (Jones 1988a). Hyperkeratosis of the nonglandular stomach was found in rats that received a single gavage dose of 100 mg/kg Telone C-17<sup>®</sup> (Mizell et al. 1988b) or 75 mg/kg Telone II<sup>®a</sup> (Jones and Collier 1986a).

In rats exposed to microencapsulated Telone II<sup>®b</sup> in the diet for 13 weeks, basal cell hyperplasia of the nonglandular stomach was observed at doses of  $\geq 15$  mg/kg/day and hyperkeratosis was observed at 100 mg/kg/day (Haut et al. 1996). Gross and microscopic evaluation of the gastrointestinal tract revealed no lesions attributable to oral administration of  $\leq 30$  mg/kg of 78% Telone<sup>®</sup> to rats for 13 weeks (Til et al. 1973). Similarly, no gastrointestinal lesions were found in rats that received  $\leq 50$  mg/kg of 89% Telone II<sup>®a</sup> for 9 months (NTP 1985) or in mice exposed to  $\leq 100$  mg/kg/day Telone II<sup>®b</sup> in feed for 13 weeks (Haut et al. 1996). As described in Appendix A and the footnote to Table 3-4, an intermediate-duration oral MRL of 0.04 mg/kg/day was derived for 1,3-dichloropropene based on benchmark dose analysis of incidence data for basal cell hyperplasia of the nonglandular stomach in rats exposed to microencapsulated Telone II<sup>®b</sup> in the diet for 13 weeks.

Chronic oral exposure to 1,3-dichloropropene causes nonneoplastic and neoplastic lesions in the gastrointestinal systems of rats and mice.

## 3. HEALTH EFFECTS

Significant dose-related increases in basal cell or epithelial cell hyperplasia of the forestomach were observed in male and female rats that received  $\geq 25$  mg/kg Telone II<sup>®</sup>a for 2 years (NTP 1985). Additionally, female rats that received 50 mg/kg had hyperkeratosis of the forestomach. Male rats suffered an increase in pancreatic periarteritis at both 25 and 50 mg/kg.

Dose-related increases in epithelial cell hyperplasia of the forestomach were observed in female mice receiving  $\geq 50$  mg/kg Telone II<sup>®</sup>a by oral gavage (NTP 1985). Although data in male mice were limited, the incidence of forestomach epithelial cell hyperplasia was similar to that in the females. Neoplastic lesions of the stomach were also observed in rats and mice that received gavage doses of Telone II<sup>®</sup>a for 2 years (Section 3.2.2.7).

In chronic oral studies involving microencapsulated Telone II<sup>®</sup>b (95.8% 1,3-dichloropropene) in feed, basal cell hyperplasia of the nonglandular stomach mucosa was observed in male and female rats receiving 12.5 mg/kg/day for 2 years (Stebbins et al. 2000), but not in mice receiving doses of  $\leq 50$  mg/kg/day for 2 years (Stebbins et al. 2000) or dogs receiving  $\leq 15$  mg/kg/day for 1 year (Stebbins et al. 1999). A portal-of-entry effect in dogs was indicated by inflammation of the tongue in some dogs exposed at  $\leq 15$  mg/kg/day for 1 year (Stebbins et al. 1999); the study authors suggested that some of the microcapsules dissolved in saliva, releasing 1,3-dichloropropene into the oral cavity with resulting irritant effects. No gastric tumors were observed in rats, mice, or dogs exposed to Telone II<sup>®</sup>b in the diet. As described in Appendix A and a footnote to Table 3-4, a chronic-duration oral exposure MRL of 0.03 mg/kg/day was derived from benchmark dose analysis of incidence data for basal cell hyperplasia of the nonglandular stomach in female rats exposed to microencapsulated Telone II<sup>®</sup>b in the diet for 2 years.

**Hematological Effects.**

***1,3-Dichloropropene.*** No studies were located regarding hematological effects in humans after oral exposure to 1,3-dichloropropene.

Evaluation of hematological profiles and clinical chemistry revealed no adverse effects in rats that received  $\leq 30$  mg/kg 78% Telone<sup>®</sup> by oral gavage for 13 weeks (Til et al. 1973). In 13-week studies administering microencapsulated 95.8% Telone II<sup>®</sup>b in the diet, no significant hematological effects were noted in rats or mice exposed at  $\leq 100$  mg/kg/day (Haut et al. 1996). Conversely, dogs exposed to the same test material at concentrations of  $\geq 15$  mg/kg/day exhibited microcytic anemia (19–29% reductions in hemoglobin and hematocrit counts) (Stebbins et al. 1999).

## 3. HEALTH EFFECTS

Extensive clinical chemistry and hematological profiles of male and female rats exposed by gavage to  $\leq 50$  mg/kg 1,3-dichloropropene (89% plus 1% epichlorohydrin) (NTP 1985) or to microencapsulated Telone II<sup>®</sup>b at  $\leq 25$  mg/kg/day (Stebbins et al. 2000) for 2 years revealed no signs of adverse effects (NTP 1985). However, dogs exposed to the microencapsulated Telone II<sup>®</sup>b in the diet at concentrations of  $\geq 15$  mg/kg/day exhibited macrocytic anemia (reductions in hemoglobin, hematocrit, and mean corpuscular volumes) (Stebbins et al. 1999). This hematological effect in dogs was selected as a co-critical effect for chronic oral exposure. As described in Appendix A, hematological effects in dogs were not selected as the basis for the chronic-duration oral MRL because benchmark dose analysis of the other co-critical effect, stomach lesions in rats, provided a lower, more protective point of departure.

**Musculoskeletal Effects.**

*1,3-Dichloropropene.* No studies were located regarding musculoskeletal effects in humans after oral exposure to 1,3-dichloropropene.

Histological evaluation of musculoskeletal tissue revealed no exposure-related lesions in rats exposed to  $\leq 30$  mg/kg of Telone<sup>®</sup> by gavage for 13 weeks (Til et al. 1973).

Gross and histological examination of musculoskeletal tissue revealed no lesions in rats that received up to 50 mg/kg or in mice that received up to 100 mg Telone II<sup>®</sup>a/kg by gavage for 2 years (NTP 1985). With dietary administration of microencapsulated Telone II<sup>®</sup>b in feed, no increased incidences of musculoskeletal lesions were found in rats or mice exposed to doses  $\leq 25$  or  $\leq 50$  mg/kg/day, respectively, for 2 years (Stebbins et al. 2000) or in dogs exposed to  $\leq 41$  mg/kg/day for 1 year (Stebbins et al. 1999).

**Hepatic Effects.**

*1,3-Dichloropropene.* No studies were located regarding hepatic effects in humans after oral exposure to 1,3-dichloropropene.

Rats that received a single gavage dose of  $\geq 110$  mg cis-1,3-dichloropropene/kg developed dark and patchy livers and hemorrhage of the liver (Jones 1988a). Similarly, a single gavage dose of 170 mg/kg Telone II<sup>®</sup>a produced mottled and dark livers in rats (Jones and Collier 1986a).

## 3. HEALTH EFFECTS

An increased liver:body weight ratio was observed in rats that received 30 mg/kg, but not  $\leq 10$  mg/kg, of Telone<sup>®</sup> for 13 weeks (Til et al. 1973). Histological examination and clinical chemistry variables revealed no adverse hepatic effects in rats or mice exposed to 100 or 50 mg/kg/day, respectively, Telone II<sup>®b</sup> in feed for 13 weeks (Haut et al. 1996).

Histological examination revealed no hepatic lesions that were attributable to oral gavage administration of 50 mg/kg Telone II<sup>®a</sup> to rats for 9–24 months (NTP 1985). Similarly, no hepatic lesions attributable to Telone II<sup>®a</sup> were found in mice after they received gavage doses for 2 years. In contrast, an increased incidence of hepatic neoplastic nodules was observed in male rats that received Telone II<sup>®a</sup> by gavage for 2 years (Section 3.2.2.7). In male and female rats ingesting microencapsulated Telone II<sup>®b</sup> in the diet for 2 years, there was no increase in the total number of hepatic foci, but treated rats had more eosinophilic foci than basophilic foci (Stebbins et al. 2000). In the same study, an increase in benign hepatic tumors (adenomas) was observed in male rats exposed at 25 mg/kg/day (see Section 3.2.2.7). No nonneoplastic or neoplastic hepatic effects were found in mice exposed to  $\leq 50$  mg/kg/day Telone II<sup>®b</sup> in feed for 2 years (Stebbins et al. 2000), or in dogs exposed to  $\leq 41$  mg/kg/day for 1 year (Stebbins et al. 1999).

***2,3-Dichloropropene.*** No data were available for hepatic effects in humans orally exposed to 2,3-dichloropropene.

Congestion of the liver was observed in rats that died in following ingestion of lethal doses of 2,3-dichloropropene (Smyth et al. 1962; Union Carbide Corp. 1958).

***1,2-Dichloropropene.*** No data were available for hepatic effects in humans orally exposed to 1,2-dichloropropene.

As mentioned in a brief summary, two rats that survived a single oral dose of 2,000 mg/kg 1,2-dichloropropene exhibited considerable (unspecified) injury to the liver at necropsy (Dow 1962).

**Renal Effects.**

***1,3-Dichloropropene.*** The autopsy of a 27-year-old male who died 40 hours after accidentally ingesting 1,3-dichloropropene revealed acute tubular necrosis of the kidney (Hernandez et al. 1994).

## 3. HEALTH EFFECTS

A single gavage dose of 170 mg/kg Telone II<sup>®</sup>a produced dark kidneys in rats (Jones and Collier 1986a). The toxicological significance of this observation was not discussed. The NOAEL for this effect was 110 mg/kg.

An increase in the kidney:body weight ratio was observed in rats that received 10 mg/kg, but not 3 mg/kg, Telone<sup>®</sup> (78% purity) for 13 weeks (Til et al. 1973). In contrast, no renal lesions were observed after gross and microscopic examination in rats that received  $\leq 50$  mg/kg of Telone II<sup>®</sup>a for 9–24 months (NTP 1985). No adverse renal effects were observed in rats, mice, or dogs that received Telone II<sup>®</sup>b in the diet for 13 weeks (Haut et al. 1996; Stebbins et al. 1999).

Female mice developed a dose-related increase in kidney hydronephrosis after oral exposure to 50 or 100 mg/kg Telone II<sup>®</sup>a for 2 years (NTP 1985). A primary target organ of 1,3-dichloropropene in female mice was the urinary bladder, where a dose-related increase in epithelial cell hyperplasia and transitional cell carcinoma (Section 3.2.2.7) was observed. Although data for male mice were not adequate, there was some indication that Telone II<sup>®</sup>a also caused transitional cell carcinomas in the urinary bladder. Similar neoplastic and nonneoplastic lesions were not found in male and female rats exposed to up to 50 mg/kg 1,3-dichloropropene for 2 years (NTP 1985). No adverse renal effects were observed in rats or mice that received Telone II<sup>®</sup>b in the diet for 2 years, or in dogs similarly exposed for 1 year (Stebbins et al. 1999, 2000).

**2,3-Dichloropropene.** No data were available for renal effects in humans orally exposed to 2,3-dichloropropene.

Congestion of the kidneys was observed in rats that died following ingestion of lethal doses of 2,3-dichloropropene (Smyth et al. 1962; Union Carbide Corp. 1958).

**1,2-Dichloropropene.** No data were available for renal effects in humans orally exposed to 1,2-dichloropropene.

As mentioned in a brief summary, two rats that survived a single oral dose of 2,000 mg/kg 1,2-dichloropropene exhibited considerable (unspecified) injury to the kidneys at necropsy (Dow 1962).

## 3. HEALTH EFFECTS

**Dermal and Ocular Effects.**

*1,3-Dichloropropene.* No studies were located regarding dermal/ocular effects in humans after oral exposure to 1,3-dichloropropene.

Gross and histological examination of the eyes and skin in rats and of the skin only in mice that received gavage doses of Telone II<sup>®</sup>a for 2 years revealed no lesions attributable to Telone II<sup>®</sup>a (NTP 1985). Likewise, no exposure-related adverse effects were apparent from histologic examination of skin and eyes of rats or mice exposed to  $\leq 25$  mg/kg/day and  $\leq 50$  mg/kg/day Telone II<sup>®</sup>b in the feed for 2 years (Stebbins et al. 2000) or eyes of dogs exposed to  $\leq 41$  mg/kg/day Telone II<sup>®</sup>b in the feed for 1 year (Stebbins et al. 1999).

**Body Weight Effects.**

*1,3-Dichloropropene.* No data were available for body weight effects in humans following oral exposure to 1,3-dichloropropene.

Reductions in terminal body weights compared to controls were observed in dogs exposed at  $\geq 15$  mg/kg/day (Stebbins et al. 1999), rats at  $\geq 50$  mg/kg/day, and mice at  $\geq 100$  mg/kg/day (Haut et al. 1996) in 13-week studies in which microencapsulated Telone II<sup>®</sup>b was added to the diet.

Reductions in body weights compared to controls were observed studies in rats and mice exposed to microencapsulated Telone II<sup>®</sup>b in the diet at 25 mg/kg/day for 2 years (Stebbins et al. 2000) or dogs exposed at 15 mg/kg/day for 1 year (Stebbins et al. 1999).

In the intermediate- and chronic-duration studies using Telone II<sup>®</sup>b, the authors reported that reduced feed intake was largely responsible for the reduced body weight gains.

**Metabolic Effects.**

*1,3-Dichloropropene.* Metabolic acidosis developed in a 27-year-old male within hours after fatal ingestion of 1,3-dichloropropene (Hernandez et al. 1994).



## 3. HEALTH EFFECTS

No studies were located regarding metabolic effects in animals after oral exposure to 1,3-dichloropropene.

**3.2.2.3 Immunological and Lymphoreticular Effects**

*1,3-Dichloropropene.* No studies were located regarding immunological effects in humans or animals after oral exposure to 1,3-dichloropropene.

Histological examination of spleen and thymus revealed no exposure-related adverse changes in rats or mice exposed to  $\leq 25$  and  $\leq 50$  mg/kg/day Telone II<sup>®</sup>b, respectively, in the feed for 2 years (Stebbins et al. 2000) or in dogs exposed to  $\leq 41$  mg/kg/day Telone II<sup>®</sup>b in the feed for 1 year (Stebbins et al. 1999).

**3.2.2.4 Neurological Effects**

*1,3-Dichloropropene.* No studies were located regarding neurological effects in humans after oral exposure to 1,3-dichloropropene.

Studies specifically designed to examine neurological end points in animals after acute-, intermediate-, or chronic-duration oral exposure to 1,3-dichloropropene were not located.

Clinical signs of neurotoxicity were observed in rats 1 hour after receiving a single oral dose of 170 or 250 mg/kg or 4 hours after receiving a single dose of 75 or 110 mg/kg 1,3-dichloropropene (Jones 1988a). The observations included hunched posture, pilo-erection, lethargy, ptosis, ataxia, and decreased respiratory rate. More sensitive tests for neurological effects, however, were not used.

No histologic changes in brain or spinal cord tissue or gross clinical signs of toxicity were found in rats and mice exposed to  $\leq 25$  and  $\leq 50$  mg/kg/day, respectively, Telone II<sup>®</sup>b in the feed for 2 years (Stebbins et al. 2000), in dogs exposed to  $\leq 41$  mg/kg/day Telone II<sup>®</sup>b in the feed for 1 year (Stebbins et al. 1999), or in rats and mice exposed to  $\leq 50$  and  $\leq 100$  mg/kg/day, respectively, Telone II<sup>®</sup>a by gavage for 2 years (NTP 1985).

## 3. HEALTH EFFECTS

**3.2.2.5 Reproductive Effects**

*1,3-Dichloropropene.* No studies were located regarding reproductive effects in humans following oral exposure to 1,3-dichloropropene.

Histological evaluation of reproductive organs and tissues from rats and mice that received oral doses of Telone II<sup>®</sup>a by gavage or dietary exposure to Telone II<sup>®</sup>b for 2 years revealed no lesions attributable to the exposure (NTP 1985; Stebbins et al. 2000). More sensitive tests for reproductive effects, however, were not performed in these studies.

Studies specifically designed to examine reproductive performance end points in animals after acute-, intermediate-, or chronic-duration oral exposure to 1,3-dichloropropene were not located.

**3.2.2.6 Developmental Effects**

No studies were located regarding developmental effects in humans or animals after oral exposure to any isomer of dichloropropene.

**3.2.2.7 Cancer**

*1,3-Dichloropropene.* No studies were located regarding cancer in humans after oral exposure to 1,3-dichloropropene.

In a 2-year gavage study, rats that received 25 or 50 mg Telone II<sup>®</sup>a/kg/day developed squamous cell papillomas and carcinomas of the forestomach (NTP 1985). Male rats also developed neoplastic nodules of the liver. Female mice that received 50 or 100 mg/kg/day developed squamous cell papillomas and carcinomas of the forestomach, transitional cell carcinomas of the urinary bladder, and an increased incidence of alveolar/bronchiolar adenomas. The data in male mice were considered inadequate for assessment of carcinogenicity, because 25 of 50 vehicle controls died of myocarditis during weeks 48–51 of the study; however, there was some indication that the same neoplastic lesions found in increased incidences in female mice also occurred in male mice (NTP 1985).

## 3. HEALTH EFFECTS

More recent 2-year studies testing microencapsulated Telone II<sup>®</sup>b (a formulation in which epichlorohydrin was replaced with epoxidized soybean oil) suggest that epichlorohydrin enhances the carcinogenicity of 1,3-dichloropropene in animals (Stebbins et al. 1999, 2000). In contrast to the carcinogenic responses observed in mice exposed by gavage to Telone II<sup>®</sup>a (a formulation with epichlorohydrin), mice receiving dietary doses of  $\leq 50$  mg/kg/day encapsulated Telone II<sup>®</sup>b did not show any statistically significant carcinogenic response (Stebbins et al. 2000). In male rats receiving doses of 25 mg/kg/day via dietary exposure to Telone II<sup>®</sup>b, the incidence of benign hepatocellular adenomas was significantly increased compared to controls and one male had a hepatocellular carcinoma (Stebbins et al. 2000). Female rats exhibited a significant positive trend for these liver tumors, although the incidence at 25 mg/kg/day, the highest dose tested, was not significantly increased compared to controls (Stebbins et al. 2000). No increased tumor incidence was observed in dogs receiving doses of  $\leq 41$  mg/kg/day for 1 year (Stebbins et al. 1999). From these results, it appears that lifetime oral exposure to 1,3-dichloropropene increased hepatic tumors in rats (either with gavage exposure to Telone II<sup>®</sup>a or dietary exposure to Telone II<sup>®</sup>b), but that tumors at other locations in rats (such as the forestomach) or at any locations in mice or dogs may arise only from an interaction with epichlorohydrin or with gavage exposure.

The CELs in rats and mice are recorded in Table 3-4 and plotted in Figure 3-3.

### 3.2.3 Dermal Exposure

Dermal toxicity data are available for 1,3-dichloropropene and, to a lesser extent, for 2,3-dichloropropene and 1,2-dichloropropene. The highest NOAEL and all reliable LOAEL values after dermal exposure to 1,3- and 2,3-dichloropropene are recorded in Tables 3-6 and 3-7, respectively. Median lethal doses and other reliable quantifiable mortality data are recorded as serious LOAELs in these tables and figures.

Unless otherwise noted, dermal toxicity studies employed occlusive or semioclusive coverings of the application site, protected to prevent evaporation or ingestion of the test material.

#### 3.2.3.1 Death

**1,3-Dichloropropene.** No studies were located regarding death in humans after dermal exposure to 1,3-dichloropropene.

Table 3-6 Levels of Significant Exposure to 1,3-dichloropropene - Dermal

Species (Strain)	Exposure/Duration/Frequency (Route)	System	NOAEL	LOAEL		Reference Chemical Form	Comments
				Less Serious	Serious		
<b>ACUTE EXPOSURE</b>							
<b>Death</b>							
Rat	1 d 24 hr/d			1200 B mg/kg	(LD50)	Jones and Collier 1986b T IIa	Purity: 97.2% 1,3-DCP.
Rabbit (New Zealand)	1 d 24 hr/d			333 mg/kg	(LD50)	Jeffrey et al. 1987b T IIa	Purity: 97.54% 1,3-DCP
Rabbit	1 d 24 hr/d			504 B mg/kg	(LD50)	Lichy and Olson 1975 M-3993	Purity: 92% 1,3-DCP.
Rabbit (New Zealand)	1 d 24 hr/d			500 mg/kg	(6/10 died)	Mizell et al. 1988b T C-17	Purity: 79.1% 1,3-DCP, 19.4% chloropicrin.
<b>Systemic</b>							
Rat	1 d 24 hr/d	Resp		800 M mg/kg	(lung hemorrhage)	Jones and Collier 1986b T IIa	Purity: 97.2% 1,3-DCP.
				500 M mg/kg	(lung congestion)		
		Gastro	500 B mg/kg	800 B mg/kg	(stomach hemorrhage)		
		Dermal		500 B mg/kg	(adhesion of skin to underlying tissue)		

\*\*\*DRAFT FOR PUBLIC COMMENT\*\*\*

Table 3-6 Levels of Significant Exposure to 1,3-dichloropropene - Dermal

(continued)

Species (Strain)	Exposure/Duration/Frequency (Route)	System	LOAEL			Reference Chemical Form	Comments
			NOAEL	Less Serious	Serious		
Rabbit (New Zealand)	1 d 1 x/d	Ocular		0.1 B ml (eye irritation)		Jeffrey 1987b T IIa	Purity: 97.54% 1,3-DCP.
Rabbit (New Zealand)	1 d 4 hr/d	Dermal		0.5 B ml (erythema/edema)		Jeffrey 1987c T IIa	Purity: 97.54% 1,3-DCP.
Rabbit (New Zealand)	1 d 24 hr/d	Dermal		200 B mg/kg (erythema, necrosis)		Jeffrey et al. 1987b T IIa	Purity: 97.54% 1,3-DCP.
Rabbit	3 d 24 hr/d				0.5 ml (erythema/edema)	Lichy and Olson 1975 M-3993	Purity: 92% 1,3-DCP.
Rabbit	3 d 24 hr/d	Dermal		0.5 B ml (erythema/edema)		Lichy and Olson 1975 M-3993	Purity: 92% 1,3-DCP.
Rabbit	1 d 1 x/d	Ocular		0.1 ml (eye irritation)		Lichy and Olson 1975 M-3993	Purity: 92% 1,3-DCP.
Rabbit (New Zealand)	1 d 4 hr/d	Dermal		0.5 ml (necrosis/exfoliation)		Mizell 1988a T C-17	Purity: 79.1% 1,3-DCP; 19.4% chloropicrin.

\*\*\*DRAFT FOR PUBLIC COMMENT\*\*\*

Table 3-6 Levels of Significant Exposure to 1,3-dichloropropene - Dermal

(continued)

Species (Strain)	Exposure/ Duration/ Frequency (Route)	System	LOAEL			Reference Chemical Form	Comments
			NOAEL	Less Serious	Serious		
Rabbit	1 d 24 hr/d	Musc/skel		500 B mg/kg	(skeletal muscle hemorrhage)	Mizell et al. 1988b T C-17	Purity: 79.1% 1,3-DCP, 19.4% chloropicrin.
		Dermal		500 B mg/kg	(necrosis)		
<b>Immuno/ Lymphoret</b>							
Gn Pig	1 wk 4 x/wk	Dermal		0.1 ml	(erythema)	Carreon and Wall 1983 T IIa	Purity: 92% 1,3-DCP.
Gn Pig (Hartley)	1 wk 4 x/wk			0.1 M ml	(positive sensitization reaction in 4/10)	Carreon and Wall 1983 T IIa	Purity: 92.1% 1,3-DCP.
<b>INTERMEDIATE EXPOSURE</b>							
<b>Immuno/ Lymphoret</b>							
Gn Pig (Hartley)	4 wk 1 d/wk 6 h/d			0.4 M ml	(positive sensitization reaction in 9/10)	Jeffrey 1987a T IIa	Purity: 97.54% 1,3-DCP.
Gn Pig	3 wk 3 d/wk 6 hr/d			0.2 ml	(contact sensitization)	Jones 1988b cis	

B = both male and female; d = day(s); Gastro = gastrointestinal; hr = hour(s); Resp = respiratory; wk = week(s)

\*\*\*DRAFT FOR PUBLIC COMMENT\*\*\*

DICHLOROPROPENES

3. HEALTH EFFECTS

Table 3-7 Levels of Significant Exposure to 2,3-dichloropropene - Dermal

Species (Strain)	Exposure/Duration/Frequency (Route)	System	LOAEL			Reference Chemical Form	Comments
			NOAEL	Less Serious	Serious		
<b>ACUTE EXPOSURE</b>							
<b>Death</b>							
Rabbit (New Zealand)	24 hr				1913 M (24-hour LD50) mg/kg	Smyth et al. 1962; Union Carbide Corp 1958 2,3-dichloropropene	Purity not reported.
<b>Systemic</b>							
Rabbit (New Zealand)	once 24 hr	Ocular		0.1 ml	(moderate eye irritation)	Monsanto 1967 2,3-dichloropropene	Purity not reported.

hr = hour(s); LD50 = lethal dose, 50% kill; LOAEL = lowest-observed-adverse-effect level; M = male; NOAEL = no-observed-adverse-effect level

\*\*\*DRAFT FOR PUBLIC COMMENT\*\*\*

## 3. HEALTH EFFECTS

Several acute dermal lethality studies have been conducted for 1,3-dichloropropene (95% confidence limits are given in parentheses). The acute dermal LD<sub>50</sub> for Telone II<sup>®</sup>a in rats was 1,200 (1,000–1,400) mg/kg (Jones and Collier 1986b). The acute dermal LD<sub>50</sub> in rabbits for M-3993 was 713 mg/kg for males and 407 mg/kg for females, for an average of 504 (220–1,150) mg/kg (Lichy and Olson 1975). In a similar study, the dermal LD<sub>50</sub> for Telone II<sup>®</sup>a in rabbits was 333 (102–610) mg/kg (Jeffrey et al. 1987b). Six of 10 rabbits died or were submitted to pathology in a moribund condition within 4 days after receiving a dermal application of 500 mg/kg Telone C-17<sup>®</sup> (Mizell et al. 1988b).

**2,3-Dichloropropene.** No data were available for mortality in humans following dermal exposure to 2,3-dichloropropene.

The dermal LD<sub>50</sub> for 2,3-dichloropropene in rabbits was 1,913 (1,405–2,579) mg/kg for a single 24-hour exposure period (Smyth et al. 1962; Union Carbide Corp. 1958). The minimum lethal dose for dermal exposure to undiluted 2,3-dichloropropene was between 3,890 and 6,310 mg/kg (Younger 1967).

### 3.2.3.2 Systemic Effects

No studies were located regarding cardiovascular, hematological, renal, endocrine, or body weight effects in humans or animals after dermal exposure to any isomer of dichloropropene. No studies were located regarding respiratory, gastrointestinal, musculoskeletal, or hepatic effects in humans following dermal exposure to any isomer of dichloropropene.

#### Respiratory Effects.

**1,3-Dichloropropene.** Gross necropsy revealed abnormally red lungs in rats that died after dermal application of 800 mg/kg cis-1,3-dichloropropene (Jones 1988b). Rats that received a single dermal application of 500 mg/kg Telone II<sup>®</sup>a developed lung congestion, and at 800 mg/kg, lung hemorrhage (Jones and Collier 1986b).

#### Gastrointestinal Effects.

**1,3-Dichloropropene.** No studies were located regarding gastrointestinal effects in humans following dermal exposure to 1,3-dichloropropene.



## 3. HEALTH EFFECTS

Gross necropsy revealed that rats that received a single dermal application of 800 mg cis-1,3-dichloropropene/kg had hemorrhage and ulceration of the glandular gastric mucosa (Jones 1988b). Similarly, rats that received a single dermal application of 800 mg/kg Telone II<sup>®</sup> a suffered hemorrhage of the stomach and congestion and hemorrhage of the intestines (Jones and Collier 1986b). No gastrointestinal effects were observed in rats that received 500 mg/kg cis-1,3-dichloropropene or 500 mg/kg Telone II<sup>®</sup> a.

**Musculoskeletal Effects.**

*1,3-Dichloropropene.* No studies were located regarding musculoskeletal effects in humans following dermal exposure to 1,3-dichloropropene.

Of six rabbits that died following dermal application of 500 mg/kg Telone C-17<sup>®</sup>, two had developed skeletal muscle hemorrhage underneath the site of application (Mizell et al. 1988b).

**Hepatic Effects.**

*1,3-Dichloropropene.* No studies were located regarding hepatic effects in humans following dermal exposure to 1,3-dichloropropene.

Gross necropsy revealed abnormally dark livers in rats that received a single dermal application of  $\geq 800$  mg cis-1,3-dichloropropene/kg (Jones 1988b). The toxicological significance of this observation was not discussed. No other studies were located regarding hepatic effects in animals after dermal exposure to 1,3-dichloropropene.

**Dermal and Ocular Effects.**

*1,3-Dichloropropene.* Contact dermatitis has been reported in several agricultural workers following dermal exposure to 1,3-dichloropropene as a pesticide (Bousema et al. 1991; Corazza et al. 2003; Vozza et al. 1996). In cases where the liquid was in direct contact with the skin, dermatitis (erythema) developed immediately or within hours (Corazza et al. 2003; Vozza et al. 1996). In one case, a farmer developed acute bullous dermatitis on his feet 10 days after soiling his shoes in DD-95 (95% 1,3-dichloropropene), during which time he continued to wear the shoes (Bousema et al. 1991). In all three cases, allergic reactions subsequently developed (see Section 3.2.3.3).

## 3. HEALTH EFFECTS

Acute dermal application of dilute or full strength Telone II<sup>®</sup>a or M-3993 rapidly produced erythema and edema in rats, rabbits, and guinea pigs (Carreon and Wall 1983; Jeffrey 1987c; Jones and Collier 1986b; Lichy and Olson 1975; Mizell 1988a). At concentrations of  $\geq 200$  mg/kg, necrosis and subcutaneous/skeletal muscle hemorrhage were observed (Jones and Collier 1986b; Mizell 1988a; Mizell et al. 1988b).

Telone II<sup>®</sup>a and Telone C-17<sup>®</sup> also produced a delayed-type hypersensitivity in guinea pigs (Carreon and Wall 1983; Jeffrey 1987a; Mizell 1988b).

Severe conjunctival irritation, corneal injury, and corneal opacity were observed after instillation of 0.1 mL Telone II<sup>®</sup>a or M-3993 into the conjunctival sacs of rabbits (Jeffrey 1987b; Lichy and Olson 1975).

**2,3-Dichloropropene.** No data were available for dermal or ocular effects in humans following dermal exposure to 2,3-dichloropropene.

Results of primary eye and dermal irritation studies on 2,3-dichloropropene were described brief reports with little experimental detail. Moderate damage to the eye was observed in rabbits receiving a topical dose of 6.15 mg 2,3-dichloropropene (Smyth et al. 1962; Union Carbide Corp. 1958) or 0.1 mL (Younger 1967). In 24-hour dermal studies, moderate dermal irritation (erythema) was observed in rabbits that were exposed at a dose of 12 mg (Smyth et al. 1962; Union Carbide Corp. 1958) and mild dermal irritation was observed following exposure to an unspecified dose (Younger 1967).

**1,2-Dichloropropene.** No data were available for dermal or ocular effects in humans topically exposed to 1,2-dichloropropene.

A brief summary of results of a primary skin irritation assay in rabbits reported moderate hyperemia, edema, and deep burn with scarring following dermal exposure to an unspecified amount of 1,2-dichloropropene (Dow 1962). As reported in the same summary, effects in rabbits exposed to an unreported amount of 1,2-dichloropropene in a primary eye irritation assay included pain, moderate-to-extensive conjunctivitis, and slight iritis that subsided within a week.

## 3. HEALTH EFFECTS

**3.2.3.3 Immunological and Lymphoreticular Effects**

*1,3-Dichloropropene.* Skin sensitization reactions have been reported in workers involved in the production or use of pesticides containing 1,3-dichloropropene. A 28-year-old male who developed dermatitis on his hands, abdomen, and flanks from spilled 1,3-dichloropropene developed erythema, vesicles, and itching at the previous sites of exposure 3 weeks later (Corazza et al. 2003). A 44-year-old male who had developed acute bullous dermatitis on his feet from shoes contaminated with DD-95 (95% 1,3-dichloropropene) developed the same dermatitis following a similar exposure a year later (Bousema et al. 1991). A 23-year-old male who developed dermatitis on his hands and abdomen from accidental exposure to liquid 1,3-dichloropropene developed itching vesicles at the sites of exposure 1 week later (Vozza et al. 1996). The authors diagnosed this as a case of ‘contact pemphigus’, a type of autoimmune reaction initially triggered from contact dermatitis. Skin sensitization to DD-92<sup>®</sup> was noted as an itchy rash on the hands and feet of a 26-year-old male exposed during the manufacture of a soil fumigant (van Joost and de Jong 1988). Positive patch tests for 1,3-dichloropropene confirmed the sensitization in all four cases.

Delayed-type hypersensitivity reactions to Telone II<sup>®</sup>a and Telone C-17<sup>®</sup> were observed in guinea pigs (Carreon and Wall 1983; Jeffrey 1987a; Mizell 1988b). Guinea pigs also developed contact sensitization to cis-1,3-dichloropropene (Jones 1988b).

**3.2.3.4 Neurological Effects**

*1,3-Dichloropropene.* No studies were located regarding neurological effects in humans after dermal exposure to 1,3-dichloropropene.

Rats that received single dermal applications of  $\geq 500$  mg cis-1,3-dichloropropene/kg were lethargic and had increased salivation (Jones 1988b). At  $\geq 800$  mg/kg, ptosis, hunched posture, pilo-erection, lethargy, and decreased respiration rate were noted. Ataxia was observed in this study at dose levels of 1,300 and 2,000 mg/kg (Jones 1988b). Rats that received a single dermal application of  $\geq 1,300$  mg/kg of Telone II<sup>®</sup>a became ataxic and lost the righting reflex, indicating neurological deficits (Jones and Collier 1986b). Several studies reported clinical signs in rats and rabbits that possibly indicate a neurological effect of 1,3-dichloropropene after dermal application. These signs included lethargy, salivation, lacrimation, and labored respiration (Jeffrey et al. 1987b; Jones and Collier 1986b; Mizell et al. 1988b).

## 3. HEALTH EFFECTS

No studies were located regarding the following effects in humans or animals after dermal exposure to any isomer of dichloropropene:

**3.2.3.5 Reproductive Effects****3.2.3.6 Developmental Effects****3.2.3.7 Cancer**

***1,3-Dichloropropene.*** No studies were located regarding cancer in humans after dermal exposure to 1,3-dichloropropene.

1,3-Dichloropropene was not a tumor-initiator in mice treated with a single application of 122 mg per mouse, followed by repeated applications of the tumor-promoter, phorbol myristic acid, for 58 weeks. 1,3-Dichloropropene did not induce skin-papilloma formation in mice after dermal application of 122 mg per mouse three times weekly for 74 weeks—averaging 1481 mg/kg/day (Van Duuren et al. 1979); in addition there was no significant increase in lung or forestomach tumors compared to untreated or acetone-treated controls. Therefore, 1,3-dichloropropene does not appear able to initiate or induce skin tumors in mice.

**3.2.4 Other Routes of Exposure**

No studies were located regarding effects in humans or animals exposed to any isomer of dichloropropene by routes of exposure other than oral, inhalation, or dermal.

**3.3 GENOTOXICITY**

Genotoxicity data for dichloropropenes are presented in Table 3-8 for *in vivo* studies and Table 3-9 for *in vitro* studies. Formulations are given in the tables.

**Genotoxic Effects *in Vivo.*** No studies were located regarding genotoxic effects in humans after inhalation, oral, or dermal exposure to any isomer of dichloropropene. Genotoxic effects were observed in animals *in vivo* following exposure to 1,1- and 1,3-dichloropropene (Table 3-8).

## 3. HEALTH EFFECTS

**Table 3-8. Genotoxicity of Dichloropropenes *In Vivo***

Species (test system)	End point	Results	Reference	Isomer/ formulation
<b>1,1-Dichloropropene</b>				
Fish ( $\lambda$ transgenic medaka), immersion at 0.44–16.60 mg/L for 6 weeks	Mutation at <i>cII</i> bacterial locus (liver)	+	Winn et al. 2006	Purity not reported
<b>1,3-Dichloropropene</b>				
<i>Drosophila melanogaster</i> , in 10% ethanol in feed	Sex-linked lethal mutation	+	Valencia et al. 1985	cis, trans; 95.5% pure
Rat (Sprague-Dawley); females; by oral gavage in corn oil; 94 mg/kg	DNA fragmentation (alkaline elution) (liver)	+	Kitchin and Brown 1994	NS
Rat (Sprague-Dawley); females; by oral gavage in corn oil; 9.4 mg/kg	DNA fragmentation (alkaline elution) (liver)	–	Kitchin and Brown 1994	NS
Rat (Sprague-Dawley); males; by oral gavage in DMSO; 125 mg/kg	DNA fragmentation (lung, bone marrow, brain)	–	Ghia et al. 1993	cis, trans
Rat (Sprague-Dawley); males; by oral gavage in DMSO; 62.5-250 mg/kg	DNA fragmentation (liver, gastric mucosa; kidney at 125 mg/kg)	+	Ghia et al. 1993	cis, trans
Mouse (CD-1), male; by oral gavage in olive oil; 150 mg/kg	DNA fragmentation (stomach, liver, kidney, bladder, lung, brain, bone marrow)	+	Sasaki et al. 1998	cis, trans
Rat (CD); males exposed by inhalation at $\leq$ 150 ppm, 6 hours/day, 7 days/week, 10 weeks	Dominant lethal mutation	–	Gollapudi et al. 1998	Telone II <sup>®</sup> b 49.3–49.9% cis/ 46.7% trans
Rat (Sprague-Dawley); males; by oral gavage in DMSO; 125 mg/kg	Unscheduled DNA synthesis (hepatocytes)	–	Ghia et al. 1993	cis, trans
Mouse (ICR), male; by i.p. injection in olive oil; 150 mg/kg	Increased micronucleated reticulocytes (peripheral blood)	–	Sasaki et al. 1994	NS
Rat (Sprague-Dawley); males; by oral gavage in DMSO; 125 mg/kg	Increased micronuclei (bone marrow)	–	Ghia et al. 1993	cis, trans

## 3. HEALTH EFFECTS

**Table 3-8. Genotoxicity of Dichloropropenes *In Vivo***

Species (test system)	End point	Results	Reference	Isomer/ formulation
Mouse (NMRI), female and female; by oral gavage in corn oil; 187 mg/kg	Increased micronuclei (bone marrow)	+	Kevekordes et al. 1996	cis, trans; 95% pure
Mouse (NMRI), male and female; by oral gavage in corn oil; ≤280 mg/kg	Increased micronuclei (bone marrow)	-	Kevekordes et al. 1996	cis, trans; 95% pure
Mouse (CD-1), male; by i.p. injection; single treatment	Micronucleus induction	-	Morita et al. 1997a	Technical grade
Mouse (CD-1), male; by oral gavage in olive oil; 150 mg/kg	DNA fragmentation (stomach, liver, kidney, bladder, lung, brain, bone marrow)	+	Sasaki et al. 1998	cis, trans

<sup>a</sup>cis- and trans-1,3-dichloropropene supplied by K&K Laboratories

<sup>b</sup>cis- and trans-1,3-dichloropropene supplied by Pfaltz and Bauer, Inc.

<sup>c</sup>Low-boiling 1,3-dichloropropene supplied by K&K Laboratories

<sup>d</sup>High-boiling 1,3-dichloropropene supplied by K&K Laboratories

<sup>e</sup>Pfaltz and Bauer 1,3-dichloropropene was purified; impurities were then added back (refluxed) for the mutagenicity assay.

<sup>f</sup>cis-1, 3-dichloropropene

<sup>g</sup>Impurities from purified cis-1,3-dichloropropene

+ = positive response; - = negative response; DMSO = dimethyl sulfoxide; NS = not specified

## 3. HEALTH EFFECTS

Table 3-9. Genotoxicity of Dichloropropenes *In Vitro*

Species (test system)	End point	Results		Reference	Isomer/ formulation
		With activation	Without activation		
<b>1,1-Dichloropropene</b>					
Prokaryotic organisms:					
<i>Salmonella typhimurium</i> (TA98, TA100, TA1535, TA104)	Mutagenicity	–	–	Granville et al. 2005	99% pure
<i>S. typhimurium</i> (RSJ100)	Mutagenicity	+	+	Granville et al. 2005	98% pure
<i>S. typhimurium</i> (TA100)	Mutagenicity	+	+	Neudecker et al. 1986	99.5% pure
Eukaryotic organisms:					
<i>Aspergillus nidulans</i>	Mitotic segregation	No data	–	Crebelli et al. 1992	97% pure
<i>A. nidulans</i>	Induced aneuploidy	No data	–	Rosenkranz and Klopman 1996	NS
Human lymphoblastoid cells	DNA damage	–	–	Granville et al. 2005	98% pure
<b>1,2-Dichloropropene</b>					
<i>S. typhimurium</i> (TA100)	Mutagenicity	–	–	Neudecker et al. 1986	99% pure
<b>1,3-Dichloropropene</b>					
Prokaryotic organisms:					
<i>S. typhimurium</i> (TA100)	Reverse mutation	+	+	Creedy et al. 1984	cis, trans
<i>S. typhimurium</i> (TA1535, TA1978, TA100)	Reverse mutation	+	+	De Lorenzo et al. 1977	cis
<i>S. typhimurium</i> (TA1978, TA1978, TA100)	Reverse mutation	+	+	De Lorenzo et al. 1977	trans
<i>S. typhimurium</i> (TA100)	Reverse mutation	+	+	Eder et al. 1982a, 1982b	cis, trans
<i>S. typhimurium</i> (TA100, TA1535, TA1537, TA98)	Reverse mutation	+	+	Haworth et al. 1983	cis, trans
<i>S. typhimurium</i> (TA1535, TA1537, TA1538)	Reverse mutation	+	+	Neudecker et al. 1977	cis, trans
<i>S. typhimurium</i> (TA100)	Reverse mutation	+	+	Neudecker et al. 1980; Neudecker and Henschler 1986	cis, trans 99.5% pure
<i>S. typhimurium</i> (TA100)	Reverse mutation	+	+	Stolzenberg and Hine 1980	cis, trans

## 3. HEALTH EFFECTS

Table 3-9. Genotoxicity of Dichloropropenes *In Vitro*

Species (test system)	End point	Results		Reference	Isomer/ formulation
		With activation	Without activation		
<i>S. typhimurium</i> (TA100)	Reverse mutation	No data	–	Talcott and King 1984	Not pure <sup>a</sup> 85%
<i>S. typhimurium</i> (TA100)	Reverse mutation	No data	–	Talcott and King 1984	Purified <sup>a</sup> 92%
<i>S. typhimurium</i> (TA100)	Reverse mutation	No data	+	Talcott and King 1984	Not pure <sup>b</sup> 77%
<i>S. typhimurium</i> (TA100)	Reverse mutation	No data	–	Talcott and King 1984	Purified <sup>b</sup> 85%
<i>S. typhimurium</i> (TA100)	Reverse mutation	No data	+	Talcott and King 1984	Not pure <sup>c</sup> 75%
<i>S. typhimurium</i> (TA100)	Reverse mutation	No data	–	Talcott and King 1984	Purified <sup>c</sup> 86%
<i>S. typhimurium</i> (TA100)	Reverse mutation	No data	+	Talcott and King 1984	Not pure <sup>d</sup> 88%
<i>S. typhimurium</i> (TA100)	Reverse mutation	No data	–	Talcott and King 1984	Purified <sup>d</sup> 95%
<i>S. typhimurium</i> (TA100)	Reverse mutation	No data	+	Talcott and King 1984	cis + trans <sup>e</sup> 80% plus impurities
<i>S. typhimurium</i> (TA98)	Reverse mutation	No data	+	Vithayathil et al. 1983	cis, trans
<i>S. typhimurium</i> (TA98)	Rifampicin resistance	No data	+	Vithayathil et al. 1983	cis, trans
<i>Escherichia coli</i> (PQ37)	DNA damage (SOS induction)	No data	+	von der Hude et al. 1988	cis, trans
<i>S. typhimurium</i> (TA100)	Reverse mutation	+	+	Watson et al. 1987	Not pure <sup>f</sup>
<i>S. typhimurium</i> (TA100)	Reverse mutation	–	–	Watson et al. 1987	Purified <sup>f</sup>
<i>S. typhimurium</i> (TA100)	Reverse mutation	+	+	Watson et al. 1987	Impurities <sup>g</sup>
<i>S. typhimurium</i> (TA100, TA102, TA97)	Reverse mutation	–	+	Connors et al. 1990	cis or trans; 3-chloroallyl alcohol <sup>h</sup>
Eukaryotic organisms:					
<i>A. nidulans</i>	Mitotic segregation	No data	–	Crebelli et al. 1992	95% pure
<i>A. nidulans</i>	Induced aneuploidy	No data	–	Rosenkranz and Klopman 1996	NS
HeLa cells	Unscheduled DNA synthesis	No data	+	Eder et al. 1987	cis, trans
HeLa cells	Unscheduled DNA synthesis	No data	+	Schiffmann et al. 1983	cis, trans



## 3. HEALTH EFFECTS

**Table 3-9. Genotoxicity of Dichloropropenes *In Vitro***

Species (test system)	End point	Results		Reference	Isomer/ formulation
		With activation	Without activation		
Mouse lymphoma cell L5178Y	Mutagenesis	No data	+	Myhr and Caspary 1991	Telone II cis, trans
Chinese hamster ovary cells	Sister chromatid exchange	+	+	Loveday et al. 1989	97.1% pure
Chinese hamster ovary cells	Chromosomal aberrations	-	-	Loveday et al. 1989	97.1% pure
Chinese hamster V79 cells	Sister chromatid exchange	-	+	von der Hude et al. 1987	cis, trans
Chinese hamster lung cells	Mitotic aberrations	+	+	Sasaki et al. 1988	cis + trans
Chinese hamster lung cells	Chromosomal aberrations	+	+	Matsuoka et al. 1998	96.5% pure
Rat hepatocytes	Unscheduled DNA synthesis	No data	+	Martelli 1997	NS
Human lymphocytes	Unscheduled DNA synthesis	No data	+	Martelli 1997	NS
Human lymphocytes	Sister chromatid exchange	+	+	Kevekordes et al. 1996	cis, trans 95% pure
<b>Acellular test system</b>					
2'-Deoxyguanosine	Adduct formation	NA	+	Schneider et al. 1998a	cis or trans epoxide; 3-chloro- 3-hydroxy- propanal <sup>n</sup>
2'-Deoxyadenosine or 2'-Deoxycytidine	Adduct formation	NA	-	Schneider et al. 1998a	cis or trans epoxide; 3-chloro- 3-hydroxy- propanal <sup>n</sup>
<b>2,3-Dichloropropene</b>					
<b>Prokaryotic organisms</b>					
<i>S. typhimurium</i> (TA102, TA2638)	Reverse mutation	+	+	Watanabe et al. 1998	NS
<i>S. typhimurium</i> (TA100, TA1535, TA97, TA98)	Reverse mutation	+	+	Zeiger et al. 1988)	98% pure
<i>E. coli</i> (WP2/pKM101)	Reverse mutation	-	-	Watanabe et al. 1998	NS
<i>E. coli</i> (WP2 <i>uvrA</i> /pKM101)	Reverse mutation	+	+	Watanabe et al. 1998	NS
<i>S. typhimurium</i> (TA100)	Reverse mutation	-	-	Lag et al. 1994	98% pure
<i>S. typhimurium</i> (TA100)	Reverse mutation	No data	+	Neudecker and Henschler 1986	99.5% pure

## 3. HEALTH EFFECTS

**Table 3-9. Genotoxicity of Dichloropropenes *In Vitro***

Species (test system)	End point	Results		Reference	Isomer/ formulation
		With activation	Without activation		
<i>S. typhimurium</i> (TA100)	Reverse mutation	+	+	Stolzenberg and Hine 1980	98% pure
<i>S. typhimurium</i> (TA1535, TA1978, TA100)	Reverse mutation	+	+	De Lorenzo et al. 1977	cis, trans
<i>S. typhimurium</i> (TA100)	Reverse mutation	+	+	Eder et al. 1982a, 1986	NS
Eukaryotic organisms:					
<i>A. nidulans</i>	Mitotic segregation	No data	+	Crebelli et al. 1992	98% pure
<i>A. nidulans</i>	Induced aneuploidy	No data	+	Rosenkranz and Klopman 1996	NS
Chinese hamster ovary cells	Sister chromatid exchange	+	+	Loveday et al. 1990	98% pure
Chinese hamster V79 cells	Sister chromatid exchange	+	+	von der Hude et al. 1987	99% pure
Chinese hamster ovary cells	Chromosomal aberrations	+	+	Loveday et al. 1990	98% pure
Rat hepatocyte	DNA repair	No data	–	Williams et al. 1989	NS
HeLa cells	Unscheduled DNA synthesis	No data	+	Schiffmann et al. 1983	NS

<sup>a</sup>cis- and trans-1,3-dichloropropene supplied by K&K Laboratories

<sup>b</sup>cis- and trans-1,3-dichloropropene supplied by Pfaltz and Bauer, Inc.

<sup>c</sup>Low-boiling 1,3-dichloropropene supplied by K&K Laboratories

<sup>d</sup>High-boiling 1,3-dichloropropene supplied by K&K Laboratories

<sup>e</sup>Pfaltz and Bauer 1,3-dichloropropene was purified; impurities were then added back (refluxed) for the mutagenicity assay.

<sup>f</sup>cis-1, 3-dichloropropene

<sup>g</sup>Impurities from purified cis-1,3-dichloropropene

<sup>h</sup>Metabolites of 1,3-dichloropropene

+ = positive response; – = negative response

## 3. HEALTH EFFECTS

**1,1-Dichloropropene.** Positive evidence for the mutagenicity of 1,1-dichloropropene was reported for the  $\lambda$  (lambda) transgenic medaka fish that were exposed in aquaria water continuously for 6 weeks (Winn et al. 2006). The transgenic medaka is homozygous for the lambda bacteriophage vector that expresses *lacI* and *cII* bacterial genes. Assays of liver DNA for mutations in the *cII* gene revealed concentration-related increases in mutation frequencies in exposed fish compared to controls: from a 6-fold increase at 0.44 mg/L to a 32-fold increase at 16.60 mg/L. The pattern of induced mutation types was distinct from that produced spontaneously in controls, with the most frequent induced type being a +1 frameshift mutation (comprising 69.4% of the mutations) occurring at a 166-fold increase in fish treated at 16.6 mg/L compared to controls.

**1,3-Dichloropropene.** A single inhalation-exposure study reported no evidence of an increase in dominant lethal mutations in rats exposed intermittently at 150 ppm for up to 10 weeks (Gollapudi et al. 1998).

Positive evidence for genotoxicity of 1,3-dichloropropene was reported in several oral-exposure studies. In a *Drosophila melanogaster* feeding study 1,3-dichloropropene produced sex-linked recessive lethal mutations (Valencia et al. 1985). DNA fragmentation was detected by alkaline elution in livers of female rats orally dosed with 94 mg/kg (Kitchin and Brown 1994), the livers and gastric mucosa of male rats orally dosed with  $\geq 62.5$  mg/kg and kidneys of male rats orally dosed with 125 mg/kg (Ghia et al. 1993), and the stomach, liver, kidney, bladder, lung, brain, and bone marrow of male mice orally dosed with 150 mg/kg (Sasaki et al. 1998). No DNA fragmentation was observed in rat lung, bone marrow, or brain of rats orally dosed with up to 125 mg/kg (Ghia et al. 1993). Some of the studies reported positive evidence of DNA damage a few hours after exposure, but apparent recovery to normal conditions by 24 hours after exposure was noted.

No increase in unscheduled DNA synthesis was observed in rats dosed orally with 125 mg/kg (Ghia et al. 1993). One study reported positive results for increased micronucleus production in bone marrow of mice that received an oral dose of 187 mg/kg 1,3-dichloropropene (Kevekordes et al. 1996), but all other micronucleus assays in rats or mice were negative (Ghia et al. 1993; Kevekordes et al. 1996; Morita et al. 1997a; Sasaki et al. 1994).

Studies examining genotoxic endpoints in mammals following *in vivo* exposure to 1,1-, 1,2- and 2,3-dichloropropene were not located.

## 3. HEALTH EFFECTS

**Genotoxic Effects *in Vitro*.** Four of the isomers, 1,1-dichloropropene, 1,2-dichloropropene, 1,3-dichloropropene, and 2,3-dichloropropene, have been tested for genotoxicity *in vitro* (Table 3-9).

**1,1-Dichloropropene.** Positive results following exposure to 1,1-dichloropropene were reported for reverse mutation in *Salmonella typhimurium* strain TA100 with or without metabolic activation (Neudecker et al. 1986). However, a more recent study reported negative results in TA100, but positive results in strain RSJ100, which expresses glutathione transferase (Granville et al. 2005). This isomer apparently is bioactivated by glutathione (directly or by catalysis by glutathione transferase) to form a mutagenic epoxide (Granville et al. 2005). Other negative results were reported for mutagenicity in *S. typhimurium* strains TA1535 and TA104 (Granville et al. 2005), mitotic segregation or induced aneuploidy in yeast (Crebelli et al. 1992; Rosenkranz and Klopman 1996), and DNA fragmentation in cultured human lymphoblastoid cells (Granville et al. 2005).

**1,2-Dichloropropene.** A single study reported no increase in the frequency of reverse mutations in *S. typhimurium* strain TA100 exposed to 1,2-dichloropropene (Neudecker et al. 1986).

**1,3-Dichloropropene.** A significant amount of evidence is available for the genotoxicity of 1,3-dichloropropene *in vitro*. Several groups have reported that 1,3-dichloropropene is mutagenic *in vitro* with and without metabolic activation in *S. typhimurium* (Creedy et al. 1984; De Lorenzo et al. 1977; Eder et al. 1982a, 1982b; Haworth et al. 1983; Neudecker and Henschler 1986; Neudecker et al. 1977, 1980; Stolzenberg and Hine 1980; Vithayathil et al. 1983). In contrast, 1,3-dichloropropene purified on silic acid columns was not mutagenic in *S. typhimurium* strain TA100 without activation (Talcott and King 1984). Silic acid removes polar impurities, which when added back to the purified 1,3-dichloropropene, restore the mutagenic activity (Talcott and King 1984). For one of the batches (indicated by footnote b in Table 3-9), the mutagenic impurities were identified as oxidation products of 1,3-dichloropropene, namely epichlorohydrin and 1,3-dichloro-2-propanol. An independent group confirmed the lack of mutagenicity of purified 1,3-dichloropropene in strain TA100 without activation and also found that the trace impurities alone, *cis*- and *trans*-2-chloro-3-(chloromethyl)oxiranes (dichloropropene oxides), formed slowly by autoxidation were mutagenic (Watson et al. 1987). As Watson et al. (1987) determined that storage under nitrogen prevented the production of the mutagenic dichloropropene oxides, it seems likely that relatively pure 1,3-dichloropropene will develop trace amounts of mutagenic autoxidation products if stored in contact with oxygen in air. Watson et al. (1987) also demonstrated that the presence of physiological levels of glutathione were sufficient to block mutagenicity of bioactivated 1,3-dichloro-

## 3. HEALTH EFFECTS

propene. Positive evidence of DNA damage, as indicated by SOS induction, were observed in *Escherichia coli* PQ37 without activation (von der Hude et al. 1988).

In cultured eukaryotic systems, 1,3-dichloropropene was mutagenic in mouse lymphoma L5178Y cells without exogenous activation (Myhr and Caspary 1991). Exposure to 1,3-dichloropropene increased the frequency of mitotic aberrations in Chinese hamster lung cells (Sasaki et al. 1988), but did not induce aberrant mitotic segregation or aneuploidy in yeast cells (Crebelli et al. 1992; Rosenkranz and Klopman 1996). Increases in the frequency of sister chromatid exchange were observed in exposed Chinese hamster V79 cells without activation (von der Hude et al. 1987), human lymphocytes with or without activation (Kevekordes et al. 1996), and Chinese hamster ovary cells with or without activation (Loveday et al. 1989). 1,3-Dichloropropene triggered unscheduled DNA synthesis in HeLa cells (Eder et al. 1987; Schiffmann et al. 1983), and in human lymphocytes and rat hepatocytes without exogenous activation (Martelli 1997).

In an acellular test system, three metabolites of 1,3-dichloropropene, namely the cis and trans epoxides of 1,3-dichloropropene and 3-chloro-3-hydroxypropanal, formed adducts with 2'-deoxyguanosine, but not with 2'-deoxyadenosine or 2'-deoxycytidine (Schneider et al. 1998b).

**2,3-Dichloropropene.** There is positive evidence for genotoxicity of 2,3-dichloropropene in prokaryotic and eukaryotic systems.

Increases in the frequency of reverse mutations, with or without activation, were observed for most studies in *S. typhimurium* strains TA100, TA102, TA97, TA98, TA1535, TA1978, and TA2638 (De Lorenzo et al. 1977; Eder et al. 1982a; Neudecker and Henschler 1986; Stolzenberg and Hine 1980; Watanabe et al. 1998; Zeiger et al. 1988). An increase in reverse mutations was observed in *E. coli* strain WP2 *uvr*/pkM101, with or without activation, but not in strain WP2/pkM101 (Watanabe et al. 1998).

In eukaryotic systems, 2,3-dichloropropene increased aberrant mitotic segregation and aneuploidy in yeast (Crebelli et al. 1992; Rosenkranz and Klopman 1996), the frequency of sister chromatid exchanges in Chinese hamster ovary cells (Loveday et al. 1990) and Chinese hamster V79 cells (von der Hude et al. 1987), and the frequency of chromosomal aberrations in Chinese Hamster ovary cells (Loveday et al. 1990). An increase in unscheduled DNA synthesis was observed in HeLa cells exposed without activation (Schiffmann et al. 1983), but there was no evidence of increased DNA repair in cultured rat hepatocytes (Williams et al. 1989).

## 3. HEALTH EFFECTS

**3.4 TOXICOKINETICS**

1,3-Dichloropropene is quickly and extensively absorbed through both the respiratory tract and gastrointestinal tract; 1,3-dichloropropene vapor can be absorbed through the skin. Absorbed 1,3-dichloropropene is distributed widely throughout the body, at greatest levels in the stomach and urinary bladder after oral exposure. 1,3-Dichloropropene is primarily metabolized in the liver by conjugation to glutathione, resulting in the excretion of mercapturic acid metabolite in urine. Two minor metabolic pathways include hydrolysis with dechlorination resulting in intermediates that are substrates for alcohol dehydrogenase, and reaction with cytochrome P-450, resulting in the formation of mutagenic epoxides. Elimination of 1,3-dichloropropene is very rapid, irrespective of the route of absorption.

2,3-Dichloropropene is rapidly and extensively absorbed through the gastrointestinal tract and respiratory tract; no toxicokinetic data are available for absorption of this isomer through the skin. Absorbed 2,3-dichloropropene is distributed widely throughout the body, especially the urinary bladder, nasal turbinates, and kidney after inhalation exposure, and liver, kidney, testes, and lung after oral exposure. The primary metabolic pathway of 2,3-dichloropropene is similar to that of 1,3-dichloropropene, with conjugation to glutathione resulting in the urinary elimination of a mercapturic acid metabolite. Minor pathways include a hydrolysis and dechlorination pathway resulting in the formation of glucuronide metabolite or an epoxidation pathway. The majority of absorbed 2,3-dichloropropene is eliminated within the first 24 hours of exposure.

No data are available for the absorption, distribution, or elimination of 1,1-dichloropropene by any route of exposure. Data from an *in vitro* metabolism study indicate that bioactivation of 1,1-dichloropropene by reaction with glutathione results in the formation of a mutagenic episulfonium ion.

No data are available for the absorption, distribution, metabolism, or elimination of 1,2- or 3,3-dichloropropene.

**3.4.1 Absorption**

The absorption of 1,3- and 2,3-dichloropropene is rapid by the inhalation and oral routes.

## 3. HEALTH EFFECTS

**3.4.1.1 Inhalation Exposure**

**1,3-Dichloropropene.** Published quantitative data are not available for the absorption of 1,3-dichloropropene in humans following inhalation exposure. An unpublished study by Waechter et al. (1992) described absorption pharmacokinetics in six male human volunteers exposed to 1 ppm Telone II<sup>®</sup> (50.6% cis isomer; 42% trans isomer) for 6 hours. Specimens of expired air and venous blood collected 5, 15, 30, 45, 60, 180, 240, and 360 minutes from the start of exposure and 5, 10, 15, 20, 30, 60, 120, and 240 minutes after the end of exposure were assayed for the presence of cis and trans isomers. Urine samples collected for two consecutive 12-hour periods just before exposure, a short period just before exposure, the 6 hours of exposure, and the first 6 hours and seven consecutive 12-hour periods after exposure were assayed for the presence of creatinine and mercapturic acid metabolites (cis- and trans-N-acetyl-S-(3-chloroprop-2-enyl)cysteine). Calculation of the percent absorption of 1,3-dichloropropene for the six individuals ranged from 72 to 80% for the cis isomer and from 77 to 82% for the trans isomer. Indirect evidence for absorption comes from the detection of the N-acetyl-cysteine conjugate of 1,3-dichloropropene in the urine of four men 24 hours after field application of Telone II<sup>®</sup>a (Osterloh et al. 1984).

Quantitative data from animal studies support this observation in humans. Mixtures of cis and trans isomers of 1,3-dichloropropene were rapidly absorbed by rats after inhalation exposure (Stott and Kastl 1986). The rates of vapor uptake in rats exposed to 30, 90, 300, or 900 ppm were 144±14, 307±13, 880±83, or 1810±76 nmol/minute, respectively. However, because a decrease in the respiratory rate was observed in rats exposed to ≥90 ppm, the average calculated percentages of inhaled vapors that were absorbed were similar: 82, 65, 66, and 62%, respectively for the low-to-high exposures. Steady-state blood levels were reached within 1 hour at 30 and 90 ppm and within 2–3 hours at 300 ppm, but did not reach steady state within 3 hours at 900 ppm. The increased length of time required to reach steady state at 300 and 900 ppm was likely a function of the observed decrease in respiratory rate. Nonlinear excretion kinetics also contributed to the decreased uptake observed at 300 and 900 ppm; disproportionate increases in the blood levels of cis-1,3-dichloropropene at 900 ppm and of trans-1,3-dichloropropene at 300 and 900 ppm could indicate changes in distribution and/or metabolism.

An apparent steady state in blood levels of the glutathione conjugate of 1,3-dichloropropene was detected in rats first assayed within 1 hour after exposure to 78, 155, or 404 ppm Telone II<sup>®</sup>a (Fisher and Kilgore 1989). No exposure-response relationship was detected: each of these exposure conditions produced similar concentrations of the glutathione conjugate in blood.

## 3. HEALTH EFFECTS

**2,3-Dichloropropene.** Quantitative data are not available on the absorption of 2,3-dichloropropene in humans following inhalation exposure, but data are available for animals. In Fischer 344 rats exposed (nose-only) to radiolabeled 2,3-dichloropropene vapor at 0.4 ppm for 6 hours, 5.9 ppm for 5.1 hours, or 40.3 ppm for 6 hours (17, 240, or 1,650 nmol/L), the percentages of inhaled compound that was absorbed were 40, 35, or 39%, respectively, or 38% on average (Dutcher et al. 1985). A 25% decrease in the respiratory rate during exposure at 40.3 ppm compared to 0.4 ppm resulted in a statistically significant 15% reduction in the minute volume (170 mL/minute compared to 200 mL/minute), but this had no effect on the percentage of compound absorbed. No data were located for steady-state blood levels of 2,3-dichloropropene following inhalation exposure.

**3.4.1.2 Oral Exposure**

**1,3-Dichloropropene.** No studies were located regarding absorption of 1,3-dichloropropene in humans after oral exposure.

1,3-Dichloropropene was well absorbed following gavage administration of <sup>14</sup>C-labeled cis- and/or trans-1,3-dichloropropene in rats (Climie et al. 1979; Hutson et al. 1971). Recovery of [<sup>14</sup>C]cis-1,3-dichloropropene in 24-hour urine collections was 82–84% in rats (Climie et al. 1979). Similarly, 82–84% of <sup>14</sup>C-labeled cis-1,3-dichloropropene was recovered in urine, and 2–3% was recovered in feces during a 96-hour urine collection period after gavage administration in rats (Hutson et al. 1971). In contrast, only 55–60% of the <sup>14</sup>C-labeled trans-1,3-dichloropropene was recovered in the urine and 2% was recovered in the feces during the same period. These data indicate that both isomers of 1,3-dichloropropene are extensively absorbed by the oral route of exposure, which could lead to distribution throughout the body.

Since a microencapsulation method was developed for administering 1,3-dichloropropene as Telone II<sup>®b</sup> in diets, Stott et al. (1998) conducted experiments to verify that the compound would be bioavailable in that form. The absorption of neat <sup>13</sup>C-labeled-1,3-dichloropropene and 1,3-dichloropropene microencapsulated in a starch/sucrose matrix was compared in rats dosed simultaneously with equal amounts (25 mg/kg) of the two forms by oral gavage (Stott et al. 1998). Absorption of either form was rapid, peak blood concentrations being reached within 10 minutes of dosing. The half-lives of absorption into the blood (not defined, but presumably the half-times to reach maximal levels in blood) were short: 2.5 minutes for the neat cis isomer, 1.3 minutes for the encapsulated cis isomer, 2.7 minutes for the neat trans isomer, and 2.3 minutes for the encapsulated trans isomer. Blood area under the curve (AUC)



### 3. HEALTH EFFECTS

values were 1.239 mg · minute/L for the neat cis isomer, 1.601 mg · minute/L for the encapsulated cis isomer, 4.369 · minute/L for the neat trans isomer, and 5.552 mg · minute/L for the encapsulated trans isomer. Encapsulated compound represented a larger proportion of the total AUC: 56 versus 44%. In a real-time monitoring experiment, the half-life of absorption of neat 1,3-dichloropropene was 5.5 minutes and that of encapsulated compound was 3.2 minutes. Under these conditions, neat compound represented 34% of the AUC and encapsulated represented 66%. This study confirmed the bioavailability of 1,3-dichloropropene administered microencapsulated in feed.

**2,3-Dichloropropene.** No studies were located regarding absorption of 2,3-dichloropropene in humans after oral exposure.

2,3-Dichloropropene was well absorbed following oral gavage administration in rats (Medinsky et al. 1984). In rats given 32 mg/kg of <sup>14</sup>C-labeled 2,3-dichloropropene by oral gavage, approximately 91% of the oral dose was absorbed, as estimated from recovery of radioactivity from urine.

#### 3.4.1.3 Dermal Exposure

**1,3-Dichloropropene.** In an experiment in which volunteers exposed forearm skin to cis-1,3-dichloropropene vapor at a concentration of 86 mg/m<sup>3</sup> (19 ppm) for 45 minutes, penetration of the compound was detected by the presence of the metabolite cis-1,3-dichloropropene-mercaptopuric acid in urine over a 20-hour period (Kezic et al. 1996). The authors estimated that dermal absorption would account for 2–5% of absorption from inhalation in a whole-body exposure scenario. No studies were located regarding the absorption of 1,3-dichloropropene after dermal exposure in humans or animals. The dermal LD<sub>50</sub> for 1,3-dichloropropene in rabbits has been determined and indicates that this compound is absorbed by the dermal route of exposure (Lichy and Olson 1975).

#### 3.4.2 Distribution

##### 3.4.2.1 Inhalation Exposure

**1,3-Dichloropropene.** In six volunteers who inhaled 1 ppm of 1,3-dichloropropene (50.6% cis; 45% trans; 2% epoxidized soybean oil) for 6 hours, blood concentrations ranged from 0.3 to 2 ppb for the cis isomer and from 1 to 3.6 ppb for the trans isomer (Waechter et al. 1992).

## 3. HEALTH EFFECTS

**2,3-Dichloropropene.** In male Fischer rats immediately following a 6-hour inhalation exposure to radiolabeled 2,3-dichloropropene vapor at a concentration of 250 nmol/L, peak concentrations of label in blood (8 nmol/mL) occurred at the end of exposure (Bond et al. 1985). Immediately after exposure, about 9% of the absorbed radioactivity was detected in tissues: 150 nmol/g in urinary bladder, 125 nmol/g in nasal turbinates, 84 nmol/g in kidneys, 61 nmol/g in small intestine, 35 nmol/g in liver, 15.6 nmol/g in trachea, 11.9 nmol/g in larynx, and smaller concentrations in other tissues. Immediately after exposure, the carcass (muscle, bone, pelt, and fat) accounted for 15% of absorbed label. Tissue concentrations of label were reduced by 80% after 60 hours.

Following inhalation exposure of male Fischer 344 rats to radiolabeled 2,3-dichloropropene at concentrations between 0.4 and 40 ppm, the percentages of initial burden detected in tissues (per gram of tissue) 60 hours after exposure were highest for nasal turbinates (0.43%), kidney (0.35%), pelt (0.21%), and lung (0.09%) (Dutcher et al. 1985). Radioactivity associated with hair accounted for 75% of that found in the pelt.

#### 3.4.2.2 Oral Exposure

**1,3-Dichloropropene.** No studies were located regarding distribution of 1,3-dichloropropene in humans after oral exposure.

Analysis of the distribution of radioactivity 48 hours after gavage administration of <sup>14</sup>C-cis/trans-1,3-dichloropropene to rats revealed essentially equal distribution of 1,3-dichloropropene or its metabolites to most organs and tissues (Waechter and Kastl 1988). The highest concentrations of radioactivity were found in the nonglandular stomach and the urinary bladder. Lower concentrations of radioactivity were also found in blood, bone, brain, fat, heart, kidney, liver, lung, skeletal muscle, skin, spleen, ovaries, and testes.

**2,3-Dichloropropene.** Seventy-two hours after male Fischer 344 rats received an oral dose of 32 mg/kg radiolabeled 2,3-dichloropropene, 20% of retained label was found in the liver, and lesser, but substantial amounts (not quantified in the report) were found in the kidney, testes, lung, and brain (Medinsky et al. 1984). Tissues that had, on a per gram basis, label concentrations higher than the carcass (8 nmol/g), included the liver, kidney, testes, lung, brain, adrenals, spleen, and nasal turbinates.

## 3. HEALTH EFFECTS

**3.4.2.3 Dermal Exposure**

No studies were located regarding the distribution of any isomer of dichloropropene after inhalation exposure in humans or animals.

**3.4.3 Metabolism**

**1,3-Dichloropropene.** The proposed metabolic pathways for 1,3-dichloropropene in rats are presented in Figure 3-5. The major metabolic pathway is rapid conjugation with glutathione, resulting in the formation of a mercapturic acid metabolite that is excreted in the urine. 1,3-Dichloropropene may also undergo hydrolysis and dechlorination to form 1-chloroallyl alcohol, an intermediate that reacts with alcohol dehydrogenase to form 1-chloroacrolein. Another minor pathway involves reaction with cytochrome P450 to form mutagenic cis and trans epoxides that convert to the mutagen 3-chloro-2-hydroxy-propanal (Schneider et al. 1998a).

The N-acetyl-cysteine conjugate of cis-1,3-dichloropropene was detected in the urine of four men exposed occupationally to Telone II<sup>®</sup>a, indicating that glutathione conjugation is a metabolic pathway in humans (Osterloh et al. 1984). Exposure levels were monitored by personal dosimeters. A strong correlation was found between exposure levels of 1,3-dichloropropene and urinary excretion of the N-acetyl-cysteine conjugate ( $r=0.83$ ). These data are presented in Figure 3-6.

1,3-Dichloropropene was rapidly metabolized to the glutathione conjugate in rats after inhalation exposure (Fisher and Kilgore 1989). The blood level of the glutathione conjugate reached a steady state of 116 nmol/mL within 15 minutes after exposure of rats to 610 ppm Telone II<sup>®</sup>a or 1 hour after exposure to 78, 155, or 404 ppm. These results may reflect saturation of metabolism (or depletion of co-factor). The increase in blood levels of the glutathione conjugate correlated with the decrease in nonprotein sulfhydryl (glutathione) content of nasal tissues (Fisher and Kilgore 1988a). Glutathione levels in the kidney and liver were also decreased after inhalation exposure of rats to 90 ppm Telone II<sup>®</sup>a (the only concentration tested), but lung levels were not affected (Stott and Kastl 1986). The data indicate that conjugation with glutathione can occur in the nasal tissue, kidney, and liver. The glutathione conjugate of 1,3-dichloropropene is then converted to the mercapturic acid and acetylated for excretion as the N-acetyl-cysteine metabolite (Fisher and Kilgore 1988b).

## 3. HEALTH EFFECTS

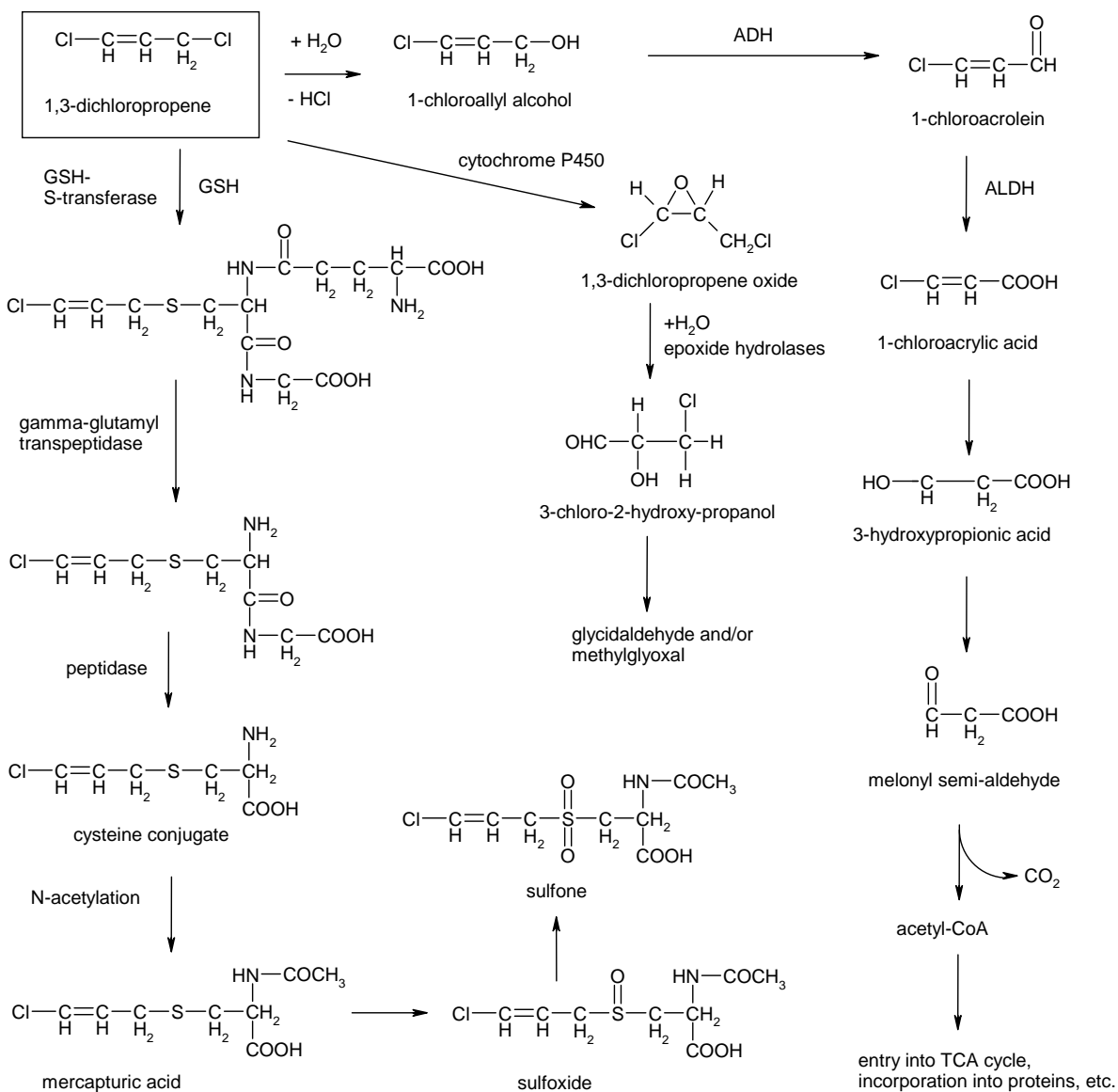
**Figure 3-5. Proposed Metabolic Pathway for 1,3-Dichloropropene in the Rat**

Source: adapted from Schneider et al. 1998

## 3. HEALTH EFFECTS

**Figure 3-6. Correlation of Exposure to 1,3-Dichloropropene with Urinary Excretion of the N-Acetyl Cysteine Metabolite**

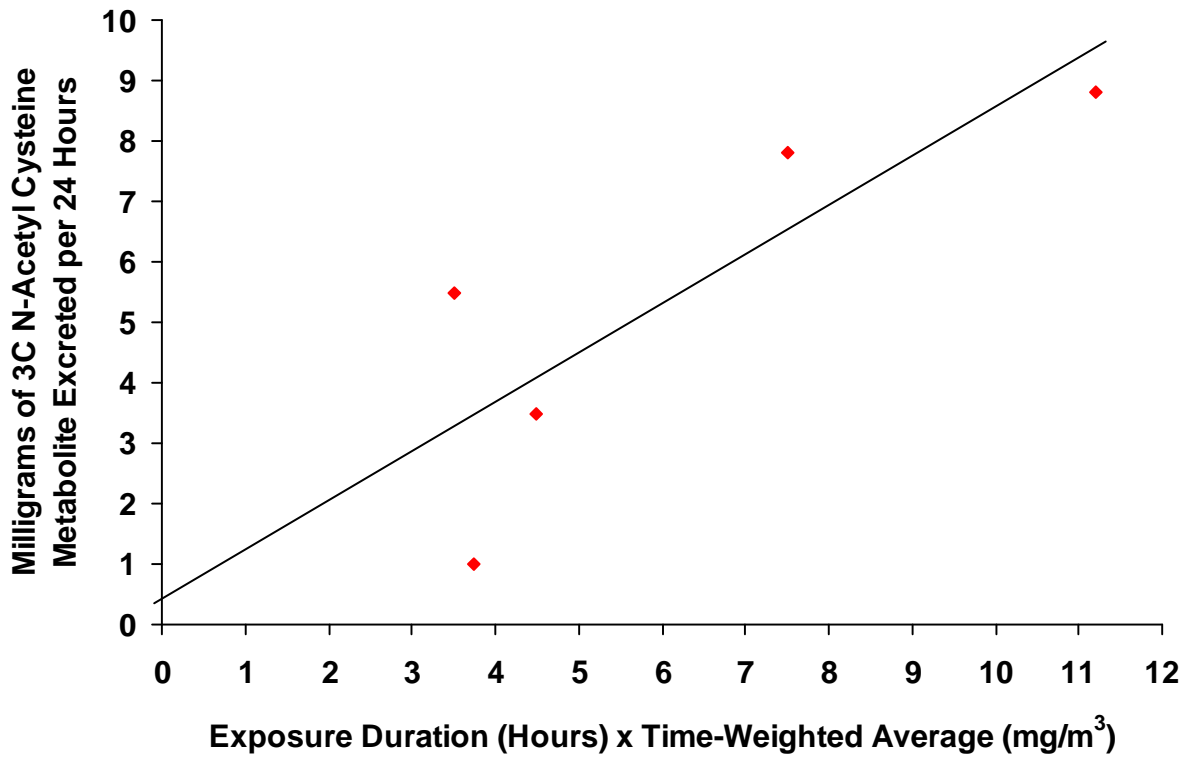

Source: derived from Osterloh et al. 1984

## 3. HEALTH EFFECTS

The two isomers of 1,3-dichloropropene appear to be metabolized at different rates. Plateau blood levels of the cis and trans isomers were  $0.085 \pm 0.024$  and  $0.12 \pm 0.03$   $\mu\text{g/mL}$ , respectively, in rats exposed to 30 ppm Telone II<sup>®</sup>a for 1 hour, and  $0.20 \pm 0.04$  and  $0.26 \pm 0.03$   $\mu\text{g/mL}$ , respectively, in rats exposed to 90 ppm Telone II<sup>®</sup>a for 1 hour. Plateau blood levels reached after 2–3 hours in rats exposed to 300 ppm were  $0.89 \pm 0.2$  and  $1.87 \pm 0.27$   $\mu\text{g/mL}$  for the cis and trans isomers, respectively (Stott and Kastl 1986). *In vitro* studies using a rat liver enzyme preparation revealed that the cis isomer was metabolized four to five times faster than the trans isomer (Climie et al. 1979).

Orally administered 1,3-dichloropropene is also metabolized by conjugation with glutathione (Climie et al. 1979). Urine collected for 24 hours after oral administration of <sup>14</sup>C-labeled cis-1,3-dichloropropene in rats yielded 82–84% of the radioactivity as the N-acetyl-cysteine conjugate of 1,3-dichloropropene. Two other urinary metabolites that accounted for 3 and 5% of the administered radioactivity were found but not identified (Climie et al. 1979). Tissue nonprotein sulfhydryl content was assayed in mice following a single gavage administration of 50 mg/kg cis- and trans-1,3-dichloropropene (Dietz et al. 1982). Decreased tissue nonprotein sulfhydryl levels were observed in the forestomach, glandular stomach, liver, and kidney, which indicated that glutathione conjugation occurred at these sites.

No differences were observed in the distribution or the rate and extent of metabolism or excretion of 1,3-dichloropropene after gavage administration between rats that received a single dose and rats that received repeated doses. Furthermore, no differences in distribution, metabolism, or excretion of 1,3-dichloropropene were observed between male and female rats (Waechter and Kastl 1988).

The mercapturic acid metabolite of cis-1,3-dichloropropene was detected in the urine of volunteers who exposed their forearm skin to a vapor concentration of  $86 \text{ mg/m}^3$  (19 ppm) for 45 minutes (Kezic et al. 1996).

Alternative metabolic pathways for cis and trans 1,3-dichloropropenes (individually and as an equimolar mixture) were studied in the liver of mice exposed by intraperitoneal injection (Schneider et al. 1998a). Within 150 minutes of injection, reaction with cytochrome P-450 resulted in the formation of cis- and trans-1,3-dichloropropene epoxides, with the cis-epoxide preferentially formed at a ratio of 4:1; the higher level of the cis epoxide was detectable within 10 minutes of exposure. The epoxides were stereospecific to the parent compound. The 1,3-dichloropropene epoxides undergo hydrolysis, possibly catalyzed by epoxide hydrolase, to 3-chloro-2-hydroxypropanal. *In vitro* experiments confirmed the generation of isomer-specific epoxides when cis and trans 1,3-dichloropropene were incubated in the presence of mouse

## 3. HEALTH EFFECTS

liver microsomes plus NADPH (Schneider et al. 1998a). No recovery of acroleins (2-acrolein or cis- and trans-3-acrolein) were detectable in these *in vitro* experiments, suggesting that oxidation by cytochrome P-450 is a minor pathway.

In an oral gavage study in F344 rats and B6C3F1 mice, Bartels et al. (2000) evaluated the epoxidation pathway proposed for 1,3-dichloropropene by Schneider et al. (1998a) on the basis of intraperitoneal injection. Following gavage administration of 100 mg/kg by oral gavage, no dichloropropene oxides were detectable in liver or blood of rats or mice during the 90 minutes postdosing (detection limit was 10 ng/g tissue). In mice injected with 100 mg/kg, no dichloropropene oxides were detectable in liver and only a small amount (17 ng/g) was detected in blood. Significant detection of dichloropropene oxides occurred after injection of 700 mg/kg into mice, a dose that caused significant hepatotoxicity and/or death. Bartels et al. (2000) concluded that the epoxidation pathway was of minor significance for exposures not leading to hepatotoxicity or death.

The metabolism of 1,3-dichloropropene was evaluated in an *in vitro* system in which the compound was added as a vapor in the headspace above a mixture containing rat liver microsomes or cytosol from rat or mouse (Granville et al. 2005). Glutathione reacted nonenzymatically with 1,3-dichloropropene at a rate about half that catalyzed by glutathione transferase. Monochloropropenes were the products of these reactions. The rate of glutathione transferase-dependent conjugation to glutathione was 10.3 nmol glutathione/minute/mg protein.

In an analysis of metabolism of cis and trans isomers of 1,3-dichloropropene, Vos et al. (1991) identified individuals that did not express the mu class of glutathione S-transferase enzymes, but did express alpha- and pi-class GST. Although the mu class enzyme was demonstrated to have 2- to 3-fold higher activity with the cis than the trans isomer of 1,3-dichloropropene, and higher activity with cis-1,3-dichloropropene compared to alpha- and pi-class GST, individuals not expressing the mu enzyme showed no significant differences with respect to urinary excretion ratios of cis- and trans-mercapturic acid metabolites. These results suggest that glutathione S-transferases, besides mu-class enzymes, may play a more significant role in the metabolism of 1,3-dichloropropene.

**2,3-Dichloropropene.** Proposed metabolic pathways for 2,3-dichloropropene are shown in Figure 3-7. The major pathway is a detoxifying conjugation to glutathione, leading to the elimination of mercapturic acid metabolites in the urine (Bond et al. 1985; Eder and Dornbusch 1988; Eder et al. 1987). Two secondary pathways result in the formation of mutagenic metabolites. One involves cytochrome P450-

## 3. HEALTH EFFECTS

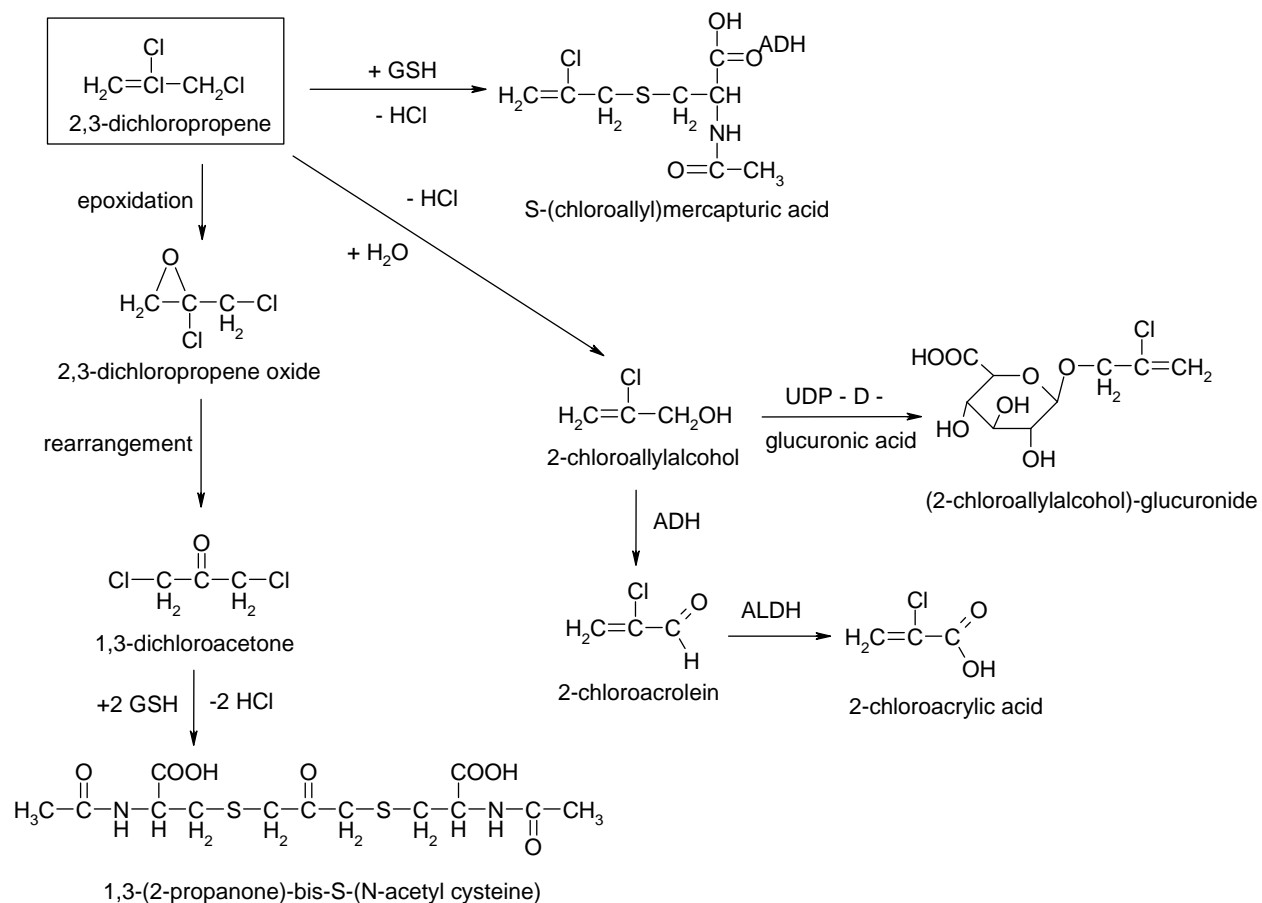
**Figure 3-7. Proposed Metabolic Pathway for 2,3-Dichloropropene in the Rat**

Source: adapted from Eder et al. (1987)



### 3. HEALTH EFFECTS

induced formation of an epoxide that undergoes spontaneous rearrangement to form the mutagen 1,3-dichloroacetone. The other involves hydrolysis and dechlorination to form an intermediate (2-chloroallyl alcohol) that can either be detoxified by conjugation to glucuronic acid or bioactivated by alcohol dehydrogenase to form the mutagen 2-chloroacrolein (Eder and Dornbusch 1988; Eder et al. 1986, 1987). It is evident that depletion of glutathione stores, more likely to occur under bolus exposure conditions, would result in the formation of proportionally more mutagenic metabolites.

***1,1-Dichloropropene.*** The metabolism of 1,1-dichloropropene was evaluated in an *in vitro* system in which the compound was added as a vapor in the headspace above a mixture containing rat liver microsomes or cytosol from rat or mouse (Granville et al. 2005). Results of this study indicated that glutathione transferase catalyzes the bioactivation of 1,1-dichloropropene by glutathione to a single unsaturated S-conjugate retaining one chlorine atom. The rate of conjugation was 0.33 nmol glutathione/minute/mg protein, which was lower than the rate for 1,3-dichloropropene (see above). It was postulated that the thiolate ion of glutathione could attack 1,1-dichloropropene at either the C1 or C2 position, with attack at the C2 position resulting in the formation of a mutagenic episulfonium ion. This hypothesis was supported by separate experiments showing mutagenicity of 1,1-dichloropropene in *S. typhimurium* strain RSJ100, which expresses rat glutathione transferase (GSTT1-1), but not in the nonexpressing strain TA100.

#### 3.4.4 Elimination and Excretion

##### 3.4.4.1 Inhalation Exposure

***1,3-Dichloropropene.*** In male volunteers exposed by inhalation to 1 ppm 1,3-dichloropropene (50.6% cis; 45% trans; 2% epoxidized soybean oil) for 6 hours, concentrations of cis and trans isomers (parent compound) in exhaled air reached a plateau within the first hour of exposure and fell rapidly to undetectable levels within 1 hour after the end of exposure (Waechter et al. 1992). In the same study, urinary excretion of N-acetyl-cysteine conjugates of cis- and trans-1,3-dichloropropene exhibited a biphasic pattern. The half-lives for urinary elimination of the cis and trans conjugates averaged  $4.2 \pm 0.8$  and  $3.2 \pm 0.8$  hours, respectively, for the initial phase, and  $12.3 \pm 2.4$  and  $17.1 \pm 6.0$  hours, respectively, for the terminal phase. Urinary excretion was 89–99% complete by 24 hours from the start of exposure. Approximately 75% of the absorbed dose of cis-1,3-dichloropropene was excreted in urine as 1,3-dichloropropene-N-acetyl-cysteine, whereas only 25% of absorbed trans-1,3-dichloropropene was excreted in urine as the N-acetyl-cysteine conjugate.

## 3. HEALTH EFFECTS

A strong correlation was reported for humans between occupational exposure to Telone II<sup>®</sup>a and urinary levels of the N-acetyl-cysteine conjugate of cis-1,3-dichloropropene ( $r=0.83$ ) (Osterloh et al. 1984). In 12 soil fumigators exposed to 8-hour time weighted average (TWA) concentrations from 1.9 to 18.9 mg/m<sup>3</sup> cis/trans-dichloropropene, the half-life of elimination of N-acetyl-cysteine conjugates was 11.4 hours for the cis isomer and 10.8 hours for the trans isomer (Verberk et al. 1990).

Rats exposed by inhalation for 1 hour to 0, 40, 107, 284, 398, or 789 ppm Telone II<sup>®</sup>a excreted 0, 0.11, 0.49, 2.7, 3.7, or 4.0 μmol N-acetyl-cysteine conjugate/mL of urine in the 24 hours following exposure (Fisher and Kilgore 1988b). Uptake levels, however, were not measured, which precludes correlation with excretion.

In male Fischer rats exposed by inhalation to 30, 90, 300, or 900 ppm technical-grade 1,3-dichloropropene for 3 hours, rapid absorption was followed by a biphasic pattern of elimination from the bloodstream (Stott and Kastl 1986). At concentrations up to 300 ppm, a rapid elimination phase (half-time of 3–6 minutes) was followed by a slower phase with a half-life of 33–43 minutes. Following exposure to 900 ppm, the rapid elimination phase was 14–27 minutes.

**2,3-Dichloropropene.** In male Fischer 344 rats exposed (nose only) for 6 hours to radiolabeled 2,3-dichloropropene vapor at a concentration of 250 nmol/L, 54.6% of the amount absorbed was excreted as metabolites in urine, 16.8% was eliminated in feces, 3.2% was expired as carbon dioxide, and 1.2% was expired as the parent compound (Bond et al. 1985). The remainder was detected in the carcass. Approximately 75% of the urinary and fecal elimination occurred within the first 24 hours after exposure. The half-times for elimination were 9.8 hours for urine and 12.9 hours for feces. Elimination as carbon dioxide had a biphasic pattern: 87% exhaled within 3.4 hours and 13% exhaled within 19.7 hours. Levels of label in blood had a biphasic pattern of elimination, with estimated half-lives of 2.4 and 113.6 hours, for the two phases, respectively.

The rates and relative amounts of elimination of absorbed radiolabeled 2,3-dichloropropene in urine or feces was not affected by inhaled concentrations between 0.4 and 44 ppm (Dutcher et al. 1985). Half-lives of excretion were between 9.1 and 11.3 hours for urinary excretion 10.4–16.5 hours for excretion in feces. The half-time associated with the rapid phase of elimination as carbon dioxide (representing 81–94% of that exhaled) was 2.2–4.3 hours, whereas the half-time associated with the slow phase of elimination (6–19% of that exhaled) was 15.3–30.8 hours.

## 3. HEALTH EFFECTS

**3.4.4.2 Oral Exposure**

**1,3-Dichloropropene.** No studies were located regarding excretion of 1,3-dichloropropene after oral exposure in humans.

Significant recoveries of  $^{14}\text{C}$ -labeled 1,3-dichloropropene were reported in two studies with rats after oral exposure (Climie et al. 1979; Hutson et al. 1971). In both studies, 82–84% of the administered cis isomer was recovered as the mercapturic acid conjugate of 1,3-dichloropropene in a 24-hour collection of urine. Two other minor metabolites that accounted for 3 and 5% of the radioactivity were observed, but these metabolites were not identified (Climie et al. 1979). Comparison of the excretory pathways for the cis and trans isomers of 1,3-dichloropropene revealed that 82–84% of the cis isomer was recovered as the mercapturic acid conjugate in the 24-hour urine collection; only 55–60% of the trans isomer was recovered as the mercapturic acid conjugate in the urine (Hutson et al. 1971). A significant portion of the trans isomer was recovered as  $^{14}\text{CO}_2$  (22–25%). A smaller percentage of each isomer was recovered in the feces: 2–3% of the cis and 2% of the trans isomer. Less than 2% of either compound remained in the carcass after 4 days (Hutson et al. 1971). These data indicate that neither isomer of 1,3-dichloropropene has a tendency to concentrate in the body.

Whether administered neat or encapsulated in sucrose/starch microspheres, 1,3-dichloropropene reached peak blood levels in rats within 10 minutes (Stott et al. 1998). Clearance from the blood occurred in a biphasic manner, with a relatively rapid alpha phase with a half-life of 5–7 minutes and a slower beta phase with a half-life of 20–43 minutes. Urinary excretion of mercapturic-acid conjugates of 1,3-dichloropropene (DMA) was evaluated in rats simultaneously dosed with equal doses of neat  $^{13}\text{C}$ -labeled-1,3-dichloropropene and 1,3-dichloropropene microencapsulated in a starch/sucrose matrix (Stott et al. 1998). Of the total amount of DMA excreted in urine, 56% was derived from neat 1,3-dichloropropene (58% cis-DMA and 52% trans-DMA) and 44% was derived from encapsulated compound (42% cis-DMA and 49% trans-DMA).

**2,3-Dichloropropene.** Seventy-two hours after male Fischer 344 rats were given an oral dose of 32 mg/kg radiolabeled 2,3-dichloropropene, 66% of the dose was recovered as urinary metabolites, 21% was eliminated in feces, 8% was exhaled as carbon dioxide, 2% was exhaled as parent compound, and 2% remained in carcass and tissues (Medinsky et al. 1984). The half-time for urinary excretion was 7.5 hours.

## 3. HEALTH EFFECTS

**3.4.4.3 Dermal Exposure**

*1,3-Dichloropropene.* In volunteers whose forearms were exposed to 86 mg/m<sup>3</sup> (19 ppm) vapor of 1,3-dichloropropene for 45 minutes, the half-life for urinary excretion of the mercapturic acid metabolite was approximately 6 hours (Kezic et al. 1996).

No studies were located regarding excretion of 1,3-dichloropropene after dermal exposure in animals.

**3.4.5 Physiologically Based Pharmacokinetic (PBPK)/Pharmacodynamic (PD) Models**

Physiologically based pharmacokinetic (PBPK) models use mathematical descriptions of the uptake and disposition of chemical substances to quantitatively describe the relationships among critical biological processes (Krishnan et al. 1994). PBPK models are also called biologically based tissue dosimetry models. PBPK models are increasingly used in risk assessments, primarily to predict the concentration of potentially toxic moieties of a chemical that will be delivered to any given target tissue following various combinations of route, dose level, and test species (Clewell and Andersen 1985). Physiologically based pharmacodynamic (PBPD) models use mathematical descriptions of the dose-response function to quantitatively describe the relationship between target tissue dose and toxic end points.

PBPK/PD models refine our understanding of complex quantitative dose behaviors by helping to delineate and characterize the relationships between: (1) the external/exposure concentration and target tissue dose of the toxic moiety, and (2) the target tissue dose and observed responses (Andersen and Krishnan 1994; Andersen et al. 1987). These models are biologically and mechanistically based and can be used to extrapolate the pharmacokinetic behavior of chemical substances from high to low dose, from route to route, between species, and between subpopulations within a species. The biological basis of PBPK models results in more meaningful extrapolations than those generated with the more conventional use of uncertainty factors.

The PBPK model for a chemical substance is developed in four interconnected steps: (1) model representation, (2) model parameterization, (3) model simulation, and (4) model validation (Krishnan and Andersen 1994). In the early 1990s, validated PBPK models were developed for a number of toxicologically important chemical substances, both volatile and nonvolatile (Krishnan and Andersen

## 3. HEALTH EFFECTS

1994; Leung 1993). PBPK models for a particular substance require estimates of the chemical substance-specific physicochemical parameters, and species-specific physiological and biological parameters. The numerical estimates of these model parameters are incorporated within a set of differential and algebraic equations that describe the pharmacokinetic processes. Solving these differential and algebraic equations provides the predictions of tissue dose. Computers then provide process simulations based on these solutions.

The structure and mathematical expressions used in PBPK models significantly simplify the true complexities of biological systems. If the uptake and disposition of the chemical substance(s) are adequately described, however, this simplification is desirable because data are often unavailable for many biological processes. A simplified scheme reduces the magnitude of cumulative uncertainty. The adequacy of the model is, therefore, of great importance, and model validation is essential to the use of PBPK models in risk assessment.

PBPK models improve the pharmacokinetic extrapolations used in risk assessments that identify the maximal (i.e., the safe) levels for human exposure to chemical substances (Andersen and Krishnan 1994). PBPK models provide a scientifically sound means to predict the target tissue dose of chemicals in humans who are exposed to environmental levels (for example, levels that might occur at hazardous waste sites) based on the results of studies where doses were higher or were administered in different species. Figure 3-8 shows a conceptualized representation of a PBPK model.

If PBPK models for dichloropropenes exist, the overall results and individual models are discussed in this section in terms of their use in risk assessment, tissue dosimetry, and dose, route, and species extrapolations.

In an unpublished study, Waechter et al. (1992) developed a PBPK model based on data collected for six male volunteers exposed by inhalation to 1 ppm 1,3-dichloropropene (50.6% cis; 45% trans; 2% epoxidized soybean oil) for 6 hours (Figure 3-9). The model included a poorly perfused compartment (fat), a well-perfused compartment, and terms for the excretion of dichloropropene in blood and exhaled air. Data were collected for concentrations of 1,3-dichloropropene isomers in exhaled air and in blood, as well as for the concentrations of N-acetyl-cysteine conjugates of each isomer present in urine (results discussed above in Sections 3.4.1.1, 3.4.2.1, and 3.4.4.1). The model was designed to predict average urinary excretion rates for the two isomeric conjugates in urine following 6-hour exposures to 0.1, 0.01, or 0.001 ppm cis-/trans-1,3-dichloropropene. Based on the limit of detection (10 ng/mL) and an average

## 3. HEALTH EFFECTS

**Figure 3-8. Conceptual Representation of a Physiologically Based Pharmacokinetic (PBPK) Model for a Hypothetical Chemical Substance**

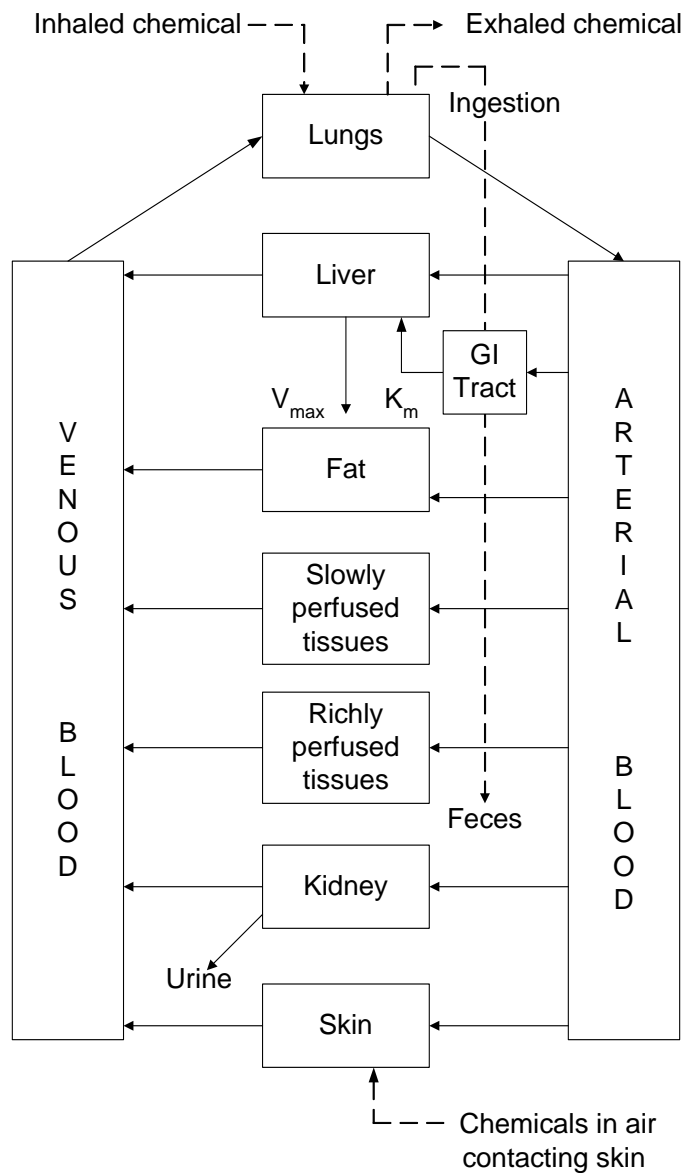

Source: adapted from Krishnan et al. 1994

Note: This is a conceptual representation of a physiologically based pharmacokinetic (PBPK) model for a hypothetical chemical substance. The chemical substance is shown to be absorbed via the skin, by inhalation, or by ingestion, metabolized in the liver, and excreted in the urine or by exhalation.

## 3. HEALTH EFFECTS

**Figure 3-9. Kinetic Model for Uptake and Elimination of 1,3-Dichloropropene Humans Exposed by Inhalation**

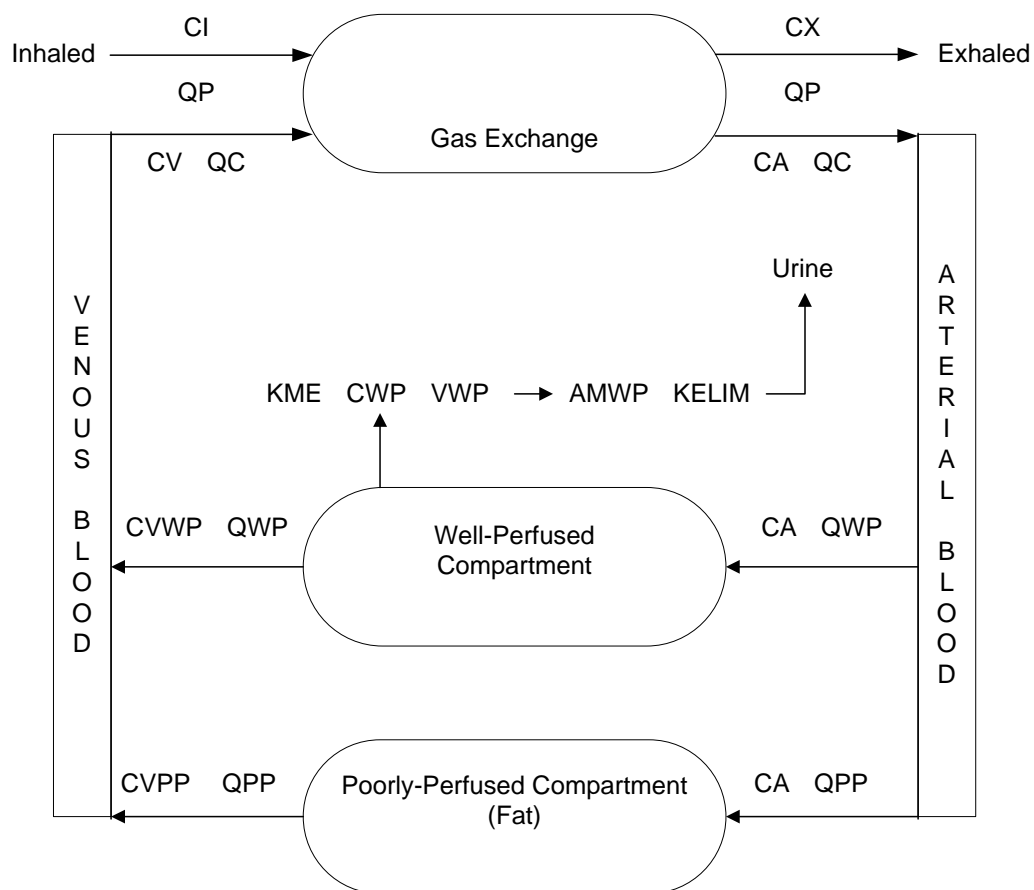

**Model terms**

CI	Concentration inhaled
CX	Concentration exhaled
QP	Ventilation rate
QC	Cardiac output
CV	Venous blood concentration
CA	Arterial blood concentration
QWP	Blood flow to well perfused compartment
QPP	Blood flow to fat
CVPP	Concentration in venous blood leaving poorly perfused compartment
CVWP	Concentration in venous blood leaving well perfused compartment
KME	First-order rate constant for metabolism
CWP	Concentration in well perfused compartment
VWP	Volume of well perfused compartment
AMWP	Amount of metabolite in well perfused compartment
KELIM	First-order rate constant for elimination of metabolite

Source: Adapted from Waechter et al. 1992

## 3. HEALTH EFFECTS

urine output of 58.3 mL/hour, the model predicted that urinary excretion after exposure to 0.1 ppm could be followed for 35 hours (from the start of exposure) for the cis isomer and 24 hours for the trans isomer and after exposure to 0.01 ppm, 20 and 10 hours, respectively. Exposure to 0.001 ppm was predicted to result in values below the limit of detection. These results are considered tentative, since the model has not yet been validated.

### 3.5 MECHANISMS OF ACTION

#### 3.5.1 Pharmacokinetic Mechanisms

**Absorption.** Studies in humans and/or animals indicate that the absorption of 1,3- and 2,3-dichloropropene is rapid (Bond et al. 1985; Dutcher et al. 1985; Stott and Kastl 1986; Stott et al. 1998; Waechter et al. 1992). Given the relatively small size of the molecules and their lipid-soluble properties, absorption by any route is most likely by simple passive diffusion across cellular lipid membranes.

**Distribution.** The small molecular size and lipid solubility properties of dichloropropenes undoubtedly contribute to the rapid distribution following absorption by any route. The highest concentrations of inhaled 1,3- or 2,3-dichloropropene are found in portal-of-entry tissues (nasal turbinates, larynx, trachea, lung) as well as the blood and tissues involved in metabolism and elimination (liver, kidney, urinary bladder) (Bond et al. 1985; Dutcher et al. 1985). Similarly, oral exposure results in high concentrations in the stomach and urinary bladder compared to other tissues (Stott et al. 1998; Waechter and Kastl 1988).

**Metabolism.** It is likely that steric differences in the position of chlorine atoms with respect to the double bond account for the different metabolic pathways among the different isomers of dichloropropene. Three different metabolic pathways have been identified for 1,3-dichloropropene in the liver (Figure 3-5). The primary pathway is the glutathione transferase-dependent conjugation of the chloromethyl moiety with glutathione to form mercapturic acid metabolites (Osterloh and Feldman 1993; Osterloh et al. 1984; Stott et al. 1998). The cis isomer of 1,3-dichloropropene has a faster rate of conjugation than the trans isomer (Stott et al. 1998). A secondary pathway is cytochrome P450-dependent epoxidation, which apparently becomes significant at high exposure levels (Schneider et al. 1998a). The rate of glutathione depletion appears to affect the degree to which the secondary pathway is used in specific tissues. An *in vitro* study indicated that glutathione transferase-dependent conjugation to glutathione results in the bioactivation of 1,1-dichloropropene to an episulfonium ion (Granville et al. 2005). Specific metabolites of inhaled 2,3-dichloropropene were not identified by Dutcher et al. (1985),



## 3. HEALTH EFFECTS

but these authors suggested, based on a pattern of elimination similar to that observed for 1,3-dichloropropene, that conjugation to glutathione was the primary metabolic pathway.

**Excretion.** Human and/or animal data indicate that 1,3-dichloropropene and 2,3-dichloropropene are rapidly eliminated from the body, primarily as urinary metabolites, with lesser amounts eliminated in feces and exhaled air (Dutcher et al. 1985; Medinsky et al. 1984; Waechter et al. 1992). Both carbon dioxide and parent compound have been detected in exhaled air (Bond et al. 1985). Half-lives of excretion have been estimated as <14 hours (Dutcher et al. 1985; Medinsky et al. 1984). The physicochemical properties of dichloropropenes and their metabolites likely facilitate their rapid removal from the body.

### 3.5.2 Mechanisms of Toxicity

The primary toxic effects of dichloropropenes are portal-of-entry effects resulting from the chemical reactivity of the compounds and their physicochemical properties. Repeated irritation results in a hyperplastic response in the target tissues (respiratory tract for inhalation exposure, forestomach of rats exposed orally). Studies that analyzed tissue retention of absorbed dichloropropenes confirmed the relatively high concentrations in target tissues such as the nasal turbinates, but high concentrations detected in urinary bladder, kidney, and liver may reflect the presence of parent compound or reactive metabolites in those tissues (Bond et al. 1985; Dutcher et al. 1985; Medinsky et al. 1984)

Metabolic processes may contribute to toxicity. The mutagenicity of cis or trans 1,3-dichloropropenes was attributed to their biotransformation by cytochrome P-450 to stereospecific epoxides and the hydrolysis product, 3-chloro-2-hydroxypropanal (Schneider et al. 1998a). It is likely that depletion of glutathione would block the major detoxification pathway for 1,3- and 2,3-dichloropropene, resulting in increased toxicity of organs such as the liver and kidney because of binding of reactive intermediates to macromolecules in cells. On the other hand, mutagenicity of 1,1-dichloropropene has been related to its glutathione transferase-dependent bioactivation by the thiolate ion of glutathione and the resulting episulfonium ion (Granville et al. 2005).

There is some evidence that cytotoxicity of hepatic cells exposed to 1,3-dichloropropene *in vitro* is preceded by increased levels of phospholipid hydroperoxides (phosphatidylcholine hydroperoxide and phosphatidylethanolamine hydroperoxide) (Suzuki et al. 1994a). This appears to confirm the role of

## 3. HEALTH EFFECTS

reactive intermediates inducing lipid peroxidation as a significant mechanism of toxicity for 1,3-dichloropropene.

### 3.5.3 Animal-to-Human Extrapolations

The critical toxic effects of dichloropropenes are portal-of-entry effects relating to their irritant properties. In the absence of data to indicate otherwise, the portal-of-entry effects observed in animals are assumed to be relevant to humans. EPA (1994) has developed dosimetry methods that are used to scale from inhalation exposures in animals to human equivalent concentrations. The major metabolic pathway for elimination of 1,3- and 2,3-dichloropropenes (conjugation to glutathione) is common to both humans and animals.

## 3.6 TOXICITIES MEDIATED THROUGH THE ENDOCRINE AXIS

Recently, attention has focused on the potential hazardous effects of certain chemicals on the endocrine system because of the ability of these chemicals to mimic or block endogenous hormones. Chemicals with this type of activity are most commonly referred to as *endocrine disruptors*. However, appropriate terminology to describe such effects remains controversial. The terminology *endocrine disruptors*, initially used by Thomas and Colborn (1992), was also used in 1996 when Congress mandated the EPA to develop a screening program for "...certain substances [which] may have an effect produced by a naturally occurring estrogen, or other such endocrine effect[s]...". To meet this mandate, EPA convened a panel called the Endocrine Disruptors Screening and Testing Advisory Committee (EDSTAC), and in 1998, the EDSTAC completed its deliberations and made recommendations to EPA concerning *endocrine disruptors*. In 1999, the National Academy of Sciences released a report that referred to these same types of chemicals as *hormonally active agents*. The terminology *endocrine modulators* has also been used to convey the fact that effects caused by such chemicals may not necessarily be adverse. Many scientists agree that chemicals with the ability to disrupt or modulate the endocrine system are a potential threat to the health of humans, aquatic animals, and wildlife. However, others think that endocrine-active chemicals do not pose a significant health risk, particularly in view of the fact that hormone mimics exist in the natural environment. Examples of natural hormone mimics are the isoflavonoid phytoestrogens (Adlercreutz 1995; Livingston 1978; Mayr et al. 1992). These chemicals are derived from plants and are similar in structure and action to endogenous estrogen. Although the public health significance and descriptive terminology of substances capable of affecting the endocrine system remains controversial,

### 3. HEALTH EFFECTS

scientists agree that these chemicals may affect the synthesis, secretion, transport, binding, action, or elimination of natural hormones in the body responsible for maintaining homeostasis, reproduction, development, and/or behavior (EPA 1997). Stated differently, such compounds may cause toxicities that are mediated through the neuroendocrine axis. As a result, these chemicals may play a role in altering, for example, metabolic, sexual, immune, and neurobehavioral function. Such chemicals are also thought to be involved in inducing breast, testicular, and prostate cancers, as well as endometriosis (Berger 1994; Giwercman et al. 1993; Hoel et al. 1992).

No studies were located regarding endocrine disruption in humans after exposure to 1,3-dichloropropene or 2,3-dichloropropene. None of the intermediate-duration inhalation rodent assays on these compounds reported adverse effects on male or female reproductive parameters such as estrus cycling, sperm counts or morphology, or the outcome of a one-generation reproductive assays (Johannsen et al. 1991; NTP 1985; see Section 3.2.1.5).

Nishihara et al. (2000) used a yeast two-hybrid screening assay, employing expression plasmids for the estrogen receptor and a cofactor, to assay chemicals for endocrine disruption activity. The level of reporter gene activity was expressed as the 10% relative effective concentration compared to the optimal concentration ( $10^{-7}$  M) of the agonist 17-beta-estradiol. 1,3-Dichloropropene at concentrations as high as  $1 \times 10^{-3}$  M yielded negative in this assay, suggesting that it does not disrupt estradiol signalling.

#### 3.7 CHILDREN'S SUSCEPTIBILITY

This section discusses potential health effects from exposures during the period from conception to maturity at 18 years of age in humans, when all biological systems will have fully developed. Potential effects on offspring resulting from exposures of parental germ cells are considered, as well as any indirect effects on the fetus and neonate resulting from maternal exposure during gestation and lactation. Relevant animal and *in vitro* models are also discussed.

Children are not small adults. They differ from adults in their exposures and may differ in their susceptibility to hazardous chemicals. Children's unique physiology and behavior can influence the extent of their exposure. Exposures of children are discussed in Section 6.6, Exposures of Children.

Children sometimes differ from adults in their susceptibility to hazardous chemicals, but whether there is a difference depends on the chemical (Guzelian et al. 1992; NRC 1993). Children may be more or less

## 3. HEALTH EFFECTS

susceptible than adults to health effects, and the relationship may change with developmental age (Guzelian et al. 1992; NRC 1993). Vulnerability often depends on developmental stage. There are critical periods of structural and functional development during both prenatal and postnatal life, and a particular structure or function will be most sensitive to disruption during its critical period(s). Damage may not be evident until a later stage of development. There are often differences in pharmacokinetics and metabolism between children and adults. For example, absorption may be different in neonates because of the immaturity of their gastrointestinal tract and their larger skin surface area in proportion to body weight (Morselli et al. 1980; NRC 1993); the gastrointestinal absorption of lead is greatest in infants and young children (Ziegler et al. 1978). Distribution of xenobiotics may be different; for example, infants have a larger proportion of their bodies as extracellular water, and their brains and livers are proportionately larger (Altman and Dittmer 1974; Fomon 1966; Fomon et al. 1982; Owen and Brozek 1966; Widdowson and Dickerson 1964). The infant also has an immature blood-brain barrier (Adinolfi 1985; Johanson 1980) and probably an immature blood-testis barrier (Setchell and Waites 1975). Many xenobiotic metabolizing enzymes have distinctive developmental patterns. At various stages of growth and development, levels of particular enzymes may be higher or lower than those of adults, and sometimes unique enzymes may exist at particular developmental stages (Komori et al. 1990; Leeder and Kearns 1997; NRC 1993; Vieira et al. 1996). Whether differences in xenobiotic metabolism make the child more or less susceptible also depends on whether the relevant enzymes are involved in activation of the parent compound to its toxic form or in detoxification. There may also be differences in excretion, particularly in newborns who all have a low glomerular filtration rate and have not developed efficient tubular secretion and resorption capacities (Altman and Dittmer 1974; NRC 1993; West et al. 1948). Children and adults may differ in their capacity to repair damage from chemical insults. Children also have a longer remaining lifetime in which to express damage from chemicals; this potential is particularly relevant to cancer.

Certain characteristics of the developing human may increase exposure or susceptibility, whereas others may decrease susceptibility to the same chemical. For example, although infants breathe more air per kilogram of body weight than adults breathe, this difference might be somewhat counterbalanced by their alveoli being less developed, which results in a disproportionately smaller surface area for alveolar absorption (NRC 1993).

No data are available for health effects on children from exposure to any dichloropropene isomer by any route.

### 3. HEALTH EFFECTS

No adverse effects on fetuses have been noted in developmental or two-generation reproductive studies in animals exposed by inhalation to 1,3-dichloropropene at levels not toxic to the mother (Breslin et al. 1989; Kloes et al. 1983). It has been observed that decreased food and water consumption and reduced maternal body weight, likely resulting from irritant effects of the vapor, are the primary reason for observed delayed ossification effects in rat pups (Hanley et al. 1987).

Since the major effects of exposure to dichloropropenes involve portal-of-entry effects from irritant properties of these chemicals, similar effects would be expected to occur in children. Because the skin of children is thinner and surface areas to body weight ratios are larger for children (de Zwart et al. 2004), they would likely absorb a higher dose (per kg body weight) than adults from a similar dermal exposure. Also, since alveolar ventilation rates are faster in children than adults (de Zwart et al. 2004), the uptake of dichloropropene vapor would be higher in children than adults exposed by inhalation to the same concentration of the compound.

The small size and physicochemical properties of dichloropropenes and their distribution by passive diffusion suggest that maternally absorbed dichloropropene is likely to be distributed across the placenta to the fetus. This likely would occur only in the short term after exposure. Dichloropropene was detected in only one of eight samples of human breast milk taken from nursing mothers at four locations (two in New Jersey, one in Louisiana, and one in Pennsylvania), limited evidence that dichloropropene could be transferred from mother to nursing infant (Pellizzari et al. 1982).

#### **3.8 BIOMARKERS OF EXPOSURE AND EFFECT**

Biomarkers are broadly defined as indicators signaling events in biologic systems or samples. They have been classified as markers of exposure, markers of effect, and markers of susceptibility (NAS/NRC 1989).

Due to a nascent understanding of the use and interpretation of biomarkers, implementation of biomarkers as tools of exposure in the general population is very limited. A biomarker of exposure is a xenobiotic substance or its metabolite(s) or the product of an interaction between a xenobiotic agent and some target molecule(s) or cell(s) that is measured within a compartment of an organism (NAS/NRC 1989). The preferred biomarkers of exposure are generally the substance itself, substance-specific metabolites in readily obtainable body fluid(s), or excreta. However, several factors can confound the use and interpretation of biomarkers of exposure. The body burden of a substance may be the result of exposures

## 3. HEALTH EFFECTS

from more than one source. The substance being measured may be a metabolite of another xenobiotic substance (e.g., high urinary levels of phenol can result from exposure to several different aromatic compounds). Depending on the properties of the substance (e.g., biologic half-life) and environmental conditions (e.g., duration and route of exposure), the substance and all of its metabolites may have left the body by the time samples can be taken. It may be difficult to identify individuals exposed to hazardous substances that are commonly found in body tissues and fluids (e.g., essential mineral nutrients such as copper, zinc, and selenium). Biomarkers of exposure to dichloropropenes are discussed in Section 3.8.1.

Biomarkers of effect are defined as any measurable biochemical, physiologic, or other alteration within an organism that, depending on magnitude, can be recognized as an established or potential health impairment or disease (NAS/NRC 1989). This definition encompasses biochemical or cellular signals of tissue dysfunction (e.g., increased liver enzyme activity or pathologic changes in female genital epithelial cells), as well as physiologic signs of dysfunction such as increased blood pressure or decreased lung capacity. Note that these markers are not often substance specific. They also may not be directly adverse, but can indicate potential health impairment (e.g., DNA adducts). Biomarkers of effects caused by dichloropropenes are discussed in Section 3.8.2.

A biomarker of susceptibility is an indicator of an inherent or acquired limitation of an organism's ability to respond to the challenge of exposure to a specific xenobiotic substance. It can be an intrinsic genetic or other characteristic or a preexisting disease that results in an increase in absorbed dose, a decrease in the biologically effective dose, or a target tissue response. If biomarkers of susceptibility exist, they are discussed in Section 3.10, Populations That Are Unusually Susceptible.

### 3.8.1 Biomarkers Used to Identify or Quantify Exposure to Dichloropropene

**1,3-Dichloropropene.** Inhalation exposure to various concentrations of 1,3-dichloropropene correlated well with the urinary level of the N-acetyl cysteine (mercapturic acid) metabolite in humans. Urinary excretion of the N-acetyl cysteine metabolite was measured in four men occupationally exposed to technical-grade 1,3-dichloropropene (Telone II<sup>®</sup>a). Exposure levels were monitored by personal dosimeters. A strong correlation was found between exposure levels of 1,3-dichloropropene and urinary excretion of the N-acetyl-cysteine metabolite ( $r=0.83$ , see Figure 3-6 in Section 3.4.3) (Osterloh et al. 1984). Human dermal exposure to cis-1,3-dichloropropene vapor was successfully monitored by the urinary level of the mercapturic acid metabolite (Kezic et al. 1996). The rapid excretion of the metabolite

## 3. HEALTH EFFECTS

(75% complete within the first 24 hours) limits the usefulness of this biomarker to the first 2 days after exposure.

Blood levels of the glutathione-conjugate of 1,3-dichloropropene might also be used as a biomarker. Steady-state levels of the glutathione-conjugate were reached within 1 hour in rats exposed to 78, 155, or 404 ppm (Fisher and Kilgore 1989). In this study, however, the correlation between exposure and blood levels was not calculated.

1,3-Dichloropropene is rapidly cleared from the body. The elimination half-time, determined after a 1-hour inhalation exposure in rats, was 17 hours (Fisher and Kilgore 1989). Furthermore, <2% of the 1,3-dichloropropene administered by gavage to rats remained in the carcass after 4 days (Hutson et al. 1971). These data indicate that 1,3-dichloropropene does not concentrate in the body. Therefore, biomarkers based on tissue or blood levels of 1,3-dichloropropene are of limited value in assessing long-term exposure.

**2,3-Dichloropropene.** As with 1,3-dichloropropene, most of the absorbed compound following inhalation or oral exposure is rapidly metabolized to a mercapturic acid derivative that is detectable in the urine (Bond et al. 1985; Dutcher et al. 1985; Eder and Dornbusch 1988; Medinsky et al. 1984). Rapid clearance from the body, however, restricts the use of this biomarker to short-term exposures.

### 3.8.2 Biomarkers Used to Characterize Effects Caused by Dichloropropene

Few specific quantifiable biomarkers that characterize effects caused by 1,3- or 2,3-dichloropropene were identified. Consistent findings in animal studies involve portal-of-entry effects include hyperplasia and/or degeneration of portions of the nasal epithelium after inhalation exposure, hyperplasia and/or neoplastic changes in the forestomach after oral exposure, and erythema/edema after dermal exposure. These are nonspecific effects and are, therefore, of little value as biomarkers.

Some occupational monitoring studies on 1,3-dichloropropene have assayed for hepatic and renal damage using serum or urinary concentrations of tissue-specific proteins (Osterloh and Feldman 1993; Osterloh et al. 1989; Verplanke et al. 2000). N-acetylglucosamidase and retinol binding protein as markers for renal tubular damage were detectable several days following exposure.

## 3. HEALTH EFFECTS

**3.9 INTERACTIONS WITH OTHER CHEMICALS**

No studies were located regarding the interaction of 1,3-dichloropropene with other chemicals to produce health effects. 1,3-Dichloropropene is widely used as a preplanting soil fumigant for the control of parasitic nematodes. The commercial product used in agriculture contains a mixture of the cis and trans isomers in approximately equal proportions, as well as stabilizers including 1,2-dichloropropene and epichlorohydrin or epoxidized soybean oil. Occupational exposure would most likely occur to this mixture. Whether interactions occur between 1,3-dichloropropene and other components is not known. Comparisons of animal toxicity assays on different formulations of Telone<sup>®</sup> II indicate that the irritant properties of 1,3-dichloropropene cause portal-of-entry effects in the nasal epithelium and stomach, but suggest that increased tumor incidences in those tissues may be partly attributed to the presence of epichlorohydrin in the formulation (Lomax et al. 1989; NTP 1985; Stebbins et al. 2000). In addition, there is also evidence that pure 1,3-dichloropropene can slowly undergo autoxidation to produce amounts of highly mutagenic oxides when stored in the presence of air (see Section 3.4) (Talcott and King 1984; Watson et al. 1987). Thus, it appears that trace amounts of mutagens, with detectable mutagenic activity, will gradually appear in pure 1,3-dichloropropene unless the liquid is stored under a nitrogen atmosphere.

Simultaneous exposure to other chemicals, such as acetaminophen, that are detoxified via conjugation to glutathione would tend to increase the toxicity of 1,3- and 2,3-dichloropropenes because glutathione depletion would result in metabolism via epoxide-generating pathways (Schneider et al. 1998a).

**3.10 POPULATIONS THAT ARE UNUSUALLY SUSCEPTIBLE**

A susceptible population will exhibit a different or enhanced response to 1,3-dichloropropene than will most persons exposed to the same level of 1,3-dichloropropene in the environment. Reasons may include genetic makeup, age, health and nutritional status, and exposure to other toxic substances (e.g., cigarette smoke). These parameters result in reduced detoxification or excretion of 1,3-dichloropropene, or compromised function of organs affected by 1,3-dichloropropene. Populations who are at greater risk due to their unusually high exposure to 1,3-dichloropropene are discussed in Section 6.7, Populations with Potentially High Exposures.

No data were located regarding populations that are unusually susceptible to the toxicity of 1,3- or 2,3-dichloropropenes; however, glutathione availability is critical for detoxification of these isomers. Depletion of glutathione pools may enhance the toxicity of 1,3- or 2,3-dichloropropene (see Section 3.11).



### 3. HEALTH EFFECTS

Glutathione pools could be depleted by repeated exposures to 1,3-dichloropropene or other xenobiotics that are metabolized in whole or in part by glutathione-dependent pathways. Urinary excretion of the mercapturic acids of 1,3- and 2,3-dichloropropenes is the primary excretory pathway for these isomers; therefore, kidney disease or deficiencies in the mercapturic acid transport system may also enhance the toxicity of 1,3- and 2,3-dichloropropene. As 1,1-dichloropropene appears to become bioactivated by glutathione (see Granville et al. 2005; also Section 3.3, Genotoxicity), glutathione depletion would not be expected to increase susceptibility to adverse effects from exposure to this isomer.

Individuals taking drugs such as acetaminophen that are also detoxified by glutathione, may be more susceptible to the effects of glutathione depletion when exposed to 1,3- or 2,3-dichloropropene.

#### 3.11 METHODS FOR REDUCING TOXIC EFFECTS

This section will describe clinical practice and research concerning methods for reducing toxic effects of exposure to 1,3-dichloropropene. However, because some of the treatments discussed may be experimental and unproven, this section should not be used as a guide for treatment of exposures to 1,3-dichloropropene. When specific exposures have occurred, poison control centers and medical toxicologists should be consulted for medical advice. The following texts provide specific information about treatment following exposures to 1,3-dichloropropene:

Bronstein AC, Currance PL. 1988. Emergency care for hazardous materials exposure. Washington, DC: The C.V. Mosby Company, 53, 155-156.

Ellenhorn MJ, Schonwald S, Ordog G, et al. 1997. 1,3-Dichloropropene. Ellenhorn's medical toxicology: Diagnosis and treatment of human poisoning. 2nd ed. Baltimore, MD: Williams and Wilkins, 1656, 1657, 1659.

Stutz DR, Janusz SJ. 1988. Hazardous materials injuries: A handbook for pre-hospital care. 2nd ed. Beltsville, MD: Bradford Communications Corporation, v, 300-301.

##### 3.11.1 Reducing Peak Absorption Following Exposure

Recommendations have been made for managing and treating persons exposed to 1,3-dichloropropene (Bronstein and Currance 1988; Ellenhorn et al. 1997; Stutz and Janusz 1988). Common practices for reducing peak absorption following exposure include removing the exposed person from the contaminated area and removing contaminated clothing. Exposed skin is decontaminated by immediately

### 3. HEALTH EFFECTS

washing with copious amounts of soapy water to insure appropriate dilution of the chemical and rinsing with copious amounts of water. Contaminated eyes are thoroughly flushed with water. If the victim is in respiratory distress, ventilation assistance is provided, and oxygens administered. If oral exposure occurred recently, the victim is given water or milk to dilute the chemical and activated charcoal to adsorb the chemical. Emetics are not administered (Bronstein and Currance 1988). Please refer to Bronstein and Currance (1988) and Stutz and Janusz (1988) for more complete information on treatment of specific symptoms.

#### **3.11.2 Reducing Body Burden**

No specific information was located on reducing the body burden of dichloropropenes in exposed individuals. Based on animal studies on 1,3- and 2,3-dichloropropene, the major portion of absorbed dichloropropenes are eliminated as urinary metabolites within 2 days and elimination in feces and exhaled air is also rapid (Bond et al. 1985; Climie et al. 1979; Dutcher et al. 1985; Hutson et al. 1971; Medinsky et al. 1984). Dichloropropenes do not appear to accumulate in the body.

#### **3.11.3 Interfering with the Mechanism of Action for Toxic Effects**

No specific information was located regarding the mitigation of effects of 1,3-dichloropropene once it has entered the bloodstream. Animal studies indicated that the critical effects of inhalation exposure to 1,3- and 2,3-dichloropropene are irritation and degenerative effects on the nasal and respiratory epithelium; 1,3-dichloropropene also causes hyperplasia of the urinary bladder. The major effects of oral exposure to 1,3-dichloropropene are stomach irritation, hyperplasia, and hyperkeratosis, and mild liver and kidney effects. Studies on the metabolism of 1,3-dichloropropene and 2,3-dichloropropene indicate that the major pathway occurs via conjugation of the dichloropropene with glutathione resulting in the excretion of innocuous mercapturic acids and N-acetyl-cysteine conjugates (see Section 3.4.3). Inhalation exposure of rats to 1,3-dichloropropene resulted in decreased levels of glutathione in the nasal tissue, kidney, and liver (Fisher and Kilgore 1988a). Oral exposure of mice to 1,3-dichloropropene resulted in decreased levels of glutathione in the forestomach, glandular stomach, liver, and kidney, suggesting that the compound is conjugated in those tissues (Dietz et al. 1982). If the glutathione detoxification pathway becomes saturated, secondary metabolic pathways that result in epoxidation and the formation of toxic metabolites may become prominent (Schneider et al. 1998a). It is possible that therapies that increase tissue levels of glutathione (for example, N-acetylcysteine) would help ameliorate the toxicity of 1,3- and

### 3. HEALTH EFFECTS

2,3-dichloropropenes by reducing the use of the epoxidation pathways. This approach may not be suitable for 1,1-dichloropropene because there is evidence that glutathione may be involved in the metabolism of this isomer to a mutagenic intermediate (Granville et al. 2005; see Section 3.3, Genotoxicity).

As studied *in vitro*, pretreatment with d,l-alpha-tocopherol prevented membrane phospholipid peroxidation and the consequent cytotoxicity of hepatic cells treated with 1,3-dichloropropene (Suzuki et al. 1994b).

#### 3.12 ADEQUACY OF THE DATABASE

Section 104(I)(5) of CERCLA, as amended, directs the Administrator of ATSDR (in consultation with the Administrator of EPA and agencies and programs of the Public Health Service) to assess whether adequate information on the health effects of dichloropropenes is available. Where adequate information is not available, ATSDR, in conjunction with the National Toxicology Program (NTP), is required to assure the initiation of a program of research designed to determine the health effects (and techniques for developing methods to determine such health effects) of dichloropropenes.

The following categories of possible data needs have been identified by a joint team of scientists from ATSDR, NTP, and EPA. They are defined as substance-specific informational needs that if met would reduce the uncertainties of human health assessment. This definition should not be interpreted to mean that all data needs discussed in this section must be filled. In the future, the identified data needs will be evaluated and prioritized, and a substance-specific research agenda will be proposed.

##### 3.12.1 Existing Information on Health Effects of Dichloropropenes

The existing data on health effects of inhalation, oral, and dermal exposure of humans and animals to 1,1-, 3,3-, 1,2-, 2,3-, and 1,3-dichloropropene are summarized in Figures 3-10, 3-11, 3-12, 3-13, and 3-14, respectively. The purpose of this figure is to illustrate the existing information concerning the health effects of dichloropropenes. Each dot in the figure indicates that one or more studies provide information associated with that particular effect. The dot does not necessarily imply anything about the quality of the study or studies, nor should missing information in this figure be interpreted as a "data need". A data need, as defined in ATSDR's *Decision Guide for Identifying Substance-Specific Data Needs Related to*

3. HEALTH EFFECTS

**Figure 3-10. Existing Information on Health Effects of 1,1-Dichloropropene**

	Systemic									
	Death	Acute	Intermediate	Chronic	Immunologic/Lymphoretic	Neurologic	Reproductive	Developmental	Genotoxic	Cancer
Inhalation										
Oral										
Dermal										

**Human**

	Systemic									
	Death	Acute	Intermediate	Chronic	Immunologic/Lymphoretic	Neurologic	Reproductive	Developmental	Genotoxic	Cancer
Inhalation										
Oral										
Dermal										

**Animal**

● Existing Studies

3. HEALTH EFFECTS

**Figure 3-11. Existing Information on Health Effects of 3,3-Dichloropropene**

	Systemic									
	Death	Acute	Intermediate	Chronic	Immunologic/Lymphoretic	Neurologic	Reproductive	Developmental	Genotoxic	Cancer
Inhalation										
Oral										
Dermal										

**Human**

	Systemic									
	Death	Acute	Intermediate	Chronic	Immunologic/Lymphoretic	Neurologic	Reproductive	Developmental	Genotoxic	Cancer
Inhalation										
Oral										
Dermal										

**Animal**

● Existing Studies

3. HEALTH EFFECTS

**Figure 3-12. Existing Information on Health Effects of 1,2-Dichloropropene**

	Systemic									
	Death	Acute	Intermediate	Chronic	Immunologic/Lymphoretic	Neurologic	Reproductive	Developmental	Genotoxic	Cancer
Inhalation										
Oral										
Dermal										

**Human**

	Systemic									
	Death	Acute	Intermediate	Chronic	Immunologic/Lymphoretic	Neurologic	Reproductive	Developmental	Genotoxic	Cancer
Inhalation	●	●				●				
Oral	●	●								
Dermal		●								

**Animal**

● Existing Studies

3. HEALTH EFFECTS

**Figure 3-13. Existing Information on Health Effects of 2,3-Dichloropropene**

	Systemic									
	Death	Acute	Intermediate	Chronic	Immunologic/Lymphoretic	Neurologic	Reproductive	Developmental	Genotoxic	Cancer
Inhalation										
Oral										
Dermal										

**Human**

	Systemic									
	Death	Acute	Intermediate	Chronic	Immunologic/Lymphoretic	Neurologic	Reproductive	Developmental	Genotoxic	Cancer
Inhalation	●	●	●			●	●			
Oral	●	●								
Dermal	●	●								

**Animal**

● Existing Studies

3. HEALTH EFFECTS

**Figure 3-14. Existing Information on Health Effects of 1,3-Dichloropropene**

	Systemic									
	Death	Acute	Intermediate	Chronic	Immunologic/Lymphoretic	Neurologic	Reproductive	Developmental	Genotoxic	Cancer
Inhalation		●	●							●
Oral	●	●								
Dermal		●		●						

**Human**

	Systemic									
	Death	Acute	Intermediate	Chronic	Immunologic/Lymphoretic	Neurologic	Reproductive	Developmental	Genotoxic	Cancer
Inhalation	●	●	●	●		●	●	●	●	●
Oral	●	●	●	●		●			●	●
Dermal	●	●			●	●				●

**Animal**

● Existing Studies



## 3. HEALTH EFFECTS

*Toxicological Profiles* (Agency for Toxic Substances and Disease Registry 1989), is substance-specific information necessary to conduct comprehensive public health assessments. Generally, ATSDR defines a data gap more broadly as any substance-specific information missing from the scientific literature.

Existing information regarding the health effects of dichloropropenes in humans is limited. No human toxicity data are available for 1,1-dichloropropene (Figure 3-10), 3,3-dichloropropene (Figure 3-10), 1,2-dichloropropene (Figure 3-12), or 2,3-dichloropropene (Figure 3-13). A limited amount of human toxicity data are available for 1,3-dichloropropene, mostly case reports in which levels and durations of exposure to 1,3-dichloropropene were unknown (Figure 3-14). For persons exposed by inhalation, there is information on systemic effects and possible carcinogenicity, although the number of cases is too small to provide definitive proof of carcinogenicity and the association is weak. For oral exposure, there is information on death and the systemic effects following ingestion of a lethal dose in one case report. For persons exposed dermally to 1,3-dichloropropene, there are case reports of dermatitis and allergic reactions at the site of contact.

Data available on health effects of dichloropropenes in animals are more extensive than in humans. No animal toxicity data are available for 1,1-dichloropropene (Figure 3-10) or 3,3-dichloropropene (Figure 3-11). For animals exposed by inhalation to 1,2-dichloropropene, there is one brief summary of lethality and neurological effects in a few rats exposed to a saturated vapor atmosphere (Figure 3-12). In animals exposed orally to 1,2-dichloropropene at a limit dose, there is information on survival and systemic effects. Primary dermal and ocular irritation data are available for 1,2-dichloropropene. In animals exposed by inhalation to 2,3-dichloropropene (Figure 3-13), there are data for acute lethality, complete data for systemic effects following repeated acute-duration exposures, and incomplete data for systemic effects following intermediate-duration inhalation exposures. In animals exposed orally to 2,3-dichloropropene, there are data for mortality and systemic effects following acute lethal exposure. Data for dermal exposure to 2,3-dichloropropene include acute lethality and systemic effects, and primary dermal and ocular irritation. Animal data are more extensive for 1,3-dichloropropene compared to the other isomers (Figure 3-14). For animals exposed by inhalation to 1,3-dichloropropene, there are data for mortality, systemic effects, genotoxic effects, and developmental toxicity following acute-duration exposure, systemic and reproductive effects following intermediate-duration exposure, and systemic and carcinogenic effects following chronic exposure. For animals exposed orally, there are mortality, neurotoxicity, genotoxicity, and systemic toxicity data for acute-duration exposure, systemic effects following intermediate-duration exposure, and systemic and carcinogenic effects following chronic-

## 3. HEALTH EFFECTS

duration exposure. Studies in animals dermally exposed to 1,3-dichloropropene involve lethality, neurotoxicity, systemic, immunological, and possible carcinogenic effects following acute exposure.

### 3.12.2 Identification of Data Needs

Information regarding the health effects of exposure to pure dichloropropenes is limited. Although older toxicological studies tested various commercial formulations of 1,3-dichloropropene, recent studies have used higher purity formulations that contain very low levels of confounding chemicals such as 1,2-dichloropropane, epichlorohydrin or chloropicrin. Some acute-duration toxicological data are available for some of the other isomers, but no reliable long-term studies. As a consequence of their chemical reactivity, portal-of-entry effects are the major toxicological sequelae of exposure to dichloropropenes. Any new tests need to include a thorough histopathological examination of portal-of-entry tissues. Although the following discussion covers all isomers of dichloropropene, testing to fill data gaps for 1,3-dichloropropene should take priority, since it is the only isomer currently in production at a significant volume.

#### Acute-Duration Exposure.

***1,3-Dichloropropene.*** Data regarding human exposures to 1,3-dichloropropene are limited to clinical reports describing isolated cases of non-Hodgkin's (histiocytic) lymphoma and acute myelomonocytic leukemia after inhalation exposure (Markovitz and Crosby 1984), delayed-type hypersensitivity after dermal exposure (Bousema et al. 1991; Corazza et al. 2003; van Joost and de Jong 1988; Vozza et al. 1996), and nonspecific clinical signs such as headache, nausea, vomiting, fatigue, impotence, and malaise after inhalation (and possibly dermal) exposure. Respiratory symptoms such as chest discomfort, breathing difficulty, coughing, and mucous membrane irritation (Flessel et al. 1978; Markovitz and Crosby 1984) indicate that the respiratory system is a target in humans. Animal studies of acute-duration exposure at high dose levels describe nonspecific clinical signs including lethargy, labored breathing, salivation, lacrimation, palpebral closure, and diarrhea. The primary target organ in animals after acute inhalation is also the respiratory tract. Lung hemorrhage and congestion, atelectasis, emphysema, pulmonary edema, and tracheal congestion have been observed (Cracknell et al. 1987; Streeter and Lomax 1988; Streeter et al. 1987). Since acute-duration inhalation studies did not examine the nasal turbinates for histopathology, a reliable NOAEL value cannot be identified in the available studies and no acute-duration inhalation MRL was derived for 1,3-dichloropropene.

## 3. HEALTH EFFECTS

One case report of acute lethal oral exposure to 1,3-dichloropropene identified gastrointestinal, respiratory, and cardiac effects prior to multiorgan failure (Hernandez et al. 1994). Acute oral studies in rats have identified the stomach, lungs, and possibly the liver and kidney as targets (Jones 1988a; Jones and Collier 1986a; Mizell et al. 1988a), but the data are not sufficient to calculate an acute oral MRL.

Dermal exposure of humans to 1,3-dichloropropene has produced delayed-type hypersensitivity (Bousema et al. 1991; Corazza et al. 2003; van Joost and de Jong 1988; Vozza et al. 1996). Delayed-type hypersensitivity to 1,3-dichloropropene has also been observed in animals (Carreon and Wall 1983; Jeffrey 1987c; Mizell 1988b). Animal studies have shown that 1,3-dichloropropene causes erythema/edema, necrosis, exfoliation, and subcutaneous hemorrhage when applied dermally (Carreon and Wall 1983; Jeffrey 1987c; Jones and Collier 1986b; Lichy and Olson 1975; Mizell et al. 1988a, 1988b). Data regarding systemic toxicity in animals are limited. Hemorrhage of the lungs and glandular stomach was reported in a few studies (Jones 1988b; Jones and Collier 1986b).

Information on the distribution of 1,3-dichloropropene following inhalation and dermal exposure is not available to help identify other target organs across routes of exposure. Intermediate- and chronic-duration studies in rats and mice, which included extensive histological examinations, have identified targets of inhalation and oral exposure. Additional acute studies (single- and repeated-exposure) by all routes should focus on histological examinations of major organs and tissues, especially portal-of-entry tissues such as the lungs and nasal turbinates following inhalation exposure, the stomach following oral exposure, and the skin at the site of administration in dermal studies. These studies of systemic toxicity by the inhalation and oral route are needed for the derivation of acute-duration MRLs for 1,3-dichloropropene. Studies should be conducted in rats and mice since longer-term studies showed some species-specific variation in response to 1,3-dichloropropene. Since suitable data were available for the acute-duration inhalation MRL for 2,3-dichloropropene, an inhalation study would permit the assessment of the relative toxicity of the two isomers.

***2,3-Dichloropropene.*** No data are available for effects in humans following acute-duration exposure to 2,3-dichloropropene. A well-conducted repeated-exposure acute inhalation toxicity study in rats and mice revealed the respiratory tract to be the most sensitive target of inhaled 2,3-dichloropropene, with slightly different effects observed the two species (Zempel et al. 1987). An acute-duration inhalation MRL was based on the lowest concentration, 5 ppm, a LOAEL for minimal nasal respiratory effects in mice and rats. As a NOAEL was not observed in this study, additional testing would be useful to ascertain the NOAEL for acute respiratory effects.

## 3. HEALTH EFFECTS

The only animal oral toxicity data for 2,3-dichloropropene was for an acute lethality study in which congestion of the lung and kidney were reported in rats (Smyth et al. 1962; Union Carbide Corp. 1958). Repeated-dose acute-duration oral toxicity testing at nonlethal doses would be useful to identify critical target organs and dose responses for the derivation of an acute-duration oral MRL.

The only animal dermal toxicity data for 2,3-dichloropropene was for acute lethality or skin irritation following dermal exposure at high or unspecified doses (Monsanto 1967; Smyth et al. 1962; Union Carbide Corp. 1958). Additional acute-duration dermal testing would be useful to determine thresholds for irritant responses and necrotic effects. This information would be relevant to possible occupational exposures.

***1,2-Dichloropropene.*** Acute-duration toxicity data for 1,2-dichloropropene are limited to a summary of results for a high-concentration inhalation lethality study, an acute oral limit dose test, and primary dermal and eye irritation tests (Dow 1962). Results of these studies suggest that suppression of the central nervous system may occur at high inhalation concentrations, and that irritant effects may occur from topical exposure. Additional testing by all routes would be useful to determine the NOAEL and LOAEL values for effects in critical target organs following acute exposure. This information could be used for the derivation of acute-duration inhalation and oral MRLs.

***1,1- and 3,3-Dichloropropene.*** No acute-duration toxicity data by any route of exposure are available for either isomer. Testing of 1,1-dichloropropene may be especially useful since it, unlike 1,3- and 2,3-dichloropropene, appears to be bioactivated rather than detoxified by reaction with glutathione. Additional testing by all routes would help to determine NOAEL and LOAEL values for effects in critical target organs following acute exposure to either isomer. Results of these studies could be used for the derivation of acute-duration inhalation and oral MRLs.

**Intermediate-Duration Exposure.** Data are not available that identify target organs in humans after intermediate-duration exposure to any isomer of dichloropropene by any route.

***1,3-Dichloropropene.*** Most earlier intermediate-duration studies in animals exposed to 1,3-dichloropropene were conducted using formulations that contained other toxic compounds such as epichlorohydrin. Animal studies using more purified formulations indicate that the primary target organs of 1,3-dichloropropene toxicity after intermediate-duration inhalation exposure are the nasal epithelia and

## 3. HEALTH EFFECTS

urinary bladder (Breslin et al. 1989; Coate 1979a; Lomax et al. 1989). An intermediate inhalation MRL has been calculated based on histopathology in nasal epithelia in rats. Intermediate-duration oral toxicity studies using dietary exposure to a microencapsulated formulation lacking epichlorohydrin demonstrated that the forestomach in rats and erythrocytes in dogs were the critical targets of 1,3-dichloropropene (Haut et al. 1996; Stebbins et al. 1999). An intermediate oral MRL has been calculated based on forestomach lesions in rats.

No information on target organs other than the skin (Jeffrey 1987a) was located for intermediate-duration dermal exposure. No distribution data following inhalation, oral, or dermal exposure were located to help identify target organs of dermal exposure. An intermediate-duration dermal study in animals that examined organs other than skin should help identify the possible effects of repeated dermal exposure to internal tissues. Because 1,3-dichloropropene is a component of a soil fumigant, contact with soil is one way that dermal exposure of humans could occur. Furthermore, 1,3-dichloropropene may be present in the soil at hazardous waste sites, where residents may be exposed for intermediate durations.

***2,3-Dichloropropene.*** No intermediate-duration toxicity data are available for exposure to 2,3-dichloropropene by the oral or inhalation routes, and the available data by the inhalation route are not suitable as a basis for an intermediate-duration MRL. Reliable NOAEL and LOAEL values could not be identified in the published 13-week inhalation rat study by Johannsen et al. (1991), since the nasal turbinates were not examined for histopathology, although clinical signs of red nasal discharge were observed at the highest exposure level (15 ppm). The reproduction toxicity study described in the same paper also lacks information about nasal effects in exposed parents. Lung weight data from a terminated 13-week inhalation study in mice (NTP 1989, 2006) add support to the identification of the respiratory tract as the critical target of repeated inhalation exposure to 2,3-dichloropropene, but the lack of histopathology and other data render this study unsuitable as the basis for derivation for an MRL. In addition, significant toxicity in the liver was shown by serum parameters and in the kidneys by urinalysis results. New testing for intermediate-duration exposure to 2,3-dichloropropene by all routes in which respiratory and renal tissues are adequately examined for histopathology would help to identify more reliable NOAELs and LOAELs for this isomer. Results of oral and inhalation studies could be used for the derivation of intermediate-duration MRLs.

***1,1-, 1,2-, and 3,3-Dichloropropene.*** No intermediate-duration toxicity data by any route of exposure are available for any of these isomers. Testing by all routes would help to determine the NOAEL and

## 3. HEALTH EFFECTS

LOAEL values for effects in critical target organs following intermediate-duration exposure. Results of these studies could be used for the derivation of intermediate-duration inhalation and oral MRLs.

**Chronic-Duration Exposure and Cancer.** There is no information in humans to identify target organs following chronic exposure to any isomer of dichloropropene by inhalation, oral, or dermal routes.

***1,3-Dichloropropene.*** The chronic toxicity of 1,3-dichloropropene using formulations not containing epichlorohydrin has been assessed in several animal studies: a 2-year inhalation study in rats and mice (Lomax et al. 1989); a 2-year study in rats and mice administered a microencapsulated form in the diet (Stebbins et al. 2000); and a 1-year study in dogs also fed the microencapsulated form in the diet (Stebbins et al. 1999). Lesions of the nasal epithelia in rats and mice and of the urinary bladder epithelium of mice were the principal nonneoplastic effects following chronic inhalation exposure. An increased incidence of bronchioalveolar adenomas was also observed in mice exposed by inhalation. Lesions of the forestomach in rats, and microcytic anemia in dogs were the critical effects of chronic oral studies. Data from these chronic studies were sufficient to derive chronic-duration inhalation and oral MRLs for 1,3-dichloropropene. No data were available for chronic dermal exposure in animals. Such testing would help to evaluate the consequence of repeated dermal exposure, which might occur from occupational exposure or residence in communities in which release of the chemical into the environment is significant.

A few isolated case reports describing three men who developed lymphoma or leukemia following acute exposure (Markovitz and Crosby 1984) suggests, but does not prove, a carcinogenic potential for 1,3-dichloropropene in humans. The fact that some carcinogenic effects were observed in some earlier chronic-duration bioassays, but not observed in later studies with purer test material, indicate that impurities or additives such as epichlorohydrin in the formulations may have contributed to carcinogenesis. Following inhalation exposure to a purer test material, an increased incidence of bronchioalveolar adenomas (benign lung tumors) in mice was the only carcinogenic effect of 1,3-dichloropropene (Lomax et al. 1989). Dietary exposure to the purer microencapsulated test material did not result in increased tumor incidences in rats, mice or dogs (Stebbins et al. 1999, 2000). It is not certain whether the lack of tumor formation in the dietary studies, compared to increased tumors incidences (for squamous cell papillomas and carcinomas of the forestomach in rats and mice and transitional cell carcinomas of the urinary bladder in mice) in a 2-year gavage study (NTP 1985), were related to the absence of epichlorohydrin in the later studies, or the lack of bolus dosing. Bolus dosing by itself could have contributed to glutathione depletion and resultant saturation of the major detoxifying pathway, resulting in an increased generation

## 3. HEALTH EFFECTS

of mutagenic metabolites by minor pathways. No additional chronic-duration toxicity testing by the inhalation or oral routes is needed.

An initiation-promotion study of cis-1,3-dichloropropene by dermal exposure in mice indicated that cis-1,3-dichloropropene was not an initiator of skin tumors (Van Duuren et al. 1979). Furthermore, cis-1,3-dichloropropene alone did not induce skin tumors after repeated dermal application for 74 weeks. No studies were located regarding the carcinogenic mechanism of action of 1,3-dichloropropene. Available data indicate, however, that 1,3-dichloropropene or its unavoidable impurities is mutagenic in prokaryotic and eukaryotic test systems and that it is a strong tissue irritant. Both properties may underlie the carcinogenic potential of 1,3-dichloropropene.

***1,1-, 1,2-, 2,3-, and 3,3-Dichloropropene.*** No chronic-duration toxicity data by any route of exposure are available for any of these isomers. Testing by all routes would help to determine NOAEL and LOAEL values for effects in critical target organs following chronic-duration exposure. Results of these studies could be used for the derivation of chronic-duration inhalation and oral MRLs.

**Genotoxicity.** No data are available regarding genotoxicity in humans after exposure to any isomer of dichloropropene by any route.

***1,1-Dichloropropene.*** Mixed results for mutagenicity were reported for *S. typhimurium* TA100 and negative results in other strains (Granville et al. 2005; Neudecker et al. 1986), but positive results were reported for a TA100-based strain that expressed glutathione transferase in the presence of glutathione. Granville et al. (2005) indicated that bioactivation by glutathione transferase generates the production of a mutagenic epoxide from 1,1-dichloropropene. The observation that no DNA fragmentation was observed in a cell line deficient in glutathione transferase supports this observation. The paradoxical effect of glutathione on this isomer (others detoxified by glutathione) suggests that any additional *in vitro* genotoxicity tests should be conducted with and without glutathione transferase. *In vivo* genotoxicity tests would help to determine whether the pattern of increased mutagenicity from interaction with glutathione is relevant to inhalation or oral exposure. Testing for chromosomal aberration in cultured mammalian cells would also be useful.

***1,2-Dichloropropene.*** A negative result for *S. typhimurium* TA100 represents the only genotoxicity data for 1,2-dichloropropene. Additional *in vitro* testing on bacterial strains that detect other mutagenic

## 3. HEALTH EFFECTS

lesions and for chromosomal aberration in mammalian cells would help to assess the genotoxic potential of this isomer.

**1,3-Dichloropropene.** Positive results for DNA fragmentation in specific tissues (stomach liver, urinary bladder, kidney, lung, brain, bone marrow) and for micronucleus formation in one assay were reported following oral exposure to 1,3-dichloropropene (Ghia et al. 1993; Kevekordes et al. 1996; Kitchin and Brown 1994; Sasaki et al. 1998), but negative results were reported for other types of assays (unscheduled DNA synthesis, four of five micronucleus assays). A single dominant lethal mutation assay in rats exposed by inhalation for 10 weeks was negative (Gollapudi et al. 1998), which is consistent with the lack of toxicity in the testes in systemic toxicity assays. *In vivo* genotoxicity testing for mutagenicity in target organs (stomach, lung, nasal epithelium, urinary bladder, and possibly lymphocytes) would be useful, since previous tests with formulations containing epichlorohydrin have resulted in tumor increases.

Studies by Talcott and King (1984) and Watson et al. (1987) demonstrated that the mutagenicity of technical-grade 1,3-dichloropropene in *S. typhimurium* TA100 could be entirely attributed to impurities, and that the purified chemical can undergo slow autoxidation to form mutagenic oxides. This may account for the many earlier positive results for mutagenicity in TA100 in older studies (Table 3-9). It is not clear whether the positive results for genotoxicity (sister chromatid exchange, mitotic aberration, unscheduled DNA synthesis) in cultured mammalian cells exposed to relatively pure (>95%) 1,3-dichloropropene were caused by the parent compound, *in vivo* metabolism to a mutagenic metabolite, a mutagenic autoxidation product that formed during storage, or an impurity remaining after manufacture (Kevekordes et al. 1996; Loveday et al. 1989; Matsuoka et al. 1998). Cis and trans epoxides of 1,3-dichloropropene, as well as 3-chloro-3-hydroxypropanal, three mutagens formed by a minor metabolic pathway, specifically form adducts to 2'-deoxyguanosine and not to 2-deoxyadenosine or 2'-deoxycytidine in solution (Schneider et al. 1998b). Additional studies to examine the potential for adduct formation *in vivo* or exposed cells *in vitro* would help to better characterize the genotoxic potential of this isomer.

**2,3-Dichloropropene.** Positive results have been reported for mutagenicity in bacteria, aneuploidy in yeast, and sister chromatid exchange, chromosomal aberration, and unscheduled DNA synthesis in mammalian cells following exposure to 2,3-dichloropropene. Given the generally positive results of *in vitro* testing, additional studies would be helpful to ascertain the genotoxic potential of this isomer *in vivo*. Tissues subject to portal-of-entry effects, as well as the liver, kidney, and urinary bladder should be evaluated in these studies.



## 3. HEALTH EFFECTS

**3,3-Dichloropropene.** *In vitro* genotoxicity studies for mutagenicity in bacterial cells and chromosomal aberration in mammalian cells for 3,3-dichloropropene would help to determine the genotoxic potential of this isomer.

**Reproductive Toxicity.** No information is available regarding the reproductive toxicity of any isomer of dichloropropene by any route of exposure in humans.

**1,3-Dichloropropene.** Pharmacokinetic data in rats indicate that 1,3-dichloropropene or its metabolites are found in low concentrations in reproductive organs and tissues (Waechter and Kastl 1988). However, no effects on reproductive parameters of rats were found in a two-generation inhalation study (Breslin et al. 1989). Furthermore, no lesions attributable to 1,3-dichloropropene were observed after gross and histologic evaluation of reproductive tissues and organs in several animal studies. These studies include a two-generation reproductive/developmental inhalation study (Breslin et al. 1989), a 2-year inhalation study (Lomax et al. 1989), and a 2-year oral study (NTP 1985). No studies regarding reproductive effects in animals following dermal exposure were found; however, the results of the inhalation and oral studies indicate no reason to suspect that 1,3-dichloropropene would have reproductive effects by this route. Additional reproductive studies would not be useful at this time.

**2,3-Dichloropropene.** No histopathology of male or female reproductive organs was observed in a repeated acute-duration inhalation exposure study in rats or mice exposed at  $\leq 75$  ppm (Zempel et al. 1987). A reproductive toxicity assay for rats exposed to 2,3-dichloropropene by inhalation (Johannsen et al. 1991) reported no reproductive effects at 1 or 5 ppm, although there was a statistically insignificant reduction in female fertility in exposed animals. It seems likely, based on the results of the acute-duration repeated inhalation assay by Zempel et al. (1987), that rat dams in the study by Johannsen et al. (1991) experienced irritation of the nasal tissues, which was unreported because the nasal turbinates were not examined for histopathology. The incomplete data available for intermediate-duration inhalation toxicity in rats and mice suggest that 2,3-dichloropropene does not have a direct adverse effect on reproductive organs or sperm or estrus cycle parameters (NTP 1989, 2006). Additional reproductive toxicity testing that includes examination of portal-of-entry tissues in exposed parents would help to determine reliable NOAEL and LOAEL values for reproductive effects and parental toxicity. Studies in mice exposed by inhalation would help to determine whether the more extensive damage to the respiratory tract, compared to rats, affects reproductive function because of irritation-induced parental stress.

## 3. HEALTH EFFECTS

*1,1-, 1,2-, and 3,3-Dichloropropene.* Because no data are available for any of these isomers by any route of exposure, testing in animals would help to determine the reproductive toxicity of these isomers.

**Developmental Toxicity.**

*1,3-Dichloropropene.* Both acute-duration developmental inhalation studies in rats and rabbits (Hanley et al. 1987; Kloes et al. 1983) and intermediate-duration reproductive inhalation studies in rats (Breslin et al. 1989) have shown that 1,3-dichloropropene is not teratogenic. However, fetotoxicity in the rabbits could not be assessed because significant maternal toxicity at the highest tested concentration (300 ppm) resulted in the death of six of seven rabbits (Kloes et al. 1983). Maternal toxicity in rats, also at 300 ppm, may have resulted in fetotoxicity and the subsequent decrease in fetuses per litter. Lower concentrations of 1,3-dichloropropene ( $\leq 150$  ppm) were not fetotoxic in these studies, although an exposure of 120 ppm to pregnant rats resulted in delayed ossification, which may have been due to decreased body weight of the dams. A weakness of these studies is that the dams were not evaluated for effects in the respiratory tract, especially the nasal turbinates, so the NOAEL for maternal toxicity may have been overestimated. It seems possible that repeated irritation might contribute to maternal stress, resulting in lower feed intake, decreased maternal body weight gain, and fetal effects such as delayed ossification. New inhalation exposure studies that include examination of the nasal turbinates, as well as a pair-fed group, would allow the reason for delayed development to be identified.

*2,3-Dichloropropene.* An intermediate-duration reproductive study in rats exposed by inhalation, reported no fetal effects at exposures at 1 or 5 ppm, reportedly below the level of maternal toxicity (Johannsen et al. 1991). A weakness of this study is that the dams were not evaluated for effects in the nasal turbinates, the primary target tissue in acutely exposed rats (Zempel et al. 1987), so the maternal NOAEL may not have been accurately identified. Additional developmental toxicity studies that include examination of the maternal portal-of-entry tissues in rats, and also in mice (which had more extensive respiratory tract effects than rats exposed under identical conditions [Zempel et al. 1987]), would help to better characterize the developmental toxicity of this isomer.

*1,1-, 1,2-, and 3,3-Dichloropropene.* Because no data are available for any of these isomers by any route of exposure, testing in animals would help to determine the potential of these isomers to induce developmental effects.

## 3. HEALTH EFFECTS

**Immunotoxicity.**

***1,3-Dichloropropene.*** Several clinical reports on the development of a delayed-type hypersensitivity after skin contact in workers occupationally exposed to 1,3-dichloropropene (Bousema et al. 1991; Corazza et al. 2003; van Joost and de Jong 1988; Vozza et al. 1996) indicate the possibility of immunotoxicity in humans. This is supported by animal studies that document the development of delayed-type hypersensitivity in guinea pigs (Carreon and Wall 1983; Jeffrey 1987a; Jones 1988b; Mizell 1988b). Since the immune system may be a target of 1,3-dichloropropene toxicity, a battery of immune function tests appears to be warranted at this time. However, no animal studies showed adverse effects on lymphocytes, despite exposure by inhalation or gavage for intermediate or chronic duration (Haut et al. 1996; Lomax et al. 1989; NTP 1985; Stebbins et al. 2000; Stott et al. 1988; Til et al. 1973; Torkelson and Oyen 1977). Furthermore, gross and histological examination of the lymph nodes and the thymus in several animal studies of inhalation and oral exposure revealed no lesions attributable to 1,3-dichloropropene as Telone II (Lomax et al. 1989; NTP 1985; Stott et al. 1988).

***1,1-, 1,2-, 2,3-, and 3,3-Dichloropropene.*** No data are available for immunotoxicity of these isomers in humans or animals. Since immunological effects have been observed in humans and animals exposed dermally to 1,3-dichloropropene, primary skin sensitization studies in animals would help to characterize the potential of these isomers to induce immunotoxicity. Additional immune function testing could then be conducted based on the results of the skin sensitization studies.

**Neurotoxicity.**

***1,3-Dichloropropene.*** No neurotoxicity was observed in humans accidentally exposed to 1,3-dichloropropene at concentrations high enough to require medical attention (Markovitz and Crosby 1984). No evidence for neurotoxicity was found following gross and histological examination of brain, nerves, and the spinal cord from rats and mice after inhalation (Coate 1979a; Lomax et al. 1989; Stott et al. 1988) and oral exposure to 1,3-dichloropropene (Haut et al. 1996; NTP 1985; Stebbins et al. 1999, 2000). Clinical signs that indicate possible neurotoxicity, however, were noted in rabbits after dermal exposure to high concentrations of 1,3-dichloropropene (Jones 1988b), and in rabbits after inhalation exposure to high concentrations of 1,3-dichloropropene (Kloes et al. 1983). These signs included ataxia, loss of the righting reflex, lacrimation, salivation, and lethargy. Studies determining the threshold inhalation concentrations associated with neurological effects following acute exposure at high levels might be

## 3. HEALTH EFFECTS

helpful for identifying hazards due to neurological impairment during accidental exposure. Such studies would be less useful for the typical exposures experienced by the general population.

***1,2-Dichloropropene.*** The only data available for neurotoxicity following exposure to 1,2-dichloropropene was a report of unconsciousness in rats exposed to a saturated vapor atmosphere estimated at 63,764 ppm (Dow 1962). Additional testing would help to determine the threshold for neurotoxicity of 1,2-dichloropropene at more typical experimental exposure levels.

***2,3-Dichloropropene.*** There is no information as to the neurotoxicity of 2,3-dichloropropene in humans and no neurotoxic effects, clinical signs, or histopathology were observed in rats or mice exposed repeatedly at  $\leq 75$  ppm by inhalation in an acute study (Zempel et al. 1987). Acute lethality studies reported signs of suppression of the central nervous system following single inhalation exposures at levels of 500 ppm and higher (Dietz et al. 1985b; Monsanto 1967). Because of reporting deficiencies, these data do not reliably identify NOAEL or LOAEL values for neurotoxicity following single inhalation exposure.

***1,1- and 3,3-Dichloropropene.*** As no neurotoxicity or systemic toxicity data are available for these isomers, acute-duration testing in animals would help to determine the thresholds for neurological effects following oral or inhalation exposure.

### **Epidemiological and Human Dosimetry Studies.**

***1,3-Dichloropropene.*** One pharmacokinetic study in humans described a strong correlation between exposure levels during the application of 1,3-dichloropropene on farms and urinary excretion levels of 1,3-dichloropropene metabolites (Osterloh et al. 1984). Additional monitoring studies reported slight increases in urinary excretion of N-acetylglucosamidase, a possible biomarker for subclinical renal effects (Osterloh and Feldman 1993; Osterloh et al. 1989). A case-control study reported an apparent increase in risk of death from pancreatic cancer associated with long-term (20-year) residence in three communities in which high quantities of 1,3-dichloropropene were used for fumigation (Clary and Ritz 2003). However, there was no direct exposure data for the subjects, and given the products available at the time, it is possible that carcinogenic effects could have been caused by additives (for example, epichlorohydrin) no longer present in current products. Given the lack of data for humans exposed long-term to 1,3-dichloropropene, epidemiological studies of respiratory effects and possible carcinogenicity in, for example, agricultural workers exposed occupationally, would be especially valuable. Additionally, long-term follow-up studies of chronic toxicity and carcinogenicity in people exposed to high concentrations of

## 3. HEALTH EFFECTS

1,3-dichloropropene at the site of a spill would be valuable. Chronic toxicity evaluation should focus on the nasal epithelia, forestomach, lungs, liver, and kidneys, which are the primary target organs identified in animal studies.

Limited evidence suggests that the mu class of glutathione S-transferase may not play a significant role in the metabolism of 1,3-dichloropropene in humans (Vos et al. 1991). Systematic evaluation of isoforms of the enzymes involved in metabolism of dichloropropenes (glutathione S-transferase and cytochrome P-450) in humans would help interpret the basis of individual variability in human studies (see Comparative Toxicokinetics below).

***1,1-, 1,2-, 2,3-, and 3,3-Dichloropropene.*** No studies were located regarding the epidemiology or human dosimetry of these isomers

**Biomarkers of Exposure and Effect.*****Exposure.***

***1,3-Dichloropropene.*** The primary biomarker of exposure identified in the literature is the mercapturic acid metabolite of 1,3-dichloropropene found in the urine of animals exposed by inhalation (Fisher and Kilgore 1988b) and orally (Climie et al. 1979; Hutson et al. 1971) and humans exposed occupationally (Osterloh and Feldman 1993; Osterloh et al. 1984; Van Welie et al. 1989). Because 1,3-dichloropropene does not appear to accumulate in the body, only short-term and possibly intermediate-duration exposures can be assessed using the urinary metabolite as a biomarker. Depletion of glutathione stores would represent a biomarker of exposure, but would not be practical in the absence of data for preexposure glutathione levels. Although no pharmacokinetic studies have investigated chronic exposure, this duration of exposure may not be assessed reliably if some period of time has passed between the last exposure and biomarker analysis. Since hematological and clinical chemistry analyses performed in animal studies of intermediate and chronic exposure have not identified significant alterations indicative of exposure, attempts to develop biomarkers that use easily obtained biological fluids may not be fruitful. Studies in dogs exposed orally have shown evidence of microcytic anemia (Haut et al. 1996; Stebbins et al. 1999), but this would not represent a specific biomarker for 1,3-dichloropropene. Research to identify a biomarker would facilitate future medical surveillance, which could lead to early detection and treatment. If future *in vivo* assays for DNA adduct formation (see Genotoxicity, above) yield positive results, it is possible that adduct frequency in blood cells might be developed as a biomarker. However,

## 3. HEALTH EFFECTS

given that mutagenic metabolites of 1,3-dichloropropene form under high-exposure conditions, adduct frequency is unlikely to be a useful biomarker for low-level exposures.

**2,3-Dichloropropene.** There is no information on biomarkers in humans for exposure to 2,3-dichloropropene. Based on toxicokinetic studies in animals exposed orally or by inhalation, urinary mercapturic acid metabolite represents a biomarker of exposure for the first few days after exposure (Bond et al. 1985; Dutcher et al. 1985; Eder and Dornbusch 1988; Medinsky et al. 1984). Elimination is too rapid for this metabolite to be a useful biomarker for exposures that ended several days earlier.

**1,1-, 1,2-, and 3,3-Dichloropropene.** No data are available for biomarkers of exposure to these isomers. Toxicity studies in animals exposed by inhalation, oral, or dermal exposure would help to identify target organ specificities for these isomers.

**Effect.**

**1,3-Dichloropropene.** Irritant effects have been noted in humans acutely exposed to high doses by the oral or inhalation routes, and dermal exposure resulted in contact dermatitis and delayed sensitivity reactions. The effects identified in animal studies include portal-of-entry effects such as lung trauma in acutely exposed rats, hyperplasia/hypertrophy of the nasal respiratory epithelium in rats and mice, hyperplasia of the nonglandular stomach in rats and mice, as well as hyperplasia of the urinary bladder in mice, and anemia in dogs. It is evident that none of the effects observed in humans and animals are unique to dichloropropenes. Furthermore, it is not known whether the anemia observed in orally-exposed dogs is relevant to humans. Analysis of serum and urinary biomarkers for liver and renal effects did not show significant changes in workers occupationally exposed at low levels to cis or racemic 1,3-dichloropropene (Boogard et al. 1993; Verplanke et al. 2000). This is not unexpected given that neither the liver nor the kidney is the most vulnerable target of toxicity for 1,3-dichloropropene. Development of new biomarkers of effect requires a thorough knowledge of the health effects and more subtle physiological or biochemical changes caused by 1,3-dichloropropene. Further studies on the products of the minor metabolic pathways, which might form adducts detectable in cells circulating in the bloodstream, may identify biomarkers of effect for this isomer.

**2,3-Dichloropropene.** No information is available as to toxic effects in humans exposed to 2,3-dichloropropene. Effects in exposed animals appear to be similar to the portal-of-entry effects observed for 1,3-dichloropropene, except that the former causes more severe respiratory tract lesions. Reliable

## 3. HEALTH EFFECTS

intermediate- and chronic-duration toxicity studies could help to determine whether longer-term exposure to 2,3-dichloropropene reveals unique biomarkers of effect.

***1,1-, 1,2-, and 3,3-Dichloropropene.*** No reliable data are available as to the toxicity of these isomers in humans or animals exposed by any route, although unspecified liver and kidney effects were observed in rats following gavage exposure to 1,2-dichloropropene at 2,000 mg/kg (Dow 1962). Reliable studies, initially for acute-duration exposure, would help to identify target tissues and possible biomarkers of effect for these isomers.

**Absorption, Distribution, Metabolism, and Excretion.**

***1,3-Dichloropropene.*** 1,3-Dichloropropene is absorbed by all routes of exposure. Absorption by the pulmonary (Stott and Kastl 1986) and gastrointestinal (Climie et al. 1979; Hutson et al. 1971; Stott et al. 1998; Waechter and Kastl 1988) tracts is extensive and rapid. The only data for dermal absorption was for skin in contact with cis-1,3-dichloropropene as vapor, not liquid (Kezic et al. 1996). Similarly, metabolism, primarily via conjugation to glutathione is rapid following oral or inhalation exposure, resulting in rapid elimination of mercapturic acid metabolites in urine and feces, and carbon dioxide in exhaled air (Climie et al. 1979; Fisher and Kilgore 1989; Hutson et al. 1971; Stott et al. 1998; Waechter and Kastl 1988). Absorbed 1,3-dichloropropene is widely distributed throughout the body, with the highest initial concentrations found in portal-of-entry tissues (nonglandular stomach) as well as the liver, kidney, and urinary bladder (Dietz et al. 1985a; Waechter and Kastl 1988). The absorption of 1,3-dichloropropene following dermal exposure and the distribution following inhalation or dermal exposure have not been adequately investigated for either single- or repeated-exposure scenarios.

***2,3-Dichloropropene.*** No data are available for the toxicokinetics of 2,3-dichloropropene in humans, but studies are available for rats exposed by inhalation (Bond et al. 1985; Dutcher et al. 1985) and by oral gavage (Eder and Dornbusch 1988; Medinsky et al. 1984). The results of these studies indicate that metabolic pathways and patterns of excretion for 2,3-dichloropropene are similar to those described for 1,3-dichloropropene. However, a comparison of inhalation toxicity studies shows that exposure to 2,3-dichloropropene results in more severe respiratory effects in rats or mice than exposure to 1,3-dichloropropene (Lomax et al. 1989; NTP 1989, 2006; Zempel et al. 1987). Studies are needed to determine the toxicokinetic basis for the apparent greater toxicity of 2,3-dichloropropene compared to 1,3-dichloropropene. This may be associated with differences in rates of reaction with glutathione or relative kinetics

## 3. HEALTH EFFECTS

of metabolic pathways. Studies to determine the toxicokinetics of 2,3-dichloropropene following dermal exposure would be useful since no data are available for this likely route of exposure.

***1,1-Dichloropropene.*** Currently, no data are available for the toxicokinetics of 1,1-dichloropropene in humans or animals. However, *in vitro* data suggest that 1,1-dichloropropene, unlike 1,3- and 2,3-dichloropropene is not detoxified, but rather bioactivated to a mutagenic form by reaction with glutathione (Granville et al. 2005). Studies on the absorption, distribution, metabolism, and excretion following exposure to 1,1-dichloropropene after oral, inhalation, or dermal exposure may help to explain this apparent paradoxical response.

***1,2- and 3,3-Dichloropropene.*** No toxicokinetic data are available for these compounds. Studies on their toxicokinetics should be deferred until the toxicity of these compounds has been adequately investigated.

**Comparative Toxicokinetics.**

A data need relevant to all dichloropropenes is an evaluation of the isoforms of enzymes involved in the detoxification or bioactivation of these compounds. Enzyme polymorphisms could explain individual variations in human studies, possibly identifying vulnerable populations, or strain differences in responses in animal studies. This information would be useful in supporting valid extrapolations across species using PBPK models.

***1,3-Dichloropropene.*** In humans occupationally exposed to 1,3-dichloropropene, the major urinary metabolite found was the mercapturic acid conjugate of 1,3-dichloropropene (Osterloh and Feldman 1993; Osterloh et al. 1984; Van Welie et al. 1989). Studies in rats (Climie et al. 1979; Fisher and Kilgore 1989; Hutson et al. 1971; Stott and Kastl 1986; Stott et al. 1998; Waechter and Kastl 1988) and one study in mice (Dietz et al. 1982) support the identification of the mercapturic acid metabolite as the primary 1,3-dichloropropene metabolite. The excretion data in mice and rats are similar; excretion in urine is the primary route, followed by excretion of CO<sub>2</sub> in the expired air and then by excretion in the feces. It is reasonable to expect that excretion is similar in humans; therefore, rats provide a good model for further pharmacokinetic and toxicity studies of 1,3-dichloropropene. Additional pharmacokinetic studies should focus on the rates of absorption, distribution, metabolism, and excretion, particularly by the dermal route, after acute or repeated exposures. Dose-response information on the relative depletion of glutathione stores in target organs would help define conditions under which toxicity would be increased.



## 3. HEALTH EFFECTS

**2,3-Dichloropropene.** No data are available for the toxicokinetics of 2,3-dichloropropene in humans and the only animal studies were conducted in rats. Studies in rats exposed by inhalation (Bond et al. 1985; Dutcher et al. 1985) and by oral gavage (Eder and Dornbusch 1988; Medinsky et al. 1984) indicate that metabolic pathways and patterns of excretion are similar to those described for 1,3-dichloropropene. Rats and mice exhibit a different pattern of toxicity in respiratory tissues following inhalation exposure to 2,3-dichloropropene, with both species showing nasal effects, but only mice exhibiting toxicity in the lung (NTP 1989, 2006; Zempel et al. 1987). Additional studies on the toxicokinetic basis of this difference could help to explain whether or not the differences could be related to differences in respiratory physiology, the size of glutathione stores in respiratory tissues, or the tissue-specific availability of other pathways for detoxification.

**1,1-Dichloropropene.** Currently, no data are available for the toxicokinetics of 1,1-dichloropropene in humans or animals. However, *in vitro* data suggest that 1,1-dichloropropene, unlike 1,3- and 2,3-dichloropropene is not detoxified, but rather bioactivated to a mutagenic form by reaction with glutathione (Granville et al. 2005). Studies on the absorption, distribution, metabolism, and excretion in rats and mice following exposure to 1,1-dichloropropene after oral, inhalation, and dermal exposure would help to establish the basis of this apparent paradoxical response.

**1,2- and 3,3-Dichloropropene.** No toxicokinetic data are available for these compounds. Studies on the comparative toxicokinetics should be deferred until the toxicity of these compounds has been adequately investigated.

**Methods for Reducing Toxic Effects.** Information on the metabolism of 1,3-dichloropropene in humans (Osterloh and Feldman 1993; Osterloh et al. 1984; Van Welie et al. 1989) and for 1,3- and 2,3-dichloropropene in animals (Bond et al. 1985; Dietz et al. 1982; Eder and Dornbusch 1988; Fisher and Kilgore 1988a; Waechter and Kastl 1988) indicates that the major detoxifying pathway occurs via conjugation with glutathione, which can occur in target organs such as portal-of-entry tissues (nasal epithelia and the stomach) as well as the liver and kidney. Since depletion of glutathione results in saturation of the detoxification pathway, resulting in the use of secondary metabolic pathways that produce mutagenic metabolites (Schneider et al. 1998a), research on therapies that increase tissue levels of glutathione (for example, N-acetylcysteine) is needed. Conversely, since 1,1-dichloropropene produces mutagenic metabolites upon reaction with glutathione, therapies that interfere with that reaction are needed. Additional studies on the metabolism of 1,1-dichloropropene would help to identify possible detoxifying pathways so that therapies could be developed.

### 3. HEALTH EFFECTS

Additional data are needed on the toxicity of 1,2-, and 3,3-dichloropropene before any studies can be conducted on methods for reducing toxic effects of these isomers.

**Children's Susceptibility.** Data needs relating to both prenatal and childhood exposures, and developmental effects expressed either prenatally or during childhood, are discussed in detail in the Developmental Toxicity subsection above.

The scant information on the toxicity of dichloropropenes in humans is limited to studies in adults exposed to 1,3-dichloropropene. Data relating to health effects in children are lacking. As physiological parameters differ in fetuses, newborns, young children, and adults (EPA 2001d), studies should be conducted in animals to determine the effect on those differences on toxicity of dichloropropenes. Especially since children and adults differ with respect to respiratory parameters, animal testing should be conducted by the inhalation route to determine whether juveniles are at greater or lesser risk compared to adults following exposure. More information is needed on transfer of dichloropropenes across the placenta, the kinetics of transfer, and placental metabolism of dichloropropenes. Since depletion of glutathione stores is possibly related to increased use of bioactivating metabolic pathways by 1,3- and 2,3-dichloropropene, studies monitoring the conditions under which placental glutathione stores are depleted would be useful. As dichloropropene was previously reported in one of eight samples of human breast milk, additional toxicokinetic research is needed to define the risk associated with transfer via milk (Pellizzari et al. 1982).

Child health data needs relating to exposure are discussed in Section 6.8.1, Identification of Data Needs: Exposures of Children.

#### 3.12.3 Ongoing Studies

No ongoing studies were located on the toxicity or mechanism of action of dichloropropenes.