

# Chapter 6



# Flight Instruments

Flight instruments enable an airplane to be operated with maximum performance and enhanced safety, especially when flying long distances. Manufacturers provide the necessary flight instruments, but to use them effectively, pilots need to understand how they operate. This chapter covers the operational aspects of the pitot-static system and associated instruments, the vacuum system and associated instruments, and the magnetic compass.

## PITOT-STATIC FLIGHT INSTRUMENTS

There are two major parts of the pitot-static system: the impact pressure chamber and lines, and the static pressure chamber and lines. They provide the source of ambient air pressure for the operation of the altimeter, vertical speed indicator (vertical velocity indicator), and the airspeed indicator. [Figure 6-1]

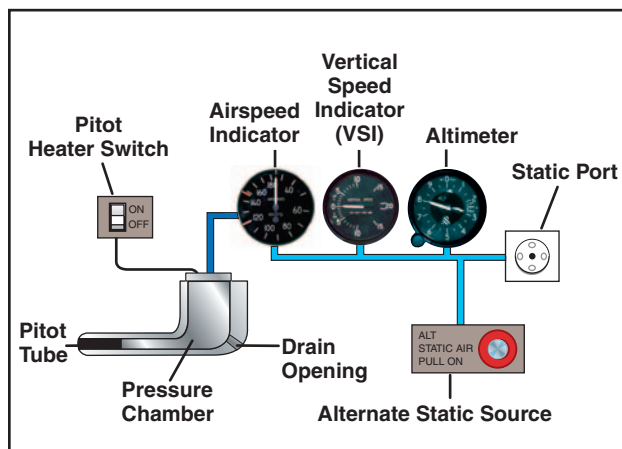


Figure 6-1. Pitot-static system and instruments.

## IMPACT PRESSURE CHAMBER AND LINES

In this system, the impact air pressure (air striking the airplane because of its forward motion) is taken from a pitot tube, which is mounted in locations that provide minimum disturbance or turbulence caused by the motion of the airplane through the air. The static pressure (pressure of the still air) is usually taken from the static line attached to a vent or vents mounted flush with the side of the fuselage. This compensates for any possible variation in static pressure due to erratic changes in airplane attitude.

The openings of both the pitot tube and the static vent must be checked during the preflight inspection to assure that they are free from obstructions. Blocked or partially blocked openings should be cleaned by a certificated mechanic. Blowing into these openings is not recommended because this could damage the instruments.

As the airplane moves through the air, the impact pressure on the open pitot tube affects the pressure in the pitot chamber. Any change of pressure in the pitot chamber is transmitted through a line connected to the airspeed indicator, which utilizes impact pressure for its operation.

## STATIC PRESSURE CHAMBER AND LINES

The static chamber is vented through small holes to the free undisturbed air, and as the atmospheric pressure increases or decreases, the pressure in the static chamber changes accordingly. Again, this pressure change is transmitted through lines to the instruments which utilize static pressure.

An alternate source for static pressure is provided in some airplanes in the event the static ports become blocked. This source usually is vented to the pressure inside the cockpit. Because of the venturi effect of the flow of air over the cockpit, this alternate static pressure is usually lower than the pressure provided by the normal static air source. When the alternate static source is used, the following differences in the instrument indications usually occur: the altimeter will indicate higher than the actual altitude, the airspeed will indicate greater than the actual airspeed, and the vertical speed will indicate a climb while in level flight. Consult the Airplane Flight Manual or Pilot's Operating Handbook (AFM/POH) to determine the amount of error.

If the airplane is not equipped with an alternate static source, breaking the glass seal of the vertical speed indicator allows ambient air pressure to enter the static system. This makes the VSI unusable.

## ALTIMETER

The altimeter measures the height of the airplane above a given pressure level. Since it is the only instrument that gives altitude information, the altimeter is one of the most vital instruments in the airplane. To use the altimeter effectively, its operation and how atmospheric pressure and temperature affect it must be thoroughly understood. A stack of sealed **aneroid** wafers comprises the main component of the altimeter. These wafers expand and contract with changes in atmospheric pressure from the static source. The mechanical linkage translates these changes into pointer movements on the indicator. [Figure 6-2]

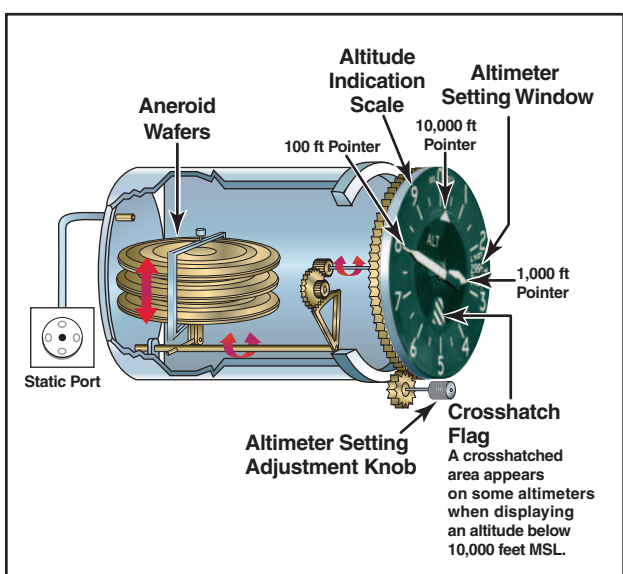


Figure 6-2. Altimeter.

**Aneroid**—A sealed flexible container, which expands or contracts in relation to the surrounding air pressure. It is used in an altimeter or a barometer to measure the pressure of the air.

## PRINCIPLE OF OPERATION

The pressure altimeter is an aneroid barometer that measures the pressure of the atmosphere at the level where the altimeter is located, and presents an altitude indication in feet. The altimeter uses static pressure as its source of operation. Air is denser at sea level than aloft, so as altitude increases, atmospheric pressure decreases. This difference in pressure at various levels causes the altimeter to indicate changes in altitude.

The presentation of altitude varies considerably between different types of altimeters. Some have one pointer while others have two or more. Only the multipointer type will be discussed in this handbook. The dial of a typical altimeter is graduated with numerals arranged clockwise from 0 to 9. Movement of the aneroid element is transmitted through gears to the three hands that indicate altitude. The shortest hand indicates altitude in tens of thousands of feet; the intermediate hand in thousands of feet; and the longest hand in hundreds of feet.

This indicated altitude is correct, however, only when the sea level barometric pressure is standard (29.92 inches of mercury), the sea level free air temperature is standard (+15°C or 59°F), and the pressure and temperature decrease at a standard rate with an increase in altitude. Adjustments for nonstandard conditions are accomplished by setting the corrected pressure into a barometric scale located on the face of the altimeter. Only after the altimeter is set does it indicate the correct altitude.

## EFFECT OF NONSTANDARD PRESSURE AND TEMPERATURE

If no means were provided for adjusting altimeters to nonstandard pressure, flight could be hazardous. For example, if flying from a high-pressure area to a low-pressure area without adjusting the altimeter, the actual altitude of the airplane would be **LOWER** than the indicated altitude. An old saying, “HIGH TO LOW, LOOK OUT BELOW” is a way of remembering which condition is dangerous. When flying from a low-pressure area to a high-pressure area without adjusting the altimeter, the actual altitude of the airplane is **HIGHER** than the indicated altitude.

Figure 6-3 shows how variations in air temperature also affect the altimeter. On a warm day, a given mass of air expands to a larger volume than on a cold day, raising the pressure levels. For example, the pressure level where the altimeter indicates 5,000 feet is **HIGHER** on a warm day than under standard conditions. On a cold day, the reverse is true, and the pressure level where the altimeter indicates 5,000 feet is **LOWER**.

The adjustment to compensate for nonstandard pressure does not compensate for nonstandard temperature.

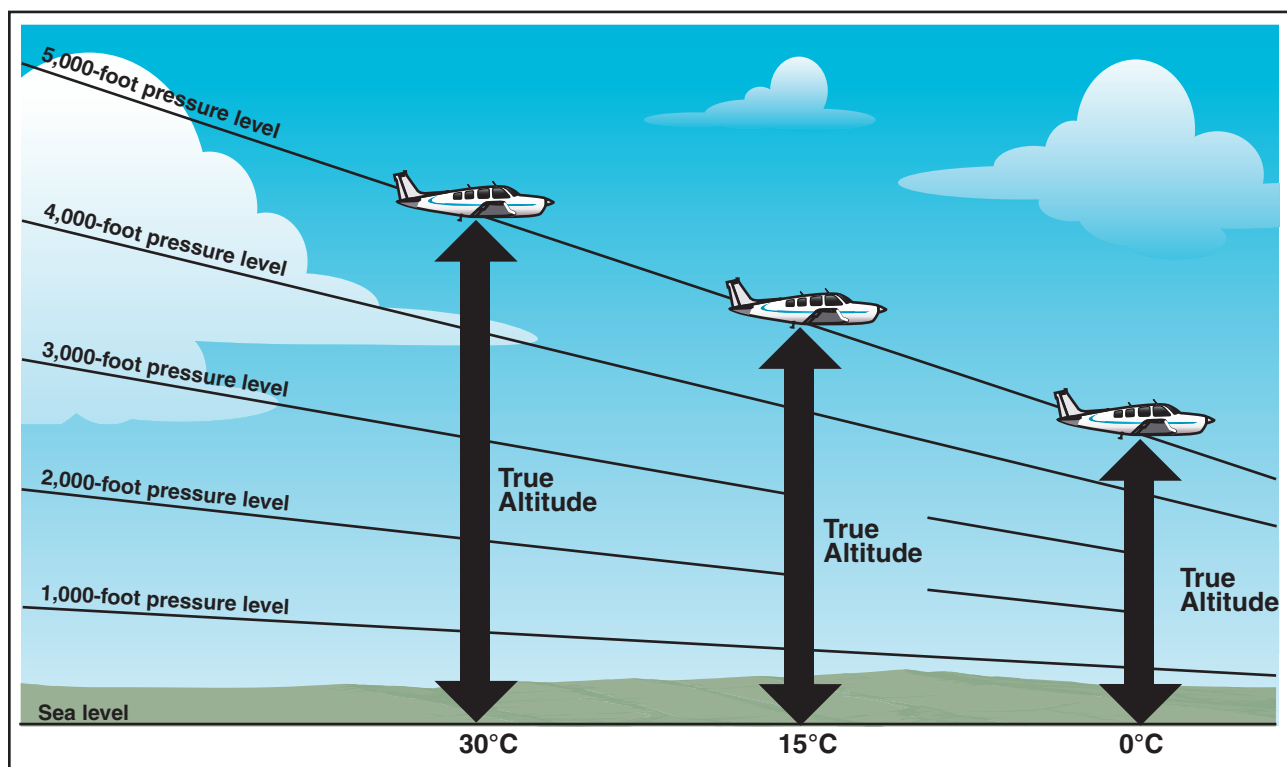


Figure 6-3. Effects of nonstandard temperature on an altimeter.

If terrain or obstacle clearance is a factor in selecting a cruising altitude, particularly at higher altitudes, remember to anticipate that a colder-than-standard temperature places the airplane **LOWER** than the altimeter indicates. Therefore, it is necessary to use a higher indicated altitude to provide adequate terrain clearance. Modify the memory aid to “**HIGH TO LOW OR HOT TO COLD, LOOK OUT BELOW.**”

### SETTING THE ALTIMETER

Most altimeters are equipped with a barometric pressure setting window (sometimes referred to as the Kollsman window) providing a means to adjust the altimeter. A knob is located at the bottom of the instrument for this adjustment.

To adjust the altimeter for variation in atmospheric pressure, the pressure scale in the altimeter setting window, calibrated in inches of mercury (in. Hg) and/or millibars (Mb), is adjusted to match the given altimeter setting. Altimeter setting is defined as station pressure reduced to sea level. However, an altimeter setting is accurate only in the vicinity of the reporting station. Therefore, the altimeter must be adjusted as the flight progresses from one station to the next.

Many pilots confidently expect that the current altimeter setting will compensate for irregularities in atmospheric pressure at all altitudes, but this is not always true. The altimeter setting broadcast by ground stations is the

station pressure corrected to mean sea level. It does not account for the irregularities at higher levels, particularly the effect of nonstandard temperature. However, if each pilot in a given area is using the same altimeter setting, each altimeter should be equally affected by temperature and pressure variation errors, making it possible to maintain the desired vertical separation between aircraft.

When flying over high, mountainous terrain, certain atmospheric conditions can cause the altimeter to indicate an altitude of 1,000 feet, or more, **HIGHER** than the actual altitude. For this reason, a generous margin of altitude should be allowed—not only for possible altimeter error, but also for possible downdrafts that might be associated with high winds.

To illustrate the use of the altimeter setting system, follow a flight from Dallas Love Field, Texas to Abilene Municipal Airport, Texas via Mineral Wells. Before taking off from Love Field, the pilot receives a current altimeter setting of 29.85 from the control tower or **automatic terminal information service (ATIS)**, and sets this value in the altimeter setting

**Automatic Terminal Information Service (ATIS)**—The continuous broadcast of recorded noncontrol information in selected terminal areas. Its purpose is to improve controller effectiveness and to relieve frequency congestion by automating the repetitive transmission of essential but routine information.

window. The altimeter indication should then be compared with the known airport elevation of 487 feet. Since most altimeters are not perfectly calibrated, an error may exist.

When over Mineral Wells, assume the pilot receives a current altimeter setting of 29.94 and sets this in the altimeter window. Before entering the traffic pattern at Abilene Municipal Airport, a new altimeter setting of 29.69 is received from the Abilene Control Tower, and set in the altimeter setting window. If the pilot desires to fly the traffic pattern at approximately 800 feet above the terrain, and the field elevation of Abilene is 1,791 feet, an indicated altitude of 2,600 feet should be maintained (1,791 feet + 800 feet = 2,591 feet rounded to 2,600 feet).

The importance of properly setting the altimeter cannot be overemphasized. Assume that the pilot did not adjust the altimeter at Abilene to the current setting, and continued using the Mineral Wells setting of 29.94. When entering the Abilene traffic pattern at an indicated altitude of 2,600 feet, the airplane would be approximately 250 feet below the proper traffic pattern altitude. Upon landing, the altimeter would indicate approximately 250 feet higher than the field elevation.

Altimeter setting	29.94
Current altimeter setting	<u>29.69</u>
Difference	.25

(Since 1 inch of pressure is equal to approximately 1,000 feet of altitude,  $.25 \times 1,000$  feet = 250 feet.)

When determining whether to add or subtract the amount of altimeter error, remember that, when the actual pressure is lower than what is set in the altimeter window, the actual altitude of the airplane will be lower than what is indicated on the altimeter.

### ALTIMETER OPERATION

There are two means by which the altimeter pointers can be moved. The first is a change in air pressure, while the other is an adjustment to the barometric scale. When the airplane climbs or descends, changing pressure within the altimeter case expands or contracts the aneroid barometer. This movement is transmitted through mechanical linkage to rotate the pointers. A decrease in pressure causes the altimeter to indicate an increase in altitude, and an increase in pressure causes the altimeter to indicate a decrease in altitude. Accordingly, if the airplane is flown from a pressure level of 28.75 in. Hg. to a pressure level of 29.75 in. Hg., the altimeter would show a decrease of approximately 1,000 feet in altitude.

The other method of moving the pointers does not rely on changing air pressure, but the mechanical construction of the altimeter. Do not be confused by the fact that as the barometric pressure scale is moved, the indicator needles move in the same direction, which is opposite to the reaction the pointers have when air pressure changes. To illustrate this point, suppose the pilot lands at an airport with an elevation of 1,000 feet and the altimeter is correctly set to the current sea level pressure of 30.00 in. Hg. While the airplane is parked on the ramp, the pressure decreases to 29.50. The altimeter senses this as a climb and now indicates 1,500 feet. When returning to the airplane, if the setting in the altimeter window is decreased to the current sea level pressure of 29.50, the indication will be reduced back down to 1,000 feet.

Knowing the airplane's altitude is vitally important to a pilot. The pilot must be sure that the airplane is flying high enough to clear the highest terrain or obstruction along the intended route. It is especially important to have accurate altitude information when visibility is restricted. To clear obstructions, the pilot must constantly be aware of the altitude of the airplane and the elevation of the surrounding terrain. To reduce the possibility of a midair collision, it is essential to maintain altitude in accordance with air traffic rules.

### TYPES OF ALTITUDE

Altitude is vertical distance above some point or level used as a reference. There are as many kinds of altitude as there are reference levels from which altitude is measured, and each may be used for specific reasons. Pilots are mainly concerned with five types of altitudes:

**Indicated Altitude**—That altitude read directly from the altimeter (uncorrected) when it is set to the current altimeter setting.

**True Altitude**—The vertical distance of the airplane above sea level—the actual altitude. It is often expressed as feet above mean sea level (MSL). Airport, terrain, and obstacle elevations on aeronautical charts are true altitudes.

**Absolute Altitude**—The vertical distance of an airplane above the terrain, or above ground level (AGL).

**Pressure Altitude**—The altitude indicated when the altimeter setting window (barometric scale) is adjusted to 29.92. This is the altitude above the standard datum plane, which is a theoretical plane where air pressure

(corrected to 15°C) equals 29.92 in. Hg. Pressure altitude is used to compute density altitude, true altitude, true airspeed, and other performance data.

**Density Altitude**—This altitude is pressure altitude corrected for variations from standard temperature. When conditions are standard, pressure altitude and density altitude are the same. If the temperature is above standard, the density altitude is higher than pressure altitude. If the temperature is below standard, the density altitude is lower than pressure altitude. This is an important altitude because it is directly related to the airplane's performance.

As an example, consider an airport with a field elevation of 5,048 feet MSL where the standard temperature is 5°C. Under these conditions, pressure altitude and density altitude are the same—5,048 feet. If the temperature changes to 30°C, the density altitude increases to 7,855 feet. This means an airplane would perform on takeoff as though the field elevation were 7,855 feet at standard temperature. Conversely, a temperature of -25°C would result in a density altitude of 1,232 feet. An airplane would have much better performance under these conditions.

**Instrument Check**—To determine the condition of an altimeter, set the barometric scale to the altimeter setting transmitted by the local automated flight service station (AFSS) or any other reliable source. The altimeter pointers should indicate the surveyed elevation of the airport. If the indication is off more than 75 feet from the surveyed elevation, the instrument should be referred to a certificated instrument repair station for recalibration.

## VERTICAL SPEED INDICATOR

The vertical speed indicator (VSI), which is sometimes called a vertical velocity indicator (VVI), indicates whether the airplane is climbing, descending, or in level flight. The rate of climb or descent is indicated in feet per minute. If properly calibrated, the VSI indicates zero in level flight. [Figure 6-4]

### PRINCIPLE OF OPERATION

Although the vertical speed indicator operates solely from static pressure, it is a differential pressure instrument. It contains a diaphragm with connecting linkage and gearing to the indicator pointer inside an airtight case. The inside of the diaphragm is connected directly to the static line of the pitot-static system. The area outside the diaphragm, which is inside the instrument case, is also connected to the static line, but through a restricted orifice (calibrated leak).

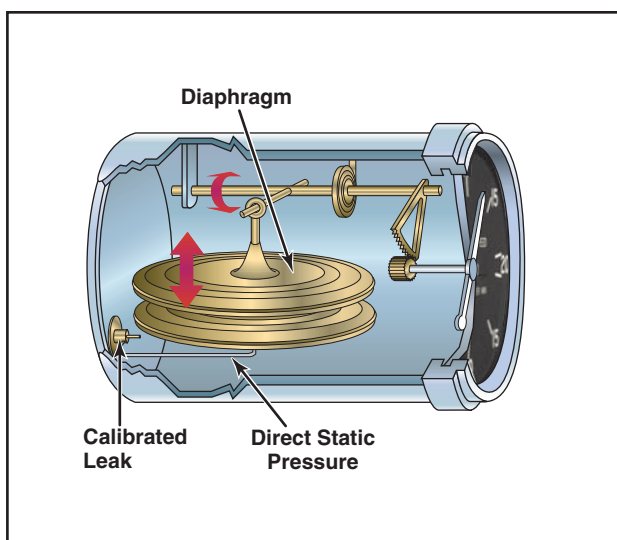


Figure 6-4. Vertical speed indicator.

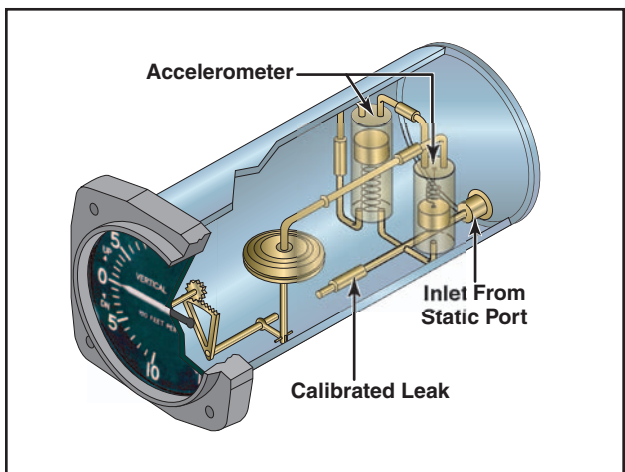
Both the diaphragm and the case receive air from the static line at existing atmospheric pressure. When the airplane is on the ground or in level flight, the pressures inside the diaphragm and the instrument case remain the same and the pointer is at the zero indication. When the airplane climbs or descends, the pressure inside the diaphragm changes immediately, but due to the metering action of the restricted passage, the case pressure remains higher or lower for a short time, causing the diaphragm to contract or expand. This causes a pressure differential that is indicated on the instrument needle as a climb or descent. When the pressure differential stabilizes at a definite ratio, the needle indicates the rate of altitude change.

The vertical speed indicator is capable of displaying two different types of information:

- Trend information shows an immediate indication of an increase or decrease in the airplane's rate of climb or descent.
- Rate information shows a stabilized rate of change in altitude.

For example, if maintaining a steady 500-foot per minute (f.p.m.) climb, and the nose is lowered slightly, the VSI immediately senses this change and indicates a decrease in the rate of climb. This first indication is called the trend. After a short time, the VSI needle stabilizes on the new rate of climb, which in this example, is something less than 500 f.p.m. The time from the initial change in the rate of climb, until the VSI displays an accurate indication of the new rate, is called the lag. Rough control technique and turbulence can extend the lag period and cause erratic and unstable rate indications. Some airplanes are

equipped with an instantaneous vertical speed indicator (IVSI), which incorporates accelerometers to compensate for the lag in the typical VSI. [Figure 6-5]

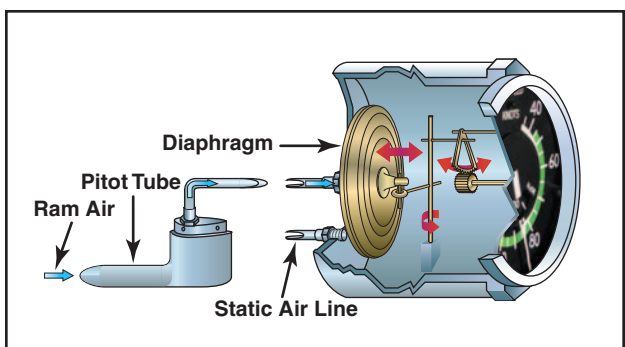


**Figure 6-5.** An instantaneous vertical speed indicator incorporates accelerometers to help the instrument immediately indicate changes in vertical speed.

**Instrument Check**—To verify proper operation, make sure the VSI is indicating near zero prior to takeoff. After takeoff, it should indicate a positive rate of climb.

## AIRSPEED INDICATOR

The airspeed indicator is a sensitive, differential pressure gauge which measures and shows promptly the difference between pitot or impact pressure, and static pressure, the undisturbed atmospheric pressure at level flight. These two pressures will be equal when the airplane is parked on the ground in calm air. When the airplane moves through the air, the pressure on the pitot line becomes greater than the pressure in the static lines. This difference in pressure is registered by the airspeed pointer on the face of the instrument, which is calibrated in miles per hour, **knots**, or both. [Figure 6-6]



**Figure 6-6.** Airspeed indicator.

**Knots**—Nautical miles per hour.

Pilots should understand the following speeds:

**Indicated Airspeed (IAS)**—The direct instrument reading obtained from the airspeed indicator, uncorrected for variations in atmospheric density, installation error, or instrument error. Manufacturers use this airspeed as the basis for determining airplane performance. Takeoff, landing, and stall speeds listed in the AFM or POH are indicated airspeeds and do not normally vary with altitude or temperature.

**Calibrated Airspeed (CAS)**—Indicated airspeed corrected for installation error and instrument error. Although manufacturers attempt to keep airspeed errors to a minimum, it is not possible to eliminate all errors throughout the airspeed operating range. At certain airspeeds and with certain flap settings, the installation and instrument errors may total several knots. This error is generally greatest at low airspeeds. In the cruising and higher airspeed ranges, indicated airspeed and calibrated airspeed are approximately the same. Refer to the airspeed calibration chart to correct for possible airspeed errors.

**True Airspeed (TAS)**—Calibrated airspeed corrected for altitude and nonstandard temperature. Because air density decreases with an increase in altitude, an airplane has to be flown faster at higher altitudes to cause the same pressure difference between pitot impact pressure and static pressure. Therefore, for a given calibrated airspeed, true airspeed increases as altitude increases; or for a given true airspeed, calibrated airspeed decreases as altitude increases.

A pilot can find true airspeed by two methods. The most accurate method is to use a flight computer. With this method, the calibrated airspeed is corrected for temperature and pressure variation by using the airspeed correction scale on the computer. Extremely accurate electronic flight computers are also available. Just enter the CAS, pressure altitude, and temperature and the computer calculates the true airspeed.

A second method, which is a “rule of thumb,” will provide the approximate true airspeed. Simply add 2 percent to the calibrated airspeed for each 1,000 feet of altitude.

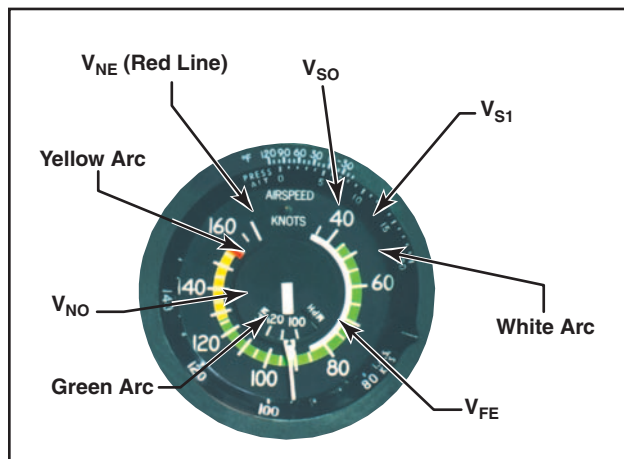
**Groundspeed (GS)**—The actual speed of the airplane over the ground. It is true airspeed adjusted for wind. Groundspeed decreases with a headwind, and increases with a tailwind.

## AIRSPEED INDICATOR MARKINGS

Airplanes weighing 12,500 pounds or less, manufactured after 1945, and certificated by the FAA, are required to have airspeed indicators marked in accordance with a standard color-coded marking

system. This system of color-coded markings enables a pilot to determine at a glance certain airspeed limitations that are important to the safe operation of the airplane. For example, if during the execution of a maneuver, it is noted that the airspeed needle is in the yellow arc and rapidly approaching the red line, the immediate reaction should be to reduce airspeed.

As shown in figure 6-7, airspeed indicators on single-engine small airplanes include the following standard color-coded markings:



**Figure 6-7.** In addition to delineating various speed ranges, the boundaries of the color-coded arcs also identify airspeed limitations.

- White arc—This arc is commonly referred to as the flap operating range since its lower limit represents the full flap stall speed and its upper limit provides the maximum flap speed. Approaches and landings are usually flown at speeds within the white arc.
- Lower limit of white arc ( $V_{S0}$ )—The stalling speed or the minimum steady flight speed in the landing configuration. In small airplanes, this is the power-off stall speed at the maximum landing weight in the landing configuration (gear and flaps down).
- Upper limit of the white arc ( $V_{FE}$ )—The maximum speed with the flaps extended.
- Green arc—This is the normal operating range of the airplane. Most flying occurs within this range.
- Lower limit of green arc ( $V_{S1}$ )—The stalling speed or the minimum steady flight speed obtained in a specified configuration. For most airplanes, this is the power-off stall speed at the maximum takeoff weight in the clean configuration (gear up, if retractable, and flaps up).
- Upper limit of green arc ( $V_{NO}$ )—The maximum structural cruising speed. Do not exceed this speed except in smooth air.
- Yellow arc—Caution range. Fly within this range only in smooth air, and then, only with caution.
- Red line ( $V_{NE}$ )—Never-exceed speed. Operating above this speed is prohibited since it may result in damage or structural failure.

## OTHER AIRSPEED LIMITATIONS

Some important airspeed limitations are not marked on the face of the airspeed indicator, but are found on placards and in the AFM or POH. These airspeeds include:

- Design maneuvering speed ( $V_A$ )—This is the “rough air” speed and the maximum speed for abrupt maneuvers. If during flight, rough air or severe turbulence is encountered, reduce the airspeed to maneuvering speed or less to minimize stress on the airplane structure. It is important to consider weight when referencing this speed. For example,  $V_A$  may be 100 knots when an airplane is heavily loaded, but only 90 knots when the load is light.
- Landing gear operating speed ( $V_{LO}$ )—The maximum speed for extending or retracting the landing gear if using an airplane equipped with retractable landing gear.
- Landing gear extended speed ( $V_{LE}$ )—The maximum speed at which an airplane can be safely flown with the landing gear extended.
- Best angle-of-climb speed ( $V_X$ )—The airspeed at which an airplane gains the greatest amount of altitude in a given distance. It is used during a short-field takeoff to clear an obstacle.
- Best rate-of-climb speed ( $V_Y$ )—This airspeed provides the most altitude gain in a given period of time.
- Minimum control speed ( $V_{MC}$ )—This is the minimum flight speed at which a light, twin-engine airplane can be satisfactorily controlled when an engine suddenly becomes inoperative and the remaining engine is at takeoff power.
- Best rate of climb with one engine inoperative ( $V_{YSE}$ )—This airspeed provides the most altitude gain in a given period of time in a light, twin-engine airplane following an engine failure.

**Instrument Check**—Prior to takeoff, the airspeed indicator should read zero. However, if there is a strong wind blowing directly into the pitot tube, the airspeed

indicator may read higher than zero. When beginning the takeoff, make sure the airspeed is increasing at an appropriate rate.

### BLOCKAGE OF THE PITOT-STATIC SYSTEM

Errors almost always indicate blockage of the pitot tube, the static port(s), or both. Blockage may be caused by moisture (including ice), dirt, or even insects. During pre-flight, make sure the pitot tube cover is removed. Then, check the pitot and static port openings. A blocked pitot tube affects the accuracy of only the airspeed indicator. However, a blockage of the static system not only affects the airspeed indicator, but can also cause errors in the altimeter and vertical speed indicator.

### BLOCKED PITOT SYSTEM

The pitot system can become blocked completely or only partially if the pitot tube drain hole remains open. If the pitot tube becomes blocked and its associated drain hole remains clear, ram air no longer is able to enter the pitot system. Air already in the system will vent through the drain hole, and the remaining pressure will drop to ambient (outside) air pressure. Under these circumstances, the airspeed indicator reading decreases to zero, because the airspeed indicator senses no difference between ram and static air pressure. The airspeed indicator acts as if the airplane were stationary on the ramp. The apparent loss of airspeed is not usually instantaneous. Instead, the airspeed will drop toward zero. [Figure 6-8]

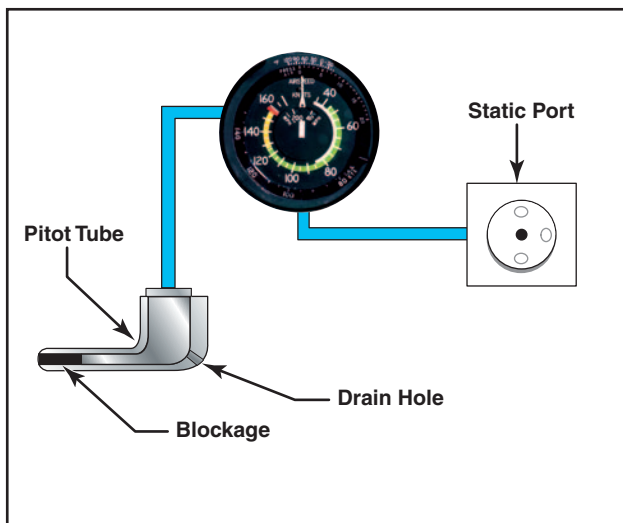


Figure 6-8. A blocked pitot tube, but clear drain hole.

If the pitot tube, drain hole, and static system all become blocked in flight, changes in airspeed will not be indicated, due to the trapped pressures. However, if the static system remains clear, the airspeed indicator acts as an altimeter. An apparent increase in the ram air pressure relative to static pressure occurs as altitude increases above the level where the pitot tube and drain hole became blocked. This pressure differential causes

6-8

the airspeed indicator to show an increase in speed. A decrease in indicated airspeed occurs as the airplane descends below the altitude at which the pitot system became blocked. [Figure 6-9]

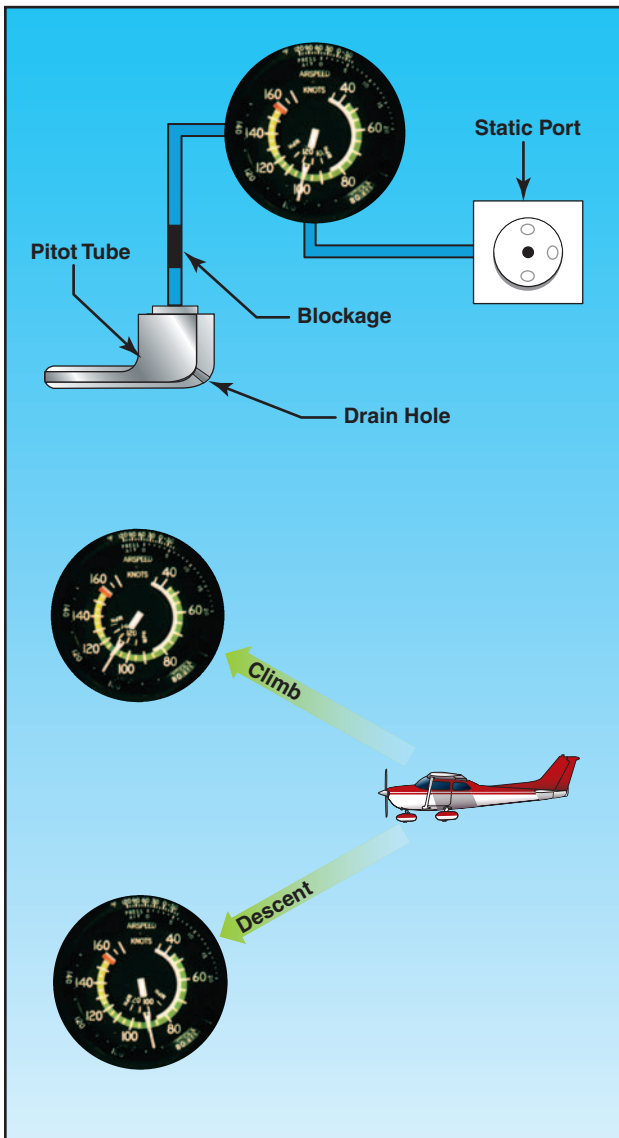


Figure 6-9. Blocked pitot system with clear static system.

The pitot tube may become blocked during flight through visible moisture. Some airplanes may be equipped with pitot heat for flight in visible moisture. Consult the AFM or POH for specific procedures regarding the use of pitot heat.

### BLOCKED STATIC SYSTEM

If the static system becomes blocked but the pitot tube remains clear, the airspeed indicator continues to operate; however, it is inaccurate. Airspeed indications are slower than the actual speed when the airplane is operated above the altitude where the static ports became blocked, because the trapped static pressure is higher than normal for that altitude. When operating at



a lower altitude, a faster than actual airspeed is displayed due to the relatively low static pressure trapped in the system.

A blockage of the static system also affects the altimeter and VSI. Trapped static pressure causes the altimeter to freeze at the altitude where the blockage occurred. In the case of the VSI, a blocked static system produces a continuous zero indication. [Figure 6-10]

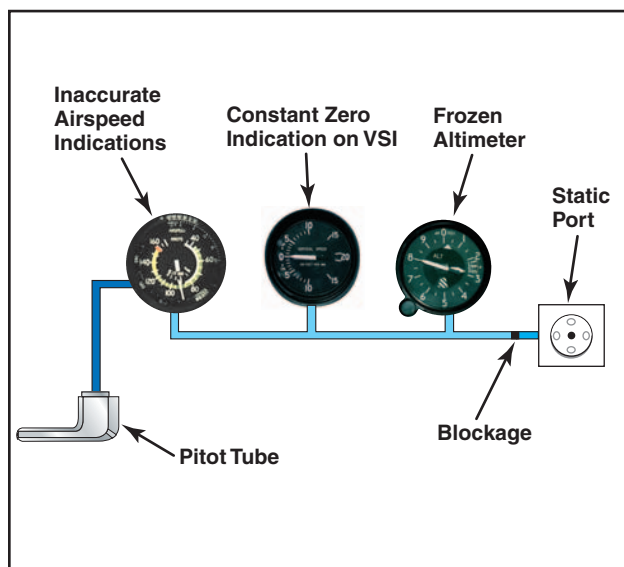


Figure 6-10. Blocked static system.

## GYROSCOPIC FLIGHT INSTRUMENTS

Several flight instruments utilize the properties of a gyroscope for their operation. The most common instruments containing gyroscopes are the turn coordinator, heading indicator, and the attitude indicator. To understand how these instruments operate requires knowledge of the instrument power systems, gyroscopic principles, and the operating principles of each instrument.

### GYROSCOPIC PRINCIPLES

Any spinning object exhibits gyroscopic properties. A wheel or rotor designed and mounted to utilize these properties is called a gyroscope. Two important design characteristics of an instrument gyro are great weight for its size, or high density, and rotation at high speed with low friction bearings.

There are two general types of mountings; the type used depends upon which property of the gyro is utilized. A freely or universally mounted gyroscope is free to rotate in any direction about its center of gravity. Such a wheel is said to have three planes of freedom. The wheel or rotor is free to rotate in any plane in relation to the base and is so balanced that with the gyro wheel at rest, it will remain in the position in which it is placed. Restricted or

semirigidly mounted gyroscopes are those mounted so that one of the planes of freedom is held fixed in relation to the base.

There are two fundamental properties of gyroscopic action—rigidity in space and precession.

### RIGIDITY IN SPACE

Rigidity in space refers to the principle that a gyroscope remains in a fixed position in the plane in which it is spinning. By mounting this wheel, or gyroscope, on a set of **gimbal rings**, the gyro is able to rotate freely in any direction. Thus, if the gimbal rings are tilted, twisted, or otherwise moved, the gyro remains in the plane in which it was originally spinning. [Figure 6-11]

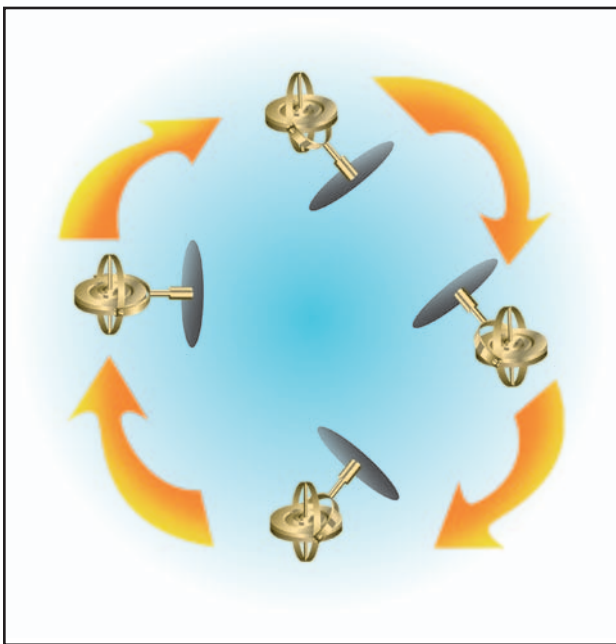


Figure 6-11. Regardless of the position of its base, a gyro tends to remain rigid in space, with its axis of rotation pointed in a constant direction.

### PRECESSION

Precession is the tilting or turning of a gyro in response to a deflective force. The reaction to this force does not occur at the point where it was applied; rather, it occurs at a point that is  $90^\circ$  later in the direction of rotation. This principle allows the gyro to determine a rate of turn by sensing the amount of pressure created by a change in direction. The rate at which the gyro precesses is inversely proportional to the speed of the rotor and proportional to the deflective force.

**Gimbal Ring**—A type of support that allows an object, such as a gyroscope, to remain in an upright condition when its base is tilted.

Precession can also create some minor errors in some instruments. [Figure 6-12]

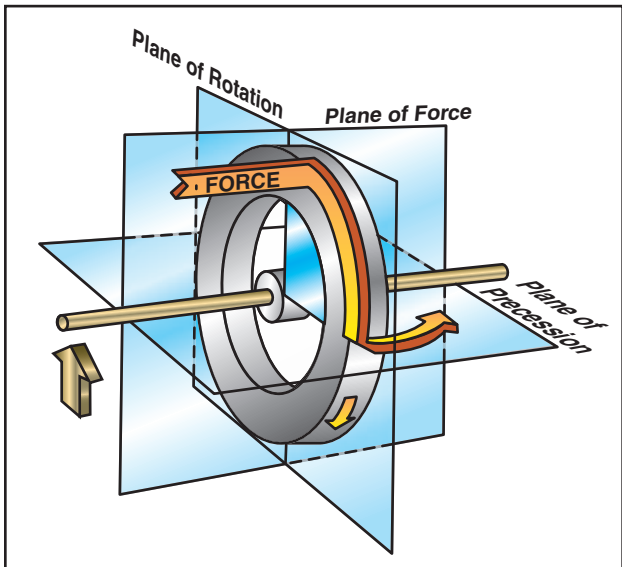


Figure 6-12. Precession of a gyroscope resulting from an applied deflective force.

## SOURCES OF POWER

In some airplanes, all the gyros are vacuum, pressure, or electrically operated; in others, vacuum or pressure systems provide the power for the heading and attitude indicators, while the electrical system provides the power for the turn coordinator. Most airplanes have at least two sources of power to ensure at least one source of bank information if one power source fails.

The vacuum or pressure system spins the gyro by drawing a stream of air against the rotor vanes to spin the rotor at high speed, much like the operation of a waterwheel or turbine. The amount of vacuum or

pressure required for instrument operation varies, but is usually between 4.5 and 5.5 in. Hg.

One source of vacuum for the gyros is a vane-type engine-driven pump that is mounted on the accessory case of the engine. Pump capacity varies in different airplanes, depending on the number of gyros.

A typical vacuum system consists of an engine-driven vacuum pump, relief valve, air filter, gauge, and tubing necessary to complete the connections. The gauge is mounted in the airplane's instrument panel and indicates the amount of pressure in the system (vacuum is measured in inches of mercury less than ambient pressure).

As shown in figure 6-13, air is drawn into the vacuum system by the engine-driven vacuum pump. It first goes through a filter, which prevents foreign matter from entering the vacuum or pressure system. The air then moves through the attitude and heading indicators, where it causes the gyros to spin. A relief valve prevents the vacuum pressure, or suction, from exceeding prescribed limits. After that, the air is expelled overboard or used in other systems, such as for inflating pneumatic deicing boots.

It is important to monitor vacuum pressure during flight, because the attitude and heading indicators may not provide reliable information when suction pressure is low. The vacuum, or suction, gauge generally is marked to indicate the normal range. Some airplanes are equipped with a warning light that illuminates when the vacuum pressure drops below the acceptable level.

## TURN INDICATORS

Airplanes use two types of turn indicators—the turn-and-slip indicator and the turn coordinator. Because of

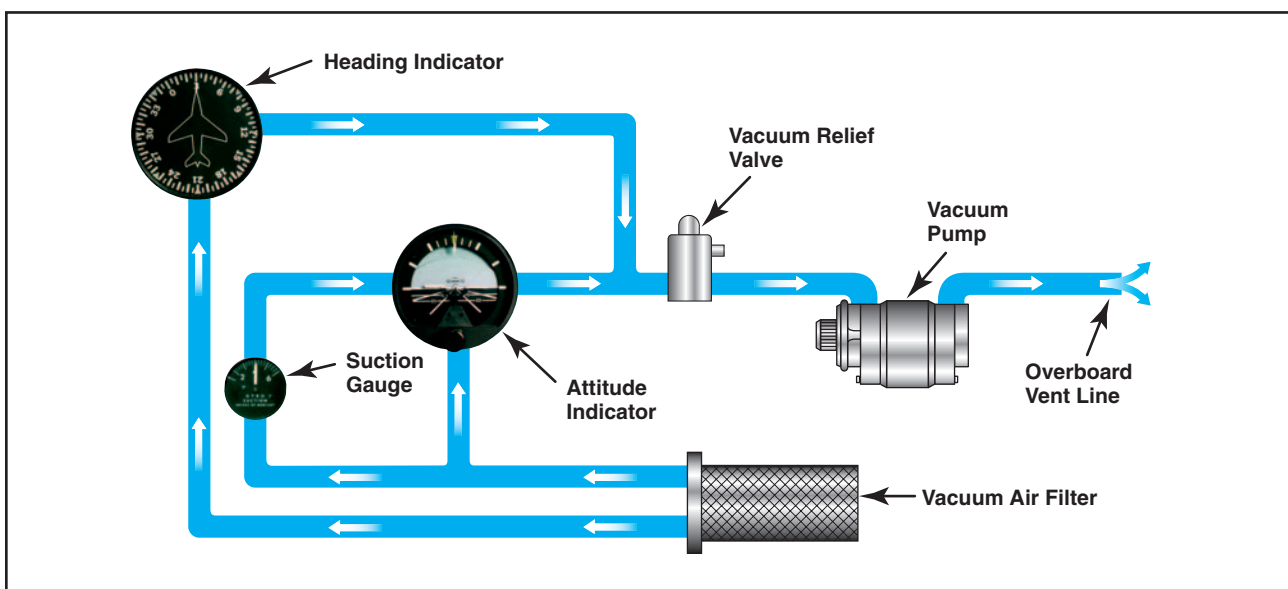


Figure 6-13. Typical Vacuum System.

the way the gyro is mounted, the turn-and-slip indicator only shows the rate of turn in degrees per second. Because the gyro on the turn coordinator is set at an angle, or canted, it can initially also show roll rate. Once the roll stabilizes, it indicates rate of turn. Both instruments indicate turn direction and quality (coordination), and also serve as a backup source of bank information in the event an attitude indicator fails. Coordination is achieved by referring to the **inclinometer**, which consists of a liquid-filled curved tube with a ball inside. [Figure 6-14]

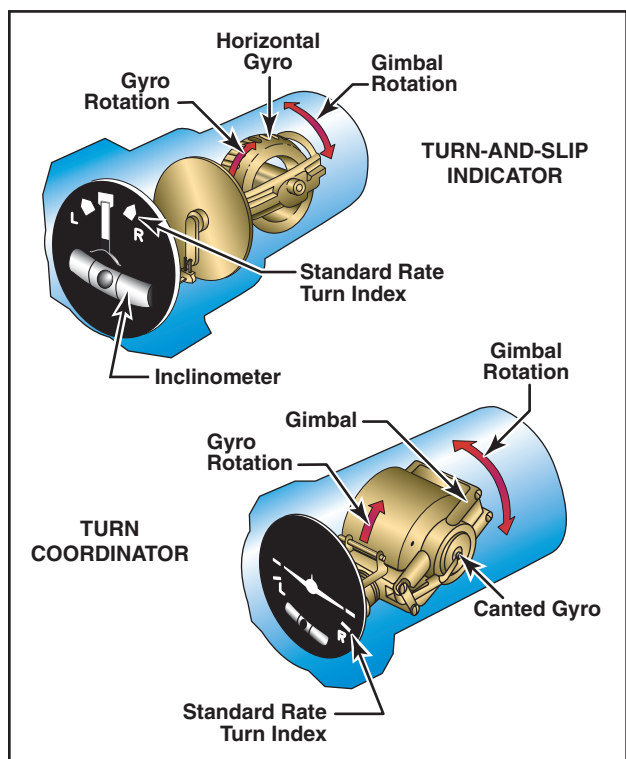


Figure 6-14. Turn indicators rely on controlled precession for their operation.

### TURN-AND-SLIP INDICATOR

The gyro in the turn-and-slip indicator rotates in the vertical plane, corresponding to the airplane's longitudinal axis. A single gimbal limits the planes in which the gyro can tilt, and a spring tries to return it to center. Because of precession, a yawing force causes the gyro to tilt left or right as viewed from the pilot seat. The turn-and-slip indicator uses a pointer, called the turn needle, to show the direction and rate of turn.

### TURN COORDINATOR

The gimbal in the turn coordinator is canted; therefore, its gyro can sense both rate of roll and rate of turn. Since turn coordinators are more prevalent in training

**Inclinometer**—An instrument consisting of a curved glass tube, housing a glass ball, and damped with a fluid similar to kerosene. It may be used to indicate inclination, as a level, or, as used in the turn indicators, to show the relationship between gravity and centrifugal force in a turn.

airplanes, this discussion concentrates on that instrument. When rolling into or out of a turn, the miniature airplane banks in the direction the airplane is rolled. A rapid roll rate causes the miniature airplane to bank more steeply than a slow roll rate.

The turn coordinator can be used to establish and maintain a **standard-rate-turn** by aligning the wing of the miniature airplane with the turn index. The turn coordinator indicates only the rate and direction of turn; it does not display a specific angle of bank.

### INCLINOMETER

The inclinometer is used to depict airplane yaw, which is the side-to-side movement of the airplane's nose. During coordinated, straight-and-level flight, the force of gravity causes the ball to rest in the lowest part of the tube, centered between the reference lines. Coordinated flight is maintained by keeping the ball centered. If the ball is not centered, it can be centered by using the rudder. To do this, apply rudder pressure on the side where the ball is deflected. Use the simple rule, "step on the ball," to remember which rudder pedal to press.

If aileron and rudder are coordinated during a turn, the ball remains centered in the tube. If aerodynamic forces are unbalanced, the ball moves away from the center of the tube. As shown in figure 6-15, in a slip, the rate of

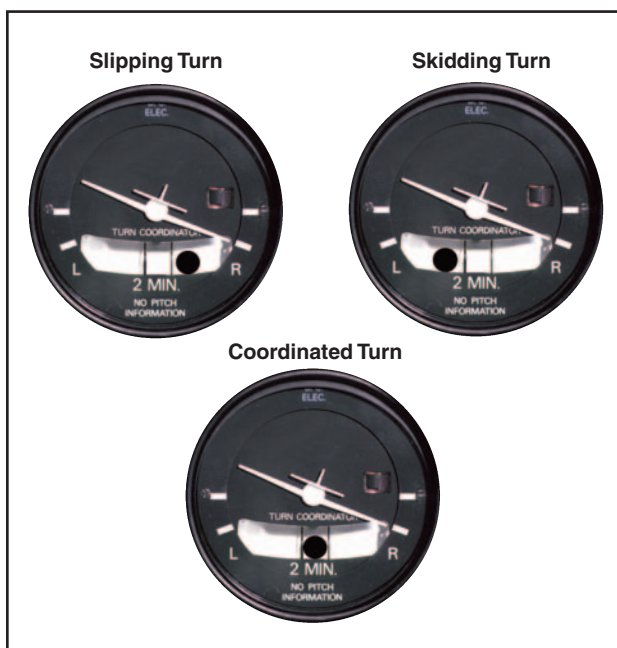


Figure 6-15. If inadequate right rudder is applied in a right turn, a slip results. Too much right rudder causes the airplane to skid through the turn. Centering the ball results in a coordinated turn.

**Standard-Rate-Turn**—A turn of  $3^\circ$  per second. A complete  $360^\circ$  turn takes 2 minutes. A rule of thumb for determining the approximate bank angle required for a standard-rate turn is to divide the true airspeed by 10 and add one-half the result. For example, at 120 knots, approximately  $18^\circ$  of bank is required ( $120 \div 10 = 12 + 6 = 18$ ). At 200 knots, it would take approximately  $30^\circ$  of bank for a standard-rate-turn.

turn is too slow for the angle of bank, and the ball moves to the inside of the turn. In a skid, the rate of turn is too great for the angle of bank, and the ball moves to the outside of the turn. To correct for these conditions, and improve the quality of the turn, remember to “step on the ball.” Varying the angle of bank can also help restore coordinated flight from a slip or skid. To correct for a slip, decrease bank and/or increase the rate of turn. To correct for a skid, increase the bank and/or decrease the rate of turn.

**Instrument Check**—During the preflight, check to see that the inclinometer is full of fluid and has no air bubbles. The ball should also be resting at its lowest point. When taxiing, the turn coordinator should indicate a turn in the correct direction.

### THE ATTITUDE INDICATOR

The attitude indicator, with its miniature airplane and horizon bar, displays a picture of the attitude of the airplane. The relationship of the miniature airplane to the horizon bar is the same as the relationship of the real airplane to the actual horizon. The instrument gives an instantaneous indication of even the smallest changes in attitude.

The gyro in the attitude indicator is mounted on a horizontal plane and depends upon rigidity in space for its operation. The horizon bar represents the true horizon. This bar is fixed to the gyro and remains in a horizontal plane as the airplane is pitched or banked about its lateral or longitudinal axis, indicating the attitude of the airplane relative to the true horizon. [Figure 6-16]

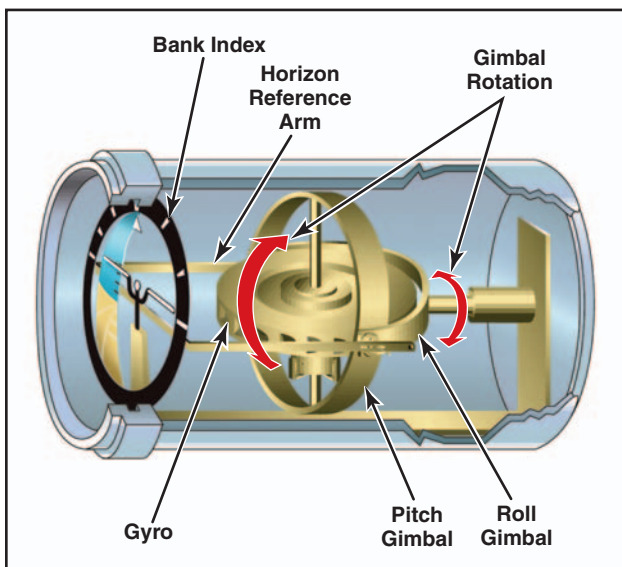


Figure 6-16. Attitude indicator.

An adjustment knob is provided with which the pilot may move the miniature airplane up or down to align the miniature airplane with the horizon bar to suit the pilot's line of vision. Normally, the miniature airplane

is adjusted so that the wings overlap the horizon bar when the airplane is in straight-and-level cruising flight.

The pitch and bank limits depend upon the make and model of the instrument. Limits in the banking plane are usually from  $100^{\circ}$  to  $110^{\circ}$ , and the pitch limits are usually from  $60^{\circ}$  to  $70^{\circ}$ . If either limit is exceeded, the instrument will tumble or spill and will give incorrect indications until restabilized. A number of modern attitude indicators will not tumble.

Every pilot should be able to interpret the banking scale illustrated in figure 6-17. Most banking scale indicators on the top of the instrument move in the same direction from that in which the airplane is actually banked. Some other models move in the opposite direction from that in which the airplane is actually banked. This may confuse the pilot if the indicator is used to determine the direction of bank. This scale should be used only to control the degree of desired bank. The relationship of the miniature airplane to the horizon bar should be used for an indication of the direction of bank.

The attitude indicator is reliable and the most realistic flight instrument on the instrument panel. Its indications are very close approximations of the actual attitude of the airplane.

### HEADING INDICATOR

The heading indicator (or directional gyro) is fundamentally a mechanical instrument designed to facilitate the use of the magnetic compass. Errors in the magnetic compass are numerous, making straight flight and precision turns to headings difficult to accomplish, particularly in turbulent air. A heading indicator, however, is not affected by the forces that make the magnetic compass difficult to interpret. [Figure 6-18]

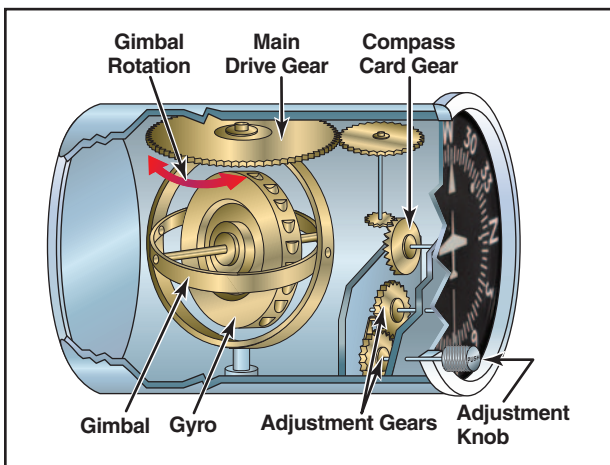


Figure 6-18. A heading indicator displays headings based on a  $360^{\circ}$  azimuth, with the final zero omitted. For example, a 6 represents  $060^{\circ}$ , while a 21 indicates  $210^{\circ}$ . The adjustment knob is used to align the heading indicator with the magnetic compass.

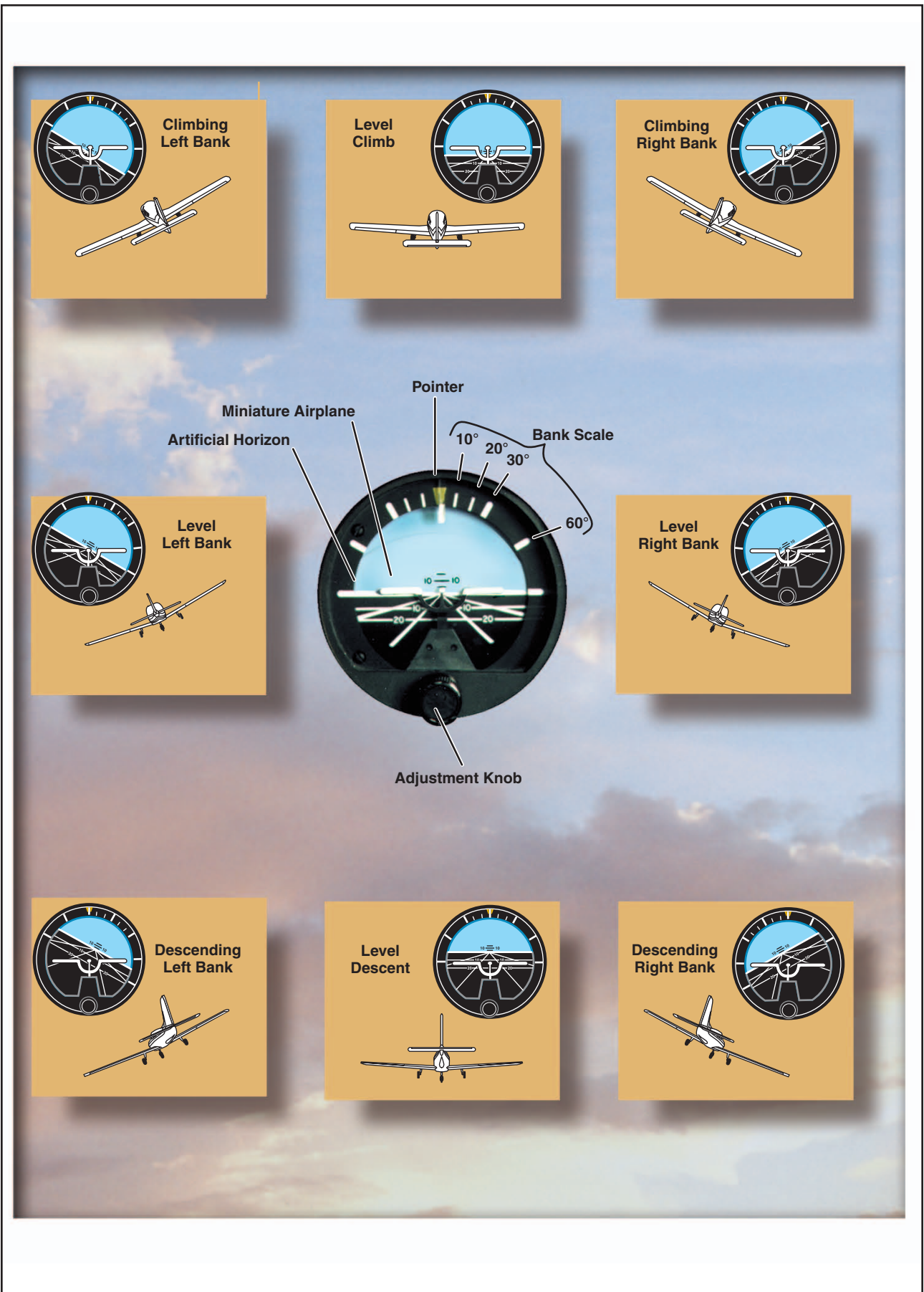
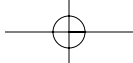
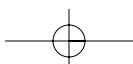


Figure 6-17. Attitude representation by the attitude indicator corresponds to that of the airplane to the real horizon.



The operation of the heading indicator depends upon the principle of rigidity in space. The rotor turns in a vertical plane, and fixed to the rotor is a compass card. Since the rotor remains rigid in space, the points on the card hold the same position in space relative to the vertical plane. As the instrument case and the airplane revolve around the vertical axis, the card provides clear and accurate heading information.

Because of precession, caused by friction, the heading indicator will creep or drift from a heading to which it is set. Among other factors, the amount of drift depends largely upon the condition of the instrument. If the bearings are worn, dirty, or improperly lubricated, the drift may be excessive. Another error in the heading indicator is caused by the fact that the gyro is oriented in space, and the earth rotates in space at a rate of  $15^\circ$  in 1 hour. Thus, discounting precession caused by friction, the heading indicator may indicate as much as  $15^\circ$  error per every hour of operation.

Some heading indicators receive a magnetic north reference from a magnetic slaving transmitter, and generally need no adjustment. Heading indicators that do not have this automatic north-seeking capability are called “free” gyros, and require periodic adjustment. It is important to check the indications frequently (approximately every 15 minutes) and reset the heading indicator to align it with the magnetic compass when required. Adjust the heading indicator to the magnetic compass heading when the airplane is straight and level at a constant speed to avoid compass errors.

The bank and pitch limits of the heading indicator vary with the particular design and make of instrument. On some heading indicators found in light airplanes, the limits are approximately  $55^\circ$  of pitch and  $55^\circ$  of bank. When either of these attitude limits is exceeded, the instrument “tumbles” or “spills” and no longer gives the correct indication until reset. After spilling, it may be reset with the caging knob. Many of the modern instruments used are designed in such a manner that they will not tumble.

**Instrument Check**—As the gyro spools up, make sure there are no abnormal sounds. While taxiing, the instrument should indicate turns in the correct direction, and precession should not be abnormal. At idle power settings, the gyroscopic instruments using the vacuum system might not be up to operating speeds and precession might occur more rapidly than during flight.

## MAGNETIC COMPASS

Since the magnetic compass works on the principle of magnetism, it is well for the pilot to have at least a basic understanding of magnetism. A simple bar magnet has two centers of magnetism which are called poles. Lines

of magnetic force flow out from each pole in all directions, eventually bending around and returning to the other pole. The area through which these lines of force flow is called the field of the magnet. For the purpose of this discussion, the poles are designated “north” and “south.” If two bar magnets are placed near each other, the north pole of one will attract the south pole of the other. There is evidence that there is a magnetic field surrounding the Earth, and this theory is applied in the design of the magnetic compass. It acts very much as though there were a huge bar magnet running along the axis of the Earth which ends several hundred miles below the surface. [Figure 6-19]

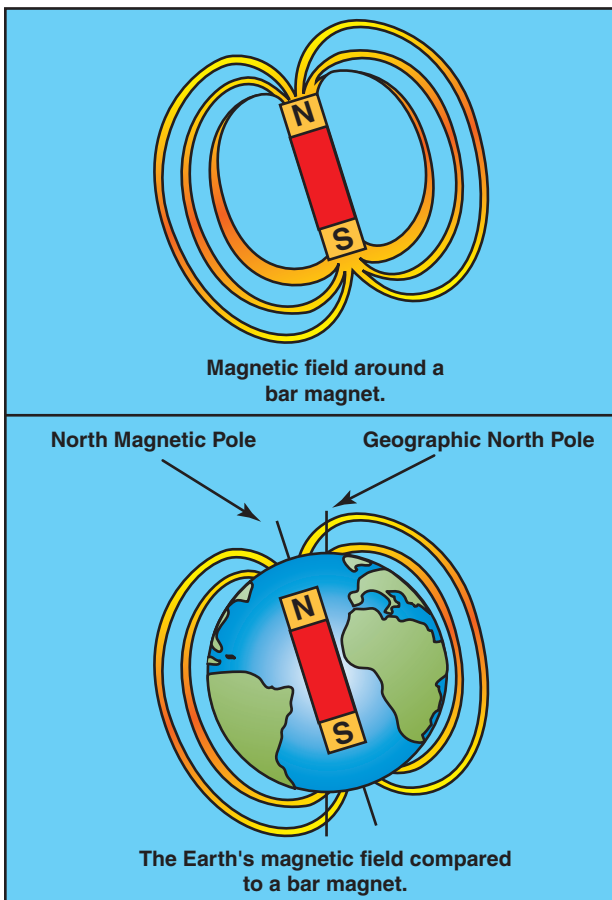
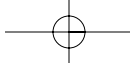


Figure 6-19. Earth's magnetic field.

The geographic north and south poles form the axis for the Earth's rotation. These positions are also referred to as true north and south. Another axis is formed by the magnetic north and south poles. Lines of magnetic force flow out from each pole in all directions, and eventually return to the opposite pole. A compass aligns itself with the magnetic axis formed by the north/south magnetic field of the Earth.

The lines of force have a vertical component (or pull) which is zero at the Equator, but builds to 100 percent of the total force at the magnetic poles. If magnetic needles, such as in the airplane's magnetic compass, are held along these lines of force, the vertical component



causes one end of the needle to dip or deflect downward. The amount of dip increases as the needles are moved closer and closer to the poles. It is this deflection, or dip, that causes some of the larger compass errors.

The magnetic compass, which is usually the only direction-seeking instrument in the airplane, is simple in construction. It contains two steel magnetized needles fastened to a float, around which is mounted a compass card. The needles are parallel, with their north-seeking ends pointing in the same direction. The compass card has letters for cardinal headings, and each 30° interval is represented by a number, the last zero of which is omitted. For example, 30° appears as a 3 and 300° appears as a 30. Between these numbers, the card is graduated for each 5°. The magnetic compass is required equipment in all airplanes. It is used to set the gyroscopic heading indicator, correct for precession, and as a backup in the event the heading indicator(s) fails. [Figure 6-20]

### COMPASS ERRORS

#### VARIATION

Although the magnetic field of the Earth lies roughly north and south, the Earth's magnetic poles do not coincide with its geographic poles, which are used in the construction of aeronautical charts. Consequently, at most places on the Earth's surface, the direction-sensitive steel needles that seek the Earth's magnetic field will not point to true north, but to magnetic north. Furthermore, local magnetic fields from mineral deposits and other conditions may distort the Earth's magnetic field, and cause additional error in the

position of the compass' north-seeking magnetized needles with reference to true north.

The angular difference between magnetic north, the reference for the magnetic compass, and true north is variation. Lines that connect points of equal variation are called isogonic lines. The line connecting points where the magnetic variation is zero is an agonic line. To convert from true courses or headings to magnetic, subtract easterly variation and add westerly variation. Reverse the process to convert from magnetic to true. [Figure 6-21]

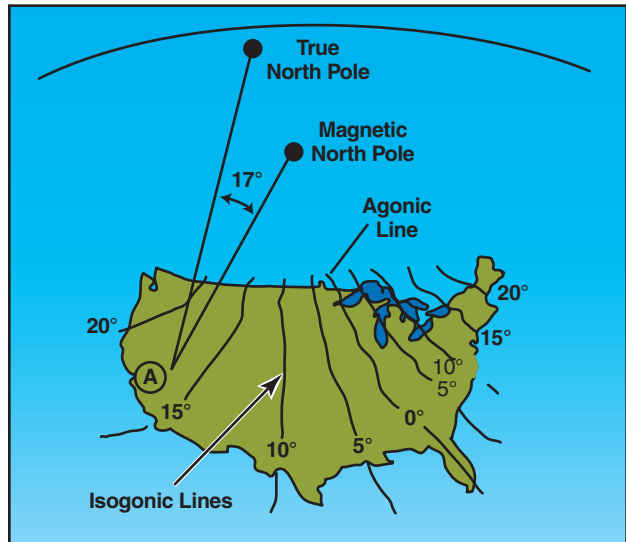


Figure 6-21. Variation at point A in the western United States is 17°. Since the magnetic north pole is located to the east of the true north pole in relation to this point, the variation is easterly. When the magnetic pole falls to the west of the true north pole, variation is westerly.

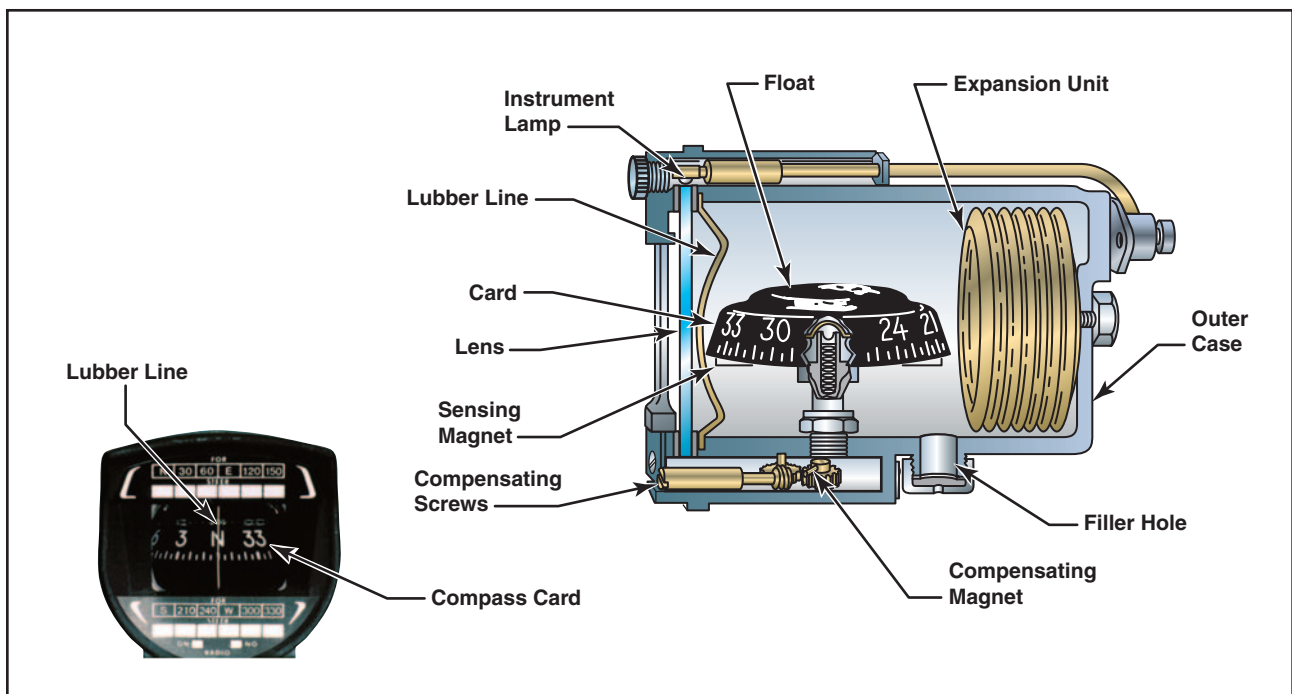
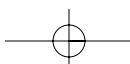
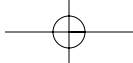


Figure 6-20. Magnetic compass.





**COMPASS DEVIATION**

Besides the magnetic fields generated by the Earth, other magnetic fields are produced by metal and electrical accessories within the airplane. These magnetic fields distort the Earth’s magnetic force, and cause the compass to swing away from the correct heading. This error is called deviation. Manufacturers install compensating magnets within the compass housing to reduce the effects of deviation. The magnets are usually adjusted while the engine is running and all electrical equipment is operating. However, it is not possible to completely eliminate deviation error; therefore, a compass correction card is mounted near the compass. This card corrects for deviation that occurs from one heading to the next as the lines of force interact at different angles. [Figure 6-22]

**MAGNETIC DIP**

Magnetic dip is the result of the vertical component of the Earth’s magnetic field. This dip is virtually non-existent at the magnetic equator, since the lines of force are parallel to the Earth’s surface and the vertical component is minimal. When a compass is moved toward the poles, the vertical component increases, and magnetic dip becomes more apparent at higher latitudes. Magnetic dip is responsible for compass errors during acceleration, deceleration, and turns.

**USING THE MAGNETIC COMPASS**

**ACCELERATION/DECELERATION ERRORS**

Acceleration and deceleration errors are fluctuations in the compass during changes in speed. In the Northern Hemisphere, the compass swings towards the north during acceleration, and towards the south during deceleration. When the speed stabilizes, the compass returns to an accurate indication. This error is most pronounced when flying on a heading of east or west, and decreases gradually when flying closer to a north or south heading. The error does not occur when flying directly north or south. The memory aid, ANDS (Accelerate North, Decelerate South) may help in recalling this error. In the Southern Hemisphere, this error occurs in the opposite direction.

**TURNING ERRORS**

Turning errors are most apparent when turning to or from a heading of north or south. This error increases as the poles are neared and magnetic dip becomes more apparent. There is no turning error when flying near the magnetic equator.

In the Northern Hemisphere, when making a turn from a northerly heading, the compass gives an initial indication of a turn in the opposite direction. It then begins to show the turn in the proper direction, but lags behind the actual heading. The amount of lag decreases as the turn continues, then disappears as the airplane reaches a heading of east or west. When turning from a heading of east or west to a heading of north, there is no error as the turn begins. However, as the heading approaches north, the compass increasingly lags behind the airplane’s actual heading. When making a turn from a southerly heading, the compass gives an indication of a turn in the correct direction, but leads the actual heading. This error also disappears as the airplane approaches an east or west heading. Turning from east or west to a heading of south causes the compass to move correctly at the start of a turn, but then it increasingly leads the actual heading as the airplane nears a southerly direction.

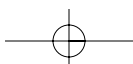
The amount of lead or lag is approximately equal to the latitude of the airplane. For example, if turning from a heading of south to a heading of west while flying at 40° north latitude, the compass rapidly turns to a heading of 220° (180° + 40°). At the midpoint of the turn, the lead decreases to approximately half (20°), and upon reaching a heading of west, it is zero.

The magnetic compass, which is the only direction-seeking instrument in the airplane, should be read only when the airplane is flying straight and level at a constant speed. This will help reduce errors to a minimum.

If the pilot thoroughly understands the errors and characteristics of the magnetic compass, this instrument can become the most reliable means of determining headings.

<b>FOR (MH)</b>	<b>0°</b>	<b>30°</b>	<b>60°</b>	<b>90°</b>	<b>120°</b>	<b>150°</b>	<b>180°</b>	<b>210°</b>	<b>240°</b>	<b>270°</b>	<b>300°</b>	<b>330°</b>
<b>STEER (CH)</b>	359°	30°	60°	88°	120°	152°	183°	212°	240°	268°	300°	329°
<b>RADIO ON</b> <input checked="" type="checkbox"/>				<b>RADIO OFF</b> <input type="checkbox"/>								

Figure 6-22. Compass correction card.





**Instrument Check**—Prior to flight, make sure that the compass is full of fluid. Then during turns, the compass should swing freely and indicate known headings.

### VERTICAL CARD COMPASS

A newer design, the vertical card compass significantly reduces the inherent error of the older compass designs. It consists of an azimuth on a rotating vertical card, and resembles a heading indicator with a fixed miniature airplane to accurately present the heading of the airplane. The presentation is easy to read, and the pilot can see the complete 360° dial in relation to the airplane heading. This design uses **eddy current damping** to minimize lead and lag during turns. [Figure 6-23]

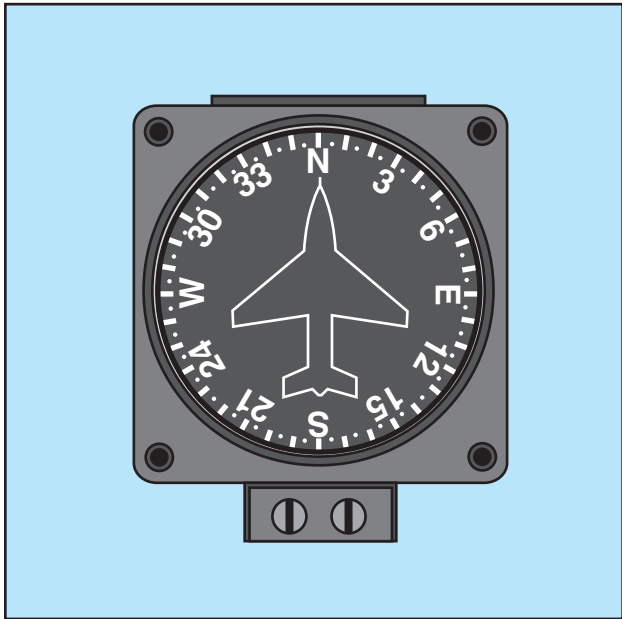


Figure 6-23. Vertical card compass.

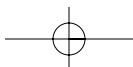
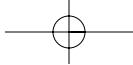
### OUTSIDE AIR TEMPERATURE GAUGE

The outside air temperature gauge (OAT) is a simple and effective device mounted so that the sensing element is exposed to the outside air. The sensing element consists of a bimetallic-type thermometer in which two dissimilar materials are welded together in a single strip and twisted into a helix. One end is anchored into protective tube and the other end is affixed to the pointer, which reads against the calibration on a circular face. OAT gauges are calibrated in degrees Celsius, Fahrenheit, or both. An accurate air temperature will provide the pilot with useful information about temperature lapse rate with altitude change. [Figure 6-24].

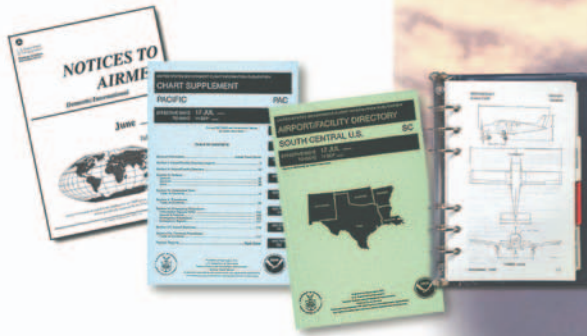


Figure 6-24. Outside air temperature gauge.

**Eddy Current Damping**—The decreased amplitude of oscillations by the interaction of magnetic fields. In the case of a vertical card magnetic compass, flux from the oscillating permanent magnet produces eddy currents in a damping disk or cup. The magnetic flux produced by the eddy currents opposes the flux from the permanent magnet and decreases the oscillations.



## Chapter 7



# Flight Manuals and Other Documents

### AIRPLANE FLIGHT MANUALS

An airplane flight manual is a document developed by the airplane manufacturer and approved by the Federal Aviation Administration (FAA). It is specific to a particular make and model airplane by serial number and contains operating procedures and limitations. Title 14 of the Code of Federal Regulations (14 CFR) part 91 requires that pilots comply with the operating limitations specified in the approved airplane flight manuals, markings, and placards. Originally, flight manuals followed whatever format and content the manufacturer felt was appropriate. This changed with the acceptance of the General Aviation Manufacturers Association's (GAMA) *Specification for Pilot's Operating Handbook*, which established a standardized format for all general aviation airplane and rotorcraft flight manuals. The Pilot's Operating Handbook (POH) is developed by the airplane manufacturer and contains the FAA-approved Airplane Flight Manual (AFM) information. However, if *Pilot's Operating Handbook* is used as the main title instead of *Airplane Flight Manual*, a statement must be included on the title page indicating that sections of the document are FAA-approved as the Airplane Flight Manual. [Figure 7-1]

An airplane owner/information manual is a document developed by the airplane manufacturer containing general information about the make and model of airplane. The airplane owner's manual is not FAA-approved and is not specific to a particular serial numbered airplane. This manual provides general information about the operation of the airplane and is not kept current, and therefore cannot be substituted for the AFM/POH.

Besides the preliminary pages, a POH may contain as many as ten sections. These sections are: General;



Figure 7-1. Airplane Flight Manuals.

Limitations; Emergency Procedures; Normal Procedures; Performance; Weight and Balance/Equipment List; Systems Description; Handling, Service, and Maintenance; and Supplements. Manufacturers have the option of including a tenth section on Safety Tips, as well as an alphabetical index at the end of the POH.

### PRELIMINARY PAGES

While the AFM/POH may appear similar for the same make and model of airplane, each manual is unique since it contains specific information about a particular airplane, such as the equipment installed and weight and balance information. Therefore, manufacturers are required to include the serial number and registration on the title page to identify the airplane to which the manual belongs. If a manual does not indicate a specific airplane registration and serial number, it is limited to general study purposes only.

Most manufacturers include a table of contents, which identifies the order of the entire manual by section

number and title. Usually, each section also contains its own table of contents. Page numbers reflect the section and page within that section (1-1, 1-2, 2-1, 3-1, and so forth). If the manual is published in loose-leaf form, each section is usually marked with a divider tab indicating the section number or title, or both. The Emergency Procedures section may have a red tab for quick identification and reference.

## GENERAL (SECTION 1)

The General section provides the basic descriptive information on the airplane and powerplant(s). Some manuals include a three-view drawing of the airplane that provides dimensions of various components. Included are such items as wingspan, maximum height, overall length, wheelbase length, main landing gear track width, maximum propeller diameter, propeller ground clearance, minimum turning radius, and wing area. This section serves as a quick reference in becoming familiar with the airplane.

The last segment of the General section contains definitions, abbreviations, explanations of symbology, and some of the terminology used in the POH. At the option of the manufacturer, metric and other conversion tables may also be included.

## LIMITATIONS (SECTION 2)

The Limitations section contains only those limitations required by regulation or that are necessary for the safe operation of the airplane, powerplant, systems, and equipment. It includes operating limitations, instrument markings, color-coding, and basic placards. Some of the limitation areas are: airspeed, powerplant, weight and loading distribution, and flight.

### AIRSPEED

Airspeed limitations are shown on the airspeed indicator by color-coding and on placards or graphs in the airplane. [Figure 7-2] A red line on the airspeed indicator shows the airspeed limit beyond which structural damage could occur. This is called the never-exceed speed ( $V_{NE}$ ). A yellow arc indicates the speed range between maximum structural cruising speed ( $V_{NO}$ ) and  $V_{NE}$ . Operation of the airplane in the yellow airspeed arc is for smooth air only, and then with caution. A green arc depicts the normal operating speed range, with the upper end at  $V_{NO}$ , and the lower end at stalling speed at maximum weight with the landing gear and flaps retracted ( $V_{S1}$ ). The flap operating range is depicted by the white arc, with the upper end at the maximum flap extended speed ( $V_{FE}$ ), and the lower end at the stalling speed with the landing gear and flaps in the landing configuration ( $V_{SO}$ ).

In addition to the markings listed above, small multi-engine airplanes will have a red radial line to indicate single-engine minimum controllable airspeed ( $V_{MC}$ ). A

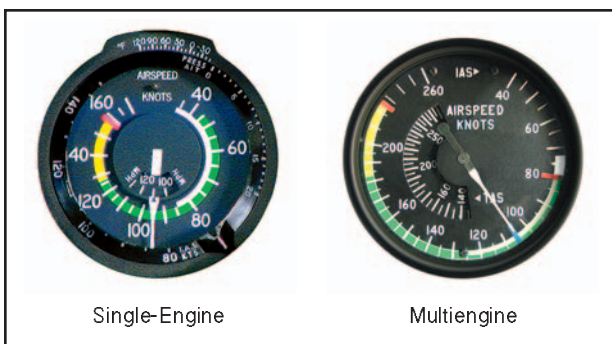


Figure 7-2. Airspeed limitations are depicted by colored arcs and radial lines.

blue radial line is used to indicate single-engine best rate-of-climb speed at maximum weight at sea level ( $V_{YSE}$ ).

### POWERPLANT

The Powerplant Limitations area describes operating limitations on the airplane's reciprocating or turbine engine(s). These include limitations for takeoff power, maximum continuous power, and maximum normal operating power, which is the maximum power the engine can produce without any restrictions, and is depicted by a green arc. Other items that can be included in this area are the minimum and maximum oil and fuel pressures, oil and fuel grades, and propeller operating limits. [Figure 7-3]



Figure 7-3. Minimum, maximum, and normal operating range markings on oil gauge.

All reciprocating-engine powered airplanes must have an r.p.m. indicator for each engine. Airplanes equipped with a constant-speed propeller use a manifold pressure gauge to monitor power output and an r.p.m. gauge to monitor propeller speed. Both instruments depict the maximum operating limit with a red radial line and the normal operating range with a green arc. Some instruments may have a yellow arc to indicate a caution area. [Figure 7-4]

### WEIGHT AND LOADING DISTRIBUTION

The Weight and Loading Distribution area contains the maximum certificated weights, as well as the center-of-gravity (CG) range. The location of the reference datum used in balance computations is included in this

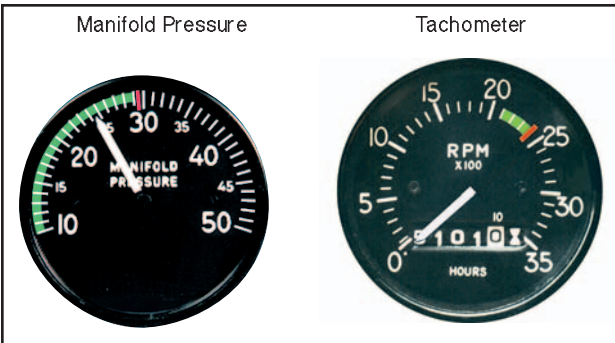


Figure 7-4. Manifold pressure and r.p.m. indicators.

section. Weight and balance computations are not provided in this area, but rather in the Weight and Balance section of the AFM/POH.

### FLIGHT LIMITS

This area lists authorized maneuvers with appropriate entry speeds, flight load factor limits, and kinds of operation limits. It also indicates those maneuvers that are prohibited, such as spins, acrobatic flight, and operational limitations such as flight into known icing conditions.

### PLACARDS

Most airplanes display one or more placards that contain information having a direct bearing on the safe operation of the airplane. These placards are located in conspicuous places within the airplane and are reproduced in the Limitations section or as directed by an Airworthiness Directive (AD). [Figure 7-5]



Figure 7-5. Placards are a common method of depicting airplane limitations.

### EMERGENCY PROCEDURES (SECTION 3)

Checklists describing the recommended procedures and airspeeds for coping with various types of

emergencies or critical situations are located in the Emergency Procedures section. Some of the emergencies covered include: engine failure, fires, and systems failures. The procedures for in-flight engine restarting and ditching may also be included.

Manufacturers may first show the emergencies checklists in an abbreviated form with the order of items reflecting the sequence of action. Amplified checklists that provide additional information on the procedures follow the abbreviated checklist. To be prepared for emergency situations, memorize the immediate action items and after completion, refer to the appropriate checklist.

Manufacturers may include an optional area titled “Abnormal Procedures.” This section describes recommended procedures for handling malfunctions that are not considered emergencies in nature.

### NORMAL PROCEDURES (SECTION 4)

This section begins with a listing of the airspeeds for normal operations. The next area consists of several checklists that may include preflight inspection, before starting procedures, starting engine, before taxiing, taxiing, before takeoff, takeoff, climb, cruise, descent, before landing, bailed landing, after landing, and post-flight procedures. An Amplified Procedures area follows the checklists to provide more detailed information about the various procedures.

To avoid missing important steps, always use the appropriate checklists whenever they are available. Consistent adherence to approved checklists is a sign of a disciplined and competent pilot.

### PERFORMANCE (SECTION 5)

The Performance section contains all the information required by the aircraft certification regulations, and any additional performance information the manufacturer feels may enhance a pilot’s ability to safely operate the airplane. Performance charts, tables, and graphs vary in style, but all contain the same basic information. Some examples of the performance information found in most flight manuals include a graph or table for converting calibrated airspeed into true airspeed; stall speeds in various configurations; and data for determining takeoff and climb performance, cruise performance, and landing performance. Figure 7-6 is an example of a typical performance graph. For more information on how to use the charts, graphs, and tables, refer to Chapter 9—Aircraft Performance.

### WEIGHT AND BALANCE/EQUIPMENT LIST (SECTION 6)

The Weight and Balance/Equipment List section contains all the information required by the FAA to calculate the weight and balance of the airplane.

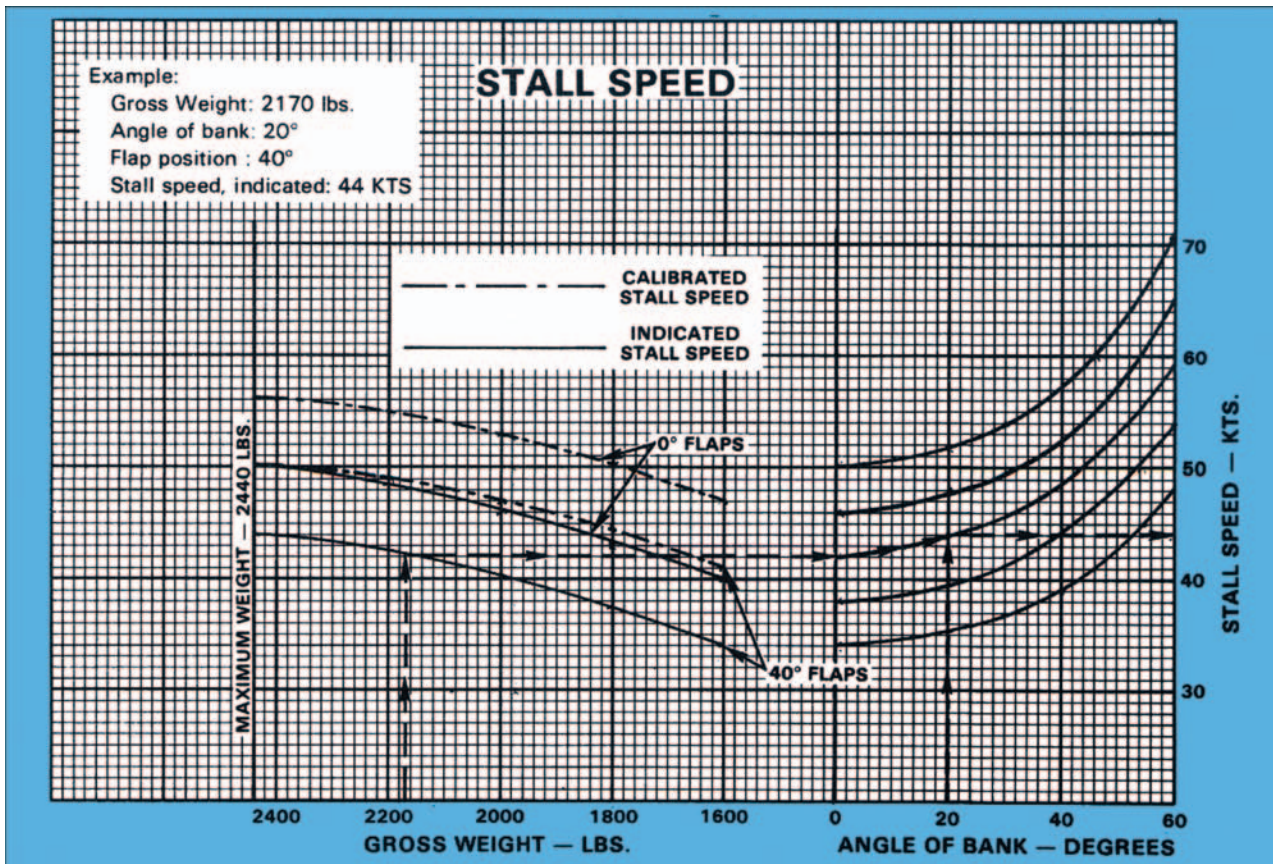


Figure 7-6. Stall speed chart.

Manufacturers include sample weight and balance problems. Weight and balance is discussed in greater detail in Chapter 8—Weight and Balance.

### SYSTEMS DESCRIPTION (SECTION 7)

The Systems Description section is where the manufacturer describes the systems in enough detail for the pilot to understand how the systems operate. For more information on airplane systems, refer to Chapter 5—Aircraft Systems.

### HANDLING, SERVICE, AND MAINTENANCE (SECTION 8)

The Handling, Service, and Maintenance section describes the maintenance and inspections recommended by the manufacturer and the regulations. Additional maintenance or inspections may be required by the issuance of [Airworthiness Directives \(AD\)](#) applicable to the airplane, engine, propeller, and components.

**Airworthiness Directive (AD)**—A regulatory notice that is sent out by the FAA to the registered owners of aircraft informing them of the discovery of a condition that keeps their aircraft from continuing to meet its conditions for airworthiness. For further information, see 14 CFR part 39.

This section also describes preventive maintenance that may be accomplished by certificated pilots, as well as the manufacturer's recommended ground handling procedures. This includes considerations for hangaring, tie-down, and general storage procedures for the airplane.

### SUPPLEMENTS (SECTION 9)

The Supplements section describes pertinent information necessary to safely and efficiently operate the airplane when equipped with the various optional systems and equipment not provided with the standard airplane. Some of this information may be supplied by the airplane manufacturer, or by the manufacturer of the optional equipment. The appropriate information is inserted into the flight manual at the time the equipment is installed. Autopilots, navigation systems, and air-conditioning systems are examples of equipment described in this section.

### SAFETY TIPS (SECTION 10)

The Safety Tips section is an optional section containing a review of information that enhances the safe operation of the airplane. Some examples of the information that might be covered include: physiological factors, general weather information, fuel conservation procedures, high altitude operations, and cold weather operations.

- The aircraft's registration is canceled at the written request of the holder of the certificate.
- The aircraft is totally destroyed or scrapped.
- The ownership of the aircraft is transferred.
- The holder of the certificate loses United States citizenship.

## AIRCRAFT DOCUMENTS

### CERTIFICATE OF AIRCRAFT REGISTRATION

Before an aircraft can be flown legally, it must be registered with the FAA Civil Aviation Registry. The Certificate of Aircraft Registration, which is issued to the owner as evidence of the registration, must be carried in the aircraft at all times. [Figure 7-7]

For additional events, see 14 CFR section 47.41.

When one of the events listed in 14 CFR section 47.41 occurs, the previous owner must notify the FAA by filling in the back of the Certificate of Aircraft Registration, and mailing it to:

Federal Aviation Administration  
Civil Aviation Registry, AFS-750  
P.O. Box 25504  
Oklahoma City, OK 73125

The Certificate of Aircraft Registration cannot be used for operations when:

- The aircraft is registered under the laws of a foreign country.

A dealer's aircraft registration certificate is another form of registration certificate, but is valid only for

REGISTRATION NOT TRANSFERABLE	
UNITED STATES OF AMERICA DEPARTMENT OF TRANSPORTATION - FEDERAL AVIATION ADMINISTRATION CERTIFICATE OF AIRCRAFT REGISTRATION	
NATIONALITY AND REGISTRATION MARKS <b>N48SB</b>	AIRCRAFT SERIAL NO. <b>9411</b>
MANUFACTURER AND MANUFACTURER'S DESIGNATION OF AIRCRAFT <b>PITTS SIS</b> ICAO Aircraft Address Code: <b>5163722</b>	
ISSUED TO <b>JACOBS MARK W.                      520 BIPLANE LANE                      TECUMSEH, MI 49286</b>	This certificate is issued for registration purposes only and is not a certificate of title. The Federal Aviation Administration does not determine rights of ownership as between private persons.
It is certified that the above described aircraft has been entered on the register of the Federal Aviation Administration, United States of America, in accordance with the Convention on International Civil Aviation, dated December 7, 1944, and with the Federal Aviation Act of 1958, and regulations issued hereunder.	
DATE OF ISSUE <b>JUNE 3, 1995</b>	U.S. Department of Transportation Federal Aviation Administration
AC Form 8050-3(11/93) Supersedes previous editions	
<b>EFFECT OF REGISTRATION</b> Section 501(b) of the Federal Aviation Act of 1958 (49 U.S.C. 1401) provides: "...Registration shall not be evidence of ownership of aircraft in any proceeding in which such ownership by a particular person is, or may be, in issue." THIS CERTIFICATE MUST BE SIGNED AND RETURNED BY THE REGISTERED OWNER WITHIN 60 DAYS WHEN IT IS NO LONGER IN EFFECT FOR ANY REASON UNDER 14 C.F.R. 47.41(a)(1) THROUGH (9)	
a. <input type="checkbox"/> Registration is cancelled at the request of the owner. (Also check and/or complete Block, b, c, d, e, or f.)	e. <input type="checkbox"/> The aircraft is to be registered under the laws of a foreign country: (NAME OF FOREIGN COUNTRY) _____
b. <input type="checkbox"/> The aircraft is totally destroyed or scrapped.	f. <input type="checkbox"/> The ownership of the aircraft is transferred to: (NAME) _____ (ADDRESS) _____ (CITY, STATE, ZIP) _____
c. <input type="checkbox"/> United States citizenship has been lost, or the owner's status as a resident alien has changed (unless changed to that of a U.S. citizen).	(SIGNATURE) _____ (TITLE) _____ (DATE) _____
d. <input type="checkbox"/> Thirty days have elapsed since the death of the registered owner (estate representative should sign).	This certificate must be returned to: AIRCRAFT REGISTRATION BRANCH, P.O. BOX 25504, OKLAHOMA CITY, OKLAHOMA 73125-0504

U.S. Department of Transportation  
Federal Aviation Administration  
Office of Aviation System Standards  
P.O. Box 25504  
Oklahoma City, OK 73125-0504  
Official Business  
Penalty for Private Use \$300  
AC Form 8050-3(11/93) Supersedes previous editions

TO:  
**MARK W. JACOBS  
 520 BIPLANE LANE  
 TECUMSEH, MI 49286**

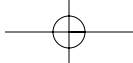
RETAIN THIS INFORMATION FOR FUTURE REFERENCE

CHANGE OF ADDRESS  
 Federal Aviation Regulations require that the registered owner of the aircraft shall report in writing within 30 days any change in permanent mailing address. A revised Certificate of Registration will be issued without charge. The Application for Registration, AC Form 8050-1, may be used to report a change of address.

REPLACEMENT OF CERTIFICATE  
 If this certificate is lost, destroyed, or mutilated, a replacement may be obtained at the written request of the holder. Send your request and \$2.00 (check or money order made payable to United States Treasury) to:  
 Aircraft Registration Branch  
 P.O. Box 25504  
 Oklahoma City, Oklahoma 73125-0504

NOTE: All correspondence should include the registration "N" number, manufacturer, model, and serial number of the aircraft.

Figure 7-7. AC Form 8050-3, Certificate of Aircraft Registration.



required flight tests by the manufacturer or in flights that are necessary for the sale of the aircraft by the manufacturer or a dealer. The dealer must remove it when the aircraft is sold.

After compliance with 14 CFR section 47.31, the pink copy of the application for a Certificate of Aircraft Registration is authorization to operate an unregistered aircraft for a period not to exceed 90 days. Since the aircraft is unregistered, it cannot be operated outside of the United States until a permanent Certificate of Aircraft Registration is received and placed in the aircraft.

The FAA does not issue any certificate of ownership or endorse any information with respect to ownership on a Certificate of Aircraft Registration.

**NOTE:** For additional information concerning the Aircraft Registration Application or the Aircraft Bill of Sale, contact the nearest FAA Flight Standards District Office (FSDO).

**AIRWORTHINESS CERTIFICATE**

An Airworthiness Certificate is issued by a representative of the FAA after the aircraft has been inspected, is found to meet the requirements of 14 CFR part 21, and is in condition for safe operation. The Airworthiness Certificate must be displayed in the aircraft so it is legible to the passengers and crew whenever it is operated. The Airworthiness Certificate is

transferred with the aircraft except when it is sold to a foreign purchaser.

A Standard Airworthiness Certificate is issued for aircraft type certificated in the normal, utility, acrobatic, commuter, and transport categories or for manned free balloons. Figure 7-8 illustrates a Standard Airworthiness Certificate, and an explanation of each item in the certificate follows.

**Item 1 Nationality**—The “N” indicates the aircraft is registered in the United States. Registration marks consist of a series of up to five numbers or numbers and letters. In this case, N2631A is the registration number assigned to this airplane.

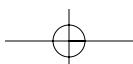
**Item 2**—Indicates the manufacturer, make, and model of the aircraft.

**Item 3**—Indicates the manufacturer’s serial number assigned to the aircraft, as noted on the aircraft data plate.

**Item 4**—Indicates the category in which the aircraft must be operated. In this case, it must be operated in accordance with the limitations specified for the “NORMAL” category.

UNITED STATES OF AMERICA DEPARTMENT OF TRANSPORTATION—FEDERAL AVIATION ADMINISTRATION <b>STANDARD AIRWORTHINESS CERTIFICATE</b>			
1 NATIONALITY AND REGISTRATION MARKS <b>N2631A</b>	2 MANUFACTURER AND MODEL <b>PIPER PA-22-135</b>	3 AIRCRAFT SERIAL NUMBER <b>22-903</b>	4 CATEGORY <b>NORMAL</b>
5. AUTHORITY AND BASIS FOR ISSUANCE This airworthiness certificate is issued pursuant to the Federal Aviation Act of 1958 and certifies that, as of the date of issuance, the aircraft to which issued has been inspected and found to conform to the type certificate therefor, to be in condition for safe operation, and has been shown to meet the requirements of the applicable comprehensive and detailed airworthiness code as provided by Annex 8 to the Convention on International Civil Aviation, except as noted herein. Exceptions:  <b>NONE</b>			
6 TERMS AND CONDITIONS Unless sooner surrendered, suspended, revoked, or a termination date is otherwise established by the Administrator, this airworthiness certificate is effective as long as the maintenance, preventative maintenance, and alterations are performed in accordance with Parts 21, 43, and 91 of the Federal Aviation Regulations, as appropriate, and the aircraft is registered in the United States.			
DATE OF ISSUANCE <b>08-10-95</b>	FAA REPRESENTATIVE <i>Marion W. Williams</i> <b>MARION W. WILLIAMS</b>	DESIGNATION NUMBER <b>SW-FSDO-OKC</b>	
Any alteration, reproduction, or misuse of this certificate may be punishable by a fine not exceeding \$1,000, or imprisonment not exceeding 3 years, or both. THIS CERTIFICATE MUST BE DISPLAYED IN THE AIRCRAFT IN ACCORDANCE WITH APPLICABLE FEDERAL AVIATION REGULATIONS.			
<b>FAA Form 8100-2</b> (8-82)		GPO 892-804	

Figure 7-8. FAA Form 8100-2, Standard Airworthiness Certificate.





**Item 5**—Indicates the aircraft conforms to its type certificate and is considered in condition for safe operation at the time of inspection and issuance of the certificate. Any exemptions from the applicable airworthiness standards are briefly noted here and the exemption number given. The word “NONE” is entered if no exemption exists.

**Item 6**—Indicates the Airworthiness Certificate is in effect indefinitely if the aircraft is maintained in accordance with 14 CFR parts 21, 43, and 91, and the aircraft is registered in the United States.

Also included are the date the certificate was issued and the signature and office identification of the FAA representative.

A Standard Airworthiness Certificate remains in effect as long as the aircraft receives the required maintenance and is properly registered in the United States. Flight safety relies, in part, on the condition of the aircraft, which is determined by inspections performed by mechanics, approved repair stations, or manufacturers who meet specific requirements of 14 CFR part 43.

A Special Airworthiness Certificate is issued for all aircraft certificated in other than the Standard classifications, such as Experimental, Restricted, Limited, Provisional, and Sport Pilot. When purchasing an aircraft classified as other than Standard, it is recommended that the local FSDO be contacted for an explanation of the pertinent airworthiness requirements and the limitations of such a certificate.

## AIRCRAFT MAINTENANCE

Maintenance is defined as the preservation, inspection, overhaul, and repair of an aircraft, including the replacement of parts. A PROPERLY MAINTAINED AIRCRAFT IS A SAFE AIRCRAFT. In addition, regular and proper maintenance ensures that an aircraft meets an acceptable standard of airworthiness throughout its operational life.

Although maintenance requirements vary for different types of aircraft, experience shows that aircraft need some type of preventive maintenance every 25 hours of flying time or less, and minor maintenance at least every 100 hours. This is influenced by the kind of operation, climatic conditions, storage facilities, age, and construction of the aircraft. Manufacturers supply maintenance manuals, parts catalogs, and other service information that should be used in maintaining the aircraft.

## AIRCRAFT INSPECTIONS

14 CFR part 91 places primary responsibility on the owner or operator for maintaining an aircraft in an

airworthy condition. Certain inspections must be performed on the aircraft, and the owner must maintain the airworthiness of the aircraft during the time between required inspections by having any defects corrected.

14 CFR part 91, subpart E, requires the inspection of all civil aircraft at specific intervals to determine the overall condition. The interval depends upon the type of operations in which the aircraft is engaged. Some aircraft need to be inspected at least once each 12-calendar months, while inspection is required for others after each 100 hours of operation. In some instances, an aircraft may be inspected in accordance with an inspection system set up to provide for total inspection of the aircraft on the basis of calendar time, time in service, number of system operations, or any combination of these.

All inspections should follow the current manufacturer’s maintenance manual, including the Instructions for Continued Airworthiness concerning inspections intervals, parts replacement, and life-limited items as applicable to the aircraft.

### ANNUAL INSPECTION

Any reciprocating-engine powered or single-engine-turbojet/turbo-propeller powered small aircraft (12,500 pounds and under) flown for business or pleasure and not flown for compensation or hire is required to be inspected at least annually. The inspection shall be performed by a certificated airframe and powerplant (A&P) mechanic who holds an Inspection Authorization (IA), by the manufacturer, or by a certificated and appropriately rated repair station. The aircraft may not be operated unless the annual inspection has been performed within the preceding 12-calendar months. A period of 12-calendar months extends from any day of a month to the last day of the same month the following year. An aircraft overdue for an annual inspection may be operated under a Special Flight Permit issued by the FAA for the purpose of flying the aircraft to a location where the annual inspection can be performed. However, all applicable Airworthiness Directives that are due must be complied with.

### 100-HOUR INSPECTION

All aircraft under 12,500 pounds (except turbojet/turbo-propeller powered multiengine airplanes and turbine powered rotorcraft), used to carry passengers for hire, must have received a 100-hour inspection within the preceding 100 hours of time in service and have been approved for return to service. Additionally, an aircraft used for flight instruction for hire, when provided by the person giving the flight instruction, must also have received a 100-hour inspection. This inspection must be performed by an FAA certificated A&P mechanic, an appropriately rated FAA certificated repair station,

or by the aircraft manufacturer. An annual inspection, or an inspection for the issuance of an Airworthiness Certificate may be substituted for a required 100-hour inspection. The 100-hour limitation may be exceeded by not more than 10 hours while en route to reach a place where the inspection can be done. The excess time used to reach a place where the inspection can be done must be included in computing the next 100 hours of time in service.

### OTHER INSPECTION PROGRAMS

The annual and 100-hour inspection requirements do not apply to large (over 12,500 pounds) airplanes, turbojets, or turbo-propeller powered multiengine airplanes or to aircraft for which the owner complies with a progressive inspection program. Details of these requirements may be determined by reference to 14 CFR part 43, section 43.11 and part 91, subpart E, and by inquiring at a local FSDO.

### ALTIMETER SYSTEM INSPECTION

14 CFR part 91, section 91.411 requires that the altimeter, encoding altimeter, and related system be tested and inspected in the preceding 24 months before operated in controlled airspace under instrument flight rules (IFR).

### TRANSPONDER INSPECTION

14 CFR part 91, section 91.413 requires that before a transponder can be used under 14 CFR part 91, section 91.215(a), it shall be tested and inspected within the preceding 24 months.

### PREFLIGHT INSPECTIONS

The preflight inspection is a thorough and systematic means by which a pilot determines if the aircraft is airworthy and in condition for safe operation. POHs and owner/information manuals contain a section devoted to a systematic method of performing a preflight inspection.

### MINIMUM EQUIPMENT LISTS (MEL) AND OPERATIONS WITH INOPERATIVE EQUIPMENT

The Code of Federal Regulations (CFRs) requires that all aircraft instruments and installed equipment are operative prior to each departure. When the FAA adopted the **minimum equipment list (MEL)** concept for 14 CFR part 91 operations, this allowed for the first time, operations with inoperative items determined to be nonessential for safe flight. At the same

time, it allowed part 91 operators, without an MEL, to defer repairs on nonessential equipment within the guidelines of part 91.

There are two primary methods of deferring maintenance on small rotorcraft, non-turbine powered airplanes, gliders, or lighter-than-air aircraft operated under part 91. They are the deferral provision of 14 CFR part 91, section 91.213(d) and an FAA-approved MEL.

The deferral provision of section 91.213(d) is widely used by most pilot/operators. Its popularity is due to simplicity and minimal paperwork. When inoperative equipment is found during preflight or prior to departure, the decision should be to cancel the flight, obtain maintenance prior to flight, or to defer the item or equipment.

Maintenance deferrals are not used for in-flight discrepancies. The manufacturer's AFM/POH procedures are to be used in those situations. The discussion that follows assumes that the pilot wishes to defer maintenance that would ordinarily be required prior to flight.

Using the deferral provision of section 91.213(d), the pilot determines whether the inoperative equipment is required by type design, the CFRs, or ADs. If the inoperative item is not required, and the aircraft can be safely operated without it, the deferral may be made. The inoperative item shall be deactivated or removed and an INOPERATIVE placard placed near the appropriate switch, control, or indicator. If deactivation or removal involves maintenance (removal always will), it must be accomplished by certificated maintenance personnel.

For example, if the position lights (installed equipment) were discovered to be inoperative prior to a daytime flight, the pilot would follow the requirements of section 91.213(d).

The deactivation may be a process as simple as the pilot positioning a circuit breaker to the OFF position, or as complex as rendering instruments or equipment totally inoperable. Complex maintenance tasks require a certificated and appropriately rated maintenance person to perform the deactivation. In all cases, the item or equipment must be placarded INOPERATIVE.

**Minimum Equipment List (MEL)**—An inventory of instruments and equipment that may legally be inoperative, with the specific conditions under which an aircraft may be flown with such items inoperative.

All small rotorcraft, non-turbine powered airplanes, gliders, or lighter-than-air aircraft operated under part 91 are eligible to use the maintenance deferral provisions of section 91.213(d). However, once an operator requests an MEL, and a Letter of Authorization (LOA) is issued by the FAA, then the use of the MEL becomes mandatory for that aircraft. All maintenance deferrals must be accomplished in accordance with the terms and conditions of the MEL and the operator-generated procedures document.

The use of an MEL for an aircraft operated under part 91 also allows for the deferral of inoperative items or equipment. The primary guidance becomes the FAA-approved MEL issued to that specific operator and N-numbered aircraft.

The FAA has developed master minimum equipment lists (MMELs) for aircraft in current use. Upon written request by an operator, the local FSDO may issue the appropriate make and model MMEL, along with an LOA, and the preamble. The operator then develops operations and maintenance (O&M) procedures from the MMEL. This MMEL with O&M procedures now becomes the operator's MEL. The MEL, LOA, preamble, and procedures document developed by the operator must be on board the aircraft when it is operated.

The FAA considers an approved MEL to be a supplemental type certificate (STC) issued to an aircraft by serial number and registration number. It therefore becomes the authority to operate that aircraft in a condition other than originally type certificated.

With an approved MEL, if the position lights were discovered inoperative prior to a daytime flight, the pilot would make an entry in the maintenance record or discrepancy record provided for that purpose. The item is then either repaired or deferred in accordance with the MEL. Upon confirming that daytime flight with inoperative position lights is acceptable in accordance with the provisions of the MEL, the pilot would leave the position lights switch OFF, open the circuit breaker (or whatever action is called for in the procedures document), and placard the position light switch as INOPERATIVE.

There are exceptions to the use of the MEL for deferral. For example, should a component fail that is not listed in the MEL as deferrable (the tachometer, flaps, or stall warning device, for example), then repairs are required to be performed prior to departure. If maintenance or parts are not readily available at that location, a special flight permit can be obtained from the nearest FSDO. This permit allows the aircraft to be flown to another location for maintenance. This allows an aircraft that may not currently meet applicable airworthiness requirements, but is capable of safe flight, to be

operated under the restrictive special terms and conditions attached to the special flight permit.

Deferral of maintenance is not to be taken lightly, and due consideration should be given to the effect an inoperative component may have on the operation of an aircraft, particularly if other items are inoperative. Further information regarding MELs and operations with inoperative equipment can be found in Advisory Circular (AC) 91-67, Minimum Equipment Requirements for General Aviation Operations Under FAR Part 91.

## PREVENTIVE MAINTENANCE

Preventive maintenance is considered to be simple or minor preservation operations and the replacement of small standard parts, not involving complex assembly operations. Certificated pilots, excluding student pilots, sport pilots, and recreational pilots, may perform preventive maintenance on any aircraft that is owned or operated by them provided that aircraft is not used in air carrier service. (Sport pilots operating light sport aircraft, refer to 14 CFR part 65 for maintenance privileges.) 14 CFR part 43, Appendix A, contains a list of the operations that are considered to be preventive maintenance.

## REPAIRS AND ALTERATIONS

Repairs and alterations are classified as either major or minor. 14 CFR part 43, Appendix A, describes the alterations and repairs considered major. Major repairs or alterations shall be approved for return to service on FAA Form 337, Major Repairs and Major Alterations, by an appropriately rated certificated repair station, an FAA certificated A&P mechanic holding an Inspection Authorization, or a representative of the Administrator. Minor repairs and minor alterations may be approved for return to service with a proper entry in the maintenance records by an FAA certificated A&P mechanic or an appropriately certificated repair station.

For modifications of experimental aircraft, refer to the operating limitations issued to that aircraft. Modifications in accordance with FAA Order 8130.2, Airworthiness Certification of Aircraft and Related Products, may require the notification of the issuing authority.

## SPECIAL FLIGHT PERMITS

A special flight permit is a Special Airworthiness Certificate issued authorizing operation of an aircraft that does not currently meet applicable airworthiness requirements but is safe for a specific flight. Before the permit is issued, an FAA inspector may personally inspect the aircraft, or require it to be inspected by an FAA certificated A&P mechanic or an appropriately certificated repair station, to determine its safety for the intended flight. The inspection shall be recorded in the aircraft records.

The special flight permit is issued to allow the aircraft to be flown to a base where repairs, alterations, or maintenance can be performed; for delivering or exporting the aircraft; or for evacuating an aircraft from an area of impending danger. A special flight permit may be issued to allow the operation of an overweight aircraft for flight beyond its normal range over water or land areas where adequate landing facilities or fuel is not available.

If a special flight permit is needed, assistance and the necessary forms may be obtained from the local FSDO or Designated Airworthiness Representative (DAR). [Figure 7-9]

**AIRWORTHINESS DIRECTIVES**

A primary safety function of the FAA is to require correction of unsafe conditions found in an aircraft, aircraft engine, propeller, or appliance when such conditions exist and are likely to exist or develop in other products of the same design. The unsafe condition may exist because of a design defect, maintenance, or other causes. 14 CFR part 39, Airworthiness Directives (ADs), defines the authority and responsibility of the Administrator for requiring the necessary corrective action. ADs are the means used to notify aircraft owners and other interested persons of unsafe conditions and to specify the conditions under which the product may continue to be operated.

ADs may be divided into two categories:

1. those of an emergency nature requiring immediate compliance prior to further flight, and
2. those of a less urgent nature requiring compliance within a specified period of time.

Airworthiness Directives are regulatory and shall be complied with unless a specific exemption is granted. It is the aircraft owner or operator’s responsibility to ensure compliance with all pertinent ADs. This includes those ADs that require recurrent or continuing action. For example, an AD may require a repetitive inspection each 50 hours of operation, meaning the particular inspection shall be accomplished and recorded every 50 hours of time in service. Owners/operators are reminded there is no provision to overfly the maximum hour requirement of an AD unless it is specifically written into the AD. To help determine if an AD applies to an amateur-built aircraft, contact the local FSDO.

14 CFR part 91, section 91.417 requires a record to be maintained that shows the current status of applicable ADs, including the method of compliance; the AD number and revision date, if recurring; the time and date when due again; the signature; kind of certificate; and certificate number of the repair station or mechanic who performed the work. For ready reference, many

UNITED STATES OF AMERICA DEPARTMENT OF TRANSPORTATION - FEDERAL AVIATION ADMINISTRATION <b>SPECIAL AIRWORTHINESS CERTIFICATE</b>			
<b>A</b>	CATEGORY/DESIGNATION <b>EXPERIMENTAL</b>		
	PURPOSE <b>OPERATING AMATEUR-BUILT AIRCRAFT</b>		
<b>B</b>	MANU-FACTURER	NAME <b>N/A</b>	
		ADDRESS <b>N/A</b>	
<b>C</b>	FLIGHT	FROM <b>N/A</b>	
		TO <b>N/A</b>	
<b>D</b>	N- <b>48SB</b>		SERIAL NO. <b>9411</b>
	BUILDER <b>MARK W. JACOBS</b>		MODEL <b>PITTS SIS</b>
<b>E</b>	DATE OF ISSUANCE <b>04-01-95</b>		EXPIRY <b>UNLIMITED</b>
	OPERATING LIMITATIONS DATED <b>04-01-95</b> ARE A PART OF THIS CERTIFICATE		
	SIGNATURE OF FAA REPRESENTATIVE <b><i>Darrel A. Freeman</i></b>		DESIGNATION OR OFFICE NO. <b>OKC-MIDO-41</b>
Any alteration, reproduction or misuse of this certificate may be punishable by a fine not exceeding \$1,000 or imprisonment not exceeding 3 years, or both. THIS CERTIFICATE MUST BE DISPLAYED IN THE AIRCRAFT IN ACCORDANCE WITH APPLICABLE FEDERAL AVIATION REGULATIONS.			
FAA FORM 8130-7 (10/82)		SEE REVERSE SIDE	

Figure 7-9. FAA Form 8130-7, Special Airworthiness Certificate.

aircraft owners have a chronological listing of the pertinent ADs in the back of their aircraft, engine, and propeller maintenance records.

All Airworthiness Directives and the AD Biweekly are free on the Internet at **[www.airweb.faa.gov/rgl](http://www.airweb.faa.gov/rgl)**

Paper copies of the Summary of Airworthiness Directives and the AD Biweekly may be purchased from the Superintendent of Documents. The Summary contains all the valid ADs previously published and is divided into two areas. The small aircraft and rotorcraft books contain all ADs applicable to small aircraft (12,500 pounds or less maximum certificated takeoff weight) and ADs applicable to all helicopters. The large aircraft books contain all ADs applicable to large aircraft.

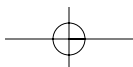
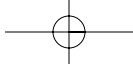
For further information on how to order ADs and the current price, contact:

U.S. Department of Transportation  
Federal Aviation Administration  
Delegation & Airworthiness Programs Branch,  
AIR-140  
P.O. Box 26460  
Oklahoma City, OK 73125  
Telephone Number: (405) 954-4103  
Fax: (405) 954-4104

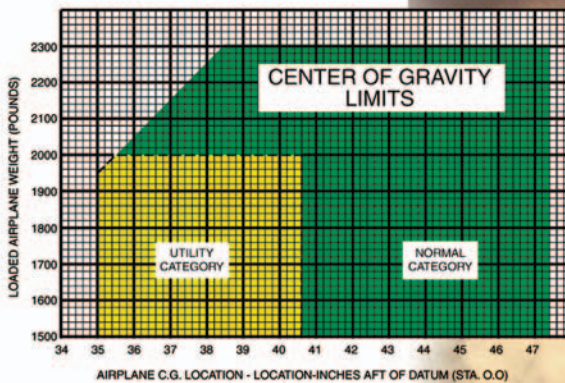
## **AIRCRAFT OWNER/OPERATOR RESPONSIBILITIES**

The registered owner/operator of an aircraft is responsible for certain items such as:

- Having a current Airworthiness Certificate and a Certificate of Aircraft Registration in the aircraft.
- Maintaining the aircraft in an airworthy condition, including compliance with all applicable Airworthiness Directives.
- Assuring that maintenance is properly recorded.
- Keeping abreast of current regulations concerning the operation and maintenance of the aircraft.
- Notifying the FAA Civil Aviation Registry immediately of any change of permanent mailing address, or of the sale or export of the aircraft, or of the loss of the eligibility to register an aircraft. (Refer to 14 CFR part 47, section 47.41.)
- Having a current FCC radio station license if equipped with radios, including emergency locator transmitter (ELT), if operated outside of the United States.



## Chapter 8



# Weight and Balance

Compliance with the weight and balance limits of any airplane is critical to flight safety. Operating an airplane above the maximum weight limitation compromises the structural integrity of the airplane and adversely affects its performance. Operation with the center of gravity (CG) outside the approved limits may result in control difficulty.

### WEIGHT CONTROL

Weight is the force with which gravity attracts a body toward the center of the earth. It is a product of the mass of a body and the acceleration acting on the body. Weight is a major factor in airplane construction and operation, and demands respect from all pilots.

The force of gravity continually attempts to pull the airplane down toward earth. The force of lift is the only force that counteracts weight and sustains the airplane in flight. However, the amount of lift produced by an airfoil is limited by the airfoil design, angle of attack, airspeed, and air density. Therefore, to assure that the lift generated is sufficient to counteract weight, loading the airplane beyond the manufacturer's recommended weight must be avoided. If the weight is greater than the lift generated, the airplane may be incapable of flight.

### EFFECTS OF WEIGHT

Any item aboard the airplane that increases the total weight is undesirable as far as performance is concerned. Manufacturers attempt to make the airplane as light as possible without sacrificing strength or safety.

The pilot of an airplane should always be aware of the consequences of overloading. An overloaded airplane may not be able to leave the ground, or if it does become airborne, it may exhibit unexpected and

unusually poor flight characteristics. If an airplane is not properly loaded, the initial indication of poor performance usually takes place during takeoff.

Excessive weight reduces the flight performance of an airplane in almost every respect. The most important performance deficiencies of the overloaded airplane are:

- Higher takeoff speed.
- Longer takeoff run.
- Reduced rate and angle of climb.
- Lower maximum altitude.
- Shorter range.
- Reduced cruising speed.
- Reduced maneuverability.
- Higher stalling speed.
- Higher approach and landing speed.
- Longer landing roll.
- Excessive weight on the nosewheel or tailwheel.

The pilot must be knowledgeable in the effect of weight on the performance of the particular airplane being flown. Preflight planning should include a check of performance charts to determine if the airplane's weight may contribute to hazardous flight operations. Excessive weight in itself reduces the safety margins available to the pilot, and becomes even more hazardous when other performance-reducing factors are combined with overweight. The pilot must also consider the consequences of an overweight airplane if an emergency

condition arises. If an engine fails on takeoff or airframe ice forms at low altitude, it is usually too late to reduce the airplane's weight to keep it in the air.

## WEIGHT CHANGES

The weight of the airplane can be changed by altering the fuel load. Gasoline has considerable weight—6 pounds per gallon—30 gallons may weigh more than one passenger. But it must be remembered that if weight is lowered by reducing fuel, the range of the airplane is decreased. During flight, fuel burn is normally the only weight change that takes place. As fuel is used, the airplane becomes lighter and performance is improved.

Changes of fixed equipment have a major effect upon the weight of the airplane. An airplane can be overloaded by the installation of extra radios or instruments. Repairs or modifications may also affect the weight of the airplane.

## BALANCE, STABILITY, AND CENTER OF GRAVITY

Balance refers to the location of the center of gravity (CG) of an airplane, and is important to airplane stability and safety in flight. The center of gravity is a point at which an airplane would balance if it were suspended at that point.

The prime concern of airplane balancing is the fore and aft location of the CG along the longitudinal axis. The center of gravity is not necessarily a fixed point; its location depends on the distribution of weight in the airplane. As variable load items are shifted or expended, there is a resultant shift in CG location. The pilot should realize that if the CG of an airplane is displaced too far forward on the longitudinal axis, a nose-heavy condition will result. Conversely, if the CG is displaced too far aft on the longitudinal axis, a tail-heavy condition will result. It is possible that an unfavorable location of the CG could produce such an unstable condition that the pilot could not control the airplane. [Figure 8-1]

Location of the CG with reference to the lateral axis is also important. For each item of weight existing to the left of the fuselage centerline, there is an equal weight existing at a corresponding location on the right. This may be upset, however, by unbalanced lateral loading. The position of the lateral CG is not computed, but the pilot must be aware that adverse effects will certainly arise as a result of a laterally unbalanced condition. Lateral unbalance will occur if the fuel load is mismanaged by supplying the engine(s) unevenly from tanks on one side of the airplane. The pilot can compensate for the resulting wing-heavy condition by adjusting the aileron trim tab or by holding a constant aileron control

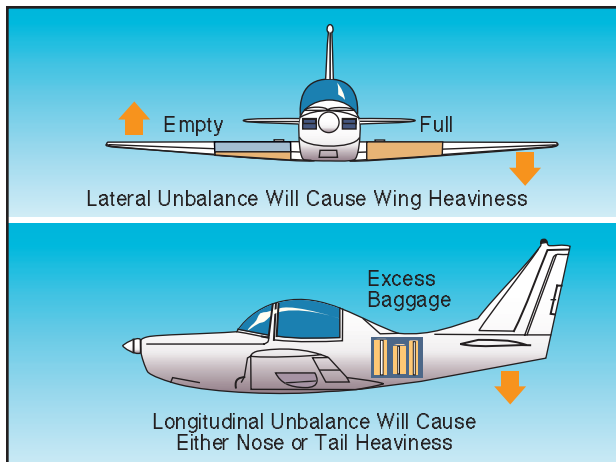


Figure 8-1. Lateral or longitudinal unbalance.

pressure. However, this places the airplane controls in an out-of-streamline condition, increases drag, and results in decreased operating efficiency. Since lateral balance is relatively easy to control and longitudinal balance is more critical, further reference to balance in this handbook will mean longitudinal location of the center of gravity.

In any event, flying an airplane that is out of balance can produce increased pilot fatigue with obvious effects on the safety and efficiency of flight. The pilot's natural correction for longitudinal unbalance is a change of trim to remove the excessive control pressure. Excessive trim, however, has the effect of not only reducing aerodynamic efficiency but also reducing primary control travel distance in the direction the trim is applied.

## EFFECTS OF ADVERSE BALANCE

Adverse balance conditions affect airplane flight characteristics in much the same manner as those mentioned for an excess weight condition. In addition, there are two essential airplane characteristics that may be seriously affected by improper balance; these are stability and control. Loading in a nose-heavy condition causes problems in controlling and raising the nose, especially during takeoff and landing. Loading in a tail-heavy condition has a most serious effect upon longitudinal stability, and can reduce the airplane's capability to recover from stalls and spins. Another undesirable characteristic produced from tail-heavy loading is that it produces very light control forces. This makes it easy for the pilot to inadvertently overstress the airplane.

Limits for the location of the airplane's center of gravity are established by the manufacturer. These are the fore and aft limits beyond which the CG should not be located for flight. These limits are published for each airplane in the Type Certificate Data Sheet, or Aircraft Specification and the Airplane Flight Manual or Pilot's



Operating Handbook (AFM/POH). If, after loading, the CG is not within the allowable limits, it will be necessary to relocate some items within the airplane before flight is attempted.

The forward center-of-gravity limit is often established at a location that is determined by the landing characteristics of the airplane. During landing, which is one of the most critical phases of flight, exceeding the forward CG limit may result in excessive loads on the nosewheel; a tendency to nose over on tailwheel-type airplanes; decreased performance; higher stalling speeds; and higher control forces. In extreme cases, a CG location that is forward of the forward limit may result in nose heaviness to the extent that it may be difficult or impossible to flare for landing. Manufacturers purposely place the forward CG limit as far rearward as possible to aid pilots in avoiding damage to the airplane when landing. In addition to decreased static and dynamic longitudinal stability, other undesirable effects caused by a CG location aft of the allowable range may include extreme control difficulty, violent stall characteristics, and very light stick forces that make it easy to overstress the airplane inadvertently.

A restricted forward center-of-gravity limit is also specified to assure that sufficient elevator deflection is available at minimum airspeed. When structural limitations or large stick forces do not limit the forward CG position, it is located at the position where full-up elevator is required to obtain a high angle of attack for landing.

The aft center-of-gravity limit is the most rearward position at which the CG can be located for the most critical maneuver or operation. As the CG moves aft, a less stable condition occurs, which decreases the ability of the airplane to right itself after maneuvering or turbulence.

For some airplanes the CG limits, both fore and aft, may be specified to vary as gross weight changes. They may also be changed for certain operations such as acrobatic flight, retraction of the landing gear, or the installation of special loads and devices that change the flight characteristics.

The actual location of the CG can be altered by many variable factors and is usually controlled by the pilot. Placement of baggage and cargo items determines the CG location. The assignment of seats to passengers can also be used as a means of obtaining a favorable balance. If the airplane is tail-heavy, it is only logical to place heavy passengers in forward seats. Also, fuel burn can affect the CG based on the location of the fuel tanks.

## MANAGEMENT OF WEIGHT AND BALANCE CONTROL

Weight and balance control should be a matter of concern to all pilots. The pilot has control over loading and fuel management (the two variable factors that can change both total weight and CG location) of a particular airplane.

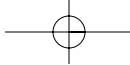
The airplane owner or operator should make certain that up-to-date information is available in the airplane for the pilot's use, and should ensure that appropriate entries are made in the airplane records when repairs or modifications have been accomplished. Weight changes must be accounted for and the proper notations made in weight and balance records. The equipment list must be updated, if appropriate. Without such information, the pilot has no foundation upon which to base the necessary calculations and decisions.

Before any flight, the pilot should determine the weight and balance condition of the airplane. Simple and orderly procedures, based on sound principles, have been devised by airplane manufacturers for the determination of loading conditions. The pilot must use these procedures and exercise good judgment. In many modern airplanes, it is not possible to fill all seats, baggage compartments, and fuel tanks, and still remain within the approved weight and balance limits. If the maximum passenger load is carried, the pilot must often reduce the fuel load or reduce the amount of baggage.

## TERMS AND DEFINITIONS

The pilot should be familiar with terms used in working the problems related to weight and balance. The following list of terms and their definitions is well standardized, and knowledge of these terms will aid the pilot to better understand weight and balance calculations of any airplane. Terms defined by the *General Aviation Manufacturers Association* as an industry standard are marked in the titles with *GAMA*.

- **Arm (moment arm)**—is the horizontal distance in inches from the reference datum line to the center of gravity of an item. The algebraic sign is plus (+) if measured aft of the datum, and minus (−) if measured forward of the datum.
- **Basic empty weight (GAMA)**—includes the standard empty weight plus optional and special equipment that has been installed.
- **Center of gravity (CG)**—is the point about which an airplane would balance if it were possible to suspend it at that point. It is the mass center of the airplane, or the theoretical point at which the entire weight of the airplane is assumed to be concentrated. It may be expressed in inches from



the reference datum, or in percent of mean aerodynamic chord (MAC).

- **Center-of-gravity limits**—are the specified forward and aft points within which the CG must be located during flight. These limits are indicated on pertinent airplane specifications.
- **Center-of-gravity range**—is the distance between the forward and aft CG limits indicated on pertinent airplane specifications.
- **Datum (reference datum)**—is an imaginary vertical plane or line from which all measurements of arm are taken. The datum is established by the manufacturer. Once the datum has been selected, all moment arms and the location of CG range are measured from this point.
- **Delta**—is a Greek letter expressed by the symbol  $\Delta$  to indicate a change of values. As an example,  $\Delta$  CG indicates a change (or movement) of the CG.
- **Floor load limit**—is the maximum weight the floor can sustain per square inch/foot as provided by the manufacturer.
- **Fuel load**—is the expendable part of the load of the airplane. It includes only usable fuel, not fuel required to fill the lines or that which remains trapped in the tank sumps.
- **Licensed empty weight**—is the empty weight that consists of the airframe, engine(s), unusable fuel, and undrainable oil plus standard and optional equipment as specified in the equipment list. Some manufacturers used this term prior to GAMA standardization.
- **Maximum landing weight**—is the greatest weight that an airplane normally is allowed to have at landing.
- **Maximum ramp weight**—is the total weight of a loaded aircraft, and includes all fuel. It is greater than the takeoff weight due to the fuel that will be burned during the taxi and runup operations. Ramp weight may also be referred to as taxi weight.
- **Maximum takeoff weight**—is the maximum allowable weight for takeoff.
- **Maximum weight**—is the maximum authorized weight of the aircraft and all of its equipment as specified in the Type Certificate Data Sheets (TCDS) for the aircraft.
- **Maximum zero fuel weight (GAMA)**—is the maximum weight, exclusive of usable fuel.

- **Mean aerodynamic chord (MAC)**—is the average distance from the leading edge to the trailing edge of the wing.
- **Moment**—is the product of the weight of an item multiplied by its arm. Moments are expressed in pound-inches (lb-in). Total moment is the weight of the airplane multiplied by the distance between the datum and the CG.
- **Moment index (or index)**—is a moment divided by a constant such as 100, 1,000, or 10,000. The purpose of using a moment index is to simplify weight and balance computations of airplanes where heavy items and long arms result in large, unmanageable numbers.
- **Payload (GAMA)**—is the weight of occupants, cargo, and baggage.
- **Standard empty weight (GAMA)**—consists of the airframe, engines, and all items of operating equipment that have fixed locations and are permanently installed in the airplane; including fixed ballast, hydraulic fluid, unusable fuel, and full engine oil.
- **Standard weights**—have been established for numerous items involved in weight and balance computations. These weights should not be used if actual weights are available. Some of the standard weights are:

---

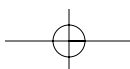
Gasoline . . . . .	6 lb/US gal
Jet A, Jet A-1 . . . . .	6.8 lb/US gal
Jet B . . . . .	6.5 lb/US gal
Oil . . . . .	7.5 lb/US gal
Water . . . . .	8.35 lb/US gal

---

- **Station**—is a location in the airplane that is identified by a number designating its distance in inches from the datum. The datum is, therefore, identified as station zero. An item located at station +50 would have an arm of 50 inches.
- **Useful load**—is the weight of the pilot, copilot, passengers, baggage, usable fuel, and drainable oil. It is the basic empty weight subtracted from the maximum allowable gross weight. This term applies to general aviation aircraft only.

### BASIC PRINCIPLES OF WEIGHT AND BALANCE COMPUTATIONS

It might be advantageous at this point to review and discuss some of the basic principles of how weight and balance can be determined. The following method of computation can be applied to any object or vehicle where weight and balance information is essential; but



to fulfill the purpose of this handbook, it is directed primarily toward the airplane.

By determining the weight of the empty airplane and adding the weight of everything loaded on the airplane, a total weight can be determined. This is quite simple; but to distribute this weight in such a manner that the entire mass of the loaded airplane is balanced around a point (CG), which must be located within specified limits, presents a greater problem, particularly if the basic principles of weight and balance are not understood.

The point where the airplane will balance can be determined by locating the center of gravity, which is, as stated in the definitions of terms, the imaginary point where all the weight is concentrated. To provide the necessary balance between longitudinal stability and elevator control, the center of gravity is usually located slightly forward of the center of lift. This loading condition causes a nose-down tendency in flight, which is desirable during flight at a high angle of attack and slow speeds.

A safe zone within which the balance point (CG) must fall is called the CG range. The extremities of the range are called the forward CG limits and aft CG limits. These limits are usually specified in inches, along the longitudinal axis of the airplane, measured from a datum reference. The datum is an arbitrary point, established by airplane designers, which may vary in location between different airplanes. [Figure 8-2]

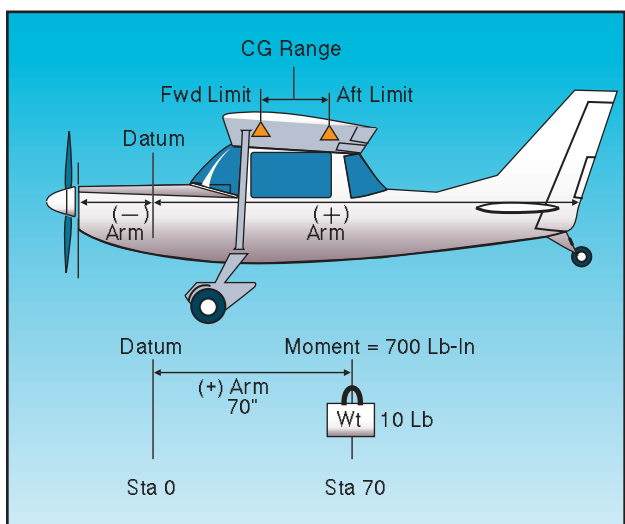


Figure 8-2. Weight and balance illustrated.

The distance from the datum to any component part of the airplane, or any object loaded on the airplane, is called the arm. When the object or component is located aft of the datum, it is measured in positive inches; if located forward of the datum, it is measured as negative inches, or minus inches. The location of the object or part is often referred to as the station. If

the weight of any object or component is multiplied by the distance from the datum (arm), the product is the moment. The moment is the measurement of the gravitational force that causes a tendency of the weight to rotate about a point or axis and is expressed in pound-inches.

To illustrate, assume a weight of 50 pounds is placed on the board at a station or point 100 inches from the datum. The downward force of the weight can be determined by multiplying 50 pounds by 100 inches, which produces a moment of 5,000 lb-in. [Figure 8-3]

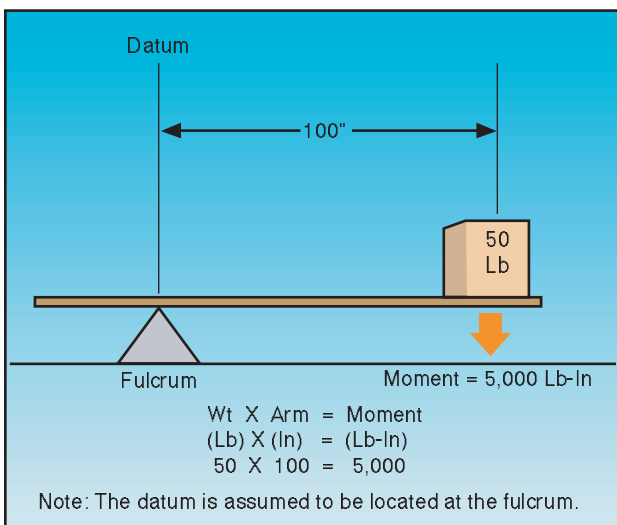


Figure 8-3. Determining moments.

To establish a balance, a total of 5,000 lb-in must be applied to the other end of the board. Any combination of weight and distance which, when multiplied, produces a 5,000 lb-in moment will balance the board. For example, as illustrated in figure 8-4, if a 100-pound weight is placed at a point (station) 25 inches from the datum, and another 50-pound weight is placed at a point (station) 50 inches from the datum, the sum of the product of the two weights and their distances will total a moment of 5,000 lb-in, which will balance the board.

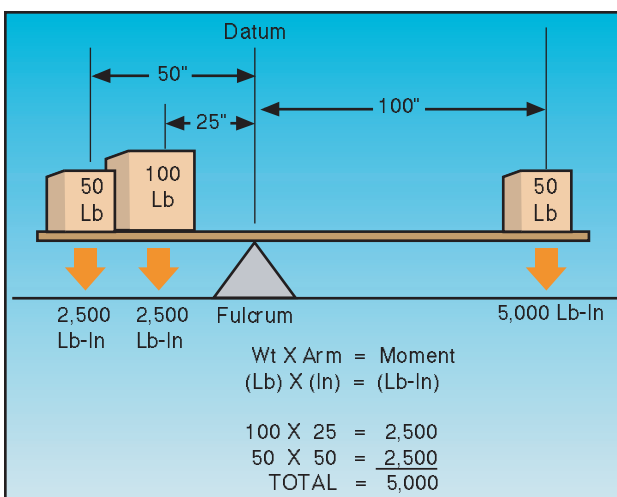


Figure 8-4. Establishing a balance.

## WEIGHT AND BALANCE RESTRICTIONS

The airplane's weight and balance restrictions should be closely followed. The loading conditions and empty weight of a particular airplane may differ from that found in the AFM/POH because modifications or equipment changes may have been made. Sample loading problems in the AFM/POH are intended for guidance only; therefore, each airplane must be treated separately. Although an airplane is certified for a specified maximum gross takeoff weight, it will not safely take off with this load under all conditions. Conditions that affect takeoff and climb performance such as high elevations, high temperatures, and high humidity (high-density altitudes) may require a reduction in weight before flight is attempted. Other factors to consider prior to takeoff are runway length, runway surface, runway slope, surface wind, and the presence of obstacles. These factors may require a reduction in weight prior to flight.

Some airplanes are designed so that it is difficult to load them in a manner that will place the CG out of limits. These are usually small airplanes with the seats, fuel, and baggage areas located near the CG limit. These airplanes, however, can be overloaded in weight.

Other airplanes can be loaded in such a manner that they will be out of CG limits even though the useful load has not been exceeded.

Because of the effects of an out-of-balance or overweight condition, a pilot should always be sure that an airplane is properly loaded.

## DETERMINING LOADED WEIGHT AND CENTER OF GRAVITY

There are various methods for determining the loaded weight and center of gravity of an aircraft. There is the computation method, as well as methods that utilize graphs and tables provided by the aircraft manufacturer.

### COMPUTATIONAL METHOD

The computational method involves the application of basic math functions. The following is an example of the computational method.

Given:

Maximum Gross Weight	3400 lb
Center-of-Gravity Range	78-86 in
Front Seat Occupants	340 lb
Rear Seat Occupants	350 lb
Fuel	75 gal
Baggage Area 1	80 lb

To determine the loaded weight and CG, follow these steps.

**Step 1**—List the weight of the airplane, occupants, fuel, and baggage. Remember that fuel weighs 6 pounds per gallon.

**Step 2**—Enter the moment for each item listed. Remember “weight x arm = moment.”

**Step 3**—Total the weight and moments.

**Step 4**—To determine the CG, divide the total moment by the total weight.

NOTE: The weight and balance records for a particular airplane will provide the empty weight and moment as well as the information on the arm distance.

Item	Weight	Arm	Moment
Airplane Empty Weight	2,100	78.3	164,430
Front Seat Occupants	340	85.0	28,900
Rear Seat Occupants	350	121.0	42,350
Fuel	450	75.0	33,750
Baggage Area 1	80	150.0	12,000
Total	3,320		281,430
			281,430 divided by 3,320 = 84.8

The total loaded weight of 3,320 pounds does not exceed the maximum gross weight of 3,400 pounds and the CG of 84.8 is within the 78-86 inch range; therefore, the airplane is loaded within limits.

### GRAPH METHOD

Another method for determining the loaded weight and CG is the use of graphs provided by the manufacturers. To simplify calculations, the moment may sometimes be divided by 100, 1,000, or 10,000. The following is an example of the graph method. [Figures 8-5 and 8-6]

Given:

Front Seat Occupants	340 lb
Rear Seat Occupants	300 lb
Fuel	40 gal
Baggage Area 1	20 lb

The same steps should be followed as in the computational method except the graphs provided will calculate the moments and allow the pilot to determine if the airplane is loaded within limits. To determine the

SAMPLE LOADING PROBLEM	Weight (Lb)	Moment (Lb-In/1000)
1. Basic Empty Weight (Use the data pertaining to your airplane as it is presently equipped.) Includes unusable fuel and full oil	1,467	57.3
2. Usable Fuel (At 6 Lb/Gal)		
Standard Tanks (40 Gal Maximum)	240	11.5
Long Range Tanks (50 Gal Maximum)		
Integral Tanks (62 Gal Maximum)		
Integral Reduced Fuel (42 Gal)		
3. Pilot and Front Passenger (Station 34 to 46)	340	12.7
4. Rear Passengers	300	21.8
5. Baggage Area 1 or Passenger on Child's Seat (Station 82 to 108, 120 Lb Max)	20	1.9
6. Baggage Area 2 (Station 108 to 142, 50 Lb Max)		
7. Weight and Moment	2,367	105.2

moment using the loading graph, find the weight and draw a line straight across until it intercepts the item for which the moment is to be calculated. Then draw a line straight down to determine the moment. (The red line on the loading graph represents the moment for the pilot and front passenger. All other moments were determined in the same way.) Once this has been done for each item, total the weight and moments and draw a line for both weight and moment on the center-of-gravity envelope graph. If the lines intersect within the envelope, the airplane is loaded within limits. In this sample loading problem, the airplane is loaded within limits.

Figure 8-5. Weight and balance data.

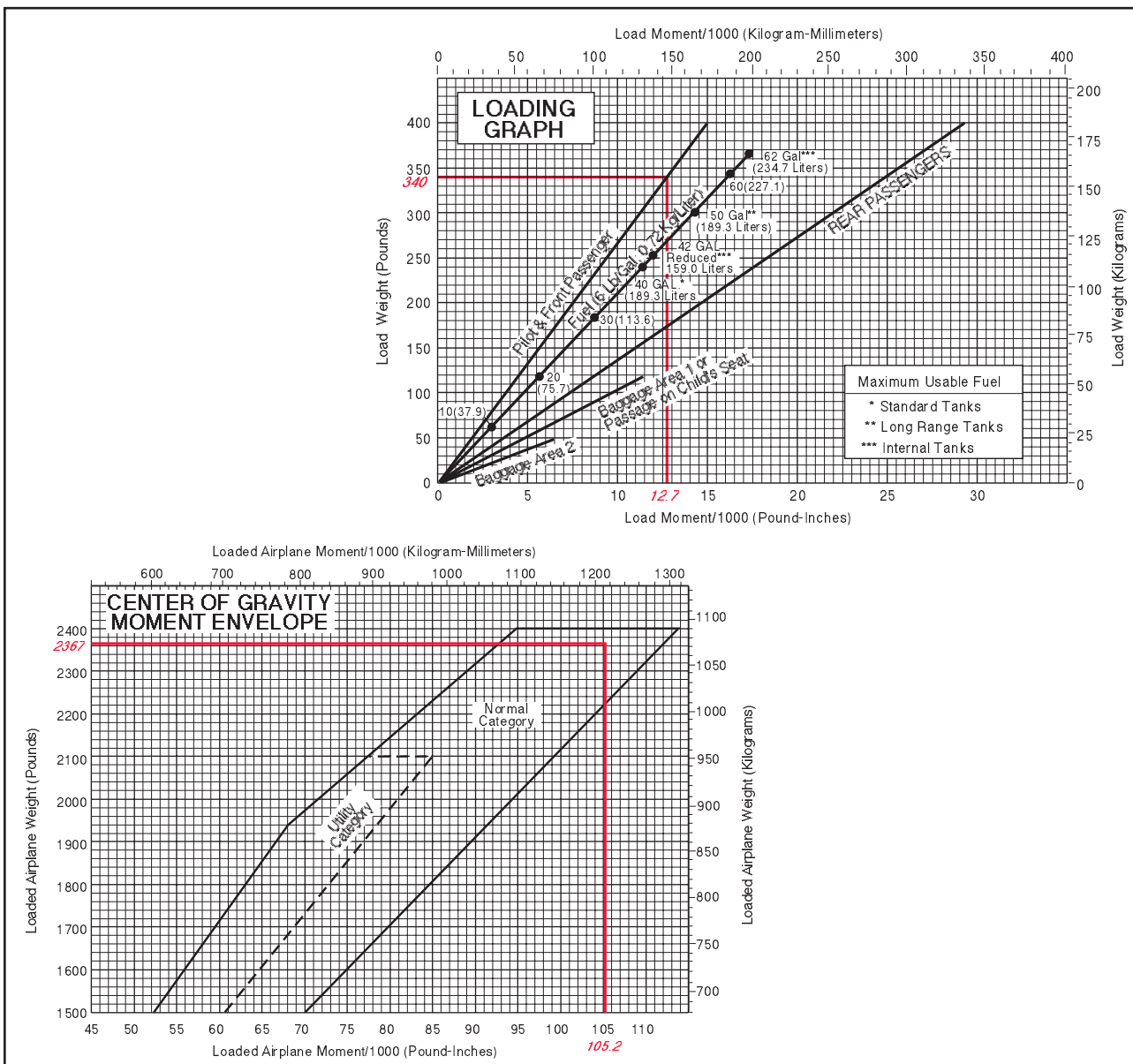


Figure 8-6. CG moment envelope and loading graph.

### TABLE METHOD

The table method applies the same principles as the computational and graph methods. The information and limitations are contained in tables provided by the manufacturer. Figure 8-7 is an example of a table and a weight and balance calculation based on that table. In this problem, the total weight of 2,799 pounds and moment of 2,278/100 are within the limits of the table.

### COMPUTATIONS WITH A NEGATIVE ARM

Figure 8-8 is a sample of weight and balance computation using an airplane with a negative arm. It is important to remember that a positive times a negative equals a negative, and a negative would be subtracted from the total moments.

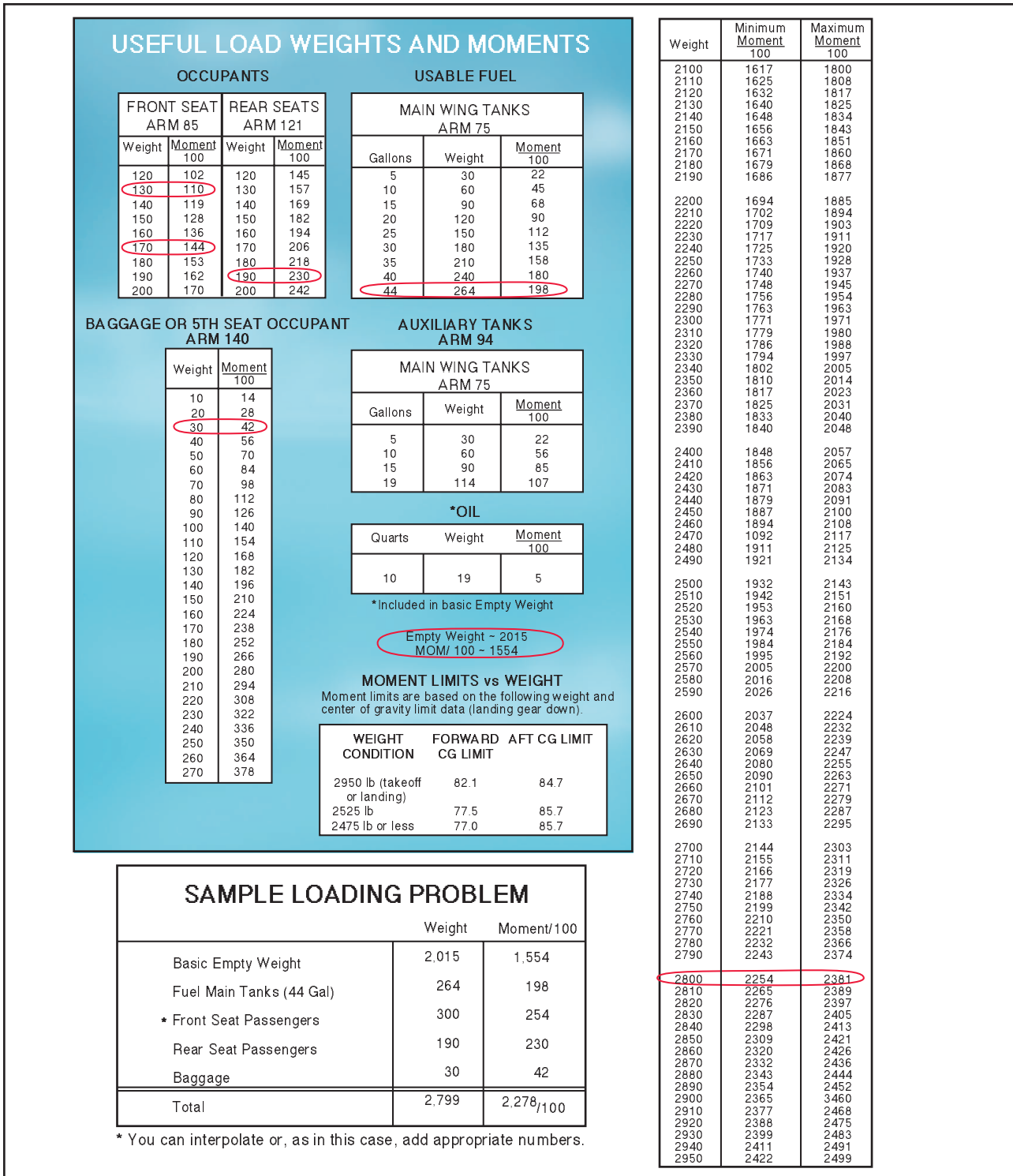


Figure 8-7. Loading schedule placard.

Item	Weight	Arm	Moment
Licensed Empty Weight	1,011.9	68.6	69,393.0
Oil (6 qt)	11.0	-31.0	-341.0
Fuel (18 gal)	108.0	84.0	9,072.0
Fuel, Auxiliary (18 gal)	108.0	84.0	9,072.0
Pilot	170.0	81.0	13,770.0
Passenger	170.0	81.0	13,770.0
Baggage	70.0	105.0	7,350.0
Total	1,648.9		122,086.0
CG		74.0	

Figure 8-8. Sample weight and balance using a negative.

### COMPUTATIONS WITH ZERO FUEL WEIGHT

Figure 8-9 is a sample of weight and balance computation using an airplane with a zero fuel weight. In this example, the total weight of the airplane less fuel is 4,240 pounds, which is under the zero fuel weight of 4,400 pounds. If the total weight of the airplane without fuel had exceeded 4,400 pounds, passengers or cargo would have to be reduced to bring the weight at or below the max zero fuel weight.

### SHIFTING, ADDING, AND REMOVING WEIGHT

A pilot must be able to accurately and rapidly solve any problems that involve the shift, addition, or removal of

Item	Weight	Arm	Moment
Basic Empty Weight	3,230	CG 90.5	292,315.0
Front Seat Occupants	335	89.0	2,9815.0
3 <sup>rd</sup> and 4 <sup>th</sup> Seat Occupants Fwd Facing	350	126.0	44,100.0
5 <sup>th</sup> and 6 <sup>th</sup> Seat Occupants	200	157.0	31,400.0
Nose Baggage	100	10.0	1,000.0
Aft Baggage	25	183.0	4,575.0
Zero Fuel Weight Max 4400 lb. Sub Total	4,240	CG 95.1	403,205.0
Fuel	822	113.0	92,886.0
Ramp Weight Max 5224 lb. Sub Total Ramp Weight	5,062	CG 98.0	496,091.0
* Less Fuel for Start, Taxi, and Takeoff	-24	113.0	-2,712.0
Sub Total Takeoff Weight	5,038	CG 97.9	493,379.0
Less Fuel to Destination	-450	113.0	-50,850.0
Max Landing Weight 4940 lb. Actual Landing Weight	4,588	CG 96.5	442,529.0
*Fuel for Start, Taxi, and Takeoff is normally 24 lb.			

Figure 8-9. Sample weight and balance using an airplane with a published zero fuel weight.

weight. For example, the pilot may load the aircraft within the allowable takeoff weight limit, then find a CG limit has been exceeded. The most satisfactory solution to this problem is to shift baggage, passengers, or both. The pilot should be able to determine the minimum load shift needed to make the aircraft safe for flight. Pilots should be able to determine if shifting a load to a new location will correct an out-of-limit condition. There are some standardized calculations that can help make these determinations.

### WEIGHT SHIFTING

When weight is shifted from one location to another, the total weight of the aircraft is unchanged. The total moments, however, do change in relation and proportion to the direction and distance the weight is moved. When weight is moved forward, the total moments decrease; when weight is moved aft, total moments increase. The moment change is proportional to the amount of weight moved. Since many aircraft have forward and aft baggage compartments, weight may be shifted from one to the other to change the CG. If starting with a known aircraft weight, CG, and total moments, calculate the new CG (after the weight shift) by dividing the new total moments by the total aircraft weight.

To determine the new total moments, find out how many moments are gained or lost when the weight is shifted. Assume that 100 pounds has been shifted from station 30 to station 150. This movement increases the total moments of the aircraft by 12,000 lb-in.

Moment when

$$\text{at station 150} = 100 \text{ lb} \times 150 \text{ in} = 15,000 \text{ lb-in}$$

Moment when

$$\text{at station 30} = 100 \text{ lb} \times 30 \text{ in} = 3,000 \text{ lb-in}$$

Moment change

$$= 12,000 \text{ lb-in}$$

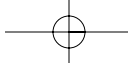
By adding the moment change to the original moment (or subtracting if the weight has been moved forward instead of aft), the new total moments are obtained. Then determine the new CG by dividing the new moments by the total weight:

$$\text{Total moments} = 616,000 + 12,000 = 628,000$$

$$\text{CG} = \frac{628,000}{8,000 \text{ (Total weight)}} = 78.5 \text{ in}$$

The shift has caused the CG to shift to station 78.5

A simpler solution may be obtained by using a computer or calculator and a proportional formula. This can be done because the CG will shift a distance that is proportional to the distance the weight is shifted.



**EXAMPLE**

$$\frac{\text{Weight Shifted}}{\text{Total Weight}} = \frac{\Delta\text{CG (change of CG)}}{\text{Distance weight is shifted}}$$

$$\frac{100}{8,000} = \frac{\Delta\text{CG}}{120}$$

$$\Delta\text{CG} = 1.5 \text{ in}$$

The change of CG is added to (or subtracted from when appropriate) the original CG to determine the new CG:

$$77 + 1.5 = 78.5 \text{ inches aft of datum}$$

The shifting weight proportion formula can also be used to determine how much weight must be shifted to achieve a particular shift of the CG. The following problem illustrates a solution of this type.

**EXAMPLE**

Given:

Aircraft Total Weight	.....	7,800 lb
CG	.....	Station 81.5
Aft CG Limit	.....	80.5

Determine how much cargo must be shifted from the aft cargo compartment at station 150 to the forward cargo compartment at station 30 to move the CG to exactly the aft limit.

Solution:

$$\frac{\text{Weight to be Shifted}}{\text{Total Weight}} = \frac{\Delta\text{CG}}{\text{Distance weight is shifted}}$$

$$\frac{\text{Weight to be Shifted}}{7,800} = \frac{1.0 \text{ in}}{120 \text{ in}}$$

$$\text{Weight to be Shifted} = 65 \text{ lb}$$

**WEIGHT ADDITION OR REMOVAL**

In many instances, the weight and balance of the aircraft will be changed by the addition or removal of weight. When this happens, a new CG must be calculated and checked against the limitations to see if the location is acceptable. This type of weight and balance problem is commonly encountered when the aircraft burns fuel in flight, thereby reducing the weight located at the fuel tanks. Most small aircraft are designed with the fuel tanks positioned close to the CG; therefore, the consumption of fuel does not affect the CG to any great extent.

The addition or removal of cargo presents a CG change problem that must be calculated before flight. The problem may always be solved by calculations involving total moments. A typical problem may involve the calculation of a new CG for an aircraft which, when loaded and ready for flight, receives some additional cargo or passengers just before departure time.

**EXAMPLE**

Given:

Aircraft Total Weight	.....	6,860 lb
CG Station	.....	80.0

Determine the location of the CG if 140 pounds of baggage is added to station 150.

Solution:

$$\frac{\text{Added Weight}}{\text{New Total Weight}} = \frac{\Delta\text{CG}}{\text{Distance between weight and old CG}}$$

$$\frac{140}{6,860 + 140} = \frac{\Delta\text{CG}}{150 - 80}$$

$$\frac{140}{7,000} = \frac{\Delta\text{CG}}{70}$$

$$\text{CG} = 1.4 \text{ in aft}$$

Add  $\Delta\text{CG}$  to old CG

$$\text{New CG} = 80.0 \text{ in} + 1.4 \text{ in} = 81.4 \text{ in}$$

**EXAMPLE**

Given:

Aircraft Total Weight	.....	6,100 lb
CG Station	.....	80.0

Determine the location of the CG if 100 pounds is removed from station 150.

Solution:

$$\frac{\text{Weight Removed}}{\text{New Total Weight}} = \frac{\Delta\text{CG}}{\text{Distance between weight and old CG}}$$

$$\frac{100}{6,100 - 100} = \frac{\Delta\text{CG}}{150 - 80}$$

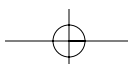
$$\frac{100}{6,000} = \frac{\Delta\text{CG}}{70}$$

$$\text{CG} = 1.2 \text{ in forward}$$

Subtract  $\Delta\text{CG}$  from old CG

$$\text{New CG} = 80 \text{ in} - 1.2 \text{ in} = 78.8 \text{ in}$$

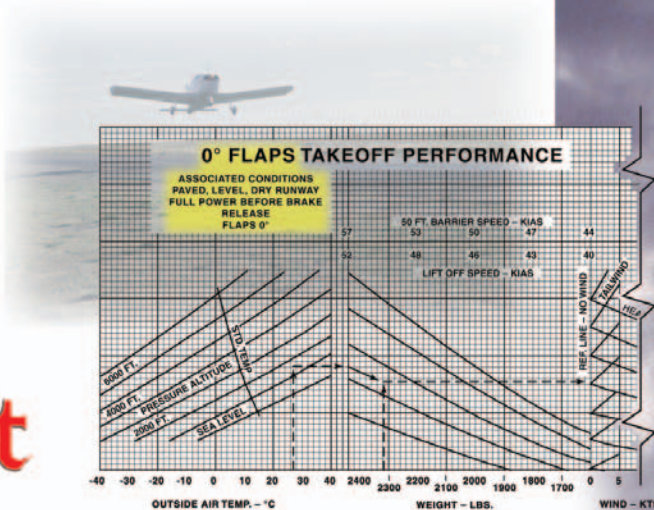
In the previous examples, the  $\Delta\text{CG}$  is either added or subtracted from the old CG. Deciding which to accomplish is best handled by mentally calculating which way the CG will shift for the particular weight change. If the CG is shifting aft, the  $\Delta\text{CG}$  is added to the old CG; if the CG is shifting forward, the  $\Delta\text{CG}$  is subtracted from the old CG.





## Chapter 9

# Aircraft Performance



This chapter discusses the factors that affect airplane performance, which includes the airplane weight, atmospheric conditions, runway environment, and the fundamental physical laws governing the forces acting on an airplane.

### IMPORTANCE OF PERFORMANCE DATA

The performance or operational information section of the Airplane Flight Manual/Pilot's Operating Handbook (AFM/POH) contains the operating data for the airplane; that is, the data pertaining to takeoff, climb, range, endurance, descent, and landing. The use of this data in flying operations is mandatory for safe and efficient operation. Considerable knowledge and familiarity of the airplane can be gained through study of this material.

It must be emphasized that the manufacturers' information and data furnished in the AFM/POH is not standardized. Some provide the data in tabular form, while others use graphs. In addition, the performance data may be presented on the basis of standard atmospheric conditions, pressure altitude, or density altitude. The performance information in the AFM/POH has little or no value unless the user recognizes those variations and makes the necessary adjustments.

To be able to make practical use of the airplane's capabilities and limitations, it is essential to understand the significance of the operational data. The pilot must be cognizant of the basis for the performance data, as well as the meanings of the various terms used in expressing performance capabilities and limitations.

Since the characteristics of the atmosphere have a predominant effect on performance, it is necessary to review some of the dominant factors—pressure and temperature.

### STRUCTURE OF THE ATMOSPHERE

The atmosphere is an envelope of air that surrounds the earth and rests upon its surface. It is as much a part of the earth as the seas or the land. However, air differs from land and water inasmuch as it is a mixture of gases. It has mass, weight, and indefinite shape.

Air, like any other fluid, is able to flow and change its shape when subjected to even minute pressures because of the lack of strong molecular cohesion. For example, gas will completely fill any container into which it is placed, expanding or contracting to adjust its shape to the limits of the container.

The atmosphere is composed of 78 percent nitrogen, 21 percent oxygen, and 1 percent other gases, such as argon or helium. Most of the oxygen is contained below 35,000 feet altitude.

### ATMOSPHERIC PRESSURE

Though there are various kinds of pressure, pilots are mainly concerned with atmospheric pressure. It is one of the basic factors in weather changes, helps to lift the airplane, and actuates some of the important flight instruments in the airplane. These instruments are the altimeter, the airspeed indicator, the rate-of-climb indicator, and the manifold pressure gauge.

Though air is very light, it has mass and is affected by the attraction of gravity. Therefore, like any other

substance, it has weight, and because of its weight, it has force. Since it is a fluid substance, this force is exerted equally in all directions, and its effect on bodies within the air is called pressure. Under standard conditions at sea level, the average pressure exerted by the weight of the atmosphere is approximately 14.7 lb/in. The density of air has significant effects on the airplane's performance. As air becomes less dense, it reduces:

- power because the engine takes in less air,
- thrust because the propeller is less efficient in thin air, and
- lift because the thin air exerts less force on the airfoils.

The pressure of the atmosphere varies with time and location. Due to the changing atmospheric pressure, a standard reference was developed. The standard atmosphere at sea level is a surface temperature of 59°F or 15°C and a surface pressure of 29.92 in. Hg or 1013.2 millibars. [Figure 9-1]

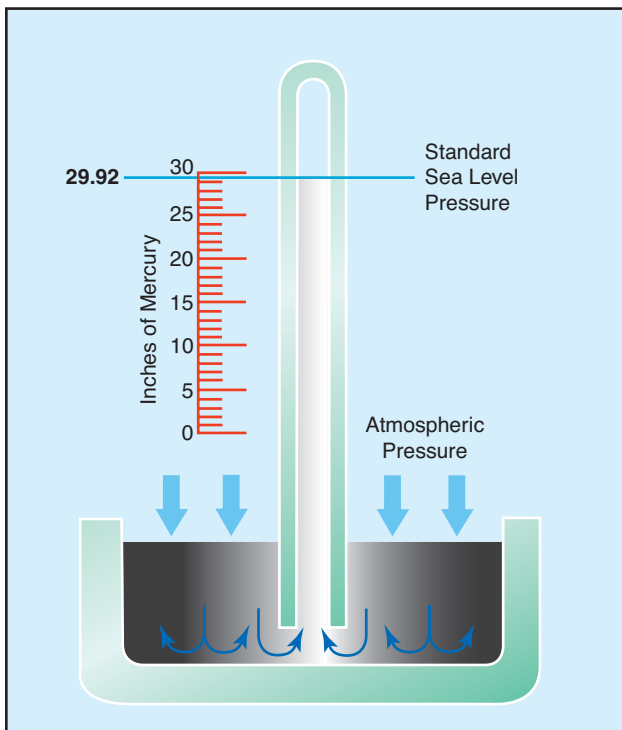


Figure 9-1. Standard sea level pressure.

A standard temperature lapse rate is one in which the temperature decreases at the rate of approximately 3.5°F or 2°C per thousand feet up to 36,000 feet. Above this point, the temperature is considered constant up to 80,000 feet. A standard pressure lapse rate is one in which pressure decreases at a rate of approximately 1 in. Hg per 1,000 feet of altitude gain to 10,000 feet. [Figure 9-2] The International Civil Aviation Organization (ICAO) has established this as a worldwide standard, and it is often referred to as

**International Standard Atmosphere (ISA)** or ICAO Standard Atmosphere. Any temperature or pressure that differs from the standard lapse rates is considered non-standard temperature and pressure. Adjustments for nonstandard temperatures and pressures are provided on the manufacturer's performance charts.

Standard Atmosphere			
Altitude (ft)	Pressure (in. Hg)	Temp. (°C)	Temp. (°F)
0	29.92	15.0	59.0
1,000	28.86	13.0	55.4
2,000	27.82	11.0	51.9
3,000	26.82	9.1	48.3
4,000	25.84	7.1	44.7
5,000	24.89	5.1	41.2
6,000	23.98	3.1	37.6
7,000	23.09	1.1	34.0
8,000	22.22	-0.9	30.5
9,000	21.38	-2.8	26.9
10,000	20.57	-4.8	23.3
11,000	19.79	-6.8	19.8
12,000	19.02	-8.8	16.2
13,000	18.29	-10.8	12.6
14,000	17.57	-12.7	9.1
15,000	16.88	-14.7	5.5
16,000	16.21	-16.7	1.9
17,000	15.56	-18.7	-1.6
18,000	14.94	-20.7	-5.2
19,000	14.33	-22.6	-8.8
20,000	13.74	-24.6	-12.3

Figure 9-2. Properties of standard atmosphere.

Since all airplane performance is compared and evaluated with respect to the standard atmosphere, all aircraft instruments are calibrated for the standard atmosphere. Thus, certain corrections must apply to the instrumentation, as well as the airplane performance, if the actual operating conditions do not fit the standard atmosphere. In order to account properly for the non-standard atmosphere, certain related terms must be defined.

## PRESSURE ALTITUDE

Pressure altitude is the height above a standard datum plane. The airplane altimeter is essentially a sensitive barometer calibrated to indicate altitude in the standard atmosphere. If the altimeter is set for 29.92 in. Hg Standard Datum Plane (SDP), the altitude indicated is the pressure altitude—the altitude in the standard atmosphere corresponding to the sensed pressure.

The SDP is a theoretical level where the weight of the atmosphere is 29.92 in. Hg as measured by a barometer. As atmospheric pressure changes, the SDP may be below, at, or above sea level. Pressure altitude is important as a

**International Standard Atmosphere (ISA)**—Also known as a standard day. A representative model of atmospheric air pressure, temperature, and density at various altitudes for reference purposes. At sea level, the ISA has a temperature of 59°F or 15°C and a pressure of 29.92 in. Hg or 1013.2 millibars.

**Pressure Altitude**—The height above a standard datum plane.

basis for determining airplane performance as well as for assigning flight levels to airplanes operating at above 18,000 feet.

The pressure altitude can be determined by either of two methods:

1. by setting the barometric scale of the altimeter to 29.92 and reading the indicated altitude, or
2. by applying a correction factor to the indicated altitude according to the reported "altimeter setting."

### DENSITY ALTITUDE

The more appropriate term for correlating aerodynamic performance in the nonstandard atmosphere is **density altitude**—the altitude in the standard atmosphere corresponding to a particular value of air density.

Density altitude is pressure altitude corrected for nonstandard temperature. As the density of the air increases (lower density altitude), airplane performance increases and conversely as air density decreases (higher density altitude), airplane performance decreases. *A decrease in air density means a high density altitude; and an increase in air density means a lower density altitude.* Density altitude is used in calculating airplane performance. Under standard atmospheric condition, air at each level in the atmosphere has a specific density, and under standard conditions, pressure altitude and density altitude identify the same level. Density altitude, then, is the vertical distance above sea level in the standard atmosphere at which a given density is to be found.

The computation of density altitude must involve consideration of pressure (pressure altitude) and temperature. Since airplane performance data at any level is based upon air density under standard day conditions, such performance data apply to air density levels that may not be identical with altimeter indications. Under conditions higher or lower than standard, these levels cannot be determined directly from the altimeter.

Density altitude is determined by first finding pressure altitude, and then correcting this altitude for nonstandard temperature variations. Since density varies directly with pressure, and inversely with temperature, a given pressure altitude may exist for a wide range of temperature by allowing the density to vary. However, a known density occurs for any one temperature and pressure altitude. The density of the air, of course, has a pronounced effect on airplane and engine performance. Regardless of the actual altitude at which the airplane is operating, it will perform as though it were operating at an altitude equal to the existing density altitude.

For example, when set at 29.92, the altimeter may indicate a pressure altitude of 5,000 feet. According to the

**Density Altitude**—Pressure altitude corrected for nonstandard temperature.

AFM/POH, the ground run on takeoff may require a distance of 790 feet under standard temperature conditions. However, if the temperature is 20°C above standard, the expansion of air raises the density level. Using temperature correction data from tables or graphs, or by deriving the density altitude with a computer, it may be found that the density level is above 7,000 feet, and the ground run may be closer to 1,000 feet.

Air density is affected by changes in altitude, temperature, and humidity. High density altitude refers to thin air while low density altitude refers to dense air. The conditions that result in a high density altitude are high elevations, low atmospheric pressures, high temperatures, high humidity, or some combination of these factors. Lower elevations, high atmospheric pressure, low temperatures, and low humidity are more indicative of low density altitude.

Using a flight computer, density altitude can be computed by inputting the pressure altitude and outside air temperature at flight level. Density altitude can also be determined by referring to the table and chart in figures 9-3 and 9-4.

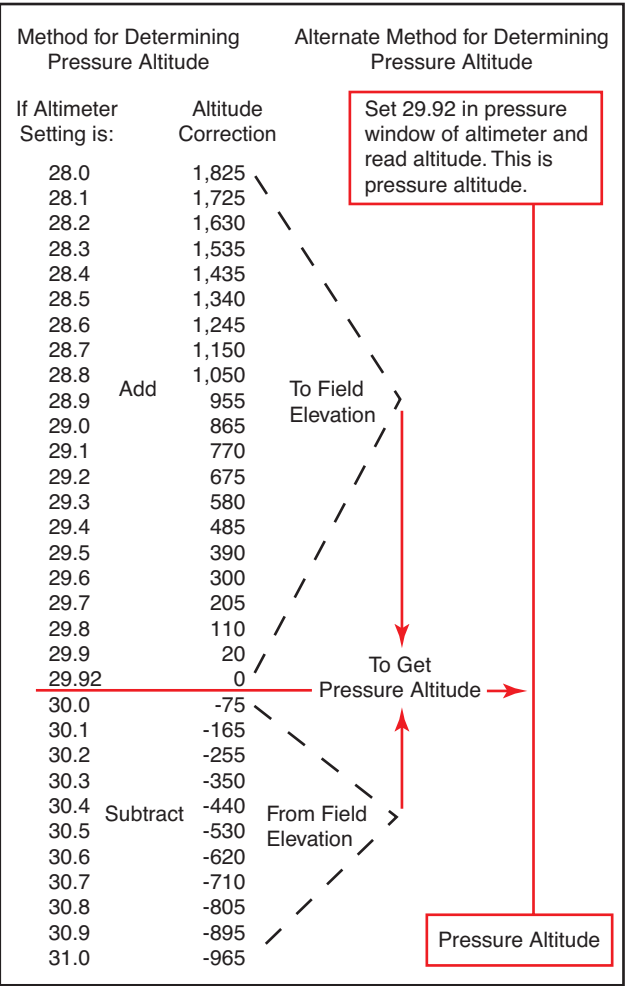


Figure 9-3. Field elevation versus pressure altitude.

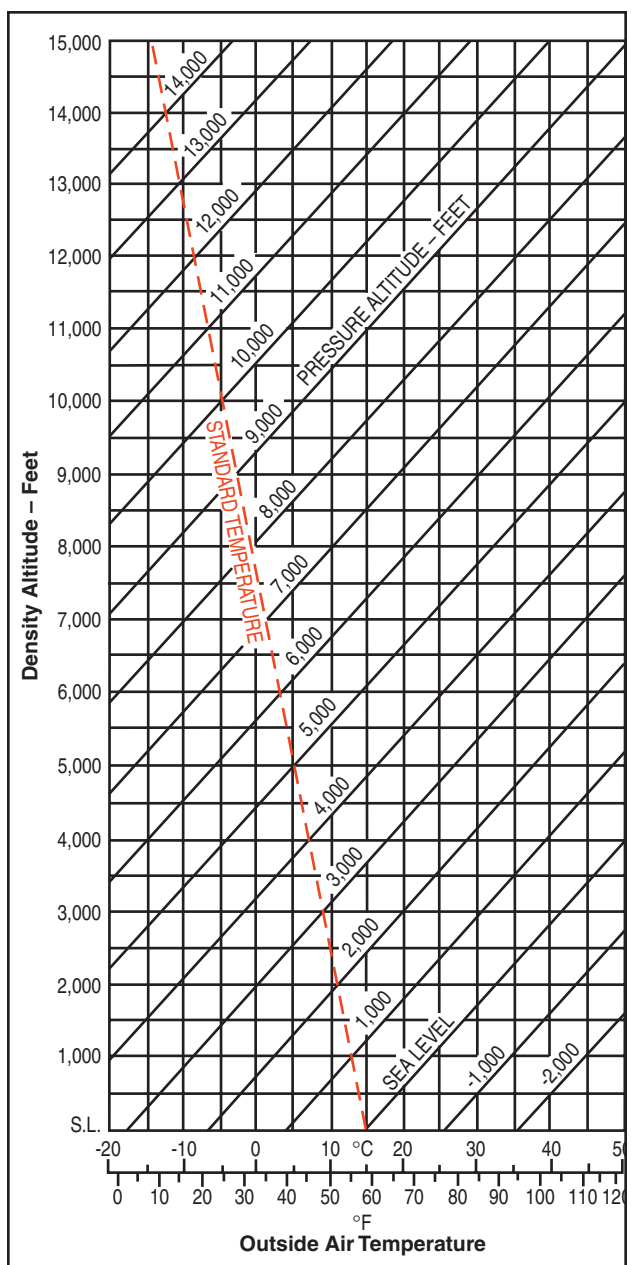


Figure 9-4. Density altitude chart.

### EFFECTS OF PRESSURE ON DENSITY

Since air is a gas, it can be compressed or expanded. When air is compressed, a greater amount of air can occupy a given volume. Conversely, when pressure on a given volume of air is decreased, the air expands and occupies a greater space. That is, the original column of air at a lower pressure contains a smaller mass of air. In other words, the density is decreased. In fact, density is directly proportional to pressure. If the pressure is doubled, the density is doubled, and if the pressure is lowered, so is the density. This statement is true only at a constant temperature.

### EFFECT OF TEMPERATURE ON DENSITY

Increasing the temperature of a substance decreases its density. Conversely, decreasing the temperature

increases the density. Thus, the density of air varies inversely with temperature. This statement is true only at a constant pressure.

In the atmosphere, both temperature and pressure decrease with altitude, and have conflicting effects upon density. However, the fairly rapid drop in pressure as altitude is increased usually has the dominating effect. Hence, pilots can expect the density to decrease with altitude.

### EFFECT OF HUMIDITY (MOISTURE) ON DENSITY

The preceding paragraphs have assumed that the air was perfectly dry. In reality, it is never completely dry. The small amount of water vapor suspended in the atmosphere may be almost negligible under certain conditions, but in other conditions humidity may become an important factor in the performance of an airplane. Water vapor is lighter than air; consequently, moist air is lighter than dry air. Therefore, as the water content of the air increases, the air becomes less dense, increasing density altitude and decreasing performance. It is lightest or least dense when, in a given set of conditions, it contains the maximum amount of water vapor.

Humidity, also called “**relative humidity**,” refers to the amount of water vapor contained in the atmosphere, and is expressed as a percentage of the maximum amount of water vapor the air can hold. This amount varies with the temperature; warm air can hold more water vapor, while colder air can hold less. Perfectly dry air that contains no water vapor has a relative humidity of 0 percent, while saturated air, that cannot hold any more water vapor, has a relative humidity of 100 percent. Humidity alone is usually not considered an important factor in calculating density altitude and airplane performance; however, it does contribute.

The higher the temperature, the greater amount of water vapor that the air can hold. When comparing two separate air masses, the first warm and moist (both qualities tending to lighten the air) and the second cold and dry (both qualities making it heavier), the first necessarily must be less dense than the second. Pressure, temperature, and humidity have a great influence on airplane performance because of their effect upon density. There are no rules-of-thumb or charts used to compute the effects of humidity on density altitude, so take this into consideration by expecting a decrease in overall performance in high humidity conditions.

## PERFORMANCE

“Performance” is a term used to describe the ability of an airplane to accomplish certain things that make it

**Relative Humidity**—The amount of water vapor contained in the air compared to the amount the air could hold.

useful for certain purposes. For example, the ability of the airplane to land and take off in a very short distance is an important factor to the pilot who operates in and out of short, unimproved airfields. The ability to carry heavy loads, fly at high altitudes at fast speeds, or travel long distances is essential performance for operators of airline and executive type airplanes.

The chief elements of performance are the takeoff and landing distance, rate of climb, ceiling, payload, range, speed, maneuverability, stability, and fuel economy. Some of these factors are often directly opposed: for example, high speed versus shortness of landing distance; long range versus great payload; and high rate of climb versus fuel economy. It is the preeminence of one or more of these factors which dictates differences between airplanes and which explains the high degree of specialization found in modern airplanes.

The various items of airplane performance result from the combination of airplane and powerplant characteristics. The aerodynamic characteristics of the airplane generally define the power and thrust requirements at various conditions of flight while powerplant characteristics generally define the power and thrust available at various conditions of flight. The matching of the aerodynamic configuration with the powerplant is accomplished by the manufacturer to provide maximum performance at the specific design condition; e.g., range, endurance, and climb.

### STRAIGHT-AND-LEVEL FLIGHT

All of the principal items of flight performance involve steady-state flight conditions and equilibrium of the airplane. For the airplane to remain in steady, level flight, equilibrium must be obtained by a lift equal to the airplane weight and a powerplant thrust equal to the airplane drag. Thus, the airplane drag defines the thrust required to maintain steady, level flight.

All parts of the airplane that are exposed to the air contribute to the drag, though only the wings provide lift of any significance. For this reason, and certain others related to it, the total drag may be divided into two parts: the wing drag (induced) and the drag of everything but the wings (parasite).

The total power required for flight then can be considered as the sum of induced and parasite effects; that is, the total drag of the airplane. Parasite drag is the sum of pressure and friction drag, which is due to the airplane's basic configuration and, as defined, is independent of lift. Induced drag is the undesirable but unavoidable consequence of the development of lift.

While the parasite drag predominates at high speed, induced drag predominates at low speed. [Figure 9-5] For example, if an airplane in a steady flight condition at 100 knots is then accelerated to 200 knots, the

parasite drag becomes four times as great, but the power required to overcome that drag is eight times the original value. Conversely, when the airplane is operated in steady, level flight at twice as great a speed, the induced drag is one-fourth the original value, and the power required to overcome that drag is only one-half the original value.

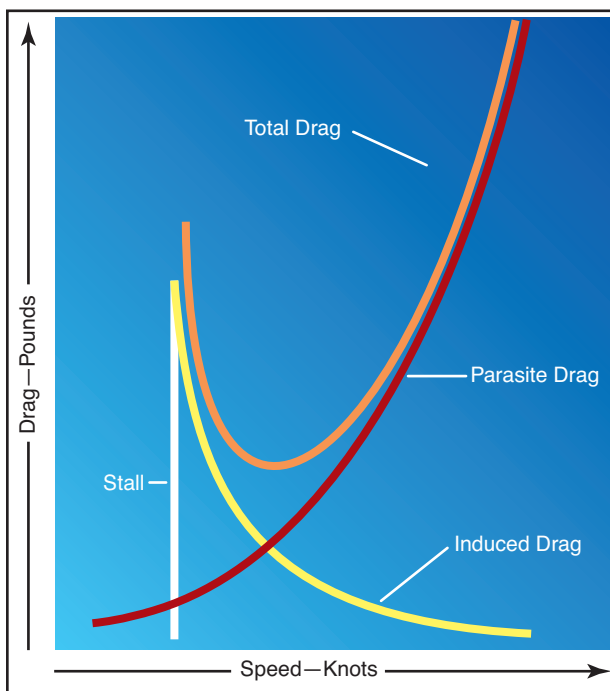


Figure 9-5. Drag versus speed.

The wing or induced drag changes with speed in a very different way, because of the changes in the angle of attack. Near the stalling speed, the wing is inclined to the relative wind at nearly the stalling angle, and its drag is very strong. But at cruise flying speed, with the angle of attack nearly zero, induced drag is minimal. After attaining cruise speed, the angle of attack changes very little with any further increase in speed, and the drag of the wing increases in direct proportion to any further increase in speed. This does not consider the factor of compressibility drag that is involved at speeds beyond 260 knots.

To sum up these changes, as the speed increases from stalling speed to VNE, the induced drag decreases and parasite drag increases.

When the airplane is in steady, level flight, the condition of equilibrium must prevail. The unaccelerated condition of flight is achieved with the airplane trimmed for lift equal to weight and the powerplant set for a thrust to equal the airplane drag.

The maximum level flight speed for the airplane will be obtained when the power or thrust required equals the maximum power or thrust available from the

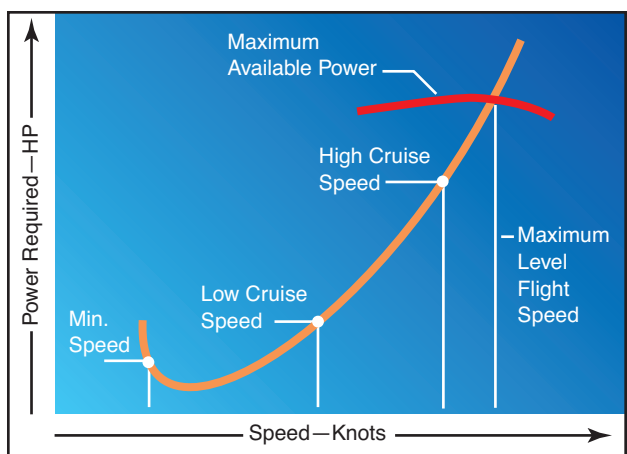


Figure 9-6. Power versus speed.

powerplant. [Figure 9-6] The minimum level flight airspeed is not usually defined by thrust or power requirement since conditions of stall or stability and control problems generally predominate.

### CLIMB PERFORMANCE

Climb depends upon the reserve power or thrust. Reserve power is the available power over and above that required to maintain horizontal flight at a given speed. Thus, if an airplane is equipped with an engine that produces 200 total available horsepower and the airplane requires only 130 horsepower at a certain level flight speed, the power available for climb is 70 horsepower.

Although the terms “**power**” and “**thrust**” are sometimes used interchangeably, erroneously implying that they are synonymous, it is important to distinguish between the two when discussing climb performance. **Work** is the product of a force moving through a distance and is usually independent of time. Work is measured by several standards; the most common unit is called a “foot-pound.” If a 1-pound mass is raised 1 foot, a work unit of 1 foot-pound has been performed. The common unit of mechanical power is horsepower; one horsepower is work equivalent to lifting 33,000 pounds a vertical distance of 1 foot in 1 minute. The term “power” implies work rate or units of work per unit of time, and as such is a function of the speed at which the force is developed. “Thrust,” also a function of work, means the force that imparts a change in the velocity of a mass. This force is measured in pounds but has no element of time or rate. It can be said then, that during a steady climb, the rate of climb is a function of excess thrust.

**Power**—Work rate or units of work per unit of time, and is a function of the speed at which the force is developed.

**Thrust**—Also a function of work and means the force that imparts a change in the velocity of a mass.

**Work**—The product of a force moving through a distance and is usually expressed in foot-pounds.

When the airplane is in steady, level flight or with a slight angle of climb, the vertical component of lift is very nearly the same as the actual total lift. Such climbing flight would exist with the lift very nearly equal to the weight. The net thrust of the powerplant may be inclined relative to the flightpath, but this effect will be neglected here for the sake of simplicity. Although the weight of the airplane acts vertically, a component of weight will act rearward along the flightpath. [Figure 9-7]

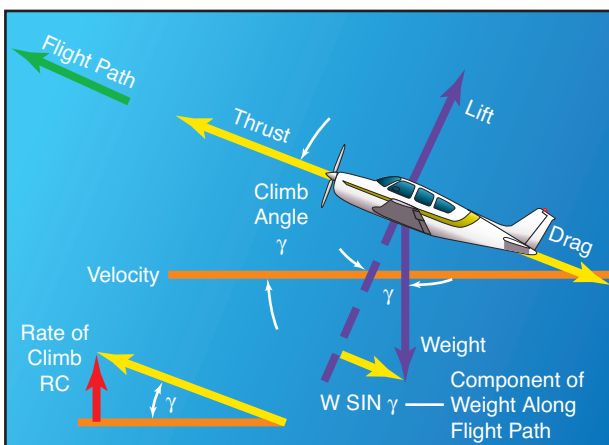


Figure 9-7. Weight has rearward component.

If it is assumed that the airplane is in a steady climb with essentially a small inclination of the flightpath, the summation of forces along the flightpath resolves to the following:

#### Forces forward = Forces aft

The basic relationship neglects some of the factors that may be of importance for airplanes of very high climb performance. (For example, a more detailed consideration would account for the inclination of thrust from the flightpath, lift not being equal to weight, and a subsequent change of induced drag.) However, this basic relationship will define the principal factors affecting climb performance.

This relationship means that, for a given weight of the airplane, the angle of climb depends on the difference between thrust and drag, or the excess thrust. [Figure 9-8] Of course, when the excess thrust is zero, the inclination of the flightpath is zero, and the airplane will be in steady, level flight. When the thrust is greater than the drag, the excess thrust will allow a climb angle depending on the value of excess thrust. On the other hand, when the thrust is less than the drag, the deficiency of thrust will allow an angle of descent.

The most immediate interest in the climb angle performance involves obstacle clearance. The most obvious purpose for which it might be used

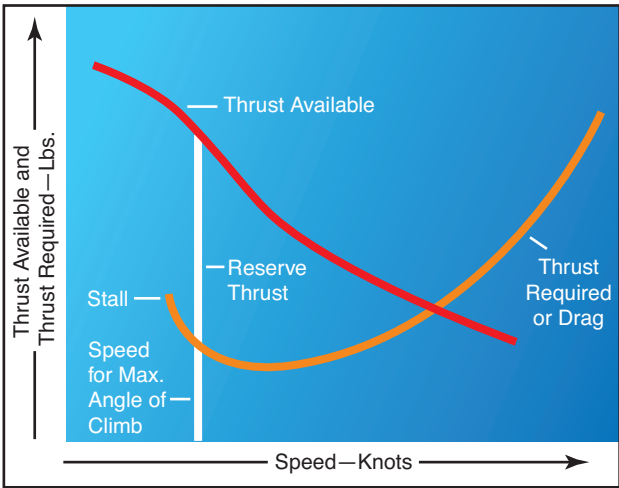


Figure 9-8. Thrust versus climb angle.

is to clear obstacles when climbing out of short or confined airports.

The maximum angle of climb would occur where there exists the greatest difference between thrust available and thrust required; i.e., for the propeller-powered airplane, the maximum excess thrust and angle of climb will occur at some speed just above the stall speed. Thus, if it is necessary to clear an obstacle after takeoff, the propeller-powered airplane will attain maximum angle of climb at an airspeed close to—if not at—the takeoff speed.

Of greater interest in climb performance are the factors that affect the rate of climb. The vertical velocity of an airplane depends on the flight speed and the inclination of the flightpath. In fact, the rate of climb is the vertical component of the flightpath velocity.

For rate of climb, the maximum rate would occur where there exists the greatest difference between power available and power required. [Figure 9-9] The above relationship means that, for a given weight of the

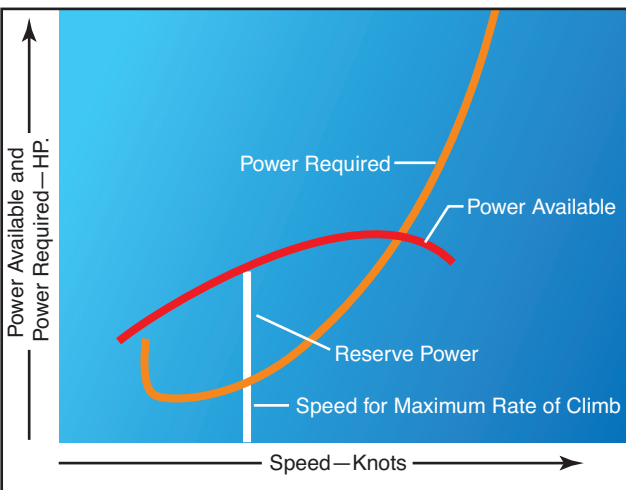


Figure 9-9. Power versus climb rate.

airplane, the rate of climb depends on the difference between the power available and the power required, or the excess power. Of course, when the excess power is zero, the rate of climb is zero and the airplane is in steady, level flight. When power available is greater than the power required, the excess power will allow a rate of climb specific to the magnitude of excess power.

During a steady climb, the rate of climb will depend on excess power while the angle of climb is a function of excess thrust.

The climb performance of an airplane is affected by certain variables. The conditions of the airplane's maximum climb angle or maximum climb rate occur at specific speeds, and variations in speed will produce variations in climb performance. There is sufficient latitude in most airplanes that small variations in speed from the optimum do not produce large changes in climb performance, and certain operational considerations may require speeds slightly different from the optimum. Of course, climb performance would be most critical with high gross weight, at high altitude, in obstructed takeoff areas, or during malfunction of a powerplant. Then, optimum climb speeds are necessary.

Weight has a very pronounced effect on airplane performance. If weight is added to the airplane, it must fly at a higher angle of attack to maintain a given altitude and speed. This increases the induced drag of the wings, as well as the parasite drag of the airplane. Increased drag means that additional thrust is needed to overcome it, which in turn means that less reserve thrust is available for climbing. Airplane designers go to great effort to minimize the weight since it has such a marked effect on the factors pertaining to performance.

A change in the airplane's weight produces a twofold effect on climb performance. First, a change in weight will change the drag and the power required. This alters the reserve power available, which in turn, affects both the climb angle and the climb rate. Secondly, an increase in weight will reduce the maximum rate of climb, but the airplane must be operated at a higher climb speed to achieve the smaller peak climb rate.

An increase in altitude also will increase the power required and decrease the power available. Therefore, the climb performance of an airplane diminishes with altitude. The speeds for maximum rate of climb, maximum angle of climb, and maximum and minimum level flight airspeeds vary with altitude. As altitude is increased, these various speeds finally converge at the absolute ceiling of the airplane. At the absolute ceiling, there is no excess of power and only one speed will

allow steady, level flight. Consequently, the absolute ceiling of the airplane produces zero rate of climb. The service ceiling is the altitude at which the airplane is unable to climb at a rate greater than 100 feet per minute. Usually, these specific performance reference points are provided for the airplane at a specific design configuration. [Figure 9-10]

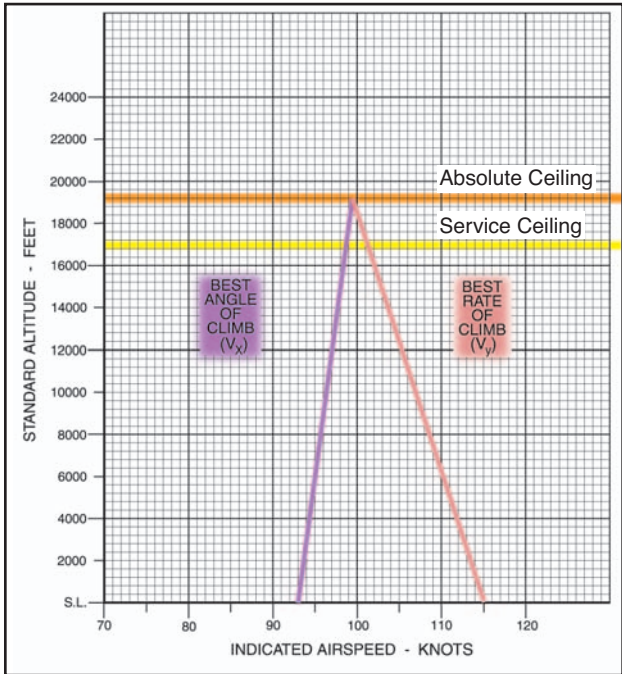


Figure 9-10. Absolute and service ceiling.

In discussing performance, it frequently is convenient to use the terms “power loading” and “wing loading.” Power loading is expressed in pounds per horsepower and is obtained by dividing the total weight of the airplane by the rated horsepower of the engine. It is a significant factor in the airplane’s takeoff and climb capabilities. Wing loading is expressed in pounds per square foot and is obtained by dividing the total weight of the airplane in pounds by the wing area (including ailerons) in square feet. It is the airplane’s wing loading that determines the landing speed. These factors are discussed in subsequent sections of this chapter.

**RANGE PERFORMANCE**

The ability of an airplane to convert fuel energy into flying distance is one of the most important items of airplane performance. In flying operations, the problem of efficient range operation of an airplane appears in two general forms:

1. to extract the maximum flying distance from a given fuel load or,
2. to fly a specified distance with a minimum expenditure of fuel.

A common denominator for each of these operating problems is the “specific range”; that is, nautical miles

of flying distance per pound of fuel. Cruise flight operations for maximum range should be conducted so that the airplane obtains maximum specific range throughout the flight.

The specific range can be defined by the following relationship:

$$\text{specific range} = \frac{\text{nautical miles}}{\text{lb. of fuel}}$$

or,

$$\text{specific range} = \frac{\text{nautical miles/hr.}}{\text{lb. of fuel/hr.}}$$

or,

$$\text{specific range} = \frac{\text{knots}}{\text{fuel flow}}$$

If maximum specific range is desired, the flight condition must provide a maximum of speed per fuel flow.

Range must be clearly distinguished from the item of endurance. [Figure 9-11] The item of range involves consideration of flying distance, while endurance involves consideration of flying time. Thus, it is appropriate to define a separate term, “specific endurance.”

$$\text{specific endurance} = \frac{\text{flight hours}}{\text{lb. of fuel}}$$

or,

$$\text{specific endurance} = \frac{\text{flight hours/hr.}}{\text{lb. of fuel/hr.}}$$

or,

$$\text{specific endurance} = \frac{1}{\text{fuel flow}}$$

If maximum endurance is desired, the flight condition must provide a minimum of fuel flow. While the peak value of specific range would provide maximum range operation, long-range cruise operation is generally recommended at some slightly higher airspeed. Most long-range cruise operations are conducted at the flight condition that provides 99 percent of the absolute maximum specific range. The advantage of such operation is that 1 percent of range is traded for 3 to 5 percent higher cruise speed. Since the higher cruise speed has a great number of advantages, the small sacrifice of



range is a fair bargain. The values of specific range versus speed are affected by three principal variables:

1. airplane gross weight,
2. altitude, and
3. the external aerodynamic configuration of the airplane. These are the source of range and endurance operating data included in the performance section of the AFM/POH.

“Cruise control” of an airplane implies that the airplane is operated to maintain the recommended long-range cruise condition throughout the flight. Since fuel is consumed during cruise, the gross weight of the airplane will vary and optimum airspeed, altitude, and power setting can also vary. “Cruise control” means the control of the optimum airspeed, altitude, and power setting to maintain the 99 percent maximum specific range condition. At the beginning of cruise flight, the relatively high initial weight of the airplane will require specific values of airspeed, altitude, and power setting to produce the recommended cruise condition. As fuel is consumed and the airplane’s gross weight decreases, the optimum airspeed and power setting may decrease, or, the optimum altitude may increase. In addition, the optimum specific range will increase. Therefore, the pilot must provide the proper cruise control procedure to ensure that optimum conditions are maintained.

Total range is dependent on both fuel available and specific range. When range and economy of operation are the principal goals, the pilot must ensure that the airplane will be operated at the recommended long-range cruise condition. By this procedure, the airplane will be capable of its maximum design-operating radius, or can achieve flight distances less than the maximum with a maximum of fuel reserve at the destination.

The propeller-driven airplane combines the propeller with the reciprocating engine for propulsive power. In the case of the reciprocating engine, fuel flow is determined mainly by the shaft power put into the propeller rather than thrust. Thus, the fuel flow can be related directly to the power required to maintain the airplane in steady, level flight. This fact allows for the determination of range through analysis of power required versus speed.

The maximum endurance condition would be obtained at the point of minimum power required since this would require the lowest fuel flow to keep the airplane in steady, level flight. Maximum range condition would occur where the proportion between speed and power required is greatest. [Figure 9-11]

The maximum range condition is obtained at maximum lift/drag ratio (L/D max), and it is important to note that

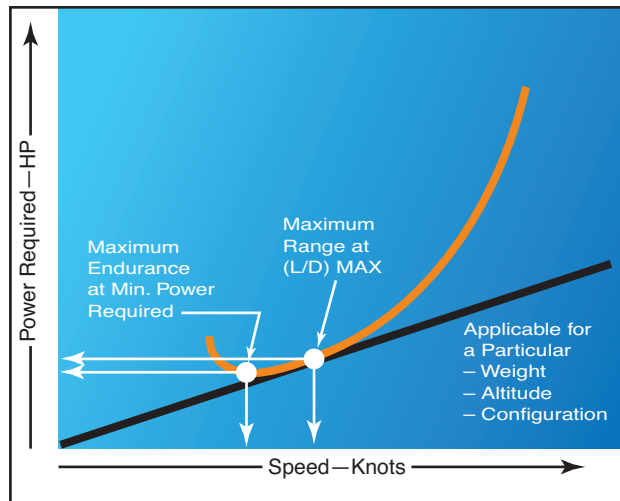


Figure 9-11. Airspeeds for maximum endurance vs. maximum range.

for a given airplane configuration, the maximum lift/drag ratio occurs at a particular angle of attack and lift coefficient, and is unaffected by weight or altitude. A variation in weight will alter the values of airspeed and power required to obtain the maximum lift/drag ratio. [Figure 9-12]

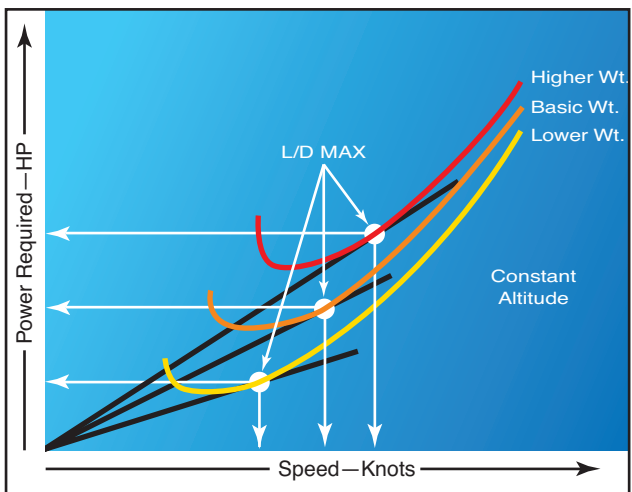


Figure 9-12. Effect of weight on speed for maximum range.

The variations of speed and power required must be monitored by the pilot as part of the cruise control procedure to maintain the maximum lift/drag ratio. When the airplane’s fuel weight is a small part of the gross weight and the airplane’s range is small, the cruise control procedure can be simplified to essentially maintaining a constant speed and power setting throughout the time of cruise flight. The long-range airplane has a fuel weight that is a considerable part of the gross weight, and cruise control procedures must employ scheduled airspeed and power changes to maintain optimum range conditions.

The effect of altitude on the range of the propeller-driven airplane may be understood by inspection of figure 9-13. A flight conducted at high altitude will have a greater true airspeed, and the power required will be proportionately greater than when conducted at sea level. The drag of the airplane at altitude is the same as the drag at sea level, but the higher true airspeed causes a proportionately greater power required. Note that the straight line that is tangent to the sea level power curve is also tangent to the altitude power curve.

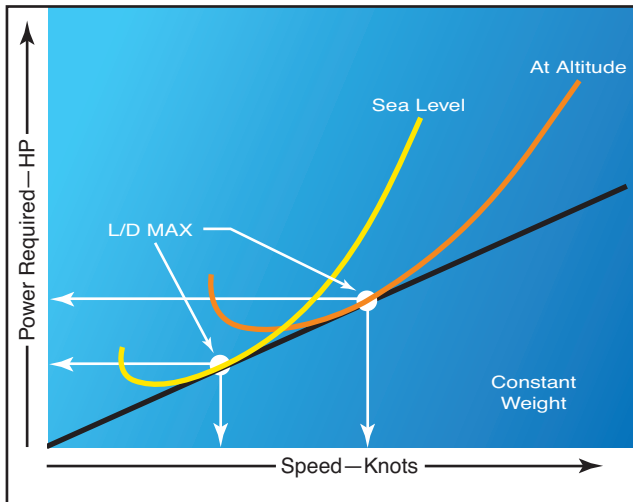


Figure 9-13. Effect of altitude on range.

The effect of altitude on specific range also can be appreciated from the previous relationships. If a change in altitude causes identical changes in speed and power required, the proportion of speed to power required would be unchanged. The fact implies that the specific range of the propeller-driven airplane would be unaffected by altitude. Actually, this is true to the extent that specific fuel consumption and propeller efficiency are the principal factors that could cause a variation of specific range with altitude. If compressibility effects are negligible, any variation of specific range with altitude is strictly a function of engine/propeller performance.

The airplane equipped with the reciprocating engine will experience very little, if any, variation of specific range up to its absolute altitude. There is negligible variation of **brake specific fuel consumption** for values of **brake horsepower** below the maximum cruise power rating of the engine that is the lean range of engine operation. Thus, an increase in altitude will produce a decrease in specific range only when the increased power requirement exceeds the maximum cruise power rating of the engine. One advantage of supercharging is that the cruise power may be maintained at high altitude, and the airplane may achieve the range at high altitude with the corresponding increase in true airspeed. The principal differences in

the high altitude cruise and low altitude cruise are the true airspeeds and climb fuel requirements.

## GROUND EFFECT

**Ground effect** is due to the interference of the surface with the flow pattern about the airplane in flight. Ground effect can be detected and measured up to an altitude equal to one wing span above the surface. However, ground effect is most significant when the airplane (especially the low-wing airplane) is maintaining a constant attitude at low airspeed and low altitude (for example, during landing flare before touchdown, and during takeoff when the airplane lifts off and accelerates to climb speed).

When the wing is under the influence of ground effect, there is a reduction in upwash, downwash, and tip vortices. As a result of the reduced tip vortices, induced drag is reduced. When the wing is at a height equal to one-fourth the span, the reduction in induced drag is about 25 percent, and when the wing is at a height equal to one-tenth the span, the reduction in induced drag is about 50 percent. At high speeds where parasite drag predominates, induced drag is a small part of the total drag. Consequently, the effects of ground effect are of greater concern during takeoff and landing. [Figure 9-14]

Assuming that the airplane descends into ground effect maintaining a constant angle of attack and a constant airspeed, the following effects will take place:

Because of the reduction in drag, a smaller wing angle of attack will be required to produce the same lift coefficient or, if a constant wing angle of attack is maintained, the wing will experience an increase in lift coefficient.

As a result of the reduction in drag, the thrust required at low speeds will be reduced.

The reduction in downwash at the horizontal tail will reduce the effectiveness of the elevator. It may cause a pitch-down tendency, thus requiring greater up elevator to trim the airplane.

In the majority of cases, ground effect will cause an increase in pressure at the static source and produce a lower indication of airspeed and altitude.

During the landing flare when the airplane is brought into ground effect at a constant angle of attack, the airplane will experience an increase in lift coefficient.

**Brake Specific Fuel Consumption**—The number of pounds of fuel burned per hour to produce one horsepower in a reciprocating engine.

**Brake Horsepower**—The power delivered at the propeller shaft (main drive or main output) of an aircraft engine.

**Ground Effect**—A condition due to the interference of the surface with the airflow around the wing and which can be detected up to an altitude of one wing span above the surface.

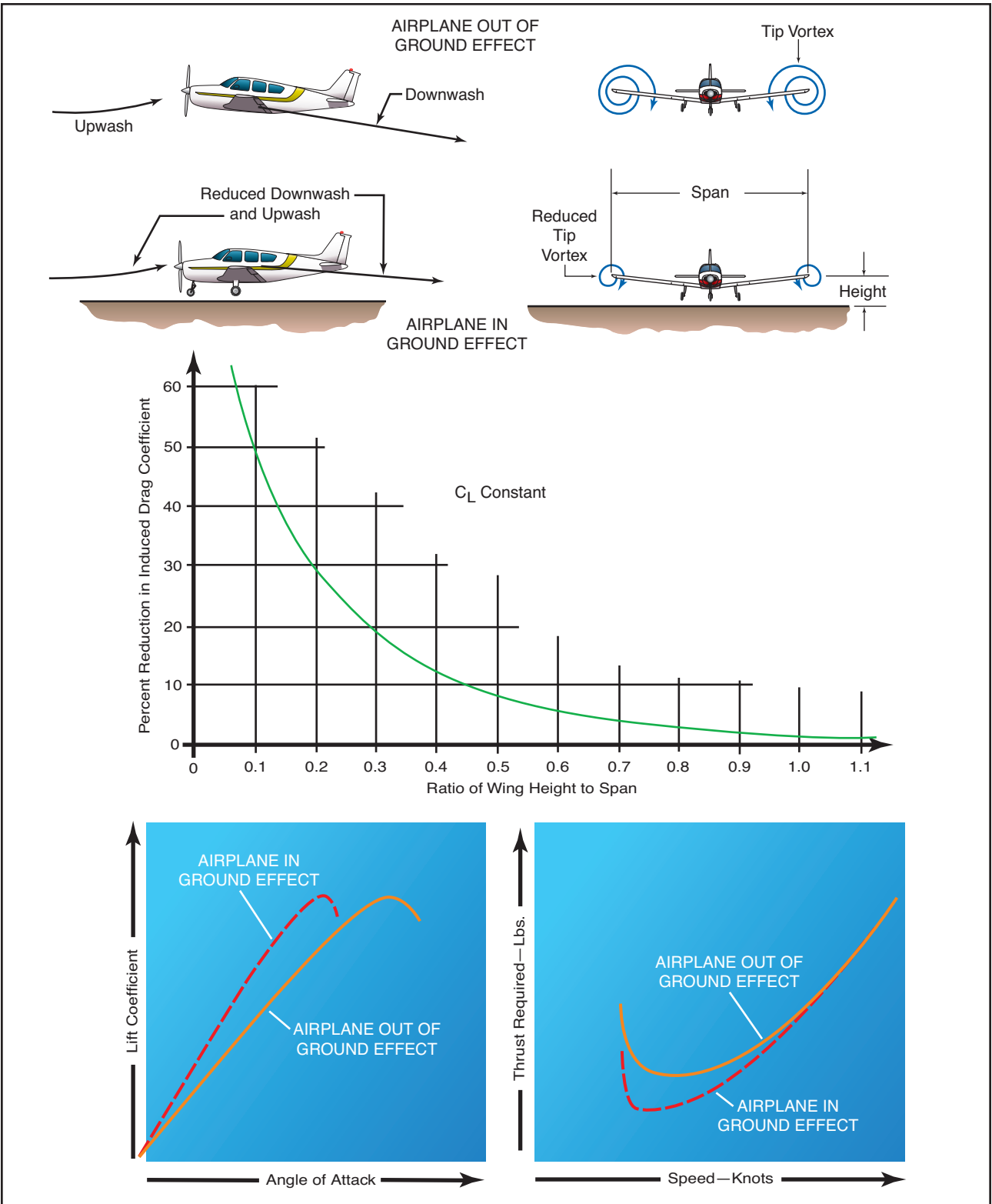
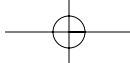
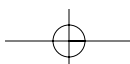


Figure 9-14. Ground effect.

Thus, a “floating” sensation may be experienced. Because of the reduced drag in ground effect, any excess speed at the point of landing flare may result in a considerable “float” distance. If a power approach is being made, the power setting should be reduced as the airplane descends into ground effect to avoid overshooting the desired touchdown point.

During takeoff, the airplane leaving ground effect encounters the reverse of entering ground effect. For example, an airplane leaving ground effect will:

require an increase in angle of attack to maintain the same lift coefficient,



experience an increase in induced drag and thrust required,

experience a pitch-up tendency requiring less elevator travel to trim the airplane because of the increase in downwash at the horizontal tail, and

usually experience a reduction in static source pressure and an increase in indicated airspeed.

Due to the reduced drag in ground effect, the airplane may seem able to take off below the recommended airspeed. However, as the airplane rises out of ground effect with an insufficient airspeed, initial climb performance may prove to be marginal because of the increased drag. Under extreme conditions such as high-density altitude, high temperature, and maximum gross weight, the airplane may be able to become airborne at an insufficient airspeed, but unable to fly out of ground effect. Consequently, the airplane may not be able to clear an obstruction, or may settle back on the runway. Under marginal conditions, it is important the airplane takes off at the recommended speed that will provide adequate initial climb performance. If the runway is long enough, or no obstacles exist, ground effect can be used to an advantage by using the reduced drag to improve initial acceleration. Ground effect is important to normal flight operations in the performance of soft and rough field takeoffs and landings. The procedure for takeoff from these surfaces is to transfer as much weight as possible to the wings during the ground run, and to lift off with the aid of ground effect before true flying speed is attained. It is then necessary to reduce the angle of attack gradually until normal airspeed is attained before attempting to climb away from the ground effect.

### REGION OF REVERSED COMMAND

The aerodynamic properties of the airplane generally determine the power requirements at various conditions of flight, while the powerplant capabilities generally determine the power available at various conditions of flight. When the airplane is in steady, level flight, the condition of equilibrium must prevail. An unaccelerated condition of flight is achieved when lift equals weight, and the powerplant is set for a thrust equal to the airplane drag. The power required to achieve equilibrium in constant-altitude flight at various airspeeds is depicted on a power required curve. The power required curve illustrates the fact that at low airspeeds near the stall or minimum controllable airspeed, the power setting required for steady, level flight is quite high.

Flight in the region of normal command means that while holding a constant altitude, a higher airspeed requires a higher power setting and a lower airspeed requires a lower power setting. The majority of all air-

plane flying (climb, cruise, and maneuvers) is conducted in the region of normal command.

Flight in the **region of reversed command** means that a higher airspeed requires a lower power setting and a lower airspeed requires a higher power setting to hold altitude. It does not imply that a decrease in power will produce lower airspeed. The region of reversed command is encountered in the low speed phases of flight. Flight speeds below the speed for maximum endurance (lowest point on the power curve) require higher power settings with a decrease in airspeed. Since the need to increase the required power setting with decreased speed is contrary to the normal command of flight, the regime of flight speeds between the speed for minimum required power setting and the stall speed (or minimum control speed) is termed the region of reversed command. In the region of reversed command, a decrease in airspeed must be accompanied by an increased power setting in order to maintain steady flight.

Figure 9-15 shows the “maximum power available” as a curved line. Lower power settings, such as cruise power, would also appear in a similar curve. The lowest point on the power required curve represents the speed at which the lowest brake horsepower will sustain level flight. This is termed the best endurance airspeed.

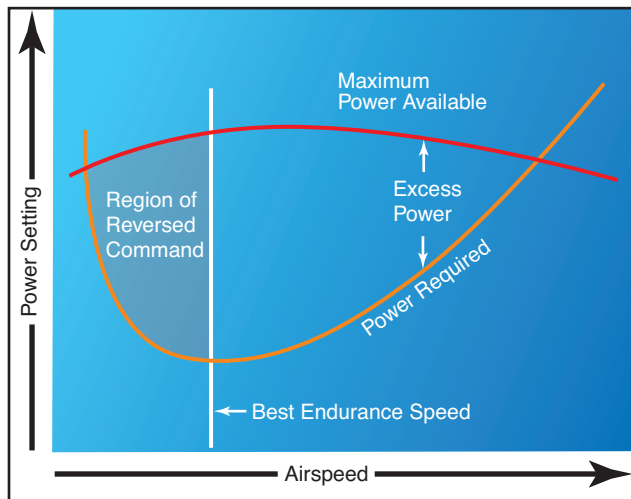


Figure 9-15. Power required curve.

An airplane performing a low airspeed, high pitch attitude power approach for a short-field landing is an example of operating in the region of reversed command. If an unacceptably high sink rate should develop, it may be possible for the pilot to reduce or stop the descent by applying power. But without further use of power, the airplane would probably stall or be incapable of flaring for the landing. Merely

**Region of Reversed Command**—Means in flight a higher airspeed requires a lower power setting and a lower airspeed requires a higher power setting to maintain altitude.

lowering the nose of the airplane to regain flying speed in this situation, without the use of power, would result in a rapid sink rate and corresponding loss of altitude.

If during a soft-field takeoff and climb, for example, the pilot attempts to climb out of ground effect without first attaining normal climb pitch attitude and airspeed, the airplane may inadvertently enter the region of reversed command at a dangerously low altitude. Even with full power, the airplane may be incapable of climbing or even maintaining altitude. The pilot's only recourse in this situation is to lower the pitch attitude in order to increase airspeed, which will inevitably result in a loss of altitude.

Airplane pilots must give particular attention to precise control of airspeed when operating in the low flight speeds of the region of reversed command.

### RUNWAY SURFACE AND GRADIENT

Runway conditions affect takeoff and landing performance. Typically, performance chart information assumes paved, level, smooth, and dry runway surfaces. Since no two runways are alike, the runway surface differs from one runway to another, as does the runway gradient or slope. [Figure 9-16]

Runway surfaces vary widely from one airport to another. The runway surface encountered may be concrete, asphalt, gravel, dirt, or grass. The runway surface for a specific airport is noted in the *Airport/Facility Directory*. Any surface that is not hard and smooth will increase the ground roll during takeoff. This is due to the inability of the tires to smoothly roll along the runway. Tires can sink into soft, grassy, or muddy runways. Potholes or other ruts in the pavement can be the cause of poor tire movement along the runway.

Obstructions such as mud, snow, or standing water reduce the airplane's acceleration down the runway. Although muddy and wet surface conditions can reduce friction between the runway and the tires, they can also act as obstructions and reduce the landing distance. [Figure 9-17]

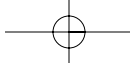


Figure 9-17. Airplane performance depends greatly on the runway surface.

Braking effectiveness is another consideration when dealing with various runway types. The condition of the surface affects the braking ability of the airplane.

TAKEOFF DISTANCE MAXIMUM WEIGHT 3800 LBS																								
<b>SHORT FIELD</b>																								
<p><b>CONDITIONS:</b>                      Flaps 10°                      2850 RPM, Full Throttle and Mixture Set at Placard Fuel Flow Prior to Brake Release                      Cowl Flaps Open                      Paved, Level, Dry Runway                      Zero Wind</p>																								
<p><b>MIXTURE SETTING</b></p> <table border="1"> <thead> <tr> <th>PRESS ALT</th> <th>PPH</th> </tr> </thead> <tbody> <tr> <td>S.L.</td> <td>144</td> </tr> <tr> <td>2000</td> <td>138</td> </tr> <tr> <td>4000</td> <td>132</td> </tr> <tr> <td>6000</td> <td>126</td> </tr> <tr> <td>8000</td> <td>120</td> </tr> </tbody> </table>													PRESS ALT	PPH	S.L.	144	2000	138	4000	132	6000	126	8000	120
PRESS ALT	PPH																							
S.L.	144																							
2000	138																							
4000	132																							
6000	126																							
8000	120																							
<p><b>NOTES:</b></p> <ol style="list-style-type: none"> <li>Short field technique as specified in Section 4.</li> <li>Landing gear extended until takeoff obstacle is cleared.</li> <li>Where distance value has been deleted, climb performance after lift-off is less than 150 fpm. Rate of climb is based on landing gear extended and flaps 10° at takeoff speed.</li> <li>Decrease distances 10% for each 10 knots headwind. For operation with tailwinds up to 10 knots, increase distances by 10% for each 2.5 knots.</li> <li>For operation on a dry, grass runway, increase distances by 15% of the "ground roll" figure.</li> </ol>																								
WEIGHT LBS	TAKEOFF SPEED KIAS		PRESS ALT FT	0°C		10°C		20°C		30°C		40°C												
	LIFT	AT		GRND ROLL 150 FT OPS	TOTAL TO CLEAR	GRND ROLL 150 FT OPS	TOTAL TO CLEAR	GRND ROLL 150 FT OPS	TOTAL TO CLEAR	GRND ROLL 150 FT OPS	TOTAL TO CLEAR													

Figure 9-16. Charts assume paved, level, dry runway conditions.



The amount of power that is applied to the brakes without skidding the tires is referred to as braking effectiveness. Ensure that runways are adequate in length for takeoff acceleration and landing deceleration when less than ideal surface conditions are being reported.

The gradient or slope of the runway is the amount of change in runway height over the length of the runway. The gradient is expressed as a percentage such as a 3 percent gradient. This means that for every 100 feet of runway length, the runway height changes by 3 feet. A positive gradient indicates that the runway height increases, and a negative gradient indicates that the runway decreases in height. An upsloping runway impedes acceleration and results in a longer ground run during takeoff. However, landing on an upsloping runway typically reduces the landing roll. A downsloping runway aids in acceleration on takeoff resulting in shorter takeoff distances. The opposite is true when landing, as landing on a downsloping runway increases landing distances. Runway slope information is contained in the *Airport/Facility Directory*. [Figure 9-18]

### WATER ON THE RUNWAY AND DYNAMIC HYDROPLANING

Water on the runways reduces the friction between the tires and the ground, and can reduce braking effectiveness. The ability to brake can be completely lost when the tires are hydroplaning because a layer of water separates the tires from the runway surface. This is also true of braking effectiveness when runways are covered in ice.

When the runway is wet, the pilot may be confronted with dynamic hydroplaning. **Dynamic hydroplaning** is a condition in which the airplane tires ride on a thin

sheet of water rather than on the runway's surface. Because hydroplaning wheels are not touching the runway, braking and directional control are almost nil.

To help minimize dynamic hydroplaning, some runways are grooved to help drain off water; but most runways are not.

Tire pressure is a factor in dynamic hydroplaning. By the simple formula in figure 9-19, the pilot can calculate the minimum speed, in knots, at which hydroplaning will begin. In plain language, the minimum hydroplaning speed is determined by multiplying the square root of the main gear tire pressure in pounds per square inch (p.s.i.), by nine. For example, if the main gear tire pressure is at 36 pounds per square inch, the airplane would begin hydroplaning at 54 knots.

**MINIMUM DYNAMIC  
HYDROPLANING SPEED  
(ROUNDED OFF) =**

---

**$9 \times \sqrt{\text{TIRE PRESSURE (IN PSI)}}$**

---

$\sqrt{36} = 6$   
 **$9 \times 6 = 54 \text{ KNOTS}$**

Figure 9-19. Dynamic hydroplane formula and example for a tire pressure of 36 pounds.

**Dynamic Hydroplaning**—A condition in which the airplane tires ride on a thin sheet of water rather than the runway surface.

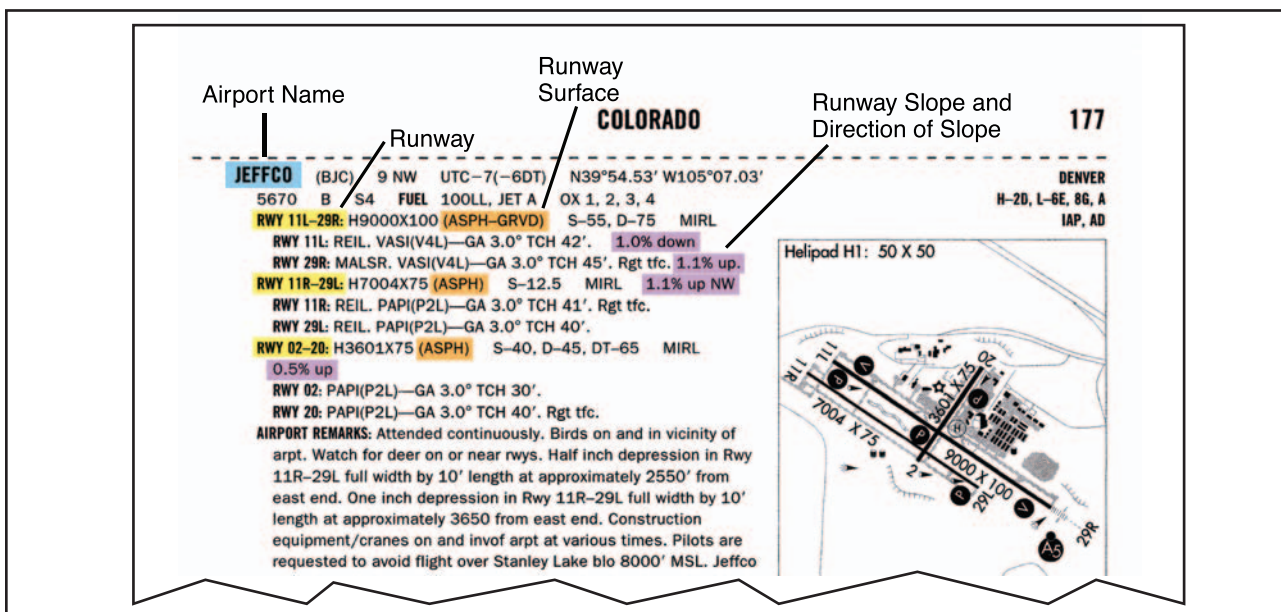
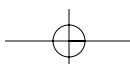


Figure 9-18. A/FDs provide information regarding runway slope.



Landing at higher than recommended touchdown speeds will expose the airplane to a greater potential for hydroplaning. And once hydroplaning starts, it can continue well below the minimum, initial hydroplaning speed.

On wet runways, directional control can be maximized by landing into the wind. Abrupt control inputs should be avoided. When the runway is wet, anticipate braking problems well before landing and be prepared for hydroplaning. Opt for a suitable runway most aligned with the wind. Mechanical braking may be ineffective, so aerodynamic braking should be used to its fullest advantage.

## TAKEOFF AND LANDING PERFORMANCE

The majority of pilot-caused airplane accidents occur during the takeoff and landing phase of flight. Because of this fact, the pilot must be familiar with all the variables that influence the takeoff and landing performance of an airplane and must strive for exacting, professional procedures of operation during these phases of flight.

Takeoff and landing performance is a condition of accelerated and decelerated motion. For instance, during takeoff, the airplane starts at zero speed and accelerates to the takeoff speed to become airborne. During landing, the airplane touches down at the landing speed and decelerates to zero speed.

The important factors of takeoff or landing performance are as follows:

- The takeoff or landing speed which will generally be a function of the stall speed or minimum flying speed.
- The rate of acceleration and deceleration during the takeoff or landing roll. The acceleration and deceleration experienced by any object varies directly with the imbalance of force and inversely with the mass of the object.
- The takeoff or landing roll distance is a function of both acceleration/deceleration and speed.

### TAKEOFF PERFORMANCE

The minimum takeoff distance is of primary interest in the operation of any airplane because it defines the runway requirements. The minimum takeoff distance is obtained by taking off at some minimum safe speed that allows sufficient margin above stall and provides satisfactory control and initial rate of climb. Generally, the lift-off speed is some fixed percentage of the stall speed or minimum control speed for the airplane in the takeoff configuration. As such, the lift-off will be accomplished at some particular value of lift coeffi-

cient and angle of attack. Depending on the airplane characteristics, the lift-off speed will be anywhere from 1.05 to 1.25 times the stall speed or minimum control speed.

To obtain minimum takeoff distance at the specific lift-off speed, the forces that act on the airplane must provide the maximum acceleration during the takeoff roll. The various forces acting on the airplane may or may not be under the control of the pilot, and various procedures may be necessary in certain airplanes to maintain takeoff acceleration at the highest value.

The powerplant thrust is the principal force to provide the acceleration and, for minimum takeoff distance, the output thrust should be at a maximum. Lift and drag are produced as soon as the airplane has speed, and the values of lift and drag depend on the angle of attack and dynamic pressure.

In addition to the important factors of proper procedures, many other variables affect the takeoff performance of an airplane. Any item that alters the takeoff speed or acceleration rate during the takeoff roll will affect the takeoff distance.

For example, the effect of gross weight on takeoff distance is significant and proper consideration of this item must be made in predicting the airplane's takeoff distance. Increased gross weight can be considered to produce a threefold effect on takeoff performance:

1. higher lift-off speed,
  2. greater mass to accelerate, and
  3. increased retarding force (drag and ground friction).
- If the gross weight increases, a greater speed is necessary to produce the greater lift necessary to get the airplane airborne at the takeoff lift coefficient. As an example of the effect of a change in gross weight, a 21 percent increase in takeoff weight will require a 10 percent increase in lift-off speed to support the greater weight.

A change in gross weight will change the net accelerating force and change the mass that is being accelerated. If the airplane has a relatively high thrust-to-weight ratio, the change in the net accelerating force is slight and the principal effect on acceleration is due to the change in mass.

The takeoff distance will vary at least as the square of the gross weight. For example, a 10 percent increase in takeoff gross weight would cause:

- a 5 percent increase in takeoff velocity,
- at least a 9 percent decrease in rate of acceleration, and
- at least a 21 percent increase in takeoff distance.

For the airplane with a high thrust-to-weight ratio, the increase in takeoff distance might be approximately 21 to 22 percent, but for the airplane with a relatively low thrust-to-weight ratio, the increase in takeoff distance would be approximately 25 to 30 percent. Such a powerful effect requires proper consideration of gross weight in predicting takeoff distance.

The effect of wind on takeoff distance is large, and proper consideration also must be provided when predicting takeoff distance. The effect of a headwind is to allow the airplane to reach the lift-off speed at a lower groundspeed while the effect of a tailwind is to require the airplane to achieve a greater groundspeed to attain the lift-off speed.

A headwind that is 10 percent of the takeoff airspeed will reduce the takeoff distance approximately 19 percent. However, a tailwind that is 10 percent of the takeoff airspeed will increase the takeoff distance approximately 21 percent. In the case where the headwind speed is 50 percent of the takeoff speed, the takeoff distance would be approximately 25 percent of the zero wind takeoff distance (75 percent reduction).

The effect of wind on landing distance is identical to the effect on takeoff distance. Figure 9-20 illustrates the general effect of wind by the percent change in takeoff or landing distance as a function of the ratio of wind velocity to takeoff or landing speed.

The effect of proper takeoff speed is especially important when runway lengths and takeoff distances are critical. The takeoff speeds specified in the AFM/POH are generally the minimum

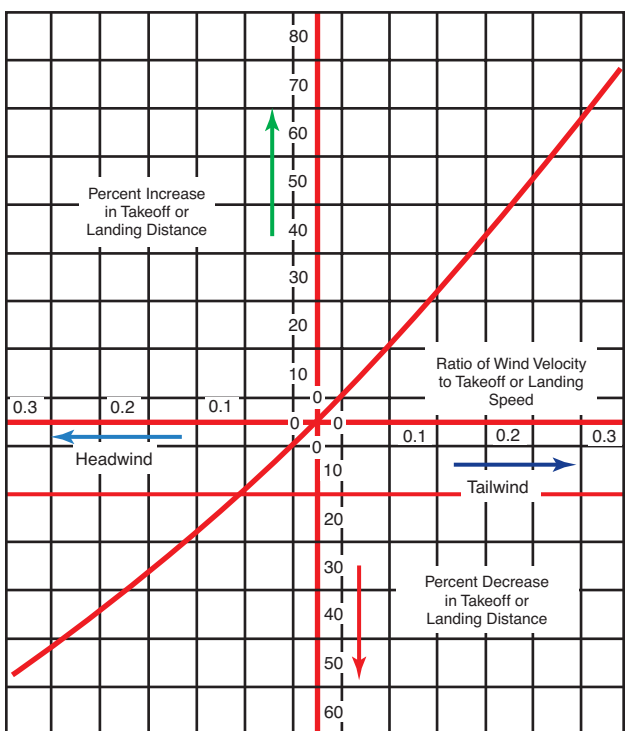


Figure 9-20. Effect of wind on takeoff and landing.

safe speeds at which the airplane can become airborne. Any attempt to take off below the recommended speed could mean that the airplane may stall, be difficult to control, or have a very low initial rate of climb. In some cases, an excessive angle of attack may not allow the airplane to climb out of ground effect. On the other hand, an excessive airspeed at takeoff may improve the initial rate of climb and “feel” of the airplane, but will produce an undesirable increase in takeoff distance. Assuming that the acceleration is essentially unaffected, the takeoff distance varies as the square of the takeoff velocity.

Thus, 10 percent excess airspeed would increase the takeoff distance 21 percent. In most critical takeoff conditions, such an increase in takeoff distance would be prohibitive, and the pilot must adhere to the recommended takeoff speeds.

The effect of pressure altitude and ambient temperature is to define primarily the density altitude and its effect on takeoff performance. While subsequent corrections are appropriate for the effect of temperature on certain items of powerplant performance, density altitude defines specific effects on takeoff performance. An increase in density altitude can produce a twofold effect on takeoff performance:

1. greater takeoff speed and
2. decreased thrust and reduced net accelerating force.

If an airplane of given weight and configuration is operated at greater heights above standard sea level, the airplane will still require the same dynamic pressure to become airborne at the takeoff lift coefficient. Thus, the airplane at altitude will take off at the same indicated airspeed as at sea level, but because of the reduced air density, the true airspeed will be greater.

The effect of density altitude on powerplant thrust depends much on the type of powerplant. An increase in altitude above standard sea level will bring an immediate decrease in power output for the unsupercharged reciprocating engine. However, an increase in altitude above standard sea level will not cause a decrease in power output for the supercharged reciprocating engine until the altitude exceeds the critical operating altitude. For those powerplants that experience a decay in thrust with an increase in altitude, the effect on the net accelerating force and acceleration rate can be approximated by assuming a direct variation with density. Actually, this assumed variation would closely approximate the effect on airplanes with high thrust-to-weight ratios.

Proper accounting of pressure altitude (field elevation is a poor substitute) and temperature is mandatory for accurate prediction of takeoff roll distance.



The most critical conditions of takeoff performance are the result of some combination of high gross weight, altitude, temperature, and unfavorable wind. In all cases, the pilot must make an accurate prediction of takeoff distance from the performance data of the AFM/POH, regardless of the runway available, and strive for a polished, professional takeoff procedure.

In the prediction of takeoff distance from the AFM/POH data, the following primary considerations must be given:

- Pressure altitude and temperature—to define the effect of density altitude on distance.
- Gross weight—a large effect on distance.
- Wind—a large effect due to the wind or wind component along the runway.
- Runway slope and condition—the effect of an incline and the retarding effect of factors such as snow or ice.

## LANDING PERFORMANCE

In many cases, the landing distance of an airplane will define the runway requirements for flying operations. The minimum landing distance is obtained by landing at some minimum safe speed, which allows sufficient margin above stall and provides satisfactory control and capability for a go-around. Generally, the landing speed is some fixed percentage of the stall speed or minimum control speed for the airplane in the landing configuration. As such, the landing will be accomplished at some particular value of lift coefficient and angle of attack. The exact values will depend on the airplane characteristics but, once defined, the values are independent of weight, altitude, and wind.

To obtain minimum landing distance at the specified landing speed, the forces that act on the airplane must provide maximum deceleration during the landing roll. The forces acting on the airplane during the landing roll may require various procedures to maintain landing deceleration at the peak value.

A distinction should be made between the procedures for minimum landing distance and an ordinary landing roll with considerable excess runway available. Minimum landing distance will be obtained by creating a continuous peak deceleration of the airplane; that is, extensive use of the brakes for maximum deceleration. On the other hand, an ordinary landing roll with considerable excess runway may allow extensive use of aerodynamic drag to minimize wear and tear on the tires and brakes. If aerodynamic drag is sufficient to cause deceleration of the airplane, it can be used in deference to the brakes in the early stages of the landing

roll; i.e., brakes and tires suffer from continuous hard use, but airplane aerodynamic drag is free and does not wear out with use. The use of aerodynamic drag is applicable only for deceleration to 60 or 70 percent of the touchdown speed. At speeds less than 60 to 70 percent of the touchdown speed, aerodynamic drag is so slight as to be of little use, and braking must be utilized to produce continued deceleration of the airplane. Since the objective during the landing roll is to decelerate, the powerplant thrust should be the smallest possible positive value (or largest possible negative value in the case of thrust reversers).

In addition to the important factors of proper procedures, many other variables affect the landing performance. Any item that alters the landing speed or deceleration rate during the landing roll will affect the landing distance.

The effect of gross weight on landing distance is one of the principal items determining the landing distance. One effect of an increased gross weight is that a greater speed will be required to support the airplane at the landing angle of attack and lift coefficient.

For an example of the effect of a change in gross weight, a 21 percent increase in landing weight will require a 10 percent increase in landing speed to support the greater weight.

When minimum landing distances are considered, braking friction forces predominate during the landing roll and, for the majority of airplane configurations, braking friction is the main source of deceleration.

The minimum landing distance will vary in direct proportion to the gross weight. For example, a 10 percent increase in gross weight at landing would cause a:

- 5 percent increase in landing velocity and
- 10 percent increase in landing distance.

A contingency of this is the relationship between weight and braking friction force.

The effect of wind on landing distance is large and deserves proper consideration when predicting landing distance. Since the airplane will land at a particular airspeed independent of the wind, the principal effect of wind on landing distance is due to the change in the groundspeed at which the airplane touches down. The effect of wind on deceleration during the landing is identical to the effect on acceleration during the take-off.

A headwind that is 10 percent of the landing airspeed will reduce the landing distance approximately 19 percent, but

a tailwind that is 10 percent of the landing speed will increase the landing distance approximately 21 percent. Figure 9-20 illustrates this general effect.

The effect of pressure altitude and ambient temperature is to define density altitude and its effect on landing performance. An increase in density altitude will increase the landing speed but will not alter the net retarding force. Thus, the airplane at altitude will land at the same indicated airspeed as at sea level but, because of the reduced density, the true airspeed (TAS) will be greater. Since the airplane lands at altitude with the same weight and dynamic pressure, the drag and braking friction throughout the landing roll have the same values as at sea level. As long as the condition is within the capability of the brakes, the net retarding force is unchanged, and the deceleration is the same as with the landing at sea level. Since an increase in altitude does not alter deceleration, the effect of density altitude on landing distance would actually be due to the greater TAS.

The minimum landing distance at 5,000 feet would be 16 percent greater than the minimum landing distance at sea level. The approximate increase in landing distance with altitude is approximately 3 1/2 percent for each 1,000 feet of altitude. Proper accounting of density altitude is necessary to accurately predict landing distance.

The effect of proper landing speed is important when runway lengths and landing distances are critical. The landing speeds specified in the AFM/POH are generally the minimum safe speeds at which the airplane can be landed. Any attempt to land at below the specified speed may mean that the airplane may stall, be difficult to control, or develop high rates of descent. On the other hand, an excessive speed at landing may improve the controllability slightly (especially in crosswinds), but will cause an undesirable increase in landing distance.

A 10 percent excess landing speed would cause at least a 21 percent increase in landing distance. The excess speed places a greater working load on the brakes because of the additional kinetic energy to be dissipated. Also, the additional speed causes increased drag and lift in the normal ground attitude, and the increased lift will reduce the normal force on the braking surfaces. The deceleration during this range of speed immediately after touchdown may suffer, and it will be more likely that a tire can be blown out from braking at this point.

The most critical conditions of landing performance are the result of some combination of high gross weight, high density altitude, and unfavorable wind. These conditions produce the greatest landing distance

and provide critical levels of energy dissipation required of the brakes. In all cases, it is necessary to make an accurate prediction of minimum landing distance to compare with the available runway. A polished, professional landing procedure is necessary because the landing phase of flight accounts for more pilot-caused airplane accidents than any other single phase of flight.

In the prediction of minimum landing distance from the AFM/POH data, the following considerations must be given:

- Pressure altitude and temperature—to define the effect of density altitude.
- Gross weight—which defines the CAS for landing.
- Wind—a large effect due to wind or wind component along the runway.
- Runway slope and condition—relatively small correction for ordinary values of runway slope, but a significant effect of snow, ice, or soft ground.

## PERFORMANCE SPEEDS

True Airspeed (TAS) – the speed of the airplane in relation to the air mass in which it is flying.

Indicated Airspeed (IAS) – the speed of the airplane as observed on the airspeed indicator. It is the airspeed without correction for indicator, position (or installation), or compressibility errors.

Calibrated Airspeed (CAS) – the airspeed indicator reading corrected for position (or installation), and instrument errors. (CAS is equal to TAS at sea level in standard atmosphere.) The color-coding for various design speeds marked on airspeed indicators may be IAS or CAS.

Equivalent Airspeed (EAS) – the airspeed indicator reading corrected for position (or installation), or instrument error, and for adiabatic compressible flow for the particular altitude. (EAS is equal to CAS at sea level in standard atmosphere.)

$V_{S0}$  – the calibrated power-off stalling speed or the minimum steady flight speed at which the airplane is controllable in the landing configuration.

$V_{S1}$  – the calibrated power-off stalling speed or the minimum steady flight speed at which the airplane is controllable in a specified configuration.

$V_Y$  – the calibrated airspeed at which the airplane will obtain the maximum increase in altitude per unit of

time. This best rate-of-climb speed normally decreases slightly with altitude.

$V_X$  – the calibrated airspeed at which the airplane will obtain the highest altitude in a given horizontal distance. This best angle-of-climb speed normally increases slightly with altitude.

$V_{LE}$  – the maximum calibrated airspeed at which the airplane can be safely flown with the landing gear extended. This is a problem involving stability and controllability.

$V_{LO}$  – the maximum calibrated airspeed at which the landing gear can be safely extended or retracted. This is a problem involving the air loads imposed on the operating mechanism during extension or retraction of the gear.

$V_{FE}$  – the highest calibrated airspeed permissible with the wing flaps in a prescribed extended position. This is because of the air loads imposed on the structure of the flaps.

$V_A$  – the calibrated design maneuvering airspeed. This is the maximum speed at which the limit load can be imposed (either by gusts or full deflection of the control surfaces) without causing structural damage.

$V_{NO}$  – the maximum calibrated airspeed for normal operation or the maximum structural cruising speed. This is the speed at which exceeding the limit load factor may cause permanent deformation of the airplane structure.

$V_{NE}$  – the calibrated airspeed which should NEVER be exceeded. If flight is attempted above this speed, structural damage or structural failure may result.

## PERFORMANCE CHARTS

Performance charts allow a pilot to predict the takeoff, climb, cruise, and landing performance of the airplane. These charts, provided by the manufacturer, are included in the AFM/POH. The information the manufacturer provides on these charts has been gathered from test flights conducted in a new airplane, under normal operating conditions while using average piloting skills, and with the airplane and engine in good working order. Engineers record the flight data and create performance charts based on the behavior of the airplane during the test flights. By using these performance charts, a pilot can determine the runway length needed to take off and land, the amount of fuel that will be used during flight, and the length of time it will take to arrive at the destination. It is important to remember that the data from the charts will not be accurate if the airplane is not in good working order or when operating under adverse conditions. So take into consideration that it is necessary to compensate the performance numbers if the airplane is not in good working order or piloting skills are below average. Each airplane performs differently and therefore, has different performance numbers. Compute the performance of the airplane prior to every flight, as every flight is different.

Every chart is based on certain conditions and contains notes on how to adapt the information for flight conditions. It is important to read every chart and understand how to use it. Read the accompanying instructions provided by the manufacturer. For an explanation on how to use the charts, refer to the example provided by the manufacturer for that specific chart. [Figure 9-21]

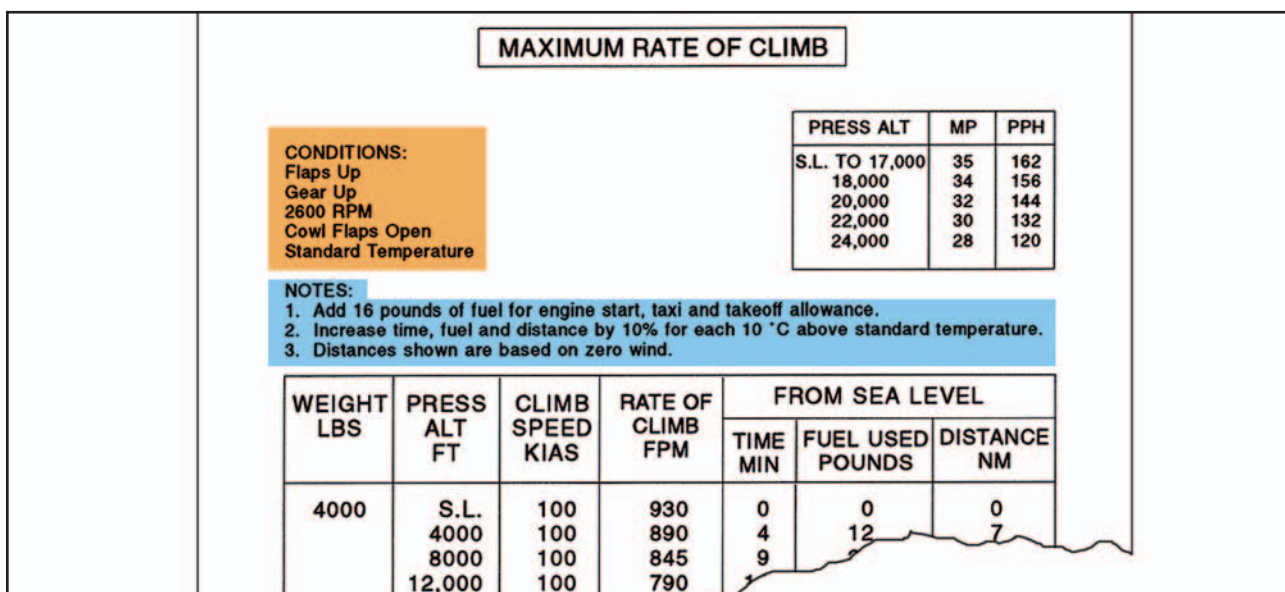
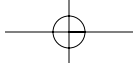


Figure 9-21. Carefully read all conditions and notes for every chart.



The information manufacturers furnish is not standardized. Information may be contained in a table format, and other information may be contained in a graph format. Sometimes combined graphs incorporate two or more graphs into one chart to compensate for multiple conditions of flight. Combined graphs allow the pilot to predict airplane performance for variations in density altitude, weight, and winds all on one chart. Because of the vast amount of information that can be extracted from this type of chart, it is important to be very accurate in reading the chart. A small error in the beginning can lead to a large error at the end.

The remainder of this section covers performance information for airplanes in general and discusses what information the charts contain and how to extract information from the charts by direct reading and interpolation methods. Every chart contains a wealth of information that should be used when flight planning. Examples of the table, graph, and combined graph formats for all aspects of flight will be discussed.

**INTERPOLATION**

Not all of the information on the charts is easily extracted. Some charts require interpolation to find the information for specific flight conditions. Interpolating information means that by taking the known information, a pilot can compute intermediate information. However, pilots sometimes round off values from charts to a more conservative figure.

Using values that reflect slightly more adverse conditions provides a reasonable estimate of performance information and gives a slight margin of safety. The following illustration is an example of interpolating information from a takeoff distance chart. [Figure 9-22]

**DENSITY ALTITUDE CHARTS**

Use a density altitude chart to figure the density altitude at the departing airport. Using figure 9-23, determine the density altitude based on the given information.

**Sample Problem 1**

Airport Elevation.....5,883 feet  
 OAT.....70°F  
 Altimeter.....30.10 in. Hg

First, compute the pressure altitude conversion. Find 30.10 under the altimeter heading. Read across to the second column. It reads “-165.” Therefore, it is necessary to subtract 165 from the airport elevation giving a pressure altitude of 5,718 feet. Next, locate the outside air temperature on the scale along the bottom of the graph. From 70°, draw a line up to the 5,718 feet pressure altitude line, which is about two-thirds of the way up between the 5,000 and 6,000-foot lines. Draw a line straight across to the far left side of the graph and read the approximate density altitude. The approximate density altitude in thousands of feet is 7,700 feet.

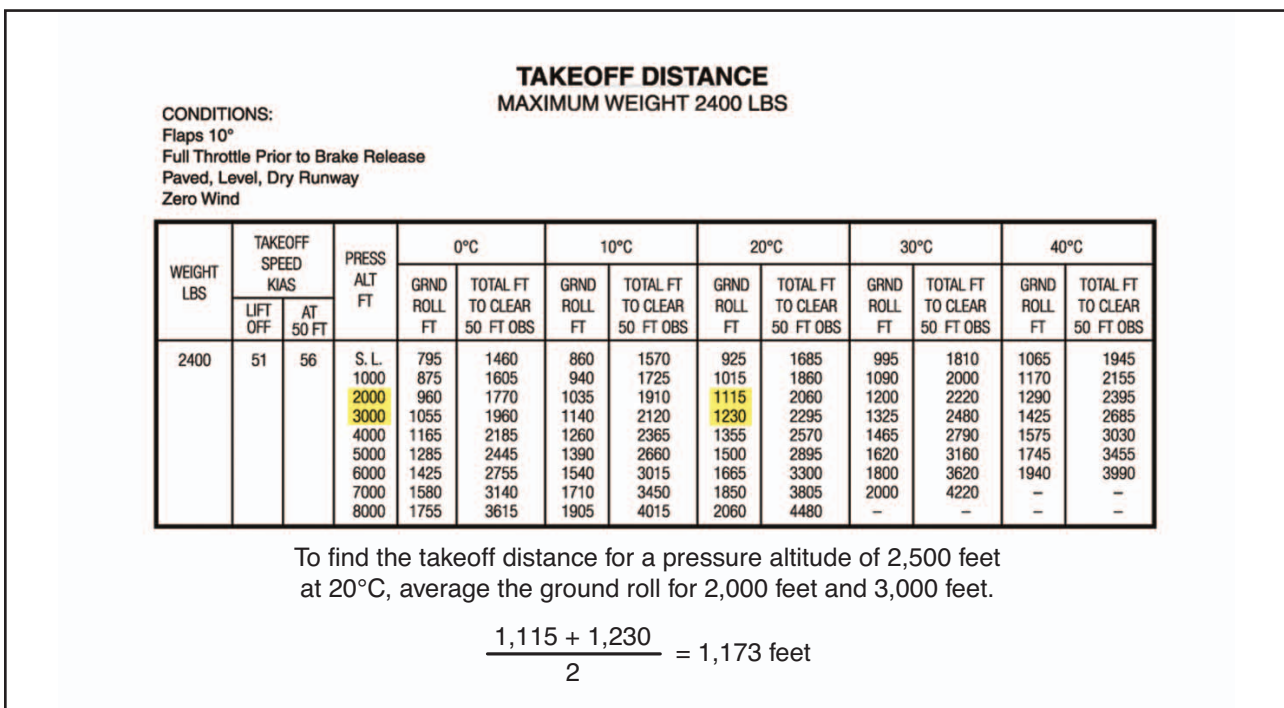
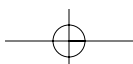


Figure 9-22. Interpolating charts.



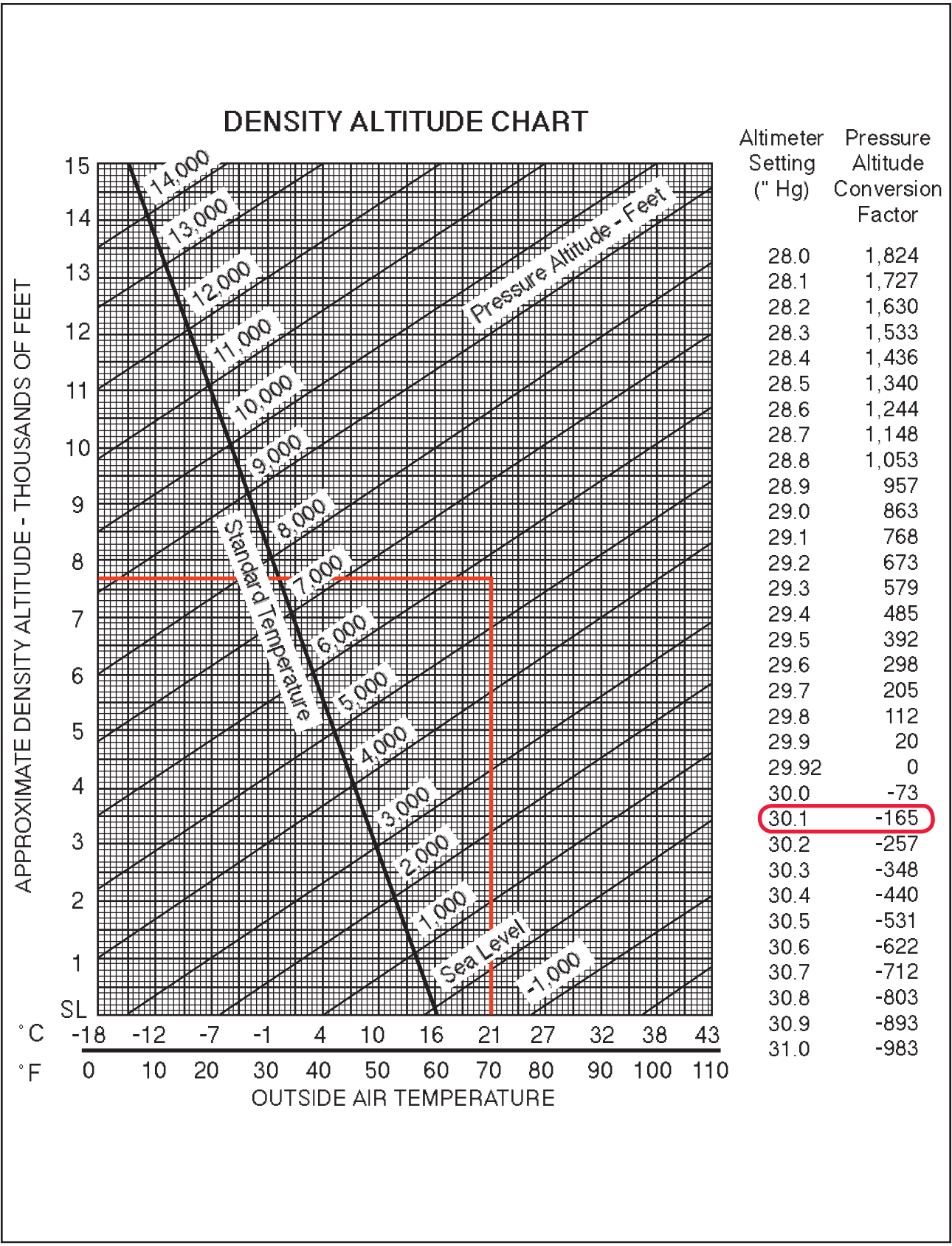
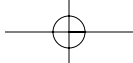
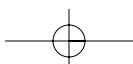


Figure 9-23. Density altitude chart.



### TAKEOFF CHARTS

Takeoff charts are typically provided in several forms. They allow a pilot to compute the takeoff distance of the airplane with no flaps or with a specific flap configuration. A pilot can also compute distances for a no flap takeoff over a 50-foot obstacle scenario as well as with flaps over a 50-foot obstacle. The takeoff distance chart provides for various airplane weights, altitudes, temperatures, winds, and obstacle heights.

#### Sample Problem 2

Pressure Altitude.....2,000 feet  
 OAT.....22°C  
 Takeoff Weight.....2,600 pounds  
 Headwind.....6 knots  
 Obstacle Height.....50-foot obstacle

Refer to figure 9-24. This chart is an example of a combined takeoff distance graph. It takes into consideration pressure altitude, temperature, weight, wind, and obstacles all on one chart. First, find the correct temperature on the bottom left-hand side of the graph. Follow the line from 22°C straight up until it intersects the 2,000-foot altitude line. From that point, draw a line straight across to the first dark reference line. Continue to draw the line from the reference point in a diagonal direction following the surrounding lines until it intersects the corresponding weight line. From the intersection of

2,600 pounds, draw a line straight across until it reaches the second reference line. Once again, follow the lines in a diagonal manner until it reaches the 6-knot headwind mark. Follow straight across to the third reference line and from here, draw a line in two directions. First, draw a line straight across to figure the ground roll distance. Next, follow the diagonal lines again until it reaches the corresponding obstacle height. In this case, it is a 50-foot obstacle. Therefore, draw the diagonal line to the far edge of the chart. This results in a 600-foot ground roll distance and a total distance of 1,200 feet over a 50-foot obstacle. To find the corresponding takeoff speeds at lift-off and over the 50-foot obstacle, refer to the table on the top of the chart. In this case, the lift-off speed at 2,600 pounds would be 63 knots and over the 50-foot obstacle would be 68 knots.

#### Sample Problem 3

Pressure Altitude.....3,000 feet  
 OAT.....30°C  
 Takeoff Weight.....2,400 pounds  
 Headwind.....18 knots

Refer to figure 9-25. This chart is an example of a takeoff distance table for short-field takeoffs. For this table, first find the takeoff weight. Once at 2,400 pounds, begin reading from left to right across the

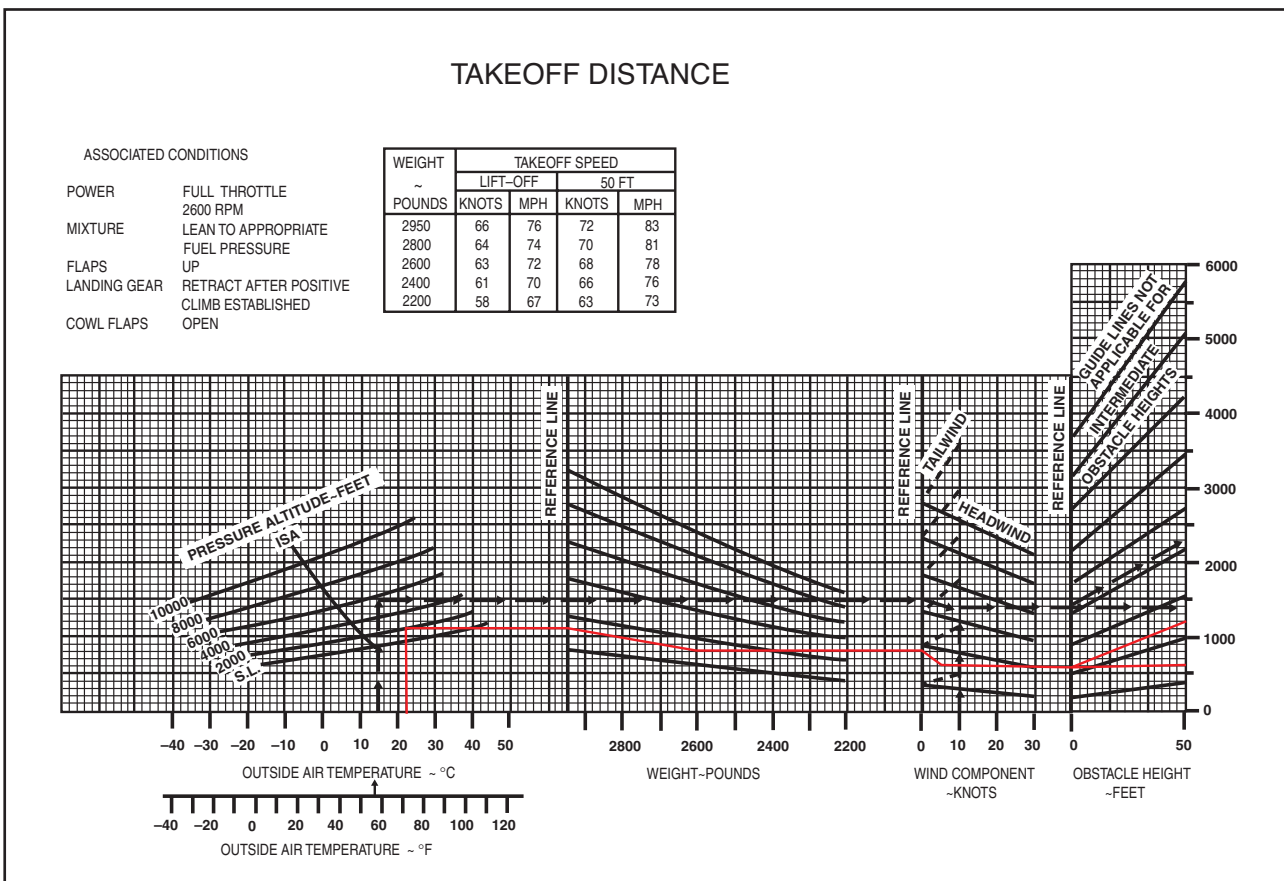


Figure 9-24. Combined takeoff distance graph.

table. The takeoff speed is in the second column and, in the third column under pressure altitude, find the pressure altitude of 3,000 feet. Carefully follow that line to the right until it is under the correct temperature column of 30°C. The ground roll total reads 1,325 feet and the total required to clear a 50-foot obstacle is 2,480 feet. At this point, there are 18 knots of headwind. Reading in the notes section under point number two, it says to decrease the distances by 10 percent for each 9 knots of headwind. With 18 knots of headwind, it is necessary to decrease the distance by 20 percent. Multiply 1,325 feet by 20 percent or by .20 (1325 x .20 = 265), then subtract that amount from the total distance (1325 – 265 = 1060). Repeat this process for the total distance over a 50-foot obstacle. The ground roll distance is 1,060 feet and the total distance over a 50-foot obstacle is 1,984 feet.

### CLIMB AND CRUISE CHARTS

Climb and cruise chart information is based on actual flight tests conducted in an airplane of the same type. This information is extremely useful when planning a cross-country to predict the performance and fuel consumption of the airplane. Manufacturers produce

several different charts for climb and cruise performance. These charts will include everything from fuel, time, and distance to climb, to best power setting during cruise, to cruise range performance.

The first chart to check for climb performance is a fuel, time, and distance-to-climb chart. This chart will give the fuel amount used during the climb, the time it will take to accomplish the climb, and the ground distance that will be covered during the climb. To use this chart, obtain the information for the departing airport and for the cruise altitude. Using figure 9-26, calculate the fuel, time, and distance to climb based on the information provided.

#### Sample Problem 4

Departing Airport Pressure Altitude.....6,000 feet  
 Departing Airport OAT.....25°C  
 Cruise Pressure Altitude.....10,000 feet  
 Cruise OAT.....10°C

First, find the information for the departing airport. Find the OAT for the departing airport along the bottom, left-hand side of the graph. Follow the line from

<b>TAKEOFF DISTANCE MAXIMUM WEIGHT 2400 LB</b>													
<b>SHORT FIELD</b>													
CONDITIONS: Flaps 10° Full Throttle Prior to Brake Release Paved Level Runway Zero Wind													
NOTES: 1. Prior to takeoff from fields above 3000 feet elevation, the mixture should be leaned to give maximum RPM in a full throttle, static runup. 2. Decrease distances 10% for each 9 knots headwind. For operation with tailwind up to 10 knots, increase distances by 10% for each 2 knots. 3. For operation on a dry, grass runway, increase distances by 15% of the "ground roll" figure.													
WEIGHT LB	TAKEOFF SPEED KIAS		PRESS ALT FT	0 °C		10 °C		20 °C		30 °C		40 °C	
	LIFT OFF	AT 50 FT		GRND ROLL FT	TOTAL FT TO CLEAR 50 FT OBS	GRND ROLL FT	TOTAL FT TO CLEAR 50 FT OBS	GRND ROLL FT	TOTAL FT TO CLEAR 50 FT OBS	GRND ROLL FT	TOTAL FT TO CLEAR 50 FT OBS	GRND ROLL FT	TOTAL FT TO CLEAR 50 FT OBS
2400	51	56	S.L.	795	1460	860	1570	925	1685	995	1810	1065	1945
			1000	875	1605	940	1725	1015	1860	1090	2000	1170	2155
			2000	960	1770	1035	1910	1115	2060	1200	2220	1290	2395
			3000	1055	1960	1140	2120	1230	2295	1325	2480	1425	2685
			4000	1165	2185	1260	2365	1355	2570	1465	2790	1575	3030
			5000	1285	2445	1390	2660	1500	2895	1620	3160	1745	3455
			6000	1425	2755	1540	3015	1665	3300	1800	3620	1940	3990
			7000	1580	3140	1710	3450	1850	3805	2000	4220	---	---
			8000	1755	3615	1905	4015	2060	4480	---	---	---	---
2200	49	54	S.L.	650	1195	700	1280	750	1375	805	1470	865	1575
			1000	710	1310	765	1405	825	1510	885	1615	950	1735
			2000	780	1440	840	1545	905	1660	975	1785	1045	1915
			3000	855	1585	925	1705	985	1835	1070	1975	1150	2130
			4000	945	1750	1020	1890	1100	2040	1180	2200	1270	2375
			5000	1040	1945	1125	2105	1210	2275	1305	2465	1405	2665
			6000	1150	2170	1240	2355	1340	2555	1445	2775	1555	3020
			7000	1270	2440	1375	2655	1485	2890	1605	3155	1730	3450
			8000	1410	2760	1525	3015	1650	3305	1785	3630	1925	4005
2000	46	51	S.L.	525	970	565	1035	605	1110	650	1185	695	1265
			1000	570	1060	615	1135	665	1215	710	1295	765	1385
			2000	625	1160	675	1240	725	1330	780	1425	840	1525
			3000	690	1270	740	1365	800	1465	860	1570	920	1685
			4000	755	1400	815	1500	880	1615	945	1735	1015	1865
			5000	830	1545	900	1660	970	1790	1045	1925	1120	2070
			6000	920	1710	990	1845	1070	1990	1150	2145	1235	2315
			7000	1015	1900	1095	2055	1180	2225	1275	2405	1370	2605
			8000	1125	2125	1215	2305	1310	2500	1410	2715	1520	2950

Figure 9-25. Takeoff distance table, short-field.

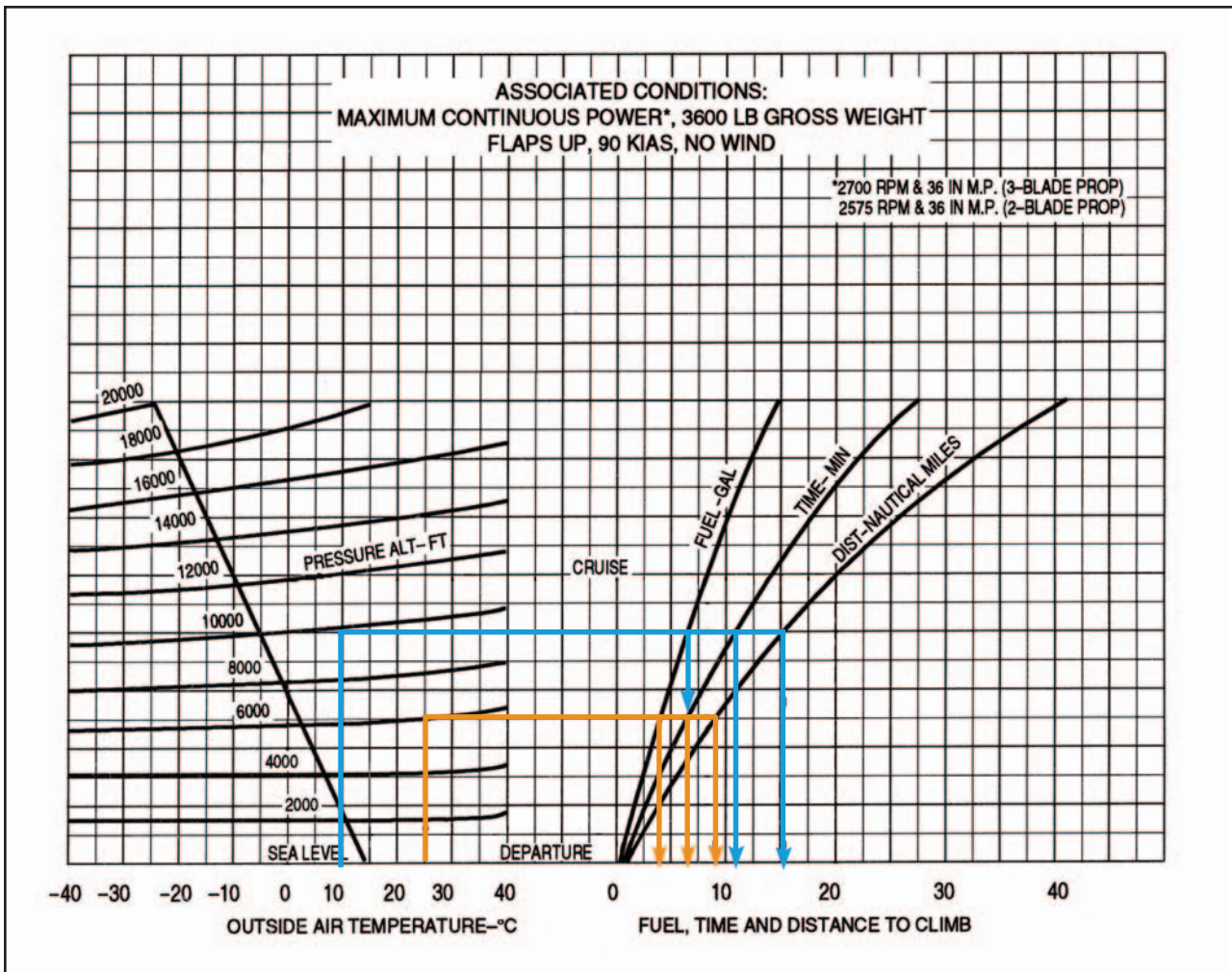


Figure 9-26. Fuel, time, and distance-to-climb chart.

25°C straight up until it intersects the line corresponding to the pressure altitude of 6,000 feet. Continue this line straight across until it intersects all three lines for fuel, time, and distance. Draw a line straight down from the intersection of altitude and fuel, altitude and time, and a third line at altitude and distance. It should read 3.5 gallons of fuel, 6.5 minutes of time, and 9 nautical miles. Next, repeat the steps to find the information for the cruise altitude. It should read 6.5 gallons of fuel, 11.5 minutes of time, and 15 nautical miles. Take each set of numbers for fuel, time, and distance and subtract them from one another (6.5 - 3.5 = 3 gallons of fuel). It will take 3 gallons of fuel and 5 minutes of time to climb to 10,000 feet. During that climb, the distance covered is 6 nautical miles. Remember, according to the notes at the top of the chart, these numbers do not take into account wind, and it is assumed maximum continuous power is being used.

The next example is a fuel, time, and distance-to-climb table. For this table, use the same basic criteria as for the previous chart. However, it is necessary to figure

the information in a different manner. Refer to figure 9-27 to work the following sample problem.

**Sample Problem 5**

Departing Airport Pressure Altitude.....	Sea Level
Departing Airport OAT.....	22°C
Cruise Pressure Altitude.....	8,000 feet
Takeoff Weight.....	3,400 pounds

To begin, find the given weight of 3,400 in the first column of the chart. Move across to the pressure altitude column to find the sea level altitude numbers. At sea level, the numbers read zero. Next, read the line that corresponds with the cruising altitude of 8,000 feet. Normally, a pilot would subtract these two sets of number from one another, but given the fact that the numbers read zero at sea level, it is known that the time to climb from sea level to 8,000 feet is 10 minutes. It is also known that 21 pounds of fuel will be used and 20 nautical miles will be covered during the climb. However, the temperature is 22°C, which is 7° above the standard temperature of 15°C. The notes section of this chart indicate that our findings must



**NORMAL CLIMB – 110 KIAS**

**CONDITIONS:**  
 Flaps Up  
 Gear Up  
 2500 RPM  
 30 Inches Hg  
 120 PPH Fuel Flow  
 Cowl Flaps Open  
 Standard Temperature

- NOTES:**  
 1. Add 16 pounds of fuel for engine start, taxi and takeoff allowance.  
 2. Increase time, fuel and distance by 10% for each 7 °C above standard temperature.  
 3. Distances shown are based on zero wind.

WEIGHT LBS	PRESS ALT FT	RATE OF CLIMB FPM	FROM SEA LEVEL		
			TIME MIN	FUEL USED POUNDS	DISTANCE NM
4000	S.L.	605	0	0	0
	4000	570	7	14	13
	8000	530	14	28	27
	12,000	485	22	44	43
	16,000	430	31	62	63
	20,000	365	41	82	87
3700	S.L.	700	0	0	0
	4000	665	6	12	11
	8000	625	12	24	23
	12,000	580	19	37	37
	16,000	525	26	52	53
	20,000	460	34	68	72
3400	S.L.	810	0	0	0
	4000	775	5	10	9
	8000	735	10	21	20
	12,000	690	16	32	31
	16,000	635	22	44	45
	20,000	565	29	57	61

Figure 9-27. Fuel, time, and distance-to-climb table.

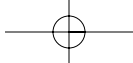
be increased by 10 percent for each 7° above standard. Multiply the findings by 10 percent or .10 (10 x .10 = 1, 1 + 10 = 11 minutes). After accounting for the additional 10 percent, the findings should read 11 minutes, 23.1 pounds of fuel, and 22 nautical miles. Notice that the fuel is reported in pounds of fuel, not gallons. Aviation fuel weighs 6 pounds per gallon, so 23.1 pounds of fuel is equal to 3.85 gallons of fuel (23.1 / 6 = 3.85).

The next example is a cruise and range performance chart. This type of table is designed to give true air-speed, fuel consumption, endurance in hours, and range in miles at specific cruise configurations. Use figure 9-28 to determine the cruise and range performance under the given conditions.

**Sample Problem 6**

Pressure Altitude.....5,000 feet  
 RPM.....2,400 r.p.m.  
 Fuel Carrying Capacity.....38 gallons, no reserve

Find 5,000 feet pressure altitude in the first column on the left-hand side of the table. Next, find the correct r.p.m. of 2,400 in the second column. Follow that line straight across and read the TAS of 116 m.p.h., and a fuel burn rate of 6.9 gallons per hour. As per the example, the airplane is equipped with a fuel carrying capacity of 38 gallons. Under this column, read that the endurance in hours is 5.5 hours and the range in miles is 635 miles.



Gross Weight- 2300 Lbs.  
Standard Conditions  
Zero Wind Lean Mixture

**NOTE: Maximum cruise is normally limited to 75% power.**

ALT.	RPM	% BHP	TAS MPH	GAL/HOUR	38 GAL (NO RESERVE)		48 GAL (NO RESERVE)	
					ENDR. HOURS	RANGE MILES	ENDR. HOURS	RANGE MILES
2500	2700	86	134	9.7	3.9	525	4.9	660
	2600	79	129	8.6	4.4	570	5.6	720
	2500	72	123	7.8	4.9	600	6.2	760
	2400	65	117	7.2	5.3	620	6.7	780
	2300	58	111	6.7	5.7	630	7.2	795
	2200	52	103	6.3	6.1	625	7.7	790
	5000	2700	82	134	9.0	4.2	565	5.3
2600		75	128	8.1	4.7	600	5.9	760
2500		68	122	7.4	5.1	625	6.4	790
2400		61	116	6.9	5.5	635	6.9	805
2300		55	108	6.5	5.9	635	7.4	805
2200		49	100	6.0	6.3	630	7.9	795
7500		2700	78	133	8.4	4.5	600	5.7
	2600	71	127	7.7	4.9	625	6.2	790
	2500	64	121	7.1	5.3	645	6.7	810
	2400	58	113	6.7	5.7	645	7.2	820
	2300	52	105	6.2	6.1	640	7.7	810
	10,000	2650	70	129	7.6	5.0	640	6.3
2600		67	125	7.3	5.2	650	6.5	820
2500		61	118	6.9	5.5	655	7.0	830
2400		55	110	6.4	5.9	650	7.5	825
2300		49	100	6.0	6.3	635	8.0	800

Figure 9-28. Cruise and range performance.

Cruise power setting tables are useful when planning cross-country flights. The table gives the correct cruise power settings as well as the fuel flow and airspeed performance numbers at that altitude and airspeed.

**Sample Problem 7**

Pressure Altitude @ Cruise.....6,000 feet  
OAT.....36°F above standard

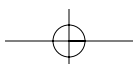
Refer to figure 9-29 for this sample problem. First, locate the pressure altitude of 6,000 feet on the far left side of the table. Follow that line across to the far right side of the table under the 20°C (or 36°F) column. At 6,000 feet, the r.p.m. setting of 2,450 will maintain 65

percent continuous power at 21.0 inches of manifold pressure with a fuel flow rate of 11.5 gallons per hour and airspeed of 161 knots.

Another type of cruise chart is a best power mixture range graph. This graph gives the best range based on power setting and altitude. Using figure 9-30, find the range at 65 percent power with and without a reserve based on the provided conditions.

**Sample Problem 8**

OAT.....Standard  
Pressure Altitude.....5,000 feet



### CRUISE POWER SETTINGS

65% MAXIMUM CONTINUOUS POWER (OR FULL THROTTLE)  
2800 POUNDS

PRESS ALT.	ISA -20 °C (-36 °F)								STANDARD DAY (ISA)								ISA +20 °C (+36 °F)							
	IOAT		ENGINE SPEED	MAN. PRESS	FUEL FLOW PER ENGINE		TAS		IOAT		ENGINE SPEED	MAN. PRESS	FUEL FLOW PER ENGINE		TAS		IOAT		ENGINE SPEED	MAN. PRESS	FUEL FLOW PER ENGINE		TAS	
	FEET	°F	°C	RPM	IN HG	PSI	GPH	KTS	MPH	°F	°C	RPM	IN HG	PSI	GPH	KTS	MPH	°F	°C	RPM	IN HG	PSI	GPH	KTS
SL	27	-3	2450	20.7	6.6	11.5	147	169	63	17	2450	21.2	6.6	11.5	150	173	99	37	2450	21.8	6.6	11.5	153	176
2000	19	-7	2450	20.4	6.6	11.5	149	171	55	13	2450	21.0	6.6	11.5	153	176	91	33	2450	21.5	6.6	11.5	156	180
4000	12	-11	2450	20.1	6.6	11.5	152	175	48	9	2450	20.7	6.6	11.5	156	180	84	29	2450	21.3	6.6	11.5	159	183
6000	5	-15	2450	19.8	6.6	11.5	155	178	41	5	2450	20.4	6.6	11.5	158	182	79	26	2450	21.0	6.6	11.5	161	185
8000	-2	-19	2450	19.5	6.6	11.5	157	181	36	2	2450	20.2	6.6	11.5	161	185	72	22	2450	20.8	6.6	11.5	164	189
10000	-8	-22	2450	19.2	6.6	11.5	160	184	28	-2	2450	19.9	6.6	11.5	163	188	64	18	2450	20.3	6.5	11.4	166	191
12000	-15	-26	2450	18.8	6.4	11.3	162	186	21	-6	2450	18.8	6.1	10.9	163	188	57	14	2450	18.8	5.9	10.6	163	188
14000	-22	-30	2450	17.4	5.8	10.5	159	183	14	-10	2450	17.4	5.6	10.1	160	184	50	10	2450	17.4	5.4	9.8	160	184
16000	-29	-34	2450	16.1	5.3	9.7	156	180	7	-14	2450	16.1	5.1	9.4	156	180	43	6	2450	16.1	4.9	9.1	155	178

NOTES: 1. Full throttle manifold pressure settings are approximate.  
2. Shaded area represents operation with full throttle.

Figure 9-29. Cruise power setting table.

First, move up the left side of the graph to 5,000 feet and standard temperature. Follow the line straight across the graph until it intersects the 65 percent line under both the reserve and no reserve categories. Draw

a line straight down from both intersections to the bottom of the graph. At 65 percent power with a reserve, the range is approximately 522 miles. At 65 percent power with no reserve, the range should be 581 miles.

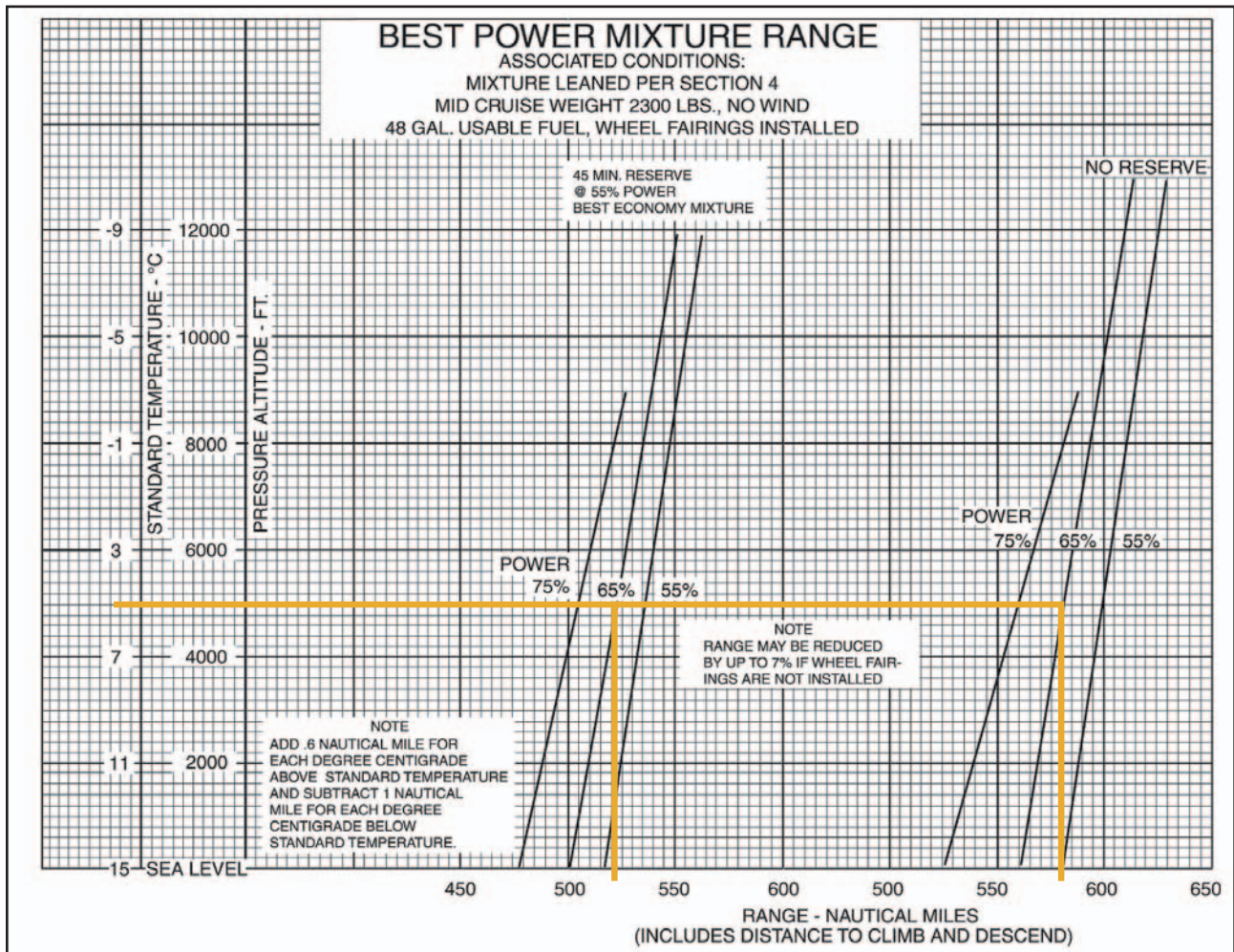
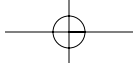


Figure 9-30. Best power mixture range graph.



The last cruise chart referenced is a cruise performance graph. This graph is designed to tell the true airspeed (TAS) performance of the airplane depending on the altitude, temperature, and power setting. Using figure 9-31, find the TAS performance based on the given information.

**Sample Problem 9**

OAT.....16°C  
 Pressure Altitude.....6,000 feet  
 Power Setting.....65 percent, best power  
 Wheel Fairings.....Not installed

Begin by finding the correct OAT on the bottom, left-hand side of the graph. Move up that line until it intersects the pressure altitude of 6,000 feet. Draw a line straight across to the 65 percent, best power line. This is the solid line, not the dashed line, which represents best economy. Draw a line straight down from this intersection to the bottom of the graph. The true airspeed at 65 percent best power is 140 knots. However, it is necessary to subtract 8 knots from the speed since there are no wheel fairings. This note is listed under the title and conditions. The true airspeed will be 132 knots.

**CROSSWIND AND HEADWIND COMPONENT CHART**

Every airplane is tested according to FAA regulations prior to certification. The airplane is tested by a pilot with average piloting skills in 90° crosswinds with a velocity up to 0.2 V<sub>SO</sub> or two-tenths of the airplane’s stalling speed with power off, gear down, and flaps down. This means that if the stalling speed of the airplane is 45 knots, it must be capable of being landed in a 9 knot, 90° crosswind. The maximum demonstrated crosswind component is published in the AFM/POH. The crosswind and headwind component chart allows for figuring the headwind and crosswind component for any given wind direction and velocity.

**Sample Problem 10**

Runway.....17  
 Wind.....140° @ 25 knots

Refer to figure 9-32 to solve this problem. First, determine how many degrees difference there is between the runway and the wind direction. It is known that runway 17 means a direction of 170° and from that, subtract the wind direction of 140°. This gives a 30° angular difference. This is the wind angle. Next, locate the 30° mark and draw a line from there until it intersects the correct wind velocity of 25

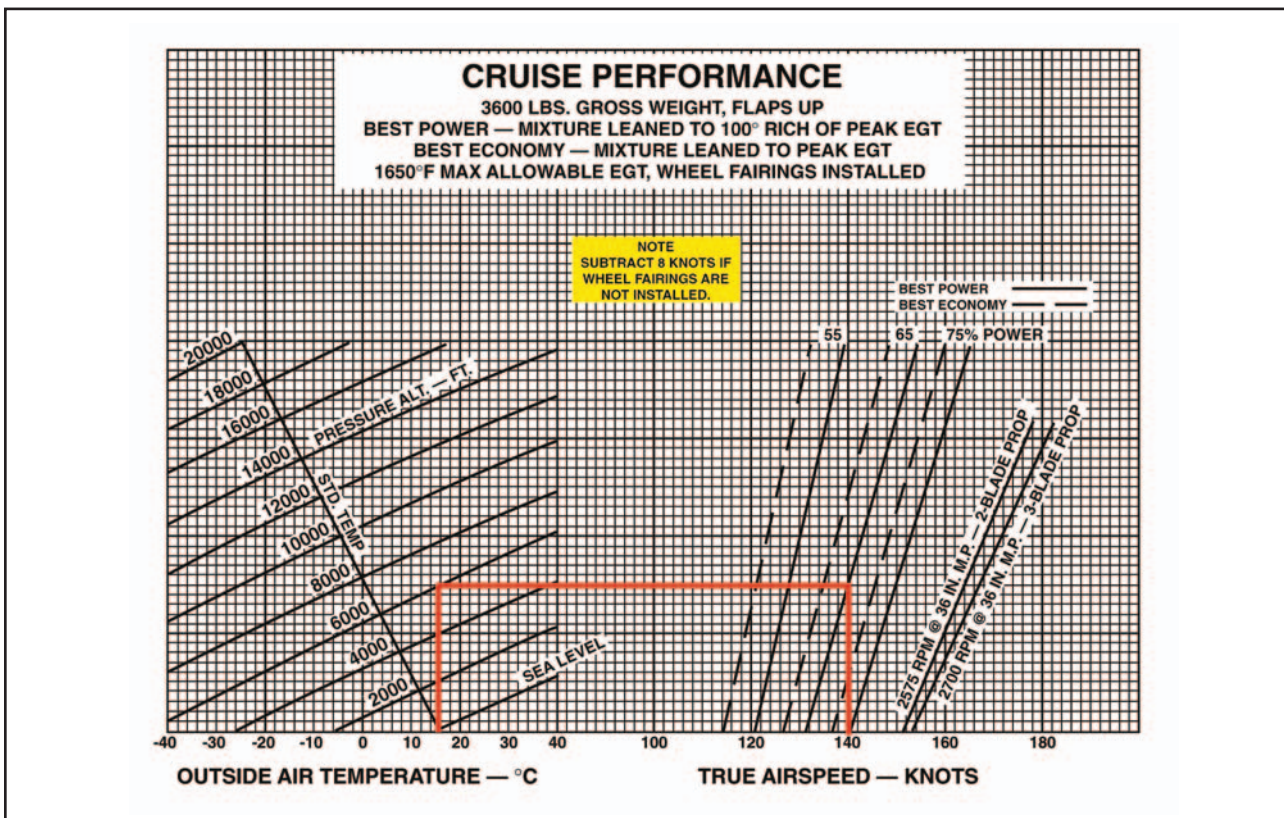
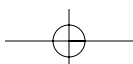


Figure 9-31. Cruise performance graph.



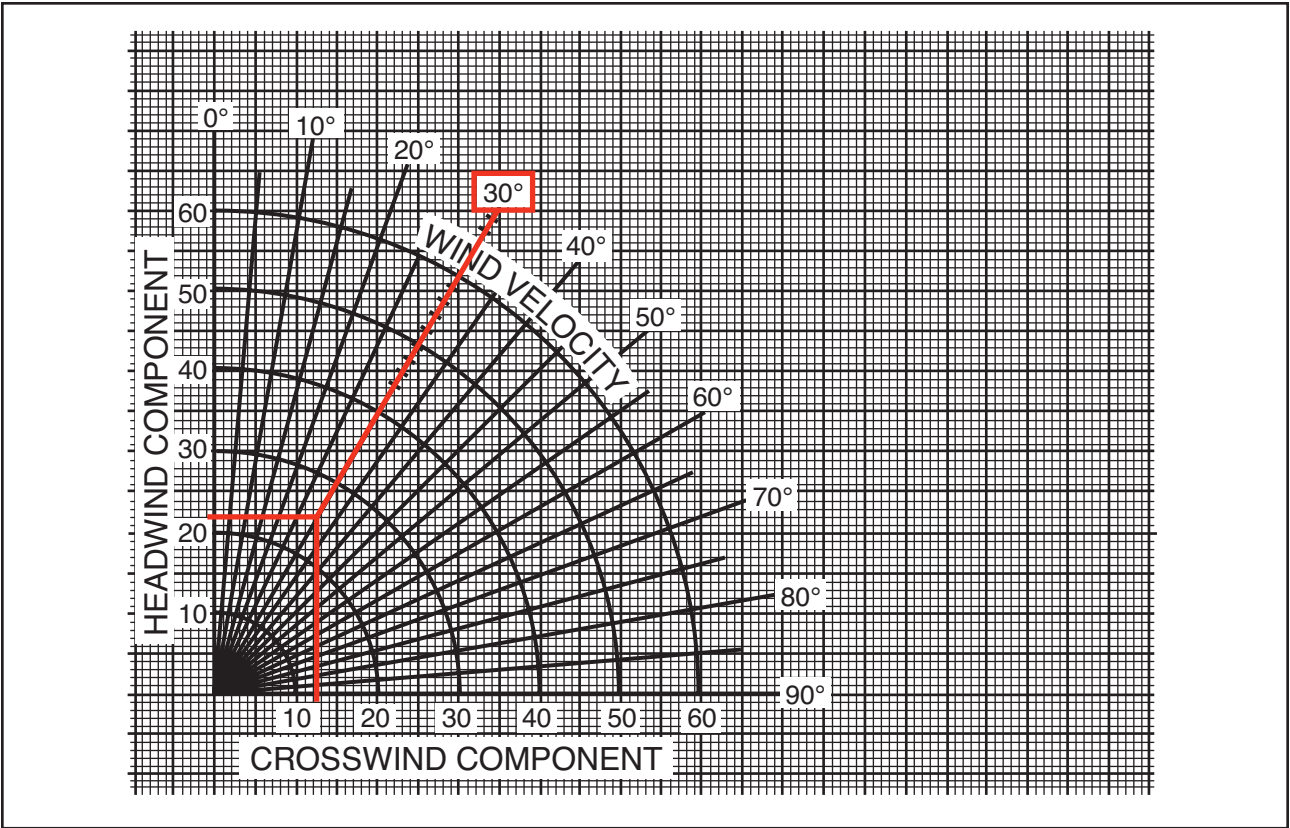


Figure 9-32. Crosswind component chart.

knots. From there, draw a line straight down and a line straight across. The headwind component is 22 knots and the crosswind component is 13 knots. This information is important when taking off and landing so that, first of all, the appropriate runway can be picked if more than one exists at a particular airport, but also so that the airplane is not pushed beyond its tested limits.

**LANDING CHARTS**

Landing performance is affected by variables similar to those affecting takeoff performance. It is necessary to compensate for differences in density altitude, weight of the airplane, and headwinds. Like takeoff performance charts, landing distance information is available as normal landing information as well as landing distance over a 50-foot obstacle. As usual, read the associated conditions and notes in order to

ascertain the basis of the chart information. Remember, when calculating landing distance that the landing weight will not be the same as the takeoff weight. The weight must be recalculated to compensate for the fuel that was used during the flight.

**Sample Problem 11**

Pressure Altitude.....1,250 feet  
 Temperature.....Standard

Refer to figure 9-33. This example makes use of a landing distance table. Notice that the altitude of 1,250 feet is not on this table. It is therefore necessary to use interpolation skills to find the correct landing distance. The pressure altitude of 1,250 is halfway between sea level and 2,500 feet. First, find the column for sea level and the column for 2,500 feet. Take the total distance of 1,075 for sea level and the total

LANDING DISTANCE						FLAPS LOWERED TO 40° - POWER OFF HARD SURFACE RUNWAY - ZERO WIND			
GROSS WEIGHT LB	APPROACH SPEED IAS, MPH	AT SEA LEVEL & 59 °F		AT 2500 FT & 50 °F		AT 5000 FT & 41 °F		AT 7500 FT & 32 °F	
		GROUND ROLL	TOTAL TO CLEAR 50 FT OBS	GROUND ROLL	TOTAL TO CLEAR 50 FT OBS	GROUND ROLL	TOTAL TO CLEAR 50 FT OBS	GROUND ROLL	TOTAL TO CLEAR 50 FT OBS
1600	60	445	1075	470	1135	495	1195	520	1255

NOTES: 1. Decrease the distances shown by 10% for each 4 knots of headwind.  
 2. Increase the distance by 10% for each 60 °F temperature increase above standard.  
 3. For operation on a dry, grass runway, increase distances (both "ground roll" and "total to clear 50 ft obstacle") by 20% of the "total to clear 50 ft obstacle" figure.

Figure 9-33. Landing distance table.

distance of 1,135 for 2,500 and add them together. Divide the total by two to obtain the distance for 1,250 feet. The distance is 1,105 feet total landing distance to clear a 50-foot obstacle. Repeat this process to obtain the ground roll distance for the pressure altitude. The ground roll should be 457.5 feet.

**Sample Problem 12**

OAT.....57°F  
 Pressure Altitude.....4,000 feet  
 Landing Weight.....2,400 pounds  
 Headwind.....6 knots  
 Obstacle Height.....50 foot

Using the given conditions and figure 9-34, determine the landing distance for the airplane. This graph is an example of a combined landing distance graph and allows compensation for temperature, weight, headwinds, tailwinds, and varying obstacle height. Begin by finding the correct OAT on the Fahrenheit scale on the left-hand side of the chart. Move up in a straight line to the correct pressure altitude of 4,000 feet. From this intersection, move straight across to the first dark reference line. Follow the lines in the same diagonal fashion until the correct landing weight is reached. At 2,400 pounds, continue in a straight line across to the second dark reference line. Once again, draw a line in a

diagonal manner to the correct wind component and then straight across to the third dark reference line. From this point, draw a line in two separate directions: one straight across to figure the ground roll and one in a diagonal manner to the correct obstacle height. This should be 900 feet for the total ground roll and 1,300 feet for the total distance over a 50-foot obstacle.

**STALL SPEED PERFORMANCE CHARTS**

Stall speed performance charts are designed to give an understanding of the speed at which the airplane will stall in a given configuration. This type of chart will typically take into account the angle of bank, the position of the gear and flaps, and the throttle position. Use figure 9-35 and the accompanying conditions to find the speed at which the airplane will stall.

**Sample Problem 13**

Power.....OFF  
 Flaps.....Down  
 Gear.....Down  
 Angle of Bank.....45°

First, locate the correct flap and gear configuration. The bottom half of the chart should be used since the gear and flaps are down. Next, choose the row corresponding to a power-off situation. Now find the correct

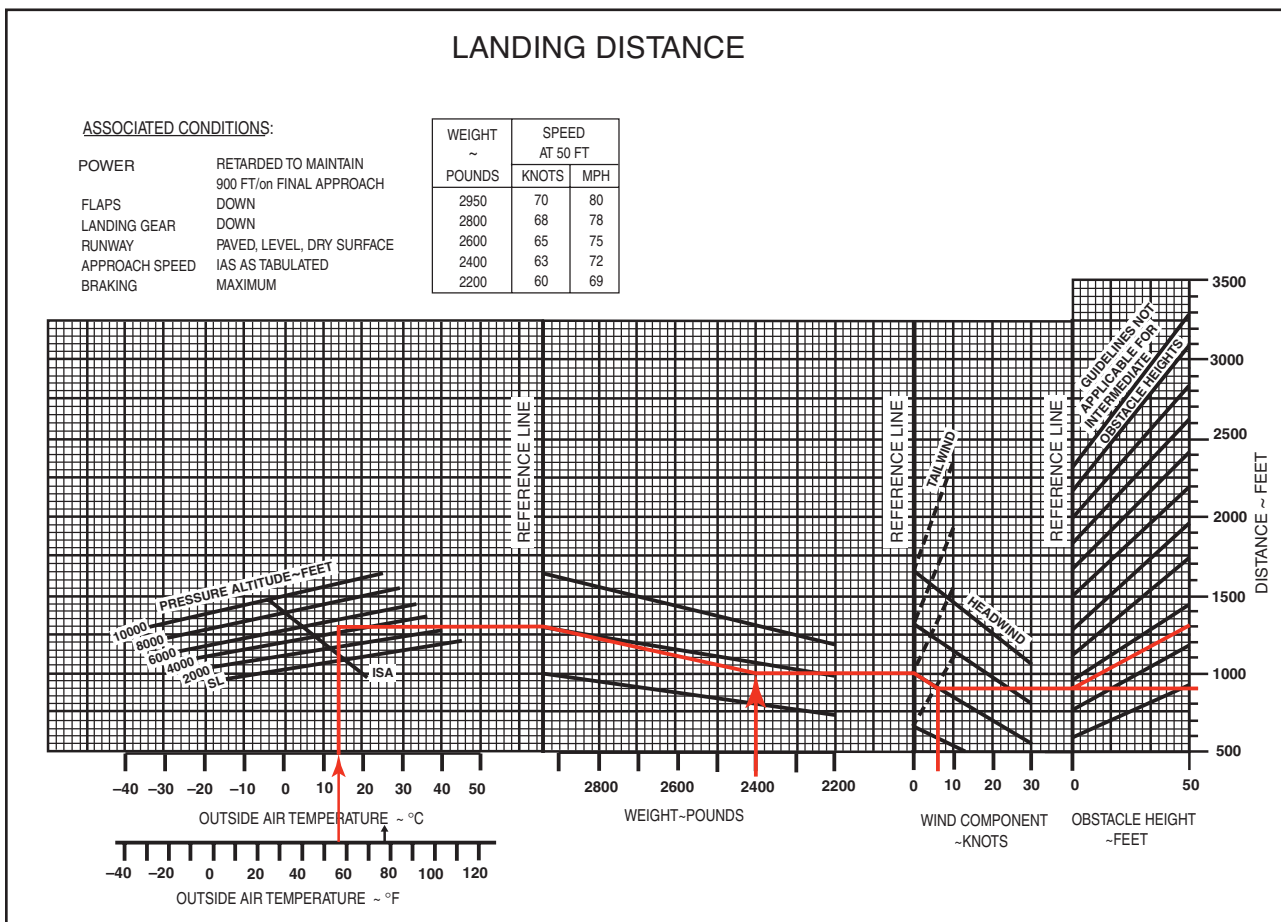


Figure 9-34. Landing distance graph.

GROSS WEIGHT 2750 LBS		ANGLE OF BANK			
		LEVEL	30°	45°	60°
POWER		GEAR AND FLAPS UP			
ON	MPH	62	67	74	88
	KTS	54	58	64	76
OFF	MPH	75	81	89	106
	KTS	65	70	77	92
		GEAR AND FLAPS DOWN			
ON	MPH	54	58	64	76
	KTS	47	50	56	66
OFF	MPH	66	71	78	93
	KTS	57	62	68	81

Figure 9-35. Stall speed table.

angle of bank column, which is 45°. The stall speed in miles per hour (m.p.h.) is 78 m.p.h., and the stall speed in knots would be 68 knots.

Performance charts provide valuable information to the pilot. Take advantage of these charts. A pilot can predict the performance of the airplane under most flying conditions, and this enables a better plan for every flight. The Code of Federal Regulations (CFR) requires that a pilot be familiar with all information available prior to any flight. Pilots should use the information to their advantage as it can only contribute to safety in flight.

## TRANSPORT CATEGORY AIRPLANE PERFORMANCE

Transport category airplanes are certificated under Title 14 of the Code of Federal Regulations (14 CFR) part 25. The airworthiness certification standards of part 25 require proven levels of performance and guaranteed safety margins for these airplanes, regardless of the specific operating regulations under which they are employed.

### MAJOR DIFFERENCES IN TRANSPORT CATEGORY VERSUS NON-TRANSPORT CATEGORY PERFORMANCE REQUIREMENTS

- **Full Temperature Accountability**  
All of the performance charts for the transport category airplanes require that takeoff and climb

performance be computed with the full effects of temperature considered.

- **Climb Performance Expressed as Percent Gradient of Climb**

The transport category airplane’s climb performance is expressed as a percent gradient of climb rather than a figure calculated in feet per minute of climb. This percent gradient of climb is a much more practical expression of performance since it is the airplane’s angle of climb that is critical in an obstacle clearance situation.

- **Change in Lift-off Technique**

Lift-off technique in transport category airplanes allows the reaching of V<sub>2</sub> (takeoff safety speed) after the airplane is airborne. This is possible because of the excellent acceleration and reliability characteristics of the engines on these airplanes and also because of the larger surplus of power.

- **Performance Requirements Applicable to all Segments of Aviation**

All airplanes certificated by the FAA in the transport category, whatever the size, must be operated in accordance with the same performance criteria. This applies to both commercial and non-commercial operations.

## PERFORMANCE REQUIREMENTS

The performance requirements that the transport category airplane must meet are as follows:

### TAKEOFF

- Takeoff speeds
- Takeoff runway required
- Takeoff climb required
- Obstacle clearance requirements

### LANDING

- Landing speeds
- Landing runway required
- Landing climb required

### TAKEOFF PLANNING

The following are the speeds that affect the transport category airplane’s takeoff performance. The flight crew must be thoroughly familiar with each of these speeds and how they are used in takeoff planning.

Speed	Definition
$V_S$	Stalling speed or the minimum steady flight speed at which the airplane is controllable.
$V_{MCG}$	Minimum control speed on the ground, with one engine inoperative, (critical engine on two-engine airplanes) takeoff power on other engine(s), using aerodynamic controls only for directional control. (Must be less than $V_1$ ).
$V_{MCA}$	Minimum control speed in the air, with one engine inoperative, (critical engine on two-engine airplanes) operating engine(s) at take off power, maximum of 5° bank into the good engine(s).
$V_1$	Critical engine failure speed or decision speed. Engine failure below this speed shall result in an aborted takeoff; above this speed the take off run should be continued.
$V_R$	Speed at which the rotation of the airplane is initiated to takeoff attitude. This speed cannot be less than $V_1$ or less than 1.05 times VMC. With an engine failure, it must also allow for the acceleration to $V_2$ at the 35-foot height at the end of the runway.
$V_{LO}$	Lift-off speed. The speed at which the airplane first becomes airborne.
$V_2$	The takeoff safety speed which must be attained at the 35-foot height at the end of the required runway distance. This is essentially the best one-engine inoperative angle of climb speed for the airplane and should be held until clearing obstacles after takeoff, or until at least 400 feet above the ground.
$V_{FS}$	Final segment climb speed, which is based upon one-engine inoperative climb, clean configuration, and maximum continuous power setting.

All of the above V speeds should be considered during every takeoff. The  $V_1$ ,  $V_R$ ,  $V_2$  and  $V_{FS}$  speeds should be visibly posted in the cockpit for reference during the takeoff.

Takeoff speeds vary with airplane weight. Before takeoff speeds can be computed, the pilot must first determine the maximum allowable takeoff weight. The three items that can limit takeoff weight are runway require-

ments, takeoff climb requirements, and obstacle clearance requirements.

## RUNWAY REQUIREMENTS

The runway requirements for takeoff will be affected by the following:

- Pressure altitude
- Temperature
- Headwind component
- Runway gradient or slope
- Airplane weight

The runway required for takeoff must be based upon the possible loss of an engine at the most critical point, which is at  $V_1$  (decision speed). By regulation, the airplane's takeoff weight has to accommodate the longest of three distances:

1. **Accelerate-Go Distance**  
The distance required to accelerate to  $V_1$  with all engines at takeoff power, experience an engine failure at  $V_1$  and continue the takeoff on the remaining engine(s). The runway required includes the distance required to climb to 35 feet by which time  $V_2$  speed must be attained.
2. **Accelerate-Stop Distance**  
The distance required to accelerate to  $V_1$  with all engines at takeoff power, experience an engine failure at  $V_1$ , and abort the takeoff and bring the airplane to a stop using braking action only (use of thrust reversing is not considered).
3. **Takeoff Distance**  
The distance required to complete an all-engines operative takeoff to the 35-foot height. It must be at least 15 percent less than the distance required for a one-engine inoperative engine takeoff. This distance is not normally a limiting factor as it is usually less than the one-engine inoperative takeoff distance.

These three required takeoff runway considerations are shown in figure 9-36.

## BALANCED FIELD LENGTH

In most cases, the pilot will be working with a performance chart for takeoff runway required, which will give "balanced field length" information. This means that the distance shown for the takeoff will include both the accelerate-go and accelerate-stop distances. One



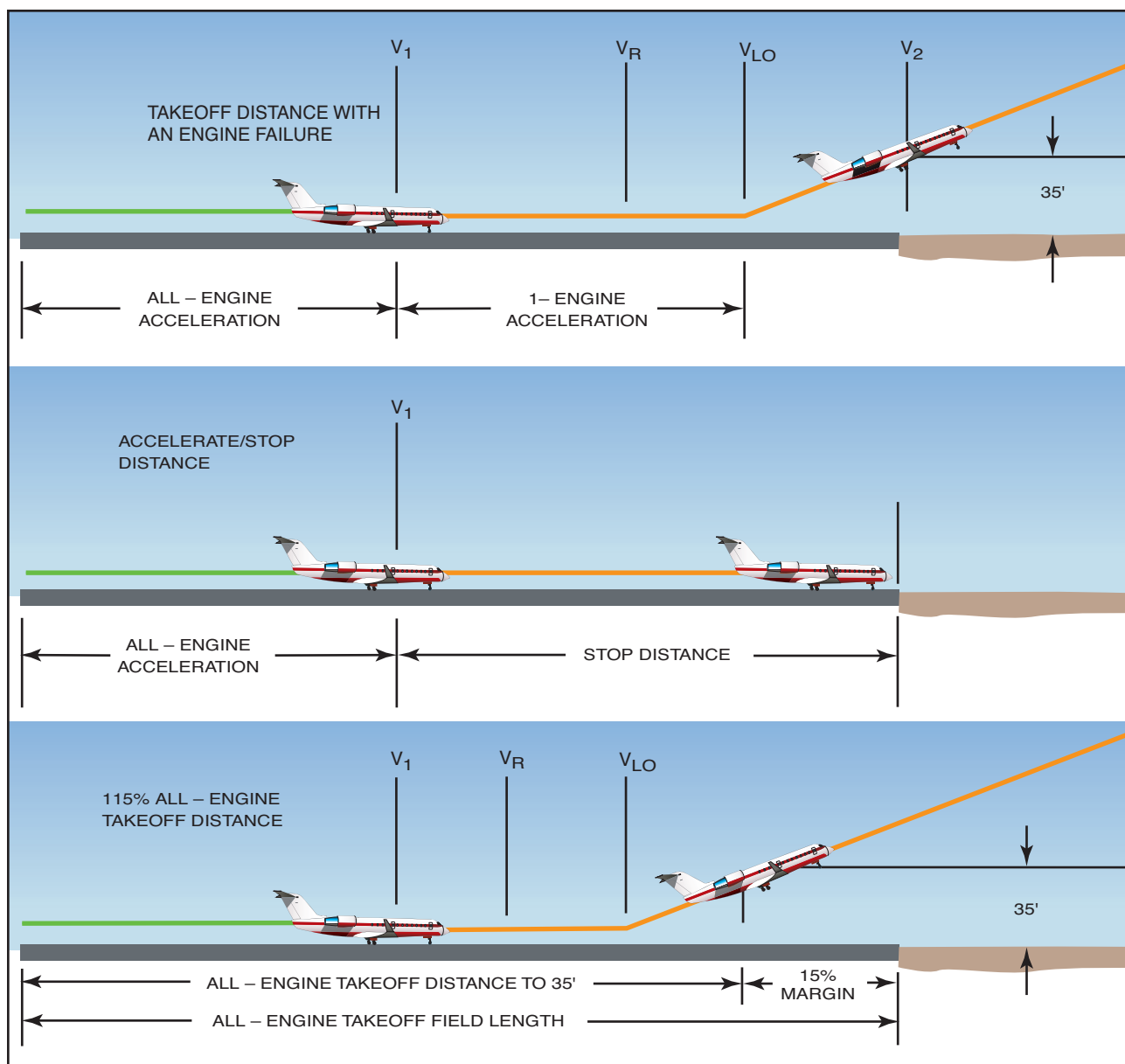


Figure 9-36. Minimum required takeoff runway lengths.

effective means of presenting the normal takeoff data is shown in the tabulated chart in figure 9-37.

The chart in figure 9-37 shows the runway distance required under normal conditions and is useful as a quick reference chart for the standard takeoff. The  $V$  speeds for the various weights and conditions are also shown.

For other than normal takeoff conditions, such as with engine anti-ice, anti-skid brakes inoperative, or extremes in temperature or runway slope, the pilot should consult the appropriate takeoff performance

charts in the performance section of the Airplane Flight Manual.

There are other occasions of very high weight and temperature where the runway requirement may be dictated by the maximum brake kinetic energy limits that affect the airplane's ability to stop. Under these conditions, the accelerate-stop distance may be greater than the accelerate-go. The procedure to bring performance back to a balanced field takeoff condition is to limit the  $V_1$  speed so that it does not exceed the maximum brake kinetic energy speed (sometimes called VBE). This procedure also results in a reduction in allowable takeoff weight.

**TAKE-OFF RUNWAY REQUIREMENTS**

Standard ISA Conditions

Cabin Pressurization ON

Zero slope runway

No Flaps – Anti-ice RAM air inlets OFF

Anti-skid ON

Distances – 100 feet (V<sub>1</sub> – KIAS)

TAKE-OFF GROSS WT. AT BRAKE RELEASE	TEMP		PRESSURE ALTITUDE – FEET						Head-wind (Knots)	
	°F	°C	SEA LEVEL (V <sub>1</sub> )	1000 (V <sub>1</sub> )	2000 (V <sub>1</sub> )	3000 (V <sub>1</sub> )	4000 (V <sub>1</sub> )	5000 (V <sub>1</sub> )		6000 (V <sub>1</sub> )
19,612 V <sub>R</sub> = 126 V <sub>2</sub> = 134	30	-1.1	47 (121)	48 (121)	50 (120)	53 (121)	57 (122)	62 (123)	70 (123)	0
	50	10	48 (121)	51 (121)	55 (121)	60 (122)	63 (123)	69 (124)	77 (125)	
	70	21	53 (122)	56 (122)	60 (123)	65 (124)	70 (125)	77 (125)	85 (126)	
	90	32	58 (123)	62 (124)	68 (124)	73 (125)	78 (126)	85 (127)	95 (129)	
19,000 V <sub>R</sub> = 124 V <sub>2</sub> = 131	30	-1.1	45 (118)	45 (118)	47 (117)	50 (118)	54 (119)	59 (120)	66 (120)	0
	50	10	46 (118)	48 (118)	51 (118)	56 (119)	59 (120)	65 (121)	73 (121)	
	70	21	50 (118)	53 (119)	57 (120)	66 (121)	66 (121)	72 (122)	80 (123)	
	90	32	55 (120)	59 (121)	64 (121)	73 (122)	73 (122)	80 (124)	90 (124)	
18,000 V <sub>R</sub> = 119 V <sub>2</sub> = 127	30	-1.1	40 (114)	41 (114)	42 (113)	45 (113)	49 (114)	53 (115)	60 (115)	0
	50	10	41 (115)	43 (114)	46 (114)	50 (115)	53 (115)	59 (116)	66 (117)	
	70	21	45 (114)	48 (115)	51 (115)	56 (116)	59 (116)	65 (116)	72 (117)	
	90	32	50 (115)	53 (116)	58 (116)	62 (117)	66 (118)	73 (118)	80 (119)	
17,000 V <sub>R</sub> = 115 V <sub>2</sub> = 124	30	-1.1	36 (108)	37 (108)	38 (107)	40 (108)	44 (109)	48 (110)	53 (111)	0
	50	10	37 (110)	39 (108)	41 (109)	45 (110)	48 (110)	53 (111)	59 (112)	
	70	21	40 (108)	43 (110)	46 (111)	50 (111)	53 (112)	58 (111)	65 (113)	
	90	32	45 (111)	46 (112)	52 (112)	56 (113)	59 (114)	65 (114)	72 (114)	
16,000 V <sub>R</sub> = 111 V <sub>2</sub> = 120	30	-1.1	32 (104)	33 (103)	34 (103)	36 (103)	39 (105)	43 (106)	48 (106)	0
	50	10	34 (105)	35 (103)	37 (104)	41 (105)	43 (106)	47 (107)	53 (107)	
	70	21	36 (104)	38 (105)	41 (105)	45 (106)	48 (107)	52 (107)	58 (108)	
	90	32	41 (106)	43 (107)	46 (107)	50 (108)	53 (108)	58 (109)	64 (110)	
15,000 V <sub>R</sub> = 106 V <sub>2</sub> = 116	30	-1.1	28 (98)	30 (98)	30 (98)	32 (98)	35 (99)	38 (101)	42 (101)	0
	50	10	30 (100)	31 (98)	33 (99)	36 (100)	38 (101)	42 (102)	46 (102)	
	70	21	32 (99)	34 (100)	37 (101)	40 (102)	42 (102)	46 (102)	51 (103)	
	90	32	36 (101)	38 (102)	41 (102)	44 (103)	47 (104)	51 (104)	56 (105)	
15,000 V <sub>R</sub> = 106 V <sub>2</sub> = 116	30	-1.1	25 (98)	27 (98)	27 (98)	29 (98)	32 (99)	34 (101)	38 (101)	20
	50	10	27 (100)	29 (98)	30 (99)	32 (100)	34 (101)	38 (102)	42 (102)	
	70	21	29 (99)	31 (100)	33 (101)	36 (102)	38 (102)	42 (102)	46 (103)	
	90	32	32 (101)	34 (102)	37 (102)	40 (103)	43 (104)	46 (104)	51 (105)	

**Note: Shaded area indicates conditions that do not meet second segment climb requirements. Refer to F.M. for takeoff limitations.**

Figure 9-37. Normal takeoff runway required.

**CLIMB REQUIREMENTS**

After the airplane has reached the 35-foot height with one engine inoperative, there is a requirement that it be able to climb at a specified climb gradient. This is known as the takeoff flightpath requirement. The airplane's performance must be considered based upon a one-engine inoperative climb up to 1,500 feet above the ground.

The takeoff flightpath profile with required gradients of climb for the various segments and configurations is shown in figure 9-38.

Note: Climb gradient can best be described as being a certain gain of vertical height for a given distance covered horizontally. For instance, a 2.4 percent gradient means that 24 feet of altitude would be gained for each

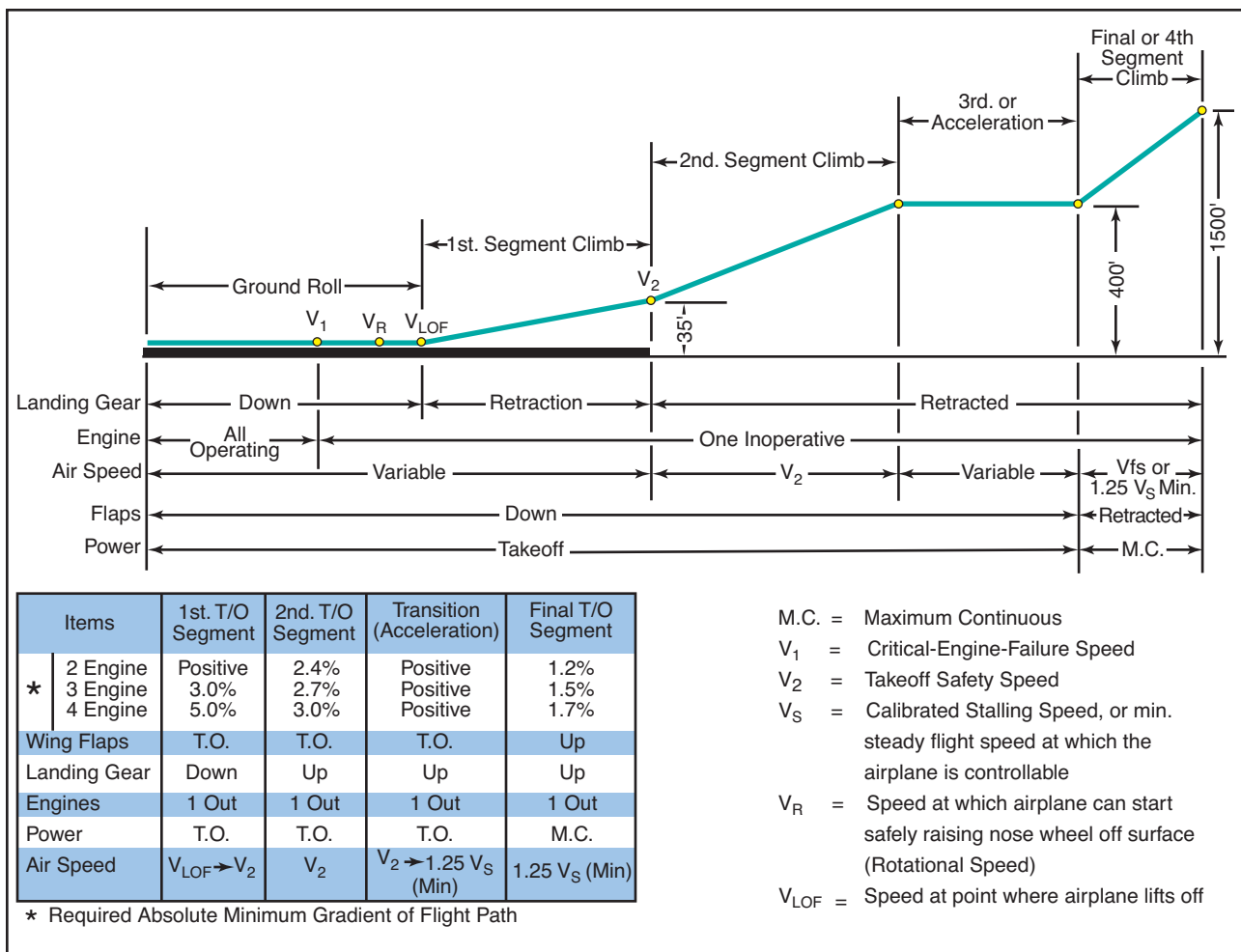


Figure 9-38. One-engine inoperative takeoff flightpath.

1,000 feet of distance covered horizontally across the ground.

The following brief explanation of the one-engine inoperative climb profile may be helpful in understanding the chart in figure 9-38.

**FIRST SEGMENT**

This segment is included in the takeoff runway required charts and is measured from the point at which the airplane becomes airborne until it reaches the 35-foot height at the end of the runway distance required. Speed initially is  $V_{LO}$  and must be  $V_2$  at the 35-foot height.

**SECOND SEGMENT**

This is the most critical segment of the profile. The second segment is the climb from the 35-foot height to 400 feet above the ground. The climb is done at full takeoff power on the operating engine(s), at  $V_2$  speed, and with the flaps in the takeoff configuration. The required climb gradient in this segment is 2.4 percent for two-engine airplanes, 2.7 percent for three-engine airplanes, and 3.0 percent for four-engine airplanes.

**THIRD OR ACCELERATION SEGMENT**

During this segment, the airplane is considered to be maintaining the 400 feet above the ground and accelerating from the  $V_2$  speed to the  $V_{FS}$  speed before the climb profile is continued. The flaps are raised at the beginning of the acceleration segment and power is maintained at the takeoff setting as long as possible (5 minutes maximum).

**FOURTH OR FINAL SEGMENT**

This segment is from the 400 to 1,500-foot AGL altitude with power set at maximum continuous. The required climb in this segment is a gradient of 1.2 percent for two-engine airplanes, 1.55 for three-engine airplanes, and 1.7 percent for four-engine airplanes.

**SECOND SEGMENT CLIMB LIMITATIONS**

The second segment climb requirements, from 35 to 400 feet, are the most restrictive (or hardest to meet) of the climb segments. The pilot must determine that the second segment climb is met for each takeoff. In order to achieve this performance at the higher density altitude conditions, it may be necessary to limit the takeoff weight of the airplane.

It must be realized that, regardless of the actual available length of the takeoff runway, takeoff weight must be adjusted so that the second segment climb requirements can be met. The airplane may well be capable of lifting off with one engine inoperative, but it must then be able to climb and clear obstacles. Although second segment climb may not present much of a problem at the lower altitudes, at the higher altitude airports and higher temperatures the second segment climb chart should be consulted to determine the effects on maximum takeoff weights before figuring takeoff runway distance required.

## AIR CARRIER OBSTACLE CLEARANCE REQUIREMENTS

Regulations require that large transport category turbine powered airplanes certificated after September 30, 1958, be taken off at a weight that allows a net takeoff flightpath (one engine inoperative) that clears all obstacles either by a height of at least 35 feet vertically, or by at least 200 feet horizontally within the airport boundaries and by at least 300 feet horizontally after passing the boundaries. The takeoff flightpath is considered to begin 35 feet above the takeoff surface at the end of the takeoff distance, and extends to a point in the takeoff at which the airplane is 1,500 feet above the takeoff surface, or at which the transition from the takeoff to the enroute configuration is completed. The net takeoff flightpath is the actual takeoff flightpath reduced at each point by 0.8 percent for two-engine airplanes, 0.9 percent for three-engine airplanes, and 1.0 percent for four-engine airplanes.

Air carrier pilots therefore are responsible not only for determining that there is enough runway available for an engine inoperative takeoff (balanced field length), and the ability to meet required climb gradients; but

they must also assure that the airplane will be able to safely clear any obstacles that may be in the takeoff flightpath.

The net takeoff flightpath and obstacle clearance required are shown in figure 9-39.

The usual method of computing net takeoff flightpath performance is to add up the total ground distances required for each of the climb segments and/or use obstacle clearance performance charts in the AFM. Although this obstacle clearance requirement is seldom a limitation at the normally used airports, it is quite often an important consideration under critical conditions such as high takeoff weight and/or high-density altitude. Consider that at a 2.4 percent climb gradient (2.4 feet up for every 100 feet forward) a 1,500-foot altitude gain would take a horizontal distance of 10.4 nautical miles to achieve.

## SUMMARY OF TAKEOFF REQUIREMENTS

In order to establish the allowable takeoff weight for a transport category airplane, at any airfield, the following must be considered:

- Airfield pressure altitude
- Temperature
- Headwind component
- Runway length
- Runway gradient or slope
- Obstacles in the flightpath

Once the above details are known and applied to the appropriate performance charts, it is possible to determine the maximum allowable takeoff weight. This

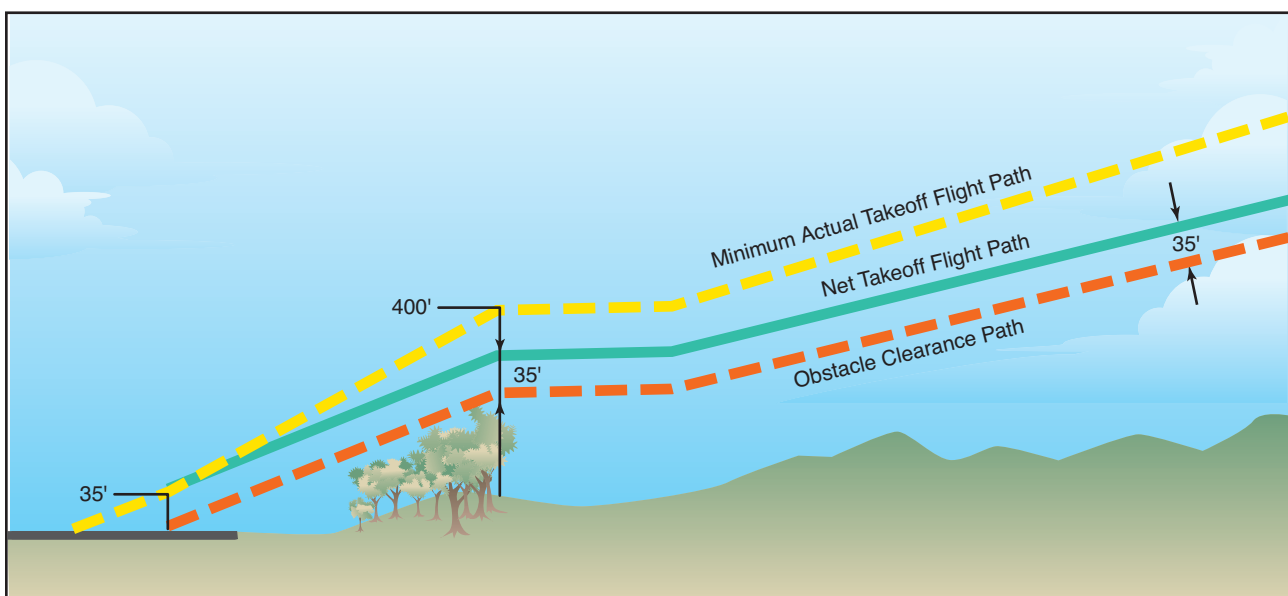


Figure 9-39. Takeoff obstacle clearance requirements.

weight would be the lower of the maximum weights as allowed by:

- Balanced field length required
- Engine inoperative climb ability (second segment limited)
- Obstacle clearance requirement

In practice, restrictions to takeoff weight at low altitude airports are usually due to runway length limitations; engine inoperative climb limitations are most common at the higher altitude airports. All limitations to weight must be observed. Since the combined weight of fuel and payload in the airplane may amount to nearly half the maximum takeoff weight, it is usually possible to reduce fuel weight to meet takeoff limitations. If this is done, however, flight planning must be recalculated in light of reduced fuel and range.

**LANDING PERFORMANCE**

As in the takeoff planning, certain speeds must be considered during landing. These speeds are shown below.

**LEVEL CONDITION**

Speed	Definition
$V_{SO}$	Stalling speed or the minimum steady flight speed in the landing configuration.
$V_{REF}$	1.3 times the stalling speed in the landing configuration. This is the required speed at the 50-foot height above the threshold end of the runway.
<b>Approach Climb</b>	The approach climb speed is the speed which would give the best climb performance in the approach configuration, with one engine inoperative, and with maximum takeoff power on the operating engine(s). The required gradient of climb in this configuration is 2.1 percent for two-engine airplanes, 2.4 percent for three-engine airplanes, and 2.7 percent for four-engine airplanes.
<b>Landing Climb</b>	This speed would give the best performance in the full landing configuration with maximum takeoff power on all engines. The gradient of climb required in this configuration is 3.2 percent.

**PLANNING THE LANDING**

As in the takeoff, the landing speeds shown above should be precomputed and visible to both pilots prior to the landing. The  $V_{REF}$  speed, or threshold speed, is used as a reference speed throughout the traffic pattern or instrument approach as in the following example:

- $V_{REF}$  plus 30K .....Downwind or procedure turn
- $V_{REF}$  plus 20K .....Base leg or final course inbound to final fix
- $V_{REF}$  plus 10K .....Final or final course inbound from fix (ILS final)
- $V_{REF}$  .....Speed at the 50-foot height above the threshold

**LANDING REQUIREMENTS**

The maximum landing weight of an airplane can be restricted by either the approach climb requirements or by the landing runway available.

**APPROACH CLIMB REQUIREMENTS**

The approach climb is usually more limiting (or more difficult to meet) than the landing climb, primarily because it is based upon the ability to execute a missed approach with one engine inoperative. The required climb gradient can be affected by pressure altitude and temperature and, as in the second segment climb in the takeoff, airplane weight must be limited as needed in order to comply with this climb requirement.

**LANDING RUNWAY REQUIRED**

The runway distance needed for landing can be affected by the following:

- Pressure altitude
- Temperature
- Headwind component
- Runway gradient or slope
- Airplane weight

In computing the landing distance required, some manufacturers do not include all of the above items in their charts, since the regulations state that only pressure altitude, wind, and airplane weight must be considered. Charts are provided for anti-skid on and anti-skid off conditions, but the use of reverse thrust is not used in computing required landing distances.

The landing distance, as required by the regulations, is that distance needed to land and come to a complete stop from a point 50 feet above the threshold end of the runway. It includes the air distance required to travel from the 50-foot height to touchdown (which can consume 1,000 feet of runway distance), plus the stopping

distance, with no margin left over. This is all that is required for 14 CFR part 91 operators (non-air carrier), and all that is shown on some landing distance required charts.

For air carriers and other commercial operators subjected to 14 CFR part 121, a different set of rules applies which states that the required landing distance from the 50-foot height cannot exceed 60 percent of the actual runway length available. In all cases, the minimum airspeed allowed at the 50-foot height must be no less than 1.3 times the airplane's stalling speed in the landing configuration. This speed is commonly called the airplane's VREF speed and will vary with landing weight. Figure 9-40 is a diagram of these landing runway requirements.

### SUMMARY OF LANDING REQUIREMENTS

In order to establish the allowable landing weight for a transport category airplane, the following details must be considered:

- Airfield pressure altitude
- Temperature
- Headwind component
- Runway length
- Runway gradient or slope
- Runway surface condition

With these details, it is possible to establish the maximum allowable landing weight, which will be the lower of the weights as dictated by:

- Landing runway requirements
- Approach climb requirements

In practice, the approach climb limitations (ability to climb in approach configuration with one engine inoperative) are seldom encountered because the landing weights upon arrival at the destination airport are usually light. However, as in the second segment climb requirement for takeoff, this approach climb gradient must be met and landing weights must be restricted if necessary. The most likely conditions that would make the approach climb critical would be the landings at high weights and high-pressure altitudes and temperatures, which might be encountered if a landing were required shortly after takeoff.

Landing field requirements can more frequently limit an airplane's allowable landing weight than the approach climb limitations. Again, however, unless the runway is particularly short, this is seldom problematic as the average landing weight at the destination seldom approaches the maximum design landing weight due to fuel burn off.

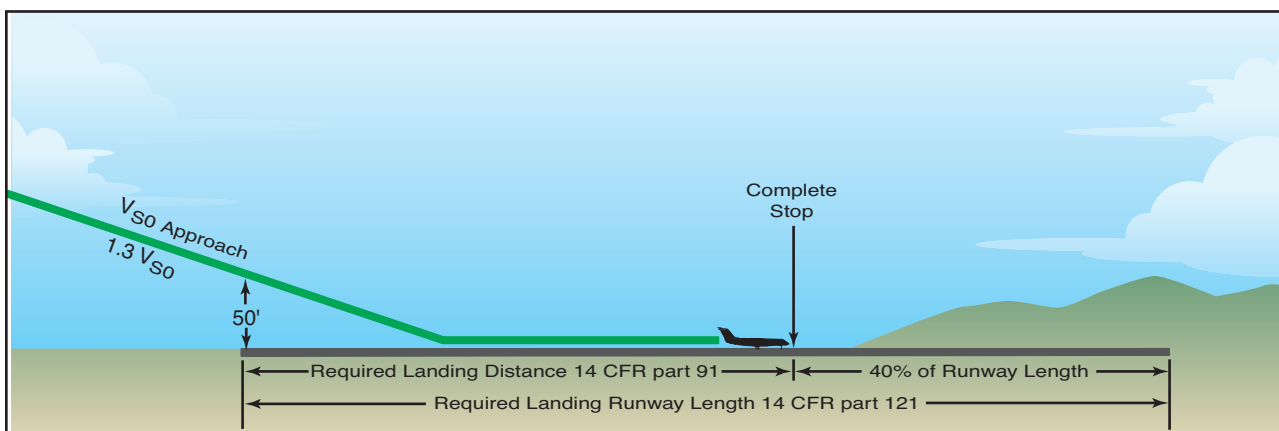
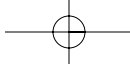
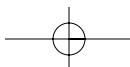


Figure 9-40. Landing runway requirements.



## **EXAMPLES OF PERFORMANCE CHARTS**

Figures 9-41 through 9-62 are examples of charts used for transport category airplanes.



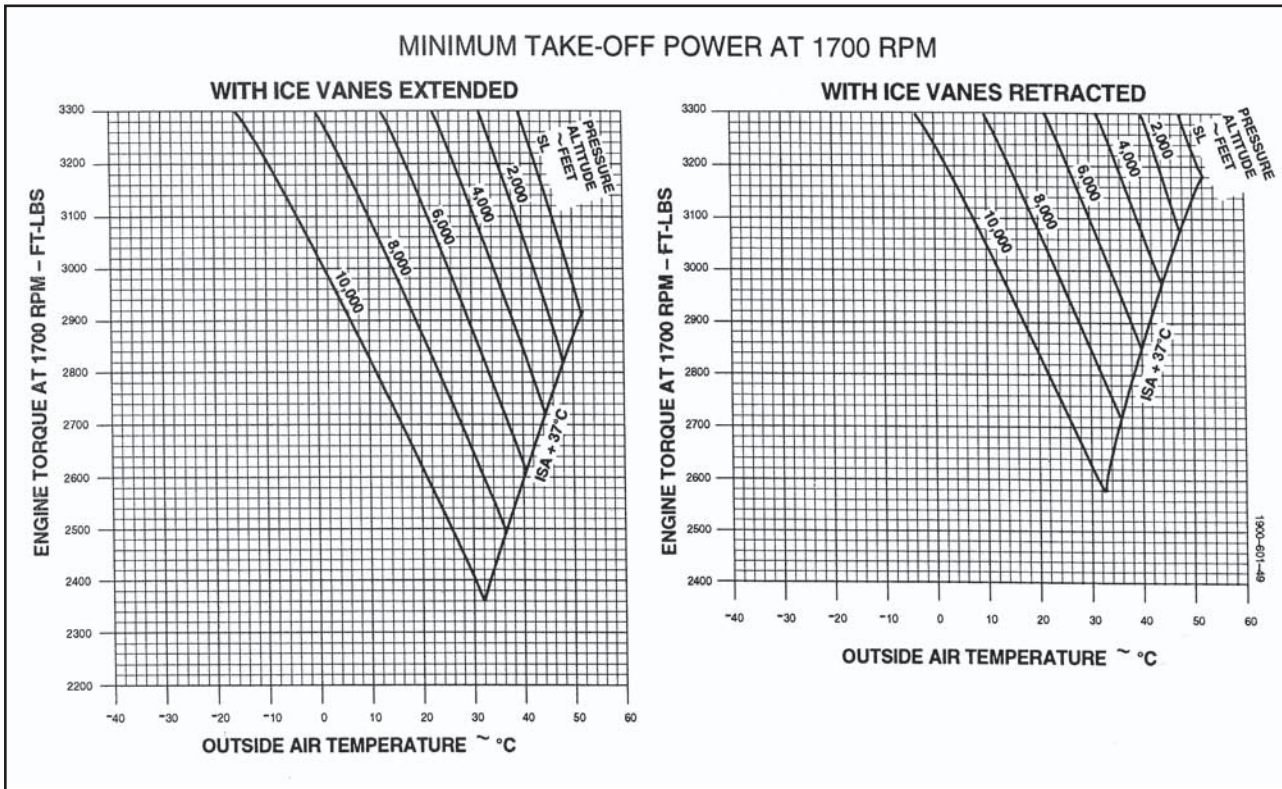
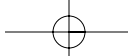


Figure 9-41. Minimum takeoff power at 1700 r.p.m.

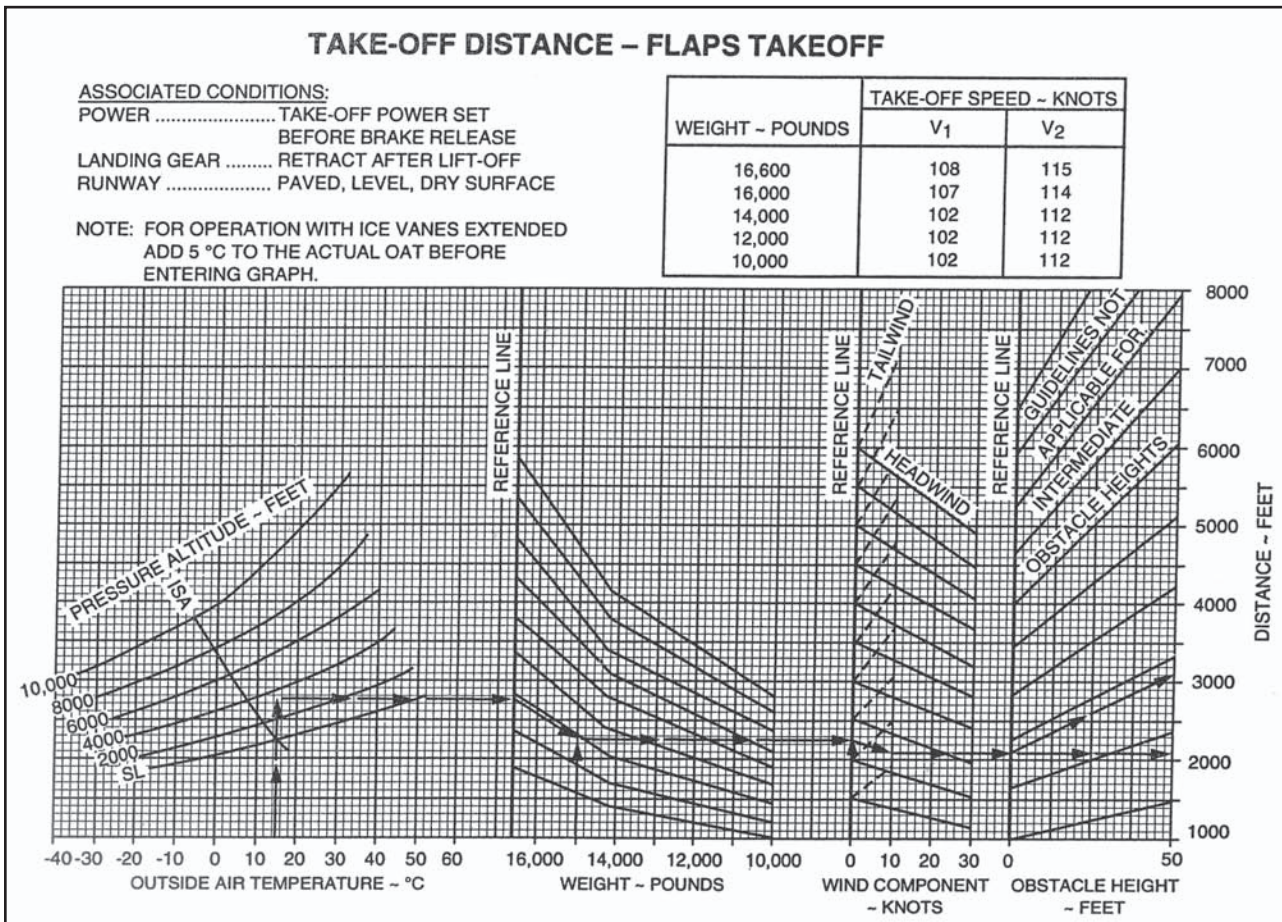
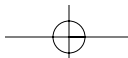


Figure 9-42. Takeoff distance—Flaps takeoff.





## ACCELERATE-STOP — FLAPS TAKEOFF

**ASSOCIATED CONDITIONS:**

- POWER ..... 1. TAKE-OFF POWER SET  
BEFORE BRAKE RELEASE
- 2. BOTH ENGINES IDLE AT V<sub>1</sub> SPEED
- AUTOFEATHER ..... ARMED
- BRAKING ..... MAXIMUM
- RUNWAY ..... PAVED, LEVEL, DRY SURFACE

WEIGHT - POUNDS	V <sub>1</sub> - KNOTS
16,600	108
16,000	107
14,000	102
12,000	102
10,000	102

NOTE: FOR OPERATION WITH ICE VANES EXTENDED,  
ADD 3 °C TO THE ACTUAL OAT BEFORE  
ENTERING GRAPH.

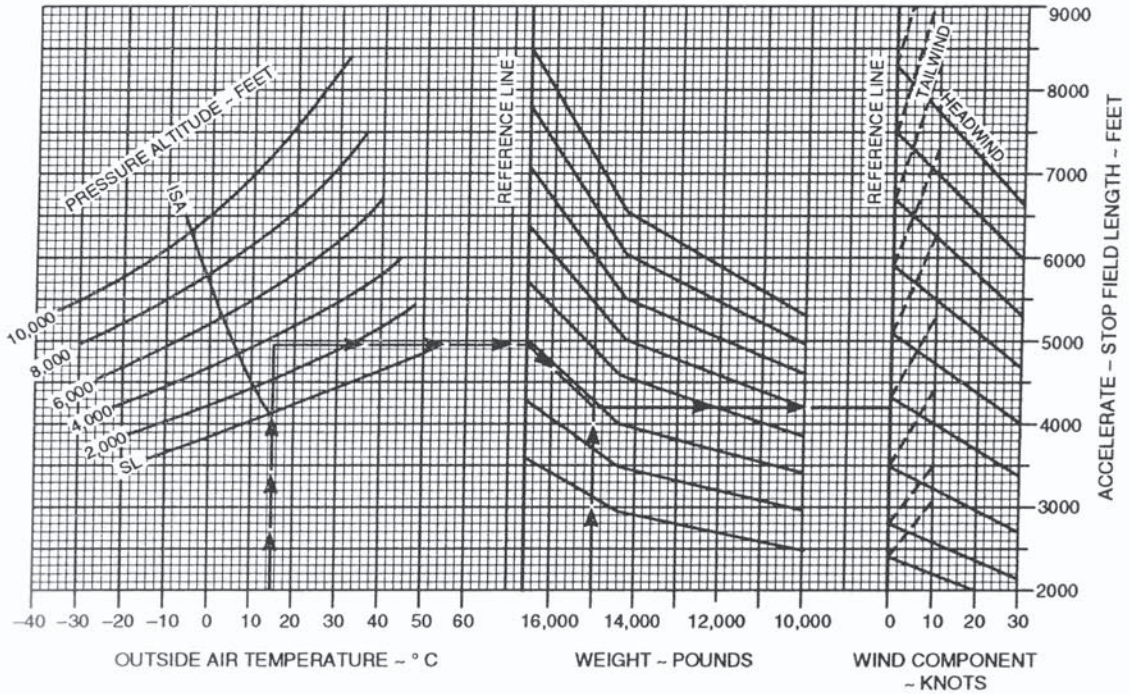
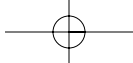


Figure 9-43. Accelerate stop—Flaps takeoff.



### CLIMB — TWO ENGINES — FLAPS UP

**ASSOCIATED CONDITIONS:**

POWER ..... MAXIMUM  
 CONTINUOUS  
 FLAPS ..... UP  
 LANDING GEAR ..... UP

WEIGHT - POUNDS	CLIMB SPEED - KNOTS
16,600	135
16,000	134
14,000	130
12,000	125
10,000	121

**EXAMPLE:**

OAT ..... -4 °C  
 PRESSURE ALTITUDE ..... 9,000 FT  
 WEIGHT ..... 14,500 LBS  
 RATE OF CLIMB ..... 2490 FT/MIN  
 CLIMB GRADIENT ..... 14.7 %  
 CLIMB SPEED ..... 131 KTS

NOTE: DURING OPERATION WITH ICE VANES EXTENDED, RATE OF CLIMB WILL BE REDUCED APPROXIMATELY 240 FEET PER MINUTE.

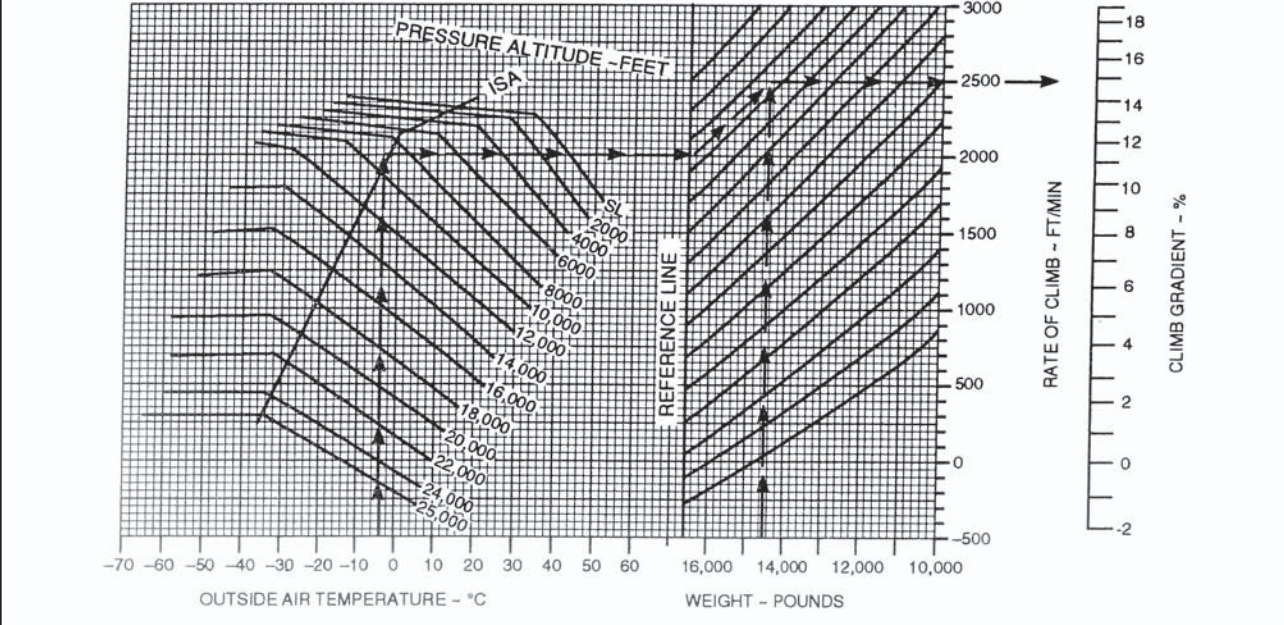
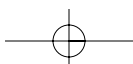


Figure 9-44. Climb – Two engines—Flaps up.



# TIME, FUEL, AND DISTANCE TO CRUISE CLIMB

**ASSOCIATED CONDITIONS:**

PROPELLER SPEED ..... 1550 RPM  
 POWER:  
 ITT ..... 750 °C  
 OR TORQUE ..... 3400 FT-LBS

ALTITUDE - FEET	CLIMB SPEED - KNOTS
SL TO 10,000	160
10,000 TO 15,000	150
15,000 TO 20,000	140
20,000 TO 25,000	130

**EXAMPLE:**

OAT AT TAKEOFF ..... 15 °C  
 OAT AT CRUISE ..... -10 °C  
 AIRPORT PRESSURE ALTITUDE ..... 3499 FT  
 CRUISE ALTITUDE ..... 11,000 FT  
 INITIAL CLIMB WEIGHT ..... 15,000 LBS  
 TIME TO CLIMB (4.8-8) ..... 4 MIN  
 FUEL TO CLIMB (93-25) ..... 68 LBS  
 DISTANCE TO CLIMB (13-2) ..... 11 NM

- NOTES: 1. ADD 110 LBS FUEL FOR START, TAXI, AND TAKEOFF  
 2. FOR OPERATION WITH ICE VANES EXTENDED, ADD 10 °C TO THE ACTUAL OAT BEFORE ENTERING THE GRAPH

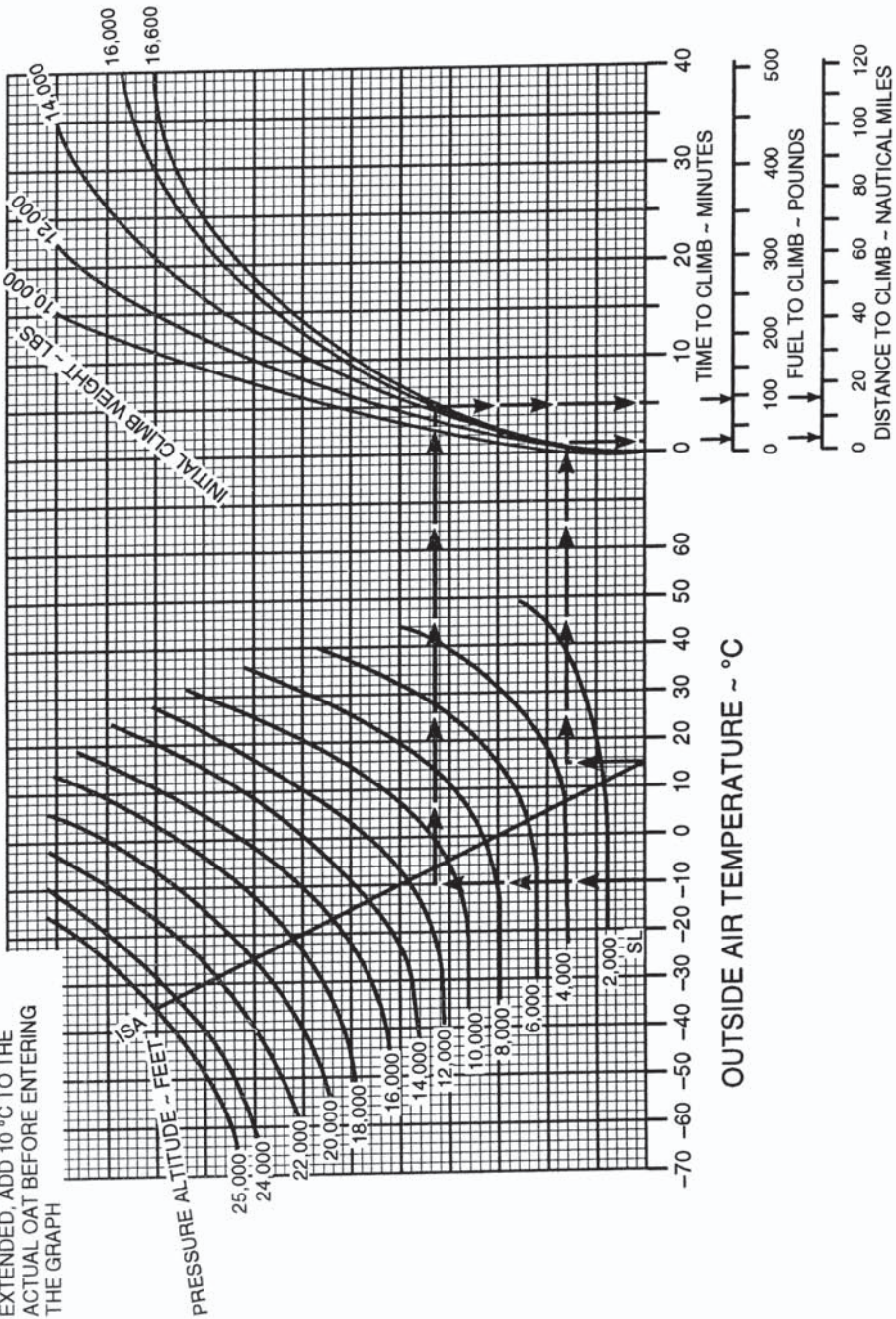


Figure 9-45. Time, fuel, and distance to cruise climb.

# CLIMB — ONE ENGINE INOPERATIVE

## BLEED AIR ON

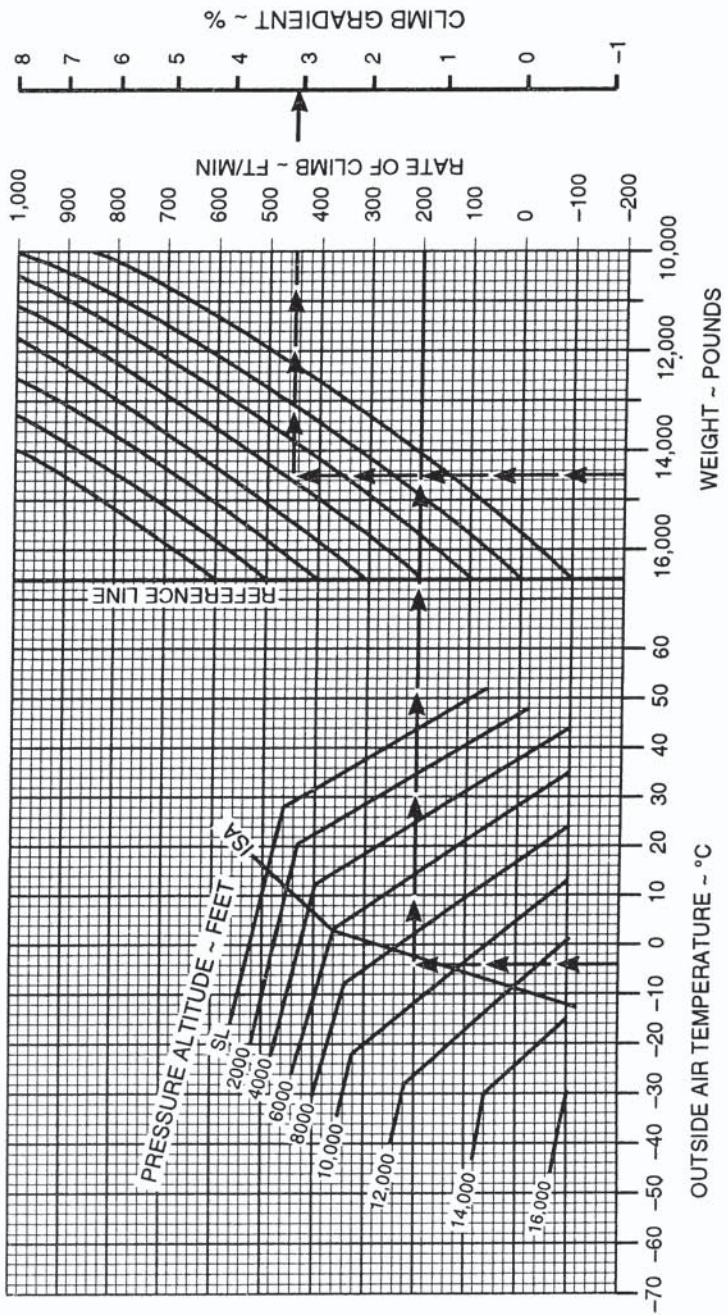
ASSOCIATED CONDITIONS:  
 POWER ..... MAXIMUM CONTINUOUS  
 FLAPS ..... UP  
 LANDING GEAR ..... UP  
 INOPERATIVE PROPELLER ..... FEATHERED

WEIGHT ~ POUNDS	CLIMB SPEED ~ KNOTS
16,600	125
16,000	124
14,000	119
12,000	116
10,000	112

EXAMPLE:

OAT ..... -4 °C  
 PRESSURE ALTITUDE ..... 9,000 FT  
 WEIGHT ..... 14,500 LBS  
 RATE OF CLIMB ..... 450 FT/MIN  
 CLIMB GRADIENT ..... 3.1 %  
 CLIMB SPEED ..... 120 KTS

NOTES: DURING OPERATION WITH ICE VANES EXTENDED, RATE OF CLIMB WILL BE REDUCED APPROXIMATELY 115 FEET PER MINUTE.



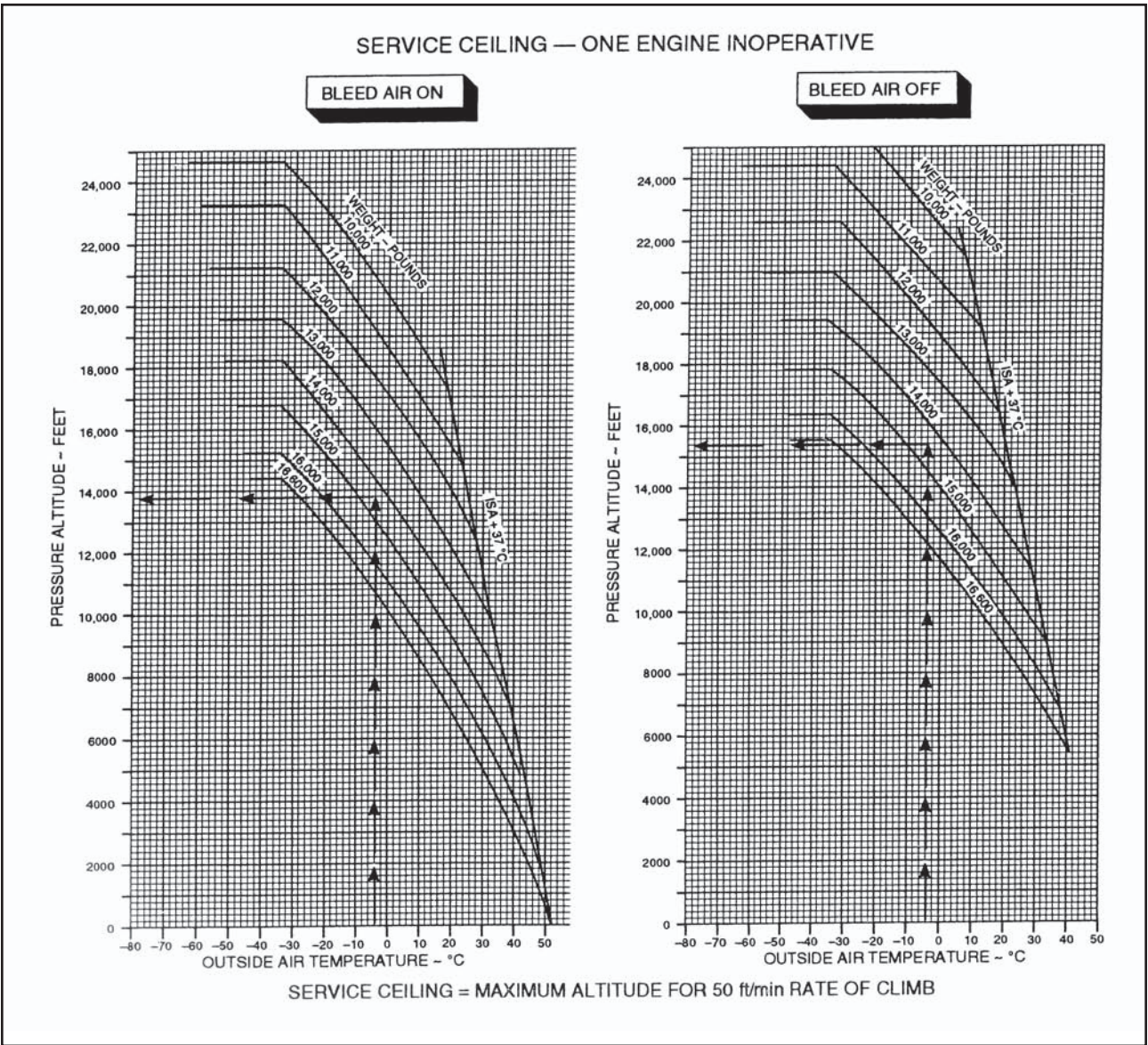


Figure 9-47. Service ceiling—One engine inoperative.

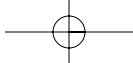
## RECOMMENDED CRUISE POWER

**1550 RPM**

**ISA +10 °C**

WEIGHT			16,000 POUNDS						14,000 POUNDS						12,000 POUNDS						10,000 POUNDS					
PRESSURE ALTITUDE	IOAT	OAT	TORQUE PER ENG	FUEL FLOW PER ENG	TOTAL FUEL FLOW	IAS	TAS	TORQUE PER ENG	FUEL FLOW PER ENG	TOTAL FUEL FLOW	IAS	TAS	TORQUE PER ENG	FUEL FLOW PER ENG	TOTAL FUEL FLOW	IAS	TAS	TORQUE PER ENG	FUEL FLOW PER ENG	TOTAL FUEL FLOW	IAS	TAS				
FEET	°C	°C	FT-LBS	LBS/HR	LBS/HR	KTS	KTS	FT-LBS	LBS/HR	LBS/HR	KTS	KTS	FT-LBS	LBS/HR	LBS/HR	KTS	KTS	FT-LBS	LBS/HR	LBS/HR	KTS	KTS				
SL	30	25	3294	577	1154	232	239	3301	577	1154	235	241	3307	577	1154	237	243	3312	577	1154	238	245				
2000	26	21	3191	551	1102	227	240	3198	551	1102	230	243	3204	552	1104	232	245	3209	552	1104	233	247				
4000	22	17	3092	527	1054	222	242	3100	528	1056	224	244	3106	528	1056	227	247	3111	528	1056	228	249				
6000	19	13	2992	504	1008	216	243	3000	505	1010	219	246	3006	505	1010	222	249	3012	505	1010	224	251				
8000	15	9	2886	481	962	211	244	2896	482	964	214	247	2903	482	964	216	250	2909	482	964	219	253				
10,000	11	5	2778	458	916	205	244	2789	458	916	208	248	2797	459	918	211	252	2804	459	918	213	254				
12,000	7	1	2636	432	864	198	243	2648	433	866	202	248	2657	433	866	205	252	2664	434	868	207	255				
14,000	3	-3	2495	408	816	190	241	2508	409	818	195	247	2518	409	818	198	251	2525	409	818	201	255				
16,000	-1	-7	2352	384	768	182	239	2367	385	770	188	246	2378	385	770	192	251	2386	386	772	195	255				
18,000	-6	-11	2208	361	722	174	235	2226	362	724	180	243	2239	363	726	185	250	2248	363	726	188	254				
20,000	-10	-15	2063	338	676	164	229	2085	340	680	172	240	2100	341	682	177	248	2111	341	682	181	253				
22,000	-14	-19	1911	316	632	153	221	1939	317	634	163	235	1957	319	638	169	245	1969	319	638	174	252				
24,000	-19	-23	1749	292	584	137	206	1790	295	590	152	229	1812	297	594	161	241	1827	298	596	167	249				
25,000	-21	-25	1649	279	558	122	187	1714	284	568	147	224	1739	286	572	156	238	1756	287	574	163	248				

Figure 9-48. Recommended cruise power—ISA +10° C



## TIME, FUEL, AND DISTANCE TO DESCEND AT 200 KNOTS

**ASSOCIATED CONDITIONS:**

POWER ..... AS REQUIRED TO  
DESCEND AT  
1500 FT/MIN  
LANDING GEAR ..... UP  
FLAPS ..... UP

**EXAMPLE**

INITIAL ALTITUDE ..... 11,000 FT  
FINAL ALTITUDE ..... 5,998 FT  
TIME TO DESCEND (7.4-4.1) ..... 3.3 MIN  
FUEL TO DESCEND (74-41) ..... 33 LBS  
DISTANCE TO DESCEND (26-13) ..... 13 NM

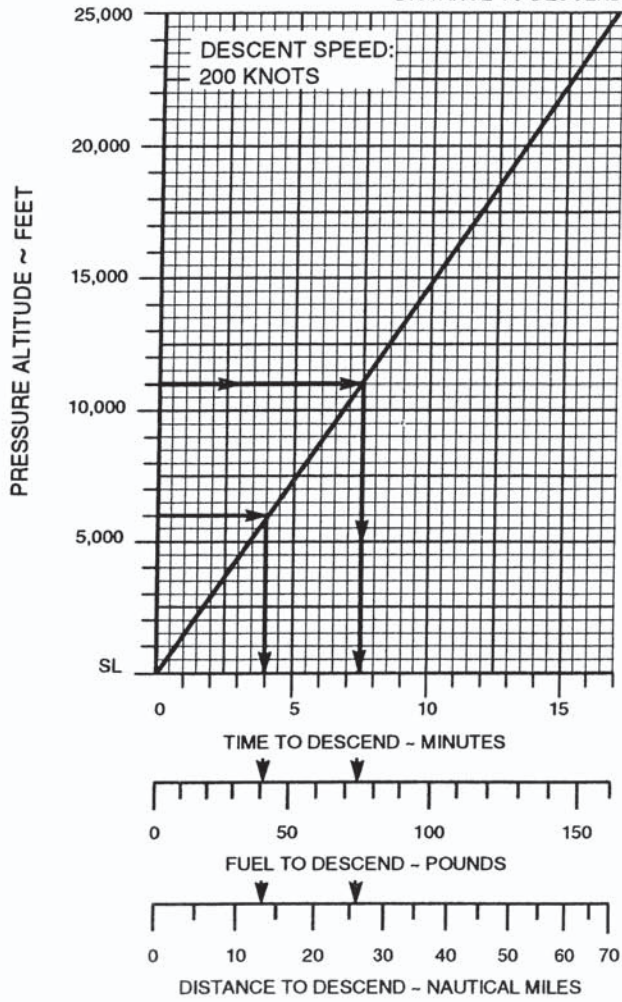
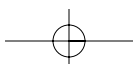


Figure 9-49. Time, fuel, and distance to descend.



# NORMAL LANDING DISTANCE — FLAPS LANDING ANTI-SKID ON

**EXAMPLE:**

OAT ..... 25 °C  
 PRESSURE ALTITUDE ..... 5998 FT  
 LANDING WEIGHT ..... 14,182 LBS  
 HEADWIND COMPONENT ..... 10 KTS  
 GROUND ROLL ..... 1150 FT  
 TOTAL OVER 50-FT OBSTACLE ..... 2195 FT  
 APPROACH SPEED ..... 108 KTS

WEIGHT - POUNDS	APPROACH SPEED - KNOTS
16,100	113
14,000	107
12,000	101
10,000	93

**ASSOCIATED CONDITIONS:**  
 POWER ..... RETARD TO MAINTAIN 800 FT/MIN ON FINAL APPROACH  
 RUNWAY ..... PAVED, LEVEL, DRY SURFACE  
 APPROACH SPEED ..... IAS AS TABULATED  
 BRAKING ..... MAXIMUM

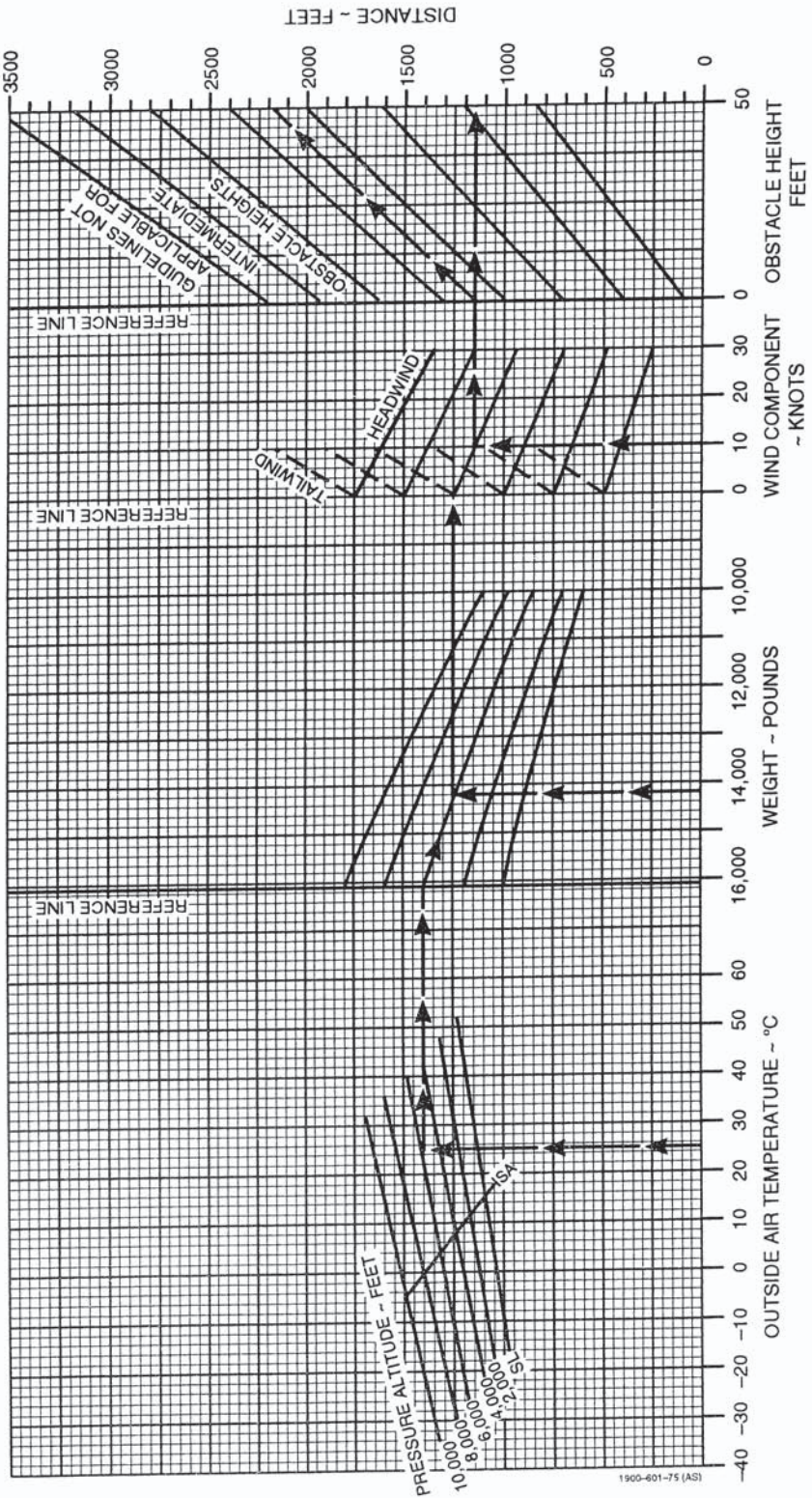


Figure 9-50. Normal landing distance—Flaps landing.



### MODEL DC-9 TAKEOFF SPEEDS JT8D-1 ENGINES

TAKEOFF SPEED – 20 ° FLAPS								
EITHER NO ICE PROTECTION OR ENGINE ICE PROTECTION ONLY								
TAKEOFF WEIGHT (1000 LB)	60	65	70	75	80	85	90	95
$V_1$ (KNOTS, IAS)	104.0	110.0	115.0	120.5	125.0	129.5	133.5	136.0
$V_R$ (KNOTS, IAS)	106.5	112.5	118.0	123.5	129.0	134.0	139.0	143.5
$V_2$ (KNOTS, IAS)	117.0	121.5	126.5	130.5	135.0	139.0	143.0	147.0

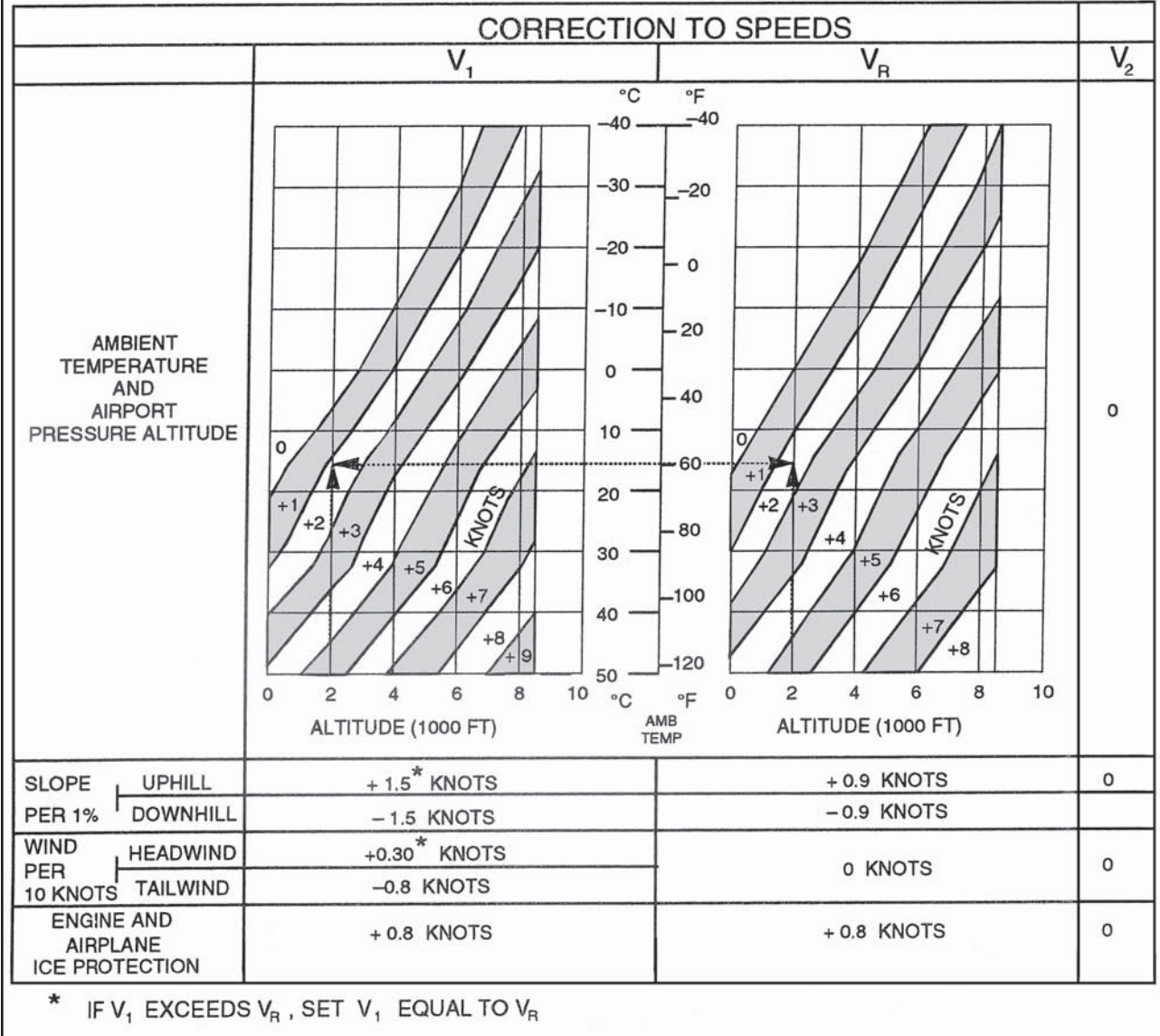


Figure 9-51. DC-9—Takeoff speeds.

**TIME, FUEL, AND DISTANCE TO CLIMB  
JT8D-1 ENGINES - NORMAL BLEED  
DC-9 SERIES 10 - LONG RANGE CLIMB SCHEDULE  
CLIMB AT 290 KNOTS IAS TO 26860 FT ALTITUDE THEN CLIMB AT M .72**

INITIAL WEIGHT = 78000. POUNDS				INITIAL WEIGHT = 82000. POUNDS			
PRES. ALT. FEET	TIME MIN.	FUEL BURNED LB.	DIST. N. MI.	PRES. ALT. FEET	TIME MIN.	FUEL BURNED LB.	DIST. N. MI.
0.	0.	0.	0.	0.	0.	0.	0.
2000.	0.5	113.	2.2	2000.	0.5	120.	2.4
4000.	0.9	227.	4.6	4000.	1.0	241.	4.9
6000.	1.5	342.	7.3	6000.	1.5	363.	7.7
8000.	2.0	457.	10.2	8000.	2.1	486.	10.8
10000.	2.6	574.	13.3	10000.	2.7	610.	14.2
12000.	3.2	693.	16.8	12000.	3.4	737.	17.9
14000.	3.9	815.	20.7	14000.	4.1	868.	22.1
16000.	4.6	941.	25.0	16000.	4.9	1002.	26.7
18000.	5.4	1070.	29.9	18000.	5.7	1141.	31.9
20000.	6.3	1205.	35.4	20000.	6.7	1286.	37.9
22000.	7.2	1347.	41.7	22000.	7.7	1439.	44.6
24000.	8.3	1498.	49.0	24000.	8.9	1602.	52.5
26000.	9.5	1661.	57.6	26000.	10.2	1780.	61.9
26860.	10.1	1736.	61.8	26860.	10.9	1863.	66.5
26860.	10.1	1736.	61.8	26860.	10.9	1863.	66.5
28000.	10.7	1813.	66.2	28000.	11.6	1948.	71.4
30000.	11.9	1953.	74.6	30000.	12.9	2104.	80.8
32000.	13.3	2102.	84.2	32000.	14.4	2274.	91.7
34000.	14.9	2267.	95.4	34000.	16.3	2464.	104.6
36000.	16.9	2456.	109.2	36000.	18.7	2693.	121.3

INITIAL WEIGHT = 80000. POUNDS				INITIAL WEIGHT = 84000. POUNDS			
PRES. ALT. FEET	TIME MIN.	FUEL BURNED LB.	DIST. N. MI.	PRES. ALT. FEET	TIME MIN.	FUEL BURNED LB.	DIST. N. MI.
0.	0.	0.	0.	0.	0.	0.	0.
2000.	0.5	117.	2.3	2000.	0.5	124.	2.4
4000.	1.0	234.	4.8	4000.	1.0	248.	5.1
6000.	1.5	352.	7.5	6000.	1.6	374.	8.0
8000.	2.1	471.	10.5	8000.	2.2	500.	11.1
10000.	2.7	592.	13.7	10000.	2.8	629.	14.6
12000.	3.3	715.	17.4	12000.	3.5	760.	18.5
14000.	4.0	841.	21.4	14000.	4.2	894.	22.8
16000.	4.7	971.	25.9	16000.	5.1	1033.	27.6
18000.	5.6	1105.	30.9	18000.	5.9	1177.	33.0
20000.	6.5	1245.	36.6	20000.	6.9	1327.	39.1
22000.	7.5	1392.	43.2	22000.	8.0	1486.	46.2
24000.	8.6	1549.	50.7	24000.	9.2	1656.	54.4
26000.	9.9	1719.	59.7	26000.	10.6	1841.	64.1
26860.	10.5	1798.	64.1	26860.	11.3	1928.	69.0
26860.	10.5	1798.	64.1	26860.	11.3	1928.	69.0
28000.	11.1	1879.	68.7	28000.	12.0	2018.	74.1
30000.	12.4	2027.	77.7	30000.	13.4	2183.	84.1
32000.	13.8	2186.	87.8	32000.	15.0	2364.	95.7
34000.	15.6	2362.	99.8	34000.	17.1	2570.	109.7
36000.	17.7	2570.	114.9	36000.	19.7	2826.	128.3

Figure 9-52. Long range climb schedule.

<b>ALTERNATE PLANNING CHART</b>													
DIST. - NAM	20	30	40	50	60	70	80	90	100	110	120	130	140
OPTM. ALT.	2000	3000	4000	5000	6000	7000	8000	9000	10000	11000	12000	13000	14000
TIME:	:16	:17	:19	:20	:22	:23	:25	:26	:28	:29	:30	:32	:33
FUEL	2500	2600	2700	2800	2900	3000	3100	3200	3300	3400	3500	3600	3700
TAS	275	280	283	286	289	292	296	300	303	306	309	312	315
DIST. NAM	150	160	170	180	190	200	210	220	230	240	250	260	270
OPTM. ALT.	15000	16000	17000	18000	19000	20000	21000	22000	23000	24000	25000	26000	27000
TIME:	:35	:36	:38	:39	:40	:42	:43	:45	:46	:48	:49	:50	:52
FUEL	3800	3900	4000	4100	4200	4300	4400	4500	4600	4700	4800	4900	5000
TAS	319	323	326	330	334	338	341	345	349	353	357	361	365
DIST. - NAM	280	290	300	310	320	330	340	350	360	370	380	390	400
OPTM. ALT.	27000	28000	28000	29000	29000	30000	30000	31000	31000	31000	31000	31000	31000
TIME:	:53	:55	:56	:58	:59	1:00	1:02	1:03	1:04	1:05	1:07	1:08	1:10
FUEL	5150	5250	5350	5450	5600	5700	5800	5900	6050	6150	6250	6350	6500
TAS	368	372	376	380	385	388	392	397	397	397	397	397	397
<b>NOTES:</b>													
1. Fuel includes 1/2 climb distance en route credit, fuel to cruise remaining distance at LRC schedule, 15 minutes holding at alternate, and 800 lbs. for descent.													
2. Time includes 1/2 climb distance credit, time to cruise distance shown at LRC schedule and 8 minutes for descent. 15 minutes holding is not included in time.													

Figure 9-53. Alternate planning chart.

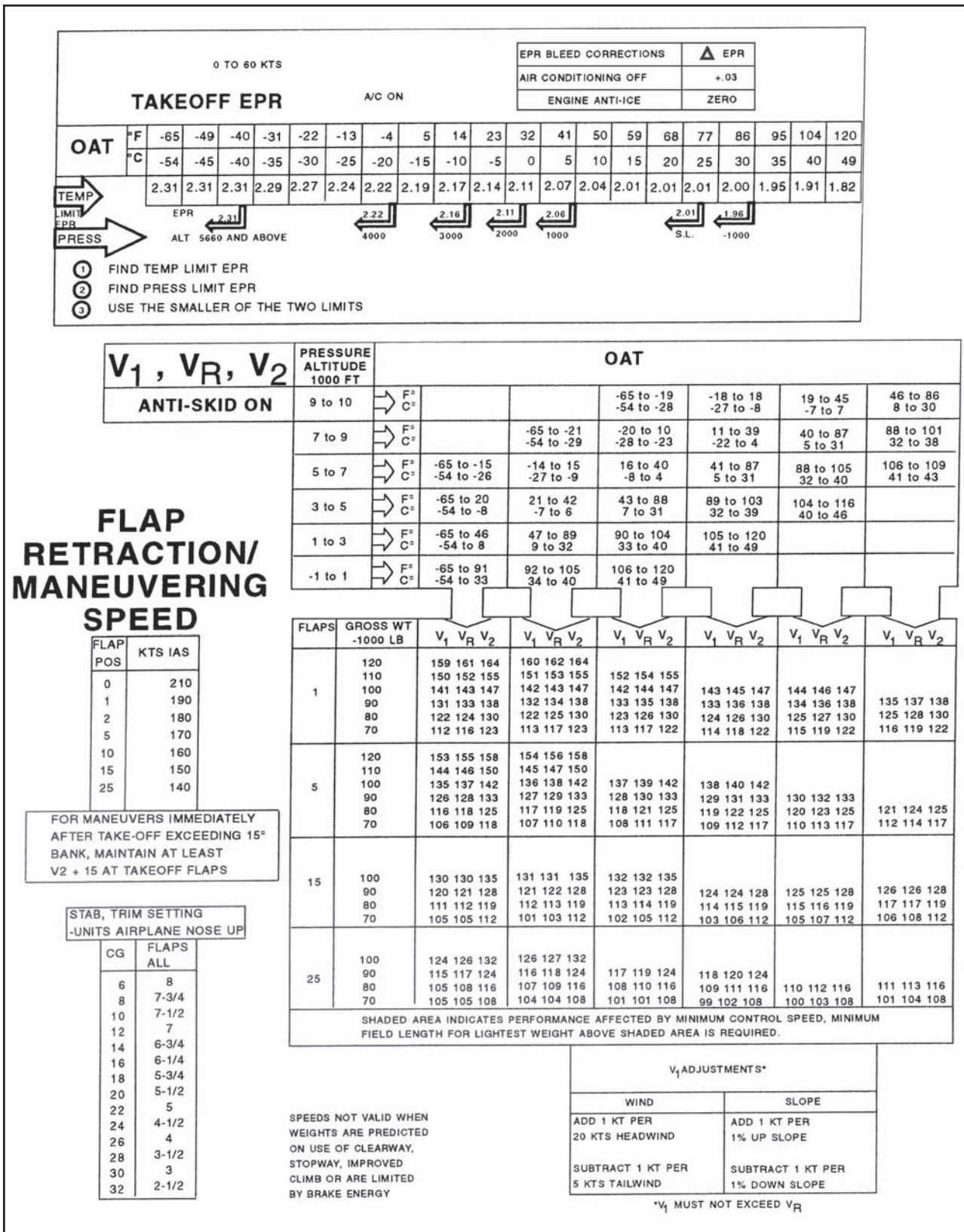


Figure 9-54. B-737—Takeoff performance.

### EN ROUTE CLIMB 280/.70 ISA +10 °C

PRESSURE ALTITUDE - FT	UNITS MIN/LB NM/KNOTS	BRAKE RELEASE WEIGHT - LB										
		120000	115000	110000	105000	100000	95000	90000	85000	80000	75000	65000
37000	TIME/FUEL DIST./TAS			42/5700 263/395	34/4700 206/391	29/4100 174/389	25/3700 151/388	23/3300 133/386	20/3000 119/385	18/2700 107/384	16/2500 96/384	13/2100 78/382
36000	TIME/FUEL DIST./TAS		43/5900 266/394	35/5000 211/391	30/4400 179/389	26/3900 156/387	23/3500 138/385	21/3200 123/384	19/2900 111/383	17/2700 100/383	16/2400 90/382	13/2000 74/381
35000	TIME/FUEL DIST./TAS	45/6200 275/394	36/5300 219/390	31/4600 186/388	27/4100 162/386	24/3700 143/385	22/3400 128/384	20/3100 115/383	10/2800 104/382	16/2600 94/381	15/2400 85/380	12/2000 70/379
34000	TIME/FUEL DIST./TAS	38/5600 228/390	32/4900 193/387	28/4400 168/386	25/3900 149/384	23/3600 133/383	21/3300 120/382	19/3000 108/381	17/2700 98/380	16/2500 89/379	14/2300 81/379	12/1900 67/378
33000	TIME/FUEL DIST./TAS	34/5100 200/387	30/4600 174/385	26/4100 154/383	24/3800 138/382	22/3400 124/381	20/3100 113/380	18/2900 102/379	16/2600 93/378	15/2400 85/378	14/2200 77/377	11/1900 64/376
32000	TIME/FUEL DIST./TAS	31/4800 180/384	28/4400 160/382	25/4000 143/381	23/3600 129/379	21/3300 116/378	19/3000 106/378	17/2800 96/377	16/2600 88/376	14/2400 80/376	13/2200 73/375	11/1800 61/374
31000	TIME/FUEL DIST./TAS	29/4600 165/381	26/4200 147/379	23/3800 133/378	21/3500 120/377	20/3200 109/376	18/2900 100/375	16/2700 91/375	15/2500 83/374	14/2300 76/374	13/2100 70/373	11/1800 58/372
30000	TIME/FUEL DIST./TAS	27/4400 152/378	24/4000 137/376	22/3700 124/375	20/3400 113/374	19/3100 103/374	17/2900 94/373	16/2600 86/372	14/2400 79/372	13/2200 72/371	12/2100 66/371	10/1700 55/370
29000	TIME/FUEL DIST./TAS	25/4200 141/375	23/3800 128/374	21/3500 116/373	19/3200 106/372	18/3000 97/371	16/2800 89/370	15/2600 82/370	14/2400 75/369	13/2200 69/369	12/2000 63/369	10/1700 52/368
28000	TIME/FUEL DIST./TAS	24/4000 131/371	22/3700 119/370	20/3400 109/369	18/3100 100/369	17/2900 91/368	16/2700 84/368	14/2500 77/367	13/2300 71/367	12/2100 65/366	11/1900 60/366	9/1600 50/365
27000	TIME/FUEL DIST./TAS	22/3800 121/368	21/3500 111/367	19/3300 102/366	18/3000 93/366	16/2800 86/365	15/2600 79/364	14/2400 73/364	13/2200 67/364	12/2000 61/363	11/1900 56/363	9/1600 47/363
26000	TIME/FUEL DIST./TAS	21/3600 110/363	19/3400 101/362	18/3100 93/362	16/2900 86/361	15/2700 79/361	14/2500 73/360	13/2300 67/360	12/2100 62/360	11/2000 57/359	10/1800 52/359	9/1500 44/359
25000	TIME/FUEL DIST./TAS	19/3400 101/358	18/3200 93/358	17/3000 85/357	15/2800 79/357	14/2600 73/357	13/2400 67/356	12/2200 62/356	11/2000 57/356	10/1900 53/356	10/1700 48/355	8/1500 41/355
24000	TIME/FUEL DIST./TAS	18/3300 92/354	17/3000 85/354	16/2800 78/353	15/2600 72/353	13/2400 67/353	12/2300 62/352	12/2100 57/352	11/1900 53/352	10/1800 49/352	9/1700 45/352	8/1400 38/351
23000	TIME/FUEL DIST./TAS	17/3100 84/350	16/2900 78/350	15/2900 72/350	14/2500 67/349	13/2300 62/349	12/2200 57/349	11/2000 53/349	10/1900 49/348	9/1700 45/348	9/1600 42/348	7/1300 35/348
22000	TIME/FUEL DIST./TAS	16/3000 77/346	15/2800 71/346	14/2600 66/346	13/2400 61/346	12/2200 57/345	11/2100 53/345	10/1900 49/345	10/1800 45/345	9/1700 42/345	8/1500 38/345	7/1300 32/344
6000	TIME/FUEL DIST./TAS	5/1100 10/301	4/1000 10/301	4/900 9/301	4/900 9/301	4/800 8/301	3/800 8/301	3/700 7/301	3/700 7/301	3/600 6/301	3/600 6/301	2/500 5/301
1500	TIME/FUEL	3/600	2/600	2/500	2/500	2/500	2/500	2/400	2/400	2/400	1/300	1/300
<b>FUEL ADJUSTMENT FOR HIGH ELEVATION AIRPORTS</b>						<b>AIRPORT ELEVATION</b>	<b>2000</b>	<b>4000</b>	<b>6000</b>	<b>8000</b>	<b>10000</b>	<b>12000</b>
<b>EFFECT ON TIME AND DISTANCE IS NEGLIGIBLE</b>						<b>FUEL ADJUSTMENT</b>	<b>-100</b>	<b>-300</b>	<b>-400</b>	<b>-500</b>	<b>-600</b>	<b>-800</b>

Figure 9-55. En route climb 280/.70 ISA.

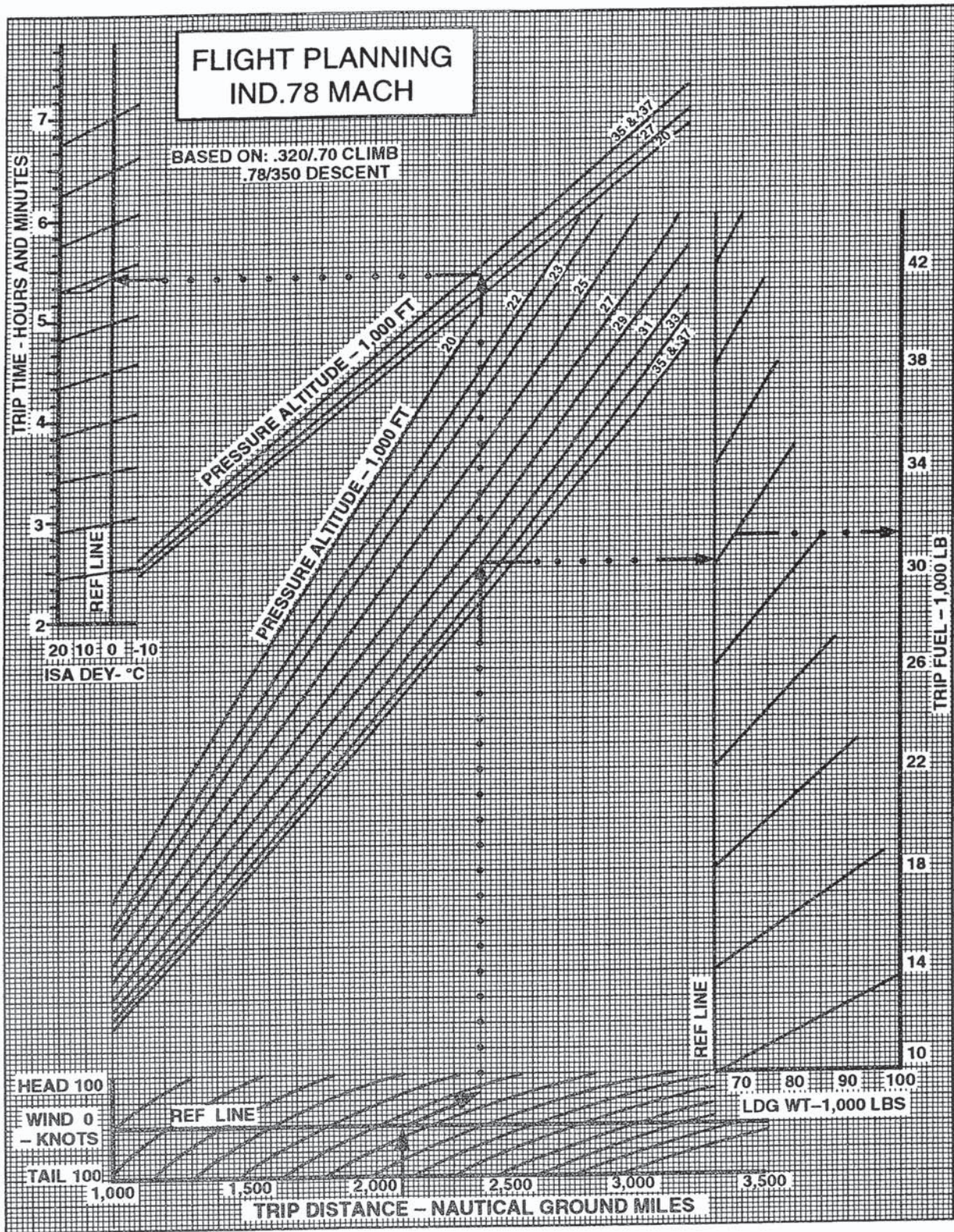


Figure 9-56. B-737—Flight planning .78 mach indicated.

# 1 ENGINE INOP

**ENGINE A/I OFF**

GROSS WEIGHT 1000 LB		OPTIMUM DRIFTDOWN SPEED KIAS	ISA DEV °C			
AT ENGINE FAILURE	AT LEVEL OFF (APPROX)		-10	0	10	20
APPROX GROSS LEVEL OFF PRESS ALT FT						
80	77	184	27900	26800	25400	22800
90	86	195	25000	23800	21700	20000
100	96	206	22000	20500	20000	18500
110	105	216	20000	19100	17500	15400
120	114	224	18200	16600	14700	12200

**ENGINE A/I ON**

GROSS WEIGHT 1000 LB		OPTIMUM DRIFTDOWN SPEED KIAS	ISA DEV °C			
AT ENGINE FAILURE	AT LEVEL OFF (APPROX)		-10	0	10	20
APPROX GROSS LEVEL OFF PRESS ALT FT						
80	77	184	25500	24600	22800	20000
90	86	195	23000	21400	20000	19400
100	96	206	20000	19400	18700	15600
110	105	216	18100	16600	14700	12200
120	114	224	15500	13800	11800	8800

**ENGINE AND WING A/I ON**

GROSS WEIGHT 1000 LB		OPTIMUM DRIFTDOWN SPEED KIAS	ISA DEV °C			
AT ENGINE FAILURE	AT LEVEL OFF (APPROX)		-10	0	10	20
APPROX GROSS LEVEL OFF PRESS ALT FT						
80	77	184	24400	23400	21400	20000
90	86	195	21600	20100	19800	18000
100	96	206	19600	18000	16400	14200
110	105	216	16800	15100	13300	10700
120	114	224	14000	12200	10300	7200

**NOTE:**

WHEN ENGINE BLEED FOR AIR CONDITIONING  
IS OFF BELOW 17,000 FT., INCREASE  
LEVEL-OFF ALTITUDE BY 800 FT.

Figure 9-57. Drift-down performance chart.

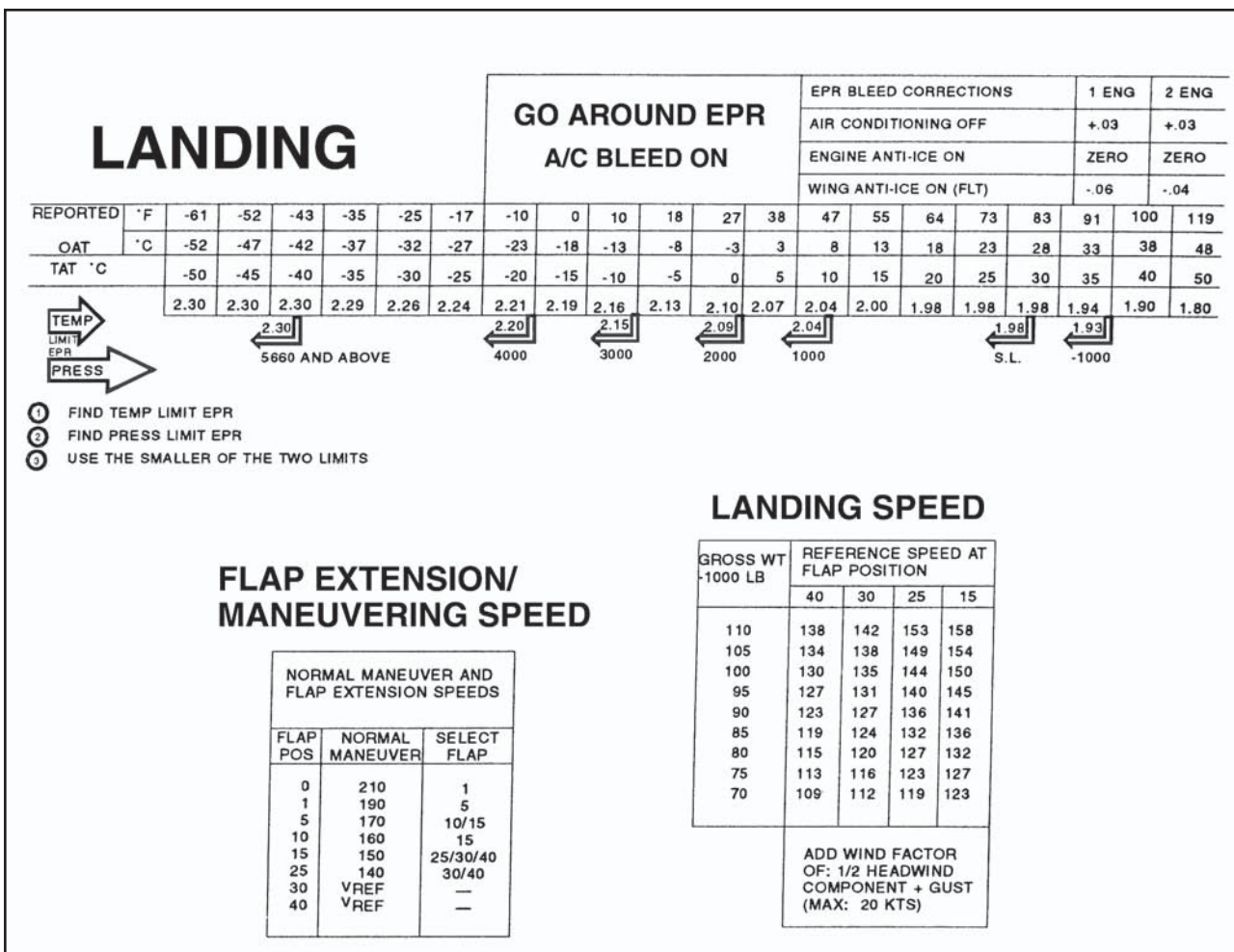


Figure 9-58. Landing performance chart.





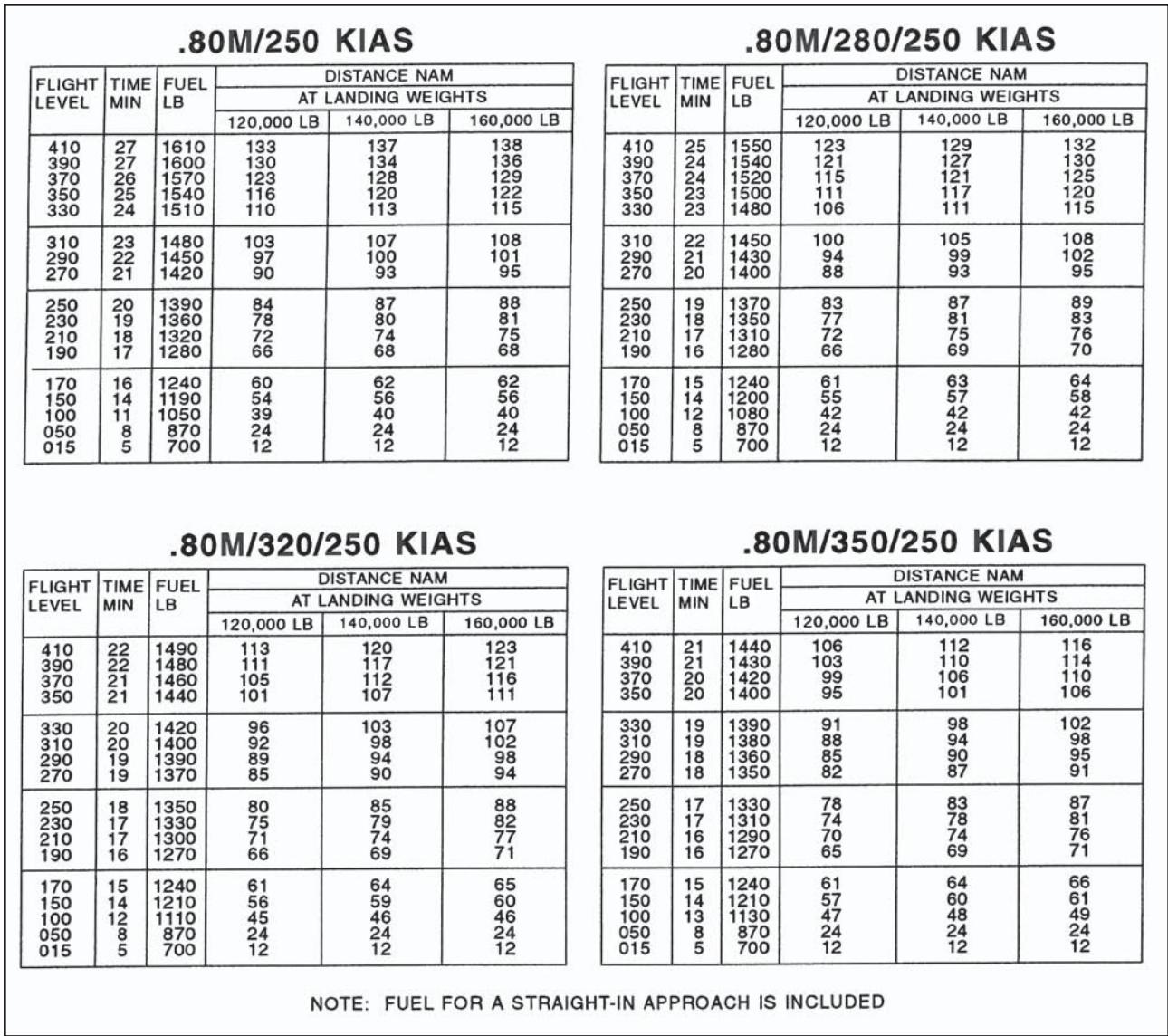
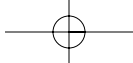
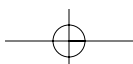
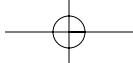


Figure 9-60. Descent performance chart.

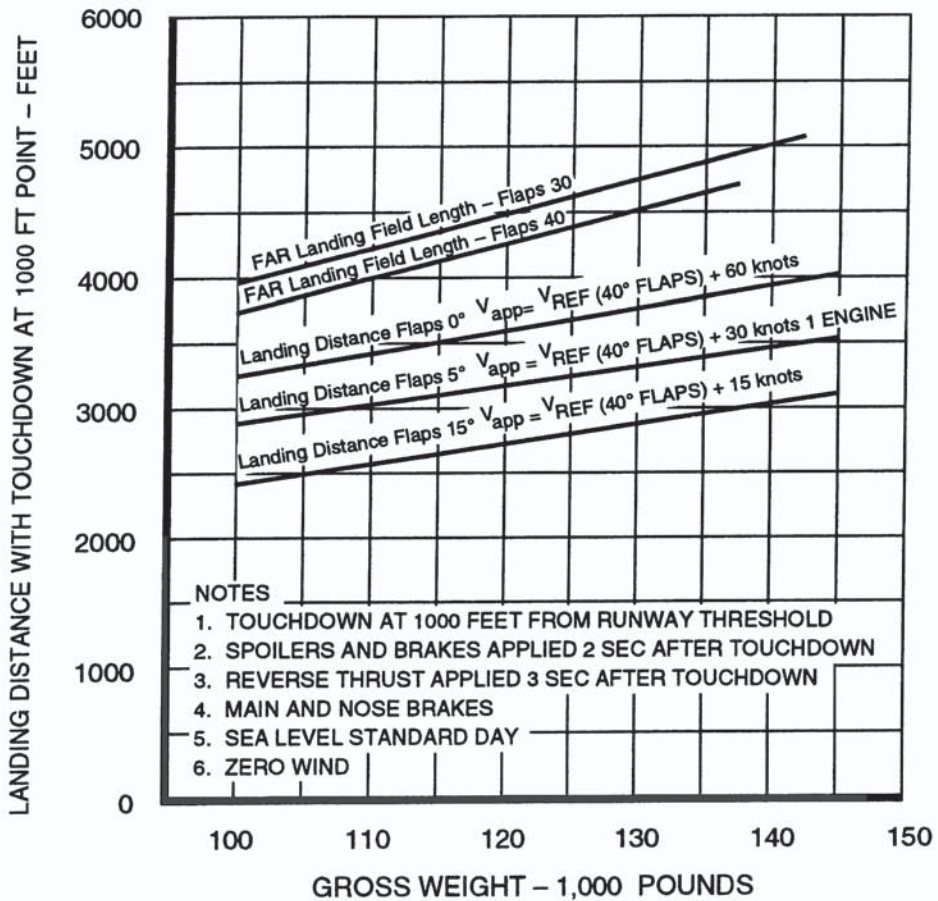




**LANDING DISTANCE COMPARISON**

FLAPS 0  
 FLAPS 5  
 FLAPS 15

TOUCHDOWN AT 1000 FEET FROM RUNWAY THRESHOLD  
 SPOILERS AND BRAKES APPLIED 2 SECONDS AFTER TOUCHDOWN  
 REVERSE THRUST APPLIED 3 SECONDS AFTER TOUCHDOWN  
 MAIN AND NOSE BRAKES  
 SEA LEVEL, STANDARD DAY  
 ZERO WIND, DRY RUNWAY  
 ANTI-SKID OPERATIVE

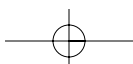


- NOTES**
1. TOUCHDOWN AT 1000 FEET FROM RUNWAY THRESHOLD
  2. SPOILERS AND BRAKES APPLIED 2 SEC AFTER TOUCHDOWN
  3. REVERSE THRUST APPLIED 3 SEC AFTER TOUCHDOWN
  4. MAIN AND NOSE BRAKES
  5. SEA LEVEL STANDARD DAY
  6. ZERO WIND

TRAINING INFORMATION ONLY REPRESENTATIVE

**NORMAL LANDING**

Figure 9-61. B-727—Normal landing distance comparison.



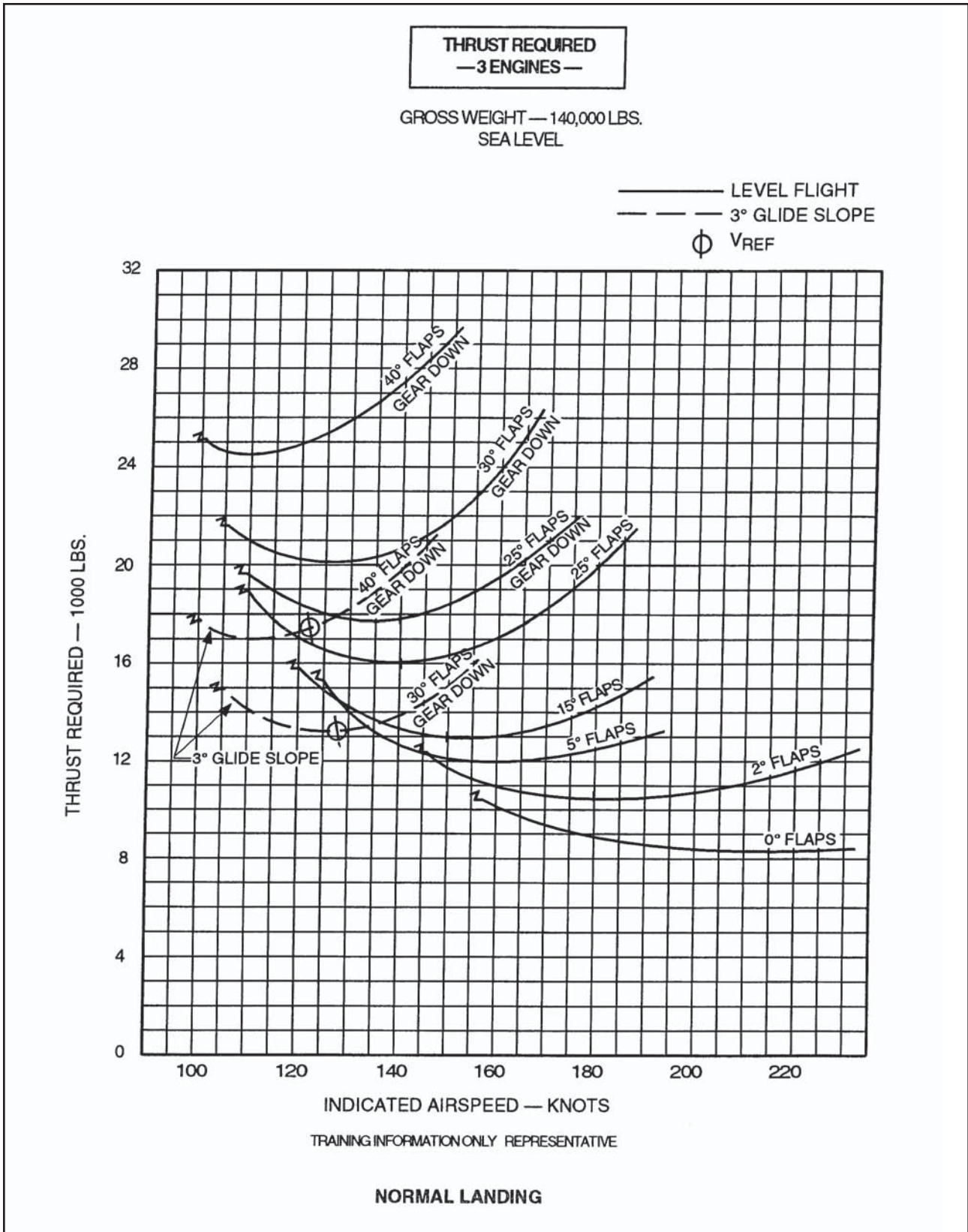
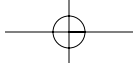


Figure 9-62. B-727—Landing thrust—140,000 pounds.

