

**DRAFT  
TOXICOLOGICAL PROFILE FOR  
DICHLOROPROPENES**

U.S. DEPARTMENT OF HEALTH AND HUMAN SERVICES  
Public Health Service  
Agency for Toxic Substances and Disease Registry

September 2006

## DISCLAIMER

The use of company or product name(s) is for identification only and does not imply endorsement by the Agency for Toxic Substances and Disease Registry.

This information is distributed solely for the purpose of pre dissemination public comment under applicable information quality guidelines. It has not been formally disseminated by the Agency for Toxic Substances and Disease Registry. It does not represent and should not be construed to represent any agency determination or policy.

## UPDATE STATEMENT

A Toxicological Profile for 1,3-Dichloropropene was released in 1992. This edition supersedes any previously released draft or final profile.

Toxicological profiles are revised and republished as necessary. For information regarding the update status of previously released profiles, contact ATSDR at:

Agency for Toxic Substances and Disease Registry  
Division of Toxicology and Environmental Medicine/Applied Toxicology Branch  
1600 Clifton Road NE  
Mailstop F-32  
Atlanta, Georgia 30333

This page is intentionally blank.

## FOREWORD

This toxicological profile is prepared in accordance with guidelines developed by the Agency for Toxic Substances and Disease Registry (ATSDR) and the Environmental Protection Agency (EPA). The original guidelines were published in the *Federal Register* on April 17, 1987. Each profile will be revised and republished as necessary.

The ATSDR toxicological profile succinctly characterizes the toxicologic and adverse health effects information for the hazardous substance described therein. Each peer-reviewed profile identifies and reviews the key literature that describes a hazardous substance's toxicologic properties. Other pertinent literature is also presented, but is described in less detail than the key studies. The profile is not intended to be an exhaustive document; however, more comprehensive sources of specialty information are referenced.

The focus of the profiles is on health and toxicologic information; therefore, each toxicological profile begins with a public health statement that describes, in nontechnical language, a substance's relevant toxicological properties. Following the public health statement is information concerning levels of significant human exposure and, where known, significant health effects. The adequacy of information to determine a substance's health effects is described in a health effects summary. Data needs that are of significance to protection of public health are identified by ATSDR and EPA.

Each profile includes the following:

- (A) The examination, summary, and interpretation of available toxicologic information and epidemiologic evaluations on a hazardous substance to ascertain the levels of significant human exposure for the substance and the associated acute, subacute, and chronic health effects;
- (B) A determination of whether adequate information on the health effects of each substance is available or in the process of development to determine levels of exposure that present a significant risk to human health of acute, subacute, and chronic health effects; and
- (C) Where appropriate, identification of toxicologic testing needed to identify the types or levels of exposure that may present significant risk of adverse health effects in humans.

The principal audiences for the toxicological profiles are health professionals at the Federal, State, and local levels; interested private sector organizations and groups; and members of the public. We plan to revise these documents in response to public comments and as additional data become available. Therefore, we encourage comments that will make the toxicological profile series of the greatest use.

Comments should be sent to:

Agency for Toxic Substances and Disease Registry  
Division of Toxicology and Environmental Medicine  
1600 Clifton Road, N.E.  
Mail Stop F-32  
Atlanta, Georgia 30333

The toxicological profiles are developed in response to the Superfund Amendments and Reauthorization Act (SARA) of 1986 (Public Law 99-499) which amended the Comprehensive Environmental Response, Compensation, and Liability Act of 1980 (CERCLA or Superfund). This public law directed ATSDR to prepare toxicological profiles for hazardous substances most commonly found at facilities on the CERCLA National Priorities List and that pose the most significant potential threat to human health, as determined by ATSDR and the EPA. The availability of the revised priority list of 275 hazardous substances was announced in the *Federal Register* on December 7, 2005 (70 FR 72840). For prior versions of the list of substances, see *Federal Register* notices dated April 17, 1987 (52 FR 12866); October 20, 1988 (53 FR 41280); October 26, 1989 (54 FR 43619); October 17, 1990 (55 FR 42067); October 17, 1991 (56 FR 52166); October 28, 1992 (57 FR 48801); February 28, 1994 (59 FR 9486); April 29, 1996 (61 FR 18744); November 17, 1997 (62 FR 61332); October 21, 1999 (64 FR 56792); October 25, 2001 (66 FR 54014); and November 7, 2003 (68 FR 63098). Section 104(i)(3) of CERCLA, as amended, directs the Administrator of ATSDR to prepare a toxicological profile for each substance on the list.

This profile reflects ATSDR's assessment of all relevant toxicologic testing and information that has been peer-reviewed. Staff of the Centers for Disease Control and Prevention and other Federal scientists have also reviewed the profile. In addition, this profile has been peer-reviewed by a nongovernmental panel and is being made available for public review. Final responsibility for the contents and views expressed in this toxicological profile resides with ATSDR.



Howard Frumkin, M.D., Dr. P.H.  
Director

National Center for Environmental Health/  
Agency for Toxic Substances and  
Disease Registry

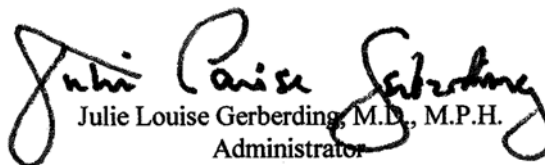

Julie Louise Gerberding, M.D., M.P.H.  
Administrator

Agency for Toxic Substances and  
Disease Registry

## QUICK REFERENCE FOR HEALTH CARE PROVIDERS

Toxicological Profiles are a unique compilation of toxicological information on a given hazardous substance. Each profile reflects a comprehensive and extensive evaluation, summary, and interpretation of available toxicologic and epidemiologic information on a substance. Health care providers treating patients potentially exposed to hazardous substances will find the following information helpful for fast answers to often-asked questions.

---

### *Primary Chapters/Sections of Interest*

**Chapter 1: Public Health Statement:** The Public Health Statement can be a useful tool for educating patients about possible exposure to a hazardous substance. It explains a substance's relevant toxicologic properties in a nontechnical, question-and-answer format, and it includes a review of the general health effects observed following exposure.

**Chapter 2: Relevance to Public Health:** The Relevance to Public Health Section evaluates, interprets, and assesses the significance of toxicity data to human health.

**Chapter 3: Health Effects:** Specific health effects of a given hazardous compound are reported by type of health effect (death, systemic, immunologic, reproductive), by route of exposure, and by length of exposure (acute, intermediate, and chronic). In addition, both human and animal studies are reported in this section.

**NOTE:** Not all health effects reported in this section are necessarily observed in the clinical setting. Please refer to the Public Health Statement to identify general health effects observed following exposure.

**Pediatrics:** Four new sections have been added to each Toxicological Profile to address child health issues:

<b>Section 1.6</b>	<b>How Can (Chemical X) Affect Children?</b>
<b>Section 1.7</b>	<b>How Can Families Reduce the Risk of Exposure to (Chemical X)?</b>
<b>Section 3.7</b>	<b>Children's Susceptibility</b>
<b>Section 6.6</b>	<b>Exposures of Children</b>

### **Other Sections of Interest:**

<b>Section 3.8</b>	<b>Biomarkers of Exposure and Effect</b>
<b>Section 3.11</b>	<b>Methods for Reducing Toxic Effects</b>

---

### **ATSDR Information Center**

**Phone:** 1-800-CDC-INFO (800-232-4636) or 1-888-232-6348 (TTY)      **Fax:** (770) 488-4178

**E-mail:** [cdcinfo@cdc.gov](mailto:cdcinfo@cdc.gov)      **Internet:** <http://www.atsdr.cdc.gov>

The following additional material can be ordered through the ATSDR Information Center:

*Case Studies in Environmental Medicine: Taking an Exposure History*—The importance of taking an exposure history and how to conduct one are described, and an example of a thorough exposure history is provided. Other case studies of interest include *Reproductive and Developmental*

*Hazards; Skin Lesions and Environmental Exposures; Cholinesterase-Inhibiting Pesticide Toxicity*; and numerous chemical-specific case studies.

*Managing Hazardous Materials Incidents* is a three-volume set of recommendations for on-scene (prehospital) and hospital medical management of patients exposed during a hazardous materials incident. Volumes I and II are planning guides to assist first responders and hospital emergency department personnel in planning for incidents that involve hazardous materials. Volume III—*Medical Management Guidelines for Acute Chemical Exposures*—is a guide for health care professionals treating patients exposed to hazardous materials.

*Fact Sheets (ToxFAQs)* provide answers to frequently asked questions about toxic substances.

---

### ***Other Agencies and Organizations***

*The National Center for Environmental Health (NCEH)* focuses on preventing or controlling disease, injury, and disability related to the interactions between people and their environment outside the workplace. Contact: NCEH, Mailstop F-29, 4770 Buford Highway, NE, Atlanta, GA 30341-3724 • Phone: 770-488-7000 • FAX: 770-488-7015.

*The National Institute for Occupational Safety and Health (NIOSH)* conducts research on occupational diseases and injuries, responds to requests for assistance by investigating problems of health and safety in the workplace, recommends standards to the Occupational Safety and Health Administration (OSHA) and the Mine Safety and Health Administration (MSHA), and trains professionals in occupational safety and health. Contact: NIOSH, 200 Independence Avenue, SW, Washington, DC 20201 • Phone: 800-356-4674 or NIOSH Technical Information Branch, Robert A. Taft Laboratory, Mailstop C-19, 4676 Columbia Parkway, Cincinnati, OH 45226-1998 • Phone: 800-35-NIOSH.

*The National Institute of Environmental Health Sciences (NIEHS)* is the principal federal agency for biomedical research on the effects of chemical, physical, and biologic environmental agents on human health and well-being. Contact: NIEHS, PO Box 12233, 104 T.W. Alexander Drive, Research Triangle Park, NC 27709 • Phone: 919-541-3212.

---

### ***Referrals***

*The Association of Occupational and Environmental Clinics (AOEC)* has developed a network of clinics in the United States to provide expertise in occupational and environmental issues. Contact: AOEC, 1010 Vermont Avenue, NW, #513, Washington, DC 20005 • Phone: 202-347-4976 • FAX: 202-347-4950 • e-mail: [AOEC@AOEC.ORG](mailto:AOEC@AOEC.ORG) • Web Page: <http://www.aoec.org/>.

*The American College of Occupational and Environmental Medicine (ACOEM)* is an association of physicians and other health care providers specializing in the field of occupational and environmental medicine. Contact: ACOEM, 25 Northwest Point Boulevard, Suite 700, Elk Grove Village, IL 60007-1030 • Phone: 847-818-1800 • FAX: 847-818-9266.



## CONTRIBUTORS

### CHEMICAL MANAGER(S)/AUTHOR(S):

Annette Ashizawa, Ph.D.  
Sharon Wilbur, MA.  
Heraline Hicks, Ph.D.  
ATSDR, Division of Toxicology and Environmental Medicine, Atlanta, GA

Margaret E. Fransen, Ph.D.  
Daniel J. Plewak, B.S.  
Syracuse Research Corporation, North Syracuse, NY

### THE PROFILE HAS UNDERGONE THE FOLLOWING ATSDR INTERNAL REVIEWS:

1. Health Effects Review. The Health Effects Review Committee examines the health effects chapter of each profile for consistency and accuracy in interpreting health effects and classifying end points.
2. Minimal Risk Level Review. The Minimal Risk Level Workgroup considers issues relevant to substance-specific Minimal Risk Levels (MRLs), reviews the health effects database of each profile, and makes recommendations for derivation of MRLs.
3. Data Needs Review. The Research Implementation Branch reviews data needs sections to assure consistency across profiles and adherence to instructions in the Guidance.
4. Green Border Review. Green Border review assures the consistency with ATSDR policy.

This page is intentionally blank.

## PEER REVIEW

A peer review panel was assembled in 2006 for dichloropropenes. The panel consisted of the following members:

1. Dr. Mary Davis, Professor, Department of Physiology and Pharmacology, West Virginia University Medical Center, Morgantown, West Virginia;
2. Dr. Rogene Henderson, Senior Scientist (retired), Lovelace Respiratory Research Institute, Albuquerque, New Mexico;
3. Dr. Lisa M. Kamendulis, Assistant Professor, Department of Pharmacology and Toxicology, Indiana University School of Medicine, Indianapolis, Indiana;

These experts collectively have knowledge of 1,3-dichloropropene's physical and chemical properties, toxicokinetics, key health end points, mechanisms of action, human and animal exposure, and quantification of risk to humans. All reviewers were selected in conformity with the conditions for peer review specified in Section 104(I)(13) of the Comprehensive Environmental Response, Compensation, and Liability Act, as amended.

Scientists from the Agency for Toxic Substances and Disease Registry (ATSDR) have reviewed the peer reviewers' comments and determined which comments will be included in the profile. A listing of the peer reviewers' comments not incorporated in the profile, with a brief explanation of the rationale for their exclusion, exists as part of the administrative record for this compound.

The citation of the peer review panel should not be understood to imply its approval of the profile's final content. The responsibility for the content of this profile lies with the ATSDR.

This page is intentionally blank.

## CONTENTS

DISCLAIMER .....	ii
UPDATE STATEMENT .....	iii
FOREWORD .....	v
QUICK REFERENCE FOR HEALTH CARE PROVIDERS.....	vii
CONTRIBUTORS .....	ix
PEER REVIEW .....	xi
CONTENTS.....	xiii
LIST OF FIGURES .....	xvii
LIST OF TABLES .....	xix
1. PUBLIC HEALTH STATEMENT.....	1
1.1    WHAT ARE DICHLOROPROPENES?.....	1
1.2    WHAT HAPPENS TO DICHLOROPROPENES WHEN THEY ENTER THE ENVIRONMENT? .....	3
1.3    HOW MIGHT I BE EXPOSED TO DICHLOROPROPENES?.....	4
1.4    HOW CAN DICHLOROPROPENES ENTER AND LEAVE MY BODY?.....	5
1.5    HOW CAN DICHLOROPROPENES AFFECT MY HEALTH?.....	6
1.6    HOW CAN DICHLOROPROPENES AFFECT CHILDREN?.....	8
1.7    HOW CAN FAMILIES REDUCE THE RISK OF EXPOSURE TO DICHLOROPROPENES?.....	9
1.8    IS THERE A MEDICAL TEST TO DETERMINE WHETHER I HAVE BEEN EXPOSED TO DICHLOROPROPENES?.....	9
1.9    WHAT RECOMMENDATIONS HAS THE FEDERAL GOVERNMENT MADE TO PROTECT HUMAN HEALTH?.....	9
1.10   WHERE CAN I GET MORE INFORMATION? .....	10
2. RELEVANCE TO PUBLIC HEALTH .....	13
2.1    BACKGROUND AND ENVIRONMENTAL EXPOSURES TO DICHLOROPROPENES IN THE UNITED STATES.....	13
2.2    SUMMARY OF HEALTH EFFECTS.....	14
2.3    MINIMAL RISK LEVELS (MRLs) .....	21
3. HEALTH EFFECTS.....	39
3.1    INTRODUCTION.....	39
3.2    DISCUSSION OF HEALTH EFFECTS BY ROUTE OF EXPOSURE .....	41
3.2.1  Inhalation Exposure .....	42
3.2.1.1  Death .....	66
3.2.1.2  Systemic Effects.....	67
3.2.1.3  Immunological and Lymphoreticular Effects.....	76
3.2.1.4  Neurological Effects.....	77
3.2.1.5  Reproductive Effects .....	78
3.2.1.6  Developmental Effects .....	79
3.2.1.7  Cancer.....	79
3.2.2  Oral Exposure.....	80
3.2.2.1  Death .....	81
3.2.2.2  Systemic Effects.....	103
3.2.2.3  Immunological and Lymphoreticular Effects.....	111

3.2.2.4	Neurological Effects .....	111
3.2.2.5	Reproductive Effects .....	112
3.2.2.6	Developmental Effects .....	112
3.2.2.7	Cancer .....	112
3.2.3	Dermal Exposure .....	113
3.2.3.1	Death .....	113
3.2.3.2	Systemic Effects .....	118
3.2.3.3	Immunological and Lymphoreticular Effects .....	121
3.2.3.4	Neurological Effects .....	121
3.2.3.5	Reproductive Effects .....	122
3.2.3.6	Developmental Effects .....	122
3.2.3.7	Cancer .....	122
3.2.4	Other Routes of Exposure .....	122
3.3	GENOTOXICITY .....	122
3.4	TOXICOKINETICS .....	132
3.4.1	Absorption .....	132
3.4.1.1	Inhalation Exposure .....	133
3.4.1.2	Oral Exposure .....	134
3.4.1.3	Dermal Exposure .....	135
3.4.2	Distribution .....	135
3.4.2.1	Inhalation Exposure .....	135
3.4.2.2	Oral Exposure .....	136
3.4.2.3	Dermal Exposure .....	137
3.4.3	Metabolism .....	137
3.4.4	Elimination and Excretion .....	143
3.4.4.1	Inhalation Exposure .....	143
3.4.4.2	Oral Exposure .....	145
3.4.4.3	Dermal Exposure .....	146
3.4.5	Physiologically Based Pharmacokinetic (PBPK)/Pharmacodynamic (PD) Models .....	146
3.5	MECHANISMS OF ACTION .....	150
3.5.1	Pharmacokinetic Mechanisms .....	150
3.5.2	Mechanisms of Toxicity .....	151
3.5.3	Animal-to-Human Extrapolations .....	152
3.6	TOXICITIES MEDIATED THROUGH THE NEUROENDOCRINE AXIS .....	152
3.7	CHILDREN'S SUSCEPTIBILITY .....	153
3.8	BIOMARKERS OF EXPOSURE AND EFFECT .....	155
3.8.1	Biomarkers Used to Identify or Quantify Exposure to Dichloropropene .....	156
3.8.2	Biomarkers Used to Characterize Effects Caused by Dichloropropene .....	157
3.9	INTERACTIONS WITH OTHER CHEMICALS .....	158
3.10	POPULATIONS THAT ARE UNUSUALLY SUSCEPTIBLE .....	158
3.11	METHODS FOR REDUCING TOXIC EFFECTS .....	159
3.11.1	Reducing Peak Absorption Following Exposure .....	159
3.11.2	Reducing Body Burden .....	160
3.11.3	Interfering with the Mechanism of Action for Toxic Effects .....	160
3.12	ADEQUACY OF THE DATABASE .....	161
3.12.1	Existing Information on Health Effects of Dichloropropenes .....	161
3.12.2	Identification of Data Needs .....	168
3.12.3	Ongoing Studies .....	184

4. CHEMICAL AND PHYSICAL INFORMATION.....	185
4.1 CHEMICAL IDENTITY.....	185
4.2 PHYSICAL AND CHEMICAL PROPERTIES.....	185
5. PRODUCTION, IMPORT/EXPORT, USE, AND DISPOSAL.....	193
5.1 PRODUCTION.....	193
5.2 IMPORT/EXPORT.....	194
5.3 USE.....	194
5.4 DISPOSAL.....	198
6. POTENTIAL FOR HUMAN EXPOSURE.....	199
6.1 OVERVIEW.....	199
6.2 RELEASES TO THE ENVIRONMENT.....	204
6.2.1 Air.....	204
6.2.2 Water.....	209
6.2.3 Soil.....	210
6.3 ENVIRONMENTAL FATE.....	211
6.3.1 Transport and Partitioning.....	211
6.3.2 Transformation and Degradation.....	215
6.3.2.1 Air.....	215
6.3.2.2 Water.....	216
6.3.2.3 Sediment and Soil.....	217
6.4 LEVELS MONITORED OR ESTIMATED IN THE ENVIRONMENT.....	219
6.4.1 Air.....	220
6.4.2 Water.....	221
6.4.3 Sediment and Soil.....	224
6.4.4 Other Environmental Media.....	224
6.5 GENERAL POPULATION AND OCCUPATIONAL EXPOSURE.....	225
6.6 EXPOSURES OF CHILDREN.....	229
6.7 POPULATIONS WITH POTENTIALLY HIGH EXPOSURES.....	229
6.8 ADEQUACY OF THE DATABASE.....	230
6.8.1 Identification of Data Needs.....	230
6.8.2 Ongoing Studies.....	233
7. ANALYTICAL METHODS.....	235
7.1 BIOLOGICAL MATERIALS.....	235
7.2 ENVIRONMENTAL SAMPLES.....	238
7.3 ADEQUACY OF THE DATABASE.....	239
7.3.1 Identification of Data Needs.....	243
7.3.2 Ongoing Studies.....	244
8. REGULATIONS AND ADVISORIES.....	245
9. REFERENCES.....	251
10. GLOSSARY.....	275

APPENDICES

A. ATSDR MINIMAL RISK LEVELS AND WORKSHEETS ..... A-1

B. USER’S GUIDE..... B-1

C. ACRONYMS, ABBREVIATIONS, AND SYMBOLS..... C-1

D. INDEX ..... D-1



## LIST OF FIGURES

3-1. Levels of Significant Exposure to 1,3-Dichloropropene – Inhalation .....	54
3-2. Levels of Significant Exposure to 2,3-Dichloropropene – Inhalation .....	64
3-3. Levels of Significant Exposure to 1,3-Dichloropropene – Oral .....	97
3-4. Levels of Significant Exposure to 2,3-Dichloropropene – Oral .....	102
3-5. Proposed Metabolic Pathway for 1,3-Dichloropropene in the Rat .....	138
3-6. Correlation of Exposure to 1,3-Dichloropropene with Urinary Excretion of the N-Acetyl Cysteine Metabolite.....	139
3-7. Proposed Metabolic Pathway for 2,3-Dichloropropene in the Rat .....	142
3-8. Conceptual Representation of a Physiologically Based Pharmacokinetic (PBPK) Model for a Hypothetical Chemical Substance.....	148
3-9. Kinetic Model for Uptake and Elimination of 1,3-Dichloropropene.....	149
3-10. Existing Information on Health Effects of 1,1-Dichloropropene .....	162
3-11. Existing Information on Health Effects of 3,3-Dichloropropene .....	163
3-12. Existing Information on Health Effects of 1,2-Dichloropropene .....	164
3-13. Existing Information on Health Effects of 2,3-Dichloropropene .....	165
3-14. Existing Information on Health Effects of 1,3-Dichloropropene .....	166
6-1. Frequency of NPL Sites with 1,3-Dichloropropene Contamination.....	200
6-2. Frequency of NPL Sites with 1,2-Dichloropropene Contamination.....	201
6-3. Frequency of NPL Sites with 2,3-Dichloropropene Contamination.....	202

This page is intentionally blank.

## LIST OF TABLES

2-1. Summary of Minimum Risk Levels (MRLs) Derived for Dichloropropenes.....	23
2-2. Incidence of Significant Lesions in Fischer 344 Rats and B6C3F1 Mice Exposed to 2,3-Dichloropropene (>99%) Vapor 6 Hours/Day, for 9/11 Days.....	34
3-1. Trade Names and Components of Pure 1,3-Dichloropropene Formulations.....	40
3-2. Levels of Significant Exposure to 1,3-Dichloropropene – Inhalation.....	43
3-3. Levels of Significant Exposure to 2,3-Dichloropropene – Inhalation.....	59
3-4. Levels of Significant Exposure to 1,3-Dichloropropene – Oral.....	82
3-5. Levels of Significant Exposure to 2,3-Dichloropropene – Oral.....	101
3-6. Levels of Significant Exposure to 1,3-Dichloropropene – Dermal.....	114
3-7. Levels of Significant Exposure to 2,3-Dichloropropene – Dermal.....	117
3-8. Genotoxicity of Dichloropropenes <i>In Vivo</i> .....	123
3-9. Genotoxicity of Dichloropropenes <i>In Vitro</i> .....	125
4-1. Chemical Identity of the Isomers of Dichloropropene.....	186
4-2. Physical and Chemical Properties of the Isomers of Dichloropropene.....	189
5-1. Facilities that Produce, Process, or Use 1,3-Dichloropropene.....	195
5-2. Facilities that Produce, Process, or Use 2,3-Dichloropropene.....	196
5-3. Compositions of Actively Registered Commercial Products Containing 1,3-Dichloropropene.....	197
6-1. Releases to the Environment from Facilities that Produce, Process, or Use 1,3-Dichloropropene.....	206
6-2. Releases to the Environment from Facilities that Produce, Process, or Use 2,3-Dichloropropene.....	207
6-3. Maximum Concentrations (24-Hour Time-Weighted Average) of 1,3-Dichloropropene in Air at Varying Distances from Treated Fields.....	208
6-4. Estimated Annual Use of 1,3-Dichloropropene in the United States.....	212
6-5. Exposure Levels of Employees to 1,3-Dichloropropene Measured During Loading and Application.....	227

7-1. Analytical Methods for Determining cis- and trans-1,3-Dichloropropene and Metabolites in Biological Materials .....	237
7-2. Analytical Methods for Determining 1,3-Dichloropropene in Environmental Materials.....	240
7-3. Analytical Methods for Determining 1,1-Dichloropropene in Environmental Materials.....	242
8-1. Regulations and Guidelines Applicable to Dichloropropenes .....	248

## 1. PUBLIC HEALTH STATEMENT

This public health statement tells you about dichloropropenes and the effects of exposure to it.

The Environmental Protection Agency (EPA) identifies the most serious hazardous waste sites in the nation. These sites are then placed on the National Priorities List (NPL) and are targeted for long-term federal clean-up activities. 1,2-, 1,3-, and 2,3-Dichloropropene have been found in at least 5, 112, and 3 of the 1,678 current or former NPL sites, respectively. 1,1- and 3,3-Dichloropropene were not identified in any of the 1,678 current or former NPL sites. Although the total number of NPL sites evaluated for this substance is not known, the possibility exists that the number of sites at which dichloropropenes are found may increase in the future as more sites are evaluated. This information is important because these sites may be sources of exposure and exposure to dichloropropenes may harm you.

When a substance is released either from a large area, such as an industrial plant, or from a container, such as a drum or bottle, it enters the environment. Such a release does not always lead to exposure. You can be exposed to a substance only when you come in contact with it. You may be exposed by breathing, eating, or drinking the substance, or by skin contact.

If you are exposed to dichloropropenes, many factors will determine whether you will be harmed. These factors include the dose (how much), the duration (how long), and how you come in contact with these substances. You must also consider any other chemicals you are exposed to and your age, sex, diet, family traits, lifestyle, and state of health.

### 1.1 WHAT ARE DICHLOROPROPENES?

Dichloropropene molecules are made of a chain of three carbon atoms with a double bond connecting the first two carbons. Two chlorine atoms are attached at varying positions on this carbon chain. Since there are five possible arrangements of chlorine atoms around this carbon chain, there are five different types (or isomers) of dichloropropene molecules. The names of

## 1. PUBLIC HEALTH STATEMENT

these dichloropropenes are 1,1-dichloropropene; 1,2-dichloropropene; 1,3-dichloropropene; 2,3-dichloropropene; and 3,3-dichloropropene. The numbers at the beginning of these names specify the carbon atoms (first, second, or third) to which each chlorine atom is attached.

1,3-Dichloropropene is a colorless liquid with a sweet smell. It dissolves in water and evaporates easily. 1,3-Dichloropropene is used mainly in farming to kill tiny pests called nematodes that eat the roots of important crops.

Much less information is available for the other dichloropropenes (1,1-, 1,2-, 2,3-, and 3,3-dichloropropene). It appears that only 2,3-dichloropropene is produced and used in industry; it is used to make other chemicals. Uses for 1,1-, 1,2-, or 3,3-dichloropropene were not found. Based on available data, less than 10,000 pounds (4.5 metric tons) of 1,1-, 1,2-, 2,3-, and 3,3-dichloropropene were produced in 2002 compared to a production amount of between 1 and 10 million pounds (450–4,500 metric tons) of 1,3-dichloropropene during that year.

Because 1,3-dichloropropene is produced and used in much higher amounts than 1,1-, 1,2-, 2,3-, and 3,3-dichloropropene and because 1,3-dichloropropene is released to the environment as a pesticide, the available dichloropropene data are primarily for 1,3-dichloropropene. Therefore, the focus of this ATSDR profile is on the 1,3-dichloropropene isomer. Discussion of 1,1-, 1,2-, 2,3-, and 3,3-dichloropropene are only included where data are available for these substances or when conclusions can be drawn based on similarities in physical and chemical properties between these substances and 1,3-dichloropropene.

You will find more information on the chemical properties of dichloropropenes in Chapter 4. The uses of dichloropropenes are described in Chapter 5. More information on how dichloropropenes will behave in the environment is given in Chapter 6.

## 1. PUBLIC HEALTH STATEMENT

**1.2 WHAT HAPPENS TO DICHLOROPROPENES WHEN THEY ENTER THE ENVIRONMENT?**

When 1,3-dichloropropene is used in farm fields, it is sprayed into the ground. Once in the soil, some of it is likely to be broken down into smaller chemicals (listed in Section 6.3.2.3) by either water or living things. Some of it may be carried deeper into the ground and may reach underground water supplies. However, in high crop-producing states like California where it has been used often, very little 1,3-dichloropropene has actually been found in groundwater. 1,3-Dichloropropene may also be carried into groundwater and soil from landfills and hazardous waste sites.

Some of the 1,3-dichloropropene sprayed onto the ground will evaporate into the air. In the air, 1,3-dichloropropene will be broken down into smaller chemicals. Some of the 1,3-dichloropropene in air may be washed down onto the ground, lakes, or streams by rain. 1,3-Dichloropropene is also expected to be broken down in soil and water. Some of the 1,3-dichloropropene in soil or water will also go back into the air.

Information on what happens to 1,1-, 1,2-, 2,3-, and 3,3-dichloropropene when they enter the environment are not available. Based on their physical and chemical properties, these substances are expected to behave similarly to 1,3-dichloropropene. However, reactions with water are expected to be much slower for 1,1- and 1,2-dichloropropene than for 1,3-, 2,3-, and 3,3-dichloropropene.

You will find more information on the chemical properties of 1,3-dichloropropene in Chapter 4. The uses of 1,3-dichloropropene are described in Chapter 5. More information on how 1,3-dichloropropene will behave in the environment is given in Chapter 6.

## 1. PUBLIC HEALTH STATEMENT

**1.3 HOW MIGHT I BE EXPOSED TO DICHLOROPROPENES?**

You can breathe 1,3-dichloropropene from the air. It can also get on your skin. The people most likely to breathe air containing 1,3-dichloropropene or to get it on their skin are workers who use it for farming or make it in factories.

Food grown in 1,3-dichloropropene treated fields has not been shown to contain 1,3-dichloropropene. A possible explanation for this is that since 1,3-dichloropropene is applied several months before planting, it may be rapidly broken down or removed from the soil before the crop plants grow and are able to take this chemical up through their roots.

Very small amounts of 1,3-dichloropropene from sewage treatment facilities, electrical power stations, and industrial facilities that use water to cool high-temperature furnaces may go into streams, rivers, and lakes. Some may go into the air.

People who live near garbage dumps or places where chemicals are stored or buried, including hazardous waste sites, may breathe 1,3-dichloropropene if it escapes into the air or may drink well water contaminated with this chemical. They may also be exposed through skin contact with soil containing it. People living in these areas who bathe or shower in contaminated well water may be exposed to 1,3-dichloropropene through breathing or skin contact.

Based on available information, 1,3-dichloropropene is not commonly found in surface water, drinking water, soil, or foods. 1,3-Dichloropropene is also not commonly found in air; however, it has been found in the air in some cities and in some farming areas. The average levels of 1,3-dichloropropene measured in the air at these locations are between 0.088 and 0.33 parts per billion (ppb). 1,3-Dichloropropene has been found in water at many locations across the United States; however, the levels of this pesticide are too low to be measured at most of these locations (scientists cannot accurately determine how much is present). 1,3-Dichloropropene has not been found in many drinking water samples. The average levels of 1,3-dichloropropene are around 0.5 ppb in groundwater at locations where it is measurable.



## 1. PUBLIC HEALTH STATEMENT

Based on available information, 1,1-, 1,2-, 2,3-, and 3,3-dichloropropene are not commonly found in measurable quantities in air, surface water, drinking water, groundwater, soil, or food. 1,1-Dichloropropene has been found in water at many locations across the United States; however, the levels of this pesticide are too low to be measured at most of these locations. 1,1-Dichloropropene has not been found in many drinking water samples. The potential for human exposure to 1,1-, 1,2-, and 3,3-dichloropropene is expected to be low because they are not produced or used in high amounts. Higher amounts of 2,3-dichloropropene may be released from facilities where this substance is produced or used. Individuals who work or live near these facilities may be exposed to 2,3-dichloropropene; however, exposure of the general population to this chemical is not expected to be important.

You can find more information on the amounts of 1,3-dichloropropene and the other dichloropropene chemicals that have been found in the environment and how you can be exposed to these chemicals in Chapter 6.

#### **1.4 HOW CAN DICHLOROPROPENES ENTER AND LEAVE MY BODY?**

Dichloropropene can enter the body through the lungs if you breathe air that contains it, through the stomach and intestine if you drink water that is contaminated with it, or through the skin if you touch it. Studies with animals exposed to 1,3- or 2,3-dichloropropene have shown that if you breathe air that has dichloropropene in it, most of the chemical will get into the bloodstream. With increasing exposure, there is a greater likelihood that it will enter your body and get into the bloodstream.

Dichloropropenes are not likely to build up in the body because the liver changes (metabolizes) the chemical to a harmless form that can leave the body fairly quickly. Studies with animals have shown that most 1,3- or 2,3-dichloropropene leaves the body within 2 days after exposure. Most dichloropropenes leave the body in urine, and smaller amounts leave in feces and the air you breathe out. If you take in very large amounts of 1,3- or 2,3-dichloropropene, this may overwhelm the ability of the liver to change all of the chemical to a harmless form. When this

## 1. PUBLIC HEALTH STATEMENT

happens, some may be changed to a harmful form that may bind to tissues and damage them. For more information on how dichloropropenes get into and leave your body, see Chapter 3.

## 1.5 HOW CAN DICHLOROPROPENES AFFECT MY HEALTH?

Scientists use many tests to protect the public from harmful effects of toxic chemicals and to find ways for treating persons who have been harmed.

One way to learn whether a chemical will harm people is to determine how the body absorbs, uses, and releases the chemical. For some chemicals, animal testing may be necessary. Animal testing may also help identify health effects such as cancer or birth defects. Without laboratory animals, scientists would lose a basic method for getting information needed to make wise decisions that protect public health. Scientists have the responsibility to treat research animals with care and compassion. Scientists must comply with strict animal care guidelines because laws today protect the welfare of research animals.

Dichloropropenes are reactive chemicals, which means that they may cause irritation at the point of contact. Health effects seen in humans or animals generally occurred at exposure levels that are much higher than the background levels found in air or water. This means that health effects are not likely to be seen in the general population, but may be seen among people who are exposed to relatively high concentrations in their jobs or from being near fields during fumigation.

The main health effects seen in humans who breathed 1,3-dichloropropene are: nausea; vomiting; irritation of the skin, eyes, nose, and throat; breathing difficulties; coughing; headache; and fatigue. Some people who breathed 1,3-dichloropropene could smell it when the amount reached 1 part 1,3-dichloropropene per million parts of air (ppm), but you may be able to smell it at even lower amounts. A few workers who had skin contact with pesticides containing 1,3-dichloropropene developed blisters and an allergic reaction on their skin. A man who accidentally drank some 1,3-dichloropropene died with severe damage to his stomach and surrounding organs. We do not know if 1,3-dichloropropene causes cancer in humans; however, three men

## 1. PUBLIC HEALTH STATEMENT

who breathed in 1,3-dichloropropene during the cleanup of a tanker spill or during field spraying developed cancers of the blood cells. This small number of cases does not provide proof that 1,3-dichloropropene was the cause of cancer, especially since the liquids may have contained other chemicals besides 1,3-dichloropropene.

At levels more than a thousand times higher than background, dichloropropenes caused irritation at the point of contact in animals. Rats and mice had damage to the lining of the nose, and mice had damage to the lung after repeatedly breathing 5 ppm of 2,3-dichloropropene vapor several hours a day for less than 2 weeks. Rats and mice had damage to the lining of the nose, and mice had damage to the lining of the urinary bladder after breathing 60 ppm 1,3-dichloropropene for several months or 20 ppm for 2 years. Male mice (but not female mice or female or male rats) developed a benign (nonspreading) lung tumor after breathing 60 ppm 1,3-dichloropropene for 2 years. Rats that ate 1,3-dichloropropene in their feed at a daily dose of 15 mg per kg body weight for several months or longer had damage to the lining of the stomach and dogs had anemia. At a higher dose, rats, but not mice, developed a benign (nonspreading) liver tumor. Direct contact with liquid dichloropropenes caused irritation to eyes and skin in animals and a skin allergic reaction in guinea pigs. Animals tested at high levels, like those seen in accidental exposures in humans, also developed serious injury to the lungs from breathing the chemical vapor or to the stomach from oral exposure. At these unusually high levels, liver and kidney damage was seen, and death occurred because of breathing difficulty and internal bleeding.

The Department of Health and Human Services has determined that 1,3-dichloropropene may reasonably be anticipated to be a carcinogen. The International Agency for Research on Cancer has determined that 1,3-dichloropropene is possibly carcinogenic to humans. The EPA has classified 1,3-dichloropropene as a probable human carcinogen.

You can find a more complete discussion of the health effects of 1,3- and 2,3-dichloropropene in humans and animals in Chapter 3.

## 1. PUBLIC HEALTH STATEMENT

**1.6 HOW CAN DICHLOROPROPENES AFFECT CHILDREN?**

This section discusses potential health effects in humans from exposures during the period from conception to maturity at 18 years of age.

Like adults, children can be exposed to dichloropropenes by breathing air or drinking water that contains the chemicals, but the amounts are usually very low. The most likely exposure occurs near agricultural fields where 1,3-dichloropropene is used to treat the soil before planting. Children are not more likely than adults in the general population to be exposed to dichloropropenes in air, but since they drink more water than adults relative to their body weight, they may have higher exposures from well water.

The effects of dichloropropenes have not been studied in children, but they would likely experience the same health effects seen in adults exposed to the chemical. We do not know whether children differ from adults in their susceptibility to health effects from exposure to dichloropropenes.

We do not know whether dichloropropenes can cause birth defects in humans. Although 1,3-dichloropropene did not cause birth defects in animals, pregnant rats that breathed it gave birth to fewer rat pups or pups with lower body weight. These effects only happened at exposures high enough to be toxic to the mother and reduce her feed intake.

The way that dichloropropenes enter and leave a child's body is likely to be the same as for adults. The liver process that makes the chemicals less harmful in adults is the same in children by their first year of age.

## 1. PUBLIC HEALTH STATEMENT

**1.7 HOW CAN FAMILIES REDUCE THE RISK OF EXPOSURE TO DICHLOROPROPENES?**

If your doctor finds that you have been exposed to substantial amounts of dichloropropene, ask whether your children might also have been exposed. Your doctor might need to ask your state health department to investigate.

Families can reduce their exposure to dichloropropene by staying away from treated fields during pesticide application. Workers who handle dichloropropene should wash their hands before entering their homes and keep contaminated clothing isolated before it is washed. Children should be encouraged to wash their hands after playing near treated soil and discouraged from putting their hands in their mouths.

**1.8 IS THERE A MEDICAL TEST TO DETERMINE WHETHER I HAVE BEEN EXPOSED TO DICHLOROPROPENES?**

It is possible to measure 1,3- or 2,3-dichloropropene or their breakdown products in blood and urine. In humans, the blood levels of breakdown products from 1,3-dichloropropene could be used to predict how much 1,3-dichloropropene has been breathed. However, tests for 1,3- or 2,3-dichloropropene in the blood and urine would only be useful for recent exposures, because dichloropropenes leave the body within 1–2 days. You can find more information about these tests in Chapters 3 and 7.

**1.9 WHAT RECOMMENDATIONS HAS THE FEDERAL GOVERNMENT MADE TO PROTECT HUMAN HEALTH?**

The federal government develops regulations and recommendations to protect public health. Regulations can be enforced by law. The EPA, the Occupational Safety and Health Administration (OSHA), and the Food and Drug Administration (FDA) are some federal agencies that develop regulations for toxic substances. Recommendations provide valuable guidelines to protect public health, but cannot be enforced by law. The Agency for Toxic Substances and Disease Registry (ATSDR) and the National Institute for Occupational Safety

## 1. PUBLIC HEALTH STATEMENT

and Health (NIOSH) are two federal organizations that develop recommendations for toxic substances.

Regulations and recommendations can be expressed as “not-to-exceed” levels, that is, levels of a toxic substance in air, water, soil, or food that do not exceed a critical value that is usually based on levels that affect animals; they are then adjusted to levels that will help protect humans. Sometimes these not-to-exceed levels differ among federal organizations because they used different exposure times (an 8-hour workday or a 24-hour day), different animal studies, or other factors.

Recommendations and regulations are also updated periodically as more information becomes available. For the most current information, check with the federal agency or organization that provides it. Some regulations and recommendations for dichloropropenes include the following:

EPA has set 100 pounds per year as the limit of 1,3- or 2,3-dichloropropene that can be released into the environment at any particular site; releases of more than that must be reported. EPA sets limits on the amount of chemicals allowed in drinking water, but has not established an enforceable standard (maximum contaminant level) for 1,3-dichloropropene. As a guideline, EPA established a health advisory level for 1,3-dichloropropene of 0.03 mg per liter of water that should not be exceeded in order to protect children’s health.

OSHA has not set a limit for allowable worker exposure to 1,3-dichloropropene in air, but NIOSH sets guidelines (recommended exposure limits or RELs) for chemicals in workplace air. The REL for 1,3-dichloropropene is 1 part per million (4.54 mg per cubic meter) averaged over a 10-hour workday. For more information on the regulations for 1,3- and 2,3-dichloropropene, see Chapter 8.

### **1.10 WHERE CAN I GET MORE INFORMATION?**

If you have any more questions or concerns, please contact your community or state health or environmental quality department, or contact ATSDR at the address and phone number below.

## 1. PUBLIC HEALTH STATEMENT

ATSDR can also tell you the location of occupational and environmental health clinics. These clinics specialize in recognizing, evaluating, and treating illnesses that result from exposure to hazardous substances.

Toxicological profiles are also available on-line at [www.atsdr.cdc.gov](http://www.atsdr.cdc.gov) and on CD-ROM. You may request a copy of the ATSDR ToxProfiles™ CD-ROM by calling the toll-free information and technical assistance number at 1-800-CDCINFO (1-800-232-4636), by e-mail at [cdcinfo@cdc.gov](mailto:cdcinfo@cdc.gov), or by writing to:

Agency for Toxic Substances and Disease Registry  
Division of Toxicology and Environmental Medicine  
1600 Clifton Road NE  
Mailstop F-32  
Atlanta, GA 30333  
Fax: 1-770-488-4178

Organizations for-profit may request copies of final Toxicological Profiles from the following:

National Technical Information Service (NTIS)  
5285 Port Royal Road  
Springfield, VA 22161  
Phone: 1-800-553-6847 or 1-703-605-6000  
Web site: <http://www.ntis.gov/>

1. PUBLIC HEALTH STATEMENT

This page is intentionally blank.



## 2. RELEVANCE TO PUBLIC HEALTH

### 2.1 BACKGROUND AND ENVIRONMENTAL EXPOSURES TO DICHLOROPROPENES IN THE UNITED STATES

1,3-Dichloropropene is a mixture of volatile cis and trans isomers and is primarily used as a nematocide to fumigate soil before planting. Commercial formulations of 1,3-dichloropropene contain stabilizers to inhibit degradation of the compound (Table 3-1). Older formulations contained chloropicrin or epichlorohydrin, whereas currently, the less toxic epoxidized soybean oil is used as a stabilizer. 1,3-Dichloropropene is released to the atmosphere in fugitive or accidental emissions from industrial sources (e.g., petroleum refineries, sewage treatment facilities, and electricity-generating power facilities) and also during its use as a fumigant. Accidental discharges into surface waters from industrial sources or leaching into groundwater from hazardous waste sites or agricultural uses also occur.

A significant proportion of the 1,3-dichloropropene released into soil or surface waters is expected to volatilize into the atmosphere where it is degraded by photooxidation with hydroxyl radicals or reaction with ozone. The half-life of 1,3-dichloropropene in ambient air is expected to range between 7 and 50 hours, depending on the concentrations of cis- and trans- isomers and reactive hydroxyl radicals. 1,3-Dichloropropene may also undergo biodegradation or hydrolysis in natural waters and in soil. Experimental data indicate increased rates of hydrolysis with higher temperature, the hydrolysis half-life in deionized water being about 10 days at 20 °C.

1,3-Dichloropropene is not a widely-occurring atmospheric pollutant. Mean concentrations in positive air samples from urban and rural regions have ranged between 0.088 and 0.33 ppb in one report, but concentrations as high as 35.2 ppb have been measured in high-use agricultural regions. 1,3-Dichloropropene has been detected in 40% of 12,673 water samples, but only 6% of the samples contained 1,3-dichloropropene above the quantifiable limit. The range of quantifiable concentrations in water was 0.002–25 ppb, with a mean of 0.5 ppb. 1,3-Dichloropropene was detected in only 0.1% of 70,631 public water system samples collected in the United States between 1993 and 1997. 1,3-Dichloropropene has not been detected in table-ready foods.

Possible routes of human exposure to 1,3-dichloropropene include inhalation of contaminated air, ingestion of contaminated drinking water, and dermal contact with pesticides containing 1,3-dichloro-

## 2. RELEVANCE TO PUBLIC HEALTH

propene. Due to the volatility of 1,3-dichloropropene, inhalation exposure, particularly in regions where the pesticide is used commercially to fumigate soil, appears to be the major route of exposure for the general population. Children residing in regions of pesticide use are likely to be exposed to 1,3-dichloropropene by the same routes that affect adults. Occupational exposure or accidental exposure resulting from a spill is likely to occur through inhalation and dermal contact.

Information on the release, environmental fate and partitioning, concentrations in environmental media, and potential for human exposure is very limited for 1,1-, 1,2-, 2,3-, and 3,3-dichloropropene. Based on their physical and chemical properties, these substances are expected to behave similarly to 1,3-dichloropropene when they are released into the environment. However, hydrolysis of 1,1- and 1,2-dichloropropene is expected to be much slower than hydrolysis of the other dichloropropene isomers due to the inhibiting effect of the vinylic chlorine atoms.

1,1-, 1,2-, 2,3-, and 3,3-Dichloropropene are not commonly found at measurable concentrations in air, surface water, drinking water, groundwater, soil or food. 1,1-Dichloropropene has been detected in 64% of 5,348 water samples collected in the United States, but only 1% of the samples contained 1,1-dichloropropene above the quantifiable limit. The range of quantifiable concentrations in water was 0.001–5 ppb, with a mean of 0.4 ppb. 1,1-Dichloropropene was detected in only 0.01% of 97,698 public water system samples collected in the United States between 1993 and 1997.

The potential for human exposure to 1,1-, 1,2-, and 3,3-dichloropropene is expected to be low because these chemicals are not produced or used in high amounts. Higher amounts of 2,3-dichloropropene may be released from facilities where this substance is produced or used. Individuals who work or live near these facilities may be exposed to 2,3-dichloropropene; however, exposure of the general population to this chemical is not expected to be important.

### 2.2 SUMMARY OF HEALTH EFFECTS

As volatile halogenated alkenes, dichloropropenes are reactive and cause irritant effects at the point of contact. Their small molecular size and lipid solubility facilitate rapid absorption and distribution throughout the body. Metabolism, primarily in the liver, but also in other tissues, results either in detoxification and elimination, or bioactivation to more a toxic or mutagenic metabolite. Since there is some evidence that the isomers behave differently with respect to metabolic pathways, and the available toxicity data are not necessarily comparable, health effects are discussed for each isomer individually. No

## 2. RELEVANCE TO PUBLIC HEALTH

studies have compared the relative toxicity of dichloropropenes in mammals, but limited data suggest that inhaled 2,3-dichloropropene is more damaging to the respiratory tract than 1,3-dichloropropene.

***1,3-Dichloropropene.*** 1,3-Dichloropropene is readily absorbed by all routes of exposure. The compound does not accumulate in the body and is readily excreted in the urine following conjugation to glutathione and metabolic conversion to mercapturic acid derivatives. Consistent with its reactive properties, some of the major effects of exposure occur at the point of contact: nasal epithelium following inhalation exposure, stomach following oral exposure, and skin following dermal exposure. The urinary bladder in mice exposed by inhalation and erythrocytes in dogs exposed orally are also targets of 1,3-dichloropropene.

The available information on the toxicity of 1,3-dichloropropene in humans is largely limited to case reports lacking exposure quantification and occupational studies. Case reports of high level (unquantified) exposures confirm portal-of-entry effects in the respiratory system after inhalation exposure, gastrointestinal effects following accidental ingestion, and contact dermatitis leading to sensitization reactions following dermal exposure. Additional effects noted following high-level exposure included cardiovascular effects (tachycardia and hypovolemia) prior to multiorgan failure and death. No hepatic or renal urinary biomarkers were elevated following repeated occupational exposures to cis-1,3-dichloropropene at relatively low levels (0.6 ppm). An association was reported between occupational exposure to 0.06 to 2.1 ppm 1,3-dichloropropene and urinary excretion of biomarkers indicative of renal damage, but the levels were subclinical and could be considered nonadverse.

Experimental studies of 1,3-dichloropropene in animals have been conducted using various commercial formulations, most of which contained chloropicrin (Telone C-17 contains 19–21% chloropicrin) or epichlorohydrin (Telone II<sup>®</sup>a contains 1% epichlorohydrin) as stabilizers, or significant amounts of 1,2-dichloropropane (DD contains 25–29% 1,2-dichloropropane). More recent studies have tested Telone II<sup>®</sup>b, which was relatively pure ( $\geq 90\%$  1,3-dichloropropene) and contained 2% epoxidized soybean oil (ESO) as a stabilizer. Comparison of results of the new dietary studies with results of earlier oral gavage studies, suggest that either bolus dosing and/or the presence of epichlorohydrin may have been responsible for some effects in observed in earlier studies.

Results from repeated-dose animal studies indicate that respiratory effects (hyperplasia of the nasal respiratory epithelium in rats and mice) and urinary effects (hyperplasia of the urinary bladder in mice) following chronic inhalation exposure at  $\geq 20$  ppm 6 hours/day, 5 days/week, and gastrointestinal

## 2. RELEVANCE TO PUBLIC HEALTH

(hyperplasia of the forestomach in rats) and hematological effects (microcytic anemia in dogs) following long-term oral exposure to Telone II<sup>®</sup>b at ~12–15 mg/kg/day or to Telone II<sup>®</sup>a at 11 mg/kg/day (25 mg/kg/day, 3 days/week) are the most sensitive effects induced by exposure to 1,3-dichloropropene. Renal effects or urinary bladder hyperplasia were not observed in animals treated in the diet with Telone II<sup>®</sup>b, but hyperplasia of the urinary bladder was observed in animals treated by gavage with Telone II<sup>®</sup>a at 21 mg/kg/day (50 mg/kg/day, 3 days/week) for 2 years. These effects are discussed in greater detail below.

Other effects of exposure to 1,3-dichloropropene involve the skin and eyes, liver, and nervous system. Liquid 1,3-dichloropropene is irritating to the eyes of rabbits, a 0.1 mL application causing erythema, lacrimation, or palpebral closure. Liquid application to skin of rats, rabbits, or guinea pigs resulted in erythema/edema from a single 4-hour application at 0.5 mL or repeated applications at 0.1 mL, and necrosis resulted from a single 24-hour application at 200 mg/kg. Contact sensitization was noted in guinea pigs following repeated dermal application at 0.2 mL. Neurological effects included ataxia and loss of the righting reflex in pregnant rabbits exposed by inhalation to 300 ppm for 13 days, but this exposure level was fatal to six of seven does. No direct developmental effects were noted in animals exposed at <120 ppm by inhalation for 10 days or <90 ppm for 3 months, but reduced litter sizes were observed in pregnant rats exposed to 150 ppm, a level causing maternal toxicity (reductions in feed intake, water intake, and body weight). No adverse effect on reproduction was noted in rats exposed by inhalation at <90 ppm for two generations.

Extremely limited data (a few case reports and one epidemiological study) are available for carcinogenic effects of 1,3-dichloropropenes in humans. In chronic animal bioassays using Telone II<sup>®</sup>b increases in benign tumors (adenomas) were reported in the mouse lung following inhalation exposure and rat liver following oral dietary exposure. A chronic oral gavage bioassay using Telone II<sup>®</sup>a resulted in more severe carcinogenic effects, but it is not known whether that was a consequence of the presence of epichlorohydrin in Telone II<sup>®</sup>a or bolus dosing. Carcinogenicity of 1,3-dichloropropene is discussed in greater detail below.

The health effects of 1,3-dichloropropene exposure are discussed in detail in Chapter 3.

The following section discuss the most significant effects of exposure to 1,3-dichloropropene, which involve the gastrointestinal, hematological, respiratory, and urinary systems and cancer.

## 2. RELEVANCE TO PUBLIC HEALTH

**Respiratory Effects.** Due to the reactivity of 1,3-dichloropropene, irritant effects on the respiratory tract can be expected from inhalation exposure in humans and animals. In humans accidentally exposed to presumably high concentrations of 1,3-dichloropropene, respiratory effects included mucous membrane irritation, chest pain, and cough. In one case, repeated exposure for 30 days to pesticide spray from a leaky hose (presumably a combined vapor and droplet exposure) resulted in hyperemia and superficial ulcerations of the nasal mucosa and inflammation of the pharynx. No data are available for effects in humans repeatedly exposed at lower levels.

Respiratory effects in rats exposed to 1,3-dichloropropene vapor at high concentrations in acute lethality studies included atelectasis after 1 hour at 206 ppm for TC-17 (21.1% chloropicrin), and in 4-hour exposures, lung edema at 595 ppm, congestion at 676 ppm for Telone II<sup>®</sup>a, and hemorrhage at 1,035 ppm. Nasal turbinates were not examined for histopathology in these acute-duration studies. In intermediate-duration studies using sublethal exposures to Telone II<sup>®</sup>b or Telone II<sup>®</sup>a vapor, hyperplasia/hypertrophy of the nasal respiratory epithelium was observed in rats at  $\geq 90$  ppm or mice at  $\geq 60$  ppm and degeneration of the nasal olfactory epithelium was observed in rats at  $\geq 90$  ppm. Exposure for 2 years to Telone II<sup>®</sup>b vapor resulted in hyperplasia/hypertrophy of the nasal respiratory epithelium in mice at  $\geq 20$  ppm and rats at 60 ppm and degeneration of the nasal olfactory epithelium in rats and mice at 60 ppm.

Lung effects (congestion, hemorrhage) that were observed in rats during acute lethality studies by the oral or dermal routes may have arisen from inhalation of 1,3-dichloropropene vapor during administration of high doses of the test material.

**Gastrointestinal Effects.** Irritant effects on the gastrointestinal system have been observed in humans and animals following oral exposure to 1,3-dichloropropene. Gastrointestinal effects observed in one case of fatal ingestion included initial acute gastroenteritis and abdominal pain on deep palpation, subsequent bloody diarrhea, hemorrhagic exudate of the stomach at autopsy, histopathological evidence of congestion of gastric mucosal vessels, autolysis, and mucosal erosions of the stomach. Nausea and vomiting were observed following accidental exposure to a high concentration of 1,3-dichloropropene vapor, but it is possible that these could be a nonspecific effect of neurotoxicity. No data are available for effects in humans repeatedly exposed at lower doses.

Gastrointestinal effects observed in rats following exposure to 1,3-dichloropropene as single oral gavage doses of various pesticide formulations include hyperkeratosis of the forestomach at  $\geq 75$  mg/kg and hemorrhaging of the small intestine at  $\geq 110$  mg/kg. In repeated-dose oral studies at sublethal exposures,

## 2. RELEVANCE TO PUBLIC HEALTH

basal cell hyperplasia of the nonglandular stomach developed in rats ingesting 15 mg/kg/day 1,3-dichloropropene as microencapsulated Telone II<sup>®</sup>b in the diet for 13 weeks or 12.5 mg/kg/day for 2 years, or in rats and mice exposed by oral gavage to respective TWA doses of 11 or 21 mg/kg (25 or 50 mg/kg/day, 3 days/week) Telone II<sup>®</sup>a for 2 years. Mice exposed to 60 ppm Telone II<sup>®</sup>b for 2 years by inhalation developed hyperplasia and hyperkeratosis of the forestomach.

**Hematological Effects.** Limited human data suggest that hematological malignancies (histiocytic lymphoma, acute myelomonocytic leukemia) may be associated with accidental inhalation exposure to 1,3-dichloropropene vapor or aerosol at relatively high levels. In one of these cases, pallor and a reduced hemoglobin count accompanied the leukemia. The only significant hematological effects reported in animals were reductions in hemoglobin and hematocrit counts consistent with microcytic anemia in dogs exposed to 15 mg/kg/day microencapsulated Telone II<sup>®</sup>b in the diet for 13 weeks or 1 year. The NOAELs for hematological effects in dogs were 5 mg/kg/day in the 13-week study and 2.5 mg/kg/day in the 1-year study.

**Urinary System Effects.** Urinary bladder hyperplasia was a consistent finding in mice exposed to  $\geq 60$  ppm 1,3-dichloropropene Telone II<sup>®</sup>b by inhalation for 6 months or  $\geq 20$  ppm for 2 years. Oral gavage administration of epichlorohydrin-containing Telone II<sup>®</sup>a at doses of 21 mg/kg/day (50 mg/kg, 3 days/week) to mice also increased the incidence of urinary bladder hyperplasia, but this lesion was not observed in mice exposed to Telone II<sup>®</sup>b in the diet at doses up to 50 mg/kg/day. The degree to which oral bolus dosing, which could overwhelm the major detoxification pathway, and/or epichlorohydrin, which is a mutagen, contributed to the different results of the two chronic mouse studies is not known.

**Cancer.** Evidence for the carcinogenicity of 1,3-dichloropropene in humans is inadequate. Clinical reports describing the development of neoplasms in three men following inhalation (and possibly dermal) exposure suggest a possible association between exposure and cancer in humans, but are inadequate to establish the association. One source of uncertainty is the lack of information about the specific pesticide formulation and possible carcinogenic additives to which the individuals may have been exposed (see discussion of animal studies below). Two of the men were exposed to 1,3-dichloropropene during the cleanup of a tank truck spill. Six years later, both men simultaneously developed and succumbed to histiocytic lymphoma that was refractory to treatment. The same report described a farmer who developed acute myelomonocytic leukemia after being exposed to 1,3-dichloropropene while applying the chemical to his fields. This leukemia was also refractory to treatment, and the man died approximately 1 year later. A case-control study provided suggestive evidence that populations living for 20 years in

## 2. RELEVANCE TO PUBLIC HEALTH

regions with high usage of 1,3-dichloropropene pesticide may be at increased risk for death from pancreatic cancer.

Results from several cancer bioassays provide adequate evidence of carcinogenicity in animals. In chronic bioassays using Telone II<sup>®</sup>b, the only observed increased tumor incidences were for bronchioalveolar adenomas in mice exposed by inhalation to 60 ppm and for hepatocellular adenomas and carcinomas (combined) in rats exposed in the diet at 25 mg/kg/day. In a chronic oral gavage bioassay using Telone II<sup>®</sup>a, increased incidences were observed for squamous cell papillomas and carcinomas in the forestomach of rats exposed at 11 mg/kg/day (25 mg/kg/day, 3 days/week) and for squamous cell papillomas and carcinomas in the forestomach, bronchioalveolar adenomas, and transitional cell carcinomas of the urinary bladder in mice exposed at 21 mg/kg/day (50 mg/kg/day, 3 days/week). There is some uncertainty as to whether bolus dosing or the presence of epichlorohydrin in Telone II<sup>®</sup>a contributed to increased incidences of forestomach squamous cell papillomas and carcinomas in rats and mice or urinary bladder transitional cell carcinomas in mice, thyroid adenomas and carcinomas, or adrenal gland pheochromocytomas. Aspiration of Telone II<sup>®</sup>a may have contributed to the increased incidence of bronchioalveolar adenomas in mice treated by oral gavage for 2 years. Positive development of sarcomas in mice subcutaneously injected with 1,3-dichloropropene and positive results for chromosomal aberration and deoxyribonucleic acid (DNA) fragmentation in short-term genotoxicity assays (see Section 3.3) lend support to the carcinogenic potential of 1,3-dichloropropene. It should be noted that positive results in mutagenicity assays have been attributed to impurities in the test material (see Section 3.3). The Department of Health and Human Services has determined that 1,3-dichloropropene may reasonably be anticipated to be a carcinogen based on sufficient evidence of carcinogenicity in experimental animals. The International Agency for Research on Cancer has determined that 1,3-dichloropropene is possibly carcinogenic to humans. In 2000, a study classified 1,3-dichloropropene as a probable human carcinogen.

**2,3-Dichloropropene.** The toxicokinetic properties of 2,3-dichloropropene appear to be similar to those of 1,3-dichloropropene. It is readily absorbed in animals exposed by the inhalation and oral routes, and once absorbed, is distributed rapidly throughout the body. It is a weakly alkylating compound that can react directly with biological macromolecules. The major metabolic pathway for 2,3-dichloropropene is a detoxifying conjugation to glutathione, leading to the elimination of mercapturic acid metabolites in the urine. Two minor pathways result in the formation of the mutagens 1,2-dichloroacetone or 2-chloroacrolein. Saturation of the detoxifying conjugation pathways, which might occur under high exposure conditions, could result in the production of proportionally more mutagens via the alternate pathways.

## 2. RELEVANCE TO PUBLIC HEALTH

Reliable data in rats and mice suggest that the most sensitive effect of repeated acute-duration inhalation exposure to 2,3-dichloropropene at 5 ppm is damage to the respiratory tract. Limited data in 13-week studies appear to confirm the sensitivity of the respiratory tract to inhalation exposure (see below). In these 13-week studies, hepatic and renal organ weight increases and altered serum chemistry or urinalysis parameters occur in rats exposed at 40–80 ppm, but not at 15 ppm. Acute inhalation exposure at high levels (>500 ppm) may result in signs indicative of suppression of the central system (unconsciousness) and/or death. The acute-duration study by Zempel et al. (1987) is the only study that allows reliable identification of NOAELs and LOAELs for all systemic end points. No data are available for developmental or carcinogenic effects of exposure to 2,3-dichloropropene.

Repeated exposure to 5–75 ppm for 6 hours/day for 9 out of 11 days resulted in significant concentration-related increases in the incidence and severity of lesions of the respiratory tract in rats and mice. Nearly all rats and mice were affected at the 5 ppm level, with hyperplasia of the nasal respiratory epithelium in both species and diffuse degeneration of the bronchial/bronchiolar epithelium in mice. At  $\geq 25$  ppm, all rats and mice exhibited hyperplasia of the nasal olfactory epithelium and mice had hyperplasia of the laryngeal epithelium. Rats and mice differed in that nasal tissues were the only respiratory tract target in rats, whereas the lungs were also affected in mice. A NOAEL for respiratory effects was not identified in this study.

Intermediate-duration studies provide supportive evidence for respiratory tract effects, but the data do not adequately identify reliable NOAELs or LOAELs. Rats exposed to 15 ppm 6 hours/day, 5 days/week for 13 weeks did not have alterations in lung histology, but did show an increase in red nasal discharge, a sign of nasal irritation. Since the nasal turbinates, the most sensitive target in rats exposed acutely, were not examined for histopathology, a LOAEL for respiratory effects cannot be assigned reliably. An unfinished bioassay, terminated when a drop in U.S. production volumes indicated the compound was of low priority, showed increases in absolute and relative lung weights in female mice exposed at  $\geq 5$  ppm and male mice exposed at  $\geq 10$  ppm for 6 hours/day, 5 days/week for 13 weeks. Although no histopathology data are available for this bioassay, the fact that the lung was the only organ to show weight increases at 5 ppm appears to confirm that the respiratory tract is a specific target of inhaled 2,3-dichloropropene.

***1,2-Dichloropropene.*** No information is available about the toxicokinetic properties of 1,2-dichloropropene. Toxicity information is limited to a brief summary of results of acute-duration studies in



## 2. RELEVANCE TO PUBLIC HEALTH

animals exposed at high or unreported exposure levels. Rats exposed for a few minutes to a saturated vapor atmosphere estimated at 63,764 ppm experienced unconsciousness, with liver, lung, and kidney injury occurring in those that died. Kidney and liver injury were also observed in rats exposed by oral gavage at 2,000 mg/kg. Irritant effects in eyes and skin were observed following topical application of 1,2-dichloropropene at an unspecified dose. The scant information on this isomer suggests that it shares irritant properties with 1,3-dichloropropene and 2,3-dichloropropene.

***1,1-Dichloropropene.*** No *in vivo* toxicity or toxicokinetic data were located for 1,1-dichloropropene. *In vitro* metabolism results of one study indicate that this isomer differs from 1,3-dichloropropene and 2,3-dichloropropene in that conjugation to glutathione results in bioactivation to a mutagenic metabolite, rather than the production of innocuous mercapturic acid metabolites. This finding indicates that estimates of toxicity based on 1,3- or 2,3-dichloropropene may not necessarily apply to 1,1-dichloropropene.

***3,3-Dichloropropene.*** No toxicity or toxicokinetic data were located for 3,3-dichloropropene.

### 2.3 MINIMAL RISK LEVELS (MRLs)

Estimates of exposure levels posing minimal risk to humans (MRLs) have been made for 1,3- and 2,3-dichloropropene. An MRL is defined as an estimate of daily human exposure to a substance that is likely to be without an appreciable risk of adverse effects (noncarcinogenic) over a specified duration of exposure. MRLs are derived when reliable and sufficient data exist to identify the target organ(s) of effect or the most sensitive health effect(s) for a specific duration within a given route of exposure. MRLs are based on noncancerous health effects only and do not consider carcinogenic effects. MRLs can be derived for acute, intermediate, and chronic duration exposures for inhalation and oral routes. Appropriate methodology does not exist to develop MRLs for dermal exposure.

Although methods have been established to derive these levels (Barnes and Dourson 1988; EPA 1990), uncertainties are associated with these techniques. Furthermore, ATSDR acknowledges additional uncertainties inherent in the application of the procedures to derive less than lifetime MRLs. As an example, acute inhalation MRLs may not be protective for health effects that are delayed in development or are acquired following repeated acute insults, such as hypersensitivity reactions, asthma, or chronic bronchitis. As these kinds of health effects data become available and methods to assess levels of significant human exposure improve, these MRLs will be revised.

## 2. RELEVANCE TO PUBLIC HEALTH

The following discussion of inhalation and oral MRLs and the supporting databases is organized by isomer. Intermediate- and chronic-duration inhalation and oral MRLs have been derived for 1,3-dichloropropene and an acute-duration inhalation MRL has been derived for 2,3-dichloropropene (Table 2-1). Additional details of MRL derivations are presented in Appendix A.

***1,3-Dichloropropene.******Inhalation MRLs.***

The data for acute toxic effects in human exposed by inhalation to 1,3-dichloropropene came from accidental exposures for which the concentrations in air were not measured. Acute effects in humans involved the respiratory system (mucous membrane irritation, chest pain, cough, and breathing difficulties) (Flessel et al. 1978; Markovitz and Crosby 1984). Most of the acute-duration inhalation data in animals comes from 1–4-hour acute lethality rat studies that did not employ a control group. Eye irritation was reported at 206 ppm for Telone C-17<sup>®</sup> (21.1% chloropicrin) (Streeter and Lomax 1988) and 775–1,146 ppm for Telone II<sup>®</sup>a (Streeter et al. 1987; Yakel and Kociba 1977). Respiratory effects included atelectasis at 206 ppm for Telone C-17<sup>®</sup> (21.1% chloropicrin) (Streeter and Lomax 1988), lung edema at 595 ppm and congestion at 676 ppm for Telone II<sup>®</sup>a (Cracknell et al. 1987) and hemorrhage at 1,035 ppm (Streeter et al. 1987). Adrenal congestion was noted at 676 ppm for Telone II<sup>®</sup>a (Cracknell et al. 1987). The 1-hour LC<sub>50</sub> for Telone C-17 (21.1% chloropicrin) was 253 ppm (Streeter and Lomax 1988), and 4-hour LC<sub>50</sub> values of 676 and 904 ppm were reported for Telone II<sup>®</sup>a (Cracknell et al. 1987; Streeter et al. 1987). In repeated-dose developmental studies, no maternal effects were noted in rat dams exposed to Telone II<sup>®</sup>a at 300 ppm, but litter sizes were decreased (Kloes et al. 1983). Conversely, 300 ppm had no effect on rabbit development, but resulted in ataxia and death in six of seven does (Kloes et al. 1983). The no-observed-adverse-effect level (NOAEL) of 150 ppm for maternal effects in rats or developmental effects in rabbits exposed to Telone II<sup>®</sup>a (Kloes et al. 1983) cannot be used as the basis for an acute-duration inhalation MRL, because the lack of histopathological examination of the nasal turbinates, the likely target organ, in dams casts doubt on the reliability of 150 ppm as a NOAEL for systemic effects, although it appears to be a reliable NOAEL for developmental effects.

- An MRL of 0.008 ppm has been derived for intermediate-duration inhalation exposure (15–354 days) to 1,3-dichloropropene.

## 2. RELEVANCE TO PUBLIC HEALTH

**Table 2-1. Summary of Minimum Risk Levels (MRLs) Derived for Dichloropropenes**

Compound	Route	Duration	MRL value	Effect	References
1,3-Dichloropropene	Inhalation	Acute	Insufficient data		
	Inhalation	Intermediate	0.008 ppm	Hypertrophy/hyperplasia of nasal respiratory epithelium	Lomax et al. 1989
	Inhalation	Chronic	0.007 ppm	Hypertrophy/hyperplasia of nasal respiratory epithelium	Lomax et al. 1989
	Oral	Acute	Insufficient data		
	Oral	Intermediate	0.04 mg/kg/day	Basal cell hyperplasia of nonglandular stomach	Haut et al. 1996
	Oral	Chronic	0.03 mg/kg/day	Basal cell hyperplasia of nonglandular stomach	Stebbins et al. 2000
2,3-Dichloropropene	Inhalation	Acute	0.002 ppm	Hyperplasia of nasal respiratory epithelium	Zempel et al. 1987
	Inhalation	Intermediate	Insufficient data		
	Inhalation	Chronic	No data		
	Oral	Acute	Insufficient data		
	Oral	Intermediate	No data		
	Oral	Chronic	No data		
1,2-Dichloropropene	Inhalation	Acute	Insufficient data		
	Inhalation	Intermediate	No data		
	Inhalation	Chronic	No data		
	Oral	Acute	Insufficient data		
	Oral	Intermediate	No data		
	Oral	Chronic	No data		
1,1-Dichloropropene	Both	All	No data		
3,3-Dichloropropene	Both	All	No data		

## 2. RELEVANCE TO PUBLIC HEALTH

In the only intermediate-duration inhalation study in humans, no evidence of renal or hepatic damage was detected in clinical chemistry analyses of blood and serum in pesticide applicators using cis-1,3-dichloropropene for an average of 521 ( $\pm 230$ ) minutes/day at a geometric mean concentration (8-hour TWA) of 2.7 mg/m<sup>3</sup> (range 0.1–9.5 mg/m<sup>3</sup>) (0.594 [0.22–2.09] ppm) over a 117-day period compared to unexposed controls (Verplanke et al. 2000). No other end points were examined in this study. Respiratory effects (mucous membrane irritation, chest pain, cough, and breathing difficulties) have been observed following accidental acute exposure to high concentrations (Flessel et al. 1978; Markovitz and Crosby 1984).

The available data from the inhalation exposure animal studies indicate that hypertrophy/hyperplasia of the nasal respiratory epithelium and hyperplasia of the urinary bladder in mice are the most sensitive effects associated with intermediate-duration exposure to 1,3-dichloropropene. Increased incidences of hypertrophy/hyperplasia of the nasal respiratory epithelium occurred in male and female B6C3F1 mice exposed to 60 ppm Telone II<sup>®</sup>b (92.1% 1,3-dichloropropene with 2% ESO) vapor 6 hours/day, 5 days/week for 6 months (Lomax et al. 1989). Female mice in this study exposed at 60 ppm also had a marginally increased incidence of hyperplasia of the urinary bladder. Fischer 344 rats exposed in this study under the same protocol did not exhibit increased incidences of histologically detected lesions in any organs or tissues after 6 months of exposure (Lomax et al. 1989). Slight reductions in body weights were observed in rats and mice exposed at 60 ppm, but the differences were not biologically significant (<10% lower than controls) at 6 months (Lomax et al. 1989). Nasal lesions were also observed in rats exposed to  $\geq 90$  ppm Telone II<sup>®</sup>b 6 hours/day, 5–7 days/week for 3 months in a reproductive toxicity assay (Breslin et al. 1989). Nasal hyperplasia in rats and mice and urinary bladder hyperplasia in mice occurred in groups exposed to  $\geq 90$  ppm Telone II<sup>®</sup>a (90.9% 1,3-dichloropropene with 1.2% epichlorohydrin) 6 hours/day, 5 days/week for 13 weeks (Stott et al. 1988). One 13-week study by Coate (1979a) reported nasal lesions in rats exposed 6 hours/day, 5 days/week to Telone II<sup>®</sup>a at 30 ppm, but since the purity of the test material was not reported, the significance of the result is uncertain.

Although increased incidences of hypertrophy/hyperplasia of the nasal respiratory epithelium and hyperplasia of the urinary bladder were both sensitive effects in mice at a LOAEL of 60 ppm, the urinary bladder lesions were observed only in females and at a marginal increase ( $p=0.043$ ; Fisher Exact Test) over controls. Since the nasal lesions were observed in both sexes at a higher incidence, they are selected as the critical effect for development of the intermediate-duration MRL for 1,3-dichloropropene. The 6-month study with male and female mice exposed to Telone II<sup>®</sup>b by Lomax et al. (1989) is selected as the principal study because the study was adequately designed and reported and the test material was a relatively high concentration of 1,3-dichloropropene without the confounding presence of

## 2. RELEVANCE TO PUBLIC HEALTH

epichlorohydrin. Lomax et al. (1989) exposed groups (10/sex/concentration) of B6C3F1 mice to vapors of 1,3-dichloropropene 6 hours/day, 5 days/week for 6 months at concentrations of 0, 5, 20, or 60 ppm. These were designed as interim satellite groups for a 2-year study. The test material was 92.1% pure (49.5% cis; 42.6% trans) and contained 2.0% ESO as a stabilizer, 0.7% 1,2-dichloropropane, and 5.2% mixtures of hexanes and hexadienes. Mice were examined for clinical signs of toxicity, body weight changes, and terminal hematology and clinical chemistry parameters. Terminal examinations of all animals included gross necropsy, measurement of selected organ weights (brain, heart, kidney, liver, and testes) and histopathological examination of an extensive array of organs and tissues. Exposure to 1,3-dichloropropene for 6 months had no adverse effect on survival, clinical signs, or hematological or clinical chemistry parameters in mice. Significant histological lesions included hypertrophy/hyperplasia of the nasal respiratory epithelium in male and female mice and hyperplasia of the urinary bladder in female mice at 60 ppm. NOAELs of 20 ppm and LOAELs of 60 ppm are identified for hypertrophy/hyperplasia of the nasal respiratory epithelium in male and female mice and hyperplasia of the urinary bladder in female mice. As the increased incidence of hyperplasia of the urinary bladder in female mice was only marginally significant, hypertrophy/hyperplasia of the nasal respiratory epithelium in male and female mice is chosen as the critical effect for MRL derivation.

Potential points of departure for deriving the intermediate-duration MRL were derived using benchmark concentration analysis, the details of which are provided in Appendix A. Before the analysis, exposure concentrations were adjusted for 92.1% purity and discontinuous exposure. For increased incidence of hypertrophy/hyperplasia of nasal epithelium in male and female mice, the potential point of departure was the benchmark concentration limit (BMCL) associated with 10% extra risk, the default benchmark response (BMR) recommended by EPA (2000a). Models for dichotomous data were fit to the incidence data in the key study. The best fitting model for nasal lesions in male and female mice was the gamma model, which generated a  $BMC_{10}$  of 2.8 ppm and a  $BMCL_{10}$  of 1.3 ppm for males and  $BMC_{10}$  of 6.3 ppm and a  $BMCL_{10}$  of 3.0 ppm for females.

The respective  $BMCL_{10}$  values for nasal lesions in male and female mice were converted to human equivalent concentrations ( $[BMCL_{10}]_{HEC}$ ) by multiplying by the extrathoracic regional gas dose ratio (B6C3F1 mouse/human) for males (0.1779) and females (0.1368) according to EPA (1994) guidance for inhalation dosimetry for a category 1 gas, as a default for a category 2 gas. The resulting  $[BMCL_{10}]_{HEC}$  values were 0.23 ppm for male mice and 0.41 ppm for female mice. The lower  $[BMCL_{10}]_{HEC}$  value of 0.23 ppm derived from male mice was used as the point of departure for deriving the MRL. A total uncertainty factor of 30 (3 for conversion from animals to humans using dosimetric adjustment and 10 for

## 2. RELEVANCE TO PUBLIC HEALTH

human variability) was applied to the male [BMCL<sub>10</sub>]<sub>HEC</sub> to calculate an intermediate-duration inhalation MRL of 0.008 ppm for 1,3-dichloropropene.

- An MRL of 0.007 ppm has been derived for chronic-duration inhalation exposure ( $\geq 1$  year) to 1,3-dichloropropene.

No data are available for effects in humans following chronic-duration inhalation exposure to 1,3-dichloropropene. Fischer F344 rats and B6C3F1 mice were evaluated for chronic-duration inhalation exposure to Telone II<sup>®</sup>b (92.1% 1,3-dichloropropene stabilized with 2% epoxidized soybean oil, ESO) for 1 or 2 years (Lomax et al. 1989).

The available data from chronic-duration studies indicate that lesions of the nasal epithelium and urinary bladder in mice are the most sensitive effects associated with chronic-duration inhalation exposure to 1,3-dichloropropene. After 1 year, incidences of hypertrophy/hyperplasia of the nasal respiratory epithelium were increased in male mice exposed at  $\geq 20$  ppm and female mice at 60 ppm. In addition, the incidences of hyperplasia and inflammation of the urinary bladder were increased in female mice exposed to 60 ppm for 1 year. After 2 years of exposure, increased incidences of hypertrophy/hyperplasia of the nasal respiratory epithelium occurred in female mice at  $\geq 20$  ppm and males exposed at 60 ppm, and increased degeneration of the nasal olfactory epithelium occurred in male and female mice exposed at 60 ppm. In rats, nasal lesions (decreased thickness of the olfactory epithelium in males and females, erosion of the olfactory epithelium in males, and submucosal fibrosis in males) were only detected at 60 ppm after 2 years of exposure and at lower incidences than in exposed mice. The incidences of epithelial hyperplasia of the urinary bladder were increased in female mice exposed for 2 years at  $\geq 20$  ppm and male mice exposed at 60 ppm; the incidence of inflammation of the bladder epithelium was increased in female mice exposed for 2 years at  $\geq 20$  ppm, but not in males. No histopathology of the urinary bladder was observed in rats.

Based on these findings, hypertrophy/hyperplasia of the nasal respiratory epithelium and hyperplasia of the urinary bladder epithelium in mice exposed for 2 years were selected as co-critical effects for the development of the chronic-duration inhalation MRL for 1,3-dichloropropene. The mouse study by Lomax et al. (1989) is the principal study because the test material in this adequately designed and reported study had a purity of 92.1% and did not contain epichlorohydrin or chloropicrin as a possibly confounding toxic additive. Lomax et al. (1989) exposed groups (50/sex/concentration) of B6C3F1 mice to vapors of 1,3-dichloropropene (Telone II<sup>®</sup>b) 6 hours/day, 5 days/week for 2 years at concentrations of 0, 5, 20, or 60 ppm. Additional satellite groups (10/sex/concentration) were established for interim

## 2. RELEVANCE TO PUBLIC HEALTH

sacrifices at 6 and 12 months (results for the 6-month sacrifice are given under the description for the intermediate-duration inhalation MRL). The test material was 92.1% pure (49.5% cis; 42.6% trans) and contained 2.0% ESO as a stabilizer, 0.7% 1,2-dichloropropane, and 5.2% mixtures of hexanes and hexadienes. Mice were examined for clinical signs of toxicity, body weight changes, and terminal hematology and clinical chemistry parameters. Terminal examinations of all animals included gross necropsy, measurement of selected organ weights (brain, heart, kidney, liver, and testes), and histopathological examination of an extensive array of organs and tissues. Exposure to Telone II<sup>®</sup>b vapor for 2 years had no significant adverse effect on survival, body weight, the incidence of clinical signs, hematology, or clinical chemistry parameters in mice. In the 1-year satellite group, incidences of hypertrophy/hyperplasia of the nasal respiratory epithelium were significantly higher than controls in males at  $\geq 20$  ppm and in females at 60 ppm; females at 60 ppm also had increased incidences of epithelial hyperplasia and inflammation of the urinary bladder. After 2 years of exposure, incidences nasal and urinary bladder hyperplasia were elevated in males at 60 ppm and in females at  $\geq 20$  ppm. Increases in inflammation of the urinary bladder were not observed in males and were relatively small in females. Degeneration of the nasal olfactory epithelium was not statistically elevated in either sex at concentrations  $< 60$  ppm. NOAELs of 5 ppm and LOAELs of 20 ppm were identified for hypertrophy/hyperplasia of the nasal respiratory epithelium and epithelial hyperplasia of the urinary bladder in females.

Potential points of departure for deriving the chronic-duration inhalation MRL were calculated using benchmark concentration analysis, the details of which are provided in Appendix A. Before the analysis, exposure concentrations in ppm were adjusted for 92.1% purity and discontinuous exposure. Models for dichotomous data were fit to the incidence data in the key study. None of the models in the EPA benchmark dose (BMD) software provided an adequate fit to the data for hypertrophy/hyperplasia of the nasal respiratory epithelium in male mice, so no BMCL could be calculated. For increased incidences of hypertrophy/hyperplasia of nasal respiratory epithelium in female mice or hypertrophy of urinary bladder epithelium in male and female mice, the potential points of departure were the 95% lower confidence limits on estimated concentrations (BMCLs) associated with 10% extra risk compared to control values. This benchmark response (BMR) level is the default recommended by EPA (2000a). The log-probit model gave the best fit to data for nasal lesions in female mice, resulting in a  $BMC_{10}$  of 1.56 ppm and a  $BMCL_{10}$  of 1.0 ppm. The logistic model gave the best fit to data for urinary bladder lesions in male mice, resulting in a  $BMC_{10}$  of 2.18 ppm and a  $BMCL_{10}$  of 1.78 ppm. The quantal-quadratic model gave the best fit to data for urinary bladder lesions in female mice, resulting in a  $BMC_{10}$  of 1.52 ppm and a  $BMCL_{10}$  of 1.30 ppm.

## 2. RELEVANCE TO PUBLIC HEALTH

Mouse BMCL values were converted to human equivalent concentrations (HECs) using EPA (1994) dosimetry methods. The BMCL<sub>10</sub> of 1.0 ppm for hypertrophy/hyperplasia of nasal respiratory epithelium in female mice was multiplied by the extrathoracic regional dose ratio (mouse/human) of 0.1999, resulting in a HEC of 0.20 ppm. As no mouse or human blood:air partition coefficients were available for 1,3-dichloropropene, the BMCL<sub>10</sub> values for urinary bladder lesions in male and female mice were multiplied by the default blood:gas partition coefficient ratio of 1 (for calculating the HECs for the extrarrespiratory effects), resulting in [BMCL<sub>10</sub>]<sub>HEC</sub> values for male and female mice of 1.78 and 1.30 ppm, respectively. The [BMCL<sub>10</sub>]<sub>HEC</sub> value of 0.20 ppm for hypertrophy/hyperplasia of nasal respiratory epithelium in female mice was selected as the more sensitive point of departure. A total uncertainty factor of 30 (3 for extrapolation from animal to human using dosimetric adjustment and 10 for human variability) was applied to the [BMCL<sub>10</sub>]<sub>HEC</sub> of 0.20 ppm, resulting in a chronic-duration inhalation MRL of 0.007 ppm for 1,3-dichloropropene.

**Oral MRLs.** No acute-duration oral MRL was derived for 1,3-dichloropropene. The only information on toxic effects in humans following oral exposure to 1,3-dichloropropene comes from a case report of effects following accidental ingestion of an undetermined fatal dose (Hernandez et al. 1994). The gastrointestinal effects observed in this case (initially acute gastroenteritis and abdominal pain on deep palpation, subsequent bloody diarrhea, hemorrhagic exudate of the stomach at autopsy, histopathological evidence of congestion of gastric mucosal vessels, autolysis, and mucosal erosions of the stomach) support the significance of portal-of-entry effects of ingested 1,3-dichloropropene. Other effects included tachycardia, tachypnea, hypovolemia, adult respiratory distress syndrome, and multiorgan failure prior to death. The database for oral toxicity of 1,3-dichloropropene in animals consists entirely of several acute lethality studies in rats conducted by oral gavage under protocols that do not include a control group. Suppression of the central nervous system following exposure to Telone II<sup>®</sup>a was indicated by clinical signs such as reduced respiratory rate at  $\geq 75$  mg/kg, lethargy at  $\geq 110$  mg/kg, and ataxia at  $\geq 170$  mg/kg (Jones and Collier 1986a); rats exposed to the cis isomer exhibited ataxia at  $\geq 75$  mg/kg (Jones 1988a). Hemorrhaging was observed in the lung, gastrointestinal tract, and liver in rats dosed with  $\geq 110$  mg/kg of 97.2% cis-1,3-dichloropropene (Jones 1988a); hemorrhaging was observed in the gastrointestinal tract and lungs of rats dosed at  $\geq 170$  or 250 mg/kg, respectively, with 97.2% mixed isomers (Jones and Collier 1986a). Hyperkeratosis of the stomach was observed in rats exposed to  $\geq 75$  mg/kg 1,3-dichloropropene (97.2% mixed isomers) (Jones and Collier 1986a) or 100 mg/kg 79.1% 1,3-dichloropropene with 19% chloropicrin (Mizell et al. 1988a). LD<sub>50</sub> values in rats were 121 mg/kg for the cis isomer (97.2%), 304 mg/kg for 79.1% 1,3-dichloropropene with 19% chloropicrin (Mizell et al. 1988a), and 150–



## 2. RELEVANCE TO PUBLIC HEALTH

470 mg/kg for mixed isomer formulations with purities between 92 and 97.54% (Jeffrey et al. 1987a; Jones and Collier 1986a; Lichy and Olson 1975).

- An MRL of 0.04 mg/kg/day has been derived for intermediate-duration oral exposure (15–364 days) to 1,3-dichloropropene.

No data are available for effects in humans following intermediate-duration oral exposure to 1,3-dichloropropene. Intermediate-duration oral exposure studies with rats, mice, and dogs exposed to different commercial formulations of 1,3-dichloropropene isomers have been conducted by oral gavage or dietary exposure.

As shown in the following overview, available data from the oral exposure animal studies indicate that lesions in the nonglandular stomach mucosa in rats and microcytic anemia in dogs are the most sensitive effects associated with intermediate-duration oral exposure to 1,3-dichloropropene. Increased incidences of basal cell hyperplasia of the nonglandular stomach occurred in male Fischer 344 rats exposed to doses  $\geq 15$  mg/kg/day Telone II<sup>®</sup>b microencapsulated in feed for 13 weeks; female rats displayed hyperkeratosis of the nonglandular stomach epithelium at doses of 100 mg/kg/day in this study (Haut et al. 1996). B6C3F1 mice exposed to Telone II<sup>®</sup>b via the same protocol for 13 weeks did not display any adverse effects on histologic or hematologic end points (Haut et al. 1996). Microcytic anemia (decreased hematocrit, hemoglobin concentration, and corpuscular volume) occurred in beagle dogs exposed to doses  $\geq 15$  mg/kg/day Telone II<sup>®</sup>b encapsulated in feed for 13 weeks (Stebbins et al. 1999). Reductions in terminal body weight were observed in rats, mice, and dogs exposed to Telone II<sup>®</sup>b in feed for 13 weeks, but reduced food intake associated with decreased palatability may have contributed to these effects (Haut et al. 1996; Stebbins et al. 1999). In an earlier 13-week study with Telone<sup>®</sup>, a commercial formulation of lesser 1,3-dichloropropene purity than Telone II<sup>®</sup>b, increased liver or kidney weights were observed in rats at doses as low as 10 and 30 mg/kg/day, respectively, but the lack of renal or kidney adverse noncancer effects in the intermediate- or chronic-duration studies with Telone II<sup>®</sup>b suggests that these organs are not consistently observed noncancer toxicity targets of 1,3-dichloropropene.

The study describing hematological effects in dogs was not selected for MRL derivation due to the small group sizes (4/sex/group) and the lack of histopathological examination. Therefore, the other sensitive effect, basal cell hyperplasia in the nonglandular stomach of male rats, was selected the critical effect for development of the intermediate-duration MRL for 1,3-dichloropropene. The 13-week study with male rats (Haut et al. 1996) exposed to microencapsulated Telone II<sup>®</sup>b was selected as the principal study, because the test material in this adequately designed and reported study was the most purified 1,3-di-

## 2. RELEVANCE TO PUBLIC HEALTH

chloropropene formulation tested and did not contain potentially confounding toxic materials such as epichlorohydrin or chloropicrin. The test material, Telone II<sup>®</sup>b, was 95.8% pure 1,3-dichloropropene (50.7% cis; 45.1% trans) and was microencapsulated in a starch/sucrose (80:20) microsphere matrix before addition to the diets for 13 weeks. In the Haut et al. (1996) study, groups of male and female Fischer 344 rats (10/sex/group) received 1,3-dichloropropene at reported doses of 0, 5, 15, 50, or 100 mg/kg/day. Animals were evaluated for clinical signs of toxicity, body weight changes, feed intake, and hematological, clinical chemistry, and urinalysis parameters. All rats received a gross necropsy examination and were evaluated for histopathology in a full array of tissues and organs. Ingestion of Telone II<sup>®</sup>b had no effect on survival in rats. Significant histopathological lesions in this study included basal cell hyperplasia of the nonglandular stomach in male rats exposed at  $\geq 15$  mg/kg/day and hyperkeratosis of the nonglandular stomach epithelium at 100 mg/kg/day. In this study, a NOAEL of 5 mg/kg/day and a LOAEL of 15 mg/kg/day were identified for cell hyperplasia in the nonglandular stomach of male rats (Haut et al. 1996).

Potential points of departure for deriving the intermediate-duration MRL were derived using benchmark dose analysis, the details of which are described in Appendix A. For increased incidence of basal hyperplasia in nonglandular stomach mucosa of rats, the potential point of departure was the BMDL associated with 10% extra risk; this BMR was selected as the default following EPA (2000a) guidance. Models for dichotomous data in the BMD software were fit to the incidence data in the key study. The best fitting model for forestomach lesions in male rats was the multistage model, which generated a BMD<sub>10</sub> of 9.0 mg/kg/day and a BMDL<sub>10</sub> of 3.6 mg/kg/day. The BMDL<sub>10</sub> of 3.6 mg/kg/day for basal cell hyperplasia in male rats was selected as the point of departure for deriving the intermediate-duration oral MRL.

An intermediate-duration oral MRL of 0.04 mg/kg/day was derived by dividing the BMDL<sub>10</sub> of 3.6 mg/kg/day by an uncertainty factor of 100 (10 for extrapolation from animals to humans and 10 for human variability).

- An MRL of 0.03 mg/kg/day has been derived for chronic-duration oral exposure ( $\geq 1$  year) to 1,3-dichloropropene.

No data are available for effects in humans following chronic-duration oral exposure to 1,3-dichloropropene. Chronic-duration oral exposure studies with rats, mice, and dogs exposed to different commercial formulations of 1,3-dichloropropene isomers have been conducted by oral gavage or dietary exposure.

## 2. RELEVANCE TO PUBLIC HEALTH

As shown in the following overview, the available data indicate that lesions in the nonglandular stomach mucosa in rats and microcytic anemia in dogs are the most sensitive effects associated with chronic-duration oral exposure to 1,3-dichloropropene. Basal cell hyperplasia of the nonglandular stomach mucosa was observed in male and female Fischer 344 rats exposed to doses as low as 12.5 mg/kg/day Telone II<sup>®</sup>b (but not 2.5 mg/kg/day) encapsulated in feed for 1 or 2 years (Stebbins et al. 2000), and in male and female F344 rats and female B6C3F1 mice exposed to gavage doses of 25 mg/kg/day Telone II<sup>®</sup>a (89% dichloropropene isomers plus 1% epichlorohydrin) 3 times/week for up to 2 years (NTP 1985). Increased incidences of this lesion did not occur in male or female B6C3F1 mice exposed to 2.5, 25, or 50 mg/kg/day Telone II<sup>®</sup>b encapsulated in feed for 1 or 2 years (Stebbins et al. 2000) or in male or female beagle dogs exposed to 0.5, 2.5, or 15 mg/kg/day Telone II<sup>®</sup>b encapsulated in feed for 1 year (Stebbins et al. 1999). However, male and female beagle dogs exposed to 15 mg/kg/day, but not 2.5 mg/kg/day, Telone II<sup>®</sup>b encapsulated in feed for 1 year showed decreased values for mean hematocrit, hemoglobin concentration, and corpuscular volume, compared with control values, which are indicative of microcytic anemia. Exposure-related reductions in terminal body weight were observed in rats, mice, and dogs exposed to Telone II<sup>®</sup>b in feed for 1 or 2 years, but reduced food intake associated with decreased palatability may have contributed to these effects (Stebbins et al. 1999, 2000).

Adverse noncancer effects on the liver or kidney are not as clearly associated with chronic-duration oral exposure to 1,3-dichloropropene as forestomach basal cell hyperplasia in rats or microcytic anemia in dogs. Exposure-related kidney effects include increased incidence of hydronephrosis in female, but not male, B6C3F1 mice exposed to gavage doses of 100 mg/kg/day Telone II<sup>®</sup>a, but not 50 mg/kg/day, for up to 2 years (NTP 1985) and increased incidence of nephropathy in female, but not male, Fischer 344 rats exposed to 25 or 50 mg/kg/day Telone II<sup>®</sup>a for up to 2 years (NTP 1985). However, no exposure-related kidney effects were observed in Fischer 344 rats, B6C3F1 mice, or beagle dogs exposed to Telone II<sup>®</sup>b encapsulated in feed for 1 or 2 years at doses as high as 25 mg/kg/day for rats, 50 mg/kg/day for mice, and 15 mg/kg/day for dogs (Stebbins et al. 1999, 2000). Observed noncancer effects in the liver include decreased size of hepatocytes in male, but not female, B6C3F1 mice exposed to 50 mg/kg/day, but not 25 mg/kg/day, Telone II<sup>®</sup>b encapsulated in feed for 1 year, but not in mice exposed for 2 years (Stebbins et al. 2000) and increased incidence of slight or very slight eosinophilic foci of altered liver cells in male and female Fischer 344 rats exposed to 2.5, 12.5, or 25 mg/kg/day Telone II<sup>®</sup>b encapsulated in feed for 2 years. The toxicological significance of these apparent liver effects is equivocal given the inconsistency of the findings in the mouse study and the common spontaneous occurrence of liver foci (eosinophilic or basophilic) in aged Fischer 344 rats.

## 2. RELEVANCE TO PUBLIC HEALTH

Based on the findings from the chronic-duration oral exposure animal studies, basal cell hyperplasia in the nonglandular stomach of male rats and decreased hemoglobin concentration and corpuscular volume in male or female dogs were selected as co-critical effects for development of the chronic-duration MRL for 1,3-dichloropropene. The 2-year rat study (Stebbins et al. 2000) and 1-year dog study (Stebbins et al. 1999) involving exposure to microencapsulated Telone II<sup>®</sup>b were selected as the principal studies, because the test material in these adequately designed and reported studies was the most purified 1,3-dichloropropene formulation tested (95.8% pure 1,3-dichloropropene—50.7% cis; 45.1% trans—with 2% ESO as a stabilizer) and did not contain potentially confounding toxic materials such as epichlorohydrin or chloropicrin. In the study by Stebbins et al. (2000), the main group of male and female Fischer 344 rats (50/sex/group) received doses of 0, 2.5, 12.5, or 25 mg/kg/day for 2 years and a satellite group of 10/sex/group received the same treatment for 12 months. In the Stebbins et al. (1999) study, groups of beagle dogs (4/sex/dose) had intakes of 0, 0.5, 2.5, or 15 mg/kg/day for 12 months. Both studies evaluated animals for clinical signs of toxicity, body weight changes, feed intake, and hematological, clinical chemistry, and urinalysis parameters. All animals received a gross necropsy examination, with evaluation of a full array of tissues and organs for histopathological examination. Ingestion of Telone II<sup>®</sup>b had no effect on survival in rats or dogs. The primary histological lesion in rats was basal cell hyperplasia of the nonglandular stomach mucosa observed in males and females exposed to  $\geq 12.5$  mg/kg/day. In these studies, a NOAEL of 2.5 mg/kg/day and a LOAEL of 12.5 mg/kg/day were identified for cell hyperplasia in the nonglandular stomach of male rats (Stebbins et al. 2000) and a NOAEL of 2.5 mg/kg/day and a LOAEL of 15 mg/kg/day were identified for decreased hemoglobin concentration and corpuscular volume in male or female dogs (Stebbins et al. 1999).

Potential points of departure for deriving the chronic-duration MRL were derived with benchmark dose analysis, the details of which are described in Appendix A. For decreased hemoglobin concentration, which was as an index of 1,3-dichloropropene-induced microcytic anemia in dogs, potential points of departure were 95% lower confidence limits on estimated doses (i.e., BMDLs) associated with a value lower than 10<sup>th</sup> percentile values for the distribution of hemoglobin concentrations in a sample of normal beagle dogs. The linear model for continuous data was modeled to the hemoglobin data in dogs, resulting in a BMD<sub>10th%ile</sub> of 8.35 mg/kg/day and a BMDL<sub>10th%ile</sub> of 6.05 mg/kg/day for male dogs and a BMD<sub>10th%ile</sub> of 10.98 mg/kg/day and a BMDL<sub>10th%ile</sub> of 8.83 mg/kg/day for female dogs. For increased incidence of basal hyperplasia in nonglandular stomach mucosa of rats, the potential point of departure was the BMDL associated with 10% extra risk. This BMR is the default recommended by EPA (2000a). Models for dichotomous data were applied to the incidence data in rats. The log-probit model gave the best fit to the

## 2. RELEVANCE TO PUBLIC HEALTH

data for male rats, resulting in a BMD<sub>10</sub> of 5.34 mg/kg/day and a BMDL<sub>10</sub> of 4.26 mg/kg/day. The log-logistic model gave the best fit to the data for female rats, resulting in a BMD<sub>10</sub> of 5.42 mg/kg/day and a BMDL<sub>10</sub> of 3.51 mg/kg/day. The lowest BMDL is the BMDL<sub>10</sub> of 3.51 mg/kg/day for increased incidence of nonglandular stomach basal cell hyperplasia in rats. A chronic-duration oral MRL based on the BMDL<sub>10</sub> of 3.51 mg/kg/day for basal cell hyperplasia in rats divided by an uncertainty factor of 100 (10 for extrapolation from animals to humans and 10 for human variability) would be 0.04 mg/kg/day. This value is in agreement with EPA's chronic oral RfD of 0.03 mg/kg/day, which was based on a point of departure of 3.4 mg/kg/day (see Chapter 8 and Appendix A). Therefore, 0.03 mg/kg/day was selected as the chronic oral MRL for 1,3-dichloropropene.

### *2,3-Dichloropropene*

#### *Inhalation MRLs*

- An MRL of 0.002 ppm has been derived for acute-duration inhalation exposure (<15 days) to 2,3-dichloropropene.

No information was located regarding the acute inhalation toxicity of 2,3-dichloropropene in humans. The available data from inhalation studies in animals indicate that hyperplasia of the nasal respiratory epithelium in male and female rats and mice and degeneration of the bronchial/bronchiolar epithelium in male and female mice are the most sensitive effects associated with acute-duration exposure to 2,3-dichloropropene. Increased concentration-related incidences and severity (see Table 2-2, the same as Table A-1 in Appendix A) of hyperplasia of the nasal respiratory epithelium occurred in male and female Fischer 344 rats and B6C3F1 mice, and slight diffuse degeneration of bronchial/bronchial epithelium occurred in male and female B6C3F1 mice exposed to 5 ppm 2,3-dichloropropene (>99% purity) vapor 6 hours/day for nine exposures over 11 days (Zempel et al. 1987). Male and female rats and mice in this study exposed at  $\geq 25$  ppm had slight-to-moderate hyperplasia of the nasal olfactory epithelium, and male and female mice exposed at  $\geq 25$  ppm had very slight-to-slight hyperplasia of the laryngeal epithelium. Reductions (12–25%) in terminal body weights in male and female mice exposed at 25 or 75 ppm appeared to be related to reduced feed intake.

Respiratory lesions were also observed in single-exposure acute lethality studies described in cursory and/or incomplete reports. In a 6-hour exposure study, crusted noses were observed in rats exposed at 250 ppm and bloody noses at 500 ppm, whereas in a 1-hour study, gasping and shallow respiration were observed during exposure at  $\geq 693$  ppm and labored respiration was observed after exposure at 1,963 ppm

## 2. RELEVANCE TO PUBLIC HEALTH

**Table 2-2. Incidence of Significant Lesions in Fischer 344 Rats and B6C3F1 Mice Exposed to 2,3-Dichloropropene (>99%) Vapor 6 Hours/Day, for 9/11 Days<sup>a</sup>**

	Control	5 ppm	25 ppm	75 ppm
<b>Rats</b>				
Hyperplasia of nasal respiratory epithelium				
Male rats	0/5	4/5*	5/5**	5/5***
Female rats	0/5	5/5*	5/5**	5/5***
<b>Mice</b>				
Hyperplasia of nasal respiratory epithelium				
Male mice	0/5	3/5*	5/5**	5/5***
Female mice	0/5	4/5*	5/5**	5/5***
Diffuse degeneration of bronchial/bronchiolar epithelium				
Male mice	0/5	5/5**	5/5***	5/5****
Female mice	0/5	5/5**	3/5***+ 2/5****	5/5****

<sup>a</sup>Severity: \*very slight; \*\*slight;\*\*\*moderate;\*\*\*\*severe

Source: Zempel et al. 1987

## 2. RELEVANCE TO PUBLIC HEALTH

in rats (Dietz et al. 1985b). Exposure to an unquantified concentrated vapor atmosphere resulted in gasping, labored breathing, and nasal discharge as clinical signs, as well as hemorrhagic lungs and inflammation of the nasal mucosal in rats (Younger 1967). In these studies, evidence of suppression of the central nervous system was observed at concentrations in excess of 500 ppm (Dietz et al. 1985b; Younger 1967).

The acute study in male and female rats and mice by Zempel et al. (1987) is selected as the principal study because it was adequately designed and reported, the purity of the test material was high, and it reported critical effects at the lowest tested concentration.

Zempel et al. (1987) exposed (whole body) groups of B6C3F1 mice and F344 rats (5/sex/species/group) to vapors of 2,3-dichloropropene (>99% purity) 6 hours/day for nine exposures over 11 days at concentrations of 0, 5, 25, or 75 ppm. Rats and mice were examined for clinical signs of toxicity, body weight changes, hematology and serum chemistry analyses of terminal blood samples, and, in rats only, urinalyses. Terminal examinations of all rats and mice included a complete necropsy (for rats, including the eyes), measurement of selected organ weights (brain, heart, liver, thymus, kidneys, and testes), and microscopic examination of all tissues for animals in the control and 75 ppm groups, and for target tissues (liver, kidneys, bone marrow, lungs, and nasal tissues, and in mice, thymus, trachea, and larynx) in the 5 and 25 ppm groups. Exposure to 2,3-dichloropropene had no significant effect on survival in rats or mice. No alterations in activity levels or hematology, serum chemistry, or urinalysis results were observed in rats. Alterations in hematology and clinical chemistry parameters observed in mice were ascribed by the study authors to mild dehydration (and resulting hemoconcentration) and stress. Significant histological lesions of the respiratory tract are presented in Table 2-2. Other histopathological lesions were not considered to be compound related: stress-related cortical atrophy of the thymus and dehydration-related reduced extramedullary hematopoiesis in the liver and spleen of mice at 75 ppm. The lowest exposure level, 5 ppm, was a minimal LOAEL for very slight hyperplasia of the nasal respiratory epithelium in male and female rats and mice and slight diffuse degeneration of the bronchial/bronchiolar epithelium in male and female mice.

Potential points of departure for deriving the acute-duration inhalation MRL were obtained by first adjusting for intermittent exposure, resulting in a duration-adjusted LOAEL of 1.25 ppm. Using EPA (1994) dosimetry adjustments, regional gas dose ratios (RGDRs) were calculated for extrathoracic (ET) effects (nasal lesions) in rats and mice and tracheobronchial (TB) effects (bronchial/bronchiolar lesions) in mice. Although 2,3-dichloropropene is a category 2 gas, the equations for a category 1 gas were used

## 2. RELEVANCE TO PUBLIC HEALTH

by default since an equation is not available for category 2 gases. The calculated RGDRs were applied to the duration adjusted LOAEL of 1.25 ppm to obtain the human equivalent concentrations (LOAEL<sub>HEC</sub>): 0.20 and 0.14 ppm for extrathoracic effects in male and female rats, respectively, 0.18 and 0.15 ppm for extrathoracic effects in male and female mice, respectively, and 2.22 and 1.79 ppm for tracheobronchial effects in male and female mice, respectively. The lowest LOAEL<sub>HEC</sub> of 0.14 ppm for hyperplasia of the nasal respiratory epithelium in female rats was chosen as the point of departure for the MRL since it would be protective against all observed effects. A composite uncertainty factor of 90 (3 for the use of a minimal LOAEL, 3 for extrapolation from animals to humans using dosimetric adjustments, and 10 for human variability) was applied to the LOAEL<sub>HEC</sub> of 0.14 ppm for hyperplasia of the nasal respiratory epithelium in female rats, resulting in an MRL of 0.002 ppm.

No intermediate-duration inhalation MRL was derived for 2,3-dichloropropene because of a lack of suitable data. No studies were located regarding the intermediate-duration inhalation toxicity of 2,3-dichloropropene in humans. Intermediate-duration inhalation studies in animals exposed to 2,3-dichloropropene are not adequate for derivation of an intermediate-duration inhalation MRL because of deficiencies that prevent the accurate determination of reliable NOAELs or LOAELs for respiratory lesions (Johannsen et al. 1991; NTP 1989). NTP (1989) began 13-week studies (Study No. C61881) in Fischer 344 rats and B6C3F1 mice exposed 6 hours/day, 5 days/week to 0, 5, 10, 20, 40, or 80 ppm 2,3-dichloropropene, but terminated the postexposure work on the studies when new data showed that production volumes of 2,3-dichloropropene in the United States had dropped below 100 kg/year (NTP 2006; communication from NTP to SRC). Some data tables are available for this study on the NTP website, providing definitive concentration-response information for body weights and hematology parameters, but not for most other end points because no histopathology data are available. The 13-week systemic toxicity and 13–16-week reproductive toxicity studies by Johannsen et al. (1991), in which Sprague-Dawley rats were exposed 6 hours/day, 5 days/week at concentrations of 0, 1, 5, or 15 ppm or 0, 1, or 5 ppm, respectively, are deficient in the failure to examine the likely target organ, the nasal turbinates.

The following results were reported in the 13-week studies in rats and mice. No effects on survival, hematology, serum chemistry, histopathology, body weight, or organ weights were observed in rats exposed at  $\leq 15$  ppm (Johannsen et al. 1991). In rats, respiratory effects in rats included red nasal discharge (increasing in frequency during the study), but no observed lung histopathology, at  $\leq 15$  ppm (Johannsen et al. 1991), and no lung weight increases at  $\leq 80$  ppm (NTP 1989). Female mice exposed at 5–40 ppm had 25–33% increases in absolute lung weight and 25–47% increases in relative lung weight,



## 2. RELEVANCE TO PUBLIC HEALTH

whereas male mice had absolute lung weights increased by 13–36% at 10–80 ppm and relative lung weights increased by 22–33% at 10–40 ppm and by 200% at 80 ppm (NTP 1989). No female mice exposed at 80 ppm survived to 13 weeks (NTP 1989); no mortality data were available for male and female rats or male mice exposed to  $\leq 80$  ppm (NTP 1989). Significant concentration-related ( $>10\%$ ) reductions in terminal body weights compared to controls were observed in male rats and male and female mice exposed at 40 or 80 ppm (NTP 1989). Hepatic toxicity was observed in female rats: 33% increased absolute and 37% increased relative liver weights, a 60% increase in serum alkaline phosphatase, and a 6-fold increase in total serum bile acids at 80 ppm, and  $>3$ -fold increases in serum alanine aminotransferase (ALT) and sorbitol dehydrogenase (SDH) at 40–80 ppm (NTP 1989). No hepatic weight changes were observed in female mice exposed at  $\leq 40$  ppm, or male rats or mice exposed at  $\leq 80$  ppm (NTP 1989). A 17% increase in absolute and 23% increase in relative kidney weights were observed in female rats at 80 ppm (NTP 1989); urine volume was increased with exposure in female rats, but decreased in male rats. No kidney weight changes were observed in female mice exposed at  $\leq 40$  ppm, or male rats or mice exposed at  $\leq 80$  ppm (NTP 1989). No significant compound-related effects were observed on hematology parameters in rats or mice exposed at  $\leq 80$  ppm (NTP 1989). No significant effects were observed on reproductive parameters—gonadal weight or sperm parameters in male or estrus cycling in female rats or mice exposed at  $\leq 80$  ppm (Johannsen et al. 1991; NTP 1989) or mating and fertility indices in rats exposed at  $\leq 5$  ppm (Johannsen et al. 1991). The available limited data provide suggestive evidence that the respiratory system is the primary target of intermediate-duration inhalation exposure to 2,3-dichloropropene, presumably a portal-of-entry effect related to repeated irritation. The lung weight effects at 5 ppm in the NTP study are consistent with the acute-duration inhalation study by Zempel et al. (1987) in that lung effects were observed in mice, but not in rats.

Neither of the available studies provide a suitable basis for derivation of an intermediate-duration inhalation MRL for 2,3-dichloropropene. Although Johannsen et al. (1991) appears to identify irritation of the respiratory tract as the most sensitive effect of exposure, an accurate NOAEL or LOAEL for respiratory effects cannot be determined for this study because no incidence data were reported for red nasal discharge at 15 ppm and no histopathological examination was conducted for the nasal turbinates. Furthermore, the incomplete NTP (1989) study in mice appears to show lung effects in mice at 5 ppm, but also lacks histopathology data for the lung and nasal turbinates. Consequently, no intermediate-duration inhalation MRL was derived.

No chronic-duration inhalation MRL was derived for 2,3-dichloropropene because of a lack of data in humans or animals.

## 2. RELEVANCE TO PUBLIC HEALTH

**Oral MRLs.** No oral MRLs were derived for 2,3-dichloropropene. No information was located regarding the oral toxicity of 2,3-dichloropropene. Animal data are limited to two acute lethality studies in rats that did not include control groups. A study by Younger (1967) was only available as a summary that reported an acute oral LD<sub>50</sub> of 285 (250–326) mg/kg for male and female rats combined and did not report target organ specificity. A study by Union Carbide Corp. (1958), results of which were published in Smyth et al. (1962), reported an acute oral LD<sub>50</sub> of 320 (260–400) mg/kg (Smyth et al. [1962] misreported the unit as mL/kg). Necropsy results included congestion in lungs, liver, and kidney, and opacity of the gastrointestinal tract. These studies are not suitable for MRL derivation because they provide no dose-response information for nonlethal effects.

***1,2-Dichloropropene***

**Inhalation MRLs.** No inhalation MRLs were derived for 1,2-dichloropropene. No information was located regarding the acute inhalation toxicity of 1,2-dichloropropene in humans. Animal data are limited to an unpublished summary of an acute lethality study in which small numbers of rats (3 or 4) were exposed to saturated vapor at an estimated concentration of 63,764 ppm and 1/4 died after 6 minutes and 3/3 died after 12 minutes (Dow 1962); the study included no other exposure levels and no control group. Effects noted in this study were unconsciousness and, in one rat at necropsy, considerable (unspecified) injury to lung, liver, and kidney. The numerous deficiencies in design (small group size, lack of control group, single exposure level, lack of a nonlethal exposure level) and reporting, render this study unsuitable for MRL derivation.

**Oral MRLs.** No oral MRLs were derived for 1,2-dichloropropene. No information was located regarding the oral toxicity of 1,2-dichloropropene in humans. Animal data are limited to an unpublished summary of a range-finding study in which two rats were given 1,2-dichloropropene by oral gavage in corn oil at a dose of 2,000 mg/kg (Dow 1962). Neither animal died, but necropsy revealed considerable (unspecified) injury to the liver and kidney. This study is unreliable because of the inadequate design (small group size, lack of control group) and inadequate reporting of methods and results.

***1,1-Dichloropropene and 3,3-Dichloropropene***

No MRLs were derived for 1,1- or 3,3-dichloropropene because of a lack of toxicity data in humans or animals exposed to these isomers by the inhalation or oral routes.

### 3. HEALTH EFFECTS

#### 3.1 INTRODUCTION

The primary purpose of this chapter is to provide public health officials, physicians, toxicologists, and other interested individuals and groups with an overall perspective on the toxicology of dichloropropenes. It contains descriptions and evaluations of toxicological studies and epidemiological investigations and provides conclusions, where possible, on the relevance of toxicity and toxicokinetic data to public health.

A glossary and list of acronyms, abbreviations, and symbols can be found at the end of this profile.

The majority of toxicity and toxicokinetic information on dichloropropenes relates to the 1,3-dichloropropene isomer. 1,3-Dichloropropene is widely used as a preplanting soil fumigant for the control of nematodes, and it has been available for agricultural use in many formulations. Formulations, instead of pure 1,3-dichloropropene, were used in most of the studies discussed here. The trade names and components of these formulations are listed in Table 3-1.

In some studies, the investigation of the toxicity of 1,3-dichloropropene may have been confounded by other components in a formulation (e.g., chloropicrin and epichlorohydrin). This possibility is discussed in the appropriate sections of the text. The most recent toxicity studies have been conducted using Telone II<sup>®</sup>b (stabilized with 2% epoxidized soybean oil); recent dietary studies administered this material microencapsulated in a starch/sucrose matrix (80/20%) to avoid loss from evaporation and degradation in feed. Intermediate- and chronic-duration MRLs for 1,3-dichloropropene are based on studies that tested Telone II<sup>®</sup>b. Separate tables and figures for each formulation of 1,3-dichloropropene are not presented. Instead, the formulation used in each study is identified in the appropriate table; purity data and noteworthy impurities/additives are also provided as reported in the original studies. Further information on the formulations of 1,3-dichloropropene can be found in Chapter 5. Previously cited toxicity studies that examined formulations with a relatively low content of 1,3-dichloropropene, such as DD<sup>®</sup> (52% 1,3-dichloropropene; ≤29% 1,2-dichloropropane), have been removed from this profile because they have been superseded by studies on higher-purity formulations.

Little toxicity information, none for exposed humans, is available for other isomers of dichloropropene. No *in vivo* mammalian toxicity data are available for 1,1-dichloropropene, which is sometimes detected in

## 3. HEALTH EFFECTS

**Table 3-1. Trade Names and Components of Pure 1,3-Dichloropropene Formulations**

Formulation	Composition	Additives
Telone <sup>®</sup>	40.2% cis, 38.3% trans	Not otherwise specified
Telone C-17 <sup>®</sup>	40–41% cis, 38–39%trans	19–21% chloropicrin
Telone II <sup>®a</sup>	48–53% cis, 42–45% trans	1% epichlorohydrin, not otherwise specific
Telone II <sup>®b</sup>	48–53% cis, 42–45% trans	2% epoxidized soybean oil (ESO)
DD <sup>®</sup>	25–28% cis, 25–27% trans	25–29% 1,2-dichloropropene
DD-92 <sup>®</sup>	92% cis/trans	Not otherwise specified
DD-95 <sup>®</sup>	95% cis/trans	Not otherwise specified

<sup>a</sup>Also called M-3993

### 3. HEALTH EFFECTS

water systems, or 3,3-dichloropropene, which was present in some older pesticide formulations. A few acute-duration toxicity studies have been conducted on 1,2-dichloropropene, and both acute- and intermediate-duration studies have been conducted on 2,3-dichloropropene. An 11-day inhalation study on 2,3-dichloropropene was the basis for an acute-duration inhalation MRL (Zempel et al. 1987). NTP (1989) began a 13-week inhalation assay on 2,3-dichloropropene, but disbanded the postexposure data analysis when a new report indicated that production of the chemical in the United States had fallen below 100 kg/year (NTP 2006). The available records of that study are discussed in Chapter 3, since they provide some evidence for target-organ specificity of 2,3-dichloropropene following repeated exposure, but the data are not used for derivation of an intermediate-duration inhalation MRL. *In vivo* toxicokinetic studies have been conducted on 2,3-dichloropropene and one *in vitro* study has been conducted on 1,1-dichloropropene. All of the isomers except 3,3-dichloropropene have been investigated for genotoxicity.

#### 3.2 DISCUSSION OF HEALTH EFFECTS BY ROUTE OF EXPOSURE

To help public health professionals and others address the needs of persons living or working near hazardous waste sites, the information in this section is organized first by route of exposure (inhalation, oral, and dermal) and then by health effect (death, systemic, immunological, neurological, reproductive, developmental, genotoxic, and carcinogenic effects). These data are discussed in terms of three exposure periods: acute (14 days or less), intermediate (15–364 days), and chronic (365 days or more).

Levels of significant exposure for each route and duration are presented in tables and illustrated in figures. The points in the figures showing no-observed-adverse-effect levels (NOAELs) or lowest-observed-adverse-effect levels (LOAELs) reflect the actual doses (levels of exposure) used in the studies. LOAELs have been classified into "less serious" or "serious" effects. "Serious" effects are those that evoke failure in a biological system and can lead to morbidity or mortality (e.g., acute respiratory distress or death). "Less serious" effects are those that are not expected to cause significant dysfunction or death, or those whose significance to the organism is not entirely clear. ATSDR acknowledges that a considerable amount of judgment may be required in establishing whether an end point should be classified as a NOAEL, "less serious" LOAEL, or "serious" LOAEL, and that in some cases, there will be insufficient data to decide whether the effect is indicative of significant dysfunction. However, the Agency has established guidelines and policies that are used to classify these end points. ATSDR believes that there is sufficient merit in this approach to warrant an attempt at distinguishing between "less serious" and "serious" effects. The distinction between "less serious" effects and "serious" effects is considered to be important because it helps the users of the profiles to identify levels of exposure at which

### 3. HEALTH EFFECTS

major health effects start to appear. LOAELs or NOAELs should also help in determining whether or not the effects vary with dose and/or duration, and place into perspective the possible significance of these effects to human health.

The significance of the exposure levels shown in the Levels of Significant Exposure (LSE) tables and figures may differ depending on the user's perspective. Public health officials and others concerned with appropriate actions to take at hazardous waste sites may want information on levels of exposure associated with more subtle effects in humans or animals (LOAELs) or exposure levels below which no adverse effects (NOAELs) have been observed. Estimates of levels posing minimal risk to humans (Minimal Risk Levels or MRLs) may be of interest to health professionals and citizens alike. MRLs derived for dichloropropenes are summarized in Table 2-1, briefly described in Section 2.3 and described in detail in Appendix A.

Levels of exposure associated with carcinogenic effects (Cancer Effect Levels, CELs) of 1,3-dichloropropene are indicated in Tables 3-2 and 3-4 and Figures 3-1 and 3-3. Because cancer effects could occur at lower exposure levels, Figures 3-1 and 3-3 also show ranges for the upper bound of estimated excess risks, ranging from a risk of 1 in 10,000 to 1 in 10,000,000 ( $10^{-4}$  to  $10^{-7}$ ), as developed by EPA. Carcinogenicity studies were not available for other isomers of dichloropropene.

A User's Guide has been provided at the end of this profile (see Appendix B). This guide should aid in the interpretation of the tables and figures for Levels of Significant Exposure and the MRLs.

In Section 3.2, data for individual isomers (1,3-, 2,3-, and 1,2-dichloropropene) are presented under italicized subheadings under each end point. No subheading was created for an isomer if no data were located for that end point.

#### **3.2.1 Inhalation Exposure**

Reliable inhalation toxicity data are available for 1,3-dichloropropene and, to a lesser extent, for 2,3-dichloropropene. The highest NOAEL and all reliable LOAEL values after inhalation exposure to 1,3- and 2,3-dichloropropene are recorded in Tables 3-2 and 3-3, respectively, and plotted in Figures 3-1 and 3-2, respectively. Median lethal concentrations and other reliable mortality data are recorded as serious LOAELs in these tables and figures.

Table 3-2 Levels of Significant Exposure to 1,3-dichloropropene - Inhalation

Key to Figure <sup>a</sup>	Species (Strain)	Exposure/ Duration/ Frequency (Route)	System	NOAEL (ppm)	LOAEL		Reference Chemical Form	Comments
					Less Serious (ppm)	Serious (ppm)		
<b>ACUTE EXPOSURE</b>								
<b>Death</b>								
1	Rat (Wistar)	1 d 4 hr/d				675 (6/10 died)	Cracknell et al. 1987 T IIa	Purity: 98.4% 1,3-DCP.
2	Rat (Fischer- 344)	1 d 1 hr/d				253 (LC50)	Streeter and Lomax 1988 T C-17	Purity: 78.9% 1,3-DCP; 21.1% chloropicrin.
3	Rat (Fischer- 344)	1 d 4 hr/d				904 (LC50 females)	Streeter et al. 1987 T IIa	Purity: 97.5% 1,3-DCP.
4	Rabbit (New Zealand)	13 d Gd 6-18 6 hr/d				300 F (6/7 died)	Kloes et al. 1983 T IIa	Purity: 92.1% 1,3-DCP; 1% epichlorohydrin.
<b>Systemic</b>								
5	Rat (Wistar)	1 d 4 hr/d	Resp	581 M		594 M (lung edema)	Cracknell et al. 1987 T IIa	Purity: 98.4% 1,3-DCP.
			Endocr	594	675	(adrenal congestion in decedents)		
			Bd Wt		356 M	(final body weight 10% lower than controls)		
6	Rat (Fischer- 344)	1 d 1 hr/d	Resp			206 (atelectasis, multifocal)	Streeter and Lomax 1988 T C-17	Purity: 78.9% 1,3-DCP; 21.1% chloropicrin.
			Ocular		206	(eye irritation)		

\*\*\*DRAFT FOR PUBLIC COMMENT\*\*\*

DICHLOROPROPENES

3. HEALTH EFFECTS

Table 3-2 Levels of Significant Exposure to 1,3-dichloropropene - Inhalation

(continued)

Key to Figure <sup>a</sup>	Species (Strain)	Exposure/Duration/Frequency (Route)	System	NOAEL (ppm)	LOAEL		Reference Chemical Form	Comments	
					Less Serious (ppm)	Serious (ppm)			
7	Rat (Fischer- 344)	1 d 4 hr/d	Resp			1035	(lung hemorrhage)	Streeter et al. 1987 T IIa	Purity: 97.5% 1,3-DCP.
			Ocular		775	(eye irritation)			
8	Rat (Sprague-Dawley)	1 d 1 hr/d	Ocular			1146	(eye irritation)	Yakel and Kociba 1977 T IIa	Purity: 92% 1,3-DCP.
<b>Neurological</b>									
9	Rabbit (New Zealand)	13 d 6 hr/d		150 F		300 F	(ataxia)	Kloes et al. 1983 T IIa	Purity: 92.1% 1,3-DCP; 1% epichlorohydrin.
<b>Developmental</b>									
10	Rat	Gd 6-15 6 hr/d		120				Hanley et al. 1987 T IIa	1,3-DCP: 47.7% cis; 42.4% trans.
11	Rat (Fischer- 344)	10 d Gd 6-15 6 hr/d		150 F		300 F	(decreased litter size)	Kloes et al. 1983 T IIa	Purity: 92.1% 1,3-DCP; 1% epichlorohydrin.
12	Rabbit (New Zealand)	13 d Gd 6-18 6 hr/d		150 F				Kloes et al. 1983 T	Purity: 92.1% 1,3-DCP; 1% epichlorohydrin.
<b>INTERMEDIATE EXPOSURE</b>									
<b>Systemic</b>									
13	Human	117 d 521 min/d (Occup)	Hepatic	0.59 M				Verplanke et al. 2000 cis	
			Renal	0.59 M					

\*\*\*DRAFT FOR PUBLIC COMMENT\*\*\*

DICHLOROPROPENES

3. HEALTH EFFECTS



Table 3-2 Levels of Significant Exposure to 1,3-dichloropropene - Inhalation

(continued)

Key to Figure	Species (Strain)	Exposure/Duration/Frequency (Route)	System	NOAEL (ppm)	LOAEL		Reference Chemical Form	Comments
					Less Serious (ppm)	Serious (ppm)		
14	Rat (Fischer- 344)	180 d 5-7 d/wk 6 hr/d	Resp	30	90	(nasal lesions)	Breslin et al. 1989 T IIb	Purity: 92% 1,3-DCP; 2% ESO.
			Gastro	90				
			Hepatic	90				
			Renal	90				
15	Rat (Fischer- 344)	13 wk 5 d/wk 6 hr/d	Resp	10	30	(decreased cytoplasm, disorganization of nuclei in epithelium of dorsal nasal turbinates)	Coate 1979a T IIa	Purity not reported.
			Cardio	90				
			Hepatic	90				
			Renal	90				
16	Rat	4 wk 5 d/wk 6 hr/d	Resp	30			Coate 1979b T IIa	No purity data.
			Cardio	30				
			Hepatic	30				
			Renal	30				

\*\*\*DRAFT FOR PUBLIC COMMENT\*\*\*

DICHLOROPROPENES

3. HEALTH EFFECTS

Table 3-2 Levels of Significant Exposure to 1,3-dichloropropene - Inhalation

(continued)

Key to Figure	Species (Strain)	Exposure/Duration/Frequency (Route)	System	NOAEL (ppm)	LOAEL		Reference Chemical Form	Comments
					Less Serious (ppm)	Serious (ppm)		
17	Rat (Fischer- 344)	13 wk 5 d/wk 6 hr/d	Resp	30	90	(nasal hyperplasia)	Stott et al. 1988 T IIa	Purity: 90.9% 1,3-DCP; 1.2% epichlorohydrin.
			Cardio	150				
			Gastro	150				
			Hemato	150				
			Musc/skel	150				
			Hepatic	150				
			Renal	150				
			Dermal	150				
18	Rat	6 mo 5 d/wk 7 hr/d	Resp	3			Torkelson and Oyen 1977 T IIa	Purity: 99% 1,3-DCP; 1% epichlorohydrin.
			Cardio	3				
			Hemato	3				
			Hepatic	3				
19	Mouse (CD-1)	13 wk 5 d/wk 6 hr/d	Resp		90	(decreased epithelial cytoplasm of dorsal nasal turbinates)	Coate 1979a T IIa	Purity not reported.
			Cardio	90				
			Hepatic	90				
			Renal	90				

\*\*\*DRAFT FOR PUBLIC COMMENT\*\*\*

DICHLOROPROPENES

3. HEALTH EFFECTS

Table 3-2 Levels of Significant Exposure to 1,3-dichloropropene - Inhalation

(continued)

Key to Figure	Species <sup>a</sup> (Strain)	Exposure/Duration/Frequency (Route)	System	NOAEL (ppm)	LOAEL		Reference Chemical Form	Comments
					Less Serious (ppm)	Serious (ppm)		
20	Mouse (B6C3F1)	6 mo 5 d/wk 6 hr/d	Resp	20	60 <sup>b</sup>	(hyperplasia/hypertrophy of nasal respiratory epithelium)	Lomax et al. 1989 T IIb	Purity: 92.1% 1,3-DCP; 2% ESO.
			Cardio	60				
			Gastro	60				
			Hemato	60				
			Musc/skel	60				
			Hepatic	60				
			Renal	20	60 F	(bladder hyperplasia)		
Dermal	60							
21	Mouse (B6C3F1)	13 wk 5 d/wk 6 hr/d	Resp	30	90	(nasal hyperplasia)	Stott et al. 1988 T IIa	Purity: 90.9% 1,3-DCP; 1.2% epichlorohydrin.
			Cardio	150				
			Gastro	150				
			Hemato	150				
			Musc/skel	150				
			Hepatic	150				
Renal	30	90	(bladder hyperplasia)					

\*\*\*DRAFT FOR PUBLIC COMMENT\*\*\*

DICHLOROPROPENES

3. HEALTH EFFECTS

Table 3-2 Levels of Significant Exposure to 1,3-dichloropropene - Inhalation

(continued)

Key to Figure <sup>a</sup>	Species (Strain)	Exposure/ Duration/ Frequency (Route)	System	NOAEL (ppm)	LOAEL		Reference Chemical Form	Comments
					Less Serious (ppm)	Serious (ppm)		
22	Gn Pig	6 mo 5 d/wk .5-4 hr/d	Resp	3			Torkelson and Oyen 1977 T IIa	Purity: 99% 1,3-DCP; 1% epichlorohydrin.
			Cardio	3				
			Hemato	3				
			Hepatic	3				
			Renal	3				
23	Dog	6 mo 5 d/wk .5-4 hr/d	Resp	3			Torkelson and Oyen 1977 T IIa	Purity: 99% 1,3-DCP; 1% epichlorohydrin.
			Cardio	3				
			Gastro	3				
			Hemato	3				
			Musc/skel	3				
			Renal	3				
24	Rabbit	6 mo 5 d/wk .5-4 hr/d	Resp	3			Torkelson and Oyen 1977 T IIa	Purity: 99% 1,3-DCP; 1% epichlorohydrin.
			Cardio	3				
			Hemato	3				
			Hepatic	3				
			Renal	3				

\*\*\*DRAFT FOR PUBLIC COMMENT\*\*\*

DICHLOROPROPENES

3. HEALTH EFFECTS

Table 3-2 Levels of Significant Exposure to 1,3-dichloropropene - Inhalation

(continued)

Key to Figure <sup>a</sup>	Species (Strain)	Exposure/Duration/Frequency (Route)	System	NOAEL (ppm)	LOAEL		Reference Chemical Form	Comments
					Less Serious (ppm)	Serious (ppm)		
<b>Immuno/ Lymphoret</b>								
25	Rat (Fischer- 344)	6-12 mo 5 d/wk 6 hr/d		60			Lomax et al. 1989 T IIb	Purity: 92.1% 1,3-DCP.
26	Rat (Fischer- 344)	13 wk 5 d/wk 6 hr/d		150			Stott et al. 1988 T IIa	Purity: 90.9% 1,3-DCP; 1.2% epichlorohydrin.
27	Mouse (B6C3F1)	6-12 mo 5 d/wk 6 hr/d		60			Lomax et al. 1989 T IIb	Purity: 92.1% 1,3-DCP.
28	Mouse (B6C3F1)	13 wk 5 d/wk 6 hr/d		150			Stott et al. 1988 T IIa	Purity: 90.9% 1,3-DCP; 1.2% epichlorohydrin.
<b>Neurological</b>								
29	Rat (Fischer- 344)	6-12 mo 5 d/wk 6 hr/d		60			Lomax et al. 1989 T IIb	Purity: 92.1% 1,3-DCP.
30	Rat (Fischer- 344)	13 wk 5 d/wk 6 hr/d		150			Stott et al. 1988 T IIa	Purity: 90.9% 1,3-DCP; 1.2% epichlorohydrin.
31	Mouse (CD-1)	13 wk 5 d/wk 6 hr/d		90			Coate 1979a T IIa	Purity not reported.
32	Mouse (B6C3F1)	6-12 mo 5 d/wk 6 hr/d		60			Lomax et al. 1989 T IIb	Purity: 92.1% 1,3-DCP.

\*\*\*DRAFT FOR PUBLIC COMMENT\*\*\*

DICHLOROPROPENES

3. HEALTH EFFECTS

Table 3-2 Levels of Significant Exposure to 1,3-dichloropropene - Inhalation

(continued)

Key to Figure <sup>a</sup>	Species (Strain)	Exposure/Duration/Frequency (Route)	System	NOAEL (ppm)	LOAEL		Reference Chemical Form	Comments
					Less Serious (ppm)	Serious (ppm)		
33	Mouse (B6C3F1)	13 wk 5 d/wk 6 hr/d		150			Stott et al. 1988 T IIa	Purity: 90.9% 1,3-DCP; 1.2% epichlorohydrin.
34	Gn Pig	6 mo 5 d/wk .5-4 hr/d		3			Torkelson and Oyen 1977 T IIa	Purity: 99% 1,3-DCP; 1% epichlorohydrin.
35	Dog	6 mo 5 d/wk .5-4 hr/d		3			Torkelson and Oyen 1977 T IIa	Purity: 99% 1,3-DCP; 1% epichlorohydrin.
36	Rabbit	6 mo 5 d/wk .5-4 hr/d		3			Torkelson and Oyen 1977 T IIa	Purity: 99% 1,3-DCP; 1% epichlorohydrin.
<b>Reproductive</b>								
37	Rat (Fischer- 344)	180 d 5-7 d/wk 6 hr/d		90			Breslin et al. 1989 T IIb	Purity: 92% 1,3-DCP; 2% ESO.
38	Rat (Fischer- 344)	6-12 mo 5 d/wk 6 hr/d		60			Lomax et al. 1989 T IIb	Purity: 92.1% 1,3-DCP.
39	Rat (Fischer- 344)	13 wk 5 d/wk 6 hr/d		150			Stott et al. 1988 T IIa	Purity: 90.9% 1,3-DCP; 1.2% epichlorohydrin.
40	Mouse (B6C3F1)	6-12 mo 5 d/wk 6 hr/d		60			Lomax et al. 1989 T IIb	Purity: 92.1% 1,3-DCP.

\*\*\*DRAFT FOR PUBLIC COMMENT\*\*\*

Table 3-2 Levels of Significant Exposure to 1,3-dichloropropene - Inhalation

(continued)

Key to Figure	Species (Strain)	Exposure/Duration/Frequency (Route)	System	NOAEL (ppm)	LOAEL		Reference Chemical Form	Comments
					Less Serious (ppm)	Serious (ppm)		
41	Mouse (B6C3F1)	13 wk 5 d/wk 6 hr/d		150			Stott et al. 1988 T IIa	Purity: 90.9% 1,3-DCP; 1.2% epichlorohydrin.
<b>Developmental</b>								
42	Rat (Fischer- 344)	180 d 5-7 d/wk 6 hr/d		90			Breslin et al. 1989 T IIb	Purity: 92% 1,3-DCP; 2% ESO.
<b>CHRONIC EXPOSURE</b>								
<b>Systemic</b>								
43	Rat (Fischer- 344)	2 yr 5 d/wk 6 hr/d	Resp	20	60	(epithelial degeneration)	Lomax et al. 1989 T IIb	Purity: 92.1% 1,3-DCP.
			Cardio	60				
			Gastro	60				
			Hemato	60				
			Musc/skel	60				
			Hepatic	60				
			Renal	60				
			Dermal	60				

\*\*\*DRAFT FOR PUBLIC COMMENT\*\*\*

Table 3-2 Levels of Significant Exposure to 1,3-dichloropropene - Inhalation

(continued)

Key to Figure	Species <sup>a</sup> (Strain)	Exposure/Duration/Frequency (Route)	System	NOAEL (ppm)	LOAEL		Reference Chemical Form	Comments
					Less Serious (ppm)	Serious (ppm)		
44	Mouse (B6C3F1)	2 yr 5 d/wk 6 hr/d	Resp	5 F	20 <sup>c</sup> F (hypertrophy/hyperplasia of nasal respiratory epithelium)		Lomax et al. 1989 T IIb	Purity: 92.1% 1,3-DCP.
			Cardio	60				
			Gastro	20 M	60 M (hyperplasia and hyperkeratosis of forestomach)			
			Hemato	60				
			Musc/skel	60				
			Hepatic	60				
			Renal	5 F	20 F (epithelial hyperplasia of urinary bladder)			
	Dermal	60						
<b>Immuno/ Lymphoret</b>								
45	Rat (Fischer- 344)	2 yr 5 d/wk 6 hr/d		60			Lomax et al. 1989 T IIb	Purity: 92.1% 1,3-DCP.
<b>Neurological</b>								
46	Rat (Fischer- 344)	2 yr 5 d/wk 6 hr/d		60			Lomax et al. 1989 T IIb	Purity: 92.1% 1,3-DCP.
47	Mouse (B6C3F1)	2 yr 5 d/wk 6 hr/d		60			Lomax et al. 1989 T IIb	Purity: 92.1% 1,3-DCP.

\*\*\*DRAFT FOR PUBLIC COMMENT\*\*\*

DICHLOROPROPENES

3. HEALTH EFFECTS

52



Table 3-2 Levels of Significant Exposure to 1,3-dichloropropene - Inhalation

(continued)

Key to Figure <sup>a</sup>	Species (Strain)	Exposure/Duration/Frequency (Route)	System	NOAEL (ppm)	LOAEL		Reference Chemical Form	Comments
					Less Serious (ppm)	Serious (ppm)		
<b>Reproductive</b>								
48	Rat (Fischer- 344)	2 yr 5 d/wk 6 hr/d		60			Lomax et al. 1989 T IIb	Purity: 92.1% 1,3-DCP.
49	Mouse (B6C3F1)	2 yr 5 d/wk 6 hr/d		60			Lomax et al. 1989 T IIb	Purity: 92.1% 1,3-DCP.
<b>Cancer</b>								
50	Mouse (B6C3F1)	2 yr 5 d/wk 6 hr/d				60 M (CEL: bronchioalveolar adenoma)	Lomax et al. 1989 T IIb	Purity: 92.1% 1,3-DCP.

a The number corresponds to entries in Figure 3-1.

b Study results used to derive an intermediate-duration inhalation minimal risk level (MRL) of 0.008 ppm for 1,3-dichloropropene, as described in detail in Appendix A. Benchmark dose analysis was performed using reported concentrations (adjusted for <100% purity and intermittent exposure) and incidences of hypertrophy/hyperplasia of the nasal respiratory epithelium in male and female mice to select a point of departure. The selected point of departure, based on nasal lesions in male mice, was adjusted to a human equivalent concentration, and then divided by an uncertainty factor of 30 (3 for extrapolation from animals to humans using dosimetric adjustment and 10 for human variability) (See Appendix A).

c Study results used to derive a chronic-duration inhalation minimal risk level (MRL) of 0.007 ppm for 1,3-dichloropropene, as described in detail in Appendix A. Benchmark dose analysis was performed using reported concentrations (adjusted for <100% purity and intermittent exposure) and incidences of hypertrophy/hyperplasia of the nasal respiratory epithelium in female mice to select a point of departure, which was adjusted to a human equivalent concentration, and then divided by an uncertainty factor of 30 (3 for extrapolation from animals to humans using dosimetric adjustment and 10 for human variability) (See Appendix A).

Bd Wt = body weight; ESO = epoxidized soybean oil; Cardio = cardiovascular; CEL = cancer effect level; d = day(s); F = female; Gastro = gastrointestinal; Gd = gestational day; Gn pig = guinea pig; hemato = hematological; hr = hour(s); Immuno/Lymphoret = immunological/lymphoretic; LC50 = lethal concentration, 50% kill; LOAEL = lowest-observed-adverse-effect level; M = male; mo = month(s); Musc/skel = musculoskeletal; NOAEL = no-observed-adverse-effect level; Resp = respiratory; wk = week(s); yr = year(s)

\*\*\*DRAFT FOR PUBLIC COMMENT\*\*\*

Figure 3-1 Levels of Significant Exposure to 1,3-dichloropropene - Inhalation  
Acute (≤14 days)

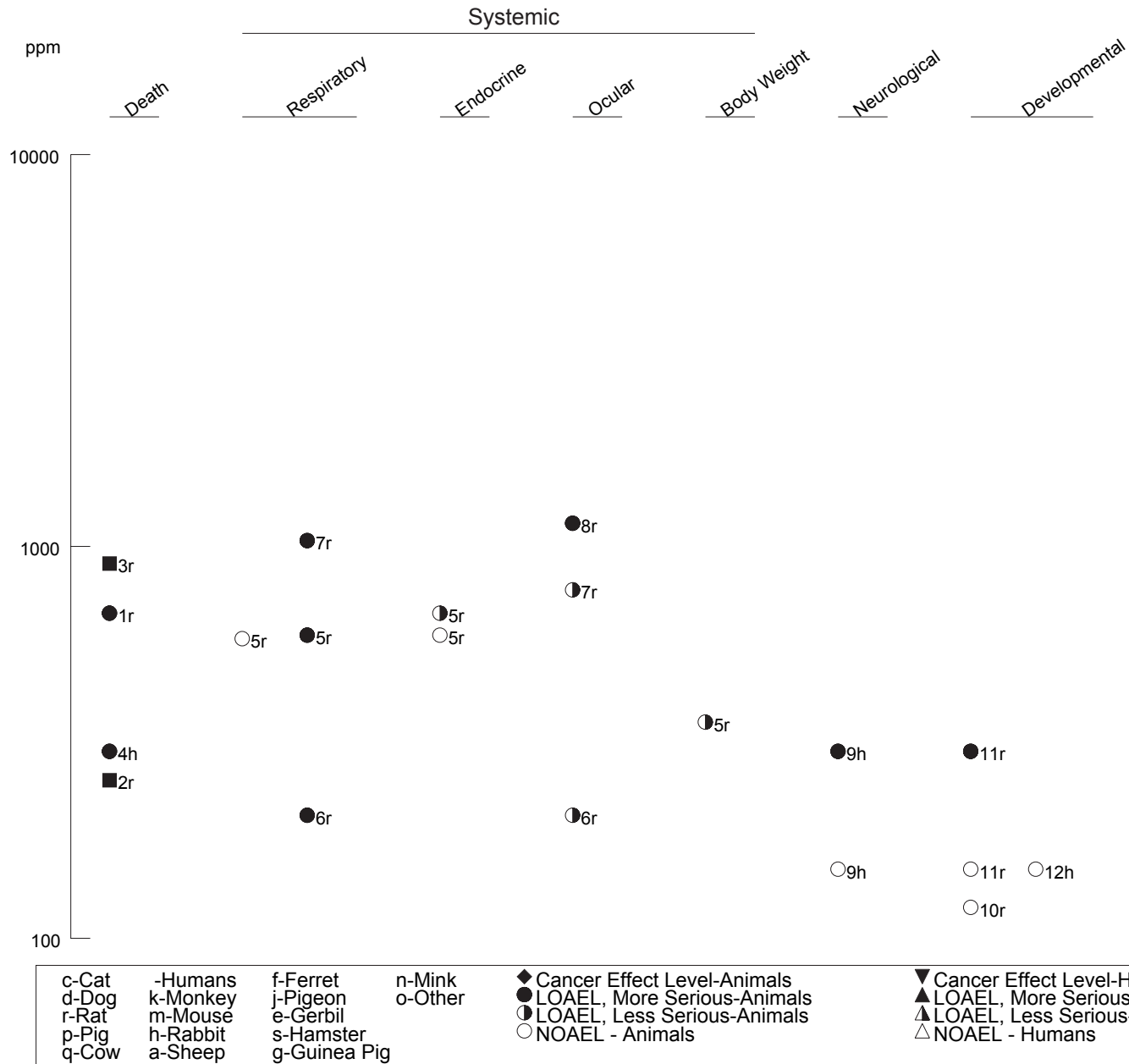
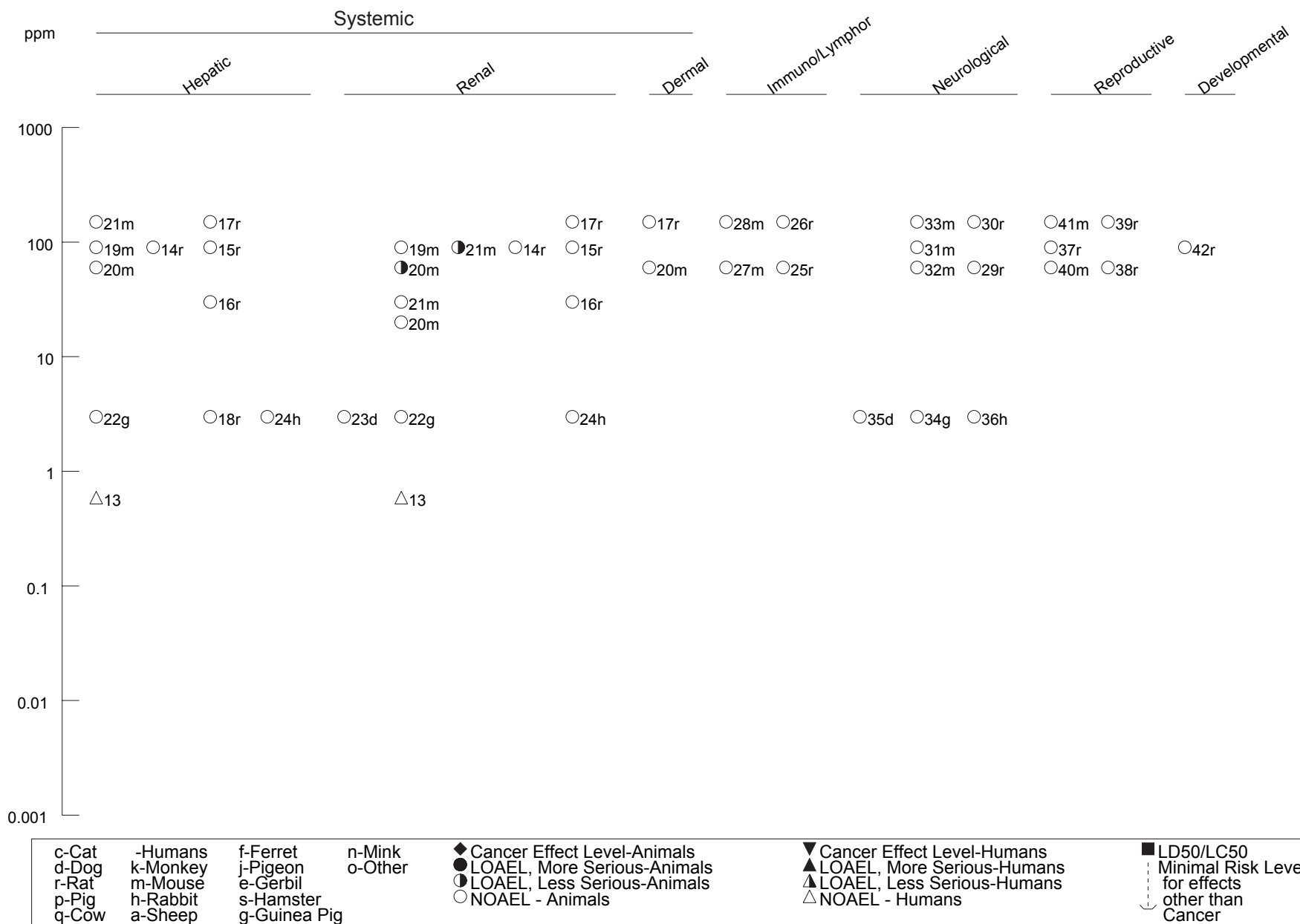



Figure 3-1 Levels of Significant Exposure to 1,3-dichloropropene - Inhalation (Continued)

Intermediate (15-364 days)



\*\*\*DRAFT FOR PUBLIC COMMENT\*\*\*



Figure 3-1 Levels of Significant Exposure to 1,3-dichloropropene - Inhalation (Continued)  
Chronic (≥365 days)

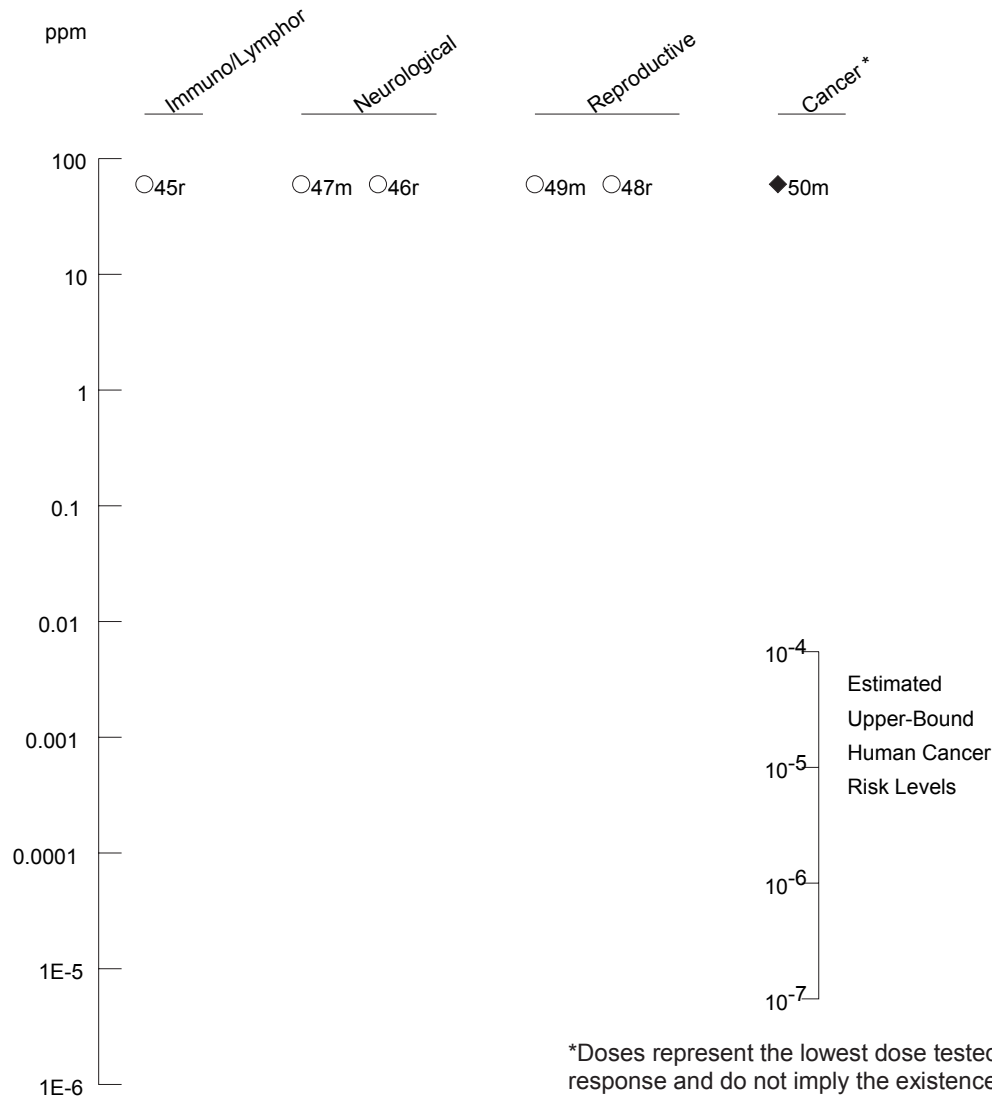

\*\*\*DRAFT FOR PUBLIC COMMENT\*\*\*

c-Cat	-Humans	f-Ferret	n-Mink	◆ Cancer Effect Level-Animals	▼ Cancer Effect Level-Humans	■ LD50/LC50
d-Dog	k-Monkey	j-Pigeon	o-Other	● LOAEL, More Serious-Animals	▲ LOAEL, More Serious-Humans	⋮ Minimal Risk Level
r-Rat	m-Mouse	e-Gerbil		◐ LOAEL, Less Serious-Animals	△ LOAEL, Less Serious-Humans	⋮ for effects
p-Pig	h-Rabbit	s-Hamster		○ NOAEL - Animals	△ NOAEL - Humans	other than
q-Cow	a-Sheep	g-Guinea Pig				Cancer

Table 3-3 Levels of Significant Exposure to 2,3-dichloropropene - Inhalation

Key to Figure <sup>a</sup>	Species (Strain)	Exposure/ Duration/ Frequency (Route)	System	NOAEL (ppm)	LOAEL		Reference Chemical Form	Comments
					Less Serious (ppm)	Serious (ppm)		
<b>ACUTE EXPOSURE</b>								
<b>Death</b>								
1	Rat (Fischer- 344)	once 1 hr				1331 F (1-hour LC50)	Dietz et al. 1985b 2,3-dichloropropene	Purity: >98%.
2	Rat (Wistar)	once 4 hr				500 (3/6 rats died)	Smyth et al. 1962; Union Carbide Corp 1958 2,3-dichloropropene	Purity not reported.
<b>Systemic</b>								
3	Rat (Fischer- 344)	9 d/11 d 6 hr/d	Resp		<sup>b</sup> 5	(very slight hyperplasia of nasal respiratory epithelium in 9/10)	Zempel et al. 1987 2,3-dichloropropene	Purity: >99%; NOAELs based on histological examination.
			Cardio	75				
			Gastro	75				
			Hemato	75				
			Musc/skel	75				
			Hepatic	75				
			Endocr	75				
			Dermal	75				
			Ocular	75				
			Bd Wt	75				

\*\*\*DRAFT FOR PUBLIC COMMENT\*\*\*

Table 3-3 Levels of Significant Exposure to 2,3-dichloropropene - Inhalation

(continued)

Key to Figure <sup>a</sup>	Species (Strain)	Exposure/Duration/Frequency (Route)	System	NOAEL (ppm)	LOAEL		Reference Chemical Form	Comments
					Less Serious (ppm)	Serious (ppm)		
4	Mouse (B6C3F1)	9 d/11 d 6 hr/d	Resp		5	(very slight hyperplasia of nasal respiratory epithelium in 7/10; slight diffuse degeneration of bronchial/bronchiolar epithelium in 10/10)	Zempel et al. 1987 2,3-dichloropropene	Purity: >99%; NOAELs based on histological examination.
			Cardio	75				
			Gastro	75				
			Hepatic	75				
			Renal	75				
			Endocr	75				
			Ocular	75				
Bd Wt	5	25	(final bd wt 12% lower in males and 16% lower in females compared to controls)					
<b>Neurological</b>								
5	Rat (Fischer- 344)	9 d/11 d 6 hr/d		75			Zempel et al. 1987 2,3-dichloropropene	Purity: >99%; NOAELs based on histological examination.

\*\*\*DRAFT FOR PUBLIC COMMENT\*\*\*

DICHLOROPROPENES

3. HEALTH EFFECTS



Table 3-3 Levels of Significant Exposure to 2,3-dichloropropene - Inhalation

(continued)

Key to Figure	Species <sup>a</sup> (Strain)	Exposure/Duration/Frequency (Route)	System	NOAEL (ppm)	LOAEL		Reference Chemical Form	Comments
					Less Serious (ppm)	Serious (ppm)		
6	Mouse (B6C3F1)	9 d/11 d 6 hr/d		75			Zempel et al. 1987 2,3-dichloropropene	Purity: >99%; NOAELs based on histological examination.
<b>INTERMEDIATE EXPOSURE</b>								
<b>Systemic</b>								
7	Rat (Sprague-Dawley)	13 wk 5 d/wk 6 hr/d	Cardio	15			Johannsen et al. 1991 2,3-dichloropropene	Purity: >99%; nasal turbinates were not examined for histopathology; NOAELs based on histological examination.
			Hemato	15				
			Musc/skel	15				
			Hepatic	15				
			Renal	15				
			Bd Wt	15				

\*\*\*DRAFT FOR PUBLIC COMMENT\*\*\*

DICHLOROPROPENES

3. HEALTH EFFECTS

Table 3-3 Levels of Significant Exposure to 2,3-dichloropropene - Inhalation

(continued)

Key to Figure	Species (Strain)	Exposure/Duration/Frequency (Route)	System	NOAEL (ppm)	LOAEL		Reference Chemical Form	Comments
					Less Serious (ppm)	Serious (ppm)		
8	Rat (Fischer- 344)	13 wk 5 d/wk 6 hr/d	Hemato	80			NTP 1989, 2006 2,3-dichloropropene	Purity: 99.4% 2,3-DCP; incomplete, abandoned study; no histopathology data.
			Hepatic	40 F	80 F (absolute and relative liver weights increased >30%)			
			Renal	20 F	40 F (urine volume doubled)			
			Bd Wt	20 M 80 F	40 M (terminal body weight 13% lower than control)			
9	Mouse (B6C3F1)	13 wk 5 d/wk 6 hr/d	Resp		5 F (absolute lung weight increased 29% and relative lung weight increased 25% in females compared to control)	NTP 1989, 2006 2,3-dichloropropene	Purity: 99.4% 2,3-DCP; incomplete, abandoned study; no histopathology data.	
			Hemato	80 M				
			Hepatic	20 F	40 F (3-fold increases in serum ALT and SDH)			
<b>Reproductive</b>								
10	Rat (Sprague-Dawley)	13 wk 5 d/wk 6 hr/d		5			Johannsen et al. 1991 2,3-dichloropropene	Purity: >99%; nasal turbinates were not examined for histopathology.

\*\*\*DRAFT FOR PUBLIC COMMENT\*\*\*

DICHLOROPROPENES

3. HEALTH EFFECTS

Table 3-3 Levels of Significant Exposure to 2,3-dichloropropene - Inhalation

(continued)

Key to Figure	Species (Strain)	Exposure/Duration/Frequency (Route)	System	NOAEL (ppm)	LOAEL		Reference Chemical Form	Comments
					Less Serious (ppm)	Serious (ppm)		
11	Rat (Fischer- 344)	13 wk 5 d/wk 6 hr/d		80			NTP 1989, 2006 2,3-dichloropropene	Purity: 99.4% 2,3-DCP; incomplete, abandoned study.
12	Mouse (B6C3F1)	13 wk 5 d/wk 6 hr/d		20			NTP 1989, 2006 2,3-dichloropropene	Purity: 99.4% 2,3-DCP; incomplete, abandoned study.

a The number corresponds to entries in Figure 3-2.

b. The minimal LOAEL was used to derive an acute-duration inhalation minimal risk level (MRL) of 0.002 ppm for 2,3-dichloropropene, as described in detail in Appendix A. The minimal LOAEL was adjusted for intermittent exposure [multiplied by (6 hours/24 hours)] and multiplied by the regional gas dose ratio for extrathoracic effects in female rats (0.1143) to obtain the human equivalent concentration of 0.14 ppm. This was divided by uncertainty factor of 90 (3 for use of a minimal LOAEL, 3 for extrapolation from animal to human using dosimetric adjustment, and 10 for human variability) to derive the MRL (See Appendix A).

ALT = alanine aminotransferase; Bd Wt = body weight; Cardio = cardiovascular; d = day(s); Endocr = endocrine; F = Female; Gastro = gastrointestinal; Hemato = hematological; hr = hour(s); LC50 = lethal concentration, 50% kill, LOAEL = lowest-observed-adverse-effect level; Musc/skel = musculoskeletal; NOAEL = no-observed-adverse-effect level; Resp = respiratory; SDH = sorbitol dehydrogenase

\*\*\*DRAFT FOR PUBLIC COMMENT\*\*\*



Figure 3-2 Levels of Significant Exposure to 2,3-dichloropropene - Inhalation (Continued)

Intermediate (15-364 days)

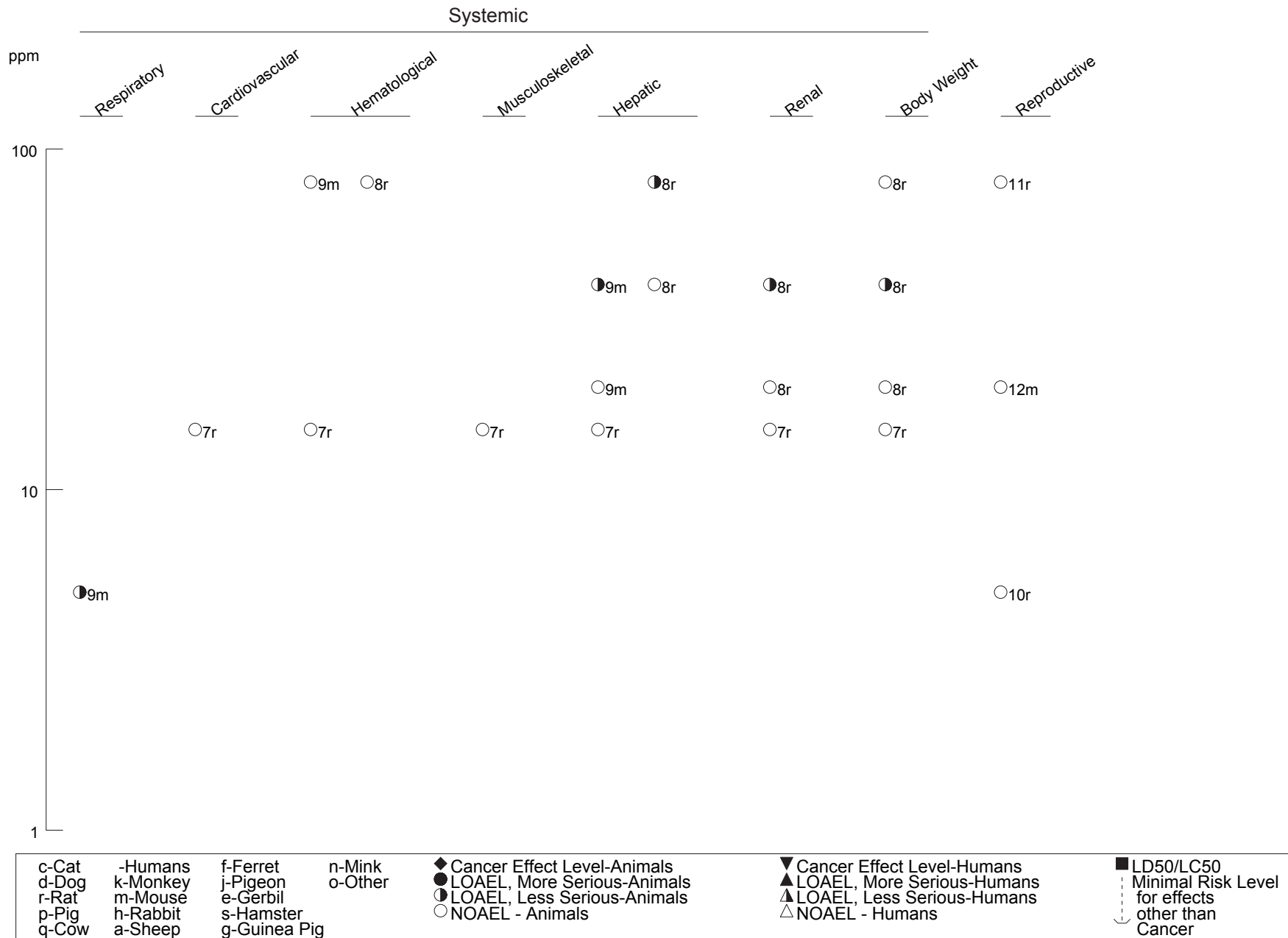

\*\*\*DRAFT FOR PUBLIC COMMENT\*\*\*

## 3. HEALTH EFFECTS

**3.2.1.1 Death**

**1,3-Dichloropropene.** No studies were located regarding death in humans after inhalation exposure to 1,3-dichloropropene.

LC<sub>50</sub> values for inhalation exposure to 1,3-dichloropropene have been determined in rats (Streeter and Lomax 1988; Streeter et al. 1987). The LC<sub>50</sub> for female rats exposed to Telone II<sup>®</sup>a for 4 hours was 904 ppm (95% confidence interval [CI]=846–990 ppm) (Streeter et al. 1987). The LC<sub>50</sub> for male rats could not be determined in this study, but fell in the range of 855–1,035 ppm 1,3-dichloropropene. Telone C-17<sup>®</sup> appears to be more toxic than Telone II<sup>®</sup>a; the LC<sub>50</sub> for rats after a 1-hour exposure to Telone C-17<sup>®</sup> was 253 ppm (no range reported) (Streeter and Lomax 1988). Telone C-17<sup>®</sup> contains a relatively high proportion of chloropicrin, which may account for the enhanced toxicity. Six of 10 rats died after a 4-hour exposure to 676 ppm Telone II<sup>®</sup>a. In the same study, no rats died after a 4-hour exposure to ≤595 ppm of Telone II<sup>®</sup>a (Cracknell et al. 1987).

Rabbits exposed to 300 ppm during gestation days 6–18 developed ataxia and died (Kloes et al. 1983). The cause of death was not determined, although lung congestion and edema were noted on necropsy.

Intermediate- or chronic-duration exposures of mice, rats, guinea pigs, rabbits, and dogs to Telone II<sup>®</sup>a or Telone II<sup>®</sup>b (1–150 ppm for 4 weeks to 2 years) had no effect on survival rates compared to control groups that were untreated or exposed to filtered room air (Coate 1979a, 1979b; Lomax et al. 1989; Stott et al. 1988; Torkelson and Oyen 1977).

**2,3-Dichloropropene.** No mortality data are available for humans exposed to 2,3-dichloropropene by inhalation.

Acute-duration animal studies indicate that single exposures at high concentrations may be fatal, possibly from suppression of the central nervous system. Exposure to 2,3-dichloropropene at high (unspecified) vapor concentrations was fatal to rats within 15–30 minutes (Monsanto 1967). As described in an incomplete report (even-numbered pages were missing), a 1-hour LC<sub>50</sub> of 1,331 ppm (1,250–1,406 ppm, 95% confidence interval [CI]) in males and 1,461 ppm (1,326–1,639 ppm) for females was reported for rats exposed to 2,3-dichloropropene vapor (Dietz et al. 1985b). After 4 hours of exposure to 500 ppm 2,3-dichloropropene vapor, three of six rats died within 2 weeks, whereas none exposed at 250 ppm died

### 3. HEALTH EFFECTS

(Smyth et al. 1962). No rats or mice died following exposure to  $\leq 75$  ppm 2,3-dichloropropene for 6 hours/day on 9 out of 11 days (Zempel et al. 1987).

No mortality was observed in rats exposed to 2,3-dichloropropene vapor at  $\leq 15$  ppm for 6 hours/day for 13 weeks (Johannsen et al. 1991). As indicated in the available records of an unfinished 13-week bioassay, no female mice exposed to 80 ppm for 6 hours/day, 5 days/week survived to termination (NTP 1989, 2006); no mortality records were available for female mice exposed to  $\leq 40$  ppm or male mice, male rats, or female rats exposed to  $\leq 80$  ppm in this study. Based on the available lung weight data, and results of the acute-duration study by Zempel et al. (1987), it is possible that toxicity of the respiratory tract from repeated irritation was a contributing factor to reduced survival in female mice.

***1,2-Dichloropropene.*** As described in a brief summary, exposure to a saturated atmosphere of 1,2-dichloropropene estimated at 63,764 ppm was fatal to all three rats exposed for 12 minutes and one of four rats exposed for 6 minutes (Dow 1962). It is likely that death was caused by suppression of the nervous system, since all exposed animals exhibited unconsciousness before the end of the exposure.

#### **3.2.1.2 Systemic Effects**

The systemic effects observed in humans or animals after inhalation exposure to 1,3-dichloropropene, 2,3-dichloropropene, or 1,2-dichloropropene are discussed below. The highest NOAEL values and all reliable LOAEL values for each systemic effect for each species and duration category are recorded in Table 3-2 and 3-3, respectively, and plotted in Figure 3-1 and 3-2, respectively, for the 1,3- and 2,3-dichloropropenes.

#### **Respiratory Effects.**

***1,3-Dichloropropene.*** Humans exposed to 1,3-dichloropropene (formulation unknown) after a tank truck spill complained of mucous membrane irritation, chest pain, cough, and breathing difficulties (Flessel et al. 1978; Markovitz and Crosby 1984).

Acute-duration exposures of rats to various formulations of 1,3-dichloropropene caused respiratory effects. Gross pathological examination revealed atelectasis, emphysema, and/or edema in rats exposed to 206 ppm of Telone C-17<sup>®</sup> for 1 hour. Atelectasis was still present in animals surviving the 2-week observation period (Streeter and Lomax 1988). As noted for death in Section 3.2.1.1, Telone C-17<sup>®</sup> also

## 3. HEALTH EFFECTS

appears to be more toxic than Telone II<sup>®</sup>a after acute-duration exposure. The presence of chloropicrin may enhance the toxicity of Telone C-17<sup>®</sup>. No respiratory effects were noted in rats after a 4-hour exposure to 581 ppm of Telone II<sup>®</sup>a, although swollen lungs were observed in 2 out of 10 rats after a 4-hour exposure to 594 ppm (Cracknell et al. 1987). In the same study, rats that died following exposure to 675 ppm of Telone II<sup>®</sup>a had lung congestion, tracheal congestion, and fluid in the thoracic cavity, but survivors had no respiratory lesions (Cracknell et al. 1987). Multifocal lung hemorrhage was observed in rats exposed for 4 hours to 1,035 ppm of Telone II<sup>®</sup>a (Streeter et al. 1987).

Intermediate-duration exposure studies indicate that effects on the upper respiratory tract appear to be concentration- and duration-related. Rats and mice had no respiratory lesions attributable to Telone II<sup>®</sup>a after exposure to  $\leq 30$  ppm for 4 weeks (Coate 1979b). No respiratory effects were observed in rats exposed to 10 ppm Telone II<sup>®</sup>a for 13 weeks (Coate 1979a). In contrast, rats exposed to  $\geq 30$  ppm Telone II<sup>®</sup>a for 13 weeks developed epithelial changes in the nasal turbinates that included loss of cytoplasm, nuclei disorganization, and occasional necrotic cells (Coate 1979a). No information was available as to the 1,3-dichloropropene concentration or the amount or types of impurities/additives present in the test material. The epithelial lesions were more severe in rats exposed to  $\geq 90$  ppm of Telone II<sup>®</sup>a or Telone II<sup>®</sup>b for  $\geq 13$  weeks and included hyperplasia and focal necrosis (Breslin et al. 1989; Coate 1979a; Stott et al. 1988). No significant respiratory effects were observed in rats exposed to 60 ppm Telone II<sup>®</sup>b, the highest concentration tested, for 6 months (Lomax et al. 1989). Mice also developed hyperplastic and/or degenerative lesions of the nasal epithelium after exposure to 90 ppm Telone II<sup>®</sup>a for 13 weeks (Stott et al. 1988) or to 60 ppm Telone II<sup>®</sup>b for 6 months (Lomax et al. 1989). Based on nasal lesion data in mice exposed for 6 months, an intermediate-duration inhalation MRL for 1,3-dichloropropene of 0.008 ppm was calculated using benchmark concentration modeling as described in Appendix A and the footnote to Table 3-2. No respiratory effects were noted on gross or histopathological examinations after an intermediate inhalation exposure of rats, guinea pigs, rabbits, or dogs to 3 ppm Telone II<sup>®</sup>a for 6 months (Torkelson and Oyen 1977). Higher concentrations were not tested in this study.

Exposure to 60 ppm of Telone II<sup>®</sup>b for 6–12 months did not result in respiratory effects in rats, but exposure to the same concentration for 2 years caused nasal olfactory epithelium degeneration (Lomax et al. 1989). A statistically significant increase in bronchioalveolar adenomas, benign lung tumors, was also noted in male rats exposed to 60 ppm for 2 years, but not in females. In mice exposed to 20 or 60 ppm Telone II<sup>®</sup>b, hypertrophy/hyperplasia of the nasal respiratory epithelium did not progress in severity between 6 and 24 months, but occurred in  $\geq 96\%$  of mice treated at 60 ppm. Degeneration of the



## 3. HEALTH EFFECTS

nasal olfactory epithelium, however, was noted in  $\geq 90\%$  of male and female mice exposed to 60 ppm, for 2 years (Lomax et al. 1989). Based on benchmark concentration modeling of the nasal lesion data in mice, a chronic inhalation MRL of 0.007 ppm was calculated as described in Appendix A and the footnote in Table 3-2.

These data indicate that acute exposure to 1,3-dichloropropene at high concentrations has effects on the lungs of rats, whereas intermediate or chronic inhalation exposure to 1,3-dichloropropene at lower concentrations produces hyperplastic lesions of the upper respiratory tract in rats and mice and degeneration of the olfactory epithelium in mice.

***2,3-Dichloropropene.*** No data are available for respiratory effects in humans exposed to 2,3-dichloropropene by inhalation.

Irritation of the respiratory tract is a major effect of inhalation exposure to 2,3-dichloropropene in animals. In acute lethality studies, respiratory effects included gasping, shallow respiration, labored breathing, hemorrhage of the lungs, and inflammation of nasal mucosae (Union Carbide Corp. 1958; Dietz et al. 1985b; Smyth et al. 1962; Younger 1967). Concentration-related increases in the incidence and severity of respiratory tract effects were observed in rats and mice exposed to 2,3-dichloropropene vapor 6 hours/day for 9 out of 11 days (Zempel et al. 1987). At  $\geq 5$  ppm, hyperplasia of the nasal respiratory epithelium occurred in 9/10 rats and 7/10 mice and diffuse degeneration occurred in the bronchial/bronchiolar epithelium of 10/10 mice. At  $\geq 25$  ppm, all rats and mice exhibited hyperplasia of the nasal olfactory epithelium and mice exhibited hyperplasia of the laryngeal epithelium. As described in Appendix A and the footnote to Table 3-3, an acute-duration inhalation exposure MRL of 0.002 ppm was derived for 2,3-dichloropropene based on the human equivalent to a minimal LOAEL of 5 ppm for very slight hyperplasia of the nasal respiratory epithelium in female rats (Zempel et al. 1987).

Studies in rodents indicate that the respiratory tract is vulnerable to irritant effects from repeated exposure to 2,3-dichloropropene. Red nasal discharge, an indicator of nasal irritation, was the only effect observed in rats exposed to 2,3-dichloropropene vapor at 15 ppm, 6 hours/day, 5 days/week for 13 weeks (Johannsen et al. 1991). Although the frequency was reported to increase during the course of the study, the nasal turbinates were not evaluated for histopathology. No lung histopathology was observed at  $\geq 15$  ppm in rats in this study, but because of the lack of histopathology data for the nasal turbinates, the likely target organ in rats, a NOAEL for the respiratory tract was not entered into the Table 3-3. The available records from an unfinished 13-week inhalation study indicate significant 25% increases in

## 3. HEALTH EFFECTS

absolute and relative lung weight in female mice exposed at 5 ppm and 13 and 22% increases, respectively, in absolute and relative lung weight in male mice exposed at 10 ppm (NTP 1989, 2006). Lung weight increases generally increased with concentration, the relative increase in male mice reaching 200% in the 80 ppm group compared with controls. Despite the lack of histological data for this study, it provides suggestive evidence that the respiratory tract is the most sensitive target of inhaled 2,3-dichloropropene. The NTP (1989) study is consistent with the acute-duration study by Zempel et al. (1987) in that lung effects were observed in mice, but not rats at low exposure levels.

***1,2-Dichloropropene.*** No information was available on respiratory effects in humans exposed to 1,2-dichloropropene.

As described in a brief summary, lethal exposure for 6–12 minutes to a saturated atmosphere of 1,2-dichloropropene estimated at 63,764 ppm resulted in unspecified lung damage in rats (Dow 1962).

**Cardiovascular Effects.**

***1,3-Dichloropropene.*** No studies were located regarding cardiovascular effects in humans after inhalation exposure to 1,3-dichloropropene.

No lesions attributable to Telone II<sup>®</sup>a were found upon histological evaluation of the heart and aorta from rats and mice exposed to  $\leq 150$  ppm for up to 13 weeks (Coate 1979a, 1979b; Stott et al. 1988), or rats and mice exposed to 60 ppm Telone II<sup>®</sup>b for 6, 12, or 24 months (Lomax et al. 1989).

Although other indices of cardiovascular toxicity were not examined, 1,3-dichloropropene does not appear to have cardiovascular effects.

***2,3-Dichloropropene.*** No data are available for cardiovascular effects in humans exposed to 2,3-dichloropropene by inhalation.

No cardiovascular histopathology was observed in rats or mice exposed to  $\leq 75$  ppm 2,3-dichloropropene vapor for 6 hours/day, for 9 out of 11 days (Zempel et al. 1987). No histopathology was observed in the heart of rats exposed to  $\leq 75$  ppm 2,3-dichloropropene vapor for 6 hours/day, 5 days/week for 13 weeks (Johannsen et al. 1991).

## 3. HEALTH EFFECTS

**Gastrointestinal Effects.**

***1,3-Dichloropropene.*** No studies were located regarding gastrointestinal effects in humans after inhalation exposure to 1,3-dichloropropene.

No gastrointestinal effects were noted after gross and histologic examinations of the stomachs and intestines of rats or mice exposed to  $\leq 150$  ppm Telone II<sup>®</sup>a for 13 weeks (Stott et al. 1988), or rats or mice exposed to 60 ppm of Telone II<sup>®</sup>b for 6 or 12 months (Lomax et al. 1989). Similarly, no gastrointestinal lesions attributable to 1,3-dichloropropene were observed in rats exposed to 60 ppm of Telone II<sup>®</sup>b for 2 years (Lomax et al. 1989). In contrast, 8 of 50 male mice exposed to 60 ppm Telone II<sup>®</sup>b for 2 years had hyperplasia and hyperkeratosis of the forestomach. The NOAEL for this effect was 20 ppm in the male mice. Female mice did not develop hyperplasia or hyperkeratosis of the forestomach (Lomax et al. 1989).

***2,3-Dichloropropene.*** No data are available for gastrointestinal effects in humans exposed to 2,3-dichloropropene by inhalation.

No gastrointestinal histopathology was observed in rats or mice exposed to  $\leq 75$  ppm 2,3-dichloropropene vapor for 6 hours/day, for 9 out of 11 days (Zempel et al. 1987). No histopathology was observed in the gastrointestinal tract of rats exposed to  $\leq 15$  ppm 2,3-dichloropropene vapor for 6 hours/day, 5 days/week for 13 weeks (Johannsen et al. 1991).

**Hematological Effects.**

***1,3-Dichloropropene.*** No studies were located regarding hematological effects in humans after inhalation exposure to 1,3-dichloropropene.

Hematological parameters have been examined in many studies of intermediate or chronic duration in which several species were exposed by inhalation to formulations of 1,3-dichloropropene. No exposure-related hematological effects were observed in rats, guinea pigs, rabbits, or dogs exposed to 3 ppm Telone II<sup>®</sup>a for 6 months (Torkelson and Oyen 1977), in rats and mice exposed to 150 ppm Telone II<sup>®</sup>a for 13 weeks (Stott et al. 1988), or to 60 ppm Telone II<sup>®</sup>b for 6–24 months (Lomax et al. 1989).

## 3. HEALTH EFFECTS

Histological examination of bone marrow also did not reveal any adverse effects in either intermediate- or chronic-duration exposure studies (Lomax et al. 1989; Stott et al. 1988).

***2,3-Dichloropropene.*** No data are available for hematological effects in humans exposed to 2,3-dichloropropene by inhalation.

No hematological effects were observed in rats or mice exposed to  $\leq 75$  ppm 2,3-dichloropropene vapor for 6 hours/day, for 9 out of 11 days (Zempel et al. 1987). No hematological effects were observed in rats exposed to 2,3-dichloropropene vapor at  $\leq 15$  ppm for 6 hours/day, 5 days/week for 13 weeks (Johannsen et al. 1991). Available records from an unfinished 13-week study indicate that no hematological effects were observed in rats or mice exposed to  $\leq 80$  ppm 6 hours/day, 5 days/week (NTP 1989, 2006).

**Musculoskeletal Effects.**

***1,3-Dichloropropene.*** No studies were located regarding musculoskeletal effects in humans after inhalation exposure to 1,3-dichloropropene.

Gross and histopathological examination of bone and skeletal muscle did not reveal any differences between exposed and control groups of rats and mice exposed to  $\leq 150$  ppm Telone II<sup>®</sup>a for 13 weeks (Stott et al. 1988), or 60 ppm Telone II<sup>®</sup>b for 6–24 months (Lomax et al. 1989).

***2,3-Dichloropropene.*** No data are available for musculoskeletal effects in humans exposed to 2,3-dichloropropene by inhalation.

No musculoskeletal effects were observed in rats or mice exposed to  $\leq 75$  ppm 2,3-dichloropropene vapor for 6 hours/day, for 9 out of 11 days (Zempel et al. 1987). No musculoskeletal effects were observed in rats exposed to 2,3-dichloropropene vapor at  $\leq 15$  ppm for 6 hours/day, 5 days/week for 13 weeks (Johannsen et al. 1991).

**Hepatic Effects.**

***1,3-Dichloropropene.*** A few studies assessed hepatic toxicity in workers exposed to 1,3-dichloropropene, but found no differences in urinary or serum biomarkers between the exposed group and matched controls. Verplanke et al. (2000) measured hepatic effect variables in 13 commercial pesticide

## 3. HEALTH EFFECTS

application workers exposed to cis-1,3-dichloropropene at a (8-hour time-weighted average [TWA]) geometric mean exposure of 0.59 ppm (range 0.2–2.1 ppm) (2.7 mg/m<sup>3</sup>; range, 0.1–9.5 mg/m<sup>3</sup>) for an average of 521 (±230) minutes/day for 117 days and 22 matched control workers. Based on results from urine and blood data collected before, during, and after fumigation, no significant difference in hepatic parameters was detected between the exposed and control group. Boogard et al. (1993) compared 73 male operators who had worked at an average of 8.2 years (0.5–23 years) in a chemical plant where they were exposed to 1,3-dichloropropene at geometric mean (8-hour TWA) concentrations between 0.03 and 0.31 ppm (0.14 and 1.39 mg/m<sup>3</sup>) between 1981 and 1984 and 35 matched control male workers. Although no significant difference in hepatic biomarkers was observed between the exposed and control group, the study does not provide useful information about 1,3-dichloropropene since the exposures had ended 7 years prior to testing and exposures to other compounds were more recent.

Gross and histopathological examination of livers did not reveal any differences between exposed and control groups of rats and mice after inhalation exposure to ≤150 ppm of Telone II<sup>®</sup>a for ≤13 weeks (Coate 1979b; Stott et al. 1988), or to ≤60 ppm Telone II<sup>®</sup>b for ≤24 months (Lomax et al. 1989).

**2,3-Dichloropropene.** No data are available for hepatic effects in humans exposed to 2,3-dichloropropene by inhalation.

Hepatic effects in animals have been observed following exposure to relatively high exposure levels, but not consistently across studies. No effects on hepatic histology or serum parameters were observed in rats or mice exposed to ≤75 ppm 2,3-dichloropropene vapor for 6 hours/day, for 9 out of 11 days (Zempel et al. 1987). No effects on hepatic histology or serum parameters were observed in rats exposed to 2,3-dichloropropene vapor at ≤15 ppm for 6 hours/day, 5 days/week for 13 weeks (Johannsen et al. 1991). Available records from an unfinished 13-week inhalation bioassay indicate that hepatic toxicity increases in female, but not male rats exposed at higher concentrations 6 hours/day, 5 days/week (NTP 1989, 2006). Three-fold and higher increases in serum ALT and SDH occurred in female mice at 40–80 ppm and a 60% increase in alkaline phosphatase and a six-fold increase in total bile acids were observed at 80 ppm (NTP 1989, 2006). In female rats at 80 ppm, absolute liver weights were increased by 33% and relative liver weights by 37% compared to controls (NTP 1989, 2006). Hepatic LOAELs and NOAELs were entered into Table 3-3, although the lack of histopathology data was noted.

**1,2-Dichloropropene.** No information was available on hepatic effects in humans exposed to 1,2-dichloropropene.

## 3. HEALTH EFFECTS

As described in a brief summary, lethal exposure for 6–12 minutes to a saturated atmosphere of 1,2-dichloropropene estimated at 63,764 ppm resulted in unspecified liver damage in rats (Dow 1962).

**Renal Effects.**

**1,3-Dichloropropene.** A few studies assessed renal toxicity in workers exposed to 1,3-dichloropropene, but found no differences in urinary or serum biomarkers between the exposed group and matched controls. Verplanke et al. (2000) measured renal effect variables in 13 commercial pesticide application workers exposed to cis-1,3-dichloropropene at a (8-hour TWA) geometric mean exposure of 0.59 ppm (range 0.2–2.1 ppm (2.7 mg/m<sup>3</sup>; range, 0.1–9.5 mg/m<sup>3</sup>) for an average of 521 (±230) minutes/day for 117 days and 22 matched control workers. Based on results from urine and blood data collected before, during, and after fumigation, no significant difference in renal parameters was detected between the exposed and control group. Boogard et al. (1993) compared 73 male operators who had worked at an average of 8.2 years (0.5–23 years) in a chemical plant where they were exposed to 1,3-dichloropropene at geometric mean (8-hour TWA) concentrations between 0.03 and 0.31 ppm (0.14 and 1.39 mg/m<sup>3</sup>) between 1981 and 1984 and 35 matched control male workers. Although no significant difference in renal biomarkers was observed between the exposed and control group, the study does not provide useful information about 1,3-dichloropropene since the exposures had ended 7 years prior to testing and exposures to other compounds were more recent.

Other studies showed an association between exposure to 1,3-dichloropropene and the urinary excretion of enzymes possibly indicative of damage to renal tubules (Osterloh and Feldman 1993; Osterloh et al. 1989). Fumigation workers were exposed to Telone<sup>®</sup> (formulation not specified) at a mean concentration of 0.6 ppm (range 0.06–2.1 ppm) 2–7 hours/day for 5 days and urine samples were collected at intervals. The studies did not include unexposed groups or urinary measurements >24 hours after exposure. Urinalysis showed a correlation between exposure (concentration x duration) and cumulative 24-hour excretion of the metabolite N-acetyl-S-(cis-3-chloroprop-2-enyl)-cysteine (3CNAC) and excretion of the enzymes N-acetylglucosaminidase (NAG, indicative of damage to renal tubules) and retinol binding protein (RBP, indicative of impaired tubular reabsorption of filtered protein). The RBP data were based on urine that had been stored at -70°C for several years (Osterloh and Feldman 1993). For daily urine excretions of 3CNAC in excess of 1.5 mg/day (7 workers), mean amounts of NAG and RBP excreted over 24 hours were slightly, but significantly increased 2-fold compared to values for 3CNAC <1.5 mg/day (7 workers). These results were considered evidence of possible low-level subclinical

## 3. HEALTH EFFECTS

(nonadverse) renal tissue damage but demonstrate that the enzymes could be employed as biomarkers for renal toxicity. These studies are not included in Table 3-2 because the exposure levels were expressed in terms of excretion of 3CNAC and cannot be directly compared to atmospheric concentrations of 1,3-dichloropropene.

Male and female rats exposed to 3 ppm Telone II<sup>®</sup>a for 6 months developed reversible cloudy swelling of the renal tubular epithelium (Torkelson and Oyen 1977). No adverse renal effects were observed in rats allowed to recover for 3 months following the last exposure. The cloudy swelling observed in these rats was not confirmed in more recent studies, even at longer durations and/or higher concentrations. Exposure to 1 ppm in this study had no renal effects in the rats. Guinea pigs, rabbits, and dogs exposed to 3 ppm suffered no renal effects under the same exposure protocol (Torkelson and Oyen 1977).

Gross and histological examination of the kidneys from rats and mice exposed to up to  $\leq 150$  ppm Telone II<sup>®</sup>a for 4–13 weeks (Coate 1979b; Stott et al. 1988) revealed no differences in the incidence of renal lesions between exposed and control groups. Urinalysis also revealed no differences between exposed and control groups of rats and mice (Lomax et al. 1989; Stott et al. 1988).

Moderate hyperplasia of the transitional epithelium of the urinary bladder was found in female mice exposed to 90 or 150 ppm Telone II<sup>®</sup>a for 13 weeks (Stott et al. 1988). Mice exposed to 30 ppm did not show hyperplasia of the urinary bladder. Rats exposed for 6–24 months and mice exposed for 6 months to  $\leq 60$  ppm Telone II<sup>®</sup>b did not show hyperplasia of the urinary bladder (Lomax et al. 1989). However, female mice exposed to Telone II<sup>®</sup>b for 1 year at 60 ppm or 2 years at 20 or 60 ppm showed an increase in epithelial hyperplasia and inflammation of the urinary bladder (Lomax et al. 1989); epithelial hyperplasia of the urinary bladder occurred in male mice exposed at 60 ppm for 2 years.

**2,3-Dichloropropene.** No data are available for renal effects in humans exposed to 2,3-dichloropropene by inhalation.

Renal effects in animals have been observed at relatively high exposure levels. Slight mineralization of the corticomedullary junction was observed in 2/5 female rats following exposure to 5–75 ppm 2,3-dichloropropene vapor for 6 hours/day, for 9 out of 11 days (Zempel et al. 1987). The significance of this lesion is uncertain, given the small group size and the fact that neither the incidence nor severity showed concentration-related increases; because of this ambiguity, neither a NOAEL nor a LOAEL is specified for renal effects in rats in Table 3-3. No effects on renal histology in male rats or male or

## 3. HEALTH EFFECTS

female mice or urinalysis parameters in male rats were observed following exposure to  $\leq 75$  ppm in the same study. No effects on renal histology or urinalysis parameters were observed in rats exposed to 2,3-dichloropropene vapor at  $\leq 15$  ppm for 6 hours/day, 5 days/week for 13 weeks (Johannsen et al. 1991). Available records from an unfinished 13-week inhalation bioassay indicate that renal effects may occur in rats exposed at  $\geq 40$  ppm for 6 hours/day, 5 days/week (NTP 1989, 2006). Urine volumes compared to control values were increased 2- and 5-fold, respectively, in female rats at 40 and 80 ppm, but reduced by one third in male rats at 40–80 ppm. Urinary alkaline phosphatase was increased by 48–59% in male rats at 20–80 ppm, but the magnitudes of these increases are not biologically significant (NTP 1989, 2006). In female rats at 80 ppm, absolute kidney weights were increased by 17% and relative weights by 23% compared to controls (NTP 1989, 2006). NOAELs and LOAELs for kidney effects in rats were entered into Table 3-3, although the lack of histopathology data was noted.

***1,2-Dichloropropene.*** No information was available on renal effects in humans exposed by inhalation to 1,2-dichloropropene.

As described in a brief summary, lethal exposure for 6–12 minutes to a saturated atmosphere of 1,2-dichloropropene estimated at 63,764 ppm resulted in unspecified kidney damage in rats (Dow 1962).

**Dermal and Ocular Effects.**

***1,3-Dichloropropene.*** No studies were located regarding dermal or ocular effects in humans after inhalation exposure to 1,3-dichloropropene.

Gross and histological examination of the eyes and skin of rats and mice exposed to up to 150 ppm Telone II<sup>®</sup>a for 13 weeks (Stott et al. 1988) or to 60 ppm for 6–24 months (Lomax et al. 1989) revealed no differences between exposed and control groups.

**3.2.1.3 Immunological and Lymphoreticular Effects**

***1,3-Dichloropropene.*** No studies were located regarding immunological effects in humans after inhalation exposure to 1,3-dichloropropene.

Gross and histological examination of the thymus and lymph nodes of rats and mice exposed to  $\leq 150$  ppm of Telone II<sup>®</sup>a for 13 weeks (Stott et al. 1988), or to 60 ppm Telone II<sup>®</sup>b for 6–24 months (Lomax et al.



## 3. HEALTH EFFECTS

1989), revealed no lesions attributable to 1,3-dichloropropene exposure. However, more sensitive tests for immune system function were not used.

**3.2.1.4 Neurological Effects**

**1,3-Dichloropropene.** No neurological effects were observed in humans occupationally exposed to 1,3-dichloropropene at levels high enough to require medical attention (Markovitz and Crosby 1984).

Ataxia of the hindlimbs and loss of the righting reflex was observed in six of seven pregnant rabbits exposed 6 hours/day to 300 ppm of Telone II<sup>®</sup>a during gestation days 6–18; the onset of ataxia was observed during gestation days 14–19 (Kloes et al. 1983). In the same study, no neurological signs of toxicity were observed in pregnant rabbits exposed to 50 or 150 ppm or in pregnant rats exposed to  $\leq 300$  ppm.

No gross clinical signs of neurotoxicity were observed in rats, guinea pigs, rabbits, or dogs after inhalation exposure to 3 ppm Telone II<sup>®</sup>a for 6 months (Torkelson and Oyen 1977), in rats or mice exposed to up to 150 ppm Telone II<sup>®</sup>a for 13 weeks (Coate 1979a; Stott et al. 1988), or to 60 ppm Telone II<sup>®</sup>b for 6–24 months (Lomax et al. 1989). The absence of clinical signs is supported by histological examinations of brain and spinal cords in rats and mice that revealed no lesions attributable to 1,3-dichloropropene exposure (Coate 1979a; Lomax et al. 1989; Stott et al. 1988). More sensitive tests for neurological effects, however, were not included in these studies.

**2,3-Dichloropropene.** No data are available for neurological effects in humans exposed to 2,3-dichloropropene by inhalation.

Neurological effects in animals have been observed at relatively high exposure levels. Rats exposed to high vapor concentrations in acute lethality studies exhibited lethargy and hyperactivity (Dietz et al. 1985b). No histopathology of brain or spinal cord was observed in rats or mice exposed to  $\leq 75$  ppm 2,3-dichloropropene vapor for 6 hours/day, for 9 out of 11 days (Zempel et al. 1987). No histopathology was observed in the brain or spinal cord of rats or mice to 2,3-dichloropropene vapor at  $\leq 15$  ppm for 6 hours/day, 5 days/week for 13 weeks (Johannsen et al. 1991).

**1,2-Dichloropropene.** No data were available for neurological effects in humans exposed by inhalation to 1,2-dichloropropene.

## 3. HEALTH EFFECTS

As mentioned in a brief summary, exposure to a saturated atmosphere of 1,2-dichloropropene estimated at 63,764 ppm resulted in signs of central nervous system depression (unconsciousness) in rats within 6 minutes of exposure (Dow 1962).

**3.2.1.5 Reproductive Effects**

**1,3-Dichloropropene.** No studies were located regarding reproductive effects in humans after inhalation exposure to 1,3-dichloropropene.

No adverse reproductive effects and no histological changes in reproductive organs were observed in parental groups or progeny of male and female rats exposed to up to 90 ppm Telone II<sup>®</sup>b for two generations (Breslin et al. 1989).

Gross and histological examination of reproductive organs and tissues of rats and mice exposed to  $\leq 150$  ppm of Telone II<sup>®</sup>a for 13 weeks (Stott et al. 1988) or  $\leq 60$  ppm Telone II<sup>®</sup>a for 6–24 months (Lomax et al. 1989) revealed no lesions attributable to 1,3-dichloropropene. More sensitive tests for reproductive effects, however, were not included in these studies.

**2,3-Dichloropropene.** No studies were located regarding reproductive effects in humans after inhalation exposure to 2,3-dichloropropene.

No significant adverse effects were observed in a one-generation reproductive assay in rats exposed to 2,3-dichloropropene vapor at  $\leq 5$  ppm for 6 hours/day, 5 days/week although there was a statistically insignificant reduction in mating in treated groups (Johannsen et al. 1991). Available reports from an incomplete study indicated that there were no adverse effects on estrus cycling or sperm parameters in rats or mice exposed to 2,3-dichloropropene vapor at  $\leq 80$  ppm for 6 hours/day, 5 days/week for 13 weeks (NTP 1989, 2006); no female mice exposed at 80 ppm survived for analysis of the estrus cycle, but no adverse effects were observed in those exposed at  $\leq 40$  ppm.

## 3. HEALTH EFFECTS

**3.2.1.6 Developmental Effects**

**1,3-Dichloropropene.** No studies were located regarding developmental effects in humans after inhalation exposure to 1,3-dichloropropene.

No developmental effects were found in groups of rats exposed to 50 or 150 ppm Telone II<sup>®</sup>a during gestation days 6–15 (Kloes et al. 1983). In contrast, rats exposed to 300 ppm Telone II<sup>®</sup>a during gestation days 6–15 had fewer fetuses per litter, an increase in the incidence of litters totally resorbed, and an increase in the number of litters with resorptions. Rats exposed to 300 ppm Telone II<sup>®</sup>a had urine and fecal staining, nasal exudate, a red crusty material around the eyes, and significantly decreased food and water consumption and body weight. These observations indicate serious maternal toxicity in rats exposed to 300 ppm, which could account for the decreased litter size, increased resorptions, and increased number of litters with resorptions. Rabbits were evaluated for developmental effects after exposure to up to 300 ppm Telone II<sup>®</sup>a during gestation days 6–18 (Kloes et al. 1983). No developmental effects attributable to 1,3-dichloropropene exposure were observed in the 50 and 150 ppm groups. In contrast, marked maternal toxicity in the 300 ppm group precluded evaluation of developmental effects; signs of maternal toxicity included ataxia, loss of the righting reflex, significantly decreased body weight, and the death of six of seven rabbits.

No developmental effects were observed in the progeny of groups of male and female rats exposed to ≤90 ppm Telone II<sup>®</sup>b for two generations (Breslin et al. 1989), or in pregnant rats exposed for 6 hours/day during gestation days 6–15 and rabbits exposed during gestation days 6–18 to ≤120 ppm 1,3-dichloropropene (90.1% purity) (Hanley et al. 1987). The parameters monitored included pup survival, pup body weight, pup crown-rump length, and gross pathology. Delayed ossification was noted in 14 rat pups of 21 litters exposed *in utero* to 120 ppm, but this may have been due to the decreased food and water consumption and body weight of the dams during the exposure period (Hanley et al. 1987).

**3.2.1.7 Cancer**

**1,3-Dichloropropene.** Few studies are available that link inhalation exposure to 1,3-dichloropropene with the development of cancer in humans.

Clary and Ritz (2003) conducted a case-control study using mortality odds ratios to compare deaths from pancreatic cancer (1989–1996) with a random sample of noncancer deaths in three agricultural counties in

## 3. HEALTH EFFECTS

California. A total of 1,002 cases in which pancreatic cancer was named as the cause of death (data from state records) were identified within 102 zip codes in the three-county area. About 10 controls (total 10,002) were selected for each case at random from all noncancer deaths in these counties. The state's pesticide use reporting (PUR) database was used to classify pesticide use within each zip code. The analysis showed an increased risk of death from pancreatic cancer for long-term residence (20 years) in the three-county area and residence at the time of death in zip codes showing the highest quartile of 1,3-dichloropropene application (107 cases, prevalence odds ratio of 1.89 [95% CI=1.13–3.15]). This study provides suggestive, but not definitive, evidence that exposure to 1,3-dichloropropene may be a risk factor for pancreatic cancer.

A clinical report describing three cases of neoplasms that developed after exposure to 1,3-dichloropropene provides other suggestive evidence that there may be an association between exposure and cancer (Markovitz and Crosby 1984). Nine firemen were exposed to 1,3-dichloropropene during cleanup of a tank truck spill. Six years later, two of the men developed histiocytic lymphomas that were refractory to treatment. Both men soon died. In addition, a 52-year-old farmer who had been in good health developed pain in the right ear, nasal mucosa, and pharynx after being exposed to 1,3-dichloropropene (not otherwise specified) from his tractor for 30 days. The hose carrying the 1,3-dichloropropene had a small leak that sprayed the chemical near the right side of the man's face. Over the next year, the man developed leukemia that was refractory to treatment. He died of pneumonia 5 weeks after hospital admission. None of these reports identified the formulation of 1,3-dichloropropene or stated whether the chemical included additives such as epichlorohydrin.

In the only study regarding the carcinogenic potential of 1,3-dichloropropene in animals after inhalation exposure, a statistically significant increase in the incidence of bronchioalveolar adenomas was observed in male mice exposed to 60 ppm Telone II<sup>®</sup>b for 24 months (Lomax et al. 1989). An increased incidence of this benign lung tumor, however, was not observed in female mice nor in male or female rats exposed to Telone II<sup>®</sup>b under the same protocol.

The cancer effect level (CEL) in male mice is recorded in Table 3-2 and plotted in Figure 3-1.

### 3.2.2 Oral Exposure

Reliable oral toxicity data are available for 1,3-dichloropropene and for acute toxicity of 2,3-dichloropropene; a brief summary of an acute lethality study is available for 1,2-dichloropropene. The highest

## 3. HEALTH EFFECTS

NOAEL and all reliable LOAEL values after oral exposure to 1,3- and 2,3-dichloropropene are recorded in Tables 3-4 and 3-5, respectively, and plotted in Figures 3-3 and 3-4, respectively. Median lethal concentrations and other reliable mortality data are recorded as serious LOAELs in these tables and figures.

**3.2.2.1 Death**

**1,3-Dichloropropene.** A 27-year-old male died 40 hours after accidentally drinking 1,3-dichloropropene (mixed cis and trans isomers) (Hernandez et al. 1994). Upon recognizing his error, he vomited, but 2 hours later in an emergency room, he exhibited acute gastrointestinal distress, tachypnea, tachycardia, sweating, and hypovolemia; abdominal pain was evident at deep palpation. The level of 1,3-dichloropropene at this time was 1.13 micromol/L in blood and 0.20 micromol/L in urine. Subsequent effects included bloody diarrhea, metabolic acidosis, adult respiratory distress syndrome, and release of pancreatic enzymes into peritoneal fluid. Multiorgan failure preceded death.

Several studies were located that reported oral LD<sub>50</sub> values for 1,3-dichloropropene in various formulations (95% confidence limits are given in parentheses). The oral LD<sub>50</sub> for M-3993 was 713 mg/kg (no range calculable) in male rats and 470 (337–636) mg/kg in female rats (Lichy and Olson 1975). In a similar study, the oral LD<sub>50</sub> for Telone C-17<sup>®</sup> was 519 (305–1,009) mg/kg in male rats and 304 (147–516) mg/kg in female rats (Mizell et al. 1988b). These data indicate that female rats are more sensitive to 1,3-dichloropropene in its various formulations than male rats. Much lower LD<sub>50</sub> values of 150 (130–170) mg/kg was reported for Telone II<sup>®a</sup> in CFY-strain Sprague-Dawley rats (Jones and Collier 1986a) and 224 mg/kg for Telone II<sup>®a</sup> in female F344 rats (Jeffrey et al. 1987a). Similarly, the LD<sub>50</sub> value determined for the cis-isomer of 1,3-dichloropropene for male and female rats combined was 121 (107–137) mg/kg; for male rats only, 126 (108–148) mg/kg; and for female rats only, 117 (96–142) mg/kg (Jones 1988a). The variability in LD<sub>50</sub> values could result from different rat stocks or strains, or from differences in the 1,3-dichloropropene formulations used.

No deaths were reported among rats that received gavage doses up to 30 mg/kg/day of Telone<sup>®</sup> for 13 weeks (Til et al. 1973), rats or mice exposed to up to 50 or 100 mg/kg/day, respectively, Telone II<sup>®b</sup> in feed for 13 weeks (Haut et al. 1996), or dogs exposed to up to 41 mg/kg/day Telone II<sup>®b</sup> in feed for 13 weeks (Stebbins et al. 1999). No differences were observed in the survival rates of rats that received 0, 25, or 50 mg/kg, or of mice that received 0, 50, or 100 mg/kg Telone II<sup>®b</sup> by gavage in corn oil for 2 years (NTP 1985). No effects on survival were observed in dogs exposed to doses of Telone II<sup>®b</sup> in

Table 3-4 Levels of Significant Exposure to 1,3-dichloropropene - Oral

Key to Figure <sup>a</sup>	Species (Strain)	Exposure/ Duration/ Frequency (Route)	System	NOAEL (mg/kg/day)	LOAEL		Reference Chemical Form	Comments
					Less Serious (mg/kg/day)	Serious (mg/kg/day)		
<b>ACUTE EXPOSURE</b>								
<b>Death</b>								
1	Rat (Fischer- 344)	once (GO)				224 F (LD50)	Jeffrey et al. 1987a T IIa	Purity: 97.54% 1,3-DCP.
2	Rat (Sprague-Dawley)	1 d 1 x/d (GO)				121 (LD50)	Jones 1988a cis	Purity: 97.2% 1,3-DCP.
3	Rat (Sprague-Dawley)	1 d 1 x/d (GO)				150 (LD50)	Jones and Collier 1986a T IIa	Purity: 97.2% 1,3-DCP.
4	Rat (Sprague-Dawley)	1 d 1 x/d (G)				713 M (LD50) <sup>b</sup> 470 F (LD50)	Lichy and Olson 1975 M-3993	Purity: 92% 1,3-DCP.
5	Rat (Fischer- 344)	1 d 1 x/d (GO)				519 M (LD50) <sup>b</sup> 304 F (LD50)	Mizell et al. 1988a T C-17	Purity: 79% 1,3-DCP, 19% chloropicrin.
<b>Systemic</b>								
6	Rat (Sprague-Dawley)	1 d 1 x/d (GO)	Resp			110 (lung hemorrhage)	Jones 1988a cis	Purity: 97.2% 1,3-DCP.
			Gastro			110 (hemorrhage)		
			Hepatic			110 (intestinal hemorrhage, liver hemorrhage)		

\*\*\*DRAFT FOR PUBLIC COMMENT\*\*\*

DICHLOROPROPENES

3. HEALTH EFFECTS

Table 3-4 Levels of Significant Exposure to 1,3-dichloropropene - Oral

(continued)

Key to Figure	Species <sup>a</sup> (Strain)	Exposure/Duration/Frequency (Route)	System	NOAEL (mg/kg/day)	LOAEL		Reference Chemical Form	Comments
					Less Serious (mg/kg/day)	Serious (mg/kg/day)		
7	Rat (Sprague-Dawley)	1 d 1 x/d (GO)	Resp		75 (lung congestion)	250 (lung hemorrhage)	Jones and Collier 1986a T IIa	Purity: 97.2% 1,3-DCP.
			Gastro		75 M (hyperkeratosis of stomach)	170 M (stomach hemorrhage)		
			Hepatic	250				
			Renal	250				
8	Rat (Fischer-344)	1 d 1 x/d (GO)	Gastro		100 (hyperkeratosis)		Mizell et al. 1988a T C-17	Purity: 79% 1,3-DCP, 19% chloropicrin.
<b>Neurological</b>								
9	Rat (Sprague-Dawley)	1 d 1 x/d (GO)				75 (ataxia)	Jones 1988a cis	Purity: 97.2% 1,3-DCP.

\*\*\*DRAFT FOR PUBLIC COMMENT\*\*\*

DICHLOROPROPENES

3. HEALTH EFFECTS

Table 3-4 Levels of Significant Exposure to 1,3-dichloropropene - Oral

(continued)

Key to Figure	Species <sup>a</sup> (Strain)	Exposure/Duration/Frequency (Route)	System	NOAEL (mg/kg/day)	LOAEL		Reference Chemical Form	Comments
					Less Serious (mg/kg/day)	Serious (mg/kg/day)		
<b>INTERMEDIATE EXPOSURE</b>								
<b>Systemic</b>								
10	Rat (Fischer-344)	13 wk ad lib (F)	Resp	100 M			Haut et al. 1996 T IIb	Purity: 95.8% 1,3-DCP; 2% ESO; microencapsulated.
			Gastro	5 M	15 <sup>C</sup> M (basal cell hyperplasia of nonglandular stomach mucosa)			
			Hemato	100 M				
			Hepatic	100 M				
			Renal	100 M				
			Bd Wt	15 M	50 M (terminal weight 16% lower than control)			
11	Rat (Fischer-344)	9 mo 3 d/wk 1 x/d (GO)	Gastro	50			NTP 1985 T IIa	Purity: 89% 1,3-DCP; 1% epichlorohydrin.
			Hepatic	50				
			Renal	50				

\*\*\*DRAFT FOR PUBLIC COMMENT\*\*\*

DICHLOROPROPENES

3. HEALTH EFFECTS



Table 3-4 Levels of Significant Exposure to 1,3-dichloropropene - Oral

(continued)

Key to Figure	Species (Strain)	Exposure/Duration/Frequency (Route)	System	NOAEL (mg/kg/day)	LOAEL		Reference Chemical Form	Comments
					Less Serious (mg/kg/day)	Serious (mg/kg/day)		
12	Rat (Wistar)	13 wk 6 d/wk 1 x/d (GO)	Resp	30			Til et al. 1973 T	Purity: 78% 1,3-DCP.
			Cardio	30				
			Gastro	30				
			Hemato	30				
			Musc/skel	30				
			Hepatic	30				
			Renal	30				
Bd Wt	30							
13	Mouse (B6C3F1)	13 wk ad lib (F)	Resp	100			Haut et al. 1996 T IIb	Purity: 95.8% 1,3-DCP; 2% ESO; microencapsulated.
			Gastro	100				
			Hemato	100				
			Hepatic	100				
			Renal	100				
			Bd Wt	50	100	(terminal weight 11-12% lower than control)		

\*\*\*DRAFT FOR PUBLIC COMMENT\*\*\*

Table 3-4 Levels of Significant Exposure to 1,3-dichloropropene - Oral

(continued)

Key to Figure	Species <sup>a</sup> (Strain)	Exposure/Duration/Frequency (Route)	System	NOAEL (mg/kg/day)	LOAEL		Reference Chemical Form	Comments
					Less Serious (mg/kg/day)	Serious (mg/kg/day)		
14	Dog (Beagle)	13 wk ad lib (F)	Hemato	5	15	(19-29% reductions in hemoglobin and hematocrit)	Stebbins et al. 1999 T IIb	Purity: 95.8% 1,3-DCP; 2% ESO; microencapsulated.
			Hepatic	41				
			Renal	41				
			Bd Wt	5 F	15 F	(terminal weight 12% lower than control)		
<b>Neurological</b>								
15	Rat (Fischer- 344)	13 wk ad lib (F)		100			Haut et al. 1996 T IIb	Purity: 95.8% 1,3-DCP; 2% ESO; microencapsulated; brain weight and gross clinical signs were examined.
<b>Reproductive</b>								
16	Rat (Fischer- 344)	13 wk ad lib (F)		100			Haut et al. 1996 T IIb	Purity: 95.8% 1,3-DCP; 2% ESO; microencapsulated; testes and ovary weight and histopathology were examined.

\*\*\*DRAFT FOR PUBLIC COMMENT\*\*\*

DICHLOROPROPENES

3. HEALTH EFFECTS

Table 3-4 Levels of Significant Exposure to 1,3-dichloropropene - Oral

(continued)

Key to Figure <sup>a</sup>	Species (Strain)	Exposure/Duration/Frequency (Route)	System	NOAEL (mg/kg/day)	LOAEL		Reference Chemical Form	Comments
					Less Serious (mg/kg/day)	Serious (mg/kg/day)		
<b>CHRONIC EXPOSURE</b>								
<b>Systemic</b>								
17	Rat (Fischer- 344)	104 wk 3 d/wk 1 x/d (GO)	Resp	50			NTP 1985 T IIa	Purity: 89% 1,3-DCP; 1% epichlorohydrin.
			Cardio	50				
			Gastro		25	(basal cell hyperplasia in nonglandular stomach mucosa)		
			Hemato	50				
			Musc/skel	50				
			Hepatic	50				
			Renal		25	(nephropathy only in females)		
			Dermal	50				

\*\*\*DRAFT FOR PUBLIC COMMENT\*\*\*

DICHLOROPROPENES

3. HEALTH EFFECTS

Table 3-4 Levels of Significant Exposure to 1,3-dichloropropene - Oral

(continued)

Key to Figure <sup>a</sup>	Species (Strain)	Exposure/Duration/Frequency (Route)	System	NOAEL (mg/kg/day)	LOAEL		Reference Chemical Form	Comments
					Less Serious (mg/kg/day)	Serious (mg/kg/day)		
18	Rat (Fischer-344)	2 yr ad lib (F)	Resp	25			Stebbins et al. 2000 T IIb	Purity: 95.8% 1,3-DCP; 2% ESO; microencapsulated.
			Cardio	25				
			Gastro	2.5	12.5 <sup>d</sup>	(basal cell hyperplasia of nonglandular stomach mucosa)		
			Hemato	25				
			Musc/skel	25				
			Hepatic	25				
			Renal	25				
			Dermal	25				
			Ocular	25				
Bd Wt	12.5	25	(terminal weight 13-14% lower than control)					

\*\*\*DRAFT FOR PUBLIC COMMENT\*\*\*

DICHLOROPROPENES

3. HEALTH EFFECTS

Table 3-4 Levels of Significant Exposure to 1,3-dichloropropene - Oral

(continued)

Key to Figure	Species (Strain)	Exposure/Duration/Frequency (Route)	System	NOAEL (mg/kg/day)	LOAEL		Reference Chemical Form	Comments
					Less Serious (mg/kg/day)	Serious (mg/kg/day)		
19	Mouse (B6C3F1)	104 wk 3 d/wk 1 x/d (GO)	Resp	100			NTP 1985 T IIa	Purity: 89% 1,3-DCP; 1% epichlorohydrin.
			Cardio	100				
			Gastro		50 F (hyperplasia of nonglandular stomach)			
			Hemato	100				
			Musc/skel	100				
			Hepatic	100				
			Renal	50 F	100 F (hydronephrosis in females only)			
Dermal	100							

\*\*\*DRAFT FOR PUBLIC COMMENT\*\*\*

DICHLOROPROPENES

3. HEALTH EFFECTS

Table 3-4 Levels of Significant Exposure to 1,3-dichloropropene - Oral

(continued)

Key to Figure <sup>a</sup>	Species (Strain)	Exposure/Duration/Frequency (Route)	System	NOAEL (mg/kg/day)	LOAEL		Reference Chemical Form	Comments
					Less Serious (mg/kg/day)	Serious (mg/kg/day)		
20	Mouse (B6C3F1)	2 yr ad lib (F)	Resp	50			Stebbins et al. 2000 T IIb	Purity: 95.8% 1,3-DCP; 2% ESO; microencapsulated.
			Cardio	50				
			Gastro	50				
			Hemato	50				
			Musc/skel	50				
			Hepatic	50				
			Renal	50				
			Dermal	50				
			Ocular	50				
Bd Wt	2.5 M	25 M (terminal weight 15% lower than control)						

\*\*\*DRAFT FOR PUBLIC COMMENT\*\*\*

Table 3-4 Levels of Significant Exposure to 1,3-dichloropropene - Oral

(continued)

Key to Figure	Species (Strain)	Exposure/Duration/Frequency (Route)	System	NOAEL (mg/kg/day)	LOAEL		Reference Chemical Form	Comments
					Less Serious (mg/kg/day)	Serious (mg/kg/day)		
21	Dog (Beagle)	1 yr ad lib (F)	Resp	15			Stebbins et al. 1999 T IIb	Purity: 95.8% 1,3-DCP; 2% ESO; microencapsulated.
			Cardio	15				
			Gastro	15				
			Hemato	2.5	15	(microcytic anemia; increased extramedullary hematopoiesis in spleen)		
			Hepatic	15				
			Renal	15				
			Bd Wt	2.5	15	(terminal weight 13-19% lower than control)		
<b>Immuno/ Lymphoret</b>								
22	Rat (Fischer- 344)	2 yr 3 d/wk 1 x/d (GO)		50			NTP 1985 T IIa	Purity: 89% 1,3-DCP; 1% epichlorohydrin; immunological endpoints restricted to histological examination of spleen and thymus.

\*\*\*DRAFT FOR PUBLIC COMMENT\*\*\*

Table 3-4 Levels of Significant Exposure to 1,3-dichloropropene - Oral

(continued)

Key to Figure	Species <sup>a</sup> (Strain)	Exposure/Duration/Frequency (Route)	System	NOAEL (mg/kg/day)	LOAEL		Reference	Comments
					Less Serious (mg/kg/day)	Serious (mg/kg/day)		
23	Rat (Fischer-344)	2 yr ad lib (F)		25			Stebbins et al. 2000 T IIb	Purity: 95.8% 1,3-DCP; 2% ESO; microencapsulated; spleen, lymph nodes, and thymus were examined.
24	Mouse (B6C3F1)	2 yr 3 d/wk 1 x/d (GO)		100			NTP 1985 T IIa	Purity: 89% 1,3-DCP; 1% epichlorohydrin; immunological endpoints restricted to histological examination of spleen and thymus.
25	Mouse (B6C3F1)	2 yr ad lib (F)		50			Stebbins et al. 2000 T IIb	Purity: 95.8% 1,3-DCP; 2% ESO; microencapsulated; spleen, lymph nodes, and thymus were examined.
26	Dog (Beagle)	1 yr ad lib (F)		15			Stebbins et al. 1999 T IIb	Purity 95.8% 1,3-DCP; 2% ESO; microencapsulated; thymus and spleen weight and histopathology were examined.

\*\*\*DRAFT FOR PUBLIC COMMENT\*\*\*



Table 3-4 Levels of Significant Exposure to 1,3-dichloropropene - Oral

(continued)

Key to Figure <sup>a</sup>	Species (Strain)	Exposure/Duration/Frequency (Route)	System	NOAEL (mg/kg/day)	LOAEL		Reference Chemical Form	Comments
					Less Serious (mg/kg/day)	Serious (mg/kg/day)		
<b>Neurological</b>								
27	Rat (Fischer- 344)	2 yr 3 d/wk 1 x/d (GO)		50			NTP 1985 T IIa	Purity: 89% 1,3-DCP; 1% epichlorohydrin; histopathology of brain and spinal cord were examined.
28	Rat (Fischer- 344)	2 yr ad lib (F)		25			Stebbins et al. 2000 T IIb	Purity: 95.8% 1,3-DCP; 2% ESO; microencapsulated; examination included clinical signs and histopathology.
29	Mouse (B6C3F1)	2 yr 3 d/wk 1 x/d (GO)		100			NTP 1985 T IIa	Purity: 89% 1,3-DCP; 1% epichlorohydrin; brain and spinal cord were examined for histopathology.
30	Mouse (B6C3F1)	2 yr ad lib (F)		50			Stebbins et al. 2000 T IIb	Purity: 95.8% 1,3-DCP; 2% ESO; microencapsulated; examination included clinical signs and histopathology.

\*\*\*DRAFT FOR PUBLIC COMMENT\*\*\*

DICHLOROPROPENES

3. HEALTH EFFECTS

93

Table 3-4 Levels of Significant Exposure to 1,3-dichloropropene - Oral

(continued)

Key to Figure <sup>a</sup>	Species (Strain)	Exposure/ Duration/ Frequency (Route)	System	NOAEL (mg/kg/day)	LOAEL		Reference	Comments
					Less Serious (mg/kg/day)	Serious (mg/kg/day)		
31	Dog (Beagle)	1 yr ad lib (F)		15			Stebbins et al. 1999 T IIb	Purity 95.8% 1,3-DCP; 2% ESO; microencapsulated; brain weight and gross clinical signs were examined.
<b>Reproductive</b>								
32	Rat (Fischer- 344)	2 yr 3 d/wk 1 x/d (GO)		50			NTP 1985 T IIa	Purity: 89% 1,3-DCP; 1% epichlorohydrin; NOAELs based on histological examination of reproductive organs in males and females.
33	Rat (Fischer- 344)	2 yr ad lib (F)		25			Stebbins et al. 2000 T IIb	Purity: 95.8% 1,3-DCP; 2% ESO; microencapsulated; mammary gland, seminal vesicle, testes, uterus, ovaries and vagina were examined.
34	Mouse (B6C3F1)	2 yr 3 d/wk 1 x/d (GO)		100			NTP 1985 T IIa	Purity: 89% 1,3-DCP; 1% epichlorohydrin; NOAELs based on histological examination of reproductive organs in males and females.

\*\*\*DRAFT FOR PUBLIC COMMENT\*\*\*

DICHLOROPROPENES

3. HEALTH EFFECTS

94

Table 3-4 Levels of Significant Exposure to 1,3-dichloropropene - Oral

(continued)

Key to Figure <sup>a</sup>	Species (Strain)	Exposure/Duration/Frequency (Route)	System	NOAEL (mg/kg/day)	LOAEL		Reference Chemical Form	Comments
					Less Serious (mg/kg/day)	Serious (mg/kg/day)		
35	Mouse (B6C3F1)	2 yr ad lib (F)		50			Stebbins et al. 2000 T IIb	Purity: 95.8% 1,3-DCP; 2% ESO; microencapsulated; mammary gland, seminal vesicle, testes, uterus, ovaries and vagina were examined.
36	Dog (Beagle)	1 yr ad lib (F)		15			Stebbins et al. 1999 T IIb	Purity 95.8% 1,3-DCP; 2% ESO; microencapsulated; ovary and testes weight and histopathology were examined.
<b>Cancer</b>								
37	Rat (Fischer- 344)	104 wk 3 d/wk 1 x/d (GO)			25	(forestomach squamous cell tumors; neoplastic hepatic nodules)	NTP 1985 T IIa	Purity: 89% 1,3-DCP; 1% epichlorohydrin.
38	Rat (Fischer- 344)	2 yr ad lib (F)			25 M	(CEL: hepatocellular adenoma in 9/50, carcinoma in 1/50)	Stebbins et al. 2000 T IIb	Purity: 95.8% 1,3-DCP, 2% ESO; microencapsulated.

\*\*\*DRAFT FOR PUBLIC COMMENT\*\*\*

Table 3-4 Levels of Significant Exposure to 1,3-dichloropropene - Oral

(continued)

Key to Figure	Species <sup>a</sup> (Strain)	Exposure/ Duration/ Frequency (Route)	System	NOAEL (mg/kg/day)	LOAEL		Reference Chemical Form	Comments	
					Less Serious (mg/kg/day)	Serious (mg/kg/day)			
39	Mouse (B6C3F1)	2 yr 3 d/wk 1 x/d (GO)				50	(CEL: bronchioalveolar adenoma of lung; transitional cell carcinoma of urinary bladder; forestomach squamous cell tumors)	NTP 1985 T IIa	Purity: 89% 1,3-DCP; 1% epichlorohydrin.

a The number corresponds to entries in Figure 3-3.

b Differences in levels of health effects and cancer effects between male and females are not indicated in Figure 3-4. Where such differences exist, only the levels of effect for the most sensitive gender are presented.

c Study results used to derive an intermediate-duration oral minimal risk level (MRL) of 0.04 mg/kg/day for 1,3-dichloropropene, as described in detail in Appendix A. Benchmark dose analysis was performed for incidences of hyperplasia of the nonglandular stomach mucosa in male rats to select a point of departure, which was divided by an uncertainty factor of 100 (10 for extrapolation from animals to humans using dosimetric adjustment and 10 for human variability) (See Appendix A).

d Study results used to derive a chronic-duration oral minimal risk level (MRL) of 0.04 mg/kg/day for 1,3-dichloropropene, as described in detail in Appendix A. Benchmark dose analysis was performed for incidences of hyperplasia of the nonglandular stomach mucosa in male and female rats and for reduced hemoglobin concentrations in male and female dogs to select a point of departure. The selected point of departure, based on stomach hyperplasia in female rats, was divided by an uncertainty factor of 100 (10 for extrapolation from animals to humans using dosimetric adjustment and 10 for human variability) (See Appendix A).

ad lib = ad libitum; Bd Wt = body weight; Cardio = cardiovascular; CEL = cancer effect level; d = day(s); ESO = epoxidized soybean oil; (F) = feed; Gastro = gastrointestinal; (G)= gavage; (GO) = gavage in oil; hemato = hematological; LD50 = lethal dose, 50% kill; LOAEL = lowest-observed-adverse-effect level; mo = month(s); Musc/skel = musculoskeletal; NOAEL = no-observed-adverse-effect level; Resp = respiratory; x = time(s); wk = week(s); yr = year(s)

\*\*\*DRAFT FOR PUBLIC COMMENT\*\*\*

Figure 3-3 Levels of Significant Exposure to 1,3-dichloropropene - Oral  
Acute (≤14 days)

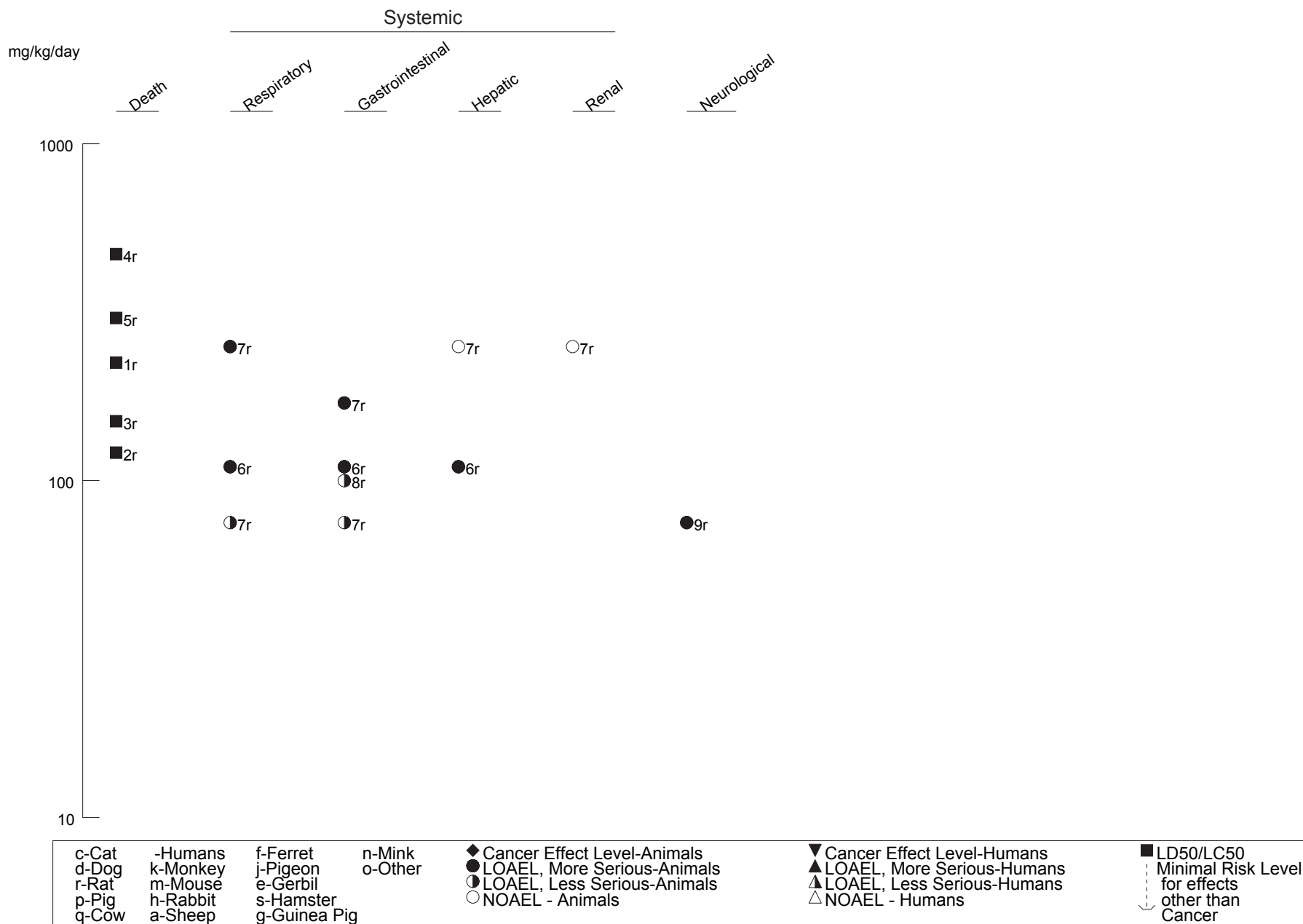

\*\*\*DRAFT FOR PUBLIC COMMENT\*\*\*

Figure 3-3 Levels of Significant Exposure to 1,3-dichloropropene - Oral (Continued)  
Intermediate (15-364 days)

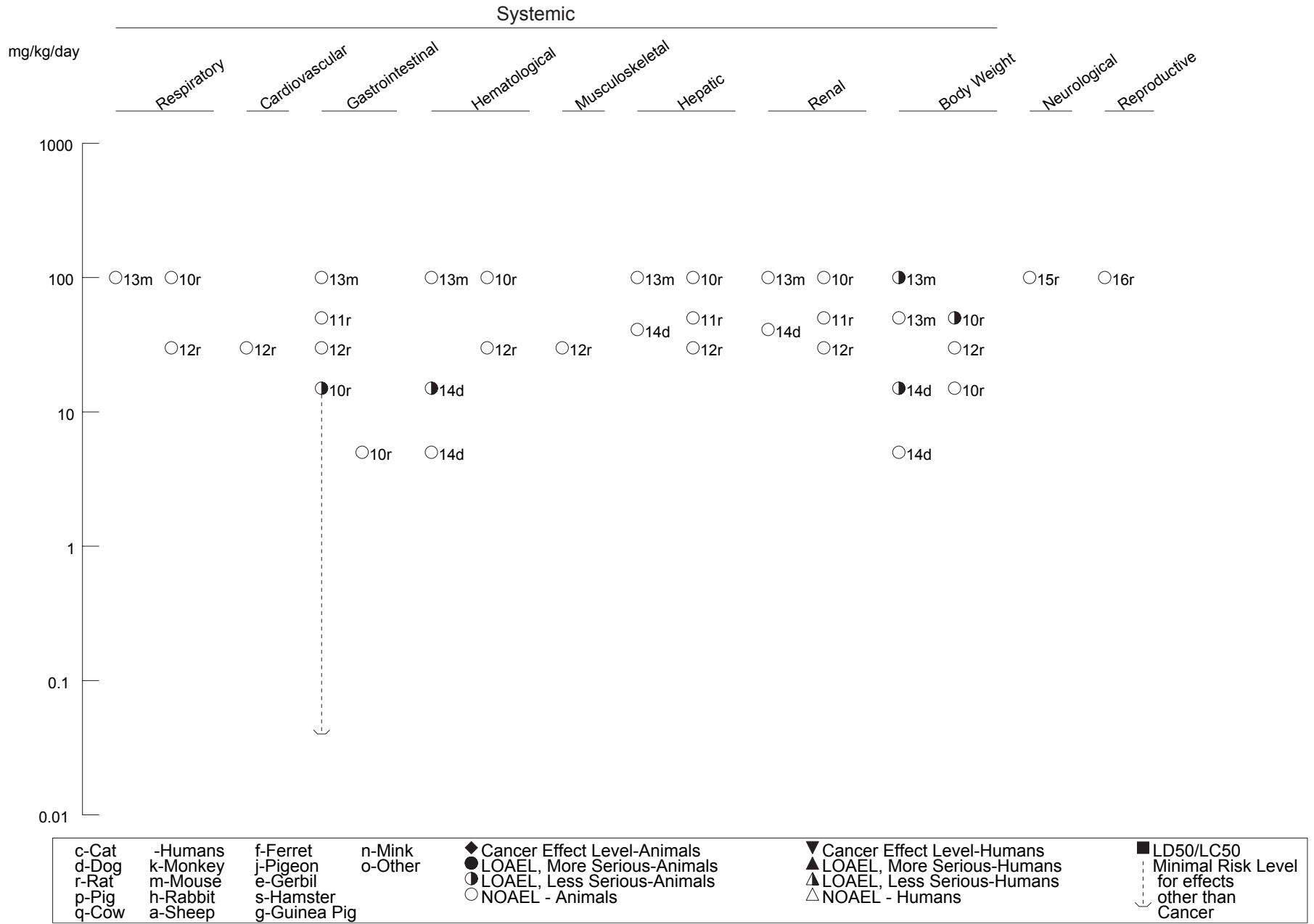

\*\*\*DRAFT FOR PUBLIC COMMENT\*\*\*

Figure 3-3 Levels of Significant Exposure to 1,3-dichloropropene - Oral (Continued)  
Chronic (≥365 days)

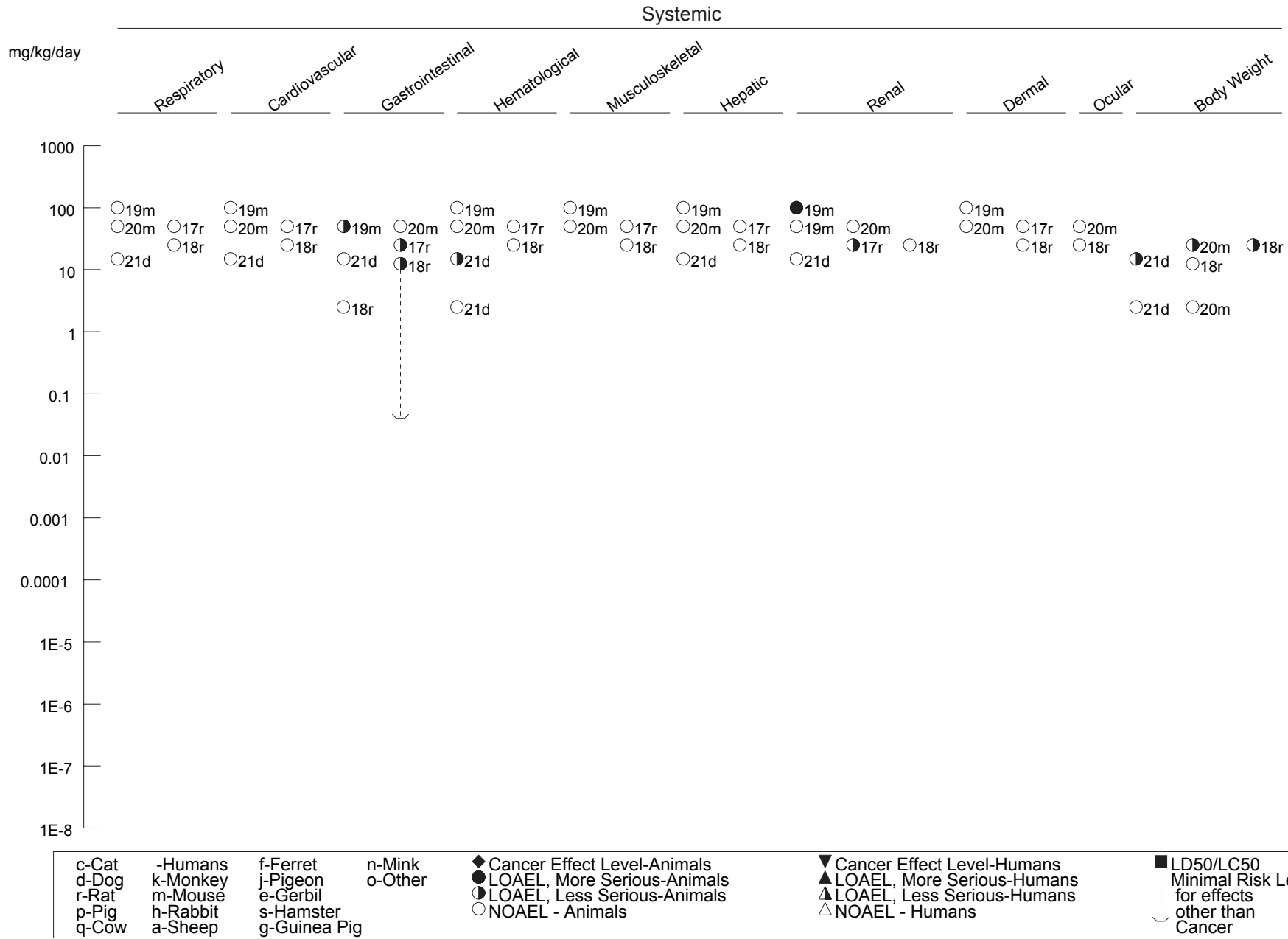

\*\*\*DRAFT FOR PUBLIC COMMENT\*\*\*

Figure 3-3 Levels of Significant Exposure to 1,3-dichloropropene - Oral (Continued)  
Chronic (≥365 days)

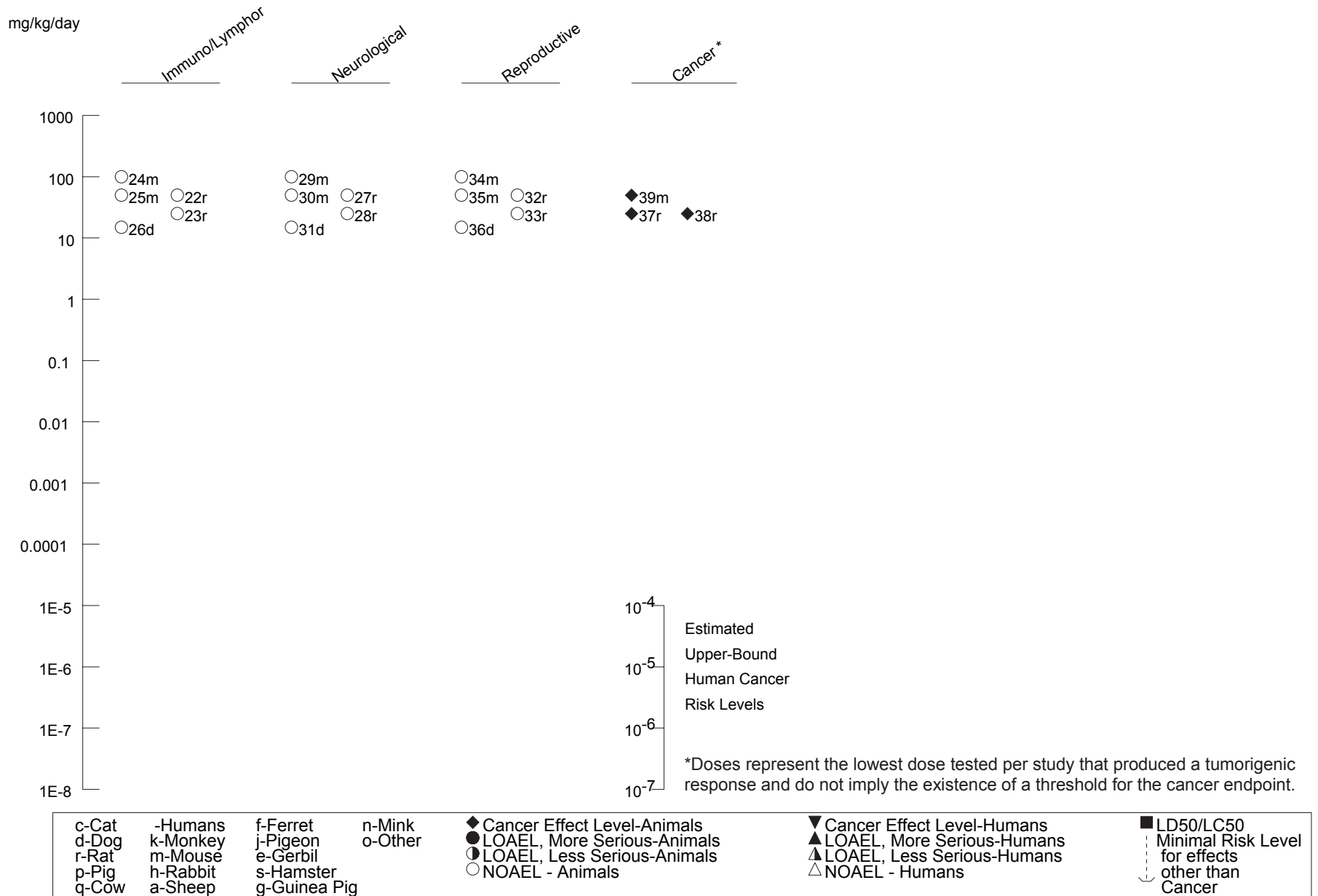

\*\*\*DRAFT FOR PUBLIC COMMENT\*\*\*



Table 3-5 Levels of Significant Exposure to 2,3-dichloropropene - Oral

Key to Figure <sup>a</sup>	Species (Strain)	Exposure/Duration/Frequency (Route)	System	NOAEL (mg/kg)	LOAEL		Reference Chemical Form	Comments
					Less Serious (mg/kg)	Serious (mg/kg)		
<b>ACUTE EXPOSURE</b>								
<b>Death</b>								
1	Rat (Sprague-Dawley)	once (G)				285 (LD50)	Monsanto 1967 2,3-dichloropropene	Purity not reported.
2	Rat (Wistar)	once (GO)				320 M (LD50)	Smyth et al. 1962; Union Carbide Corp 1958 2,3-dichloropropene	Purity not reported.

<sup>a</sup> The number corresponds to entries in Figure 3-4.

(G)= gavage; (GO) = gavage in oil; LD50 = lethal dose, 50% kill; LOAEL = lowest-observed-adverse-effect level; M = male; NOAEL = no-observed-adverse-effect level

\*\*\*DRAFT FOR PUBLIC COMMENT\*\*\*

Figure 3-4 Levels of Significant Exposure to 2,3-dichloropropene - Oral  
Acute ( $\leq 14$  days)

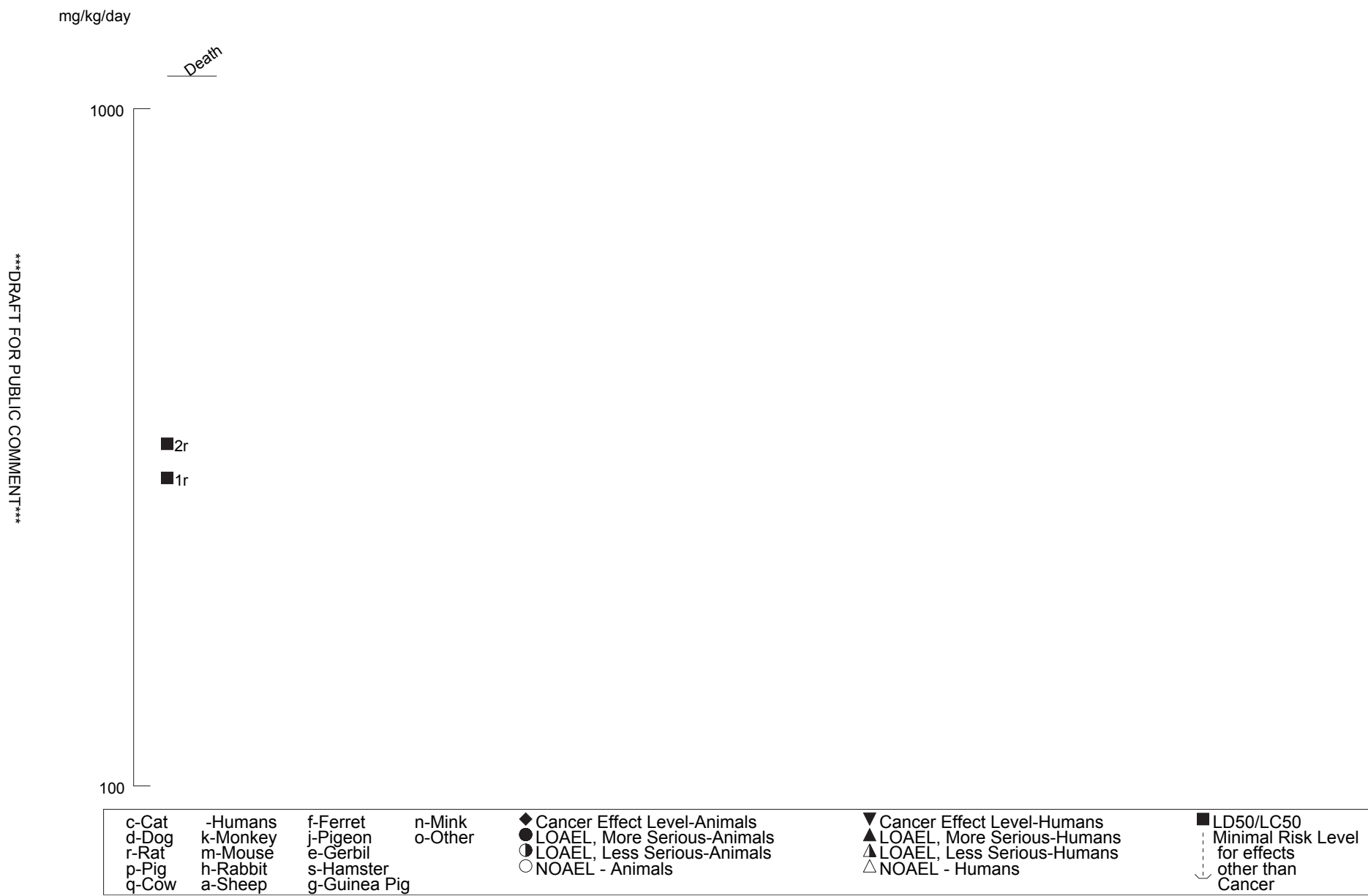

## 3. HEALTH EFFECTS

feed as high as 15 mg/kg/day for 1 year (Stebbins et al. 1999) or in rats or mice exposed to doses up to 25 or 50 mg/kg/day, respectively, for 2 years (Stebbins et al. 2000).

**2,3-Dichloropropene.** No mortality data were available for humans orally exposed to 2,3-dichloropropene.

The oral LD<sub>50</sub> for 2,3-dichloropropene in rats was 320 (260–400) mg/kg (Smyth et al. 1962).

**1,2-Dichloropropene.** No mortality data were available for humans orally exposed to 1,2-dichloropropene.

As mentioned in a brief summary, two rats survived that were given 2,000 mg/kg 1,2-dichloropropene by oral gavage (Dow 1962).

### 3.2.2.2 Systemic Effects

The systemic effects observed in humans or animals after oral exposure to 1,3-, 2,3-, or 1,2-dichloropropene are discussed below. The highest NOAELs and all reliable LOAELs for each systemic effect for each species and duration category are recorded in Tables 3-4 and 3-5, respectively, and plotted in Figures 3-3 and 3-4, respectively, for the 1,3- and 2,3-dichloropropenes.

#### Respiratory Effects.

**1,3-Dichloropropene.** In the 27-year-old male who died after accidentally ingesting 1,3-dichloropropene, tachypnea was an early sign of toxicity, and diffuse bilateral edema of the lungs consistent with adult respiratory distress syndrome developed several hours before death (Hernandez et al. 1994).

In a rat LD<sub>50</sub> study, a single oral administration of Telone II<sup>®</sup> a caused dose-related respiratory effects including lung congestion and lung hemorrhage (Jones and Collier 1986a). Abnormally red and hemorrhagic lungs were observed in rats that received a single oral dose of cis-1,3-dichloropropene in an LD<sub>50</sub> study (Jones 1988a).

Gross and microscopic examination revealed no respiratory effects in male and female rats exposed to ≤30 mg Telone<sup>®</sup>/kg/day by gavage for 13 weeks (Til et al. 1973), ≤50 mg Telone II<sup>®</sup> a/kg/day by gavage

## 3. HEALTH EFFECTS

for 9 months (NTP 1985), or  $\leq 100$  mg Telone II<sup>®</sup>b/kg/day in the feed for 13 weeks (Haut et al. 1996). Likewise, no exposure-related histologic lesions were found in the lungs of male and female mice exposed to doses  $\leq 100$  mg Telone II<sup>®</sup>b /kg/day in feed for 13 weeks (Haut et al. 1996).

Gross and histological examination revealed no neoplastic or nonneoplastic respiratory lesions in rats and no nonneoplastic respiratory lesions in mice receiving Telone II<sup>®</sup>a for 2 years at gavage doses of  $\leq 50$  mg/kg/day for rats or  $\leq 100$  mg/kg/day for mice (NTP 1985). In contrast, an increased incidence of bronchioalveolar adenomas was observed in female mice receiving Telone II<sup>®</sup>a for 2 years (Section 3.2.2.8). With dietary administration of microencapsulated Telone II<sup>®</sup>b in feed, no increased incidences of nonneoplastic respiratory lesions were found in rats or mice exposed to doses  $\leq 25$  or  $\leq 50$  mg/kg/day, respectively, for 2 years (Stebbins et al. 2000) or in dogs exposed to  $\leq 41$  mg/kg/day for 1 year (Stebbins et al. 1999).

**2,3-Dichloropropene.** No data were available for respiratory effects in humans orally exposed to 2,3-dichloropropene.

Congestion of the lungs was observed in rats that died in following ingestion of lethal doses of 2,3-dichloropropene (Smyth et al. 1962; Union Carbide Corp. 1958).

**Cardiovascular Effects.**

**1,3-Dichloropropene.** In the 27-year-old male who died after accidentally ingesting 1,3-dichloropropene, tachycardia was an early sign of toxicity and hypovolemia subsequently developed (Hernandez et al. 1994). At autopsy, there was evidence of hemorrhages in the stomach and brain.

Histological evaluation of the hearts revealed no exposure-related lesions in rats exposed to  $\leq 30$  mg/kg of Telone<sup>®</sup> by gavage for 13 weeks (Til et al. 1973).

Following chronic-duration exposure, gross and histological examination of hearts revealed no cardiovascular lesions in rats that received  $\leq 50$  mg/kg or in mice that received  $\leq 100$  mg Telone II<sup>®</sup>a/kg by gavage for 2 years (NTP 1985). Data in male mice were of limited value, because 25 of 50 vehicle controls died of myocarditis after 48–51 weeks. With dietary administration of microencapsulated Telone II<sup>®</sup>b in feed, no increased incidences of nonneoplastic cardiovascular lesions were found in rats or

## 3. HEALTH EFFECTS

mice exposed to doses  $\leq 25$  or  $\leq 50$  mg/kg/day, respectively, for 2 years (Stebbins et al. 2000) or in dogs exposed to  $\leq 41$  mg/kg/day for 1 year (Stebbins et al. 1999).

**Gastrointestinal Effects.**

***1,3-Dichloropropene.*** The only information on gastrointestinal effects in humans following oral exposure to 1,3-dichloropropene comes from a fatal accidental poisoning case (Hernandez et al. 1994). Acute gastrointestinal distress and abdominal pain were among the initial symptoms in a 27-year-old male who died 40 hours after accidentally drinking 1,3-dichloropropene. Subsequent signs included bloody diarrhea and the presence of pancreatic enzymes in the peritoneal fluid; the study authors could not rule out the possibility of a preexisting pancreatic illness. Hemorrhagic exudate of the stomach was observed at autopsy. Histopathological analysis of the stomach revealed congestion of gastric mucosal vessels, autolysis, and mucosal erosions.

Rats that received a single oral dose of  $\geq 110$  mg cis-1,3-dichloropropene/kg developed ulcerations of the glandular stomach and hemorrhage of the small intestine (Jones 1988a). Hyperkeratosis of the nonglandular stomach was found in rats that received a single gavage dose of 100 mg/kg Telone C-17<sup>®</sup> (Mizell et al. 1988b) or 75 mg/kg Telone II<sup>®</sup>a (Jones and Collier 1986a).

In rats exposed to microencapsulated Telone II<sup>®</sup>b in the diet for 13 weeks, basal cell hyperplasia of the nonglandular stomach was observed at doses of  $\geq 15$  mg/kg/day and hyperkeratosis was observed at 100 mg/kg/day (Haut et al. 1996). Gross and microscopic evaluation of the gastrointestinal tract revealed no lesions attributable to oral administration of  $\leq 30$  mg/kg of 78% Telone<sup>®</sup> to rats for 13 weeks (Til et al. 1973). Similarly, no gastrointestinal lesions were found in rats that received  $\leq 50$  mg/kg of 89% Telone II<sup>®</sup>a for 9 months (NTP 1985) or in mice exposed to  $\leq 100$  mg/kg/day Telone II<sup>®</sup>b in feed for 13 weeks (Haut et al. 1996). As described in Appendix A and the footnote to Table 3-4, an intermediate-duration oral MRL of 0.04 mg/kg/day was derived for 1,3-dichloropropene based on benchmark dose analysis of incidence data for basal cell hyperplasia of the nonglandular stomach in rats exposed to microencapsulated Telone II<sup>®</sup>b in the diet for 13 weeks.

Chronic oral exposure to 1,3-dichloropropene causes nonneoplastic and neoplastic lesions in the gastrointestinal systems of rats and mice.

## 3. HEALTH EFFECTS

Significant dose-related increases in basal cell or epithelial cell hyperplasia of the forestomach were observed in male and female rats that received  $\geq 25$  mg/kg Telone II<sup>®</sup>a for 2 years (NTP 1985). Additionally, female rats that received 50 mg/kg had hyperkeratosis of the forestomach. Male rats suffered an increase in pancreatic periarteritis at both 25 and 50 mg/kg.

Dose-related increases in epithelial cell hyperplasia of the forestomach were observed in female mice receiving  $\geq 50$  mg/kg Telone II<sup>®</sup>a by oral gavage (NTP 1985). Although data in male mice were limited, the incidence of forestomach epithelial cell hyperplasia was similar to that in the females. Neoplastic lesions of the stomach were also observed in rats and mice that received gavage doses of Telone II<sup>®</sup>a for 2 years (Section 3.2.2.7).

In chronic oral studies involving microencapsulated Telone II<sup>®</sup>b (95.8% 1,3-dichloropropene) in feed, basal cell hyperplasia of the nonglandular stomach mucosa was observed in male and female rats receiving 12.5 mg/kg/day for 2 years (Stebbins et al. 2000), but not in mice receiving doses of  $\leq 50$  mg/kg/day for 2 years (Stebbins et al. 2000) or dogs receiving  $\leq 15$  mg/kg/day for 1 year (Stebbins et al. 1999). A portal-of-entry effect in dogs was indicated by inflammation of the tongue in some dogs exposed at  $\leq 15$  mg/kg/day for 1 year (Stebbins et al. 1999); the study authors suggested that some of the microcapsules dissolved in saliva, releasing 1,3-dichloropropene into the oral cavity with resulting irritant effects. No gastric tumors were observed in rats, mice, or dogs exposed to Telone II<sup>®</sup>b in the diet. As described in Appendix A and a footnote to Table 3-4, a chronic-duration oral exposure MRL of 0.03 mg/kg/day was derived from benchmark dose analysis of incidence data for basal cell hyperplasia of the nonglandular stomach in female rats exposed to microencapsulated Telone II<sup>®</sup>b in the diet for 2 years.

**Hematological Effects.**

***1,3-Dichloropropene.*** No studies were located regarding hematological effects in humans after oral exposure to 1,3-dichloropropene.

Evaluation of hematological profiles and clinical chemistry revealed no adverse effects in rats that received  $\leq 30$  mg/kg 78% Telone<sup>®</sup> by oral gavage for 13 weeks (Til et al. 1973). In 13-week studies administering microencapsulated 95.8% Telone II<sup>®</sup>b in the diet, no significant hematological effects were noted in rats or mice exposed at  $\leq 100$  mg/kg/day (Haut et al. 1996). Conversely, dogs exposed to the same test material at concentrations of  $\geq 15$  mg/kg/day exhibited microcytic anemia (19–29% reductions in hemoglobin and hematocrit counts) (Stebbins et al. 1999).

## 3. HEALTH EFFECTS

Extensive clinical chemistry and hematological profiles of male and female rats exposed by gavage to  $\leq 50$  mg/kg 1,3-dichloropropene (89% plus 1% epichlorohydrin) (NTP 1985) or to microencapsulated Telone II<sup>®</sup>b at  $\leq 25$  mg/kg/day (Stebbins et al. 2000) for 2 years revealed no signs of adverse effects (NTP 1985). However, dogs exposed to the microencapsulated Telone II<sup>®</sup>b in the diet at concentrations of  $\geq 15$  mg/kg/day exhibited macrocytic anemia (reductions in hemoglobin, hematocrit, and mean corpuscular volumes) (Stebbins et al. 1999). This hematological effect in dogs was selected as a co-critical effect for chronic oral exposure. As described in Appendix A, hematological effects in dogs were not selected as the basis for the chronic-duration oral MRL because benchmark dose analysis of the other co-critical effect, stomach lesions in rats, provided a lower, more protective point of departure.

**Musculoskeletal Effects.**

*1,3-Dichloropropene.* No studies were located regarding musculoskeletal effects in humans after oral exposure to 1,3-dichloropropene.

Histological evaluation of musculoskeletal tissue revealed no exposure-related lesions in rats exposed to  $\leq 30$  mg/kg of Telone<sup>®</sup> by gavage for 13 weeks (Til et al. 1973).

Gross and histological examination of musculoskeletal tissue revealed no lesions in rats that received up to 50 mg/kg or in mice that received up to 100 mg Telone II<sup>®</sup>a/kg by gavage for 2 years (NTP 1985). With dietary administration of microencapsulated Telone II<sup>®</sup>b in feed, no increased incidences of musculoskeletal lesions were found in rats or mice exposed to doses  $\leq 25$  or  $\leq 50$  mg/kg/day, respectively, for 2 years (Stebbins et al. 2000) or in dogs exposed to  $\leq 41$  mg/kg/day for 1 year (Stebbins et al. 1999).

**Hepatic Effects.**

*1,3-Dichloropropene.* No studies were located regarding hepatic effects in humans after oral exposure to 1,3-dichloropropene.

Rats that received a single gavage dose of  $\geq 110$  mg cis-1,3-dichloropropene/kg developed dark and patchy livers and hemorrhage of the liver (Jones 1988a). Similarly, a single gavage dose of 170 mg/kg Telone II<sup>®</sup>a produced mottled and dark livers in rats (Jones and Collier 1986a).

## 3. HEALTH EFFECTS

An increased liver:body weight ratio was observed in rats that received 30 mg/kg, but not  $\leq 10$  mg/kg, of Telone<sup>®</sup> for 13 weeks (Til et al. 1973). Histological examination and clinical chemistry variables revealed no adverse hepatic effects in rats or mice exposed to 100 or 50 mg/kg/day, respectively, Telone II<sup>®b</sup> in feed for 13 weeks (Haut et al. 1996).

Histological examination revealed no hepatic lesions that were attributable to oral gavage administration of 50 mg/kg Telone II<sup>®a</sup> to rats for 9–24 months (NTP 1985). Similarly, no hepatic lesions attributable to Telone II<sup>®a</sup> were found in mice after they received gavage doses for 2 years. In contrast, an increased incidence of hepatic neoplastic nodules was observed in male rats that received Telone II<sup>®a</sup> by gavage for 2 years (Section 3.2.2.7). In male and female rats ingesting microencapsulated Telone II<sup>®b</sup> in the diet for 2 years, there was no increase in the total number of hepatic foci, but treated rats had more eosinophilic foci than basophilic foci (Stebbins et al. 2000). In the same study, an increase in benign hepatic tumors (adenomas) was observed in male rats exposed at 25 mg/kg/day (see Section 3.2.2.7). No nonneoplastic or neoplastic hepatic effects were found in mice exposed to  $\leq 50$  mg/kg/day Telone II<sup>®b</sup> in feed for 2 years (Stebbins et al. 2000), or in dogs exposed to  $\leq 41$  mg/kg/day for 1 year (Stebbins et al. 1999).

**2,3-Dichloropropene.** No data were available for hepatic effects in humans orally exposed to 2,3-dichloropropene.

Congestion of the liver was observed in rats that died in following ingestion of lethal doses of 2,3-dichloropropene (Smyth et al. 1962; Union Carbide Corp. 1958).

**1,2-Dichloropropene.** No data were available for hepatic effects in humans orally exposed to 1,2-dichloropropene.

As mentioned in a brief summary, two rats that survived a single oral dose of 2,000 mg/kg 1,2-dichloropropene exhibited considerable (unspecified) injury to the liver at necropsy (Dow 1962).

**Renal Effects.**

**1,3-Dichloropropene.** The autopsy of a 27-year-old male who died 40 hours after accidentally ingesting 1,3-dichloropropene revealed acute tubular necrosis of the kidney (Hernandez et al. 1994).



## 3. HEALTH EFFECTS

A single gavage dose of 170 mg/kg Telone II<sup>®</sup>a produced dark kidneys in rats (Jones and Collier 1986a). The toxicological significance of this observation was not discussed. The NOAEL for this effect was 110 mg/kg.

An increase in the kidney:body weight ratio was observed in rats that received 10 mg/kg, but not 3 mg/kg, Telone<sup>®</sup> (78% purity) for 13 weeks (Til et al. 1973). In contrast, no renal lesions were observed after gross and microscopic examination in rats that received  $\leq 50$  mg/kg of Telone II<sup>®</sup>a for 9–24 months (NTP 1985). No adverse renal effects were observed in rats, mice, or dogs that received Telone II<sup>®</sup>b in the diet for 13 weeks (Haut et al. 1996; Stebbins et al. 1999).

Female mice developed a dose-related increase in kidney hydronephrosis after oral exposure to 50 or 100 mg/kg Telone II<sup>®</sup>a for 2 years (NTP 1985). A primary target organ of 1,3-dichloropropene in female mice was the urinary bladder, where a dose-related increase in epithelial cell hyperplasia and transitional cell carcinoma (Section 3.2.2.7) was observed. Although data for male mice were not adequate, there was some indication that Telone II<sup>®</sup>a also caused transitional cell carcinomas in the urinary bladder. Similar neoplastic and nonneoplastic lesions were not found in male and female rats exposed to up to 50 mg/kg 1,3-dichloropropene for 2 years (NTP 1985). No adverse renal effects were observed in rats or mice that received Telone II<sup>®</sup>b in the diet for 2 years, or in dogs similarly exposed for 1 year (Stebbins et al. 1999, 2000).

**2,3-Dichloropropene.** No data were available for renal effects in humans orally exposed to 2,3-dichloropropene.

Congestion of the kidneys was observed in rats that died following ingestion of lethal doses of 2,3-dichloropropene (Smyth et al. 1962; Union Carbide Corp. 1958).

**1,2-Dichloropropene.** No data were available for renal effects in humans orally exposed to 1,2-dichloropropene.

As mentioned in a brief summary, two rats that survived a single oral dose of 2,000 mg/kg 1,2-dichloropropene exhibited considerable (unspecified) injury to the kidneys at necropsy (Dow 1962).

## 3. HEALTH EFFECTS

**Dermal and Ocular Effects.**

*1,3-Dichloropropene.* No studies were located regarding dermal/ocular effects in humans after oral exposure to 1,3-dichloropropene.

Gross and histological examination of the eyes and skin in rats and of the skin only in mice that received gavage doses of Telone II<sup>®</sup>a for 2 years revealed no lesions attributable to Telone II<sup>®</sup>a (NTP 1985). Likewise, no exposure-related adverse effects were apparent from histologic examination of skin and eyes of rats or mice exposed to  $\leq 25$  mg/kg/day and  $\leq 50$  mg/kg/day Telone II<sup>®</sup>b in the feed for 2 years (Stebbins et al. 2000) or eyes of dogs exposed to  $\leq 41$  mg/kg/day Telone II<sup>®</sup>b in the feed for 1 year (Stebbins et al. 1999).

**Body Weight Effects.**

*1,3-Dichloropropene.* No data were available for body weight effects in humans following oral exposure to 1,3-dichloropropene.

Reductions in terminal body weights compared to controls were observed in dogs exposed at  $\geq 15$  mg/kg/day (Stebbins et al. 1999), rats at  $\geq 50$  mg/kg/day, and mice at  $\geq 100$  mg/kg/day (Haut et al. 1996) in 13-week studies in which microencapsulated Telone II<sup>®</sup>b was added to the diet.

Reductions in body weights compared to controls were observed studies in rats and mice exposed to microencapsulated Telone II<sup>®</sup>b in the diet at 25 mg/kg/day for 2 years (Stebbins et al. 2000) or dogs exposed at 15 mg/kg/day for 1 year (Stebbins et al. 1999).

In the intermediate- and chronic-duration studies using Telone II<sup>®</sup>b, the authors reported that reduced feed intake was largely responsible for the reduced body weight gains.

**Metabolic Effects.**

*1,3-Dichloropropene.* Metabolic acidosis developed in a 27-year-old male within hours after fatal ingestion of 1,3-dichloropropene (Hernandez et al. 1994).

## 3. HEALTH EFFECTS

No studies were located regarding metabolic effects in animals after oral exposure to 1,3-dichloropropene.

**3.2.2.3 Immunological and Lymphoreticular Effects**

*1,3-Dichloropropene.* No studies were located regarding immunological effects in humans or animals after oral exposure to 1,3-dichloropropene.

Histological examination of spleen and thymus revealed no exposure-related adverse changes in rats or mice exposed to  $\leq 25$  and  $\leq 50$  mg/kg/day Telone II<sup>®</sup>b, respectively, in the feed for 2 years (Stebbins et al. 2000) or in dogs exposed to  $\leq 41$  mg/kg/day Telone II<sup>®</sup>b in the feed for 1 year (Stebbins et al. 1999).

**3.2.2.4 Neurological Effects**

*1,3-Dichloropropene.* No studies were located regarding neurological effects in humans after oral exposure to 1,3-dichloropropene.

Studies specifically designed to examine neurological end points in animals after acute-, intermediate-, or chronic-duration oral exposure to 1,3-dichloropropene were not located.

Clinical signs of neurotoxicity were observed in rats 1 hour after receiving a single oral dose of 170 or 250 mg/kg or 4 hours after receiving a single dose of 75 or 110 mg/kg 1,3-dichloropropene (Jones 1988a). The observations included hunched posture, pilo-erection, lethargy, ptosis, ataxia, and decreased respiratory rate. More sensitive tests for neurological effects, however, were not used.

No histologic changes in brain or spinal cord tissue or gross clinical signs of toxicity were found in rats and mice exposed to  $\leq 25$  and  $\leq 50$  mg/kg/day, respectively, Telone II<sup>®</sup>b in the feed for 2 years (Stebbins et al. 2000), in dogs exposed to  $\leq 41$  mg/kg/day Telone II<sup>®</sup>b in the feed for 1 year (Stebbins et al. 1999), or in rats and mice exposed to  $\leq 50$  and  $\leq 100$  mg/kg/day, respectively, Telone II<sup>®</sup>a by gavage for 2 years (NTP 1985).

## 3. HEALTH EFFECTS

**3.2.2.5 Reproductive Effects**

*1,3-Dichloropropene.* No studies were located regarding reproductive effects in humans following oral exposure to 1,3-dichloropropene.

Histological evaluation of reproductive organs and tissues from rats and mice that received oral doses of Telone II<sup>®</sup>a by gavage or dietary exposure to Telone II<sup>®</sup>b for 2 years revealed no lesions attributable to the exposure (NTP 1985; Stebbins et al. 2000). More sensitive tests for reproductive effects, however, were not performed in these studies.

Studies specifically designed to examine reproductive performance end points in animals after acute-, intermediate-, or chronic-duration oral exposure to 1,3-dichloropropene were not located.

**3.2.2.6 Developmental Effects**

No studies were located regarding developmental effects in humans or animals after oral exposure to any isomer of dichloropropene.

**3.2.2.7 Cancer**

*1,3-Dichloropropene.* No studies were located regarding cancer in humans after oral exposure to 1,3-dichloropropene.

In a 2-year gavage study, rats that received 25 or 50 mg Telone II<sup>®</sup>a/kg/day developed squamous cell papillomas and carcinomas of the forestomach (NTP 1985). Male rats also developed neoplastic nodules of the liver. Female mice that received 50 or 100 mg/kg/day developed squamous cell papillomas and carcinomas of the forestomach, transitional cell carcinomas of the urinary bladder, and an increased incidence of alveolar/bronchiolar adenomas. The data in male mice were considered inadequate for assessment of carcinogenicity, because 25 of 50 vehicle controls died of myocarditis during weeks 48–51 of the study; however, there was some indication that the same neoplastic lesions found in increased incidences in female mice also occurred in male mice (NTP 1985).

## 3. HEALTH EFFECTS

More recent 2-year studies testing microencapsulated Telone II<sup>®</sup>b (a formulation in which epichlorohydrin was replaced with epoxidized soybean oil) suggest that epichlorohydrin enhances the carcinogenicity of 1,3-dichloropropene in animals (Stebbins et al. 1999, 2000). In contrast to the carcinogenic responses observed in mice exposed by gavage to Telone II<sup>®</sup>a (a formulation with epichlorohydrin), mice receiving dietary doses of  $\leq 50$  mg/kg/day encapsulated Telone II<sup>®</sup>b did not show any statistically significant carcinogenic response (Stebbins et al. 2000). In male rats receiving doses of 25 mg/kg/day via dietary exposure to Telone II<sup>®</sup>b, the incidence of benign hepatocellular adenomas was significantly increased compared to controls and one male had a hepatocellular carcinoma (Stebbins et al. 2000). Female rats exhibited a significant positive trend for these liver tumors, although the incidence at 25 mg/kg/day, the highest dose tested, was not significantly increased compared to controls (Stebbins et al. 2000). No increased tumor incidence was observed in dogs receiving doses of  $\leq 41$  mg/kg/day for 1 year (Stebbins et al. 1999). From these results, it appears that lifetime oral exposure to 1,3-dichloropropene increased hepatic tumors in rats (either with gavage exposure to Telone II<sup>®</sup>a or dietary exposure to Telone II<sup>®</sup>b), but that tumors at other locations in rats (such as the forestomach) or at any locations in mice or dogs may arise only from an interaction with epichlorohydrin or with gavage exposure.

The CELs in rats and mice are recorded in Table 3-4 and plotted in Figure 3-3.

### 3.2.3 Dermal Exposure

Dermal toxicity data are available for 1,3-dichloropropene and, to a lesser extent, for 2,3-dichloropropene and 1,2-dichloropropene. The highest NOAEL and all reliable LOAEL values after dermal exposure to 1,3- and 2,3-dichloropropene are recorded in Tables 3-6 and 3-7, respectively. Median lethal doses and other reliable quantifiable mortality data are recorded as serious LOAELs in these tables and figures.

Unless otherwise noted, dermal toxicity studies employed occlusive or semioclusive coverings of the application site, protected to prevent evaporation or ingestion of the test material.

#### 3.2.3.1 Death

**1,3-Dichloropropene.** No studies were located regarding death in humans after dermal exposure to 1,3-dichloropropene.

Table 3-6 Levels of Significant Exposure to 1,3-dichloropropene - Dermal

Species (Strain)	Exposure/ Duration/ Frequency/ (Route)	System	NOAEL	LOAEL		Reference Chemical Form	Comments
				Less Serious	Serious		
<b>ACUTE EXPOSURE</b>							
<b>Death</b>							
Rat	1 d 24 hr/d			1200 B mg/kg	(LD50)	Jones and Collier 1986b T IIa	Purity: 97.2% 1,3-DCP.
Rabbit (New Zealand)	1 d 24 hr/d			333 mg/kg	(LD50)	Jeffrey et al. 1987b T IIa	Purity: 97.54% 1,3-DCP
Rabbit	1 d 24 hr/d			504 B mg/kg	(LD50)	Lichy and Olson 1975 M-3993	Purity: 92% 1,3-DCP.
Rabbit (New Zealand)	1 d 24 hr/d			500 mg/kg	(6/10 died)	Mizell et al. 1988b T C-17	Purity: 79.1% 1,3-DCP, 19.4% chloropicrin.
<b>Systemic</b>							
Rat	1 d 24 hr/d	Resp		800 M mg/kg	(lung hemorrhage)	Jones and Collier 1986b T IIa	Purity: 97.2% 1,3-DCP.
				500 M mg/kg	(lung congestion)		
		Gastro	500 B mg/kg	800 B mg/kg	(stomach hemorrhage)		
		Dermal		500 B mg/kg	(adhesion of skin to underlying tissue)		

\*\*\*DRAFT FOR PUBLIC COMMENT\*\*\*

Table 3-6 Levels of Significant Exposure to 1,3-dichloropropene - Dermal

(continued)

Species (Strain)	Exposure/Duration/Frequency (Route)	System	LOAEL			Reference Chemical Form	Comments
			NOAEL	Less Serious	Serious		
Rabbit (New Zealand)	1 d 1 x/d	Ocular		0.1 B ml (eye irritation)		Jeffrey 1987b T IIa	Purity: 97.54% 1,3-DCP.
Rabbit (New Zealand)	1 d 4 hr/d	Dermal		0.5 B ml (erythema/edema)		Jeffrey 1987c T IIa	Purity: 97.54% 1,3-DCP.
Rabbit (New Zealand)	1 d 24 hr/d	Dermal		200 B mg/kg (erythema, necrosis)		Jeffrey et al. 1987b T IIa	Purity: 97.54% 1,3-DCP.
Rabbit	3 d 24 hr/d				0.5 ml (erythema/edema)	Lichy and Olson 1975 M-3993	Purity: 92% 1,3-DCP.
Rabbit	3 d 24 hr/d	Dermal		0.5 B ml (erythema/edema)		Lichy and Olson 1975 M-3993	Purity: 92% 1,3-DCP.
Rabbit	1 d 1 x/d	Ocular		0.1 ml (eye irritation)		Lichy and Olson 1975 M-3993	Purity: 92% 1,3-DCP.
Rabbit (New Zealand)	1 d 4 hr/d	Dermal		0.5 ml (necrosis/exfoliation)		Mizell 1988a T C-17	Purity: 79.1% 1,3-DCP; 19.4% chloropicrin.

\*\*\*DRAFT FOR PUBLIC COMMENT\*\*\*

Table 3-6 Levels of Significant Exposure to 1,3-dichloropropene - Dermal

(continued)

Species (Strain)	Exposure/ Duration/ Frequency (Route)	System	LOAEL			Reference Chemical Form	Comments
			NOAEL	Less Serious	Serious		
Rabbit	1 d 24 hr/d	Musc/skel		500 B mg/kg	(skeletal muscle hemorrhage)	Mizell et al. 1988b T C-17	Purity: 79.1% 1,3-DCP, 19.4% chloropicrin.
		Dermal		500 B mg/kg	(necrosis)		
<b>Immuno/ Lymphoret</b> Gn Pig	1 wk 4 x/wk	Dermal		0.1 ml	(erythema)	Carreon and Wall 1983 T IIa	Purity: 92% 1,3-DCP.
Gn Pig (Hartley)	1 wk 4 x/wk			0.1 M ml	(positive sensitization reaction in 4/10)	Carreon and Wall 1983 T IIa	Purity: 92.1% 1,3-DCP.
<b>INTERMEDIATE EXPOSURE</b>							
<b>Immuno/ Lymphoret</b> Gn Pig (Hartley)	4 wk 1 d/wk 6 h/d			0.4 M ml	(positive sensitization reaction in 9/10)	Jeffrey 1987a T IIa	Purity: 97.54% 1,3-DCP.
Gn Pig	3 wk 3 d/wk 6 hr/d			0.2 ml	(contact sensitization)	Jones 1988b cis	

B = both male and female; d = day(s); Gastro = gastrointestinal; hr = hour(s); Resp = respiratory; wk = week(s)

\*\*\*DRAFT FOR PUBLIC COMMENT\*\*\*

DICHLOROPROPENES

3. HEALTH EFFECTS



Table 3-7 Levels of Significant Exposure to 2,3-dichloropropene - Dermal

Species (Strain)	Exposure/ Duration/ Frequency (Route)	System	LOAEL			Reference Chemical Form	Comments
			NOAEL	Less Serious	Serious		
<b>ACUTE EXPOSURE</b>							
<b>Death</b>							
Rabbit (New Zealand)	24 hr			1913 M (24-hour LD50) mg/kg		Smyth et al. 1962; Union Carbide Corp 1958 2,3-dichloropropene	Purity not reported.
<b>Systemic</b>							
Rabbit (New Zealand)	once 24 hr	Ocular		0.1 ml (moderate eye irritation)		Monsanto 1967 2,3-dichloropropene	Purity not reported.

hr = hour(s); LD50 = lethal dose, 50% kill; LOAEL = lowest-observed-adverse-effect level; M = male; NOAEL = no-observed-adverse-effect level

\*\*\*DRAFT FOR PUBLIC COMMENT\*\*\*

## 3. HEALTH EFFECTS

Several acute dermal lethality studies have been conducted for 1,3-dichloropropene (95% confidence limits are given in parentheses). The acute dermal LD<sub>50</sub> for Telone II<sup>®</sup>a in rats was 1,200 (1,000–1,400) mg/kg (Jones and Collier 1986b). The acute dermal LD<sub>50</sub> in rabbits for M-3993 was 713 mg/kg for males and 407 mg/kg for females, for an average of 504 (220–1,150) mg/kg (Lichy and Olson 1975). In a similar study, the dermal LD<sub>50</sub> for Telone II<sup>®</sup>a in rabbits was 333 (102–610) mg/kg (Jeffrey et al. 1987b). Six of 10 rabbits died or were submitted to pathology in a moribund condition within 4 days after receiving a dermal application of 500 mg/kg Telone C-17<sup>®</sup> (Mizell et al. 1988b).

**2,3-Dichloropropene.** No data were available for mortality in humans following dermal exposure to 2,3-dichloropropene.

The dermal LD<sub>50</sub> for 2,3-dichloropropene in rabbits was 1,913 (1,405–2,579) mg/kg for a single 24-hour exposure period (Smyth et al. 1962; Union Carbide Corp. 1958). The minimum lethal dose for dermal exposure to undiluted 2,3-dichloropropene was between 3,890 and 6,310 mg/kg (Younger 1967).

### 3.2.3.2 Systemic Effects

No studies were located regarding cardiovascular, hematological, renal, endocrine, or body weight effects in humans or animals after dermal exposure to any isomer of dichloropropene. No studies were located regarding respiratory, gastrointestinal, musculoskeletal, or hepatic effects in humans following dermal exposure to any isomer of dichloropropene.

#### Respiratory Effects.

**1,3-Dichloropropene.** Gross necropsy revealed abnormally red lungs in rats that died after dermal application of 800 mg/kg cis-1,3-dichloropropene (Jones 1988b). Rats that received a single dermal application of 500 mg/kg Telone II<sup>®</sup>a developed lung congestion, and at 800 mg/kg, lung hemorrhage (Jones and Collier 1986b).

#### Gastrointestinal Effects.

**1,3-Dichloropropene.** No studies were located regarding gastrointestinal effects in humans following dermal exposure to 1,3-dichloropropene.

## 3. HEALTH EFFECTS

Gross necropsy revealed that rats that received a single dermal application of 800 mg cis-1,3-dichloropropene/kg had hemorrhage and ulceration of the glandular gastric mucosa (Jones 1988b). Similarly, rats that received a single dermal application of 800 mg/kg Telone II<sup>®</sup>a suffered hemorrhage of the stomach and congestion and hemorrhage of the intestines (Jones and Collier 1986b). No gastrointestinal effects were observed in rats that received 500 mg/kg cis-1,3-dichloropropene or 500 mg/kg Telone II<sup>®</sup>a.

**Musculoskeletal Effects.**

*1,3-Dichloropropene.* No studies were located regarding musculoskeletal effects in humans following dermal exposure to 1,3-dichloropropene.

Of six rabbits that died following dermal application of 500 mg/kg Telone C-17<sup>®</sup>, two had developed skeletal muscle hemorrhage underneath the site of application (Mizell et al. 1988b).

**Hepatic Effects.**

*1,3-Dichloropropene.* No studies were located regarding hepatic effects in humans following dermal exposure to 1,3-dichloropropene.

Gross necropsy revealed abnormally dark livers in rats that received a single dermal application of  $\geq 800$  mg cis-1,3-dichloropropene/kg (Jones 1988b). The toxicological significance of this observation was not discussed. No other studies were located regarding hepatic effects in animals after dermal exposure to 1,3-dichloropropene.

**Dermal and Ocular Effects.**

*1,3-Dichloropropene.* Contact dermatitis has been reported in several agricultural workers following dermal exposure to 1,3-dichloropropene as a pesticide (Bousema et al. 1991; Corazza et al. 2003; Vozza et al. 1996). In cases where the liquid was in direct contact with the skin, dermatitis (erythema) developed immediately or within hours (Corazza et al. 2003; Vozza et al. 1996). In one case, a farmer developed acute bullous dermatitis on his feet 10 days after soiling his shoes in DD-95 (95% 1,3-dichloropropene), during which time he continued to wear the shoes (Bousema et al. 1991). In all three cases, allergic reactions subsequently developed (see Section 3.2.3.3).

## 3. HEALTH EFFECTS

Acute dermal application of dilute or full strength Telone II<sup>®</sup>a or M-3993 rapidly produced erythema and edema in rats, rabbits, and guinea pigs (Carreon and Wall 1983; Jeffrey 1987c; Jones and Collier 1986b; Lichy and Olson 1975; Mizell 1988a). At concentrations of  $\geq 200$  mg/kg, necrosis and subcutaneous/skeletal muscle hemorrhage were observed (Jones and Collier 1986b; Mizell 1988a; Mizell et al. 1988b).

Telone II<sup>®</sup>a and Telone C-17<sup>®</sup> also produced a delayed-type hypersensitivity in guinea pigs (Carreon and Wall 1983; Jeffrey 1987a; Mizell 1988b).

Severe conjunctival irritation, corneal injury, and corneal opacity were observed after instillation of 0.1 mL Telone II<sup>®</sup>a or M-3993 into the conjunctival sacs of rabbits (Jeffrey 1987b; Lichy and Olson 1975).

**2,3-Dichloropropene.** No data were available for dermal or ocular effects in humans following dermal exposure to 2,3-dichloropropene.

Results of primary eye and dermal irritation studies on 2,3-dichloropropene were described brief reports with little experimental detail. Moderate damage to the eye was observed in rabbits receiving a topical dose of 6.15 mg 2,3-dichloropropene (Smyth et al. 1962; Union Carbide Corp. 1958) or 0.1 mL (Younger 1967). In 24-hour dermal studies, moderate dermal irritation (erythema) was observed in rabbits that were exposed at a dose of 12 mg (Smyth et al. 1962; Union Carbide Corp. 1958) and mild dermal irritation was observed following exposure to an unspecified dose (Younger 1967).

**1,2-Dichloropropene.** No data were available for dermal or ocular effects in humans topically exposed to 1,2-dichloropropene.

A brief summary of results of a primary skin irritation assay in rabbits reported moderate hyperemia, edema, and deep burn with scarring following dermal exposure to an unspecified amount of 1,2-dichloropropene (Dow 1962). As reported in the same summary, effects in rabbits exposed to an unreported amount of 1,2-dichloropropene in a primary eye irritation assay included pain, moderate-to-extensive conjunctivitis, and slight iritis that subsided within a week.

## 3. HEALTH EFFECTS

**3.2.3.3 Immunological and Lymphoreticular Effects**

**1,3-Dichloropropene.** Skin sensitization reactions have been reported in workers involved in the production or use of pesticides containing 1,3-dichloropropene. A 28-year-old male who developed dermatitis on his hands, abdomen, and flanks from spilled 1,3-dichloropropene developed erythema, vesicles, and itching at the previous sites of exposure 3 weeks later (Corazza et al. 2003). A 44-year-old male who had developed acute bullous dermatitis on his feet from shoes contaminated with DD-95 (95% 1,3-dichloropropene) developed the same dermatitis following a similar exposure a year later (Bousema et al. 1991). A 23-year-old male who developed dermatitis on his hands and abdomen from accidental exposure to liquid 1,3-dichloropropene developed itching vesicles at the sites of exposure 1 week later (Vozza et al. 1996). The authors diagnosed this as a case of ‘contact pemphigus’, a type of autoimmune reaction initially triggered from contact dermatitis. Skin sensitization to DD-92<sup>®</sup> was noted as an itchy rash on the hands and feet of a 26-year-old male exposed during the manufacture of a soil fumigant (van Joost and de Jong 1988). Positive patch tests for 1,3-dichloropropene confirmed the sensitization in all four cases.

Delayed-type hypersensitivity reactions to Telone II<sup>®</sup> a and Telone C-17<sup>®</sup> were observed in guinea pigs (Carreon and Wall 1983; Jeffrey 1987a; Mizell 1988b). Guinea pigs also developed contact sensitization to cis-1,3-dichloropropene (Jones 1988b).

**3.2.3.4 Neurological Effects**

**1,3-Dichloropropene.** No studies were located regarding neurological effects in humans after dermal exposure to 1,3-dichloropropene.

Rats that received single dermal applications of  $\geq 500$  mg cis-1,3-dichloropropene/kg were lethargic and had increased salivation (Jones 1988b). At  $\geq 800$  mg/kg, ptosis, hunched posture, pilo-erection, lethargy, and decreased respiration rate were noted. Ataxia was observed in this study at dose levels of 1,300 and 2,000 mg/kg (Jones 1988b). Rats that received a single dermal application of  $\geq 1,300$  mg/kg of Telone II<sup>®</sup> a became ataxic and lost the righting reflex, indicating neurological deficits (Jones and Collier 1986b). Several studies reported clinical signs in rats and rabbits that possibly indicate a neurological effect of 1,3-dichloropropene after dermal application. These signs included lethargy, salivation, lacrimation, and labored respiration (Jeffrey et al. 1987b; Jones and Collier 1986b; Mizell et al. 1988b).

## 3. HEALTH EFFECTS

No studies were located regarding the following effects in humans or animals after dermal exposure to any isomer of dichloropropene:

**3.2.3.5 Reproductive Effects****3.2.3.6 Developmental Effects****3.2.3.7 Cancer**

**1,3-Dichloropropene.** No studies were located regarding cancer in humans after dermal exposure to 1,3-dichloropropene.

1,3-Dichloropropene was not a tumor-initiator in mice treated with a single application of 122 mg per mouse, followed by repeated applications of the tumor-promoter, phorbol myristic acid, for 58 weeks. 1,3-Dichloropropene did not induce skin-papilloma formation in mice after dermal application of 122 mg per mouse three times weekly for 74 weeks—averaging 1481 mg/kg/day (Van Duuren et al. 1979); in addition there was no significant increase in lung or forestomach tumors compared to untreated or acetone-treated controls. Therefore, 1,3-dichloropropene does not appear able to initiate or induce skin tumors in mice.

**3.2.4 Other Routes of Exposure**

No studies were located regarding effects in humans or animals exposed to any isomer of dichloropropene by routes of exposure other than oral, inhalation, or dermal.

**3.3 GENOTOXICITY**

Genotoxicity data for dichloropropenes are presented in Table 3-8 for *in vivo* studies and Table 3-9 for *in vitro* studies. Formulations are given in the tables.

**Genotoxic Effects *in Vivo*.** No studies were located regarding genotoxic effects in humans after inhalation, oral, or dermal exposure to any isomer of dichloropropene. Genotoxic effects were observed in animals *in vivo* following exposure to 1,1- and 1,3-dichloropropene (Table 3-8).

## 3. HEALTH EFFECTS

**Table 3-8. Genotoxicity of Dichloropropenes *In Vivo***

Species (test system)	End point	Results	Reference	Isomer/ formulation
<b>1,1-Dichloropropene</b>				
Fish ( $\lambda$ transgenic medaka), immersion at 0.44–16.60 mg/L for 6 weeks	Mutation at <i>cII</i> bacterial locus (liver)	+	Winn et al. 2006	Purity not reported
<b>1,3-Dichloropropene</b>				
<i>Drosophila melanogaster</i> , in 10% ethanol in feed	Sex-linked lethal mutation	+	Valencia et al. 1985	cis, trans; 95.5% pure
Rat (Sprague-Dawley); females; by oral gavage in corn oil; 94 mg/kg	DNA fragmentation (alkaline elution) (liver)	+	Kitchin and Brown 1994	NS
Rat (Sprague-Dawley); females; by oral gavage in corn oil; 9.4 mg/kg	DNA fragmentation (alkaline elution) (liver)	–	Kitchin and Brown 1994	NS
Rat (Sprague-Dawley); males; by oral gavage in DMSO; 125 mg/kg	DNA fragmentation (lung, bone marrow, brain)	–	Ghia et al. 1993	cis, trans
Rat (Sprague-Dawley); males; by oral gavage in DMSO; 62.5-250 mg/kg	DNA fragmentation (liver, gastric mucosa; kidney at 125 mg/kg)	+	Ghia et al. 1993	cis, trans
Mouse (CD-1), male; by oral gavage in olive oil; 150 mg/kg	DNA fragmentation (stomach, liver, kidney, bladder, lung, brain, bone marrow)	+	Sasaki et al. 1998	cis, trans
Rat (CD); males exposed by inhalation at $\leq$ 150 ppm, 6 hours/day, 7 days/week, 10 weeks	Dominant lethal mutation	–	Gollapudi et al. 1998	Telone II <sup>®</sup> b 49.3–49.9% cis/ 46.7% trans
Rat (Sprague-Dawley); males; by oral gavage in DMSO; 125 mg/kg	Unscheduled DNA synthesis (hepatocytes)	–	Ghia et al. 1993	cis, trans
Mouse (ICR), male; by i.p. injection in olive oil; 150 mg/kg	Increased micronucleated reticulocytes (peripheral blood)	–	Sasaki et al. 1994	NS
Rat (Sprague-Dawley); males; by oral gavage in DMSO; 125 mg/kg	Increased micronuclei (bone marrow)	–	Ghia et al. 1993	cis, trans

## 3. HEALTH EFFECTS

**Table 3-8. Genotoxicity of Dichloropropenes *In Vivo***

Species (test system)	End point	Results	Reference	Isomer/ formulation
Mouse (NMRI), female and female; by oral gavage in corn oil; 187 mg/kg	Increased micronuclei (bone marrow)	+	Kevekordes et al. 1996	cis, trans; 95% pure
Mouse (NMRI), male and female; by oral gavage in corn oil; ≤280 mg/kg	Increased micronuclei (bone marrow)	-	Kevekordes et al. 1996	cis, trans; 95% pure
Mouse (CD-1), male; by i.p. injection; single treatment	Micronucleus induction	-	Morita et al. 1997a	Technical grade
Mouse (CD-1), male; by oral gavage in olive oil; 150 mg/kg	DNA fragmentation (stomach, liver, kidney, bladder, lung, brain, bone marrow)	+	Sasaki et al. 1998	cis, trans

<sup>a</sup>cis- and trans-1,3-dichloropropene supplied by K&K Laboratories

<sup>b</sup>cis- and trans-1,3-dichloropropene supplied by Pfaltz and Bauer, Inc.

<sup>c</sup>Low-boiling 1,3-dichloropropene supplied by K&K Laboratories

<sup>d</sup>High-boiling 1,3-dichloropropene supplied by K&K Laboratories

<sup>e</sup>Pfaltz and Bauer 1,3-dichloropropene was purified; impurities were then added back (refluxed) for the mutagenicity assay.

<sup>f</sup>cis-1, 3-dichloropropene

<sup>g</sup>Impurities from purified cis-1,3-dichloropropene

+ = positive response; - = negative response; DMSO = dimethyl sulfoxide; NS = not specified



## 3. HEALTH EFFECTS

Table 3-9. Genotoxicity of Dichloropropenes *In Vitro*

Species (test system)	End point	Results		Reference	Isomer/ formulation
		With activation	Without activation		
<b>1,1-Dichloropropene</b>					
Prokaryotic organisms:					
<i>Salmonella typhimurium</i> (TA98, TA100, TA1535, TA104)	Mutagenicity	–	–	Granville et al. 2005	99% pure
<i>S. typhimurium</i> (RSJ100)	Mutagenicity	+	+	Granville et al. 2005	98% pure
<i>S. typhimurium</i> (TA100)	Mutagenicity	+	+	Neudecker et al. 1986	99.5% pure
Eukaryotic organisms:					
<i>Aspergillus nidulans</i>	Mitotic segregation	No data	–	Crebelli et al. 1992	97% pure
<i>A. nidulans</i>	Induced aneuploidy	No data	–	Rosenkranz and Klopman 1996	NS
Human lymphoblastoid cells	DNA damage	–	–	Granville et al. 2005	98% pure
<b>1,2-Dichloropropene</b>					
<i>S. typhimurium</i> (TA100)	Mutagenicity	–	–	Neudecker et al. 1986	99% pure
<b>1,3-Dichloropropene</b>					
Prokaryotic organisms:					
<i>S. typhimurium</i> (TA100)	Reverse mutation	+	+	Creedy et al. 1984	cis, trans
<i>S. typhimurium</i> (TA1535, TA1978, TA100)	Reverse mutation	+	+	De Lorenzo et al. 1977	cis
<i>S. typhimurium</i> (TA1978, TA1978, TA100)	Reverse mutation	+	+	De Lorenzo et al. 1977	trans
<i>S. typhimurium</i> (TA100)	Reverse mutation	+	+	Eder et al. 1982a, 1982b	cis, trans
<i>S. typhimurium</i> (TA100, TA1535, TA1537, TA98)	Reverse mutation	+	+	Haworth et al. 1983	cis, trans
<i>S. typhimurium</i> (TA1535, TA1537, TA1538)	Reverse mutation	+	+	Neudecker et al. 1977	cis, trans
<i>S. typhimurium</i> (TA100)	Reverse mutation	+	+	Neudecker et al. 1980; Neudecker and Henschler 1986	cis, trans 99.5% pure
<i>S. typhimurium</i> (TA100)	Reverse mutation	+	+	Stolzenberg and Hine 1980	cis, trans

## 3. HEALTH EFFECTS

Table 3-9. Genotoxicity of Dichloropropenes *In Vitro*

Species (test system)	End point	Results		Reference	Isomer/ formulation
		With activation	Without activation		
<i>S. typhimurium</i> (TA100)	Reverse mutation	No data	–	Talcott and King 1984	Not pure <sup>a</sup> 85%
<i>S. typhimurium</i> (TA100)	Reverse mutation	No data	–	Talcott and King 1984	Purified <sup>a</sup> 92%
<i>S. typhimurium</i> (TA100)	Reverse mutation	No data	+	Talcott and King 1984	Not pure <sup>b</sup> 77%
<i>S. typhimurium</i> (TA100)	Reverse mutation	No data	–	Talcott and King 1984	Purified <sup>b</sup> 85%
<i>S. typhimurium</i> (TA100)	Reverse mutation	No data	+	Talcott and King 1984	Not pure <sup>c</sup> 75%
<i>S. typhimurium</i> (TA100)	Reverse mutation	No data	–	Talcott and King 1984	Purified <sup>c</sup> 86%
<i>S. typhimurium</i> (TA100)	Reverse mutation	No data	+	Talcott and King 1984	Not pure <sup>d</sup> 88%
<i>S. typhimurium</i> (TA100)	Reverse mutation	No data	–	Talcott and King 1984	Purified <sup>d</sup> 95%
<i>S. typhimurium</i> (TA100)	Reverse mutation	No data	+	Talcott and King 1984	cis + trans <sup>e</sup> 80% plus impurities
<i>S. typhimurium</i> (TA98)	Reverse mutation	No data	+	Vithayathil et al. 1983	cis, trans
<i>S. typhimurium</i> (TA98)	Rifampicin resistance	No data	+	Vithayathil et al. 1983	cis, trans
<i>Escherichia coli</i> (PQ37)	DNA damage (SOS induction)	No data	+	von der Hude et al. 1988	cis, trans
<i>S. typhimurium</i> (TA100)	Reverse mutation	+	+	Watson et al. 1987	Not pure <sup>f</sup>
<i>S. typhimurium</i> (TA100)	Reverse mutation	–	–	Watson et al. 1987	Purified <sup>f</sup>
<i>S. typhimurium</i> (TA100)	Reverse mutation	+	+	Watson et al. 1987	Impurities <sup>g</sup>
<i>S. typhimurium</i> (TA100, TA102, TA97)	Reverse mutation	–	+	Connors et al. 1990	cis or trans; 3-chloroallyl alcohol <sup>h</sup>
Eukaryotic organisms:					
<i>A. nidulans</i>	Mitotic segregation	No data	–	Crebelli et al. 1992	95% pure
<i>A. nidulans</i>	Induced aneuploidy	No data	–	Rosenkranz and Klopman 1996	NS
HeLa cells	Unscheduled DNA synthesis	No data	+	Eder et al. 1987	cis, trans
HeLa cells	Unscheduled DNA synthesis	No data	+	Schiffmann et al. 1983	cis, trans

## 3. HEALTH EFFECTS

**Table 3-9. Genotoxicity of Dichloropropenes *In Vitro***

Species (test system)	End point	Results		Reference	Isomer/ formulation
		With activation	Without activation		
Mouse lymphoma cell L5178Y	Mutagenesis	No data	+	Myhr and Caspary 1991	Telone II cis, trans
Chinese hamster ovary cells	Sister chromatid exchange	+	+	Loveday et al. 1989	97.1% pure
Chinese hamster ovary cells	Chromosomal aberrations	–	–	Loveday et al. 1989	97.1% pure
Chinese hamster V79 cells	Sister chromatid exchange	–	+	von der Hude et al. 1987	cis, trans
Chinese hamster lung cells	Mitotic aberrations	+	+	Sasaki et al. 1988	cis + trans
Chinese hamster lung cells	Chromosomal aberrations	+	+	Matsuoka et al. 1998	96.5% pure
Rat hepatocytes	Unscheduled DNA synthesis	No data	+	Martelli 1997	NS
Human lymphocytes	Unscheduled DNA synthesis	No data	+	Martelli 1997	NS
Human lymphocytes	Sister chromatid exchange	+	+	Kevekordes et al. 1996	cis, trans 95% pure
<b>Acellular test system</b>					
2'-Deoxyguanosine	Adduct formation	NA	+	Schneider et al. 1998a	cis or trans epoxide; 3-chloro- 3-hydroxy- propanal <sup>n</sup>
2'-Deoxyadenosine or 2'-Deoxycytidine	Adduct formation	NA	–	Schneider et al. 1998a	cis or trans epoxide; 3-chloro- 3-hydroxy- propanal <sup>n</sup>
<b>2,3-Dichloropropene</b>					
<b>Prokaryotic organisms</b>					
<i>S. typhimurium</i> (TA102, TA2638)	Reverse mutation	+	+	Watanabe et al. 1998	NS
<i>S. typhimurium</i> (TA100, TA1535, TA97, TA98)	Reverse mutation	+	+	Zeiger et al. 1988)	98% pure
<i>E. coli</i> (WP2/pKM101)	Reverse mutation	–	–	Watanabe et al. 1998	NS
<i>E. coli</i> (WP2 <i>uvrA</i> /pKM101)	Reverse mutation	+	+	Watanabe et al. 1998	NS
<i>S. typhimurium</i> (TA100)	Reverse mutation	–	–	Lag et al. 1994	98% pure
<i>S. typhimurium</i> (TA100)	Reverse mutation	No data	+	Neudecker and Henschler 1986	99.5% pure

## 3. HEALTH EFFECTS

**Table 3-9. Genotoxicity of Dichloropropenes *In Vitro***

Species (test system)	End point	Results		Reference	Isomer/ formulation
		With activation	Without activation		
<i>S. typhimurium</i> (TA100)	Reverse mutation	+	+	Stolzenberg and Hine 1980	98% pure
<i>S. typhimurium</i> (TA1535, TA1978, TA100)	Reverse mutation	+	+	De Lorenzo et al. 1977	cis, trans
<i>S. typhimurium</i> (TA100)	Reverse mutation	+	+	Eder et al. 1982a, 1986	NS
Eukaryotic organisms:					
<i>A. nidulans</i>	Mitotic segregation	No data	+	Crebelli et al. 1992	98% pure
<i>A. nidulans</i>	Induced aneuploidy	No data	+	Rosenkranz and Klopman 1996	NS
Chinese hamster ovary cells	Sister chromatid exchange	+	+	Loveday et al. 1990	98% pure
Chinese hamster V79 cells	Sister chromatid exchange	+	+	von der Hude et al. 1987	99% pure
Chinese hamster ovary cells	Chromosomal aberrations	+	+	Loveday et al. 1990	98% pure
Rat hepatocyte	DNA repair	No data	–	Williams et al. 1989	NS
HeLa cells	Unscheduled DNA synthesis	No data	+	Schiffmann et al. 1983	NS

<sup>a</sup>cis- and trans-1,3-dichloropropene supplied by K&K Laboratories

<sup>b</sup>cis- and trans-1,3-dichloropropene supplied by Pfaltz and Bauer, Inc.

<sup>c</sup>Low-boiling 1,3-dichloropropene supplied by K&K Laboratories

<sup>d</sup>High-boiling 1,3-dichloropropene supplied by K&K Laboratories

<sup>e</sup>Pfaltz and Bauer 1,3-dichloropropene was purified; impurities were then added back (refluxed) for the mutagenicity assay.

<sup>f</sup>cis-1, 3-dichloropropene

<sup>g</sup>Impurities from purified cis-1,3-dichloropropene

<sup>h</sup>Metabolites of 1,3-dichloropropene

+ = positive response; – = negative response

## 3. HEALTH EFFECTS

***1,1-Dichloropropene.*** Positive evidence for the mutagenicity of 1,1-dichloropropene was reported for the  $\lambda$  (lambda) transgenic medaka fish that were exposed in aquaria water continuously for 6 weeks (Winn et al. 2006). The transgenic medaka is homozygous for the lambda bacteriophage vector that expresses *lacI* and *cII* bacterial genes. Assays of liver DNA for mutations in the *cII* gene revealed concentration-related increases in mutation frequencies in exposed fish compared to controls: from a 6-fold increase at 0.44 mg/L to a 32-fold increase at 16.60 mg/L. The pattern of induced mutation types was distinct from that produced spontaneously in controls, with the most frequent induced type being a +1 frameshift mutation (comprising 69.4% of the mutations) occurring at a 166-fold increase in fish treated at 16.6 mg/L compared to controls.

***1,3-Dichloropropene.*** A single inhalation-exposure study reported no evidence of an increase in dominant lethal mutations in rats exposed intermittently at 150 ppm for up to 10 weeks (Gollapudi et al. 1998).

Positive evidence for genotoxicity of 1,3-dichloropropene was reported in several oral-exposure studies. In a *Drosophila melanogaster* feeding study 1,3-dichloropropene produced sex-linked recessive lethal mutations (Valencia et al. 1985). DNA fragmentation was detected by alkaline elution in livers of female rats orally dosed with 94 mg/kg (Kitchin and Brown 1994), the livers and gastric mucosa of male rats orally dosed with  $\geq 62.5$  mg/kg and kidneys of male rats orally dosed with 125 mg/kg (Ghia et al. 1993), and the stomach, liver, kidney, bladder, lung, brain, and bone marrow of male mice orally dosed with 150 mg/kg (Sasaki et al. 1998). No DNA fragmentation was observed in rat lung, bone marrow, or brain of rats orally dosed with up to 125 mg/kg (Ghia et al. 1993). Some of the studies reported positive evidence of DNA damage a few hours after exposure, but apparent recovery to normal conditions by 24 hours after exposure was noted.

No increase in unscheduled DNA synthesis was observed in rats dosed orally with 125 mg/kg (Ghia et al. 1993). One study reported positive results for increased micronucleus production in bone marrow of mice that received an oral dose of 187 mg/kg 1,3-dichloropropene (Kevekordes et al. 1996), but all other micronucleus assays in rats or mice were negative (Ghia et al. 1993; Kevekordes et al. 1996; Morita et al. 1997a; Sasaki et al. 1994).

Studies examining genotoxic endpoints in mammals following *in vivo* exposure to 1,1-, 1,2- and 2,3-dichloropropene were not located.

## 3. HEALTH EFFECTS

**Genotoxic Effects *in Vitro*.** Four of the isomers, 1,1-dichloropropene, 1,2-dichloropropene, 1,3-dichloropropene, and 2,3-dichloropropene, have been tested for genotoxicity *in vitro* (Table 3-9).

***1,1-Dichloropropene.*** Positive results following exposure to 1,1-dichloropropene were reported for reverse mutation in *Salmonella typhimurium* strain TA100 with or without metabolic activation (Neudecker et al. 1986). However, a more recent study reported negative results in TA100, but positive results in strain RSJ100, which expresses glutathione transferase (Granville et al. 2005). This isomer apparently is bioactivated by glutathione (directly or by catalysis by glutathione transferase) to form a mutagenic epoxide (Granville et al. 2005). Other negative results were reported for mutagenicity in *S. typhimurium* strains TA1535 and TA104 (Granville et al. 2005), mitotic segregation or induced aneuploidy in yeast (Crebelli et al. 1992; Rosenkranz and Klopman 1996), and DNA fragmentation in cultured human lymphoblastoid cells (Granville et al. 2005).

***1,2-Dichloropropene.*** A single study reported no increase in the frequency of reverse mutations in *S. typhimurium* strain TA100 exposed to 1,2-dichloropropene (Neudecker et al. 1986).

***1,3-Dichloropropene.*** A significant amount of evidence is available for the genotoxicity of 1,3-dichloropropene *in vitro*. Several groups have reported that 1,3-dichloropropene is mutagenic *in vitro* with and without metabolic activation in *S. typhimurium* (Creedy et al. 1984; De Lorenzo et al. 1977; Eder et al. 1982a, 1982b; Haworth et al. 1983; Neudecker and Henschler 1986; Neudecker et al. 1977, 1980; Stolzenberg and Hine 1980; Vithayathil et al. 1983). In contrast, 1,3-dichloropropene purified on silic acid columns was not mutagenic in *S. typhimurium* strain TA100 without activation (Talcott and King 1984). Silic acid removes polar impurities, which when added back to the purified 1,3-dichloropropene, restore the mutagenic activity (Talcott and King 1984). For one of the batches (indicated by footnote b in Table 3-9), the mutagenic impurities were identified as oxidation products of 1,3-dichloropropene, namely epichlorohydrin and 1,3-dichloro-2-propanol. An independent group confirmed the lack of mutagenicity of purified 1,3-dichloropropene in strain TA100 without activation and also found that the trace impurities alone, *cis*- and *trans*-2-chloro-3-(chloromethyl)oxiranes (dichloropropene oxides), formed slowly by autoxidation were mutagenic (Watson et al. 1987). As Watson et al. (1987) determined that storage under nitrogen prevented the production of the mutagenic dichloropropene oxides, it seems likely that relatively pure 1,3-dichloropropene will develop trace amounts of mutagenic autoxidation products if stored in contact with oxygen in air. Watson et al. (1987) also demonstrated that the presence of physiological levels of glutathione were sufficient to block mutagenicity of bioactivated 1,3-dichloro-

## 3. HEALTH EFFECTS

propene. Positive evidence of DNA damage, as indicated by SOS induction, were observed in *Escherichia coli* PQ37 without activation (von der Hude et al. 1988).

In cultured eukaryotic systems, 1,3-dichloropropene was mutagenic in mouse lymphoma L5178Y cells without exogenous activation (Myhr and Caspary 1991). Exposure to 1,3-dichloropropene increased the frequency of mitotic aberrations in Chinese hamster lung cells (Sasaki et al. 1988), but did not induce aberrant mitotic segregation or aneuploidy in yeast cells (Crebelli et al. 1992; Rosenkranz and Klopman 1996). Increases in the frequency of sister chromatid exchange were observed in exposed Chinese hamster V79 cells without activation (von der Hude et al. 1987), human lymphocytes with or without activation (Kevekordes et al. 1996), and Chinese hamster ovary cells with or without activation (Loveday et al. 1989). 1,3-Dichloropropene triggered unscheduled DNA synthesis in HeLa cells (Eder et al. 1987; Schiffmann et al. 1983), and in human lymphocytes and rat hepatocytes without exogenous activation (Martelli 1997).

In an acellular test system, three metabolites of 1,3-dichloropropene, namely the cis and trans epoxides of 1,3-dichloropropene and 3-chloro-3-hydroxypropanal, formed adducts with 2'-deoxyguanosine, but not with 2'-deoxyadenosine or 2'-deoxycytidine (Schneider et al. 1998b).

**2,3-Dichloropropene.** There is positive evidence for genotoxicity of 2,3-dichloropropene in prokaryotic and eukaryotic systems.

Increases in the frequency of reverse mutations, with or without activation, were observed for most studies in *S. typhimurium* strains TA100, TA102, TA97, TA98, TA1535, TA1978, and TA2638 (De Lorenzo et al. 1977; Eder et al. 1982a; Neudecker and Henschler 1986; Stolzenberg and Hine 1980; Watanabe et al. 1998; Zeiger et al. 1988). An increase in reverse mutations was observed in *E. coli* strain WP2 *uvr*/pkM101, with or without activation, but not in strain WP2/pkM101 (Watanabe et al. 1998).

In eukaryotic systems, 2,3-dichloropropene increased aberrant mitotic segregation and aneuploidy in yeast (Crebelli et al. 1992; Rosenkranz and Klopman 1996), the frequency of sister chromatid exchanges in Chinese hamster ovary cells (Loveday et al. 1990) and Chinese hamster V79 cells (von der Hude et al. 1987), and the frequency of chromosomal aberrations in Chinese Hamster ovary cells (Loveday et al. 1990). An increase in unscheduled DNA synthesis was observed in HeLa cells exposed without activation (Schiffmann et al. 1983), but there was no evidence of increased DNA repair in cultured rat hepatocytes (Williams et al. 1989).

## 3. HEALTH EFFECTS

**3.4 TOXICOKINETICS**

1,3-Dichloropropene is quickly and extensively absorbed through both the respiratory tract and gastrointestinal tract; 1,3-dichloropropene vapor can be absorbed through the skin. Absorbed 1,3-dichloropropene is distributed widely throughout the body, at greatest levels in the stomach and urinary bladder after oral exposure. 1,3-Dichloropropene is primarily metabolized in the liver by conjugation to glutathione, resulting in the excretion of mercapturic acid metabolite in urine. Two minor metabolic pathways include hydrolysis with dechlorination resulting in intermediates that are substrates for alcohol dehydrogenase, and reaction with cytochrome P-450, resulting in the formation of mutagenic epoxides. Elimination of 1,3-dichloropropene is very rapid, irrespective of the route of absorption.

2,3-Dichloropropene is rapidly and extensively absorbed through the gastrointestinal tract and respiratory tract; no toxicokinetic data are available for absorption of this isomer through the skin. Absorbed 2,3-dichloropropene is distributed widely throughout the body, especially the urinary bladder, nasal turbinates, and kidney after inhalation exposure, and liver, kidney, testes, and lung after oral exposure. The primary metabolic pathway of 2,3-dichloropropene is similar to that of 1,3-dichloropropene, with conjugation to glutathione resulting in the urinary elimination of a mercapturic acid metabolite. Minor pathways include a hydrolysis and dechlorination pathway resulting in the formation of glucuronide metabolite or an epoxidation pathway. The majority of absorbed 2,3-dichloropropene is eliminated within the first 24 hours of exposure.

No data are available for the absorption, distribution, or elimination of 1,1-dichloropropene by any route of exposure. Data from an *in vitro* metabolism study indicate that bioactivation of 1,1-dichloropropene by reaction with glutathione results in the formation of a mutagenic episulfonium ion.

No data are available for the absorption, distribution, metabolism, or elimination of 1,2- or 3,3-dichloropropene.

**3.4.1 Absorption**

The absorption of 1,3- and 2,3-dichloropropene is rapid by the inhalation and oral routes.



## 3. HEALTH EFFECTS

**3.4.1.1 Inhalation Exposure**

**1,3-Dichloropropene.** Published quantitative data are not available for the absorption of 1,3-dichloropropene in humans following inhalation exposure. An unpublished study by Waechter et al. (1992) described absorption pharmacokinetics in six male human volunteers exposed to 1 ppm Telone II<sup>®</sup> (50.6% cis isomer; 42% trans isomer) for 6 hours. Specimens of expired air and venous blood collected 5, 15, 30, 45, 60, 180, 240, and 360 minutes from the start of exposure and 5, 10, 15, 20, 30, 60, 120, and 240 minutes after the end of exposure were assayed for the presence of cis and trans isomers. Urine samples collected for two consecutive 12-hour periods just before exposure, a short period just before exposure, the 6 hours of exposure, and the first 6 hours and seven consecutive 12-hour periods after exposure were assayed for the presence of creatinine and mercapturic acid metabolites (cis- and trans-N-acetyl-S-(3-chloroprop-2-enyl)cysteine). Calculation of the percent absorption of 1,3-dichloropropene for the six individuals ranged from 72 to 80% for the cis isomer and from 77 to 82% for the trans isomer. Indirect evidence for absorption comes from the detection of the N-acetyl-cysteine conjugate of 1,3-dichloropropene in the urine of four men 24 hours after field application of Telone II<sup>®</sup>a (Osterloh et al. 1984).

Quantitative data from animal studies support this observation in humans. Mixtures of cis and trans isomers of 1,3-dichloropropene were rapidly absorbed by rats after inhalation exposure (Stott and Kastl 1986). The rates of vapor uptake in rats exposed to 30, 90, 300, or 900 ppm were 144±14, 307±13, 880±83, or 1810±76 nmol/minute, respectively. However, because a decrease in the respiratory rate was observed in rats exposed to ≥90 ppm, the average calculated percentages of inhaled vapors that were absorbed were similar: 82, 65, 66, and 62%, respectively for the low-to-high exposures. Steady-state blood levels were reached within 1 hour at 30 and 90 ppm and within 2–3 hours at 300 ppm, but did not reach steady state within 3 hours at 900 ppm. The increased length of time required to reach steady state at 300 and 900 ppm was likely a function of the observed decrease in respiratory rate. Nonlinear excretion kinetics also contributed to the decreased uptake observed at 300 and 900 ppm; disproportionate increases in the blood levels of cis-1,3-dichloropropene at 900 ppm and of trans-1,3-dichloropropene at 300 and 900 ppm could indicate changes in distribution and/or metabolism.

An apparent steady state in blood levels of the glutathione conjugate of 1,3-dichloropropene was detected in rats first assayed within 1 hour after exposure to 78, 155, or 404 ppm Telone II<sup>®</sup>a (Fisher and Kilgore 1989). No exposure-response relationship was detected: each of these exposure conditions produced similar concentrations of the glutathione conjugate in blood.

## 3. HEALTH EFFECTS

**2,3-Dichloropropene.** Quantitative data are not available on the absorption of 2,3-dichloropropene in humans following inhalation exposure, but data are available for animals. In Fischer 344 rats exposed (nose-only) to radiolabeled 2,3-dichloropropene vapor at 0.4 ppm for 6 hours, 5.9 ppm for 5.1 hours, or 40.3 ppm for 6 hours (17, 240, or 1,650 nmol/L), the percentages of inhaled compound that was absorbed were 40, 35, or 39%, respectively, or 38% on average (Dutcher et al. 1985). A 25% decrease in the respiratory rate during exposure at 40.3 ppm compared to 0.4 ppm resulted in a statistically significant 15% reduction in the minute volume (170 mL/minute compared to 200 mL/minute), but this had no effect on the percentage of compound absorbed. No data were located for steady-state blood levels of 2,3-dichloropropene following inhalation exposure.

**3.4.1.2 Oral Exposure**

**1,3-Dichloropropene.** No studies were located regarding absorption of 1,3-dichloropropene in humans after oral exposure.

1,3-Dichloropropene was well absorbed following gavage administration of <sup>14</sup>C-labeled cis- and/or trans-1,3-dichloropropene in rats (Climie et al. 1979; Hutson et al. 1971). Recovery of [<sup>14</sup>C]cis-1,3-dichloropropene in 24-hour urine collections was 82–84% in rats (Climie et al. 1979). Similarly, 82–84% of <sup>14</sup>C-labeled cis-1,3-dichloropropene was recovered in urine, and 2–3% was recovered in feces during a 96-hour urine collection period after gavage administration in rats (Hutson et al. 1971). In contrast, only 55–60% of the <sup>14</sup>C-labeled trans-1,3-dichloropropene was recovered in the urine and 2% was recovered in the feces during the same period. These data indicate that both isomers of 1,3-dichloropropene are extensively absorbed by the oral route of exposure, which could lead to distribution throughout the body.

Since a microencapsulation method was developed for administering 1,3-dichloropropene as Telone II<sup>®</sup>b in diets, Stott et al. (1998) conducted experiments to verify that the compound would be bioavailable in that form. The absorption of neat <sup>13</sup>C-labeled-1,3-dichloropropene and 1,3-dichloropropene microencapsulated in a starch/sucrose matrix was compared in rats dosed simultaneously with equal amounts (25 mg/kg) of the two forms by oral gavage (Stott et al. 1998). Absorption of either form was rapid, peak blood concentrations being reached within 10 minutes of dosing. The half-lives of absorption into the blood (not defined, but presumably the half-times to reach maximal levels in blood) were short: 2.5 minutes for the neat cis isomer, 1.3 minutes for the encapsulated cis isomer, 2.7 minutes for the neat trans isomer, and 2.3 minutes for the encapsulated trans isomer. Blood area under the curve (AUC)

## 3. HEALTH EFFECTS

values were 1.239 mg · minute/L for the neat cis isomer, 1.601 mg · minute/L for the encapsulated cis isomer, 4.369 · minute/L for the neat trans isomer, and 5.552 mg · minute/L for the encapsulated trans isomer. Encapsulated compound represented a larger proportion of the total AUC: 56 versus 44%. In a real-time monitoring experiment, the half-life of absorption of neat 1,3-dichloropropene was 5.5 minutes and that of encapsulated compound was 3.2 minutes. Under these conditions, neat compound represented 34% of the AUC and encapsulated represented 66%. This study confirmed the bioavailability of 1,3-dichloropropene administered microencapsulated in feed.

**2,3-Dichloropropene.** No studies were located regarding absorption of 2,3-dichloropropene in humans after oral exposure.

2,3-Dichloropropene was well absorbed following oral gavage administration in rats (Medinsky et al. 1984). In rats given 32 mg/kg of <sup>14</sup>C-labeled 2,3-dichloropropene by oral gavage, approximately 91% of the oral dose was absorbed, as estimated from recovery of radioactivity from urine.

### 3.4.1.3 Dermal Exposure

**1,3-Dichloropropene.** In an experiment in which volunteers exposed forearm skin to cis-1,3-dichloropropene vapor at a concentration of 86 mg/m<sup>3</sup> (19 ppm) for 45 minutes, penetration of the compound was detected by the presence of the metabolite cis-1,3-dichloropropene-mercapturic acid in urine over a 20-hour period (Kezic et al. 1996). The authors estimated that dermal absorption would account for 2–5% of absorption from inhalation in a whole-body exposure scenario. No studies were located regarding the absorption of 1,3-dichloropropene after dermal exposure in humans or animals. The dermal LD<sub>50</sub> for 1,3-dichloropropene in rabbits has been determined and indicates that this compound is absorbed by the dermal route of exposure (Lichy and Olson 1975).

## 3.4.2 Distribution

### 3.4.2.1 Inhalation Exposure

**1,3-Dichloropropene.** In six volunteers who inhaled 1 ppm of 1,3-dichloropropene (50.6% cis; 45% trans; 2% epoxidized soybean oil) for 6 hours, blood concentrations ranged from 0.3 to 2 ppb for the cis isomer and from 1 to 3.6 ppb for the trans isomer (Waechter et al. 1992).

## 3. HEALTH EFFECTS

**2,3-Dichloropropene.** In male Fischer rats immediately following a 6-hour inhalation exposure to radiolabeled 2,3-dichloropropene vapor at a concentration of 250 nmol/L, peak concentrations of label in blood (8 nmol/mL) occurred at the end of exposure (Bond et al. 1985). Immediately after exposure, about 9% of the absorbed radioactivity was detected in tissues: 150 nmol/g in urinary bladder, 125 nmol/g in nasal turbinates, 84 nmol/g in kidneys, 61 nmol/g in small intestine, 35 nmol/g in liver, 15.6 nmol/g in trachea, 11.9 nmol/g in larynx, and smaller concentrations in other tissues. Immediately after exposure, the carcass (muscle, bone, pelt, and fat) accounted for 15% of absorbed label. Tissue concentrations of label were reduced by 80% after 60 hours.

Following inhalation exposure of male Fischer 344 rats to radiolabeled 2,3-dichloropropene at concentrations between 0.4 and 40 ppm, the percentages of initial burden detected in tissues (per gram of tissue) 60 hours after exposure were highest for nasal turbinates (0.43%), kidney (0.35%), pelt (0.21%), and lung (0.09%) (Dutcher et al. 1985). Radioactivity associated with hair accounted for 75% of that found in the pelt.

#### 3.4.2.2 Oral Exposure

**1,3-Dichloropropene.** No studies were located regarding distribution of 1,3-dichloropropene in humans after oral exposure.

Analysis of the distribution of radioactivity 48 hours after gavage administration of <sup>14</sup>C-cis/trans-1,3-dichloropropene to rats revealed essentially equal distribution of 1,3-dichloropropene or its metabolites to most organs and tissues (Waechter and Kastl 1988). The highest concentrations of radioactivity were found in the nonglandular stomach and the urinary bladder. Lower concentrations of radioactivity were also found in blood, bone, brain, fat, heart, kidney, liver, lung, skeletal muscle, skin, spleen, ovaries, and testes.

**2,3-Dichloropropene.** Seventy-two hours after male Fischer 344 rats received an oral dose of 32 mg/kg radiolabeled 2,3-dichloropropene, 20% of retained label was found in the liver, and lesser, but substantial amounts (not quantified in the report) were found in the kidney, testes, lung, and brain (Medinsky et al. 1984). Tissues that had, on a per gram basis, label concentrations higher than the carcass (8 nmol/g), included the liver, kidney, testes, lung, brain, adrenals, spleen, and nasal turbinates.

## 3. HEALTH EFFECTS

**3.4.2.3 Dermal Exposure**

No studies were located regarding the distribution of any isomer of dichloropropene after inhalation exposure in humans or animals.

**3.4.3 Metabolism**

**1,3-Dichloropropene.** The proposed metabolic pathways for 1,3-dichloropropene in rats are presented in Figure 3-5. The major metabolic pathway is rapid conjugation with glutathione, resulting in the formation of a mercapturic acid metabolite that is excreted in the urine. 1,3-Dichloropropene may also undergo hydrolysis and dechlorination to form 1-chloroallyl alcohol, an intermediate that reacts with alcohol dehydrogenase to form 1-chloroacrolein. Another minor pathway involves reaction with cytochrome P450 to form mutagenic cis and trans epoxides that convert to the mutagen 3-chloro-2-hydroxy-propanal (Schneider et al. 1998a).

The N-acetyl-cysteine conjugate of cis-1,3-dichloropropene was detected in the urine of four men exposed occupationally to Telone II<sup>®</sup>a, indicating that glutathione conjugation is a metabolic pathway in humans (Osterloh et al. 1984). Exposure levels were monitored by personal dosimeters. A strong correlation was found between exposure levels of 1,3-dichloropropene and urinary excretion of the N-acetyl-cysteine conjugate ( $r=0.83$ ). These data are presented in Figure 3-6.

1,3-Dichloropropene was rapidly metabolized to the glutathione conjugate in rats after inhalation exposure (Fisher and Kilgore 1989). The blood level of the glutathione conjugate reached a steady state of 116 nmol/mL within 15 minutes after exposure of rats to 610 ppm Telone II<sup>®</sup>a or 1 hour after exposure to 78, 155, or 404 ppm. These results may reflect saturation of metabolism (or depletion of co-factor). The increase in blood levels of the glutathione conjugate correlated with the decrease in nonprotein sulfhydryl (glutathione) content of nasal tissues (Fisher and Kilgore 1988a). Glutathione levels in the kidney and liver were also decreased after inhalation exposure of rats to 90 ppm Telone II<sup>®</sup>a (the only concentration tested), but lung levels were not affected (Stott and Kastl 1986). The data indicate that conjugation with glutathione can occur in the nasal tissue, kidney, and liver. The glutathione conjugate of 1,3-dichloropropene is then converted to the mercapturic acid and acetylated for excretion as the N-acetyl-cysteine metabolite (Fisher and Kilgore 1988b).

## 3. HEALTH EFFECTS

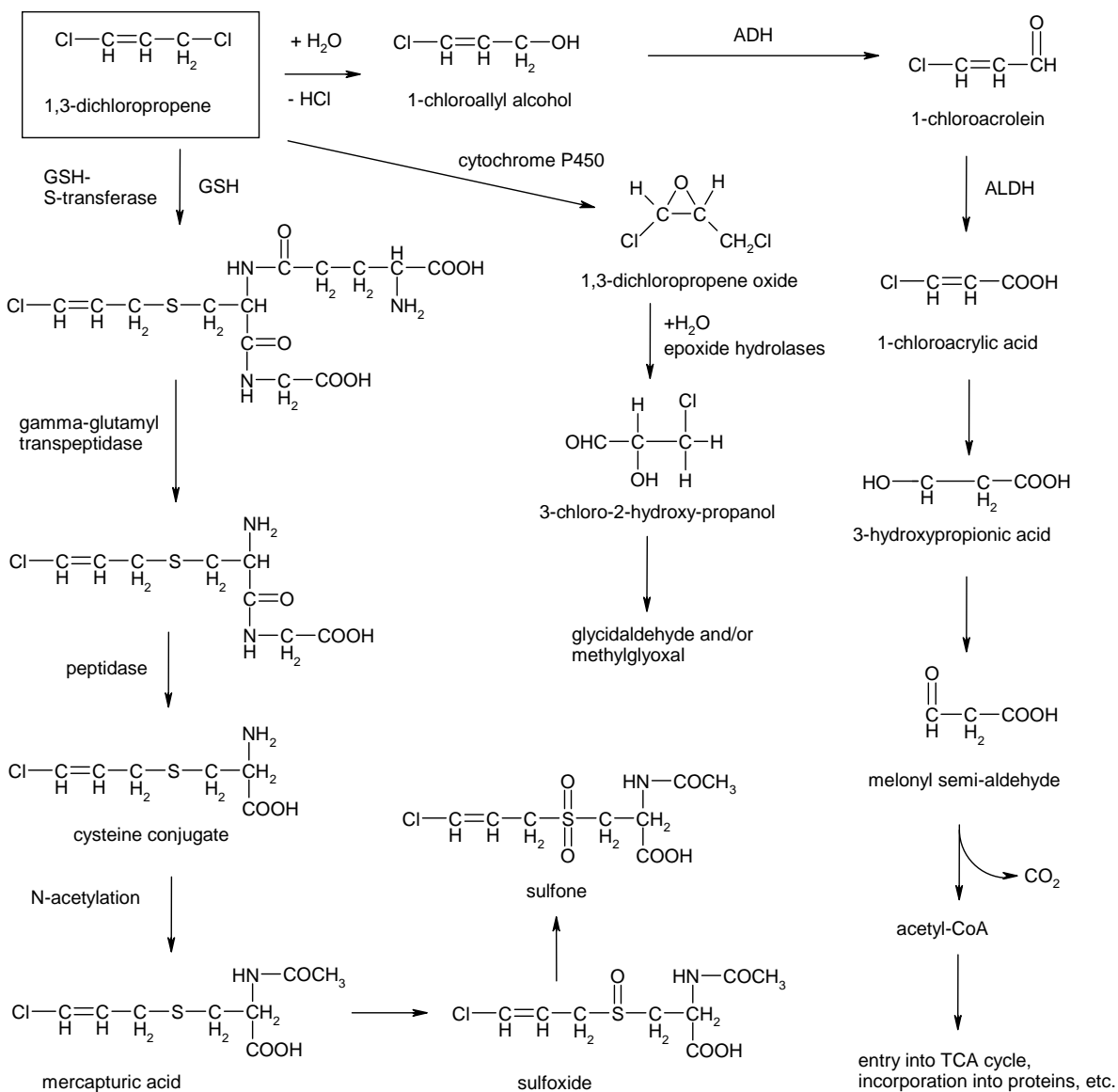
**Figure 3-5. Proposed Metabolic Pathway for 1,3-Dichloropropene in the Rat**

Source: adapted from Schneider et al. 1998

## 3. HEALTH EFFECTS

**Figure 3-6. Correlation of Exposure to 1,3-Dichloropropene with Urinary Excretion of the N-Acetyl Cysteine Metabolite**

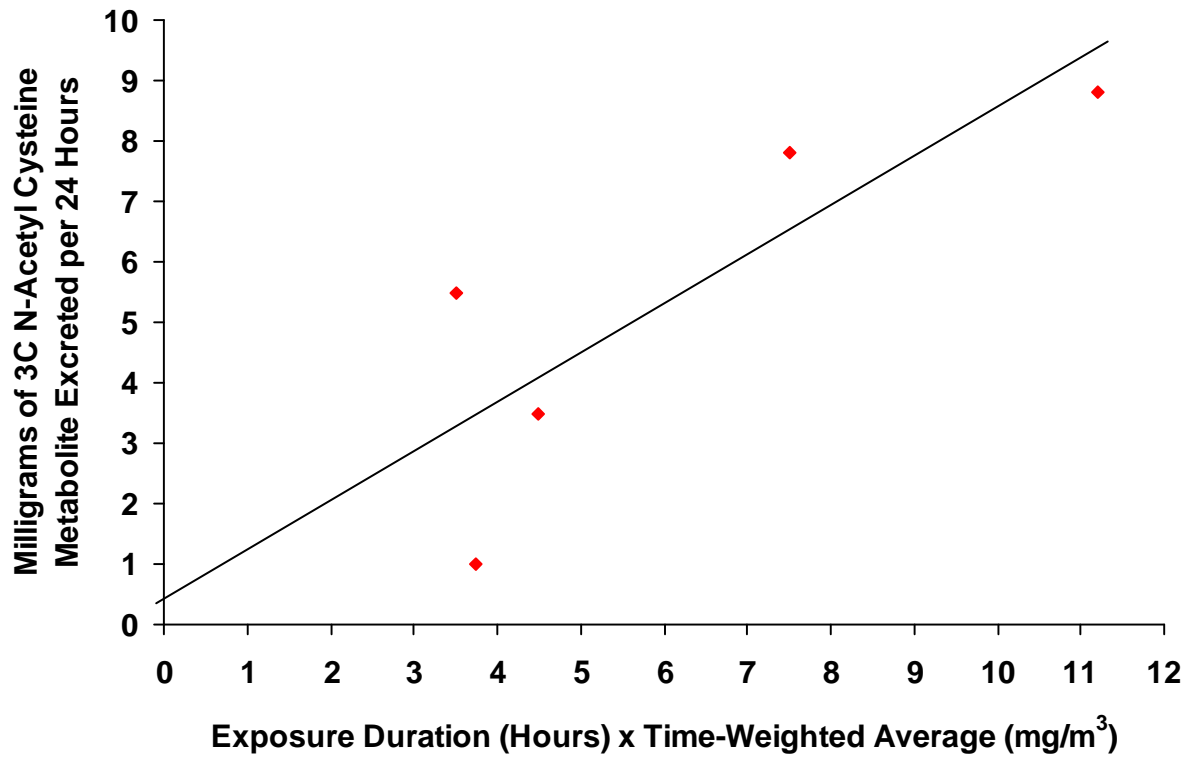

Source: derived from Osterloh et al. 1984

## 3. HEALTH EFFECTS

The two isomers of 1,3-dichloropropene appear to be metabolized at different rates. Plateau blood levels of the cis and trans isomers were  $0.085 \pm 0.024$  and  $0.12 \pm 0.03$   $\mu\text{g/mL}$ , respectively, in rats exposed to 30 ppm Telone II<sup>®</sup>a for 1 hour, and  $0.20 \pm 0.04$  and  $0.26 \pm 0.03$   $\mu\text{g/mL}$ , respectively, in rats exposed to 90 ppm Telone II<sup>®</sup>a for 1 hour. Plateau blood levels reached after 2–3 hours in rats exposed to 300 ppm were  $0.89 \pm 0.2$  and  $1.87 \pm 0.27$   $\mu\text{g/mL}$  for the cis and trans isomers, respectively (Stott and Kastl 1986). *In vitro* studies using a rat liver enzyme preparation revealed that the cis isomer was metabolized four to five times faster than the trans isomer (Climie et al. 1979).

Orally administered 1,3-dichloropropene is also metabolized by conjugation with glutathione (Climie et al. 1979). Urine collected for 24 hours after oral administration of <sup>14</sup>C-labeled cis-1,3-dichloropropene in rats yielded 82–84% of the radioactivity as the N-acetyl-cysteine conjugate of 1,3-dichloropropene. Two other urinary metabolites that accounted for 3 and 5% of the administered radioactivity were found but not identified (Climie et al. 1979). Tissue nonprotein sulfhydryl content was assayed in mice following a single gavage administration of 50 mg/kg cis- and trans-1,3-dichloropropene (Dietz et al. 1982). Decreased tissue nonprotein sulfhydryl levels were observed in the forestomach, glandular stomach, liver, and kidney, which indicated that glutathione conjugation occurred at these sites.

No differences were observed in the distribution or the rate and extent of metabolism or excretion of 1,3-dichloropropene after gavage administration between rats that received a single dose and rats that received repeated doses. Furthermore, no differences in distribution, metabolism, or excretion of 1,3-dichloropropene were observed between male and female rats (Waechter and Kastl 1988).

The mercapturic acid metabolite of cis-1,3-dichloropropene was detected in the urine of volunteers who exposed their forearm skin to a vapor concentration of  $86 \text{ mg/m}^3$  (19 ppm) for 45 minutes (Kezic et al. 1996).

Alternative metabolic pathways for cis and trans 1,3-dichloropropenes (individually and as an equimolar mixture) were studied in the liver of mice exposed by intraperitoneal injection (Schneider et al. 1998a). Within 150 minutes of injection, reaction with cytochrome P-450 resulted in the formation of cis- and trans-1,3-dichloropropene epoxides, with the cis-epoxide preferentially formed at a ratio of 4:1; the higher level of the cis epoxide was detectable within 10 minutes of exposure. The epoxides were stereospecific to the parent compound. The 1,3-dichloropropene epoxides undergo hydrolysis, possibly catalyzed by epoxide hydrolase, to 3-chloro-2-hydroxypropanal. *In vitro* experiments confirmed the generation of isomer-specific epoxides when cis and trans 1,3-dichloropropene were incubated in the presence of mouse



## 3. HEALTH EFFECTS

liver microsomes plus NADPH (Schneider et al. 1998a). No recovery of acroleins (2-acrolein or cis- and trans-3-acrolein) were detectable in these *in vitro* experiments, suggesting that oxidation by cytochrome P-450 is a minor pathway.

In an oral gavage study in F344 rats and B6C3F1 mice, Bartels et al. (2000) evaluated the epoxidation pathway proposed for 1,3-dichloropropene by Schneider et al. (1998a) on the basis of intraperitoneal injection. Following gavage administration of 100 mg/kg by oral gavage, no dichloropropene oxides were detectable in liver or blood of rats or mice during the 90 minutes postdosing (detection limit was 10 ng/g tissue). In mice injected with 100 mg/kg, no dichloropropene oxides were detectable in liver and only a small amount (17 ng/g) was detected in blood. Significant detection of dichloropropene oxides occurred after injection of 700 mg/kg into mice, a dose that caused significant hepatotoxicity and/or death. Bartels et al. (2000) concluded that the epoxidation pathway was of minor significance for exposures not leading to hepatotoxicity or death.

The metabolism of 1,3-dichloropropene was evaluated in an *in vitro* system in which the compound was added as a vapor in the headspace above a mixture containing rat liver microsomes or cytosol from rat or mouse (Granville et al. 2005). Glutathione reacted nonenzymatically with 1,3-dichloropropene at a rate about half that catalyzed by glutathione transferase. Monochloropropenes were the products of these reactions. The rate of glutathione transferase-dependent conjugation to glutathione was 10.3 nmol glutathione/minute/mg protein.

In an analysis of metabolism of cis and trans isomers of 1,3-dichloropropene, Vos et al. (1991) identified individuals that did not express the mu class of glutathione S-transferase enzymes, but did express alpha- and pi-class GST. Although the mu class enzyme was demonstrated to have 2- to 3-fold higher activity with the cis than the trans isomer of 1,3-dichloropropene, and higher activity with cis-1,3-dichloropropene compared to alpha- and pi-class GST, individuals not expressing the mu enzyme showed no significant differences with respect to urinary excretion ratios of cis- and trans-mercapturic acid metabolites. These results suggest that glutathione S-transferases, besides mu-class enzymes, may play a more significant role in the metabolism of 1,3-dichloropropene.

**2,3-Dichloropropene.** Proposed metabolic pathways for 2,3-dichloropropene are shown in Figure 3-7. The major pathway is a detoxifying conjugation to glutathione, leading to the elimination of mercapturic acid metabolites in the urine (Bond et al. 1985; Eder and Dornbusch 1988; Eder et al. 1987). Two secondary pathways result in the formation of mutagenic metabolites. One involves cytochrome P450-

## 3. HEALTH EFFECTS

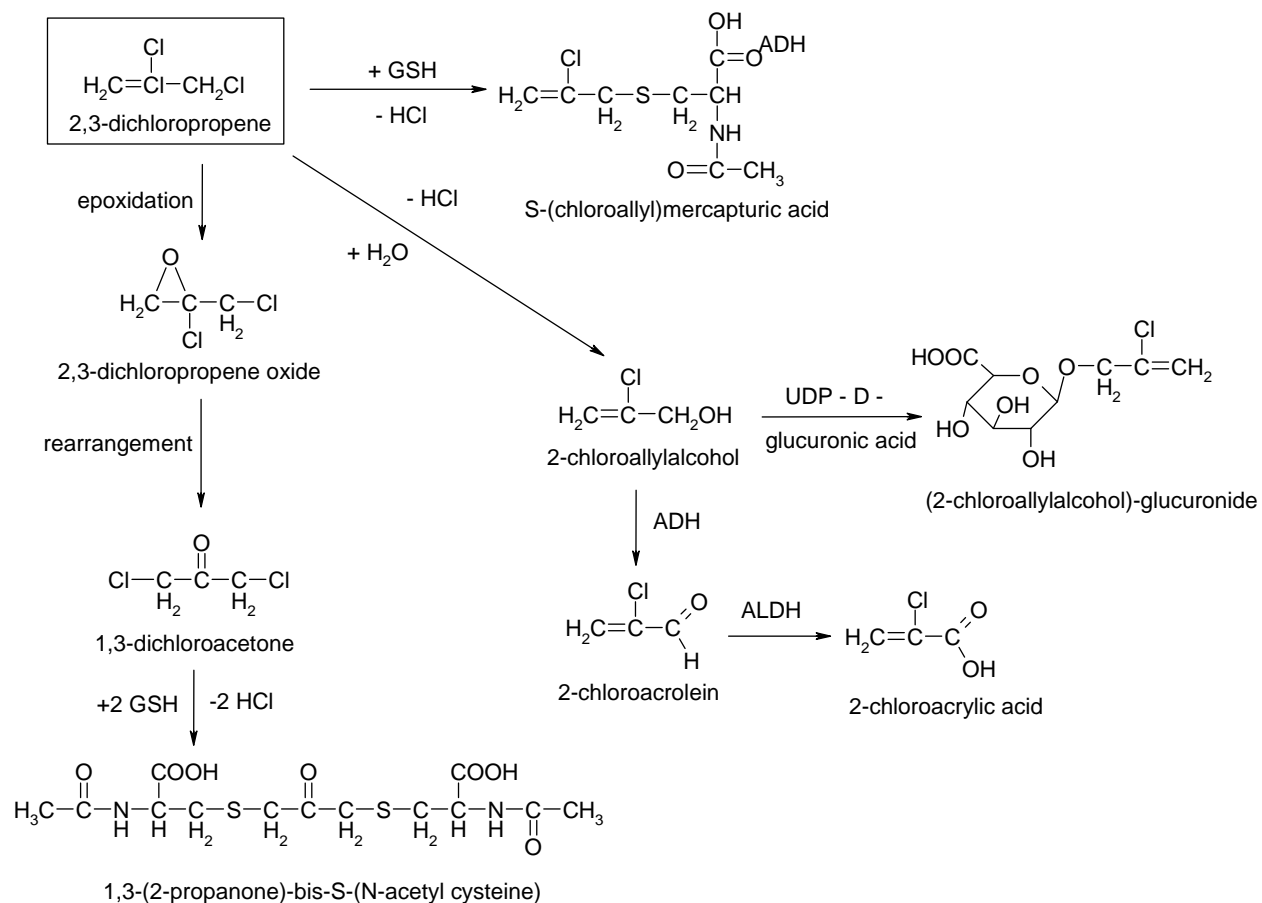
**Figure 3-7. Proposed Metabolic Pathway for 2,3-Dichloropropene in the Rat**

Source: adapted from Eder et al. (1987)

### 3. HEALTH EFFECTS

induced formation of an epoxide that undergoes spontaneous rearrangement to form the mutagen 1,3-dichloroacetone. The other involves hydrolysis and dechlorination to form an intermediate (2-chloroallyl alcohol) that can either be detoxified by conjugation to glucuronic acid or bioactivated by alcohol dehydrogenase to form the mutagen 2-chloroacrolein (Eder and Dornbusch 1988; Eder et al. 1986, 1987). It is evident that depletion of glutathione stores, more likely to occur under bolus exposure conditions, would result in the formation of proportionally more mutagenic metabolites.

***1,1-Dichloropropene.*** The metabolism of 1,1-dichloropropene was evaluated in an *in vitro* system in which the compound was added as a vapor in the headspace above a mixture containing rat liver microsomes or cytosol from rat or mouse (Granville et al. 2005). Results of this study indicated that glutathione transferase catalyzes the bioactivation of 1,1-dichloropropene by glutathione to a single unsaturated S-conjugate retaining one chlorine atom. The rate of conjugation was 0.33 nmol glutathione/minute/mg protein, which was lower than the rate for 1,3-dichloropropene (see above). It was postulated that the thiolate ion of glutathione could attack 1,1-dichloropropene at either the C1 or C2 position, with attack at the C2 position resulting in the formation of a mutagenic episulfonium ion. This hypothesis was supported by separate experiments showing mutagenicity of 1,1-dichloropropene in *S. typhimurium* strain RSJ100, which expresses rat glutathione transferase (GSTT1-1), but not in the nonexpressing strain TA100.

#### 3.4.4 Elimination and Excretion

##### 3.4.4.1 Inhalation Exposure

***1,3-Dichloropropene.*** In male volunteers exposed by inhalation to 1 ppm 1,3-dichloropropene (50.6% cis; 45% trans; 2% epoxidized soybean oil) for 6 hours, concentrations of cis and trans isomers (parent compound) in exhaled air reached a plateau within the first hour of exposure and fell rapidly to undetectable levels within 1 hour after the end of exposure (Waechter et al. 1992). In the same study, urinary excretion of N-acetyl-cysteine conjugates of cis- and trans-1,3-dichloropropene exhibited a biphasic pattern. The half-lives for urinary elimination of the cis and trans conjugates averaged  $4.2 \pm 0.8$  and  $3.2 \pm 0.8$  hours, respectively, for the initial phase, and  $12.3 \pm 2.4$  and  $17.1 \pm 6.0$  hours, respectively, for the terminal phase. Urinary excretion was 89–99% complete by 24 hours from the start of exposure. Approximately 75% of the absorbed dose of cis-1,3-dichloropropene was excreted in urine as 1,3-dichloropropene-N-acetyl-cysteine, whereas only 25% of absorbed trans-1,3-dichloropropene was excreted in urine as the N-acetyl-cysteine conjugate.

## 3. HEALTH EFFECTS

A strong correlation was reported for humans between occupational exposure to Telone II<sup>®</sup>a and urinary levels of the N-acetyl-cysteine conjugate of cis-1,3-dichloropropene ( $r=0.83$ ) (Osterloh et al. 1984). In 12 soil fumigators exposed to 8-hour time weighted average (TWA) concentrations from 1.9 to 18.9 mg/m<sup>3</sup> cis/trans-dichloropropene, the half-life of elimination of N-acetyl-cysteine conjugates was 11.4 hours for the cis isomer and 10.8 hours for the trans isomer (Verberk et al. 1990).

Rats exposed by inhalation for 1 hour to 0, 40, 107, 284, 398, or 789 ppm Telone II<sup>®</sup>a excreted 0, 0.11, 0.49, 2.7, 3.7, or 4.0  $\mu\text{mol}$  N-acetyl-cysteine conjugate/mL of urine in the 24 hours following exposure (Fisher and Kilgore 1988b). Uptake levels, however, were not measured, which precludes correlation with excretion.

In male Fischer rats exposed by inhalation to 30, 90, 300, or 900 ppm technical-grade 1,3-dichloropropene for 3 hours, rapid absorption was followed by a biphasic pattern of elimination from the bloodstream (Stott and Kastl 1986). At concentrations up to 300 ppm, a rapid elimination phase (half-time of 3–6 minutes) was followed by a slower phase with a half-life of 33–43 minutes. Following exposure to 900 ppm, the rapid elimination phase was 14–27 minutes.

**2,3-Dichloropropene.** In male Fischer 344 rats exposed (nose only) for 6 hours to radiolabeled 2,3-dichloropropene vapor at a concentration of 250 nmol/L, 54.6% of the amount absorbed was excreted as metabolites in urine, 16.8% was eliminated in feces, 3.2% was expired as carbon dioxide, and 1.2% was expired as the parent compound (Bond et al. 1985). The remainder was detected in the carcass. Approximately 75% of the urinary and fecal elimination occurred within the first 24 hours after exposure. The half-times for elimination were 9.8 hours for urine and 12.9 hours for feces. Elimination as carbon dioxide had a biphasic pattern: 87% exhaled within 3.4 hours and 13% exhaled within 19.7 hours. Levels of label in blood had a biphasic pattern of elimination, with estimated half-lives of 2.4 and 113.6 hours, for the two phases, respectively.

The rates and relative amounts of elimination of absorbed radiolabeled 2,3-dichloropropene in urine or feces was not affected by inhaled concentrations between 0.4 and 44 ppm (Dutcher et al. 1985). Half-lives of excretion were between 9.1 and 11.3 hours for urinary excretion 10.4–16.5 hours for excretion in feces. The half-time associated with the rapid phase of elimination as carbon dioxide (representing 81–94% of that exhaled) was 2.2–4.3 hours, whereas the half-time associated with the slow phase of elimination (6–19% of that exhaled) was 15.3–30.8 hours.

## 3. HEALTH EFFECTS

**3.4.4.2 Oral Exposure**

**1,3-Dichloropropene.** No studies were located regarding excretion of 1,3-dichloropropene after oral exposure in humans.

Significant recoveries of  $^{14}\text{C}$ -labeled 1,3-dichloropropene were reported in two studies with rats after oral exposure (Climie et al. 1979; Hutson et al. 1971). In both studies, 82–84% of the administered cis isomer was recovered as the mercapturic acid conjugate of 1,3-dichloropropene in a 24-hour collection of urine. Two other minor metabolites that accounted for 3 and 5% of the radioactivity were observed, but these metabolites were not identified (Climie et al. 1979). Comparison of the excretory pathways for the cis and trans isomers of 1,3-dichloropropene revealed that 82–84% of the cis isomer was recovered as the mercapturic acid conjugate in the 24-hour urine collection; only 55–60% of the trans isomer was recovered as the mercapturic acid conjugate in the urine (Hutson et al. 1971). A significant portion of the trans isomer was recovered as  $^{14}\text{CO}_2$  (22–25%). A smaller percentage of each isomer was recovered in the feces: 2–3% of the cis and 2% of the trans isomer. Less than 2% of either compound remained in the carcass after 4 days (Hutson et al. 1971). These data indicate that neither isomer of 1,3-dichloropropene has a tendency to concentrate in the body.

Whether administered neat or encapsulated in sucrose/starch microspheres, 1,3-dichloropropene reached peak blood levels in rats within 10 minutes (Stott et al. 1998). Clearance from the blood occurred in a biphasic manner, with a relatively rapid alpha phase with a half-life of 5–7 minutes and a slower beta phase with a half-life of 20–43 minutes. Urinary excretion of mercapturic-acid conjugates of 1,3-dichloropropene (DMA) was evaluated in rats simultaneously dosed with equal doses of neat  $^{13}\text{C}$ -labeled-1,3-dichloropropene and 1,3-dichloropropene microencapsulated in a starch/sucrose matrix (Stott et al. 1998). Of the total amount of DMA excreted in urine, 56% was derived from neat 1,3-dichloropropene (58% cis-DMA and 52% trans-DMA) and 44% was derived from encapsulated compound (42% cis-DMA and 49% trans-DMA).

**2,3-Dichloropropene.** Seventy-two hours after male Fischer 344 rats were given an oral dose of 32 mg/kg radiolabeled 2,3-dichloropropene, 66% of the dose was recovered as urinary metabolites, 21% was eliminated in feces, 8% was exhaled as carbon dioxide, 2% was exhaled as parent compound, and 2% remained in carcass and tissues (Medinsky et al. 1984). The half-time for urinary excretion was 7.5 hours.

## 3. HEALTH EFFECTS

**3.4.4.3 Dermal Exposure**

*1,3-Dichloropropene.* In volunteers whose forearms were exposed to 86 mg/m<sup>3</sup> (19 ppm) vapor of 1,3-dichloropropene for 45 minutes, the half-life for urinary excretion of the mercapturic acid metabolite was approximately 6 hours (Kezic et al. 1996).

No studies were located regarding excretion of 1,3-dichloropropene after dermal exposure in animals.

**3.4.5 Physiologically Based Pharmacokinetic (PBPK)/Pharmacodynamic (PD) Models**

Physiologically based pharmacokinetic (PBPK) models use mathematical descriptions of the uptake and disposition of chemical substances to quantitatively describe the relationships among critical biological processes (Krishnan et al. 1994). PBPK models are also called biologically based tissue dosimetry models. PBPK models are increasingly used in risk assessments, primarily to predict the concentration of potentially toxic moieties of a chemical that will be delivered to any given target tissue following various combinations of route, dose level, and test species (Clewell and Andersen 1985). Physiologically based pharmacodynamic (PBPD) models use mathematical descriptions of the dose-response function to quantitatively describe the relationship between target tissue dose and toxic end points.

PBPK/PD models refine our understanding of complex quantitative dose behaviors by helping to delineate and characterize the relationships between: (1) the external/exposure concentration and target tissue dose of the toxic moiety, and (2) the target tissue dose and observed responses (Andersen and Krishnan 1994; Andersen et al. 1987). These models are biologically and mechanistically based and can be used to extrapolate the pharmacokinetic behavior of chemical substances from high to low dose, from route to route, between species, and between subpopulations within a species. The biological basis of PBPK models results in more meaningful extrapolations than those generated with the more conventional use of uncertainty factors.

The PBPK model for a chemical substance is developed in four interconnected steps: (1) model representation, (2) model parameterization, (3) model simulation, and (4) model validation (Krishnan and Andersen 1994). In the early 1990s, validated PBPK models were developed for a number of toxicologically important chemical substances, both volatile and nonvolatile (Krishnan and Andersen

## 3. HEALTH EFFECTS

1994; Leung 1993). PBPK models for a particular substance require estimates of the chemical substance-specific physicochemical parameters, and species-specific physiological and biological parameters. The numerical estimates of these model parameters are incorporated within a set of differential and algebraic equations that describe the pharmacokinetic processes. Solving these differential and algebraic equations provides the predictions of tissue dose. Computers then provide process simulations based on these solutions.

The structure and mathematical expressions used in PBPK models significantly simplify the true complexities of biological systems. If the uptake and disposition of the chemical substance(s) are adequately described, however, this simplification is desirable because data are often unavailable for many biological processes. A simplified scheme reduces the magnitude of cumulative uncertainty. The adequacy of the model is, therefore, of great importance, and model validation is essential to the use of PBPK models in risk assessment.

PBPK models improve the pharmacokinetic extrapolations used in risk assessments that identify the maximal (i.e., the safe) levels for human exposure to chemical substances (Andersen and Krishnan 1994). PBPK models provide a scientifically sound means to predict the target tissue dose of chemicals in humans who are exposed to environmental levels (for example, levels that might occur at hazardous waste sites) based on the results of studies where doses were higher or were administered in different species. Figure 3-8 shows a conceptualized representation of a PBPK model.

If PBPK models for dichloropropenes exist, the overall results and individual models are discussed in this section in terms of their use in risk assessment, tissue dosimetry, and dose, route, and species extrapolations.

In an unpublished study, Waechter et al. (1992) developed a PBPK model based on data collected for six male volunteers exposed by inhalation to 1 ppm 1,3-dichloropropene (50.6% cis; 45% trans; 2% epoxidized soybean oil) for 6 hours (Figure 3-9). The model included a poorly perfused compartment (fat), a well-perfused compartment, and terms for the excretion of dichloropropene in blood and exhaled air. Data were collected for concentrations of 1,3-dichloropropene isomers in exhaled air and in blood, as well as for the concentrations of N-acetyl-cysteine conjugates of each isomer present in urine (results discussed above in Sections 3.4.1.1, 3.4.2.1, and 3.4.4.1). The model was designed to predict average urinary excretion rates for the two isomeric conjugates in urine following 6-hour exposures to 0.1, 0.01, or 0.001 ppm cis-/trans-1,3-dichloropropene. Based on the limit of detection (10 ng/mL) and an average

## 3. HEALTH EFFECTS

**Figure 3-8. Conceptual Representation of a Physiologically Based Pharmacokinetic (PBPK) Model for a Hypothetical Chemical Substance**

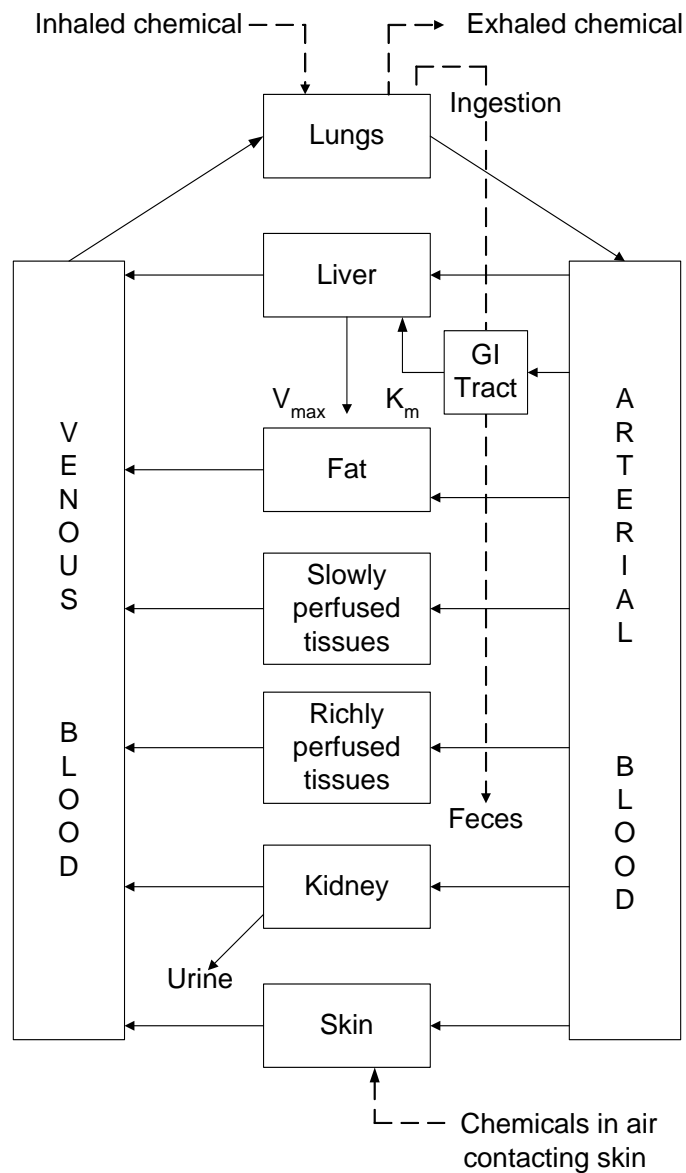

Source: adapted from Krishnan et al. 1994

Note: This is a conceptual representation of a physiologically based pharmacokinetic (PBPK) model for a hypothetical chemical substance. The chemical substance is shown to be absorbed via the skin, by inhalation, or by ingestion, metabolized in the liver, and excreted in the urine or by exhalation.



## 3. HEALTH EFFECTS

**Figure 3-9. Kinetic Model for Uptake and Elimination of 1,3-Dichloropropene Humans Exposed by Inhalation**

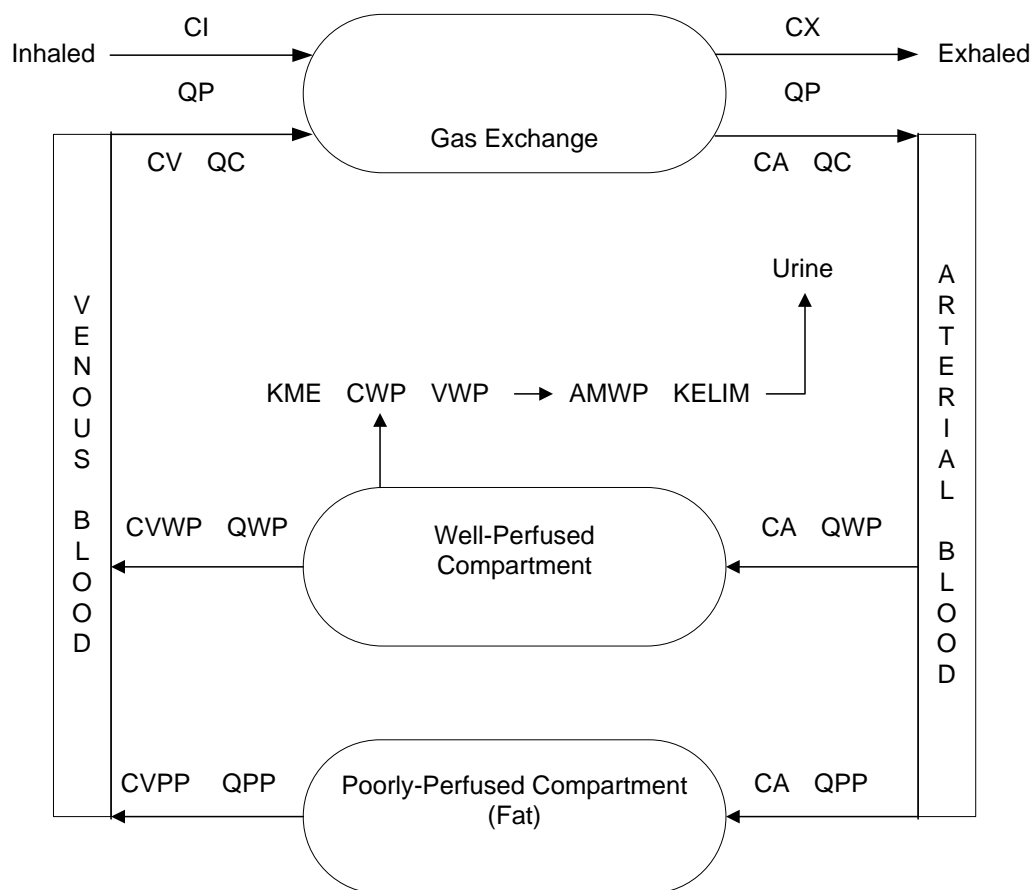

**Model terms**

CI	Concentration inhaled
CX	Concentration exhaled
QP	Ventilation rate
QC	Cardiac output
CV	Venous blood concentration
CA	Arterial blood concentration
QWP	Blood flow to well perfused compartment
QPP	Blood flow to fat
CVPP	Concentration in venous blood leaving poorly perfused compartment
CVWP	Concentration in venous blood leaving well perfused compartment
KME	First-order rate constant for metabolism
CWP	Concentration in well perfused compartment
VWP	Volume of well perfused compartment
AMWP	Amount of metabolite in well perfused compartment
KELIM	First-order rate constant for elimination of metabolite

Source: Adapted from Waechter et al. 1992

## 3. HEALTH EFFECTS

urine output of 58.3 mL/hour, the model predicted that urinary excretion after exposure to 0.1 ppm could be followed for 35 hours (from the start of exposure) for the cis isomer and 24 hours for the trans isomer and after exposure to 0.01 ppm, 20 and 10 hours, respectively. Exposure to 0.001 ppm was predicted to result in values below the limit of detection. These results are considered tentative, since the model has not yet been validated.

### 3.5 MECHANISMS OF ACTION

#### 3.5.1 Pharmacokinetic Mechanisms

**Absorption.** Studies in humans and/or animals indicate that the absorption of 1,3- and 2,3-dichloropropene is rapid (Bond et al. 1985; Dutcher et al. 1985; Stott and Kastl 1986; Stott et al. 1998; Waechter et al. 1992). Given the relatively small size of the molecules and their lipid-soluble properties, absorption by any route is most likely by simple passive diffusion across cellular lipid membranes.

**Distribution.** The small molecular size and lipid solubility properties of dichloropropenes undoubtedly contribute to the rapid distribution following absorption by any route. The highest concentrations of inhaled 1,3- or 2,3-dichloropropene are found in portal-of-entry tissues (nasal turbinates, larynx, trachea, lung) as well as the blood and tissues involved in metabolism and elimination (liver, kidney, urinary bladder) (Bond et al. 1985; Dutcher et al. 1985). Similarly, oral exposure results in high concentrations in the stomach and urinary bladder compared to other tissues (Stott et al. 1998; Waechter and Kastl 1988).

**Metabolism.** It is likely that steric differences in the position of chlorine atoms with respect to the double bond account for the different metabolic pathways among the different isomers of dichloropropene. Three different metabolic pathways have been identified for 1,3-dichloropropene in the liver (Figure 3-5). The primary pathway is the glutathione transferase-dependent conjugation of the chloromethyl moiety with glutathione to form mercapturic acid metabolites (Osterloh and Feldman 1993; Osterloh et al. 1984; Stott et al. 1998). The cis isomer of 1,3-dichloropropene has a faster rate of conjugation than the trans isomer (Stott et al. 1998). A secondary pathway is cytochrome P450-dependent epoxidation, which apparently becomes significant at high exposure levels (Schneider et al. 1998a). The rate of glutathione depletion appears to affect the degree to which the secondary pathway is used in specific tissues. An *in vitro* study indicated that glutathione transferase-dependent conjugation to glutathione results in the bioactivation of 1,1-dichloropropene to an episulfonium ion (Granville et al. 2005). Specific metabolites of inhaled 2,3-dichloropropene were not identified by Dutcher et al. (1985),

## 3. HEALTH EFFECTS

but these authors suggested, based on a pattern of elimination similar to that observed for 1,3-dichloropropene, that conjugation to glutathione was the primary metabolic pathway.

**Excretion.** Human and/or animal data indicate that 1,3-dichloropropene and 2,3-dichloropropene are rapidly eliminated from the body, primarily as urinary metabolites, with lesser amounts eliminated in feces and exhaled air (Dutcher et al. 1985; Medinsky et al. 1984; Waechter et al. 1992). Both carbon dioxide and parent compound have been detected in exhaled air (Bond et al. 1985). Half-lives of excretion have been estimated as <14 hours (Dutcher et al. 1985; Medinsky et al. 1984). The physicochemical properties of dichloropropenes and their metabolites likely facilitate their rapid removal from the body.

### 3.5.2 Mechanisms of Toxicity

The primary toxic effects of dichloropropenes are portal-of-entry effects resulting from the chemical reactivity of the compounds and their physicochemical properties. Repeated irritation results in a hyperplastic response in the target tissues (respiratory tract for inhalation exposure, forestomach of rats exposed orally). Studies that analyzed tissue retention of absorbed dichloropropenes confirmed the relatively high concentrations in target tissues such as the nasal turbinates, but high concentrations detected in urinary bladder, kidney, and liver may reflect the presence of parent compound or reactive metabolites in those tissues (Bond et al. 1985; Dutcher et al. 1985; Medinsky et al. 1984)

Metabolic processes may contribute to toxicity. The mutagenicity of cis or trans 1,3-dichloropropenes was attributed to their biotransformation by cytochrome P-450 to stereospecific epoxides and the hydrolysis product, 3-chloro-2-hydroxypropanal (Schneider et al. 1998a). It is likely that depletion of glutathione would block the major detoxification pathway for 1,3- and 2,3-dichloropropene, resulting in increased toxicity of organs such as the liver and kidney because of binding of reactive intermediates to macromolecules in cells. On the other hand, mutagenicity of 1,1-dichloropropene has been related to its glutathione transferase-dependent bioactivation by the thiolate ion of glutathione and the resulting episulfonium ion (Granville et al. 2005).

There is some evidence that cytotoxicity of hepatic cells exposed to 1,3-dichloropropene *in vitro* is preceded by increased levels of phospholipid hydroperoxides (phosphatidylcholine hydroperoxide and phosphatidylethanolamine hydroperoxide) (Suzuki et al. 1994a). This appears to confirm the role of

## 3. HEALTH EFFECTS

reactive intermediates inducing lipid peroxidation as a significant mechanism of toxicity for 1,3-dichloropropene.

### 3.5.3 Animal-to-Human Extrapolations

The critical toxic effects of dichloropropenes are portal-of-entry effects relating to their irritant properties. In the absence of data to indicate otherwise, the portal-of-entry effects observed in animals are assumed to be relevant to humans. EPA (1994) has developed dosimetry methods that are used to scale from inhalation exposures in animals to human equivalent concentrations. The major metabolic pathway for elimination of 1,3- and 2,3-dichloropropenes (conjugation to glutathione) is common to both humans and animals.

## 3.6 TOXICITIES MEDIATED THROUGH THE ENDOCRINE AXIS

Recently, attention has focused on the potential hazardous effects of certain chemicals on the endocrine system because of the ability of these chemicals to mimic or block endogenous hormones. Chemicals with this type of activity are most commonly referred to as *endocrine disruptors*. However, appropriate terminology to describe such effects remains controversial. The terminology *endocrine disruptors*, initially used by Thomas and Colborn (1992), was also used in 1996 when Congress mandated the EPA to develop a screening program for "...certain substances [which] may have an effect produced by a naturally occurring estrogen, or other such endocrine effect[s]...". To meet this mandate, EPA convened a panel called the Endocrine Disruptors Screening and Testing Advisory Committee (EDSTAC), and in 1998, the EDSTAC completed its deliberations and made recommendations to EPA concerning *endocrine disruptors*. In 1999, the National Academy of Sciences released a report that referred to these same types of chemicals as *hormonally active agents*. The terminology *endocrine modulators* has also been used to convey the fact that effects caused by such chemicals may not necessarily be adverse. Many scientists agree that chemicals with the ability to disrupt or modulate the endocrine system are a potential threat to the health of humans, aquatic animals, and wildlife. However, others think that endocrine-active chemicals do not pose a significant health risk, particularly in view of the fact that hormone mimics exist in the natural environment. Examples of natural hormone mimics are the isoflavonoid phytoestrogens (Adlercreutz 1995; Livingston 1978; Mayr et al. 1992). These chemicals are derived from plants and are similar in structure and action to endogenous estrogen. Although the public health significance and descriptive terminology of substances capable of affecting the endocrine system remains controversial,

### 3. HEALTH EFFECTS

scientists agree that these chemicals may affect the synthesis, secretion, transport, binding, action, or elimination of natural hormones in the body responsible for maintaining homeostasis, reproduction, development, and/or behavior (EPA 1997). Stated differently, such compounds may cause toxicities that are mediated through the neuroendocrine axis. As a result, these chemicals may play a role in altering, for example, metabolic, sexual, immune, and neurobehavioral function. Such chemicals are also thought to be involved in inducing breast, testicular, and prostate cancers, as well as endometriosis (Berger 1994; Giwercman et al. 1993; Hoel et al. 1992).

No studies were located regarding endocrine disruption in humans after exposure to 1,3-dichloropropene or 2,3-dichloropropene. None of the intermediate-duration inhalation rodent assays on these compounds reported adverse effects on male or female reproductive parameters such as estrus cycling, sperm counts or morphology, or the outcome of a one-generation reproductive assays (Johannsen et al. 1991; NTP 1985; see Section 3.2.1.5).

Nishihara et al. (2000) used a yeast two-hybrid screening assay, employing expression plasmids for the estrogen receptor and a cofactor, to assay chemicals for endocrine disruption activity. The level of reporter gene activity was expressed as the 10% relative effective concentration compared to the optimal concentration ( $10^{-7}$  M) of the agonist 17-beta-estradiol. 1,3-Dichloropropene at concentrations as high as  $1 \times 10^{-3}$  M yielded negative in this assay, suggesting that it does not disrupt estradiol signalling.

#### 3.7 CHILDREN'S SUSCEPTIBILITY

This section discusses potential health effects from exposures during the period from conception to maturity at 18 years of age in humans, when all biological systems will have fully developed. Potential effects on offspring resulting from exposures of parental germ cells are considered, as well as any indirect effects on the fetus and neonate resulting from maternal exposure during gestation and lactation. Relevant animal and *in vitro* models are also discussed.

Children are not small adults. They differ from adults in their exposures and may differ in their susceptibility to hazardous chemicals. Children's unique physiology and behavior can influence the extent of their exposure. Exposures of children are discussed in Section 6.6, Exposures of Children.

Children sometimes differ from adults in their susceptibility to hazardous chemicals, but whether there is a difference depends on the chemical (Guzelian et al. 1992; NRC 1993). Children may be more or less

## 3. HEALTH EFFECTS

susceptible than adults to health effects, and the relationship may change with developmental age (Guzelian et al. 1992; NRC 1993). Vulnerability often depends on developmental stage. There are critical periods of structural and functional development during both prenatal and postnatal life, and a particular structure or function will be most sensitive to disruption during its critical period(s). Damage may not be evident until a later stage of development. There are often differences in pharmacokinetics and metabolism between children and adults. For example, absorption may be different in neonates because of the immaturity of their gastrointestinal tract and their larger skin surface area in proportion to body weight (Morselli et al. 1980; NRC 1993); the gastrointestinal absorption of lead is greatest in infants and young children (Ziegler et al. 1978). Distribution of xenobiotics may be different; for example, infants have a larger proportion of their bodies as extracellular water, and their brains and livers are proportionately larger (Altman and Dittmer 1974; Fomon 1966; Fomon et al. 1982; Owen and Brozek 1966; Widdowson and Dickerson 1964). The infant also has an immature blood-brain barrier (Adinolfi 1985; Johanson 1980) and probably an immature blood-testis barrier (Setchell and Waites 1975). Many xenobiotic metabolizing enzymes have distinctive developmental patterns. At various stages of growth and development, levels of particular enzymes may be higher or lower than those of adults, and sometimes unique enzymes may exist at particular developmental stages (Komori et al. 1990; Leeder and Kearns 1997; NRC 1993; Vieira et al. 1996). Whether differences in xenobiotic metabolism make the child more or less susceptible also depends on whether the relevant enzymes are involved in activation of the parent compound to its toxic form or in detoxification. There may also be differences in excretion, particularly in newborns who all have a low glomerular filtration rate and have not developed efficient tubular secretion and resorption capacities (Altman and Dittmer 1974; NRC 1993; West et al. 1948). Children and adults may differ in their capacity to repair damage from chemical insults. Children also have a longer remaining lifetime in which to express damage from chemicals; this potential is particularly relevant to cancer.

Certain characteristics of the developing human may increase exposure or susceptibility, whereas others may decrease susceptibility to the same chemical. For example, although infants breathe more air per kilogram of body weight than adults breathe, this difference might be somewhat counterbalanced by their alveoli being less developed, which results in a disproportionately smaller surface area for alveolar absorption (NRC 1993).

No data are available for health effects on children from exposure to any dichloropropene isomer by any route.

### 3. HEALTH EFFECTS

No adverse effects on fetuses have been noted in developmental or two-generation reproductive studies in animals exposed by inhalation to 1,3-dichloropropene at levels not toxic to the mother (Breslin et al. 1989; Kloes et al. 1983). It has been observed that decreased food and water consumption and reduced maternal body weight, likely resulting from irritant effects of the vapor, are the primary reason for observed delayed ossification effects in rat pups (Hanley et al. 1987).

Since the major effects of exposure to dichloropropenes involve portal-of-entry effects from irritant properties of these chemicals, similar effects would be expected to occur in children. Because the skin of children is thinner and surface areas to body weight ratios are larger for children (de Zwart et al. 2004), they would likely absorb a higher dose (per kg body weight) than adults from a similar dermal exposure. Also, since alveolar ventilation rates are faster in children than adults (de Zwart et al. 2004), the uptake of dichloropropene vapor would be higher in children than adults exposed by inhalation to the same concentration of the compound.

The small size and physicochemical properties of dichloropropenes and their distribution by passive diffusion suggest that maternally absorbed dichloropropene is likely to be distributed across the placenta to the fetus. This likely would occur only in the short term after exposure. Dichloropropene was detected in only one of eight samples of human breast milk taken from nursing mothers at four locations (two in New Jersey, one in Louisiana, and one in Pennsylvania), limited evidence that dichloropropene could be transferred from mother to nursing infant (Pellizzari et al. 1982).

#### **3.8 BIOMARKERS OF EXPOSURE AND EFFECT**

Biomarkers are broadly defined as indicators signaling events in biologic systems or samples. They have been classified as markers of exposure, markers of effect, and markers of susceptibility (NAS/NRC 1989).

Due to a nascent understanding of the use and interpretation of biomarkers, implementation of biomarkers as tools of exposure in the general population is very limited. A biomarker of exposure is a xenobiotic substance or its metabolite(s) or the product of an interaction between a xenobiotic agent and some target molecule(s) or cell(s) that is measured within a compartment of an organism (NAS/NRC 1989). The preferred biomarkers of exposure are generally the substance itself, substance-specific metabolites in readily obtainable body fluid(s), or excreta. However, several factors can confound the use and interpretation of biomarkers of exposure. The body burden of a substance may be the result of exposures

## 3. HEALTH EFFECTS

from more than one source. The substance being measured may be a metabolite of another xenobiotic substance (e.g., high urinary levels of phenol can result from exposure to several different aromatic compounds). Depending on the properties of the substance (e.g., biologic half-life) and environmental conditions (e.g., duration and route of exposure), the substance and all of its metabolites may have left the body by the time samples can be taken. It may be difficult to identify individuals exposed to hazardous substances that are commonly found in body tissues and fluids (e.g., essential mineral nutrients such as copper, zinc, and selenium). Biomarkers of exposure to dichloropropenes are discussed in Section 3.8.1.

Biomarkers of effect are defined as any measurable biochemical, physiologic, or other alteration within an organism that, depending on magnitude, can be recognized as an established or potential health impairment or disease (NAS/NRC 1989). This definition encompasses biochemical or cellular signals of tissue dysfunction (e.g., increased liver enzyme activity or pathologic changes in female genital epithelial cells), as well as physiologic signs of dysfunction such as increased blood pressure or decreased lung capacity. Note that these markers are not often substance specific. They also may not be directly adverse, but can indicate potential health impairment (e.g., DNA adducts). Biomarkers of effects caused by dichloropropenes are discussed in Section 3.8.2.

A biomarker of susceptibility is an indicator of an inherent or acquired limitation of an organism's ability to respond to the challenge of exposure to a specific xenobiotic substance. It can be an intrinsic genetic or other characteristic or a preexisting disease that results in an increase in absorbed dose, a decrease in the biologically effective dose, or a target tissue response. If biomarkers of susceptibility exist, they are discussed in Section 3.10, Populations That Are Unusually Susceptible.

### 3.8.1 Biomarkers Used to Identify or Quantify Exposure to Dichloropropene

**1,3-Dichloropropene.** Inhalation exposure to various concentrations of 1,3-dichloropropene correlated well with the urinary level of the N-acetyl cysteine (mercapturic acid) metabolite in humans. Urinary excretion of the N-acetyl cysteine metabolite was measured in four men occupationally exposed to technical-grade 1,3-dichloropropene (Telone II<sup>®</sup>a). Exposure levels were monitored by personal dosimeters. A strong correlation was found between exposure levels of 1,3-dichloropropene and urinary excretion of the N-acetyl-cysteine metabolite ( $r=0.83$ , see Figure 3-6 in Section 3.4.3) (Osterloh et al. 1984). Human dermal exposure to cis-1,3-dichloropropene vapor was successfully monitored by the urinary level of the mercapturic acid metabolite (Kezic et al. 1996). The rapid excretion of the metabolite



## 3. HEALTH EFFECTS

(75% complete within the first 24 hours) limits the usefulness of this biomarker to the first 2 days after exposure.

Blood levels of the glutathione-conjugate of 1,3-dichloropropene might also be used as a biomarker. Steady-state levels of the glutathione-conjugate were reached within 1 hour in rats exposed to 78, 155, or 404 ppm (Fisher and Kilgore 1989). In this study, however, the correlation between exposure and blood levels was not calculated.

1,3-Dichloropropene is rapidly cleared from the body. The elimination half-time, determined after a 1-hour inhalation exposure in rats, was 17 hours (Fisher and Kilgore 1989). Furthermore, <2% of the 1,3-dichloropropene administered by gavage to rats remained in the carcass after 4 days (Hutson et al. 1971). These data indicate that 1,3-dichloropropene does not concentrate in the body. Therefore, biomarkers based on tissue or blood levels of 1,3-dichloropropene are of limited value in assessing long-term exposure.

**2,3-Dichloropropene.** As with 1,3-dichloropropene, most of the absorbed compound following inhalation or oral exposure is rapidly metabolized to a mercapturic acid derivative that is detectable in the urine (Bond et al. 1985; Dutcher et al. 1985; Eder and Dornbusch 1988; Medinsky et al. 1984). Rapid clearance from the body, however, restricts the use of this biomarker to short-term exposures.

### 3.8.2 Biomarkers Used to Characterize Effects Caused by Dichloropropene

Few specific quantifiable biomarkers that characterize effects caused by 1,3- or 2,3-dichloropropene were identified. Consistent findings in animal studies involve portal-of-entry effects include hyperplasia and/or degeneration of portions of the nasal epithelium after inhalation exposure, hyperplasia and/or neoplastic changes in the forestomach after oral exposure, and erythema/edema after dermal exposure. These are nonspecific effects and are, therefore, of little value as biomarkers.

Some occupational monitoring studies on 1,3-dichloropropene have assayed for hepatic and renal damage using serum or urinary concentrations of tissue-specific proteins (Osterloh and Feldman 1993; Osterloh et al. 1989; Verplanke et al. 2000). N-acetylglucosamidase and retinol binding protein as markers for renal tubular damage were detectable several days following exposure.

## 3. HEALTH EFFECTS

**3.9 INTERACTIONS WITH OTHER CHEMICALS**

No studies were located regarding the interaction of 1,3-dichloropropene with other chemicals to produce health effects. 1,3-Dichloropropene is widely used as a preplanting soil fumigant for the control of parasitic nematodes. The commercial product used in agriculture contains a mixture of the cis and trans isomers in approximately equal proportions, as well as stabilizers including 1,2-dichloropropene and epichlorohydrin or epoxidized soybean oil. Occupational exposure would most likely occur to this mixture. Whether interactions occur between 1,3-dichloropropene and other components is not known. Comparisons of animal toxicity assays on different formulations of Telone<sup>®</sup> II indicate that the irritant properties of 1,3-dichloropropene cause portal-of-entry effects in the nasal epithelium and stomach, but suggest that increased tumor incidences in those tissues may be partly attributed to the presence of epichlorohydrin in the formulation (Lomax et al. 1989; NTP 1985; Stebbins et al. 2000). In addition, there is also evidence that pure 1,3-dichloropropene can slowly undergo autoxidation to produce amounts of highly mutagenic oxides when stored in the presence of air (see Section 3.4) (Talcott and King 1984; Watson et al. 1987). Thus, it appears that trace amounts of mutagens, with detectable mutagenic activity, will gradually appear in pure 1,3-dichloropropene unless the liquid is stored under a nitrogen atmosphere.

Simultaneous exposure to other chemicals, such as acetaminophen, that are detoxified via conjugation to glutathione would tend to increase the toxicity of 1,3- and 2,3-dichloropropenes because glutathione depletion would result in metabolism via epoxide-generating pathways (Schneider et al. 1998a).

**3.10 POPULATIONS THAT ARE UNUSUALLY SUSCEPTIBLE**

A susceptible population will exhibit a different or enhanced response to 1,3-dichloropropene than will most persons exposed to the same level of 1,3-dichloropropene in the environment. Reasons may include genetic makeup, age, health and nutritional status, and exposure to other toxic substances (e.g., cigarette smoke). These parameters result in reduced detoxification or excretion of 1,3-dichloropropene, or compromised function of organs affected by 1,3-dichloropropene. Populations who are at greater risk due to their unusually high exposure to 1,3-dichloropropene are discussed in Section 6.7, Populations with Potentially High Exposures.

No data were located regarding populations that are unusually susceptible to the toxicity of 1,3- or 2,3-dichloropropenes; however, glutathione availability is critical for detoxification of these isomers. Depletion of glutathione pools may enhance the toxicity of 1,3- or 2,3-dichloropropene (see Section 3.11).

### 3. HEALTH EFFECTS

Glutathione pools could be depleted by repeated exposures to 1,3-dichloropropene or other xenobiotics that are metabolized in whole or in part by glutathione-dependent pathways. Urinary excretion of the mercapturic acids of 1,3- and 2,3-dichloropropenes is the primary excretory pathway for these isomers; therefore, kidney disease or deficiencies in the mercapturic acid transport system may also enhance the toxicity of 1,3- and 2,3-dichloropropene. As 1,1-dichloropropene appears to become bioactivated by glutathione (see Granville et al. 2005; also Section 3.3, Genotoxicity), glutathione depletion would not be expected to increase susceptibility to adverse effects from exposure to this isomer.

Individuals taking drugs such as acetaminophen that are also detoxified by glutathione, may be more susceptible to the effects of glutathione depletion when exposed to 1,3- or 2,3-dichloropropene.

#### 3.11 METHODS FOR REDUCING TOXIC EFFECTS

This section will describe clinical practice and research concerning methods for reducing toxic effects of exposure to 1,3-dichloropropene. However, because some of the treatments discussed may be experimental and unproven, this section should not be used as a guide for treatment of exposures to 1,3-dichloropropene. When specific exposures have occurred, poison control centers and medical toxicologists should be consulted for medical advice. The following texts provide specific information about treatment following exposures to 1,3-dichloropropene:

Bronstein AC, Currance PL. 1988. Emergency care for hazardous materials exposure. Washington, DC: The C.V. Mosby Company, 53, 155-156.

Ellenhorn MJ, Schonwald S, Ordog G, et al. 1997. 1,3-Dichloropropene. Ellenhorn's medical toxicology: Diagnosis and treatment of human poisoning. 2nd ed. Baltimore, MD: Williams and Wilkins, 1656, 1657, 1659.

Stutz DR, Janusz SJ. 1988. Hazardous materials injuries: A handbook for pre-hospital care. 2nd ed. Beltsville, MD: Bradford Communications Corporation, v, 300-301.

##### 3.11.1 Reducing Peak Absorption Following Exposure

Recommendations have been made for managing and treating persons exposed to 1,3-dichloropropene (Bronstein and Currance 1988; Ellenhorn et al. 1997; Stutz and Janusz 1988). Common practices for reducing peak absorption following exposure include removing the exposed person from the contaminated area and removing contaminated clothing. Exposed skin is decontaminated by immediately

### 3. HEALTH EFFECTS

washing with copious amounts of soapy water to insure appropriate dilution of the chemical and rinsing with copious amounts of water. Contaminated eyes are thoroughly flushed with water. If the victim is in respiratory distress, ventilation assistance is provided, and oxygens administered. If oral exposure occurred recently, the victim is given water or milk to dilute the chemical and activated charcoal to adsorb the chemical. Emetics are not administered (Bronstein and Currance 1988). Please refer to Bronstein and Currance (1988) and Stutz and Janusz (1988) for more complete information on treatment of specific symptoms.

#### **3.11.2 Reducing Body Burden**

No specific information was located on reducing the body burden of dichloropropenes in exposed individuals. Based on animal studies on 1,3- and 2,3-dichloropropene, the major portion of absorbed dichloropropenes are eliminated as urinary metabolites within 2 days and elimination in feces and exhaled air is also rapid (Bond et al. 1985; Climie et al. 1979; Dutcher et al. 1985; Hutson et al. 1971; Medinsky et al. 1984). Dichloropropenes do not appear to accumulate in the body.

#### **3.11.3 Interfering with the Mechanism of Action for Toxic Effects**

No specific information was located regarding the mitigation of effects of 1,3-dichloropropene once it has entered the bloodstream. Animal studies indicated that the critical effects of inhalation exposure to 1,3- and 2,3-dichloropropene are irritation and degenerative effects on the nasal and respiratory epithelium; 1,3-dichloropropene also causes hyperplasia of the urinary bladder. The major effects of oral exposure to 1,3-dichloropropene are stomach irritation, hyperplasia, and hyperkeratosis, and mild liver and kidney effects. Studies on the metabolism of 1,3-dichloropropene and 2,3-dichloropropene indicate that the major pathway occurs via conjugation of the dichloropropene with glutathione resulting in the excretion of innocuous mercapturic acids and N-acetyl-cysteine conjugates (see Section 3.4.3). Inhalation exposure of rats to 1,3-dichloropropene resulted in decreased levels of glutathione in the nasal tissue, kidney, and liver (Fisher and Kilgore 1988a). Oral exposure of mice to 1,3-dichloropropene resulted in decreased levels of glutathione in the forestomach, glandular stomach, liver, and kidney, suggesting that the compound is conjugated in those tissues (Dietz et al. 1982). If the glutathione detoxification pathway becomes saturated, secondary metabolic pathways that result in epoxidation and the formation of toxic metabolites may become prominent (Schneider et al. 1998a). It is possible that therapies that increase tissue levels of glutathione (for example, N-acetylcysteine) would help ameliorate the toxicity of 1,3- and

### 3. HEALTH EFFECTS

2,3-dichloropropenes by reducing the use of the epoxidation pathways. This approach may not be suitable for 1,1-dichloropropene because there is evidence that glutathione may be involved in the metabolism of this isomer to a mutagenic intermediate (Granville et al. 2005; see Section 3.3, Genotoxicity).

As studied *in vitro*, pretreatment with d,l-alpha-tocopherol prevented membrane phospholipid peroxidation and the consequent cytotoxicity of hepatic cells treated with 1,3-dichloropropene (Suzuki et al. 1994b).

#### 3.12 ADEQUACY OF THE DATABASE

Section 104(I)(5) of CERCLA, as amended, directs the Administrator of ATSDR (in consultation with the Administrator of EPA and agencies and programs of the Public Health Service) to assess whether adequate information on the health effects of dichloropropenes is available. Where adequate information is not available, ATSDR, in conjunction with the National Toxicology Program (NTP), is required to assure the initiation of a program of research designed to determine the health effects (and techniques for developing methods to determine such health effects) of dichloropropenes.

The following categories of possible data needs have been identified by a joint team of scientists from ATSDR, NTP, and EPA. They are defined as substance-specific informational needs that if met would reduce the uncertainties of human health assessment. This definition should not be interpreted to mean that all data needs discussed in this section must be filled. In the future, the identified data needs will be evaluated and prioritized, and a substance-specific research agenda will be proposed.

##### 3.12.1 Existing Information on Health Effects of Dichloropropenes

The existing data on health effects of inhalation, oral, and dermal exposure of humans and animals to 1,1-, 3,3-, 1,2-, 2,3-, and 1,3-dichloropropene are summarized in Figures 3-10, 3-11, 3-12, 3-13, and 3-14, respectively. The purpose of this figure is to illustrate the existing information concerning the health effects of dichloropropenes. Each dot in the figure indicates that one or more studies provide information associated with that particular effect. The dot does not necessarily imply anything about the quality of the study or studies, nor should missing information in this figure be interpreted as a “data need”. A data need, as defined in ATSDR’s *Decision Guide for Identifying Substance-Specific Data Needs Related to*

3. HEALTH EFFECTS

**Figure 3-10. Existing Information on Health Effects of 1,1-Dichloropropene**

	Systemic									
	Death	Acute	Intermediate	Chronic	Immunologic/Lymphoretic	Neurologic	Reproductive	Developmental	Genotoxic	Cancer
Inhalation										
Oral										
Dermal										

**Human**

	Systemic									
	Death	Acute	Intermediate	Chronic	Immunologic/Lymphoretic	Neurologic	Reproductive	Developmental	Genotoxic	Cancer
Inhalation										
Oral										
Dermal										

**Animal**

● Existing Studies

3. HEALTH EFFECTS

**Figure 3-11. Existing Information on Health Effects of 3,3-Dichloropropene**

	Systemic									
	Death	Acute	Intermediate	Chronic	Immunologic/Lymphoretic	Neurologic	Reproductive	Developmental	Genotoxic	Cancer
Inhalation										
Oral										
Dermal										

**Human**

	Systemic									
	Death	Acute	Intermediate	Chronic	Immunologic/Lymphoretic	Neurologic	Reproductive	Developmental	Genotoxic	Cancer
Inhalation										
Oral										
Dermal										

**Animal**

● Existing Studies

3. HEALTH EFFECTS

**Figure 3-12. Existing Information on Health Effects of 1,2-Dichloropropene**

	Systemic									
	Death	Acute	Intermediate	Chronic	Immunologic/Lymphoretic	Neurologic	Reproductive	Developmental	Genotoxic	Cancer
Inhalation										
Oral										
Dermal										

**Human**

	Systemic									
	Death	Acute	Intermediate	Chronic	Immunologic/Lymphoretic	Neurologic	Reproductive	Developmental	Genotoxic	Cancer
Inhalation	●	●				●				
Oral	●	●								
Dermal		●								

**Animal**

● Existing Studies



3. HEALTH EFFECTS

**Figure 3-13. Existing Information on Health Effects of 2,3-Dichloropropene**

	Systemic									
	Death	Acute	Intermediate	Chronic	Immunologic/Lymphoretic	Neurologic	Reproductive	Developmental	Genotoxic	Cancer
Inhalation										
Oral										
Dermal										

**Human**

	Systemic									
	Death	Acute	Intermediate	Chronic	Immunologic/Lymphoretic	Neurologic	Reproductive	Developmental	Genotoxic	Cancer
Inhalation	●	●	●			●	●			
Oral	●	●								
Dermal	●	●								

**Animal**

● Existing Studies

3. HEALTH EFFECTS

**Figure 3-14. Existing Information on Health Effects of 1,3-Dichloropropene**

	Death	Acute	Intermediate	Chronic	Systemic	Immunologic/Lymphoretic	Neurologic	Reproductive	Developmental	Genotoxic	Cancer
Inhalation		●	●								●
Oral	●	●									
Dermal		●			●						

**Human**

	Death	Acute	Intermediate	Chronic	Systemic	Immunologic/Lymphoretic	Neurologic	Reproductive	Developmental	Genotoxic	Cancer
Inhalation	●	●	●	●		●	●	●	●	●	●
Oral	●	●	●	●		●			●	●	
Dermal	●	●			●	●					●

**Animal**

● Existing Studies

## 3. HEALTH EFFECTS

*Toxicological Profiles* (Agency for Toxic Substances and Disease Registry 1989), is substance-specific information necessary to conduct comprehensive public health assessments. Generally, ATSDR defines a data gap more broadly as any substance-specific information missing from the scientific literature.

Existing information regarding the health effects of dichloropropenes in humans is limited. No human toxicity data are available for 1,1-dichloropropene (Figure 3-10), 3,3-dichloropropene (Figure 3-10), 1,2-dichloropropene (Figure 3-12), or 2,3-dichloropropene (Figure 3-13). A limited amount of human toxicity data are available for 1,3-dichloropropene, mostly case reports in which levels and durations of exposure to 1,3-dichloropropene were unknown (Figure 3-14). For persons exposed by inhalation, there is information on systemic effects and possible carcinogenicity, although the number of cases is too small to provide definitive proof of carcinogenicity and the association is weak. For oral exposure, there is information on death and the systemic effects following ingestion of a lethal dose in one case report. For persons exposed dermally to 1,3-dichloropropene, there are case reports of dermatitis and allergic reactions at the site of contact.

Data available on health effects of dichloropropenes in animals are more extensive than in humans. No animal toxicity data are available for 1,1-dichloropropene (Figure 3-10) or 3,3-dichloropropene (Figure 3-11). For animals exposed by inhalation to 1,2-dichloropropene, there is one brief summary of lethality and neurological effects in a few rats exposed to a saturated vapor atmosphere (Figure 3-12). In animals exposed orally to 1,2-dichloropropene at a limit dose, there is information on survival and systemic effects. Primary dermal and ocular irritation data are available for 1,2-dichloropropene. In animals exposed by inhalation to 2,3-dichloropropene (Figure 3-13), there are data for acute lethality, complete data for systemic effects following repeated acute-duration exposures, and incomplete data for systemic effects following intermediate-duration inhalation exposures. In animals exposed orally to 2,3-dichloropropene, there are data for mortality and systemic effects following acute lethal exposure. Data for dermal exposure to 2,3-dichloropropene include acute lethality and systemic effects, and primary dermal and ocular irritation. Animal data are more extensive for 1,3-dichloropropene compared to the other isomers (Figure 3-14). For animals exposed by inhalation to 1,3-dichloropropene, there are data for mortality, systemic effects, genotoxic effects, and developmental toxicity following acute-duration exposure, systemic and reproductive effects following intermediate-duration exposure, and systemic and carcinogenic effects following chronic exposure. For animals exposed orally, there are mortality, neurotoxicity, genotoxicity, and systemic toxicity data for acute-duration exposure, systemic effects following intermediate-duration exposure, and systemic and carcinogenic effects following chronic-

## 3. HEALTH EFFECTS

duration exposure. Studies in animals dermally exposed to 1,3-dichloropropene involve lethality, neurotoxicity, systemic, immunological, and possible carcinogenic effects following acute exposure.

### 3.12.2 Identification of Data Needs

Information regarding the health effects of exposure to pure dichloropropenes is limited. Although older toxicological studies tested various commercial formulations of 1,3-dichloropropene, recent studies have used higher purity formulations that contain very low levels of confounding chemicals such as 1,2-dichloropropane, epichlorohydrin or chloropicrin. Some acute-duration toxicological data are available for some of the other isomers, but no reliable long-term studies. As a consequence of their chemical reactivity, portal-of-entry effects are the major toxicological sequelae of exposure to dichloropropenes. Any new tests need to include a thorough histopathological examination of portal-of-entry tissues. Although the following discussion covers all isomers of dichloropropene, testing to fill data gaps for 1,3-dichloropropene should take priority, since it is the only isomer currently in production at a significant volume.

#### Acute-Duration Exposure.

***1,3-Dichloropropene.*** Data regarding human exposures to 1,3-dichloropropene are limited to clinical reports describing isolated cases of non-Hodgkin's (histiocytic) lymphoma and acute myelomonocytic leukemia after inhalation exposure (Markovitz and Crosby 1984), delayed-type hypersensitivity after dermal exposure (Bousema et al. 1991; Corazza et al. 2003; van Joost and de Jong 1988; Vozza et al. 1996), and nonspecific clinical signs such as headache, nausea, vomiting, fatigue, impotence, and malaise after inhalation (and possibly dermal) exposure. Respiratory symptoms such as chest discomfort, breathing difficulty, coughing, and mucous membrane irritation (Flessel et al. 1978; Markovitz and Crosby 1984) indicate that the respiratory system is a target in humans. Animal studies of acute-duration exposure at high dose levels describe nonspecific clinical signs including lethargy, labored breathing, salivation, lacrimation, palpebral closure, and diarrhea. The primary target organ in animals after acute inhalation is also the respiratory tract. Lung hemorrhage and congestion, atelectasis, emphysema, pulmonary edema, and tracheal congestion have been observed (Cracknell et al. 1987; Streeter and Lomax 1988; Streeter et al. 1987). Since acute-duration inhalation studies did not examine the nasal turbinates for histopathology, a reliable NOAEL value cannot be identified in the available studies and no acute-duration inhalation MRL was derived for 1,3-dichloropropene.

## 3. HEALTH EFFECTS

One case report of acute lethal oral exposure to 1,3-dichloropropene identified gastrointestinal, respiratory, and cardiac effects prior to multiorgan failure (Hernandez et al. 1994). Acute oral studies in rats have identified the stomach, lungs, and possibly the liver and kidney as targets (Jones 1988a; Jones and Collier 1986a; Mizell et al. 1988a), but the data are not sufficient to calculate an acute oral MRL.

Dermal exposure of humans to 1,3-dichloropropene has produced delayed-type hypersensitivity (Bousema et al. 1991; Corazza et al. 2003; van Joost and de Jong 1988; Vozza et al. 1996). Delayed-type hypersensitivity to 1,3-dichloropropene has also been observed in animals (Carreon and Wall 1983; Jeffrey 1987c; Mizell 1988b). Animal studies have shown that 1,3-dichloropropene causes erythema/edema, necrosis, exfoliation, and subcutaneous hemorrhage when applied dermally (Carreon and Wall 1983; Jeffrey 1987c; Jones and Collier 1986b; Lichy and Olson 1975; Mizell et al. 1988a, 1988b). Data regarding systemic toxicity in animals are limited. Hemorrhage of the lungs and glandular stomach was reported in a few studies (Jones 1988b; Jones and Collier 1986b).

Information on the distribution of 1,3-dichloropropene following inhalation and dermal exposure is not available to help identify other target organs across routes of exposure. Intermediate- and chronic-duration studies in rats and mice, which included extensive histological examinations, have identified targets of inhalation and oral exposure. Additional acute studies (single- and repeated-exposure) by all routes should focus on histological examinations of major organs and tissues, especially portal-of-entry tissues such as the lungs and nasal turbinates following inhalation exposure, the stomach following oral exposure, and the skin at the site of administration in dermal studies. These studies of systemic toxicity by the inhalation and oral route are needed for the derivation of acute-duration MRLs for 1,3-dichloropropene. Studies should be conducted in rats and mice since longer-term studies showed some species-specific variation in response to 1,3-dichloropropene. Since suitable data were available for the acute-duration inhalation MRL for 2,3-dichloropropene, an inhalation study would permit the assessment of the relative toxicity of the two isomers.

***2,3-Dichloropropene.*** No data are available for effects in humans following acute-duration exposure to 2,3-dichloropropene. A well-conducted repeated-exposure acute inhalation toxicity study in rats and mice revealed the respiratory tract to be the most sensitive target of inhaled 2,3-dichloropropene, with slightly different effects observed the two species (Zempel et al. 1987). An acute-duration inhalation MRL was based on the lowest concentration, 5 ppm, a LOAEL for minimal nasal respiratory effects in mice and rats. As a NOAEL was not observed in this study, additional testing would be useful to ascertain the NOAEL for acute respiratory effects.

## 3. HEALTH EFFECTS

The only animal oral toxicity data for 2,3-dichloropropene was for an acute lethality study in which congestion of the lung and kidney were reported in rats (Smyth et al. 1962; Union Carbide Corp. 1958). Repeated-dose acute-duration oral toxicity testing at nonlethal doses would be useful to identify critical target organs and dose responses for the derivation of an acute-duration oral MRL.

The only animal dermal toxicity data for 2,3-dichloropropene was for acute lethality or skin irritation following dermal exposure at high or unspecified doses (Monsanto 1967; Smyth et al. 1962; Union Carbide Corp. 1958). Additional acute-duration dermal testing would be useful to determine thresholds for irritant responses and necrotic effects. This information would be relevant to possible occupational exposures.

***1,2-Dichloropropene.*** Acute-duration toxicity data for 1,2-dichloropropene are limited to a summary of results for a high-concentration inhalation lethality study, an acute oral limit dose test, and primary dermal and eye irritation tests (Dow 1962). Results of these studies suggest that suppression of the central nervous system may occur at high inhalation concentrations, and that irritant effects may occur from topical exposure. Additional testing by all routes would be useful to determine the NOAEL and LOAEL values for effects in critical target organs following acute exposure. This information could be used for the derivation of acute-duration inhalation and oral MRLs.

***1,1- and 3,3-Dichloropropene.*** No acute-duration toxicity data by any route of exposure are available for either isomer. Testing of 1,1-dichloropropene may be especially useful since it, unlike 1,3- and 2,3-dichloropropene, appears to be bioactivated rather than detoxified by reaction with glutathione. Additional testing by all routes would help to determine NOAEL and LOAEL values for effects in critical target organs following acute exposure to either isomer. Results of these studies could be used for the derivation of acute-duration inhalation and oral MRLs.

**Intermediate-Duration Exposure.** Data are not available that identify target organs in humans after intermediate-duration exposure to any isomer of dichloropropene by any route.

***1,3-Dichloropropene.*** Most earlier intermediate-duration studies in animals exposed to 1,3-dichloropropene were conducted using formulations that contained other toxic compounds such as epichlorohydrin. Animal studies using more purified formulations indicate that the primary target organs of 1,3-dichloropropene toxicity after intermediate-duration inhalation exposure are the nasal epithelia and

## 3. HEALTH EFFECTS

urinary bladder (Breslin et al. 1989; Coate 1979a; Lomax et al. 1989). An intermediate inhalation MRL has been calculated based on histopathology in nasal epithelia in rats. Intermediate-duration oral toxicity studies using dietary exposure to a microencapsulated formulation lacking epichlorohydrin demonstrated that the forestomach in rats and erythrocytes in dogs were the critical targets of 1,3-dichloropropene (Haut et al. 1996; Stebbins et al. 1999). An intermediate oral MRL has been calculated based on forestomach lesions in rats.

No information on target organs other than the skin (Jeffrey 1987a) was located for intermediate-duration dermal exposure. No distribution data following inhalation, oral, or dermal exposure were located to help identify target organs of dermal exposure. An intermediate-duration dermal study in animals that examined organs other than skin should help identify the possible effects of repeated dermal exposure to internal tissues. Because 1,3-dichloropropene is a component of a soil fumigant, contact with soil is one way that dermal exposure of humans could occur. Furthermore, 1,3-dichloropropene may be present in the soil at hazardous waste sites, where residents may be exposed for intermediate durations.

**2,3-Dichloropropene.** No intermediate-duration toxicity data are available for exposure to 2,3-dichloropropene by the oral or inhalation routes, and the available data by the inhalation route are not suitable as a basis for an intermediate-duration MRL. Reliable NOAEL and LOAEL values could not be identified in the published 13-week inhalation rat study by Johannsen et al. (1991), since the nasal turbinates were not examined for histopathology, although clinical signs of red nasal discharge were observed at the highest exposure level (15 ppm). The reproduction toxicity study described in the same paper also lacks information about nasal effects in exposed parents. Lung weight data from a terminated 13-week inhalation study in mice (NTP 1989, 2006) add support to the identification of the respiratory tract as the critical target of repeated inhalation exposure to 2,3-dichloropropene, but the lack of histopathology and other data render this study unsuitable as the basis for derivation for an MRL. In addition, significant toxicity in the liver was shown by serum parameters and in the kidneys by urinalysis results. New testing for intermediate-duration exposure to 2,3-dichloropropene by all routes in which respiratory and renal tissues are adequately examined for histopathology would help to identify more reliable NOAELs and LOAELs for this isomer. Results of oral and inhalation studies could be used for the derivation of intermediate-duration MRLs.

**1,1-, 1,2-, and 3,3-Dichloropropene.** No intermediate-duration toxicity data by any route of exposure are available for any of these isomers. Testing by all routes would help to determine the NOAEL and

## 3. HEALTH EFFECTS

LOAEL values for effects in critical target organs following intermediate-duration exposure. Results of these studies could be used for the derivation of intermediate-duration inhalation and oral MRLs.

**Chronic-Duration Exposure and Cancer.** There is no information in humans to identify target organs following chronic exposure to any isomer of dichloropropene by inhalation, oral, or dermal routes.

***1,3-Dichloropropene.*** The chronic toxicity of 1,3-dichloropropene using formulations not containing epichlorohydrin has been assessed in several animal studies: a 2-year inhalation study in rats and mice (Lomax et al. 1989); a 2-year study in rats and mice administered a microencapsulated form in the diet (Stebbins et al. 2000); and a 1-year study in dogs also fed the microencapsulated form in the diet (Stebbins et al. 1999). Lesions of the nasal epithelia in rats and mice and of the urinary bladder epithelium of mice were the principal nonneoplastic effects following chronic inhalation exposure. An increased incidence of bronchioalveolar adenomas was also observed in mice exposed by inhalation. Lesions of the forestomach in rats, and microcytic anemia in dogs were the critical effects of chronic oral studies. Data from these chronic studies were sufficient to derive chronic-duration inhalation and oral MRLs for 1,3-dichloropropene. No data were available for chronic dermal exposure in animals. Such testing would help to evaluate the consequence of repeated dermal exposure, which might occur from occupational exposure or residence in communities in which release of the chemical into the environment is significant.

A few isolated case reports describing three men who developed lymphoma or leukemia following acute exposure (Markovitz and Crosby 1984) suggests, but does not prove, a carcinogenic potential for 1,3-dichloropropene in humans. The fact that some carcinogenic effects were observed in some earlier chronic-duration bioassays, but not observed in later studies with purer test material, indicate that impurities or additives such as epichlorohydrin in the formulations may have contributed to carcinogenesis. Following inhalation exposure to a purer test material, an increased incidence of bronchioalveolar adenomas (benign lung tumors) in mice was the only carcinogenic effect of 1,3-dichloropropene (Lomax et al. 1989). Dietary exposure to the purer microencapsulated test material did not result in increased tumor incidences in rats, mice or dogs (Stebbins et al. 1999, 2000). It is not certain whether the lack of tumor formation in the dietary studies, compared to increased tumors incidences (for squamous cell papillomas and carcinomas of the forestomach in rats and mice and transitional cell carcinomas of the urinary bladder in mice) in a 2-year gavage study (NTP 1985), were related to the absence of epichlorohydrin in the later studies, or the lack of bolus dosing. Bolus dosing by itself could have contributed to glutathione depletion and resultant saturation of the major detoxifying pathway, resulting in an increased generation



## 3. HEALTH EFFECTS

of mutagenic metabolites by minor pathways. No additional chronic-duration toxicity testing by the inhalation or oral routes is needed.

An initiation-promotion study of cis-1,3-dichloropropene by dermal exposure in mice indicated that cis-1,3-dichloropropene was not an initiator of skin tumors (Van Duuren et al. 1979). Furthermore, cis-1,3-dichloropropene alone did not induce skin tumors after repeated dermal application for 74 weeks. No studies were located regarding the carcinogenic mechanism of action of 1,3-dichloropropene. Available data indicate, however, that 1,3-dichloropropene or its unavoidable impurities is mutagenic in prokaryotic and eukaryotic test systems and that it is a strong tissue irritant. Both properties may underlie the carcinogenic potential of 1,3-dichloropropene.

***1,1-, 1,2-, 2,3-, and 3,3-Dichloropropene.*** No chronic-duration toxicity data by any route of exposure are available for any of these isomers. Testing by all routes would help to determine NOAEL and LOAEL values for effects in critical target organs following chronic-duration exposure. Results of these studies could be used for the derivation of chronic-duration inhalation and oral MRLs.

**Genotoxicity.** No data are available regarding genotoxicity in humans after exposure to any isomer of dichloropropene by any route.

***1,1-Dichloropropene.*** Mixed results for mutagenicity were reported for *S. typhimurium* TA100 and negative results in other strains (Granville et al. 2005; Neudecker et al. 1986), but positive results were reported for a TA100-based strain that expressed glutathione transferase in the presence of glutathione. Granville et al. (2005) indicated that bioactivation by glutathione transferase generates the production of a mutagenic epoxide from 1,1-dichloropropene. The observation that no DNA fragmentation was observed in a cell line deficient in glutathione transferase supports this observation. The paradoxical effect of glutathione on this isomer (others detoxified by glutathione) suggests that any additional *in vitro* genotoxicity tests should be conducted with and without glutathione transferase. *In vivo* genotoxicity tests would help to determine whether the pattern of increased mutagenicity from interaction with glutathione is relevant to inhalation or oral exposure. Testing for chromosomal aberration in cultured mammalian cells would also be useful.

***1,2-Dichloropropene.*** A negative result for *S. typhimurium* TA100 represents the only genotoxicity data for 1,2-dichloropropene. Additional *in vitro* testing on bacterial strains that detect other mutagenic

## 3. HEALTH EFFECTS

lesions and for chromosomal aberration in mammalian cells would help to assess the genotoxic potential of this isomer.

**1,3-Dichloropropene.** Positive results for DNA fragmentation in specific tissues (stomach liver, urinary bladder, kidney, lung, brain, bone marrow) and for micronucleus formation in one assay were reported following oral exposure to 1,3-dichloropropene (Ghia et al. 1993; Kevekordes et al. 1996; Kitchin and Brown 1994; Sasaki et al. 1998), but negative results were reported for other types of assays (unscheduled DNA synthesis, four of five micronucleus assays). A single dominant lethal mutation assay in rats exposed by inhalation for 10 weeks was negative (Gollapudi et al. 1998), which is consistent with the lack of toxicity in the testes in systemic toxicity assays. *In vivo* genotoxicity testing for mutagenicity in target organs (stomach, lung, nasal epithelium, urinary bladder, and possibly lymphocytes) would be useful, since previous tests with formulations containing epichlorohydrin have resulted in tumor increases.

Studies by Talcott and King (1984) and Watson et al. (1987) demonstrated that the mutagenicity of technical-grade 1,3-dichloropropene in *S. typhimurium* TA100 could be entirely attributed to impurities, and that the purified chemical can undergo slow autoxidation to form mutagenic oxides. This may account for the many earlier positive results for mutagenicity in TA100 in older studies (Table 3-9). It is not clear whether the positive results for genotoxicity (sister chromatid exchange, mitotic aberration, unscheduled DNA synthesis) in cultured mammalian cells exposed to relatively pure (>95%) 1,3-dichloropropene were caused by the parent compound, *in vivo* metabolism to a mutagenic metabolite, a mutagenic autoxidation product that formed during storage, or an impurity remaining after manufacture (Kevekordes et al. 1996; Loveday et al. 1989; Matsuoka et al. 1998). Cis and trans epoxides of 1,3-dichloropropene, as well as 3-chloro-3-hydroxypropanal, three mutagens formed by a minor metabolic pathway, specifically form adducts to 2'-deoxyguanosine and not to 2-deoxyadenosine or 2'-deoxycytidine in solution (Schneider et al. 1998b). Additional studies to examine the potential for adduct formation *in vivo* or exposed cells *in vitro* would help to better characterize the genotoxic potential of this isomer.

**2,3-Dichloropropene.** Positive results have been reported for mutagenicity in bacteria, aneuploidy in yeast, and sister chromatid exchange, chromosomal aberration, and unscheduled DNA synthesis in mammalian cells following exposure to 2,3-dichloropropene. Given the generally positive results of *in vitro* testing, additional studies would be helpful to ascertain the genotoxic potential of this isomer *in vivo*. Tissues subject to portal-of-entry effects, as well as the liver, kidney, and urinary bladder should be evaluated in these studies.

## 3. HEALTH EFFECTS

**3,3-Dichloropropene.** *In vitro* genotoxicity studies for mutagenicity in bacterial cells and chromosomal aberration in mammalian cells for 3,3-dichloropropene would help to determine the genotoxic potential of this isomer.

**Reproductive Toxicity.** No information is available regarding the reproductive toxicity of any isomer of dichloropropene by any route of exposure in humans.

**1,3-Dichloropropene.** Pharmacokinetic data in rats indicate that 1,3-dichloropropene or its metabolites are found in low concentrations in reproductive organs and tissues (Waechter and Kastl 1988). However, no effects on reproductive parameters of rats were found in a two-generation inhalation study (Breslin et al. 1989). Furthermore, no lesions attributable to 1,3-dichloropropene were observed after gross and histologic evaluation of reproductive tissues and organs in several animal studies. These studies include a two-generation reproductive/developmental inhalation study (Breslin et al. 1989), a 2-year inhalation study (Lomax et al. 1989), and a 2-year oral study (NTP 1985). No studies regarding reproductive effects in animals following dermal exposure were found; however, the results of the inhalation and oral studies indicate no reason to suspect that 1,3-dichloropropene would have reproductive effects by this route. Additional reproductive studies would not be useful at this time.

**2,3-Dichloropropene.** No histopathology of male or female reproductive organs was observed in a repeated acute-duration inhalation exposure study in rats or mice exposed at  $\leq 75$  ppm (Zempel et al. 1987). A reproductive toxicity assay for rats exposed to 2,3-dichloropropene by inhalation (Johannsen et al. 1991) reported no reproductive effects at 1 or 5 ppm, although there was a statistically insignificant reduction in female fertility in exposed animals. It seems likely, based on the results of the acute-duration repeated inhalation assay by Zempel et al. (1987), that rat dams in the study by Johannsen et al. (1991) experienced irritation of the nasal tissues, which was unreported because the nasal turbinates were not examined for histopathology. The incomplete data available for intermediate-duration inhalation toxicity in rats and mice suggest that 2,3-dichloropropene does not have a direct adverse effect on reproductive organs or sperm or estrus cycle parameters (NTP 1989, 2006). Additional reproductive toxicity testing that includes examination of portal-of-entry tissues in exposed parents would help to determine reliable NOAEL and LOAEL values for reproductive effects and parental toxicity. Studies in mice exposed by inhalation would help to determine whether the more extensive damage to the respiratory tract, compared to rats, affects reproductive function because of irritation-induced parental stress.

## 3. HEALTH EFFECTS

*1,1-, 1,2-, and 3,3-Dichloropropene.* Because no data are available for any of these isomers by any route of exposure, testing in animals would help to determine the reproductive toxicity of these isomers.

**Developmental Toxicity.**

*1,3-Dichloropropene.* Both acute-duration developmental inhalation studies in rats and rabbits (Hanley et al. 1987; Kloes et al. 1983) and intermediate-duration reproductive inhalation studies in rats (Breslin et al. 1989) have shown that 1,3-dichloropropene is not teratogenic. However, fetotoxicity in the rabbits could not be assessed because significant maternal toxicity at the highest tested concentration (300 ppm) resulted in the death of six of seven rabbits (Kloes et al. 1983). Maternal toxicity in rats, also at 300 ppm, may have resulted in fetotoxicity and the subsequent decrease in fetuses per litter. Lower concentrations of 1,3-dichloropropene ( $\leq 150$  ppm) were not fetotoxic in these studies, although an exposure of 120 ppm to pregnant rats resulted in delayed ossification, which may have been due to decreased body weight of the dams. A weakness of these studies is that the dams were not evaluated for effects in the respiratory tract, especially the nasal turbinates, so the NOAEL for maternal toxicity may have been overestimated. It seems possible that repeated irritation might contribute to maternal stress, resulting in lower feed intake, decreased maternal body weight gain, and fetal effects such as delayed ossification. New inhalation exposure studies that include examination of the nasal turbinates, as well as a pair-fed group, would allow the reason for delayed development to be identified.

*2,3-Dichloropropene.* An intermediate-duration reproductive study in rats exposed by inhalation, reported no fetal effects at exposures at 1 or 5 ppm, reportedly below the level of maternal toxicity (Johannsen et al. 1991). A weakness of this study is that the dams were not evaluated for effects in the nasal turbinates, the primary target tissue in acutely exposed rats (Zempel et al. 1987), so the maternal NOAEL may not have been accurately identified. Additional developmental toxicity studies that include examination of the maternal portal-of-entry tissues in rats, and also in mice (which had more extensive respiratory tract effects than rats exposed under identical conditions [Zempel et al. 1987]), would help to better characterize the developmental toxicity of this isomer.

*1,1-, 1,2-, and 3,3-Dichloropropene.* Because no data are available for any of these isomers by any route of exposure, testing in animals would help to determine the potential of these isomers to induce developmental effects.

## 3. HEALTH EFFECTS

**Immunotoxicity.**

***1,3-Dichloropropene.*** Several clinical reports on the development of a delayed-type hypersensitivity after skin contact in workers occupationally exposed to 1,3-dichloropropene (Bousema et al. 1991; Corazza et al. 2003; van Joost and de Jong 1988; Voza et al. 1996) indicate the possibility of immunotoxicity in humans. This is supported by animal studies that document the development of delayed-type hypersensitivity in guinea pigs (Carreon and Wall 1983; Jeffrey 1987a; Jones 1988b; Mizell 1988b). Since the immune system may be a target of 1,3-dichloropropene toxicity, a battery of immune function tests appears to be warranted at this time. However, no animal studies showed adverse effects on lymphocytes, despite exposure by inhalation or gavage for intermediate or chronic duration (Haut et al. 1996; Lomax et al. 1989; NTP 1985; Stebbins et al. 2000; Stott et al. 1988; Til et al. 1973; Torkelson and Oyen 1977). Furthermore, gross and histological examination of the lymph nodes and the thymus in several animal studies of inhalation and oral exposure revealed no lesions attributable to 1,3-dichloropropene as Telone II (Lomax et al. 1989; NTP 1985; Stott et al. 1988).

***1,1-, 1,2-, 2,3-, and 3,3-Dichloropropene.*** No data are available for immunotoxicity of these isomers in humans or animals. Since immunological effects have been observed in humans and animals exposed dermally to 1,3-dichloropropene, primary skin sensitization studies in animals would help to characterize the potential of these isomers to induce immunotoxicity. Additional immune function testing could then be conducted based on the results of the skin sensitization studies.

**Neurotoxicity.**

***1,3-Dichloropropene.*** No neurotoxicity was observed in humans accidentally exposed to 1,3-dichloropropene at concentrations high enough to require medical attention (Markovitz and Crosby 1984). No evidence for neurotoxicity was found following gross and histological examination of brain, nerves, and the spinal cord from rats and mice after inhalation (Coate 1979a; Lomax et al. 1989; Stott et al. 1988) and oral exposure to 1,3-dichloropropene (Haut et al. 1996; NTP 1985; Stebbins et al. 1999, 2000). Clinical signs that indicate possible neurotoxicity, however, were noted in rabbits after dermal exposure to high concentrations of 1,3-dichloropropene (Jones 1988b), and in rabbits after inhalation exposure to high concentrations of 1,3-dichloropropene (Kloes et al. 1983). These signs included ataxia, loss of the righting reflex, lacrimation, salivation, and lethargy. Studies determining the threshold inhalation concentrations associated with neurological effects following acute exposure at high levels might be

## 3. HEALTH EFFECTS

helpful for identifying hazards due to neurological impairment during accidental exposure. Such studies would be less useful for the typical exposures experienced by the general population.

***1,2-Dichloropropene.*** The only data available for neurotoxicity following exposure to 1,2-dichloropropene was a report of unconsciousness in rats exposed to a saturated vapor atmosphere estimated at 63,764 ppm (Dow 1962). Additional testing would help to determine the threshold for neurotoxicity of 1,2-dichloropropene at more typical experimental exposure levels.

***2,3-Dichloropropene.*** There is no information as to the neurotoxicity of 2,3-dichloropropene in humans and no neurotoxic effects, clinical signs, or histopathology were observed in rats or mice exposed repeatedly at  $\leq 75$  ppm by inhalation in an acute study (Zempel et al. 1987). Acute lethality studies reported signs of suppression of the central nervous system following single inhalation exposures at levels of 500 ppm and higher (Dietz et al. 1985b; Monsanto 1967). Because of reporting deficiencies, these data do not reliably identify NOAEL or LOAEL values for neurotoxicity following single inhalation exposure.

***1,1- and 3,3-Dichloropropene.*** As no neurotoxicity or systemic toxicity data are available for these isomers, acute-duration testing in animals would help to determine the thresholds for neurological effects following oral or inhalation exposure.

### **Epidemiological and Human Dosimetry Studies.**

***1,3-Dichloropropene.*** One pharmacokinetic study in humans described a strong correlation between exposure levels during the application of 1,3-dichloropropene on farms and urinary excretion levels of 1,3-dichloropropene metabolites (Osterloh et al. 1984). Additional monitoring studies reported slight increases in urinary excretion of N-acetylglucosamidase, a possible biomarker for subclinical renal effects (Osterloh and Feldman 1993; Osterloh et al. 1989). A case-control study reported an apparent increase in risk of death from pancreatic cancer associated with long-term (20-year) residence in three communities in which high quantities of 1,3-dichloropropene were used for fumigation (Clary and Ritz 2003). However, there was no direct exposure data for the subjects, and given the products available at the time, it is possible that carcinogenic effects could have been caused by additives (for example, epichlorohydrin) no longer present in current products. Given the lack of data for humans exposed long-term to 1,3-dichloropropene, epidemiological studies of respiratory effects and possible carcinogenicity in, for example, agricultural workers exposed occupationally, would be especially valuable. Additionally, long-term follow-up studies of chronic toxicity and carcinogenicity in people exposed to high concentrations of

## 3. HEALTH EFFECTS

1,3-dichloropropene at the site of a spill would be valuable. Chronic toxicity evaluation should focus on the nasal epithelia, forestomach, lungs, liver, and kidneys, which are the primary target organs identified in animal studies.

Limited evidence suggests that the mu class of glutathione S-transferase may not play a significant role in the metabolism of 1,3-dichloropropene in humans (Vos et al. 1991). Systematic evaluation of isoforms of the enzymes involved in metabolism of dichloropropenes (glutathione S-transferase and cytochrome P-450) in humans would help interpret the basis of individual variability in human studies (see Comparative Toxicokinetics below).

***1,1-, 1,2-, 2,3-, and 3,3-Dichloropropene.*** No studies were located regarding the epidemiology or human dosimetry of these isomers

**Biomarkers of Exposure and Effect.*****Exposure.***

***1,3-Dichloropropene.*** The primary biomarker of exposure identified in the literature is the mercapturic acid metabolite of 1,3-dichloropropene found in the urine of animals exposed by inhalation (Fisher and Kilgore 1988b) and orally (Climie et al. 1979; Hutson et al. 1971) and humans exposed occupationally (Osterloh and Feldman 1993; Osterloh et al. 1984; Van Welie et al. 1989). Because 1,3-dichloropropene does not appear to accumulate in the body, only short-term and possibly intermediate-duration exposures can be assessed using the urinary metabolite as a biomarker. Depletion of glutathione stores would represent a biomarker of exposure, but would not be practical in the absence of data for preexposure glutathione levels. Although no pharmacokinetic studies have investigated chronic exposure, this duration of exposure may not be assessed reliably if some period of time has passed between the last exposure and biomarker analysis. Since hematological and clinical chemistry analyses performed in animal studies of intermediate and chronic exposure have not identified significant alterations indicative of exposure, attempts to develop biomarkers that use easily obtained biological fluids may not be fruitful. Studies in dogs exposed orally have shown evidence of microcytic anemia (Haut et al. 1996; Stebbins et al. 1999), but this would not represent a specific biomarker for 1,3-dichloropropene. Research to identify a biomarker would facilitate future medical surveillance, which could lead to early detection and treatment. If future *in vivo* assays for DNA adduct formation (see Genotoxicity, above) yield positive results, it is possible that adduct frequency in blood cells might be developed as a biomarker. However,

## 3. HEALTH EFFECTS

given that mutagenic metabolites of 1,3-dichloropropene form under high-exposure conditions, adduct frequency is unlikely to be a useful biomarker for low-level exposures.

**2,3-Dichloropropene.** There is no information on biomarkers in humans for exposure to 2,3-dichloropropene. Based on toxicokinetic studies in animals exposed orally or by inhalation, urinary mercapturic acid metabolite represents a biomarker of exposure for the first few days after exposure (Bond et al. 1985; Dutcher et al. 1985; Eder and Dornbusch 1988; Medinsky et al. 1984). Elimination is too rapid for this metabolite to be a useful biomarker for exposures that ended several days earlier.

**1,1-, 1,2-, and 3,3-Dichloropropene.** No data are available for biomarkers of exposure to these isomers. Toxicity studies in animals exposed by inhalation, oral, or dermal exposure would help to identify target organ specificities for these isomers.

**Effect.**

**1,3-Dichloropropene.** Irritant effects have been noted in humans acutely exposed to high doses by the oral or inhalation routes, and dermal exposure resulted in contact dermatitis and delayed sensitivity reactions. The effects identified in animal studies include portal-of-entry effects such as lung trauma in acutely exposed rats, hyperplasia/hypertrophy of the nasal respiratory epithelium in rats and mice, hyperplasia of the nonglandular stomach in rats and mice, as well as hyperplasia of the urinary bladder in mice, and anemia in dogs. It is evident that none of the effects observed in humans and animals are unique to dichloropropenes. Furthermore, it is not known whether the anemia observed in orally-exposed dogs is relevant to humans. Analysis of serum and urinary biomarkers for liver and renal effects did not show significant changes in workers occupationally exposed at low levels to cis or racemic 1,3-dichloropropene (Boogard et al. 1993; Verplanke et al. 2000). This is not unexpected given that neither the liver nor the kidney is the most vulnerable target of toxicity for 1,3-dichloropropene. Development of new biomarkers of effect requires a thorough knowledge of the health effects and more subtle physiological or biochemical changes caused by 1,3-dichloropropene. Further studies on the products of the minor metabolic pathways, which might form adducts detectable in cells circulating in the bloodstream, may identify biomarkers of effect for this isomer.

**2,3-Dichloropropene.** No information is available as to toxic effects in humans exposed to 2,3-dichloropropene. Effects in exposed animals appear to be similar to the portal-of-entry effects observed for 1,3-dichloropropene, except that the former causes more severe respiratory tract lesions. Reliable



## 3. HEALTH EFFECTS

intermediate- and chronic-duration toxicity studies could help to determine whether longer-term exposure to 2,3-dichloropropene reveals unique biomarkers of effect.

***1,1-, 1,2-, and 3,3-Dichloropropene.*** No reliable data are available as to the toxicity of these isomers in humans or animals exposed by any route, although unspecified liver and kidney effects were observed in rats following gavage exposure to 1,2-dichloropropene at 2,000 mg/kg (Dow 1962). Reliable studies, initially for acute-duration exposure, would help to identify target tissues and possible biomarkers of effect for these isomers.

**Absorption, Distribution, Metabolism, and Excretion.**

***1,3-Dichloropropene.*** 1,3-Dichloropropene is absorbed by all routes of exposure. Absorption by the pulmonary (Stott and Kastl 1986) and gastrointestinal (Climie et al. 1979; Hutson et al. 1971; Stott et al. 1998; Waechter and Kastl 1988) tracts is extensive and rapid. The only data for dermal absorption was for skin in contact with cis-1,3-dichloropropene as vapor, not liquid (Kezic et al. 1996). Similarly, metabolism, primarily via conjugation to glutathione is rapid following oral or inhalation exposure, resulting in rapid elimination of mercapturic acid metabolites in urine and feces, and carbon dioxide in exhaled air (Climie et al. 1979; Fisher and Kilgore 1989; Hutson et al. 1971; Stott et al. 1998; Waechter and Kastl 1988). Absorbed 1,3-dichloropropene is widely distributed throughout the body, with the highest initial concentrations found in portal-of-entry tissues (nonglandular stomach) as well as the liver, kidney, and urinary bladder (Dietz et al. 1985a; Waechter and Kastl 1988). The absorption of 1,3-dichloropropene following dermal exposure and the distribution following inhalation or dermal exposure have not been adequately investigated for either single- or repeated-exposure scenarios.

***2,3-Dichloropropene.*** No data are available for the toxicokinetics of 2,3-dichloropropene in humans, but studies are available for rats exposed by inhalation (Bond et al. 1985; Dutcher et al. 1985) and by oral gavage (Eder and Dornbusch 1988; Medinsky et al. 1984). The results of these studies indicate that metabolic pathways and patterns of excretion for 2,3-dichloropropene are similar to those described for 1,3-dichloropropene. However, a comparison of inhalation toxicity studies shows that exposure to 2,3-dichloropropene results in more severe respiratory effects in rats or mice than exposure to 1,3-dichloropropene (Lomax et al. 1989; NTP 1989, 2006; Zempel et al. 1987). Studies are needed to determine the toxicokinetic basis for the apparent greater toxicity of 2,3-dichloropropene compared to 1,3-dichloropropene. This may be associated with differences in rates of reaction with glutathione or relative kinetics

## 3. HEALTH EFFECTS

of metabolic pathways. Studies to determine the toxicokinetics of 2,3-dichloropropene following dermal exposure would be useful since no data are available for this likely route of exposure.

***1,1-Dichloropropene.*** Currently, no data are available for the toxicokinetics of 1,1-dichloropropene in humans or animals. However, *in vitro* data suggest that 1,1-dichloropropene, unlike 1,3- and 2,3-dichloropropene is not detoxified, but rather bioactivated to a mutagenic form by reaction with glutathione (Granville et al. 2005). Studies on the absorption, distribution, metabolism, and excretion following exposure to 1,1-dichloropropene after oral, inhalation, or dermal exposure may help to explain this apparent paradoxical response.

***1,2- and 3,3-Dichloropropene.*** No toxicokinetic data are available for these compounds. Studies on their toxicokinetics should be deferred until the toxicity of these compounds has been adequately investigated.

**Comparative Toxicokinetics.**

A data need relevant to all dichloropropenes is an evaluation of the isoforms of enzymes involved in the detoxification or bioactivation of these compounds. Enzyme polymorphisms could explain individual variations in human studies, possibly identifying vulnerable populations, or strain differences in responses in animal studies. This information would be useful in supporting valid extrapolations across species using PBPK models.

***1,3-Dichloropropene.*** In humans occupationally exposed to 1,3-dichloropropene, the major urinary metabolite found was the mercapturic acid conjugate of 1,3-dichloropropene (Osterloh and Feldman 1993; Osterloh et al. 1984; Van Welie et al. 1989). Studies in rats (Climie et al. 1979; Fisher and Kilgore 1989; Hutson et al. 1971; Stott and Kastl 1986; Stott et al. 1998; Waechter and Kastl 1988) and one study in mice (Dietz et al. 1982) support the identification of the mercapturic acid metabolite as the primary 1,3-dichloropropene metabolite. The excretion data in mice and rats are similar; excretion in urine is the primary route, followed by excretion of CO<sub>2</sub> in the expired air and then by excretion in the feces. It is reasonable to expect that excretion is similar in humans; therefore, rats provide a good model for further pharmacokinetic and toxicity studies of 1,3-dichloropropene. Additional pharmacokinetic studies should focus on the rates of absorption, distribution, metabolism, and excretion, particularly by the dermal route, after acute or repeated exposures. Dose-response information on the relative depletion of glutathione stores in target organs would help define conditions under which toxicity would be increased.

## 3. HEALTH EFFECTS

**2,3-Dichloropropene.** No data are available for the toxicokinetics of 2,3-dichloropropene in humans and the only animal studies were conducted in rats. Studies in rats exposed by inhalation (Bond et al. 1985; Dutcher et al. 1985) and by oral gavage (Eder and Dornbusch 1988; Medinsky et al. 1984) indicate that metabolic pathways and patterns of excretion are similar to those described for 1,3-dichloropropene. Rats and mice exhibit a different pattern of toxicity in respiratory tissues following inhalation exposure to 2,3-dichloropropene, with both species showing nasal effects, but only mice exhibiting toxicity in the lung (NTP 1989, 2006; Zempel et al. 1987). Additional studies on the toxicokinetic basis of this difference could help to explain whether or not the differences could be related to differences in respiratory physiology, the size of glutathione stores in respiratory tissues, or the tissue-specific availability of other pathways for detoxification.

**1,1-Dichloropropene.** Currently, no data are available for the toxicokinetics of 1,1-dichloropropene in humans or animals. However, *in vitro* data suggest that 1,1-dichloropropene, unlike 1,3- and 2,3-dichloropropene is not detoxified, but rather bioactivated to a mutagenic form by reaction with glutathione (Granville et al. 2005). Studies on the absorption, distribution, metabolism, and excretion in rats and mice following exposure to 1,1-dichloropropene after oral, inhalation, and dermal exposure would help to establish the basis of this apparent paradoxical response.

**1,2- and 3,3-Dichloropropene.** No toxicokinetic data are available for these compounds. Studies on the comparative toxicokinetics should be deferred until the toxicity of these compounds has been adequately investigated.

**Methods for Reducing Toxic Effects.** Information on the metabolism of 1,3-dichloropropene in humans (Osterloh and Feldman 1993; Osterloh et al. 1984; Van Welie et al. 1989) and for 1,3- and 2,3-dichloropropene in animals (Bond et al. 1985; Dietz et al. 1982; Eder and Dornbusch 1988; Fisher and Kilgore 1988a; Waechter and Kastl 1988) indicates that the major detoxifying pathway occurs via conjugation with glutathione, which can occur in target organs such as portal-of-entry tissues (nasal epithelia and the stomach) as well as the liver and kidney. Since depletion of glutathione results in saturation of the detoxification pathway, resulting in the use of secondary metabolic pathways that produce mutagenic metabolites (Schneider et al. 1998a), research on therapies that increase tissue levels of glutathione (for example, N-acetylcysteine) is needed. Conversely, since 1,1-dichloropropene produces mutagenic metabolites upon reaction with glutathione, therapies that interfere with that reaction are needed. Additional studies on the metabolism of 1,1-dichloropropene would help to identify possible detoxifying pathways so that therapies could be developed.

### 3. HEALTH EFFECTS

Additional data are needed on the toxicity of 1,2-, and 3,3-dichloropropene before any studies can be conducted on methods for reducing toxic effects of these isomers.

**Children's Susceptibility.** Data needs relating to both prenatal and childhood exposures, and developmental effects expressed either prenatally or during childhood, are discussed in detail in the Developmental Toxicity subsection above.

The scant information on the toxicity of dichloropropenes in humans is limited to studies in adults exposed to 1,3-dichloropropene. Data relating to health effects in children are lacking. As physiological parameters differ in fetuses, newborns, young children, and adults (EPA 2001d), studies should be conducted in animals to determine the effect on those differences on toxicity of dichloropropenes. Especially since children and adults differ with respect to respiratory parameters, animal testing should be conducted by the inhalation route to determine whether juveniles are at greater or lesser risk compared to adults following exposure. More information is needed on transfer of dichloropropenes across the placenta, the kinetics of transfer, and placental metabolism of dichloropropenes. Since depletion of glutathione stores is possibly related to increased use of bioactivating metabolic pathways by 1,3- and 2,3-dichloropropene, studies monitoring the conditions under which placental glutathione stores are depleted would be useful. As dichloropropene was previously reported in one of eight samples of human breast milk, additional toxicokinetic research is needed to define the risk associated with transfer via milk (Pellizzari et al. 1982).

Child health data needs relating to exposure are discussed in Section 6.8.1, Identification of Data Needs: Exposures of Children.

#### **3.12.3 Ongoing Studies**

No ongoing studies were located on the toxicity or mechanism of action of dichloropropenes.

## 4. CHEMICAL AND PHYSICAL INFORMATION

### 4.1 CHEMICAL IDENTITY

Data pertaining to the chemical identity of 1,1-, 1,2-, cis-1,3-, trans-1,3-, 2,3-, and 3,3-dichloropropene are listed in Table 4-1.

### 4.2 PHYSICAL AND CHEMICAL PROPERTIES

The physical and chemical properties of 1,1-, 1,2-, cis-1,3-, trans-1,3-, 2,3-, and 3,3-dichloropropene are presented in Table 4-2.

## 4. CHEMICAL AND PHYSICAL INFORMATION

**Table 4-1. Chemical Identity of the Isomers of Dichloropropene**

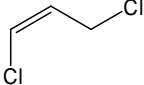
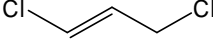
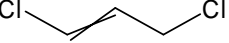
Characteristics	cis-1,3-Dichloropropene	trans-1,3-Dichloropropene	cis- and trans-1,3-Dichloropropene	References
Chemical name	cis-1,3-Dichloropropene	trans-1,3-Dichloropropene	1,3-Dichloropropene	Lide 2005; NIOSH 2005
Synonyms	(Z)-1,3-Dichloropropene; cis-1,3-dichloro-1-propene; cis-1,3-dichloropropylene; cis-DCP	(E)-1,3-Dichloropropene; trans-1,3-dichloro-1-propene; trans-1,3-dichloropropylene; trans-DCP	1,3-Dichloropropene; 1,3-dichloro-1-propene; 1,3-dichloropropylene; 1,3-D	ChemID 2006a, 2006b
Trade names	Not applicable	Not applicable	PIC CLOR; TRICAL; TRI-CAL TRILONE II; TRI-FORM; TELONE; INLINE	EPA 2006i
Chemical formula	C <sub>3</sub> H <sub>4</sub> Cl <sub>2</sub>	C <sub>3</sub> H <sub>4</sub> Cl <sub>2</sub>	C <sub>3</sub> H <sub>4</sub> Cl <sub>2</sub>	RTECS 2006
Chemical structure				ChemID 2006a, 2006b; Lemen 2001; Lide 2005;
Identification numbers:				
CAS registry	10061-01-5	10061-02-6	542-75-6	RTECS 2006
NIOSH RTECS	UC8325000	UC8320000	UC8310000	RTECS 2006
EPA hazardous waste	Not available	Not available	U084	RTECS 2006
DOT/UN/NA/IMCO shipping	UN/DOT 2047; IMO 3.2	UN/DOT 2047; IMO 3.2	UN/DOT 2047; IMO 3.3	DOT 2000; HSDB 2006
HSDB	1503	1504	1109	HSDB 2006
NCI	Not available	Not available	NCI-C03985	HSDB 2006

## 4. CHEMICAL AND PHYSICAL INFORMATION

**Table 4-1. Chemical Identity of the Isomers of Dichloropropene**

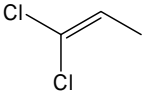
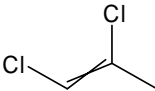
Characteristics	1,1-Dichloropropene	1,2-Dichloropropene	References
Chemical name	1,1-Dichloropropene	1,2-Dichloropropene	ChemID 2006c, 2006d; Lide 2005; RTECS 2006
Synonyms	1,1-Dichloro-1-propene; propene, 1,1-dichloro-; 1,1-dichloropropylene	Propene, 1,2-dichloro-; 1,2-dichloropropylene; propylene dichloride	ChemID 2006c, 2006d; RTECS 2006
Trade names	Not applicable	Not applicable	
Chemical formula	C <sub>3</sub> H <sub>4</sub> Cl <sub>2</sub>	C <sub>3</sub> H <sub>4</sub> Cl <sub>2</sub>	RTECS 2006
Chemical structure			ChemID 2006c, 2006d; Lide 2005
Identification numbers:			
CAS registry	563-58-6	563-54-2	RTECS 2006
NIOSH RTECS	UC8290000	UC8300000	RTECS 2006
EPA hazardous waste	Not available	Not available	RTECS 2006
DOT/UN/NA/IMCO shipping	UN/DOT 2047; IMO not available	UN/DOT 2047; IMO 3.3	DOT 2000; HSDB 2006
HSDB	Not applicable	6175	HSDB 2006
NCI	Not available	Not available	HSDB 2006

## 4. CHEMICAL AND PHYSICAL INFORMATION

**Table 4-1. Chemical Identity of the Isomers of Dichloropropene**

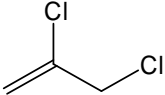
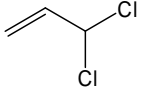
Characteristics	2,3-Dichloropropene	3,3-Dichloropropene	References
Chemical name	2,3-Dichloropropene	3,3-Dichloropropene	ChemID 2006e, 2006f; Lide 2005;
Synonyms	2,3-Dichloro-1-propene; 1,2-dichloro-2-propene; propene, 2,3-dichloro-; 2,3-dichloropropylene	1-Propene, 3,3-dichloro	ChemID 2006e, 2006f
Trade names	Not applicable	Not applicable	
Chemical formula	C <sub>3</sub> H <sub>4</sub> Cl <sub>2</sub>	C <sub>3</sub> H <sub>4</sub> Cl <sub>2</sub>	ChemID 2006e, 2006f
Chemical structure			ChemID 2006e, 2006f
Identification numbers:			
CAS registry	78-88-6	563-57-5	ChemID 2006e, 2006f
NIOSH RTECS	UC8400000	Not applicable	HSDB 2006
EPA hazardous waste	Not available	Not available	
DOT/UN/NA/IMCO shipping	UN/DOT 2047; IMO 3.3	UN/DOT 2047; IMO not available	DOT 2000
HSDB	5222	Not applicable	HSDB 2006
NCI	Not available	Not available	

CAS = Chemical Abstracts Service; DOT/UN/NA/IMCO -Department of Transportation/United Nations/North America/Intergovernmental Maritime Consultative Organization; EPA = Environmental Protection Agency; HSDB = Hazardous Substance Data Bank; NCI = National Cancer Institute; NIOSH = National Institute for Occupational Safety and Health; RTECS = Registry of Toxic Effects of Chemical Substances



## 4. CHEMICAL AND PHYSICAL INFORMATION

**Table 4-2. Physical and Chemical Properties of the Isomers of Dichloropropene**

Property	cis-1,3-Dichloropropene	trans-1,3-Dichloropropene	cis- and trans-1,3-Dichloropropene	References
Molecular weight	110.97	110.97	110.97	RTECS 2006
Color	Colorless	Colorless	Colorless to amber	Lewis 2001; Tomlin 2003
Physical state	Liquid	Liquid	Liquid	Lewis 2001; Tomlin 2003
Melting point	Not available	Not available	-84 °C	Verschueren 2001
Boiling point	104.3 °C	112.0 °C	108 °C	O'Neil 2001
Density	1.224 g/cm <sup>3</sup> at 20 °C	1.217 g/cm <sup>3</sup> at 20 °C	1.211 g/cm <sup>3</sup> at 25 °C	Meister et al. 2006; O'Neil et al. 2001
Odor	Not available	Not available	Sweet, penetrating	Tomlin 2003
Odor threshold				
Water	Not available	Not available	Not available	
Air	Not available	Not available	1 ppm	Verschueren 2001
Solubility				
Water at 20 °C	2.7x10 <sup>3</sup> mg/L	2.8x10 <sup>3</sup> mg/L	2.0x10 <sup>3</sup> mg/L	Dilling 1977; Tomlin 2003
Organic solvents	Soluble in ether, benzene, and chloroform	Soluble in ether, benzene, and chloroform	Miscible with hydrocarbons, halogenated solvents, esters, and ketones	Lide 2005; Tomlin 2003
Partition coefficients				
Log octanol/water	2.06	2.03	1.82	Tomlin 2003
K <sub>oc</sub>	23, 25.7, 26.3, 27.6	26, 27.8, 27.2, 27.5	18–60	Hamaker and Thompson 1972; Kenaga 1980; Kim et al. 2003b
Vapor pressure	30 mm Hg at 20 °C	22 mm Hg at 20 °C	27.8 mm Hg at 20 °C	Dilling 1977; EPA 1981c
Vapor density (air = 1)	Not available	Not available	3.83	Lemen 2001
Henry's law constant (atm/m <sup>3</sup> -molecule at 20 °C)	2.71x10 <sup>-3</sup>	8.71x10 <sup>-4</sup>	3.55x10 <sup>-3</sup>	EPA 1987b; Leistra 1970
Flashpoint (open cup)	21 °C (69.8 °F)	21 °C (69.8 °F)	35 °C (95 °F)	Lewis 2000, 2001
Conversion factors				
ppm (v/v) to mg/m <sup>3</sup> in air (20 °C)	4.61	4.61	4.61	Verschueren 2001
mg/m <sup>3</sup> to ppm (v/v) in air (20 °C)	0.22	0.22	0.22	Verschueren 2001
Bioconcentration factor (log BCF)	Not available	Not available	Not available	
Explosive limits	Not available	Not available	5.3–14.5%	NIOSH 2005

## 4. CHEMICAL AND PHYSICAL INFORMATION

**Table 4-2. Physical and Chemical Properties of the Isomers of Dichloropropene**

Property	1,1-Dichloropropene	1,2-Dichloropropene	References
Molecular weight	110.97	110.97	RTECS 2006
Color	Not available	Not available	
Physical state	Liquid	Liquid	EPA 1981c
Melting point	Not available	Not available	
Boiling point	76.5 °C	75 °C	Lide 2005; Verschueren 2001
Density	1.186 g/cm <sup>3</sup> at 25 °C	Not available	Lide 2005
Odor	Not available	Not available	
Odor threshold			
Water	Not available	Not available	
Air	Not available	Not available	
Solubility			
Water at	Not available	2.7x10 <sup>3</sup> mg/L at 25 °C	Gunther et al. 1968
Organic solvents	Soluble in ether, acetone, and chloroform	Soluble in ether, benzene, and chloroform	Lide 2005
Partition coefficients			
Log octanol/water	Not available	Not available	
K <sub>oc</sub>	Not available	Not available	
Vapor pressure	91 mm Hg at 20 °C	91 mm Hg at 20 °C	EPA 1981c
Vapor density (air=1)	Not available	3.83	Lewis 2000; Verschueren 2001
Henry's law constant (atm/m <sup>3</sup> -molecule at 20 °C)	Not available	Not available	
Flashpoint	Not available	Not available	
Conversion factors			
ppm (v/v) to mg/m <sup>3</sup> in air (20 °C)	4.61	4.61	Verschueren 2001
mg/m <sup>3</sup> to ppm (v/v) in air (20 °C)	0.22	0.22	Verschueren 2001
Bioconcentration factor (log BCF)	Not available	Not available	
Explosive limits	Not available	Not available	

## 4. CHEMICAL AND PHYSICAL INFORMATION

**Table 4-2. Physical and Chemical Properties of the Isomers of Dichloropropene**

Property	2,3-Dichloropropene	3,3-Dichloropropene	References
Molecular weight	110.97	110.97	ChemID 2006e, 2006f; RTECS 2006
Color	Straw-colored	Not available	Verschueren 2001
Physical state	Liquid	Liquid	Lide 2005; EPA 1981c
Melting point	10 °C	Not available	Lide 2005; Verschueren 2001
Boiling point	94 °C	84.4 °C	Lide 2005; EPA 1981c
Density (20 °C)	1.211 g/cm <sup>3</sup> at 20 °C	1.224 g/cm <sup>3</sup> at 20 °C	Lide 2005; Meister et al. 2006; O'Neil 2001
Odor	Pungent	Not available	Verschueren 2001
Odor threshold			
Water	Not available	Not available	
Air	Not available	Not available	
Solubility			
Water	2.15x10 <sup>3</sup> mg/L at 25 °C	Not available	Mackay and Shiu 1981
Organic solvents	Miscible in ethanol, soluble in ether, benzene, and chloroform	Soluble in ether, benzene, and chloroform	Lide 2005; Tomlin 2003
Partition coefficients			
Log octanol/water	Not available	Not available	
K <sub>oc</sub>	Not available	Not available	
Vapor pressure	45 mm Hg at 20 °C	71 mm Hg at 20 °C	EPA 1981c
Vapor density (air=1)	3.8	Not available	Lewis 2000; Verschueren 2001
Henry's law constant (atm/m <sup>3</sup> -molecule at 20 °C)	Not available	Not available	
Flashpoint	10 °C (50 °F)	Not available	Lewis 2000
Conversion factors			
ppm (v/v) to mg/m <sup>3</sup> in air (20 °C)	4.61	4.61	Verschueren 2001
mg/m <sup>3</sup> to ppm (v/v) in air (20 °C)	0.22	0.22	Verschueren 2001
Bioconcentration factor (log BCF)	Not available	Not available	
Explosive limits	Not available	Not available	

4. CHEMICAL AND PHYSICAL INFORMATION

This page is intentionally blank.

## 5. PRODUCTION, IMPORT/EXPORT, USE, AND DISPOSAL

### 5.1 PRODUCTION

1,3-Dichloropropene is produced by either high-temperature chlorination of propylene or from 1,3-dichloro-2-propanol by dehydration with  $\text{POCl}_3$  or  $\text{P}_2\text{O}_5$  in benzene (Hartwig et al. 2005; Krahling et al. 2005; Yang 1986). All commercial preparations of 1,3-dichloropropene are mixtures of the cis- and trans- isomers. Before 1978, approximately 25 million kilograms (25,000 metric tons) of 1,3-dichloropropene were produced annually in the United States (Yang 1986). Over 1 million kilograms (1,000 metric tons) of pesticides containing 1,3-dichloropropene were used in California alone in 1978. The production volume of 1,3-dichloropropene reported by U.S. manufacturers in 1986, 1990, 1994, 1998, and 2002 was within the range of >1 million pounds to 10 million pounds (>450–4,500 metric tons) (IUR 2002).

2,3-Dichloropropene is produced during the chlorination of propylene as a byproduct in allyl chloride synthesis (Krijgsheld and Vandergen 1986). It can also be formed by treating 1,2,3-trichloropropane with alkali or by chlorination of 2-chloro-1-propene. Production methods for 1,1-, 1,2-, and 3,3-dichloropropene were not located. Based on the International Update Rule data, the production volume of 2,3-dichloropropene reported by U.S. manufacturers was within the range of >1 million pounds to 10 million pounds (>450–4,500 metric tons) in 1986 and <10,000 pounds (4.5 metric tons) in 1990, 1994, 1998, and 2002 (IUR 2002). 1,1-, 1,2-, and 3,3-Dichloropropene were not listed as high production volume chemicals (>10,000 pounds or 4.5 metric tons produced per year) in 1986, 1990, 1994, 1998, or 2002 (IUR 2002).

According to SRI (2005), Dow AgroSciences LLC (Freeport, Texas) is the only current manufacturer of 1,3-dichloropropene. Active registrants of 1,3-dichloropropene pesticide formulations include Dow AgroSciences LLC (Indianapolis, Indiana), Soil Chemicals Corporation (Hollister, California), and Trical (Hollister, California). Current manufacturers of 1,1-, 1,2-, 2,3-, and 3,3-dichloropropene were not located in the literature.

After the use of ethylene dibromide (EDB) was suspended by EPA, 1,3-dichloropropene and methyl bromide became the major substitutes for EDB (Yang 1986). Now that the use of methyl bromide is scheduled to be phased out by EPA in 2006, 1,3-dichloropropene is expected to become a substitute for

## 5. PRODUCTION, IMPORT/EXPORT, USE, AND DISPOSAL

this pesticide as well (Cryer and van Wesenbeeck 2001; El Hadiri et al. 2003; EPA 2006k; Kim et al. 2003a, 2003b). 1,3-Dichloropropene use permits were suspended in California during 1990 after high concentrations of this pesticide were detected in air samples (Baker et al. 1996; EPA 1998b; Roby and Melichar 1997). Reintroduction of limited use was approved by the California Department of Pesticide Regulation in 1994.

Tables 5-1 and 5-2 list the facilities in each state that manufacture or process 1,3-dichloropropene and 2,3-dichloropropene, respectively. These tables give the intended use and the range of the amounts of 1,3- and 2,3-dichloropropene stored on site. The data listed in Tables 5-1 and 5-2 are derived from the Toxics Release Inventory (TRI04 2006). Only certain types of facilities were required to report (EPA 1997). Therefore, this is not an exhaustive list. TRI data are not available for 1,1-, 1,2-, and 3,3-dichloropropene.

## 5.2 IMPORT/EXPORT

Import and export data for 1,1-, 1,2-, 1,3-, 2,3-, and 3,3-dichloropropene were not located in the literature.

## 5.3 USE

1,3-Dichloropropene is the predominant component of several formulations used in agriculture as soil fumigants for parasitic nematodes (Hartwig et al. 2005; Krijgsheld and Van der Gen 1986). Currently, there are 14 registered commercial preparations of fumigants that contain 1,3-dichloropropene (EPA 2006i). The trade names of these preparations are listed in Chapter 4. Table 5-3 contains the reported chemical compositions of these mixtures. Some variation may exist in the composition of these products. Most of these fumigants are not diluted and are applied directly to the soil of vegetable and tobacco crops (Yang 1986). Much smaller quantities of 1,3-dichloropropene are used as solvents and chemical intermediates (Krijgsheld and Van der Gen 1986; Lewis 2001).

2,3-Dichloropropene is used as a chemical intermediate (Krijgsheld and Vandergen 1986). It was formerly used as an active ingredient along with ethylene dichloride in a pesticide formulation (EPA 2006i). However, the registration of this pesticide was cancelled in 1985. Uses for 1,1-, 1,2-, and 3,3-dichloropropene were not located in the available literature.

## 5. PRODUCTION, IMPORT/EXPORT, USE, AND DISPOSAL

**Table 5-1. Facilities that Produce, Process, or Use 1,3-Dichloropropene**

State <sup>a</sup>	Number of facilities	Minimum amount on site in pounds <sup>b</sup>	Maximum amount on site in pounds <sup>b</sup>	Activities and uses <sup>c</sup>
AR	2	1,000	99,999	12
CA	10	1,000	9,999,999	6, 7, 9
DE	4	10,000	9,999,999	6, 10
FL	1	1,000,000	9,999,999	7, 9
GA	2	10,000	999,999	9
HI	1	1,000	9,999	10
IL	2	1,000	99,999	7, 12
LA	18	0	9,999,999	1, 3, 4, 5, 6, 12, 13
MI	7	100,000	9,999,999	1, 3, 4, 5, 7, 9, 12
MS	1	1,000	9,999	10
NC	2	100,000	9,999,999	9
NJ	2	1,000	99,999	12
OH	3	1,000	9,999,999	1, 4, 7, 12
SC	1	10,000	99,999	6
TX	19	1,000	99,999,999	1, 2, 3, 4, 5, 6, 7, 8, 9, 11, 12, 13, 14
WA	1	1,000,000	9,999,999	9

<sup>a</sup>Post office state abbreviations used

<sup>b</sup>Amounts on site reported by facilities in each state

<sup>c</sup>Activities/Uses:

- |                          |                          |                             |
|--------------------------|--------------------------|-----------------------------|
| 1. Produce               | 6. Impurity              | 11. Chemical Processing Aid |
| 2. Import                | 7. Reactant              | 12. Manufacturing Aid       |
| 3. Onsite use/processing | 8. Formulation Component | 13. Ancillary/Other Uses    |
| 4. Sale/Distribution     | 9. Article Component     | 14. Process Impurity        |
| 5. Byproduct             | 10. Repackaging          |                             |

Source: TRI04 2006 (Data are from 2004)

## 5. PRODUCTION, IMPORT/EXPORT, USE, AND DISPOSAL

**Table 5-2. Facilities that Produce, Process, or Use 2,3-Dichloropropene**

State <sup>a</sup>	Number of facilities	Minimum amount on site in pounds <sup>b</sup>	Maximum amount on site in pounds <sup>b</sup>	Activities and uses <sup>c</sup>
IA	2	100	9,999	1, 5, 13
IN	1	10,000	99,999	6
LA	5	10,000	999,999	1, 4, 5, 12, 13
TX	17	0	49,999,999	1, 2, 3, 5, 6, 7, 8, 12, 13, 14

<sup>a</sup>Post office state abbreviations used

<sup>b</sup>Amounts on site reported by facilities in each state

<sup>c</sup>Activities/Uses:

- |                          |                          |                             |
|--------------------------|--------------------------|-----------------------------|
| 1. Produce               | 6. Impurity              | 11. Chemical Processing Aid |
| 2. Import                | 7. Reactant              | 12. Manufacturing Aid       |
| 3. Onsite use/processing | 8. Formulation Component | 13. Ancillary/Other Uses    |
| 4. Sale/Distribution     | 9. Article Component     | 14. Process Impurity        |
| 5. Byproduct             | 10. Repackaging          |                             |

Source: TRI04 2006 (Data are from 2004)



## 5. PRODUCTION, IMPORT/EXPORT, USE, AND DISPOSAL

**Table 5-3. Compositions of Actively Registered Commercial Products Containing 1,3-Dichloropropene**

Name	Composition	Manufacturer
Pic Clor 60	39% 1,3-dichloropropene 59.4% chloropicrin	Soil Chemicals Corporation
Pic-Chlor 15	82.9% 1,3-dichloropropene 14.8% chloropicrin	Soil Chemicals Corporation
Pic-Chlor 30	68.2% 1,3-dichloropropene 29.7% chloropicrin	Soil Chemicals Corporation
Tri-Cal Trilone II Soil Fumigant	94% 1,3-dichloropropene	Trical
Tri-Form 40/60	37.6% 1,3-dichloropropene 60% chloropicrin	Trical
Telone C-15	82.9% 1,3-dichloropropene 14.8% chloropicrin	Trical
Tri-Form 30	68.2% 1,3-dichloropropene 29.7% chloropicrin	Trical
Tri-Form 35	63.4% 1,3-dichloropropene 34.6% chloropicrin	Trical
Telone C-17	81.2% 1,3-dichloropropene 16.5% chloropicrin	Dow Agrosciences LLC
Telone II	97.5% 1,3-Dichloropropene	Dow Agrosciences LLC
Telone C-35	63.4% 1,3-dichloropropene 34.7% chloropicrin	Dow Agrosciences LLC
Telone EC	93.6% 1,3-dichloropropene	Dow Agrosciences LLC
Telone Technical	97.5% 1,3-dichloropropene	Dow Agrosciences LLC
Inline	60.8% 1,3-dichloropropene 33.3% chloropicrin	Dow Agrosciences LLC

Source: EPA 2006i

## 5. PRODUCTION, IMPORT/EXPORT, USE, AND DISPOSAL

**5.4 DISPOSAL**

1,3-Dichloropropene may be disposed of by using a sorbent media that is packaged in an epoxy-lined drum and placed in a Resource Conservation and Recovery Act (RCRA)-approved landfill. 1,3-Dichloropropene may also be disposed of in a high-temperature incinerator with an acid scrubber and a temperature/dwell time that will completely destroy the pesticide (HSDB 2006). Disposal methods specific to 1,1-, 1,2-, 2,3-, and 3,3-dichloropropene were not located in the literature; however, disposal methods designed for 1,3-dichloropropene are expected to apply to these isomers as well based on the similarities in physical and chemical properties.

## 6. POTENTIAL FOR HUMAN EXPOSURE

### 6.1 OVERVIEW

The majority of dichloropropene data pertaining to environmental releases, environmental fate and partitioning, monitoring in environmental media, and the potential for human exposure have been provided for the 1,3- isomer only. This is most likely because 1,3-dichloropropene is produced in much larger quantities than the other isomers and it is released directly into the environment as a pesticide. Therefore, the focus of this chapter is on 1,3-dichloropropene. Relevant data regarding 1,1-, 1,2-, 2,3-, and 3,3-dichloropropene are included whenever available.

1,2-, 1,3-, and 2,3-Dichloropropene have been identified in at least 5, 112, and 3 of the 1,678 hazardous waste sites, respectively, that have been proposed for inclusion on the EPA National Priorities List (NPL) (HazDat 2006). However, the number of sites evaluated for 1,2-, 1,3-, and 2,3-dichloropropene is not known. The frequency of sites where 1,3-dichloropropene has been identified can be seen in Figure 6-1, while those where 1,2- and 2,3-dichloropropene have been identified can be seen in Figures 6-2 and 6-3, respectively. 1,1- and 3,3-Dichloropropene were not identified in any of the 1,678 hazardous waste sites that have been proposed for inclusion on the EPA NPL.

1,3-Dichloropropene is not a naturally occurring compound (IARC 1986). It is produced synthetically and may be released to the atmosphere in fugitive or accidental emissions during its manufacture, storage, and transport. 1,3-Dichloropropene's use as a soil fumigant for the control of nematodes in various crops will result in its direct release to the environment (EPA 1978a; Lao et al. 1982). 1,3-Dichloropropene is typically applied to soils prior to planting by underground injection at a depth of 12–18 inches (EPA 1998b). Due to its volatile nature, it may migrate to the soil surface where it volatilizes to air. In order to reduce potential emissions to air and increase the effectiveness of 1,3-dichloropropene as a fumigant, soil sealing techniques such as immediate irrigation, soil compacting, and covering the treated fields with tarps are common agricultural practices when using 1,3-dichloropropene and other fumigants (EPA 1998b).

1,3-Dichloropropene may leach into groundwater and soil from landfills and hazardous waste sites (Hauser and Bromberg 1982; Sabel and Clark 1984). The most common release of 1,3-dichloropropene to soil occurs during the application of the chemical to agricultural fields when used as a soil fumigant

6. POTENTIAL FOR HUMAN EXPOSURE

**Figure 6-1. Frequency of NPL Sites with 1,3-Dichloropropene Contamination**

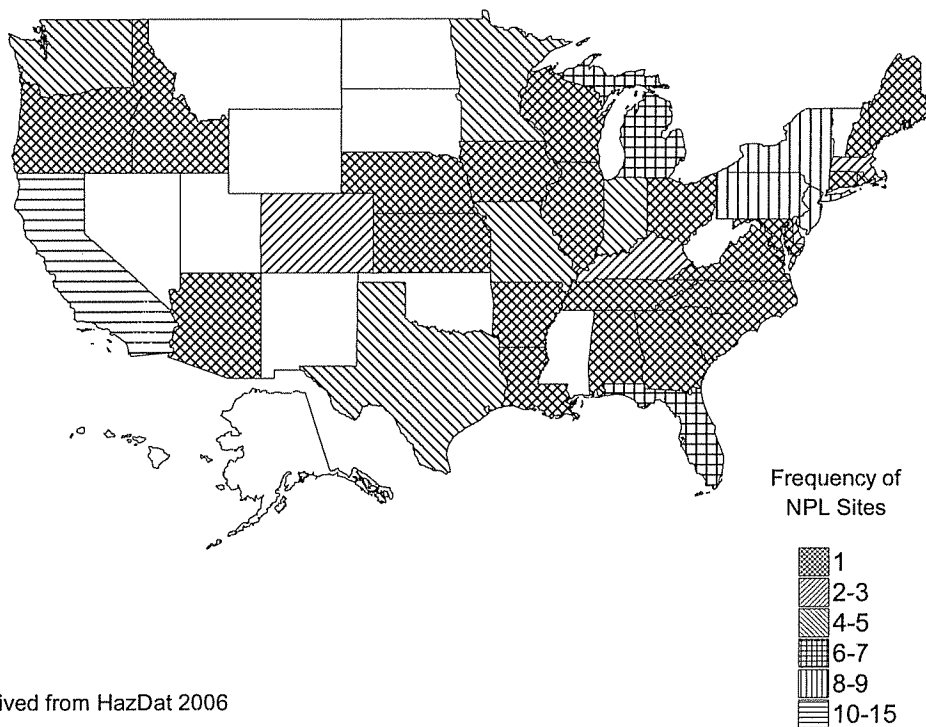

Derived from HazDat 2006

6. POTENTIAL FOR HUMAN EXPOSURE

**Figure 6-2. Frequency of NPL Sites with 1,2-Dichloropropene Contamination**

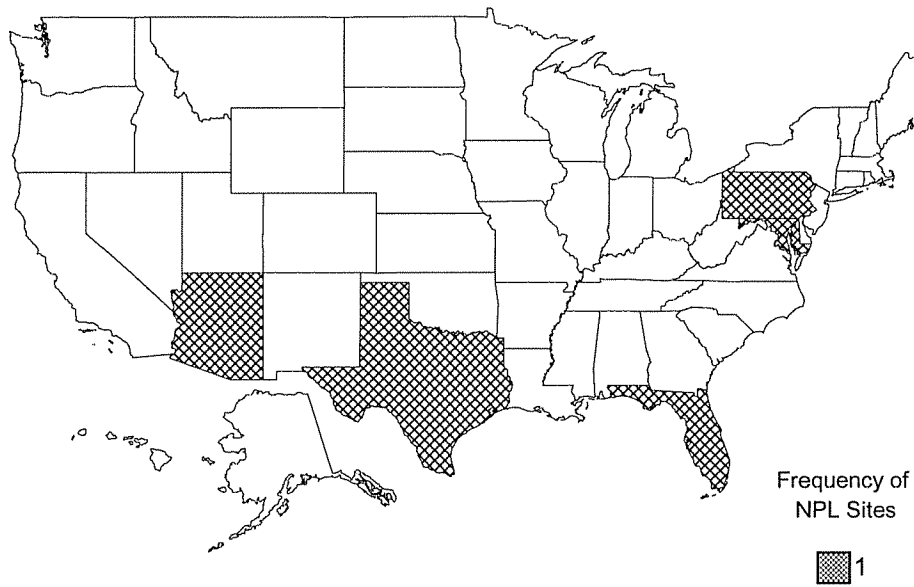

Derived from HazDat 2006

6. POTENTIAL FOR HUMAN EXPOSURE

**Figure 6-3. Frequency of NPL Sites with 2,3-Dichloropropene Contamination**

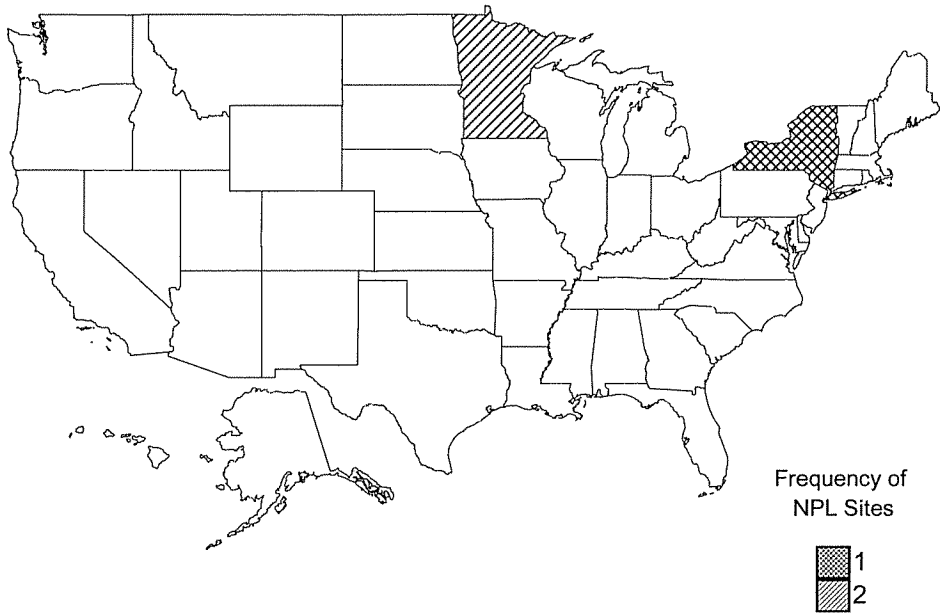

Derived from HazDat 2006

## 6. POTENTIAL FOR HUMAN EXPOSURE

(CEPA 1982; Cohen 1986; Krijgsheld and Van der Gen 1986; Maddy et al. 1982). Accidental spills may also release 1,3-dichloropropene to the environment (Markovitz and Crosby 1984; Sterrett et al. 1986). Releases of 1,1-, 1,2-, and 3,3-dichloropropene into the environment are expected to be low since these substances are not produced or used on a large scale for commercial or industrial purposes. 2,3-Dichloropropene may be released from facilities where it is produced or used.

Limited monitoring data are available for 1,3-dichloropropene in surface water, drinking water, and soil; however, the existing data indicate that this substance is not widely detected in these media (Dowty et al. 1975a, 1975b; EPA 2006j; Krijgsheld and Van der Gen 1986; Otson 1987; Rogers et al. 1987). 1,3-Dichloropropene has not been detected in table-ready foods (EPA 1998b; FDA 2005b). 1,3-Dichloropropene was positively detected in air in generally <5% of urban air samples collected across the United States. Mean concentrations among the positive samples from both urban and rural locations across the United States ranged from 0.088 to 0.33 ppb. 1,3-Dichloropropene air concentrations as high as 35.2 ppb have been measured at high-use locations. A few nationwide surveys have been conducted in which 1,3-dichloropropene was analyzed for in water; however, only the STORET database lists positive detections of this substance (EPA 2006j; Kolpin et al. 2000; Moran et al. 2004). 1,3-Dichloropropene was detected in approximately 40% of 12,673 water samples listed in STORET (EPA 2006j). However, only 6% of the samples contained 1,3-dichloropropene above the quantitation limit (unspecified). The range, mean, and median of quantifiable 1,3-dichloropropene concentrations were 0.002–25, 0.5, and 0.5 ppb, respectively. 1,3-Dichloropropene was detected in only 0.1% of 70,631 public water system samples collected in the United States between 1993 and 1997 (EPA 2001c).

1,1-, 1,2-, 2,3-, and 3,3-Dichloropropene are not commonly found at measurable concentrations in air, surface water, drinking water, groundwater, soil, or food. 1,1-Dichloropropene has been detected in 64% of 5,348 water samples listed in STORET, but only 1% of the samples contained 1,1-dichloropropene above the quantifiable limit. The range of quantifiable concentrations in water was 0.001–5 ppb, with a mean of 0.4 ppb (EPA 2006j). 1,1-Dichloropropene was detected in only 0.01% of 97,698 public water system samples collected in the United States between 1993 and 1997 (EPA 2001c).

Possible routes of human exposure to 1,3-dichloropropene include inhalation, ingestion of contaminated drinking waters, and dermal contact. 1,3-Dichloropropene is rarely detected in foods due to its relatively short environmental persistence; therefore, exposure to the general population through the consumption of food is considered to be low. High levels of exposure to 1,3-dichloropropene are most likely to occur in occupational settings where 1,3-dichloropropene is either produced or used as a soil fumigant (Albrecht

## 6. POTENTIAL FOR HUMAN EXPOSURE

1987b; Albrecht et al. 1986; Markovitz and Crosby 1984; Nater and Gooskens 1976; Osterloh et al. 1984, 1989a, 1989b; van Joost and de Jong 1988; Wang 1984). Intake by inhalation or dermal contact is the most probable route of workplace exposure to 1,3-dichloropropene. 1,3-Dichloropropene is a volatile compound and, after soil application as a fumigant, a fraction of the compound will volatilize and escape into the atmosphere (Krijgsheld and Van der Gen 1986). Inhalation and dermal contact are probably the major sources of exposure to individuals who work in fields where 1,3-dichloropropene is applied.

The potential for human exposure to 1,1-, 1,2-, and 3,3-dichloropropene is expected to be low because they are not produced or used in high amounts. Since 2,3-dichloropropene may be released from facilities where this substance is produced or used, individuals who work or live near these facilities may be exposed to this substance; however, exposure of the general population to 2,3-dichloropropene is not expected to be important.

## 6.2 RELEASES TO THE ENVIRONMENT

The Toxics Release Inventory (TRI) data should be used with caution because only certain types of facilities are required to report (EPA 2005a). This is not an exhaustive list. Manufacturing and processing facilities are required to report information to the TRI only if they employ 10 or more full-time employees; if their facility is included in Standard Industrial Classification (SIC) Codes 10 (except 1011, 1081, and 1094), 12 (except 1241), 20–39, 4911 (limited to facilities that combust coal and/or oil for the purpose of generating electricity for distribution in commerce), 4931 (limited to facilities that combust coal and/or oil for the purpose of generating electricity for distribution in commerce), 4939 (limited to facilities that combust coal and/or oil for the purpose of generating electricity for distribution in commerce), 4953 (limited to facilities regulated under RCRA Subtitle C, 42 U.S.C. section 6921 et seq.), 5169, 5171, and 7389 (limited S.C. section 6921 et seq.), 5169, 5171, and 7389 (limited to facilities primarily engaged in solvents recovery services on a contract or fee basis); and if their facility produces, imports, or processes  $\geq 25,000$  pounds of any TRI chemical or otherwise uses  $>10,000$  pounds of a TRI chemical in a calendar year (EPA 2005a).

### 6.2.1 Air

Estimated releases of 4,129 pounds (1.9 metric tons) of 1,3-dichloropropene to the atmosphere from 15 domestic manufacturing and processing facilities in 2003, accounted for about 92% of the estimated total environmental releases from facilities required to report to the TRI (TRI04 2006). Estimated



## 6. POTENTIAL FOR HUMAN EXPOSURE

releases of 5,391 pounds (2.4 metric tons) of 2,3-dichloropropene to the atmosphere from five domestic manufacturing and processing facilities in 2004, accounted for about 99% of the estimated total environmental releases from facilities required to report to the TRI (TRI04 2006). These releases of 1,3- and 2,3-dichloropropene are summarized in Tables 6-1 and 6-2, respectively. 1,1-, 1,2-, and 3,3-Dichloropropene were not listed in the TRI.

1,3-Dichloropropene is produced synthetically and may be released to the atmosphere as fugitive or accidental emissions during its manufacture (Leiber and Berk 1984; van Joost and de Jong 1988), transport (Markovitz and Crosby 1984; Sterrett et al. 1986), and storage (Albrecht et al. 1986). For example, on April 8, 1984, a rail accident that occurred about 45 miles southeast of Tucson, Arizona resulted in a spill of 15,000 gallons of 1,3-dichloropropene. During the clean-up, which took place between August 1984 and March 1985, approximately 19,000 pounds of 1,3-dichloropropene were released to ambient air by an aeration process (Sterrett et al. 1986).

A major anthropogenic release of 1,3-dichloropropene to the atmosphere occurs during its application as a soil fumigant (Albrecht 1987a; Markovitz and Crosby 1984; Osterloh et al. 1984, 1989a, 1989b). Current application methods involve injecting the fumigant at least 12 inches below the soil surface (EPA 1998b). Off-gassing of 1,3-dichloropropene in chisel trace left behind during application occurs for several days after application. Current methods used to minimize volatilization of 1,3-dichloropropene after application include soil compaction, irrigation, and covering with a tarp (EPA 1998b). Modification of current application methods and the use of organic and fertilizer amendments are being explored as ways to further minimize air emissions of 1,3-dichloropropene from treated fields (Gan et al. 1998a, 1998b; Kim et al. 2003b; Wang et al. 2001a, 2001b).

1,3-Dichloropropene was detected in atmospheric samples of three sites located in Washington state, Arizona, and North Carolina following its application (NCFA 1997). 1,3-Dichloropropene was broadcast applied to a 20-acre loamy sand field at an application rate of 252 lbs a.i./A at the Washington state site. It was row applied to a 20-acre sandy loam located in Arizona at a rate of 121.2 lbs a.i./A, and was broadcast applied at a rate of 164 lbs a.i. to a 12-acre sandy loam plot in North Carolina used to grow tobacco. Atmospheric samples were monitored over a 15-day period at each site and at distances of up to 1,600 meters from the site. These data are summarized in Table 6-3.

## 6. POTENTIAL FOR HUMAN EXPOSURE

**Table 6-1. Releases to the Environment from Facilities that Produce, Process, or Use 1,3-Dichloropropene<sup>a</sup>**

State <sup>c</sup>	RF <sup>d</sup>	Reported amounts released in pounds per year <sup>b</sup>							
		Air <sup>e</sup>	Water <sup>f</sup>	UI <sup>g</sup>	Land <sup>h</sup>	Other <sup>i</sup>	Total release		
							On-site <sup>j</sup>	Off-site <sup>k</sup>	On- and off-site
AR	1	0	0	0	0	0	0	0	0
CA	2	25	0	0	0	0	25	0	25
DE	1	34	0	0	0	0	34	0	34
FL	1	1,215	0	0	0	0	1,215	0	1,215
GA	2	618	0	0	0	0	618	0	618
LA	2	525	0	0	0	0	525	0	525
NC	1	500	0	0	0	0	500	0	500
OH	1	5	0	0	250	0	5	250	255
TX	3	1,057	0	0	92	0	1,149	0	1,149
WA	1	150	0	0	0	0	150	0	150
<b>Total</b>	<b>15</b>	<b>4,129</b>	<b>0</b>	<b>0</b>	<b>342</b>	<b>0</b>	<b>4,221</b>	<b>250</b>	<b>4,471</b>

<sup>a</sup>The TRI data should be used with caution since only certain types of facilities are required to report. This is not an exhaustive list. Data are rounded to nearest whole number.

<sup>b</sup>Data in TRI are maximum amounts released by each facility.

<sup>c</sup>Post office state abbreviations are used.

<sup>d</sup>Number of reporting facilities.

<sup>e</sup>The sum of fugitive and point source releases are included in releases to air by a given facility.

<sup>f</sup>Surface water discharges, waste water treatment-(metals only), and publicly owned treatment works (POTWs) (metal and metal compounds).

<sup>g</sup>Class I wells, Class II-V wells, and underground injection.

<sup>h</sup>Resource Conservation and Recovery Act (RCRA) subtitle C landfills; other on-site landfills, land treatment, surface impoundments, other land disposal, other landfills.

<sup>i</sup>Storage only, solidification/stabilization (metals only), other off-site management, transfers to waste broker for disposal, unknown

<sup>j</sup>The sum of all releases of the chemical to air, land, water, and underground injection wells.

<sup>k</sup>Total amount of chemical transferred off-site, including to POTWs.

RF = reporting facilities; UI = underground injection

Source: TRI04 2006 (Data are from 2004)

## 6. POTENTIAL FOR HUMAN EXPOSURE

**Table 6-2. Releases to the Environment from Facilities that Produce, Process, or Use 2,3-Dichloropropene<sup>a</sup>**

State <sup>c</sup>	RF <sup>d</sup>	Reported amounts released in pounds per year <sup>b</sup>						Total release		
		Air <sup>e</sup>	Water <sup>f</sup>	UI <sup>g</sup>	Land <sup>h</sup>	Other <sup>i</sup>	On-site <sup>j</sup>	Off-site <sup>k</sup>	On- and off-site	
IA	1	4,768	No data	0	0	0	4,768	0	4,768	
LA	2	541	No data	0	0	0	541	0	541	
TX	2	82	2	0	9	0	93	0	93	
Total	5	5,391	2	0	9	0	5,402	0	5,402	

<sup>a</sup>The TRI data should be used with caution since only certain types of facilities are required to report. This is not an exhaustive list. Data are rounded to nearest whole number.

<sup>b</sup>Data in TRI are maximum amounts released by each facility.

<sup>c</sup>Post office state abbreviations are used.

<sup>d</sup>Number of reporting facilities.

<sup>e</sup>The sum of fugitive and point source releases are included in releases to air by a given facility.

<sup>f</sup>Surface water discharges, waste water treatment-(metals only), and publicly owned treatment works (POTWs) (metal and metal compounds).

<sup>g</sup>Class I wells, Class II-V wells, and underground injection.

<sup>h</sup>Resource Conservation and Recovery Act (RCRA) subtitle C landfills; other on-site landfills, land treatment, surface impoundments, other land disposal, other landfills.

<sup>i</sup>Storage only, solidification/stabilization (metals only), other off-site management, transfers to waste broker for disposal, unknown

<sup>j</sup>The sum of all releases of the chemical to air, land, water, and underground injection wells.

<sup>k</sup>Total amount of chemical transferred off-site, including to POTWs.

RF = reporting facilities; UI = underground injection

Source: TRI04 2006 (Data are from 2004)

## 6. POTENTIAL FOR HUMAN EXPOSURE

**Table 6-3. Maximum Concentrations (24-Hour Time-Weighted Average) of 1,3-Dichloropropene in Air at Varying Distances from Treated Fields**

Distance from treated field (meters) <sup>a</sup>	Location	Maximum 4-hour concentration (ppb)	Maximum 24-hour TWA concentration (ppb)	Mean 7-day concentration (ppb)	Mean 15-day concentration (ppb)
1,600	Arizona	20.0	5.1	0.7	0.5
1,200	Arizona	34.7	10.1	1.2	0.8
800	Arizona	47.5	13.8	2.1	1.4
800	Washington	37.8	17.5	4.6	3.2
800	North Carolina	13.9	2.4	0.3	0.3
500	Arizona	106.1	30.9	4.1	2.6
500	Washington	40.3	20.2	5.3	3.8
500	North Carolina	20.3	3.5	0.5	0.3
125	Arizona	376.1	127.4	20.2	12.2
125	Washington	114.7	61.2	12.1	8.8
125	North Carolina	61.8	12.8	2.3	1.3
25	Arizona	786.6	397.5	43.1	24.7
25	Washington	68.6	46.7	16.5	13.7
25	North Carolina	86.7	49.0	5.8	3.3
5	Arizona	350.4	281.2	40.7	23.0
5	Washington	77.2	51.8	20.2	16.2
5	North Carolina	147.7	75.6	8.4	4.8
Onsite	Arizona	509.6	234.7	69.4	37.6
Onsite	Washington	77.2	58.6	33.3	25.4
Onsite	North Carolina	74.8	57.6	16.6	8.9

<sup>a</sup>All samples were obtained at a height of approximately 5 feet above ground.

Source: NCFA 1997

## 6. POTENTIAL FOR HUMAN EXPOSURE

The monitoring data indicated that 1,3-dichloropropene air concentrations peaked during the first 3 days following treatment and then declined over a period of 14 days following treatment, which was the duration of the air monitoring study.

Telone II<sup>®</sup> was applied at approximately 12.8 gallons per acre (121 lbs a.i./acre) to a fallow plot in Nevada and 1,3-dichloropropene levels were monitored for 7 days directly above the field and at locations up to one-half mile away (EPA 1998b). The average concentration of 1,3-dichloropropene at a 6-inch height above the field during 7 days was 465.31  $\mu\text{g}/\text{m}^3$ ; at a 5-foot height at the edge of the field, it was 94.81  $\mu\text{g}/\text{m}^3$ ; at a 5-foot height 100 feet away from the field, it was 39.39  $\mu\text{g}/\text{m}^3$ ; at a 5-foot height 0.25 miles from the field, it was 5.17  $\mu\text{g}/\text{m}^3$ ; and at a 5-foot height one-half mile from the field, it was 3.88  $\mu\text{g}/\text{m}^3$ . Wind velocity was determined to be the major factor in the dispersion of 1,3-dichloropropene.

1,3-Dichloropropene has been identified in air samples collected at 6 of the 1,678 NPL hazardous waste sites where it was detected in some environmental media (HazDat 2006). 1,1-, 1,2-, 2,3-, and 3,3-Dichloropropene were not identified in air samples collected at any of the 1,678 NPL hazardous waste sites.

### 6.2.2 Water

Estimated releases of 2 pounds (0.001 metric tons) of 2,3-dichloropropene to surface water from five domestic manufacturing and processing facilities in 2003, accounted for <1% of the estimated total environmental releases from facilities required to report to the TRI (TRI04 2006). These releases are summarized in Table 6-2. According to TRI estimates, there were no releases of 1,3-dichloropropene to surface water from 15 domestic manufacturing and processing facilities in 2004 (TRI04 2006). TRI data for 1,3--dichloropropene are summarized in Table 6-1. 1,1-, 1,2-, and 3,3-Dichloropropene were not listed in the TRI.

Very little information regarding the release of 1,3-dichloropropene to water was found in the available literature. It has been suggested that chlorination of organic substances during treatment in water systems can result in the formation of low levels of 1,3-dichloropropene (Dowty et al. 1975a, 1975b; Krijgsheld and Van der Gen 1986; Otson 1987; Rogers et al. 1987). Trace quantities of 1,3-dichloropropene are formed during the chlorination of cooling water, which prevents biofouling at electricity-generating power facilities (Bean et al. 1985). Very little information is available regarding the presence of 1,3-dichloropropene in drinking water. A survey of sewage treatment facilities demonstrated that 1,3-dichloro-

## 6. POTENTIAL FOR HUMAN EXPOSURE

propene may be released to surface waters via primary and secondary effluents (EPA 1978a; Lao et al. 1982). Waste water effluents from petroleum refineries may also release 1,3-dichloropropene to surface waters (Snider and Manning 1982). Waste water from 1,3-dichloropropene production sites can also release 1,3-dichloropropene to surface waters (EPA 1981a).

Due to its high mobility in soils and the fact that 1,3-dichloropropene is injected underground to a depth of 12–18 inches when used as a fumigant, migration to groundwater is possible (Cohen 1986; Krijgsheld and Van der Gen 1986; Maddy et al. 1982). 1,3-Dichloropropene may also be released to groundwater via landfills and hazardous waste sites (Hauser and Bromberg 1982; Sabel and Clark 1984).

2,3-Dichloropropene has been qualitatively identified in groundwater collected from the Ville Mercier hazardous waste site located in southern Quebec, Canada (Pakdel et al. 1994).

1,2-, 1,3-, and 3,3-Dichloropropene have been identified in groundwater samples collected at 1, 70, and 3 of the 1,678 NPL hazardous waste sites, respectively, where it was detected in some environmental media (HazDat 2006). 1,1- and 3,3-Dichloropropene were not identified in groundwater samples collected at any of the 1,678 NPL hazardous waste sites. 1,3-Dichloropropene has been identified in surface water samples collected at 10 of the 1,678 NPL hazardous waste sites, respectively, where it was detected in some environmental media (HazDat 2006). 1,1-, 1,2-, 2,3-, and 3,3-Dichloropropene were not identified in surface water samples collected at any of the 1,678 NPL hazardous waste sites.

### 6.2.3 Soil

Estimated releases of 342 pounds (0.2 metric tons) of 1,3-dichloropropene to soils from 15 domestic manufacturing and processing facilities in 2004, accounted for about 8% of the estimated total environmental releases from facilities required to report to the TRI (TRI04 2006). Estimated releases of 9 pounds (0.004 metric tons) of 2,3-dichloropropene to soils from five domestic manufacturing and processing facilities in 2004, accounted for <1% of the estimated total environmental releases from facilities required to report to the TRI (TRI04 2006). These releases of 1,3- and 2,3-dichloropropene are summarized in Tables 6-1 and 6-2, respectively. 1,1-, 1,2-, and 3,3-Dichloropropene were not listed in the TRI.

The most common release of 1,3-dichloropropene to soil occurs in agricultural fields where it is applied as a soil fumigant (CEPA 1982; Cohen 1986; Krijgsheld and Van der Gen 1986). Accidental spills may

## 6. POTENTIAL FOR HUMAN EXPOSURE

also release 1,3-dichloropropene to soil (Markovitz and Crosby 1984; Sterrett et al. 1986). For example, on April 8, 1984, a rail accident that occurred about 45 miles southeast of Tucson, Arizona resulted in a spill of 15,000 gallons of 1,3-dichloropropene (Sterrett et al. 1986).

According to the National Pesticide Use Database updated by the National Center for Food and Agricultural Policy, a total of approximately 34.7 million pounds (15,700 metric tons) of 1,3-dichloropropene was used in the United States in 1997 (NCFA 1997). The estimated amounts applied, crops grown, total acres treated in each state are provided in Table 6-4.

1,3-Dichloropropene has been identified in soil and sediment samples collected at 28 and 6 of the 1,678 NPL hazardous waste sites, respectively, where it was detected in some environmental media (HazDat 2006). 1,1-, 1,2-, 2,3-, and 3,3-Dichloropropene were not identified in soil or sediment samples collected at any of the 1,678 NPL hazardous waste sites.

### 6.3 ENVIRONMENTAL FATE

#### 6.3.1 Transport and Partitioning

The transport and partitioning of an organic compound in the environment is a function of the physical and chemical properties of that compound and the site-specific characteristics of the environment (e.g., percent soil organic matter). Based upon similarities in their physical and chemical properties, 1,1-, 1,2-, cis- and trans-1,3-, 2,3-, and 3,3-dichloropropene should behave similarly in regards to transport and partitioning within the environment.

In the atmosphere, measured vapor pressures of the dichloropropene isomers ranging from 22 to 91 mm Hg at 20 °C (EPA 1981c) suggest that these compounds will exist predominantly in the vapor phase (Eisenreich et al. 1981). Water solubility values ranging from 2,000 to 2,700 mg/L (measured at 20–25 °C) (Dilling 1977; Gunther et al. 1968; Mackay and Shiu 1981; Tomlin 2003), indicate that wet deposition may remove these compounds from the atmosphere. This is confirmed by the detection of 1,3-dichloropropene in rainwater (Section 6.4.2).

In surface waters, volatilization of dichloropropenes should be an important fate process that will compete with the transformation processes of biodegradation and hydrolysis (Section 6.3.2.2). Based on experimentally measured Henry's law constants for cis- and trans-1,3-dichloropropene of  $2.71 \times 10^{-3}$  and

## 6. POTENTIAL FOR HUMAN EXPOSURE

**Table 6-4. Estimated Annual Use of 1,3-Dichloropropene in the United States**

State	Acres treated	Pounds applied	Crops grown in treated soil
Alabama	10,478	422,120	Cotton, peanuts
Arizona	18,974	971,942	Cantaloupes, carrots, cotton, melons, watermelons
California	13,296	1,509,058	Beets, Brussels sprouts, cantaloupes, carrots, hot peppers, melons, parsley, potatoes, sweet potatoes
Colorado	3,668	246,759	Carrots, sugarbeets
Florida	29,115	1,826,311	Cotton, peanuts, potatoes, tobacco
Georgia	83,361	2,994,402	Cotton, peanuts, tobacco
Idaho	19,692	1,668,071	Onions, potatoes, sugarbeets
Maryland	321	36,492	Cucumbers
Michigan	Not available	Not available	Strawberries
Montana	2,374	113,943	Sugarbeets
Nebraska	2,418	116,024	Sugarbeets
New Mexico	22,222	1,066,983	Cotton, hot peppers
New York	2,436	640,202	Onions, strawberries
North Carolina	128,557	10,846,670	Cucumbers, peanuts, sweet peppers, sweet potatoes, tobacco
Oklahoma	Not available	Not available	Peanuts
Oregon	35,185	5,831,260	Asparagus, blueberries, carrots, onions, potatoes, strawberries
South Carolina	42,348	2,548,082	Cotton, cucumbers, peanuts, sweet potatoes, tobacco
Tennessee	191	9,159	Sweet potatoes
Texas	2,268	153,721	Cantaloupes, carrots, celery, melons, onions, peanuts, sweet peppers, sweet potatoes, watermelons
Utah	223	60,634	Onions
Washington	24,814	3,640,768	Carrots, onions, potatoes, strawberries, strawberries
Wisconsin	51	14,660	Strawberries
Wyoming	Not available	Not available	Sugarbeets

Source: data are from the National Pesticide Use Database updated in 1997 by the National Center for Food and Agricultural Policy (NCFA 1997).



## 6. POTENTIAL FOR HUMAN EXPOSURE

$8.71 \times 10^{-4}$  atm-m<sup>3</sup>/mol at 20 °C, respectively (Leistra 1970), these chemicals are expected to volatilize from environmental waters (Thomas 1982). Using the method of Thomas (1982), the estimated volatilization half-lives of cis- and trans-1,3-dichloropropene from a model river 1 meter deep, flowing at a velocity of 1 m/sec with a wind velocity of 3 m/sec are 3.8 and 4.2 hours, respectively. Experimental  $K_{oc}$  values for cis- and trans-1,3-dichloropropene in aqueous solutions are reportedly 23 and 26, respectively (Kenaga 1980). Based on these  $K_{oc}$  values, 1,3-dichloropropene is not expected to adsorb to suspended solids and sediment in the water column. Based on similarities in structure, vapor pressure, and water solubility, volatilization of 1,1-, 1,2-, 2,3-, and 3,3-dichloropropene from water surfaces and adsorption of these substances to sediment is expected to be similar to that of 1,3-dichloropropene.

In soil, 1,3-dichloropropene can exist as a gas or dissolved in water. The adsorption characteristics for each form are different. Experimental  $K_{oc}$  values for 1,3-dichloropropene in Arlington sandy loam, Chualar clay loam, Mocho silty clay loam, and Pahokee muck ranged from 18 to 60 (Kim et al. 2003b).  $K_{oc}$  values measured in soils of 3.19, 10.4, and 55.1% organic carbon were 25.7, 26.3, and 27.6, respectively, for cis-1,3-dichloropropene and 27.8, 27.2, and 27.5, respectively, for trans-1,3-dichloropropene (Hamaker and Thompson 1972). These  $K_{oc}$  values indicate a high mobility in soil (Swann et al. 1983) and a potential for leaching. Although movement in saturated soils is possible, concurrent hydrolysis and biodegradation should attenuate the amounts of 1,3-dichloropropene that may actually leach to groundwater. Furthermore, extensive groundwater monitoring programs, conducted in California, have not demonstrated that 1,3-dichloropropene is contaminating well waters in areas of continued field applications of the pesticide (Cohen 1986; Maddy et al. 1982). Measured  $K_{oc}$  values were not located for 1,1-, 1,2-, 2,3-, or 3,3-dichloropropene; however, the mobility of these substances in soils is expected to be similar to that of 1,3-dichloropropene.

1,3-Dichloropropene is more likely to adsorb to soil when it is in the vapor phase than when it is dissolved in water (Munnecke and Vangundy 1979). Adsorption for the vapor phase depends partly upon the soil's temperature and organic content (Leistra 1970). Soil adsorption isotherms show a positive correlation between adsorption of 1,3-dichloropropene and the percentage of organic matter in soil. It was also observed that adsorption of vapor-phase 1,3-dichloropropene is approximately 3 times greater at 2 °C than it is at 20 °C. Adsorption isotherms measured for humus sand, peaty sand, and peat indicate vapor-phase  $K_{oc}$  values for 1,3-dichloropropene ranging from about 450 to 750. These  $K_{oc}$  values suggest medium to low soil mobility for 1,3-dichloropropene in the vapor phase in soil (Swann et al. 1983).

## 6. POTENTIAL FOR HUMAN EXPOSURE

The factors influencing the volatility of 1,3-dichloropropene from a field following its application are soil organic matter, wind speed, soil moisture content, depth of incorporation-injection, soil temperature and soil porosity. 1,3-Dichloropropene was soil injected to a depth of 12–14 inches at an application rate of 346 lb. a.i. per acre into a sandy loam field, loamy sand field, and muck soil. At 6–12 hours posttreatment, 1,3-dichloropropene reached a maximum concentration of 0.4–20.3  $\mu\text{g}/\text{m}^3$  at a height of 6 inches above the soil surface (EPA 1998b). 1,3-Dichloropropene concentrations decreased to  $\leq 0.14 \mu\text{g}/\text{m}^3$  in all air samples from all locations by seven days posttreatment. It was not detected above the loamy sand and sandy loam soils by 14 days or above the muck soil by 21 days. Volatilization rates appeared to be inversely proportional to the amount of soil organic matter and proportional to soil porosity.

Field management practices such as covering the treated fields with tarps, compacting the treated soils, and irrigating the treated soil post injection are commonly used practices to reduce volatilization losses of soil fumigants such as 1,3-dichloropropene. Following application of 1,3-dichloropropene at 98 kg/ha (87.5 lbs/A), volatilization losses from uncovered soil columns (12.5 cm inside diameter) were 62, 47, and 36% at injection depths of 20, 30, and 40 cm, respectively, after 20 days (Gan et al. 1998b). The total volatilization loss for 1,3-dichloropropene injected to a depth of 20 cm and then covered with a high density polyethylene (HDPE) tarp was 53% after 20 days. It was determined that the high permeability of HDPE reduced its ability to act as an effective barrier for 1,3-dichloropropene. However, volatilization losses were reduced substantially if the soil was immediately irrigated post injection. Only 34% of the nominally applied 1,3-dichloropropene was volatilized after injection at a depth of 20 cm, followed by irrigation with 184 mL of water applied to the soil surface at a rate of 2 mL/minute. The authors observed that the volatilization rate of the cis isomer was consistently greater than the trans isomer in each experiment. This observation is consistent with the fact that the cis isomer possesses a lower boiling point, higher vapor pressure, and larger Henry's law constant than the trans isomer.

As discussed in Section 6.3.2.3, dichloropropenes can be removed from soils via hydrolysis, microbial degradation, and volatilization. Since the rate of these processes can vary significantly with soil conditions, the wide range of reported persistence half-lives for 1,3-dichloropropene is not surprising and demonstrates that the persistence of this substance in soil depends upon specific local conditions.

Measured bioconcentration factor (BCF) values for the dichloropropene isomers were not found in the literature. Using a measured  $\log K_{ow}$  of 2.0 and a regression derived equation, a BCF of 19.5 can be estimated for 1,3-dichloropropene (Meylan et al. 1999; Tomlin 2003). According to a classification

## 6. POTENTIAL FOR HUMAN EXPOSURE

scheme developed by Franke et al. (1994), this BCF value suggests that the potential for bioconcentration of 1,3-dichloropropene in aquatic organisms is low. Based on their structural similarities to 1,3-dichloropropene, bioconcentration of 1,1-, 1,2-, 2,3-, and 3,3-dichloropropene in aquatic organisms is also expected to be low.

### 6.3.2 Transformation and Degradation

#### 6.3.2.1 Air

The important environmental fate process for the degradation of 1,3-dichloropropene in ambient air is the vapor-phase reaction with photochemically produced hydroxyl radicals. The rate constants for the reactions of cis- and trans-1,3-dichloropropene with hydroxyl radicals have been experimentally determined to be  $7.7 \times 10^{-12}$  and  $1.3 \times 10^{-11}$  cm<sup>3</sup>/molecule-sec at 22 °C, respectively (Tuazon et al. 1984). 1,3-Dichloropropene will also be removed from air via reaction with ozone; however, this reaction is expected to be secondary to photooxidation with hydroxyl radicals. The rate constants for the reactions of cis- and trans-1,3-dichloropropene with ozone molecules have been experimentally determined to be  $1.5 \times 10^{-19}$  and  $6.7 \times 10^{-19}$  cm<sup>3</sup>/molecule-sec at 22 °C, respectively (Tuazon et al. 1984).

Assuming that the average yearly troposphere hydroxyl radical and ozone molecule concentrations are  $5.0 \times 10^5$  and  $7.0 \times 10^{11}$  molecules/cm<sup>3</sup>, respectively (Atkinson et al. 1979), the corresponding half-lives for cis-1,3-dichloropropene in air are about 2.1 days (50 hours) and 76 days. The corresponding half-lives for trans-1,3-dichloropropene in air would be about 1.2 days (30 hours) and 17 days. Tuazon et al. (1984) calculated the respective half-lives of 52 and 12 days for cis- and trans-1,3-dichloropropene reactions with ozone based on an average background tropospheric concentration for ozone of  $1.0 \times 10^{12}$  molecules/cm<sup>3</sup>. For the cis and trans isomers, the authors also calculated respective half-lives of 12 and 7 hours for the reactions with photochemically generated hydroxyl radicals present at an average concentration of  $2.0 \times 10^6$  molecules/cm<sup>3</sup> (Tuazon et al. 1984).

The estimates of average hydroxyl radical and ozone concentrations in air used by Tuazon et al. (1984) are more indicative of urban atmospheres. In general, the hydroxyl radical and ozone concentrations in polluted air may increase by an order of magnitude over those estimates used by Atkinson et al. (1979). Therefore, the half-life of 1,3-dichloropropene in ambient air may range between 7 and 50 hours, depending on the concentrations of cis- and trans-isomers and hydroxyl radicals in the troposphere.

## 6. POTENTIAL FOR HUMAN EXPOSURE

Formyl chloride and chloroacetaldehyde have been identified as reaction products of 1,3-dichloropropene with both hydroxyl radicals and ozone. Reaction with ozone also yields chloroacetic acid, formic acid, hydrogen chloride, carbon dioxide, and carbon monoxide (Tuazon et al. 1984).

1,3-Dichloropropene is also susceptible to photolysis in air. However, direct photodegradation of 1,3-dichloropropene should not be an important fate process, compared to its reaction with hydroxyl radicals (EPA 1981b). Nevertheless, some evidence that the photodecomposition of 1,3-dichloropropene may be enhanced by the presence of atmospheric particulates exists (Tuazon et al. 1984).

Data regarding the degradation of 1,1-, 1,2-, 2,3-, and 3,3-dichloropropene in air are not available. Based on the physical and chemical properties of these isomers, photooxidation is expected to be similar to that of 1,3-dichloropropene. As is expected for 1,3-dichloropropene, ozonolysis and direct photolysis may occur for 1,1-, 1,2-, 2,3-, and 3,3-dichloropropene; however, photooxidation is expected to be the dominant removal mechanism for dichloropropenes in the atmosphere.

### 6.3.2.2 Water

River die-away test data pertaining to the biodegradation of 1,3-dichloropropene in natural waters were not available in the literature. Several aerobic biological screening studies, which used settled domestic waste water for inocula, demonstrated that 1,3-dichloropropene is biodegradable (Tabak et al. 1981a, 1981b). Within 7 days, the original cultures, added to synthetic media that contained 5 mg yeast extract/L, were able to degrade about 50% of the 1,3-dichloropropene at an initial concentration of 10 ppm (Tabak et al. 1981a, 1981b). Acclimation to a series of subcultures was also demonstrated. The third subculture, with identical concentrations and under identical conditions, showed an approximate 85% removal of 1,3-dichloropropene within the same period of time (Tabak et al. 1981a, 1981b). Nevertheless, the rate of biodegradation for 1,3-dichloropropene in natural waters cannot be inferred from screening study data.

Yon et al. (1991) studied the dissipation of <sup>14</sup>C-labeled 1,3-dichloropropene at 5 µg/mL in a sediment/water system made from ditch bottom sediments and aerobic ditch water. Although 49–58% of the 1,3-dichloropropene volatilized after 7 days, degradation was also observed based on the presence of the radiolabeled metabolite 3-chloropropenic acid and other unspecified polar products. The authors reported this degradation as aerobic aquatic metabolism; however, the possible role of hydrolysis was not addressed.

## 6. POTENTIAL FOR HUMAN EXPOSURE

In addition to losses via biodegradation, 1,3-dichloropropene may undergo hydrolysis in natural waters. Hydrolysis half-lives measured in buffered solutions at pH 5, 7, and 9 were 13.5 days at 20 °C (EPA 1998b). Hydrolysis half-lives measured at pH 5.5 and 7.5 were 2 days at 29 °C, 11–13 days at 15 °C, and 90–100 days at 2 °C (EPA 1998b). McCall (1987) reported similar hydrolysis half-lives of 3.1, 11.3, and 51 days measured at 30, 20, and 10 °C, respectively, in sterile, buffered water and stated that this process was independent of pH. However, Guo et al. (2004) measured half-lives of 8.7, 7.2, and 2.8 days at pH 4, 7, and 10, respectively, in buffer solutions at 20 °C during a more extensive examination of the effect of pH on hydrolysis. In contrast to McCall (1987), these authors concluded that the rate of hydrolysis of 1,3-dichloropropene increases with increasing pH. The primary hydrolysis product of 1,3-dichloropropene is 3-chloroallyl alcohol, which is broken down further to 3-chloroacrylic acid and eventually to CO<sub>2</sub> (Guo et al. 2004).

Aquatic biodegradation and hydrolysis data were not available for 1,1-, 1,2-, 2,3-, and 3,3-dichloropropene. Based on structural similarities, these isomers are expected to biodegrade similarly to 1,3-dichloropropene. Hydrolysis of 2,3- and 3,3-dichloropropene will also be similar to that of 1,3-dichloropropene; however, hydrolysis of 1,1- and 1,2-dichloropropene is expected to be much slower due to the inhibiting effect of the two vinylic chlorine atoms (Smith and March 2001).

### 6.3.2.3 Sediment and Soil

1,3-Dichloropropene reportedly biodegrades in soil (Castro and Belser 1966, 1968; Roberts and Stoydin 1976; Tu 1988, van der Pas and Liestra 1987). Belser and Castro (1971) reported that the microbial degradative pathway for both the cis and trans isomers followed a similar sequence. The initial step of the reaction involves allylic dechlorination of 1,3-dichloropropene and hydroxyl substitution to form the corresponding chloroallyl alcohol (Castro and Belser 1966; Roberts and Stoydin 1976). Again, both cis- and trans-chloroallyl alcohols undergo oxidation, resulting in the formation of the corresponding chloroacrylic acids (Castro and Belser 1968; Roberts and Stoydin 1976). Next, vinylic chlorines are removed and subsequently, propanoic acid 3-aldehyde is oxidized to carbon dioxide (Belser and Castro 1971).

1,3-Dichloropropene is degraded more rapidly in soil that has a history of treatment with this pesticide than in previously untreated soil (Chung et al. 1999; Ou 1989, 1998; Ou et al. 1995; Verhagen et al. 1996). Furthermore, while the degradation rates of the cis- and trans- isomers are similar in untreated

## 6. POTENTIAL FOR HUMAN EXPOSURE

soil, degradation in previously treated soil has been shown to be more rapid for trans-1,3-dichloropropene than for cis-1,3-dichloropropene. For example, cis- and trans-1,3-dichloropropene applied to previously untreated soil plots (16 µg/g) were degraded by approximately 68 and 72%, respectively, after 28 days (Ou 1998). In a soil plot that had been previously treated with this pesticide 6 times over the past 12 years, cis-1,3-dichloropropene (16 µg/g) was degraded by approximately 100% after 28 days while trans-1,3-dichloropropene was degraded by approximately 99% after 14 days. Chung et al. (1999) observed the enhanced degradation of trans-1,3-dichloropropene over cis-1,3-dichloropropene in soils increasing with increasing numbers of field applications; approximately 100% of cis- and trans-1,3-dichloropropene in these soils (16 µg/g) were degraded after 5–10 and 7–14 days, respectively. However, the degradation rates of cis- and trans-1,3-dichloropropene were again similar to each other in soil that had been left untreated for 2 years and resembled degradation rates in previously untreated control soils; approximately 75–100% of cis- and trans-1,3-dichloropropene were degraded after 28 days.

1,3-Dichloropropene may also hydrolyze in moist soils. In laboratory studies, hydrolysis rates have been measured in soil slurries and buffer solutions. For soil-water slurries with a concentration of  $10^{-2}$  M, 1,3-dichloropropene hydrolyzed at a rate of 3.4% per day (Castro and Belser 1966). In general, soils possess a relative humidity of >98%. Under dry conditions, the relative humidity of soil may fall below 90% (U.S. Army 1985). Therefore, 1,3-dichloropropene is likely to hydrolyze in moist soils. Once again, corresponding chloroallyl alcohols were reported as the products of hydrolysis for cis- and trans-1,3-dichloropropene (Castro and Belser 1966). Greater than 60% of 1,3-dichloropropene applied at <61 g/kg to both sterile and nonsterile Arlington sandy loam with a 10% moisture content hydrolyzed within 30 days (Guo et al. 2004). Initially, there was no difference between the degradation in sterile and nonsterile soils; however, degradation in the nonsterile soil began to exceed degradation in the sterile soil after 10 days of incubation as soil microorganisms adapted to the pesticide.

Batzer et al. (1996) studied the fate of 1,3-dichloropropene in sealed aerobic soil incubation flasks. The degradation half-lives of  $^{14}\text{C}$ -labeled-1,3-dichloropropene measured in Wahiawa silty clay, Catlin silt loam, and Fuquay loamy sand were 1.8, 12.3, and 61 days, respectively (Batzer et al. 1996; EPA 1998b). These authors stated that the rapid degradation in the Wahiawa silty clay may have been a result of the combination of biodegradation and abiotic hydrolysis. Major metabolites formed during the biodegradation of 1,3-dichloropropene identified during this study were 3-chloroallyl alcohol and 3-chloroacrylic acid. Minor metabolites identified (<0.4% applied  $^{14}\text{C}$ ) were acetic acid, adipic acid, butyric acid, chloroacetic acid, 4-chlorobutyric acid, fumaric acid, glycolic acid, hexanoic acid, lactic acid, malonic acid, 2-methylmalonic acid, oxalic acid, propionic acid, and succinic acid.

## 6. POTENTIAL FOR HUMAN EXPOSURE

Anaerobic metabolism half-lives measured for 1,3-dichloropropene at 15 and 25 °C were 9.1 and 2.4 days, respectively, in a silty clay loam soil and 7.7 and 2.4 days, respectively, in a sandy loam soil (EPA 1998b). The metabolites identified included chloroacrylic acid and propionic acid.

The persistence of 1,3-dichloropropene in soil has been measured by a number of investigators. van der Pas and Leistra (1987) reported half-lives of 3–4 days in fields used for planting flower bulbs. Only very small amounts of 1,3-dichloropropene remained after periods up to 49 days. Leistra (1970) reported a much slower degradation rate of 0.035/day for a loam soil, which corresponds to a half-life of 19.8 days. A degradation rate of 0.01/day, which corresponds to a half-life of 69 days, was reported for sandy and peat soils (Leistra 1970). Albrecht (1987a) has reported half-lives of 3–25 days at 20 °C for 1,3-dichloropropene. Radiolabeled cis- and trans-1,3-dichloropropene was applied to soils and stored in sealed jars for 12 weeks. In a sandy loam soil, 19% of the cis isomer and 18% of the trans isomer remained, while 10% of the cis isomer and 22% of the trans isomer persisted in a medium loam soil (Roberts and Stoydin 1976). The half-lives of 1,3-dichloropropene measured in water-saturated sandy subsoils (24 g/m<sup>3</sup>) ranged from 16 to 64 days (Boesten et al. 1991). Smelt et al. (1989) reported that 1,3-dichloropropene at initial concentrations of 62–80 mg/kg in moist loamy soils was quickly degraded (100% after 5–8 days) following a 3–6-day lag phase. The initial and second half-lives of cis- and trans-1,3-dichloropropene applied at 345 lb a.i./A to bare loamy sand soil were 1 and 7 days, respectively, in the 24-inch surface layer (EPA 1998b). 1,3-Dichloropropene, applied at 342 lb a.i./A to a sand soil field plot, declined from a maximum concentration of 130,000 ppb in the 0.3–0.45 m layer of soil immediately following application to below the detection limit (10 ppb) in any soil layer after 71 days (1998b).

Biodegradation and hydrolysis data for 1,1-, 1,2-, 2,3-, and 3,3-dichloropropene in soil or sediment were not available. Based on structural similarities, these isomers are expected to biodegrade similarly to 1,3-dichloropropene. Hydrolysis of 2,3- and 3,3-dichloropropene in soil will also be similar to that of 1,3-dichloropropene; however, hydrolysis of 1,1- and 1,2-dichloropropene is expected to be much slower due to the inhibiting effect of the two vinylic chlorine atoms (Smith and March 2001).

#### 6.4 LEVELS MONITORED OR ESTIMATED IN THE ENVIRONMENT

Reliable evaluation of the potential for human exposure to 1,3-dichloropropene depends in part on the reliability of supporting analytical data from environmental samples and biological specimens. Concentrations of 1,3-dichloropropene in unpolluted atmospheres and in pristine surface waters are often

## 6. POTENTIAL FOR HUMAN EXPOSURE

so low as to be near the limits of current analytical methods. In reviewing data on 1,3-dichloropropene levels monitored or estimated in the environment, it should also be noted that the amount of chemical identified analytically is not necessarily equivalent to the amount that is bioavailable. The analytical methods available for monitoring 1,3-dichloropropene in a variety of environmental media are detailed in Chapter 7.

The majority of the available dichloropropene monitoring data are for the 1,3- isomer. Therefore, the data reported in Section 6.4 refer primarily to 1,3-dichloropropene. When available, monitoring data for the other dichloropropene isomers are included.

#### 6.4.1 Air

1,3-Dichloropropene is not a widely occurring atmospheric pollutant. According to the National Ambient Volatile Organic Compounds (VOCs) Database, a compilation of published and unpublished air monitoring data from 1970 to 1987, the median urban atmospheric concentration of cis-1,3-dichloropropene is 23.9 ppbV (parts per billion by volume) for 148 samples collected from representative locations (EPA 1988). Information regarding the occurrence of cis-1,3-dichloropropene in suburban, rural, remote, source-dominated (air surrounding a facility or known release of the chemical in question), workplace, and indoor and personal atmospheres was not included by the VOC database. Also, no data were reported for trans-1,3-dichloropropene (EPA 1988).

cis- and trans-1,3-Dichloropropene were detected in 15 (4.3%) and 10 (2.9%) out of 349 air samples, respectively, collected from Camden, New Jersey; Washington, DC; Orlando, Florida; Pensacola, Florida; Chicago, Illinois; Sauget, Illinois; Toledo, Ohio; Houston, Texas; Baton Rouge, Louisiana; Port Neches, Texas; and Wichita, Kansas during the 1990 Urban Air Toxics Program conducted by EPA (1991). The range, mean, and median of concentrations in positive samples were 0.04–0.59, 0.23, and 0.22 ppbV, respectively, for cis-1,3-dichloropropene and 0.01–2.62, 0.70, and 0.17 ppbV, respectively, for trans-1,3-dichloropropene. cis- and trans-1,3-Dichloropropene concentrations were <1 ppbV in urban air samples from 13 sites located in Louisiana, Texas, Vermont, and New Jersey collected from September 1996 to August 1997 (Mohamed et al. 2002). cis- and trans-1,3-Dichloropropene were each detected in only 3 out of 267 air samples from 13 semi-rural to urban locations in Maine, Massachusetts, New Jersey, Pennsylvania, Ohio, Illinois, Louisiana, and California collected from 1997 to 1999 (Pankow et al. 2003). Positive concentrations were 0.013–0.018 ppbV for cis-1,3-dichloropropene and 0.007–0.008 ppbV for trans-1,3-dichloropropene; limits of detection were not specified. cis- and trans-1,3-Di-



## 6. POTENTIAL FOR HUMAN EXPOSURE

chloropropene were detected in 0 and 3% of air samples, respectively, collected from six locations in the Columbus, Ohio area; concentrations and detection limits were not specified (Spicer et al. 1996). Out of 2,507 air samples collected from 25 sites across the state of Minnesota over a period of 8 years (1991–1998), cis-1,3-dichloropropene was detected above  $0.14 \mu\text{g}/\text{m}^3$  (0.031 ppb) in 43 air samples and trans-1,3-dichloropropene was detected above  $0.21 \mu\text{g}/\text{m}^3$  (0.046 ppb) in 82 air samples (Pratt et al. 2000). The mean and maximum concentrations were 0.02 and  $0.99 \mu\text{g}/\text{m}^3$  (0.004 and 0.22 ppb), respectively, for cis-1,3-dichloropropene and 0.03 and  $1.48 \mu\text{g}/\text{m}^3$  (0.007 and 0.326 ppb), respectively, for trans-1,3-dichloropropene.

During a study conducted by the California Air Resources Board in July 1995, 1,3-dichloropropene was detected in 100% of samples collected from four sites in California representative of high use areas with mean and maximum concentrations of 24 and  $160 \mu\text{g}/\text{m}^3$  (5.3 and 35.2 ppb), respectively (Baker et al. 1996). During measurements of airborne pesticide concentrations in an urban area of California, 1,3-dichloropropene was detected in 8 out of 8 samples in 1990, 16 out of 21 samples in 1996, and 14 out of 53 samples in 2000 (Lee et al. 2002). Mean 1,3-dichloropropene concentrations in these samples were 0.9, 0.57, and  $0.40 \mu\text{g}/\text{m}^3$  (0.20, 0.13, and 0.088 ppb), respectively. In air from rural California communities, 1,3-dichloropropene was detected in 32 out of 32 samples in 1990, 64 out of 84 samples in 1996, and 77 out of 267 samples in 2000. Mean 1,3-dichloropropene concentrations in these samples were 24, 1.4, and  $1.5 \mu\text{g}/\text{m}^3$  (5.3, 0.31, and 0.33 ppb), respectively.

The concentrations of dichloropropene (unspecified isomers) in air samples collected from Deer Park, Texas; Freeport, Texas; Plaquemine, Louisiana; and Baton Rouge, Louisiana during the 1970s ranged from 7 to 570 ppt where it was detected (Brodzinsky and Singh 1982; EPA 1979). Dichloropropene (unspecified isomers) was qualitatively identified in 1 out of 10 ambient air samples collected in the Kanawha Valley, West Virginia during 1977 (EPA 1978b).

#### 6.4.2 Water

According to 1999–2006 nationwide U.S monitoring data from the STORET database, 1,3-dichloropropene was detected in 5,465 out of 12,673 water samples; however, only 771 of these detections were above the quantitation limit (unspecified). The mean, median, and range of quantifiable concentrations were 0.5, 0.5, and  $0.002\text{--}25 \mu\text{g}/\text{L}$  (ppb), respectively (EPA 2006j). 1,1-Dichloropropene was detected in 3,443 out of 5,348 water samples; however, only 70 of these detections were above the quantitation limit (unspecified). The mean, median, and range of quantifiable concentrations were 0.4, 0.5, and  $0.001\text{--}$

## 6. POTENTIAL FOR HUMAN EXPOSURE

5 µg/L (ppb), respectively (EPA 2006j). The source of 1,1-dichloropropene in these water samples is unknown. 1,1-Dichloropropene does not appear to be produced or used based on available data; therefore, direct release of this substance into the environment is not expected. 1,1-Dichloropropene may be formed as a metabolite during the anaerobic degradation of higher chlorinated propenes. Data for 1,2-, 2,3-, and 3,3-dichloropropene were not listed in STORET.

1,3-Dichloropropene was detected in groundwater contaminated by leachates from municipal landfills in New York, Minnesota, and Wisconsin at concentrations up to 18 µg/L (ppb) (Sabel and Clark 1984). In California, 1,3-dichloropropene was detected in groundwater at unspecified concentrations as a result of pesticide applications (Cohen 1986). An extensive groundwater monitoring program for agricultural chemicals in California detected cis-1,3-dichloropropene in only two groundwater samples, and trans-1,3-dichloropropene in only one groundwater sample (Cohen 1986). By comparison, dibromochloropropane, another soil fumigant, was detected in 2,522 groundwater samples. In 54 municipal wells of varying depths of 65–1,200 feet in areas of California where Telone<sup>®</sup> or DD<sup>®</sup> had been applied for over 15 years, 1,3-dichloropropene was not detected in any sample at or above the quantification limit of 0.1 ppb (Maddy et al. 1982).

cis- and trans-1,3-Dichloropropene were not detected (detection limit 0.20 µg/L) in groundwater samples from 1,831 sites located in 20 of the U.S. major hydrologic basins (Kolpin et al. 2000). During the U.S. Geological Survey's (USGS) National Water-Quality Assessment (NWQA) Program conducted from 1986 to 1999, concentrations of cis- and trans-1,3-dichloropropene were below the detection limit of 0.2 µg/L (ppb) in untreated groundwater from 1,685 and 1,592 rural private wells, respectively (Moran et al. 2004). Concentrations of cis- and trans-1,3-dichloropropene were below the detection limit of 0.09 µg/L (ppb) in 30 randomly distributed monitoring wells located in Wichita, Kansas during the High Plains Regional Ground-Water Study conducted in 2000 as part of the USGS NWQA Program (USGS 2002). The concentrations of cis- and trans-1,3-dichloropropene measured in 34 wells (including 5 public use wells) in Cook Inlet Basin, Alaska during 1999 were below 0.09 and 0.13 µg/L (ppb), respectively (USGS 2001).

During the registration of Telone II<sup>®</sup>, Dow AgroSciences conducted a small-scale prospective groundwater monitoring study at a site in Wisconsin to satisfy EPA requirements (EPA 1998b). In September 1997, Telone II<sup>®</sup> was applied to a sugar beet field at 28 gallons per acre (266 pounds per acre). Depth to the groundwater of an aquifer used for drinking water ranged from 15 to 22 feet. Over a period of 11 months, the mean and maximum concentrations of 1,3-dichloropropene were 134 and 579 ppb,

## 6. POTENTIAL FOR HUMAN EXPOSURE

respectively, in on-site wells and 26.6 and 173 ppb, respectively, in an off-site well located 65 feet downgradient.

Dow AgroSciences performed a similar groundwater study in southern Florida (EPA 1998b). In December 1995, Telone C-17<sup>®</sup> was applied to a pepper field at 22.5 gallons per acre (214 pounds per acre). The concentration of 1,3-dichloropropene in eight shallow (1–2 feet deep) on-site wells peaked at 833 ppb and then dropped to 0.19 ppb by 110 days after application. The concentration in five off-site wells ranged from trace levels to 0.23 ppb. The mean and range of 1,3-dichloropropene concentrations were 0.30 and 0.05–21.6 ppb, respectively, in eight on-site wells at a depth of 10 feet and 0.04 and 0.05–1.03 ppb, respectively, in the on-site wells that tapped the Lower Tamiami Aquifer, a possible drinking water source, at a depth of 70 feet. The mean concentration of 1,3-dichloropropene plus its degradates was 1.15 ppb in the 10 feet deep on-site wells, 0.17 ppb in the 70 feet deep on-site wells, and 0.074 ppb in the off-site wells. 1,3-Dichloropropene was not detected in an off-site deep well. 1,3- and 2,3-Dichloropropene were detected above 0.1 ppb in 5 and 3 out of 42 piezometers and domestic wells, respectively, in the area of the Abbotsford aquifer in southwestern British Columbia, Canada (Zebarth et al. 1998). Maximum concentrations ranged from 0.15 to 0.76 ppb for 1,3-dichloropropene and from 0.10 to 0.67 ppb for 2,3-dichloropropene.

According to Round 2 data (1993–1997) reported under the EPA Unregulated Contaminant Monitoring Program (UCM), 1,3-dichloropropene was detected in 81 out of 70,631 samples collected from public water systems across the United States with a mean concentration of 1.282 ppb and a range of 0.20–39.00 ppb (EPA 2001c). 1,1-Dichloropropene was detected in 18 out of 97,698 public water system samples with a mean concentration of 8.944 ppb and a range of 0.10–153.00 ppb. 1,2-, 2,3-, and 3,3-Dichloropropene were not included in the UCM data; these chemicals are not listed as drinking water contaminant candidates by EPA (EPA 2001c).

1,3-Dichloropropene was qualitatively identified in New Orleans, Louisiana, drinking water collected in August 1974 (Dowty et al. 1975a, 1975b). Unspecified isomers of dichloropropene were qualitatively identified in drinking water samples collected in Philadelphia, Pennsylvania in 1995 and 1996 (Suffet et al. 1980). An analysis of 15 drinking water samples from Denver collected between October 1, 1985, and March 31, 1986, did not detect cis- or trans-1,3-dichloropropene at or above detection limits of 0.13 ppb (Rogers et al. 1987). At quantities above the detection limit of 0.1 ppb, 1,3-dichloropropene was not detected in 42 raw and 42 finished drinking water samples collected between July 1982 and May 1983 from nine municipalities along the Great Lakes (Otson 1987).

## 6. POTENTIAL FOR HUMAN EXPOSURE

The concentrations of cis- and trans-1,3-dichloropropene/L detected in rainwater collected in Portland, Oregon, in 1982 were 10 and 2 ng/L (ppt), respectively (Mazurek and Simoneit 1986).

#### 6.4.3 Sediment and Soil

According to 1999–2006 nationwide U.S monitoring data from the STORET database, 1,3-dichloropropene was detected in only 2 out of 613 soil samples (EPA 2006j). 1,3-Dichloropropene concentrations in these two samples were 0.04 and 0.005 mg/kg. According to the STORET data, 1,3-dichloropropene was detected in 139 out of 324 sediment samples; however, none of these detections were above the quantitation limit (unspecified) (EPA 2006j). 1,1-Dichloropropene was not detected above the quantitation limit (unspecified) in 74 soil samples and 37 sediment samples. Data for 1,2-, 2,3-, and 3,3-dichloropropene were not listed in STORET. No other information regarding the levels of dichloropropenes found in soil or sediment was located in the available literature.

#### 6.4.4 Other Environmental Media

1,1-, cis-1,3-, and trans-1,3-Dichloropropene were analyzed for but not detected in approximately 90 foods during the U.S. Food and Drug Administration's Total Diet Study (TDS) (FDA 2005b).

According to the National Pesticide Use Database updated by the National Center for Food and Agricultural Policy in 1997, 1,3-dichloropropene is applied to fields used to grow the following crops in the United States each year: asparagus, beets, blueberries, Brussels sprouts, cantaloupes, carrots, celery, cotton, cucumbers, hot peppers, melons, onions, parsley, peanuts, potatoes, strawberries, sugarbeets, sweet peppers, sweet potatoes, tobacco, and watermelons. However, 1,3-dichloropropene residues have not been found in crops grown in soils treated with this pesticide (EPA 1998b; Roby and Melichar 1997). This is most likely because 1,3-dichloropropene is a preplant fumigant that breaks down quickly in the soil and is therefore not expected to be available for plant uptake (EPA 1998b).

Neither 1,3-dichloropropene nor its metabolites were detected in carrot, lettuce, radish, tomato, and wheat grown in soil treated with this <sup>14</sup>C-labeled 1,3-dichloropropene; however, natural incorporation of the <sup>14</sup>C-label was observed (Barnekow et al. 1996). Similarly, soybean plants grown in <sup>14</sup>C-labeled 1,3-dichloropropene at 380 L/ha did not contain the pesticide or its metabolites (Barnekow et al. 1995). The

## 6. POTENTIAL FOR HUMAN EXPOSURE

<sup>14</sup>C-label residue was detected in the fatty acids, protein, pigments, organic acids, sucrose and other carbohydrates, and lignin of the soybean plants.

During a study of organic compounds in tobacco smoke, the concentrations of 1,3-dichloropropene in ultra low tar, full flavor low tar, and full flavor cigarette brands were 11.4, 11.7, and 14.4 µg/cigarette, respectively (Bi et al. 2005).

## 6.5 GENERAL POPULATION AND OCCUPATIONAL EXPOSURE

Possible routes of human exposure to 1,3-dichloropropene include the inhalation of vapors, ingestion of drinking water, and dermal contact.

Monitoring data regarding the presence of 1,3-dichloropropene in foods were not located (see Section 6.4.4). This may be the result of rapid degradation of 1,3-dichloropropene taking place before the pesticide can be taken up by the crop plants. It has been suggested that chlorination of water can lead to the formation of 1,3-dichloropropene, and that the detection of 1,3-dichloropropene in various treated water samples confirm this (Krijgsheld and Van der Gen 1986). However, information pertaining to the occurrence of 1,3-dichloropropene in drinking water is also very limited, and 1,3-dichloropropene is not expected to occur at levels which are a concern to human health. 1,1-Dichloropropene was detected in only 0.01% of public water system samples collected nationwide; therefore, exposure to this substance via drinking water is expected to be very low (EPA 2001c).

Occupational exposures to 1,3-dichloropropene, occurring mainly during handling and application as a soil fumigant, have been documented (Albrecht 1987a; Albrecht et al. 1986; Markovitz and Crosby 1984; Nater and Gooskens 1976; Osterloh et al. 1984, 1989a, 1989b; Schenker and McCurdy 1986; van Joost and de Jong 1988; Wang 1984). According to the NOES conducted by NIOSH between 1981 and 1983, it has been estimated that 2,162 workers were potentially exposed to 1,3-dichloropropene (NIOSH 2006). The NOES database does not contain information on the frequency, concentration, or duration of workers' exposure to any of the chemicals listed therein. The survey provides only estimates on the number of workers potentially exposed to chemicals in the workplace. The most probable routes of occupational exposure are inhalation and dermal contact at places where 1,3-dichloropropene- and/or 1,3-dichloropropene-containing compounds are produced or used as a soil fumigant. Albrecht (1987a) studied the inhalation exposure of 1,3-dichloropropene to workers involved in applying Telone II<sup>®</sup> to pineapple fields in Hawaii. Exposures were predominantly below 1 ppm. According to Osterloh et al. (1989a),

## 6. POTENTIAL FOR HUMAN EXPOSURE

15 individuals applying 1,3-dichloropropene were exposed at a mean air concentration of 2.56 mg/m<sup>3</sup> over a period of 2–7 hours. The mean concentration of the metabolite, N-acetyl-S-[cis-3-chloro-prop-2-enyl]-cysteine, in the urine of these individuals was 1.37 µg/mg creatinine following exposure.

Exposure monitoring studies were conducted for workers using 1,3-dichloropropene as a fumigant on treated fields in North Carolina, Washington, and Arizona (EPA 1998b). Employee exposure was estimated by monitoring personal air samples for product loaders, applicators, and re-entry workers over 4-hour periods or during short job specific tasks. The 4-hour samples provided time-weighted average air concentrations over a major portion of an actual work day, while the task-specific samples measured the air concentrations associated only with high-contact activities. For product loaders, these activities were the actual loading events. The 4-hour loader samples included the loading events, and the time spent on site between loading events. 1,3-Dichloropropene was broadcast applied to a sandy loam used to grow potatoes at an application rate of 252 lbs a.i./A at the Washington state site. It was row applied in Arizona to a loamy sand used to grown cotton at a rate of 121.2 lbs a.i./A, and was row applied at a rate of 82 lbs a.i. to a field in North Carolina used to grow tobacco. The exposure levels of the employees categorized by job function are summarized in Table 6-5.

The Monsanto Agricultural Products Company conducted research to ensure that workers in the workplace were not being exposed to unacceptable levels of 1,3-dichloropropene in the air during its manufacture. Under laboratory conditions simulating the workplace environment, atmospheric levels of 1,3-dichloropropene ranged from 0.4 to 4.0 ppm (Leiber and Berk 1984). These levels can be compared to the NIOSH recommended 8 and 10 hour time weighed average (TWA) of 1 ppm for 1,3-dichloropropene (NIOSH 2005).

The primary metabolites for cis- and trans-1,3-dichloropropene in the body are the corresponding mercapturic acids, metabolite N-acetyl-S-(cis- and trans-3-chloro-2-propenyl)-L-cysteine (abbreviated cis- and trans-DCP-MA) (Brouwer et al. 2000; He 1993; Van Welie et al. 1991a; Verberk et al. 1990). Exposure to 1,3-dichloropropene can be tested by analyzing for these metabolites in urine samples. The geometric mean and range of cis-DCP-MA concentrations in urine samples collected from 14 application workers in the Netherlands on 114 application days were 9.33 and 0.04–55.1 mg/g creatinine, respectively (Brouwer et al. 2000). The corresponding geometric mean and range of calculated 8-hour time-weighted average exposure concentrations were 2.7 and 0.1–9.5 mg/m<sup>3</sup>, respectively. Twelve individuals applying cis- and trans-1,3-dichloropropene to Dutch flower bulb fields were exposed to an 8-hour time-weighted average air concentrations of 0.34–10.78 mg/m<sup>3</sup> for the cis isomer and 0.11–8.07 mg/m<sup>3</sup> for the trans

## 6. POTENTIAL FOR HUMAN EXPOSURE

**Table 6-5. Exposure Levels of Employees to 1,3-Dichloropropene Measured During Loading and Application**

Job activity	Site	Exposure duration <sup>a</sup>	Range (ppb)	Mean concentration (ppb)	Median concentration (ppb)
Loading	Washington, Arizona	4 hours	38.9–1,305	359	137
Loading	Washington, Arizona	Task only	116–7,148	2,383	1,069
Loading	North Carolina	Task only	11–260	102	97.2
Application	Washington, Arizona, North Carolina	4 hours and task	9.5–1,448	299	253

<sup>a</sup>Task-specific operations lasted 4–46 minutes

## 6. POTENTIAL FOR HUMAN EXPOSURE

isomer (Brouwer et al. 1991a; van Welie et al. 1991a). At comparable respiratory exposures, cis-1,3-dichloropropene yielded approximately 3 times more mercapturic acid in urine samples than the trans isomer, which was attributed to differences in metabolism. Approximate cumulative urinary excretions of cis- and trans-DCP-MA at the maximum respiratory exposures were 50 mg (at 10.7 mg/m<sup>3</sup>) and 15 mg (at 8 mg/m<sup>3</sup>), respectively. A related study reported that the proportion between respiratory exposure to 1,3-dichloropropene and urinary mercapturic acid excretion for field bystanders was similar to that of applicators (van Welie et al. 1991b). Kezic et al. (1996) compared dermal 1,3-dichloropropene exposure to respiratory exposure. The estimated mean total uptake of cis-1,3-dichloropropene in five adults dermally exposed on the forearm and hand to 86 mg/m<sup>3</sup> of the pesticide vapor for 45 minutes was 67 µg. The average total cis-DCP-MA excreted in urine over a 24-hour period was 48 µg. The authors concluded that when whole-body dermal exposure is compared with inhalation, dermal uptake amounts to only 2–5% of absorption through inhalation.

Populations that live near hazardous waste sites may be exposed to 1,3-dichloropropene via inhalation, drinking contaminated groundwater, or dermal contact with contaminated soil. Individuals who shower or bathe in groundwater contaminated with 1,3-dichloropropene may be exposed through inhalation and dermal contact. 1,3-Dichloropropene has been identified in at least 108 of the 1,678 hazardous waste sites that have been proposed for inclusion on the EPA National Priorities List (NPL) (HazDat 2006).

Pertinent monitoring data regarding the dermal exposure of 1,3-dichloropropene were not located in the available literature. Dermal exposure is possible for workers involved in fumigant applications of 1,3-dichloropropene.

Data regarding human exposure to 1,1-, 1,2-, 2,3-, and 3,3-dichloropropene were not located in the available literature. Exposure of the general population to these substances is expected to be low since they are not produced or used in large quantities (IUR). 1,1-Dichloropropene has been detected in drinking water. However, it was found in only 0.01% of 97,698 public water system samples collected nationwide; therefore, exposure to this substance via drinking water is expected to be very low.

Occupational exposure may occur through inhalation and dermal contact at facilities where the dichloropropene isomers are produced or used. People who live near these facilities may also be exposed if these substances are released into the surrounding areas. According to the National Occupational Exposure Survey (NOES) conducted by NIOSH between 1981 and 1983, it has been estimated that 302 workers (3 female workers) were potentially exposed to 2,3-dichloropropene (NIOSH 2006).



## 6. POTENTIAL FOR HUMAN EXPOSURE

**6.6 EXPOSURES OF CHILDREN**

This section focuses on exposures from conception to maturity at 18 years in humans. Differences from adults in susceptibility to hazardous substances are discussed in Section 3.7, Children's Susceptibility.

Children are not small adults. A child's exposure may differ from an adult's exposure in many ways. Children drink more fluids, eat more food, breathe more air per kilogram of body weight, and have a larger skin surface in proportion to their body volume. A child's diet often differs from that of adults. The developing human's source of nutrition changes with age: from placental nourishment to breast milk or formula to the diet of older children who eat more of certain types of foods than adults. A child's behavior and lifestyle also influence exposure. Children crawl on the floor, put things in their mouths, sometimes eat inappropriate things (such as dirt or paint chips), and spend more time outdoors. Children also are closer to the ground, and they do not use the judgment of adults to avoid hazards (NRC 1993).

Dichloropropene (unspecified isomers) was qualitatively identified in 1 out of 12 samples of breast milk collected from Bayonne, New Jersey; Jersey City, New Jersey; Bridgeville, Pennsylvania; and Baton Rouge, Louisiana during the late 1970s (EPA 1980; Pellizzari et al. 1982).

Current data regarding the exposure of children to dichloropropenes (including body burden data, detection in breast milk, dietary exposure data, pathways of exposure, differences in intake compared to adults, and secondary exposure data) are not available. Individuals with the greatest potential for exposure to 1,3-dichloropropene include bystanders and residents located near fields treated with this fumigant who may inhale 1,3-dichloropropene that has volatilized into the air (EPA 1998b). Therefore, children who live or play near fields where 1,3-dichloropropene is applied may be exposed to this substance through inhalation.

**6.7 POPULATIONS WITH POTENTIALLY HIGH EXPOSURES**

High levels of exposure to 1,3-dichloropropene are most likely to occur in occupational settings where 1,3-dichloropropene is either produced or used as a soil fumigant. Intake by inhalation or dermal contact is the most probable route of high exposure to 1,3-dichloropropene. 1,3-Dichloropropene is a volatile compound and, after soil application as a fumigant, a fraction of the compound will volatilize and escape into the atmosphere (Krijgsheld and Van der Gen 1986). Potentially high exposures to 2,3-dichloro-

## 6. POTENTIAL FOR HUMAN EXPOSURE

propene should be limited to individuals who work at facilities where these substances are produced or used.

## 6.8 ADEQUACY OF THE DATABASE

Section 104(i)(5) of CERCLA, as amended, directs the Administrator of ATSDR (in consultation with the Administrator of EPA and agencies and programs of the Public Health Service) to assess whether adequate information on the health effects of dichloropropenes is available. Where adequate information is not available, ATSDR, in conjunction with NTP, is required to assure the initiation of a program of research designed to determine the health effects (and techniques for developing methods to determine such health effects) of dichloropropenes.

The following categories of possible data needs have been identified by a joint team of scientists from ATSDR, NTP, and EPA. They are defined as substance-specific informational needs that if met would reduce the uncertainties of human health assessment. This definition should not be interpreted to mean that all data needs discussed in this section must be filled. In the future, the identified data needs will be evaluated and prioritized, and a substance-specific research agenda will be proposed.

### 6.8.1 Identification of Data Needs

Although the following discussion covers 1,1-, 1,2-, 1,3-, and 2,3-dichloropropene, testing to fill data gaps for 1,3-dichloropropene should take priority, since it is the only isomer currently in production at a significant volume.

**Physical and Chemical Properties.** The physical and chemical properties of both cis- and trans-1,3-dichloropropene have been described and are readily available in the literature (Dilling 1977; EPA 1981a; Kenaga 1980; Leistra 1970; Lewis 2001; Lide 2005; O'Neil et al. 2001; Verschueren 2001). Some of these physical properties were required for assessing the fate and transport of 1,3-dichloropropene in the environment because experimental data were not available. The literature values were sufficient for performing the necessary estimates. No data needs regarding the physical and chemical properties of 1,3-dichloropropene are identified at this time. Measured vapor pressure values are available for 1,1-, 1,2-, 2,3-, and 3,3-dichloropropene. Measured log octanol/water partition coefficients, Henry's law constants, soil/water partitioning coefficients, and bioconcentration factors are lacking for these isomers.

## 6. POTENTIAL FOR HUMAN EXPOSURE

In addition, measured water solubility data are lacking for 1,1- and 3,3-dichloropropene. Measured values for these end points would be helpful in predicting the fate and transport of these isomers where experimental data are lacking.

**Production, Import/Export, Use, Release, and Disposal.** According to the Emergency Planning and Community Right-to-Know Act of 1986, 42 U.S.C. Section 11023, industries are required to submit substance release and off-site transfer information to the EPA. The TRI, which contains this information for 2003, became available in May of 2005. This database is updated yearly and should provide a list of industrial production facilities and emissions.

Current dichloropropene production and import/export volumes are unavailable in the literature. Much of the information regarding 1,3-dichloropropene has been included in combination with other chemicals. For example, USITC (1989) data for 1,3-dichloropropene are grouped with other soil fumigants. Historical production volumes are well documented (Yang 1986), but information regarding future domestic production, and past, present, and future imports and exports are lacking in the literature

Literature pertaining to the use of 1,3-dichloropropene as an agricultural soil fumigant is readily available (Krijgsheld and Van der Gen 1986). Information on the uses of 1,1-, 1,2-, and 3,3-dichloropropene and more detailed use information for 2,3-dichloropropene would be helpful. Disposal methods for 1,3-dichloropropene have been described and appear to be satisfactory; however, methods that describe the disposal of 1,1-, 1,2-, 2,3-, and 3,3-dichloropropene are not available.

**Environmental Fate.** Information concerning the partitioning of 1,3-dichloropropene in the environment is available (Cohen 1986; Dilling 1977; EPA 1986; Kenaga 1980; Leistra 1970; Munnecke and Vangundy 1979; Roberts and Stoydin 1976; Thomas and McKenry 1974; van der Pas and Leistra 1987). Information on the transport and degradation of 1,3-dichloropropene in environmental media is also available (Cohen 1986; Dilling 1977; EPA 1986; Leistra 1970; Munnecke and Vangundy 1979; Roberts and Stoydin 1976; Swann et al. 1983; Thomas 1982; van der Pas and Leistra 1987). No data needs are identified regarding the environmental fate of 1,3-dichloropropene. Data regarding the environmental fate of 1,1-, 1,2-, 2,3-, and 3,3-dichloropropene were not located in the literature. Although the environmental fate of these substances is expected to be similar to that of 1,3-dichloropropene, there may be some differences especially pertaining to the rates of hydrolysis and ozonolysis. Measured data for these isomers would provide a much better understanding of their environmental fate and partitioning.

## 6. POTENTIAL FOR HUMAN EXPOSURE

**Bioavailability from Environmental Media.** Case reports of people who have experienced 1,3-dichloropropene poisoning following oral, dermal, and inhalation exposure indicate that 1,3-dichloropropene can be absorbed by these routes (Albrecht 1987a; Markovitz and Crosby 1984; Osterloh et al. 1984, 1989a, 1989b). However, information regarding oral or dermal absorption of 1,3-dichloropropene in water, soil, or plant material have not been found. Studies of absorption of 1,3-dichloropropene from air, water, soil, and plant material would allow determination of the rate and extent of absorption from each of these media, and allow comparison of the potential hazard posed by 1,3-dichloropropene contained in each. A data need exists regarding the bioavailability of 1,3-dichloropropene from these media. Bioavailability data for 1,1-, 1,2-, 2,3-, and 3,3-dichloropropene were not located in the literature. Although the bioavailability of these substances is expected to be low, additional information would be helpful in verifying this.

**Food Chain Bioaccumulation.** Few data are available describing the food chain bioaccumulation of dichloropropenes. Experimental data are unavailable; therefore, we do not know if the bioconcentration potential is consistent with estimated values obtained from regression equations (Lyman 1982). Information concerning the potential for food chain biomagnification has not been described. Knowledge in this area would enable scientists to assess the dangers of human exposure to dichloropropenes via food such as fish and seafoods.

**Exposure Levels in Environmental Media.** Reliable monitoring data for the levels of dichloropropenes in contaminated media at hazardous waste sites are needed so that the information obtained on levels of dichloropropenes in the environment can be used in combination with the known body burden of the dichloropropenes to assess the potential risk of adverse health effects in populations living in the vicinity of hazardous waste sites.

Air and groundwater monitoring data are available for 1,3-dichloropropene. However, more information on the levels of 1,3-dichloropropene in surface water, drinking water, soil, and sediment would be helpful since data related to these media are lacking. Monitoring data indicate that 1,3-dichloropropene is generally not detected in table-ready foods. 1,3-Dichloropropene is not expected to be present in crops grown in soil treated with this pesticide; however, additional monitoring for 1,3-dichloropropene in these types of foods would be helpful in confirming this. Environmental monitoring data for 1,1-, 1,2-, 2,3-, and 3,3-dichloropropene are very limited. Although concentrations of these substances in the environment are expected to be low, additional information would be helpful in verifying this.

## 6. POTENTIAL FOR HUMAN EXPOSURE

**Exposure Levels in Humans.** 1,3-Dichloropropene is not a naturally occurring substance (IARC 1986). Available information shows that N-acetyl cysteine is present in the urine of people who were occupationally exposed to 1,3-dichloropropene (Osterloh et al. 1984, 1989a, 1989b). Additional information regarding the utility of this biomarker as an indicator of general population exposure to the compound may be useful in monitoring the frequency of human exposure to 1,3-dichloropropene. Information concerning the numbers of persons potentially exposed to 1,3-dichloropropene near waste sites and manufacturing, production, and use facilities is also not available. In these areas and those of widespread use, the potential for human exposure is high. Human exposure data for 1,1-, 1,2-, 2,3-, or 3,3-dichloropropene were not located in the literature. Although human exposure to these substances is not expected to be important, information would be helpful in verifying this.

**Exposures of Children.** Data regarding the exposure of children to dichloropropenes (including body burden data, detection in breast milk, dietary exposure data, pathways of exposure, differences in intake compared to adults, and secondary exposure data) are not available. Exposure data for children who live or play near fields where 1,3-dichloropropene is applied would be particularly helpful.

Child health data needs relating to susceptibility are discussed in Section 3.12.2, Identification of Data Needs: Children's Susceptibility.

**Exposure Registries.** No exposure registries for the dichloropropenes were located. These substances are not currently among the compounds for which sub-registries have been established in the National Exposure Registry. These substances will be considered in the future when chemical selection is made for sub-registries to be established. The information that is amassed in the National Exposure Registry facilitates the epidemiological research needed to assess adverse health outcomes that may be related to exposure to these substances.

### 6.8.2 Ongoing Studies

The Federal Research in Progress (FEDRIP 2006) database provides additional information obtainable from a few ongoing studies that may fill in some of the data needs identified in Section 6.8.1.

D.O. Chellemi and J.W. Noling of the University of Florida, Institute of Food and Agriculture, Gainesville, Florida are being funded by the U.S. Department of Agriculture (USDA) to conduct field-scale demonstration/validation studies of alternatives for methyl bromide using new developments in

## 6. POTENTIAL FOR HUMAN EXPOSURE

application technology and methods. S.R. Yates and S.K. Papiernik, S.K. of Agricultural Research Service, Riverside, California are being funded by the USDA to study the fate and transport of alternative fumigants and methyl bromide. L.T. Ou and A.V. Ogram of the University of Florida, Soil and Water Science, Gainesville, Florida are being funded by the USDA to study the mechanisms and mitigation of agrochemical impacts on human and environmental health. This will include characterization of biotic and abiotic processes, degradation rates, and determination of degradation products.

Ongoing studies regarding the environmental fate and partitioning, environmental monitoring, or the potential for human exposure of 1,1-, 1,2-, 2,3-, and 3,3-dichloropropene were not identified in the Federal Research in Progress database (FEDRIP 2006).

## 7. ANALYTICAL METHODS

The purpose of this chapter is to describe the analytical methods that are available for detecting, measuring, and/or monitoring dichloropropene isomers, their metabolites, and other biomarkers of exposure and effect to dichloropropene isomers. The intent is not to provide an exhaustive list of analytical methods. Rather, the intention is to identify well-established methods that are used as the standard methods of analysis. Many of the analytical methods used for environmental samples are the methods approved by federal agencies and organizations such as EPA and the National Institute for Occupational Safety and Health (NIOSH). Other methods presented in this chapter are those that are approved by groups such as the Association of Official Analytical Chemists (AOAC) and the American Public Health Association (APHA). Additionally, analytical methods are included that modify previously used methods to obtain lower detection limits and/or to improve accuracy and precision.

Since the majority of the analytical data on dichloropropenes are for the 1,3- isomer, the focus of this chapter is on methods that measure for 1,3-dichloropropene. Environmental analytical methods for 1,1- and 1,2-dichloropropene have been located; however, most of these are adequately described in the context of measuring for 1,3-dichloropropene. Analytical methods for measuring 2,3- and 3,3-dichloropropene in biological or environmental media were not located in the available literature.

### 7.1 BIOLOGICAL MATERIALS

The primary method for determining human exposure to 1,3-dichloropropene is measurement of the mercapturic acid metabolites N-acetyl-S-(cis-3-chloropropenyl-2)-L-cysteine (or cis-DCP-MA) and N-acetyl-S-(trans-3-chloropropenyl-2)-L-cysteine (or trans-DCP-MA) in the urine (Osterloh et al. 1984, 1989a, 1989b). Van Welie et al. (1989) describes a procedure whereby these metabolites are extracted from urine samples and analyzed using gas chromatography (GC) followed by sulfur-selective detection with a flame-photometric detector (FPD). During this study, the urine samples were collected from applicators before, during, and up to 24 hours after finishing soil fumigation with 1,3-dichloropropene. These samples were stored in the dark at 4 °C until they were transported (within 2 days); thereafter, they were stored at -18 °C. Methods for the analysis of these metabolites in human blood have not been located in the available literature.

## 7. ANALYTICAL METHODS

Kastl and Hermann (1983) developed an analytical procedure for determining the level of cis- and trans-1,3-dichloropropene in whole rat blood. Blood is extracted, 200  $\mu$ L n-hexane is added, and the sample is vortexed and centrifuged at 800 g for 1 minute. Samples are either directly injected onto a GC column for GC/mass spectrometry (MS) analysis or diluted with hexane for GC/electron capture detection (ECD) analysis. Percent recoveries of the GC analysis range from 80.8 to 98.5 for the cis isomer and from 81.3 to 98.2 for trans-1,3-dichloropropene. For GC/MS analysis, percent recoveries are between 83.1 and 94.9 for cis- and 88.7 and 98.8 for trans-1,3-dichloropropene. The GC/ECD method is sensitive to cis and trans isomeric concentrations in rat blood of  $5.88\text{--}1.17 \times 10^4$  and  $5.35\text{--}1.07 \times 10^4$  ng/mL, respectively. The GC/MS method is sensitive to cis- and trans-1,3-dichloropropene concentrations in rat blood of  $5.18 \times 10^1\text{--}1.29 \times 10^4$  and  $4.71 \times 10^1\text{--}1.18 \times 10^4$  ng/mL, respectively.

Fisher and Kilgore (1989) extracted the glutathione conjugate of 1,3-dichloropropene from the blood of rats. After collection, the blood was frozen and stored at  $-20$  °C until analysis. Solutions of 1 mL whole blood and 2 mL 10 mM HCl in an acetone dry-ice slurry were repeatedly frozen and thawed and then finally centrifuged. The supernatant (1 mL) was deproteinated using 0.33 mL of 70% perchloric acid and then centrifuged again. The resulting clear supernatant was either injected into the high performance liquid chromatography (HPLC) or stored at  $-20$  °C. Schneider et al. (1998a) described a method for analyzing 1,3-dichloropropene epoxides in mouse liver. Livers were homogenized in 2 mL 100 mM sodium phosphate buffer. Ethyl acetate containing 2  $\mu$ g of internal standard was added followed by homogenization and centrifugation. After removal of the organic layer, the pellet was extracted using ethyl acetate without the internal standard and analyzed using GC/MS. Recoveries for cis/trans-1,3-dichloropropene and cis/trans-1,3-dichloropropene epoxides were 81–95%. Bond et al. (1985) described a method for analyzing 2,3-dichloropropene in the urine, feces, and tissues (including blood) of rats. Tissue samples from rats exposed to C-14 labeled 2,3-dichloropropene were homogenized in ice-cold distilled water and added to acetonitrile. Following centrifugation and extraction, the supernatant was diluted in water to give a final concentration of 50% water and 50% acetonitrile. Analysis was performed using a liquid scintillation spectrometer. Recovery in spiked samples was >95%.

Table 7-1 summarizes the methods used to detect 1,3-dichloropropene in biological materials, including a procedure for detecting 1,3-dichloropropene in foods (Daft 1989).

Analytical methods for measuring 1,1-, 1,2-, 2,3-, or 3,3-dichloropropene in biological media were not located in the literature.



## 7. ANALYTICAL METHODS

**Table 7-1. Analytical Methods for Determining cis- and trans-1,3-Dichloropropene and Metabolites in Biological Materials**

Sample matrix	Preparation method	Analytical method	Sample detection limit	Percent recovery	Reference
Urine	Addition of internal standard, extraction using ethyl acetate, dissolve in methanol, methylation using ethereal diazomethane, redissolve in ethyl acetate	GC/FPD	107 ng/mL (trans-DCP-MA); 115 ng/mL (cis-DCP-MA)	69 (trans-DCP-MA); 70 (cis-DCP-MA)	Van Welie et al. 1989
Rat blood	Extract with hexane vortex and centrifuge	GC/MS	5.18 ng/mL (cis); 4.71 ng/day (trans)	83.1–94.9 (cis); 88.7–98.8 (trans)	Kastl and Hermann 1983
Rat blood	Extract with hexane vortex and centrifuge	GC/ECD	5.88 ng/day (cis); 5.35 ng/mL (trans)	80.8–98.5 (cis); 81.3–98.2 (trans)	Kastl and Hermann 1983
Food	Extract composited, table-ready foods with isooctane or acetone-aqueous phosphoric acid-isooctane mixture	GC-ECD/HECD	No data	45–112	Daft 1989, 1990

ECD = electron capture detection; FPD = Flame-photometric detection; GC = gas chromatography; HECD = Hall electron capture detection; MS = mass spectrometry

## 7. ANALYTICAL METHODS

**7.2 ENVIRONMENTAL SAMPLES**

Procedures for detecting cis- and trans-1,3-dichloropropene in water and soil samples at hazardous waste sites are outlined in the method for semivolatiles in the Contract Laboratory Program (CLP) Statement of Work for Organics Analysis (EPA 1999). The required quantification limits for both cis- and trans-1,3-dichloropropene are 10 ppb for water samples and 10 ppb for soil samples in this monitoring program.

For the most part, soil and sediment samples are analyzed in a similar manner to water samples, with the exception that a small amount of water is added to soil and sediment samples. At this point, all three matrices are subjected to a purge-and-trap cycle. An inert gas is bubbled through the sample, volatilizing 1,3-dichloropropene. The gas stream is then passed through an adsorbent tube, which recollects the 1,3-dichloropropene. The sorbent tube is attached to a GC, heated, and backflushed with an inert gas to desorb the halocarbons onto a GC column. Quantification can be accomplished using either a flame ionization detector or an MS, depending on the total concentration of organics in the sample.

EPA's Test Methods for Organic Chemical Analysis of Municipal and Industrial Wastewater (EPA 1982) and Test Methods for Solid Waste (EPA 1986) are very similar to those already outlined. However, the purge-and-trap cycle may be bypassed for aqueous process wastes with expected concentrations in excess of 10,000 µg/L. In these instances, the sample may be directly injected into the GC system with a 10 µL syringe (EPA 1986). EPA-Office of Solid Waste Methods 8021B and 8260B can be applied to solid waste (EPA 1996a, 1996b). Method 8021B uses GC followed by a photoionization detector (PID) and a Hall electron capture detector (HECD) connected in series (EPA 1996a).

It is important to note the discrepancies in detection limits between the standardized methods. CLP cites a detection limit of 10 ppb, yet gives no information regarding the percent recoveries (EPA 1999). The EPA procedures for solid wastes (EPA Method 8010) and municipal and industrial waste waters (EPA Method 601), however, maintain a detection limit of 0.34 ppb. The percent recovery, according to the Solid Waste Manual, ranges from 22 to 178 (EPA 1986). Therefore, results from EPA Method 8010 must be interpreted with caution. For municipal and industrial waste waters, the average percent recoveries for the cis- and trans-isomers are reportedly 86.7 and 73.5 with standard deviations of 6.0 and 17.2%, respectively (EPA 1982). Again, the precision at which the trans-isomer can be measured is questionable.

## 7. ANALYTICAL METHODS

Other standardized methods used for detection of 1,3-dichloropropene in water samples by purge and trap followed by GC/MS include EPA Methods 524.2, 624, and 1624, Standard Methods 6200B and 6200C, ASTM Method D5790, and USGS-NWQL Method O-4127-96 (EPA 1995a, 2001b, 2005b; NEMI 1997b, 2001; USGS 1998). Detection limits and percent recoveries for determination of both isomers in water range were 0.02–10 ppb and 78–110%, respectively, using these methods.

A few methods have appeared in the available literature. Leiber and Berk (1984) outlined a method for determining 1,3-dichloropropene in ambient air. Tenax-GC sampling tubes are used for sample collection. Solvent desorption is accomplished with isooctane containing 4.0 µg/L of 1,3,5-tribromobenzene, followed by heat treatment at 90 °C for 15 minutes; the mixture is then left to stand for 12 hours. After centrifugation, an aliquot of the resulting solution is injected onto the GC column. Sample analysis by capillary GC/ECD was validated for the range of 0.4–4.0 ppm, with a mean percent recovery of 100. Table 7-2 summarizes the methods for detecting cis- and trans-1,3-dichloropropene in environmental media.

Several of the environmental methods mentioned above for measuring 1,3-dichloropropene (EPA-OSW method 8021B and 8260 B, ASTM method D5790, Standard Methods 6200B and 6200C, and USGS-NWQL Method O-4127-96) also include 1,1-dichloropropene as an analyte (EPA 1996a, 1996b; NEMI 1997a, 1997b, 2001; USGS 1998). Table 7-3 provides information specific to the measurement of 1,1-dichloropropene in environmental media using these methods. In addition, EPA-NERL method 502.2 can be used to measure 1,1-dichloropropene in water using GC followed by either photoionization detection or electrolytic conductivity detection (EPA 1995a).

EPA method 524.2 was the only method identified for measuring 1,2-dichloropropene in environmental media. This method uses purge and trap followed by GC/MS to analyze for the substance in water. The sample detection limit and percent recovery are 0.02 ppb and 98%, respectively (NEMI 1992). Analytical methods for measuring 2,3- and 3,3-dichloropropene in environmental media were not located in the available literature.

### 7.3 ADEQUACY OF THE DATABASE

Section 104(i)(5) of CERCLA, as amended, directs the Administrator of ATSDR (in consultation with the Administrator of EPA and agencies and programs of the Public Health Service) to assess whether adequate information on the health effects of dichloropropenes is available. Where adequate information

## 7. ANALYTICAL METHODS

**Table 7-2. Analytical Methods for Determining 1,3-Dichloropropene in Environmental Materials**

Sample matrix	Preparation method	Analytical method	Sample detection limit	Percent recovery	Reference
Air	Adsorb (Tenax-GC); desorb (isooctane); inject aliquot	GC/ECD	0.4–4.0 ppm	100	Leiber and Berk 1984
Water	Purge and trap	GC/MS (EPA CLP Method)	10 ppb	No data	EPA 1999
Water	Purge and trap	GC/MS (EPA Method 8010)	0.34 ppb	22–178	EPA 1986a
Wastewater	Purge and trap	GC/MS (EPA Method 601)	0.20 ppb 0.34 ppb	100 (cis) 100 (trans)	EPA 2001a
Soil	Add water, heat, purge and trap, thermal desorption	GC/MS (EPA CLP Method)	10 ppb	No data	EPA 1999
Solid waste	Purge and trap, direct injection, vacuum distillation	GC/PID and/or HECD (EPA-OSW Method 8021B)	No data	No data	EPA 1996a
Air, water, solid waste	Purge and trap (aqueous, solid, and waste oil), direct injection (waste oil), automatic static headspace (solid), closed system vacuum distillation (aqueous, solid, oil, and tissue), or desorption from trapping media (air)	GC/MS (EPA-OSW Method 8260B)	No data	No data	EPA 1996b
Water	Purge and trap	GC/MS (EPA Method 524.2)	0.02 ppb (cis) 0.048 ppb (trans)	100 (cis) 110 (trans)	EPA 1995a
Water	Purge and trap	GC/MS (EPA Method 624)	5 ppb (cis) Not available (trans)	100 (cis) 100 (trans)	EPA 2005b
Water	Purge and trap	GC/MS (EPA Method 1624)	Not available (cis) 10 ppb (trans)	Not available (cis) Not available (trans)	EPA 2001b
Water	Purge and trap	GC/MS (ASTM Method D5790)	0.21 ppb (cis) 0.2 ppb (trans)	93% (cis) 85% (trans)	NEMI 2001
Water	Purge and trap	GC/MS (Standard Methods 6200B)	0.04 ppb (cis) 0.05 ppb (trans)	99% (cis) 101% (trans)	NEMI 1997a

## 7. ANALYTICAL METHODS

**Table 7-2. Analytical Methods for Determining 1,3-Dichloropropene in Environmental Materials**

Sample matrix	Preparation method	Analytical method	Sample detection limit	Percent recovery	Reference
Water	Purge and trap	GC (Standard Methods 6200C)	0.06 ppb (cis) 0.02 ppb (trans)	78% (cis) 78% (trans)	NEMI 1997b
Water	Purge and trap	GC/MS (USGS-NWQL Method O-4127-96)	0.048 ppb (cis) 0.072 ppb (trans)	93% (cis) 85% (trans)	USGS 1998

ECD = electron capture detection; FID = flame ionization detector; GC = gas chromatography; HECD = Hall electron capture detection; MS = mass spectrometry; PID = photoionization detector

## 7. ANALYTICAL METHODS

**Table 7-3. Analytical Methods for Determining 1,1-Dichloropropene in Environmental Materials**

Sample matrix	Preparation method	Analytical method	Sample detection limit	Percent recovery	Reference
Water	Purge and trap	GC/PID or ELCD (EPA-NERL Method 502.2)	0.02 ppb	103%	EPA 1995b
Solid waste	Purge and trap, direct injection, vacuum distillation	GC/PID and/or ELCD (EPA-OSW Method 8021B)	0.02 ppb	103%	EPA 1996a
Air, water, solid waste	Purge and trap (aqueous, solid, and waste oil), direct injection (waste oil), automatic static headspace (solid), closed system vacuum distillation (aqueous, solid, oil, and tissue), or desorption from trapping media (air)	GC/MS (EPA-OSW Method 8260B)	Not available	102%	EPA 1996b
Water	Purge and trap	GC/MS (ASTM Method D5790)	0.18 ppb	107%	NEMI 2001
Water	Purge and trap	GC/MS (Standard Methods 6200B)	0.04 ppb	110%	NEMI 1997a
Water	Purge and trap	GC (Standard Methods 6200C)	0.01 ppb	74%	NEMI 1997b
Water	Purge and trap	GC/MS (USGS-NWQL Method O-4127-96)	0.028 ppb	Not available	USGS 1998

ELCD = electrolytic conductivity detection; FID = flame ionization detector; GC = gas chromatography; MS = mass spectrometry; PID = photoionization detector

## 7. ANALYTICAL METHODS

is not available, ATSDR, in conjunction with NTP, is required to assure the initiation of a program of research designed to determine the health effects (and techniques for developing methods to determine such health effects) of dichloropropene isomers.

The following categories of possible data needs have been identified by a joint team of scientists from ATSDR, NTP, and EPA. They are defined as substance-specific informational needs that if met would reduce the uncertainties of human health assessment. This definition should not be interpreted to mean that all data needs discussed in this section must be filled. In the future, the identified data needs will be evaluated and prioritized, and a substance-specific research agenda will be proposed.

### 7.3.1 Identification of Data Needs

Although the following discussion covers 1,1-, 1,2-, 1,3-, and 2,3-dichloropropene, testing to fill data gaps for 1,3-dichloropropene should take priority, since it is the only isomer currently in production at a significant volume.

#### Methods for Determining Biomarkers of Exposure and Effect.

**Exposure.** Van Welie et al. (1989) has described a method for determining the mercapturic acid metabolites N-acetyl-S-(cis-3-chloropropenyl-2)-L-cysteine (or cis-DCP-MA) and N-acetyl-S-(trans-3-chloropropenyl-2)-L-cysteine (or trans-DCP-MA) in the urine. Additional study and the development of standardized methods regarding the detection of dichloropropene metabolites in human biological materials (urine, blood, and tissue) are needed.

**Effect.** There are no known biomarkers of effect that are unique to dichloropropenes. Therefore, standardized analytical methods for their determination are not warranted.

#### Methods for Determining Parent Compounds and Degradation Products in Environmental

**Media.** Methods for determining of 1,3-dichloropropene in environmental matrices have appeared in the literature. Of these, standardized methods exist only for the analysis of surface water, soil, or sediment samples (EPA 1982, 1986, 1999). For sediments and soils, the levels of accuracy have not been reported. Both the accuracy and precision at which the trans-isomer can be measured in water is questionable. Therefore, refinement of the current procedures and establishing standardized methods for analyzing other media such as air will aid in determining levels of human exposure to 1,3-dichloro-

## 7. ANALYTICAL METHODS

propene. A limited number of methods are available for determining 1,1- and 1,2-dichloropropene in environmental media, while no methods were located for 2,3- or 3,3-dichloropropene. Development of standardized methods for determining levels of 1,1-, 1,2-, 2,3-, and 3,3-dichloropropene in environmental materials would be helpful.

A limited number of methods is available to determine 1,3-dichloropropene in biological materials (Daft 1989; Kastl and Hermann 1983), and none of the methods have been standardized. The establishment of standardized methods for determining of 1,3-dichloropropene in biological materials, together with methods that are unique to 1,3-dichloropropene exposure, would be helpful in determining the levels of and exposure to the general population. No methods for determining 1,1-, 1,2-, 2,3-, or 3,3-dichloropropene in biological materials have been located. Development of standardized methods for determining levels of these isomers in biological materials would be helpful.

### 7.3.2 Ongoing Studies

Ongoing studies related to analytical methods for dichloropropenes were not located in the Federal Research in Progress database (FEDRIP 2006).

The Environmental Health Laboratory Sciences Division of the National Center for Environmental Health, Centers for Disease Control and Prevention, is developing methods for the analysis of dichloropropenes and other volatile organic compounds in blood. These methods use purge and trap methodology, high-resolution gas chromatography, and magnetic sector mass spectrometry, which give detection limits in the low parts per trillion (ppt) range.



## 8. REGULATIONS AND ADVISORIES

International and national regulations and guidelines pertinent to human exposure to 1,3- and 2,3-dichloropropene are summarized in Table 8-1.

**2,3-Dichloropropene.** An acute-duration inhalation MRL of 0.002 ppm was derived for very slight hyperplasia of the nasal respiratory epithelium in female rats exposed to 2,3-dichloropropene vapor at a minimal LOAEL of 5 ppm, 6 hours/day, for 9 out of 11 days (Zempel et al. 1987). The MRL was based on 0.14 ppm, the human equivalent concentration ( $LOAEL_{HEC}$ ) to the duration-adjusted minimal LOAEL of 1.25 ppm. An uncertainty factor of 90 (3 for the use of a minimal LOAEL, 3 for extrapolation from animals to humans using dosimetric adjustment, and 10 for human variability) was applied to the  $LOAEL_{HEC}$ .

**1,3-Dichloropropene.** An intermediate-duration inhalation MRL of 0.008 ppm was derived for slight hypertrophy/hyperplasia of the nasal respiratory epithelium observed in male B6CF1 mice exposed to 1,3-dichloropropene vapor (92.1% purity) at a concentration of 60 ppm, 6 hours/day, 5 days/week, for 6 months (Lomax et al. 1989). The MRL was based on 0.23 ppm, the human equivalent concentration (HEC) to the benchmark concentration limit ( $BMCL_{10}$ ), the 95% lower confidence limit on the maximum likelihood estimate of the concentration corresponding to 10% risk; concentrations were adjusted for compound purity and intermittent exposure before modeling. An uncertainty factor of 30 (3 for extrapolation between animal and human using dosimetric adjustment and 10 for human variability) was applied to the  $(BMCL_{10})_{HEC}$ . A chronic-duration inhalation MRL of 0.007 ppm has been derived for hypertrophy/hyperplasia of the nasal respiratory epithelium in female B6CF1 mice exposed to 1,3-dichloropropene vapor at a concentration of 20 ppm, 6 hours/day, 5 days/week for 2 years (Lomax et al. 1989). The MRL was based on 0.20 ppm, the human equivalent concentration to a benchmark concentration limit (95% lower confidence limit on the maximum likelihood estimate of the concentration corresponding to 10% risk) ( $[BMCL_{10}]_{HEC}$ ). An uncertainty factor of 30 (3 for extrapolation between animal and human using dosimetric adjustment and 10 for human variability) was applied to the  $(BMCL_{10})_{HEC}$ . An intermediate-duration oral MRL of 0.04 mg/kg/day has been derived based on a  $BMDL_{10}$  of 3.6 mg/kg/day for basal cell hyperplasia of the nonglandular stomach in male Fischer rats (Haut et al. 1996) exposed to Telone II<sup>®</sup>b in the diet at a dose of 15 mg/kg/day for 13 weeks; a composite uncertainty factor of 100 (10 for extrapolation between animals and humans and 10 for human variability) was applied to the  $BMDL_{10}$ . The chronic-duration oral MRL is based on benchmark dose modeling of the

## 8. REGULATIONS AND ADVISORIES

incidence of basal cell hyperplasia in female Fischer rats (Stebbins et al. 2000) exposed to Telone II<sup>®</sup> in the diet at a dose of 12.5 mg/kg/day for 2 years. Application of a composite uncertainty factor of 100 (10 for extrapolation between animals and humans and 10 for human variability) to the BMDL<sub>10</sub> of 3.51 mg/kg/day would result in a chronic oral MRL of 0.04 mg/kg/day. This value is in agreement with EPA's chronic oral RfD of 0.03 mg/kg/day, which was based on a point of departure of 3.4 mg/kg/day for the same data set. Therefore, 0.03 mg/kg/day was selected as the chronic-duration oral MRL for 1,3-dichloropropene.

In 2000, EPA derived an oral reference dose (RfD) value for 1,3-dichloropropene of 0.03 mg/kg/day based on a benchmark dose limit (95% lower confidence limit on the maximum likelihood estimate of the dose corresponding to 10% risk) (BMDL<sub>10</sub>) of 3.4 mg/kg/day for chronic irritation in Fischer 344 rats in a chronic feeding study (IRIS 2006); an uncertainty factor of 100 was applied (10 for interspecies extrapolation and 10 for intraspecies variation) (IRIS 2006).

In 2000, EPA derived an inhalation reference concentration (RfC) value for 1,3-dichloropropene of 0.02 mg/m<sup>3</sup> based on a benchmark concentration limit (95% lower confidence limit on the maximum likelihood estimate of the dose corresponding to 10% risk) (BMCL<sub>10</sub>) of 3.7 mg/m<sup>3</sup> (adjusted) (IRIS 2006) for hypertrophy/hyperplasia of the nasal respiratory epithelium in B6C3F1 mice during a chronic inhalation study (Lomax et al. 1989); an uncertainty factor of 30 was applied (3 for interspecies extrapolation to reflect the pharmacodynamic component of interspecies uncertainty and 10 for intraspecies variation) (IRIS 2006).

In 1999, the International Agency for Research on Cancer (IARC) classified 1,3-dichloropropene as a Group 2B carcinogen (possibly carcinogenic to humans) (IARC 2004). In 2000, EPA classified 1,3-dichloropropene as a B2 carcinogen (probable human carcinogen) (IRIS 2006). The National Toxicology Program (NTP) has classified 1,3-dichloropropene as reasonably anticipated to be a human carcinogen (NTP 2005). The American Conference of Governmental Industrial Hygienists (ACGIH) has classified 1,3-dichloropropene as an A3 carcinogen (confirmed animal carcinogen with unknown relevance to humans) (ACGIH 2005). The National Institute of Occupational Safety and Health (NIOSH) has also identified 1,3-dichloropropene as a potential occupational carcinogen (NIOSH 2005).

OSHA has not required employers of workers who are occupationally exposed to 1,3-dichloropropene to institute engineering controls and work practices to reduce and maintain employee exposure at or below permissible exposure limits (PELs) (OSHA 2005), although both ACGIH and NIOSH have recommended

## 8. REGULATIONS AND ADVISORIES

an 8- and 10-hour time-weighted averages (TWAs) of 1 ppm for 1,3-dichloropropene (ACGIH 2005; NIOSH 2005).

1,3-Dichloropropene is regulated by the Clean Water Effluent Guidelines for the following industrial point sources: electroplating, organic chemicals production, steam electricity power generation, asbestos product manufacturing, timber products processing, metal finishing, paving, roofing, paint formulating, ink formulating, gum and wood chemicals manufacturing, and carbon black manufacturing; see the electronic Code of Federal Regulations for details (NARA 2006).

EPA regulates 1,3-dichloropropene under the Clean Water Act (CWA) and the Clean Air Act (CAA) and has designated it as a hazardous substance and a hazardous air pollutant (HAP) (EPA 2006b, 2006c). 1,3- and 2,3-Dichloropropene are on the list of chemicals appearing in "Toxic Chemicals Subject to Section 313 of the Emergency Planning and Community Right-to-Know Act of 1986" (EPA 2006g). 1,3- and 2,3-Dichloropropene has been assigned a reportable quantity (RQ) limit of 100 pounds (EPA 2006f). The RQ represents the amount of a designated hazardous substance which, when released to the environment, must be reported to the appropriate authority.

## 8. REGULATIONS AND ADVISORIES

**Table 8-1. Regulations and Guidelines Applicable to Dichloropropenes<sup>a</sup>**

Agency	Description	Information	Reference
<u>INTERNATIONAL</u>			
Guidelines:			
IARC	Carcinogenicity classification	Group 2B <sup>b</sup>	IARC 2004
WHO	Air quality guidelines	No data	WHO 2000
	Drinking water quality guidelines	0.02 mg/L <sup>c</sup>	WHO 2004
<u>NATIONAL</u>			
Regulations and Guidelines:			
a. Air			
ACGIH	TLV (8-hour TWA)	1 ppm <sup>d</sup>	ACGIH 2005
EPA	AEGL	No data	EPA 2006a
	Hazardous air pollutant	Yes	EPA 2006c 42 USC 7412
NIOSH	REL (10-hour TWA)	1 ppm <sup>e,f</sup>	NIOSH 2005
	IDLH	No data	
OSHA	PEL (8-hour TWA) for general industry	No data	OSHA 2005 29 CFR 1910.1000
b. Water			
EPA	Designated as hazardous substances in accordance with Section 311(b)(2)(A) of the Clean Water Act for 1,3-dichloropropene and 2,3-dichloropropene	Yes	EPA 2006b 40 CFR 116.4
	Drinking water standards and health advisories		EPA 2004
	1-day health advisory for a 10-kg child	0.03 mg/L	
	10-day health advisory for a 10-kg child	0.03 mg/L	
	DWEL	1 mg/L	
	10 <sup>-4</sup> Cancer risk	0.04 mg/L	
	National primary drinking water standards	No data	EPA 2003
	Toxics criteria for those states not complying with Clean Water Act Section 303(c)(2)(B); human health (10 <sup>-6</sup> risk for carcinogens) for consumption of:		EPA 2006h 40 CFR 131.36
	Water + organisms	10 µg/L <sup>g</sup>	
	Organism only	1,700 µg/L <sup>g</sup>	
	Water quality criteria for human health consumption of:		EPA 2006e
	Water + organism	0.34 µg/L <sup>h</sup>	
	Organism only	21 µg/L <sup>h</sup>	

## 8. REGULATIONS AND ADVISORIES

**Table 8-1. Regulations and Guidelines Applicable to Dichloropropenes<sup>a</sup>**

Agency	Description	Information	Reference
<b>NATIONAL</b> (cont.)			
c. Food			
FDA	Bottled drinking water	No data	FDA 2005a 21 CFR 165.110
d. Other			
ACGIH	Carcinogenicity classification	A3 <sup>i</sup>	ACGIH 2005
EPA	Carcinogenicity classification	B2 <sup>j</sup>	IRIS 2006
	Oral slope factor	0.01 per mg/kg/day	
	Drinking water unit risk	1x10 <sup>-6</sup> to 3x10 <sup>-6</sup> per mg/kg/day	
	Inhalation unit risk	4x10 <sup>-6</sup> per mg/m <sup>3</sup>	
	RfC	0.02 mg/m <sup>3</sup>	
	RfD	0.03 mg/kg/day	
	Identification and listing of hazardous substances	U084	EPA 2006d 40 CFR 261, Appendix VIII
	Superfund, emergency planning, and community right-to-know		EPA 2006f 40 CFR 302.4
	Designated CERCLA hazardous substance	Yes	
	Reportable quantity		
	1,3-Dichloropropene	100 pounds	
	2,3-Dichloropropene	100 pounds	
	Effective date of toxic chemical release reporting		EPA 2006g 40 CFR 372.65
	1,3-Dichloropropene	01/01/87	
	2,3-Dichloropropene	01/01/90	

## 8. REGULATIONS AND ADVISORIES

**Table 8-1. Regulations and Guidelines Applicable to Dichloropropenes<sup>a</sup>**

Agency	Description	Information	Reference
NTP	Carcinogenicity classification	Reasonably anticipated to be a human carcinogen	NTP 2005

<sup>a</sup>All regulations cited are applicable to 1,3-dichloropropene except where indicated.

<sup>b</sup>Group 2B: possibly carcinogenic to humans

<sup>c</sup>For substances that are considered to be carcinogenic, the guideline value is the concentration in drinking-water associated with an upper-bound excess lifetime cancer risk of  $10^{-5}$  (one additional cancer per 100,000 of the population ingesting drinking-water containing the substance at the guideline value for 70 years).

<sup>d</sup>Skin notation: refers to the potential significant contribution to the overall exposure by the cutaneous route, including mucous membranes and the eyes, either by contact with vapors or, of probable greater significance, by direct skin contact with the substance.

<sup>e</sup>Potential occupational carcinogen

<sup>f</sup>Skin designation: indicates the potential for dermal absorption; skin exposure should be prevented as necessary through the use of good work practices, gloves, coveralls, goggles, and other appropriate equipment.

<sup>g</sup>Criteria revised to reflect current agency q1\* or RfD, as contained in the IRIS. The fish tissue bioconcentration factor from the 1980 criteria documents was retained in all cases.

<sup>h</sup>This criterion is based on carcinogenicity of  $10^{-6}$  risk.

<sup>i</sup>Group A3: confirmed animal carcinogen with unknown relevance to humans

<sup>j</sup>B2: probable human carcinogen

ACGIH = American Conference of Governmental Industrial Hygienists; AEGL = Acute Exposure Guideline Levels; CERCLA = Comprehensive Environmental Response, Compensation, and Liability Act; CFR = Code of Federal Regulations; DWEL = drinking water equivalent level; EPA = Environmental Protection Agency; FDA = Food and Drug Administration; IARC = International Agency for Research on Cancer; IDLH = immediately dangerous to life or health; NIOSH = National Institute for Occupational Safety and Health; NTP = National Toxicology Program; OSHA = Occupational Safety and Health Administration; PEL = permissible exposure limit; REL = recommended exposure limit; RfC = inhalation reference concentration; RfD = oral reference dose; TLV = threshold limit values; TWA = time-weighted average; USC = United States Code; WHO = World Health Organization

## 9. REFERENCES

- \*ACGIH. 2005. Threshold limit values for chemical substances and physical agents and biological exposure indices. Cincinnati, OH: American Conference of Governmental Industrial Hygienists.
- \*Adinolfi M. 1985. The development of the human blood-CSF-brain barrier. *Dev Med Child Neurol* 27:532-537.
- \*Adlercreutz H. 1995. Phytoestrogens: Epidemiology and a possible role in cancer protection. *Environ Health Perspect Suppl* 103(7):103-112.
- \*Agency for Toxic Substances and Disease Registry. 1989. Decision guide for identifying substance-specific data needs related to toxicological profiles; Notice. Agency for Toxic Substances and Disease Registry, Division of Toxicology. *Fed Regist* 54(174):37618-37634.
- \*Agency for Toxic Substances and Disease Registry. 1990. Biomarkers of organ damage or dysfunction for the renal, hepatobiliary, and immune systems. Subcommittee on Biomarkers of Organ Damage and Dysfunction. Atlanta, GA: Agency for Toxic Substances and Disease Registry.
- \*Albrecht W. 1987a. Occupational exposure to 1,3-dichloropropene (Telone II<sup>®</sup>) in Hawaiian pineapple culture. *Arch Environ Health* 42:286-291.
- \*Albrecht WN. 1987b. Toxicology and hazard assessment of 1,3-dichloropropene (II). *Arch Environ Health* 42:292-296.
- \*Albrecht WN, Chenchin K. 1985. Dissipation of 1,2-dibromo-3-chloropropane (DBCP), *cis*-1,3-dichloropropene (1,3-DCP), and dichloropropenes from soil to atmosphere. *Bull Environ Contam Toxicol* 34:824-831.
- \*Albrecht WN, Hagadone MR, Chenchin K. 1986. Charcoal air sampling tube storage stability and desorption efficiencies of 1,3-dibromo-3-chloropropane and 1,3-dichloropropene. *Bull Environ Contam Toxicol* 36:629-634.
- \*Altman PL, Dittmer DS. 1974. Biological handbooks: Biology data book. Vol. III. 2nd ed. Bethesda, MD: Federation of American Societies for Experimental Biology, 1987-2008, 2041.
- \*Andersen ME, Krishnan K. 1994. Relating in vitro to in vivo exposures with physiologically based tissue dosimetry and tissue response models. In: Salem H, ed. *Animal test alternatives: Refinement, reduction, replacement*. New York, NY: Marcel Dekker, Inc., 9-25.
- \*Andersen ME, Clewell HJ III, Gargas ML, et al. 1987. Physiologically based pharmacokinetics and the risk assessment process for methylene chloride. *Toxicol Appl Pharmacol* 87:185-205.
- \*Atkinson R, Darnall KR, Lloyd AC, et al. 1979. Kinetics and mechanisms of the reactions of the hydroxyl radical with organic compounds in the gas phase. *Adv Photochem* 11:375-488.

---

\* Cited in text

## 9. REFERENCES

- \*Baker LW, Fitzell DL, Seiber JN, et al. 1996. Ambient air concentrations of pesticides in California. *Environ Sci Technol* 30:1365-1368.
- \*Barnekow DE, Brown SM, Byrne SL, et al. 1995. Characterization of residues in soybeans grown in soil treated with 1,3-dichloropropene soil fumigant. *Pestic Sci* 43:211-219.
- \*Barnekow DE, Byrne SL, Huskin MA, et al. 1996. Metabolic fate and distribution of [<sup>14</sup>C]1,3-dichloropropene in carrot, lettuce, radish, tomato and wheat. *Abstr Pap Am Chem Soc* 211(1-2):AGRO 38.
- \*Barnes DG, Dourson M. 1988. Reference dose (RfD): Description and use in health risk assessments. *Regul Toxicol Pharmacol* 8:471-486.
- \*Batzer FR, Balcer JL, Peterson JR, et al. 1996. Fate of 1,3-dichloropropene in aerobic soils. *ACS Symp Ser* 652:60-78.
- \*Bean RM, Thomas BL, Neitzel DA. 1985. Analysis of sediment matter for halogenated products from chlorination of power plant cooling water. In: *Proceedings of the 5th Water Chlorination Conference*. Canton, NY: Lewis Publishers Inc., 1357-1370.
- \*Belser NO, Castro CE. 1971. Biodehalogenation: Metabolism of the nematocides cis- and trans-3-chloroallyl alcohol by a bacterium isolated from soil. *J Agric Food Chem* 19:23-26.
- \*Berger GS. 1994. Epidemiology of endometriosis. In: Berger GS, ed. *Endometriosis: Advanced management and surgical techniques*. New York, NY: Springer-Verlag, 3-7.
- \*Bi X, Sheng G, Feng Y, et al. 2005. Gas- and particulate-phase specific tracer and toxic organic compounds in environmental tobacco smoke. *Chemosphere* 61(10):1512-1522.
- \*Boesten JJ, Van der Pas LJ, Smelt JH, et al. 1991. Transformation rate of methyl isothiocyanate and 1,3-dichloropropene in water-saturated sand subsoils. *Neth J Agric Sci* 39:179-190.
- \*Bond JA, Medinsky MA, Dutcher JS, et al. 1985. Disposition and metabolism of 2,3-[<sup>14</sup>C]dichloropropene in rats after inhalation. *Toxicol Appl Pharmacol* 78:47-54.
- \*Boogard PJ, Rocchi PS, van Sittert NJ. 1993. Effects of exposure to low concentrations of chlorinated hydrocarbons on the kidney and liver of industrial workers. *Br J Ind Med* 50:331-339.
- \*Bousema MT, Wiemer GR, van Joost T. 1991. A classic case of sensitization to DD-95. *Contact Dermatitis* 24(2):132-133.
- \*Breslin W, Kirk H, Streeter C, et al. 1989. 1,3-Dichloropropene: Two-generation inhalation reproduction study in Fischer 344 rats. *Fundam Appl Toxicol* 12:129-143.
- \*Brodzinsky R, Singh HB. 1982. *Volatile organic chemicals in the atmosphere: An assessment of available data*. Menlo Park, CA: Atmospheric Science Center SRI International, 155.
- \*Bronstein AC, Currance PL. 1988. *Emergency care for hazardous materials exposure*. Washington, DC: The C.V. Mosby Company, 53, 155-156.



## 9. REFERENCES

- \*Brouwer DH, Brouwer EJ, De Vreede JA, et al. 1991a. Inhalation exposure to 1,3-dichloropropene in the Dutch flower-bulb culture. Part I. Environmental monitoring. *Arch Environ Contam Toxicol* 20(1):1-5.
- \*Brouwer EJ, Evelo CT, Verplanke AJ, et al. 1991b. Biological effect monitoring of occupational exposure to 1,3-dichloropropene: Effects on liver and renal function and on glutathione conjugation. (Erratum to: *Br J Ind Med* 48(3):167-172). *Br J Ind Med* 48(4):288.
- \*Brouwer EJ, Verplanke AJ, Boogaard PJ, et al. 2000. Personal air sampling and biological monitoring of occupational exposure to the soil fumigant cis-1,3-dichloropropene. *Occup Environ Med* 57(11):738-744.
- \*Carreon R, Wall J. 1983. Telone II<sup>®</sup>: Skin sensitization potential in the guinea pig. Dow Chemical Company. Submitted to the U.S. Environmental Protection Agency under TSCA Section 8D. OTS0515850.
- \*Castro CE, Belser NO. 1966. Hydrolysis of cis- and trans-1,3-dichloropropene in wet soil. *J Agric Food Chem* 14:69-70.
- \*Castro CE, Belser NO. 1968. Biodehalogenation. Reductive dehalogenation of the biocides ethylene dibromide, 1,2-dibromo-3-chloropropane, and 2,3-dibromobutane in soil. *Environ Sci Technol* 2:779-783.
- \*CEPA. 1982. Monitoring of Telone II<sup>®</sup> during and following experimental application by shank injection to established trees and grape vines in California in 1980 and 1981. Sacramento, CA: California Environmental Protection Agency, Department of Pesticide Regulation. Index of Worker, Health and Safety Reports, HS-967. <http://www.cdpr.ca.gov/docs/whs/pdf/hs967.pdf>. May 10, 2006.
- \*Chung K-Y, Dickson DW, Ou L-T. 1999. Differential enhanced degradation of cis- and trans-1,3-D in soil with a history of repeated field applications of 1,3-D. *J Environ Sci Health B* 34(5):749-768.
- \*Clary T, Ritz B. 2003. Pancreatic cancer mortality and organochlorine pesticide exposure in California, 1989-1996. *Am J Ind Med* 43(3):306-313.
- \*Clewell HJ III, Andersen ME. 1985. Risk assessment extrapolations and physiological modeling. *Toxicol Ind Health* 1(4):111-131.
- \*Climie I, Hutson D, Morrison B, et al. 1979. Glutathione conjugation in the detoxication of (Z)-1,3-dichloropropene (a component of the nematocide DD<sup>®</sup>) in the rat. *Xenobiotica* 9:149-156.
- \*Coate W. 1979a. Addendum to final report on the 90-day inhalation toxicity study in rats and mice - Telone II<sup>®</sup>. Dow Chemical Company. Submitted to the U.S. Environmental Protection Agency under TSCA Section 8D. OTS0515856.
- \*Coate W. 1979b. Subacute inhalation toxicity study in rats and mice of Telone II<sup>®</sup> (1,3-dichloropropene). Dow Chemical Company. Submitted to the U.S. Environmental Protection Agency under TSCA Section 8D. OTS0515834.
- \*Cohen DB. 1986. Groundwater contamination by toxic substances. A California assessment. In: American Chemical Society Symposium Series. Washington, DC: American Chemical Society, 315, 499-529.

## 9. REFERENCES

- \*Connors TF, Stuart JD, Cope JB. 1990. Chromatographic and mutagenic analyses of 1,2-dichloropropane and 1,3-dichloropropylene and their degradation products. *Bull Environ Contam Toxicol* 44(2):288-293.
- \*Corazza M, Zinna G, Virgili A. 2003. Allergic contact dermatitis due to 1,3-dichloropropene soil fumigant. *Contact Dermatitis* 48(6):341-342.
- \*Cracknell S, Jackson G, Hardy C. 1987. Telone II<sup>®</sup> (1,3-dichloropropene) - Acute inhalation study in rats - 4-hour exposure. Dow Chemical Company. Submitted to the U.S. Environmental Protection Agency under TSCA Section 8D. OTS0515821.
- \*Crebelli R, Andreoli C, Carere A, et al. 1992. The induction of mitotic chromosome malsegregation in *Aspergillus nidulans*. Quantitative structure activity relationship (QSAR) analysis with chlorinated aliphatic hydrocarbons. *Mutat Res* 266(2):117-134.
- \*Creedy C, Brooks T, Dean B, et al. 1984. The protective action of glutathione on the microbial mutagenicity of the Z- and E-isomers of 1,3-dichloropropene. *Chem Biol Interact* 50:39-48.
- \*Cryer SA, Van Wesenbeeck IJ. 2001. Predicted 1,3-dichloropropene air concentrations resulting from tree and vine applications in California. *J Environ Qual* 30:1887-1895.
- \*Daft JL. 1989. Determination of fumigants and related chemicals in fatty and non-fatty foods. *J Agric Food Chem* 37:560-564.
- \*Daft JL. 1990. Recovery of 1,3-, 2,3-dichloropropenes, 1,2-dibromo-3-chloropropane, and o-, p-dichlorobenzenes from fatty and non-fat foodstuffs by liquid extraction technique. *Arch Environ Contam Toxicol* 19(6):921-925.
- \*De Lorenzo F, Degl'innocenti S, Ruocco A, et al. 1977. Mutagenicity of pesticides containing 1,3-dichloropropene. *Cancer Res* 37:1915-1917.
- \*De Zwart LL, Haenen HE, Versantvoort CH, et al. 2004. Role of biokinetics in risk assessment of drugs and chemicals in children. *Regul Toxicol Pharmacol* 39:282-309.
- \*Dietz F, Dittenber D, Kastl P. 1982. 1,3-Dichloropropene: Effects on tissue non-protein sulfhydryl content and blood concentration time profile-probe study. Dow Chemical Company. Submitted to the U.S. Environmental Protection Agency under TSCA Section 8D. OTS0515837.
- \*Dietz FK, Grandjean M, Young JT. 1985b. 1-Hour LC50 determination in Fischer 344 rats - 2,3-dichloropropene. Dow Chemical Company. Submitted to the U.S. Environmental Protection Agency under TSCA Section 8D. OTS0515982.
- \*Dietz FK, Hermann E, Kastl P, et al. 1985a. 1,3-Dichloropropene: Pharmacokinetics, effect on tissue non-protein sulfhydryls, and macromolecular binding in Fischer-344 rats and B6C3F1 mice following oral administration. Dow Chemical Company. Submitted to the U.S. Environmental Protection Agency under TSCA Section 8D. OTS0515836.
- \*Dilling WL. 1977. Interphase transfer processes. II. Evaporation rates of chloromethanes, ethanes, ethylenes, propanes, and propylenes from dilute aqueous solutions. Comparisons with theoretical predictions. *Environ Sci Technol* 11:405-409.

## 9. REFERENCES

- \*DOT. 2000. 1,3-Dichloropropene. 2000 Emergency response guidebook (ERG2000). Washington, DC: U.S. Department of Transportation.
- \*Dow. 1962. Results of range finding toxicological tests on 1,2-dichloropropene. Rockville, MD: Dow Chemical Company. Submitted to the U.S. Environmental Protection Agency under TSCA Section 8D. OTS0510189.
- \*Dow. 1987a. Telone II (1,3-dichloropropene) OECD 401 acute oral toxicity test in the rat. Switzerland: Dow Chemical Company. Submitted to the U.S. Environmental Protection Agency under TSCA Section 8D. OTS0515823.
- \*Dowty BJ, Carlisle DR, Laseter JL. 1975a. New Orleans drinking water sources tested by gas chromatography-mass spectrometry. Occurrence and origin of aromatics and halogenated aliphatic hydrocarbons. *Environ Sci Technol* 9:762-765.
- \*Dowty B, Carlisle D, Laseter J, et al. 1975b. Halogenated hydrocarbons in New Orleans drinking water and blood plasma. *Science* 187:75-77.
- \*Dutcher JS, Medinsky MA, Bond JA, et al. 1985. Effect of vapor concentration on the disposition of inhaled 2,3-dichloropropene in Fischer-344 rats. *Fundam Appl Toxicol* 5:997-1005.
- \*Eder E, Dornbusch K. 1988. Metabolism of 2,3-dichloro-1-propene in the rat. Consideration of bioactivation mechanisms. *Drug Metab Dispos* 16 (1):60-68.
- \*Eder E, Dornbusch K, Fischer G. 1987. The role of biotransformation in the genotoxicity of allylic compounds. *Arch Toxicol* 60:182-186.
- \*Eder E, Henschler D, Neudecker T. 1982a. Mutagenic properties of allylic and  $\alpha,\beta$ -unsaturated compounds: Consideration of alkylating mechanisms. *Xenobiotica* 12:831-848.
- \*Eder E, Neudecker T, Lutz D, et al. 1982b. Correlation of alkylating and mutagenic activities of allyl and allylic compounds: Standard alkylation test vs. kinetic investigation. *Chem Biol Interact* 38:303-315.
- \*Eder E, Schiffmann D, Dornbusch K, et al. 1986. Genotoxicity of allyl compounds – a quick screening strategy based on structure-activity relationships and a battery of prescreening tests. *Food Chem Toxicol* 24(6/7):667-673.
- \*Ellenhorn MJ, Schonwald S, Ordog G, et al. 1997. 1,3-Dichloropropene. *Ellenhorn's medical toxicology: Diagnosis and treatment of human poisoning*. 2nd ed. Baltimore, MD: Williams and Wilkins, 1656, 1657, 1659.
- \*Eisenreich SJ, Looney BB, Thornton JD. 1981. Airborne organic contaminants in the Great Lakes ecosystem. *Environ Sci Technol* 15:30-38.
- \*El Hadiri N, Ammati M, Chgoura M, et al. 2003. Behavior of 1,3-dichloropropene and methyl isothiocyanate in undisturbed soil columns. *Chemosphere* 52:893-899.

## 9. REFERENCES

- \*EPA. 1978a. Toxicity of secondary effluents from textile plants. In: Symposium proceedings: Process measurements for environmental assessment (Atlanta, February 1978). Washington, DC: U.S. Environmental Protection Agency, 153-169. EPA600778168.
- \*EPA. 1978b. Analysis of organic air pollutants in the Kanawha Valley, WV and the Shenandoah Valley, VA. Philadelphia, PA: U.S. Environmental Protection Agency. EPA903978007.
- \*EPA. 1979. Formulation of a preliminary assessment of halogenated organic compounds in man and environmental media. Washington, DC: U.S. Environmental Protection Agency, Toxic Substances. EPA5601379006. PB80112170.
- \*EPA. 1980. Acquisition and chemical analysis of mother's milk for selected toxic substances. Washington, DC: U.S. Environmental Protection Agency, Office of Pesticides and Toxic Substances. EPA5601380029.
- \*EPA. 1981a. Treatability manual. Washington, DC: Office of Research and Development, U.S. Environmental Protection Agency, I.12.14-1 to I.12.14-5. EPA600880042a.
- \*EPA. 1981b. Aquatic fate process data for organic priority pollutants. Washington, DC: U.S. Environmental Protection Agency. EPA440481014.
- \*EPA. 1981c. Vapor pressure distribution of selected organic chemicals (final report). Cincinnati, OH: U.S. Environmental Protection Agency. EPA600281021. PB81171233.
- \*EPA. 1982. Test methods. Methods for organic chemical analysis of municipal and industrial wastewater: Test method purgeable halocarbons-method 601. Cincinnati, OH: U.S. Environmental Protection Agency, Environmental Monitoring and Support Laboratory. EPA6004282057.
- \*EPA. 1986. Method 8010. Halogenated volatile organics. In: Test methods for evaluating solid wastes. Volume IB: Laboratory manual, physical/chemical methods: 3rd ed. Washington, DC: U.S. Environmental Protection Agency, Office of Solid Waste and Emergency Response.
- EPA. 1987a. PCGEMS Graphical Exposure Modeling System. Washington, DC: U.S. Environmental Protection Agency. <http://www.epa.gov/oppt/cahp/actlocal/pcgems.html>. June 12, 2006.
- \*EPA. 1987b. Determination of Henry's Law constants of selected priority pollutants. Cincinnati, OH: U.S. Environmental Protection Agency. PB87212684.
- \*EPA. 1987c. Appendix A: Reference dose (RfD): Description and use in health risk assessments. Integrated risk information system supportive documentation, Volume I. Washington, DC: U.S. Environmental Protection Agency, Office of Health and Environmental Assessment. EPA600886032a.
- \*EPA. 1988. National ambient volatile organic compounds (VOCs) data base update. Research Triangle Park, NC: U.S. Environmental Protection Agency, Atmospheric Sciences Research Laboratory. EPA600388010a.
- \*EPA. 1990. Interim methods for development of inhalation reference concentrations. Washington, DC: U.S. Environmental Protection Agency, Office of Health and Environmental Assessment, Office of Research and Development, Environmental Criteria and Assessment Office. EPA600890066A.

## 9. REFERENCES

- \*EPA. 1991. 1990 Urban air toxics monitoring program. Research Triangle Park, NC: U.S. Environmental Protection Agency. EPA450491024. PB92110022.
- \*EPA. 1994. Methods for derivation of inhalation reference concentrations and application of inhalation dosimetry. Washington, DC: U.S. Environmental Protection Agency, Office of Health and Environmental Assessment, Office of Research and Development, Environmental Criteria and Assessment Office. EPA600890066F.
- \*EPA. 1995a. Method 524.2: Measurement of purgeable organic compounds in water by capillary column gas chromatography/mass spectrometry. Cincinnati, OH: U.S. Environmental Protection Agency.
- \*EPA. 1995b. Method 502.2: Volatile organic compounds in water by purge and trap capillary column gas chromatography with photoionization and electrolytic conductivity detectors in series. Cincinnati, OH: National Exposure Research Laboratory, Office of Research and Development, U.S. Environmental Protection Agency. [http://web1.er.usgs.gov/nemi/method\\_summary.jsp?param\\_method\\_id=4798](http://web1.er.usgs.gov/nemi/method_summary.jsp?param_method_id=4798). May 23, 2006.
- \*EPA. 1996a. Method 8021B: Aromatic and halogenated volatiles by gas chromatography using photoionization and/or electrolytic conductivity detectors. SW-846 online: Test methods for evaluating solid waste, physical/chemical methods. Washington, DC: U.S. Environmental Protection Agency, Office of Solid Waste. <http://www.epa.gov/epaoswer/hazwaste/test/pdfs/8021b.pdf>. April 05, 2006.
- \*EPA. 1996b. Method 8260B: Volatile organic compounds by gas chromatography/mass spectrometry (GC/MS). SW-846 online: Test methods for evaluating solid waste, physical/chemical methods. Washington, DC: U.S. Environmental Protection Agency, Office of Solid Waste.
- \*EPA. 1997. Special report on environmental endocrine disruption: An effects assessment and analysis. Washington, DC: U.S. Environmental Protection Agency, Risk Assessment Forum. EPA630R96012.
- \*EPA. 1998b. Reregistration Eligibility Decision (RED). Washington DC: U.S. Environmental Protection Agency, Office of Prevention, Pesticides and Toxic Substances. EPA738R98016.
- \*EPA. 1999. USEPA contract laboratory program statement of work for organics analysis, multi-media, multi-concentration, OLM 4.2, exhibit A-D. Washington, DC: U.S. Environmental Protection Agency. <http://www.epa.gov/superfund/programs/clp/olm4.htm#sow>. May 15, 2006.
- \*EPA. 2000a. Toxicological review of 1,3-dichloropropene. In support of summary information on the Integrated Risk Information System (IRIS). Washington DC: U.S. Environmental Protection Agency. EPA635R00001.
- \*EPA. 2000b. Benchmark dose technical guidance document. Washington, DC: U.S. Environmental Protection Agency, Risk assessment Forum. EPA630R00001.
- \*EPA. 2001a. Method 601: Purgeable halocarbons. U.S. Environmental Protection Agency. Code of Federal Regulations. 40 CFR 136 App. A, 31-44.
- \*EPA. 2001b. Method 1624 revision B: Volatile organic compounds by isotope dilution GC/MS. U.S. Environmental Protection Agency. Code of Federal Regulations. 40 CFR 136 App. A, 274-287.

## 9. REFERENCES

- \*EPA. 2001c. Unregulated contaminant monitoring program. Washington, DC: U.S. Environmental Protection Agency. [http://www.epa.gov/safewater/ucmr/ucm\\_rounds\\_1-2.html](http://www.epa.gov/safewater/ucmr/ucm_rounds_1-2.html). March 25, 2006.
- \*EPA. 2005a. Toxic chemical release inventory reporting forms and instructions: Revised 2004 version. Section 313 of the Emergency Planning and Community Right-to-Know Act (Title III of the Superfund Amendments and Reauthorization Act of 1986). U.S. Environmental Protection Agency. Office of Environmental Information. EPA260B05001.
- \*EPA. 2005b. Method 624: Purgeables. U.S. Environmental Protection Agency. Code of Federal Regulations. 40 CFR 136 App. A.
- \*EPA. 2006a. Acute exposure guideline levels (AEGLs). Office of Pollution Prevention and Toxics. Washington, DC: U.S. Environmental Protection Agency. <http://www.epa.gov/oppt/aegl/chemlist.htm>. March 07, 2006.
- \*EPA. 2006b. Designated as hazardous substances in accordance with Section 311(b)(2)(A) of the Clean Water Act. U.S. Environmental Protection Agency. Code of Federal Regulations. 40 CFR 116.4. <http://www.epa.gov/epacfr40/chapt-I.info/chi-toc.htm>. March 07, 2006.
- \*EPA. 2006c. Hazardous air pollutants. Clean Air Act. U.S. Environmental Protection Agency. United States Code. 42 USC 7412. <http://www.epa.gov/ttn/atw/orig189.html>. March 07, 2006.
- \*EPA. 2006d. Identification and listing of hazardous waste. Washington, DC: U.S. Environmental Protection Agency. Code of Federal Regulations. 40 CFR 261, Appendix VIII. <http://www.epa.gov/epacfr40/chapt-I.info/chi-toc.htm>. March 08, 2006.
- \*EPA. 2006e. National recommended water quality criteria. Washington, DC: U.S. Environmental Protection Agency, Office of Water, Office of Science and Technology. <http://www.epa.gov/waterscience/criteria/wqcriteria.html>. March 07, 2006.
- \*EPA. 2006f. Superfund, emergency planning, and community right-to-know programs. Designation, reportable quantities, and notifications. U.S. Environmental Protection Agency. Code of Federal Regulations. 40 CFR 302.4. <http://www.epa.gov/epacfr40/chapt-I.info/chi-toc.htm>. March 08, 2006.
- \*EPA. 2006g. Superfund, emergency planning, and community right-to-know programs. Toxic chemical release reporting. U.S. Environmental Protection Agency. Code of Federal Regulations. 40 CFR 372.65. <http://www.epa.gov/epacfr40/chapt-I.info/chi-toc.htm>. March 08, 2006.
- \*EPA. 2006h. Water quality standards. Toxics criteria for those states not complying with Clean Water Act section 303(c)(2)(B). U.S. Environmental Protection Agency. Code of Federal Regulations. 40 CFR 131.36. <http://www.epa.gov/epacfr40/chapt-I.info/chi-toc.htm>. March 08, 2006.
- \*EPA. 2006i. 1,3-Dichloropropene. In: National pesticide information retrieval system. Washington, DC: U.S. Environmental Protection Agency. <http://ppis.ceris.purdue.edu/htbin/rnamset.com>. March 18, 2006.
- \*EPA. 2006j. 1,3-Dichloropropene. Modernized STORET system: Regular results by geographic location (stormodb): Characteristic search by CAS number. U.S. Environmental Protection Agency. <http://www.epa.gov/storet/dbtop.html>. April 06, 2006.

## 9. REFERENCES

- \*EPA. 2006k. Protection of stratospheric ozone: The 2006 critical use exemption from the phaseout of methyl bromide. U.S. Environmental Protection Agency. Code of Federal Regulations. 40 CFR Part 82.
- \*EPA. 2006l. 2,3-Dichloropropene. In: National pesticide information retrieval system. Washington, DC: U.S. Environmental Protection Agency. <http://ppis.ceris.purdue.edu/htbin/rnamset.com>. May 22, 2006.
- \*FDA. 2005a. Beverages. Bottled water. U.S. Food and Drug Administration. Code of Federal Regulations. 21 CFR 165.110. <http://www.accessdata.fda.gov/scripts/cdrh/cfdocs/cfcfr/CFRSearch.cfm>. March 08, 2006.
- \*FDA. 2005b. Total diet study. Washington, DC: U.S. Food and Drug Administration, Center for Food Safety and Applied Nutrition. <http://www.cfsan.fda.gov/~comm/tds-toc.html>. March 18, 2006.
- \*FEDRIP. 2006. 1,3-Dichloropropene. Federal Research in Progress database. Springfield, VA: National Technical Information Service.
- \*Fisher G, Kilgore W. 1988a. Tissue levels of glutathione following acute inhalation of 1,3-dichloropropene. *J Toxicol Environ Health* 23:171-182.
- \*Fisher G, Kilgore W. 1988b. Mercapturic acid excretion by rats following inhalation exposure to 1,3-dichloropropene. *Fundam Appl Toxicol* 11:300-307.
- \*Fisher G, Kilgore W. 1989. Pharmacokinetics of S-[3-chloroprop-2-enyl] glutathione in rats following acute inhalation exposure to 1,3-dichloropropene. *Xenobiotica* 19:269-278.
- \*Flessel P, Goldsmith J, Kahn E, et al. 1978. Acute and possible long-term effects of 1,3-dichloropropene--California. *MMWR* 27:5-55.
- \*Fomon SJ. 1966. Body composition of the infant: Part I: The male reference infant. In: Falkner F, ed. *Human development*. Philadelphia, PA: WB Saunders, 239-246.
- \*Fomon SJ, Haschke F, Ziegler EE, et al. 1982. Body composition of reference children from birth to age 10 years. *Am J Clin Nutr* 35:1169-1175.
- \*Franke C, Studinger G, Berger G, et al. 1994. The assessment of bioaccumulation. *Chemosphere* 29(7):1501-1514.
- \*Gan J, Yates SR, Crowley D, et al. 1998a. Acceleration of 1,3-dichloropropene degradation by organic amendments and potential application for emissions reduction. *J Environ Qual* 27:408-414.
- \*Gan J, Yates SR, Ernst FF. 1998b. Organic chemicals in the environment: Effect of application methods on 1,3-dichloropropene volatilization from soil under controlled conditions. *J Environ Qual* 27:432-438.
- \*Ghia M, Robbiano L, Allavena A, et al. 1993. Genotoxic activity of 1,3-dichloropropene in a battery of in vivo short-term tests. *Toxicol Appl Pharmacol* 120(1):120-125.
- \*Giwerzman A, Carlsen E, Keiding N, et al. 1993. Evidence for increasing incidence of abnormalities of the human testis: A review. *Environ Health Perspect Suppl* 101(2):65-71.

## 9. REFERENCES

- \*Gollapudi BB, Cieszlak FS, Day SJ, et al. 1998. Dominant lethal test with rats exposed to 1,3-dichloropropene by inhalation. *Environ Mol Mutagen* 32(4):351-359.
- \*Granville CA, Ross MK, Tornero-Velez R, et al. 2005. Genotoxicity and metabolism of the source-water contaminant 1,1-dichloropropene: Activation by GSTT1-1 and structure-activity considerations. *Mutat Res* 572(1-2):98-112.
- \*Gunther FA, Westlake WE, Jaglan PS. 1968. Reported solubilities of 738 pesticide chemicals in water. *Res Rev* 20:1-148.
- \*Guo M, Papiernik SK, Zheng W, et al. 2004. Effects of environmental factors on 1,3-dichloropropene hydrolysis in water and soil. *J Environ Qual* 33:612-618.
- \*Guzelian PS, Henry CJ, Olin SS, eds. 1992. Similarities and differences between children and adults: Implications for risk assessment. Washington, DC: International Life Sciences Institute Press, 1-283.
- \*Hamaker JW, Thompson JM. 1972. Adsorption. In: Goring CA, Hamaker JN, eds. *Organic chemicals in the soil environment*. Marcel Dekker, Inc., 49-144.
- \*Hanley T Jr., John-Greene J, Young J, et al. 1987. Evaluation of the effects of inhalation exposure to 1,3-dichloropropene on fetal development in rats and rabbits. *Fundam Appl Toxicol* 8:562-570.
- \*Hartwig J, Sommer H, Muller F. 2005. Nematicides. In: Bohnet M, Brinker CJ, Cornils B, et al., eds. *Ullmann's encyclopedia of industrial chemistry*. New York, NY: John Wiley & Sons, Inc., 1-13.
- \*Hauser TR, Bromberg SM. 1982. EPA's monitoring program at Love Canal 1980. *Environ Monit Assess* 2:249-272.
- \*Haut KT, Stebbins KE, Johnson KA, et al. 1996. Subchronic toxicity of ingested 1,3-dichloropropene in rats and mice. *Fundam Appl Toxicol* 32(2):224-232.
- \*Haworth S, Lawlor T, Mortelmans K, et al. 1983. *Salmonella* mutagenicity test results for 250 chemicals. *Environ Mutagen Suppl* 1:3-142.
- \*HazDat. 2006. 1,3-Dichloropropene. HazDat Database: ATSDR's Hazardous Substance Release and Health Effects Database. Atlanta, GA: Agency for Toxic Substances and Disease Registry. <http://www.atsdr.cdc.gov/hazdat.html>. July 5, 2006.
- \*He F. 1993. Biological monitoring of occupational pesticides exposure. *Int Arch Occup Environ Health* 93:S69-S76.
- \*Hernandez AF, Martin-Rubi JC, Ballesteros JL, et al. 1994. Clinical and pathological findings in fatal 1,3-dichloropropene intoxication. *Hum Exp Toxicol* 13(5):303-306.
- \*Hoel DG, Davis DL, Miller AB, et al. 1992. Trends in cancer mortality in 15 industrialized countries, 1969-1986. *J Natl Cancer Inst* 84(5):313-320.
- \*HSDB. 2006. 1,3-Dichloropropene. Hazardous Substances Data Bank. National Library of Medicine. <http://toxnet.nlm.nih.gov>. March 21, 2006.



## 9. REFERENCES

- \*Hutson D, Moss J, Pickering B. 1971. Excretion and retention of components of the soil fumigant DD<sup>®</sup> and their metabolites in the rat. *Food Cosmet Toxicol* 9:677.
- \*IARC. 1986. IARC monographs of the evaluation of the carcinogenic risk of chemicals to humans. Vol. 41: 1,3-Dichloropropene. Lyon, France: International Agency for Research on Cancer, World Health Organization, 113-130.
- \*IARC. 1999. 1,3-Dichloropropene. *IARC Monogr Eval Carcinog Risk Chem Hum* 71(3):933-945.
- \*IARC. 2004. Overall evaluations of carcinogenicity to humans: As evaluated in IARC Monographs volumes 1-82 (at total of 900 agents, mixtures and exposures). Lyon, France: International Agency for Research on Cancer. <http://www-cie.iarc.fr/monoeval/crthall.html>. March 08, 2006.
- \*IRIS. 2006. 1,3 Dichloropropene. Integrated Risk Information System. Washington, DC: U.S. Environmental Protection Agency. <http://www.epa.gov/iris/subst/index.html>. March 08, 2006.
- \*IUR. 2002. Inventory update rule. Toxic Substance Control Act (TSCA) Inventory Update Database. Washington, DC: U.S. Environmental Protection Agency. <http://www.epa.gov/opptintr/iur/iur02/index.htm>. March 08, 2006.
- \*Jeffrey M. 1987a. Telone II<sup>®</sup> soil fumigant: Dermal sensitization potential in the Hartley albino guinea pig. Dow Chemical Company. Submitted to the U.S. Environmental Protection Agency under TSCA Section 8D. OTS0515819.
- \*Jeffrey M. 1987b. Telone II<sup>®</sup> soil fumigant: Primary eye irritation study in New Zealand white rabbits. Dow Chemical Company. Submitted to the U.S. Environmental Protection Agency under TSCA Section 8D. OTS0517082.
- \*Jeffrey M. 1987c. Telone II<sup>®</sup> soil fumigant: Primary dermal irritation study in New Zealand white rabbits. Dow Chemical Company. Submitted to the U.S. Environmental Protection Agency under TSCA Section 8D. OTS0517081.
- \*Jeffrey MM, Battjes JE, Lomax L. 1987a. Telone II<sup>®</sup> soil fumigant: Acute oral toxicity study in Fischer 344 rats. Dow Chemical Company. Submitted to the U.S. Environmental Protection Agency under TSCA Section 8D. OTS0517080.
- \*Jeffrey M, Schuetz D, Lomax L. 1987b. Telone II<sup>®</sup> soil fumigant: Acute dermal toxicity study in New Zealand white rabbits. Dow Chemical Company. Submitted to the U.S. Environmental Protection Agency under TSCA Section 8D. OTS0515820.
- \*Johannsen FR, Levinskas GJ, Rusch GM, et al. 1991. Subchronic inhalation toxicity and reproductive assessment in rats of three chlorinated propenes. *J Toxicol Environ Health* 33:291-302.
- \*Johanson CE. 1980. Permeability and vascularity of the developing brain: Cerebellum vs cerebral cortex. *Brain Res* 190:3-16.
- \*Jones JR. 1988a. 1,3-Dichloropropene cis-isomer: Acute oral toxicity test in the rat. Project Number 44/246. Performed by Safepharm Laboratories Limited, Derby, U.K., for Dow Chemical Company Limited, Oxfordshire, U.K.

## 9. REFERENCES

- \*Jones JR. 1988b. 1,3-Dichloropropene cis-isomer: Modified nine-induction Buehler contact sensitization study in the guinea pig. Project Number 44/249. Performed by Safepharm Laboratories Limited, Derby, U.K., for Dow Chemical Company Limited, Oxfordshire, U.K.
- Jones JR. 1988c. 1,3-Dichloropropene cis-isomer: Acute dermal toxicity test in the rat. Project Number 44/247. Performed by Safepharm Laboratories Limited, Derby, U.K., for Dow Chemical Company Limited, Oxfordshire, U.K.
- \*Jones J, Collier T. 1986a. Telone II<sup>®</sup>: OECD 401 acute oral toxicity test in the rat. Dow Chemical Company. Submitted to the U.S. Environmental Protection Agency under TSCA Section 8D. OTS0515823.
- \*Jones J, Collier T. 1986b. Telone II<sup>®</sup>: OECD 401 acute dermal toxicity test in the rat. Dow Chemical Company. Submitted to the U.S. Environmental Protection Agency under TSCA Section 8D. OTS0515824.
- \*Kastl PE, Hermann EA. 1983. Determination of cis- and trans-1,3-dichloropropene in whole rat blood by gas chromatography and gas chromatography - chemical ionization mass spectrometry with selected-ion monitoring. *J Chromatogr* 265:277-283.
- \*Kenaga EE. 1980. Predicted bioconcentration factors and soil sorption coefficients of pesticides and other chemicals. *Ecotoxicol Environ Safety* 4:26-38.
- \*Kevekordes S, Gebel T, Pav K, et al. 1996. Genotoxicity of selected pesticides in the mouse bone-marrow micronucleus test and in the sister-chromatid exchange test with human lymphocytes in vitro. *Toxicol Lett* 89(1):35-42.
- \*Kezic S, Monster AC, Verplanke AJ, et al. 1996. Dermal absorption of cis-1,3-dichloropropene vapour: Human experimental exposure. *Hum Exp Toxicol* 15(5):396-399.
- \*Kim J-H, Gan J, Farmer WJ, et al. 2003a. Effect formulation on the behavior of 1,3-dichloropropene in soil. *J Environ Qual* 32:2223-2229.
- \*Kim J-H, Gan J, Farmer WJ, et al. 2003b. Organic matter effects on phase partition of 1,3-dichloropropene in soil. *J Agric Food Chem* 51:165-169.
- \*Kitchin KT, Brown JL. 1994. Dose-response relationship for rat liver DNA damage caused by 49 rodent carcinogens. *Toxicology* 88:31-49.
- \*Kloes P, Calhoun L, Young J, et al. 1983. Telone II<sup>®</sup>: Inhalation teratology probe study in Fischer 344 rats and New Zealand white rabbits. Dow Chemical Company. Submitted to the U.S. Environmental Protection Agency under TSCA Section 8D. OTS0515853.
- \*Kolpin DW, Barbash JE, Gilliom RJ. 2000. Pesticides in ground water of the United States, 1992-1996. *Ground Water* 38(6):858-863.
- \*Komori M, Nishio K, Kitada M, et al. 1990. Fetus-specific expression of a form of cytochrome P-450 in human livers. *Biochemistry* 29:4430-4433.

## 9. REFERENCES

- \*Krahling L, Krey J, Jakobson G, et al. 2005. Allyl compounds. In: Bohnet M, Brinker CJ, Cornils B, et al., eds. Ullmann's encyclopedia of industrial chemistry. New York, NY: John Wiley & Sons, Inc., 1-15.
- \*Krijgsheld KR, van der Gen A. 1986. Assessment of the impact of the emission of certain organochlorine compounds on the aquatic environment. Part II: Allylchloride, 1,3- and 2,3-dichloropropene. *Chemosphere* 15:861-880.
- \*Krishnan K, Andersen ME. 1994. Physiologically based pharmacokinetic modeling in toxicology. In: Hayes AW, ed. Principles and methods of toxicology. 3rd ed. New York, NY: Raven Press, Ltd., 149-188.
- \*Krishnan K, Andersen ME, Clewell HJ III, et al. 1994. Physiologically based pharmacokinetic modeling of chemical mixtures. In: Yang RSH, ed. Toxicology of chemical mixtures: Case studies, mechanisms, and novel approaches. San Diego, CA: Academic Press, 399-437.
- \*Lag M, Omichinski JG, Dybing E, et al. 1994. Mutagenic activity of halogenated propanes and propenes: Effect of bromine and chlorine positioning. *Chem Biol Interact* 93(1):73-84.
- \*Lao RC, Thomas RS, Bastien P, et al. 1982. Analysis of organic priority and non-priority pollutants in environmental samples by GC/MS/computer systems. In: Albaiges J, ed. Analytical techniques in environmental chemistry II. New York, NY: Pergamon Press Ltd., 107-118.
- \*Lee S, McLaughlin R, Harnly M, et al. 2002. Community exposures to airborne agricultural pesticides in California: Ranking of inhalation risks. *Environ Health Perspect* 110(12):1175-1184.
- \*Leeder JS, Kearns GL. 1997. Pharmacogenetics in pediatrics: Implications for practice. *Pediatr Clin North Am* 44(1):55-77.
- \*Leiber MA, Berk HC. 1984. Development and validation of an air-monitoring method for 1,3-dichloropropene, trans-1,2,3-trichloropropene, cis-1,2,3-trichloropropene, 1,1,2,3-tetrachloropropene, 2,3,3-trichloroprop-2-en-1-ol and 1,1,2,2,3-pentachloropropane. *Anal Chem* 56:2134-2137.
- \*Leistra M. 1970. Distribution of 1,3-dichloropropene over the phases in soil. *J Agric Food Chem* 18:1124
- \*Lemen RA. 2001. Unsaturated halogenated hydrocarbons: 1,3-Dichloropropene. In: Bingham E, Cohrssen B, Powell CH, eds. Patty's toxicology. New York, NY: John Wiley & Sons, Inc., 1-6. <http://www.mrw.interscience.wiley.com/pattys/tox/articles/tox064/sect1.html>. March 18, 2006.
- \*Leung H-W. 1993. Physiologically-based pharmacokinetic modeling. In: Ballentyne B, Marrs T, Turner P, eds. General and applied toxicology. Vol. 1. New York, NY: Stockton Press, 153-164.
- \*Lewis RJ. 2000. Dichloropropene. Sax's dangerous properties of industrial materials. 10th ed. New York, NY: John Wiley & Sons, Inc., 1220-1222.
- \*Lewis RJ, ed. 2001. 1,3-Dichloropropene. Hawley's condensed chemical dictionary. 14th ed. New York, NY: John Wiley & Sons, Inc., 364.

## 9. REFERENCES

- \*Lichy C, Olson K. 1975. Acute toxicological properties of experimental nematicide formulation M-3993 containing 1,3-dichloropropene. Dow Chemical Company. Submitted to the U.S. Environmental Protection Agency under TSCA Section 8D. OTS0515857.
- \*Lide DR. 2005. 1,3-Dichloropropene. CRC handbook of chemistry and physics. 86th ed. Boca Raton, FL: CRC Press, Inc., 3-160, 3-161.
- \*Livingston, AL. 1978. Forage plant estrogens. J Toxicol Environ Health 4:301-324.
- \*Lomax L, Stott W, Johnson K, et al. 1989. The chronic toxicity and oncogenicity of inhaled technical grade 1,3-dichloropropene in rats and mice. Fundam Appl Toxicol 12:418-431.
- \*Loveday KS, Anderson BE, Resnick BE, et al. 1990. Chromosome aberration and sister chromatid exchange tests in Chinese hamster ovary cells in vitro: V. Results with 46 chemicals. Environ Mol Mutagen 16 (4):272-303.
- \*Loveday, KS, Lugo MH, Resnick MA, et al. 1989. Chromosome aberrations and sister chromatid exchange tests in Chinese hamster ovary cells *in vitro*. III. Results with 20 chemicals. Environ Mol Mutagen 13:60-94.
- \*Lyman WJ. 1982. Adsorption coefficient for soils and sediments. In: Lyman WJ, Reehl WF, Rosenblatt EH, eds. Handbook of chemical property estimation methods. Chapter 4. New York, NY: McGraw Hill Book Co., 4-1 to 4-33.
- \*Mackay D, Shiu WY. 1981. A critical review of Henry's Law constants for chemicals of environmental interest. J Phys Chem Ref Data 10:1175-1199.
- \*Maddy KT, Fong HR, Howe JA. 1982. A study of well water in selected California communities for residues of 1,3-dichloropropene, chloroallyl alcohol and 49 organophosphate or chlorinated hydrocarbon pesticides. Bull Environ Contam Toxicol 29:354-359.
- \*Markovitz A, Crosby WH. 1984. Chemical carcinogenesis. A soil fumigant, 1,3-dichloropropene, as possible cause of hematologic malignancies. Arch Intern Med 144:1409-1411.
- \*Martelli A. 1997. Primary human and rat hepatocytes in genotoxicity assessment. In Vivo 11(2):189-194.
- \*Matsuoka A, Hayashi M, Sofuni T. 1998. In vitro clastogenicity of 19 organic chemicals found in contaminated water and 7 structurally related chemicals. Kankyo Hen'igen Kenkho 20(3):159-165.
- \*Mayr U, Butsch A, Schneider S. 1992. Validation of two in vitro test systems for estrogenic activities with zearalenone, phytoestrogens and cereal extracts. Toxicology 74:135-149.
- \*Mazurek MA, Simoneit BRT. 1986. Organic components in bulk and wet-only precipitation. CRC Crit Rev Environ Control 16:140.
- \*McCall PJ. 1987. Hydrolysis of 1,3-dichloropropene in dilute aqueous solution. Pestic Sci 19:235-242.
- \*Medinsky MA, Bond JA, Dutcher JS, et al. 1984. Disposition of [<sup>14</sup>C]2,3-dichloropropene in Fischer-344 rats after oral or intraperitoneal administration. Toxicol Lett 23:119-125.

## 9. REFERENCES

- \*Meister RT, Sine C, Sharp DT, et al. 2006. 1,3-Dichloropropene. Crop protection handbook. Willoughby, OH: Meister Media Worldwide, D140, F34.
- \*Meylan WM, Howard PH, Boethling RS, et al. 1999. Improved method for estimating bioconcentration/bioaccumulation factor from octanol/water partition coefficient. *Environ Toxicol Chem* 18(4):664-672.
- \*Mizell M. 1988a. Telone C-17<sup>®</sup> soil fungicide and nematicide: Primary dermal irritation study in New Zealand white rabbits. Dow Chemical Company. Submitted to the U.S. Environmental Protection Agency under TSCA Section 8D. OTS0516580.
- \*Mizell M. 1988b. Telone C-17<sup>®</sup> soil fungicide and nematicide: Dermal sensitization potential in the Hartley albino guinea pig. Dow Chemical Company. Submitted to the U.S. Environmental Protection Agency under TSCA Section 8D. OTS0516507.
- \*Mizell M, Johnson K, Battjes J. 1988b. Telone C-17<sup>®</sup> soil fungicide and nematicide: Acute dermal toxicity study in New Zealand white rabbits. Dow Chemical Company. Submitted to the U.S. Environmental Protection Agency under TSCA Section 8D. OTS0517368.
- \*Mizell M, Yano BL, Battjes JE. 1988a. Telone C-17<sup>®</sup> soil fungicide and nematicide: Acute oral toxicity study in Fischer 344 rats. Dow Chemical Company. Submitted to the U.S. Environmental Protection Agency under TSCA Section 8D. OTS0516595.
- \*Mohamed MF, Kang D, Aneja VP. 2002. Volatile organic compounds in some urban locations in United States. *Chemosphere* 47:863-882.
- \*Monsanto. 1967. Initial submission: Toxicological investigation of: 2,3-dichloropropene. St. Louis MO: Monsanto Agricultural Company. Submitted to the U.S. Environmental Protection Agency under TSCA Section 8ECP. OTS0539077.
- \*Moran MJ, Lapham WW, Rowe BL, et al. 2004. Volatile organic compounds in ground water from rural private wells, 1986 to 1999. *J Am Water Resour Assoc* 40(5):1141-1157.
- \*Morita T, Asano N, Awogi T, et al. 1997a. Evaluation of the rodent micronucleus assay in the screening of IARC carcinogens (groups 1, 2A, and 2B) The summary report of the 6th collaborative study by CSGMT/JEMS MMS. (Erratum in: *Mutat Res* 391(3):259-267). *Mutat Res* 389:3-122.
- Morita T, Asano N, Awogi T, et al. 1997b. Erratum to Evaluation of the rodent micronucleus assay in the screening of IARC carcinogens (Groups 1, 2A and 2B). The summary report of the 6th collaborative study by CSGMT/JEMS MMS' [*Mutat Res* 389(1997) 3-122]. *Mutat Res* 391(3):259-267.
- \*Morselli PL, Franco-Morselli R, Bossi L. 1980. Clinical pharmacokinetics in newborns and infants: Age-related differences and therapeutic implications. *Clin Pharmacokin* 5:485-527.
- \*Munnecke DE, Vangundy SD. 1979. Movement of fumigants in soil, dosage, responses, and differential effects. *Ann Rev Phytopathol* 17:405-429.
- \*Myhr BC, Caspary WJ. 1991. Chemical mutagenesis at the thymidine kinase locus in L5178Y mouse lymphoma cells: Results for 31 coded compounds in the National Toxicology Program. *Environ Mol Mutagen* 18:51-83.

## 9. REFERENCES

- \*NARA. 2006. Electronic Code of Federal Regulations. Washington, DC: National Archives and Records Administration. <http://www.access.gpo.gov/nara/cfr/cfr-table-search.html>. March 20, 2006.
- \*NAS/NRC. 1989. Report of the oversight committee. In: Biologic markers in reproductive toxicology. Washington, DC: National Academy of Sciences, National Research Council, National Academy Press, 15-35.
- \*Nater JP, Gooskens VHJ. 1976. Occupational dermatosis due to a soil fumigant. *Contact Dermatitis* 2:227-229.
- \*NCFA. 1997. NCFAP pesticide use database. Washington, DC: National Center for Food and Agricultural Policy. <http://pestdata.ncsu.edu/ncfap/search.cfm>. March 18, 2006.
- \*NEMI. 1992. Method 524.2: Measurement of purgeable organic compounds in water by capillary column gas chromatography/mass spectrometry. National Environmental Methods Index. U.S. Environmental Protection Agency. U.S. Geological Survey. <http://www.nemi.gov>. May 25, 2006.
- \*NEMI. 1997a. Method 6200B: Volatile organic compounds in water by purge and trap capillary-column GC/MS method. National Environmental Methods Index. U.S. Environmental Protection Agency. U.S. Geological Survey. <http://www.nemi.gov>. April 05, 2006.
- \*NEMI. 1997b. Method 6200C: Volatile organic compounds in water by purge and trap capillary-column GC method. National Environmental Methods Index. U.S. Environmental Protection Agency. U.S. Geological Survey. <http://www.nemi.gov>. April 05, 2006.
- \*NEMI. 2001. Method D5790: Standard test method for measurement of purgeable organic compounds in water by capillary column gas chromatography/mass spectrometry. National Environmental Methods Index. U.S. Environmental Protection Agency. U.S. Geological Survey. <http://www.nemi.gov>. April 05, 2006.
- \*Neudecker T, Henschler D. 1986. Mutagenicity of chloroolefins in the *Salmonella*/mammalian microsome test. III. Metabolic activation of the allylic chloropropenes allyl chloride, 1,3-dichloropropene, 2,3-dichloro-1-propene, 1,2,3-trichloropropene, 1,1,2,3-tetrachloro-2-propene and hexachloropropene by S9 mix via two different metabolic pathways. *Mutat Res* 170:1-9.
- \*Neudecker T, Dekant W, Jorns M, et al. 1986. Mutagenicity of chloroolefins in the *Salmonella*/mammalian microsome test - II. Structural requirements for the metabolic activation of non-allylic chloropropenes and methylated derivatives via epoxide formation. *Biochem Pharmacol* 35(2):195-200.
- \*Neudecker T, Lutz D, Eder E, et al. 1980. Structure-activity relationship in halogen and alkyl substituted allyl and allylic compounds: Correlation of alkylating and mutagenic properties. *Biochem Pharmacol* 29:2611-2617.
- \*Neudecker T, Stefani A, Henschler D. 1977. *In vitro* mutagenicity of the soil nematicide 1,3-dichloropropene. *Experientia* 33:1084-1085.
- \*NIOSH. 2005. 1,3 Dichloropropene. NIOSH pocket guide to chemical hazards. Atlanta, GA: National Institute for Occupational Safety and Health, Centers for Disease Control and Prevention. <http://www.cdc.gov/niosh/npg/>. March 08, 2006.

## 9. REFERENCES

- \*NIOSH. 2006. 1,3-Dichloropropene. National occupational exposure survey (1981-1993). Cincinnati, OH: U.S. Department of Health and Human Services, Public Health Service, Centers for Disease Control, National Institute for Occupational Safety and Health. <http://www.cdc.gov/noes1/x3912sic.html>. May 15, 2006.
- \*Nishihara T, Nishikawa J, Kanayama T, et al. 2000. Estrogenic activities of 517 chemicals by yeast two-hybrid assay. *J Health Sci* 46(4):282-298.
- \*NRC. 1993. Pesticides in the diets of infants and children. Washington, DC: National Academy Press, National Research Council.
- \*NTP. 1985. Toxicology and carcinogenesis studies of Telone II<sup>®</sup> (technical-grade 1,3-dichloropropene [CAS No. 542-75-6] containing 1.0% epichlorohydrin as a stabilizer) in F344/N rats and B6C3F1 mice (gavage studies). U.S. Department of Health and Human Services. National Toxicology Program. Technical Report Series 269. [http://ntp.niehs.nih.gov/ntp/htdocs/LT\\_rpts/tr269.pdf](http://ntp.niehs.nih.gov/ntp/htdocs/LT_rpts/tr269.pdf). February 21, 2006.
- \*NTP. 1989. Unfinished 13-week inhalation study on 2,3-dichloropropene (2,3-dichloropropylene; CASRN 78-88-6). (1989 data tables included). Research Triangle Park, NC: National Toxicology Program. U.S. Department of Health and Human Services.
- \*NTP. 2005. Eleventh report on carcinogens. Research Triangle Park, NC: National Institute of National Health Sciences, National Toxicology Program. <http://ntp-server.niehs.nih.gov/ntp/roc/toc11.html>. March 08, 2006.
- \*NTP. 2006. Written communications between Margaret E. Fransen, Ph.D., Syracuse Research Corporation, and National Toxicology Program about unfinished 13-week inhalation study on 2,3-dichloropropene (2,3-dichloropropylene; CASRN 78-88-6).
- \*O'Neil MJ, Smith A, Heckelman PE, et al., eds. 2001. 1,3-Dichloropropene. Merck index. 13th ed. Whitehouse Station, NJ: Merck Research Laboratories, 541.
- Onkenhout W, Mulder PP, Boogaard PJ, et al. 1986. Identification and quantitative determination of mercapturic acids formed from Z- and E-1,3-dichloropropene by the rat, using gas chromatography with three different detection techniques. *Arch Toxicol* 59(4):235-241.
- \*OSHA. 2005. Limits for air contaminants. Occupational safety and health standards. Occupational Safety and Health Administration. Code of Federal Regulations. 29 CFR 1910.1000. <http://www.osha.gov/comp-links.html>. March 08, 2006.
- \*Osterloh JD, Feldman BJ. 1993. Urinary protein markers in pesticide applicators during a chlorinated hydrocarbon exposure. *Environ Res* 63(2):171-181.
- \*Osterloh JD, Cohen B-S, Pependorf W, et al. 1984. Urinary excretion of the N-acetyl cysteine conjugate of cis-1,3-dichloropropene by exposed individuals. *Arch Environ Health* 39:271-275.
- Osterloh J, Letz G, Pond S, et al. 1983. An assessment of the potential testicular toxicity of 10 pesticides using the mouse-sperm morphology assay. *Mutat Res* 116:407-415.
- \*Osterloh JD, Wang R, O'Connell L, et al. 1989b. Pilot study for biological monitoring of 1,3-dichloropropene. In: Wang RG, Franklin CA, Honeycutt RC, et al., eds. American Chemical Society Symposium Series Chapter 17. Washington, DC: American Chemical Society, 382, 215-230.

## 9. REFERENCES

- \*Osterloh JD, Wang R, Schneider F, et al. 1989a. Biological monitoring of dichloropropene: Air concentrations, urinary metabolite, and renal enzyme excretion. *Arch Environ Health* 44:207-213.
- \*Otson R. 1987. Purgeable organics in Great Lakes raw and treated water. *Int J Environ Anal Chem* 31:41-53.
- \*Ou L-T. 1989. Degradation of Telone II in contaminated and noncontaminated soils. *J Environ Sci Health B* 24(6):661-674.
- \*Ou L-T. 1998. Enhanced degradation of the volatile fumigant-nematicides 1,3-D and methyl bromide in soil. *J Nematol* 30(1):56-64.
- \*Ou L-T, Chung K-Y, Thomas JE, et al. 1995. Degradation of 1,3-dichloropropene (1,3-D) in soils with different histories of field applications of 1,3-D. *J Nematol* 27(3):249-257.
- \*Owen GM, Brozek J. 1966. Influence of age, sex and nutrition on body composition during childhood and adolescence. In: Falkner F, ed. *Human development*. Philadelphia, PA: WB Saunders, 222-238.
- \*Pakdel H, Couture G, Roy C, et al. 1994. Developing methods for the analysis of toxic chemicals in soil and groundwater: The case of Ville Mercier, Quebec, Canada. In: *Groundwater contamination and analysis at hazardous waste sites*. New York, NY: Marcel Dekker, Inc., 381-421.
- \*Pankow JF, Luo W, Bender DA, et al. 2003. Concentrations and co-occurrence correlations of 88 volatile organic compounds (VOCs) in the ambient air of 13 semi-rural to urban locations in the United States. *Atmos Environ* 37(36):5023-5046.
- \*Pellizzari ED, Hartwell TD, Harris BSH, et al. 1982. Purgeable organic compounds in mother's milk. *Bull Environ Contam Toxicol* 28:322-328.
- \*Pratt GC, Palmer K, Wu CY, et al. 2000. An assessment of air toxics in Minnesota. *Environ Health Perspect* 108(9):815-825.
- \*Roberts TR, Stoydin G. 1976. The degradation of (Z)- and (E)-1,3-dichloropropenes and 1,2-dichloropropane in soil. *Pestic Science* 7:325-335.
- \*Roby DM, Melichar MW. 1997. 1,3-Dichloropropene regulatory issues. *ACS Symp Ser* 652:25-31.
- \*Rogers SE, Peterson DL, Lauer WC. 1987. Organic contaminants removal for potable reuse. *J Water Pollut Control Fed* 59:722-732.
- \*Rosenkranz HS, Klopman G. 1996. A study of the structural basis of the ability of chlorinated alkanes and alkenes to induce aneuploidy and toxicity in the mold *Aspergillus nidulans*. *Mutat Res* 354:183-193.
- \*RTECS. 2006. 1,3-Dichloropropene. Registry of Toxic Effects on Chemical Substances. National Institute of Occupational Safety and Health. MDL Information Systems, Inc. April 05, 2006.
- \*Sabel GV, Clark TP. 1984. Volatile organic compounds as indicators of municipal solid waste leach contamination. *Waste Management Res* 2:119-130.



## 9. REFERENCES

- \*Sasaki YFX, Imanishi H, Matsumoto K, et al. 1988. 1,3-Dichloropropene: *In vitro* cytogenetics test. IET 88-0038. Prepared by Dow Chemical Japan Limited and Shell Kagaku K.K., by the Institute of Environmental Toxicology, Tokyo, Japan.
- \*Sasaki YF, Saga A, Akasaka M, et al. 1998. Detection of *in vivo* genotoxicity of haloalkanes and haloalkenes carcinogenic to rodents by the alkaline single cell gel electrophoresis (comet) assay in multiple mouse organs. *Mutat Res* 419:13-20.
- \*Sasaki YF, Sakaguchi M, Yamada H, et al. 1994. Evaluation of micronucleus induction in mice by four organochlorine pesticides: 1,2-Dibromo-3-chloropropane, 1,3-dichloropropene, 1,2-dichloroethane, and nitrofen. *Mamm Mutagen Study Group Commun* 2:87-93.
- \*Schenker M, McCurdy S. 1986. Pesticides, viruses and sunlight in the etiology of cancer among agricultural workers. In: Becker CE, Coye MJ, eds. *Cancer prevention: Strategies in the workplace*. Washington, DC: Hemisphere Publishing Corporation, 29-37.
- \*Schiffmann D, Eder E, Neudecker T, et al. 1983. Induction of unscheduled DNA synthesis in HeLa cells by allylic compounds. *Cancer Lett* 20:263-269.
- \*Schneider M, Quistad GB, Casida JE. 1998a. 1,3-Dichloropropene epoxides: Intermediates in bioactivation of the promutagen 1,3-dichloropropene. *Chem Res Toxicol* 11(10):1137-1134.
- \*Schneider M, Quistad GB, Casida JE. 1998b. N<sup>2</sup>,7-Bis(1-hydroxy-2-oxopropyl)2'-deoxyguanosine: Identical noncyclic adducts with 1,3-dichloropropene epoxides and methylglyoxal. *Chem Res Toxicol* 11(12):1536-1542.
- \*Setchell BP, Waites GMH. 1975. The blood-testis barrier. In: Creep RO, Astwood EB, Geiger SR, eds. *Handbook of physiology: Endocrinology V*. Washington, DC: American Physiological Society, 143-172.
- \*Smelt JH, Teunissen W, Crum SJH, et al. 1989. Accelerated transformation of 1,3-dichloropropene in loamy soils. *Neth J Agric Sci* 37:173-183.
- \*Smith MB, March J. 2001. *March's advanced organic chemistry reactions, mechanisms, and structure*. New York, NY: John Wiley & Sons, 428, 433, 463.
- \*Smyth HF, Carpenter CP, Weil CS, et al. 1962. Range-finding toxicity data: List VI. *Am Ind Hyg Assoc J* 23:95-107.
- \*Snider EH, Manning FS. 1982. A survey of pollutant emission levels in waste waters and residuals from the petroleum refining industry. *Environ Int* 7:237-258.
- \*Spicer CW, Buxton BE, Holdren MW, et al. 1996. Variability of hazardous air pollutants in an urban area. *Atmos Environ* 30(20):3443-3456.
- \*SRI. 2005. Pesticides: 1,3-Dichloropropene. *Directory of chemical producers*. Menlo Park, CA: Access Intelligence, LLC, 777.
- \*Stebbins KE, Johnson KA, Jeffries TK, et al. 2000. Chronic toxicity and oncogenicity studies of ingested 1,3-dichloropropene in rats and mice. *Regul Toxicol Pharmacol* 32(1):1-13.

## 9. REFERENCES

- \*Stebbins KE, Quast JF, Haut KT, et al. 1999. Subchronic and chronic toxicity of ingested 1,3-dichloropropene in dogs. *Regul Toxicol Pharmacol* 30(3):233-243.
- \*Sterrett RJ, Ransom ME, Barnhill GD. 1986. Site assessment and on-site treatment of a pesticide spill in the vadose zone. In: *Proceedings of the Conference on Hazardous Material Spills, Preparedness, Prevention, Control, and Cleanup of Releases*, Association of American Railroads, United States Coast Guard, St. Louis, MO May 5-8, 1986. Chemical Manufacturers Association, 84-92.
- \*Stolzenberg SJ, Hine CH. 1980. Mutagenicity of 2- and 3-carbon halogenated compounds in the *Salmonella*/mammalian-microsome test. *Environ Mutagen* 2:59-66.
- \*Stott W, Kastl P. 1986. Inhalation pharmacokinetics of technical grade 1,3-dichloropropene in rats. *Toxicol Appl Pharmacol* 85:332-341.
- \*Stott W, Young J, Calhoun L, et al. 1988. Subchronic toxicity of inhaled technical grade 1,3-dichloropropene in rats and mice. *Fundam Appl Toxicol* 11:207-220.
- \*Stott WT, Gilbert JR, McGuirk RJ, et al. 1998. Bioavailability and pharmacokinetics of microencapsulated 1,3-dichloropropene in rats. *Toxicol Sci* 41(1):21-28.
- Stott WT, Gollapudi BB, Rao KS. 2001. Mammalian toxicity of 1,3-dichloropropene. *Rev Environ Contam Toxicol* 168:1-42.
- Stott WT, Waechter JM, Quast JT. 1990. Comment to the editors. *Arch Environ Health* 45(4):250-255.
- \*Streeter C, Lomax L. 1988. Telone C-17<sup>®</sup> soil fungicide and nematocide: A one-hour acute vapor inhalation study in Fischer 344 rats. Dow Chemical Company. Submitted to the U.S. Environmental Protection Agency under TSCA Section 8D. OTS0517371.
- \*Streeter C, Battjes J, Lomax L. 1987. Telone II<sup>®</sup> soil fumigant: An acute vapor inhalation study in Fischer 344 rats. Dow Chemical Company. Submitted to the U.S. Environmental Protection Agency under TSCA Section 8D. OTS0517084.
- \*Stutz DR, Janusz SJ. 1988. *Hazardous materials injuries: A handbook for pre-hospital care*. 2nd ed. Beltsville, MD: Bradford Communications Corporation, 300-301.
- \*Suffet IH, Brenner L, Cairo PR. 1980. GC/MS identification of trace organics in Philadelphia drinking waters during a 2-year period. *Water Res* 14:853-867.
- Suzuki T, Komatsu M, Sasaki H, et al. 1995. Cytotoxicity of halogenated hydrocarbons and cellular phospholipid peroxidation in isolated rat hepatocytes. *Jpn J Toxicol Environ Health (Eisei Kagaku)* 41(1):35.
- \*Suzuki T, Nezu K, Sasaki H, et al. 1994a. Cytotoxicity of chlorinated hydrocarbons and lipid peroxidation in isolated rat hepatocytes. *Biol Pharm Bull* 17(1):82-86.
- \*Suzuki T, Sasaki H, Komatsu M, et al. 1994b. Cytotoxicity of 1,3-dichloropropene and cellular phospholipid peroxidation in isolated rat hepatocytes, and its prevention by alpha-tocopherol. *Biol Pharm Bull* 17(10):1351-1354.

## 9. REFERENCES

- \*Swann RL, Laskowski DA, McCall PJ, et al. 1983. A rapid method for the estimation of the environmental parameters octanol/water partition coefficient, soil sorption constant, water to air ratio and water solubility. *Res Rev* 85:17-28.
- \*Tabak HH, Quave SA, Mashni CI, et al. 1981a. Biodegradability studies with organic priority pollutant compounds. *J Water Pollut Control Fed* 53:1503-1518.
- \*Tabak HH, Quave SA, Mashni CI, et al. 1981b. Biodegradability studies for predicting the environmental fate of organic priority pollutants. In: *Test protocols for environmental fate and movement of toxicants. Symposium: 94th Annual Meeting of the Association of Official Analytical Chemists, Washington, DC.* Arlington, VA: Association of Official Analytical Chemists, 267-328.
- \*Talcott R, King J. 1984. Mutagenic impurities in 1,3-dichloropropene preparations. *J Natl Cancer Inst* 72:1113-1116.
- \*Thomas RG. 1982. Volatilization from water. In: *Handbook of Chemical Property Estimation Methods: Environmental Behavior of Organic Compounds.* Lyman WJ, Reehl WF, Rosenblatt DH, eds. Chapter 15. New York, NY: McGraw Hill Book Co., 15-1-15-34
- \*Thomas IJ, McKenry MV. 1974. Part I: Movement and fate as affected by various conditions in several soils. *Hilgardia* 42:393-421.
- \*Thomas K, Colborn T. 1992. Organochlorine endocrine disruptors in human tissue. In: Colborn T, Clement C, eds. *Chemically induced alterations in sexual and functional development: The wildlife/human connection.* Princeton, NJ: Princeton Scientific Publishing, 365-394.
- \*Til H, Spanjers T, Feron V, et al. 1973. Sub-chronic (90-day) toxicity study with Telone<sup>®</sup> in albino rats (final report). Dow Chemical Company. Submitted to the U.S. Environmental Protection Agency under TSCA Section 8D. OTS0515831.
- \*Tomlin CDS, ed. 2003. 1,3-Dichloropropene (233). In: *e-Pesticide manual.* 13th ed. United Kingdom: British Crop Protection Council.
- \*Torkelson TR, Oyen F. 1977. The toxicity of 1,3-dichloropropene as determined by repeated exposure of laboratory animals. *Am Ind Hyg Assoc J* 38:217-223.
- \*TRI04. 2006. TRI explorer: Providing access to EPA's toxics release inventory data. Washington, DC: Office of Information Analysis and Access. Office of Environmental Information. U.S. Environmental Protection Agency. Toxics Release Inventory. <http://www.epa.gov/triexplorer/>. July 25, 2006.
- \*Tu CM. 1988. Effects of selected pesticides on activities of invertase, amylase and microbial respiration in sandy soil. *Chemosphere* 17:159-163.
- \*Tuazon EC, Atkinson R, Winer AM, et al. 1984. A study of the atmospheric reactions of 1,3-dichloropropene and other selected organochlorine compounds. *Arch Environ Contam Toxicol* 13:691-700.
- \*Union Carbide Corp. 1958. Range finding tests on 2,3-dichloro-1-propene. Union Carbide Corporation. Submitted to the U.S. Environmental Protection Agency under TSCA Section 8D. OTS0515587.

## 9. REFERENCES

- \*USGS. 1998. Methods of analysis by the U.S. Geological Survey National Water Quality Laboratory: Determination of 86 volatile organic compounds in water by gas chromatography/mass spectrometry, including detections less than reporting limits. Denver, CO: U.S. Geological Survey. Open file report 97-829.
- \*USGS. 2001. Ground-water quality in the Cook Inlet Basin, Alaska, 1999. Anchorage, AK: U.S. Geological Survey. WRI Report 01-4208.
- \*USGS. 2002. Quality of shallow ground water in areas of recent residential and commercial development, Wichita, Kansas, 2000. Lawrence, KS: U.S. Geological Survey, U.S. Department of the Interior. WRI Report 02-4228.
- \*USITC. 1989. Synthetic organic chemicals, United States production and sales, 1988. Washington, DC: United States International Trade Commission. USITC Publication #2219.
- \*Valencia R, Mason J, Woodruff R, et al. 1985. Chemical mutagenesis testing in *Drosophila*. III. Results of 48 coded compounds tested for the National Toxicology Program. *Environ Mutagen* 7:325-348.
- \*van der Pas LJT, Leistra M. 1987. Movement and transformation of 1,3-dichloropropene in the soil of flower-bulb fields. *Arch Environ Contam Toxicol* 16:417-422.
- \*van Duuren B, Goldschmidt B, Loewengart G, et al. 1979. Carcinogenicity of halogenated olefinic and aliphatic hydrocarbons in mice. *J Natl Cancer Inst* 63:1433-1439.
- \*van Joost T, de Jong G. 1988. Sensitization to DD soil fumigant during manufacture. *Contact Dermatitis* 18(5):307-308.
- \*van Welie RT, van Duyn P, Brouwer DH, et al. 1991a. Inhalation exposure to 1,3-dichloropropene in the Dutch flower-bulb culture. Part II. Biological monitoring by measurement of urinary excretion of two mercapturic acid metabolites. *Arch Environ Contam Toxicol* 20(1):6-12.
- \*van Welie RT, van Marrewijk CM, de Wolff FA, et al. 1991b. Thioether excretion in urine of applicators exposed to 1,3-dichloropropene: A comparison with urinary mercapturic acid excretion. *Br J Ind Med* 48:492-498.
- \*van Welie RTH, van Duyn P, Vermeulen NPE. 1989. Determination of two mercapturic acid metabolites of 1,3-dichloropropene in human urine with gas chromatography and sulphur-selective detection. *J Chromatogr* 496:463-471.
- van Welie RTH, van Duyn P, Vermeulen NPE. 1991c. Environmental and biological monitoring of non-occupational exposure to 1,3-dichloropropene. *Int Arch Occup Environ Health* 63:169-173.
- \*Verberk MM, Brouwer DH, Brouwer EJ, et al. 1990. Health effects of pesticides in the flower-bulb culture in Holland. *Med Lav* 81(6):530-541.
- \*Verhagen C, Lebbink G, Bloem J. 1996. Enhanced biodegradation of the nematicides 1,3-dichloropropene and methyl isothiocyanate in a variety of soils. *Soil Biol Biochem* 12:1753-1756.

## 9. REFERENCES

- \*Verplanke AJ, Bloemen LJ, Brouwer EJ, et al. 2000. Occupational exposure to cis-1,3-dichloropropene: Biological effect monitoring of kidney and liver function. *Occup Environ Med* 57(11):745-751.
- \*Verschuere K, ed. 2001. 1,3-Dichloro-1-propene. Handbook of environmental data on organic chemicals. 4th ed. New York, NY: John Wiley & Sons, Inc., 810-811.
- \*Vieira I, Sonnier M, Cresteil T. 1996. Developmental expression of CYP2E1 in the human liver: Hypermethylation control of gene expression during the neonatal period. *Eur J Biochem* 238:476-483.
- \*Vithayathil AJ, McClure C, Myers JW. 1983. *Salmonella*/microsome multiple indicator mutagenicity test. *Mutat Res* 121:33-37.
- \*von der Hude W, Scheutwinkel M, Gramlich U, et al. 1987. Genotoxicity of three-carbon compounds evaluated in the SCE test *in vitro*. *Environ Mutagen* 9:401-410.
- \*Vos RM, van Welie RT, Peters WH, et al. 1991. Genetic deficiency of human class mu glutathione S-transferase isoenzymes in relation to the urinary excretion of the mercapturic acids of Z- and E-1,3-dichloropropene. *Arch Toxicol* 65(2):95-99.
- \*Voza A, Ruocco V, Brenner S, et al. 1996. Contact pemphigus. *Int J Dermatol* 35(3):199-201.
- \*Waechter J, Kastl P. 1988. 1,3-Dichloropropene: Pharmacokinetics and metabolism in Fischer 344 rats following repeated oral administration. Dow Chemical Company. Submitted to the U.S. Environmental Protection Agency under TSCA Section 8D. OTS0516660.
- \*Waechter JM, Brzak KA, McCarty LP, et al. 1992. 1,3-Dichloropropene (Telone II® soil fumigant): inhalation pharmacokinetics and metabolism in human volunteers (internal report). Dow Elanco. Submitted to the U.S. Environmental Protection Agency. MRID422903-01.
- \*Wang GM. 1984. Evaluation of pesticides which pose carcinogenicity potential in animal testing. II. Consideration of human exposure conditions for regulatory decision making. *Regul Toxicol Pharmacol* 4(4):361-371.
- \*Wang D, Yates SR, Ernst FF, et al. 2001b. Volatilization of 1,3-dichloropropene under different application methods. *Water Air Soil Pollut* 127:109-123.
- \*Wang Q, Gan J, Papiernik SK, et al. 2001a. Isomeric effects on thiosulfate transformation and detoxification of 1,3-dichloropropene. *Environ Toxicol Chem* 20(5):960-964.
- \*Watanabe K, Sakamoto K, Sasaki T. 1998. Comparisons on chemically-induced mutation among four bacterial strains, *Salmonella typhimurium* TA102 and TA2638, and *Escherichia coli* WP2/pKM101 and WP2 *uvrA*/pKM101: Collaborative study II. *Mutat Res* 412:17-31.
- \*Watson W, Brooks T, Huckle K, et al. 1987. Microbial mutagenicity studies with (Z)-1,3-dichloropropene. *Chem Biol Interact* 61(1):17-30.
- \*West JR, Smith HW, Chasis H. 1948. Glomerular filtration rate, effective renal blood flow, and maximal tubular excretory capacity in infancy. *J Pediatr* 32:10-18.

## 9. REFERENCES

- \*WHO. 2000. Air quality guidelines. 2<sup>nd</sup> ed. Geneva, Switzerland: World Health Organization. [http://www.euro.who.int/air/activities/20050223\\_4](http://www.euro.who.int/air/activities/20050223_4). March 08, 2006.
- \*WHO. 2004. Guidelines for drinking-water quality. 3<sup>rd</sup> ed. Geneva, Switzerland: World Health Organization. [http://www.who.int/water\\_sanitation\\_health/dwq/gdwq3/en/](http://www.who.int/water_sanitation_health/dwq/gdwq3/en/). March 08, 2006.
- \*Widdowson EM, Dickerson JWT. 1964. Chemical composition of the body. In: Comar CL, Bronner F, eds. Mineral metabolism: An advanced treatise. Volume II: The elements Part A. New York, NY: Academic Press, 1-247.
- \*Williams GM, Mori H, McQueen CA. 1989. Structure-activity relationships in the rat hepatocyte DNA-repair test for 300 chemicals. *Mutat Res* 221:263-286.
- \*Winn RN, Norris MB, Lothenbach D, et al. 2006. Sub-chronic exposure to 1,1-dichloropropene induces frameshift mutations in  $\lambda$  transgenic medaka. *Mutat Res* 595:52-59.
- \*Wolford ST, Schroer RA, Gohs FX, et al. 1986. Reference range data base for serum chemistry and hematology values in laboratory animals. *J Toxicol Environ Health* 18:161-188.
- \*Yakel H, Kociba R. 1977. Acute inhalation toxicity of M-3993 (Telone II<sup>®</sup>) in rats. Dow Chemical Company. Submitted to the U.S. Environmental Protection Agency under TSCA Section 8D. OTS0515858.
- \*Yang R. 1986. 1,3-Dichloropropene. *Residue Rev* 97:19-35.
- \*Yon DA, Morrison GA, McGibbon AS. 1991. Dissipation of 1,3-dichloropropene in ditch bottom sediment and associated aerobic ditch water. *Pestic Sci* 32:147-159.
- \*Zearth BJ, Szeto SY, Hii B, et al. 1998. Groundwater contamination by chlorinated hydrocarbon impurities present in soil fumigant formulations. *Water Qual Res J Can* 33 (1):31-50.
- \*Zeiger E, Anderson B, Haworth S, et al. 1988. Salmonella mutagenicity tests: 4. Results from the testing of 300 chemicals. *Environ Mol Mutagen* 11:1-158.
- \*Zempel JA, Grandjean M, Young JT. 1987. 2,3-Dichloropropene: Results of a two-week inhalation toxicity study in Fischer-344 rats and B6C3F1 mice. Dow Chemical Company. Submitted to the U.S. Environmental Protection Agency under TSCA Section FYI. OTS0000499-1.
- \*Ziegler EE, Edwards BB, Jensen RL, et al. 1978. Absorption and retention of lead by infants. *Pediatr Res* 12:29-34.

## 10. GLOSSARY

**Absorption**—The taking up of liquids by solids, or of gases by solids or liquids.

**Acute Exposure**—Exposure to a chemical for a duration of 14 days or less, as specified in the Toxicological Profiles.

**Adsorption**—The adhesion in an extremely thin layer of molecules (as of gases, solutes, or liquids) to the surfaces of solid bodies or liquids with which they are in contact.

**Adsorption Coefficient ( $K_{oc}$ )**—The ratio of the amount of a chemical adsorbed per unit weight of organic carbon in the soil or sediment to the concentration of the chemical in solution at equilibrium.

**Adsorption Ratio ( $K_d$ )**—The amount of a chemical adsorbed by sediment or soil (i.e., the solid phase) divided by the amount of chemical in the solution phase, which is in equilibrium with the solid phase, at a fixed solid/solution ratio. It is generally expressed in micrograms of chemical sorbed per gram of soil or sediment.

**Benchmark Dose (BMD)**—Usually defined as the lower confidence limit on the dose that produces a specified magnitude of changes in a specified adverse response. For example, a  $BMD_{10}$  would be the dose at the 95% lower confidence limit on a 10% response, and the benchmark response (BMR) would be 10%. The BMD is determined by modeling the dose response curve in the region of the dose response relationship where biologically observable data are feasible.

**Benchmark Dose Model**—A statistical dose-response model applied to either experimental toxicological or epidemiological data to calculate a BMD.

**Bioconcentration Factor (BCF)**—The quotient of the concentration of a chemical in aquatic organisms at a specific time or during a discrete time period of exposure divided by the concentration in the surrounding water at the same time or during the same period.

**Biomarkers**—Broadly defined as indicators signaling events in biologic systems or samples. They have been classified as markers of exposure, markers of effect, and markers of susceptibility.

**Cancer Effect Level (CEL)**—The lowest dose of chemical in a study, or group of studies, that produces significant increases in the incidence of cancer (or tumors) between the exposed population and its appropriate control.

**Carcinogen**—A chemical capable of inducing cancer.

**Case-Control Study**—A type of epidemiological study that examines the relationship between a particular outcome (disease or condition) and a variety of potential causative agents (such as toxic chemicals). In a case-controlled study, a group of people with a specified and well-defined outcome is identified and compared to a similar group of people without outcome.

**Case Report**—Describes a single individual with a particular disease or exposure. These may suggest some potential topics for scientific research, but are not actual research studies.

## 10. GLOSSARY

**Case Series**—Describes the experience of a small number of individuals with the same disease or exposure. These may suggest potential topics for scientific research, but are not actual research studies.

**Ceiling Value**—A concentration of a substance that should not be exceeded, even instantaneously.

**Chronic Exposure**—Exposure to a chemical for 365 days or more, as specified in the Toxicological Profiles.

**Cohort Study**—A type of epidemiological study of a specific group or groups of people who have had a common insult (e.g., exposure to an agent suspected of causing disease or a common disease) and are followed forward from exposure to outcome. At least one exposed group is compared to one unexposed group.

**Cross-sectional Study**—A type of epidemiological study of a group or groups of people that examines the relationship between exposure and outcome to a chemical or to chemicals at one point in time.

**Data Needs**—Substance-specific informational needs that if met would reduce the uncertainties of human health assessment.

**Developmental Toxicity**—The occurrence of adverse effects on the developing organism that may result from exposure to a chemical prior to conception (either parent), during prenatal development, or postnatally to the time of sexual maturation. Adverse developmental effects may be detected at any point in the life span of the organism.

**Dose-Response Relationship**—The quantitative relationship between the amount of exposure to a toxicant and the incidence of the adverse effects.

**Embryotoxicity and Fetotoxicity**—Any toxic effect on the conceptus as a result of prenatal exposure to a chemical; the distinguishing feature between the two terms is the stage of development during which the insult occurs. The terms, as used here, include malformations and variations, altered growth, and *in utero* death.

**Environmental Protection Agency (EPA) Health Advisory**—An estimate of acceptable drinking water levels for a chemical substance based on health effects information. A health advisory is not a legally enforceable federal standard, but serves as technical guidance to assist federal, state, and local officials.

**Epidemiology**—Refers to the investigation of factors that determine the frequency and distribution of disease or other health-related conditions within a defined human population during a specified period.

**Genotoxicity**—A specific adverse effect on the genome of living cells that, upon the duplication of affected cells, can be expressed as a mutagenic, clastogenic, or carcinogenic event because of specific alteration of the molecular structure of the genome.

**Half-life**—A measure of rate for the time required to eliminate one half of a quantity of a chemical from the body or environmental media.

**Immediately Dangerous to Life or Health (IDLH)**—The maximum environmental concentration of a contaminant from which one could escape within 30 minutes without any escape-impairing symptoms or irreversible health effects.



## 10. GLOSSARY

**Immunologic Toxicity**—The occurrence of adverse effects on the immune system that may result from exposure to environmental agents such as chemicals.

**Immunological Effects**—Functional changes in the immune response.

**Incidence**—The ratio of individuals in a population who develop a specified condition to the total number of individuals in that population who could have developed that condition in a specified time period.

**Intermediate Exposure**—Exposure to a chemical for a duration of 15–364 days, as specified in the Toxicological Profiles.

**In Vitro**—Isolated from the living organism and artificially maintained, as in a test tube.

**In Vivo**—Occurring within the living organism.

**Lethal Concentration<sub>(LO)</sub> (LC<sub>LO</sub>)**—The lowest concentration of a chemical in air that has been reported to have caused death in humans or animals.

**Lethal Concentration<sub>(50)</sub> (LC<sub>50</sub>)**—A calculated concentration of a chemical in air to which exposure for a specific length of time is expected to cause death in 50% of a defined experimental animal population.

**Lethal Dose<sub>(LO)</sub> (LD<sub>LO</sub>)**—The lowest dose of a chemical introduced by a route other than inhalation that has been reported to have caused death in humans or animals.

**Lethal Dose<sub>(50)</sub> (LD<sub>50</sub>)**—The dose of a chemical that has been calculated to cause death in 50% of a defined experimental animal population.

**Lethal Time<sub>(50)</sub> (LT<sub>50</sub>)**—A calculated period of time within which a specific concentration of a chemical is expected to cause death in 50% of a defined experimental animal population.

**Lowest-Observed-Adverse-Effect Level (LOAEL)**—The lowest exposure level of chemical in a study, or group of studies, that produces statistically or biologically significant increases in frequency or severity of adverse effects between the exposed population and its appropriate control.

**Lymphoreticular Effects**—Represent morphological effects involving lymphatic tissues such as the lymph nodes, spleen, and thymus.

**Malformations**—Permanent structural changes that may adversely affect survival, development, or function.

**Minimal Risk Level (MRL)**—An estimate of daily human exposure to a hazardous substance that is likely to be without an appreciable risk of adverse noncancer health effects over a specified route and duration of exposure.

**Modifying Factor (MF)**—A value (greater than zero) that is applied to the derivation of a Minimal Risk Level (MRL) to reflect additional concerns about the database that are not covered by the uncertainty factors. The default value for a MF is 1.

**Morbidity**—State of being diseased; morbidity rate is the incidence or prevalence of disease in a specific population.

## 10. GLOSSARY

**Mortality**—Death; mortality rate is a measure of the number of deaths in a population during a specified interval of time.

**Mutagen**—A substance that causes mutations. A mutation is a change in the DNA sequence of a cell's DNA. Mutations can lead to birth defects, miscarriages, or cancer.

**Necropsy**—The gross examination of the organs and tissues of a dead body to determine the cause of death or pathological conditions.

**Neurotoxicity**—The occurrence of adverse effects on the nervous system following exposure to a chemical.

**No-Observed-Adverse-Effect Level (NOAEL)**—The dose of a chemical at which there were no statistically or biologically significant increases in frequency or severity of adverse effects seen between the exposed population and its appropriate control. Effects may be produced at this dose, but they are not considered to be adverse.

**Octanol-Water Partition Coefficient ( $K_{ow}$ )**—The equilibrium ratio of the concentrations of a chemical in *n*-octanol and water, in dilute solution.

**Odds Ratio (OR)**—A means of measuring the association between an exposure (such as toxic substances and a disease or condition) that represents the best estimate of relative risk (risk as a ratio of the incidence among subjects exposed to a particular risk factor divided by the incidence among subjects who were not exposed to the risk factor). An OR of greater than 1 is considered to indicate greater risk of disease in the exposed group compared to the unexposed group.

**Organophosphate or Organophosphorus Compound**—A phosphorus-containing organic compound and especially a pesticide that acts by inhibiting cholinesterase.

**Permissible Exposure Limit (PEL)**—An Occupational Safety and Health Administration (OSHA) allowable exposure level in workplace air averaged over an 8-hour shift of a 40-hour workweek.

**Pesticide**—General classification of chemicals specifically developed and produced for use in the control of agricultural and public health pests.

**Pharmacokinetics**—The dynamic behavior of a material in the body, used to predict the fate (disposition) of an exogenous substance in an organism. Utilizing computational techniques, it provides the means of studying the absorption, distribution, metabolism, and excretion of chemicals by the body.

**Pharmacokinetic Model**—A set of equations that can be used to describe the time course of a parent chemical or metabolite in an animal system. There are two types of pharmacokinetic models: data-based and physiologically-based. A data-based model divides the animal system into a series of compartments, which, in general, do not represent real, identifiable anatomic regions of the body, whereas the physiologically-based model compartments represent real anatomic regions of the body.

**Physiologically Based Pharmacodynamic (PBPD) Model**—A type of physiologically based dose-response model that quantitatively describes the relationship between target tissue dose and toxic end points. These models advance the importance of physiologically based models in that they clearly describe the biological effect (response) produced by the system following exposure to an exogenous substance.

## 10. GLOSSARY

**Physiologically Based Pharmacokinetic (PBPK) Model**—Comprised of a series of compartments representing organs or tissue groups with realistic weights and blood flows. These models require a variety of physiological information: tissue volumes, blood flow rates to tissues, cardiac output, alveolar ventilation rates, and possibly membrane permeabilities. The models also utilize biochemical information, such as air/blood partition coefficients, and metabolic parameters. PBPK models are also called biologically based tissue dosimetry models.

**Prevalence**—The number of cases of a disease or condition in a population at one point in time.

**Prospective Study**—A type of cohort study in which the pertinent observations are made on events occurring after the start of the study. A group is followed over time.

**q<sub>1</sub>\***—The upper-bound estimate of the low-dose slope of the dose-response curve as determined by the multistage procedure. The q<sub>1</sub>\* can be used to calculate an estimate of carcinogenic potency, the incremental excess cancer risk per unit of exposure (usually µg/L for water, mg/kg/day for food, and µg/m<sup>3</sup> for air).

**Recommended Exposure Limit (REL)**—A National Institute for Occupational Safety and Health (NIOSH) time-weighted average (TWA) concentration for up to a 10-hour workday during a 40-hour workweek.

**Reference Concentration (RfC)**—An estimate (with uncertainty spanning perhaps an order of magnitude) of a continuous inhalation exposure to the human population (including sensitive subgroups) that is likely to be without an appreciable risk of deleterious noncancer health effects during a lifetime. The inhalation reference concentration is for continuous inhalation exposures and is appropriately expressed in units of mg/m<sup>3</sup> or ppm.

**Reference Dose (RfD)**—An estimate (with uncertainty spanning perhaps an order of magnitude) of the daily exposure of the human population to a potential hazard that is likely to be without risk of deleterious effects during a lifetime. The RfD is operationally derived from the no-observed-adverse-effect level (NOAEL, from animal and human studies) by a consistent application of uncertainty factors that reflect various types of data used to estimate RfDs and an additional modifying factor, which is based on a professional judgment of the entire database on the chemical. The RfDs are not applicable to nonthreshold effects such as cancer.

**Reportable Quantity (RQ)**—The quantity of a hazardous substance that is considered reportable under the Comprehensive Environmental Response, Compensation, and Liability Act (CERCLA). Reportable quantities are (1) 1 pound or greater or (2) for selected substances, an amount established by regulation either under CERCLA or under Section 311 of the Clean Water Act. Quantities are measured over a 24-hour period.

**Reproductive Toxicity**—The occurrence of adverse effects on the reproductive system that may result from exposure to a chemical. The toxicity may be directed to the reproductive organs and/or the related endocrine system. The manifestation of such toxicity may be noted as alterations in sexual behavior, fertility, pregnancy outcomes, or modifications in other functions that are dependent on the integrity of this system.

## 10. GLOSSARY

**Retrospective Study**—A type of cohort study based on a group of persons known to have been exposed at some time in the past. Data are collected from routinely recorded events, up to the time the study is undertaken. Retrospective studies are limited to causal factors that can be ascertained from existing records and/or examining survivors of the cohort.

**Risk**—The possibility or chance that some adverse effect will result from a given exposure to a chemical.

**Risk Factor**—An aspect of personal behavior or lifestyle, an environmental exposure, or an inborn or inherited characteristic that is associated with an increased occurrence of disease or other health-related event or condition.

**Risk Ratio**—The ratio of the risk among persons with specific risk factors compared to the risk among persons without risk factors. A risk ratio greater than 1 indicates greater risk of disease in the exposed group compared to the unexposed group.

**Short-Term Exposure Limit (STEL)**—The American Conference of Governmental Industrial Hygienists (ACGIH) maximum concentration to which workers can be exposed for up to 15 minutes continually. No more than four excursions are allowed per day, and there must be at least 60 minutes between exposure periods. The daily Threshold Limit Value-Time Weighted Average (TLV-TWA) may not be exceeded.

**Standardized Mortality Ratio (SMR)**—A ratio of the observed number of deaths and the expected number of deaths in a specific standard population.

**Target Organ Toxicity**—This term covers a broad range of adverse effects on target organs or physiological systems (e.g., renal, cardiovascular) extending from those arising through a single limited exposure to those assumed over a lifetime of exposure to a chemical.

**Teratogen**—A chemical that causes structural defects that affect the development of an organism.

**Threshold Limit Value (TLV)**—An American Conference of Governmental Industrial Hygienists (ACGIH) concentration of a substance to which most workers can be exposed without adverse effect. The TLV may be expressed as a Time Weighted Average (TWA), as a Short-Term Exposure Limit (STEL), or as a ceiling limit (CL).

**Time-Weighted Average (TWA)**—An allowable exposure concentration averaged over a normal 8-hour workday or 40-hour workweek.

**Toxic Dose<sub>(50)</sub> (TD<sub>50</sub>)**—A calculated dose of a chemical, introduced by a route other than inhalation, which is expected to cause a specific toxic effect in 50% of a defined experimental animal population.

**Toxicokinetic**—The absorption, distribution, and elimination of toxic compounds in the living organism.

## 10. GLOSSARY

**Uncertainty Factor (UF)**—A factor used in operationally deriving the Minimal Risk Level (MRL) or Reference Dose (RfD) or Reference Concentration (RfC) from experimental data. UFs are intended to account for (1) the variation in sensitivity among the members of the human population, (2) the uncertainty in extrapolating animal data to the case of human, (3) the uncertainty in extrapolating from data obtained in a study that is of less than lifetime exposure, and (4) the uncertainty in using lowest-observed-adverse-effect level (LOAEL) data rather than no-observed-adverse-effect level (NOAEL) data. A default for each individual UF is 10; if complete certainty in data exists, a value of 1 can be used; however, a reduced UF of 3 may be used on a case-by-case basis, 3 being the approximate logarithmic average of 10 and 1.

**Xenobiotic**—Any chemical that is foreign to the biological system.

10. GLOSSARY

This page is intentionally blank.

## APPENDIX A. ATSDR MINIMAL RISK LEVELS AND WORKSHEETS

The Comprehensive Environmental Response, Compensation, and Liability Act (CERCLA) [42 U.S.C. 9601 et seq.], as amended by the Superfund Amendments and Reauthorization Act (SARA) [Pub. L. 99–499], requires that the Agency for Toxic Substances and Disease Registry (ATSDR) develop jointly with the U.S. Environmental Protection Agency (EPA), in order of priority, a list of hazardous substances most commonly found at facilities on the CERCLA National Priorities List (NPL); prepare toxicological profiles for each substance included on the priority list of hazardous substances; and assure the initiation of a research program to fill identified data needs associated with the substances.

The toxicological profiles include an examination, summary, and interpretation of available toxicological information and epidemiologic evaluations of a hazardous substance. During the development of toxicological profiles, Minimal Risk Levels (MRLs) are derived when reliable and sufficient data exist to identify the target organ(s) of effect or the most sensitive health effect(s) for a specific duration for a given route of exposure. An MRL is an estimate of the daily human exposure to a hazardous substance that is likely to be without appreciable risk of adverse noncancer health effects over a specified duration of exposure. MRLs are based on noncancer health effects only and are not based on a consideration of cancer effects. These substance-specific estimates, which are intended to serve as screening levels, are used by ATSDR health assessors to identify contaminants and potential health effects that may be of concern at hazardous waste sites. It is important to note that MRLs are not intended to define clean-up or action levels.

MRLs are derived for hazardous substances using the no-observed-adverse-effect level/uncertainty factor approach. They are below levels that might cause adverse health effects in the people most sensitive to such chemical-induced effects. MRLs are derived for acute (1–14 days), intermediate (15–364 days), and chronic (365 days and longer) durations and for the oral and inhalation routes of exposure. Currently, MRLs for the dermal route of exposure are not derived because ATSDR has not yet identified a method suitable for this route of exposure. MRLs are generally based on the most sensitive chemical-induced end point considered to be of relevance to humans. Serious health effects (such as irreparable damage to the liver or kidneys, or birth defects) are not used as a basis for establishing MRLs. Exposure to a level above the MRL does not mean that adverse health effects will occur.

## APPENDIX A

MRLs are intended only to serve as a screening tool to help public health professionals decide where to look more closely. They may also be viewed as a mechanism to identify those hazardous waste sites that are not expected to cause adverse health effects. Most MRLs contain a degree of uncertainty because of the lack of precise toxicological information on the people who might be most sensitive (e.g., infants, elderly, nutritionally or immunologically compromised) to the effects of hazardous substances. ATSDR uses a conservative (i.e., protective) approach to address this uncertainty consistent with the public health principle of prevention. Although human data are preferred, MRLs often must be based on animal studies because relevant human studies are lacking. In the absence of evidence to the contrary, ATSDR assumes that humans are more sensitive to the effects of hazardous substance than animals and that certain persons may be particularly sensitive. Thus, the resulting MRL may be as much as 100-fold below levels that have been shown to be nontoxic in laboratory animals.

Proposed MRLs undergo a rigorous review process: Health Effects/MRL Workgroup reviews within the Division of Toxicology and Environmental Medicine, expert panel peer reviews, and agency-wide MRL Workgroup reviews, with participation from other federal agencies and comments from the public. They are subject to change as new information becomes available concomitant with updating the toxicological profiles. Thus, MRLs in the most recent toxicological profiles supersede previously published levels. For additional information regarding MRLs, please contact the Division of Toxicology and Environmental Medicine, Agency for Toxic Substances and Disease Registry, 1600 Clifton Road NE, Mailstop F-32, Atlanta, Georgia 30333.



## APPENDIX A

**MINIMAL RISK LEVEL (MRL) WORKSHEET**

Chemical Name: 2,3-Dichloropropene  
CAS Numbers: 78-88-6  
Date: August 2006  
Profile Status: Final Draft Pre-public  
Route:  Inhalation  Oral  
Duration:  Acute  Intermediate  Chronic  
Graph Key: 3  
Species: Rat

Minimal Risk Level: 0.002  mg/kg/day  ppm

Reference: Zempel JA, Grandjean M, Young JT. 1987. 2,3-Dichloropropene: Results of a two-week inhalation toxicity study in Fischer-344 rats and B6C3F1 mice. Dow Chemical Company. Submitted to the U.S. Environmental Protection Agency under TSCA Section FYI. OTS0000499-1.

Note: The principal study is an unpublished study that has been peer reviewed.

Experimental design: Groups (five/sex/concentration) of B6C3F1 mice and F344 rats were exposed to vapors of 2,3-dichloropropene (>99% purity) 6 hours/day for nine exposures over 11 days at concentrations of 0, 5, 25, or 75 ppm (0, 22.7, 113.5, or 340 mg/m<sup>3</sup>). Animals were examined daily for signs of toxicity. Body weights were measured on days 1, 3, 5, and 12. Urine samples were collected from rats before the last exposure on day 11. At termination on day 12 after an overnight fast, blood samples were taken from rats and mice for hematology and serum chemistry analyses. All rats and mice received a complete necropsy examination that, for rats, included the eyes. Absolute and relative organ weights were recorded and calculated for brain, heart, liver, thymus, kidneys, and testes. All saved tissues were examined microscopically for all animals in the control and 75 ppm groups; in the 5 and 25 ppm groups, target tissues were examined for histopathology (liver, kidneys, bone marrow, lungs, and nasal tissues in both species, and also thymus, trachea, and larynx in mice). The study was conducted under Good Laboratory Practice standards.

Effects noted in study and corresponding doses: NOAELs were not identified in rats or mice. The lowest tested concentration, 5 ppm, was a LOAEL for respiratory lesions in both species.

Rats: Treatment caused no significant changes in survival, daily activities, or hematology, serum chemistry, or urinalysis results in rats. Statistically significant reductions in body weight in  $\geq 25$  ppm groups compared to controls were not biologically significant. Observed organ weight changes reflected changes in body weight and were not accompanied by histopathology. Histopathology of the respiratory tract was the major effect of exposure, showing concentration-related increases in severity. In all rats exposed at 25–75 ppm, slight-to-moderate degeneration (thinning) of the nasal olfactory epithelium was observed, secondarily producing inflammation and sloughing of necrotic cells. Hyperplasia of the nasal respiratory epithelium was observed in nearly all treated rats except for one male treated at 5 ppm: the severity of this lesion was very slight at  $\geq 5$  ppm, slight at 25 ppm, and moderate at 75 ppm (Table A-1). Slight peribronchiolar infiltration of eosinophils was observed in one male at 5 ppm and most rats at 25–75 ppm, but the study authors were uncertain as to the toxicological significance of this lesion. In male and female rats, 5 ppm was a LOAEL for hyperplasia of the nasal respiratory epithelium.

## APPENDIX A

**Table A-1. Incidence of Significant Lesions in Fischer 344 Rats and B6C3F1 Mice Exposed to 2,3-Dichloropropene (>99%) Vapor 6 Hours/Day, for 9/11 Days<sup>a</sup>**

	Control	5 ppm	25 ppm	75 ppm
<b>Rats</b>				
Hyperplasia of nasal respiratory epithelium				
Male	0/5	4/5*	5/5**	5/5***
Female	0/5	5/5*	5/5**	5/5***
<b>Mice</b>				
Hyperplasia of nasal respiratory epithelium				
Male	0/5	3/5*	5/5**	5/5***
Female	0/5	4/5*	5/5**	5/5***
Diffuse degeneration of bronchial/bronchiolar epithelium				
Male	0/5	5/5**	5/5***	5/5****
Female	0/5	5/5**	3/5***+ 2/5****	5/5****

<sup>a</sup>Severity: \*very slight; \*\*slight; \*\*\*moderate; \*\*\*\*severe

Source: Zempel et al. 1987

Mice: Treatment had no significant effect on survival in mice. Upon repeated exposure, reduced activity levels were observed in all groups in a concentration-related manner; beginning with the third exposure at 25 or 75 ppm, slow and labored respiration was observed during exposure on days 3 and 5. Food intake (as estimated by fecal output) appeared to be reduced in the 25 and 75 ppm groups during the first week. Body weights were significantly lower compared to controls by 12–25% in males and 16–26% in females exposed at 25 or 75 ppm. According to the study authors, hematology and serum chemistry changes indicated mild dehydration and stress-induced lymphopenia at  $\geq 25$  ppm rather than direct toxic effects of the compound (for example, increased ALT at 75 ppm was not accompanied by histology, but seemed to be a consequence of hemoconcentration). At gross necropsy, the size and weight of the thymus were reduced in male and female mice exposed at  $\geq 25$  ppm. Microscopic examination showed diffuse cortical atrophy of the thymus, which study authors considered secondary to stress, at 75 ppm. Histopathology of the respiratory tract was the most significant effect of exposure and showed concentration-related increases in severity (Table A-1). Slight-to-moderate degeneration of nasal olfactory epithelium was observed at  $\geq 25$  ppm and very slight-to-moderate hyperplasia of the nasal respiratory mucosa occurred at  $\geq 5$  ppm. Hyperplasia (very slight-to-slight) of the laryngeal epithelium was observed at  $\geq 25$  ppm. In the bronchial/bronchiolar tissue, a diffuse degenerative lesion of the ciliated respiratory epithelium was slight at 5 ppm (irregular cells size and apical nuclei in many cells), moderate at 25 ppm and severe at 75 ppm, showing flattened or cuboidal epithelium (rather than columnar) with sparse ciliation and apical rather than basal nuclei. In male and female mice, 5 ppm was a LOAEL for very slight hyperplasia of the nasal respiratory epithelium and slight diffuse degeneration of the bronchial/bronchiolar epithelium.

Dose and end point used for MRL derivation: Very slight hyperplasia of nasal respiratory epithelium in female rats exposed to 5 ppm 2,3-dichloropropene (>99% purity), 6 hours/day, for 9/11 days. The effect is considered minimal because the severity of the lesion was characterized by the study authors as very slight. Using EPA (1994) dosimetric adjustments (see below), a regional gas dose ratio (RGDR<sub>ET</sub>) of 0.1143 for extrathoracic effects was applied to the duration-adjusted LOAEL of 1.25 ppm, resulting in a human equivalent concentration (LOAEL<sub>HEC</sub>) of 0.1429 ppm, the point of departure for the MRL.

[ ] NOAEL [X] [LOAEL]<sub>HEC</sub>

## APPENDIX A

Uncertainty Factors used in MRL derivation: 90 applied to the LOAEL<sub>HEC</sub> of 0.1429 ppm

- [X] 3 for use of a minimal LOAEL
- [X] 3 for extrapolation from animals to humans using dosimetric adjustments
- [X] 10 for human variability

0.1429 ppm / 90 = 0.0016 ppm, rounded to 0.002 ppm

Was a conversion factor used from ppm in food or water to a mg/body weight dose? Not applicable.

If an inhalation study in animals, list conversion factors used in determining human equivalent dose:  
EPA (1994) methods for calculating dosimetric adjustments across species for inhalation exposures were applied to data for nasal lesions, defined as extrathoracic (ET) effects, in rats and mice, and for bronchial and bronchiolar lesions, defined as tracheobronchial (TB) effects, in mice. Values used in these calculations and the calculated regional gas dose ratios are given in Table A-2.

**Table A-2. Values Used for Calculating Human Equivalent Concentrations to LOAELs of 5 ppm for Fischer F344 Rats and B6C3F1 Mice Exposed 6 Hours/Day, 9/11 Days to 2,3-Dichloropropene<sup>a</sup>**

	Human	Rats		Mice	
		Male	Female	Male	Female
Intercept $b_0^b$		-0.578	-0.578	0.326	0.326
Slope $b_1^b$		0.821	0.821	1.050	1.050
Time-weighted-average body weight <sup>c</sup> (kg)		0.2326 kg	0.1502 kg	0.0254 kg	0.0211 kg
VE (minute volume) (mL/minute)	13,800 <sup>b</sup>	169.42	118.3106	29.2857	24.1033
SA <sub>ET</sub> (surface area of extra-thoracic region) <sup>b</sup>	200 cm <sup>2</sup>	15 cm <sup>2</sup>	15 cm <sup>2</sup>	3 cm <sup>2</sup>	3 cm <sup>2</sup>
<b>RGDR<sub>ET</sub></b>		0.1637	<b>0.1143</b>	0.1415	0.1164
<b>(LOAEL-adjusted)<sub>HEC-ET</sub> (ppm)</b>		0.2046	<b>0.1429</b>	0.1769	0.1455
SA <sub>TB</sub> (surface area of tracheo-bronchial region) <sup>b</sup>	3,200 cm <sup>2</sup>	Not applicable	Not applicable	3.5 cm <sup>2</sup>	3.5 cm <sup>2</sup>
<b>RGDR<sub>TB</sub></b>		Not applicable	Not applicable	1.7771	1.4305
<b>(LOAEL-adjusted)<sub>HEC-TB</sub> ppm</b>		Not applicable	Not applicable	2.2214	1.7881

<sup>a</sup>Zempel et al. (1987)

<sup>b</sup>EPA (1994)

<sup>c</sup>Calculated from data in Zempel et al. (1987)

Although 2,3-dichloropropene is a category 2 gas, the extrathoracic (ET) regional gas dose ratios (RGDRs) were calculated from rat and mouse data using the equation for a category 1 gas by default, since an equation is not available for category 2 gases (EPA 1994).

$$RGDR_{ET} = (RGD_{ET})_{rodent} / (RGD_{ET})_{human} = (VE/SA_{ET})_{rodent} / (VE/SA_{ET})_{human}$$

## APPENDIX A

The tracheobronchial (TB) regional gas dose ratios were calculated from mouse data using the equation for a category 1 gas by default.

$$\text{RGDR}_{\text{TB}} = (\text{RGD}_{\text{TB}})_{\text{mouse}} / (\text{RGD}_{\text{TB}})_{\text{human}} \\ = [(\text{VE}/\text{SA}_{\text{TB}})_{\text{mouse}} / (\text{VE}/\text{SA}_{\text{TB}})_{\text{human}}] [ (e^{-[\text{SAet}/\text{VE}]_{\text{mouse}}}) / (e^{-[\text{SAet}/\text{VE}]_{\text{human}}}) ]$$

Where:

VE = minute volume in mL/minute

SA = surface area in cm<sup>2</sup>

The minute volumes (VE) for male and female rats and mice were calculated using the equation  $\text{LN}(\text{VE}) = b_0 + b_1 [\text{LN}(\text{BW in kg})]$ .

Slopes and intercepts for rats and mice were taken from EPA (1994). The acute time-weighted-average body weights for male and female B6C3F1 mice, and male and female Fischer 344 rats, were calculated from data reported in the key study. Values for calculating minute volumes are in Table A-2.

The calculated regional gas dose ratios for extrathoracic effects in rats and mice and tracheobronchial effects in mice (Table A-2) were applied to the common duration-adjusted LOAEL of 1.25 ppm. The lowest human equivalent concentration was 0.1429 ppm for extrathoracic effects (hyperplasia of nasal respiratory epithelium) in female rats, which was selected as the point of departure for calculating the MRL since it would be protective against all effects.

Although a NOAEL was not available in this study, benchmark dose modeling was not performed to estimate an exposure level without appreciable risk because the data were not suitable. The group sizes were too small to model data sets for each sex separately, and the dose-response data for the combined sets provided no information as to the shape of the response curve below the tested exposure levels. Incidences for rats or mice with respiratory tract lesions increased from 0/10 in the control to 70–100% in the lowest exposure groups (Table A-1). For these reasons, the MRL was calculated using the NOAEL/LOAEL approach.

Was a conversion used from intermittent to continuous exposure? Yes. The LOAEL, 5 ppm, was adjusted for intermittent exposure (6 hours/24 hours), resulting in a duration-adjusted LOAEL of 1.25 ppm.

Other additional studies or pertinent information that lend support to this MRL: No data were available for the acute-duration inhalation toxicity of 2,3-dichloropropene in humans, and acute-duration inhalation data for animals, aside from the principal study, are limited to lethality studies (Dietz et al. 1985b; Monsanto 1967; Smyth et al. 1962; Union Carbide Corp. 1958). Exposure to an unquantified concentrated vapor of 2,3-dichloropropene resulted in effects on the eye (closure of eyelids, lacrimation), respiratory system (gasping, labored breathing, nasal discharge and, at necropsy, hemorrhagic lungs and inflammation of the nasal mucosa) and central nervous system (reduced activity, unconsciousness), and death within 30 minutes in rats (Monsanto 1967). An acute lethality inhalation study in rats reported no mortality at 250 ppm, 50% mortality at 500 ppm, and 100% mortality at 1,000 ppm after a 4-hour exposure (Smyth et al. 1962; Union Carbide Corp. 1958); this study provided no information about target organ specificity. In a 1-hour acute inhalation lethality study (for which even-numbered pages were missing), all rats exhibited irritant effects on the eye (lacrimation), respiratory tract (gasping, shallow respiration), gastrointestinal system (diarrhea), and central nervous system (lethargy) during exposure at concentrations of 693–1,963 ppm (Dietz et al. 1985b); postexposure lethargy and labored respiration were observed in rats exposed at 1,963 ppm. As described in Dietz et al. (1985b), results of a 6-hour range-finding inhalation study in rats included no overt toxicity at 75 ppm, crusted noses at 250 ppm, and

## APPENDIX A

bloody noses, diarrhea, lethargy, and death at 500 ppm; irritation of the eyes and nose were named as the primary treatment-related effects in the range-finding study.

The limited database indicates that irritant effects, especially on the respiratory system, are the critical effects of acute-duration inhalation exposure to 2,3-dichloropropene. The study by Zempel et al. (1987) was selected as the principal study since it was adequately designed and reported, and it documented respiratory effects at the lowest tested concentration in rats and mice, providing reliable LOAELs for these effects.

Agency Contacts (Chemical Managers): Annette Ashizawa, Sharon Wilbur, and Heraline Hicks

## APPENDIX A

**MINIMAL RISK LEVEL (MRL) WORKSHEET**

Chemical Name: 1,3-Dichloropropene  
CAS Numbers: 542-75-6  
Date: August 2006  
Profile Status: Final Draft Pre-public  
Route:  Inhalation  Oral  
Duration:  Acute  Intermediate  Chronic  
Graph Key: 20  
Species: Mouse

Minimal Risk Level: 0.008  mg/kg/day  ppm

Reference: Lomax L, Stott W, Johnson K, et al. 1989. The chronic toxicity and oncogenicity of inhaled technical grade 1,3-dichloropropene in rats and mice. *Fundam Appl Toxicol* 12:418-431.

Experimental design: Groups (10/sex/concentration) of B6C3F1 mice and F344 rats were exposed to vapors of 1,3-dichloropropene 6 hours/day, 5 days/week for 6 months at concentrations of 0, 5, 20, or 60 ppm (0, 22.7, 90.8, or 272 mg/m<sup>3</sup>). These were designed as interim satellite groups for a 2-year study. The test material was 92.1% pure (49.5% cis; 42.6% trans) and contained 2.0% epoxidized soybean oil (ESO) as a stabilizer, 0.7% 1,2-dichloropropane, and 5.2% mixtures of hexanes and hexadienes. Animals were observed after each exposure for clinical signs and moribund animals necropsied to minimize postmortem autolysis. Body weights were recorded before the study began, weekly for the first 13 weeks, and at monthly intervals thereafter. Urinalysis was conducted on rats during the week prior to termination; hematology and clinical chemistry parameters were analyzed in blood samples taken from rats and mice at the time of necropsy. All animals received examination by gross necropsy, at which time absolute and relative brain, heart, kidney, liver, and testicular weights were recorded. More than 40 tissues, in addition to gross lesions, were examined for histopathology in control and high-exposure animals at scheduled sacrifice and in all animals dying prematurely. About 17 tissues, in addition to gross lesions, were examined in low- and mid-exposure animals at scheduled termination.

Effects noted in study and corresponding doses: Exposure to 1,3-dichloropropene for 6 months had no adverse effect on survival, clinical signs, or hematological or clinical chemistry parameters in mice. Body weights of high-dose mice were depressed compared to controls, but the differences were not biologically significant at 6 months. Reductions in liver and kidney weights in males at 60 ppm were attributed by study authors to the reduced body weight and were not accompanied by histopathology. Statistically significant increased incidences of histopathological lesions were observed in mice treated at 60 ppm: hypertrophy/hyperplasia of the nasal respiratory epithelium in male and female mice and hyperplasia of the urinary bladder in female mice (Table A-3).

## APPENDIX A

**Table A-3. Incidence of Significant Lesions in B6C3F1 Mice Exposed to 1,3-Dichloropropene (92.1%) Vapor 6 Hours/Day, 5 Days/Week for 6 Months**

	Control	22.7 mg/m <sup>3</sup> (5 ppm)	90.8 mg/m <sup>3</sup> (20 ppm)	272 mg/m <sup>3</sup> (60 ppm)
Slight hypertrophy/hyperplasia of nasal respiratory epithelium				
Male	1/10	0/10	3/10	10/10 <sup>a</sup>
Female	0/10	0/10	0/10	7/10 <sup>a</sup>
Hyperplasia of urinary bladder				
Male	0/10	0/10	0/10	1/10
Female	0/10	0/10	0/10	4/10 <sup>a</sup>

<sup>a</sup>Different from control using Fisher Exact Test

Source: Lomax et al. 1989

Dose and end point used for MRL derivation: Hypertrophy/hyperplasia of nasal respiratory epithelium in male and female B6C3F1 mice exposed to 60 ppm (272 mg/m<sup>3</sup>) 1,3-dichloropropene (92.1% purity), 6 hours/day, 5 days/week for 6 months was selected as the critical effect. Using benchmark concentration analysis, a BMCL<sub>10</sub> value of 1.0678 mg/m<sup>3</sup> was calculated for male mice and 13.5227 mg/m<sup>3</sup> was calculated for female mice (see Tables A-4 and A-6). Using EPA (1994) dosimetric adjustments, the male BMCL<sub>10</sub> value was converted to a human equivalent concentration ([BMCL<sub>10</sub>]<sub>HEC</sub>) of 1.0678 mg/m<sup>3</sup> (0.2349 ppm), which was selected as the point of departure for the MRL since it was lower than the female value. Note that concentrations in mg/m<sup>3</sup> were converted to ppm by using a factor of 0.22 (see Table 4-2 in this profile).

NOAEL  LOAEL  
 [BMCL<sub>10</sub>]

Uncertainty Factors used in MRL derivation: 30 applied to the [BMCL<sub>0</sub>]<sub>HEC</sub> of 0.2349 ppm for nasal effects in male mice

10 for use of a LOAEL  
 3 for extrapolation from animals to humans using dosimetric adjustments  
 10 for human variability

Was a conversion factor used from ppm in food or water to a mg/body weight dose? Not applicable.

If an inhalation study in animals, list conversion factors used in determining human equivalent dose: Although 1,3-dichloropropene is a category 2 gas, the extrathoracic (ET) regional gas dose ratios (RGDRs) were calculated from rat and mouse data using the equation for a category 1 gas by default, since an equation is not available for category 2 gases. This is equation 4-18 in EPA (1994); in this section, all pages/equations/tables refer to EPA (1994).

$$RGDR_{ET} = (Dose_{ET})_{mouse} / (Dose_{ET})_{human} = (VE/SA_{ET})_{mouse} / (VE/SA_{ET})_{human}$$

The minute volumes (VE) for male and female mice were calculated using equation 4-4.  
 LN (VE) = b<sub>0</sub> + b<sub>1</sub> [LN (BW in kg)]

## APPENDIX A

Intercept  $b_0$  of 0.326 and slope  $b_1$  of 1.050 for mouse were taken from Table A-6.

The subchronic body weights of 0.0316 kg for male and 0.0246 kg for female B6C3F1 mice were taken from Table 4-5.

$VE_{\text{mouse}}$	= mouse minute volume (L/minute)	= 36.8353 mL/minute for male mice and 28.3168 mL/minute for females.
$(SA_{\text{ET}})_{\text{mouse}}$	= mouse surface area of extrathoracic region	= 3 cm <sup>3</sup> , from Table A-4
$VE_{\text{human}}$	= human minute volume (L/minute)	= 13,800 mL/minute, from page 4-33
$(SA_{\text{ET}})_{\text{human}}$	= human surface area of extrathoracic region	= 200 cm <sup>3</sup> , from Table A-4

Extrathoracic regional gas dose ratios were calculated as 0.1779 for male mice and 0.1368 for females exposed in an intermediate-duration study. These values were used to convert the respective male and female mouse BMCL values to human equivalent concentrations (see below).

Was a conversion used from intermittent to continuous exposure? Yes. The exposure concentrations (in mg/m<sup>3</sup> as reported by study authors) were adjusted by the purity of the compound (92.1%) and intermittent exposure (6 hours/24 hours x 5 days/7 days). Benchmark concentration analyses were conducted using these adjusted exposure levels.

Other additional studies or pertinent information that lend support to this MRL: In the only intermediate-duration inhalation study in humans, no evidence of renal or hepatic damage was detected in clinical chemistry analyses of blood and serum in pesticide applicators using cis-1,3-dichloropropene for an average of 521 (±230) minutes/day at a geometric mean concentration (8-hour TWA) of 2.7 mg/m<sup>3</sup> (range 0.1–9.5 mg/m<sup>3</sup>) (0.594 [0.22–2.09] ppm) over a 117-day period compared to unexposed controls (Verplanke et al. 2000). No other end points were examined in this study. Respiratory effects (mucous membrane irritation, chest pain, cough, and breathing difficulties) have been observed following accidental acute exposure to high concentrations (Flessel et al. 1978; Markovitz and Crosby 1984).

The available data from the inhalation exposure animal studies indicate that hypertrophy/hyperplasia of the nasal respiratory epithelium and hyperplasia of the urinary bladder in mice are the most sensitive effects associated with intermediate-duration exposed to 1,3-dichloropropene. Increased incidences of hypertrophy/hyperplasia of the nasal respiratory epithelium occurred in male and female B6C3F1 mice exposed to 60 ppm Telone II<sup>®</sup>b (92.1% 1,3-dichloropropene with 2% epoxidized soybean oil) vapor 6 hours/day, 5 days/week for 6 months (Lomax et al. 1989). Female mice in this study exposed at 60 ppm also had a marginally increased incidence of hyperplasia of the urinary bladder. Fischer 344 rats exposed in this study under the same protocol did not exhibit histopathology after 6 months exposure (Lomax et al. 1989). Slight reductions in body weights were observed in rats and mice exposed at 60 ppm, but the differences were not biologically significant (were <10% lower than controls) at 6 months (Lomax et al. 1989). Nasal lesions were also observed in rats exposed to ≥90 ppm Telone II<sup>®</sup>b 6 hours/day, 5–7 days/week for 3 months in a reproductive toxicity assay (Breslin et al. 1989). Nasal hyperplasia in rats and mice and urinary bladder hyperplasia in mice occurred in groups exposed to ≥90 ppm Telone II<sup>®</sup>a (90.9% 1,3-dichloropropene with 1.2% epichlorohydrin) 6 hours/day, 5 days/week for 13 weeks (Stott et al. 1988). One 13-week study by Coate (1979a) reported nasal lesions in rats exposed 6 hours/day, 5 days/week to Telone II<sup>®</sup>a at 30 ppm, but since the purity of the test material was not reported, the significance of the result is uncertain.

Although increased incidences of hypertrophy/hyperplasia of the nasal respiratory epithelium and hyperplasia of the urinary bladder were both sensitive effects in mice at a LOAEL of 60 ppm, urinary hyperplasia was only observed in females and at a marginal increase (p=0.043; Fisher Exact Test) over



## APPENDIX A

controls. Since the nasal lesions were observed in both sexes at a higher incidence, they were selected as the critical effect for development of the intermediate-duration MRL for 1,3-dichloropropene. The 6-month study with male and female mice exposed to Telone II<sup>®</sup>b by Lomax et al. (1989) was selected as the principal study because the study was adequately designed and reported, and because the test material contained a relatively high concentration of 1,3-dichloropropene without the confounding presence of epichlorohydrin or chloropicrin.

Potential points of departure for deriving the intermediate-duration MRL, derived with benchmark dose (concentration) analysis, are shown in Table A-4. Before the analysis, exposure concentrations in ppm were converted to mg/m<sup>3</sup> and adjusted for 92.1% purity and discontinuous exposure. Additional details of the benchmark dose (concentration) analysis are described below.

For increased incidence of hypertrophy/hyperplasia of nasal epithelium in male and female mice, the potential point of departure was the BMCL associated with 10% extra risk; this BMR is the default recommended in EPA (2000a).

**Table A-4. Potential Points of Departure for Determining the Intermediate-duration Inhalation MRL for 1,3-Dichloropropene**

End point	BMC <sup>a</sup> (mg/m <sup>3</sup> )	BMCL <sup>a</sup> (mg/m <sup>3</sup> )
Increased incidence of hypertrophy/hyperplasia of nasal respiratory epithelium in male and female mice exposed to Telone II <sup>®</sup> b vapor 6 hours/day, 5 days/week for 6 months BMR = 10% extra risk	M 12.6179	M 6.0022
	F 28.7185	F 13.5227

<sup>a</sup>Adjusted for <100% purity and discontinuous exposure; To convert to ppm, multiply by 0.22

BMC = benchmark concentration; BMCL = 95% lower confidence limit for the benchmark concentration; BMR = benchmark response level; F = female; M = male; MRL = Minimal Risk Level

Source: Lomax et al. 1989

The mouse BMCL<sub>10</sub> values were multiplied by the extrathoracic regional dose ratios (mouse/human) (calculated above) for male and female B6C3F1 mice. The male BMCL<sub>20</sub> of 6.0022 mg/m<sup>3</sup> for hypertrophy/hyperplasia of nasal respiratory epithelium multiplied by an RGDR of 0.1779 results in a human equivalent concentration of 1.0678 mg/m<sup>3</sup> (0.2349 ppm). The female BMCL<sub>10</sub> of 13.5227 mg/m<sup>3</sup> for the same lesion multiplied by an RGDR of 0.1368 results in a human equivalent concentration of 1.8499 mg/m<sup>3</sup> (0.407 ppm). The lower value based on male mice was selected as the point of departure for MRL derivation because it would be more protective of human health. A total uncertainty factor of 30 was applied to the male [BMCL<sub>10</sub>]<sub>HEC</sub> of 0.2349 ppm to calculate the intermediate-duration inhalation MRL for 1,3-dichloropropene.

### Details of Benchmark Dose Analysis for the Intermediate-duration Inhalation MRL

#### Male and Female Mice:

All available dichotomous models in the EPA Benchmark Dose Software (BMDS version 1.3.2) were fit to the incidence data for hypertrophy/hyperplasia of nasal respiratory epithelium in male and female B6C3F1 mice exposed to 1,3-dichloropropene via inhalation for 6 months (Table A-5). Predicted concentrations associated with 10, 5, and 1% extra risks were calculated.

## APPENDIX A

**Table A-5. Incidence of Hypertrophy/Hyperplasia of Nasal Respiratory Epithelium in Male and Female B6C3F1 Mice Exposed 6 months, Adjusted for Purity and Discontinuous Exposure**

Administered concentration		Adjusted for 92.1% purity (mg/m <sup>3</sup> )	Adjusted for discontinuous exposure and rounded (mg/m <sup>3</sup> )	Incidence	
ppm	mg/m <sup>3</sup>			Males	Females
0	0	0	0	1/10	0/10
5	22.7	20.9067	3.7	0/10	0/10
20	90.8	83.6268	14.9	3/10	0/10
60	272	250.512	44.7	10/10	7/10

Source: Lomax et al. 1989

### Hypertrophy/hyperplasia of nasal respiratory epithelium in male and female mice

As assessed by the chi-square goodness-of-fit test, several models in the software provided adequate fits to the data ( $\chi^2$  p-value  $\geq 0.1$ ) for the incidence of hypertrophy/hyperplasia of nasal respiratory epithelium in male (Table A-6) and female (Table A-7) B6C3F1 mice. Comparing across models, a better fit is indicated by a lower Akaike's Information Criteria value (AIC) (EPA 2000b). The gamma model was determined to be the best-fitting model for both males and females, as indicated by the AIC (Tables A-6 and A-7; Figures A-1 and A-2). Benchmark concentrations (BMCs and BMCLs) associated with an extra risk of 10, 5, and 1%, calculated from the best fitting model, are shown in Table A-8.

**Table A-6. Goodness of Fit Statistics and BMC<sub>10</sub>s and BMCL<sub>10</sub>s from Models Fit to Incidence Data for Hypertrophy/Hyperplasia of Nasal Respiratory Epithelium in Male B6C3F1 Mice Exposed to 1,3-Dichloropropene via Inhalation for 6 Months**

Model	AIC	$\chi^2$ p-value <sup>a</sup>	BMC <sub>10</sub> (mg/m <sup>3</sup> ) <sup>b</sup>	BMCL <sub>10</sub> (mg/m <sup>3</sup> ) <sup>b</sup>
<b>Gamma<sup>c</sup></b>	<b>24.1579</b>	<b>0.5908</b>	<b>12.6179</b>	<b>6.00215</b>
Logistic	25.1526	0.3291	8.41841	5.1448
Log-Logistic	26.1579	0.3049	13.939	7.23456
Multistage	25.3494	0.4014	7.62026	3.9162
Probit	25.2768	0.3167	7.64022	4.69897
Log-probit	26.1579	0.3049	13.2999	6.97026
Quantal-linear	31.8559	0.0529	2.70925	1.64437

## APPENDIX A

**Table A-6. Goodness of Fit Statistics and BMC<sub>10</sub>s and BMCL<sub>10</sub>s from Models Fit to Incidence Data for Hypertrophy/Hyperplasia of Nasal Respiratory Epithelium in Male B6C3F1 Mice Exposed to 1,3-Dichloropropene via Inhalation for 6 Months**

Model	AIC	X <sup>2</sup> p-value <sup>a</sup>	BMC <sub>10</sub> (mg/m <sup>3</sup> ) <sup>b</sup>	BMCL <sub>10</sub> (mg/m <sup>3</sup> ) <sup>b</sup>
Quantal-quadratic	25.3494	0.4014	7.62026	5.43757
Weibull	26.1579	0.3049	13.1405	5.44413

<sup>a</sup>Values <0.1 fail to meet conventional goodness-of-fit criteria.

<sup>b</sup>To convert to ppm, multiply by 0.22.

<sup>c</sup>Best-fitting model

AIC = Akaike's Information Criteria; BMC = benchmark concentration; BMCL = lower confidence limit (95%) on the benchmark concentration; p = p-value from the Chi-squared test

Source: Lomax et al. 1989

**Figure A-1. Observed and Predicted Incidences of Hypertrophy/Hyperplasia of Nasal Respiratory Epithelium in Male B6C3F1 Mice Exposed to 1,3-Dichloropropene via Inhalation for 6 Months\***

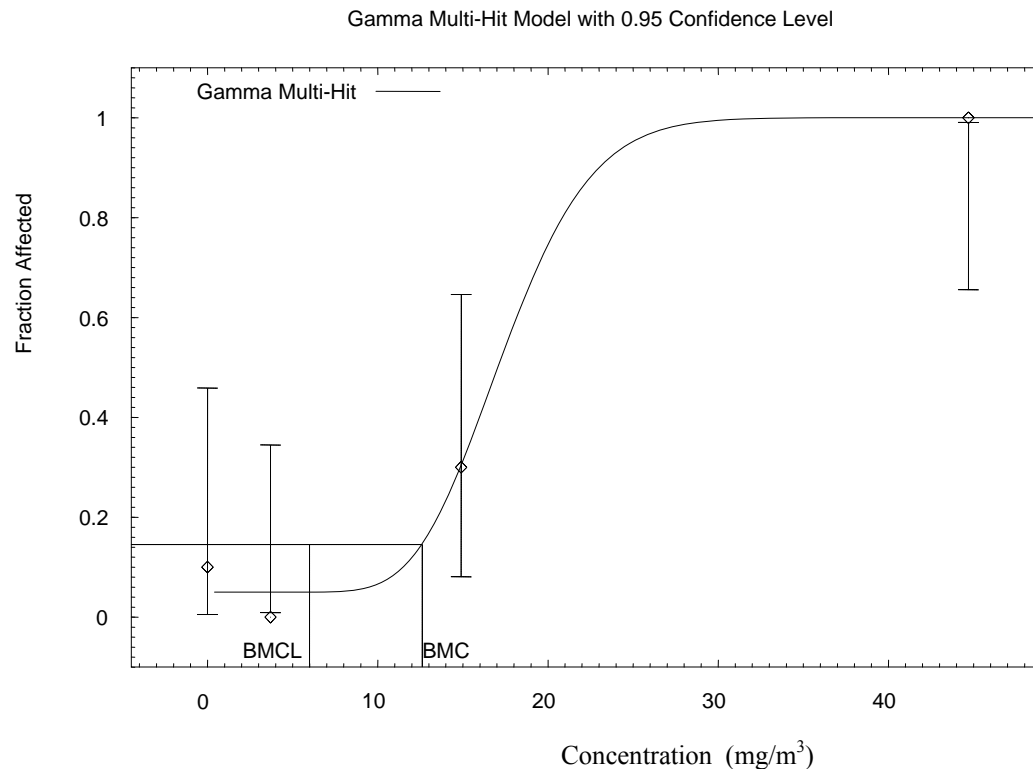

\*BMCs and BMCLs indicated are for a 10% extra risk and are in units of mg/m<sup>3</sup>.

BMC = benchmark concentration; BMCL = lower confidence limit (95%) on the benchmark concentration

Source: Lomax et al. 1989

## APPENDIX A

**The form and parameters of the gamma model for the male mouse data are as follows:**

$P[\text{response}] = \text{background} + (1 - \text{background}) * \text{CumGamma}[\text{slope} * \text{dose}, \text{power}]$ ,  
 where  $\text{CumGamma}(\cdot)$  is the cumulative Gamma distribution function

background = 0.0499995  
 slope = 1.01615  
 power = 18

**Table A-7. Goodness of Fit Statistics and BMC<sub>10</sub>s and BMCL<sub>10</sub>s from Models Fit to Incidence Data for Hypertrophy/Hyperplasia of Nasal Respiratory Epithelium in Female B6C3F1 Mice Exposed to 1,3-Dichloropropene via Inhalation for 6 Months**

Model	AIC	X <sup>2</sup> p-value <sup>a</sup>	BMC <sub>10</sub> (mg/m <sup>3</sup> ) <sup>b</sup>	BMCL <sub>10</sub> (mg/m <sup>3</sup> ) <sup>b</sup>
<b>Gamma<sup>c</sup></b>	<b>14.2213</b>	<b>1.0000</b>	<b>28.7185</b>	<b>13.5227</b>
Logistic	16.2173	1.0000	40.0892	17.7767
Log-Logistic	16.2173	1.0000	37.7164	13.5983
Multistage	16.779	0.6925	14.6277	8.36083
Probit	16.2173	1.0000	35.9801	16.19
Log-probit	16.2173	1.0000	32.4372	13.6137
Quantal-linear	21.6296	0.1851	6.90725	3.87399
Quantal-quadratic	16.779	0.6925	14.6277	10.8645
Weibull	16.2173	1.0000	38.8344	13.5533

<sup>a</sup>Values <0.1 fail to meet conventional goodness-of-fit criteria.

<sup>b</sup>To convert to ppm, multiply by 0.22.

<sup>c</sup>Best-fitting model

AIC = Akaike's Information Criteria; BMC = benchmark concentration; BMCL = lower confidence limit (95%) on the benchmark concentration; p = p-value from the Chi-squared test

Source: Lomax et al. 1989

## APPENDIX A

**Figure A-2. Observed and Predicted Incidences of Hypertrophy/Hyperplasia of Nasal Respiratory Epithelium in Female B6C3F1 Mice Exposed to 1,3-Dichloropropene via Inhalation for 6 Months\***

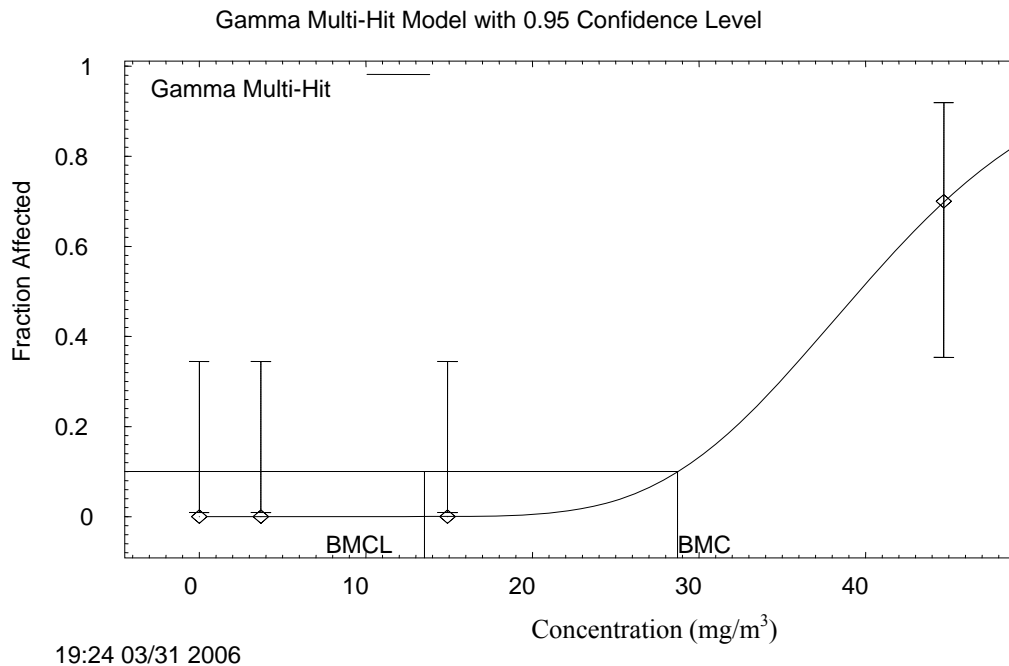

\*BMCs and BMCLs indicated are for a 10% extra risk and are in units of  $\text{mg}/\text{m}^3$ .

BMC = benchmark concentration; BMCL = lower confidence limit (95%) on the benchmark concentration

Source: Lomax et al. 1989

**The form and parameters of the gamma model for the female mouse data are as follows:**

$P[\text{response}] = \text{background} + (1 - \text{background}) * \text{CumGamma}[\text{slope} * \text{dose}, \text{power}]$ ,  
 where  $\text{CumGamma}(\cdot)$  is the cumulative Gamma distribution function

background = 0  
 slope = 0.446459  
 power = 18

## APPENDIX A

**Table A-8. Best-fitting Model Predictions for 1, 5, and 10% Extra Risk for Hypertrophy/Hyperplasia of Nasal Respiratory Epithelium in Male and Female B6C3F1 Mice Exposed to 1,3-Dichloropropene via Inhalation for 6 Months**

Best fitting model	BMR (percent extra risk)	BMC (mg/m <sup>3</sup> ) <sup>a</sup>	BMCL (mg/m <sup>3</sup> ) <sup>a</sup>
Male mice			
Gamma	1	9.46353	1.96448
	5	11.4494	4.23342
	10 <sup>b</sup>	12.6179	6.00215
Female mice			
Gamma	1	21.5391	5.06945
	5	26.059	9.93499
	10	28.7185	13.5227

<sup>a</sup>To convert to ppm, multiply by 0.22.

<sup>b</sup>Best-fitting model

BMC = benchmark concentration; BMCL = lower confidence limit (95%) on the benchmark concentration;

BMR = benchmark response

Source: Lomax et al. 1989

Agency Contacts (Chemical Managers): Annette Ashizawa, Sharon Wilbur, and Heraline Hicks

## APPENDIX A

**MINIMAL RISK LEVEL (MRL) WORKSHEET**

Chemical Name: 1,3-Dichloropropene  
CAS Numbers: 542-75-6  
Date: August 2006  
Profile Status: Final Draft Pre-public  
Route:  Inhalation  Oral  
Duration:  Acute  Intermediate  Chronic  
Graph Key: 44  
Species: Mouse

Minimal Risk Level: 0.007  mg/kg/day  ppm

Reference: Lomax L, Stott W, Johnson K, et al. 1989. The chronic toxicity and oncogenicity of inhaled technical grade 1,3-dichloropropene in rats and mice. *Fundam Appl Toxicol* 12:418-431.

Experimental design: Groups (50/sex/concentration) of B6C3F1 mice and F344 rats were exposed to vapors of 1,3-dichloropropene 6 hours/day, 5 days/week for 2 years at concentrations of 0, 5, 20, or 60 ppm (0, 22.7, 90.8, or 272 mg/m<sup>3</sup>). Additional satellite groups (10/sex/concentration) were established interim sacrifices at 6 and 12 months (results for the 6-month sacrifice are given under the description for the intermediate-duration inhalation MRL). The test material was Telone II<sup>®</sup>b, 92.1% pure 1,3-dichloropropene (49.5% cis; 42.6% trans) and contained 2.0% ESO as a stabilizer, 0.7% 1,2-dichloropropane, and 5.2% mixtures of hexanes and hexadienes. Animals were observed after each exposure for clinical signs, and moribund animals necropsied to minimize postmortem autolysis. Body weights were recorded before the study began, weekly for the first 13 weeks, and at monthly intervals thereafter. Urinalysis was conducted on rats during the week prior to termination; hematology and clinical chemistry parameters were analyzed in blood samples taken from rats and mice at the time of necropsy. All animals received examination by gross necropsy, at which time absolute and relative brain, heart, kidney, liver, and testicular weights were recorded. More than 40 tissues, in addition to gross lesions, were examined for histopathology in control and high-exposure animals at scheduled sacrifice and in all animals dying prematurely. About 17 tissues, in addition to gross lesions, were examined in low- and mid-exposure animals at scheduled termination.

Effects noted in study and corresponding doses: Exposure to Telone II<sup>®</sup>b vapor for 2 years had no significant adverse effect on survival, body weight, the incidence of clinical signs, hematology, or clinical chemistry parameters in mice. In the 1-year satellite group, incidences of hypertrophy/hyperplasia of the nasal respiratory epithelium were significantly higher than controls in males at  $\geq 20$  ppm and in females at 60 ppm; females at 60 ppm also had increased incidences of epithelial hyperplasia and inflammation of the urinary bladder. Significant lesions observed in mice after 2 years of exposure are given in Table A-9. Nasal and urinary bladder lesions were elevated in males at 60 ppm and in females at  $\geq 20$  ppm. Increases in inflammation of the urinary bladder were not observed in males and were relatively small in females. Degeneration of the nasal olfactory epithelium was not statistically elevated in either sex at concentrations lower than 60 ppm. Hypertrophy/hyperplasia of the nasal respiratory epithelium and epithelial hyperplasia of the urinary bladder in females at  $\geq 20$  ppm were the most sensitive effects in this study.

## APPENDIX A

**Table A-9. Incidence of Significant Lesions in B6C3F1 Mice Exposed to 1,3-Dichloropropene (92.1%) Vapor 6 Hours/Day, 5 Days/Week for 2 Years**

	Control	22.7 mg/m <sup>3</sup> (5 ppm)	90.8 mg/m <sup>3</sup> (20 ppm)	272 mg/m <sup>3</sup> (60 ppm)
Hypertrophy/hyperplasia of nasal respiratory epithelium (slight)				
Male	5/50	1/50	4/50	48/50 <sup>a</sup>
Female	4/50	4/50	28/50 <sup>a</sup>	49/50 <sup>a</sup>
Degeneration of nasal olfactory epithelium (slight)				
Male	1/50	0/50	1/50	48/50 <sup>a</sup>
Female	0/50	0/50	1/50	45/50 <sup>a</sup>
Hyperplasia of urinary bladder (slight-moderate)				
Male	4/48	7/48	11/48	37/47 <sup>a</sup>
Female	1/47	4/46	21/48 <sup>a</sup>	44/45 <sup>a</sup>
Inflammation of urinary bladder (slight-severe)				
Male	0/48	0/48	0/48	2/47
Female	0/47	1/46	6/48 <sup>a</sup>	8/45 <sup>a</sup>

<sup>a</sup>Statistically different from control

Source: Lomax et al. 1989

Dose and end point used for MRL derivation: Hypertrophy/hyperplasia of nasal respiratory epithelium in female B6C3F1 mice exposed at a LOAEL of 20 ppm (272 mg/m<sup>3</sup>) 1,3-dichloropropene (92.1% purity), 6 hours/day, 5 days/week for 2 years. Using benchmark concentration analysis, BMCL<sub>10</sub> value of 4.5673 mg/m<sup>3</sup> was calculated (see Tables A-10 and A-15), and a human equivalent concentration ([BMCL<sub>10</sub>]<sub>HEC</sub>) of 0.9130 mg/m<sup>3</sup> (0.2009 ppm) was calculated using EPA (1994) dosimetric adjustments. Note that concentrations in mg/m<sup>3</sup> were converted to ppm by using a factor of 0.22 (see Table 4-2 in this profile).

NOAEL  LOAEL  
 [BMCL<sub>10</sub>]

Uncertainty Factors used in MRL derivation: 30 applied to the [BMCL<sub>10</sub>]<sub>HEC</sub> of 0.2009 ppm for nasal effects in female B6C3F1 mice

10 for use of a LOAEL  
 3 for extrapolation from animals to humans  
 10 for human variability

0.2009 ppm / 30 = 0.0067, rounded to 0.007 ppm

Was a conversion factor used from ppm in food or water to a mg/body weight dose? Not applicable.



## APPENDIX A

If an inhalation study in animals, list conversion factors used in determining human equivalent dose: Although 1,3-dichloropropene is a category 2 gas, the extrathoracic (ET) regional gas dose ratios (RGDRs) were calculated from rat and mouse data using the equation for a category 1 gas by default, since an equation is not available for category 2 gases EPA (1994).

$$RGDR_{ET} = (\text{Dose}_{ET})_{\text{mouse}} / (\text{Dose}_{ET})_{\text{human}} = (\text{VE}/\text{SA}_{ET})_{\text{mouse}} / (\text{VE}/\text{SA}_{ET})_{\text{human}}$$

The minute volumes (VE) for female mice were calculated using the equation

$$\text{LN}(\text{VE}) = b_0 + b_1 [\text{LN}(\text{BW in kg})].$$

Intercept  $b_0$  of 0.326, slope  $b_1$  of 1.050 for mouse, and chronic body weight of 0.0353 kg for chronic female B6C3F1 mice were taken from (EPA, 1994).

$\text{VE}_{\text{mouse}}$	= mouse minute volume (L/minute)	= 41.3741 mL/minute for chronic female mice
$(\text{SA}_{ET})_{\text{mouse}}$	= mouse surface area of extrathoracic region	= 3 cm <sup>3</sup>
$\text{VE}_{\text{human}}$	= human minute volume (L/minute)	= 13,800 mL/minute
$(\text{SA}_{ET})_{\text{human}}$	= human surface area of extrathoracic region	= 200 cm <sup>3</sup>

An extrathoracic regional gas dose ratio of 0.1999 was calculated for female mice exposed in a chronic-duration study. These values were used to convert the female mouse BMCL value for nasal lesions to a human equivalent concentration (see below).

Since epithelial hyperplasia of the urinary bladder is an extrarepiratory effect, the conversion to a human equivalent concentration is calculated for a category 3 gas using the ratio of animal/human blood:gas partition coefficients. However, as no blood:gas partition coefficients for 1,3-dichloropropene were located in the published literature, the default ratio of 1 is applied. The human equivalent BMCL<sub>10</sub> values are unchanged from the mouse values.

Was a conversion used from intermittent to continuous exposure? Yes. The exposure concentrations (in mg/m<sup>3</sup> as reported by study authors) were adjusted for the purity of the compound (92.1%) and intermittent exposure (6 hours/24 hours x 5 days/7 days). Benchmark concentration analyses were conducted using these adjusted exposure levels.

Other additional studies or pertinent information that lend support to this MRL: No data are available for effects in humans following chronic-duration inhalation exposure to 1,3-dichloropropene. Fischer F344 rats and B6C3F1 mice were evaluated for chronic-duration inhalation exposure to Telone II<sup>®</sup>b (92.1% 1,3-dichloropropene stabilized with 2% epoxidized soybean oil) for 1 or 2 years (Lomax et al. 1989).

The available data from chronic-duration studies indicate that lesions of the nasal epithelium and urinary bladder in mice are the most sensitive effects associated with chronic-duration inhalation exposure to 1,3-dichloropropene. After 1 year, incidences of hypertrophy/hyperplasia of the nasal respiratory epithelium were increased in male mice exposed at  $\geq 20$  ppm and in female mice at 60 ppm. In addition, the incidences of hyperplasia and inflammation of the urinary bladder were increased in female mice exposed to 60 ppm for 1 year. After 2 years of exposure, increased incidences of hypertrophy/hyperplasia of the nasal respiratory epithelium occurred in female mice at  $\geq 20$  ppm and males exposed at 60 ppm, and increased degeneration of the nasal olfactory epithelium occurred in male and female mice exposed at 60 ppm. In rats, nasal lesions were only detected at 60 ppm after 2 years of exposure and at lower incidences than in exposed mice: decreased thickness of the olfactory epithelium in males and females, erosion of the olfactory epithelium in males, and submucosal fibrosis in males. The incidences of epithelial hyperplasia of the urinary bladder were increased in female mice exposed for 2 years at  $\geq 20$  ppm and male mice exposed at 60 ppm; the incidence of inflammation of the bladder epithelium was

## APPENDIX A

increased in female mice exposed for 2 years at  $\geq 20$  ppm, but not in males. No histopathology of the urinary bladder was observed in rats.

Based on these findings, hypertrophy/hyperplasia of the nasal respiratory epithelium and hyperplasia of the urinary bladder epithelium in mice exposed for 2 years were selected as co-critical effects for development of the chronic-duration inhalation MRL for 1,3-dichloropropene. The mouse study by Lomax et al. (1989) is accepted as the principal study because the test material in this adequately designed and reported study had a purity of 92.1% and did not contain epichlorohydrin or chloropicrin as a possibly confounding toxic additive.

Potential points of departure for deriving the chronic-duration inhalation MRL using benchmark concentration analysis are shown in Table A-10. Before the analysis, exposure concentrations in ppm were converted to  $\text{mg}/\text{m}^3$ , and adjusted for 92.1% purity and discontinuous exposure. Additional details of the benchmark concentration analysis are described below. None of the models in the EPA BMD software provided an adequate fit to the data for hypertrophy/hyperplasia of the nasal respiratory epithelium in male mice, so no BMCL could be calculated. For increased incidence of hypertrophy/hyperplasia of nasal respiratory epithelium in female mice or hypertrophy of urinary bladder epithelium in male and female mice, the potential points of departure were the 95% lower confidence limits on estimated concentrations ( $\text{BMCL}_{10\text{S}}$ ) associated with 10% extra risk compared to control values. This benchmark response (BMR) level is the default recommended by EPA (2000a).

**Table A-10. Potential Points of Departure for Determining the Chronic-duration Inhalation MRL for 1,3-Dichloropropene**

End point	$\text{BMC}_{10}^a$ ( $\text{mg}/\text{m}^3$ ) <sup>b</sup>	$\text{BMCL}_{10}^a$ ( $\text{mg}/\text{m}^3$ ) <sup>b</sup>
Hypertrophy/hyperplasia of nasal respiratory epithelium (slight) in B6C3F1 mice exposed to Telone II <sup>®</sup> b vapor for 2 years BMR = 10% extra risk	M <sup>c</sup> F 7.0833	M <sup>c</sup> F 4.5673
Hyperplasia of urinary bladder (slight-moderate) in B6C3F1 mice exposed to Telone II <sup>®</sup> b vapor for 2 years BMR = 10% extra risk	M 9.9024 F 6.9087	M 8.0838 F 5.9079

<sup>a</sup>Adjusted for <100% purity and discontinuous exposure

<sup>b</sup>To convert to ppm, multiply by 0.22.

<sup>c</sup>No models provided adequate fits to the data.

BMC = benchmark concentration; BMCL = 95% lower confidence limit for the benchmark concentration;  
BMR = benchmark response level

Source: Lomax et al. 1989

Mouse BMCL values were converted to human equivalent concentrations using EPA (1994) dosimetry methods. The  $\text{BMCL}_{10}$  of 4.5673  $\text{mg}/\text{m}^3$  for hypertrophy/hyperplasia of nasal respiratory epithelium in female mice was multiplied by the extrathoracic regional dose ratio (mouse/human) of 0.1999 (calculated above), resulting in a human equivalent concentration of 0.9130  $\text{mg}/\text{m}^3$  (0.2009 ppm). The default ratio of 1 was applied for calculating the human equivalent concentrations for the extrarrespiratory effects and urinary bladder lesions, resulting in values unchanged from those of male and female mice: respectively, 8.0838 and 5.9079  $\text{mg}/\text{m}^3$  (1.7784 and 1.2997 ppm).

## APPENDIX A

The [BMCL<sub>10</sub>]<sub>HEC</sub> value of 0.2009 ppm for hypertrophy/hyperplasia of nasal respiratory epithelium in female mice was selected as the more sensitive point of departure for the chronic-duration inhalation MRL for 1,3-dichloropropene.

### Details of Benchmark Dose Analysis for the Chronic-duration Inhalation MRL

#### Male and Female Mice:

All available dichotomous models in the EPA Benchmark Dose Software (BMDS version 1.3.2) were fit to the incidence data for hypertrophy/hyperplasia of nasal respiratory and urinary bladder epithelium in male and female B6C3F1 mice exposed to 1,3-dichloropropene via inhalation for 2 years (Table A-11). Predicted concentrations associated with 10, 5, and 1% extra risks were calculated.

**Table A-11. Incidence of Hypertrophy/Hyperplasia of Nasal Respiratory Epithelium and Urinary Bladder Epithelium in Male and Female B6C3F1 Mice Adjusted for Purity and Discontinuous Exposure**

	Administered concentration (mg/m <sup>3</sup> ) <sup>a</sup>	Concentration adjusted for 92.1% purity and for discontinuous exposure (mg/m <sup>3</sup> ) <sup>a</sup>	Incidence	
			Males	Females
Nasal respiratory epithelium	0	0	5/50	4/50
	22.7	3.7	1/50	4/50
	90.8	14.9	4/50	28/50
	272	44.7	48/50	49/50
Urinary bladder epithelium	0	0	4/48	1/47
	22.7	3.7	7/48	4/46
	90.8	14.9	11/48	21/48
	272	44.7	37/47	44/45

<sup>a</sup>To convert to ppm, multiply by 0.22.

Source: Lomax et al. 1989

#### Hypertrophy/hyperplasia of nasal respiratory epithelium in male and female mice

As assessed by the chi-square goodness-of-fit test, no models in the software provided adequate fits to the data for the incidence of hypertrophy/hyperplasia of nasal respiratory epithelium in male B6C3F1 mice since all of the chi-square p-values were lower than 0.1 (data not shown). Several models in the software provided adequate fits to the data for the incidence of for hypertrophy/hyperplasia of nasal respiratory epithelium in female B6C3F1 mice ( $\chi^2$  p-value  $\geq 0.1$ ) (Table A-12). Comparing across models, a better fit is indicated by a lower AIC (EPA 2000b). The log-probit model was determined to be the best-fitting model for the female data, as indicated by the AIC (Table A-12). Benchmark concentrations (BMCs and BMCLs) associated with an extra risk of 10, 5, and 1%, calculated from the best fitting model, are shown in Table A-15.

## APPENDIX A

**Table A-12. Goodness of Fit Statistics and BMC<sub>10</sub>s and BMCL<sub>10</sub>s from Models Fit to Incidence Data for Hypertrophy/Hyperplasia of Nasal Respiratory Epithelium in Female B6C3F1 Mice Exposed to 1,3-Dichloropropene via Inhalation for 2 Years**

Model	AIC	X <sup>2</sup> p-value <sup>a</sup>	BMC <sub>10</sub> (mg/m <sup>3</sup> ) <sup>b</sup>	BMCL <sub>10</sub> (mg/m <sup>3</sup> ) <sup>b</sup>
Gamma	140.696	0.4605	5.88054	3.64206
Logistic	141.091	0.1720	5.39501	4.3506
Log-Logistic	140.177	0.8712	7.6296	4.86553
Multistage	142.702	0.1047	4.9972	2.62038
Probit	142.872	0.0716	5.19777	4.23194
<b>Log-probit<sup>c</sup></b>	<b>140.166</b>	<b>0.9004</b>	<b>7.08327</b>	<b>4.56728</b>
Quantal-linear	150.075	0.0082	1.90984	1.53078
Quantal-quadratic	141.085	0.1307	6.30223	5.39173
Weibull	141.736	0.2167	4.94384	3.13411

<sup>a</sup>Values <0.1 fail to meet conventional goodness-of-fit criteria.

<sup>b</sup>To convert to ppm, multiply by 0.22.

<sup>c</sup>Best-fitting model

AIC = Akaike's Information Criteria; BMC = benchmark concentration; BMCL = lower confidence limit (95%) on the benchmark concentration; p = p-value from the Chi-squared test

Source: Lomax et al. 1989

**Figure A-3. Observed and Predicted Incidences of Hypertrophy/Hyperplasia of Nasal Respiratory Epithelium in Female B6C3F1 Mice Exposed to 1,3-Dichloropropene via Inhalation for 2 Years\***

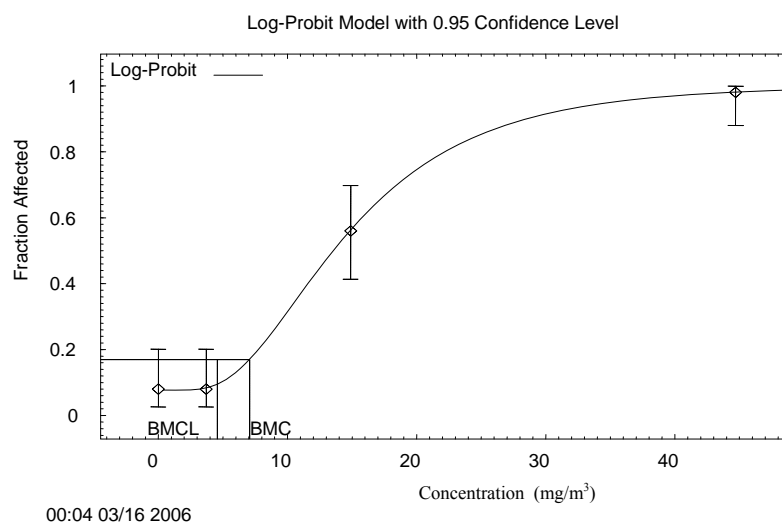

\*BMCs and BMCLs indicated are for a 10% extra risk and are in units of mg/m<sup>3</sup>.

BMC = benchmark concentration; BMCL = lower confidence limit (95%) on the benchmark concentration

Source: Lomax et al. 1989

## APPENDIX A

**The form and parameters of the log-probit model for the female mouse nasal lesion data are as follows:**

$$P[\text{response}] = \text{Background} + (1 - \text{Background}) * \text{CumNorm}(\text{Intercept} + \text{Slope} * \text{Log}(\text{Dose})),$$

where CumNorm(.) is the cumulative normal distribution function

background	=	0.0769028
intercept	=	-4.80042
slope	=	1.79742

### **Slight/moderate hyperplasia of urinary bladder epithelium in male and female mice**

As assessed by the chi-square goodness-of-fit test, several models in the software provided adequate fits to the data ( $\chi^2$  p-value  $\geq 0.1$ ) for the incidence of for slight/moderate hyperplasia of urinary bladder epithelium in male (Table A-13; Figure A-4) and female (Table A-14; Figure A-5) B6C3F1 mice. Comparing across models, a better fit is indicated by a lower AIC (EPA 2000b). The logistic model was determined to be the best fitting model for the male data (Table A-13), whereas the quantal quadratic model was determined to be the best-fitting model for the female data (Table A-14), as indicated by the AIC. Benchmark concentrations (BMCs and BMCLs) associated with an extra risk of 10, 5, and 1%, calculated from the best fitting models for both sexes, are shown in Table A-15.

**Table A-13. Goodness of Fit Statistics and BMC<sub>10</sub>s and BMCL<sub>10</sub>s from Models Fit to Incidence Data for Slight/Moderate Hyperplasia of Urinary Bladder Epithelium in Male B6C3F1 Mice Exposed to 1,3-Dichloropropene via Inhalation for 2 Years**

Model	AIC	$\chi^2$ p-value <sup>a</sup>	BMC <sub>10</sub> (mg/m <sup>3</sup> ) <sup>b</sup>	BMCL <sub>10</sub> (mg/m <sup>3</sup> ) <sup>b</sup>
Gamma	174.596	0.3561	12.9064	5.9353
<b>Logistic<sup>c</sup></b>	<b>172.196</b>	<b>0.7929</b>	<b>9.90241</b>	<b>8.08381</b>
Log-Logistic	174.593	0.3576	13.1008	7.37023
Multistage	174.403	0.4119	10.9233	4.95677
Probit	172.305	0.7515	9.13794	7.58289
Log-probit	174.671	0.3380	13.5586	8.28718
Quantal-linear	177.633	0.0631	4.15472	3.1987
Quantal-quadratic	172.465	0.6951	12.1536	10.4772
Weibull	174.465	0.3939	12.1787	5.68456

<sup>a</sup>Values <0.1 fail to meet conventional goodness-of-fit criteria.

<sup>b</sup>To convert to ppm, multiply by 0.22.

<sup>c</sup>Best-fitting model

AIC = Akaike's Information Criteria; BMC = benchmark concentration; BMCL = lower confidence limit (95%) on the benchmark concentration; p = p-value from the Chi-squared test

Source: Lomax et al. 1989

## APPENDIX A

**Figure A-4. Observed and Predicted Incidences of Slight/Moderate Hyperplasia of Urinary Bladder Epithelium in Male B6C3F1 Mice Exposed to 1,3-Dichloropropene via Inhalation for 2 Years\***

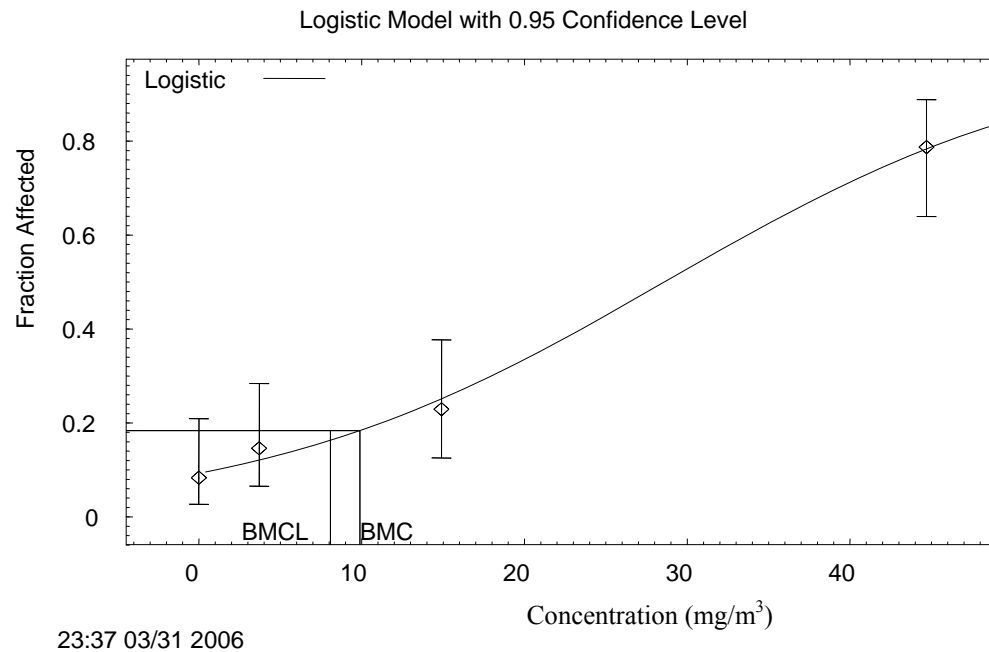

\*BMCs and BMCLs indicated are for a 10% extra risk and are in units of mg/m<sup>3</sup>.

BMC = benchmark concentration; BMCL = lower confidence limit (95%) on the benchmark concentration

Source: Lomax et al. 1989

**The form and parameters of the logistic model for the male mouse data are as follows:**

$$P[\text{response}] = 1/[1+\text{EXP}(-\text{intercept}-\text{slope}*\text{dose})]$$

background	=	0 (Specified)
intercept	=	-2.19615
slope	=	0.0769886

## APPENDIX A

**Table A-14. Goodness of Fit Statistics and BMC<sub>10</sub>s and BMCL<sub>10</sub>s from Models Fit to Incidence Data for Slight/Moderate Hyperplasia of Urinary Bladder Epithelium in Female B6C3F1 Mice Exposed to 1,3-Dichloropropene via Inhalation for 2 Years**

Model	AIC	X <sup>2</sup> p-value <sup>a</sup>	BMC <sub>10</sub> (mg/m <sup>3</sup> ) <sup>b</sup>	BMCL <sub>10</sub> (mg/m <sup>3</sup> ) <sup>b</sup>
Gamma	119.054	0.3665	5.94769	3.5405
Logistic	118.133	0.3632	6.93667	5.55287
Log-Logistic	120.1	0.1816	8.84738	5.10377
Multistage	118.241	0.9777	4.99209	2.90579
Probit	118.606	0.2979	6.62106	5.3209
Log-probit	120.27	0.1657	8.76593	4.86738
Quantal-linear	126.03	0.0206	2.16273	1.72952
<b>Quantal-quadratic<sup>c</sup></b>	<b>117.42</b>	<b>0.5326</b>	<b>6.90872</b>	<b>5.90793</b>
Weibull	118.378	0.7085	5.4465	3.42639

<sup>a</sup>Values <0.1 fail to meet conventional goodness-of-fit criteria.

<sup>b</sup>To convert to ppm, multiply by 0.22.

<sup>c</sup>Best-fitting model

AIC = Akaike's Information Criteria; BMC = benchmark concentration; BMCL = lower confidence limit (95%) on the benchmark concentration; p = p-value from the Chi-squared test

Source: Lomax et al. 1989

**Figure A-5. Observed and Predicted Incidences of Slight/Moderate Hyperplasia of Urinary Bladder Epithelium in Female B6C3F1 Mice Exposed to 1,3-Dichloropropene via Inhalation for 2 Years\***

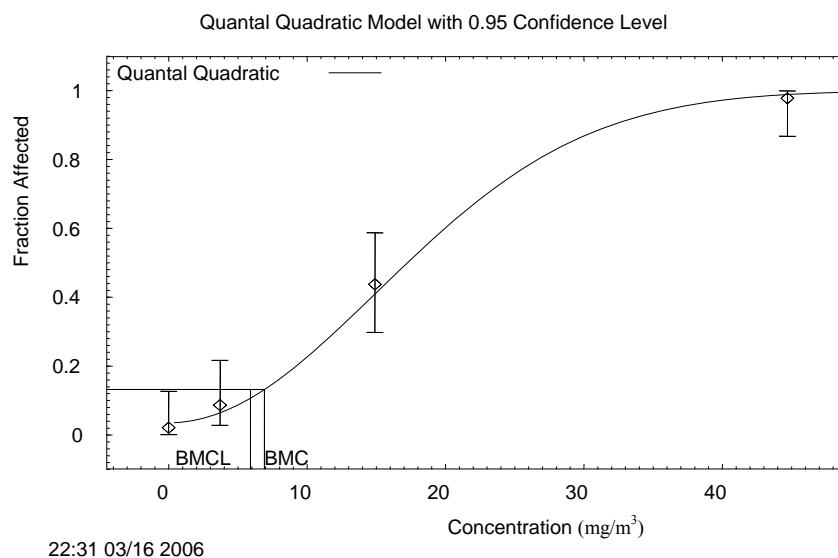

\*BMCs and BMCLs indicated are for a 10% extra risk and are in units of mg/m<sup>3</sup>.

BMC = benchmark concentration; BMCL = lower confidence limit (95%) on the benchmark concentration

Source: Lomax et al. 1989

## APPENDIX A

**The form and parameters of the quantal-quadratic model for the female mouse data are as follows:**

$$P[\text{response}] = \text{background} + (1 - \text{background}) * [1 - \text{EXP}(-\text{slope} * \text{dose}^2)]$$

background = 0.03125  
 slope = 0.00169733  
 power = 2 (Specified)

**Table A-15. Best-fitting Model Predictions for 1, 5, and 10% Extra Risk for Hypertrophy/Hyperplasia of Nasal Respiratory in Female and Urinary Bladder Epithelium in Male and Female B6C3F1 Mice Exposed to 1,3-Dichloropropene via Inhalation for 2 Years**

Best fitting model	BMR (percent extra risk)	BMC (mg/m <sup>3</sup> ) <sup>a</sup>	BMCL (mg/m <sup>3</sup> ) <sup>a</sup>
Male mice <sup>b</sup>			
Urinary bladder epithelium: quantal quadratic	1	1.30075	0.988608
	5	5.65321	4.47585
	10	9.90241	8.08381
Female mice			
Nasal respiratory epithelium: Log-Probit	1	3.96085	2.0326
	5	5.78698	3.45244
	10 <sup>c</sup>	7.08327	4.56728
Urinary bladder epithelium: quantal quadratic	1	2.13378	1.82468
	5	4.82046	4.12218
	10	6.90872	5.90793

BMC = benchmark concentration; BMCL = lower confidence limit (95%) on the benchmark concentration;  
 BMR = benchmark response

<sup>a</sup>To convert to ppm, multiply by 0.22.

<sup>b</sup>No models provided adequate fits for the incidence data for nasal lesions in male mice.

<sup>c</sup>Best-fitting model

Source: Lomax et al. 1989

Agency Contacts (Chemical Managers): Annette Ashizawa, Sharon Wilbur, and Heraline Hicks



## APPENDIX A

**MINIMAL RISK LEVEL (MRL) WORKSHEET**

Chemical Name: 1,3-Dichloropropene  
CAS Numbers: 542-75-6  
Date: August 2006  
Profile Status: Final Draft Pre-public  
Route:  Inhalation  Oral  
Duration:  Acute  Intermediate  Chronic  
Graph Key: 10  
Species: Rat

Minimal Risk Level: 0.04  mg/kg/day  ppm

Reference: Haut KT, Stebbins KE, Johnson KA, et al. 1996. Subchronic toxicity of ingested 1,3-dichloropropene in rats and mice. *Fundam Appl Toxicol* 32:224-232.

Experimental design: Haut et al. (1996) exposed groups of male and female Fischer 344 rats (10/sex/group) to 1,3-dichloropropene at doses of 0, 5, 15, 50, or 100 mg/kg/day for 13 weeks. The test material, Telone II<sup>®</sup>b, was 95.8% pure 1,3-dichloropropene (50.7% cis; 45.1% trans) stabilized with epoxidized soybean oil, and was microencapsulated in a starch/sucrose (80:20) microsphere matrix before addition to the diets; separate tests showed that the microencapsulated compound was stable in feed for at least three weeks, but test diets were mixed fresh weekly. Control diets received empty microspheres in an amount equivalent to the high-dose treated group. Animals were examined daily for clinical signs of toxicity and received a weekly clinical examination. Body weights and feed intake were recorded prior to testing and weekly during the study. For rats, urinalysis was conducted during the week before the scheduled necropsy and at necropsy, blood samples were collected for hematology and clinical chemistry evaluations. At necropsy, absolute and relative organ weights were recorded for brain, liver, kidneys, heart, and adrenals. Samples of 65 tissues from all rats were preserved and those of the control and high-dose groups were examined for histopathology; gross lesions and tissues from five organs (lung, liver, kidney, stomach, female mesenteric tissues) from low- and mid-dose animals were scheduled for histopathological examination.

Effects noted in study and corresponding doses: Treatment with 1,3-dichloropropene had no adverse effect on survival in rats. Body weights were significantly reduced by 16% in male rats treated at 50 mg/kg/day and by 11% in female rats treated at 100 mg/kg/day; statistically significant reductions in body weights at lower doses were not biologically significant. The study authors indicated that significantly reduced feed intake at the high doses likely contributed to the reduced body weights, as well as the slightly reduced absolute organ weights and increased relative organ weights. The authors attributed minor changes in clinical chemistry parameters in rats (e.g., reduction in triglycerides) to the poorer nutritional status of high-dose rats.

A NOAEL of 5 mg/kg/day and a LOAEL of 15 mg/kg/day were identified for minimal basal cell hyperplasia of the nonglandular stomach in male rats treated at 15 mg/kg/day and female rats at 50 mg/kg/day (Table A-16). Female rats at 100 mg/kg/day also exhibited hyperkeratosis of the nonglandular stomach. These lesions represent portal-of-entry effects from ingested 1,3-dichloropropene.

## APPENDIX A

**Table A-16. Incidence of Histopathological Lesions of Basal Cells in the Nonglandular Stomach in F344 Rats Exposed to 1,3-Dichloropropene (Telone II®) in the Diet for 13 Weeks**

	Dose (doses in mg/kg/day; group size = 10)				
	0	5	15	50	100
Hyperplasia					
Males	0	0	4 <sup>a</sup>	10 <sup>a</sup>	10 <sup>a</sup>
Females	0	0	3	10 <sup>a</sup>	10 <sup>a</sup>
Hyperkeratosis					
Males	0	0	1	3	3
Females	0	0	0	3	5 <sup>a</sup>

<sup>a</sup>Statistically different from control, Fisher Exact Test performed by Syracuse Research Corporation.

Source: Haut et al. 1996

Dose and end point used for MRL derivation: Minimal hyperplasia of the nonglandular stomach mucosa in male Fischer 344 rats treated at 15 mg/kg/day for 13 weeks. The calculated BMDL<sub>10</sub> value of 3.5722 mg/kg/day (see Table A-17) was used as the point of departure for the MRL

NOAEL  LOAEL  BMDL<sub>10</sub>

Uncertainty Factors used in MRL derivation: 100 applied to the BMDL<sub>10</sub> of 3.5722 mg/kg/day for increased incidence of forestomach basal cell hyperplasia in male rats

- 10 for use of a LOAEL
- 10 for extrapolation from animals to humans
- 10 for human variability

3.5722 mg/kg/day / 100 = 0.0357, rounded to 0.04 mg/kg/day

Was a conversion factor used from ppm in food or water to a mg/body weight dose? No. Study authors reported doses as calculated from feed intake.

If an inhalation study in animals, list conversion factors used in determining human equivalent dose:  
Not applicable.

Was a conversion used from intermittent to continuous exposure? Not applicable. Intake was *ad libitum*.

Other additional studies or pertinent information that lend support to this MRL: No data are available for effects in humans following intermediate-duration oral exposure to 1,3-dichloropropene. Intermediate-duration oral exposure studies with rats, mice, and dogs exposed to different commercial formulations of 1,3-dichloropropene isomers have been conducted by oral gavage or dietary exposure.

The available data from the oral exposure animal studies indicate that lesions in the nonglandular stomach mucosa in rats and microcytic anemia in dogs are the most sensitive effects associated with intermediate-duration oral exposure to 1,3-dichloropropene (see Chapter 3 for more detailed discussion of health effects associated with 1,3-dichloropropene). Increased incidences of basal cell hyperplasia of the

## APPENDIX A

nonglandular stomach occurred in male Fischer 344 rats exposed to doses  $\geq 15$  mg/kg/day Telone II<sup>®</sup>b microencapsulated in feed for 13 weeks; female rats displayed hyperkeratosis of the nonglandular stomach epithelium at doses of 100 mg/kg/day in this study (Haut et al. 1996). B6C3F1 mice exposed to Telone II<sup>®</sup>b via the same protocol for 13 weeks did not display any adverse effects on histologic or hematologic end points (Haut et al. 1996). Microcytic anemia (decreased hematocrit, hemoglobin concentration, and corpuscular volume) occurred in beagle dogs exposed to doses  $\geq 15$  mg/kg/day Telone II<sup>®</sup>b encapsulated in feed for 13 weeks (Stebbins et al. 1999). Reductions in terminal body weight were observed in rats, mice, and dogs exposed to Telone II<sup>®</sup>b in feed for 13 weeks, but reduced food intake associated with decreased palatability may have contributed to these effects (Haut et al. 1996; Stebbins et al. 1999). In an earlier 13-week study with Telone<sup>®</sup>, a commercial formulation of lesser 1,3-dichloropropene purity than Telone II<sup>®</sup>b, increased liver or kidney weights were observed in rats at doses as low as 10 and 30 mg/kg/day, respectively, but the lack of renal or kidney adverse noncancer effects in the intermediate- or chronic-duration studies with Telone II<sup>®</sup>b suggests that these organs are not consistently observed noncancer toxicity targets of 1,3-dichloropropene.

Basal cell hyperplasia in the nonglandular stomach of male rats and decreased hemoglobin concentration and corpuscular volume in male or female dogs were sensitive effects occurring at the same exposure levels. However, the intermediate-duration study in dogs by Stebbins et al. (1999) was judged to be inadequate as a critical study because no histopathology examination was conducted and the group sizes were small. Therefore, basal cell hyperplasia in the nonglandular stomach of male rats was selected as the critical effect for development of the intermediate-duration MRL for 1,3-dichloropropene. The 13-week study with male rats (Haut et al. 1996) exposed to microencapsulated Telone II<sup>®</sup>b was selected as the principal study, because the test material in these adequately designed and reported studies was the most purified 1,3-dichloropropene formulation tested and did not contain potentially confounding toxic materials such as epichlorohydrin or chloropicrin.

Potential points of departure for deriving the intermediate-duration MRL, derived with benchmark dose analysis, are shown in Table A-17. Details of the benchmark dose analyses are given below.

**Table A-17. Potential Points of Departure for Determining the Intermediate-duration Oral MRL for 1,3-Dichloropropene**

End point	BMD (mg/kg/day)	BMDL (mg/kg/day)
Increased incidence of basal cell hyperplasia of nonglandular stomach mucosa in male rats exposed to Telone II <sup>®</sup> b in feed for 13 weeks (Haut et al. 1996) BMR = 10% extra risk	9.0030	3.5722

BMD = benchmark dose; BMDL = 95% lower confidence limit for the benchmark dose; BMR = benchmark response level; MRL = Minimal Risk Level

For increased incidence of basal hyperplasia in nonglandular stomach mucosa of rats, the potential point of departure was the BMDL associated with 10% extra risk; this BMR was the default recommended in EPA (2000a).

An intermediate-duration oral MRL of 0.04 mg/kg/day was derived by dividing the rat BMDL<sub>10</sub> of 3.5722 mg/kg/day for basal cell hyperplasia by a composite uncertainty factor of 100 (10 for extrapolation from animals to humans and 10 for human variability).

## APPENDIX A

**Details of Benchmark Dose Analysis for the Intermediate-duration Oral MRL****Male Rats:**

All available dichotomous models in the EPA Benchmark Dose Software (BMDS version 1.3.2) were fit to the incidence data for basal cell hyperplasia of nonglandular stomach mucosa in male rats exposed to 1,3-dichloropropene in the diet for 13 weeks (Table A-18). Predicted doses associated with 10, 5, and 1% extra risks were calculated (Table A-20).

**Table A-18. Incidence of Basal Cell Hyperplasia of Nonglandular Stomach Mucosa (minimal) in Fisher 344 Rats Exposed to 1,3-Dichloropropene in the Diet for 13 Weeks**

	Doses in mg/kg body weight/day				
	Control	5	15	50	100
Males	0/10	0/10	4/10 <sup>a</sup>	10/10 <sup>a</sup>	10/10 <sup>a</sup>

<sup>a</sup>Statistically different from control (Fisher Exact Test performed by SRC March 2006)

Source: Haut et al. 1996

**Male Rats:**

As assessed by the chi-square goodness-of-fit test, several models in the software provided adequate fits to the data for the incidence of basal cell hyperplasia of nonglandular stomach mucosa in male rats ( $\chi^2$  p-value  $\geq 0.1$ ) (Table A-19). Comparing across models, a better fit is indicated by a lower AIC (EPA 2000b). A 3-degree polynomial multi-stage model was determined to be the best-fitting model, as indicated by the AIC (Table A-19; Figure A-6). Benchmark doses (BMDs and BMDLs) associated with an extra risk of 10, 5, and 1%, calculated from the best fitting model, are shown in Table A-20.

## APPENDIX A

**Table A-19. Goodness of Fit Statistics and BMD<sub>10</sub>s and BMDL<sub>10</sub>s from Models Fit to Incidence Data for Basal Cell Hyperplasia of Nonglandular Stomach Mucosa in Male Rats Exposed to 1,3-Dichloropropene in the Diet for 13 Weeks**

Model	AIC	X <sup>2</sup> p-value <sup>a</sup>	BMD <sub>10</sub> (mg/kg/day)	BMDL <sub>10</sub> (mg/kg/day)
Gamma	15.4607	1.0000	11.5681	5.1935
Logistic	17.4602	1.0000	14.0398	6.8305
Log-Logistic	17.4602	1.0000	13.5206	6.25073
<b>Multistage<sup>b</sup></b>	<b>15.8298</b>	<b>0.9957</b>	<b>9.00298</b>	<b>3.57217</b>
Probit	17.4602	1.0000	13.1012	6.25656
Log-probit	17.4602	1.0000	12.213	5.92308
Quantal-linear	22.7351	0.3922	2.40324	1.53389
Quantal-quadratic	16.6383	0.9616	7.05272	5.01843
Weibull	17.4612	1.0000	12.4316	4.82232

<sup>a</sup>Values <0.1 fail to meet conventional goodness-of-fit criteria.

<sup>b</sup>Best-fitting model

AIC = Akaike's Information Criteria; BMD = benchmark dose; BMDL = lower confidence limit (95%) on the benchmark dose; NA = not applicable; p = p-value from the Chi-squared test

Source: Haut et al. 1996

## APPENDIX A

**Figure A-6. Observed and Predicted Incidences of Basal Cell Hyperplasia of Nonglandular Stomach Mucosa in Male Rats Exposed to 1,3-Dichloropropene in the Diet for 13 Weeks\***

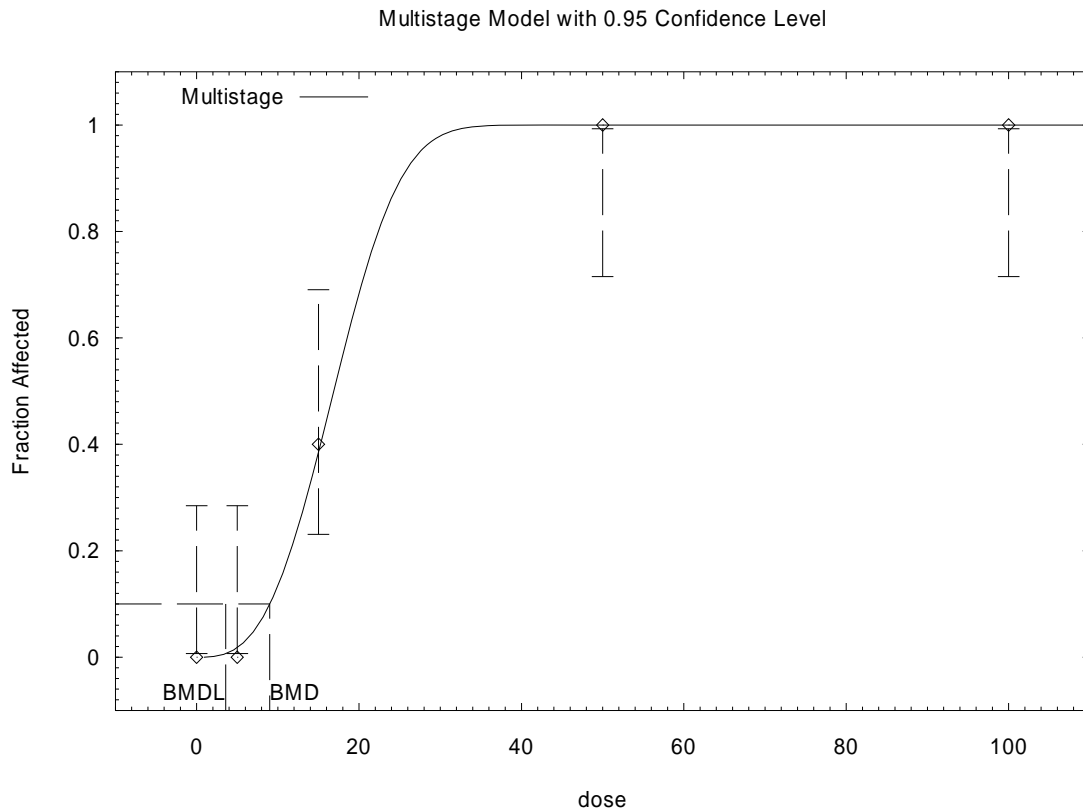

10:08 03/20 2006

\*BMDs and BMDLs indicated are for a 10% extra risk and are in units of mg/kg/day.  
BMD = benchmark dose; BMDL = lower confidence limit (95%) on the benchmark dose

Source: Haut et al. 1996

**The form and parameters of the multi-stage model for the male rat data are as follows:**

$$P[\text{response}] = \text{background} + (1 - \text{background}) * [1 - \text{EXP}(-\text{beta}1 * \text{dose}^1 - \text{beta}2 * \text{dose}^2 - \text{beta}3 * \text{dose}^3)]$$

background	=	0
Beta(1)	=	0
Beta(2)	=	0
Beta(3)	=	0.000144384

## APPENDIX A

**Table A-20. Best-fitting Model Predictions for 1, 5, and 10% Extra Risk for Basal Cell Hyperplasia of Nonglandular Stomach Mucosa in Male Rats Exposed to 1,3-Dichloropropene in the Diet for 13 Weeks**

Best fitting model	BMR (% extra risk)	BMD (mg/kg/day)	BMDL (mg/kg/day)
Male: Multistage	1	4.11358	0.416759
	5	7.0824	1.76019
	10	9.00298	3.57217

BMD = benchmark dose; BMDL = lower confidence limit (95%) on the benchmark dose; BMR = benchmark response

Source: Haut et al. 1996

Agency Contacts (Chemical Managers): Annette Ashizawa, Sharon Wilbur, and Heraline Hicks

## APPENDIX A

**MINIMAL RISK LEVEL (MRL) WORKSHEET**

Chemical Name: 1,3-Dichloropropene  
CAS Numbers: 542-75-6  
Date: August 2006  
Profile Status: Final Draft Pre-public  
Route:  Inhalation  Oral  
Duration:  Acute  Intermediate  Chronic  
Graph Key: 18  
Species: Rat

Minimal Risk Level: 0.03  mg/kg/day  ppm

References: Co-principal studies:

Stebbins KE, Johnson KA, Jeffries TK, et al. 2000. Chronic toxicity and oncogenicity studies of ingested 1,3-dichloropropene in rats and mice. *Regul Toxicol Pharmacol* 32:1-13.

Stebbins KE, Quast JF, Haut KT, et al. 1999. Subchronic and chronic toxicity of ingested 1,3-dichloropropene in dogs. *Regul Toxicol Pharmacol* 30:233-243.

Experimental design: Stebbins et al. (2000) exposed groups of male and female Fischer 344 rats (50/sex/group) to 1,3-dichloropropene in the diet at doses of 0, 2.5, 12.5, or 25 mg/kg/day for 2 years; satellite groups of 10/sex/group were scheduled for interim sacrifice at 12 months. Stebbins et al. (1999) exposed beagle dogs (4/sex/group) to dose of 0, 0.5, 2.5, or 15 mg/kg/day for 1 year. In both studies, the test material, Telone II<sup>®</sup>b, was 95.8% pure 1,3-dichloropropene (50.7% cis; 45.1% trans) with 2% ESO as a stabilizer and was microencapsulated in a starch/sucrose (80:20) microsphere matrix before addition to the diets; separate tests showed that the microencapsulated compound was stable in feed for at least three weeks, but test diets were mixed fresh weekly. Control diets received empty microspheres in an amount equivalent to that given to the high-dose treated group. Animals were examined daily for clinical signs of toxicity and received a weekly clinical examination. Body weights and feed intake were recorded prior to testing and weekly during the first 13 weeks of the study and at monthly intervals thereafter. For rats, urinalysis samples and blood samples for hematology and clinical chemistry and were obtained from the satellite groups at 6 and 12 months and from survivors in the main group at 18 months (10 animals/sex/group) and 24 months (20 animals/sex/group). For dogs, blood samples were collected prior to testing and after 3, 6, and 9 months of dosing and during the week prior to termination; urine samples were taken from dogs at necropsy. At necropsy, absolute and relative organ weights were recorded for brain, liver, kidneys, testes, ovaries, heart, and adrenals in both species and for thyroids plus parathyroids in dogs. Complete sets tissues from all animals were preserved and, in rats, those of the control and high-dose groups and animals dying prematurely were examined for histopathology; gross lesions and tissues from selected organs (lung, liver, uterus, kidney, stomach, and testes) from low- and mid-dose animals were scheduled for histopathological examination. All dogs were examined for histopathology in the full range of tissues.

Effects noted in study and corresponding doses: Both studies: Dietary exposure to Telone II<sup>®</sup>b had no effect on survival in rats exposed for 2 years or dogs exposed for 1 year.



## APPENDIX A

**Rats:**

Body weights of high-dose male and female rats were 15–16% lower than controls, but feed consumption was also reduced by 12–13%. Exposure had no significant effect on hematology, clinical chemistry, or urinalysis parameters. Reduced triglyceride counts in high-dose males and females were attributed by the authors to the decreased body weights, rather than a toxicological response.

In rats, the most sensitive effect of exposure after 2 years was basal cell hyperplasia of the nonglandular stomach mucosa observed in male and female rats exposed at 12.5 or 25 mg/kg/day (Table A-21). The incidence of this lesion was also significantly elevated in the satellite group after 1 year of exposure in males at 12.5 mg/kg/day and in females at 25 mg/kg/day. The incidence of hepatic foci of any type was not increased with treatment, but treated rats showed increases of eosinophilic foci compared to basophilic foci. The incidence of benign hepatocellular adenomas was significantly increased in male rats at 25 mg/kg/day (incidence 2/50, 1/50, 6/50, 9/50), whereas females showed a positive trend for these tumors (incidence 0/50, 0/50, 0/50, 4/50). One male rat treated at 25 mg/kg/day had a hepatic carcinoma.

**Table A-21. Incidence of Histopathological Lesions of Basal Cells in the Nonglandular Stomach in F344 Rats Exposed to 1,3-Dichloropropene (Telone II®) in the Diet for 2 Years**

	Dose (doses in mg/kg/day; group size = 50)			
	0	2.5	12.5	25
Hyperplasia				
Males	3	3	20 <sup>a</sup>	30 <sup>a</sup>
Females	0	1	20 <sup>a</sup>	37 <sup>a</sup>

<sup>a</sup>Statistically different from controls

Source: Stebbins et al. 2000

**Dogs:**

Terminal body weights were significantly lower than controls by 11% in male dogs and 15% in female dogs exposed at 15 mg/kg/day. Exposure had no effect on feed consumption or urinalysis results. The study authors indicated that changes in clinical chemistry parameters were not associated with histopathology in any organ. In dogs, the most sensitive effects were reductions in hemoglobin, hematocrit, and mean corpuscular volume, all characteristic of microcytic anemia observed in dogs at a LOAEL of 15 mg/kg/day (Table A-22); the NOAEL was 2.5 mg/kg/day in dogs.

## APPENDIX A

**Table A-22. Hematological Effects in Beagle Dogs Exposed to 1,3-Dichloropropene (Telone II®b) in the Diet for 1 Year**

	Dose (doses in mg/kg/day; group size = 4/sex/dose)			
	0	0.5	2.5	15
Hemoglobin (g/dL)				
Males	17.4±1.6	17.5±1.0	13.7±1.3	12.3±3.1 <sup>a</sup>
Females	17.3±2.1	17.1±1.2	18.0±0.6	12.6±1.2 <sup>a</sup>
Hematocrit (%)				
Males	57.0±4.1	56.6±3.0	55.7±1.4	40.5±10.4 <sup>a</sup>
Females	57.3±5.7	56.6±3.4	60.4±2.8	40.9±3.5 <sup>a</sup>
Mean corpuscular volume (fL)				
Males	73±1	72±2	69±4	44±4 <sup>a</sup>
Females	75±3	73±2	72 ±3	43±5 <sup>a</sup>

<sup>a</sup>Statistically different from control

Source: Stebbins et al. 1999

Dose and end point used for MRL derivation: Basal cell hyperplasia of the nonglandular stomach mucaosa observed in female rats exposed at a LOAEL of 12.5 mg/kg/day for 2 years. BMDL values were calculated for these and other effects (see Table A-23). If the BMDL<sub>10</sub> value of 3.5124 mg/kg/day for female rats was used as the point of departure, the derived MRL would be 0.04 mg/kg/day. This is in agreement with the EPA (2000) chronic oral RfD of 0.03 mg/kg/day based on a BMDL<sub>10</sub> of 3.4 mg/kg/day for the same data. Therefore, EPA's BMDL<sub>10</sub> of 3.4 mg/kg/day was selected as the point of departure for the chronic-duration oral MRL.

NOAEL  LOAEL  BMDL<sub>10</sub>

Uncertainty Factors used in MRL derivation: 100 applied to EPA's BMDL<sub>10</sub> of 3.4 mg/kg/day for increased incidence of forestomach basal cell hyperplasia in female rats.

10 for use of a LOAEL

10 for extrapolation from animals to humans

10 for human variability

3.4 mg/kg/day / 100 = 0.034, rounded to 0.03 mg/kg/day

Was a conversion factor used from ppm in food or water to a mg/body weight dose? No. Study authors reported doses based on feed intake data.

If an inhalation study in animals, list conversion factors used in determining human equivalent dose: Not applicable.

Was a conversion used from intermittent to continuous exposure? Not applicable. Intake was *ad libitum*.

Other additional studies or pertinent information that lend support to this MRL: No data are available for effects in humans following chronic-duration oral exposure to 1,3-dichloropropene. Chronic-duration oral exposure studies with rats, mice, and dogs exposed to different commercial formulations of 1,3-dichloropropene isomers have been conducted by oral gavage or dietary exposure.

## APPENDIX A

As with the animal data for intermediate-duration exposure, the available data indicate that lesions in the nonglandular stomach mucosa in rats and microcytic anemia in dogs are the most sensitive effects associated with chronic-duration oral exposure to 1,3-dichloropropene (see Chapter 3 for a more detailed discussion of health effects associated with 1,3-dichloropropene). Basal cell hyperplasia of the nonglandular stomach mucosa was observed in male and female Fischer 344 rats exposed to doses as low as 12.5 mg/kg/day Telone II<sup>®</sup>b (but not 2.5 mg/kg/day) encapsulated in feed for 1 or 2 years (Stebbins et al. 2000), and in male and female F344 rats and female B6C3F1 mice exposed to gavage doses of 25 mg/kg/day Telone II<sup>®</sup>a (89% dichloropropene isomers plus 1% epichlorohydrin) 3 times/week for up to 2 years (NTP 1985). Increased incidences of this lesion did not occur in male or female B6C3F1 mice exposed to 2.5, 25, or 50 mg/kg/day Telone II<sup>®</sup>b encapsulated in feed for 1 or 2 years (Stebbins et al. 2000) or in male or female beagle dogs exposed to 0.5, 2.5, or 15 mg/kg/day Telone II<sup>®</sup>b encapsulated in feed for 1 year (Stebbins et al. 1999). However, male and female beagle dogs exposed to 15 mg/kg/day, but not 2.5 mg/kg/day, Telone II<sup>®</sup>b encapsulated in feed for 1 year showed decreased values for mean hematocrit, hemoglobin concentration, and corpuscular volume, compared with control values, which are indicative of microcytic anemia. Exposure-related reductions in terminal body weight were observed in rats, mice, and dogs exposed to Telone II<sup>®</sup>b in feed for 1 or 2 years, but reduced food intake associated with decreased palatability may have contributed to these effects (Stebbins et al. 1999, 2000).

Adverse noncancer effects on the liver or kidney are not as clearly associated with chronic-duration oral exposure to 1,3-dichloropropene as forestomach basal cell hyperplasia in rats or microcytic anemia in dogs. Exposure-related kidney effects include increased incidence of hydronephrosis in female, but not male, B6C3F1 mice exposed to gavage doses of 100 mg/kg/day Telone II<sup>®</sup>a, but not 50 mg/kg/day, for up to 2 years (NTP 1985) and increased incidence of nephropathy in female, but not male, Fischer 344 rats exposed to 25 or 50 mg/kg/day Telone II<sup>®</sup>a for up to 2 years (NTP 1985). However, no exposure-related kidney effects were observed in Fischer 344 rats, B6C3F1 mice, or beagle dogs exposed to Telone II<sup>®</sup>b encapsulated in feed for 1 or 2 years at doses as high as 25 mg/kg/day for rats, 50 mg/kg/day for mice, and 15 mg/kg/day for dogs (Stebbins et al. 1999; 2000). Observed noncancer effects in the liver include decreased size of hepatocytes in male, but not female, B6C3F1 mice exposed to 50 mg/kg/day, but not 25 mg/kg/day, Telone II<sup>®</sup>b encapsulated in feed for 1 year, but not in mice exposed for 2 years (Stebbins et al. 2000) and increased incidence of slight or very slight eosinophilic foci of altered liver cells in male and female Fischer 344 rats exposed to 2.5, 12.5, or 25 mg/kg/day Telone II<sup>®</sup>b encapsulated in feed for 2 years. The toxicological significance of these apparent liver effects is equivocal given the inconsistency of the findings in the mouse study and the common spontaneous occurrence of liver foci (eosinophilic or basophilic) in aged Fischer 344 rats.

Based on the findings from the chronic-duration oral exposure animal studies, basal cell hyperplasia in the nonglandular stomach of male rats and decreased hemoglobin concentration and corpuscular volume in male or female dogs were selected as co-critical effects for development of the chronic-duration MRL for 1,3-dichloropropene. The 2-year rat study (Stebbins et al. 2000) and 1-year dog study (Stebbins et al. 1999) involving exposure to microencapsulated Telone II<sup>®</sup>b were selected as the principal studies, because the test material in these adequately designed and reported studies was the most purified 1,3-dichloropropene formulation tested (95.8% pure 1,3-dichloropropene—50.7% cis; 45.1% trans—with 2% epoxidized soybean oil as a stabilizer) and did not contain potentially confounding toxic materials such as epichlorohydrin or chloropicrin.

Potential points of departure for deriving the chronic-duration MRL, derived with benchmark dose analysis, are shown in Table A-23. Additional details of the benchmark dose analysis are described below.

## APPENDIX A

For decreased hemoglobin concentration, which was as an index of 1,3-dichloropropene-induced microcytic anemia in dogs, potential points of departure were 95% lower confidence limits on estimated doses (i.e., BMDLs) associated with a value lower than 10th percentile values for the distribution of hemoglobin concentrations in a sample of normal beagle dogs (Table A-23).

**Table A-23. Potential Points of Departure for Determining the Chronic-duration Oral MRL for 1,3-Dichloropropene**

End point	BMD (mg/kg/day)	BMDL (mg/kg/day)
Decreased hemoglobin concentration in beagle dogs exposed to Telone II <sup>®</sup> b in feed for 1 year (Stebbins et al. 1999).	M 8.3455	M 6.0453
	F 10.978	F 8.8294
BMR = 10 <sup>th</sup> percentile hemoglobin concentrations in normal beagle dogs, age >1year: 14.6 mg/dL males (n=169) and 14.1 mg/dL females (n=185) (Wolford et al. 1986).		
Increased incidence of basal cell hyperplasia of nonglandular stomach mucosa in Fischer 344 rats exposed to Telone II <sup>®</sup> b in feed for 2 years (Stebbins et al. 2000) BMR = 10 % extra risk	M 5.3432	M 4.2568
	F 5.4209	F 3.5124

BMD = benchmark dose; BMDL = 95% lower confidence limit for the benchmark dose; BMR = benchmark response level; F = female; M = male

For increased incidence of basal hyperplasia in nonglandular stomach mucosa of rats, the potential point of departure was the BMDL associated with 10% extra risk. This benchmark response (BMR) level is the default recommended by EPA (2000a).

The lowest BMDL, the BMDL<sub>10</sub> of 3.5124 mg/kg/day for increased incidence of nonglandular stomach basal cell hyperplasia in female rats, was selected as the point of departure for deriving the chronic-duration oral MRL since it should be protective against all effects.

A chronic-duration oral MRL of 0.04 mg/kg/day was derived by dividing the BMDL<sub>10</sub> of 3.5124 mg/kg/day for basal cell hyperplasia of the forestomach in female rats by a total uncertainty factor of 100 (10 for extrapolation from animals to humans and 10 for human variability).

### Details of Benchmark Dose Analysis for the Chronic-duration Oral MRL

#### Male and Female Rats:

All available dichotomous models in the EPA Benchmark Dose Software (BMDS version 1.3.2) were fit to the incidence data for basal cell hyperplasia of nonglandular stomach mucosa in male rats, female rats, and combined male and female rats exposed to 1,3-dichloropropene in the diet for 2 years (Table A-24). Predicted doses associated with 10, 5, and 1 extra risks were calculated.

## APPENDIX A

**Table A-24. Incidence of Basal Cell Hyperplasia of Nonglandular Stomach Mucosa (Slight or Very Slight) in Fisher 344 Rats Exposed to 1,3-Dichloropropene in the Diet for 2 Years**

	Control	2.5 mg/kg/day	12.5 mg/kg/day	25 mg/kg/day
Males	3/50	3/50	20/50	30/50
Females	0/50	1/50	20/50	37/50
Both sexes	3/100	4/100	40/100	67/100

**Male Rats:**

As assessed by the chi-square goodness-of-fit test, several models in the software provided adequate fits to the data for the incidence of basal cell hyperplasia of nonglandular stomach mucosa in male rats ( $\chi^2$  p-value  $\geq 0.1$ ) (Table A-25). Comparing across models, a better fit is indicated by a lower AIC (EPA 2000b). The log-probit model was determined to be the best-fitting model, as indicated by the AIC (Table A-25; Figure A-9). Benchmark doses (BMDs and BMDLs) associated with an extra risk of 10, 5, and 1%, calculated from the best fitting model, are shown in Table A-27.

**Table A-25. Goodness of Fit Statistics and BMD<sub>10</sub>s and BMDL<sub>10</sub>s from Models Fit to Incidence Data for Basal Cell Hyperplasia of Nonglandular Stomach Mucosa in Male Rats Exposed to 1,3-Dichloropropene in the Diet for 2 Years**

Model	AIC	$\chi^2$ p-value <sup>a</sup>	BMD <sub>10</sub> (mg/kg/day)	BMDL <sub>10</sub> (mg/kg/day)
Gamma	187.302	0.2589	4.89969	2.57775
Logistic	189.052	0.0784	7.13438	5.92049
Log-Logistic	186.872	0.3554	4.96556	2.47384
Multistage	188.102	0.1603	4.06715	2.46921
Probit	188.191	0.1202	6.62804	5.54609
<b>Log-probit<sup>b</sup></b>	<b>184.503</b>	<b>0.7769</b>	<b>5.34316</b>	<b>4.25684</b>
Quantal-linear	186.563	0.3216	3.09733	2.41788
Quantal-quadratic	188.62	0.0871	7.96066	6.94702
Weibull	187.529	0.2243	4.63368	2.54375

<sup>a</sup>Values <0.1 fail to meet conventional goodness-of-fit criteria.

<sup>b</sup>Best-fitting model

AIC = Akaike's Information Criteria; BMD = benchmark dose; BMDL = lower confidence limit (95%) on the benchmark dose; NA = not applicable; p = p-value from the Chi-squared test

Source: Stebbins et al. 2000

## APPENDIX A

**Figure A-7. Observed and Predicted Incidences of Basal Cell Hyperplasia of Nonglandular Stomach Mucosa in Male Rats Exposed to 1,3-Dichloropropene in the Diet for 2 Years\***

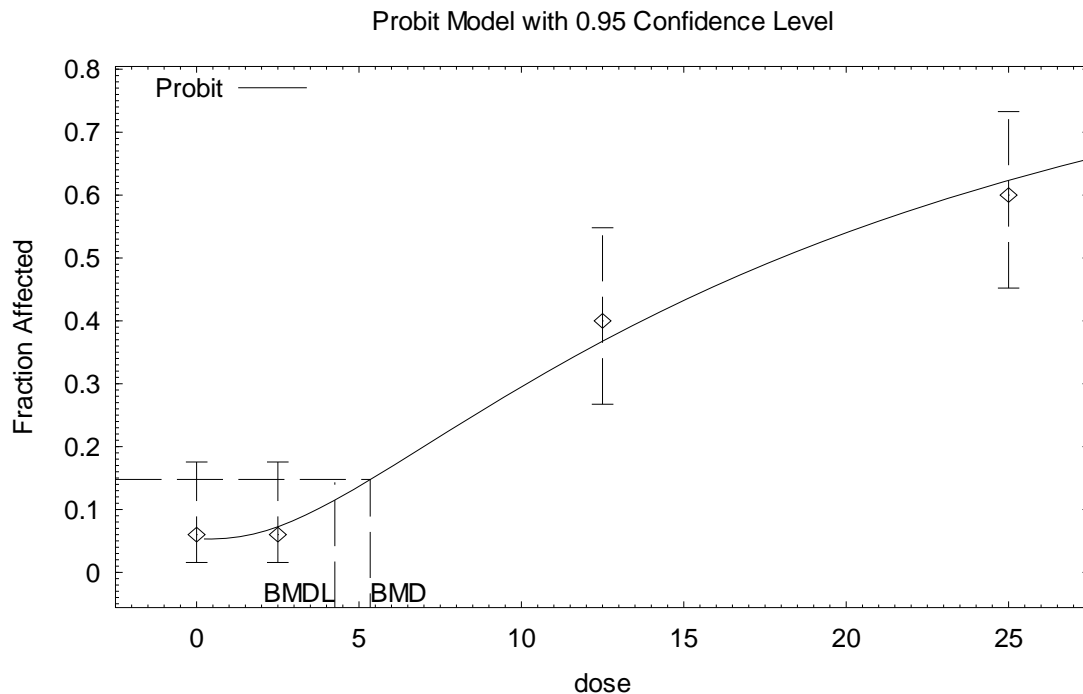

\*BMDs and BMDLs indicated are for a 10% extra risk and are in units of mg/kg/day.  
BMD = benchmark dose; BMDL = lower confidence limit (95%) on the benchmark dose

Source: Stebbins et al. 2000

**The form and parameters of the log-probit model for the male rat data are as follows:**

$$P[\text{response}] = \text{Background} + (1 - \text{Background}) * \text{CumNorm}(\text{Intercept} + \text{Slope} * \text{Log}(\text{Dose})),$$

where CumNorm(.) is the cumulative normal distribution function

background	=	0.0531859
intercept	=	-2.95737
slope	=	1

#### Female Rats:

As assessed by the chi-square goodness-of-fit test, several models in the software provided adequate fits to the data for the incidence of basal cell hyperplasia of nonglandular stomach mucosa in female rats ( $\chi^2$  p-value  $\geq 0.1$ ) (Table A-26). Comparing across models, a better fit is indicated by a lower AIC (EPA 2000b). The log-logistic model was determined to be the best-fitting model, as indicated by the AIC (Table A-26; Figure A-8). Benchmark doses (BMDs and BMDLs) associated with an extra risk of 10, 5, and 1%, calculated from the best fitting model, are shown in Table A-27.

## APPENDIX A

**Table A-26. Goodness of Fit Statistics and BMD<sub>10</sub>s and BMDL<sub>10</sub>s from Models Fit to Incidence Data for Basal Cell Hyperplasia of Nonglandular Stomach Mucosa in Female Rats Exposed to 1,3-Dichloropropene in the Diet for 2 Years**

Model	AIC	X <sup>2</sup> p-value <sup>a</sup>	BMD <sub>10</sub> (mg/kg/day)	BMDL <sub>10</sub> (mg/kg/day)
Gamma	138.598	0.9121	5.25023	3.31605
Logistic	148.131	0.0176	7.67354	6.23867
<b>Log-Logistic<sup>b</sup></b>	<b>138.416</b>	<b>0.9973</b>	<b>5.4209</b>	<b>3.51236</b>
Multistage	139.663	0.5468	5.29306	2.91991
Probit	145.812	0.0404	7.31771	5.93502
Log-probit	138.52	0.9461	5.07542	3.57721
Quantal-linear	143.267	0.1648	2.39166	1.92514
Quantal-quadratic	138.493	0.5372	6.49982	5.81197
Weibull	139.013	0.7530	5.08921	3.1648

<sup>a</sup>Values <0.1 fail to meet conventional goodness-of-fit criteria.

<sup>b</sup>Best-fitting model

AIC = Akaike's Information Criteria; BMD = benchmark dose; BMDL = lower confidence limit (95%) on the benchmark dose; NA = not applicable; p = p-value from the Chi-squared test

Source: Stebbins et al. 2000

## APPENDIX A

**Figure A-8. Observed and Predicted Incidences of Basal Cell Hyperplasia of Nonglandular Stomach Mucosa in Female Rats Exposed to 1,3-Dichloropropene in the Diet for 2 Years\***

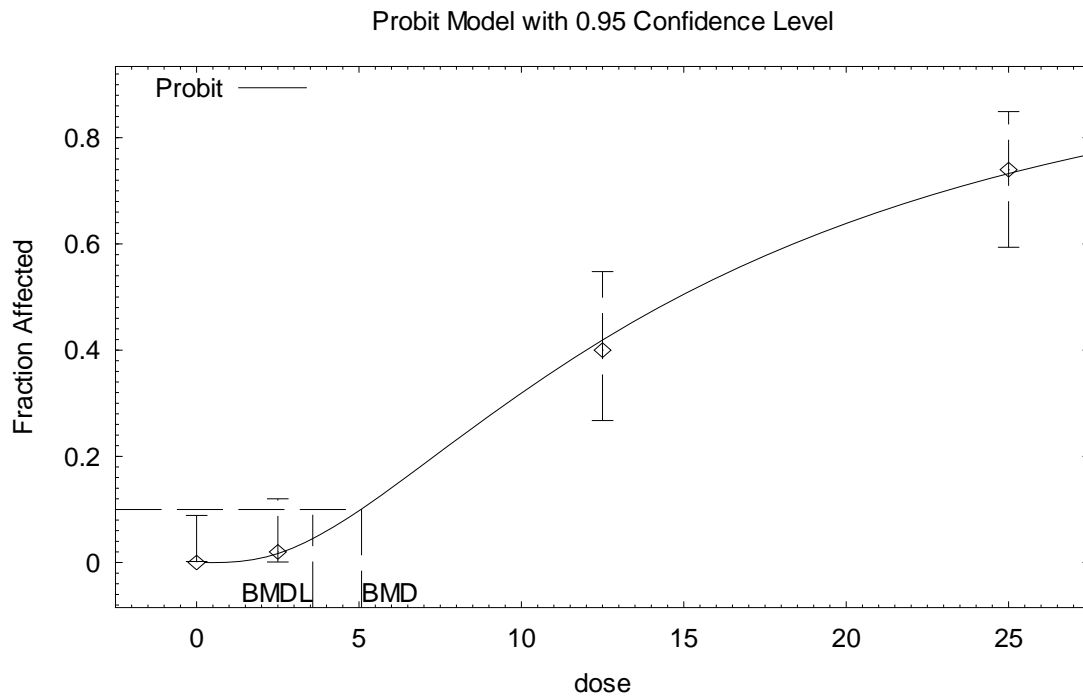

\*BMDs and BMDLs indicated are for a 10% extra risk and are in units of mg/kg/day.  
BMD = benchmark dose; BMDL = lower confidence limit (95%) on the benchmark dose

Source: Stebbins et al. 2000

**The form and parameters of the log-logistic model for the female rat data are as follows:**

$$P[\text{response}] = \text{background} + (1 - \text{background}) / [1 + \text{EXP}(-\text{intercept} - \text{slope} * \text{Log}(\text{dose}))]$$

background = 0  
intercept = -5.8536  
slope = 2.14828



## APPENDIX A

**Table A-27. Best-fitting Model Predictions for 1, 5, and 10% Extra Risk for Basal Cell Hyperplasia of Nonglandular Stomach Mucosa in Male and Female Rats Exposed to 1,3-Dichloropropene in the Diet for 2 Years**

Best fitting model	BMR (% extra risk)	BMD (mg/kg/day)	BMDL (mg/kg/day)
Male: Log-Probit	1	2.10426	1.25833
	5	3.7369	2.48751
	10	5.34316	4.25684
Female: Log-logistic	1	1.13014	0.258277
	5	3.13078	1.23116
	10	5.4209	3.51236

BMD = benchmark dose; BMDL = lower confidence limit (95%) on the benchmark dose; BMR = benchmark response

Source: Stebbins et al. 2000

### Male and Female Dogs:

The linear model in the EPA Benchmark Dose Software (BMDS version 1.3.2) was fit to the data (Table A-28) for decreased hemoglobin concentration in beagle dogs exposed to 1,3-dichloropropene in the diet for 1 year. The linear model was selected as it is the simplest model available in the BMD software which adequately fits the hemoglobin concentration data. Hemoglobin concentration was selected as the most clearly adverse variable associate with 1,3-dichloropropene-induced microcytic anemia. BMDs and BMDLs associated with a value lower than the 10<sup>th</sup> percentile value for hemoglobin in normal beagle dogs were calculated (Table A-29, Figures A-9 and A-10). The 10<sup>th</sup> percentile hemoglobin concentrations in normal beagle dogs, age >1 year for the 1-year exposure were 14.6 mg/dL for males and 14.1 mg/dL for females (Wolford et al. 1986).

**Table A-28. Hemoglobin Concentrations in Male and Female Beagle Dogs Exposed for 1 Year**

Dose mg/kg/day	Male mean hemoglobin concentration $\pm$ standard deviation (g/dL)	Female Mean hemoglobin concentration $\pm$ standard deviation (g/dL)
0	17.4 $\pm$ 1.6	17.3 $\pm$ 2.1
0.5	17.5 $\pm$ 1.0	17.1 $\pm$ 1.2
2.5	13.7 $\pm$ 1.3	18.0 $\pm$ 0.6
15	12.3 $\pm$ 3.1*	12.6 $\pm$ 1.2*

Source: Stebbins et al. 1999

## APPENDIX A

**Table A-29. Linear Model Predictions for the Dose Associated with the 10<sup>th</sup> Percentile Value for Hemoglobin Concentration in Normal Beagle Dogs with the 95% Lower Confidence Limit**

Data-set	BMD <sub>10th%ile</sub> (mg/kg/day)	BMDL <sub>10th%ile</sub> (mg/kg/day)
Chronic		
Male <sup>a</sup>	8.3455	6.04528
Female	10.978	8.82939

<sup>a</sup>Nonhomogeneous variance model

BMD = benchmark dose; BMDL = lower confidence limit (95%) on the benchmark dose

**Figure A-9. Linear (Nonhomogeneous Variance) Model Predicted Change in Hemoglobin Concentration in Male Beagle Dogs Exposed to 1,3-Dichloropropene in the Diet for 1 Year\***

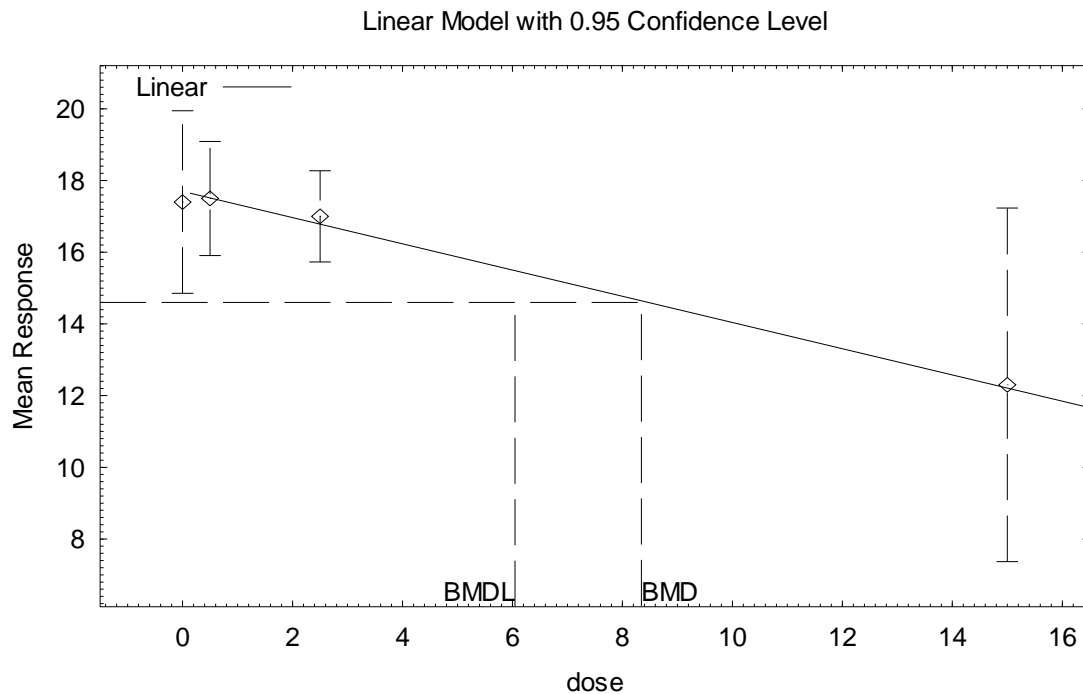

14:57 03/30 2006

\*BMDs and BMDLs indicated are doses associated with the 10<sup>th</sup> percentile value for hemoglobin concentration in normal beagle dogs and are in units of mg/kg/day.

BMD = benchmark dose; BMDL = lower confidence limit (95%) on the benchmark dose

Source: Stebbins et al. 1999

## APPENDIX A

**Figure A-10. Linear Model Predicted Change in Hemoglobin Concentration in Female Beagle Dogs Exposed to 1,3-Dichloropropene in the Diet for 1 Year\***

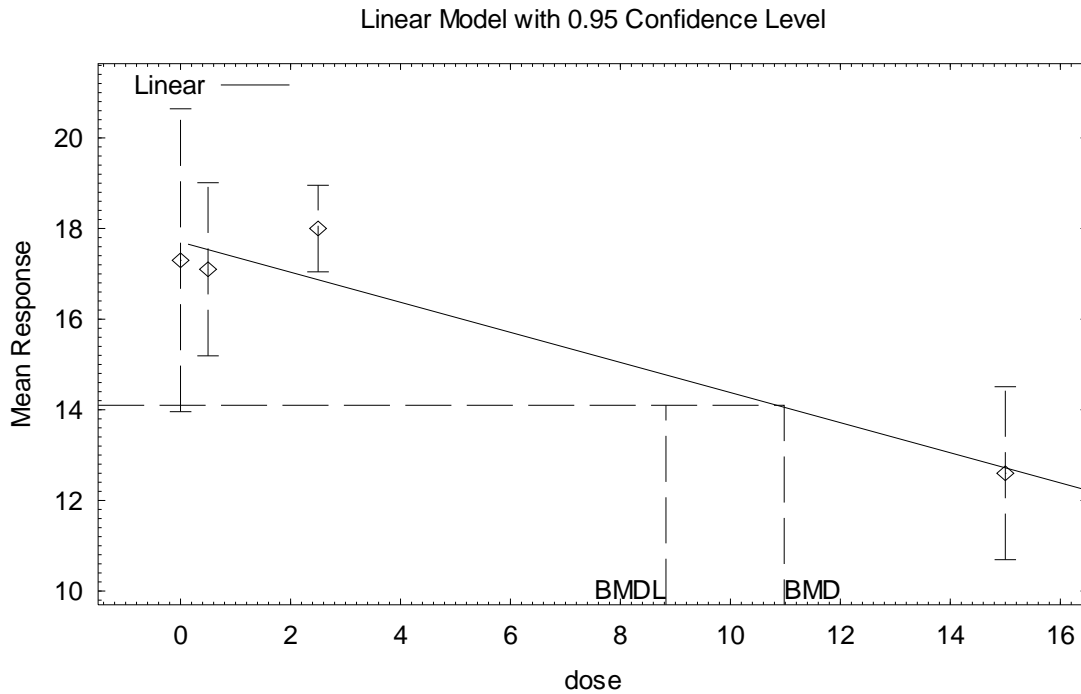

\*BMDs and BMDLs indicated are doses associated with the 10<sup>th</sup> percentile value for hemoglobin concentration in normal beagle dogs and are in units of mg/kg/day  
 BMD = benchmark dose; BMDL = lower confidence limit (95%) on the benchmark dose

Source: Stebbins et al. 1999

Agency Contacts (Chemical Managers): Annette Ashizawa, Sharon Wilbur, and Heraline Hicks

APPENDIX A

This page is intentionally blank.

## APPENDIX B. USER'S GUIDE

### Chapter 1

#### Public Health Statement

This chapter of the profile is a health effects summary written in non-technical language. Its intended audience is the general public, especially people living in the vicinity of a hazardous waste site or chemical release. If the Public Health Statement were removed from the rest of the document, it would still communicate to the lay public essential information about the chemical.

The major headings in the Public Health Statement are useful to find specific topics of concern. The topics are written in a question and answer format. The answer to each question includes a sentence that will direct the reader to chapters in the profile that will provide more information on the given topic.

### Chapter 2

#### Relevance to Public Health

This chapter provides a health effects summary based on evaluations of existing toxicologic, epidemiologic, and toxicokinetic information. This summary is designed to present interpretive, weight-of-evidence discussions for human health end points by addressing the following questions:

1. What effects are known to occur in humans?
2. What effects observed in animals are likely to be of concern to humans?
3. What exposure conditions are likely to be of concern to humans, especially around hazardous waste sites?

The chapter covers end points in the same order that they appear within the Discussion of Health Effects by Route of Exposure section, by route (inhalation, oral, and dermal) and within route by effect. Human data are presented first, then animal data. Both are organized by duration (acute, intermediate, chronic). *In vitro* data and data from parenteral routes (intramuscular, intravenous, subcutaneous, etc.) are also considered in this chapter.

The carcinogenic potential of the profiled substance is qualitatively evaluated, when appropriate, using existing toxicokinetic, genotoxic, and carcinogenic data. ATSDR does not currently assess cancer potency or perform cancer risk assessments. Minimal Risk Levels (MRLs) for noncancer end points (if derived) and the end points from which they were derived are indicated and discussed.

Limitations to existing scientific literature that prevent a satisfactory evaluation of the relevance to public health are identified in the Chapter 3 Data Needs section.

#### Interpretation of Minimal Risk Levels

Where sufficient toxicologic information is available, ATSDR has derived MRLs for inhalation and oral routes of entry at each duration of exposure (acute, intermediate, and chronic). These MRLs are not

## APPENDIX B

meant to support regulatory action, but to acquaint health professionals with exposure levels at which adverse health effects are not expected to occur in humans.

MRLs should help physicians and public health officials determine the safety of a community living near a chemical emission, given the concentration of a contaminant in air or the estimated daily dose in water. MRLs are based largely on toxicological studies in animals and on reports of human occupational exposure.

MRL users should be familiar with the toxicologic information on which the number is based. Chapter 2, "Relevance to Public Health," contains basic information known about the substance. Other sections such as Chapter 3 Section 3.9, "Interactions with Other Substances," and Section 3.10, "Populations that are Unusually Susceptible" provide important supplemental information.

MRL users should also understand the MRL derivation methodology. MRLs are derived using a modified version of the risk assessment methodology that the Environmental Protection Agency (EPA) provides (Barnes and Dourson 1988) to determine reference doses (RfDs) for lifetime exposure.

To derive an MRL, ATSDR generally selects the most sensitive end point which, in its best judgement, represents the most sensitive human health effect for a given exposure route and duration. ATSDR cannot make this judgement or derive an MRL unless information (quantitative or qualitative) is available for all potential systemic, neurological, and developmental effects. If this information and reliable quantitative data on the chosen end point are available, ATSDR derives an MRL using the most sensitive species (when information from multiple species is available) with the highest no-observed-adverse-effect level (NOAEL) that does not exceed any adverse effect levels. When a NOAEL is not available, a lowest-observed-adverse-effect level (LOAEL) can be used to derive an MRL, and an uncertainty factor (UF) of 10 must be employed. Additional uncertainty factors of 10 must be used both for human variability to protect sensitive subpopulations (people who are most susceptible to the health effects caused by the substance) and for interspecies variability (extrapolation from animals to humans). In deriving an MRL, these individual uncertainty factors are multiplied together. The product is then divided into the inhalation concentration or oral dosage selected from the study. Uncertainty factors used in developing a substance-specific MRL are provided in the footnotes of the levels of significant exposure (LSE) tables.

## Chapter 3

### Health Effects

#### Tables and Figures for Levels of Significant Exposure (LSE)

Tables and figures are used to summarize health effects and illustrate graphically levels of exposure associated with those effects. These levels cover health effects observed at increasing dose concentrations and durations, differences in response by species, MRLs to humans for noncancer end points, and EPA's estimated range associated with an upper-bound individual lifetime cancer risk of 1 in 10,000 to 1 in 10,000,000. Use the LSE tables and figures for a quick review of the health effects and to locate data for a specific exposure scenario. The LSE tables and figures should always be used in conjunction with the text. All entries in these tables and figures represent studies that provide reliable, quantitative estimates of NOAELs, LOAELs, or Cancer Effect Levels (CELs).

The legends presented below demonstrate the application of these tables and figures. Representative examples of LSE Table 3-1 and Figure 3-1 are shown. The numbers in the left column of the legends correspond to the numbers in the example table and figure.

## APPENDIX B

**LEGEND****See Sample LSE Table 3-1 (page B-6)**

- (1) Route of Exposure. One of the first considerations when reviewing the toxicity of a substance using these tables and figures should be the relevant and appropriate route of exposure. Typically when sufficient data exist, three LSE tables and two LSE figures are presented in the document. The three LSE tables present data on the three principal routes of exposure, i.e., inhalation, oral, and dermal (LSE Tables 3-1, 3-2, and 3-3, respectively). LSE figures are limited to the inhalation (LSE Figure 3-1) and oral (LSE Figure 3-2) routes. Not all substances will have data on each route of exposure and will not, therefore, have all five of the tables and figures.
- (2) Exposure Period. Three exposure periods—acute (less than 15 days), intermediate (15–364 days), and chronic (365 days or more)—are presented within each relevant route of exposure. In this example, an inhalation study of intermediate exposure duration is reported. For quick reference to health effects occurring from a known length of exposure, locate the applicable exposure period within the LSE table and figure.
- (3) Health Effect. The major categories of health effects included in LSE tables and figures are death, systemic, immunological, neurological, developmental, reproductive, and cancer. NOAELs and LOAELs can be reported in the tables and figures for all effects but cancer. Systemic effects are further defined in the "System" column of the LSE table (see key number 18).
- (4) Key to Figure. Each key number in the LSE table links study information to one or more data points using the same key number in the corresponding LSE figure. In this example, the study represented by key number 18 has been used to derive a NOAEL and a Less Serious LOAEL (also see the two "18r" data points in sample Figure 3-1).
- (5) Species. The test species, whether animal or human, are identified in this column. Chapter 2, "Relevance to Public Health," covers the relevance of animal data to human toxicity and Section 3.4, "Toxicokinetics," contains any available information on comparative toxicokinetics. Although NOAELs and LOAELs are species specific, the levels are extrapolated to equivalent human doses to derive an MRL.
- (6) Exposure Frequency/Duration. The duration of the study and the weekly and daily exposure regimens are provided in this column. This permits comparison of NOAELs and LOAELs from different studies. In this case (key number 18), rats were exposed to "Chemical x" via inhalation for 6 hours/day, 5 days/week, for 13 weeks. For a more complete review of the dosing regimen, refer to the appropriate sections of the text or the original reference paper (i.e., Nitschke et al. 1981).
- (7) System. This column further defines the systemic effects. These systems include respiratory, cardiovascular, gastrointestinal, hematological, musculoskeletal, hepatic, renal, and dermal/ocular. "Other" refers to any systemic effect (e.g., a decrease in body weight) not covered in these systems. In the example of key number 18, one systemic effect (respiratory) was investigated.
- (8) NOAEL. A NOAEL is the highest exposure level at which no harmful effects were seen in the organ system studied. Key number 18 reports a NOAEL of 3 ppm for the respiratory system,

## APPENDIX B

which was used to derive an intermediate exposure, inhalation MRL of 0.005 ppm (see footnote "b").

- (9) LOAEL. A LOAEL is the lowest dose used in the study that caused a harmful health effect. LOAELs have been classified into "Less Serious" and "Serious" effects. These distinctions help readers identify the levels of exposure at which adverse health effects first appear and the gradation of effects with increasing dose. A brief description of the specific end point used to quantify the adverse effect accompanies the LOAEL. The respiratory effect reported in key number 18 (hyperplasia) is a Less Serious LOAEL of 10 ppm. MRLs are not derived from Serious LOAELs.
- (10) Reference. The complete reference citation is given in Chapter 9 of the profile.
- (11) CEL. A CEL is the lowest exposure level associated with the onset of carcinogenesis in experimental or epidemiologic studies. CELs are always considered serious effects. The LSE tables and figures do not contain NOAELs for cancer, but the text may report doses not causing measurable cancer increases.
- (12) Footnotes. Explanations of abbreviations or reference notes for data in the LSE tables are found in the footnotes. Footnote "b" indicates that the NOAEL of 3 ppm in key number 18 was used to derive an MRL of 0.005 ppm.

**LEGEND**

**See Sample Figure 3-1 (page B-7)**

LSE figures graphically illustrate the data presented in the corresponding LSE tables. Figures help the reader quickly compare health effects according to exposure concentrations for particular exposure periods.

- (13) Exposure Period. The same exposure periods appear as in the LSE table. In this example, health effects observed within the acute and intermediate exposure periods are illustrated.
- (14) Health Effect. These are the categories of health effects for which reliable quantitative data exists. The same health effects appear in the LSE table.
- (15) Levels of Exposure. Concentrations or doses for each health effect in the LSE tables are graphically displayed in the LSE figures. Exposure concentration or dose is measured on the log scale "y" axis. Inhalation exposure is reported in mg/m<sup>3</sup> or ppm and oral exposure is reported in mg/kg/day.
- (16) NOAEL. In this example, the open circle designated 18r identifies a NOAEL critical end point in the rat upon which an intermediate inhalation exposure MRL is based. The key number 18 corresponds to the entry in the LSE table. The dashed descending arrow indicates the extrapolation from the exposure level of 3 ppm (see entry 18 in the table) to the MRL of 0.005 ppm (see footnote "b" in the LSE table).
- (17) CEL. Key number 38m is one of three studies for which CELs were derived. The diamond symbol refers to a CEL for the test species-mouse. The number 38 corresponds to the entry in the LSE table.



## APPENDIX B

- (18) Estimated Upper-Bound Human Cancer Risk Levels. This is the range associated with the upper-bound for lifetime cancer risk of 1 in 10,000 to 1 in 10,000,000. These risk levels are derived from the EPA's Human Health Assessment Group's upper-bound estimates of the slope of the cancer dose response curve at low dose levels ( $q_1^*$ ).
- (19) Key to LSE Figure. The Key explains the abbreviations and symbols used in the figure.

**SAMPLE**

1 →

**Table 3-1. Levels of Significant Exposure to [Chemical x] – Inhalation**

Key to figure <sup>a</sup>	Species	Exposure frequency/ duration	System	NOAEL (ppm)	LOAEL (effect)		Reference
					Less serious (ppm)	Serious (ppm)	
<b>INTERMEDIATE EXPOSURE</b>							
	5	6	7	8	9		10
3 →	Systemic	↓	↓	↓	↓	↓	↓
4 →	18	Rat	13 wk 5 d/wk 6 hr/d	Resp	3 <sup>b</sup>	10 (hyperplasia)	Nitschke et al. 1981
<b>CHRONIC EXPOSURE</b>							
	Cancer					11	
					↓		
	38	Rat	18 mo 5 d/wk 7 hr/d			20 (CEL, multiple organs)	Wong et al. 1982
	39	Rat	89–104 wk 5 d/wk 6 hr/d			10 (CEL, lung tumors, nasal tumors)	NTP 1982
	40	Mouse	79–103 wk 5 d/wk 6 hr/d			10 (CEL, lung tumors, hemangiosarcomas)	NTP 1982

12 →

<sup>a</sup> The number corresponds to entries in Figure 3-1.

<sup>b</sup> Used to derive an intermediate inhalation Minimal Risk Level (MRL) of  $5 \times 10^{-3}$  ppm; dose adjusted for intermittent exposure and divided by an uncertainty factor of 100 (10 for extrapolation from animal to humans, 10 for human variability).

# SAMPLE

### Figure 3-1. Levels of Significant Exposure to [Chemical X] - Inhalation

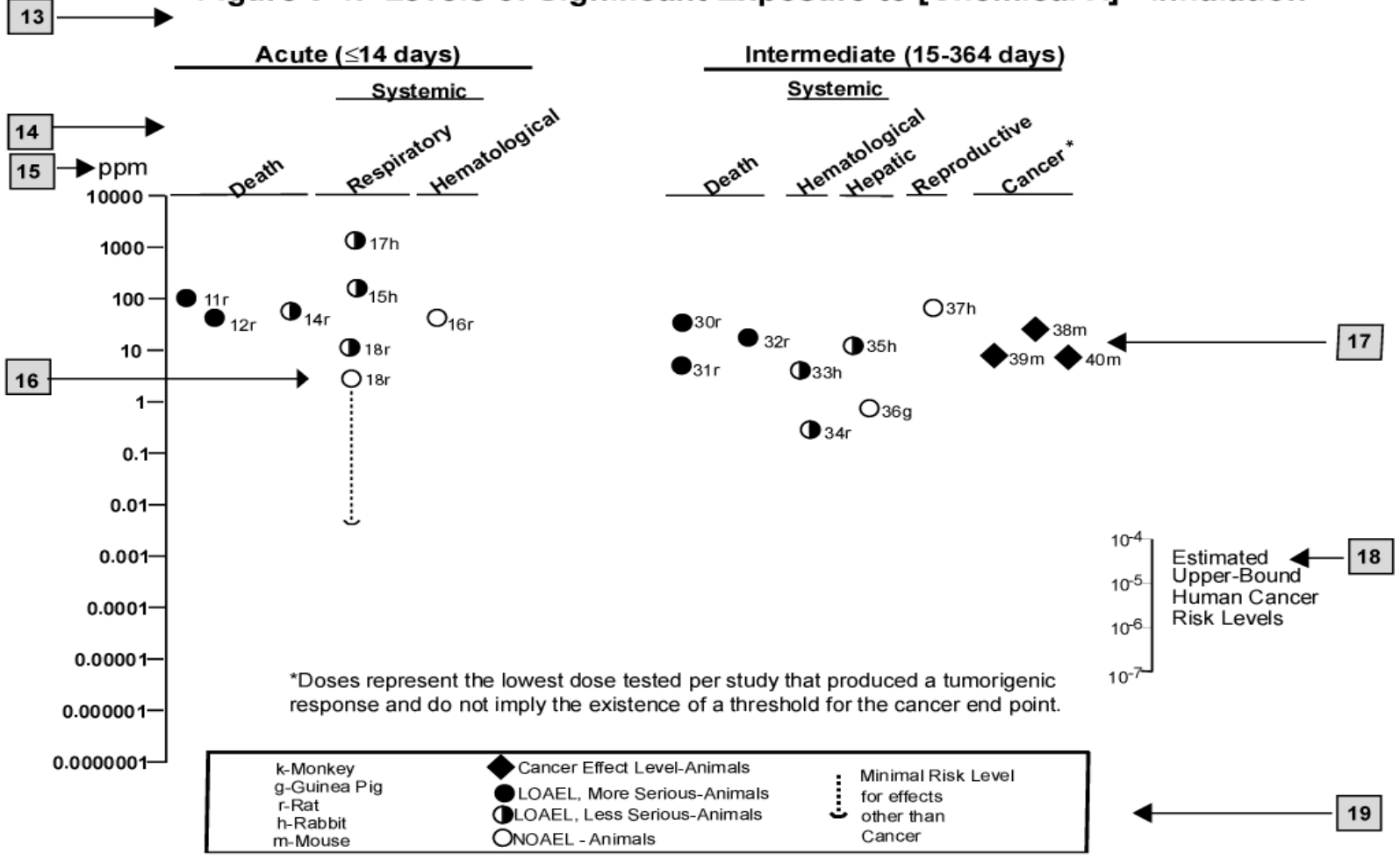

\*\*\*DRAFT FOR PUBLIC COMMENT\*\*\*

APPENDIX B

This page is intentionally blank.

**APPENDIX C. ACRONYMS, ABBREVIATIONS, AND SYMBOLS**

ACGIH	American Conference of Governmental Industrial Hygienists
ACOEM	American College of Occupational and Environmental Medicine
ADI	acceptable daily intake
ADME	absorption, distribution, metabolism, and excretion
AED	atomic emission detection
AFID	alkali flame ionization detector
AFOSH	Air Force Office of Safety and Health
ALT	alanine aminotransferase
AML	acute myeloid leukemia
AOAC	Association of Official Analytical Chemists
AOEC	Association of Occupational and Environmental Clinics
AP	alkaline phosphatase
APHA	American Public Health Association
AST	aspartate aminotransferase
atm	atmosphere
ATSDR	Agency for Toxic Substances and Disease Registry
AWQC	Ambient Water Quality Criteria
BAT	best available technology
BCF	bioconcentration factor
BEI	Biological Exposure Index
BMD	benchmark dose
BMR	benchmark response
BSC	Board of Scientific Counselors
C	centigrade
CAA	Clean Air Act
CAG	Cancer Assessment Group of the U.S. Environmental Protection Agency
CAS	Chemical Abstract Services
CDC	Centers for Disease Control and Prevention
CEL	cancer effect level
CELDS	Computer-Environmental Legislative Data System
CERCLA	Comprehensive Environmental Response, Compensation, and Liability Act
CFR	Code of Federal Regulations
Ci	curie
CI	confidence interval
CL	ceiling limit value
CLP	Contract Laboratory Program
cm	centimeter
CML	chronic myeloid leukemia
CPSC	Consumer Products Safety Commission
CWA	Clean Water Act
DHEW	Department of Health, Education, and Welfare
DHHS	Department of Health and Human Services
DNA	deoxyribonucleic acid
DOD	Department of Defense
DOE	Department of Energy
DOL	Department of Labor
DOT	Department of Transportation

## APPENDIX C

DOT/UN/ NA/IMCO	Department of Transportation/United Nations/ North America/Intergovernmental Maritime Dangerous Goods Code
DWEL	drinking water exposure level
ECD	electron capture detection
ECG/EKG	electrocardiogram
EEG	electroencephalogram
EEGL	Emergency Exposure Guidance Level
EPA	Environmental Protection Agency
F	Fahrenheit
F <sub>1</sub>	first-filial generation
FAO	Food and Agricultural Organization of the United Nations
FDA	Food and Drug Administration
FEMA	Federal Emergency Management Agency
FIFRA	Federal Insecticide, Fungicide, and Rodenticide Act
FPD	flame photometric detection
fpm	feet per minute
FR	Federal Register
FSH	follicle stimulating hormone
g	gram
GC	gas chromatography
gd	gestational day
GLC	gas liquid chromatography
GPC	gel permeation chromatography
HPLC	high-performance liquid chromatography
HRGC	high resolution gas chromatography
HSDB	Hazardous Substance Data Bank
IARC	International Agency for Research on Cancer
IDLH	immediately dangerous to life and health
ILO	International Labor Organization
IRIS	Integrated Risk Information System
K <sub>d</sub>	adsorption ratio
kg	kilogram
kgg	metric ton
K <sub>oc</sub>	organic carbon partition coefficient
K <sub>ow</sub>	octanol-water partition coefficient
L	liter
LC	liquid chromatography
LC <sub>50</sub>	lethal concentration, 50% kill
LC <sub>Lo</sub>	lethal concentration, low
LD <sub>50</sub>	lethal dose, 50% kill
LD <sub>Lo</sub>	lethal dose, low
LDH	lactic dehydrogenase
LH	lutinizing hormone
LOAEL	lowest-observed-adverse-effect level
LSE	Levels of Significant Exposure
LT <sub>50</sub>	lethal time, 50% kill
m	meter
MA	<i>trans,trans</i> -muconic acid
MAL	maximum allowable level
mCi	millicurie
MCL	maximum contaminant level

## APPENDIX C

MCLG	maximum contaminant level goal
MF	modifying factor
MFO	mixed function oxidase
mg	milligram
mL	milliliter
mm	millimeter
mmHg	millimeters of mercury
mmol	millimole
mppcf	millions of particles per cubic foot
MRL	Minimal Risk Level
MS	mass spectrometry
NAAQS	National Ambient Air Quality Standard
NAS	National Academy of Science
NATICH	National Air Toxics Information Clearinghouse
NATO	North Atlantic Treaty Organization
NCE	normochromatic erythrocytes
NCEH	National Center for Environmental Health
NCI	National Cancer Institute
ND	not detected
NFPA	National Fire Protection Association
ng	nanogram
NHANES	National Health and Nutrition Examination Survey
NIEHS	National Institute of Environmental Health Sciences
NIOSH	National Institute for Occupational Safety and Health
NIOSHTIC	NIOSH's Computerized Information Retrieval System
NLM	National Library of Medicine
nm	nanometer
nmol	nanomole
NOAEL	no-observed-adverse-effect level
NOES	National Occupational Exposure Survey
NOHS	National Occupational Hazard Survey
NPD	nitrogen phosphorus detection
NPDES	National Pollutant Discharge Elimination System
NPL	National Priorities List
NR	not reported
NRC	National Research Council
NS	not specified
NSPS	New Source Performance Standards
NTIS	National Technical Information Service
NTP	National Toxicology Program
ODW	Office of Drinking Water, EPA
OERR	Office of Emergency and Remedial Response, EPA
OHM/TADS	Oil and Hazardous Materials/Technical Assistance Data System
OPP	Office of Pesticide Programs, EPA
OPPT	Office of Pollution Prevention and Toxics, EPA
OPPTS	Office of Prevention, Pesticides and Toxic Substances, EPA
OR	odds ratio
OSHA	Occupational Safety and Health Administration
OSW	Office of Solid Waste, EPA
OTS	Office of Toxic Substances
OW	Office of Water

## APPENDIX C

OWRS	Office of Water Regulations and Standards, EPA
PAH	polycyclic aromatic hydrocarbon
PBPD	physiologically based pharmacodynamic
PBPK	physiologically based pharmacokinetic
PCE	polychromatic erythrocytes
PEL	permissible exposure limit
pg	picogram
PHS	Public Health Service
PID	photo ionization detector
pmol	picomole
PMR	proportionate mortality ratio
ppb	parts per billion
ppm	parts per million
ppt	parts per trillion
PSNS	pretreatment standards for new sources
RBC	red blood cell
REL	recommended exposure level/limit
RfC	reference concentration
RfD	reference dose
RNA	ribonucleic acid
RQ	reportable quantity
RTECS	Registry of Toxic Effects of Chemical Substances
SARA	Superfund Amendments and Reauthorization Act
SCE	sister chromatid exchange
SGOT	serum glutamic oxaloacetic transaminase
SGPT	serum glutamic pyruvic transaminase
SIC	standard industrial classification
SIM	selected ion monitoring
SMCL	secondary maximum contaminant level
SMR	standardized mortality ratio
SNARL	suggested no adverse response level
SPEGL	Short-Term Public Emergency Guidance Level
STEL	short term exposure limit
STORET	Storage and Retrieval
TD <sub>50</sub>	toxic dose, 50% specific toxic effect
TLV	threshold limit value
TOC	total organic carbon
TPQ	threshold planning quantity
TRI	Toxics Release Inventory
TSCA	Toxic Substances Control Act
TWA	time-weighted average
UF	uncertainty factor
U.S.	United States
USDA	United States Department of Agriculture
USGS	United States Geological Survey
VOC	volatile organic compound
WBC	white blood cell
WHO	World Health Organization



## APPENDIX C

>	greater than
≥	greater than or equal to
=	equal to
<	less than
≤	less than or equal to
%	percent
α	alpha
β	beta
γ	gamma
δ	delta
μm	micrometer
μg	microgram
q <sub>1</sub> *	cancer slope factor
-	negative
+	positive
(+)	weakly positive result
(-)	weakly negative result

APPENDIX C

This page is intentionally blank.

## APPENDIX D. INDEX

absorbed dose.....	143, 156
adrenal gland.....	19
adrenals.....	136
adsorption.....	213
aerobic.....	216, 218
alanine aminotransferase (see ALT).....	37
ALT (see alanine aminotransferase).....	37, 73
ambient air.....	13, 205, 215, 221, 239
anaerobic.....	222
anemia.....	7, 16, 18, 29, 31, 32, 106, 107, 172, 179, 180
bioaccumulation.....	232
bioavailability.....	135, 232
bioconcentration factor.....	214, 230, 250
biodegradation.....	13, 211, 213, 216, 217, 218
biomarker.....	15, 72, 74, 75, 155, 156, 157, 178, 179, 180, 181, 233, 235, 243
body weight effects.....	110, 118
breast milk.....	155, 184, 229, 233
cancer.....	6, 16, 18, 19, 42, 79, 80, 112, 122, 154, 178, 250
carcinogen.....	7, 19, 246, 250
carcinogenic.....	7, 16, 18, 19, 20, 21, 41, 42, 80, 113, 167, 172, 173, 178, 246, 250
carcinogenicity.....	18, 19, 112, 113, 167, 178, 250
carcinoma.....	19, 109, 112, 113, 172
cardiovascular.....	15, 70, 104, 118
cardiovascular effects.....	15, 70, 104
chromosomal aberrations.....	131
clearance.....	157
death.....	7, 15, 19, 20, 22, 28, 41, 66, 67, 79, 80, 81, 103, 113, 141, 167, 176, 178
deoxyribonucleic acid (see DNA).....	19
DNA (see deoxyribonucleic acid).....	19, 123, 124, 125, 126, 127, 128, 129, 130, 131, 156, 173, 174, 179
elimination half-time.....	157
endocrine.....	118, 152, 153
erythema.....	16, 119, 120, 121, 157, 169
estrogen receptor.....	153
fetus.....	153, 155
forestomach.....	16, 17, 19, 30, 31, 71, 106, 112, 113, 122, 140, 151, 157, 160, 171, 172, 179
gastrointestinal effects.....	15, 17, 28, 71, 105, 118, 119
general population.....	5, 6, 8, 14, 155, 178, 203, 204, 228, 233, 244
genotoxic.....	41, 122, 129, 167, 174, 175
genotoxicity.....	19, 41, 129, 130, 131, 167, 173, 174, 175
groundwater.....	3, 4, 5, 13, 14, 199, 203, 210, 213, 222, 223, 228, 232
half-life.....	13, 135, 144, 145, 146, 156, 215, 219
hematological effects.....	16, 18, 29, 71, 72, 106, 107
hepatic effects.....	72, 73, 107, 108, 118, 119
hydrolysis.....	13, 14, 132, 137, 140, 143, 151, 211, 213, 214, 216, 217, 218, 219, 231
hydroxyl radical.....	13, 215, 216
hyperplasia.....	15, 17, 18, 20, 23, 24, 25, 26, 27, 28, 29, 30, 31, 32, 33, 35, 36, 68, 69, 71, 75, 105, 106, 109, 157, 160, 180, 245

## APPENDIX D

hypertrophy .....	17, 24, 25, 26, 27, 28, 68, 180, 245, 246
immune system .....	77, 177
immunological .....	41, 76, 111, 168, 177
immunological effects.....	76, 111, 177
irritation .....	6, 7, 17, 20, 22, 24, 37, 67, 69, 120, 151, 160, 167, 168, 170, 175, 176, 246
K <sub>ow</sub> .....	214
LD <sub>50</sub> .....	28, 38, 81, 103, 118, 135
leukemia .....	18, 80, 168, 172
metabolic effects .....	110, 111
micronuclei .....	123, 124
milk .....	160, 184
musculoskeletal effects .....	72, 107, 119
nasal .....	15, 17, 20, 22, 23, 24, 25, 26, 27, 28, 33, 34, 35, 36, 37, 68, 69, 79, 80, 132, 136, 137, 150, 151, 157, 158, 160, 168, 169, 170, 171, 172, 174, 175, 176, 179, 180, 183, 245, 246
neoplastic .....	104, 105, 108, 109, 112, 157
neurobehavioral.....	153
ocular effects.....	76, 110, 120
odds ratio.....	79
partition coefficients .....	28, 230
pharmacodynamic .....	146, 246
pharmacokinetic.....	133, 146, 147, 148, 154, 178, 179, 182
photolysis .....	216
placenta .....	155, 184
rate constant .....	149, 215
renal effects.....	74, 75, 76, 108, 109, 178, 180
respiratory effects.....	17, 67, 103, 118
retention .....	151
salivation .....	121, 168, 177
solubility .....	14, 150, 211, 213, 231
thyroid.....	19
toxicokinetic.....	19, 20, 21, 39, 41, 132, 180, 181, 182, 183, 184
tumors .....	16, 68, 106, 108, 113, 122, 172, 173
vapor phase .....	211, 213
vapor pressure .....	211, 213, 214, 230
volatility .....	14, 214
volatilization .....	205, 211, 213, 214

