

# Wilbur and Orville Wright

★ ★ ★ ★ ★ ★ ★ ★ ★ ★  
★ ACTIVITY BOOKLET ★

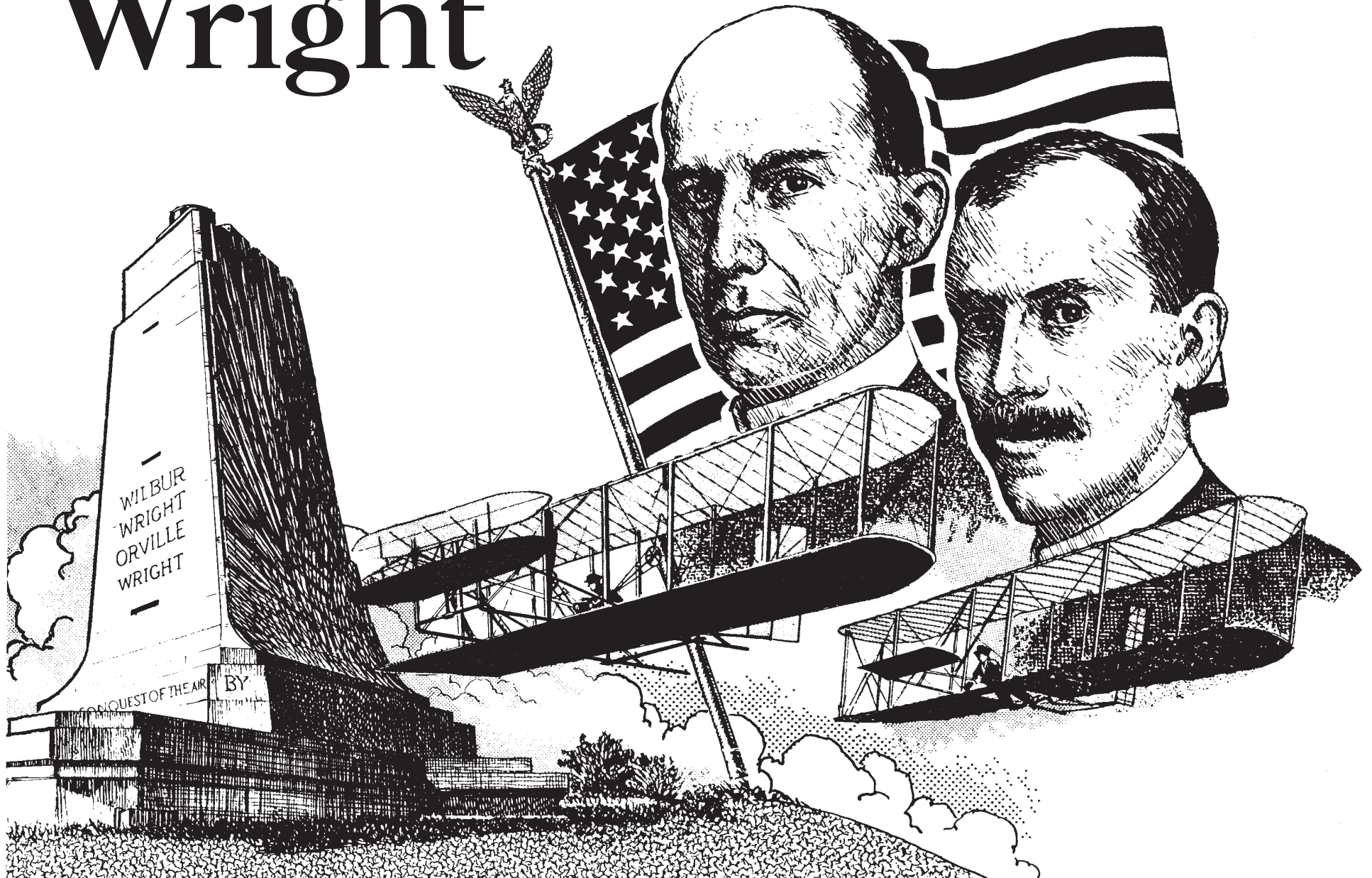



published by

NATIONAL HEADQUARTERS  
**CIVIL AIR PATROL**  
MAXWELL AFB, ALABAMA

**AEROSPACE EDUCATION & TRAINING DIRECTORATE**

---

A single copy of this publication may be ordered on school letterhead from:

NAT'L HQ CAP/ETA  
Maxwell AFB AL 36112-6332  
Telephone: (334) 953-5095

---

## ORVILLE and WILBUR WRIGHT'S EARLY LIFE

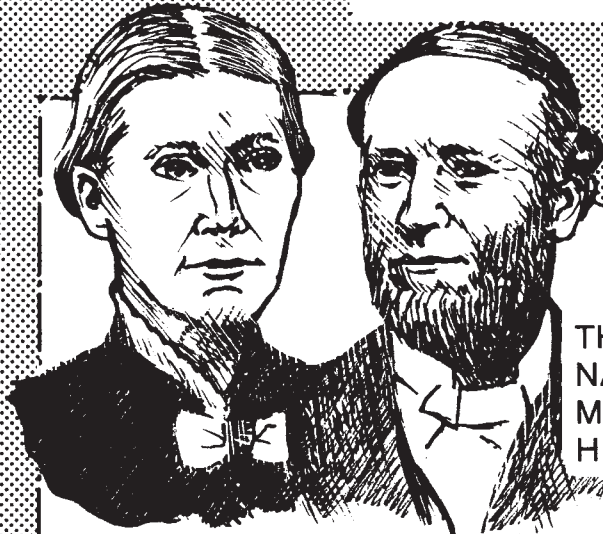

THEIR FATHER'S  
NAME WAS  
MILTON WRIGHT.  
HE WAS A MINISTER.

WILBUR WAS BORN  
IN 1867.

THEIR MOTHER'S  
NAME WAS  
SUSAN CATHERINE  
KOERNER WRIGHT.

ORVILLE WAS BORN IN  
1871.

THEY FIRST BECAME INTERESTED  
IN FLYING AFTER THEIR FATHER  
GAVE THEM A TOY HELICOPTER.

AS YOUNG BOYS, THE WRIGHT  
BROTHERS WATCHED BIRDS  
AND BUILT AND FLEW KITES.



# SEEK A WORD

Find the words in the puzzle that were important to the Wright brothers.



OHIO

DAYTON

KITE

LANGLEY

CHANUTE

FLYER

FRANCE

ARMY

BICYCLES

GLIDER

NEWSPAPER

PATENT

## THE WRIGHT BROTHERS GROW UP

ORVILLE AND WILBUR WRIGHT BOTH FINISHED HIGH SCHOOL. NEITHER OF THEM WENT TO COLLEGE.

ORVILLE BUILT HIS OWN PRINTING PRESS WHILE HE WAS IN HIGH SCHOOL. WILBUR JOINED ORVILLE AND PRINTED A NEWSPAPER.

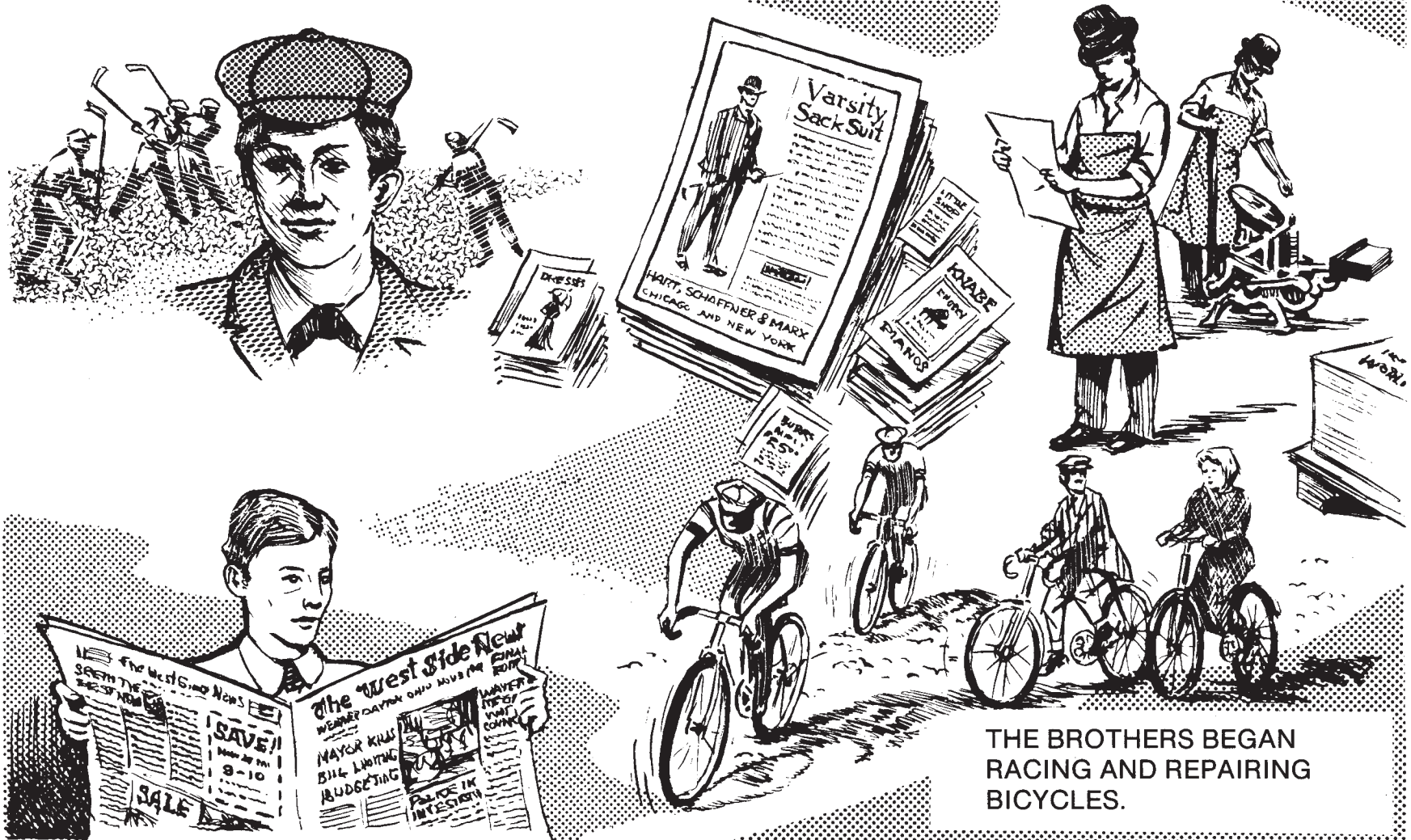

THE BROTHERS BEGAN RACING AND REPAIRING BICYCLES.

# MATH TREASURE HUNT

Follow the directions to find the answer to the Treasure Question—How long did the Wright *Flyer* stay in the air on its first flight?

WRITE THE NUMERALS..... DO YOUR WORK HERE!

(1) The year of the first flight \_\_\_\_\_

ADD

(2) The number of letters of the town where that flight took place \_\_\_\_\_

SUBTRACT

(3) The year Wilbur was born \_\_\_\_\_

DIVIDE BY

(4) Five \_\_\_\_\_

MULTIPLY BY

(5) The number of words in the state where the first flight took place \_\_\_\_\_

ADD

(6) The day of the month of the first flight \_\_\_\_\_

MULTIPLY BY

(7) The number of letters in the first name of the oldest brother \_\_\_\_\_

SUBTRACT

(8) The number that stands for bicentennial \_\_\_\_\_

ADD

(9) The number of wings on the *Flyer* \_\_\_\_\_

ANSWER \_\_\_\_\_ seconds

**1892** THE WRIGHT BROTHERS OPENED A BICYCLE SHOP.  
THEY BEGAN TO BUILD AND REPAIR BICYCLES.

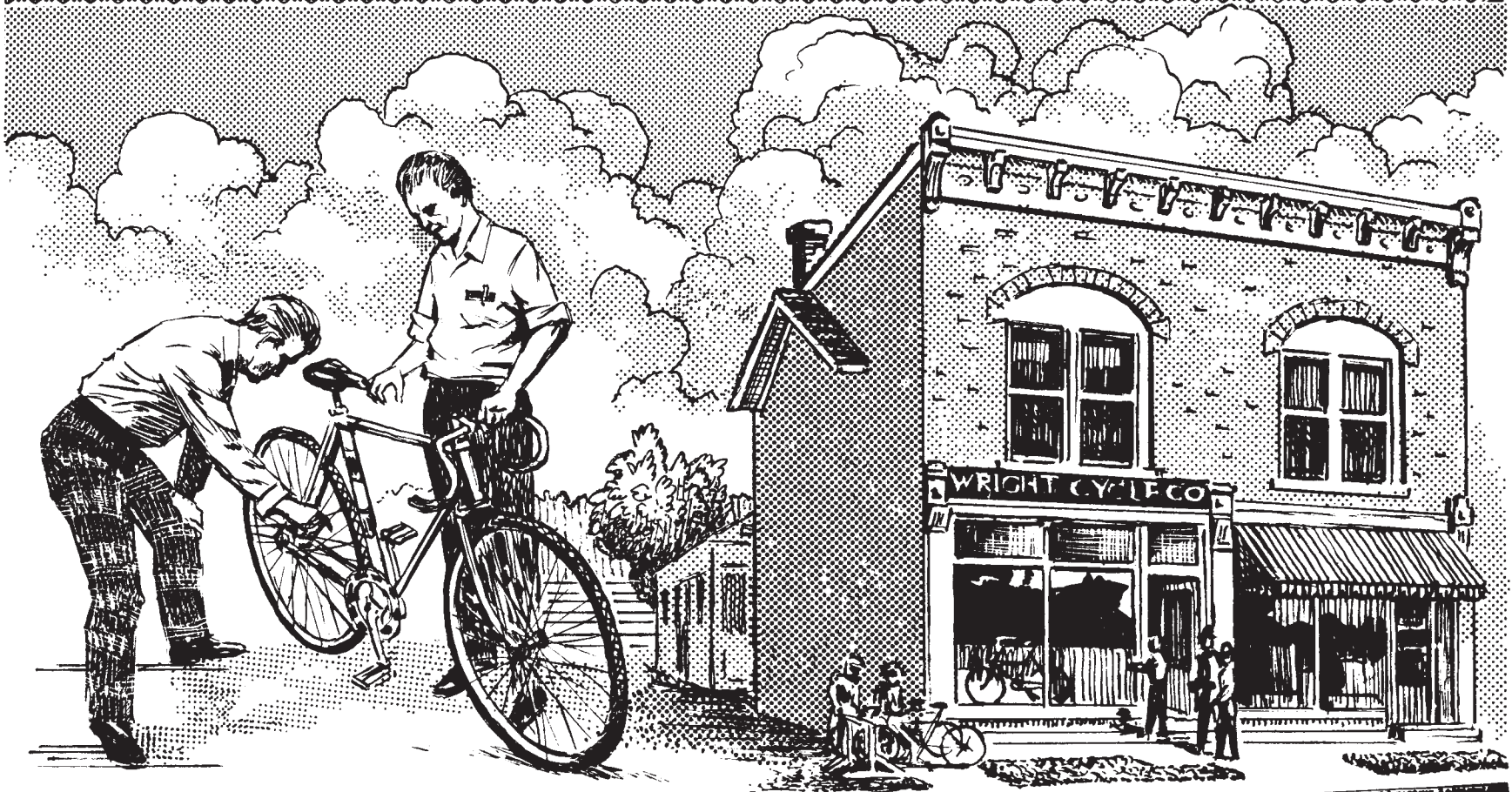

LATER ON, THE BICYCLE SHOP WAS USED TO WORK ON THEIR GLIDERS  
AND AIRPLANES.

How many words can you make from WILBUR and ORVILLE WRIGHT?

Nouns (naming words)	Verbs (doing words)	Adjectives & Adverbs (describing words)



1899

THE WRIGHT BROTHERS DECIDED TO  
STUDY FLYING.

THEY RECEIVED INFORMATION WRITTEN BY...

*Samuel Pierpont Langley and Octave Chanute*

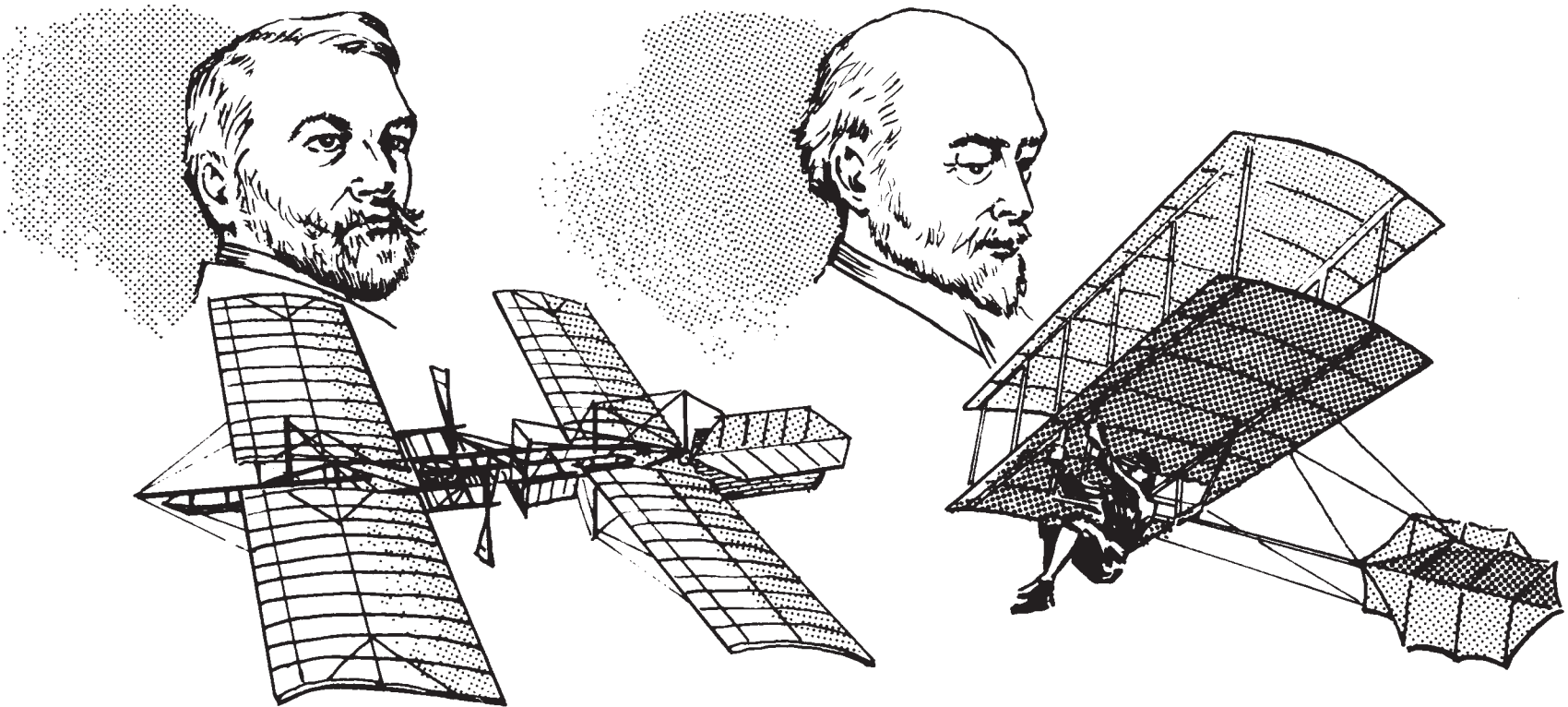

AFTER READING ALL THEY COULD FIND ABOUT FLIGHT,  
THE WRIGHT BROTHERS DECIDED TO BUILD A GLIDER.

# COPY THE WRIGHT GLIDER

Use the blank grid to draw your own Wright glider.

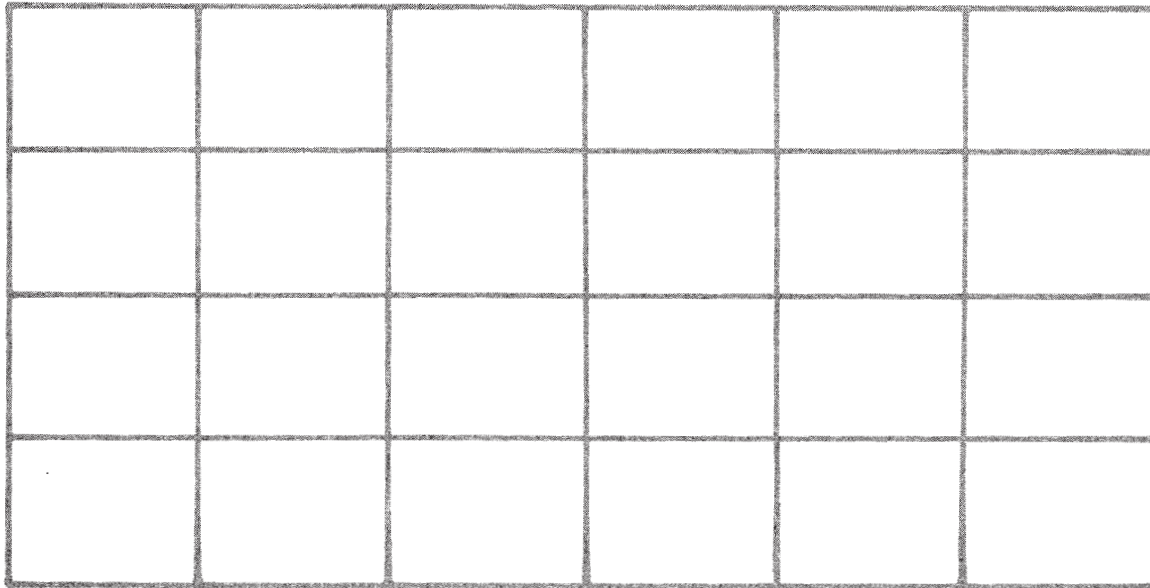
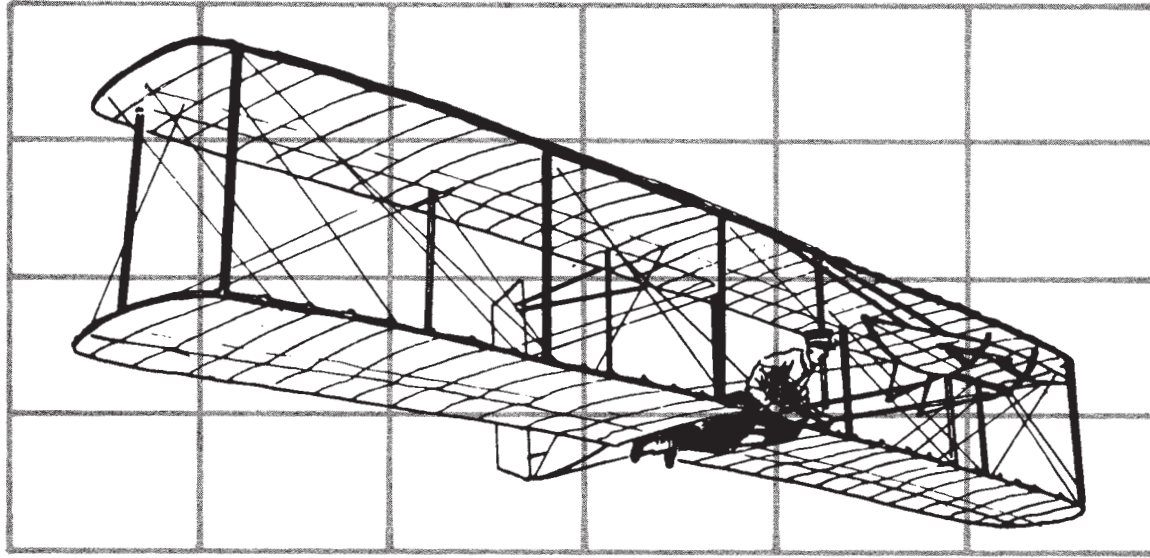

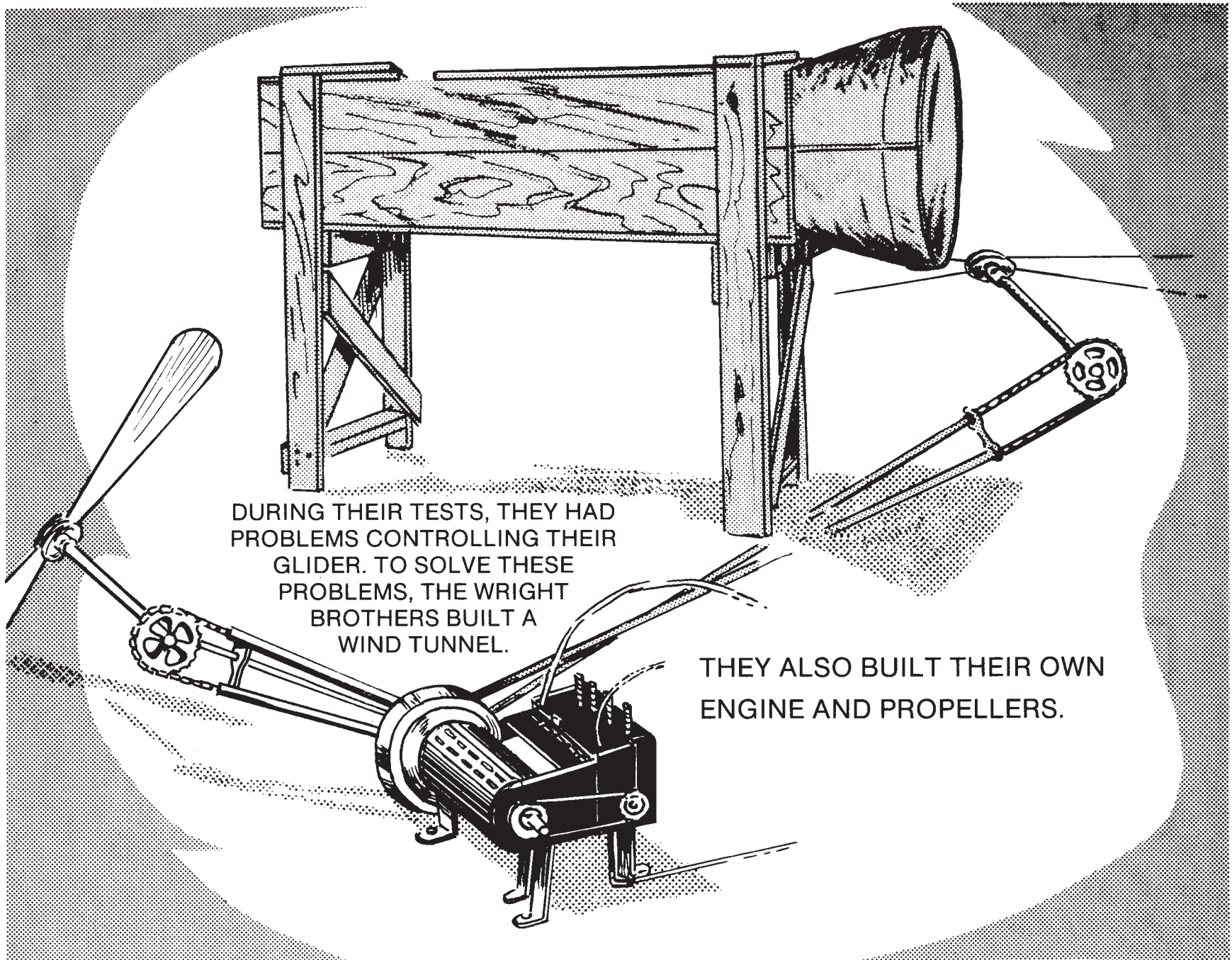

DURING THEIR TESTS, THEY HAD PROBLEMS CONTROLLING THEIR GLIDER. TO SOLVE THESE PROBLEMS, THE WRIGHT BROTHERS BUILT A WIND TUNNEL.

THEY ALSO BUILT THEIR OWN ENGINE AND PROPELLERS.

**HELP THE WRIGHT BROTHERS FIND THEIR WAY TO  
KITTY HAWK**

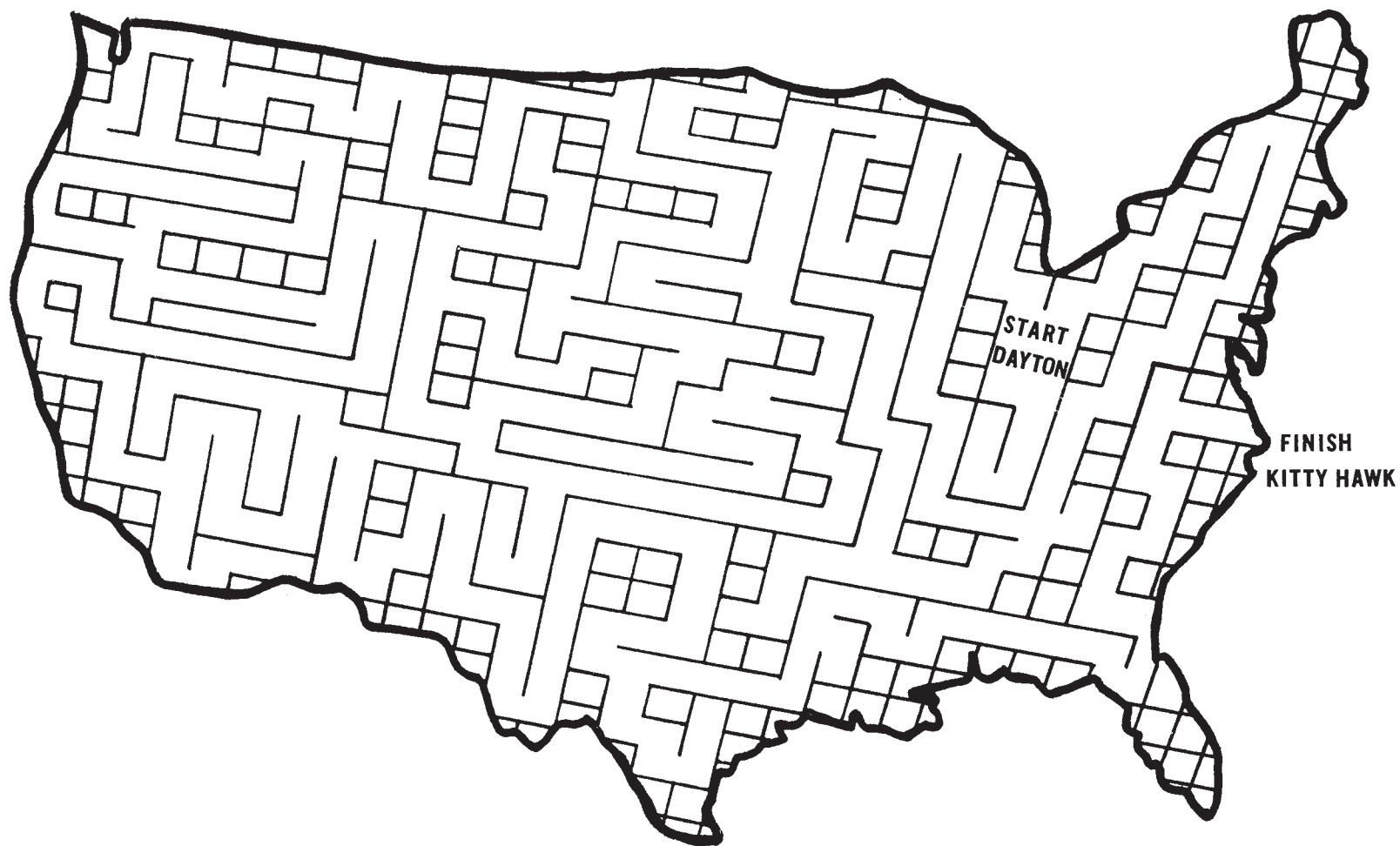

THEY NEEDED A PLACE WHERE THE WIND WAS STRONG AND STEADY TO TEST THEIR GLIDER. THE WEATHER BUREAU SUGGESTED THE SAND DUNES AROUND KITTY HAWK, NORTH CAROLINA.

1901

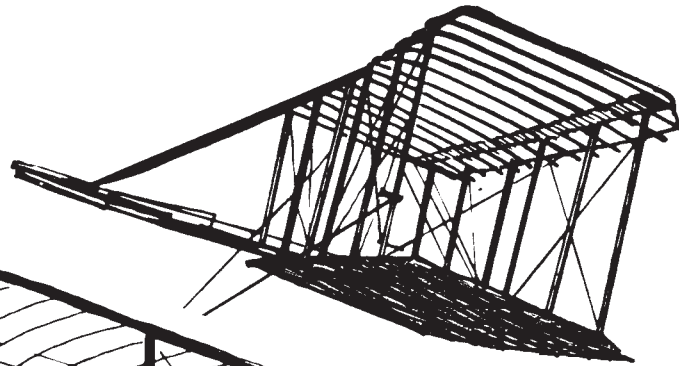

1902

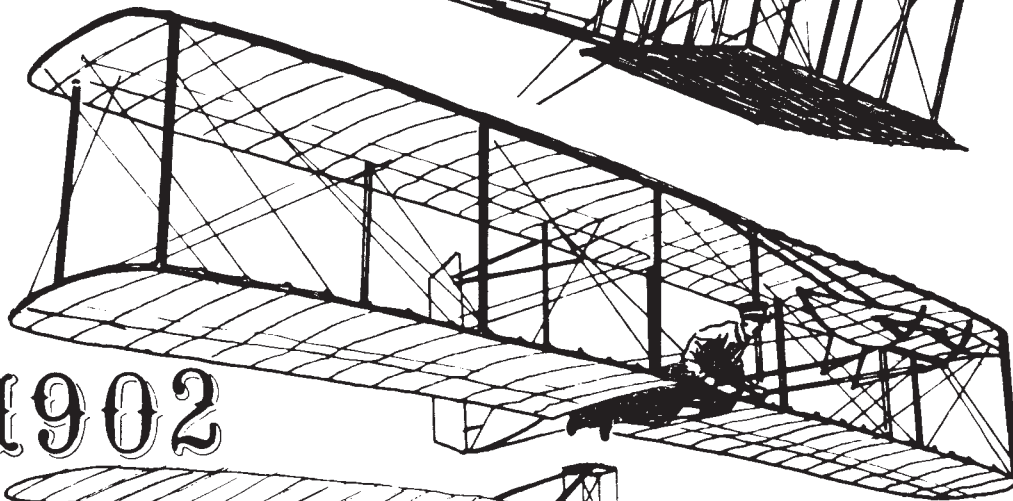

1903

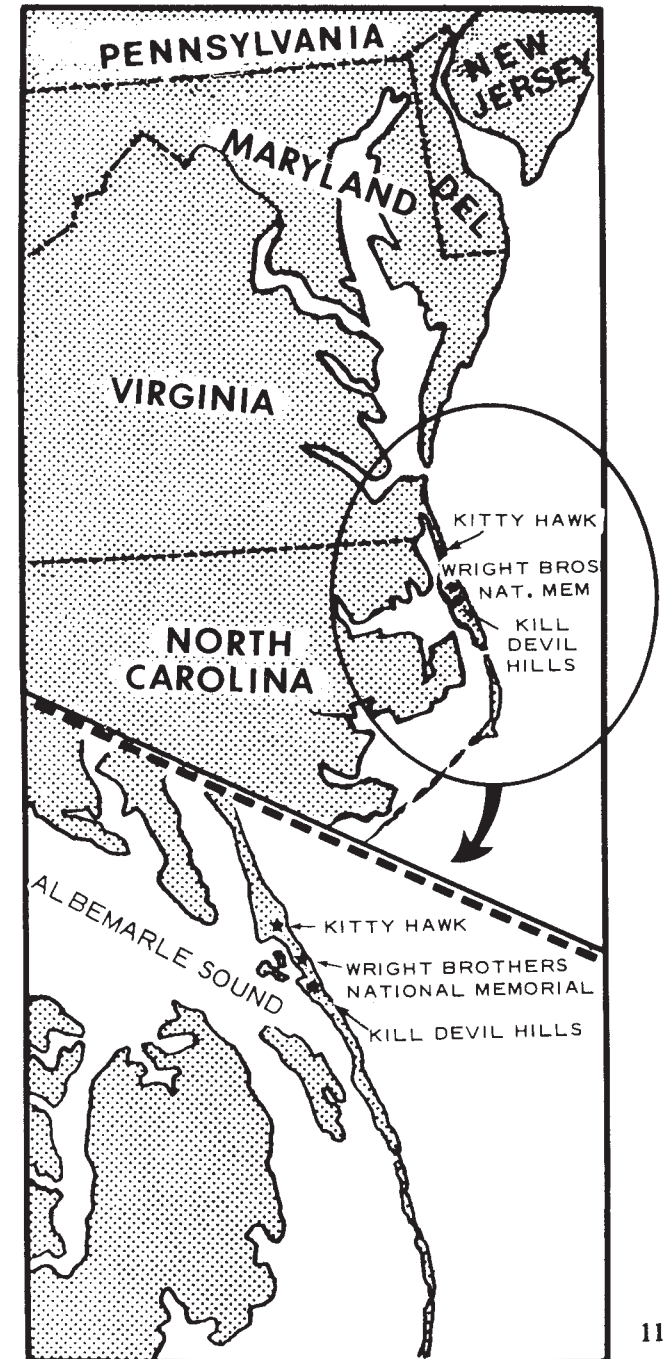
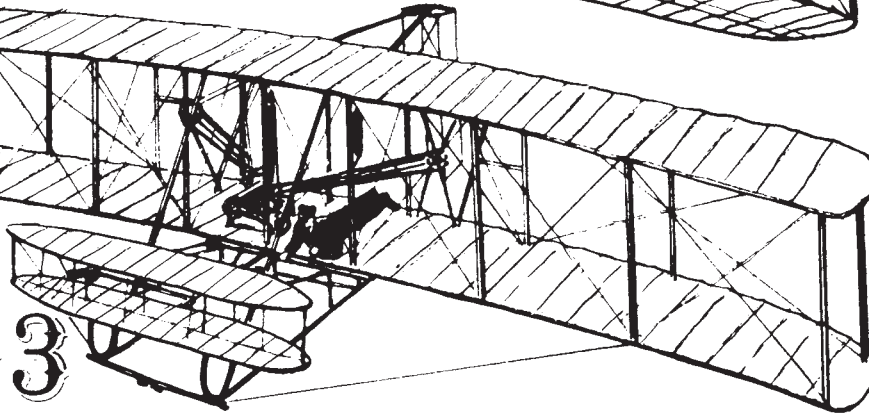

# MAKE A WORD

Add and subtract letters to discover important things and people in the Wright brothers' work in aviation.

1. window - ow tundra - dra + nellie - lie = \_\_\_\_\_  
\_\_\_\_\_

2. October - ober + a + vent - nt Chanel - el + u + ten - n = \_\_\_\_\_  
\_\_\_\_\_

3. biology - ology + cycling - ing + e cream - eam + maze - m = \_\_\_\_\_  
\_\_\_\_\_

4. grass - r - s + oh - h + line english - lish + marine - mar = \_\_\_\_\_  
\_\_\_\_\_

5. pow wow - wow + ere + deed - eed fly - y + mighty - m - y = \_\_\_\_\_  
\_\_\_\_\_

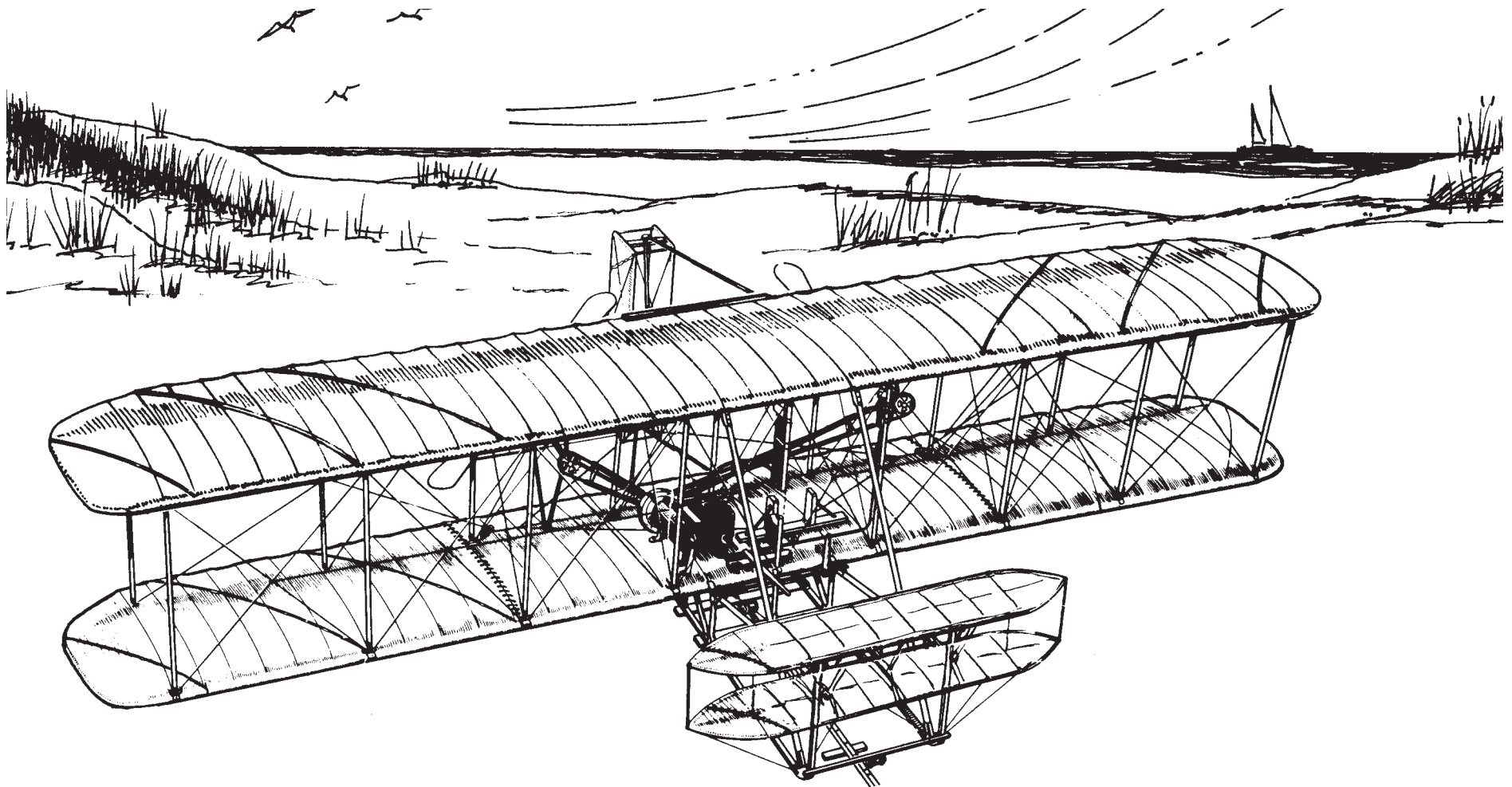

IN THE WINTER OF 1903, THE WRIGHT BROTHERS RETURNED TO NORTH CAROLINA WITH THEIR AIRPLANE WHICH THEY NAMED THE *FLYER*.

# The 1903 Wright *Flyer*

ON DECEMBER 17, 1903, THE *FLYER* FLEW SUCCESSFULLY.

THIS WAS THE FIRST CONTROLLED POWERED FLIGHT OF A HEAVIER-THAN-AIR AIRPLANE IN HISTORY.

# THE WRIGHT *FLYER* CROSSWORD PUZZLE

## ACROSS

1. The last name of Wilbur.
3. Another word for breezy.
5. A famous museum in Washington, D.C.
6. The brother of Wilbur.
7. Another word for creation or discovery.
9. \_\_\_\_\_ Carolina.
10. The month in which the first controlled powered flight of a heavier-than-air airplane took place.
12. Go fly a \_\_\_\_\_
13. Paris, \_\_\_\_\_
14. The season the first controlled powered flight of a heavier-than-air airplane took place.

## DOWN

2. One, \_\_\_\_\_, three, etc.
4. Opposite of no.
6. Dayton, \_\_\_\_\_
7. Opposite of out.
8. Another name for a hotel, motel, or lodge.

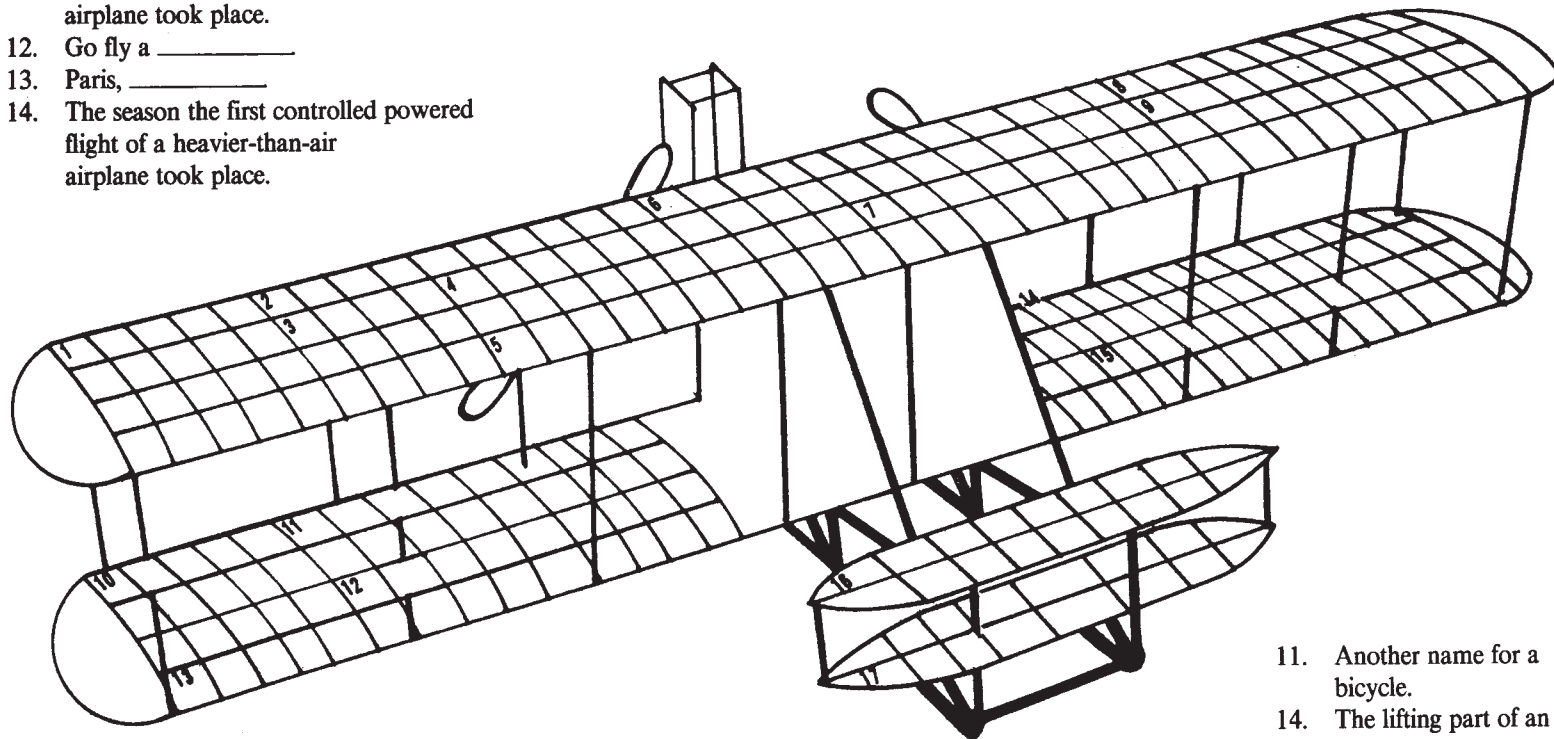

15. The state where Kitty Hawk is located.
16. Samuel Pierpont \_\_\_\_\_
17. Octave \_\_\_\_\_

11. Another name for a bicycle.
14. The lifting part of an airplane.



In 1908, the Wrights signed a contract to conduct flight tests for the U.S. Army. The tests were successful and the Army bought one of their airplanes.

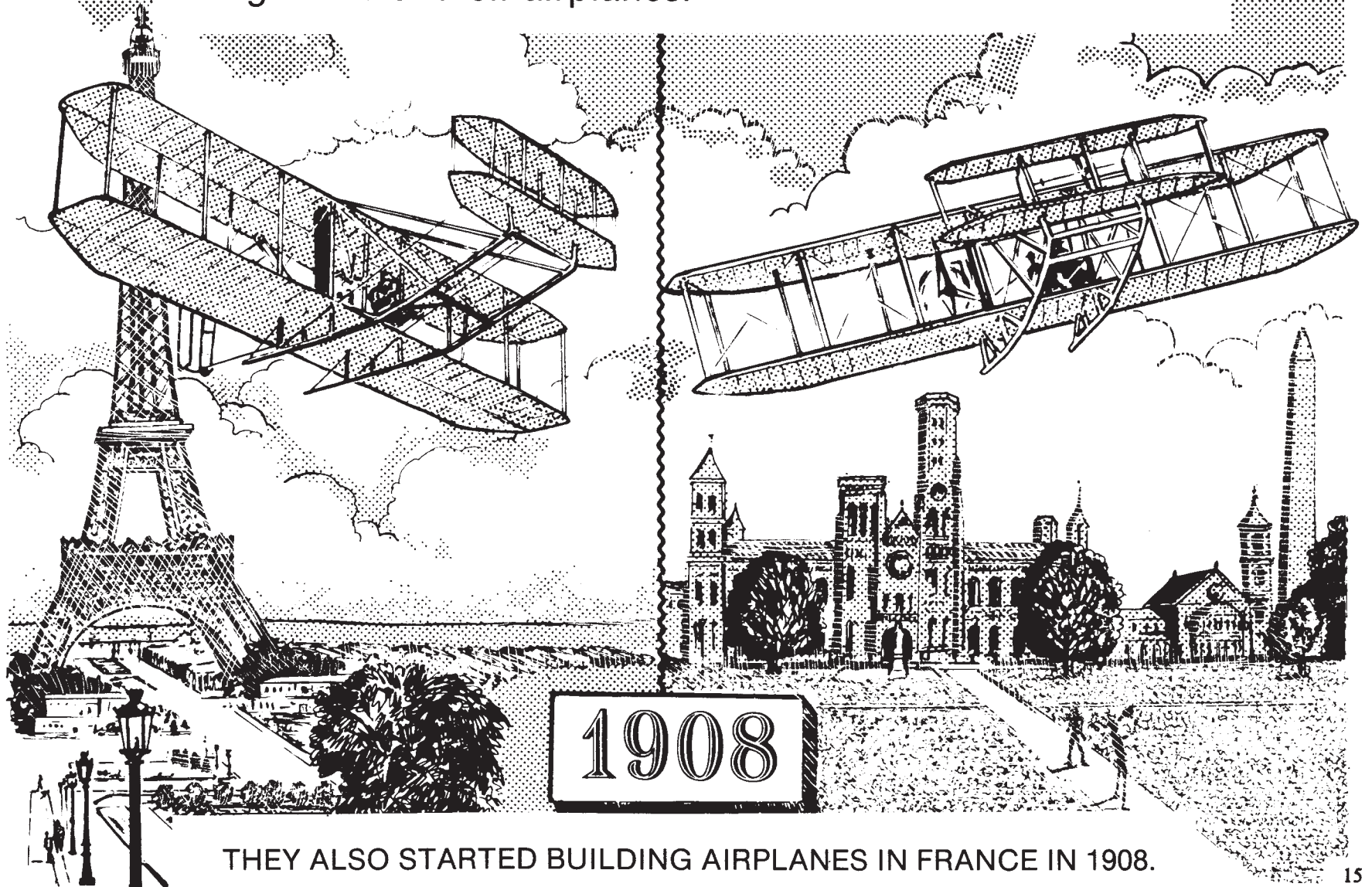

THEY ALSO STARTED BUILDING AIRPLANES IN FRANCE IN 1908.

# NUMBER CHALLENGE

Using important dates in the Wright brothers' lives, reorganize each number to make the highest number you can.

1903

\_\_\_\_\_

1917

\_\_\_\_\_

1915

\_\_\_\_\_

1909

\_\_\_\_\_

1910

\_\_\_\_\_

1908

\_\_\_\_\_

1907

\_\_\_\_\_

For added fun, add them all up. Now, what is the total number? \_\_\_\_\_

Can you write it in words? \_\_\_\_\_

THE WRIGHT BROTHERS  
STARTED A NEW APPROACH  
TO AVIATION.

WILBUR DIED IN MAY 1912.

ORVILLE WORKED IN HIS PRIVATE  
LABORATORY UNTIL HE DIED IN  
JANUARY 1948.

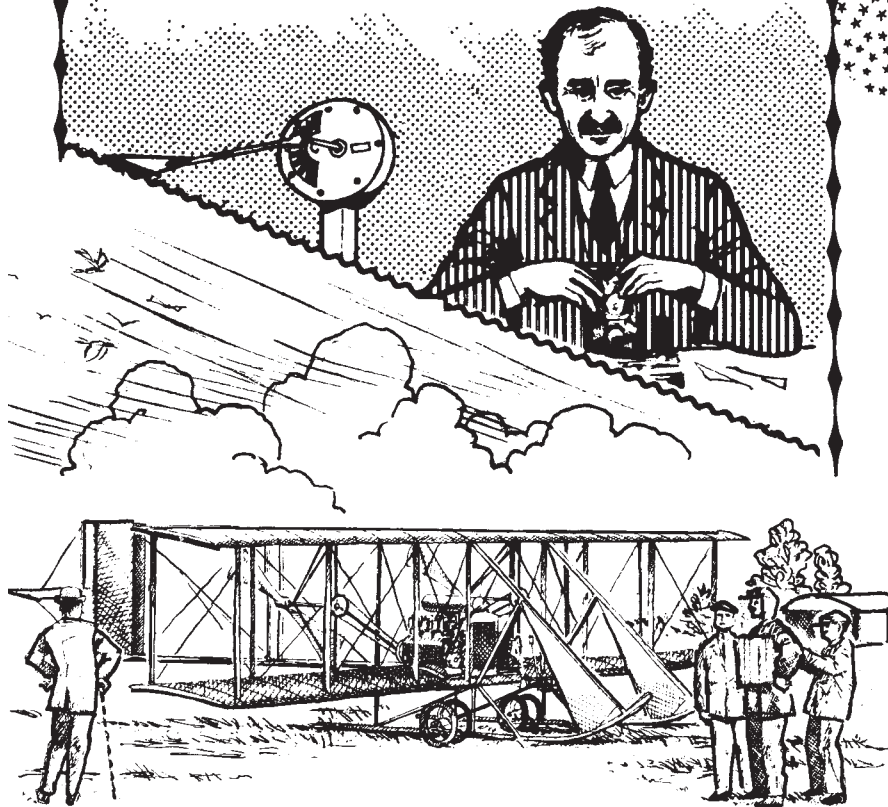

WRIGHTS' 1909 IMPROVED VERSION HAD A  
30-HORSEPOWER ENGINE.



POSTER SHOWING THE  
FIRST INTERNATIONAL AVIATION  
MEET IN THE UNITED STATES. 17

# WRIGHTS' MEMORIAL

Fill in the puzzle with the things shown in the picture.

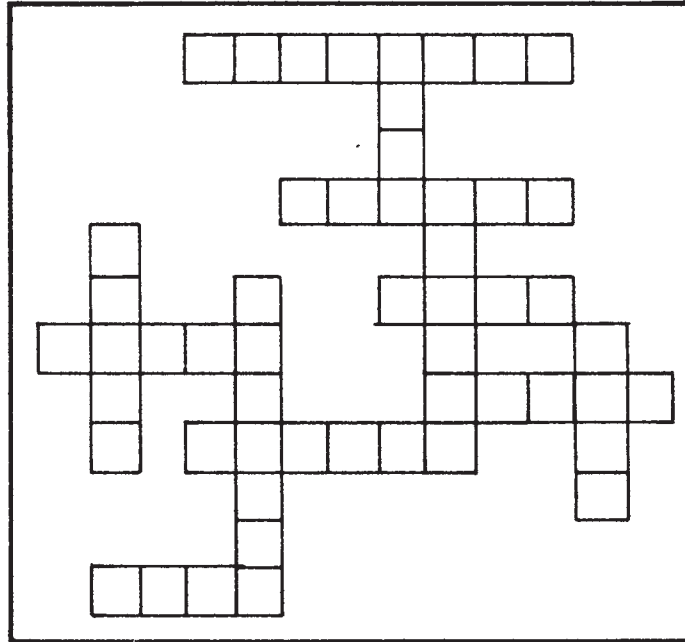

ORVILLE EAGLE KITE HANGAR CLOUD MONUMENT  
WILBUR WING FLAG GLIDER MOTOR MOON

# Wilbur and Orville Wright

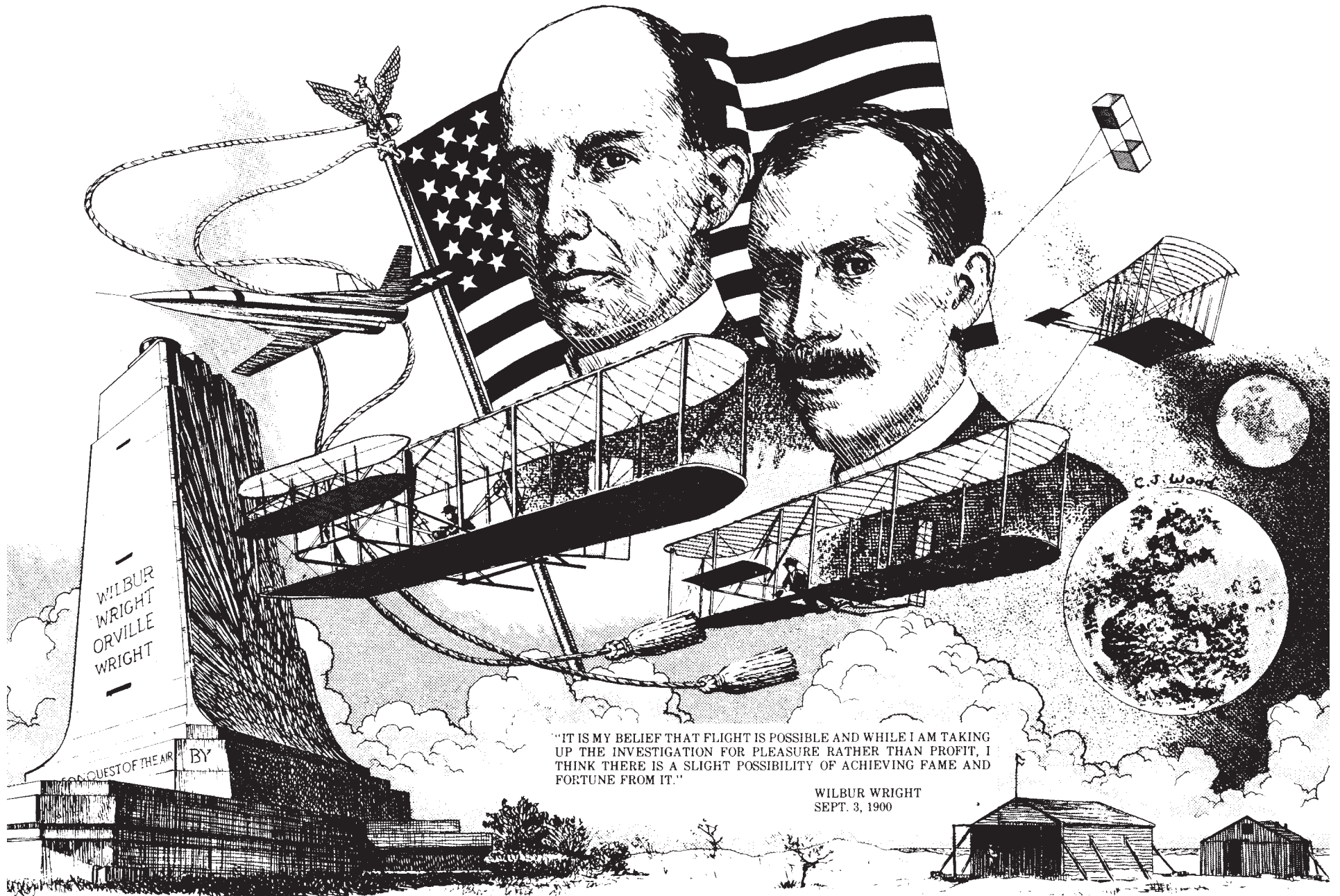

"IT IS MY BELIEF THAT FLIGHT IS POSSIBLE AND WHILE I AM TAKING UP THE INVESTIGATION FOR PLEASURE RATHER THAN PROFIT, I THINK THERE IS A SLIGHT POSSIBILITY OF ACHIEVING FAME AND FORTUNE FROM IT."

WILBUR WRIGHT  
SEPT. 3, 1900

# ANSWERS TO ACTIVITIES

Pg. 2 SEEK A WORD

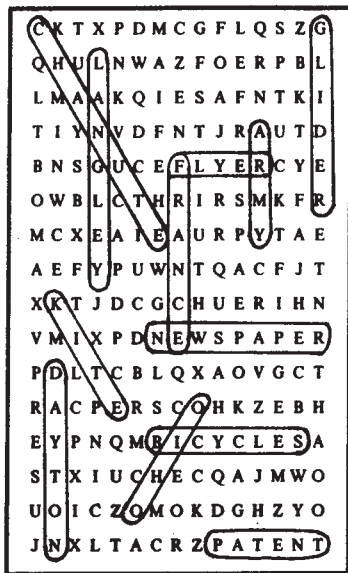

Pg. 4 MATH TREASURE HUNT

$1903 + 9$  (Kitty Hawk) =  $1912 - 1867 = 45 \div 5 = 9 \times 2$  (North Carolina)  
 $= 18 + 17 = 35 \times 6$  (Wilbur) =  $210 - 200 = 10 + 2 = 12$   
 Answer — 12 Seconds

Pg. 12 MAKE A WORD

- 1) wind tunnel 2) Octave Chanute 3) bicycle craze
- 4) gasoline engine 5) powered flight

Pg. 10 HELP THE WRIGHT BROTHERS FIND THEIR WAY TO KITTY HAWK

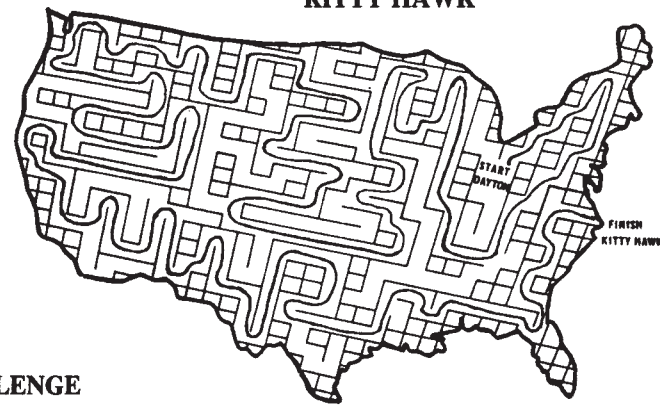

Pg. 16 NUMBER CHALLENGE

$9310, 9711, 9511, 9910, 9110, 9810, 9710$   
 Total = 67,072 — sixty-seven thousand and seventy-two

Pg. 14 THE WRIGHT FLYER CROSSWORD PUZZLE

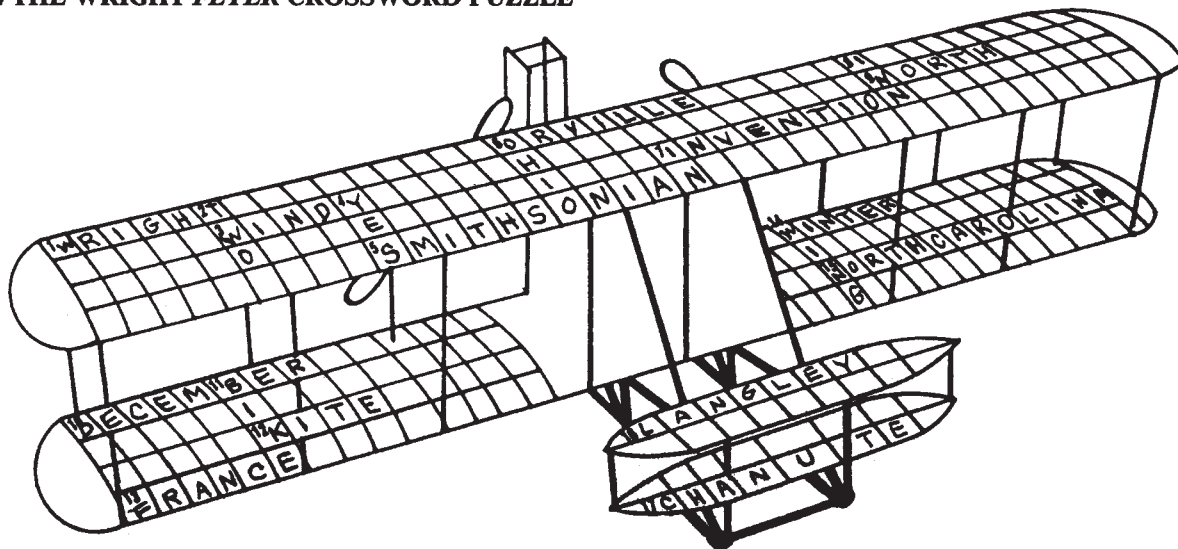

Pg. 18 WRIGHTS' MEMORIAL

