

7.2.1.2 Environmental Opportunities and Constraints Analysis

As previously discussed, the No-Action alternative assumes that projects described in Chapter 6, Maintenance and Repair, would be implemented and that additional Santa Margarita River flows would be released as specified in the 2001 settlement with the Rancho California Water District.

Because the No-Action alternative was created as a baseline condition against which other project alternatives could be compared and, therefore, represents conditions as they exist (except as specified above) prior to implementation of one or more of the engineering alternatives described in this document, this alternative would result in no new ground disturbance or construction. Accordingly, the environmental conditions described in Chapter 3 are existing conditions and not constraints to the No-Action alternative.

7.2.1.3 Surface Water Model Analysis for Alternative 1

A reservoir operations model was used to estimate the diversions from the Santa Margarita River to both the recharge ponds and Lake O'Neill. The model used 1980 to 1999 hydrology and future streamflow augmentation in order to construct streamflow at a point below the confluence of DeLuz Creek and the Santa Margarita River (Chapter 4). Applying daily estimates of streamflow and historical measurements of precipitation and evaporation, the reservoir operations model was used to predict the daily diversion during the historical period. The same model was also used to estimate daily diversion rates in Alternatives 2 through 4, based on improvements and expansion of the existing diversion facilities.

Limitations to the diversion rate from the Santa Margarita River accounted for in the reservoir operations model included not only the available water supply and physical limitations of the diversion facilities, but also such factors as available water rights, recharge pond infiltration rates, rainfall, evaporation, and spill from both the ponds and the lake. The Alternative 1 reservoir operations model also accounted for augmented surface flows and increased diversion efficiencies due to the maintenance and repair projects recommended in Chapter 6. Results from the model analysis were used by the ground-water model to estimate recharge at the ponds, streamflow past the diversion point, and releases from Lake O'Neill.

Diversions to Lake O'Neill and the recharge ponds were simulated in the reservoir operations model in order to establish baseline conditions. Simulated diversions to Lake O'Neill and the recharge ponds were estimated based on the limitations of the existing 1,500 AFY water right for diverting to Lake O'Neill and the 4,000 AFY license for diverting to the recharge ponds, complimented by the increased efficiency from the maintenance and repair of the relocated

headwall and headgate. The diversion channel was assumed to divert a maximum of 60 cfs, based on the size of the culverts in the upper road crossing that impose flow restrictions. A schematic diagram of the reservoir operations model is shown in Figure 7-1. During periods of diversion, three cfs remains in the Santa Margarita River while the remaining surface flow may be diverted to either Lake O'Neill or to the recharge ponds. The simulated diversion to Lake O'Neill is limited to 20 cfs, while the maximum simulated diversion to the recharge ponds is 60 cfs.

The timing and quantity of diversions in the Alternative 1 reservoir operations model obeys certain constraints with respect to the filling and draining of Lake O'Neill.

- Beginning November 1st of every year, the lake is drained at a rate of 20 cfs. The drained flow leaves the lake through a pipe and into a channel flowing towards the Santa Margarita River. The water drained from the lake is recaptured by ground-water recovery wells located down-gradient of the release point. Draining terminates once the volume of Lake O'Neill approaches 100 AF.
- Water is diverted to Lake O'Neill between December 1st and March 31st. Between April and October, precipitation and evaporation act to raise and lower the water levels in the lake during this period.
- The reservoir operations model commences the use of the Pre-1914 water right from December 1st to March 31st. The Pre-1914 water right allows for 1,500 AFY to be diverted from the Santa Margarita River to Lake O'Neill, at a maximum diversion rate of 20 cfs. During this time, Lake O'Neill may approach its capacity of 1,200 AF, and on occasion will spill out of the lake via a spillway located on its western side. The effects of precipitation and evaporation are applied such that in dry years it may take slightly over 1,200 AF to fill the lake, while in wet years it may take less than 1,200 AF.

Alternative 1 operations model allows for the filling of Lake O'Neill exclusively from water diverted from the Santa Margarita River. Fallbrook Creek is allowed to bypass Lake O'Neill completely, helping to recharge the ground-water basin below the percolation ponds. The Pre-1914 water right is fully maximized at least once every five years and is only dependent upon the non-winter baseflow of the Santa Margarita River. Once Lake O'Neill has completed filling, water in O'Neill Ditch is then directed to the recharge ponds.

The diversion schedule to Lake O'Neill and the recharge ponds, as dictated by the existing license and vested water right, is described in Table 7-3.

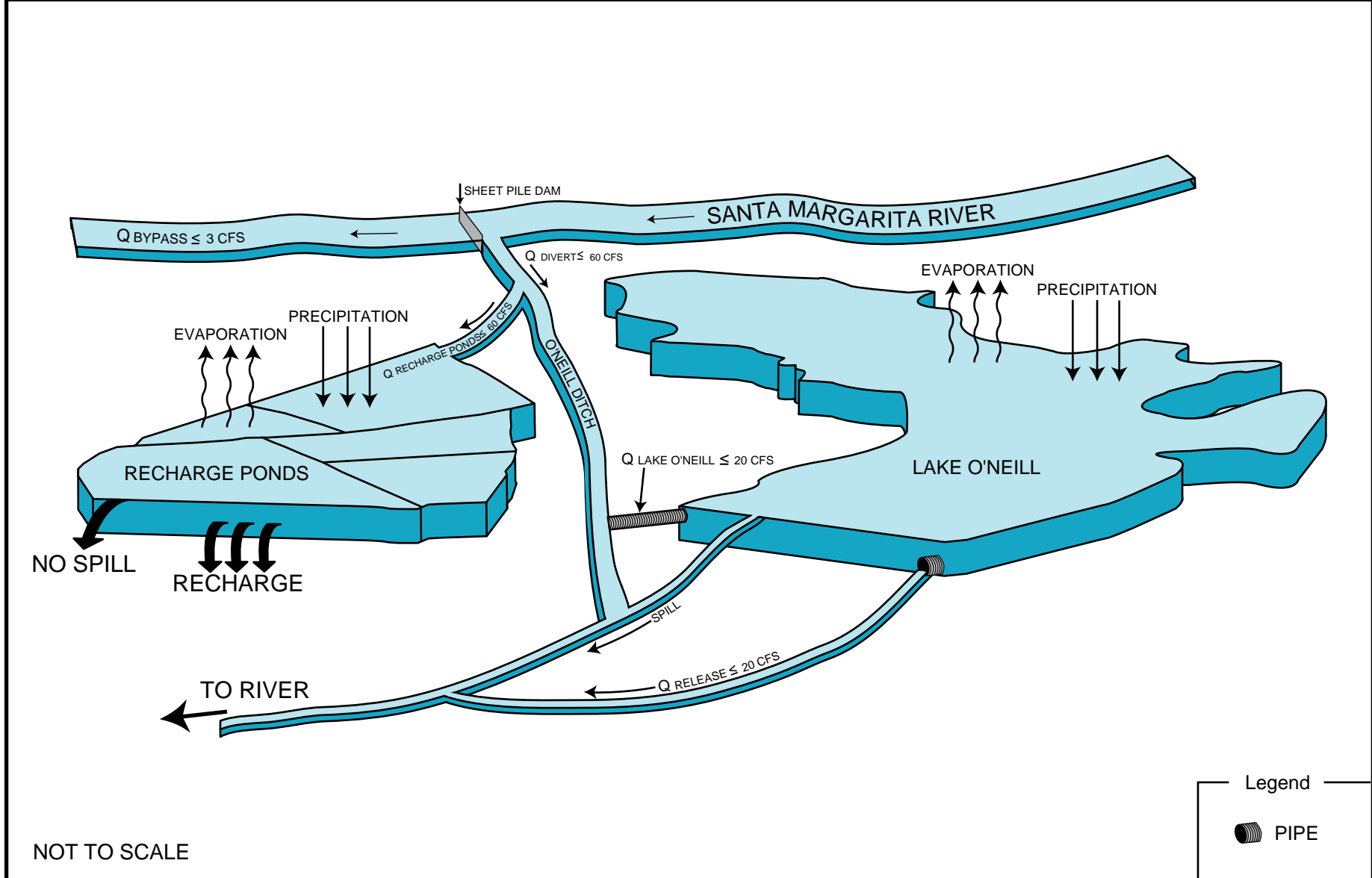

	<p>Surface Water Analysis Reservoir Operations Model</p>	<p>Alternative 1 No Project</p>
---	--	-------------------------------------

FIGURE 7-1

TABLE 7-3
ALTERNATIVE 1 DIVERSION SCHEDULE TO THE
RECHARGE PONDS

Month	Activity	Rate	Limit	Water Right
Diversions to Lake O’Neill				
Nov	Drain	$Q_{\text{release}} \leq 20 \text{ cfs}$	Min Volume = 100 AF	N/A
Dec to March	Fill	$Q_{\text{Lake O'Neill}} \leq 20 \text{ cfs}$	1,500 AF	Pre-1914 Water Right
April to Oct	Precip -Evap	$Q_{\text{spill}} = f(\text{precip-evap})$	N/A	N/A
Diversions to Recharge Ponds				
Nov	Fill w/ 100% Q_{divert}	$Q_{\text{recharge ponds}} \leq 60 \text{ cfs}$	No Spill	License 21471 A
Dec to March	Fill w/ $Q_{\text{divert}} - Q_{\text{lake O'Neill}}$	$Q_{\text{recharge ponds}} \leq 60 \text{ cfs}$	No Spill	License 21471 A
May to June	Fill w/ Q_{divert}	$Q_{\text{recharge ponds}} \leq 60 \text{ cfs}$	No Spill	License 21471 A
July to Sept	No Diversion	$Q_{\text{recharge ponds}} = 0 \text{ cfs}$	N/A	N/A
Oct	Fill w/ Q_{divert}	$Q_{\text{recharge ponds}} \leq 60 \text{ cfs}$	No Spill	License 21471 A

Applying these constraints to the augmented streamflow, the reservoir operations model estimated that 4,000 AFY could have been diverted to the recharge ponds every year during the historical calibration period, and 1,500 AFY could have been diverted to Lake O'Neill every year. The simulated annual diversions to Lake O'Neill and the recharge ponds are shown in Table 7-4. Once the recharge ponds are full, diversion from the Santa Margarita River is limited to a prescribed flow rate, as a function of infiltration, for each of the five ponds so no spilling from the ponds occurs. The daily infiltration rates vary with each pond for each month (refer to Section 4.7.4).

TABLE 7-4
ALTERNATIVE 1 DIVERSIONS TO THE RECHARGE PONDS AND LAKE O'NEILL (AFY)

Model Year	Pre-1914 Water Diverted to Lake O'Neill from Dec 1st-Mar 31st (AFY)	Alternative 1 Diversions to Recharge Ponds (AFY)	Total Diversions from the Santa Margarita River (AFY)
1	1,500	4,000	5,500
2	1,500	4,000	5,500
3	1,500	4,000	5,500
4	1,500	4,000	5,500
5	1,500	4,000	5,500
6	1,500	4,000	5,500
7	1,500	4,000	5,500
8	1,500	4,000	5,500
9	1,500	4,000	5,500
10	1,500	4,000	5,500
11	1,500	4,000	5,500
12	1,500	4,000	5,500
13	1,500	4,000	5,500
14	1,500	4,000	5,500
15	1,500	4,000	5,500
16	1,500	4,000	5,500
17	1,500	4,000	5,500
18	1,500	4,000	5,500
19	1,500	4,000	5,500
20	1,500	4,000	5,500
Total	30,000	80,000	110,000
Average	1,500	4,000	5,500
Median	1,500	4,000	5,500
Min	1,500	4,000	5,500
Max	1,500	4,000	5,500

A Camp Pendleton Public Works Survey Department drawing (1978) was used to construct a surface area to volume curve, which was used to calculate the change in storage (Appendix E). Fluctuations in the storage volume for Lake O'Neill, due to the effective evaporation and precipitation, may provide more room for the pre-1914 water dry years, or may cause spilling during wet years when rain is falling on the already full lake. Figure 7-2 shows a

Alternative 1: Operation of Lake O'Neil Model Years 9, 10, & 11

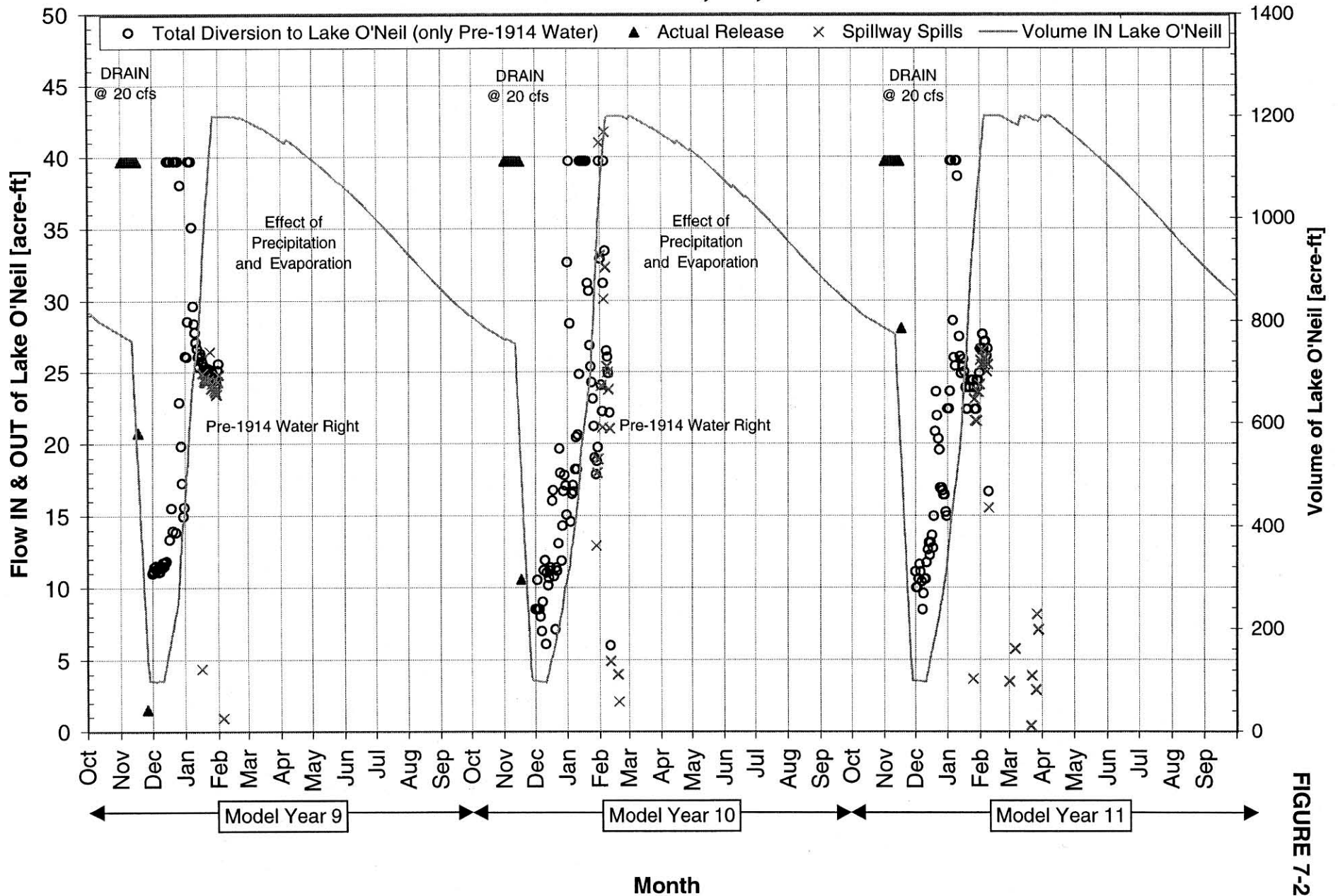

FIGURE 7-2

graphical example of the reservoir operations model output for Lake O'Neill for modeled water years 9-11.

Table 7-5 summarizes the results of the Alternative 1 reservoir operations model based on historical diversions to Lake O'Neill and diversions to the recharge ponds being a function of the 4,000 acre-foot water right license 21471A. The simulated time period is based on historical data for WY 1980-1999. The values presented in this table serve as the input to the MODFLOW ground-water model. Results from the streamflow analysis described in Chapter 4 and the Alternative 1 reservoir operations model indicate that the average flow of the Santa Margarita River was 55,860 AFY while the average diversion to the recharge ponds and Lake O'Neill was 5,500 AFY.

TABLE 7-5
ALTERNATIVE 1 – SUMMARY OF AUGMENTED BASELINE CONDITIONS

20-Year Simulated Period	SMR Augmented Flow (AF)	Total Diversion Max 60 cfs (AF)	Diversion to Lake O'Neill (AF)	Diversion to Recharge Ponds (AF)	Recharge to GW at Recharge Ponds (AF)	Net * Precip (+) Evap (-) (AF)
Total	1,117,110	110,000	30,000	80,000	80,203	-8,750
Average Annual	55,860	5,500	1,500	4,000	4,010	-440
Median Annual	30,740	5,500	1,500	4,000	4,010	-450
Min Annual	10,730	5,500	1,500	4,000	3,970	-480
Max Annual	226,230	5,500	1,500	4,000	4,060	-340

*Note: * Includes lake and pond surfaces.*

Augmentation to the streamflow due to the RCWD agreement added an average annual surface flow of 2,500 AF, allowing 4,000 AFY to be diverted to the recharge ponds during the entire period of record. The median flow in the river increased by over 3,000 AFY, also providing the necessary water supply for diversion to the recharge ponds.

7.2.1.4 Ground-Water Model Analysis for Alternative 1

The ground-water model analysis for Alternative 1 compares the expected results from conducting maintenance and repairs at the existing diversion system with the historical calibration run (Chapter 4). Alternative 1 with augmented streamflow, no wastewater, and completed maintenance and repair projects provides a baseline for comparison of Alternatives 2, 3, and 4. The result of the ground-water model simulation of Alternative 1 conditions is

compared to the historical 1980 to 1999 calibration in Table 7-6. Although the total budget between the two model runs is comparable in value, the quantity of Santa Margarita River streamflow, wastewater discharge, and diversion to recharge ponds varies greatly between the two runs.

The Model scenario for Alternative 1 considered a targeted annual diversions of 4,000 AFY to the existing five ground-water recharge ponds, and 1,500 AFY to Lake O'Neill historical pumping conditions, and no wastewater discharges or oxidation pond infiltration. The augmented streamflow has the largest impact on the water budget and tends to offset the increased diversions and discontinued wastewater releases. The Alternative 1 model scenario highlights the benefit of the existing baseline conditions over the historical 1980 to 1999 conditions.

Simulated water levels resulting from this baseline scenario were compared to the historical water levels produced during the calibration run and are presented in Figure 7-3. Consistent with the conceptual model, increased diversions to the recharge ponds resulted in elevated simulated ground-water levels in the Upper Ysidora during winter and spring months. The simulated monitoring well in the Lower Ysidora (10/5-35K5) showed a lower water level compared with the calibrated run but matched more closely with observed historical measurements (section 4.8) during summer months during drier years (MY 5, 6, 8, 10 and 11).

Comparison of the calibrated and Alternative 1 simulated streamflow at the Ysidora Gage near Basilone Road and at the Lower Ysidora is shown in Figure 7-4. The Model water budget results show an average annual increase of gaining stream conditions and decrease in losing stream conditions, yielding a net decrease in stream recharge. The increase in gaining stream conditions occurs at the narrows between the Upper Ysidora and the Chappo and in the Lower Ysidora. The occasional decrease in streamflow at the Lower Ysidora Model boundary is minimal (less than 1 cfs in most cases) and does not seem to adversely impact the riparian vegetation as shown by the extinction depth on the water level graph and the ET. The lowest water level reached by simulated well 10/5-35K5 is 16.57 feet, msl in October of MY 9. Historically water levels in this well have ranged from 16 to 25 (ground surface) feet msl.

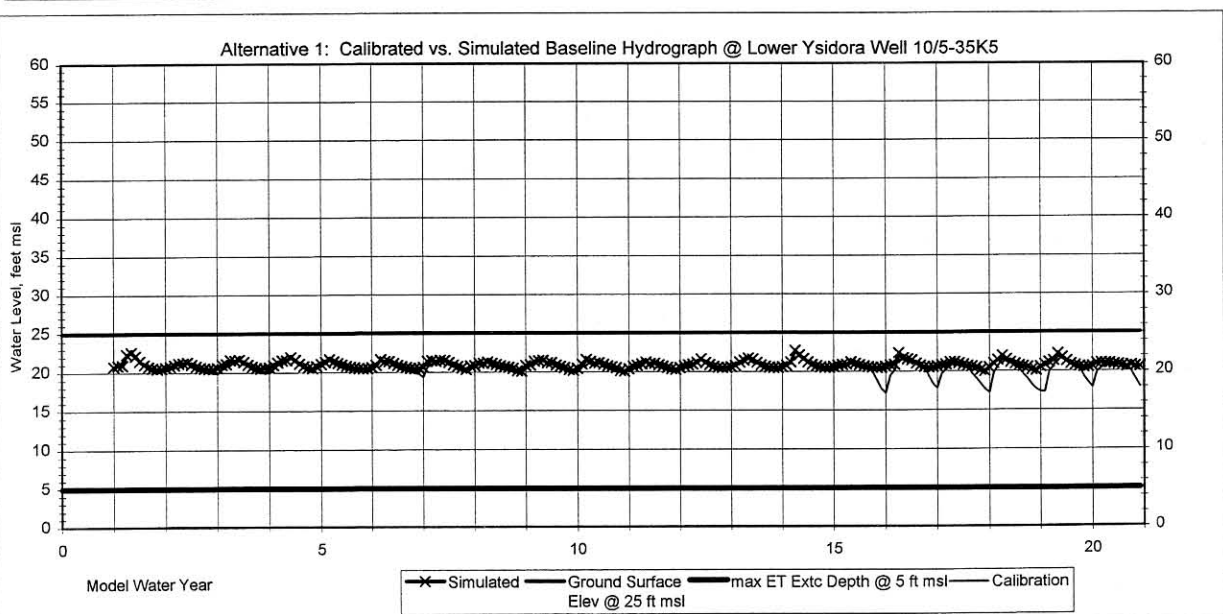
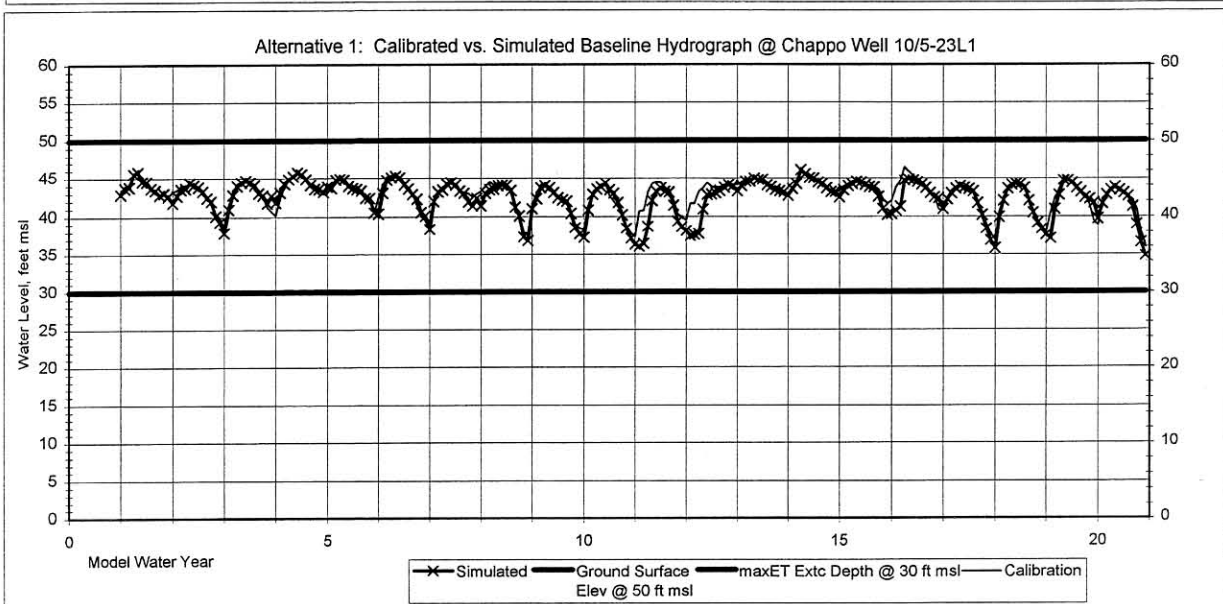
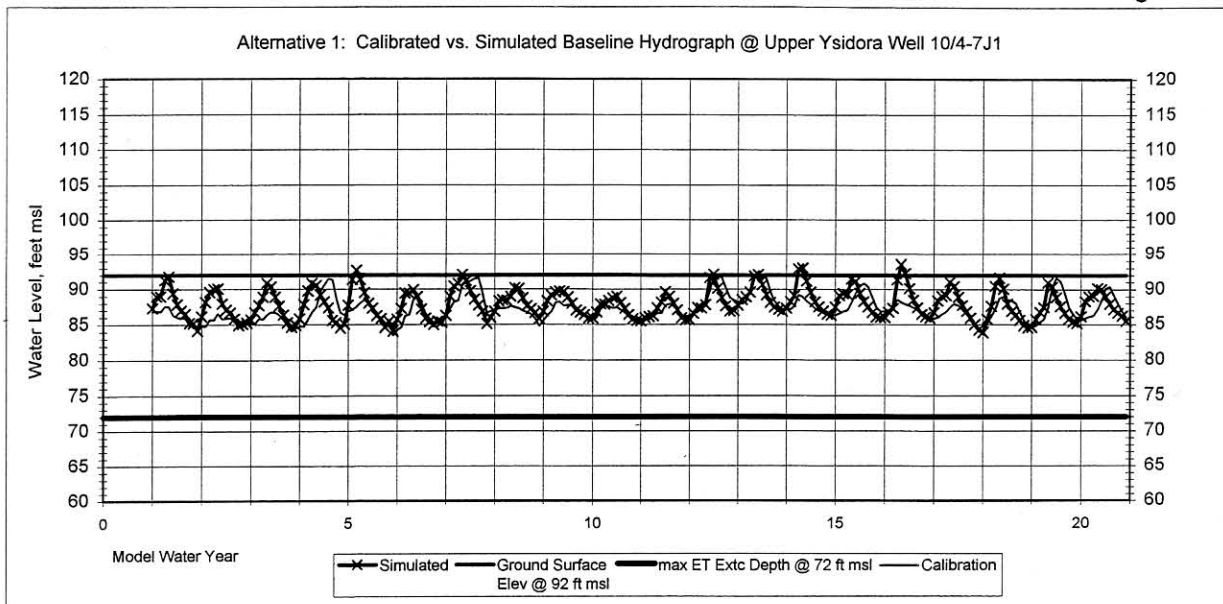

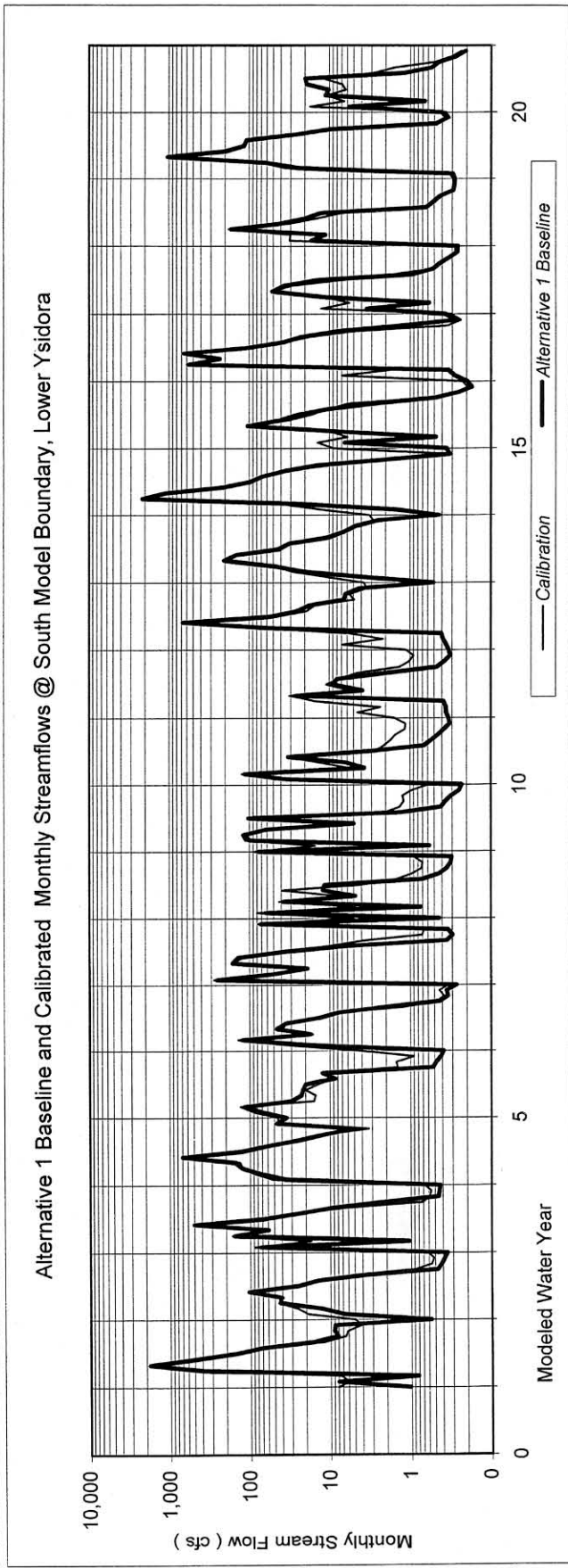
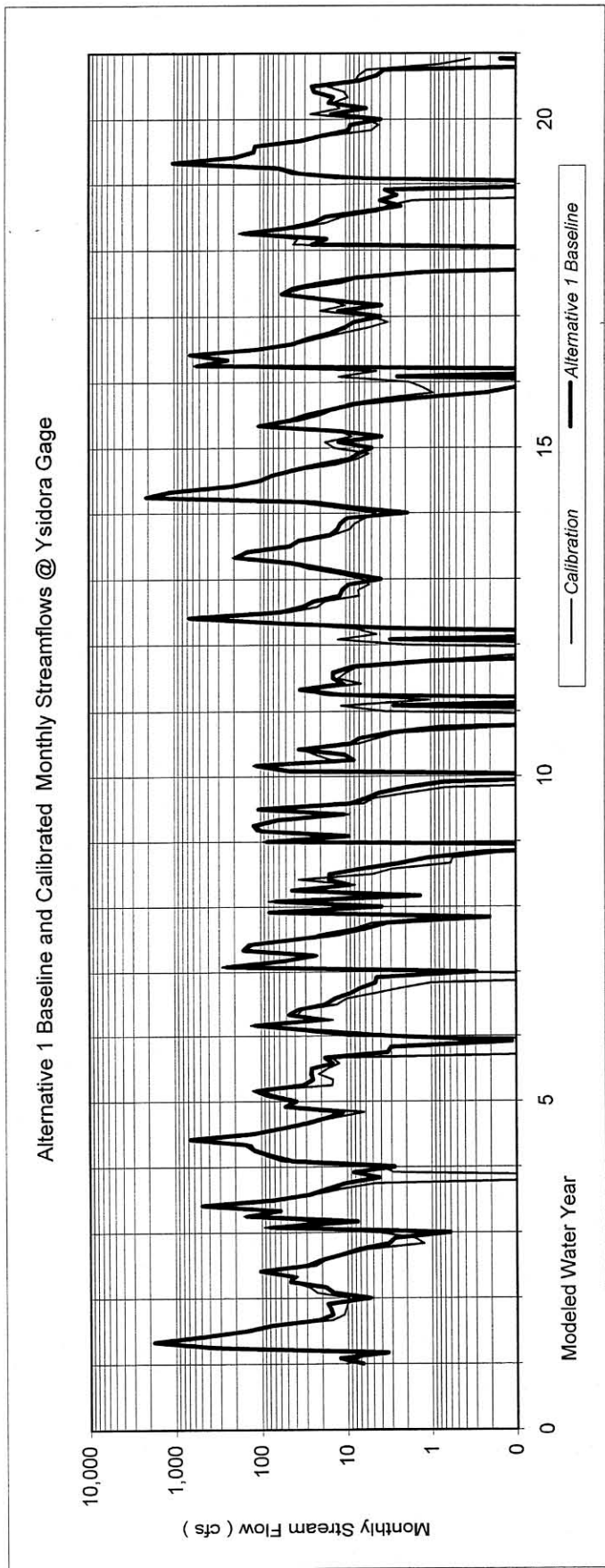

TABLE 7-6
ALTERNATIVE 1 -- AVERAGE ANNUAL WATER BUDGET FOR MY 1 - 20 (AF/WY)

		<u>Historical Calibration</u>		<u>Alt 1 - No Project; Maintnc & Repairs; Aug SMR Flows</u>	
		<u>Average Annual</u>	<u>Median Annual</u>	<u>Average Annual</u>	<u>Median Annual</u>
Inflow:	Subsurface Underflow	850	820	830	810
	Santa Margarita River Inflow	53,340	27,690	55,860	30,740
	Lake O'Neill Spill and Release	1,990	1,780	1,080	1,060
	Fallbrook Creek Bypass ¹	*	*	1,930	1,370
	Minor Tributary Drainages ¹	2,120	1,720	2,120	1,720
	Waste Water Discharge ¹	2,030	2,260	0	0
	Direct Precipitation	690	500	710	500
<i>Total Inflow:</i>		61,020	34,770	62,530	36,200
Outflow:	Subsurface Underflow	240	240	230	220
	Santa Margarita River Outflow	52,380	25,460	50,080	24,420
	Ground-Water Pumping	5,560	5,870	5,550	5,870
	Evapotranspiration	2,900	2,830	2,790	2,700
	Diversions to Lake O'Neill	490	430	1,500	1,500
	<i>Total Outflow:</i>		61,570	34,830	60,150
<i>Net change in GW and SW Storage:</i>		790	160	2,380	1,490
Water Exchange within Model Domain					
	Net Infiltration from Recharge Ponds	2,850	2,480	4,010	4,010
	Net Stream Recharge to GW	4,280	4,700	3,240	3,330

Note: * included in Lake O'Neill Spill and Release.

¹ Table revised on 10/2/03 in memo sent to Larry Carlson.

7.2.1.5 Expected Additional Yield

There is no expected increase in ground-water yield or surface diversions from the Santa Margarita River due to the No Project alternative.

7.2.1.6 Capital and Operation and Maintenance Costs

Table 7-7 identifies the estimated Capital, Operation, and Maintenance costs associated with Alternative 1. There is no capital cost associated with the No Project alternative, while operation and maintenance costs have been estimated based on labor to monitor, maintain, and operate the system, including historical costs associated with sediment removal from behind the river diversion structure.

TABLE 7-7
SUMMARY OF ALTERNATIVE 1 COSTS

Item	Cost (\$)
Capital Costs	0
Annual O & M Costs	88,000

Annual operating and maintenance costs were based on removing sediment accumulated behind the sheet pile weir, cleaning O'Neill Ditch and headgate of sediment, and scraping and removing fine sediments from the recharge ponds. The O&M estimate assumes 30,000 cubic yards of sediment would have to be removed from behind the river diversion weir every 3 years at an estimated cost of \$150,000.

7.2.2 ALTERNATIVE 2 – DIVERSION WEIR AND DITCH IMPROVEMENTS

The Alternative 2 project includes the replacement of the existing sheet pile diversion dam, increased capacity of the diversion headgate, enhancement to the existing ditch capacity, new ground-water recovery wells, and improvement to the related diversion and control structures in the ditch and recharge ponds (Figure 7-5). The increase in project yield to ground-water storage and recovery is an average annual value of 3,000 AF at an initial capital investment cost of \$3.5 million. The annually amortized cost per acre-foot of this project is approximately \$120.

The proposed project includes the replacement of the existing sheet pile diversion dam with an Obermeyer spillway gate system consisting of a single span five feet high and 280 feet long installed on a concrete foundation. Alternative 2 will also increase the existing instantaneous capacity of the headgate and ditch facilities from approximately 60 cfs to 200 cfs. Additional improvements to the ditch and recharge ponds include a new control structure from the ditch to the ponds and additional control and monitoring structures between each of the five recharge ponds. The upper road crossing will be increased from an instantaneous capacity of 60 cfs to 200 cfs, removing the existing bottleneck on the diversion system.

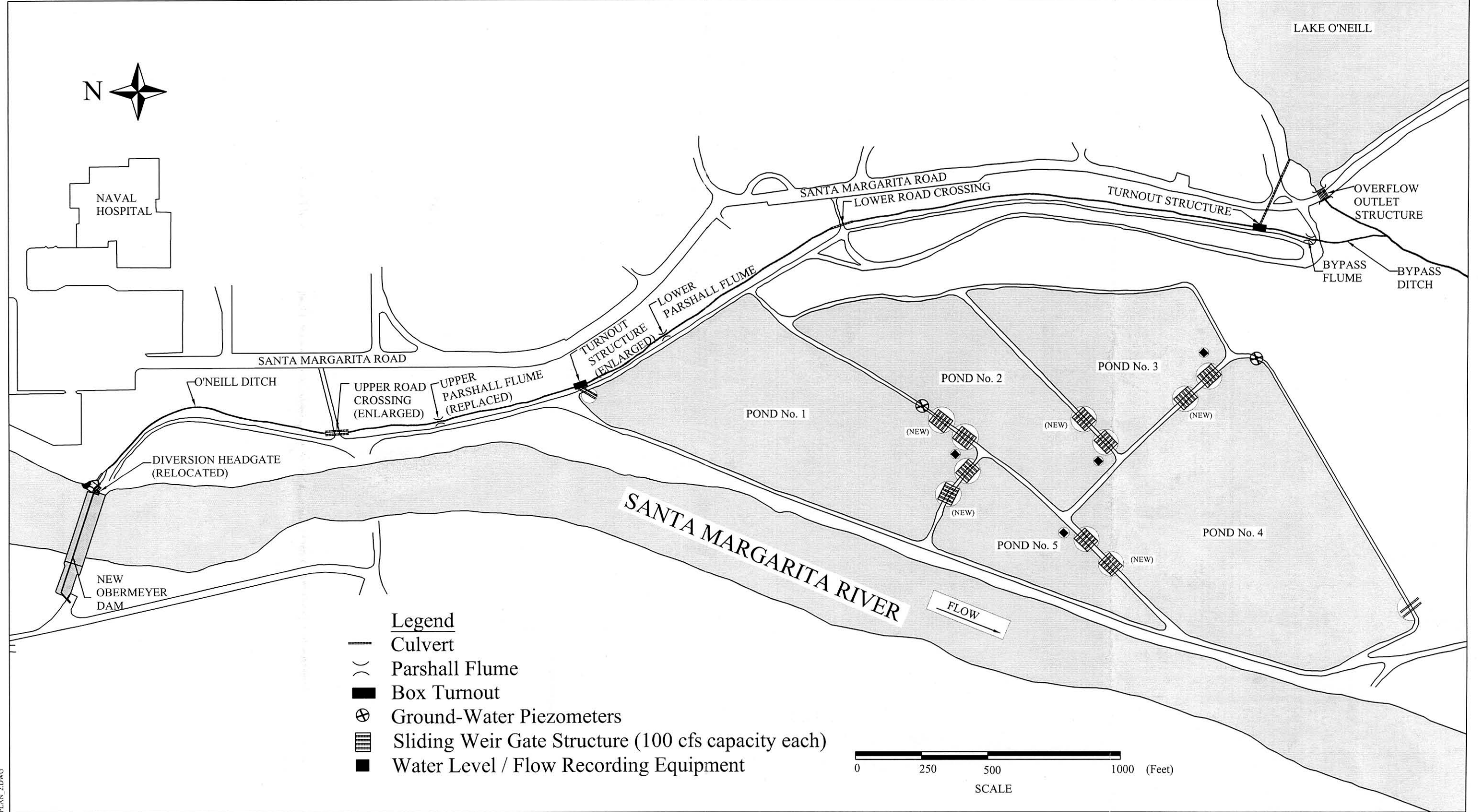

- Legend**
- Culvert
 - () Parshall Flume
 - Box Turnout
 - ⊗ Ground-Water Piezometers
 - ▤ Sliding Weir Gate Structure (100 cfs capacity each)
 - Water Level / Flow Recording Equipment

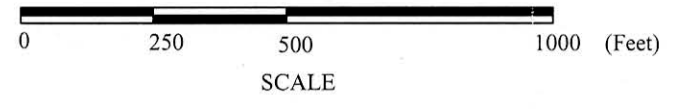

Diversion and Ground-Water Recharge System - Proposed Facilities (Alternative 2)
 Santa Margarita River

F:\DATA\1828\GUS\REC_SITE_PLAN_2.DWG



7.2.2.1 Alternative 2--Project Design and Operation

Obermeyer Dam

Alternative technologies that were reviewed for this project include: a Rubber Dam, Obermeyer Dam, Flashboard Diversion Dam, Sheet Pile Box Well, and maintenance of the existing sheet pile weir. A detailed analysis addressing each of these different types of technologies is presented in detail in Appendix F. The Obermeyer Dam was chosen as the preferred alternative since it allowed the maximum amount of water to be diverted into the O'Neill Ditch while simultaneously allowing sediment to flow downstream, reducing the operation and maintenance costs of removing sediment accumulated behind the weir and in front of the headwall and headgate.

The Obermeyer spillway gate system consists of a row of steel gate panels supported on their downstream side by inflatable air bladders (Figure 7-6). The air bladders consist of a three-ply, nylon reinforced fabric with a special five-mm thick EPDM (ethylene propylene diene monomer) outer cover to protect the dam against UV and ozone. Total fabric thickness is 0.50 inches and the expected life is more than 30 years. The bladder is inflated with air to a design pressure of 16 to 20 psi in about 30 minutes using an air compressor. The control system automatically maintains internal pressure and can be operated remotely from an office computer workstation with the addition of a modem and a phone line.

The Obermeyer spillway gate system will be lowered/deflated during the first 12 to 24 hours of a 10-year or greater flood flow allowing sediment and debris to pass down the river channel. After the flood flow has passed, the Obermeyer spillway gate system will be raised/inflated to allow for increased diversions into the ditch and to the ground-water recharge basins and Lake O'Neill. In order to determine the yield of the dam in the reservoir operations model, the dam was designed to deflate for one day during the 10-year storm event. Following the passing of the peak event, the dam inflated, allowing for the maximum diversion through the headgate and ditch.

The concrete foundation consists of a 12-inch thick reinforced concrete slab extending 280 feet across the river with vertical sidewalls and stainless steel abutment plates. The concrete footings for the slab consist of two cutoff walls 12 inches thick and four feet deep located on the downstream edge of the slab and 12 feet deep located on the upstream edge of the slab. The Obermeyer spillway gate system is attached to the concrete slab with stainless steel anchor bolts at six inches on center. The bladders are clamped over the anchor bolts and connected to the air supply pipes. The bladder hinge flaps are fastened to the gate panels. The individual steel gate panels are fabricated in widths of 10 feet. Reinforced EPDM rubber webs clamped to adjacent gate panel edges span the gaps between adjacent panels. At each abutment, an EPDM rubber



Inflatable Obermeyer Spillway Gate

wiper-type seal is affixed to the gate panel edge. This seal rides up and down the stainless steel abutment plate, keeping abutment plate seepage to a minimum.

The wedge-shaped profile of the Obermeyer gate system causes stable flow separation from the downstream edge of the gate without the vibration-inducing vortex shedding associated with simple rubber dams during overtopping. This results in a vibration-free operation and excellent controllability throughout a wide range of water elevations and gate positions. Two 60-inch by 60-inch sluice gates located on the east abutment will provide for by-pass flows of three cfs and transport sediment away from the ditch headgates during periods of high flows. A small concrete fish ladder will be installed near the east abutment for steelhead migration. The capacity of the Alternative 1 headgate for the ditch will be increased from 100 cfs to 200 cfs (Figure 7-7).

Ditch Improvements

The capacity of the existing ditch from the headgate to the ground-water recharge ponds turnout was calculated to be approximately 60 cfs based on 3.4 feet of water depth at the headgate. This is the maximum depth of water obtainable without water spilling over the sheet pile diversion dam. The ditch capacity that is appropriate for diverting the required amount of Santa Margarita River water during critical dry periods was determined to be 200 cfs. This is based on the hydrology of the river for a 75-year period of record (1925 to 1999) and available off-stream storage in the ground-water recharge ponds and Lake O'Neill. For Alternatives 2 through 4, a water depth in the existing ditch of five feet is required for a 200-cfs flow. The ditch facilities that need to be replaced or enlarged are as follows:

- Enlarge the M & R repaired headgate from 100 cfs to 200 cfs with an additional 60-inch by 60-inch headgate and one new 43-inch by 64-inch arch pipe culvert to match the existing culvert. The cost for relocating and repairing one of the headgates and culverts is included with the sluiceway costs.
- Replace the two 36-inch road-crossing culverts (first crossing) with two 60-inch diameter culverts.
- Replace the two 36-inch control gates at the first road crossing with two 60-inch steel slide gates.
- Enlarge the 400-foot section of ditch downstream of the road crossing.

Figure 7-7

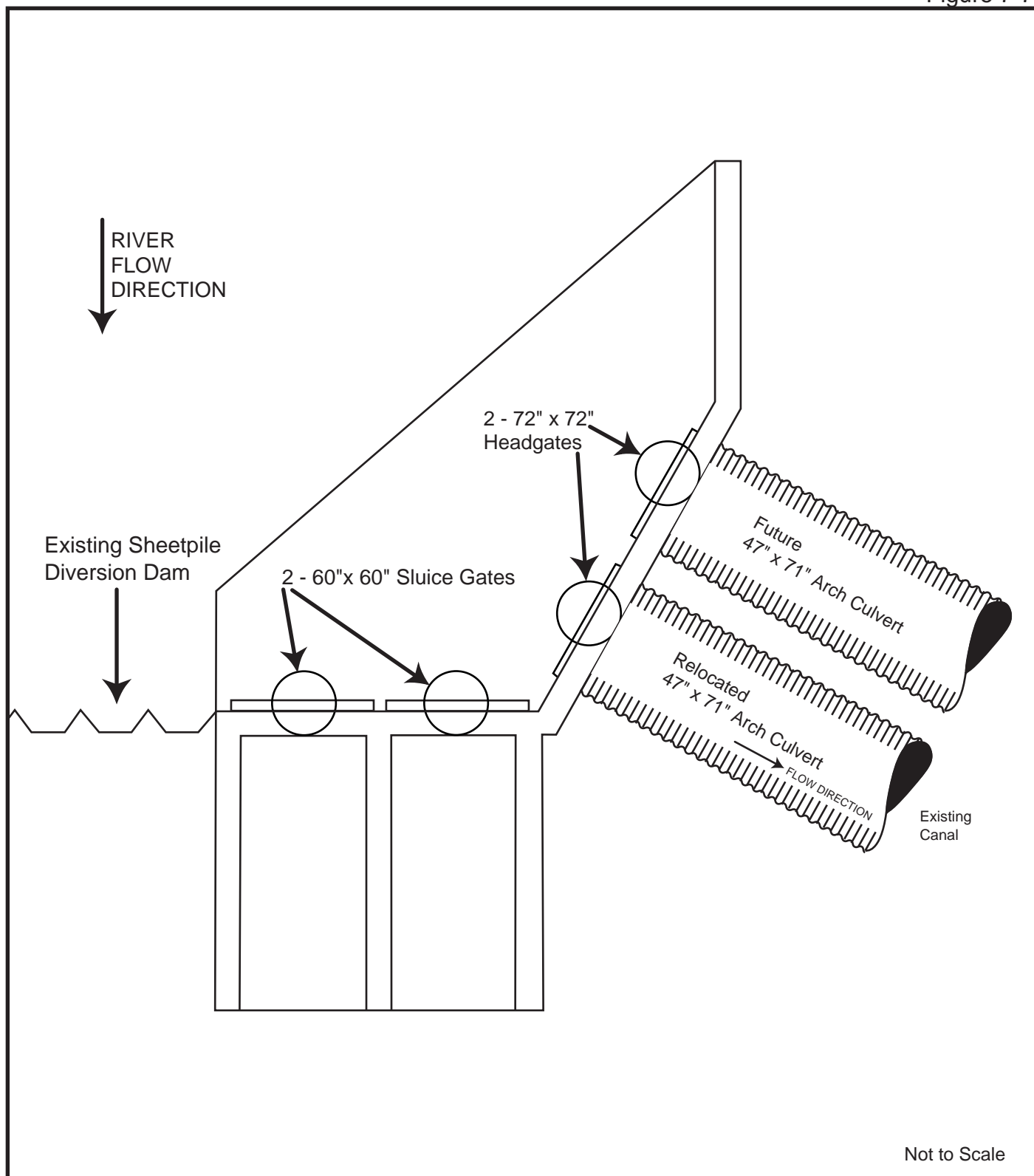

Sluice Gate and Headgate Structure

1828-324SluiceGate2.ai

- Enlarge the existing Parshall flume (5 feet wide by 4.5 feet high) with a 5 feet wide by 5.5 feet high Parshall flume.
- Install two new 60-inch turnouts to the existing ground-water recharge ponds.
- The existing 48-inch control gate in the ditch will remain.
- The 3-foot by 4.5-foot Parshall flume downstream of the water recharge pond turnout will remain.
- The 42-inch road-crossing culvert (second crossing) will remain.
- The last 3,150 feet of ditch with 8-foot bottom width will remain.
- The 24-inch diameter Lake O'Neill intake structure will remain.

Existing Recharge Pond Improvements

Due to the increased capacity of the diversion dam and conveyance facilities, capacity improvements to the recharge ponds are required to control the flow of water between each of the five ponds. Similar to the measuring and control weirs discussed in the M & R section of this report, ten additional eight foot weirs will be required to increase the instantaneous flow between each of the five recharge ponds from 100 cfs (Alternative.1) to 200 cfs.

The new control structures will include motor operated sliding weir gates mounted on cast-in-place concrete box structures to control pond water levels and to measure flow between ponds. Under Alternative 2, two 8-foot sliding weir gates will be required to pass the additional flow from Pond No. 1 into Pond No. 2, two 8-foot sliding weir gates to pass flow from Pond No. 2 into Pond No. 3, two 8-foot sliding weir gates to pass flow from Pond No. 3 into Pond No. 4, two 8-foot sliding weir gates to pass flow from Pond No. 1 into Pond No. 5, and two 8-foot sliding weir gates will be required to pass flow from Pond No. 5 into Pond No. 4. The motor operated sliding weir gates will be mounted on concrete headwalls and flow over the weirs will be conveyed between ponds through corrugated metal pipes buried in the sand levees separating ponds. See Figure 6-3 for a conceptual drawing of the sliding weir gate structure.

The sliding weir gate structures will provide the means for controlling pond water levels such that flow from one pond will cascade to another without backwater effects between ponds that are in series. Eliminating the backwater effects between ponds will allow for flow measurements to be made easily and accurately. To accomplish water level control and measurement of flow between ponds, it will be necessary to modify the existing pond operations

such that maximum pond water levels are restricted to lower elevations (roughly 1-3 feet lower than current operations). The maximum allowable pond water levels will be fixed by the crest height of each sliding weir gate. Once pond water levels and measurements of flow between ponds are made, infiltration rates within the individual ponds and variations in infiltration rates over time can be calculated and monitored.

New Ground-Water Recovery Wells for Alternative 2

Proposed new ground-water recovery wells are located in the Upper Ysidora and Chappo sub-basins. Figure 7-8 shows the 80% F3 (Table 4-8) monthly pumping schedule proposed for Alternative 2. To achieve the necessary aquifer storage and minimize the environmental impact on riparian vegetation, three new production wells are proposed for the Upper Ysidora (PW-1, PW-2, and PW-3), and one new production well is proposed for the Chappo (PW-4). F3 ground-water production management practices curtail pumping during dry years. During the second consecutive below normal hydrologic year, pumping is reduced by 3,000 AFY (May of MY 9). Management practices during the third consecutive below normal hydrologic conditions reduce pumping by an additional 3,000 AFY (May of MY 10). The determination of Below Normal and Above Normal hydrologic conditions is based on the identical methodology prescribed in the settlement agreement between the Base and the RCWD. The restricted ground-water production would continue until an above normal hydrologic year occurred. The 80% F3 pumping reduces the monthly production rates by an additional 20%. Table 7-8 shows the different water year pumping volumes during a normal and below normal period.

Ground-Water Production using 80% F3 Pumping Schedule

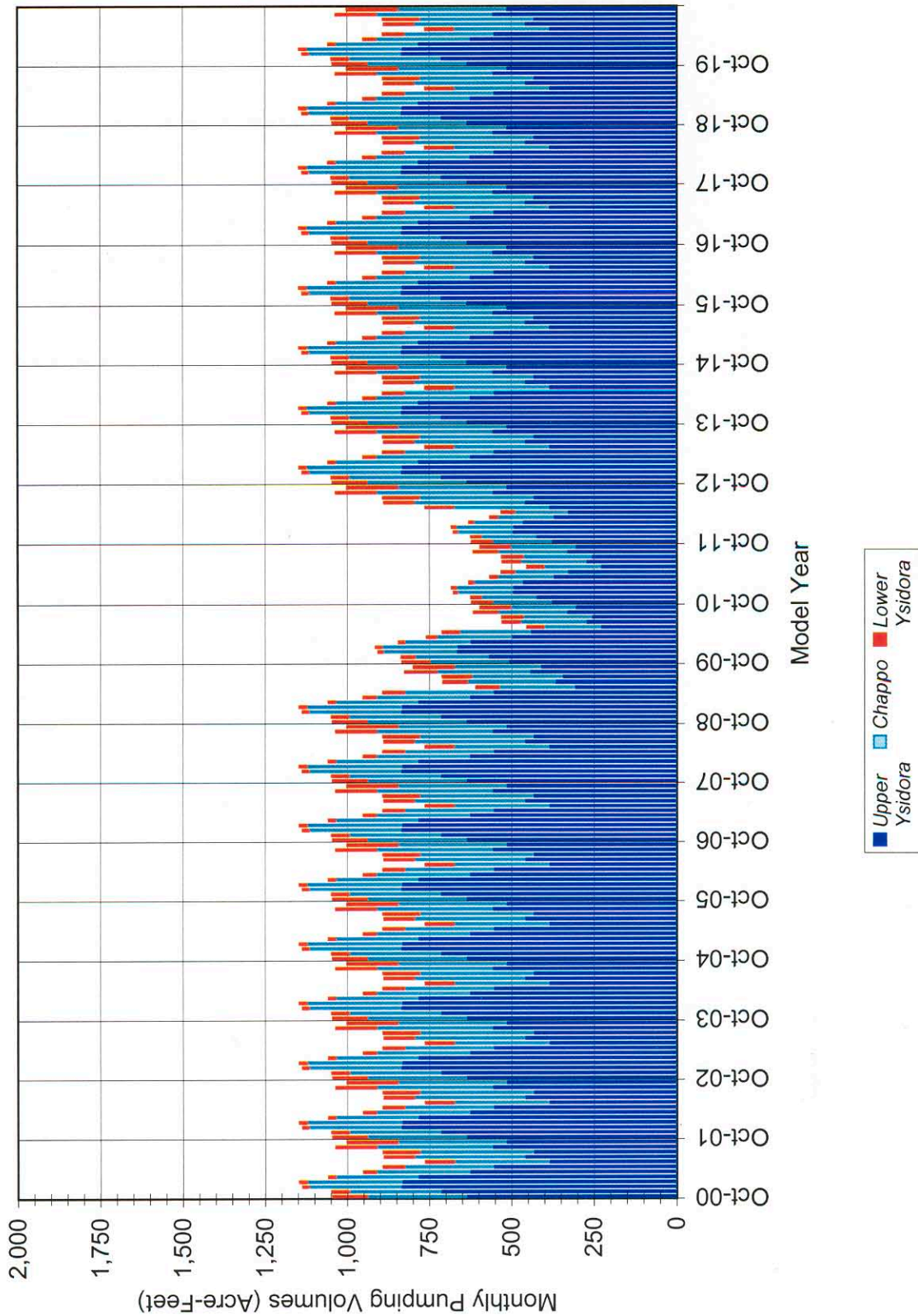

TABLE 7-8
F3 AND 80% F3 PUMPING VOLUMES (AF/WY)

MY	F3 Pumping Volume	80% F3 Pumping Volume	Hydrologic Condition
8	14,800	11,840	First year of Below Normal
9	13,670	10,910	Second year of Below Normal; decrease annual pumping by 3,000 AF from May MY 9 through April MY 10
10	10,670	8,510	Third year of Below Normal; decrease annual pumping by 6,000 AF from May MY 10 through April MY 11
11	8,800	7,040	Fourth year of Below Normal; decrease annual pumping by 6,000 AF from May MY 11 through April MY 12
12	11,800	8,440	First year of Above Normal
13	14,800	11,840	Second year of Above Normal
1-20	14,050	11,240	Average Annual of 20 year period

Note: The third dry year of below normal conditions will yield ground-water production less than the estimated build-out value of 8,800 AFY.

The F3 Pumping Volume represents a January through December annual pumping average.

7.2.2.2 Environmental Opportunities and Constraints Analysis

As previously stated, this alternative would involve replacement of the existing sheet pile diversion dam with an Obermeyer dam, increasing the capacity of the diversion headgate, enhancing existing conveyance ditch capacity, adding four new ground-water recovery wells, and improvements to the related diversion and control structures in the existing ditch and recharge ponds.

Biological Resources

Implementation of Alternative 2 would result in minimal ground disturbance. Replacement of the sheet pile dam with an Obermeyer dam structure and constructing four proposed wells would result in disturbance within the Santa Margarita River channel in the Southern Cottonwood/Willow Riparian Forest and Southern Willow Scrub vegetative communities. Construction of three additional ground-water wells as, described in this feasibility analysis, would result in disturbance within the Southern Willow Scrub vegetative

community while the remaining well would be constructed in non-native grassland. In addition to disturbance within these vegetative communities, the Alternative 2 project would affect Waters of the U.S.

Table 7-9 describes those vegetative communities potentially affected by construction of Alternative 2. These communities provide breeding, foraging and cover for the least bell's vireo, southwestern willow flycatcher, and arroyo toad. Table 7-10 describes the estimated regulatory constraints associated with compliance with regulations and statutes for implementation of the Alternative 2 project.

Table 7-9

Vegetative Communities Potentially Affected by Alternative 2 Project Features

Vegetative Community	Occurrence in Alternative 2 Project Area	Alternative 2 Project Features	Associated Focus Species¹
Southern Cottonwood/Willow Riparian Forest	Within the primary floodplain of the Santa Margarita River and associated alluvium	Obermeyer Dam, and 4 Proposed Wells	LBVI, SWFC, ARTD
Southern Willow Scrub	Inter-mixed with Southern Cottonwood/Willow Riparian Forest and in disturbed areas on the margins of riparian habitat	Conveyance Ditch, and 1 Proposed Well	LBVI, SWFC, ARTD
Non-Native Grassland	South of O'Neill Lake and the proposed dam site	2 Proposed Wells	None

¹ LBVI=Least Bell's Vireo; SWFC=Southwestern Willow Flycatcher; ARTD=Arroyo Toad

Cultural Resources

The Santa Margarita River bank area where the proposed facilities (Obermeyer dam, improved diversion headgate and ditch capacity, and four new ground-water recovery wells) would be constructed has already been surveyed for cultural resources (personal communication, Mr. Stan Berryman, Archaeological Resources Branch Head, November 2000). There are no known cultural resource sites in the vicinity of the proposed dam or diversion headgate. However, cultural resource sites have been documented in the immediate vicinity of the southern end of the conveyance ditch and immediately adjacent to the proposed well number 2 location. Unless these project features were relocated, these sites would require further investigation.

Table 7-10

Alternative 2 Estimated Regulatory Constraints

Regulation or Statute	Compliance or Permitting Requirement	Estimated Time
NEPA	An EIS would be required for this alternative due to the potential for significant adverse impacts from increased diversions to sensitive resources downstream of the proposed diversion, impacts to other sensitive biological resources, and public sensitivity to the project.	32 - 36 months
FESA	Direct and indirect impacts to listed species as a result of project actions will trigger consultation with the USFWS, development of a Biological Assessment, and development of reasonable and prudent alternatives. Consultation would result in a Biological Opinion specifying measures which must be undertaken to avoid and minimize impacts.	Statutory maximum of 135 days. Actual time between 9 - 12 months.
CWA	Dredge and fill of "Waters of the U.S." will require compliance with the Clean Water Act. An individual permit, with accompanying alternatives analysis, will likely be required for this alternative. Public review and comment periods will dovetail with NEPA process. Must meet NEPA and FESA requirements prior to ACOE issuance.	Statutory maximum of 60 to 90 days. Average time possibly 4-6 months

Should Native American artifacts be unearthed during excavation activities, work would immediately cease at the construction site and the cultural resource monitor and/or the Native American monitor would immediately notify SHPO to determine the need for testing, data recovery and excavation of the site. Should a Native American skeleton be unearthed, NAGPRA compliance would be required. NAGPRA compliance could take several months to complete, and construction activities in the vicinity of the Native American artifact would cease until SHPO cleared the site. This delay could set back that portion of the project's facilities until the following construction season (April through October), and consequently increase construction and labor costs.

As stated in Section 3.2.1, *Environmental Setting, Regulatory Framework*, the requisite Section 106 consultation with SHPO would take between two-to-three months, assuming that there are no adverse effects. In the event of unavoidable adverse effects, the Base would be required to enter into a Memorandum of Agreement (MOA) with SHPO and affected Native American tribes. There are no statutory review times for MOAs; they generally take up to six months (personal communication, Mr. Stan Berryman, Archaeological Resources Branch Head, November 2000).

Hazardous Materials and Wastes

There are no known environmental constraints that would result from implementation of Alternative 2. The proposed facilities (Obermeyer dam, improved diversion headgate and ditch capacity, and four new ground-water recovery wells) are not in the vicinity of any known IR or UST sites on Camp Pendleton.

Surface and Ground-Water Resources

Alternative 2 includes construction of a new Obermeyer dam which would extend 280 feet across the Santa Margarita River, and would require excavation 30 feet down into the riverbed to secure the dam's foundation. The footprint of this area of disturbance, and the amount of dredge material that would require removal, necessitates that the Base obtain a Clean Water Act Section 404 Individual Permit from the Los Angeles District of ACOE.

As stated in Section 3.2.1, *Environmental Setting, Regulatory Framework*, it will take between 12-to-18 months to obtain the required Section 404 permit. While the Section 404 permit process with ACOE is underway, Camp Pendleton can simultaneously pursue Section 401(b)(1) water quality certification with the San Diego RWQCB.

High Total Dissolved Solids (TDS) and nitrates are the primary detrimental water quality factors in the Santa Margarita River watershed. In addition, a MTBE plume in the Chappo sub-basin is currently migrating past monitoring wells but presents no threat to drinking water at this time. The plume is quite shallow, only 25-30 feet below ground surface, and contains very low concentrations of contaminants of volatile organic compounds (VOCs). The contaminated site identified in the feasibility analysis is relatively small and is over three miles away from the proposed new percolation ponds.

As discussed in Chapter 4, IT Corporation developed a ground-water flow and contaminant transport model for the Chappo sub-basin to determine the potential for accelerated contaminant migration as a result of ground-water pumping. The IT report determined that given the Chappo's highly porous media, dispersion factors, and dilution factors, ground water would return to background conditions within 10 years. The report recommended no action because of the short time frame for attenuating contaminant effects. Based on the modeling results in the IT report, implementation of Alternative 2 would not exacerbate plume migration potential.

7.2.2.3 Surface Water Model Analysis for Alternative 2

A reservoir operations model was used to estimate the rate of diversion from the Santa Margarita River to both the recharge ponds and Lake O'Neill for Alternative 2 projects. The model used 1980 to 1999 hydrology in order to construct streamflow at a point located below the confluence of DeLuz Creek and the Santa Margarita River (Chapter 4). Applying daily estimates of streamflow and historical measurements of precipitation and evaporation, the reservoir operations model was used to predict the daily diversion during the historical period.

The Alternative 2 reservoir operations model was altered to reflect the effects of three major improvements to the system:

- New Obermeyer spillway gate system,
- Expanded headgate diversion structure from 100 cfs to 200 cfs,
- Expanded canal capacity from 60 cfs to 200 cfs.

A schematic of the reservoir operations model shows simulated Alternative 2 diversion to Lake O'Neill and the recharge ponds (Figure 7-9).

The timing and quantity of diversions to Lake O'Neill, in the Alternative 2 reservoir operations model, is similar to the Alternative 1 reservoir operations model. An additional permit would allow for winter diversions from the Santa Margarita River to Lake O'Neill, which were not previously permitted. The Lake O'Neill diversion schedule for Alternative 2 is outlined below.

- Beginning November 1st of every year, the lake is drained at a rate of 20 cfs. The lake water leaves the lake through a pipe and into a channel flowing towards the Santa Margarita River. Draining terminates once the volume of Lake O'Neill approaches 100 AF.
- December 1st marks the filling of Lake O'Neill with water from the Permit 15000 (License 21471B) water right. Flow is diverted from the Santa Margarita River into Lake O'Neill, at a rate of 20 cfs, until it fills to the current capacity of 1,200 AF. The effects of precipitation and evapotranspiration are applied such that in dry years it may take slightly over 1,200 AF to fill the lake, while in wet years it may take less than 1,200 AF.

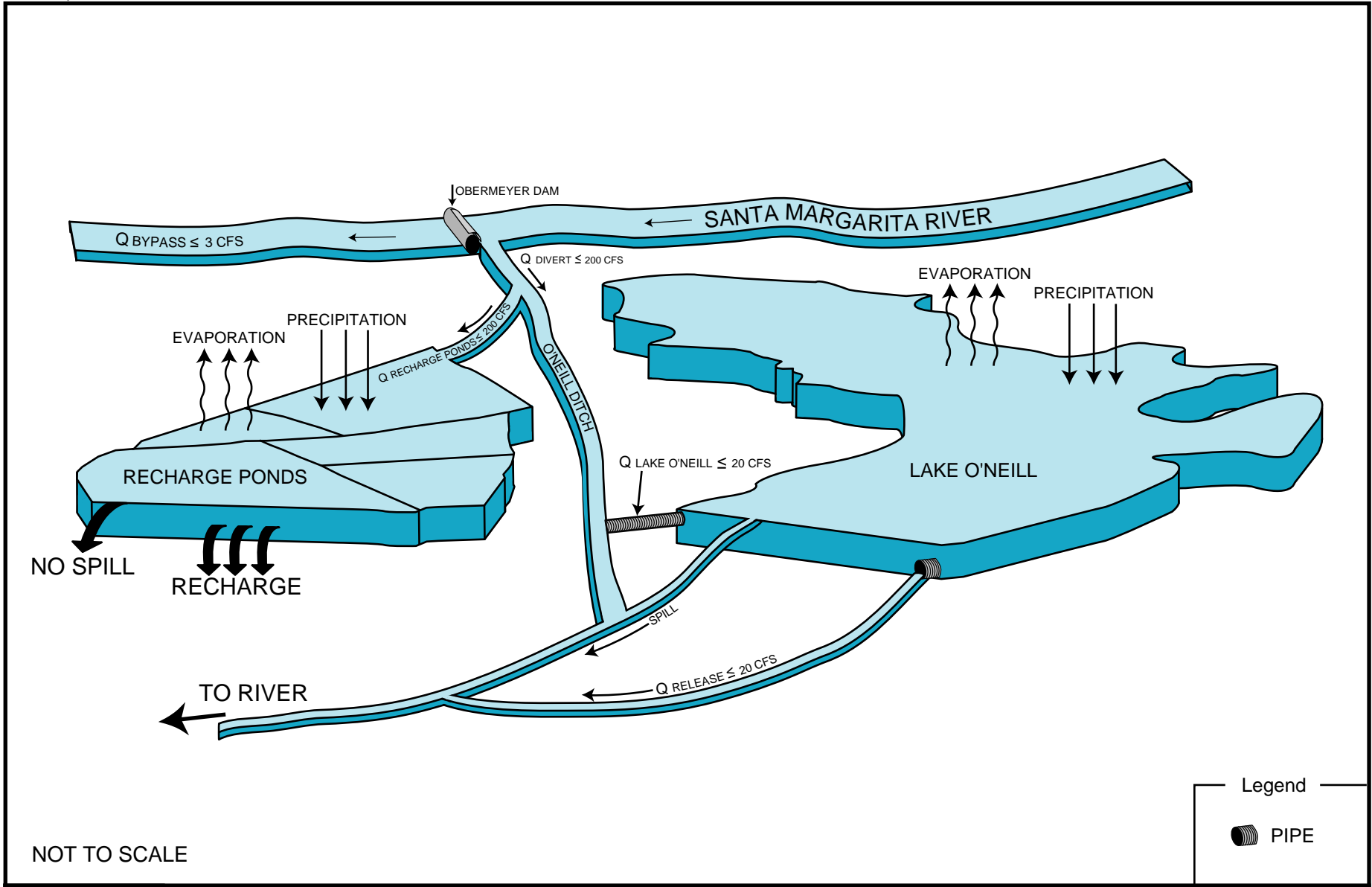

Legend

● PIPE



Surface Water Analysis
Reservoir Operations Model

Alternative 2

New Diversion Dam
Expanded Headgate
Improved Canal

FIGURE 7-9

- No water is diverted to Lake O’Neill between February 1st to May 30th. Precipitation and evaporation continue to lower and raise the water levels in the lake during this period. Flows from Fallbrook Creek are by-passed through the outlet.
- The reservoir operations model commences the use of the Pre-1914 water right from June 1st to October 31st, a time period that would optimize this water right given the last 20 years of streamflow records. The Pre-1914 water right allows for the diversion of 1,500 AFY to be diverted from the Santa Margarita River, to Lake O’Neill, at a maximum diversion rate of 20 cfs. (This right is valid from April 1st to October 31st). During this time, Lake O’Neill may approach its capacity of 1,200 AF, and on occasion, spill water out of the lake via a spillway located on its northern side.

Alternative 2 operations model allows for the filling of Lake O’Neill exclusively from water diverted from the Santa Margarita River. Fallbrook Creek is allowed to bypass Lake O’Neill completely, helping to recharge the ground-water basin below the percolation ponds. The Pre-1914 water right is fully maximized and is only dependent upon the non-winter baseflow of the Santa Margarita River. Permit 15000 water diverted to Lake O’Neill during the winter is allowed to recharge the ground-water basin as it is released from Lake O’Neill in the summer depending on the availability of pre-1914 water.

A Camp Pendleton Public Works Survey Department drawing (1978) was used to construct a surface area to volume curve which was used to calculate the change in Lake O’Neill storage. Fluctuations in the storage volume for Lake O’Neill, due to the effective evaporation and precipitation, may provide more room for the pre-1914 water in dry years, or may cause spilling during wet years when rain is falling on the already full lake. Table 7-11 describes the diversion schedule to Lake O’Neill and the recharge ponds. Figure 7-10 shows a graphical example of the reservoir operations model output for Lake O’Neill for model years 9 through 11.

The capacity of the recharge ponds remains the same as in Alternative 1, but the diversion schedule has two notable changes. First, the increased canal capacity allows 200 cfs to be diverted from the Santa Margarita River into the recharge ponds. Second, part B of Permit 15000 will allow for a greater amount of water to be diverted from the Santa Margarita River for use in the recharge ponds. The total volume diverted to the ponds is limited by the maximum infiltration potential. Once the ponds are full, the flow into the ponds equals the total infiltration rate so that there is no spilling from the final pond.

Alternative 2: Operation of Lake O'Neil Model Years 9, 10, & 11

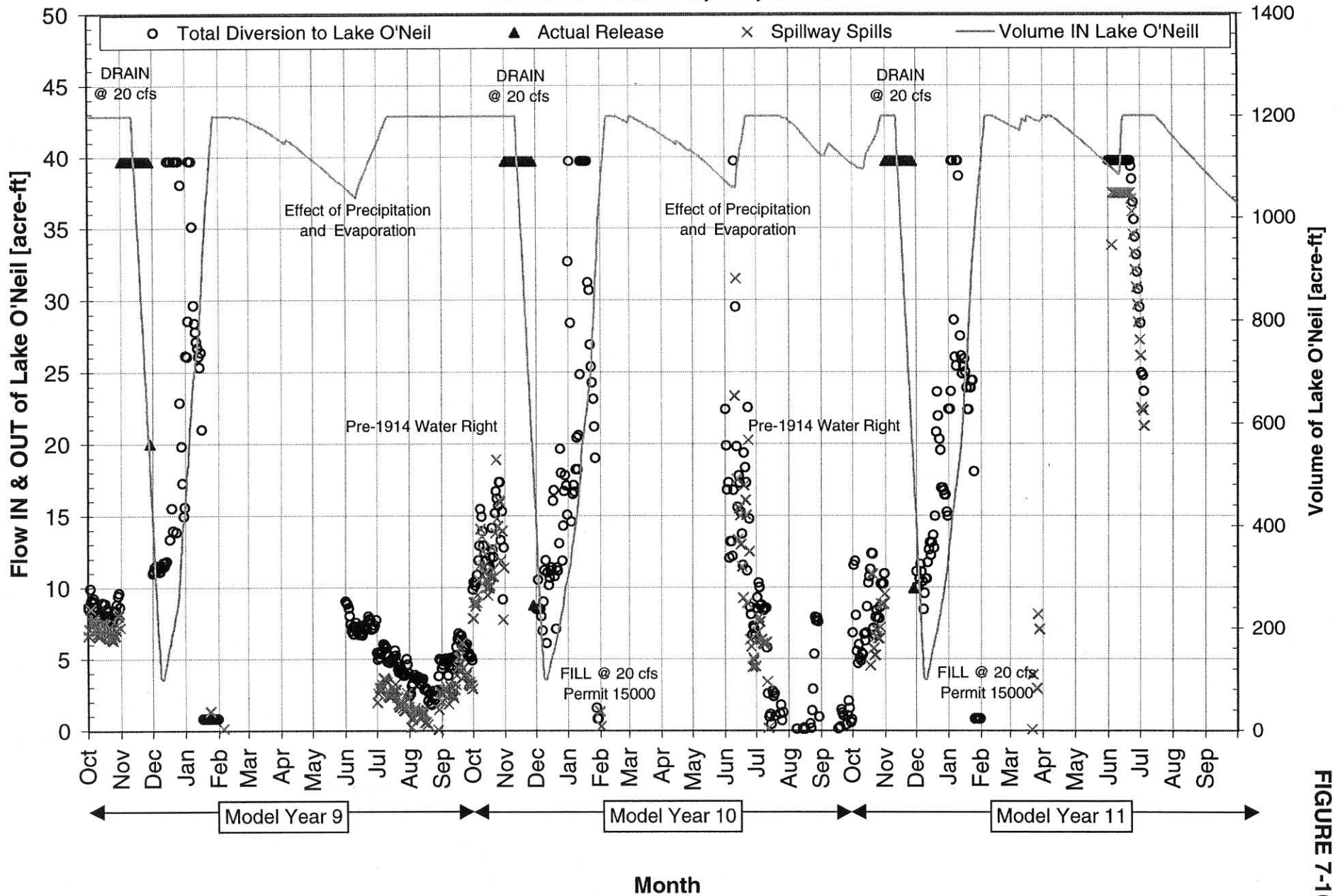

FIGURE 7-10

TABLE 7-11
ALTERNATIVE 2 DIVERSION SCHEDULE TO THE
RECHARGE PONDS AND LAKE O'NEILL

MONTH	ACTIVITY	RATE	LIMIT	WATER RIGHT *
Diversions to Lake O'Neill				
Nov	Drain	$Q_{\text{release}} \leq 20 \text{ cfs}$	Min Volume = 100 AF	Pre-1914 Water Right
Dec to Jan	Fill	$Q_{\text{lake O'Neill}} \leq 20 \text{ cfs}$	Max Volume = 1,200 AF	Permit 15000
Feb to May	Precip & Evap	$Q_{\text{spill}} = f(\text{precip \& evap})$	N/A	
June to Oct	Fill	$Q_{\text{lake O'Neill}} \leq 20 \text{ cfs}$	No spill of Pre-1914 water	Pre-1914 Water Right
Diversions to Recharge Ponds				
Nov	Fill w/ 100% Q_{divert}	$Q_{\text{recharge ponds}} \leq 200 \text{ cfs}$	No Spill	Permit 15000
Dec to Jan	Fill w/ $Q_{\text{divert}} - Q_{\text{lake O'Neill}}$	$Q_{\text{recharge ponds}} \leq 200 \text{ cfs}$	No Spill	Permit 15000
Feb to May	Fill w/ 100% Q_{divert}	$Q_{\text{recharge ponds}} \leq 200 \text{ cfs}$	No Spill	Permit 15000
Jun	Fill w/ $Q_{\text{divert}} - Q_{\text{lake O'Neill}}$	$Q_{\text{recharge ponds}} \leq 200 \text{ cfs}$	No Spill	Permit 15000
Jul to Sept	No Diversion	$Q_{\text{recharge ponds}} = 0 \text{ cfs}$	N/A	N/A
Oct	Fill w/ $Q_{\text{divert}} - Q_{\text{lake O'Neill}}$	$Q_{\text{recharge ponds}} \leq 200 \text{ cfs}$	No Spill	Permit 15000

** Note: The first 4,000 AFY is attributed to permit 15000, license 10494 while the remaining diversion to the recharge ponds would be developed under permit 15000, Application 21471B.*

The simulated performance of the reservoir operations model for Alternative 2 with augmented flows is shown in Table 7-12.

TABLE 7-12
ALTERNATIVE 2 - AUGMENTED FLOW
OBERMEYER DAM, NEW HEADGATE, AND IMPROVED CHANNEL

Model Years	Augmented Flow	Total Diversion	Diversion to Lake O'Neill	Diversion to Recharge Ponds	Recharge to Ground Water	Net Precip (+) Evap (-)
1-20	SMR	Max 200 cfs	(AF)	(AF)	(AF)	(AF) *
	(AF)	(AF)		(AF)	(AF)	
20 yr. Total	1,117,110	210,430	50,520	159,910	159,020	-7,910
Average Annual	55,860	10,520	2,530	8,000	7,950	-400
Median Annual	30,740	10,880	2,610	8,270	8,220	-400
Min Annual	10,730	6,420	2,000	4,420	4,400	-270
Max Annual	226,230	14,120	2,640	11,500	11,470	-480

**Note: Includes both lake and pond surfaces.*

The benefit of the new diversion dam and increased channel capacity allows for an average annual diversion that is 5,110 AFY greater than Alternative 1. Approximately 10,500 AFY of water can be diverted annually from the Santa Margarita River, with an average of almost 8,000 AFY of this water going to the recharge ponds.

Total diversions to Lake O'Neill, under the Pre-1914 water right, change from the Alternative 1 baseline conditions due to summer-time diversions to Lake O'Neill. The Alternative 2 facilities and augmented flows do allow for a higher diversion potential during most years, because of permit 15000's diversion license. Table 7-13 below highlights the maximum potential water available for diversion and the amount of water that was actually diverted under the Alternative 2 conditions. Note that during model years 8 to 11, the total diversion potential equals the actual pre-1914 water diverted. During these dry years it is imperative to effectively divert the maximum potential in order to fully utilize the pre-1914 water right. All diversions to Lake O'Neill are based on a maximum rate of 20 cfs.

TABLE 7-13
MAXIMIZING THE PRE-1914 WATER RIGHT AND PERMIT 15000 LICENSE
Alternative 2 (AFY)

Model Year	Maximum Divertible Water Potential from June 1st -Oct. 31st.	Pre-1914 Water Diverted to Lake O'Neill from June 1st-Oct. 31st	Permit 15000 Water Diverted to Lake O'Neill from Dec.1st-Jan.31st	Total Diversion to Lake O'Neill
1	5,590	1,500	1,130	2,630
2	3,340	1,500	1,130	2,630
3	3,580	1,500	1,120	2,620
4	4,720	1,500	1,120	2,620
5	3,350	1,500	1,110	2,610
6	3,150	1,500	1,100	2,600
7	1,840	1,500	1,130	2,630
8	1,090	1,093	1,130	2,220
9	1,490	1,494	1,100	2,600
10	890	894	1,110	2,000
11	1,040	1,040	1,120	2,160
12	3,520	1,500	1,130	2,630
13	3,900	1,500	1,090	2,590
14	4,080	1,500	1,080	2,580
15	2,020	1,500	1,140	2,640
16	3,790	1,500	1,060	2,560
17	1,200	1,202	1,130	2,340
18	1,580	1,500	1,110	2,610
19	4,200	1,500	1,130	2,630
20	1,790	1,500	1,140	2,640
Total	56,160	28,220	22,300	50,520
Average	2,810	1,410	1,120	2,530
Median	3,240	1,500	1,120	2,610
Min	890	890	1,060	2,000
Max	5,590	1,500	1,140	2,640

7.2.2.4 Ground-Water Model Analysis for Alternative 2

The ground-water model analysis for Alternative 2 compares the simulated results from improvements to the existing diversion system (Obermeyer dam system and improvements to the existing ditch and recharge ponds) and the addition of 4 new production wells to the Alternative 1 baseline Model run (Section 7.2.1.4). Alternative 2 uses future augmented streamflow, 200 cfs capacity in the diversion system, and optimized water management which yields an average diversion of approximately 8,000 AFY to the existing five ground-water recharge ponds, twice the quantity of diversions considered in the baseline, Alternative 1.

Average annual diversions to Lake O'Neill increased to 2,530 AFY, approximately 1.7 times the volume diverted in alternative 1. Average annual spills from Lake O'Neill under Alternative 2 were five times greater than alternatives 1. More water was available to be released on an average annual basis in November from Lake O'Neill in Alternative 2 than in Alternative 1. Water from Fallbrook Creek was modeled as passing through Lake O'Neill and discharging into the Lake O'Neill release canal.

Four different pumping schedules were considered under Alternative 2 to minimize impacts of ground-water level drawdown on riparian vegetation. Discussed in detail in Chapter 4.10, a conjuncture use-pumping schedule has been designed to lower the ground-water levels in the aquifer in order to capture wintertime flow events. Based on this schedule, pumping rates are greatest during the winter and curtailed during the summer to help protect the riparian habitat. Of the four pumping scenarios modeled for alternative 2, the 80% F3 pumping schedule (discussed in section 7.2.2.1) produced the most water for the least environmental impact to the ground-water basins. Appendix D describes the results from the consideration of F1, F2 and F3 pumping scenarios for Alternative 2.

The lowest water level observed in the three simulated monitoring wells during the Alternative 2 model run occurred during Dec, MY 16 (corresponding to historic December 1994 climatic conditions) in the Upper Ysidora sub-basin with water level dropping to 72.5 feet, msl. Though this water level is close to the ET extinction depth, it occurs only once during a month where most riparian vegetation is less stressed. This well also occurs a distance of 600 feet from the Santa Margarita River in a grass field. Water levels are expected to be higher near the river where more riparian vegetation grows. The highest water level occurred during May, MY4 (corresponding to historic May 83 climate conditions). Figure 7-11 shows baseline ground-water level data compared to model simulated results for Alternative 2 for all three sub-basins. The time shift in the water level highs and lows in the Upper Ysidora can be attributed to the increased ground-water production volume and the seasonal pumping schedule combined with the larger diversions. Ground-water level highs occur during the summer months due to lower pumping rates and the lag time associated with infiltrated water from the recharge ponds reaching the simulated monitoring well 10/4-7J1. Water level changes under Alternative 2 from baseline conditions are minimal in the Chappo (well 10/5-23L1) and do not appear to effect ground-water levels in the Lower Ysidora (well 10/5-35K5). The lack of response at the Lower Ysidora monitoring well is considered a good indicator that there will be no ill effects on the estuary or salt-water intrusion into the ground-water basin from implementation of Alternative 2.

Simulated and baseline monthly streamflows observed at the Ysidora gage near Basilone Road and the southwest boundary in the Lower Ysidora sub-basin are shown in Figure 7-12. The model predicts that Alternative 2 will have minimal impact on streamflow at these areas.

Alternative 2 w/ 80% F3 Pumping - Simulted Hydrograph Upper Ysidora Well 10/4-7J1

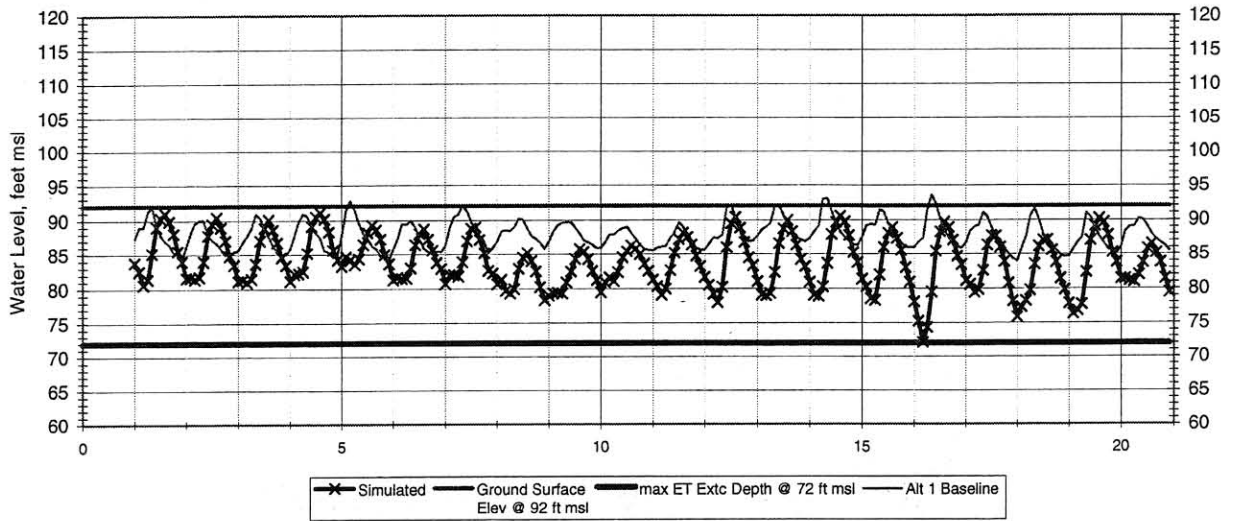

Alternative 2 w/ 80% F3 Pumping - Simulted Hydrograph Chappo Well 10/5-23L1

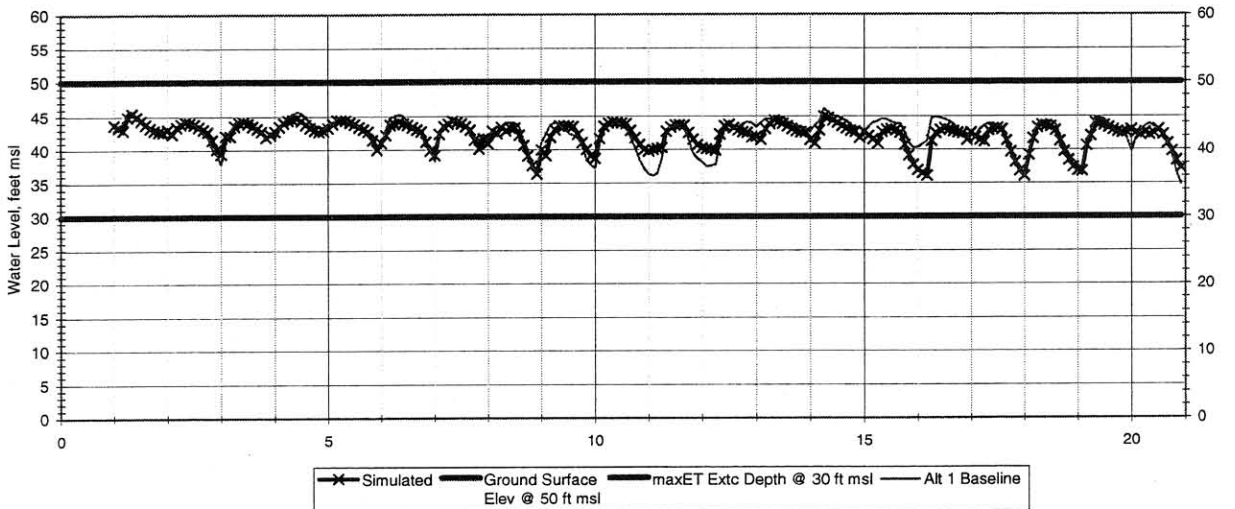

Alternative 2 w/ 80% F3 Pumping - Simulted Hydrograph Lower Ysidora Well 10/5-35K5

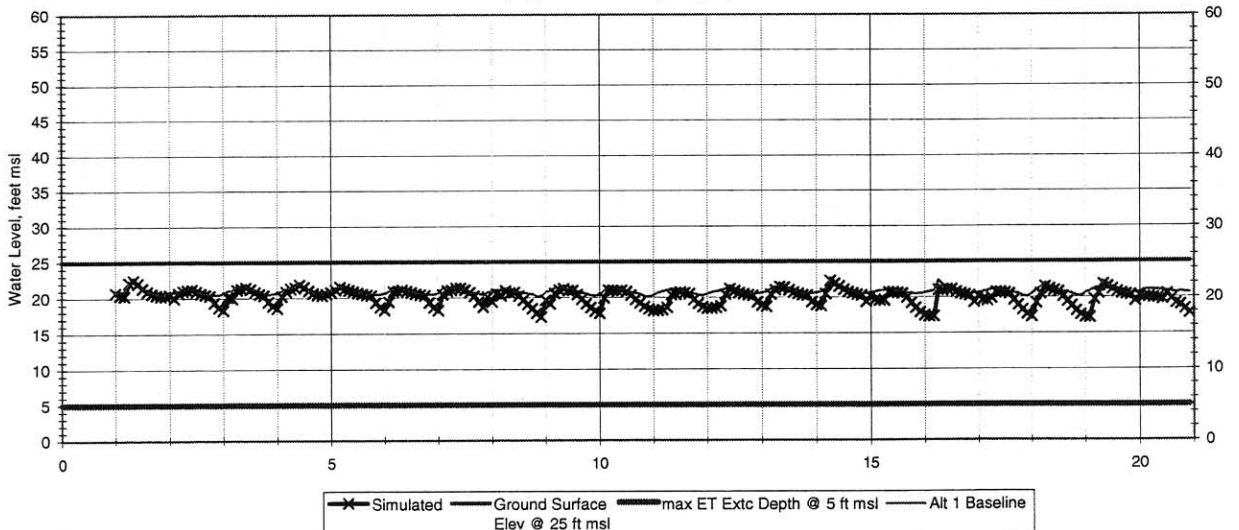

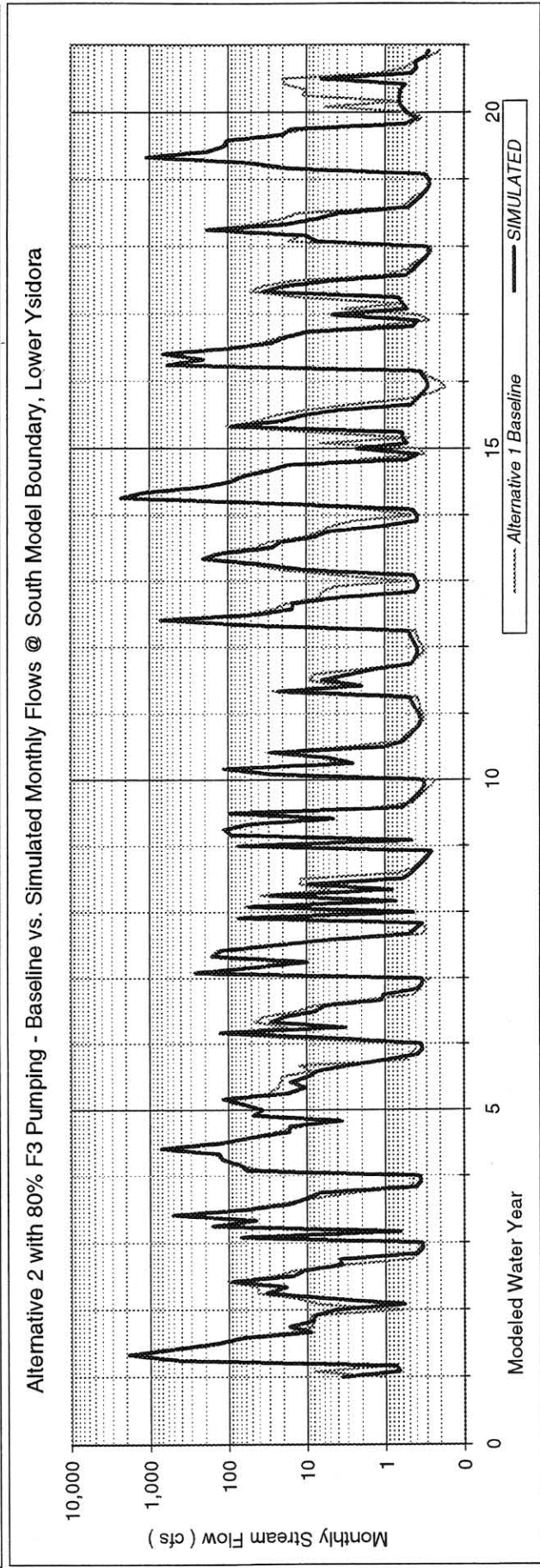
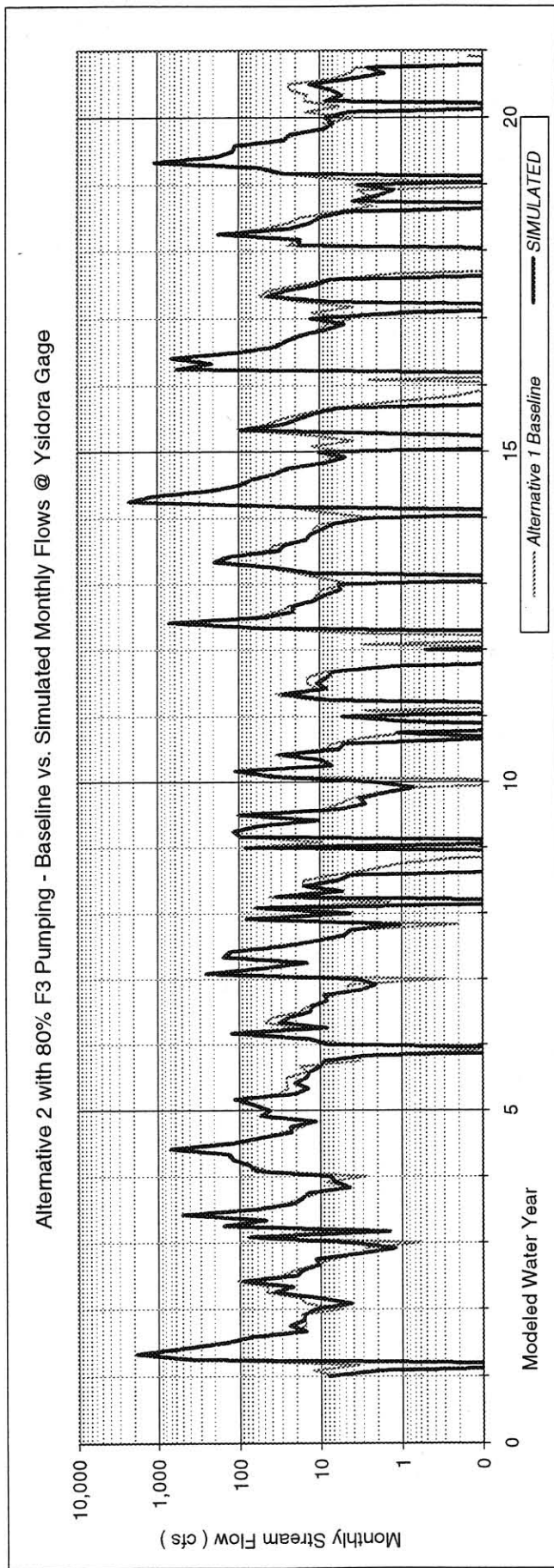

The Alternative 2 model run is summarized in the water budget presented in Table 7-14. The Model provides calculated numbers for underflow, stream flow out of the model area, and evapotranspiration. Measured and estimated model input data provides water volumes for streamflow into the model domain, diversion to and release/spill from Lake O'Neill, ground-water pumping, and recoverable water from precipitation.

TABLE 7-14
ALTERNATIVE 2 -- AVERAGE ANNUAL WATER BUDGET FOR MY 1 - 20 (AF/WY)

		<u>Alt 1 -Baseline</u>		<u>Alt 2 - 80% F3 Pumping</u>	
		<u>Average</u>	<u>Median</u>	<u>Average</u>	<u>Median</u>
		<u>Annual</u>	<u>Annual</u>	<u>Annual</u>	<u>Annual</u>
Inflow:	Subsurface Underflow	830	810	1,290	1,310
	Santa Margarita River Inflow	55,860	30,740	55,860	30,740
	Lake O'Neill Spill and Release	1,080	1,060	2,060	2,150
	Fallbrook Creek Bypass ¹	1,930	1,370	1,930	1,370
	Minor Tributary Drainages ¹	2,120	1,720	2,120	1,720
	Waste Water Discharge ¹	0	0	0	0
	Direct Precipitation	710	500	710	500
	<i>Total Inflow:</i>	62,530	36,200	63,970	37,790
Outflow:	Subsurface Underflow	230	220	230	220
	Santa Margarita River Outflow	50,080	24,420	48,520	21,380
	Ground-Water Pumping	5,550	5,870	11,240	11,840
	Evapotranspiration	2,790	2,700	2,660	2,560
	Diversions to Lake O'Neill	1,500	1,500	2,530	2,610
	<i>Total Outflow:</i>	60,150	34,710	65,180	38,610
	<i>Net change in GW and SW Storage:</i>	2,380	1,490	1,210	820
Water Exchange within Model Domain					
	Net Infiltration from Recharge Ponds	4,010	4,010	7,950	8,220
	Net Stream Recharge to GW	3,240	3,330	4,560	4,740

¹Table revised on 10/2/03 in memo sent to Larry Carlson.

7.2.2.5 Expected Additional Yield

The annual ground-water yield and surface diversion expected from the construction of Alternative 2 facilities are listed below in Table 7-15. The maximum annual surface diversion required to provide a median annual ground-water yield of 11,800 AFY is 14,100 AF. Of this amount, the unused portion of Permit 15000 would require a maximum annual diversion rate of 8,600 AF, after attributing for diversions under the existing license and pre-1914 water rights. The median annual ground-water yield attributed to Application 21471B, Permit 1500, would be 3,000 AFY. The location of the point of diversion for the unused portion of Permit 15000 would be at the identical location of the existing point of diversion.

TABLE 7-15

**ALTERNATIVE 2 – ANNUAL GROUND-WATER
YIELD AND MAXIMUM SURFACE DIVERSION**

Water Right	ALTERNATIVE 1 (AFY)	ALTERNATIVE 2 (AFY)
Maximum Existing License Yield	4,000	4,000
Maximum Pre-1914 Rights Yield	1,100	1,100
Maximum Alternative Riparian Water Right Yield	3,200	3,700
Minimum Additional Ground- Water Yield (AFY)	N/A	3,000
Total Annual Project Yield	8,300	11,800
Maximum Additional Surface Water Diversion (AFY)	N/A	8,600

7.2.2.6 Capital and Operation and Maintenance Costs

A detailed cost breakdown of each individual project in Alternative 2 is provided in Appendix F. The estimated capital costs of the new Obermeyer Dam, expansion of the headgate and conveyance facilities, and expansion of the flow control between recharge ponds is \$1.5 million including contingencies and engineering design. Adding the construction and installation of four additional ground-water extraction wells, the estimated capital cost for Alternative 2 increases to \$3.5 million. The cost of the installation for four ground-water wells is based on the 1997 actual cost to replace ground-water production wells in the Upper Ysidora sub-basin. The

TABLE 7-16
COST ESTIMATE FOR ALTERNATIVE NO. 2 – OBERMEYER DAM

<u>Item</u>	<u>Cost</u>
<u>Diversion Dam</u>	
Obermeyer Spillway Gate System	\$365,000
Removal of Existing Dam	30,000
Diversion Dam Foundation	160,000
Diversion Dam Excavating and Grading	11,000
Control Building	45,000
Fish Ladder	<u>10,000</u>
Subtotal (Diversion Dam)	621,000
<u>O'Neill Ditch</u>	
Headgate	28,000
Enlarge Portion of Ditch (Reach 3)	5,000
First Road Crossing	32,000
First Road Crossing Control Gates	18,000
Enlarge Portion of Ditch (Reach 5)	2,000
Replace Upper Parshall Flume	23,000
Turnout to Existing Recharge Ponds	<u>44,000</u>
Subtotal (O'Neill Ditch)	108,000
<u>Recharge Ponds 1-5</u>	
Additional Flow Control and Measurement Structures between Recharge Pond Nos. 1-5 (10 @ \$20,000 each) for 200 cfs	200,000
Subtotal (all items above)	929,000
Contingencies and Unlisted Items @ 25%	232,000
Subtotal	\$1,161,000
Planning, Engineering, and Design @ 15%	174,000
Project Management and Administration @ 10%	116,000
Subtotal	\$1,451,000
<u>Ground-water Wells (4 @ \$500,000 each)</u>	2,000,000
Total Estimated Capital Cost	\$3,451,000
Amortized Capital Cost ¹	307,000
Annual Operation and Maintenance Cost	56,300
Total Estimated Annual Cost	\$363,300
Unit Cost ²	\$120

1. Capital cost amortized over 30 years at 8 percent interest.
2. Unit cost based on 3,000 AFY increase in ground-water yield.

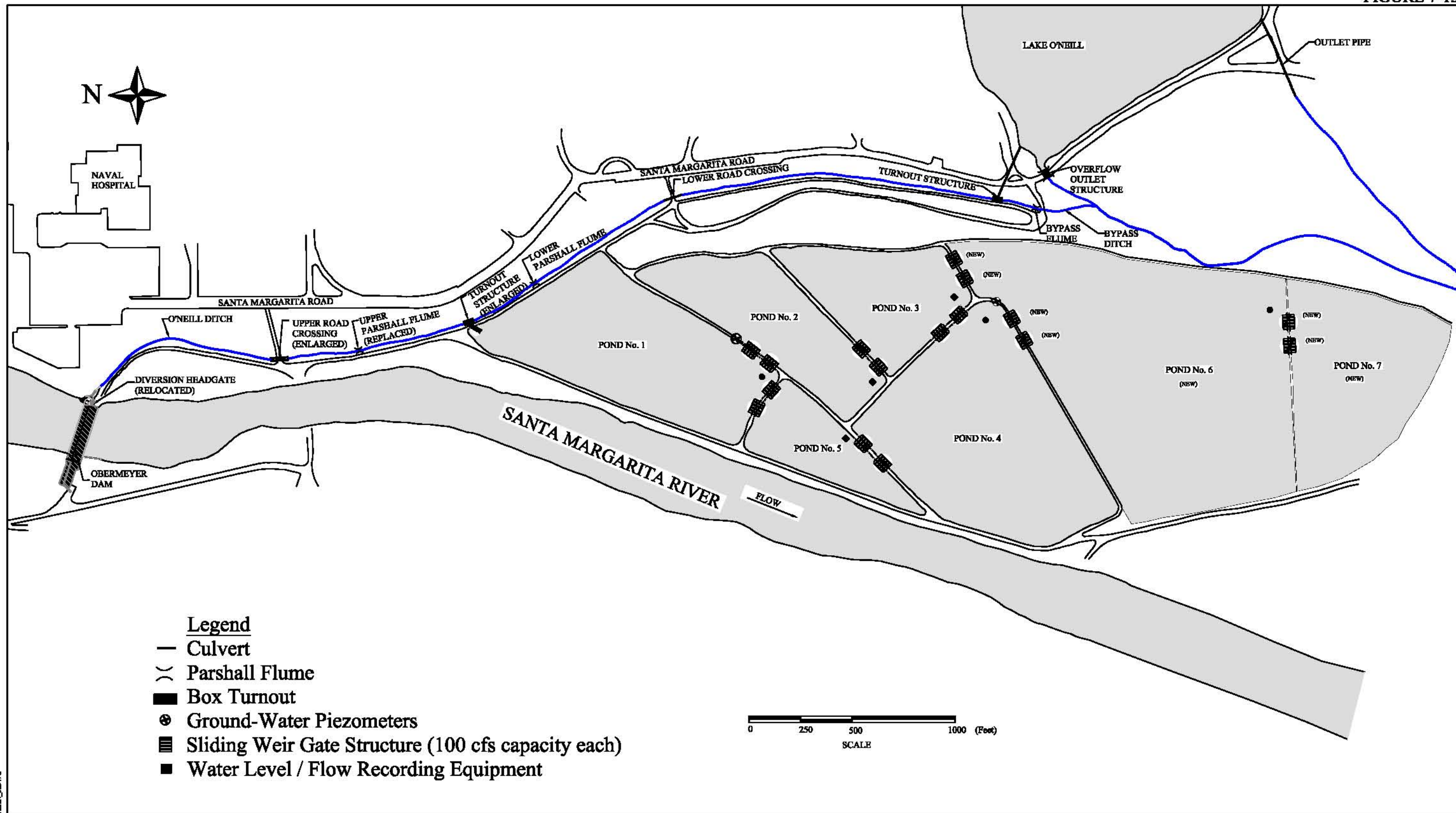

- Legend**
- Culvert
 -) (Parshall Flume
 - Box Turnout
 - ⊕ Ground-Water Piezometers
 - ▨ Sliding Weir Gate Structure (100 cfs capacity each)
 - Water Level / Flow Recording Equipment

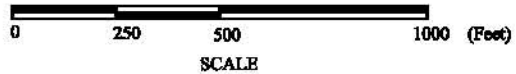

**Diversion and Ground-Water Recharge System - Proposed Facilities (Alternative 3)
Santa Margarita River**

U.S. Navy, Southwest Division, issued a \$2.5 million contract in 1997 to replace six ground-water production wells lost in the 1993 flood. Due to geologic or other limitations, only four wells were completed, the remaining two were abandoned. This capital and operation and maintenance cost for this alternative is shown in Table 7-16.

For comparison purposes, the investment cost is converted to an annual cost of \$363,300 using a 30-year project facility life and an eight-percent interest rate. The annual operation and maintenance cost is estimated to be \$56,300. Compared to Alternative 1, a net reduction of \$32,000 per year in operating and maintenance costs is realized due to the installation of the Obermeyer Dam. The estimated increase in water diverted is 3,000 AFY providing an annual cost of \$120 per acre-foot.

7.2.3 ALTERNATIVE 3 – DIVERSION WEIR, DITCH IMPROVEMENTS AND CONSTRUCTION OF NEW RECHARGE PONDS

The Alternative 3 project includes the replacement of the existing sheet pile diversion weir on the Santa Margarita River with an Obermeyer dam, expansion of the diversion headgate, expansion of the existing ditch, improvement to the five existing recharge ponds, and construction of two additional recharge ponds (Figure 7-13). The instantaneous capacity of the O'Neill diversion and ditch will increase from 60 cfs to 200 cfs, allowing the system to capture higher peak flows and use the available storage in the existing and new recharge ponds. The construction of two new ground-water recharge ponds will increase the available surface water storage on Camp Pendleton by 240 AF. As compared to Alternative 1, the increase in project yield to ground-water storage and recovery is an average annual value of 5,500 AF at an initial capital investment cost of \$5.5 million. The annually amortized cost per acre-foot of water for this project is approximately \$100.

Similar to Alternative 2, surface water is diverted from the Santa Margarita River to the ground-water recharge ponds at a maximum rate of 200 cfs. The addition of the new recharge ponds will provide the Base with the flexibility to capture a greater percentage of the high flow events that would normally flow to the ocean. Using best management practices, the addition of the new recharge ponds will also allow the Base to maximize the infiltration rate in the recharge basins due to greater flexibility in the movement of water between basins.

7.2.3.1 Alternative 3--Project Design and Operation

Obermeyer Dam

The Obermeyer spillway gate system consists of a row of steel gate panels supported on their downstream side by inflatable air bladders. The dam is designed to deflate during high

flow storm events, allowing sediment and debris to flow to the ocean. Following the passing of the peak event, the dam is inflated to allow water to be impounded and diverted into the O'Neill Ditch. The dam is designed to impound water five feet above the headgate invert elevation, providing 200 cfs of flow into the ditch. A more detailed explanation of the Obermeyer Dam is provided in Chapter 7.2.2.

Ditch Improvements

The capacity of the existing ditch is limited to 60 cfs at the upper road crossing located southwest of the Naval Hospital. Similar to Alternative 2, the existing ditch must be enlarged to 200 cfs in order to allow high flow events to recharge the existing ponds. Restrictions in the ditch limit the amount of water that can reach the recharge ponds, limiting the amount of water that may be diverted from the Santa Margarita River.

A detailed description of the required improvements to the ditch are found in Chapter 7.2.2 and are summarized below:

- Enlarge the M & R repaired headgate from 100 cfs to 200 cfs.
- Replace the two 36-inch road-crossing culverts (first crossing) with two 60-inch diameter culverts.
- Replace the two 36-inch control gates at the first road crossing with two 60-inch steel slide gate
- Enlarge the 400-foot section of ditch downstream of the road crossing.
- Enlarge the existing upper Parshall flume.
- Install two new 60-inch turnouts to the existing ground-water recharge ponds.

Existing Recharge Pond Improvements

Due to the increased capacity of the diversion dam and conveyance facilities, capacity improvements to the recharge ponds are required to control the flow of water between each of the five ponds. Similar to the measuring and control weirs discussed in the M & R section of this report, ten additional weirs will be required to increase the instantaneous flow between each of the five existing recharge ponds from 100 cfs to 200 cfs.

The new control structures will include motor operated sliding weir gates mounted on cast-in-place concrete box structures to control pond water levels and to measure flow between ponds. The sliding weir gate structures will provide the means for controlling pond water levels such that flow from one pond will cascade to another without backwater effects between ponds that are in series. Refer to Alternative 2 (Chapter 7.2.2) for a detailed discussion on the operation of the new control weirs and monitoring devices.

New Ground-Water Recharge Pond Nos. 6 and 7

In addition to constructing the Obermeyer spillway diversion dam and enlarging the capacity of O'Neill Ditch from 60 to 200 cfs, Alternative 3 includes expansion of the existing ground-water recharge pond system to include two additional recharge ponds. The two new recharge ponds (Pond Nos. 6 and 7) will occupy approximately 46 acres of land adjacent and downstream to Pond Nos. 3 and 4, bringing the total recharge pond area to 95 acres. The new recharge ponds will add an additional surface water storage capacity of approximately 242 AF to the ground-water recharge system and will allow 14,000 AF of water to infiltrate into the ground-water basin annually.

The amount of additional recharge contributed to the ground-water system by the new ponds (14,000 AF) is a conservative estimate based on infiltration rates that were observed in Pond Nos. 1 and 2 (Chapter 5). Figure 7-14 shows the ground-water recharge pond profile from the head of Pond 1 to Pond 7. Table 7-17 below summarizes the ground-water recharge pond system with the improvements that were proposed for existing Pond Nos. 1 through 5 (Maintenance and Repair Items), and the proposed new Pond Nos. 6 and 7.

The appurtenant facilities associated with constructing the new recharge ponds will include motor operated sliding weir gates to control pond water levels and to measure flow between ponds. Under Alternative 3, two 8-foot sliding weir gates will be required to pass flow from Pond No. 3 into Pond No. 6 and two 8-foot sliding weir gates will be required to pass flow from Pond No. 4 into Pond No. 6. The weir gate structures passing water from Pond Nos. 3 and 4 into Pond No. 6 will be located in close proximity to each other for ease of operation. Additionally, one 8-foot weir gate will be required to pass flow from Pond No. 6 into Pond No. 7. The motor operated sliding weir gates will be mounted on concrete headwalls and flow over the weirs will be conveyed between ponds through corrugated metal pipes buried in the sand levees separating ponds. See Figure 6-3 for a conceptual drawing of the sliding weir gate structure.

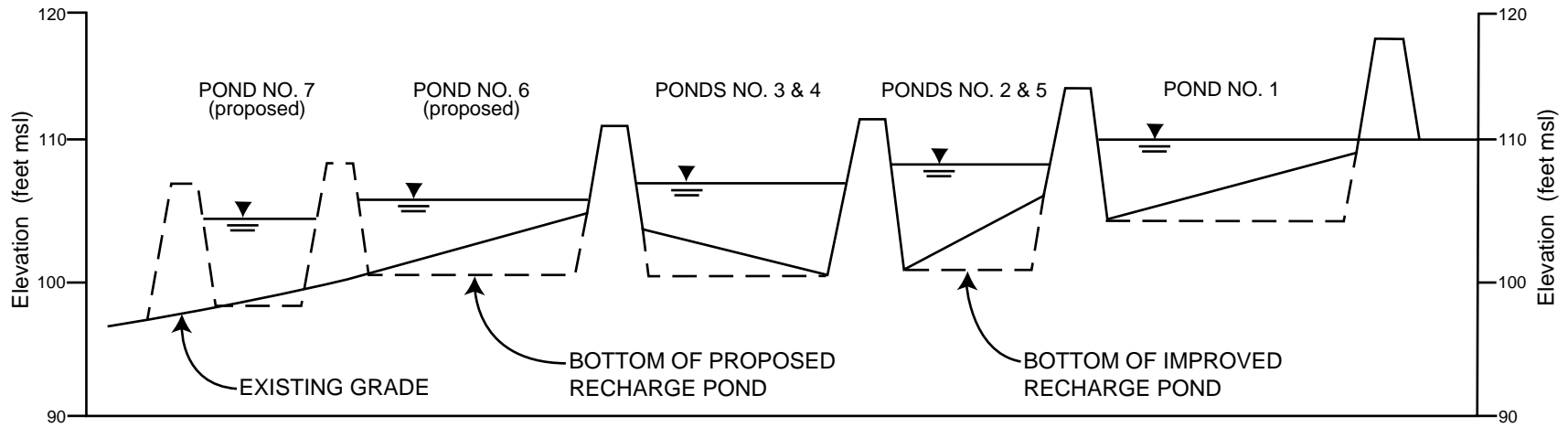

NOTES:

- 1) Pond water levels represent maximum levels after improvements.
- 2) Horizontal distances not drawn to scale.
- 3) Existing and proposed grade lines are approximate.



Ground-Water Recharge Pond Profile
Proposed System with New Pond Nos. 6 & 7

TABLE 7-17
CAPACITY OF IMPROVED GROUND-WATER RECHARGE POND SYSTEM
CAMP PENDLETON MARINE CORPS BASE

Pond Number	Surface Area (Acres)	Average Water Depth (Feet)	Volume (AF)
1	13.9	5.0	69.5
2	7.0	7.5	52.5
3	7.0	6.5	45.5
4	16.5	6.5	107.2
5	4.7	8.0	37.6
Subtotal	49.1		312.3
6 (proposed)	33.3	5.0	166.5
7 (proposed)	12.6	6.0	75.6
Subtotal	45.9		42.1
Total	95.0		554.4

The sliding weir gate structures will provide the means for controlling pond water levels such that flow from one pond will cascade to another without backwater effects between ponds connected in series. Eliminating the backwater effects between ponds will allow for flow measurements to be made easily and accurately. To accomplish water level control and measurement of flow between ponds, it will be necessary to modify the existing pond operations such that maximum pond water levels are restricted to lower elevations (roughly 1-2 feet lower than current operations). The maximum allowable pond water levels will be fixed by the crest height of each sliding weir gate. Once pond water levels and measurements of flow between ponds are made, infiltration rates within the individual ponds and variations in infiltration rates over time can be calculated and monitored.

Alternative 3 will also require the installation of water level and flow recording equipment to allow for a continuous record of the pond operations. The flow recording equipment will include submersible pressure transducers to sense water level heights in the ponds and the height of water passing over the weir gates. The flow rate of water passing over a weir is a function of water depth above the weir crest. The submersible pressure transducers will be installed with data loggers to record continuous pond water levels and calculate flow rates over the weirs. Staff gages will also be installed for use in calibrating the water level sensors and for visual inspection of pond water levels. The equipment required to monitor pond water levels and measure flow between ponds will be installed at convenient and appropriate locations near

the sliding weir gate structures. Under Alternative 3, three continuous flow-recording stations will be required. Nearby utility lines will need to be extended to the flow recording stations to power the equipment.

New Ground-Water Recovery Wells for Alternative 3

Proposed new ground-water recovery wells are located in the Upper Ysidora and Chappo sub-basins. Figure 7-15 shows the 95% F3 monthly pumping schedule proposed for Alternative 3. To achieve the necessary aquifer storage and minimize the environmental impact on riparian vegetation, four new production wells are proposed for the Upper Ysidora (PW-1, PW-2, PW-3, and PW-6), and two new production wells are proposed for the Chappo (PW-4, and PW-5). F3 ground-water production management practices curtail pumping during dry years. During the second consecutive below normal hydrologic year, pumping is reduced by 3,000 AF/month (May of MY 9). Management practices during the third consecutive below normal hydrologic conditions, reduces pumping by an additional 3,000 AF/month (May of MY 10). The restricted flow would continue until an above normal hydrologic year occurred. The 95% F3 pumping reduces the monthly production rates by an additional 5%. Table 7-18 shows the different water year pumping volumes during a normal and below normal period.

Figure 7-15

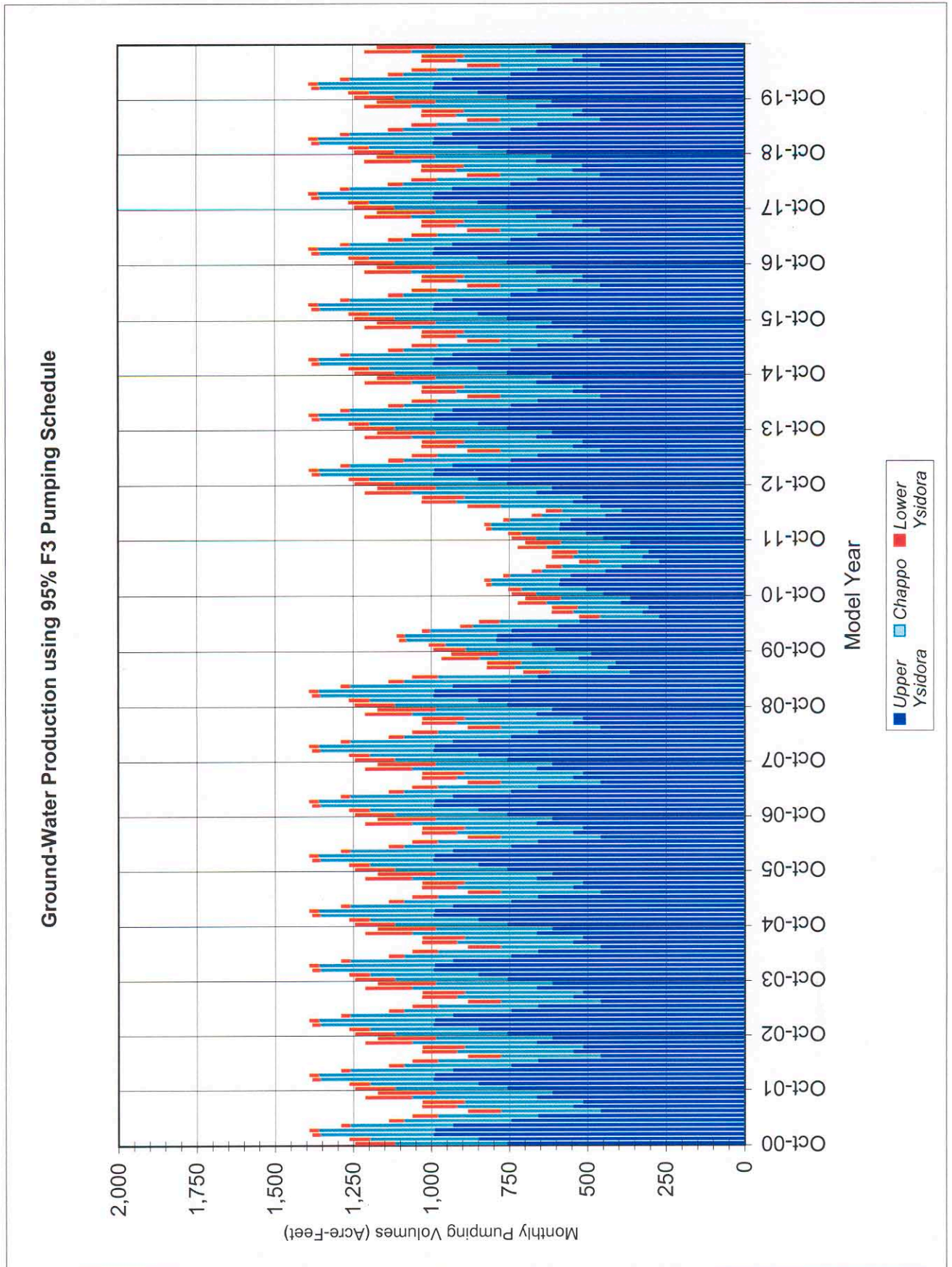

TABLE 7-18
F3 AND 95% F3 PUMPING VOLUMES (AF/WY)

MY	F3 Pumping Volume	95% F3 Pumping Volume	Condition
8	14,800	14,060	First year of Below Normal Hydrologic Conditions
9	13,670	12,980	Second year of Below Normal Hydrologic Conditions; decrease annual pumping by 3,000 AF from May MY 9 through April MY 10
10	10,670	10,130	Third year of Below Normal Hydrologic Conditions; decrease annual pumping by 6,000 AF from May MY 10 through April MY 11
11	8,800	8,360	Fourth year of Below Normal Hydrologic Conditions; decrease annual pumping by 6,000 AF from May MY 11 through April MY 12
12	11,800	11,210	First year of Above Normal Hydrologic Conditions
13	14,800	14,060	Second year of Above Normal Hydrologic Conditions

Note: The third dry year of below normal conditions will yield ground-water production less than the estimated build-out value of 8,800 AFY.

The F3 Pumping Volume represents a January through December annual pumping average.

7.2.3.2 Environmental Opportunities and Constraints Analysis

Environmental Constraints

Alternative 3 would involve construction of each feature described in Alternative 2, plus construction of six new ground-water wells and two additional percolation ponds (proposed ponds number 6 and 7).

Biological Resources

As stated in the Alternative 2 analysis, improving diversion and control structures in the ditch and recharge ponds, enhancing the conveyance structure, and increasing the capacity of the diversion headgate would result in minimal ground disturbance. However, dam replacement and installation of the six proposed ground-water wells would result in disturbance within the Santa Margarita River channel in the Southern Cottonwood/Willow Riparian Forest and Southern Willow Scrub vegetative communities. Constructing six additional ground-water wells would

result in disturbance within Southern Willow Scrub vegetative communities, while the remaining well would be constructed in non-native grassland. In addition to disturbance within these vegetative communities, Alternative 2 would affect “Waters of the U.S.”.

Construction of the proposed recharge ponds number 6 and 7 would take place entirely within lands classified as “Developed” by the Base. However, Base biological data indicate that Least Bell’s Vireo occurs within, and adjacent to, the pond construction area, and that the proposed recharge ponds occur within areas identified as critical habitat for the Southwestern Willow Flycatcher.

Table 7-19 describes those vegetative communities potentially affected by construction of Alternative 3. These communities provide breeding, foraging and cover for the Least Bell’s Vireo, Southwestern Willow Flycatcher, and Arroyo Toad. Table 7-20 describes the estimated regulatory constraints associated with compliance with the regulations and statutes for implementation of Alternative 3.

Table 7-19
Vegetative Communities Potentially Affected by Alternative 3 Project Features

Vegetative Community	Occurrence in Alternative 3 Project Area	Alternative 3 Project Features	Associated Focus Species¹
Southern Cottonwood/Willow Riparian Forest	Within the primary floodplain of the Santa Margarita River and associated alluvium	Obermeyer Dam, and 2 Proposed Wells	LBVI, SWFL, ARTD
Southern Willow Scrub	Inter-mixed with Southern Cottonwood/Willow Riparian Forest and in disturbed areas on the margins of riparian habitat	Conveyance Ditch, and 1 Proposed Well	LBVI, SWFL, ARTD
Non-Native Grassland	South of O’Neill Lake and the proposed dam site	4 Proposed Wells	None
Developed	Immediately northwest of the southern end of O’Neill Lake	2 Recharge Ponds	LBVI, SWFL, ARTD

¹ LBVI=Least Bell’s Vireo; SWFL=Southwestern Willow Flycatcher; ARTD=Arroyo Toad