

CHAPTER 3. TRANSPORT HELIPORTS

300.GENERAL. A transport heliport is intended to accommodate air carrier operators providing scheduled or unscheduled service with large helicopters. This chapter contains standards and recommendations for designing such a facility. Figure 3-1 illustrates a typical transport heliport.

The heliport consists of a touchdown and lift-off area (TLOF) surrounded by a final approach and takeoff area (FATO). A safety area is provided around the FATO. The relationship of the TLOF to the FATO and the Safety Area is shown in Figure 3-2. A FATO may NOT contain more than one TLOF.

a. Appropriate approach/ departure airspace, to allow safe approaches to and departures from landing sites is required. See Paragraph 304.

b. Flight Manual Considerations. Where helicopter flight manuals specify the minimum size required for operations in intended at the facility, the size should be taken into account in the design of the facility.

c. Heliport Site Selection. Public agencies and others planning to develop a transport heliport are encouraged to select a site capable of supporting both instrument operations and future expansion.

d. When a heliport is served by aircraft with seats for more than 30 passengers, the heliport operator is required to have an FAA certificate issued under 14 CFR Part 139, Certification and Operations: Land Airports Serving Certain Air Carriers. A Part 139 certificate is also required if any Part 121 Operating Requirements; Domestic, Flag and Supplemental Operations passenger operations are to be conducted at the heliport.

NOTE: *If tiltrotor operations are contemplated, criteria in AC 150/5390-3, Vertiport Design, are applicable.*

NOTE: *The design recommendations given in this Chapter are based on the presumption that there will never be more than one helicopter within the FATO and the associated safety area. If there is a need for more than one TLOF at a heliport, each TLOF should be located within its own FATO and within its own Safety Area.*

301.TOUCHDOWN AND LIFT-OFF AREA (TLOF).

a. TLOF Location. The TLOF of a transport heliport is normally at ground level but may be developed with the TLOF located on a pier or, when carefully planned, on the roof of a building. The TLOF is centered on the major axis of the final approach and takeoff area (FATO).

b. TLOF Size.

(1) **Minimum Dimension.** The TLOF should be a square or rectangular surface whose minimum length and width should be 1.0 times the rotor diameter (RD) of the design helicopter but not less than 50 feet (15.2 m).

(2) **Elongated TLOF:** An elongated TLOF can provide an increased safety margin and greater operational flexibility. An elongated TLOF may contain a landing position located in the center and two takeoff positions located at either end as illustrated in Figure 3-3. The landing position should have a minimum length of 1.0 times the RD of the design helicopter.

NOTE: *If an elongated TLOF is provided an elongated FATO will also be required. See Figure 3-3.*

c. Ground-level TLOF Surface Characteristics. The entire TLOF should be load bearing. The TLOF should be capable of supporting the dynamic loads of the design helicopter (Paragraph 806b). The TLOF should be constructed of Portland Cement Concrete (PCC). (An asphalt surface is not recommended.) The pavement should have a broomed surface that provides a skid-resistant surface for helicopters and non-slippery footing for people.

d. Rooftop and Other Elevated TLOFs. Elevated TLOFs and any supporting TLOF structure should be capable of supporting the dynamic loads of the design helicopter (Paragraph 806b).

(1) **TLOF Surface Characteristics.** Rooftop and other elevated heliport TLOFs should be constructed of metal or concrete (or other materials subject to local building codes). TLOF surfaces

should have a broomed pavement or other roughened finish that provides a skid-resistant surface for helicopters and non-slippery footing for people.

e. TLOF Gradients. Recommended TLOF gradients are defined in Chapter 8.

302.FINAL APPROACH AND TAKEOFF AREA. A transport heliport should have at least one FATO. The FATO should contain a TLOF within its borders at which arriving helicopters terminate their approach, and from which departing helicopters take off.

a. FATO Location. The FATO of a transport heliport is normally at ground level but may be developed on a pier or, when carefully planned, on the roof of a building.

b. FATO Size. FATOs are rectangular surfaces with the long axis aligned with the preferred flight path. See Paragraph 304.

(1) **FATO Width.** The minimum width of a FATO should be at least 2.0 RD but not less than 100 feet (30.5 m).

(2) **FATO Length.** The minimum length of the FATO should be 2.0 RD but not less than 200 feet (61 m). At elevations well above sea level, a longer FATO can provide an increased safety margin and greater operational flexibility. The additional FATO length that should be used is depicted in Figure 3-4.

(3) The minimum distance between the TLOF perimeter and the FATO perimeter should be not less than the distance $[0.5 \times (1.5 \text{ OL} - 1 \text{ RD})]$, where OL is the overall length and RD is the RD of the design helicopter.

c. FATO Surface Characteristics. The entire FATO should be load bearing capable of supporting dynamic loads of the design helicopter. (See paragraph 806b). If it is unpaved, the FATO should be treated to prevent loose stones and any other flying debris caused by rotor wash. The portion of the FATO abutting the TLOF should be continuous with the TLOF and the adjoining edges should be at the same elevation.

d. Rooftop and Other Elevated FATOs. Elevated FATOs and any FATO supporting structure should be capable of supporting the dynamic loads of the design helicopter (Paragraph 806b).

(1) **Elevation.** The FATO should be elevated above the level of any obstacle, in the Safety Area, that can not be removed. (Exception: This does not apply to frangibly mounted objects that, due to their function, must be located within the Safety Area (see paragraph 303d).)

(2) **Obstructions.** Elevator penthouses, cooling towers, exhaust vents, fresh air vents, and other raised features can impact heliport operations. Helicopter exhausts can impact building air quality if the heliport is too close to fresh air vents. These issues should be resolved during facility design. In addition, control mechanisms should be established to ensure that obstruction hazards are not installed after the heliport is operational.

(3) **FATO Surface Characteristics.** Rooftop and other elevated heliport FATOs should be constructed of metal or concrete (or other materials subject to local building codes). FATO surfaces should have a non-slippery footing for people.

(4) **Safety Net.** When the FATO is on a platform elevated more than 30 inches (76 cm) above its surroundings, a safety net, not less than 5 feet (1.5 m) wide, should be provided. A railing or fence should not be used since it would be a safety hazard during operations. The safety net should have a load-carrying capability of 50 lb/ft² (244 kg/m²). The net, as illustrated in Figure 3-20, should not project above the level of the FATO. Both the inside and outside edges of the safety net should be fastened to a solid structure.

(5) **Ramp Access.** Heliports should provide access to and from the FATO via a ramp in order to accommodate individuals with disabilities. OSHA requires two separated access points for an elevated FATO. For a transport heliport, ramp access should be provided at both points. If stairs are used as a third access point, they should be built in compliance with regulations 29 CFR 1910.24. However, inside the FATO, any handrails should not extend above the elevation of the TLOF.

(6) **Ramp Design.** The ramp surface should provide a slip-resistant surface. The slope of the ramp should be no steeper than 12:1 (12 units horizontal in 1 unit vertical). The width of the ramp should be not less than 6 feet (1.8 m) wide. The ramp should be built in compliance with state and local requirements and with regulations Appendix A of 49 CFR Part 37, Transportation Services for Individuals with Disabilities, Section 4.8. However, inside the FATO, any handrails should not extend above the elevation of the TLOF. There should be a

safety net on the edges of the ramp where a handrail complying with Appendix A of 49 CFR 37, Section 4.8 is not provided.

e. Mobile Objects Within the FATO and the Safety Area. The FATO/Safety Area design recommendations of this AC are based on the assumption that the TLOF is closed to other aircraft if a helicopter or other mobile object is within the FATO or the associated Safety Area.

f. FATO/FATO Separation. If a heliport has more than one FATO, the separation between the perimeters of two FATOs should be such that the respective Safety Areas do not overlap. This separation is based on the assumption that simultaneous approach/ departure operations will not take place.

NOTE: *If simultaneous operations are planned, greater separation will be required.*

g. FATO Gradients. Recommended FATO gradients are defined in Chapter 8.

303.SAFETY AREA. A Safety Area surrounds a FATO and should be cleared of all obstacles except small, frangible objects that, because of their function, must be located there.

a. Safety Area Width. A Safety Area should extend outward on all sides of the FATO for a distance not less than 30 feet (9 m).

b. IFR Safety Area Width. RESERVED.

c. Mobile Objects Within the Safety Area. See paragraph 302e.

d. Fixed Objects Within a Safety Area. No fixed object should be permitted within a Safety Area except for frangibly mounted objects that, due to their function, must be located there. Those objects whose functions require them to be located within the Safety Area should not exceed a height of 8 inches (20 cm) above the elevation of the FATO perimeter nor penetrate the approach/ departure surfaces or transitional surfaces.

e. Safety Area Surface. This Safety Area need not be load bearing. Figure 3-5 depicts a Safety Area extending over water. If the Safety Area is load bearing, the portion abutting the FATO should be continuous with the FATO and the adjoining edges should be at the same elevation. This is needed to avoid the risk of catching a helicopter skid or wheel.

The Safety Area should be treated to prevent loose stones and any other flying debris caused by rotor wash.

f. Safety Gradients. Recommended Safety Area gradients are defined in Chapter 8.

304.VFR APPROACH/ DEPARTURE PATHS.

The purpose of approach/ departure airspace, is to provide sufficient airspace clear of hazards to allow safe approaches to and departures from landing sites

a. Number of Approach/ Departure Paths. During approach and departure operations, flight into the wind is the ideal operation condition. Crosswind operations are acceptable within certain limitations. Heliports should be designed so pilots can choose an approach/ departure path that avoids downwind conditions and crosswind operations are kept to a minimum. To accomplish this under varying wind conditions, a heliport should have more than one approach/ departure path and the preferred flight approach/ departure path should, to the extent feasible, be aligned with the predominate wind direction. Other approach/ departure paths should be based on the assessment of the prevailing winds or when this information is not available the separation between such flight paths should be at least 135 degrees. See Figure 3-6.

b. VFR Approach/ Departure Surfaces. An approach/ departure surface is centered on each approach/ departure path. Figure 3-6 illustrates the approach/ departure and transitional surfaces that should be free of penetrations.

The approach / departure path starts at the edge of the FATO and slopes upward at 8:1 (8 units horizontal in 1 unit vertical) for a distance of 4000 ft (1219 m) where the width is 500 ft (152 m) at a height of 500 ft (152 m) above the elevation of TLOF surface.

The transitional surfaces start from the edges of the FATO parallel to the flight path center line, and from the outer edges of approach/ departure surface, and extend outwards at a slope of 2:1 (2 unit horizontal in 1 units vertical) for a distance of 250 ft (76 m) from the centerline. The transitional surfaces start at the edge of the FATO opposite the approach/ departure surfaces and extends to the end of the approach/ departure surface. See Figure 3-6.

c. Marking and Lighting of Objects that Are Difficult to See. See paragraph 311.

d. Control of Obstructions. Control mechanisms should be established to ensure that obstruction hazards are not introduced after a heliport is operational. Heliport operators should maintain a list of the GPS coordinates and the peak elevation of obstacles in the vicinity of the heliport and its approach and departure paths. Particular attention should be given to any obstacles that need to be marked or lighted. Heliport operators should reexamine obstacles in the vicinity of approach/ departure paths on at least an annual basis. This reexamination should include an appraisal of the growth of trees in close proximity to approach and departure paths. Paragraph 108 provides guidance on how to identify and mitigate hazards to air navigation.

e. Curved VFR Approach/ Departure Paths. VFR approach/ departure paths may curve in order to avoid objects or noise-sensitive areas. (More than one curve in the path is not recommended.) Heliport designers are encouraged to use the airspace above public lands, such as freeways or rivers.

NOTE: *In the next revision of this AC, the FAA intends to provide greater detail on the minimum dimensions of curved approach/ departure airspace.*

305.PROTECTION ZONE. The protection zone is the area under the approach/ departure surface starting at the FATO perimeter and extending out for a distance of 400 feet (122 m), as illustrated in Figure 3-7. The heliport proponent should own or control the property containing the protection zone. This control should include the ability to clear incompatible objects and to preclude the congregation of people.

306.WINDSOCK.

a. Specification. A windsock conforming to AC 150/5345-27, *Specification for Wind Cone Assemblies*, should be used to show the direction and magnitude of the wind. The windsock should provide the best possible color contrast to its background.

b. Windsock Location. The windsock should be located so it provides the pilot with valid wind information in the vicinity of the heliport under all wind conditions.

(1) The windsock should be sited so it is clearly visible to the pilot on the approach path when the helicopter is at a distance of 500 feet (152 m) from the TLOF.

(2) Pilots should be able to see a windsock from the TLOF.

(3) To avoid presenting an obstruction hazard, the windsock should be located outside the Safety Area, and it should not penetrate the approach/ departure or transitional surfaces.

(4) At many landing sites, there may be no single, ideal location for the windsock. At other sites, it may not be possible to site a windsock at the ideal location. Consequently, more than one windsock may be required in order to provide the pilot with all the wind information needed for safe operations.

c. Windsock Lighting. For night operations, the windsock should be internally lighted or externally illuminated to ensure that it is clearly visible.

307.TAXIWAYS AND TAXI ROUTES. Taxiways and taxi routes should be provided for the movement of helicopters from one part of a landing facility to another. They provide a connecting path between the FATO and a parking area. They also provide a maneuvering aisle within the parking area. A taxi route includes the paved taxiway plus the appropriate clearances needed on both sides. The relationship between a taxiway and a taxi route is illustrated in Figure 3-8.

a. Taxiway/Taxi Route Widths. The dimensions of taxiways and taxi routes are a function of helicopter size and type of taxi operations (ground taxi or hover taxi). These dimensions are defined in Table 3-1.

NOTE: *Normally, the requirement for hover taxi dictates the taxiway/taxi route widths. However, when the fleet comprises a combination of large ground taxiing helicopters and smaller air taxiing helicopters, the larger aircraft may dictate the taxiway/taxi route widths. If wheel-equipped helicopters taxi with wheels not touching the surface, the facility should be designed with hover taxiway widths rather than ground taxiway widths.*

b. Taxiway and Taxi Route Markings. The centerline of a taxiway should be marked with a continuous 6- inch wide (15 cm) yellow line. Both edges of the paved portion of the taxiway should be marked with two continuous 6- inch wide (15 cm) yellow lines spaced 6- inches (15 cm) apart. Figure 3-8 illustrates taxiway centerline and edge markings.

c. Taxiway to Parking Position Transition Requirements. Taxiway centerline markings should continue into parking positions and become the parking position centerlines.

d. Surfaces. Taxiways should be paved. The unpaved portions of taxi routes should have a turf cover or be treated in some way to prevent dirt and debris from being raised by a taxiing helicopter's rotor wash.

e. Gradients. Recommended taxiway and taxi route gradients are defined in chapter 8, paragraph 805.

f. Lighting. See paragraph 310.

308.HELICOPTER PARKING. A transport heliport should have a paved apron for parking helicopters. The size of the apron depends upon the number and size of helicopters to be accommodated. Parking positions should be designed to accommodate the full range of helicopter size and weights expected at the facility. Parking positions should support the static loads of the helicopters intended to use the parking area (Paragraph 806a). Separate aprons may be established for specific functions such as passenger boarding, maintenance, and parking of based and transient helicopters.

a. Location. Aircraft parking areas should not lie under an approach/ departure surface. However, aircraft parking areas may lie under the transitional surfaces. The nearest edge of a parking position should be located a minimum of ½ RD but not less than 30 feet (9.1 m) from the edge of a taxi route.

b. Size. Parking position sizes are dependent upon the helicopter size. The clearances between parking positions are dependent upon the type of taxi operations (ground-taxi or hover/ taxi) and the intended paths for maneuvering in and out of the parking position.

(1) If all parking positions are the same size, they should be large enough to accommodate the largest helicopter that will operate at the heliport.

(2) When there is more than one parking position, the facility may be designed with parking positions of various sizes with at least one position that will accommodate the largest helicopter that will operate at the heliport. Other parking positions may be smaller, designed for the size of the individual or range of individual helicopters planned to be parked at that position.

(3) The rotor diameter of the largest helicopter that the parking position is designed to accommodate should be marked (see paragraph 308c(2)).

(4) "Turn-around" parking positions should be designed as illustrated in Figure 3-9. Details of the recommended parking position marking are shown in Figure 3-10.

(5) "Taxi-through" parking positions should be designed as illustrated in Figure 3-11.

(6) "Back-out" parking positions are NOT recommended at transport heliports.

NOTE: *Heliport parking areas should be designed to allow helicopters to be parked in a direction that keeps tail rotors as far from passenger walkways as possible.*

c. Helicopter Parking Position Marking. Helicopter parking positions should have the following markings:

(1) A 12-inch wide (30 cm) solid yellow, painted line defining a circle of 1.0 RD of the largest helicopter that will park at that position (see Figure 3-12).

(2) The maximum rotor diameter of the largest helicopter that the position is designed to accommodate is indicate (e.g., 49) by numerals. This marking should be in yellow characters, clearly visible, and at least 3 feet (0.9 m) high. (See Figs. 3-12, and Appendix Figure A3-1).

(3) A 12-inch (30 cm) wide, solid yellow, painted centerline marking (see Figure 3-12).

(4) A 12-inch-wide (30- cm) extended centerline that the pilot can see when positioned in the center of the parking position. This should be a solid yellow painted line for a "taxi-through" parking position (see Figure 3-11). If the parking position will not accommodate taxi-through operations, this extended centerline should be a dashed yellow, painted line (see Figs. 3-10 and 3-12). The purpose of the extended centerline is to provide the pilot with better visual guidance during parking maneuvers.

(5) A 6-inch wide (15 cm) solid yellow shoulder line, perpendicular to the centerline, should be located so that it is under the pilot's shoulders when the main rotor of the largest helicopter for which the position is designed will be entirely within

the 1.0 RD parking circle (see Figure 3-12). This shoulder line should extend far enough from the parking position centerline so the pilot can see it on both sides of the helicopter.

(6) Parking position identifications (numbers or letters) should be marked if there is more than one parking position. These markings should be yellow characters that are clearly visible and 3 feet (0.9 m) high. (See Figs. 3-12, and Appendix Figure A3-1).

(7) A passenger walkway, as illustrated in Figure 3-10, should be clearly marked.

(8) If a parking position has a weight limitation, it should be stated in units of 1,000 pounds, as illustrated in Figure 3-12. (A number 9 indicates a weight-carrying capability of up to 9,000 pounds. Metric equivalents should NOT be used for this purpose.) This marking should be in yellow characters that are clearly visible and 3 feet (0.9 m) high. A bar may be placed under the number to minimize the possibility of being misread. See Figure 3-15, and Appendix Figures A3-1 and A3-2.

d. Passenger Walkways. Passenger movement in operational areas should be restricted to marked walkways. Layout of passenger walkways should minimize the passenger exposure to various risks during passenger loading and unloading. Figure 3-10 illustrates one marking scheme. The pavement should be designed so spilled fuel does not drain onto passenger walkways or toward parked helicopters. Two separated access points are required for elevated TLOFs.

e. Parking Area Size and Clearance Requirements for a Variety of Helicopters (Wheeled and Skid-equipped). The more demanding requirement will dictate what is required at a particular site. Usually, the parking area requirements for skid-equipped helicopters will be the most demanding. However, when the largest helicopter is a very large, wheeled aircraft (e.g., the S-61), and the skid-equipped helicopters are all much smaller, the parking size requirements for wheeled helicopters may be the most demanding. If wheel-equipped helicopters taxi with wheels not touching the surface, parking areas should be designed based on hover taxi operations rather than ground taxi operations.

f. Fueling. Helicopter fueling is typically accomplished with the use of a fuel truck or the use of a specific fueling area with stationary fuel tanks.

(1) Systems for storing and dispensing fuel must conform to Federal, state, and local requirements for petroleum handling facilities. Guidance is found in AC 150/5230-4, *Aircraft Fuel Storage, Handling, and Dispensing on Airports*, and in appropriate National Fire Protection Association (NFPA) 403, *Standard for Aircraft Rescue and Fire Fighting Services at Airports*, and NFPA 418, *Standards for Heliports*.

(2) Fueling locations should be designed and marked to minimize the potential for helicopters to collide with the dispensing equipment. Fueling areas should be designed so there is no object tall enough to be hit by the main or tail rotor blades within a distance of 1.0 times the Overall Length (OL) from the center point of the position where the helicopter would be fueled. If this is not practical at an existing facility, long fuel hoses should be installed.

(3) **Lighting.** The fueling area should be lighted if night fueling operations are contemplated. Care should be taken to ensure that any light poles do not constitute an obstruction hazard.

g. Tie-Downs. Recessed tie-downs should be installed to accommodate extended or overnight parking of based or transient helicopters. Caution should be exercised to ensure that any depression associated with the tie-downs should not have a diameter greater than one-half the width of the smallest helicopter landing wheel or landing skid anticipated to be operated on the heliport surface. In addition, tie-down chocks, chains, cables, and ropes should be stored off the heliport surface to avoid fouling landing gear. Guidance on tie-downs can be found in AC 20-35.

h. Taxiway-to-Parking-Position Transition Requirements. See paragraph 308c.

309. HELIPORT MARKERS AND MARKINGS. Markers and/or surface markings should identify the facility as a heliport. Surface markings may be paint, reflective paint, or preformed material. Lines/markings may be outlined with a 6-inch wide (15 cm) line of a contrasting color to enhance conspicuity. The following markers and markings should be used.

a. TLOF and FATO Perimeter Markings. The perimeter of the TLOF and the FATO should be defined with markers and/or lines.

(1) TLOFs. The perimeter of a TLOF should be defined with a continuous 12-inch wide (30 cm), white line, as shown in Figure 3-13 and Figure 3-14. The perimeter of an unpaved TLOF should be defined with a series of 12-inch-wide (30 cm) flush, in-ground markers, each approximately 5 feet (1.5 m) in length with end-to-end spacing of not more than 6 inches (15 cm).

(2) Unpaved FATOs. The perimeter of an unpaved FATO should be defined with 12-inch wide (30 cm), flush in-ground markers. The corners of the FATO should be defined and the perimeter markers should be 12 inches in width, approximately 5 feet (1.5 m) in length, and with end-to-end spacing of approximately 5 feet (1.5 m). (See Figure 3-13).

(3) Paved FATOs. The perimeter of a paved FATO should be defined with a 12-inch wide (30 cm) dashed white line. The corners of the FATO should be defined and the perimeter marking segments should be 12 inches in width, approximately 5 feet (1.5 m) in length, and with end-to-end spacing of approximately 5 feet (1.5 m). See Figure 3-14.

b. Standard Identification Marking. The standard identification marking is intended to identify the location as a heliport, to mark the TLOF, and to provide visual cues to the pilot. A white "H" marking should mark the TLOF. The proportions and layout of the letter H are illustrated in Figure 3-15. The height of the H is limited to 75 feet (22.9m). The H should be oriented on the axis of the preferred approach/ departure path. A bar may be placed under the H when it is necessary to distinguish the preferred approach/ departure direction. Arrows and/or landing direction lights (see paragraph 310e) may also be used to indicate one or more preferred approach/ departure paths.

c. Taxiway and Taxi Route Markings. See paragraph 307.

d. Apron Markings. In addition to the taxiway and parking position markings, the yellow (double) taxiway edge lines should continue around the apron to define its perimeter. Figures 3-9 and 3-11 illustrate apron markings.

e. Parking Position Markings. See paragraph 307.

f. Closed Heliport. All markings of a permanently closed heliport, FATO, or TLOF should be obliterated. If it is impractical to obliterate

markings, a yellow X should be placed over the H, as illustrated in Figure 3-16. The yellow X should be large enough to ensure early pilot recognition that the heliport is closed. The windsock(s) and other visual indications of an active heliport should also be removed.

g. TLOF Size Limitations. The TLOF should be marked to indicate the rotor diameter of the largest helicopter for which it is designed as indicated in Figure 3-15. (The rotor diameter should be given in feet. Metric equivalents should NOT be used for this purpose.) This marking should be centered in the lower section of a TLOF size/weight limitation 'box'. The numbers should be 5 ft (1.5 m) high (see Appendix A Figure A3-1). The numbers should be black with a white background. When viewed from the preferred approach direction, this TLOF size/weight limitation 'box' should be located on the TLOF in the lower right-hand corner, or the on right-hand side of the H of a circular TLOF.

h. Elevated TLOF Weight Limitations. If a TLOF has limited weight-carrying capability, it should be marked with the maximum takeoff weight of the design helicopter, in units of thousands of pounds as indicated in Figure 3-15 (A numeral 21 indicates a weight-carrying capability of up to 21,000 pounds. Metric equivalents should NOT be used for this purpose.) This marking should be centered in the upper section of a TLOF size/weight limitation 'box'. The numbers should be 5 ft (1.5 m) high (see Appendix A Figure A3-2). The numbers should be black with a white background. If the TLOF does not have a weight limit, a diagonal line, extending from the lower left hand corner to the upper right hand corner, should be added to the upper section of the TLOF size/weight limitation 'box'. (See Figure 3-15) When viewed from the preferred approach direction, this TLOF size/weight limitation 'box' should be located on the TLOF in the lower right-hand corner.

i. Equipment/Object Marking. Heliport maintenance and servicing equipment, as well as other objects used in the airside operational areas, should be made conspicuous with paint, reflective paint, reflective tape, or other reflective markings. Particular attention should be given to marking objects that are hard to see in marginal visibility, such as at night, heavy rain, or in fog.

j. Marking Obstructions Outside the Approach/ Departure Airspace. See paragraph 311.

k. Marking Proportions. See Appendix 3 for guidance on the proportions of painted numbers.

310.HELIPORT LIGHTING. For night operations, the TLOF, the FATO, taxiways, taxi routes, and the windsock need to be lighted. AC 150/5340-28, *Low Visibility Taxiway Lighting System*; AC 150/5340-24, *Runway and Taxiway Edge Lighting System*; and AC 150/5345-46, *Specification for Runway and Taxiway Light Fixtures*, contain technical guidance on lighting equipment and installation details. Heliport lighting ACs are available at <http://faa.gov/arp>.

a. Ground-level TLOF Perimeter Lights. Flush green lights should define the TLOF perimeter. A minimum of four flush light fixtures is recommended per side of a square or rectangular TLOF. A light should be located at each corner with additional lights uniformly spaced between the corner lights, with a maximum interval of 25 feet (8 m) between lights. Flush lights should be located within 1 foot (30 cm) inside or outside of the TLOF perimeter. Figures 3-18 and 3-19 illustrate this lighting.

b. Elevated TLOF Perimeter Lights. The TLOF perimeter should be lit with flush green lights located within 1 foot inside or outside of the TLOF edge. If raised omni-directional lights are used they should be located on the outside edge of the TLOF or the outer edge of the safety net as shown in Figure 3-20. The raised lights should not penetrate a horizontal plane at the TLOFs elevation by more than 2 inches (5 cm). In areas where it snows in the winter, the outside edge is the preferred location. (Lights on the outside edge of the TLOF are prone to breakage during snow removal.) Lighting on the outside edge also provides better visual cues to pilots at a distance from the heliport since they outline a larger area.

c. Optional TLOF Lights. An optional feature is a line of 7 white, flush L-850A lights spaced at 5-foot (1.5 m) intervals installed in the TLOF pavement. These lights are aligned on the centerline of the approach course to provide close-in directional guidance and improve TLOF surface definition. These lights are illustrated in Figure 3-17.

d. Ground FATO Perimeter Lights. Green lights should define the limits of the FATO. A light should be located at each corner with additional lights uniformly spaced between the corner lights with a maximum interval of 25 feet (8 m) between

lights. A circular pattern of FATO perimeter lights is not recommended.

(1) If flush lights are used, they should be located within 1 foot (30 cm) inside or outside of the FATO perimeter. (See Figure 3-18).

(2) If raised light fixtures are used, they should be no more than 8 inches (20 cm) high, should be located 10 feet (3 m) out from the FATO perimeter, and should not penetrate a horizontal plane at the FATO elevation by more than 2 inches (5 cm). See Figure 3-19.

e. Elevated FATO-Perimeter Lights. The FATO perimeter should be lit with green lights. If flush lights are used, they should be located within 1 foot (inside or outside) of the FATO edge. If raised omni-directional lights are used, they should be located on the outside edge of the FATO or outside edges of the safety net, as shown in Figure 3-20. The raised lights should not penetrate a horizontal plane at the FATO/TLOF elevation. In areas where it snows in the winter, the outside edge is the preferred location. (Lights on the inside edge of the safety net are prone to breakage during snow removal.) Lighting on the outside edge also provides better visual cues to pilots at a distance from the heliport since they outline a larger area.

f. Landing Direction Lights. Landing direction lights are an optional feature to be installed when it is necessary to provide directional guidance. Landing direction lights are a configuration of five yellow, omni-directional L-861 lights on the centerline of the preferred approach/ departure path. These lights are spaced at 15-foot (4.6 m) intervals beginning at a point not less than 30 feet (9 m) and not more than 60 feet (18 m) from the TLOF perimeter and extending outward in the direction of the preferred approach/ departure path, as illustrated in Figure 3-21.

g. Taxiway and Taxi Route Lighting. Flush green lights define taxiway centerlines. Blue omni-directional lights define the edges of the taxiway.

(1) Taxiway Centerline Lights. Taxiway centerlines are defined with flush L-852A bi-directional lights for straight segments and L852B lights for curved segments. These lights should be spaced at 50-foot (15 m) longitudinal intervals on straight segments and at 25-foot (7.5 m) intervals on curved segments with a minimum of four lights

needed to define the curve. Retroreflective markers are NOT recommended.

(2) Taxiway Edge Lights. Flush L-861T omni-directional blue lights should be used to mark the edges of a paved taxiway. These lights should be spaced at 50-foot (15 m) longitudinal intervals on straight segments and at 25-foot (7.5 m) intervals on curved segments with a minimum of four lights needed to define the curve. Retroreflective markers are NOT recommended.

h. Heliport Identification Beacon. A heliport identification beacon should be installed. The beacon, flashing white/green/yellow at the rate of 30 to 45 flashes per minute, should be located on or close to the heliport. Guidance on heliport beacons is found in AC 150/5345-12, *Specification for Airport and Heliport Beacon*.

i. Floodlights. Floodlights may be used to illuminate the parking apron. To eliminate the need for tall poles, these floodlights may be mounted on adjacent buildings. Care should be taken, however, to place floodlights clear of the TLOF, the FATO, the Safety Area, and the approach/ departure surfaces and any required transitional surfaces. Care should be taken to ensure that floodlights and their associated hardware do not constitute an obstruction hazard. Floodlights should be aimed down and provide a minimum of 3-foot candles (32 lux) of illumination on the apron surface. Floodlights that might interfere with pilot vision during takeoff and landings should be capable of being turned off.

j. Lighting of Obstructions. See paragraph 311.

k. Heliports at Airports. When a heliport on an airport is sited in close proximity to a taxiway, there may be a concern that the green taxiway centerline lights could be confused with the TLOF or FATO perimeter lights. In such cases, yellow lights may be used as an alternative color for marking the TLOF and the FATO.

311.MARKING AND LIGHTING OF OBSTRUCTIONS. The marking and lighting of obstructions within the approach/ departure airspace is discussed in paragraph 108b(3). This paragraph discusses the marking lighting of obstructions in close proximity but outside the approach/ departure airspace.

a. Background. Unmarked wires, antennas, poles, cell towers, and similar objects are often

difficult to see, even in the best daylight weather, in time for a pilot to successfully take evasive action. While pilots can avoid such objects during en route operations by flying well above them, approaches and departures require operation near the ground where obstacles may be in close proximity.

b. Airspace. If difficult-to-see objects penetrate the object identification surfaces illustrated in Figure 3-22, these objects should be marked to make them more conspicuous. If operations are conducted at a heliport between dusk and dawn, these difficult-to-see objects should be lighted. Guidance on marking and lighting objects is contained in AC 70/7460-1, *Obstruction Marking and Lighting*. The object identification surfaces in Figure 3-22 can also be described as follows:

(1) In all directions from the Safety Area except under the approach/ departure paths, the safety surface starts at the Safety Area perimeter and extends out horizontally a distance of 100 feet (30 m).

(2) Under the approach/ departure surface, the object identification surface starts from the outside edge of the FATO and extends horizontally out for a distance of 800 feet (244 m). From this point, the object identification surface extends out for an additional distance of 3,200 feet (975 m) while rising on a 8:1 slope (8 unit horizontal in 1 units vertical). From the point 800 feet (244 m) from the FATO perimeter, the object identification surface is 100 feet (30.5 m) beneath the approach/ departure surface.

(3) The width of the object identification surface increases as a function of distance from the Safety Area. From the Safety Area perimeter, the object identification surface extends laterally to a point 100 feet (30 m) outside the Safety Area perimeter. At the upper end of the surface, the object identification surface extends laterally 200 feet (61 m) on either side of the approach/ departure path.

c. Shielding of Objects. If there are a number of obstacles in close proximity, it may not be necessary to mark all of them if they are shielded. To meet the shielding guidelines a object would be shielded by existing structures of a permanent and substantial character or by natural terrain or topographic features of equal or greater height, and would be located in the congested area of a city, town, or settlement where it is evident beyond all reasonable doubt that the structure so shielded will not adversely affect safety in air navigation.

Additional guidance on this topic may be found in 14 CFR Part 77.15(a), Construction or alterations not requiring notice.

312.SAFETY CONSIDERATIONS.

Some safety enhancements to be considered in the design of a heliport are discussed below. Other areas such as the effects of rotor downwash may need to be addressed based on site conditions and the design helicopter.

a. Security. The operational areas of a heliport need to be kept clear of people, animals, and vehicles.

(1) **Safety Barrier.** At ground-level transport heliports, the heliport owner or operator should erect a safety barrier around the helicopter operational areas. This barrier may take the form of a fence or a wall. It should be no closer to the operation areas than the outer perimeter of the Safety Area. Barriers should not penetrate any approach/ departure (primary or transitional) surface. Thus, in the vicinity of the approach/ departure paths, the barrier may need to be well outside the outer perimeter of the Safety Area.

(2) Any barrier should be high enough to present a positive barrier to persons inadvertently entering an operational area and yet low enough to be non-hazardous to helicopter operations.

(3) Access to airside areas should be through controlled and locked gates and doors. Gates and doors should display a cautionary sign similar to that illustrated in Figure 3-23.

b. Rescue and Fire Fighting Services. State and local rescue and fire fighting regulations vary. Heliports should meet the criteria of NFPA Pamphlet 418, Standards for Heliports, and NFPA Pamphlet 403, Standard for Aircraft Rescue and Fire-fighting Services at Airports. A fire hose cabinet or extinguisher should be provided at each access gate and each fueling location. At elevated TLOF/FATOs, fire hose cabinets, fire extinguishers, and other fire fighting equipment should be located adjacent to, but below the level, of the TLOF/FATO. NFPA standards are available at the NFPA web site <http://www.nfpa.org/catalog/home/index.asp>.

c. Turbulence. Air flowing around and over buildings, stands of trees, terrain irregularities, etc. can create turbulence that may affect helicopter operations. FAA Technical Report FAA/RD-84/25,

Evaluating Wind Flow Around Buildings on Heliport Placement (Reference 41 of Appendix 4 addresses the wind's effect on helicopter operations). The following actions may be taken in selecting a site to minimize the effects of turbulence: The Technical Report is available from the National Technical Information Service (NTIS) web site <http://www.ntis.gov/>.

(1) **Ground-Level Heliports.** Helicopter operations from sites immediately adjacent to buildings trees and other large objects are subjected to air turbulence effects caused by such features. Therefore, locate the landing and takeoff area away from such objects in order to minimize air turbulence in the vicinity of the FATO and the approach/ departure paths.

(2) **Elevated Heliports.** Elevating heliports 6 feet (1.8 m) or more above the level of the roof will generally minimize the turbulent effect of air flowing over the roof edge. While elevating the platform helps reduce or eliminate the air turbulence effects, a safety net may be required (see paragraph 302d (4)).

d. Communications. A UNICOM radio may be used to provide arriving helicopters with heliport and traffic advisory information but may not be used to control air traffic. The Federal Communications Commission (FCC) should be contacted for information on UNICOM licensing.

e. Weather Information. An AWOS measures and automatically broadcasts current weather conditions at the heliport site. When an AWOS is installed, it should be located at least 100 feet (30.5 m) and not more than 700 feet (213 m) from the TLOF perimeter. Locate the AWOS so the instruments will NOT be affected by rotor wash from helicopter operations. Guidance on AWOS systems is found in AC 150/5220-16, *Automated Weather Observing Systems (AWOS) for Non-Federal Applications*.

f. Winter Operations. Swirling snow raised by a helicopter's rotor wash can cause the pilot to lose sight of the intended landing point. Swirling snow on takeoff can hide objects that need to be avoided. At least the TLOF, the FATO, and as much of the Safety Area as practical, should be kept free of snow. Heliport design should take into account the methods and equipment to be used for snow removal. The heliport design should allow the snow to be removed sufficiently so that the snow will not present an obstruction hazard to either the tail rotor or the main rotor. Guidance on winter operations is found

in AC150/5200-30, Airport Winter Safety and Operations. (Exception: In cases where the FATO is much larger than the minimum requirement, it may not be necessary to clear all of this additional area.)

313.VISUAL GLIDESLOPE INDICATORS (VGI). A VGI provides pilots with visual course and descent cues. The lowest on-course visual signal must provide a minimum of 1 degree of clearance over any object that lies within 10 degrees of the approach course centerline.

a. The optimal location of a VGI is on the extended centerline of the approach path at a distance that brings the helicopter to a hover between 3 and 8 feet (0.9 to 2.4 m) above the TLOF. Figure 3-24 illustrates VGI clearance criteria.

b. Control of the VGI. There may be merit in making operation of the visual glideslope indicator controllable from the approaching helicopter to ensure that it is “on” only when required.

c. VGI Needed. At many heliports, a VGI is an optional feature. However, a VGI should be provided if one or more of the following conditions exist, especially at night:

(1) Obstacle clearance, noise abatement, or traffic control procedures require a particular slope to be flown.

(2) The environment of the heliport provides few visual surface cues.

d. Additional Guidance. AC 150/5345-52, *Generic Visual Glideslope Indicators (GVGI)*, and AC 150/5345-28, *Precision Approach Path Indicator (PAPI) Systems*, provide additional guidance.

314.TERMINAL FACILITIES. The heliport terminal requires curbside access for passengers using private autos, taxicabs, and public transit vehicles. Public waiting areas need the usual amenities, and a counter for rental car services may be desirable. Passenger auto parking areas should accommodate current requirements and have the capability of being expanded to meet future requirements. Readily available public transportation may reduce the requirement for employee and service personnel auto parking spaces. The heliport terminal building or sheltered waiting area should be attractive and functional. AC 150/5360-9, *Planning and Design of Airport Terminal Building Facilities at Non-Hub Locations*, contains guidance on designing

terminal facilities. The AC is available at the FAA library web site:

[http://www.airweb.faa.gov/Regulatory and Guidance Library](http://www.airweb.faa.gov/Regulatory_and_Guidance_Library).

Unless screening was carried out at the helicopter passengers' departure location, Transportation Security Administration regulations may require that a screening area and/or screening be provided before passengers enter the airport's secured areas. Multiple helicopter parking positions and/or locations may be needed in the terminal area to service helicopter passenger and/or cargo inter connecting needs. Information about passenger screening is available at Transportation Security Administration web site <http://www.tsa.gov/public/>.

315.ZONING AND COMPATIBLE LAND USE. Where state and local statutes permit, a transport heliport sponsor is encouraged to develop and promote the adoption of the following zoning measures to ensure that the heliport will continue to be available for public use as well as to protect the community's investment in the facility.

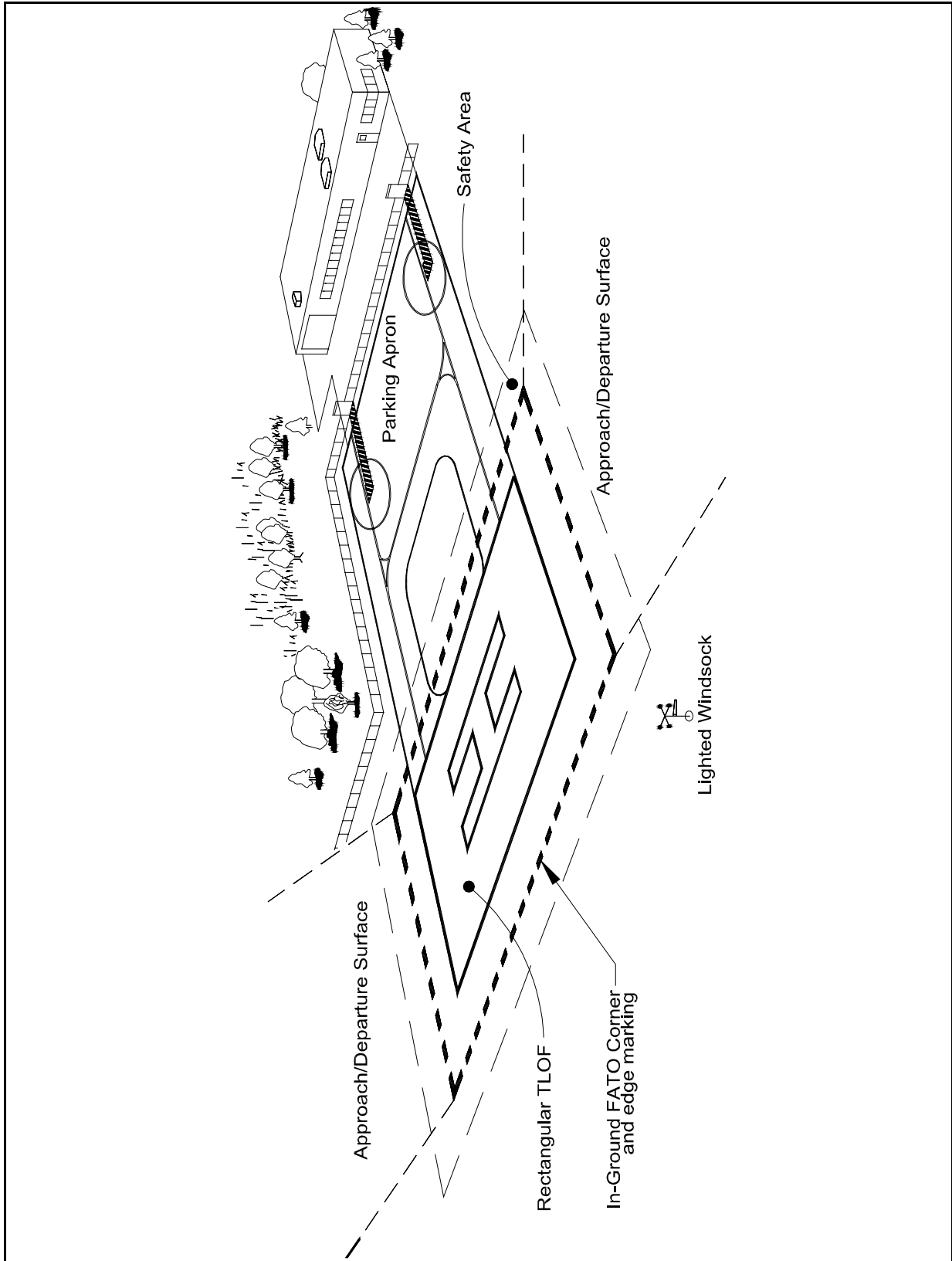
a. Zoning to Limit Building/Object Heights. General guidance on drafting an ordinance that would limit building and object heights is contained in AC 150/5190-4, *A Model Zoning Ordinance to Limit Height of Objects Around Airports*. The locally developed ordinance should substitute the heliport surfaces for the airport surfaces described in model ordinance.

b. Zoning for Compatible Land Use. A zoning ordinance may be enacted, or an existing ordinance modified, to control the use of property within the heliport approach/ departure path environment. The ordinance should restrict activities to those that are compatible with helicopter operations.

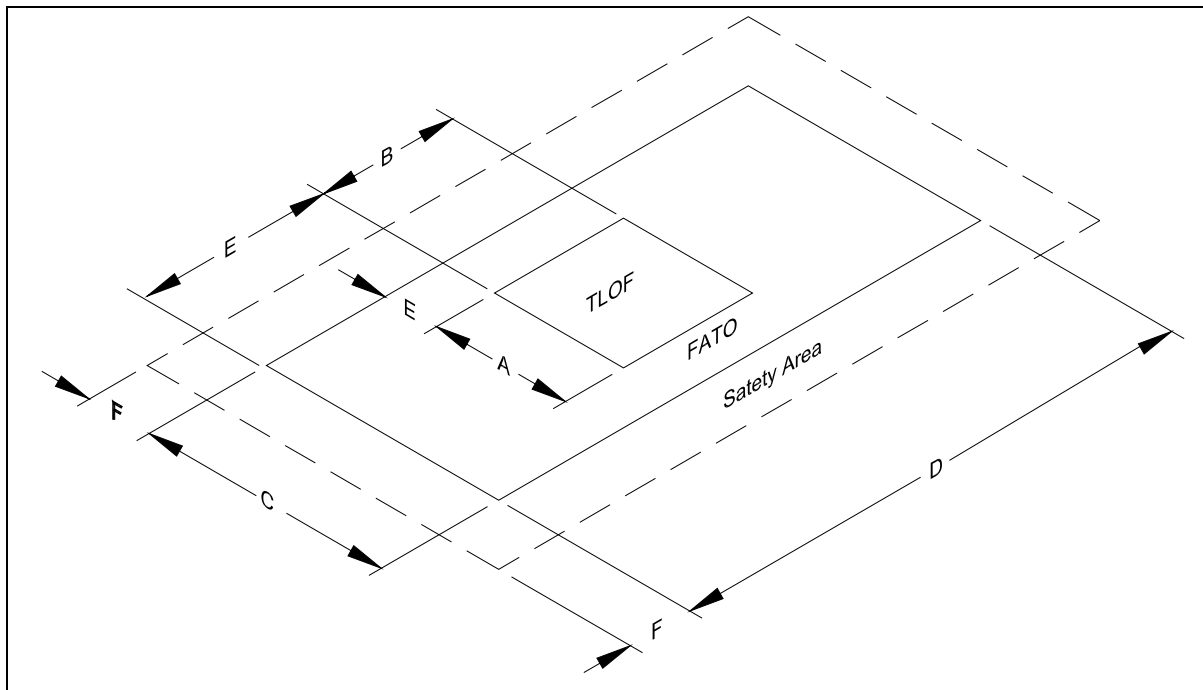
c. Air Rights and Property Easements are options that may be used to prevent the encroachment of obstacles in the vicinity of a heliport.

Table 3-1. Taxiway and Taxi Route Dimensions – Transport Heliports

Taxiway (TW) Type	Centerline Marking Type	TW Edge Marking Type	Minimum Width Of Paved Area	Lateral Separation Between TW Edge Markings	Tip Clearance on Each Side	Total Taxi Route Width
Ground Taxiway	Painted	Painted	2 x UC	2 x UC	10 ft (3 m)	1 RD plus 20 ft (6 m)
Hover Taxiway	Painted	Painted	2 x UC	2 x UC	1/3 RD plus 10 ft (3 m)	RD < 35 ft (11 m): 5/3 RD plus 20 ft (6 m) RD = 35 ft (11 m): 78.3 ft (24 m) RD > 35 ft (11 m): 2/3 RD plus 55 ft (17 m)
<p>RD: rotor diameter of the design helicopter TW: taxiway UC: undercarriage length or width (whichever is larger) of the design helicopter</p>						



**Figure 3-1. A Typical Transport Heliport:
TRANSPORT**



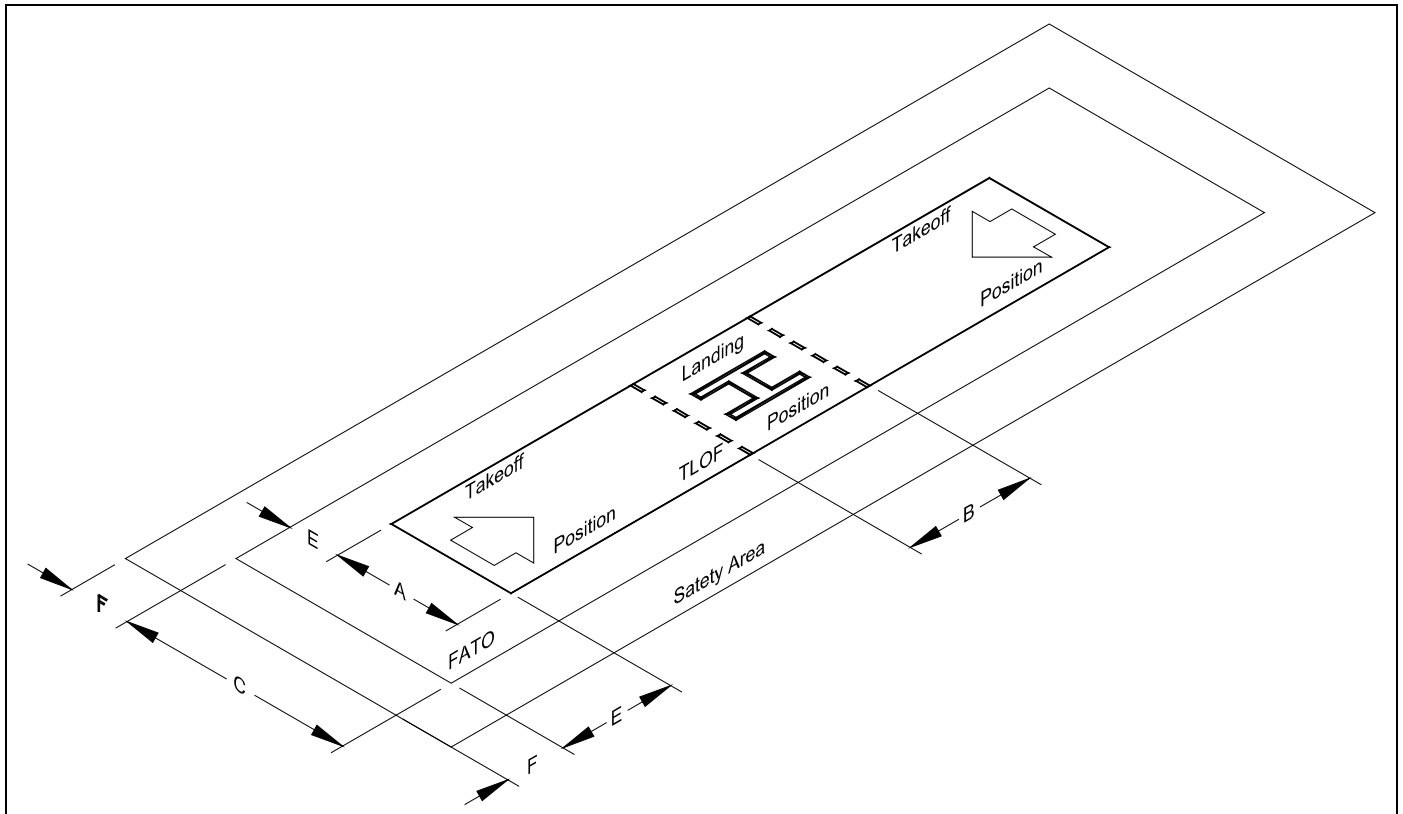
NOT DRAWN TO SCALE

- A. Minimum TLOF Width: 1.0 RD but not less than 50ft (15 m)
- B. Minimum TLOF Length: 1.0 RD but not less than 50ft (15 m)
- C. Minimum FATO Width: 2.0 RD but not less than 100 ft (30 m)
- D. Minimum FATO Length: 2.0 RD but not less than 200 ft (61 m). See paragraph 302b(2) and Figure 3-4 for adjustments for elevations above 1000ft.
- E. Minimum Separation Between the Perimeter of the TLOF and the FATO: $[0.5 (1.5 OL - 1.0 RD)]$
- F. Minimum Safety Area Width: $\frac{1}{2}$ RD but not less than 30 feet (9 m).

RD: Rotor diameter of the design helicopter

OL: Overall length of the design helicopter

**Figure 3-2. TLOF/FATO/Safety Area Relationships and Minimum Dimensions:
TRANSPORT**

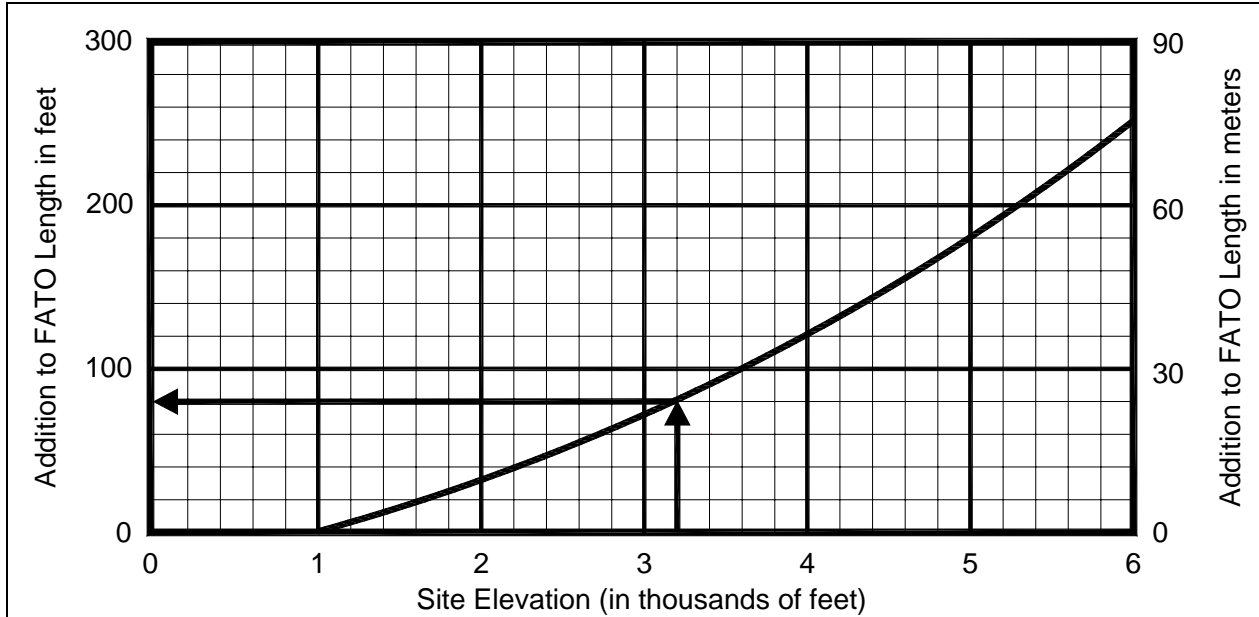


- A Minimum TLOF Width: 1.0 RD but not less than 50 feet (15 m)
- B Minimum TLOF Length: 1.0 RD but not less than 50ft (15 m)
- C Minimum FATO Width: 2.0 RD but not less than 100 ft (30 m)
- E Minimum Separation Between the Perimeters of the TLOF and the FATO: $[0.5(1.5 OL - 1.0 RD)]$
- F Minimum Safety Area Width: 30 feet (9 m)

RD: Rotor diameter of the design helicopter

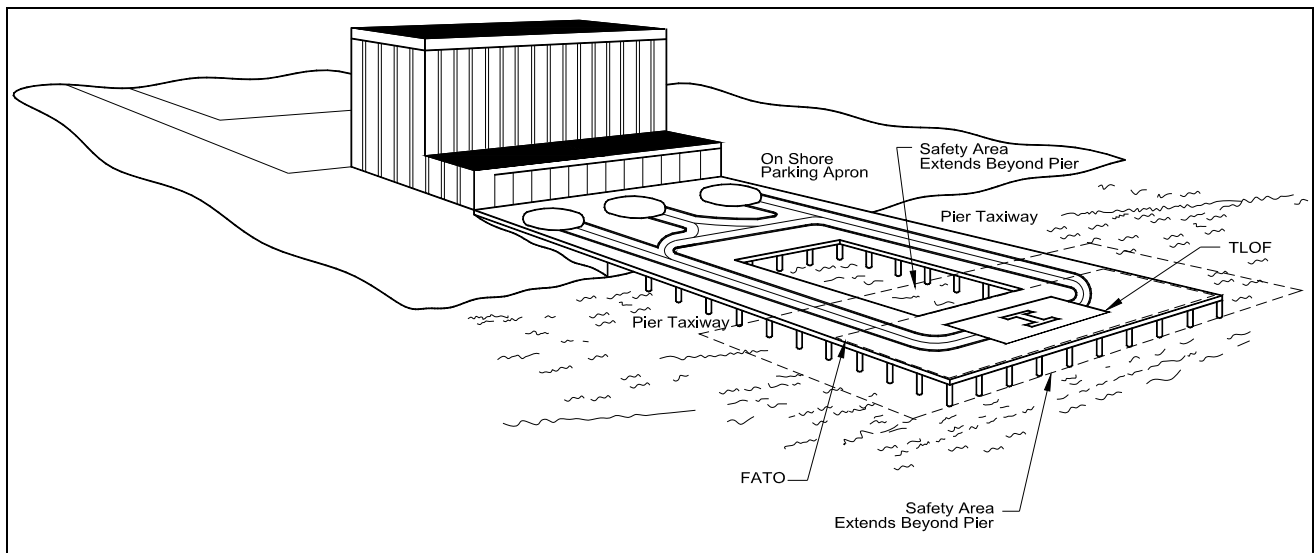
OL: Overall length of the design helicopter

**Figure 3-3. An Elongated FATO/TLOF with Two Takeoff Positions:
TRANSPORT**



Example: For a site elevation of 3,200 ft., 80 ft. should be added to the basic FATO length (200 ft. + 80 ft. = 280 ft.)

**Figure 3-4. Additional FATO Length for Heliports at Higher Elevations:
TRANSPORT**



**Figure 3-5. Non-load-bearing Safety Area:
TRANSPORT**

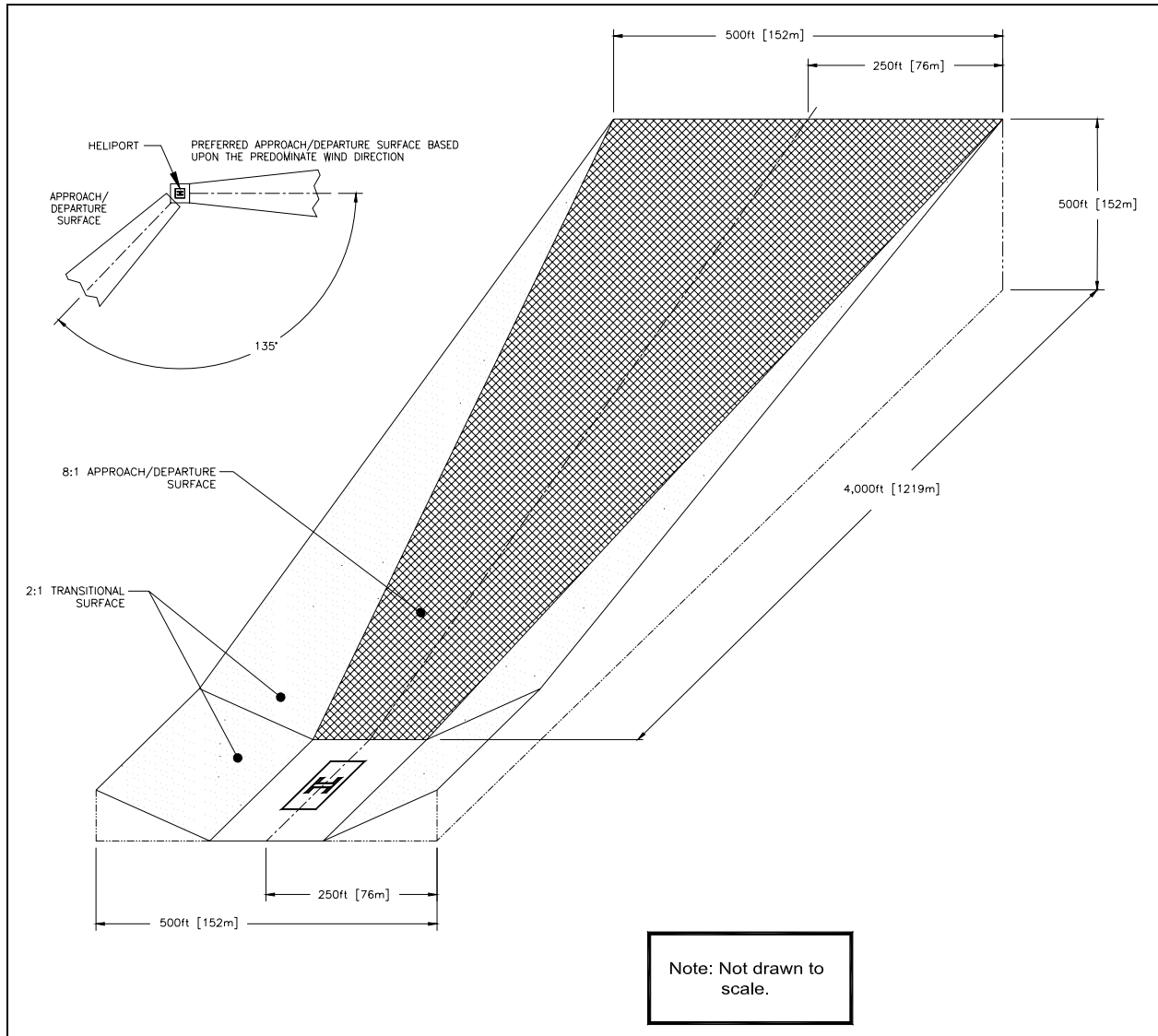
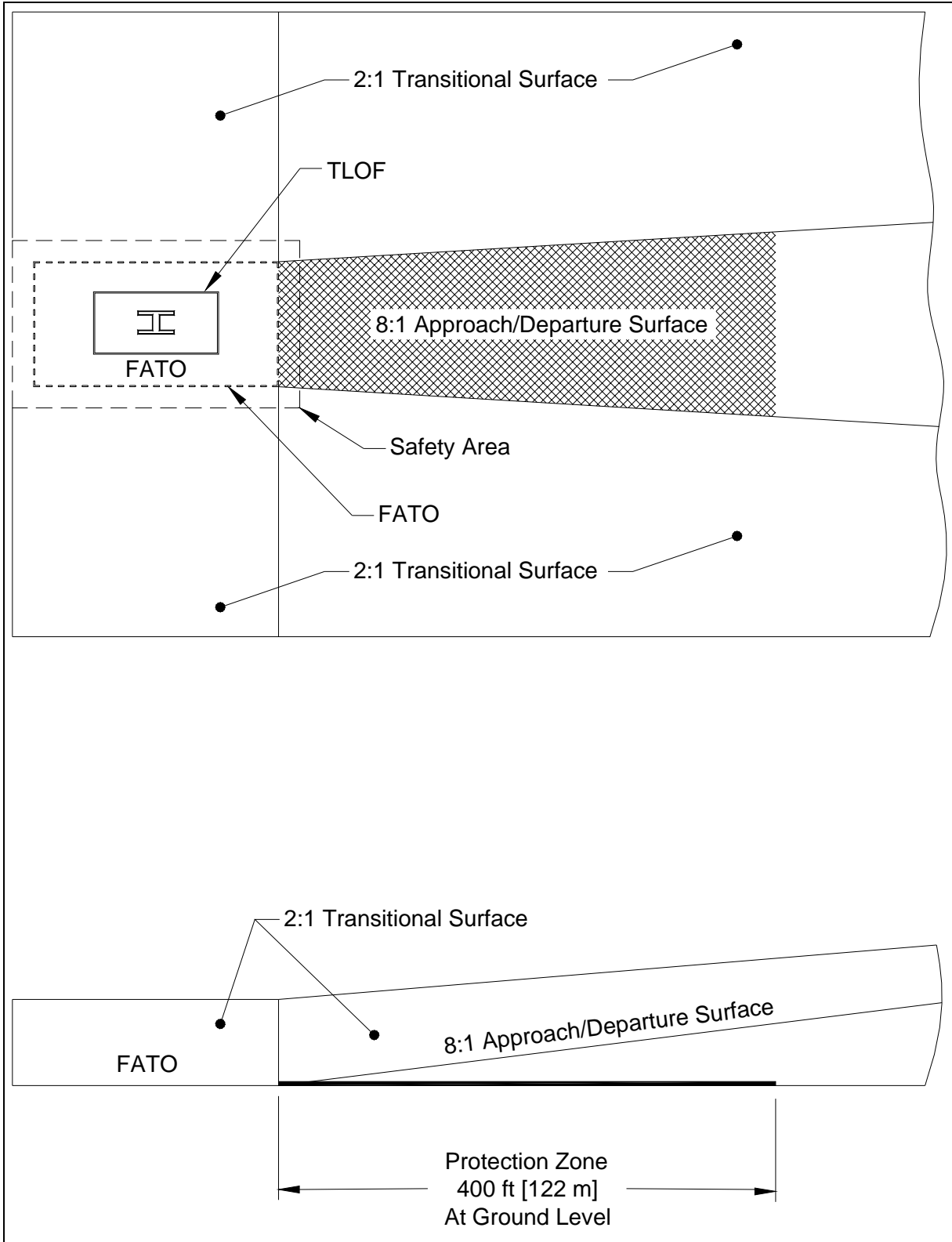
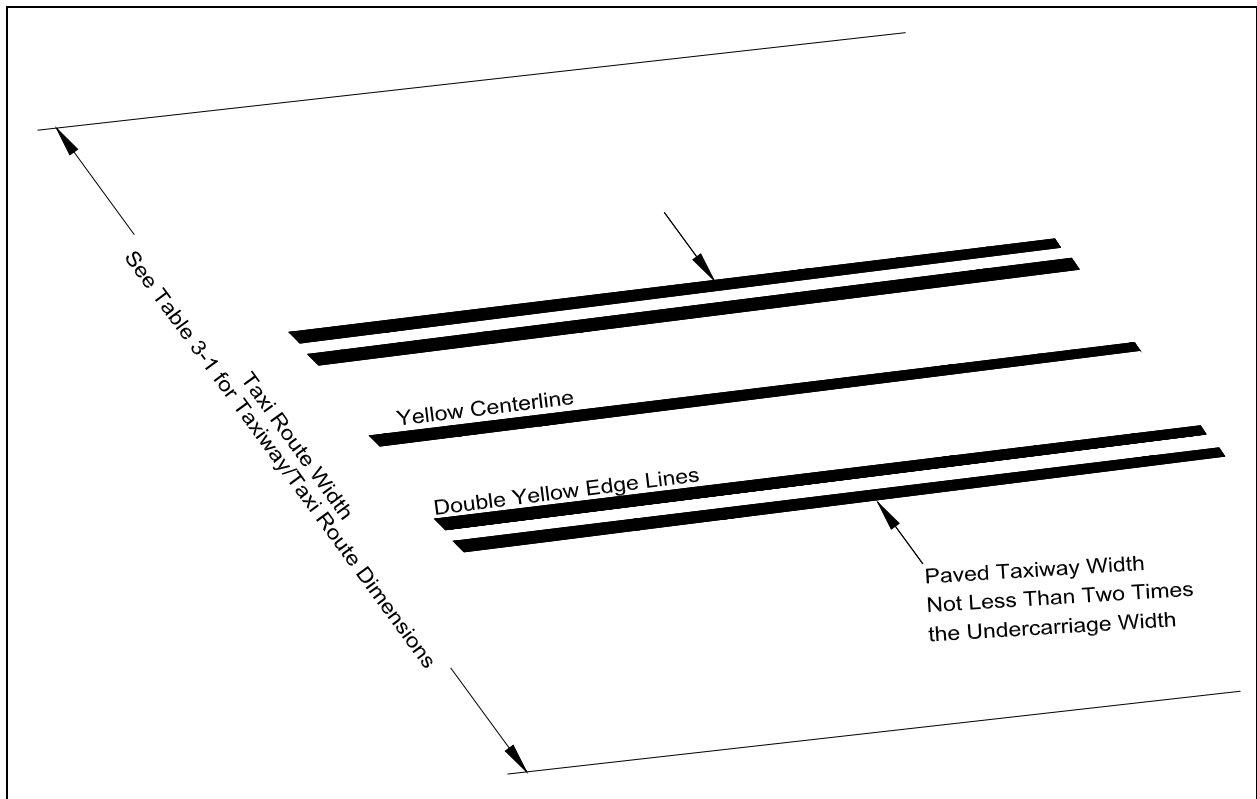


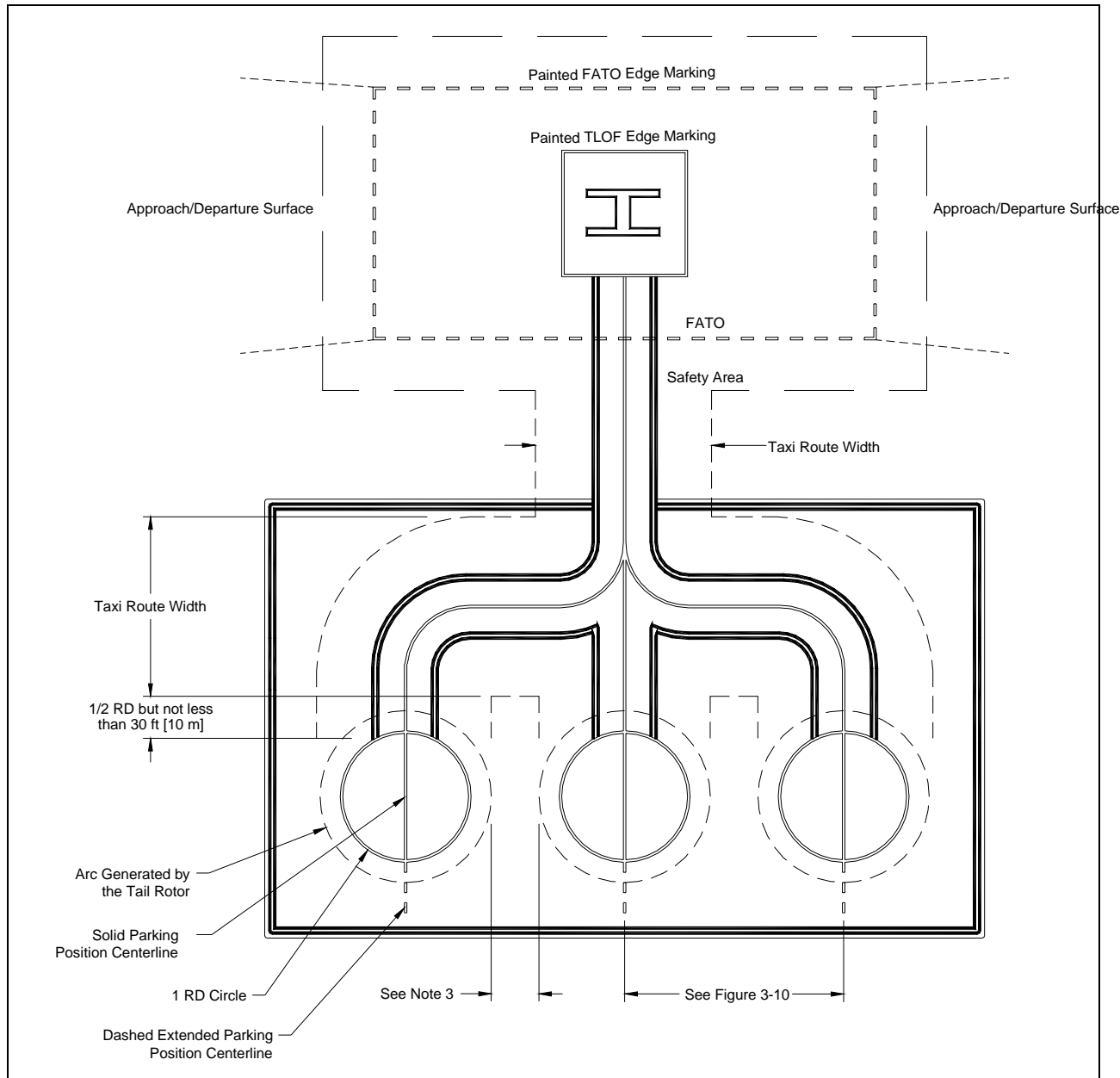
Figure 3-6. VFR Heliport Approach/Departure and Transitional Surfaces: TRANSPORT



**Figure 3-7. Protection Zone:
TRANSPORT**



**Figure 3-8. Taxiway/Taxi Route Relationship, Centerline and Edge Marking:
TRANSPORT**



NOTES:

1. For simplicity, some markings have not been shown on this figure (such as parking position identifier, passenger walkway, and rotor diameter of the largest helicopter that the FATO/TLOF or the parking position is designed to accommodate).
2. The design of these parking positions is based on the presumption that the helicopter may pivot about the mast prior to exiting the parking position.
3. The minimum recommended clearance between the arcs generated by the tail rotor:
 Hover taxi operations: $1/3$ RD
 Ground taxi operations: 10 ft (3 m)
4. Rotor diameter and weight limitation markings are not shown for simplicity.

**Figure 3-9. Parking Area Design-“Turn-around” Parking Positions:
 TRANSPORT**

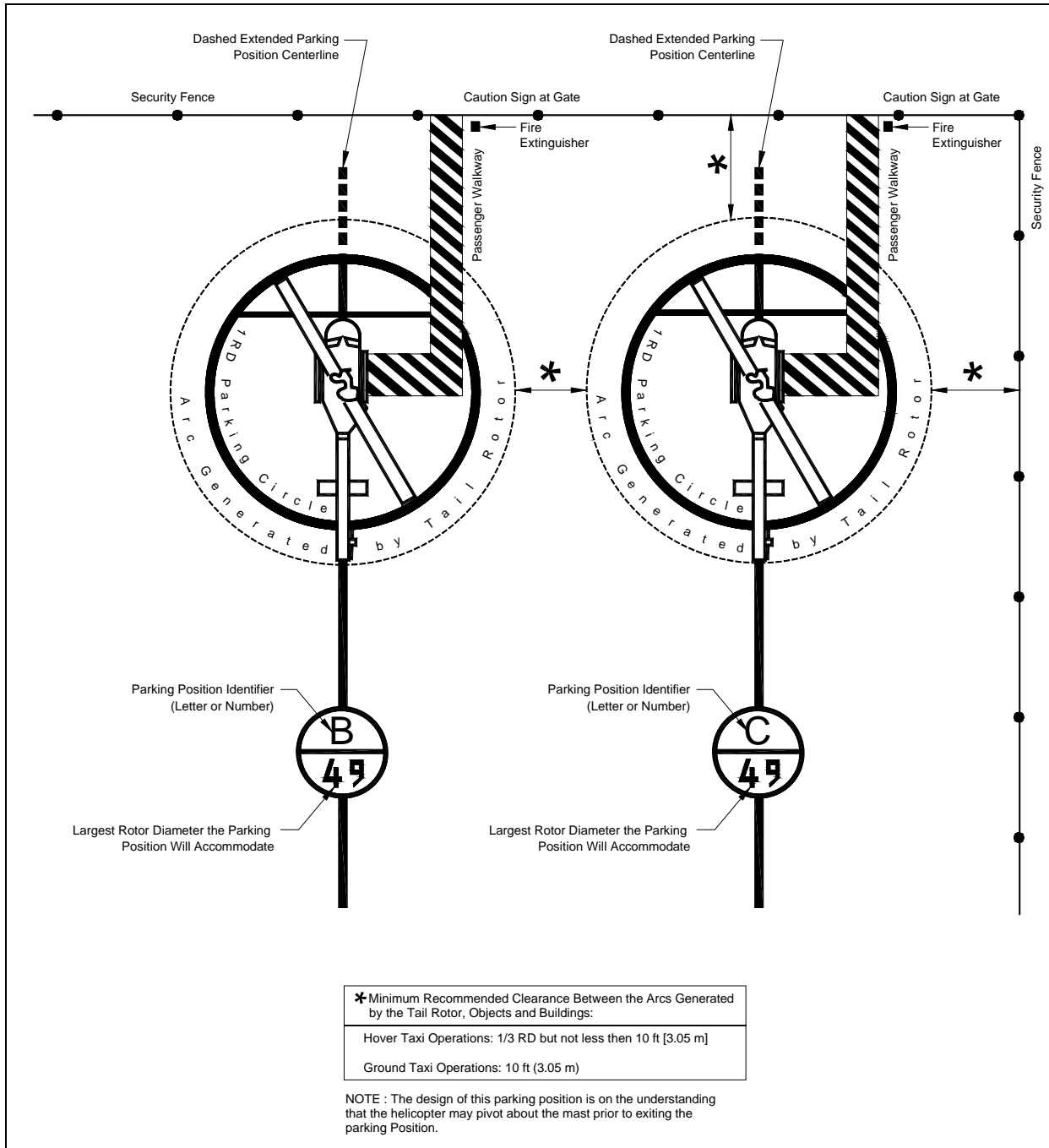
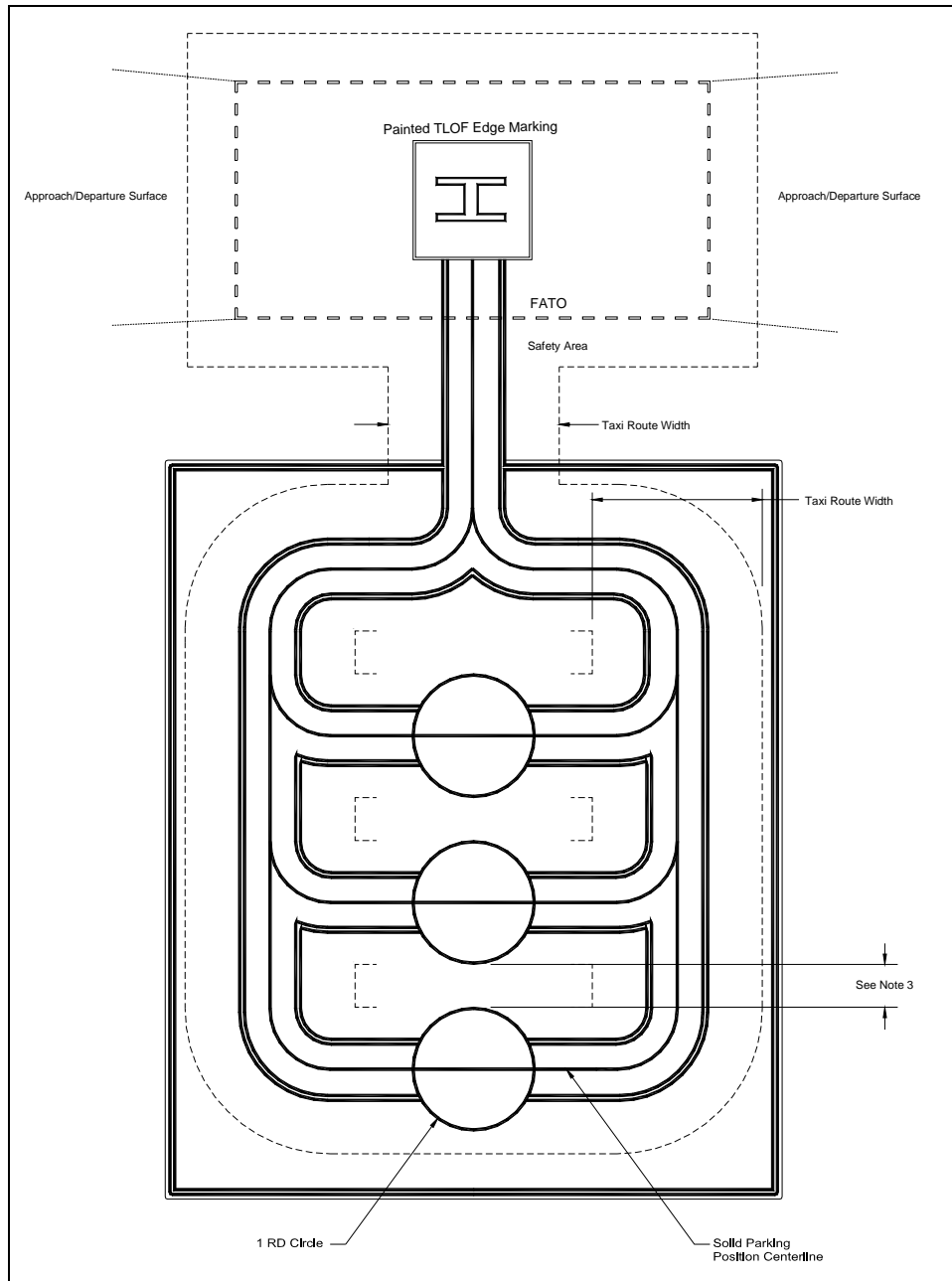


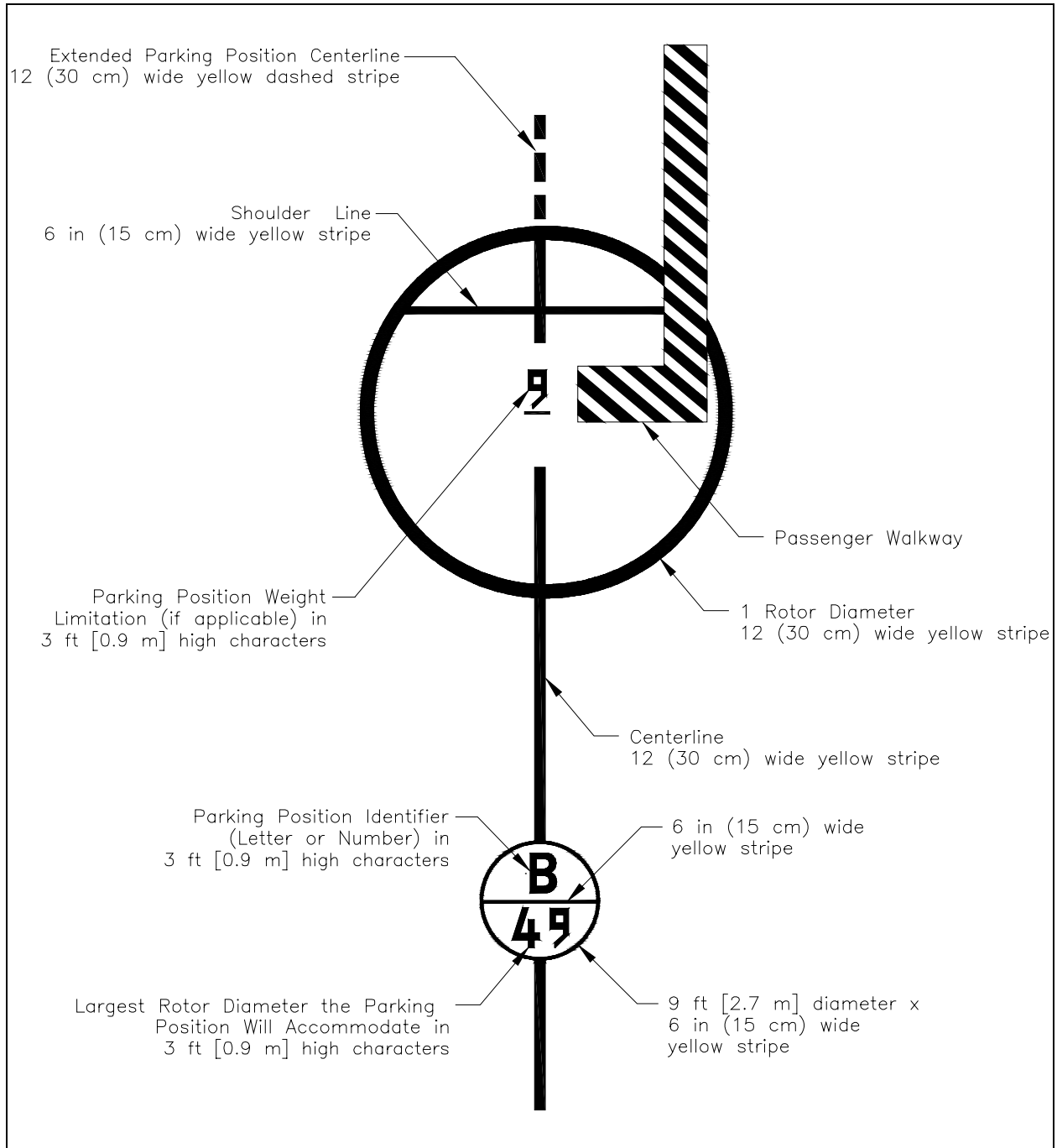
Figure 3-10. Parking Position Marking: TRANSPORT



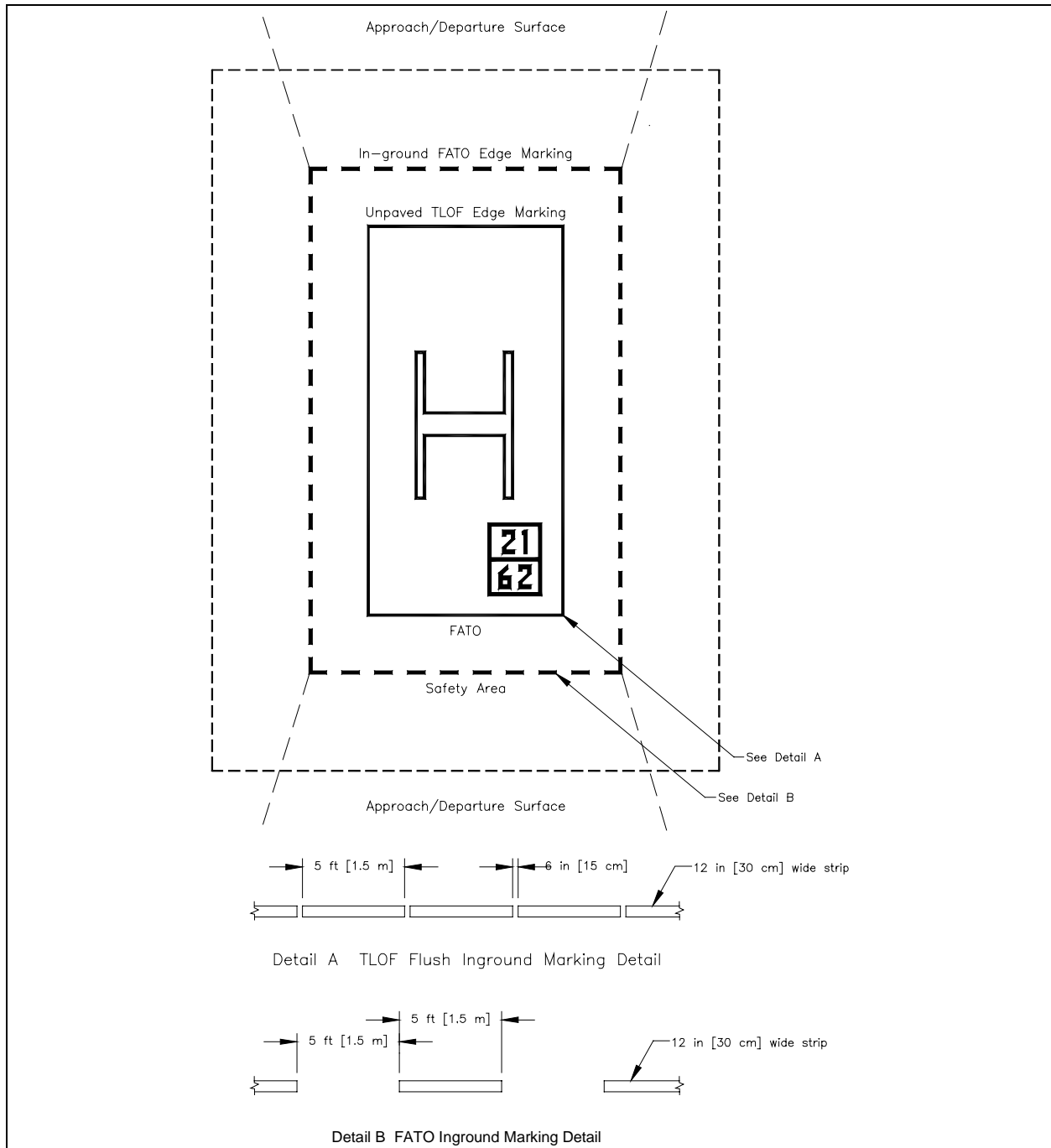
NOTES:

1. For simplicity, some markings have not been shown on this figure such as parking position identifier, passenger walkway, and rotor diameter of the largest helicopter that the FATO/TLOF or the parking position is designed to accommodate.
2. The parking areas are designed so that helicopters exit taxiing forward.
3. The minimum recommended clearance between parking positions
 Hover taxi operations: $\frac{1}{3}$ RD
 Ground taxi operations: 10 ft (3 m)
4. Rotor diameter and weight limitation markings are not shown for simplicity.

Figure 3-11. Parking Area Design-“Taxi-through” Parking Positions: TRANSPORT



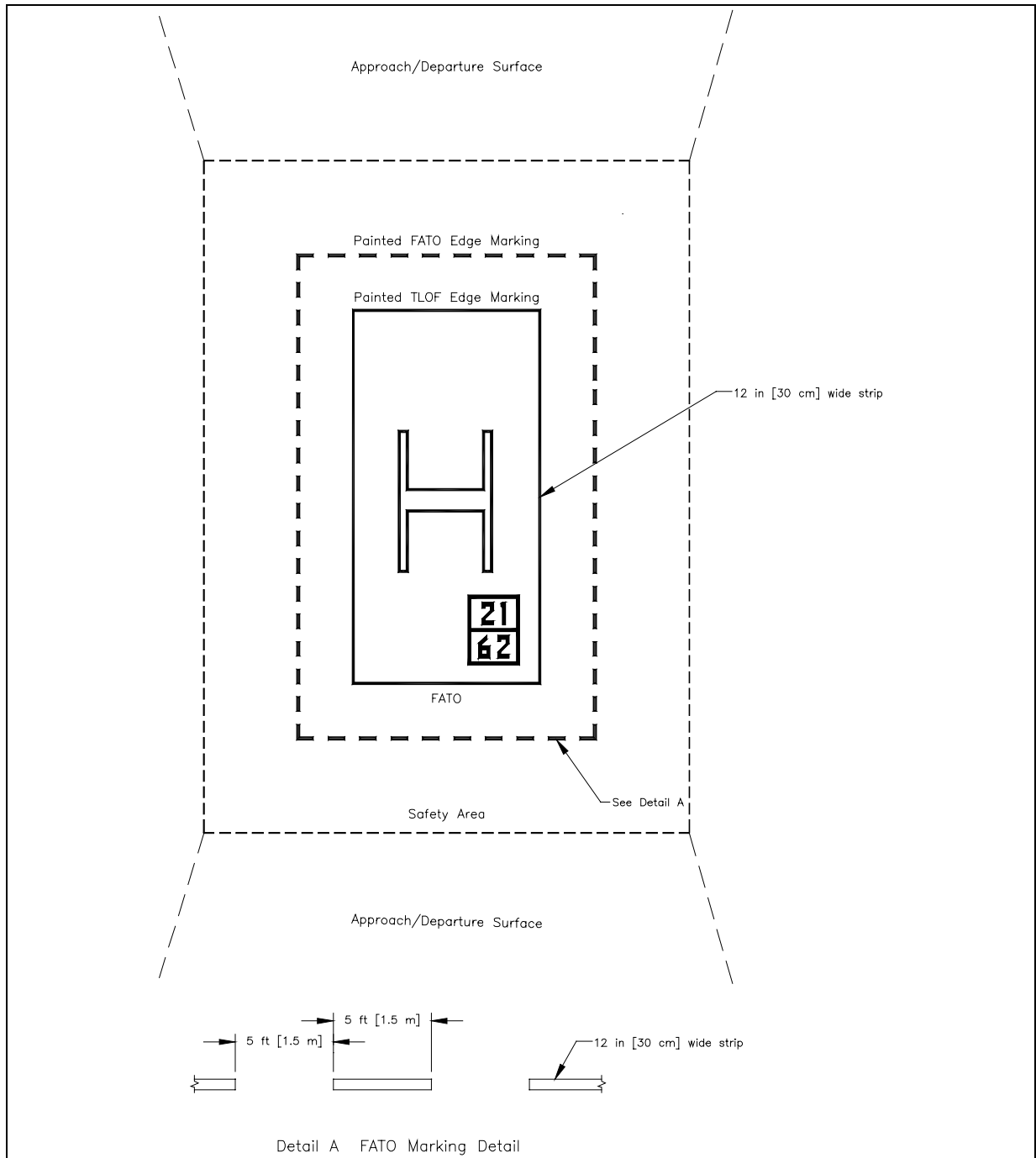
**Figure 3-12. Parking Position Identification, Size and Weight Limitations:
TRANSPORT**



NOTES:

1. The **H** should be oriented on the axis of the preferred approach/ departure path.
2. The perimeter of the TLOF and/or the FATO should be marked.
3. The perimeter of a paved or hard surfaced TLOF should be defined with a continuous, white line.
4. The perimeter of an unpaved FATO should be defined with flush, in-ground markers.

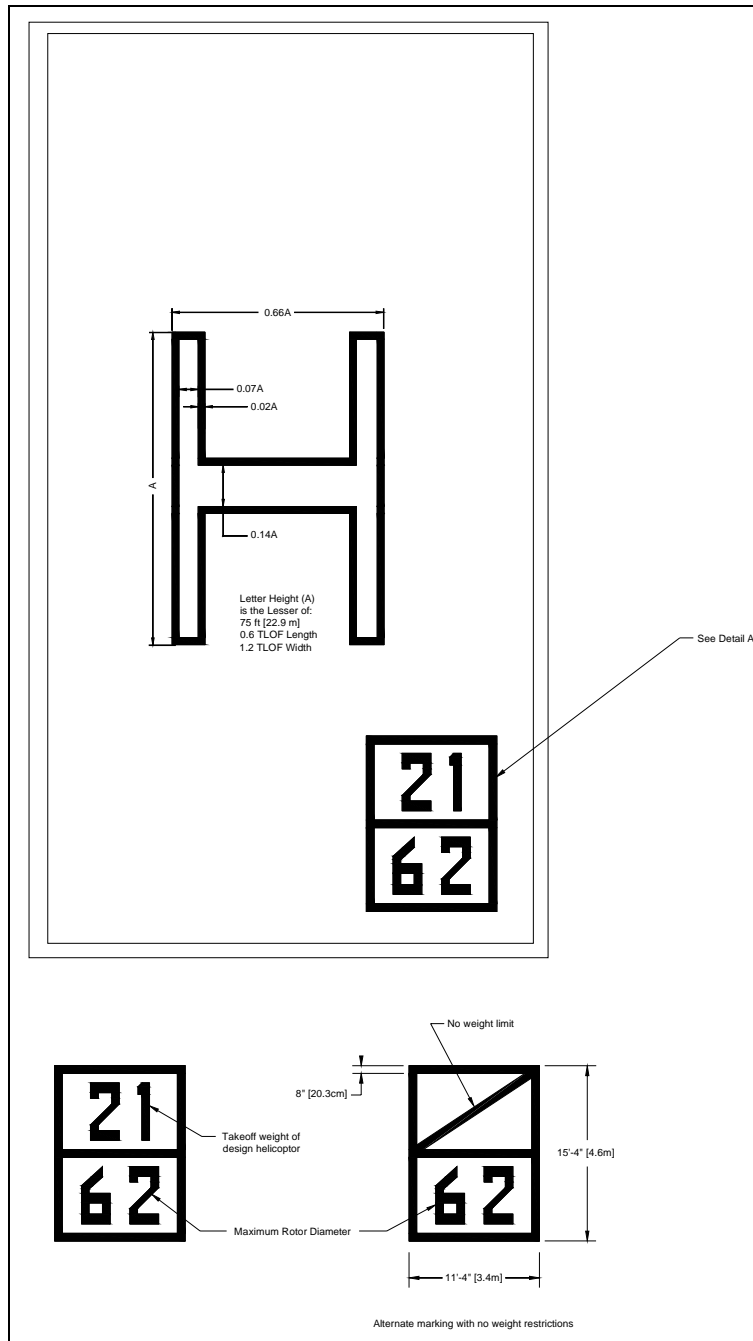
**Figure 3-13. Paved TLOF/Unpaved FATO – Markings:
TRANSPORT**



NOTES:

1. The **H** should be oriented on the axis of the preferred approach/ departure path.
2. The perimeter of the TLOF and/or the FATO should be marked.
3. The perimeter of a paved or hard surfaced TLOF should be defined with a continuous, white line.
4. The perimeter of a paved FATO should be defined with a 12-inch-wide (30 cm) dashed white line. (See detail A)
5. See Figure 3-15 for dimensions of the **H**.

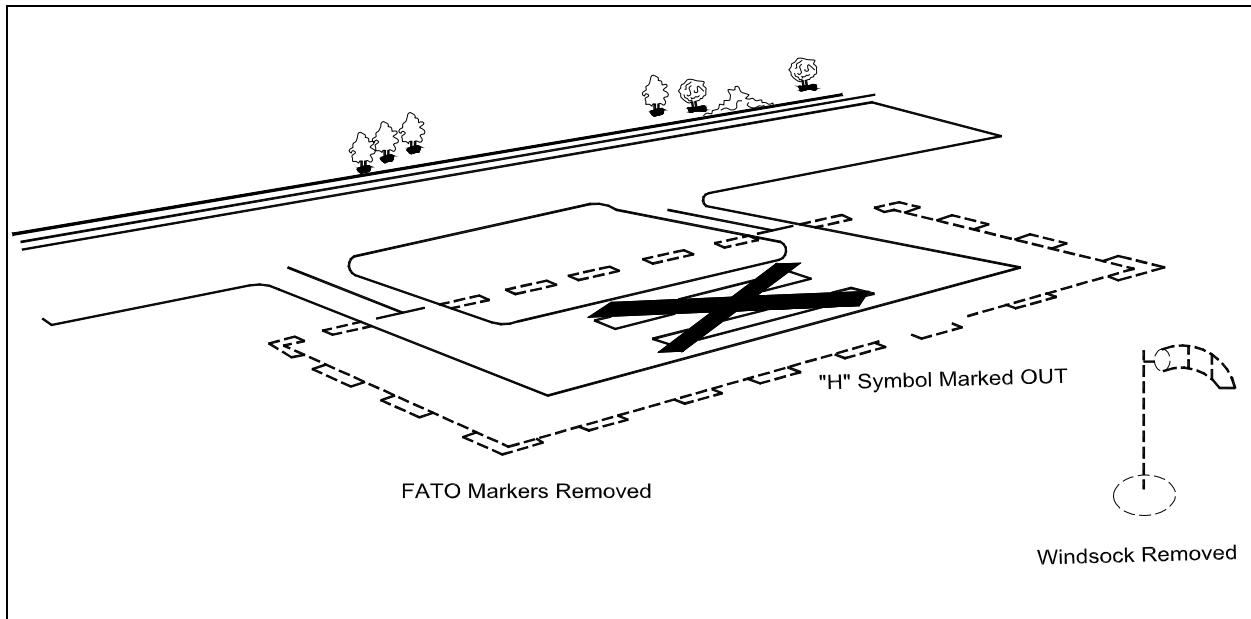
**Figure 3-14. Paved TLOF/Paved FATO – Markings:
TRANSPORT**



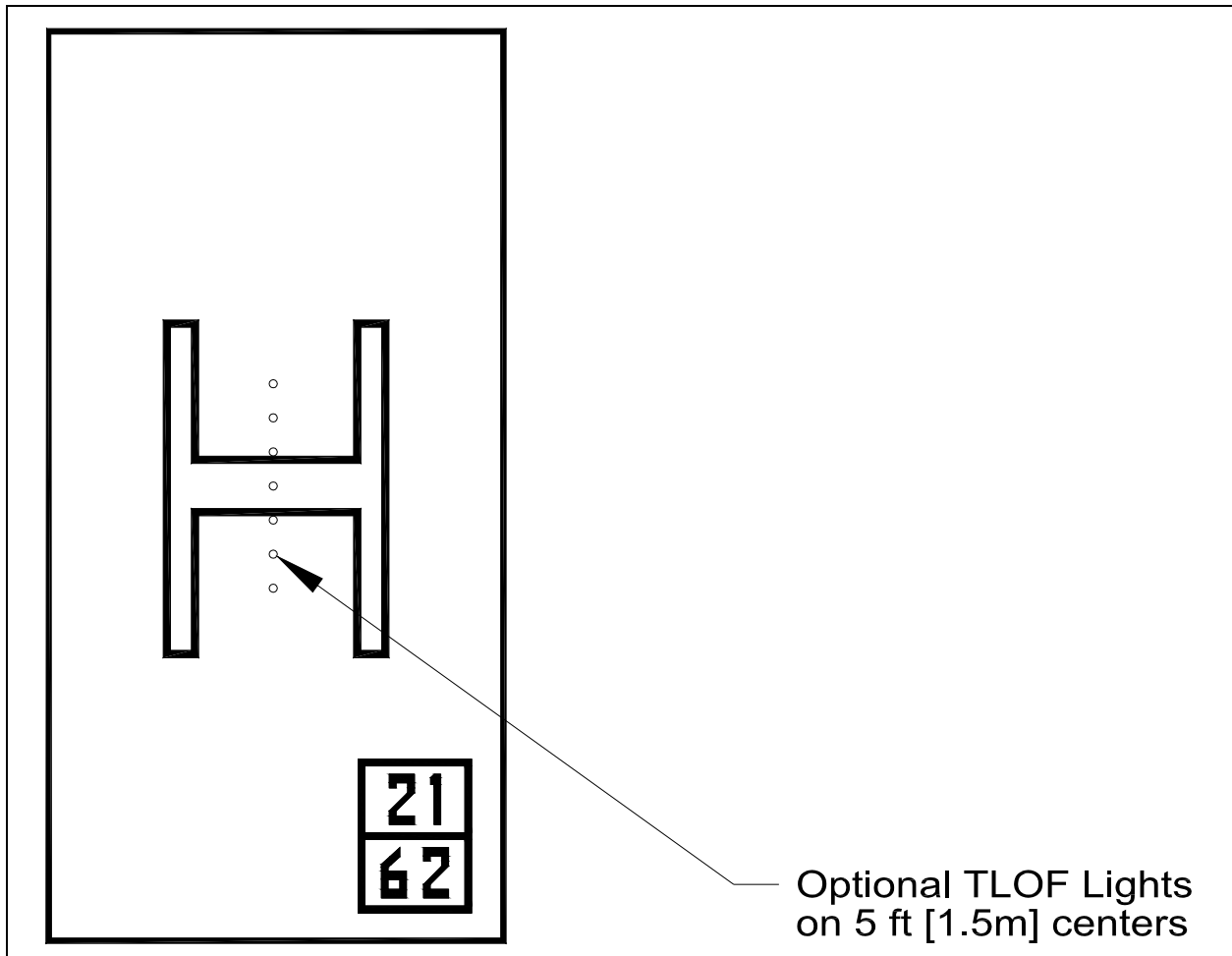
NOTES:

1. See Appendix 3 for the form and proportion of the numbers used in the size and weight limitations 'box'.
2. The **H** should be oriented on the axis of the preferred approach/ departure path.
3. **21** indicates the TLOF has limited weight-carrying capability in thousands of pounds
4. **62** indicates the rotor diameter of the largest helicopter for which the TLOF is designed.

**Figure 3-15. Standard Heliport Identification Symbol, TLOF Size, and Weight Limitations:
TRANSPORT**

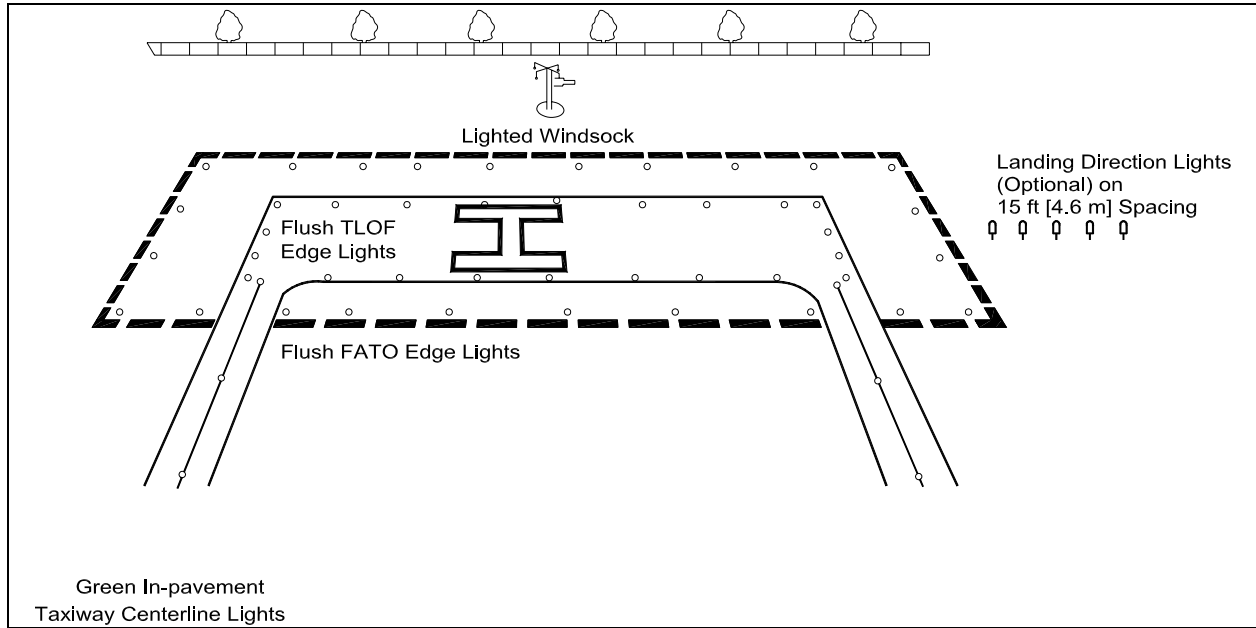


**Figure 3-16. Marking a Closed Heliport:
TRANSPORT**



NOTE: Optional white, flush L-850A TLOF lights

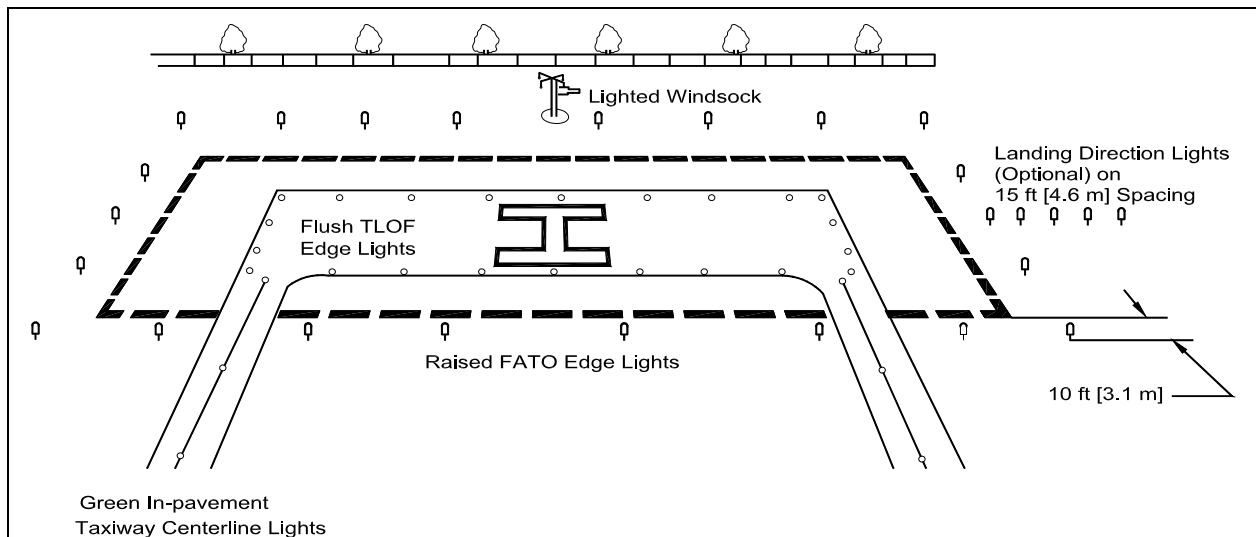
**Figure 3-17. Optional TLOF Lights:
TRANSPORT**



NOTES:

1. Flush FATO and TLOF lights may be installed inside or outside ± 1 foot of the FATO and TLOF respective perimeters.
2. Rotor diameter and weight limitation markings are not shown for simplicity

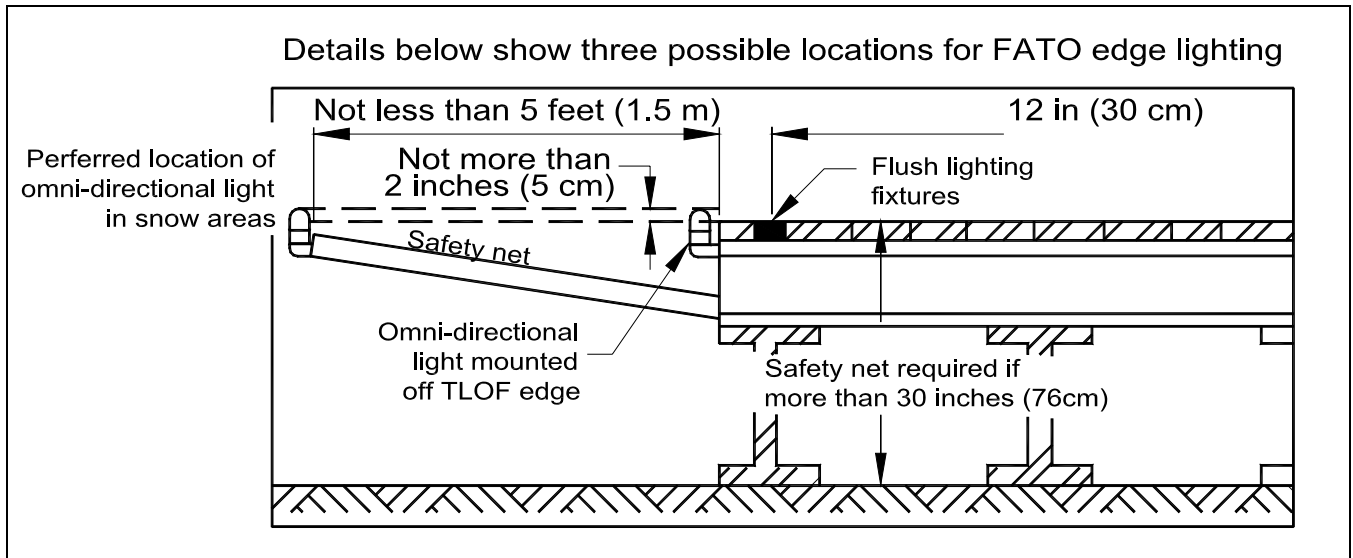
**Figure 3-18. FATO and TLOF Flush Perimeter Lighting:
TRANSPORT**



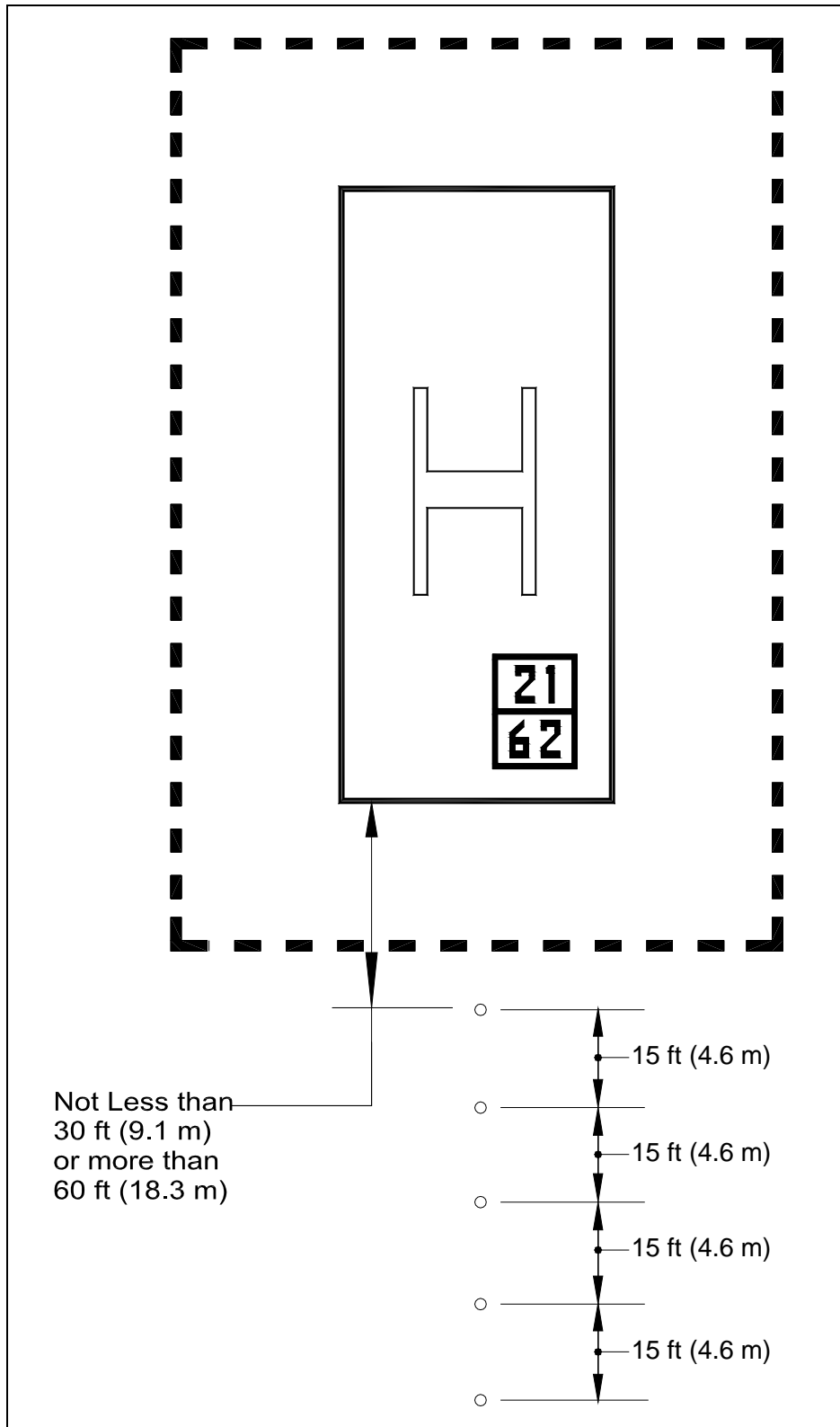
NOTES:

1. Flush TLOF lights may be installed inside or outside ± 1 foot of the TLOF perimeter.
2. Raised FATO lights may be installed 10-foot outside the FATO perimeter.
3. Rotor diameter and weight limitation markings are not shown for simplicity.

**Figure 3-19. FATO Raised and TLOF Flush Perimeter Lighting:
TRANSPORT**

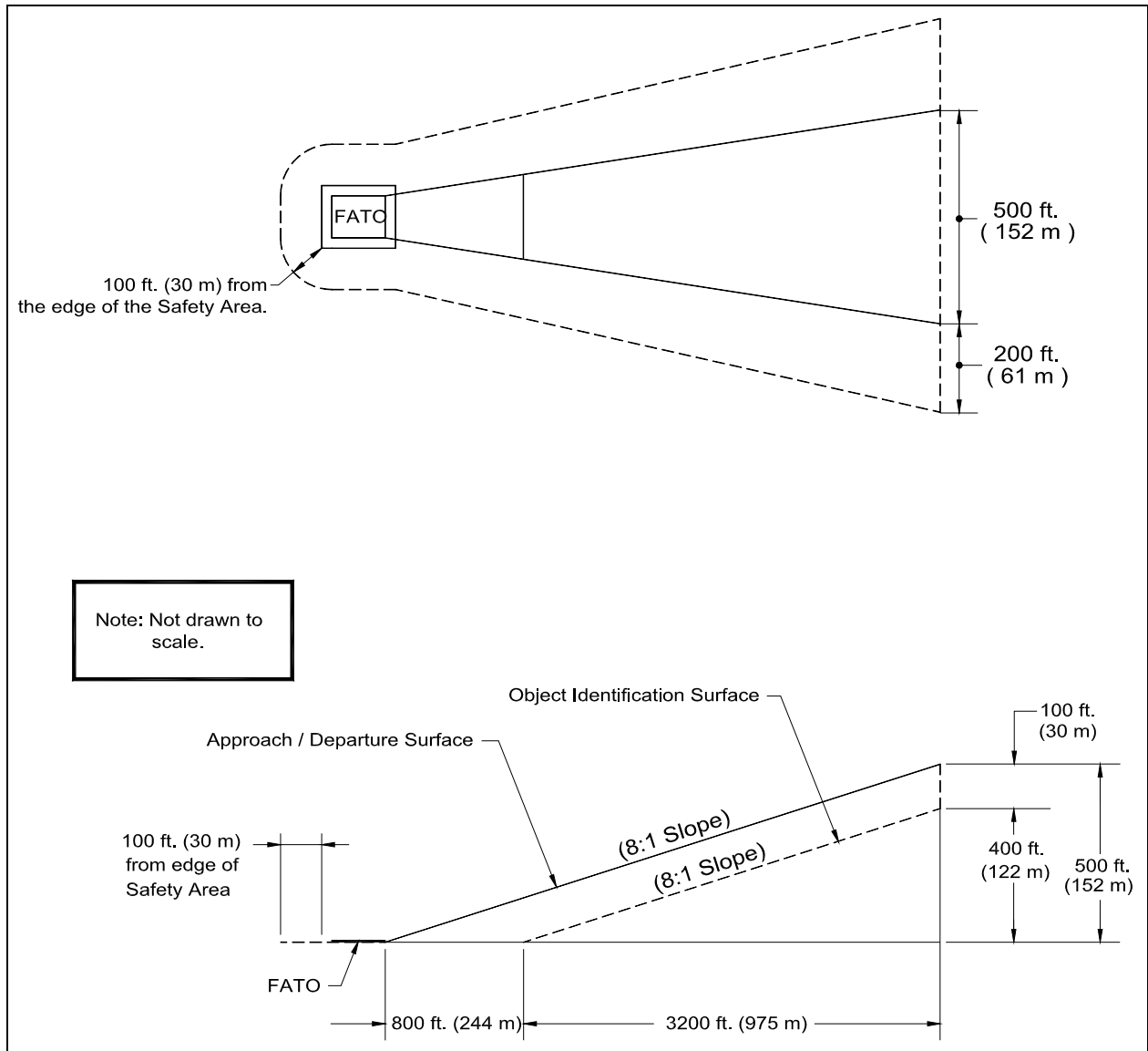


**Figure 3-20. Elevated FATO – Perimeter Lighting:
TRANSPORT**



NOTE: Yellow omni-directional lights

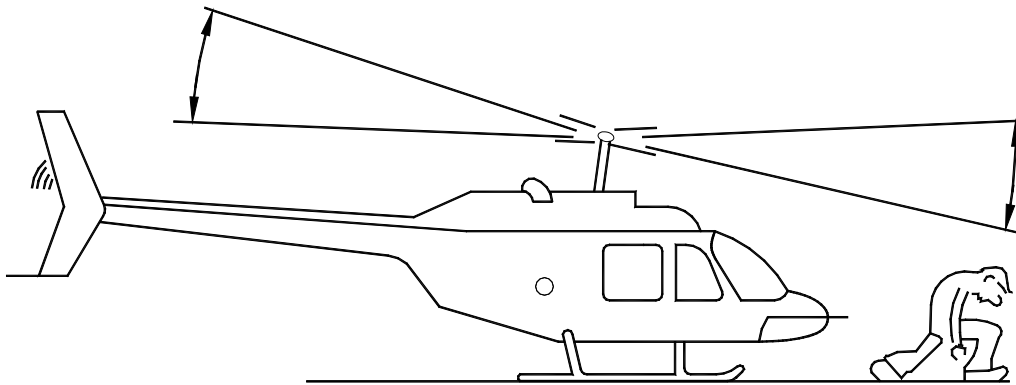
**Figure 3-21. Landing Direction Lights:
TRANSPORT**



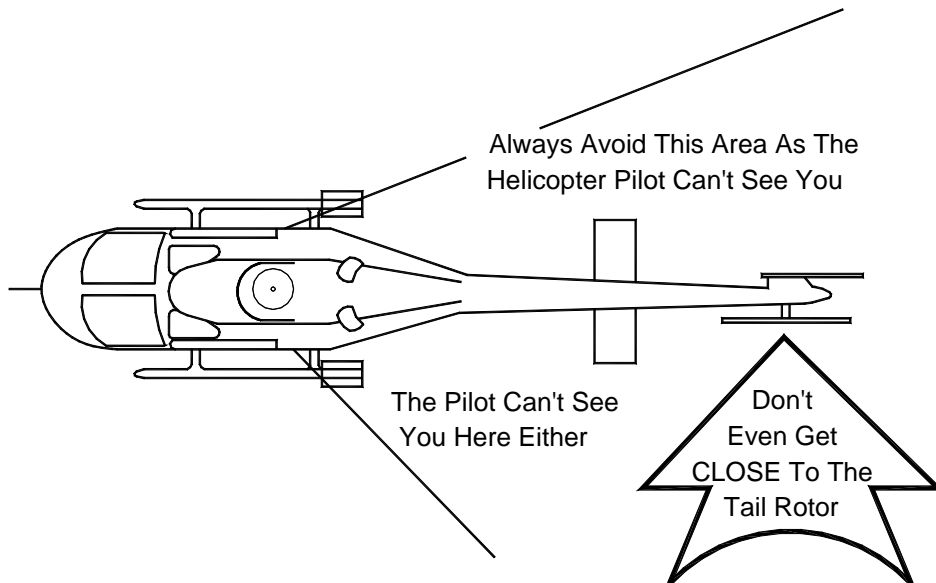
**Figure 3-22. Airspace Where Marking and Lighting Are Recommended:
TRANSPORT**

BE ALERT

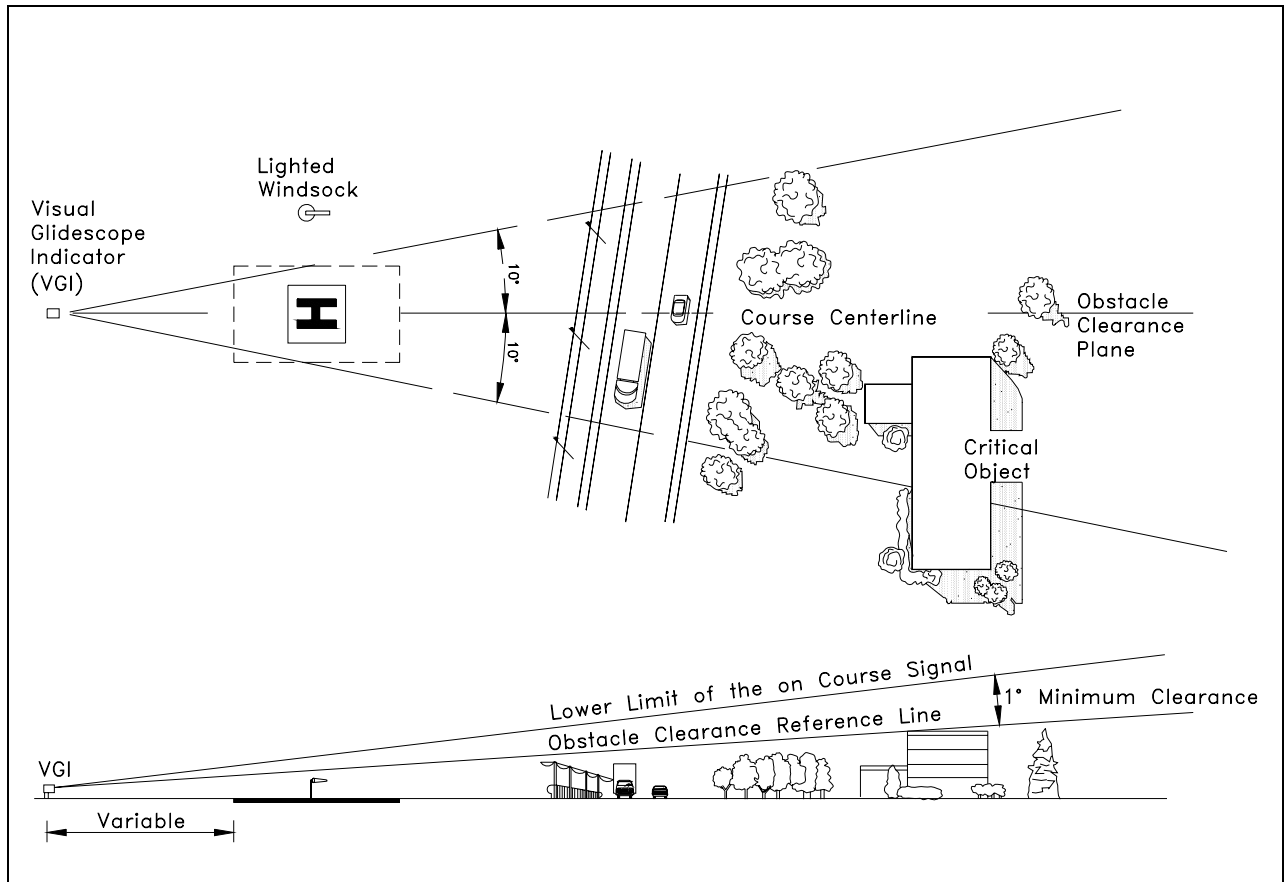
AROUND THE HELICOPTER



Approach And Leave The Helicopter In A Crouched Manner When Rotors Are Turning



**Figure 3-23. Caution Sign:
TRANSPORT**



**Figure 3-24. Visual Glideslope Indicator (VGI) Siting and Clearance Criteria:
TRANSPORT**

Intentionally Left Blank