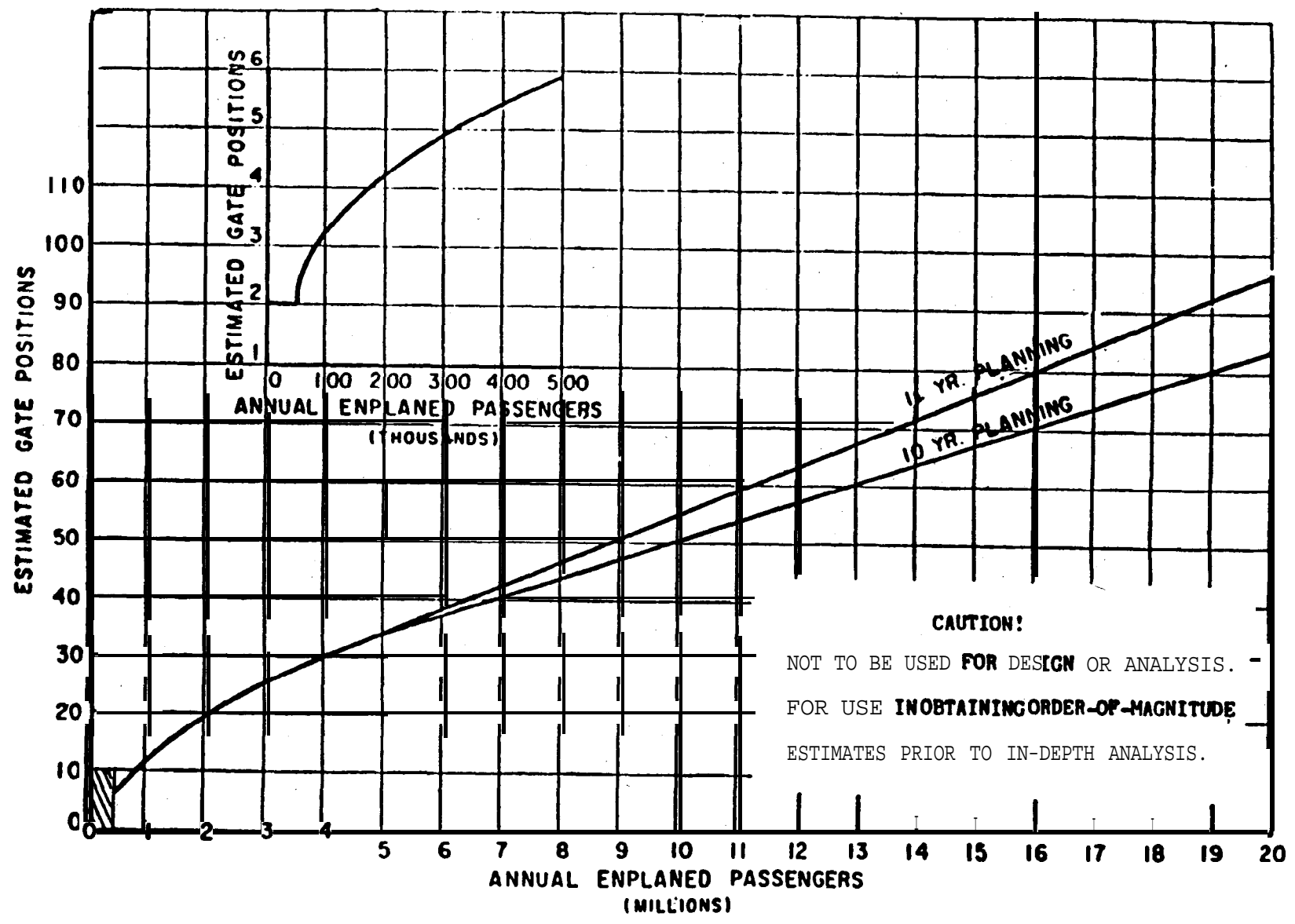

Figure 4-5. Estimating Gate Positions vs. Annual Enplaned Passengers



d. **Aircraft Extremity to Building Clearances.** A 20 feet (6 m) value is satisfactory, except that 45 feet (14 m) should be provided for inboard pier gates.

e. **Gate Sizing.** At very high activity airports, airlines will often segregate gates by assigning their use to one or several aircraft types. This permits the airline to design the gate position and provide appropriate service equipment to meet the needs of specific aircraft. At the less active airports, such segregation is often impractical and the gates serve a variety of aircraft types. In sizing a gate position, the planner/designer should first ascertain the anticipated type(s) of aircraft which will use the gate and the docking procedure to be used. Gates serving a variety of aircraft, should be designed for the largest expected aircraft. Taxi-in, push-out/power-out gates are generally the easiest to size, since the critical dimensions are limited to aircraft length, wingspan, and appropriate clearances. In designing a taxi-out gate, such additional factors as aircraft maneuverability (turning radii), jet blast, and parking angle require consideration.

f. **Gate Position Layout.** Figures 4-6 through 4-12 illustrate some typical gate position layouts. Airplane characteristics manuals published by aircraft manufacturers should be consulted to determine the precise aircraft turning radii associated with taxi-out gate positions.

46. **TAXILANES.** Taxilanes are used on aprons by aircraft taxiing between taxiways and gate positions. The required taxilane object free area (OFA) widths (refer to AC 150/5300-13) and provision of dedicated rights-of-way for apron service vehicle roads affect the minimum spacing between parked aircraft and between pier fingers. Both single and dual taxilanes are used between pier fingers, depending on the pier lengths and number of aircraft positions. When a dual taxilane is under consideration, the frequency of use by each aircraft type, as well as the number of aircraft parking positions on each side, should be considered. As a rule, a row of four aircraft on each side will not require a dual taxilane. For larger arrangements, a detailed analysis of aircraft movements and traffic delays may be necessary. Figure 4-13 provides dimensioning information on pier separation with single and dual taxilanes. Figure A9-4 in AC 150/5300-13 illustrates apron taxilane layouts with provision of dedicated space for service vehicle roads.

47. **APRON GRADIENTS.** For fueling, ease of towing, and taxiing, apron gradients should be kept to the minimum, consistent with local drainage requirements. The slope should not exceed 1.0 percent and should be directed away from the face of the terminal. Refer to AC 150/5300-13 for further guidance.

48. **AIRCRAFT PARKING GUIDANCE SYSTEMS.** Aircraft parking guidance systems are usually a visual aid to the pilot for final parking of aircraft in the gate position. These visual aids are either painted guidelines on the apron or mechanical or light-emitting guidance devices mounted at cockpit height on the facing structure. Systems using lights are becoming more popular. Lights are used to inform the pilot of the aircraft's location with respect to the centerline position desired and when to stop the aircraft at the desired nose-to-building distance. Apron installed switching devices are occasionally required at the final nosewheel location. Refer to AC 120-57, Surface Movement Guidance and Control System, and the related reading material cited therein for additional guidance.

49. **LOADING BRIDGES.** At very low activity airports, passengers usually board aircraft using integral aircraft stairs or mobile passenger stairs. At more active airports, the use of passenger loading bridges is quite common. Two types of loading bridges are illustrated in Figure 4-14. They are used for boarding passengers from an upper level and have many possible design variations. At some airports, loading bridges are employed to load passengers from grade level by constructing a stairway or ramp connection at the loading bridge entrance. Some characteristics of loading bridges which influence terminal design are discussed as follows:

a. The primary constraint in considering passenger boarding now rates normally is one of three elements: the entrance doorway to the loading bridge; the aircraft door; or the aircraft aisle width. If stairs are used at the loading bridge entrance, a fourth constraint is added. The width of the loading bridge usually is not a constraining factor.

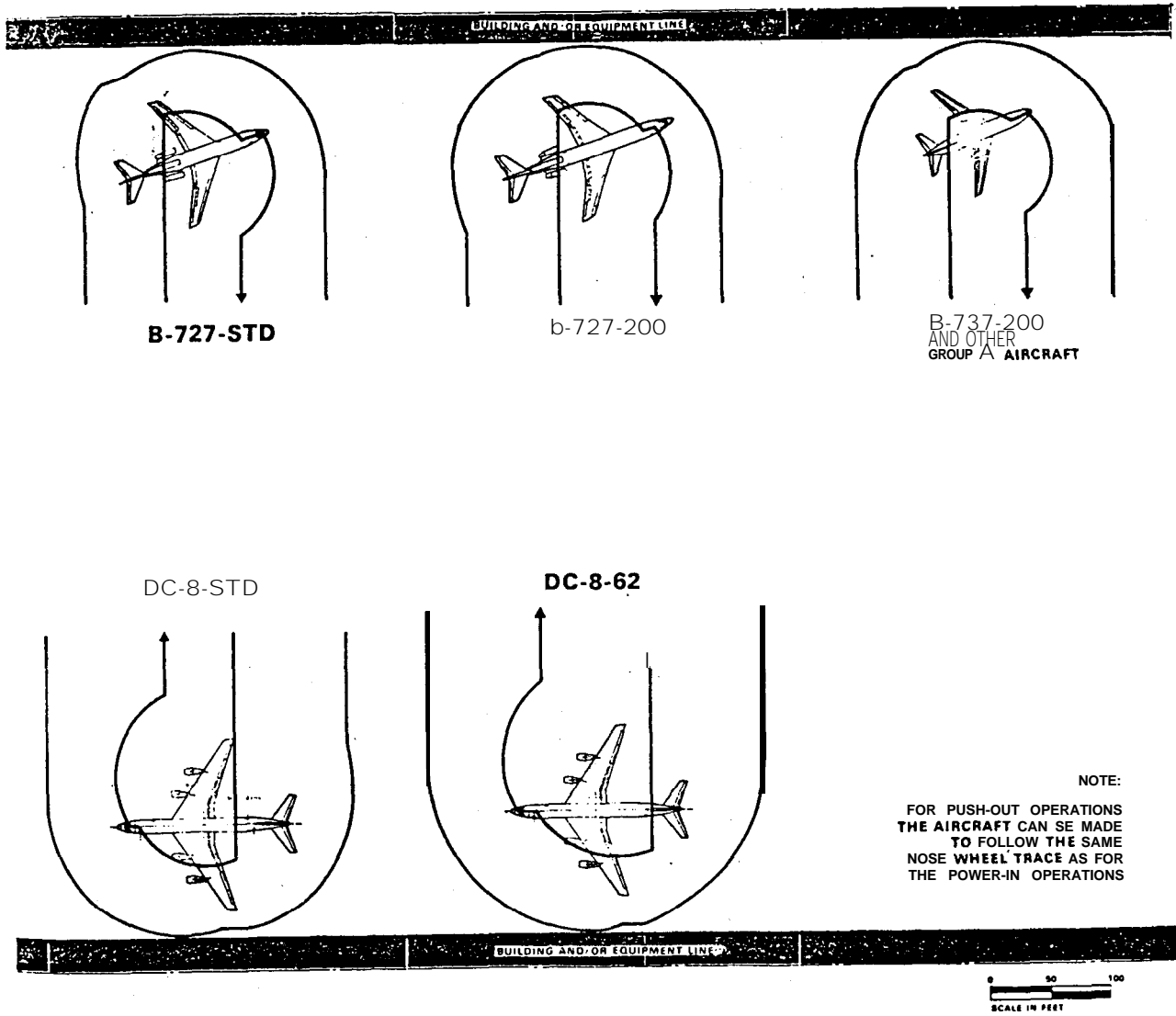
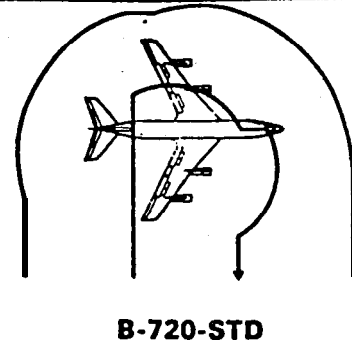
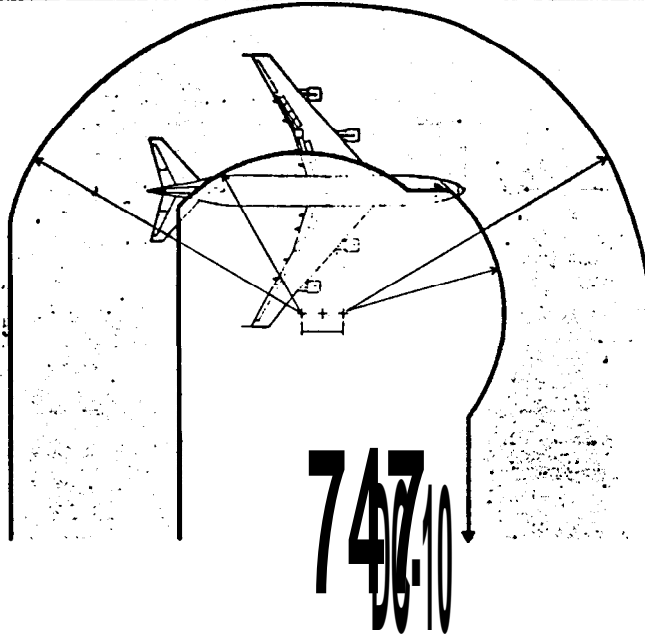
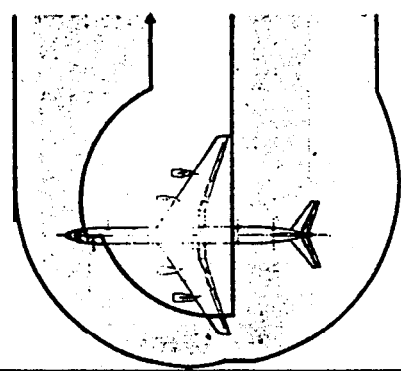
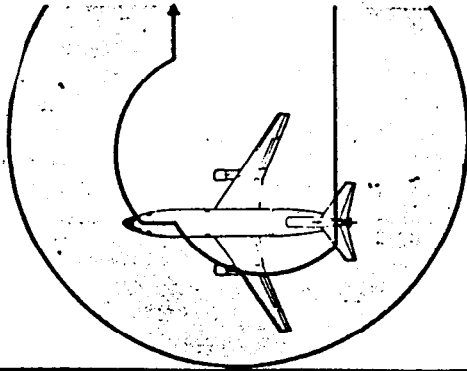

Figure 4-6. Aircraft Maneuvering Area Taxi-Out Configuration



B-720-STD



DC-8-61

0 50 100
SCALE IN FEET

Figure 4-7. Aircraft Maneuvering Area Taxi-Out Configuration

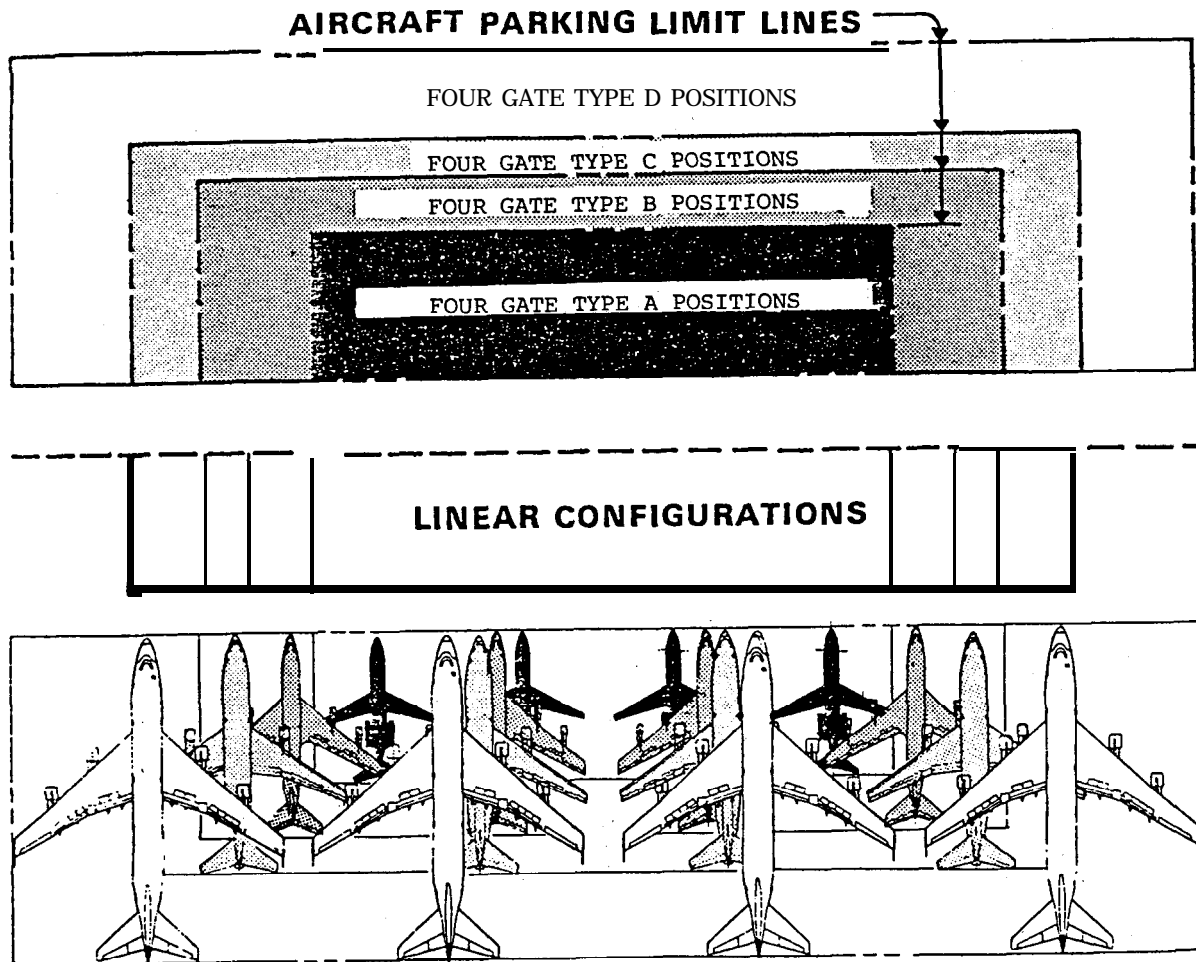

ALL WINGTIPS SHOW
20-FT CLEARANCE

0 50 100
SCALE IN FEET

Figure 4-8. Linear Configuration Pushout Gate Positioning

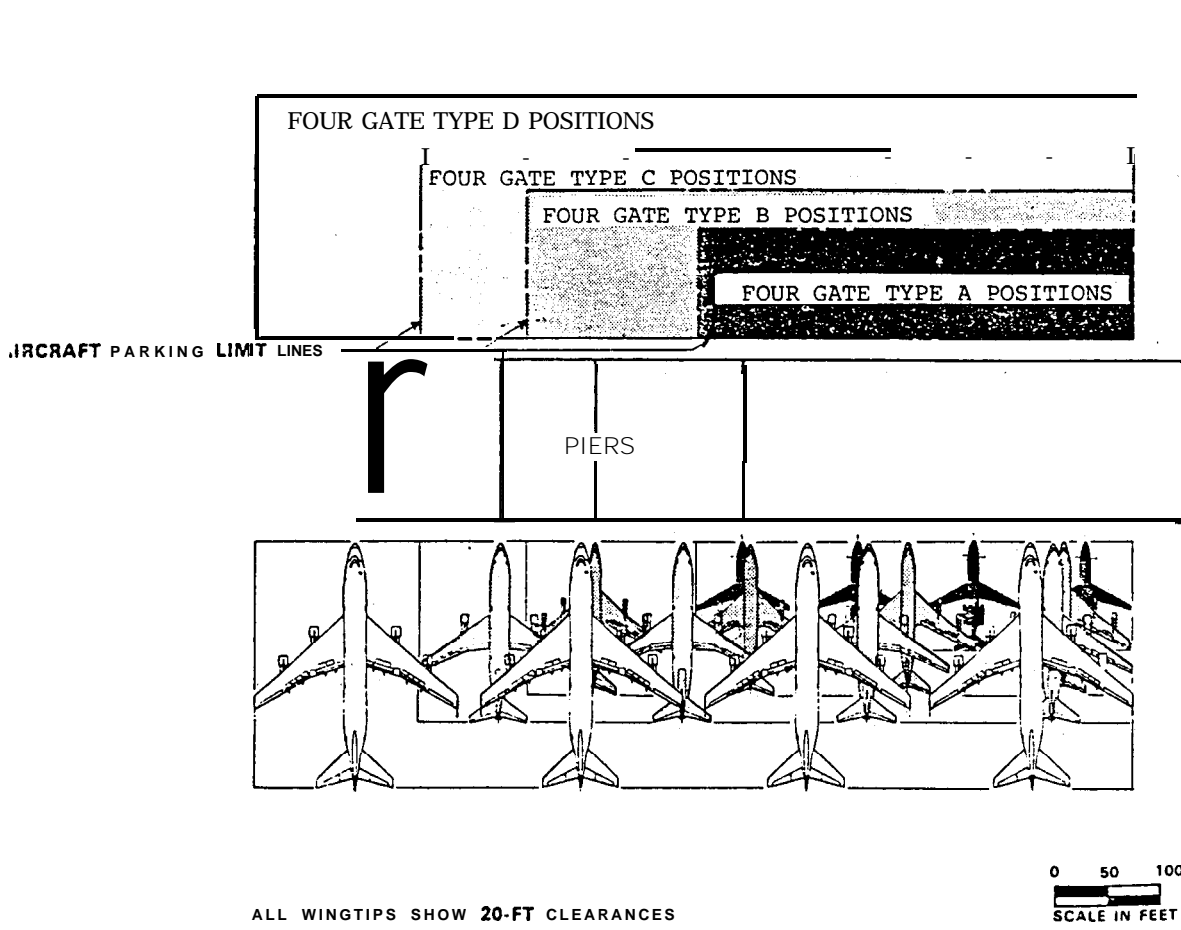

Figure 4-9. Pier Configuration Pushout Gate Positioning



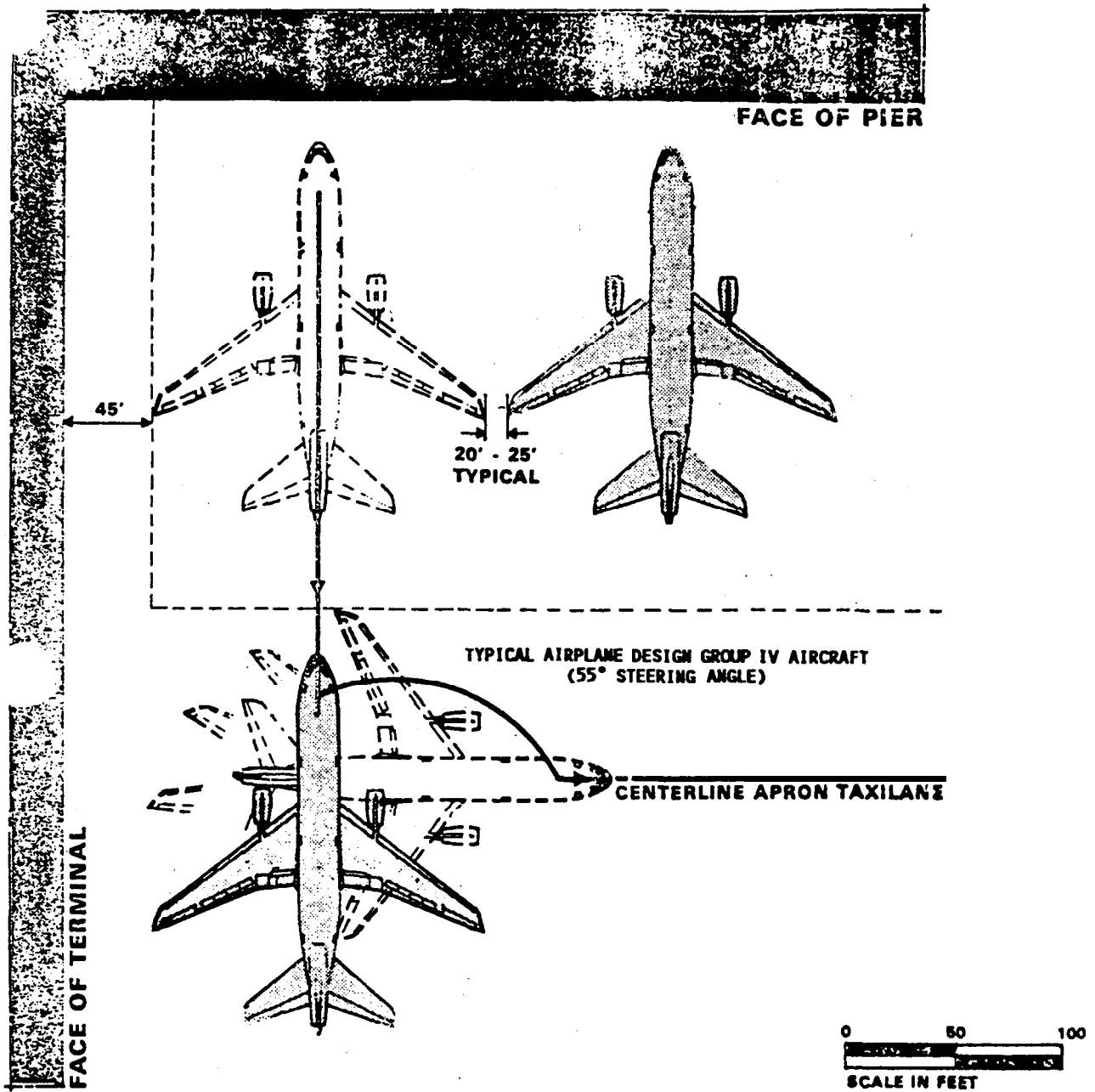

Figure 4-10. Typical Clearances--Inboard Pier Gate

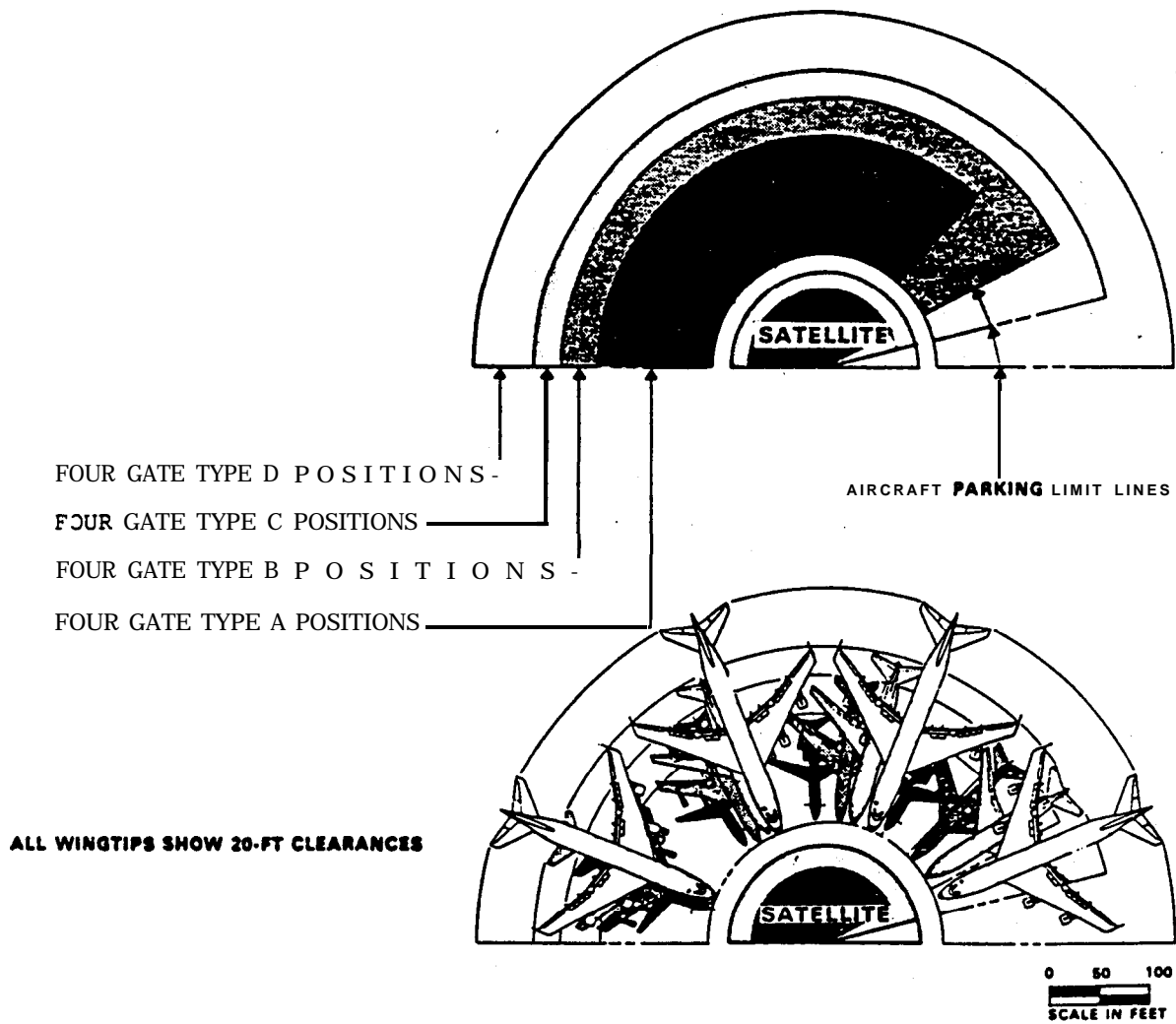
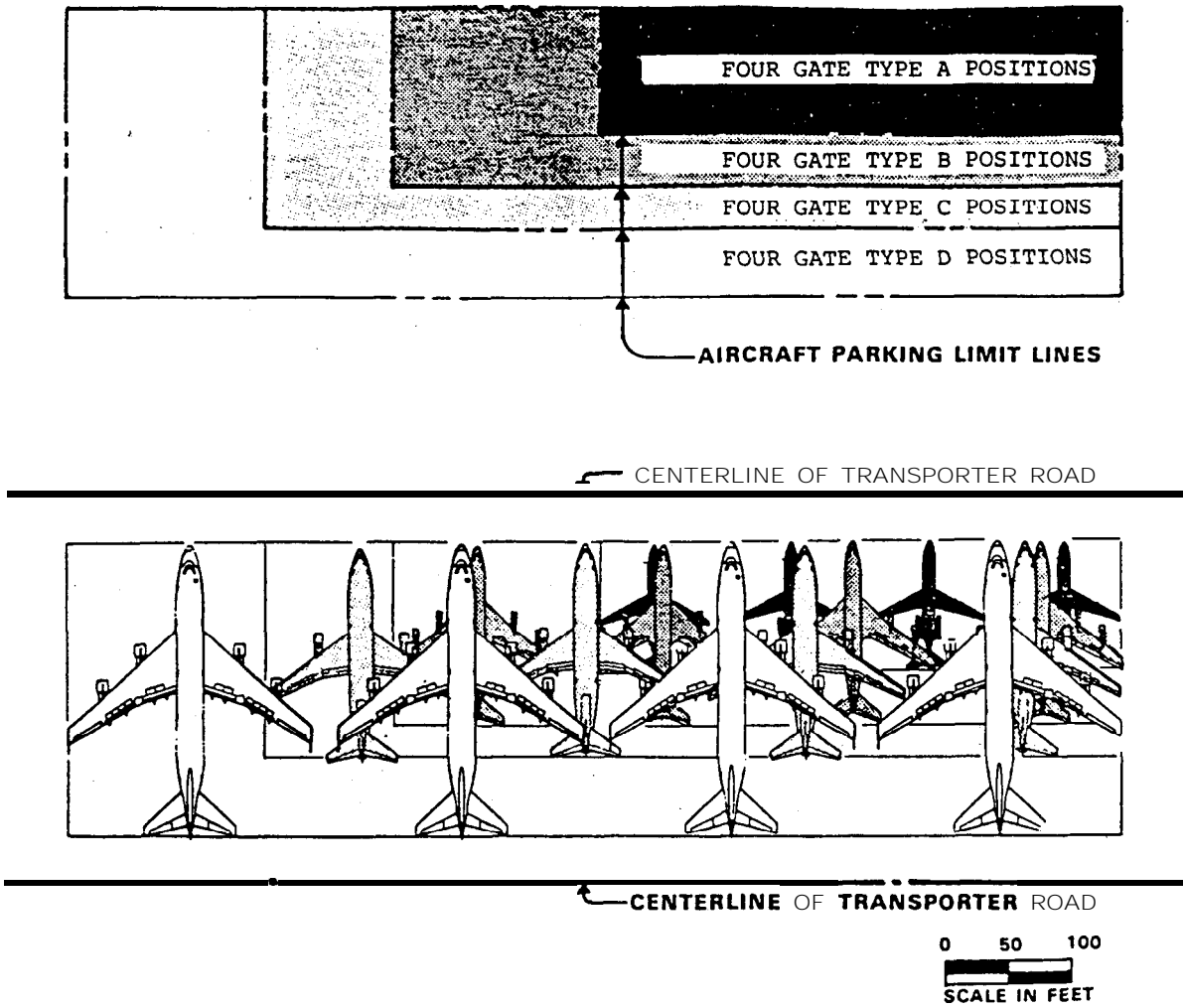

Figure 4-11. Satellite Configuration Pushout Gate Positioning



ALL WINGTIPS HAVE **45-FT** CLEARANCE
FOR TRANSPORTER MANEUVERING

FOR SERVICE BUILDINGS
SEE CHAPTER 3, CONNECTOR ELEMENT

Figure 4-12. Transporter Configuration Taxi-Through or Pushout Gate Positioning

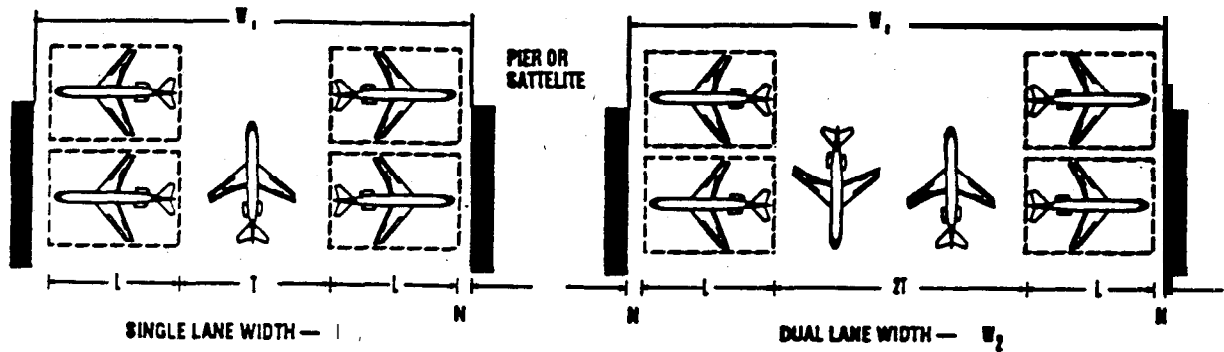

Gate Type	(N) Nose to Bldg. Distance	(T)* Taxilane OFA Width	(L) Airplane Length	(W ₁)* (2N+T+2L)	(W ₂)* (2N+2T+2L)
A	30 ft/9 m	162 ft/49 m	155 ft/47 m	532 ft/162 m	694 ft/212 m
B	20 ft/6 m	225 ft/49 m	160 ft/49 m	585 ft/179 m	810 ft/247 m
C	20 ft/6 m	225 ft/49 m	188 ft/57 m	641 ft/195 m	866 ft/264 m
D	15 ft/4.5 m	276 ft/84 m	232 ft/71 m	770 ft/235 m	1.046 ft/319 m

Note: Service vehicle roads on aprons are located outside of the taxiway object free area (OFA), and must be accounted for as a separate entity in determining W , or W_1 . (See Figure A9-4, AC 150/5300-13.)

Figure 4-13. Dual- vs. Single-Taxilane Layout

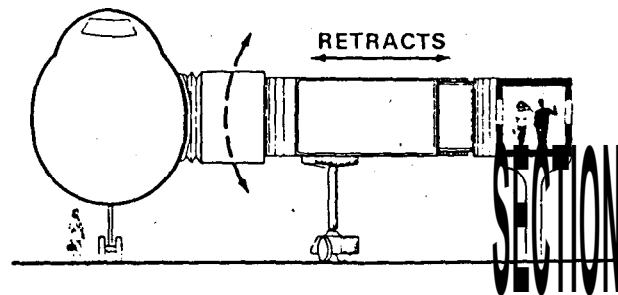
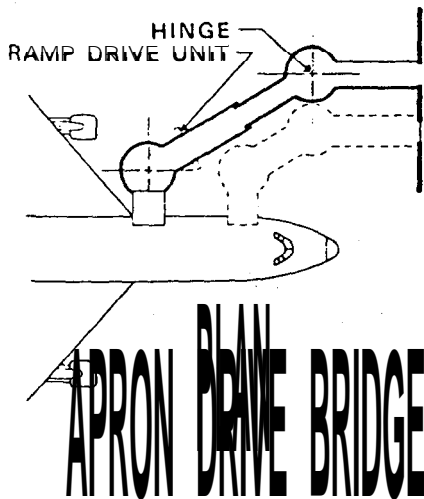
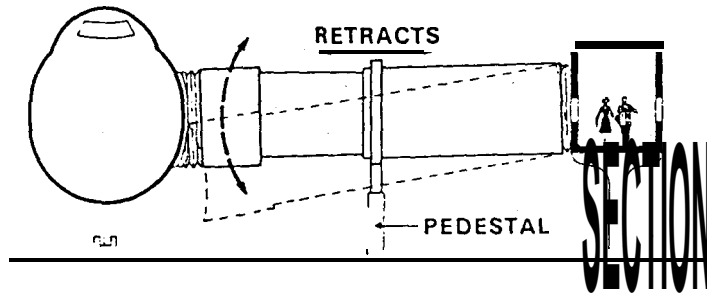
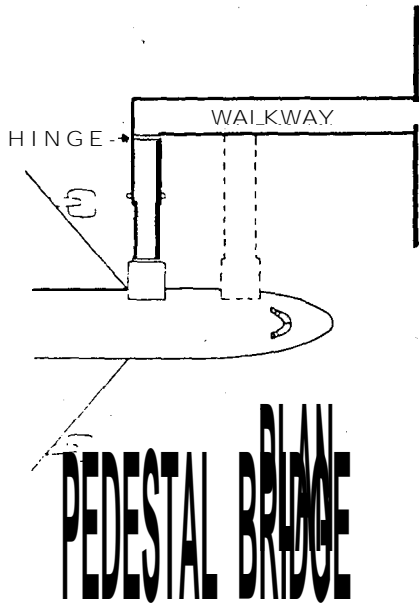

Figure 4-14. Typical Passenger Loading Bridges

b. Aircraft door widths range from 32 inches (84 cm) to 42 inches (107 cm). Their respective flow rates are approximately 25 passengers and 40 passengers per minute. A 36-inch (91 cm) entrance doorway accommodates approximately 37 passengers per minute.

c. Since aircraft aisle width can influence the flow rate of a loading bridge. Airline studies indicate a flow rate of 30 passengers per minute for a single-aisle aircraft.

d. A stairway at the loading bridge entrance reduces flow rates to approximately 20-25 passengers per minute, the same rate achieved when integral aircraft or mobile stairs are employed. A stairway or ramp not constructed within the terminal building should be provided with an enclosure for weather protection.

e. The maximum ramp gradient to comply with Americans with Disabilities Act (ADA) requirements is 1:20.

f. The length and type of loading bridge (fixed pedestal, apron drive, or suspended) are functions of a number of variables. These include apron dimensions, airline docking procedures, wingspan, door locations, fixed aircraft services, adjacent aircraft positions, and economics. For instance, an apron drive bridge, when in a stowed position, will allow a taxi-out operation, while pedestal or suspended types are limited to push-out operations. A determination on which bridge design to apply in each case should be based on the specific characteristics of the aircraft mix as well as airline operating requirements.

g. Two loading bridges for larger type aircraft are used at some airports to facilitate loading and deplaning. In most cases, however, one bridge is adequate. The decision to use more than one bridge should take into account the average peak-hour "boarding" load factor by type of aircraft at each aircraft position. At through stations, it is very likely that the boarding load factor will be low enough that only one bridge will be required for a B-747 position.

h. Figure 4-15 depicts various aircraft sill heights and door locations. The positioning of an individual aircraft is, to a great extent, a product of its door alignment with doors of other aircraft types. This facilitates the utilization of one type of loading bridge to serve a variety of aircraft. However, this is not the only consideration to be met in determining the interchangeability of a series of aircraft parked on one apron area. Normally, an apron area will be restricted for various reasons to a limited number of usually similar aircraft types. This greatly simplifies loading-bridge maneuvering requirements, as well as the positioning of fixed utilities.

i. Designers should be aware of the National Fire Protection Association (NFPA) criterion (refer to paragraph 2-2.6 of NFPA 417, Standard on Construction and Protection of Aircraft Loading Walkways) which stipulates that any door in the egress path through the loading walkway to the terminal building swing in the direction of egress from the aircraft towards the terminal building and be equipped with panic hardware on the aircraft side.

50. TRANSPORTERS.

a. Transporters are used at some airports to carry passengers between the terminal building and remotely parked aircraft. A nonelevating transporter may simply be a bus or similar vehicle, possibly modified for airport use. A stair boarding device is required to complement its operation for passenger boarding, crew access, cabin service access, and emergency egress. This type of vehicle is generally more appropriate for use on an interim basis or to supplement gate loading during very heavy peak periods. Elevating transporters are designed to mate with the terminal dock and aircraft for loading and unloading passengers. One type of elevating transporter uses an elevating gangplank with a 6 to 10 foot (1.8 to 3 m) extension which adjusts to various aircraft sill heights. This type generally has a capacity of 50-80 passengers. Another type uses an elevating passenger compartment or pod and a loading bridge-type coupling to ensure compatibility with practically all aircraft currently used by airlines. This vehicle generally has a capacity of 55 to 120 passengers.

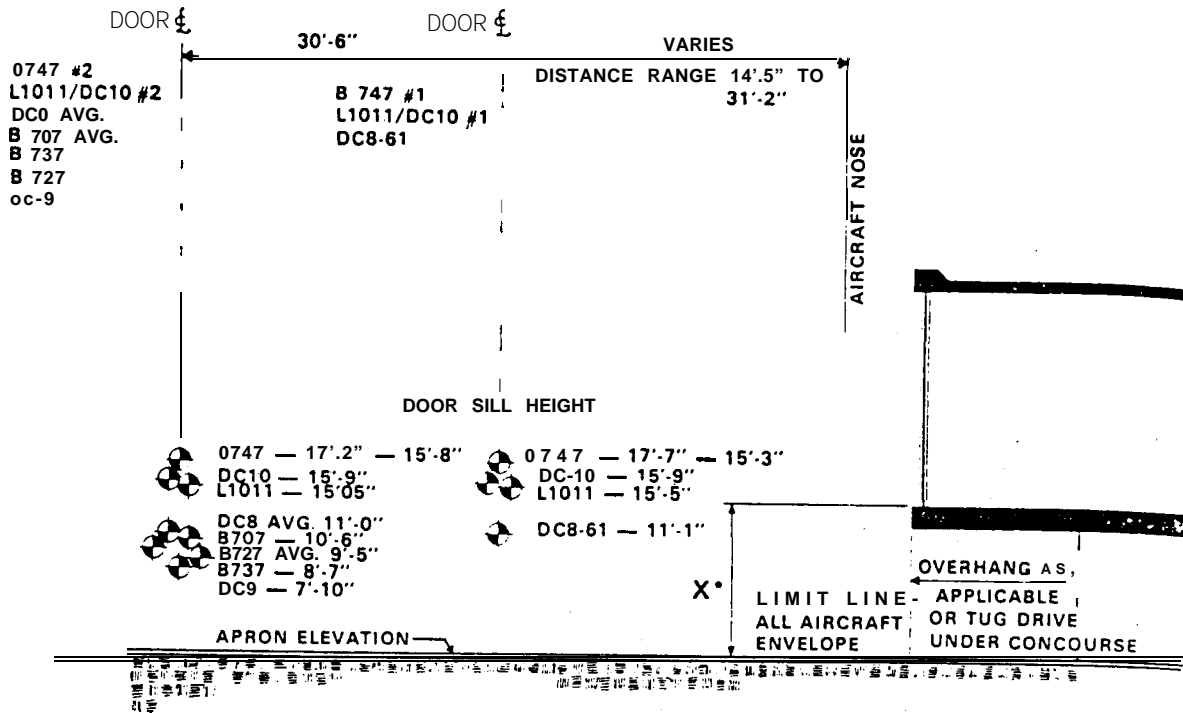

*X AVERAGE FLOOR. HEIGHT DEPENDS ON:
 (A) A/C TYPES
 (B) # DOOR SERVE
 (C) LOADING BR. TYPE USED

Figure 4-15. Aircraft Sill Heights

b. The number of transporters and docks required can be determined by developing and analyzing an aircraft flight-line scheduling plan and determining transporter cycle times for peak periods. The flight line scheduling plan includes arrival and departure times and ground time for each aircraft during peak periods for the projected design year. Transporter cycle time is defined as the time for the transporter to complete a cycle from dock to aircraft to dock. It is dependent on transporter average speed (generally from 8 to 15 miles per hour), the travel distance between terminal and the aircraft parking area, and vehicle maneuverability and docking procedures. Cycle time also depends on the **efficient** organization of the transporter operation. For instance, a transporter which has completed enplaning one flight at the flight line can position for an arriving flight without returning to the dock. Thus, the normal cycle has been interrupted, a new cycle established, time saved, and a more efficient operation promoted. Such interrupted cycle times are accountable in determining transporter requirements. Consideration for peaks within peaks is also required if

unacceptable de'lays arc to be avoided. For **example**, 50 percent of a peak hour's traffic volume may occur in 15 or 20 minutes, thereby **overloading** the system. Figure 4-16 **provides** a nomograph for estimating transporter requirements. The nomograph can be **used** in the **early stages** of planning to **determine** general requirements. Design **requirements** will necessitate **the** more precise analysis discussed previously. At the higher activity locations, simulation models may be necessary to test future **schedules**, variations in transporter runs, cycle times, and other alternatives.

51. FIXED UTILITIES. Figure 4-17 **depicts** the most common **fixed** utilities located at aircraft parking positions; namely, fueling and power systems. Optimum locations are shown for most aircraft in the U.S. air carrier fleet. Descriptions and **uses** of several of the **more** common fixed utilities are as follows:

a. Fueling. The advantages of underground fueling systems are the reduction in the amount and size of ground equipment and corresponding decrease in ramp congestion with large numbers of aircraft during the design hour. Primarily, a shift from fuel trucks to an underground system is **justified** on a cost versus volume basis. A further development of a pure underground system for each aircraft position is a common hydrant fueling point in proximity to several aircraft. In such a system, hydrant fueling trucks are used instead of large-capacity tankers. In both cases, however, trucks are required. With underground fueling, fuel is pumped from a central tank farm to a pit. The hydrant truck then connects a hose to the pit and into the aircraft. The maximum allowable fuel-truck hose lengths vary between 30 and 50 feet (9 and 15 m). AC 150/5320-4, Aircraft Fuel Storage, Handling, and Dispensing, provides additional relevant guidance.

b. Water. The **fixed** water supply at each gate position is usually an easily **adapted fixed** utility. Most existing terminal configurations, **where** aircraft park next to the building structure, arc already supplied with potable water. Provided that capacities arc adequate, this supply may be tapped and linked to the aircraft with a hose-reel cart.

c. Ground Power. Providing a fixed ground power unit for **each** gate position may be desirable. Recently, the approach has **been** simply to provide a ground power source with the loading bridge (apron-drive or fixed pedestal). This eliminates additional ramp congestion (cables, etc.) or more costly underground installations. **Power** requirements for each aircraft position vary and should be justified on an individual airline basis.

d. Air Start. Pressurized air is required for aircraft without an auxiliary power unit (APU). Although it is the **least** commonly available **fixed** utility, it can be **permanently** installed in a **manner** similar to other utility systems. In actual practice however, truck-mounted units are by far the most commonly used to provide this service. The air requirements for various aircraft range from 120 to 270 lb/min. (54.5 to 122.7 kg/min) at 40 psi (275.8 kPa).

e. Air Conditioning. An option exists for airlines to elect to introduce **fixed** air-conditioning units on the apron. **However**, APU-supplied air conditioning and **centrally furnished** low pressure preconditioned air are most commonly used.

52. APRON AREA LIGHTING. Most outdoor areas associated with the apron require some degree of illumination. Table 4-1 presents criteria for lighting in foot-candles (**lux** (lx)) for apron/apron related areas. Lighting levels should be of sufficient intensity to allow observation of **all** pedestrian activity. Mounted floodlights are the usual preferred method of lighting the apron area. They are typically mounted at a height of 25 to 50 feet (8 to 15 m) with a maximum spacing of 200 feet (60 m). Floodlight location requires coordination with the specific type(s) of aircraft using the parking position. Floodlights should be aimed and shielded to avoid glare to pilots and air traffic controllers without reducing the **required** illumination in critical areas.

STEP 1: DETERMINE THE NUMBER OF TRANSPORTER TRIPS FOR A MIX OF AIRCRAFT

AIRCRAFT TYPE	PEAK NUMBER IN PEAK HOUR (A)	TRANSPORTERS NEEDED* (B)	NUMBER OF PEAK-HOUR TRANSPORTER TRIPS (A X B)
B-737	11	1	11
DC-10	5	2	10
B-747	6	3	a
TOTAL			30

* THIS NUMBER IS A FUNCTION OF AIRCRAFT LOAD FACTORS FOR EACH AIRCRAFT POSITION AND TRANSPORTER CAPACITY.

STEP 2: DETERMINE CYCLE TIME FOR EACH TRANSPORTER TRIP; E.G., 20 MINUTES DOCK TO DOCK.

STEP 3: READ LEFT SIDE OF GRAPH TO DETERMINE NUMBER OF TRANSPORTERS REQUIRED; I.E., 12.9 TRANSPORTERS, ROUNDED OFF TO 13

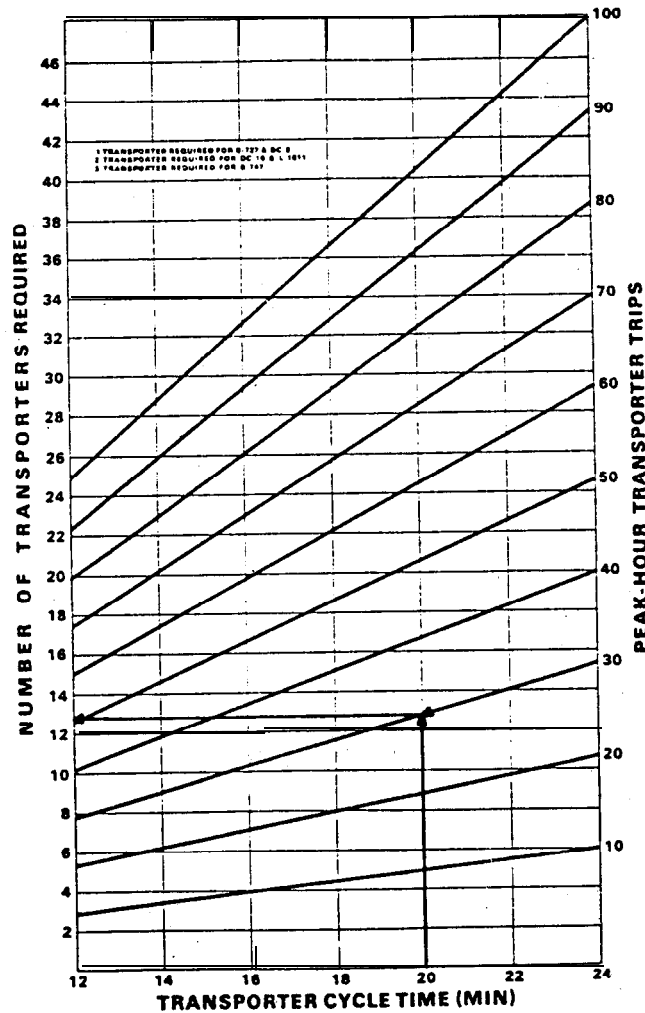

Figure 4-16. Transporter Requirements

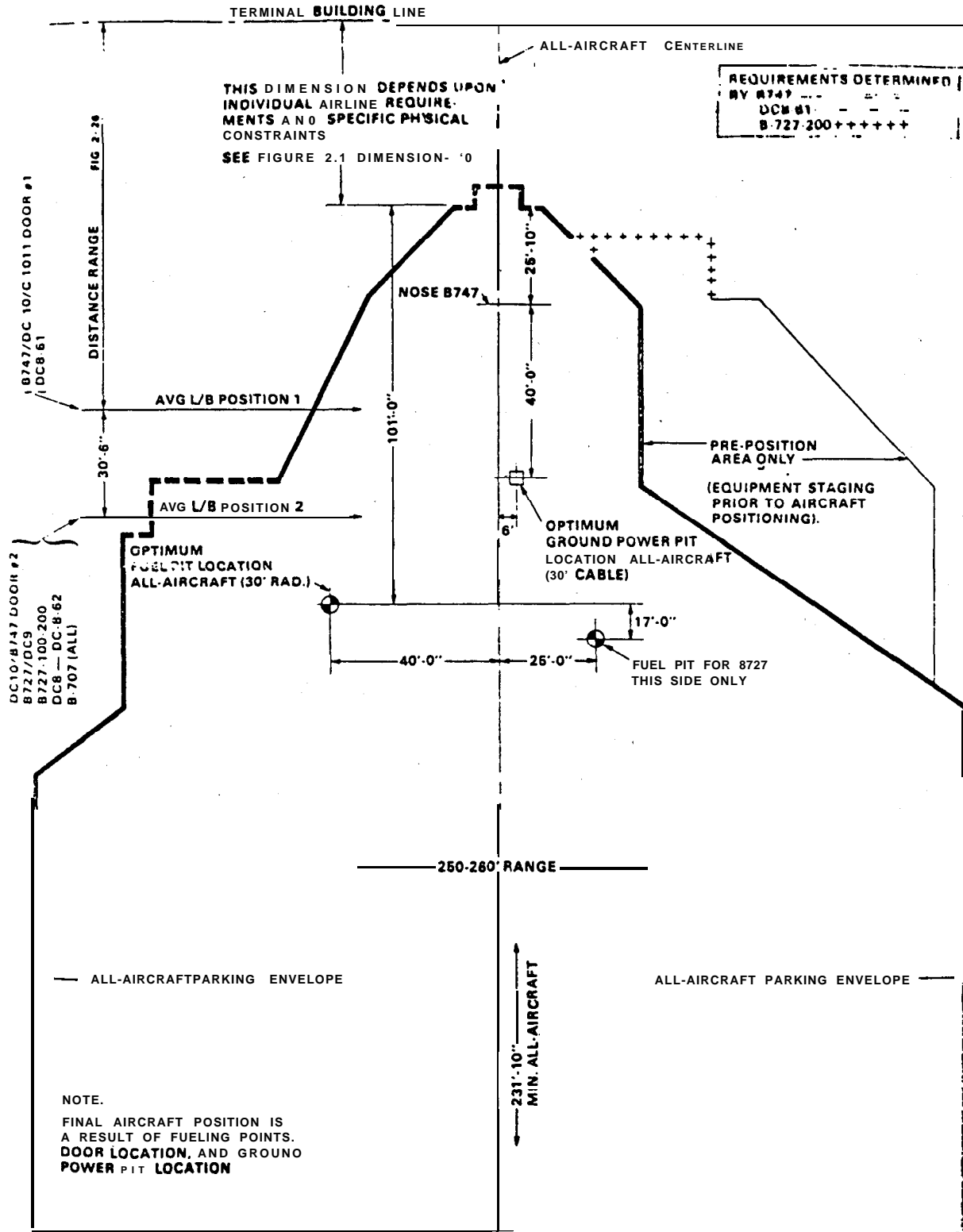

Figure 4-17. Common Fixed Utility Locations - Composite Aircraft Parking Envelope

Table 4-1. General Lighting Requirements

Area	Foot-candles (LX) ²
Fences, gates, guard-shelters, building exteriors, apron areas, associated equipment parking areas, building entrances, and exits.	5.0 (54.0)
Pedestrian entrances to aircraft operations area ¹	2.0 (22.0) max.
General aircraft operations area ¹	0.15 (1.6)
Dock Areas	10.0 (108.0)
Roadways	1.5 (16.0)

¹ FAA AC 107-1, Aviation Security-Airports.

² Measured at most remove points of areas involved, ±200 ft (60 m) 36 inches (91 cm) above ground; light target perpendicular to the direction of the light rays.

53. BLAST FENCES. Passenger and aircraft servicing facilities ground equipment should be located in areas not affected by aircraft engine blast. Blast fences are often used on terminal aprons to protect ground equipment, personnel, buildings, or other **aircraft** from aircraft blast, particularly when aircraft taxi to and from gate parking positions. They may also be used in push-out/power-out **configurations** where blast is a potential problem. The positioning of blast fences depends on aircraft or ground-equipment maneuvering patterns, while their size depends on the extent of blast requiring control. Chapter 6 of AC 150/5300-12 discusses aircraft jet blast and the design and location of blast fences.

54. - 65. **RESERVED.**

CHAPTER 5. TERMINAL BUILDING SPACE AND FACILITY GUIDELINES

66. GENERAL. This chapter provides guidance on spatial requirements for functions carried out in an airport terminal building. The guidance is indicative of the design range in use at U.S. airports to accommodate domestic scheduled passenger operations. Adjustments may be necessary for international, charter, non-scheduled, or third level operations. Airport terminals should be designed for a capacity to meet the projected needs of the community being served. This guidance should only be applied after consultation with the airlines, FAA, other users, and tenants. Modifications to the guidance may be warranted after such discussions.

67. GROSS TERMINAL BUILDING AREA ESTIMATES.

a. Gross Terminal Area Per Gate. The relationship between annual **enplaned** passengers and gross terminal area per gate for a 10-year and 20-year forecast is approximated in Figures 5-1 and 5-2, respectively. The profile of the curves is based on predicted growth in seats per aircraft for each forecast period; specifically, the growth in predicted aircraft mix during the peak hour of the average day of the peak month of the design year. With a 10 or 20 year forecast of annual enplanements and an approximate required number of gates determined by the procedures discussed in paragraphs 25 through 27, an approximation of gross terminal area can be made.

b. Rule-of-Thumb. A rule-of-thumb of about 150 square feet (14 m²) of gross terminal building area per design peak-hour passenger is sometimes used for rough estimating purposes. Another rule using 0.08 to 0.12 square feet (0.007 to 0.011 m²) per annual enplanement at airports with over 250,000 annual **enplanements** can similarly be applied. At small airports with less than 250,000 enplanements, estimates should be based on peak hour considerations and simple sketches (see AC 150/5360-9).

68. SPACE ALLOCATIONS. The terminal building area is comprised of both usable and unusable space. Unusable space involves those areas required for building columns and exterior and interior walls, about 5 percent of the total gross area. The usable space can be classified into the two broad categories of rentable and nonrentable space. Usually, 50 to 55 percent is allocated to rentable space and 45 to 50 percent to nonrentable space. Figure 5-3 presents a further breakdown of these basic categories.

69. PUBLIC LOBBY AREAS. Lobbies provide public circulation and access for carrying out the following functions: passenger ticketing; passenger and visitor waiting; housing concession areas and other passenger services; and baggage claim.

a. Ticketing Lobby.

(1) As the initial objective of most passengers, the ticketing lobby should be arranged so that the enplaning passenger has immediate access and clear visibility to the individual airline ticket counters upon entering the building. Circulation patterns should allow the option of bypassing counters with minimum interference. Provisions for seating should be minimal to avoid congestion and encourage passengers to proceed to the gate area.

(2) Ticket lobby sizing is a function of total length of airline counter frontage; queuing space in front of counters; and, additional space for lateral circulation to facilitate passenger movements. Queuing space requires a minimum of 12 to 15 feet (4 to 5 m). Lobby depths in front of the ticket counter range from 20 to 30 feet (12 to 15 m) for a ticket area serving 50 gates or more.

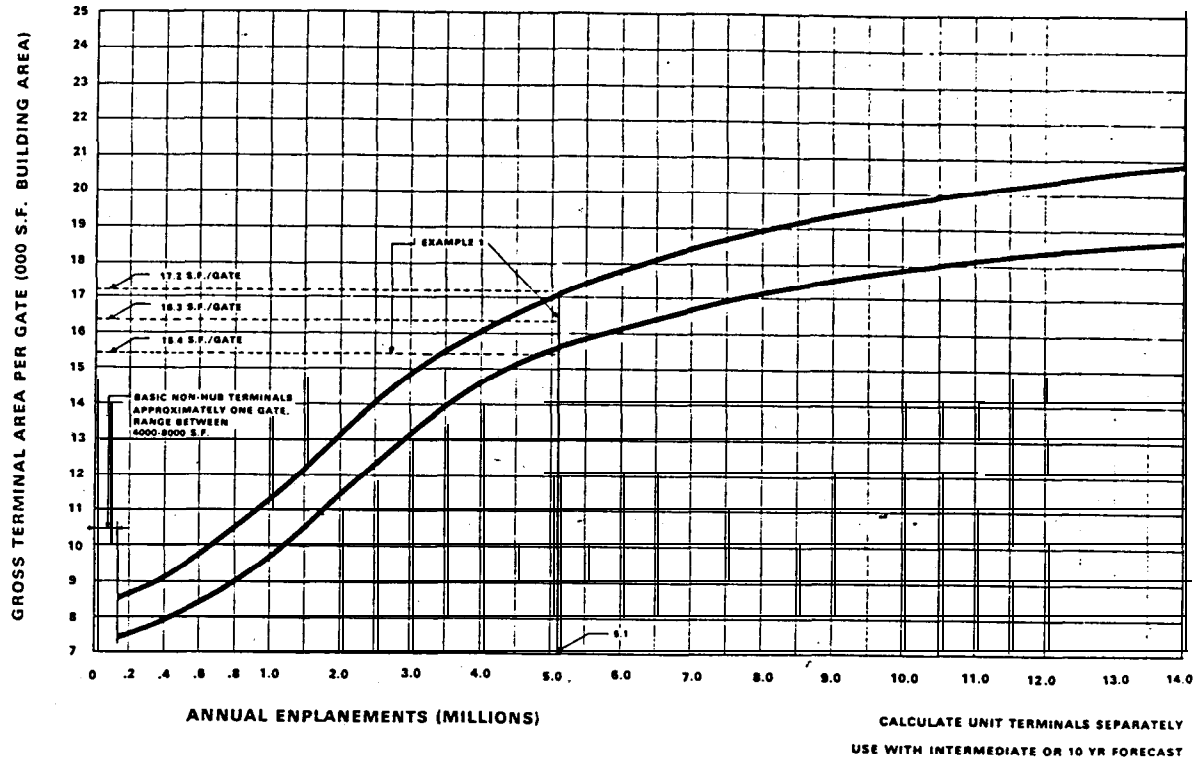

Figure 5-1. Gross Terminal Area Per Gate - Intermediate Planning

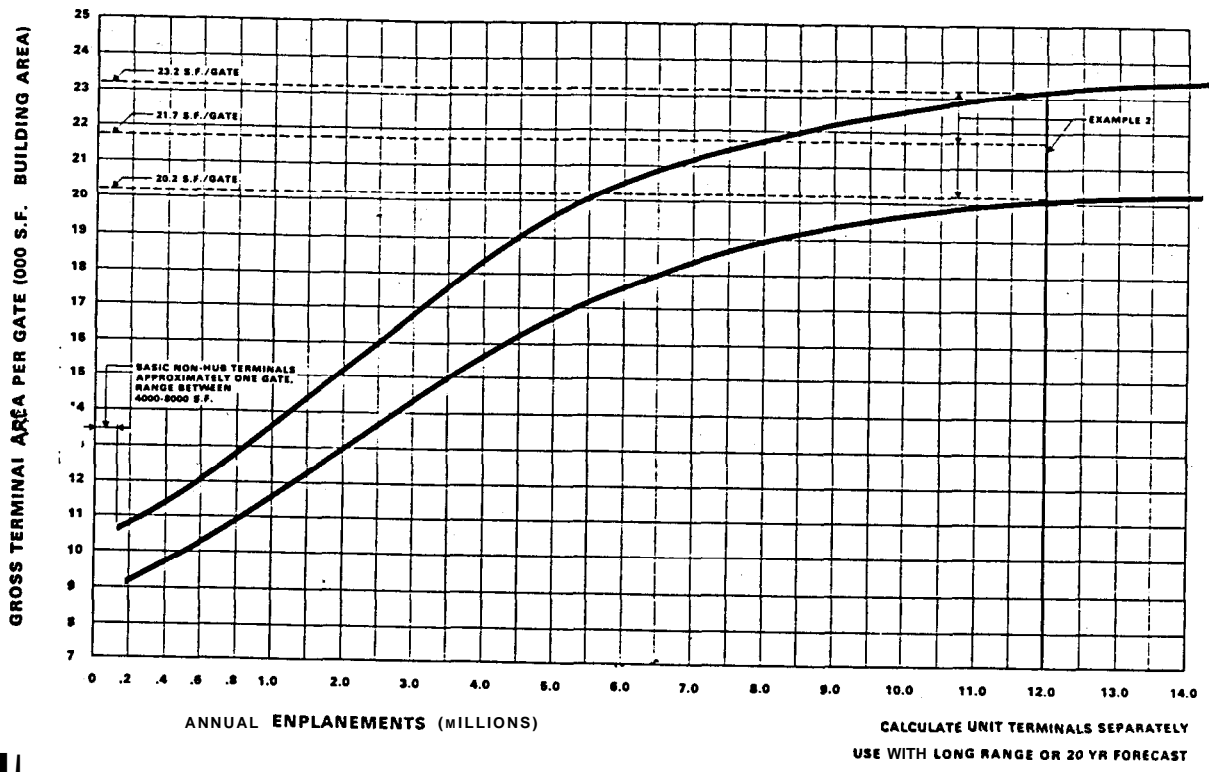

Figure 5-2. Gross Terminal Area Per Gate - Long-Range Planning

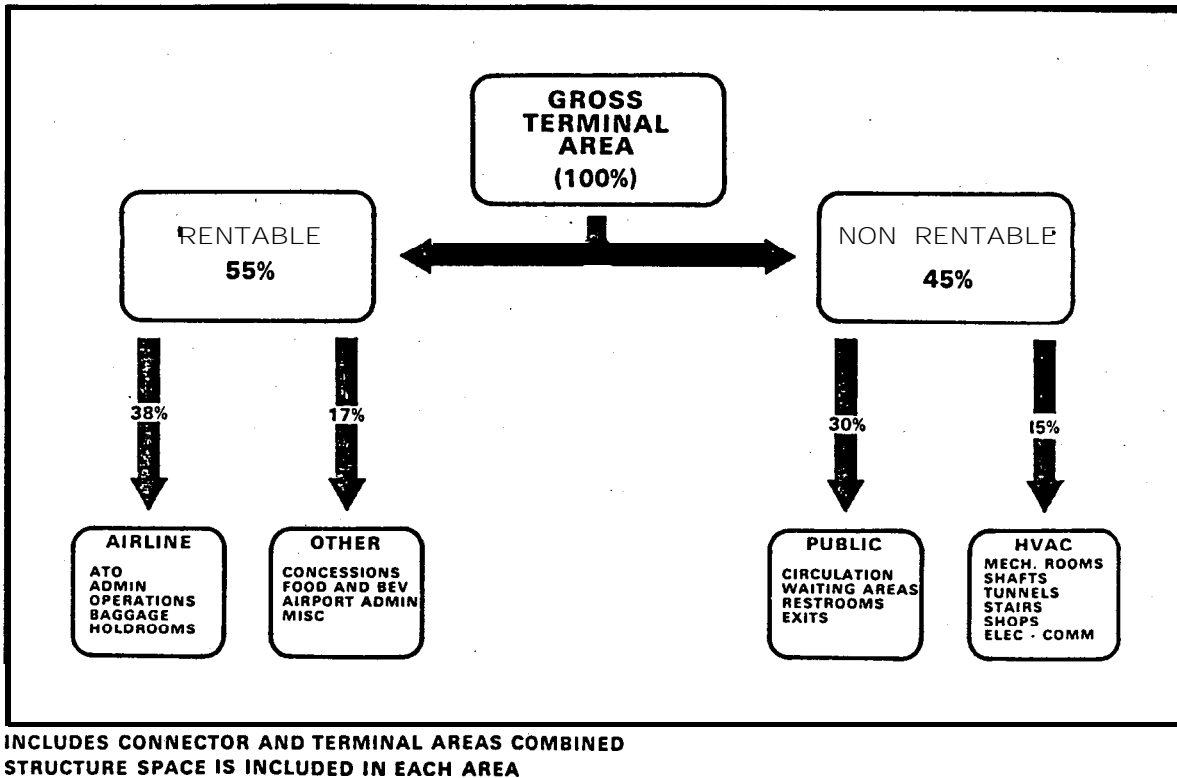

Figure 5-3. Gross Terminal Area Space Distribution

(3) Figure 5-4 contains a nomograph for approximating ticket lobby area for initial planning purposes. This nomograph includes the ticket counter and area behind the ticket counter as part of the lobby area. It is necessary to subtract the counter area when estimating only the public lobby area used for passenger queuing and circulation. Inventories at some existing large hubs indicate that additional area to that shown in the figure should be provided at the extreme ends of the ticket counters for additional circulation.

b. Waiting Lobby.

(1) Apart from providing for passenger and visitor circulation, a centralized waiting area usually provides public seating and access to passenger amenities, including rest rooms, retail shops, food service, etc. The sizing of a central waiting lobby is influenced by the number, seating capacity, and location of individual gate waiting areas. If all gate areas have seating, the central waiting lobby may be sized to seat 15 to 25 percent of the design peak hour enplaning passengers plus visitors. However, if no gate seating areas are provided or planned, seating for 60 to 70 percent of design peak hour enplanements plus visitors should be provided.

(2) Visitor-passenger ratios are best determined by means of local surveys. In the absence of such data, an assumption of one visitor per peak hour originating passenger is reasonable for planning purposes.

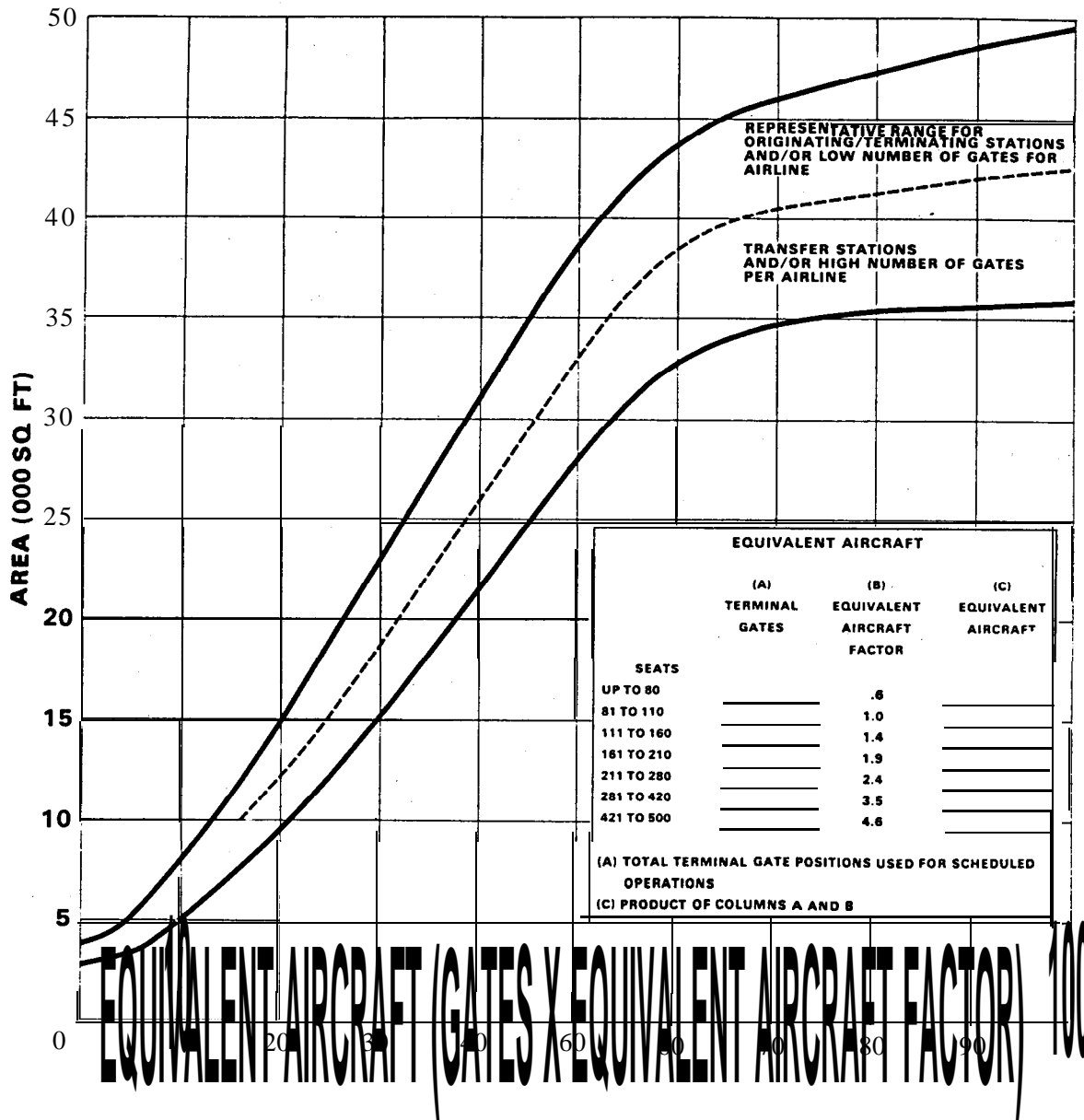

Figure 5-4. Ticket Lobby and Counter Area

(3) Figure 5-5 may be used as an approximation for converting seating requirements to lobby area. The area obtained from this nomograph provides for circulation around two sides of seating. Additional area is required for circulation around three sides.

c. Baggage Claim Lobby.

(1) This lobby provides public circulation space for access to baggage claim facilities and for egress from the claim area to the deplaning curb and ground transportation. It also furnishes space for such passenger amenities and services as car rental counters, telephones, rest rooms, limousine service, etc.

(2) Space required for the baggage claim facility is discussed in paragraph 75. Allowance for public circulation and passenger amenities outside the claim area ranges from 15 to 20 feet (5 to 6 m) in depth at

small hub airports, 20 to 30 feet (6 to 9 m) at medium hubs, and 30 to 35 feet (9 to 11 m) at those airports serving large hubs. Lobby lengths range from 50 to 75 feet (15 to 23 m) for each baggage claim device. For approximating lobby length and area, one claim device per 100 to 125 feet (30 to 38 m) of baggage claim frontage should be assumed.

d. Combined Lobbies.

(1) Airports handling less than 100,000 annual enplanements frequently provide a single combined lobby for ticketing, waiting, and baggage claim. Figure 5-5, with an assumed seating for 100 percent of peak hour enplanements, may be used to obtain a gross approximation for lobby space. This usually allows adequate space for visitors and circulation. Also, AC 150/5360-9 presents space requirements for low activity airports.

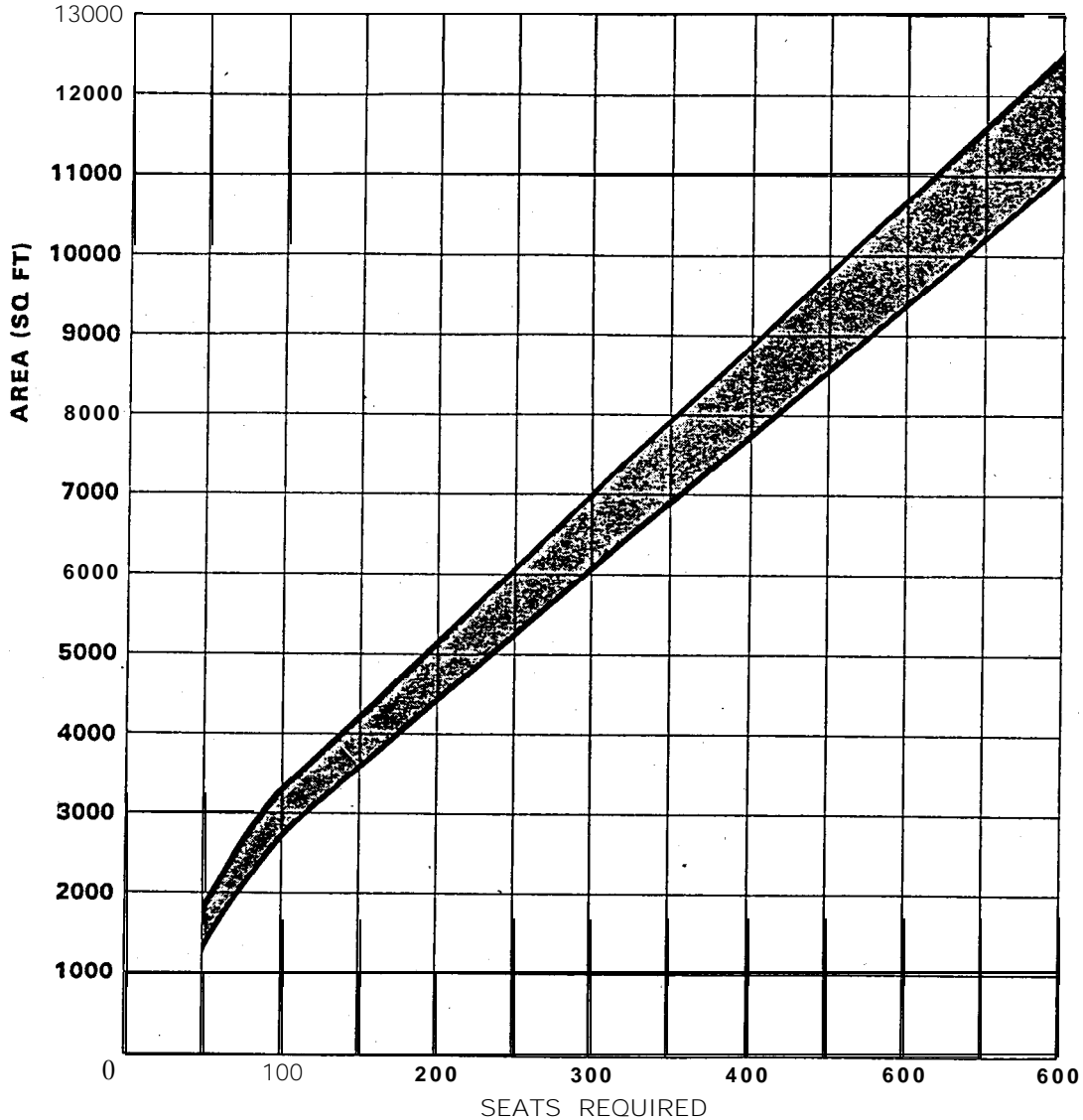

NOTE:
FOR REQUIREMENTS
OVER 600 SEATS,
USE MULTIPLES OF 200
OR MORE
GRAPH INCLUDES
PRIMARY CIRCULATION AREAS
FROM COUNTERS TO
CONCESSIONS, CONNECTOR,
ETC.

Figure 5-5. Waiting Lobby Area

For a combined lobby serving 100,000 to 200,000 annual enplanements, space requirements for various functions should be identified and sized separately, as discussed in preceding paragraphs.

(3) Above 200,000 annual enplanements, each of the three lobby types should be identifiable as distinct elements and space requirements estimated accordingly.

70. AIRLINE TICKET COUNTER/OFFICES. The Airline Ticket Counter (**ATO**) area is the primary location for passengers to complete ticket transactions and check-in baggage. It includes the airline counters, space and/or conveyors for handling outbound baggage, counter agent service areas, and related administrative/support offices. In almost all cases, ticket counter areas are leased by an airline for its exclusive use. Therefore, the planning, design, and sizing of these areas should be closely coordinated with individual airlines.

a. Ticket Counter Configurations. Three ticket counter configurations are in general use. They include:

(1) **Linear.** Linear configuration is the most frequently used one (see Figure 5-6). Multi-purpose positions indicated are those in which the agent performs several functions such as ticketing, baggage check-in, and the other services an airline may consider appropriate. During peak periods, multi-purpose positions may be utilized for a single function to expedite passenger processing for those requiring only one type of service. At high volume airports, permanent special-purpose positions may be justified.

(2) **Flow-through Counters.** Flow-through counters, as depicted in Figure 5-7, are used by some airlines, particularly at high-volume locations with a relatively high percentage of "baggage only" transactions. This configuration permits the passenger to check-in baggage before completing ticketing transaction and increases outbound baggage handling capability by providing additional belt conveyors. This type of counter requires more floor space, an additional 50-70 square feet (4.7-5.1 m²), than the linear type and involves increased investment and maintenance costs. Future application will probably be limited to relatively few airports.

(3) **Island Counters.** The island counter shown in Figure 5-8 combines some features of the flow-through and linear arrangements. The agent positions form a "U" around a single baggage conveyor belt (or pair of belts) permitting interchangeability between multipurpose or specialized positions. As with flow-through counters, this configuration has relatively limited application.

b. Office Support. The airline ticket counter/office provides space for a number of airline support activities. These activities include: accounting and safekeeping of receipts; agent supervision; communications; information display equipment; and personnel areas for rest, personal grooming, and training. At low activity locations, the ticket counter area may provide space for all company administrative and operational functions, including outbound baggage. Figure 5-9 depicts two typical layouts for low activity airports with single-level terminals. At high activity locations, there is more likelihood that additional space for airline support activities will be remotely located from the ticket counters.

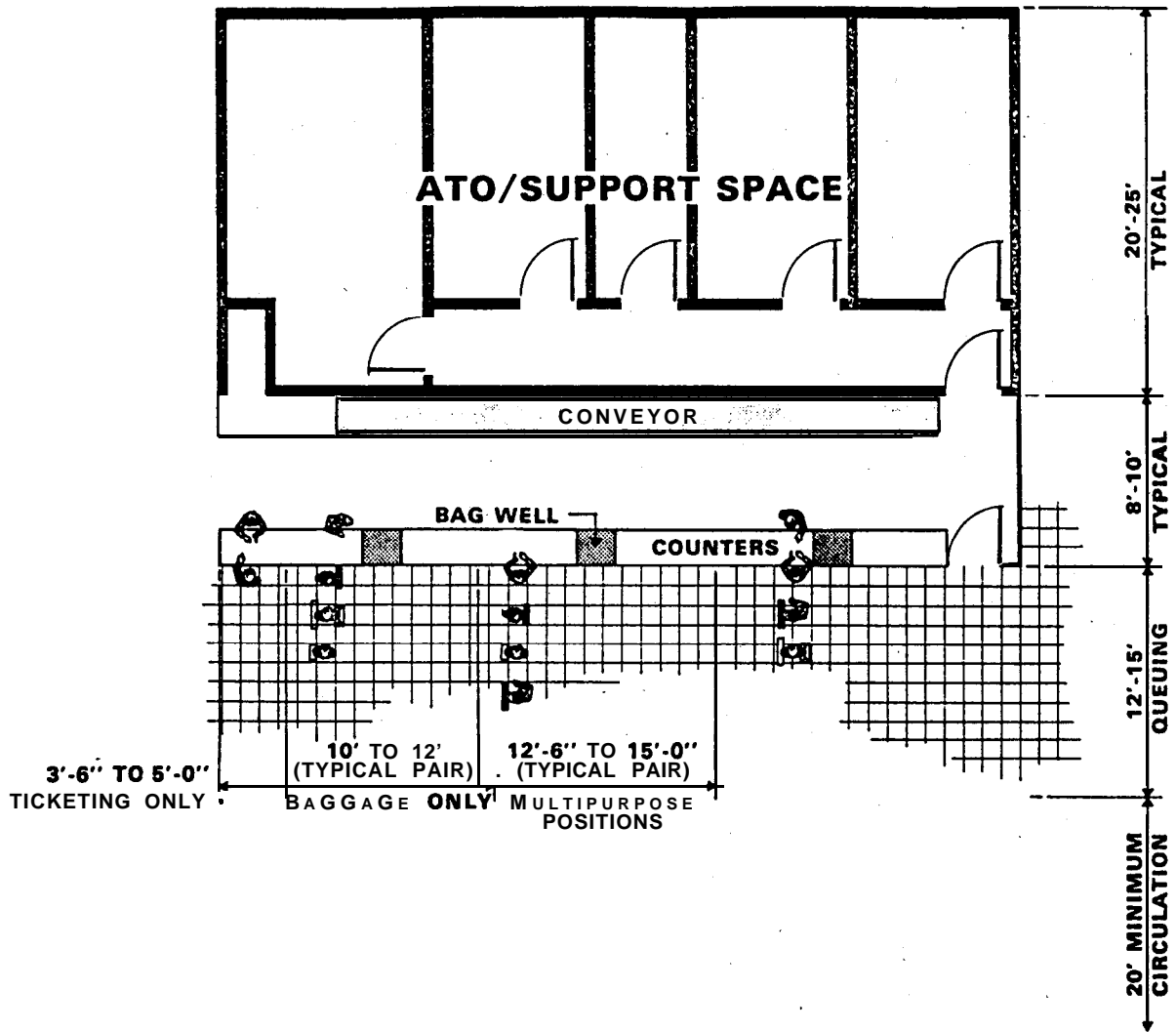

Figure 5-6. Linear Counter

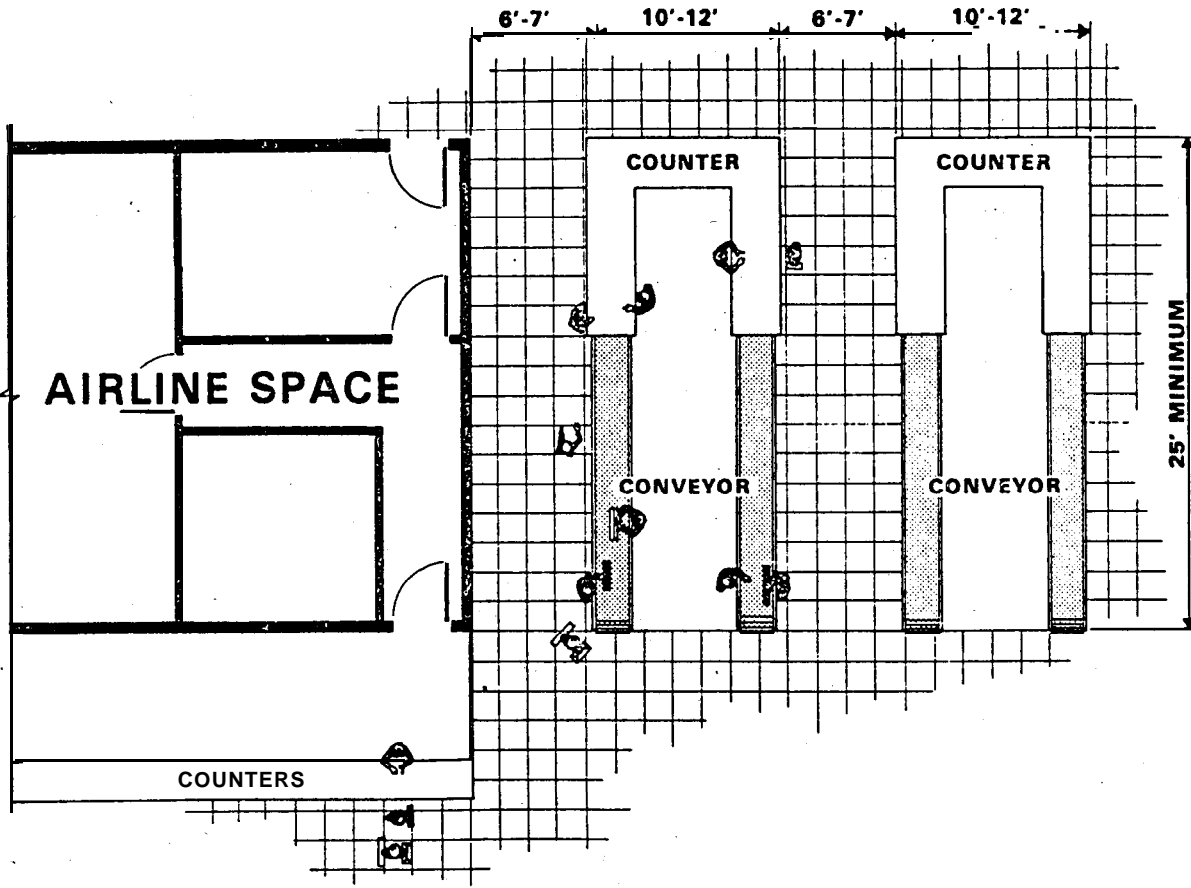

Figure 5-7. Flow-Through Counter

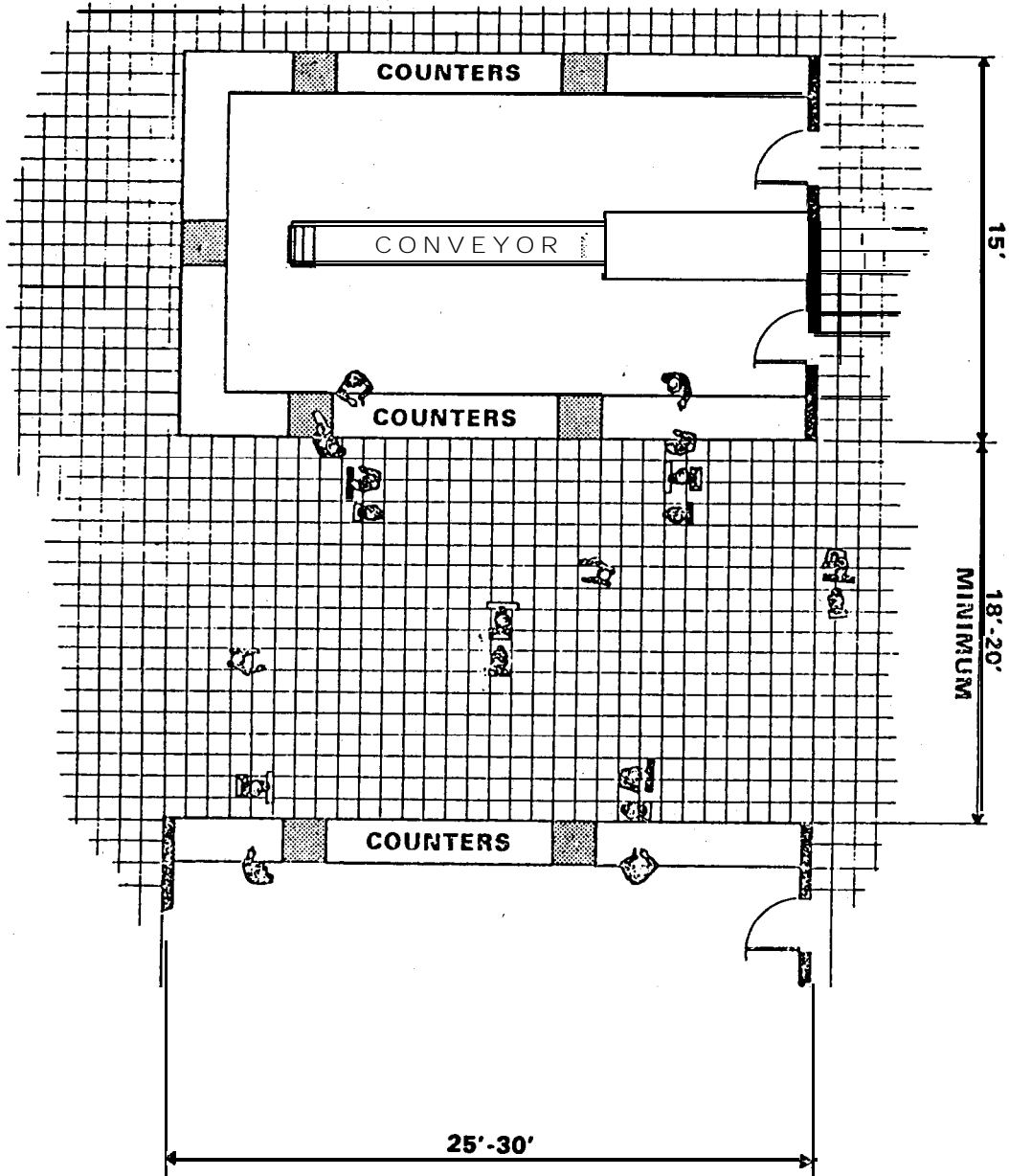

Figure 5-8. Island Counter

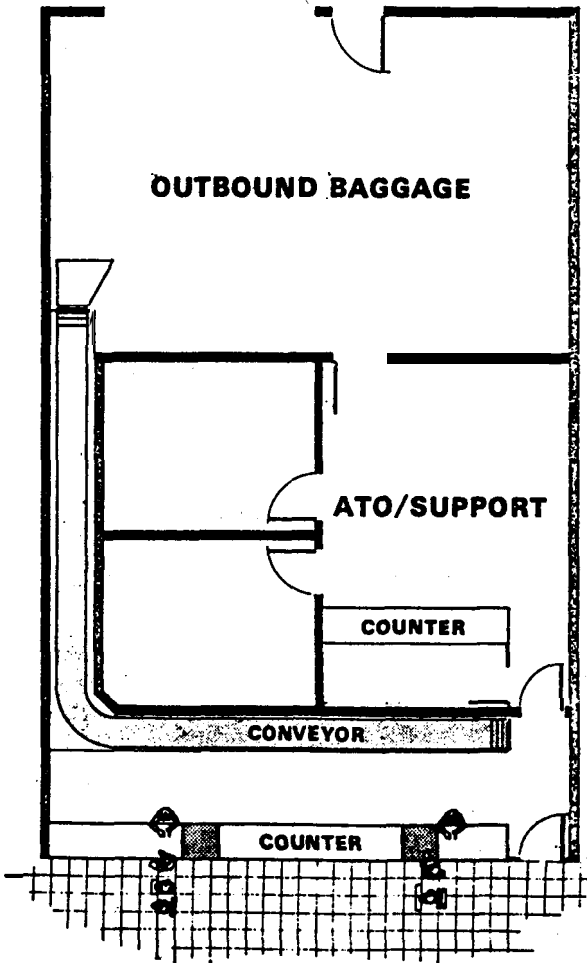
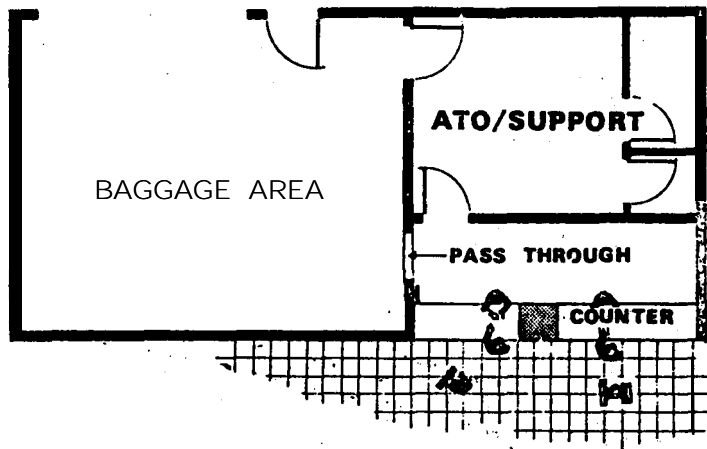

Figure 5-9. Typical ATO Layouts - Single-Level Terminals

c. **Sizing.** Figure 5-10 may be used in estimating airline ticket counter frontage for the three counter configurations previously discussed. It utilizes the EQA factors discussed in paragraph 25. The frontage obtained from the chart is based on counter positions typically required for airline peaking activities. The values determined from the chart do not include conveyor belt frontage at flow-through counter configurations. Less frontage may be required when individual airlines provide curbside check-in and ticketing at gates: In determining the counter working area, the frontage obtained from the chart is multiplied by a depth of 10 feet (3 m). Figure 5-11 shows typical ranges of AT0 support space. This is presented separately from counter working area since many of these support functions are remotely located at higher activity locations. For gate or gate equivalents exceeding those shown in this figure, quantities appropriate to the separate lobbies or sections of lobbies, unit terminals, and the like, should be used. This normally occurs at airports with over 50 gates.

7I. OUTBOUND BAGGAGE FACILITIES.

a. The outbound baggage facility is that area where baggage is received by mechanical conveyor from the ticket counters, online and offline connecting flights, and curbside check-in. It is sorted and loaded into containers or carts for subsequent delivery to aircraft. At low-volume airports, bags may be manually moved through a wall opening.

b. At most airports, outbound baggage areas are located in building spaces leased by the tenant airlines for exclusive use. Each airline provides its own baggage processing equipment and conveyors. The outbound baggage area should be located in reasonably close proximity to the ticket counters to facilitate the movement of baggage between these locations. The area should also have convenient access to the aircraft parking apron by means of carts or other mobile or mechanical conveyors.

c. On-line and inter-line transfer baggage is best handled in the same area with other outbound baggage for optimal use of personnel, space, and equipment. An area or conveyor for receiving transfer baggage from other airlines should be considered. Often, this area is adjacent to a primary traffic aisle. Security for delivered baggage makes a conveyor or pass-through into the outbound baggage area advisable. At stations where the airlines contract with a third party for all interline deliveries, a pick-up area for baggage to be delivered to other carriers should be provided with similar provisions for baggage security and control.

d. Since outbound baggage area requirements are determined by individual airline policy, early input from the airlines is essential. The minimum size for an outbound baggage room is approximately 400 to 450 sq. ft. (37 to 42 m²) per airline. Figures 5-12 and 5-13 can be used for initial estimating of outbound baggage area requirements. These nomographs were developed on the basis of an average of 1.3 bags checked per passenger. Caution should be used in applying these nomographs as substantial variance in the number of bags per passenger at different airports can range from 0.8 to 2.2. Business passengers will usually average less than 1.3, whereas vacationers needs may be substantially greater.

e. At locations where an airline proposes using some type of automated sorting, additional area to that indicated in Figure 5-13 will be necessary. The required area should be increased by at least 150 to 200 percent for tilt-tray sorting systems and 100 percent for destination-coded vehicle systems.

f. Following are some common types of outbound baggage equipment:

(1) **Belt conveyors** represent the most commonly used mechanized component for baggage systems, operating at speeds of 80 to 150 fpm (25 to 46 mpm) over short distances, and providing transport capacities of 26 to 50 bags per minute.

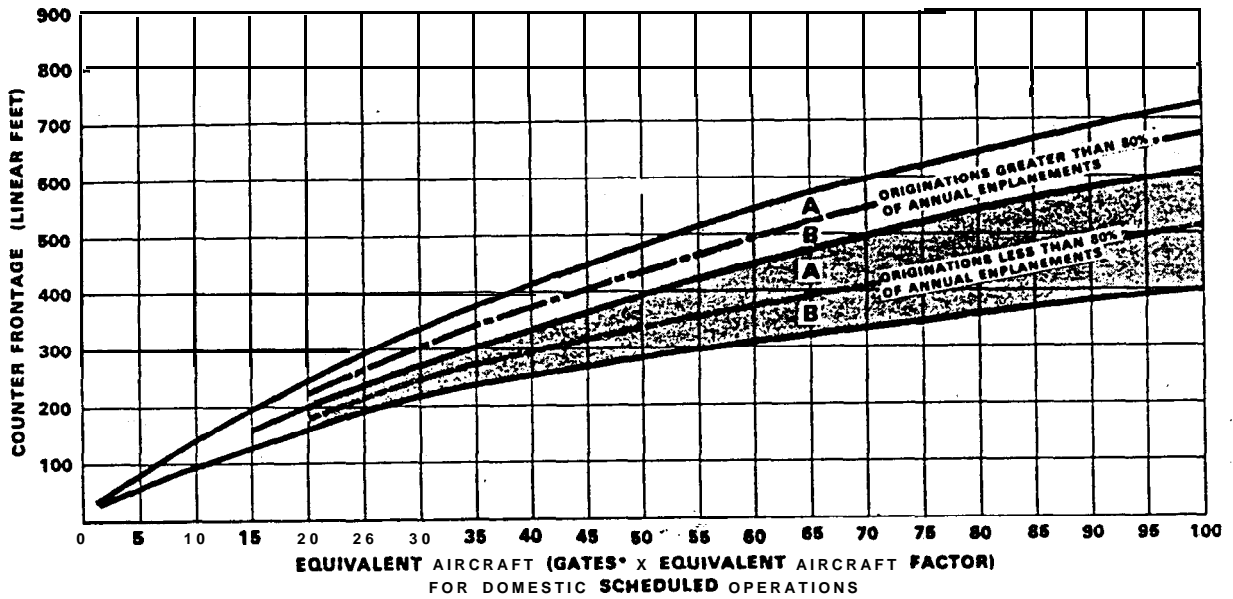

EQUIVALENT AIRCRAFT			
SEATS	(A) TERMINAL GATES	(B) EQUIVALENT AIRCRAFT FACTOR	(C) EQUIVALENT AIRCRAFT
UP TO 90	_____	.8	_____
91 TO 110	_____	1.0	_____
111 TO 180	_____	1.4	_____
181 TO 210	_____	1.9	_____
211 TO 280	_____	2.4	_____
281 TO 420	_____	3.8	_____
421 TO 800	_____	4.6	_____

(A) TOTAL TERMINAL GATE POSITIONS USED FOR SCHEDULED OPERATIONS
(C) PRODUCT OF COLUMNS A AND B

- (A) TYPICAL WHERE PEAK HOUR GATE UTILIZATION HAS HIGH PERCENTAGE OF DEPARTURES (EQUAL OR GREATER THAN 80% OF EQUIVALENT AIRCRAFT).
- (B) TYPICAL WHERE PEAK HOUR GATE UTILIZATION COMBINES ARRIVALS AND DEPARTURES (DEPARTURES LESS THAN 80% OF EQUIVALENT AIRCRAFT).

Figure S-10. Terminal Counter Frontage



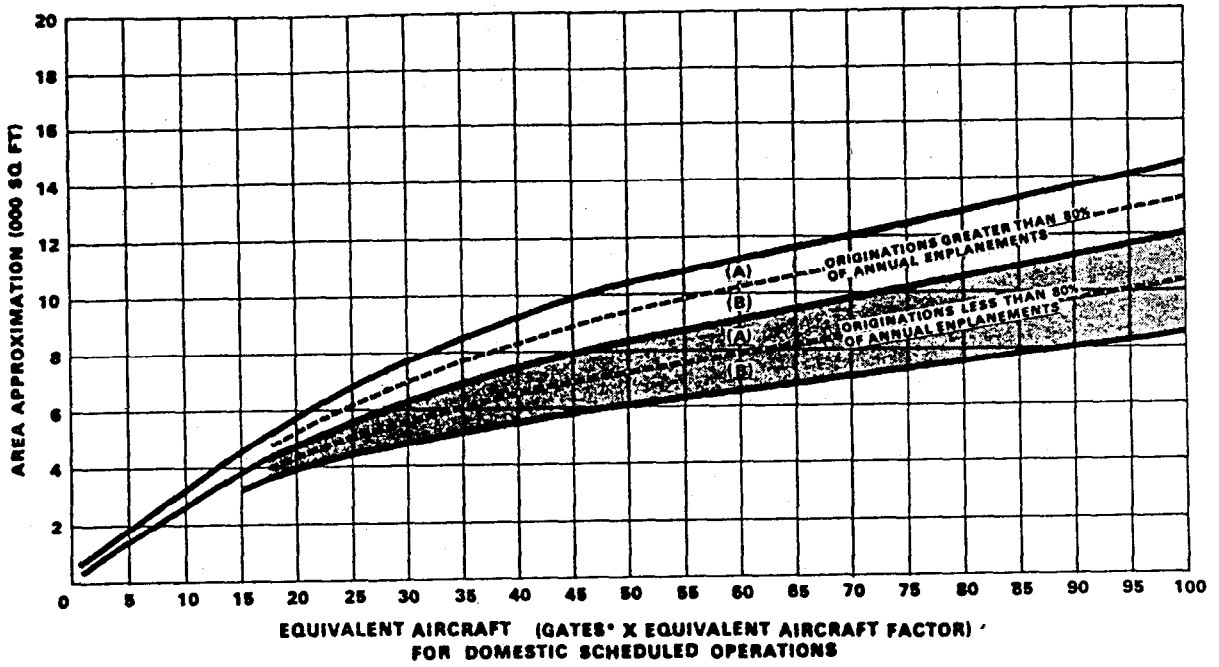

EQUIVALENT AIRCRAFT			
SEATS	(A) TERMINAL GATES	(B) EQUIVALENT AIRCRAFT FACTOR	(C) EQUIVALENT AIRCRAFT
UP TO 90	_____	.5	_____
91 TO 110	_____	1.0	_____
111 TO 150	_____	1.4	_____
151 TO 210	_____	1.9	_____
211 TO 290	_____	2.4	_____
291 TO 420	_____	3.5	_____
421 TO 500	_____	4.6	_____

(A) TOTAL TERMINAL GATE POSITIONS USED FOR SCHEDULED OPERATIONS
(C) PRODUCT OF COLUMNS A AND B

(A) TYPICAL WHERE PEAK HOUR GATE UTILIZATION WAS HIGH PERCENTAGE OF DEPARTURES (EQUAL OR GREATER THAN 80% OF EQUIVALENT AIRCRAFT).
(B) TYPICAL WHERE PEAK HOUR GATE UTILIZATION COMBINES ARRIVALS AND DEPARTURES (DEPARTURES LESS THAN 80% OF EQUIVALENT AIRCRAFT).

Figure 5-11. AT0 Office and Support Space

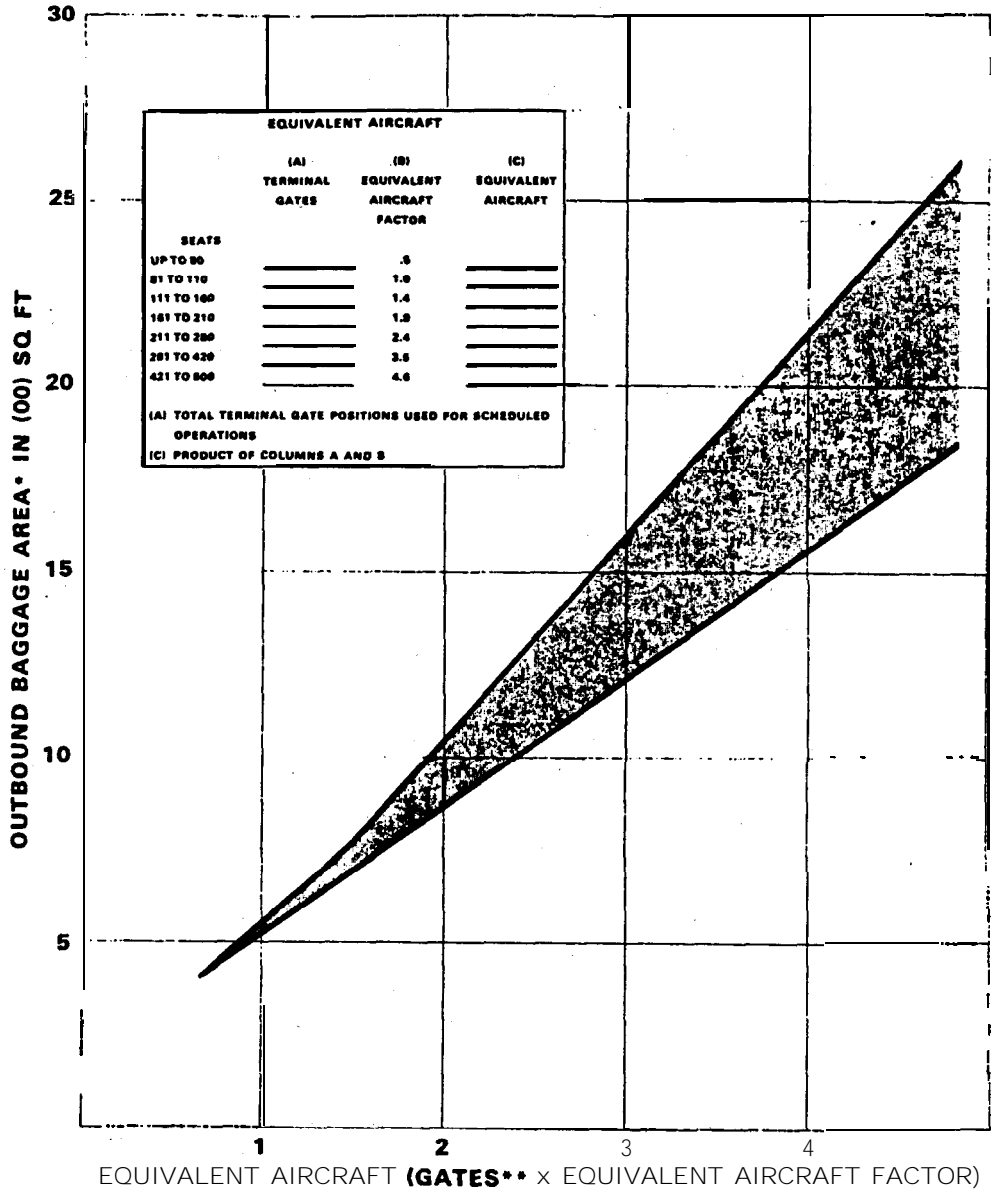

• INCLUDING CART SPACE, BAGGAGE HANDLING EQUIPMENT, SORTING AISLES AROUND EQUIPMENT AND CARTS, AND TRAFFIC LANES

EXCLUDES JOINT USE TUG DRIVE

MINIMUM SPACE REQUIREMENT @ 400 SQ. FT.

** ACTIVE LOADING POSITIONS

BASED ON 1.3 AVERAGE BAGS PER PASSENGER.

Figure 5-12. Outbound Baggage Area -- Less Than Five EQA

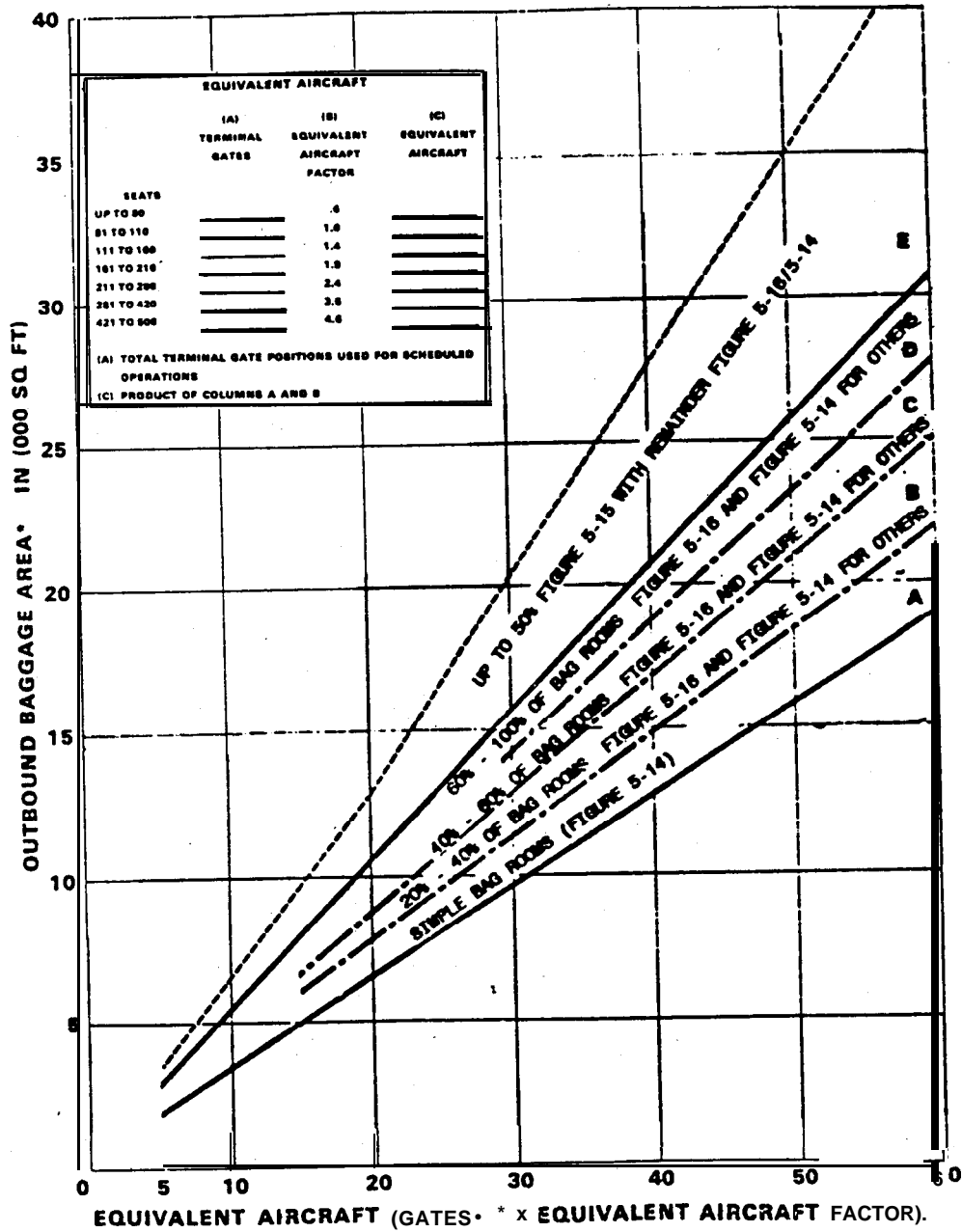

• INCLUDING CARTS, BAGGAGE HANDLING OR SORTING EQUIPMENT, SORTING AISLES AROUND EQUIPMENT AND CARTS, AND TRAFFIC LANES. EXCLUDES JOINT USE TUG DRIVE

•• ACTIVE LOADING POSITIONS

BASED ON 1.3 AVERAGE BAGS PER PASSENGER.

Figure 5-13. Outbound Baggage Area - Five or More EQA

(a) Raw belt conveyors with spill plates (Figure 5-14) tend to become less efficient as the length of unloading section is increased to process simultaneous departures. In such cases, bags not removed by the baggage handler at his normal working position must be retrieved later from the end of the spill plate. That end becomes progressively more distant as the number of flights and size of aircraft increase. This condition may be alleviated somewhat by using belt conveyors with indexing features activated by photoelectric switches.

(b) Belt conveyor capacities can be increased by adding conveyors between counter inputs and outbound baggage rooms or, marginally, by merging multiple input conveyors into a higher-speed mainline conveyor. Long segments may operate at speeds up to 300 fpm (90 mpm), with acceleration and deceleration belts at each end. This represents a practical maximum for current technology and maintenance. Accordingly, high-speed belts are primarily used to reduce transport times for long conveyor runs and seldom, if ever, increase system capacity.

(2) Inclined belts, vertical lift devices, or chutes are used with baggage rooms located on a different floor level from the ATO counters. Chutes are the least expensive but lack the means for controlling baggage movement and increase the potential for damaged bags. Inclined belts should not exceed a 22-degree slope and are usually designed for 90 to 100 fpm (28 to 31 mpm) maximum. Vertical lift devices are available with capacities of 18 to 45 bags per minute.

(3) Recirculating devices for sorting and loading baggage are normally considered when the number of departures processed concurrently exceeds the practical capabilities of a raw belt and spill plate. Equipment types include belt conveyors utilizing straight and curved segments, flat-bed devices, or sloping-bed plates. Each of these may be fed by more than one input conveyor and may require indexing belts and accumulators to control input flow. The recirculating feature facilitates sorting bags into carts for more flights and larger aircraft by fixing relatively stationary work positions for baggage handlers with "dynamic storage" of bags until they can be sorted into carts or containers.

(4) Elongated oval configurations tend to be used in lieu of circular devices as the number of carts increases. Figure 5-15 shows carts and container dollies parked parallel to a belt-loop or flat-bed sorting device. Figure 5-16 shows the same carts parked at right angles to a sloping-bed device. The sloping bed may accommodate two rows of bags to increase overall storage capacity. This can offset the reduction in perimeter frontage from that afforded with parallel parking. Although right-angle parking can reduce floor space by 30 to 50 percent, some carriers prefer parallel parking to minimize time and manpower for maneuvering and positioning of carts. In either case, the input conveyors need to be elevated to permit passage of carts and containers within the space.

(5) Semiautomated sorting utilizes mechanical equipment to move bags onto a lateral slide or conveyor designated for concurrently processing separate departures. Figure 5-17 shows a linear belt sorter capable of handling about 30 bags per minute, usually when the maximum number of departures processed concurrently does not exceed 12 to 15. The operator designates the appropriate lateral after reading the tag on each passing bag. A separate sorter is needed for each input conveyor line from the ATO.

(6) Tilt-tray sorters, as shown in Figure 5-18, are considered appropriate for very high volume stations requiring multiple inputs and greater capacities than possible with the preceding types. These systems are custom designed with relatively sophisticated coding and sorting features as well as lateral conveyors accumulating baggage for each departing flight. Terminal designs should allow the flexibility for future installation of such systems.

(7) Destination-coded vehicle systems (Figure 5-19) represent highly advanced technological proposals for handling the higher volumes, longer distances, interline transfers, and elevation changes encountered in terminals serving large hubs. Although the vehicles and propulsion methods vary, all have similar design criteria. These are: speeds up to 880 ft/min (268 m/min); elevation change capability (up to 33 degrees); fixed rights-of-way; programmable control systems and vehicle encoding; and interface with load/unload stations.

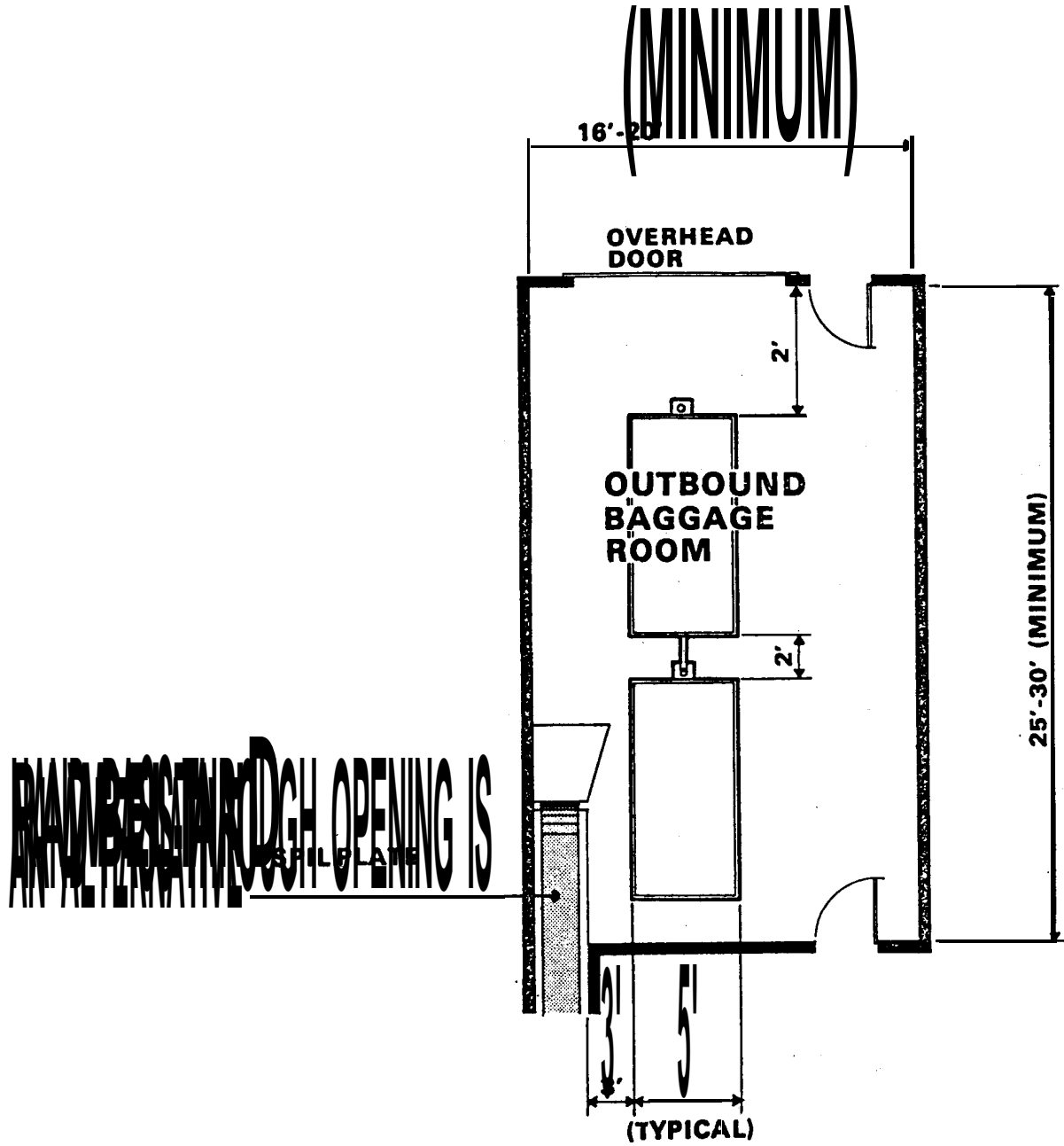

Figure 5-14. Outbound Baggage Room Typical Raw Belt Conveyor Installation

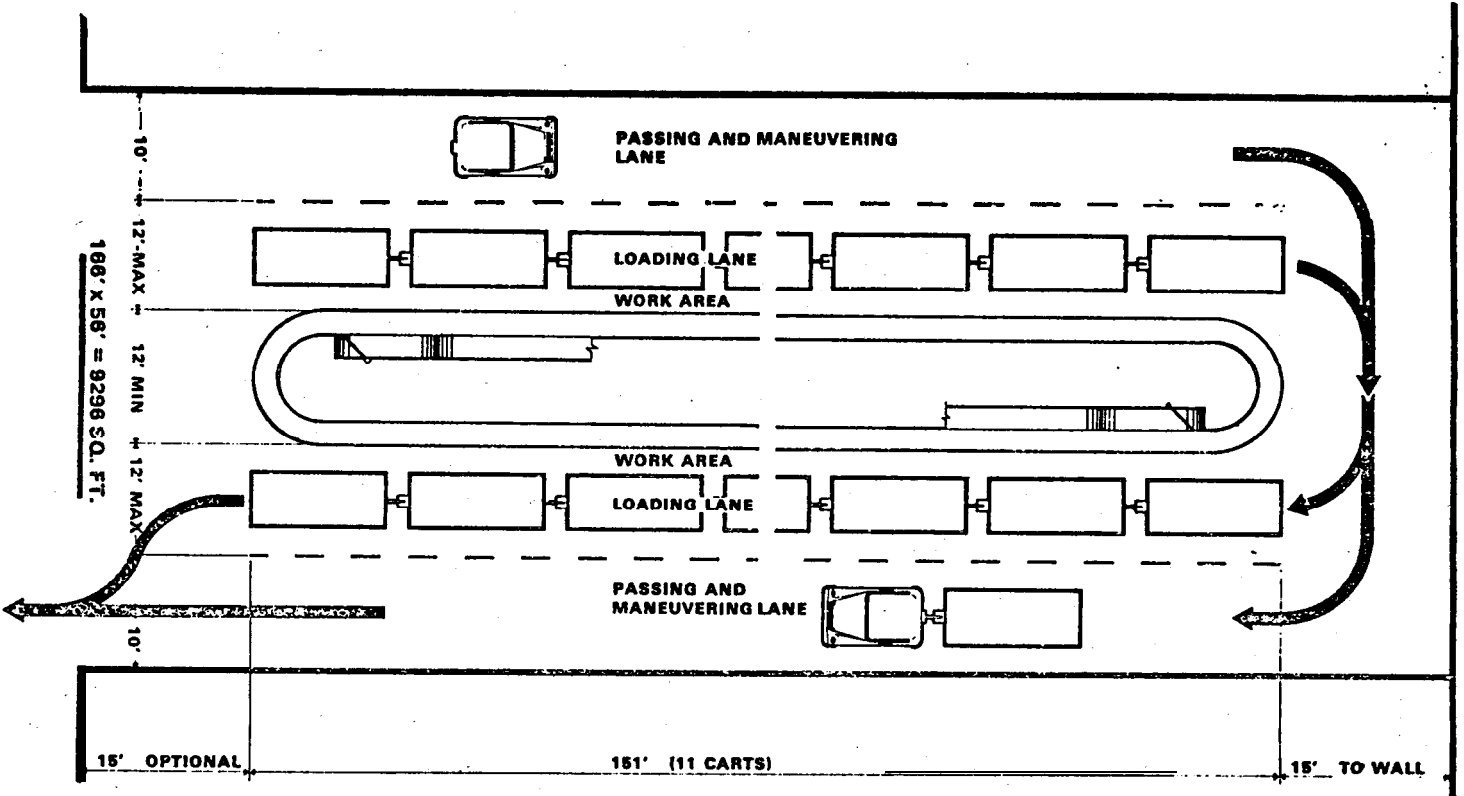

Figure 5-15. Outbound Bagga Recirculating Belt - Parallel Parking

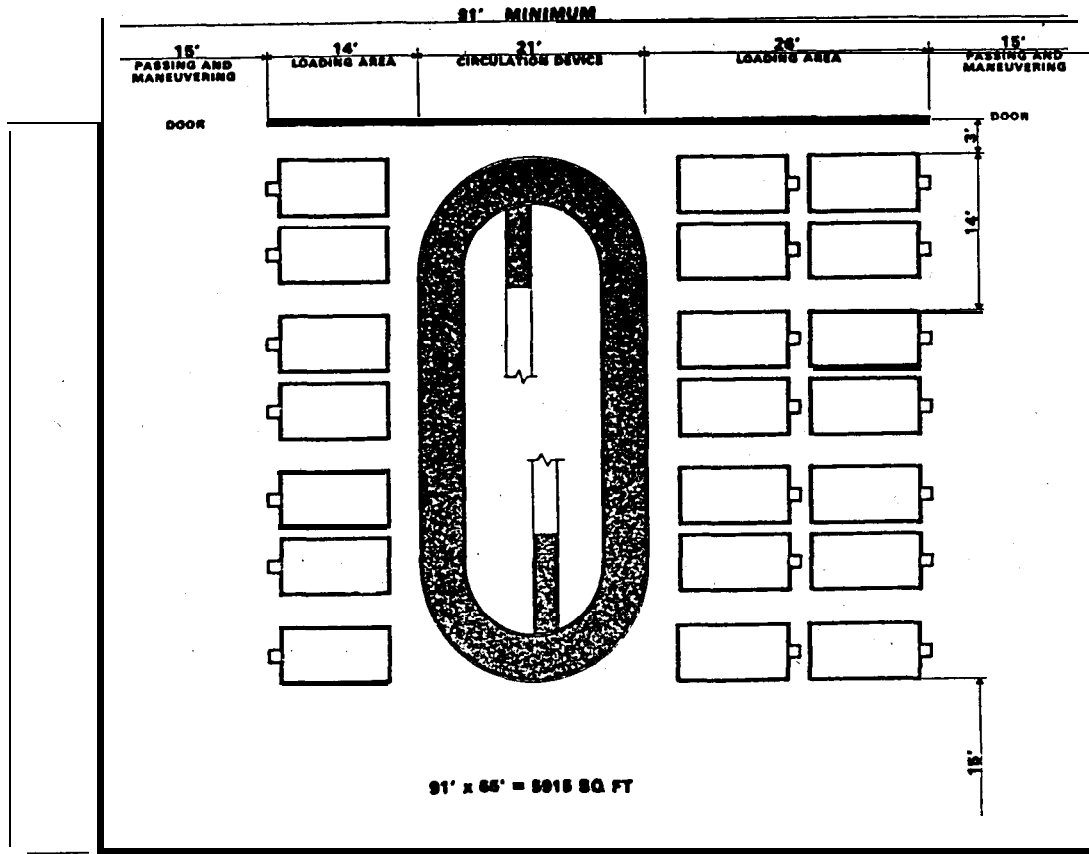

Figure 5-16. Outbound Baggage Recirculating Sloping Bed - Perpendicular Parking

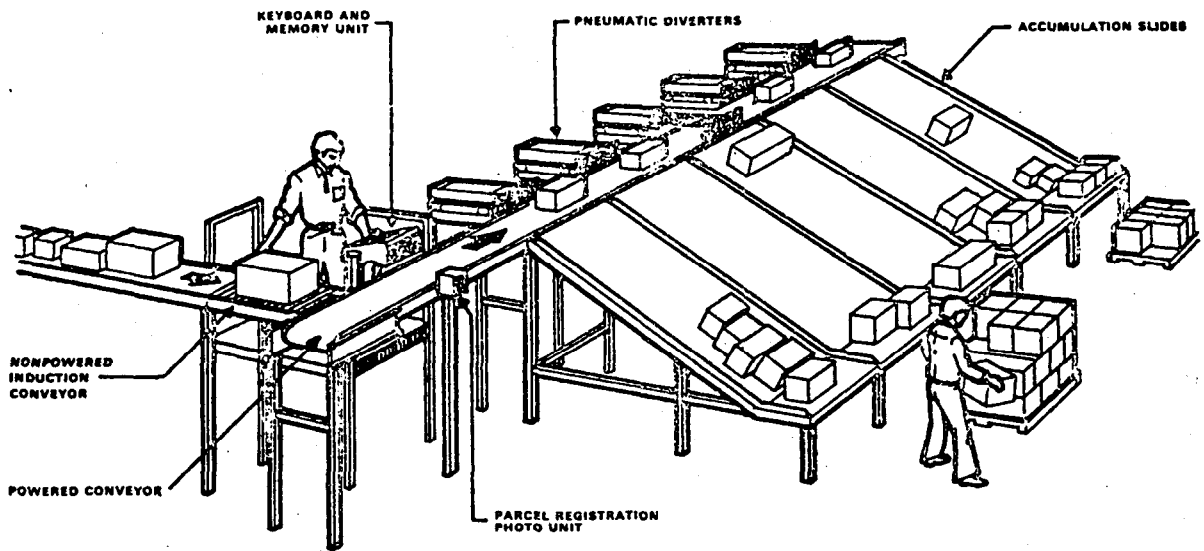

Figure 5-17. Semiautomated Linear Belt Sorter

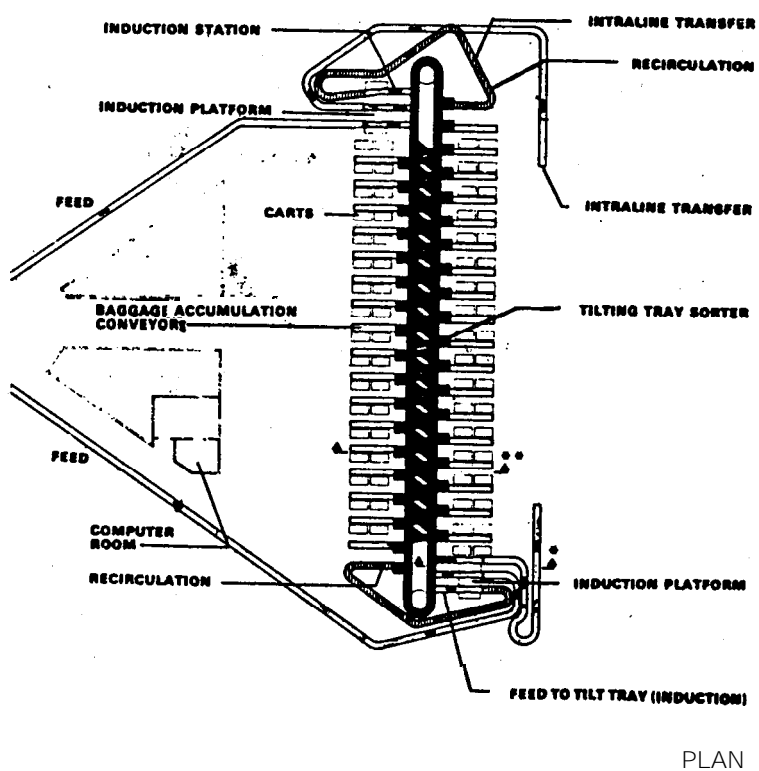
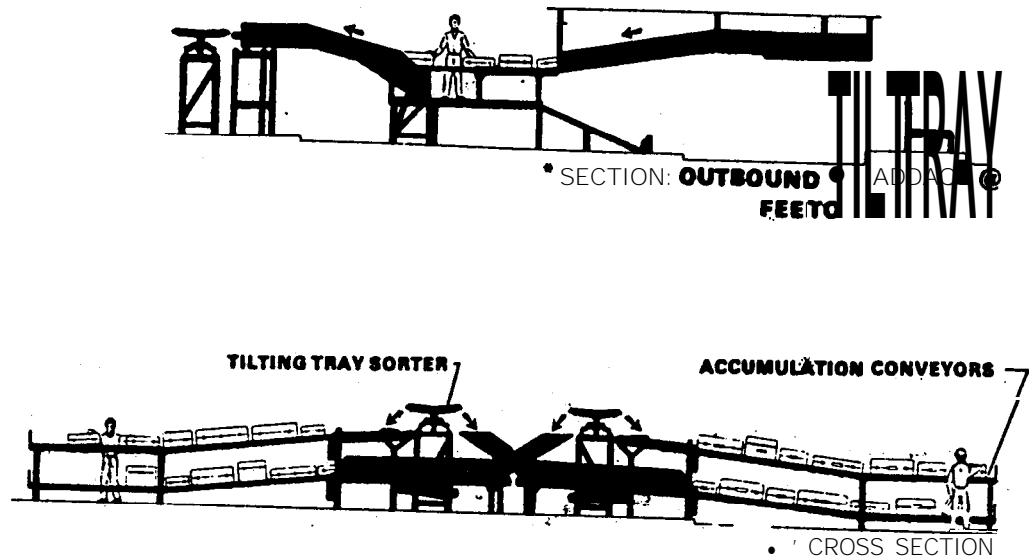

Figure 5-18. Tilt-Tray Sorter

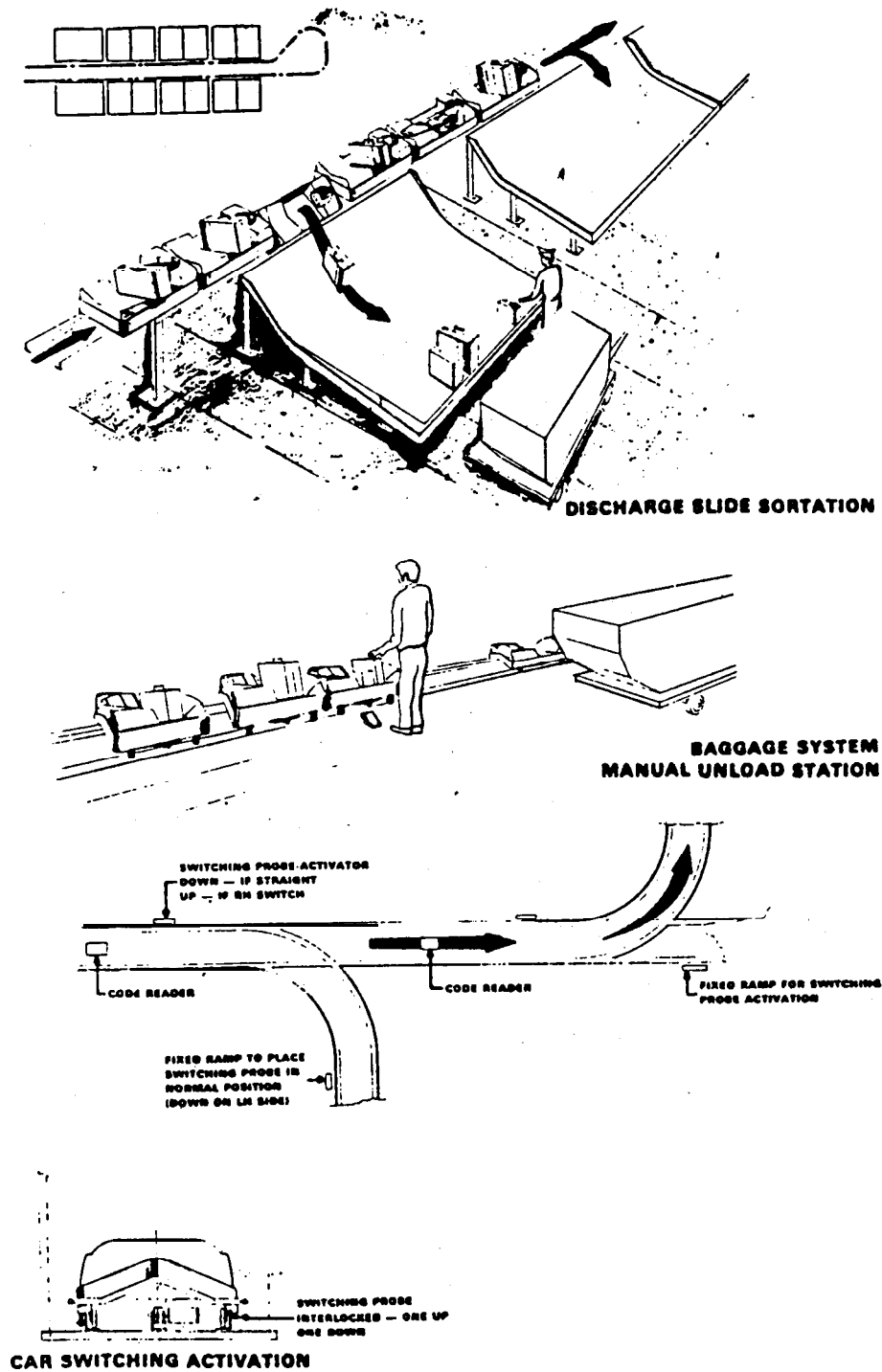

Figure 5-19. Destination-Coded Vehicle

g. Table 5-1 relates enplanement criteria and outbound baggage equipment.

Table 5-1. Recommended Selection Criteria Outbound Baggage Equipment

System type	Application Range Peak Hour Enplanements ¹ Average Day/Peak Month	Reference Figure No.
Manual (pass-through or raw belt with spill plate)	up to 200	5-14
Recirculation devices, accumulators, and indexing belts	150 to 1,500	5-15, 5-16
Linear belt sorter	300 to 800	5-17
Tilt-tray sorter	800 to 5,000+	5-18

¹ For one or more airlines sharing a single system.

h. Some noteworthy building design features in the outbound baggage area are provided below:

(1) Aisles at least **3 feet (1 m) wide** are usually required around baggage sorting device and between pairs of carts parked at right angles (unless carts only open on one side).

(2) Traffic lanes for cart trains normally require **10 feet (3 m)** with provisions for a 21 foot (6.5 m) outside radius at turns. Variations are such that airlines should be consulted.

(3) Vehicular door locations relative to the apron or restrictions in the number of such doors may necessitate additional space to manually maneuver carts or dollies.

(4) Column spacings are **particularly critical** and should be reviewed with airlines early in the planning stage.

(5) Minimum clear heights of 8 to 8.5 feet (2.4 to 2.6 m) are required by most airlines for containers on dollies for use with wide-body aircraft, although a 10 foot (3 m) clearance is often recommended.

(6) Since airline tugs/tractors have internal combustion engines, local code regulations and Federal standards for mechanical ventilation of enclosed areas should receive attention early in the **planning/design process**.

i. Trends in future outbound baggage handling systems include:

(1) **Computerized automated systems with hourly throughputs to 3,000 bags** per hour. Sorting error, other than human error, is expected to be reduced to 1 percent. Baggage is sorted by barcode tags read by a laser scanner.

(2) Large underground baggage handling facilities. These facilities will usually be located under aprons areas in order to provide the very large space needed by the baggage handling facility.

72. PUBLIC CORRIDORS.

a. Corridors are provided for public circulation between aircraft boarding gates and various lobbies and other areas within the terminal building. The effective corridor design width is the total width less obstacles (e.g., telephones, wastebaskets, benches, protruding displays, etc.) with a minimum clearance of approximately 2 feet (0.6 m) on each side. This clearance is provided because of the phenomenon known as "boundary layer" in which a person will normally maintain such a clearance between corridor, walls and obstacles. Viewing areas for video displays and passenger queue areas extending into the corridor should also be treated as obstacles in design width determinations.

b. Figure 5-20 illustrates an effective corridor design width. The design width is determined by dividing the peak corridor population per minute (visitors and passengers) by the corridor width capacity factor expressed in people per unit width per minute. Table 5-2 provides a corridor capacity matrix based on an average walk rate of 242 feet (74 m) per minute. For example, the bottom line of Table 5-2 indicates a capacity of 330 to 494 persons

per minute for a corridor with a 20 foot (6 m) effective design width, for a pedestrian occupancy width of 2.5 feet (.76 m) and depth separation ranging from 4 to 6 feet (1.2 to 1.8 m). While a relatively abrupt introduction of deplaning passengers into a corridor may retard the walk rate, it will be offset somewhat by a decrease in their depth separation. A congregation of people awaiting the arrival of passengers may also retard the flow rate. This capacity reduction is usually only brief and local in nature and does not ultimately affect the overall corridor design capacity. This congestion can be minimized by providing areas for flow surge and greeters in the corridor width.

Table 5-2. Corridor Capacity in Persons Per Foot (.305 m) Width Per Minute

Width Occupancy Ft (m)	Depth Separation - Ft (m)				
	4.0 (1.20)	4.5 (1.35)	5.0 (1.50)	5.5 (1.65)	6.0 (1.80)
2.00 (.61)	30.9	27.5	24.7	22.5	20.6
2.25 (.69)	27.4	24.4	22.0	20.0	18.3
2.50 (.76)	24.7	22.0	19.8	18.0	16.5

73. SECURITY INSPECTION STATIONS.

a. Air carriers using over 60 passenger seat aircraft in scheduled or public charter operations are required by Federal Aviation Regulations (FAR) 121.538 to screen all passengers prior to boarding in accordance with the provisions of FAR Part 108. This activity is normally handled inside the terminal building at a security screening station.

b. There are three types of passenger inspection stations, depending on the location of the station in relation to the aircraft boarding area. These include:

- (1) Boarding Gate Station;
- (2) Holding Area Station; and
- (3) Sterile Concourse Station.

c. A sterile concourse station, from both the standpoint of passenger security facilitation and economics, is the most desirable type of screening station. It is generally located in a concourse or corridor leading to one or several pier finger(s) or satellite terminal(s) and permits the screening and control of all passengers and visitors passing beyond the screening location. It thus can control a considerable number of aircraft gates with a minimum amount of inspection equipment and personnel. Pier and satellite terminal concepts are well suited for application of the Sterile Concourse Station, since the single-point entrance connector element facilitates isolation of boarding areas.

d. Because of building geometry, especially that associated with linear and transporter terminal concepts, the Sterile Concourse Station is not always feasible. Under these circumstances, several inspection stations may be required to control a number of holding areas or departure lounges. In the worst situation, a screening station may be required at each boarding gate.

e. Except at low activity airports, where manual search procedures may be employed, a security inspection station will generally include a minimum of one walk-through weapons detector and one x-ray device. Such a station has a capacity of 500 to 600 persons per hour and requires an area ranging from 100 to 150 square feet (9 to 14 sq.m). Examples of security inspection station layouts are illustrated in Figure 5-21.