

APPENDIX 1. FIGURES.

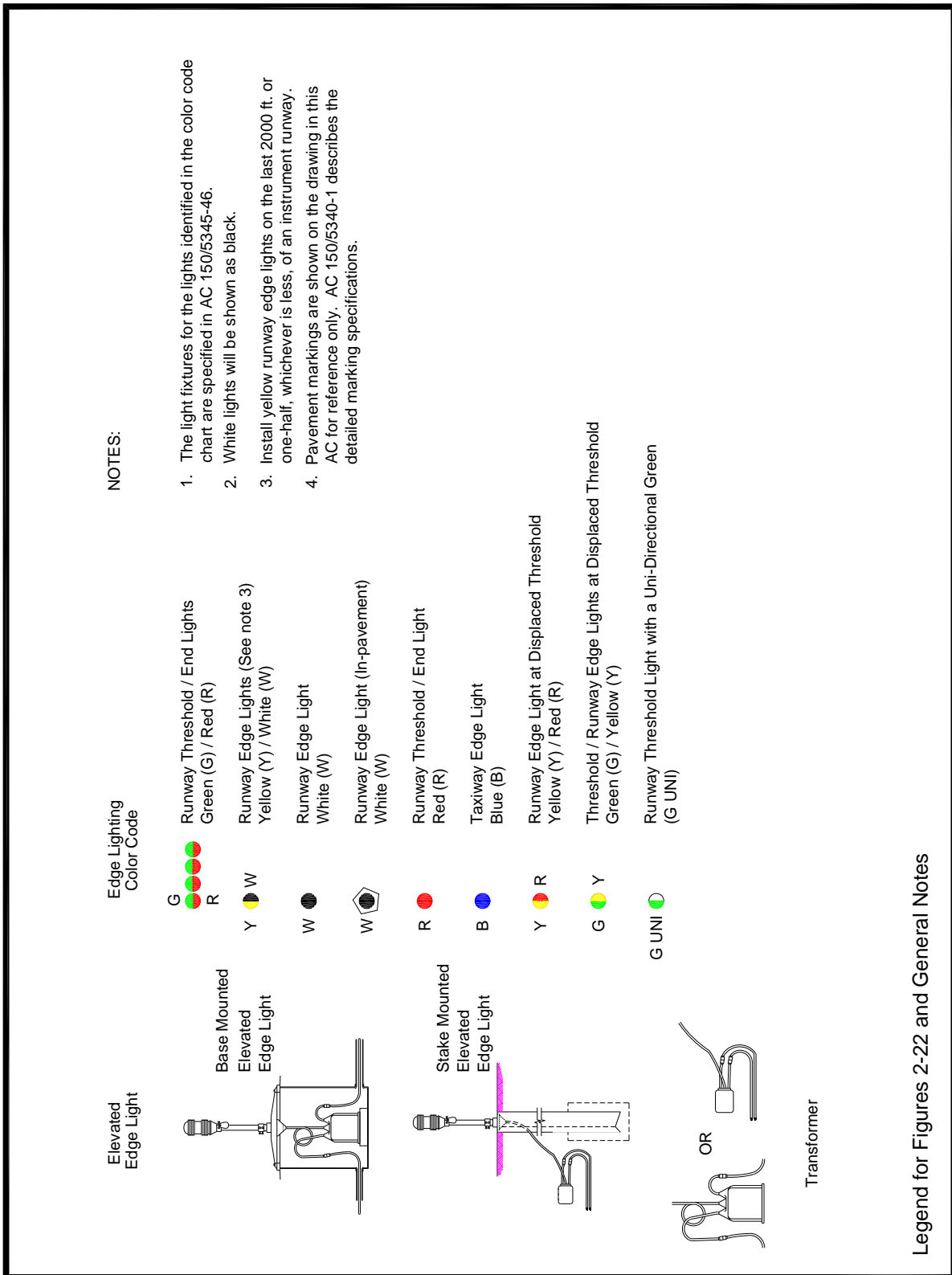

Figure 1. Legend and General Notes.

Legend for Figures 2-22 and General Notes

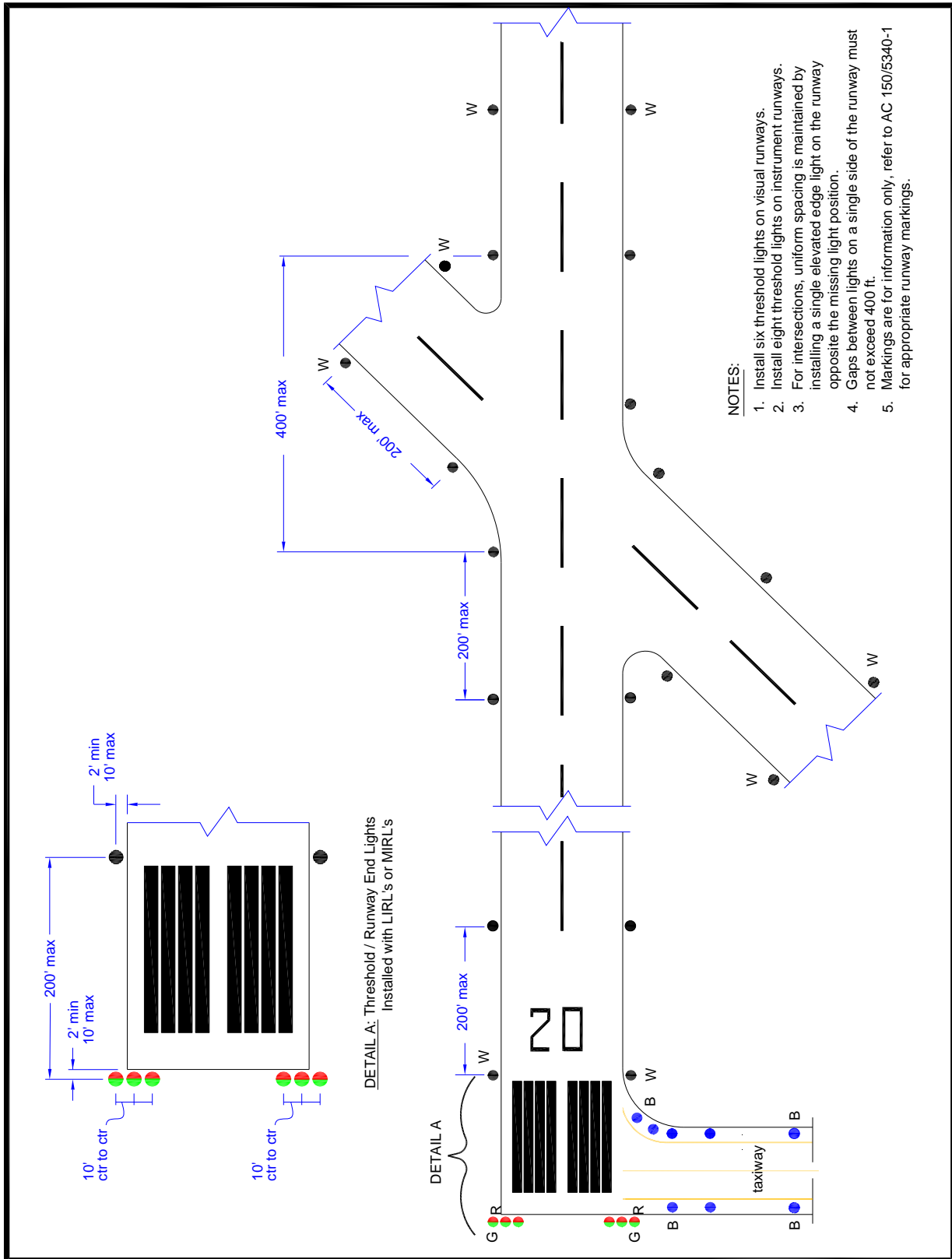

Figure 2. Runway and Threshold Lighting Configuration (LIRL & MIRL).

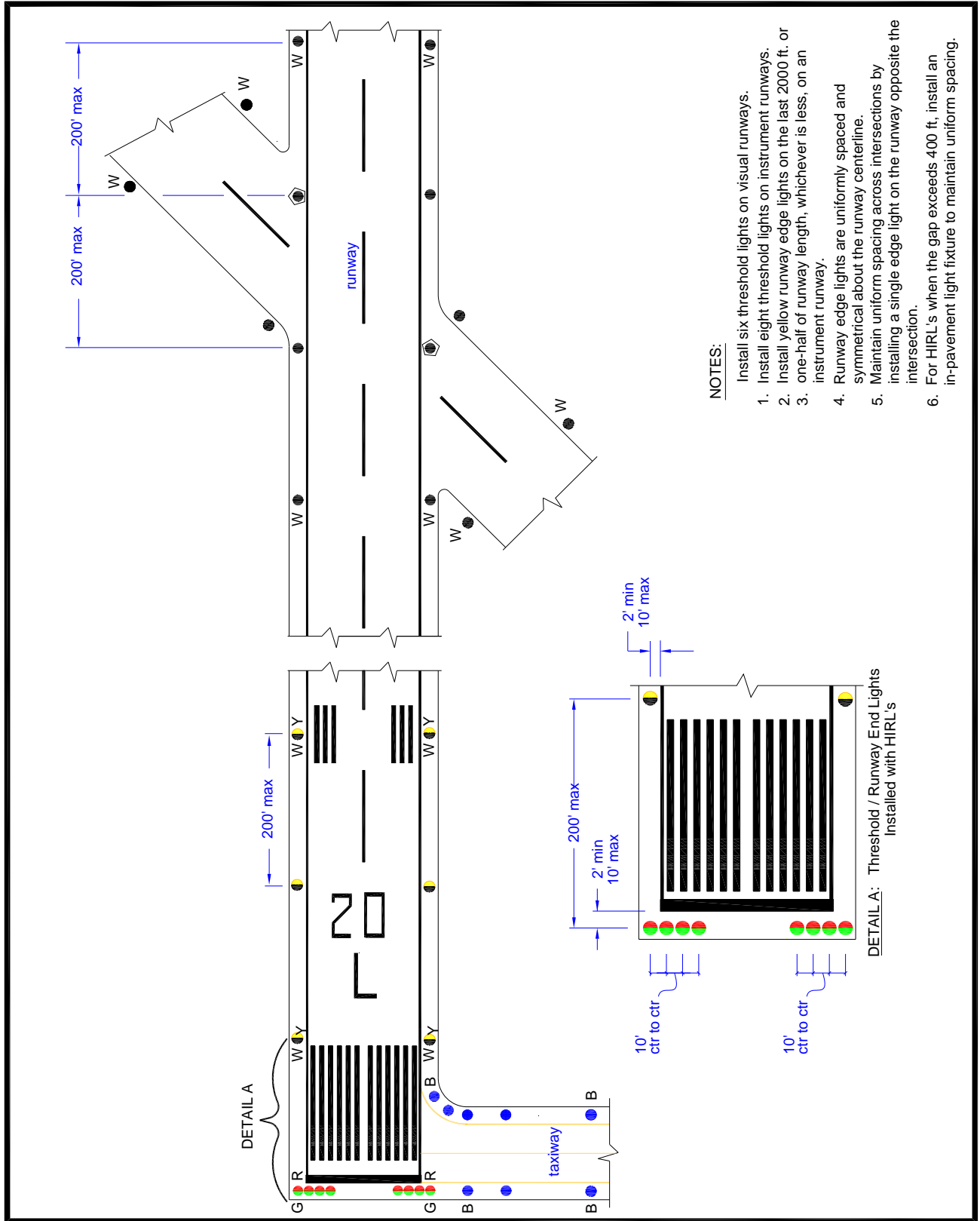

Figure 3. Runway and Threshold Lighting Configuration (HIRL).

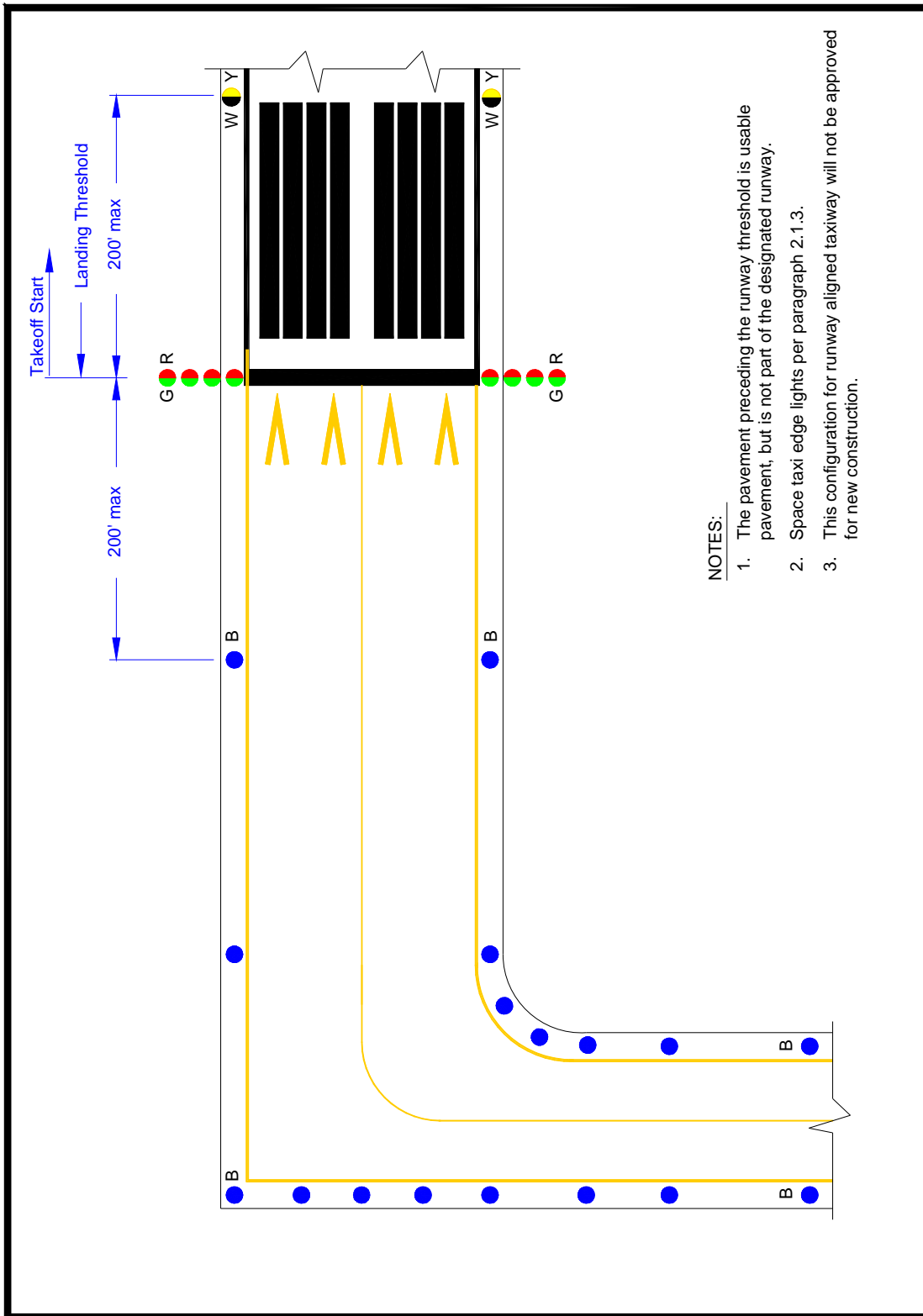

Figure 4. Runway with Taxiway at End.

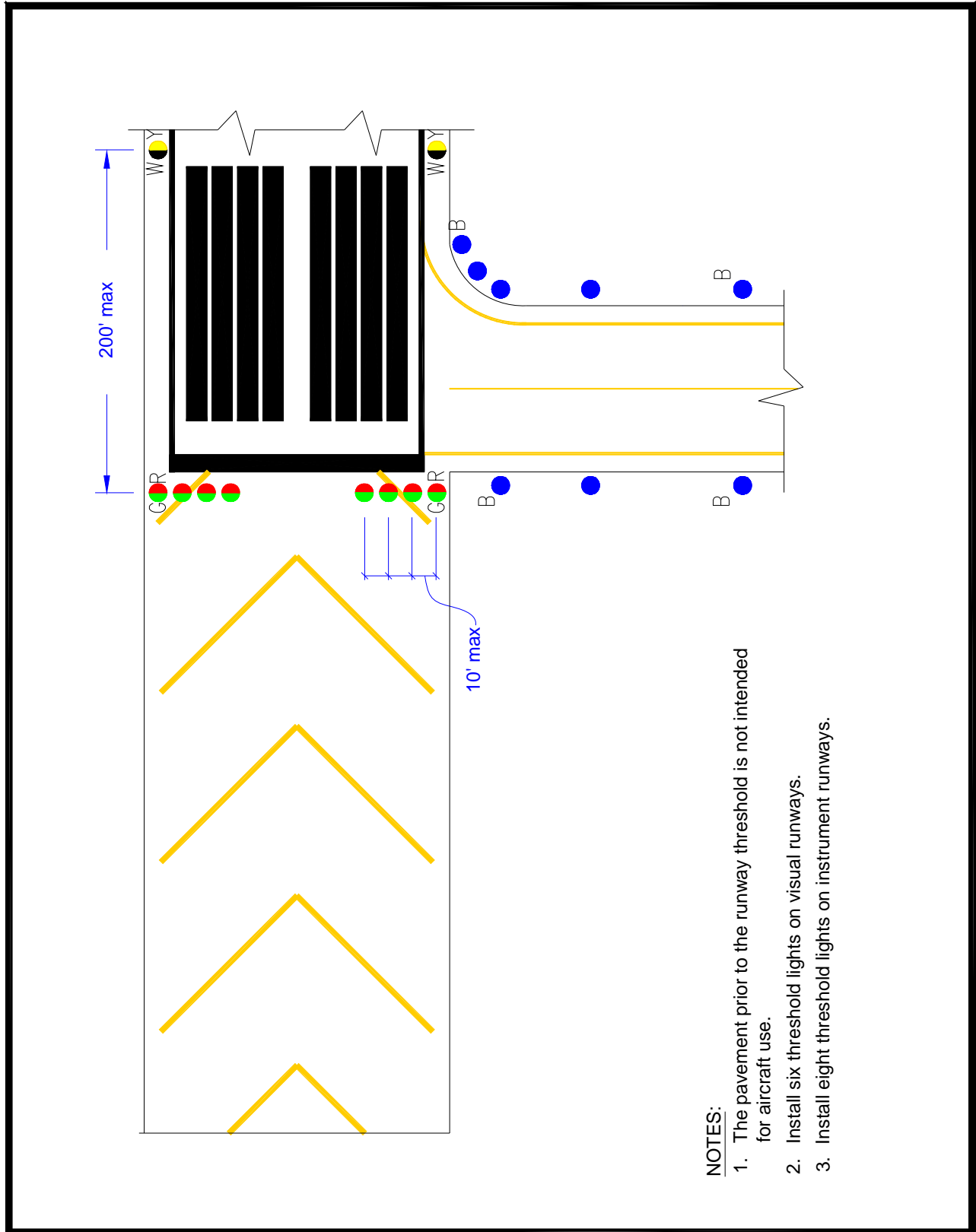

Figure 5. Runway with Blast Pad (No Traffic).

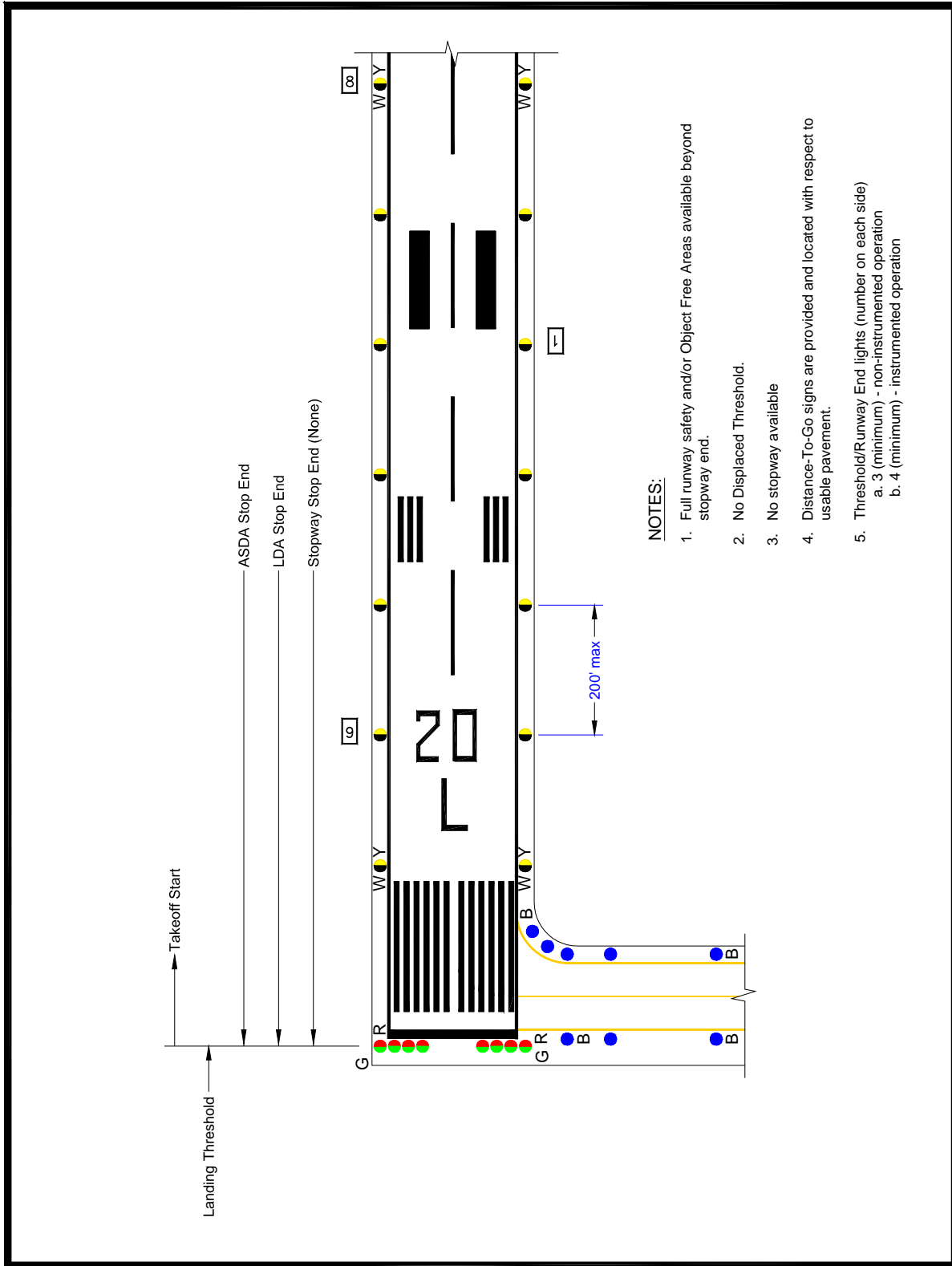

Figure 7. Normal Runway with Taxiway.

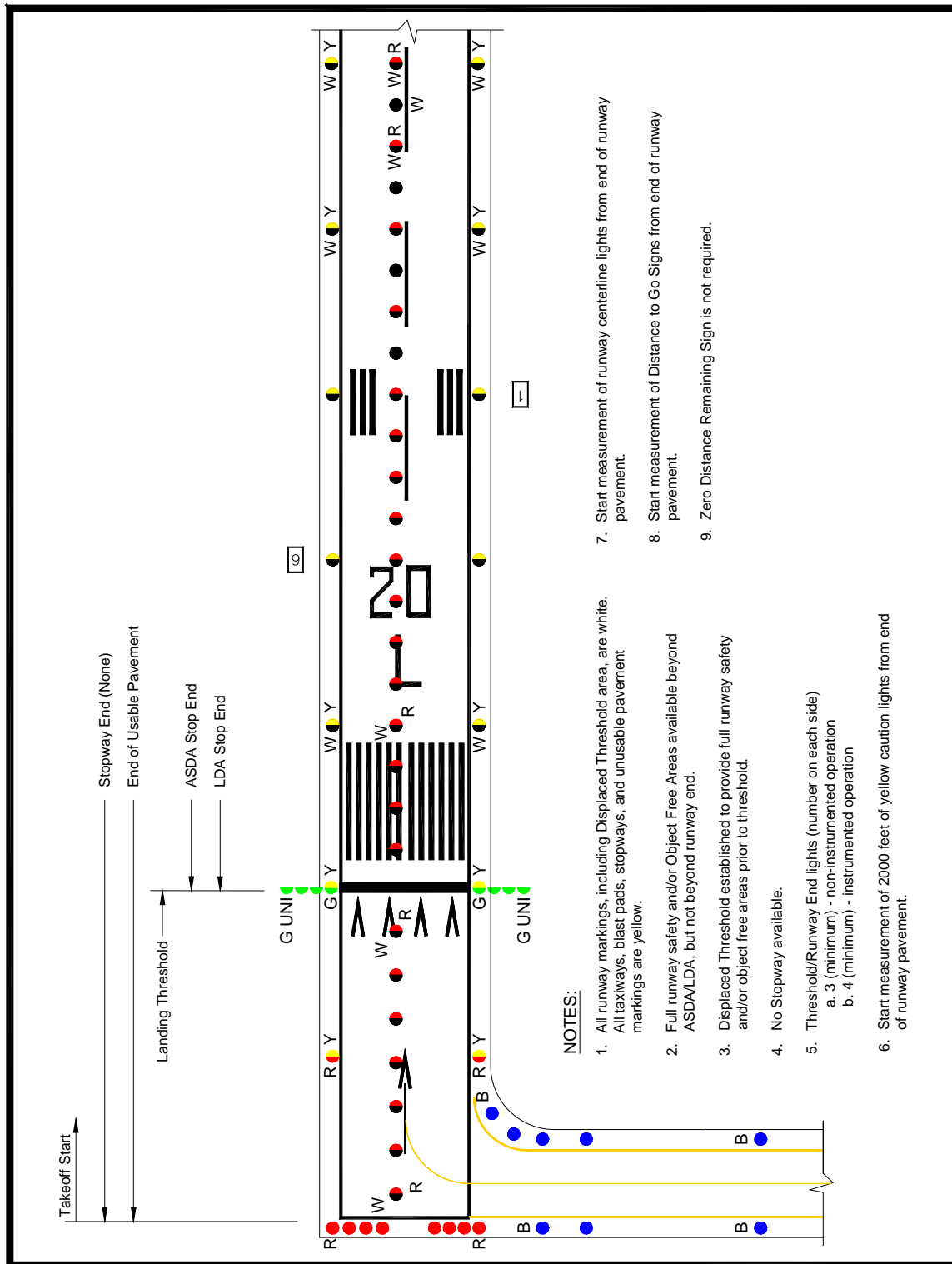

Figure 9. Lighting for Runway with Displaced Threshold/Usable Pavement.

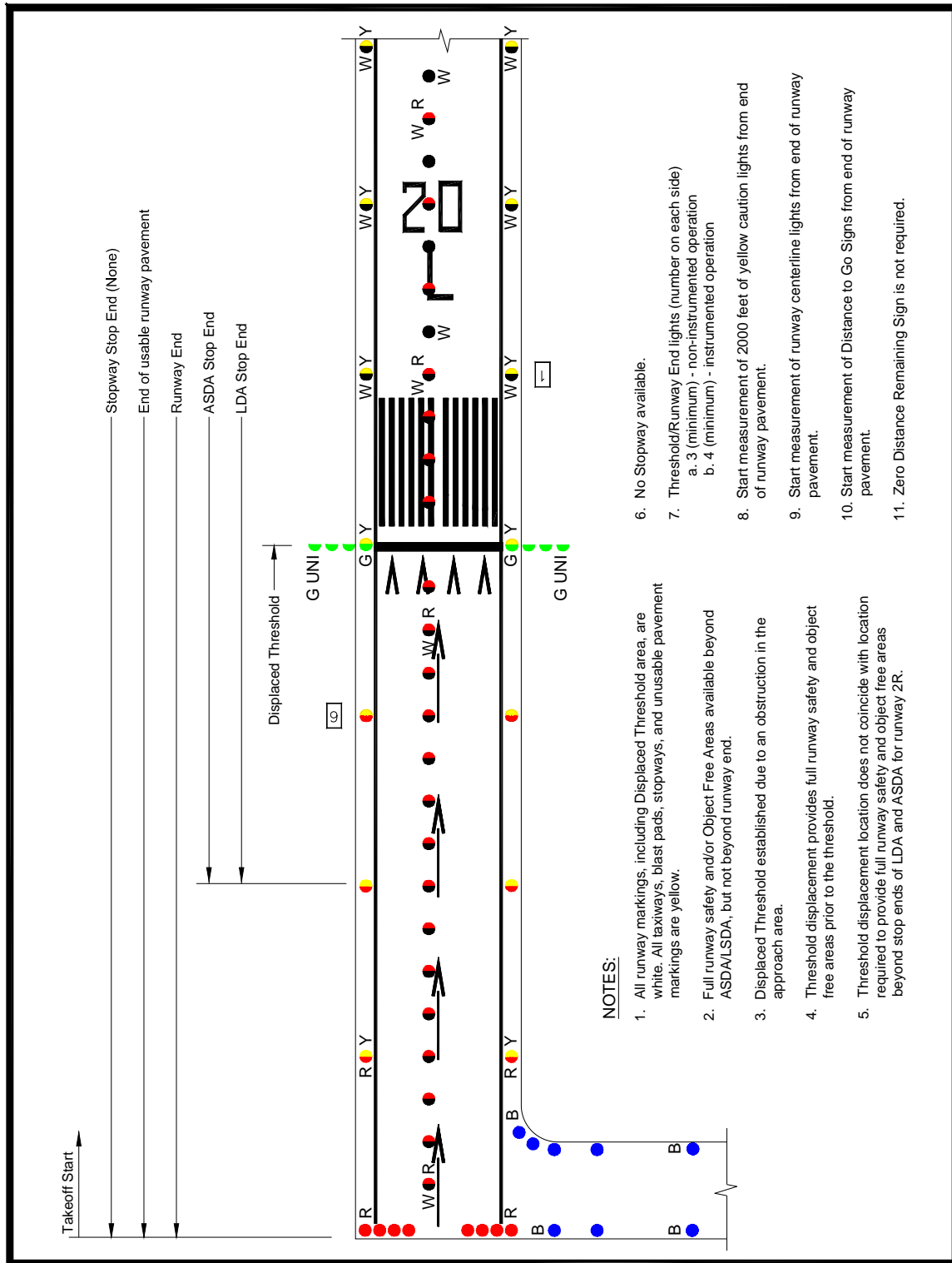

Figure 10. Lighting for Runway with Displaced Threshold not Coinciding with Opposite Runway End.

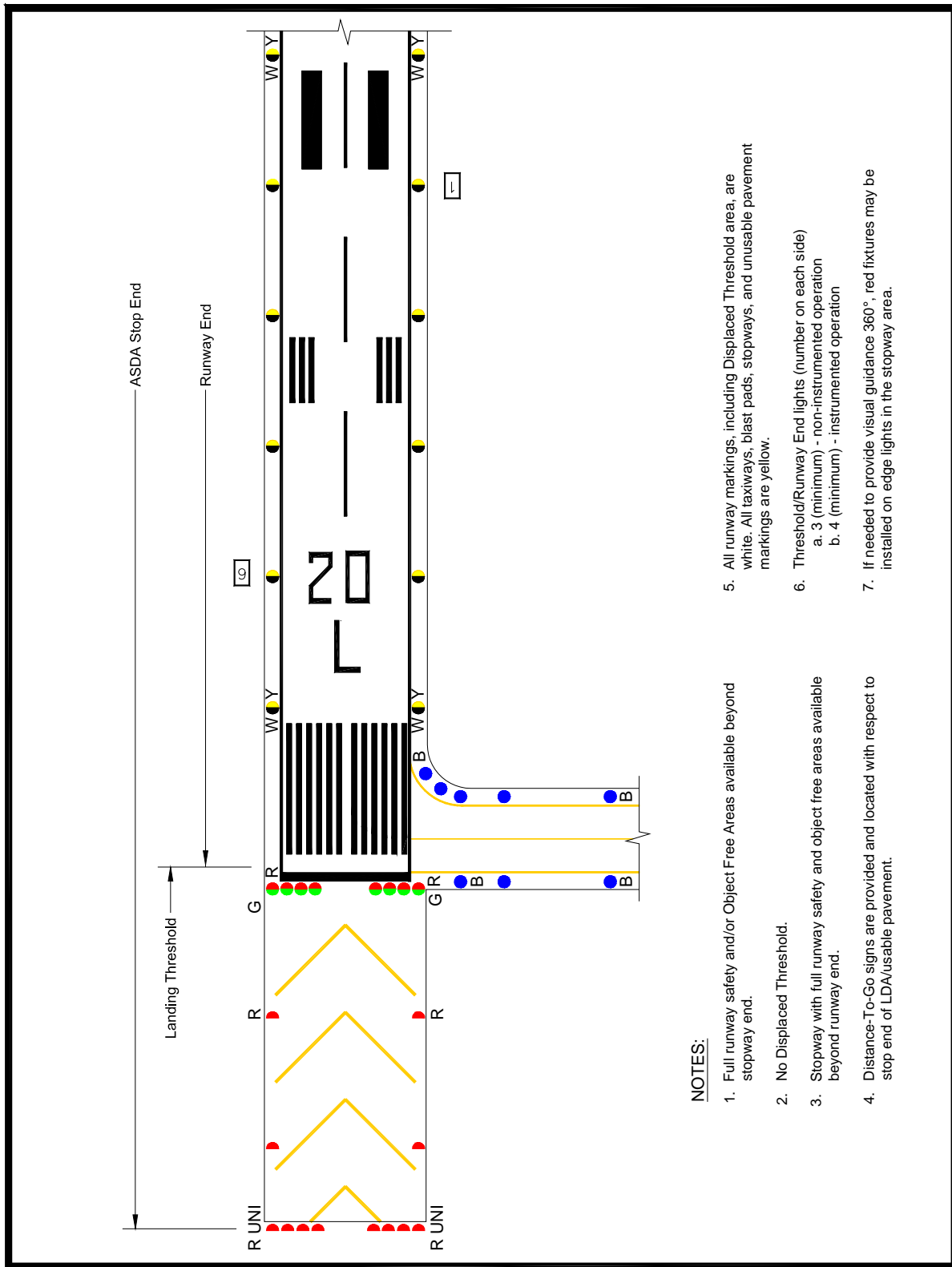
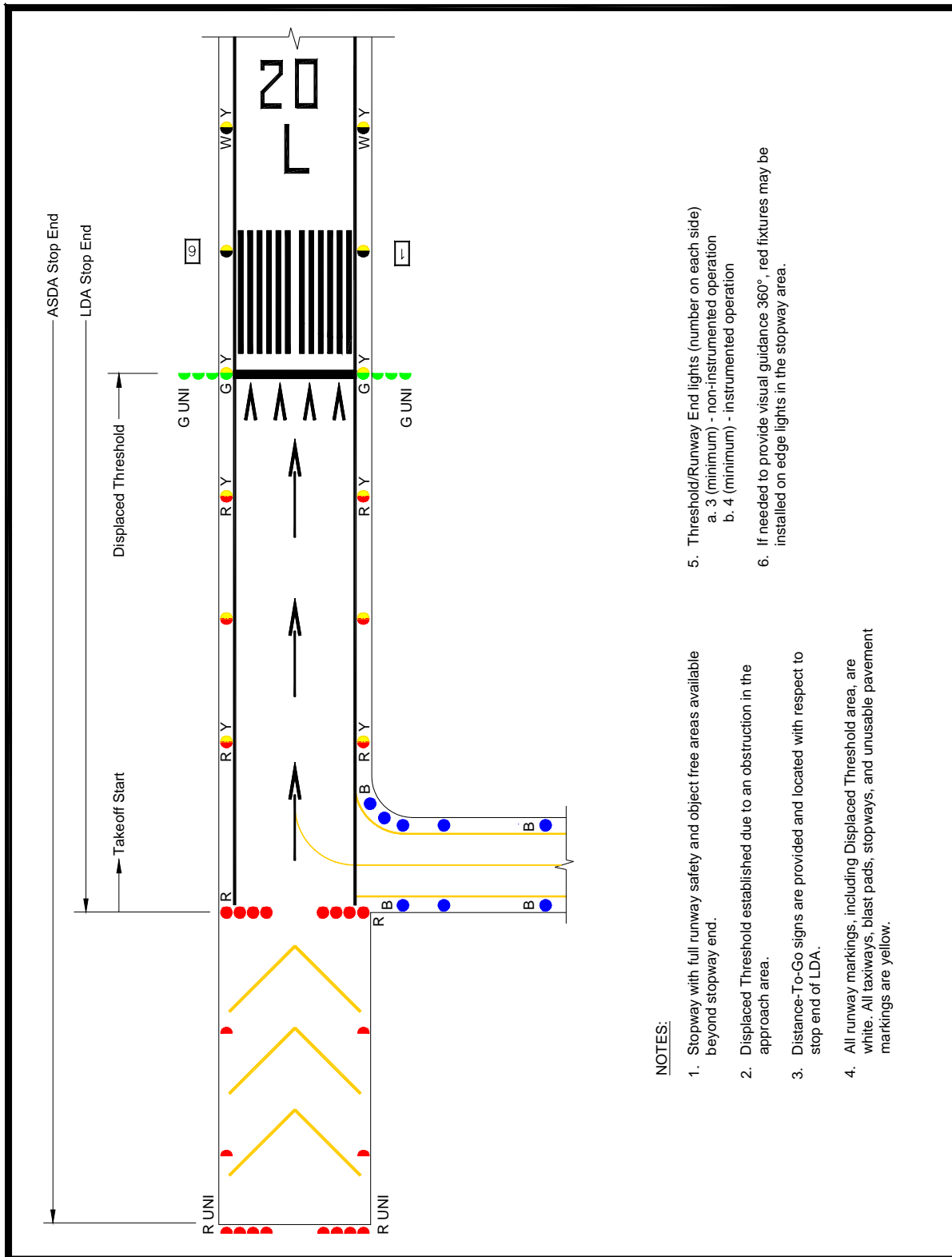

Figure 11. Lighting for Runway with Stopway.



NOTES:

1. Stopway with full runway safety and object free areas available beyond stopway end.
2. Displaced Threshold established due to an obstruction in the approach area.
3. Distance-To-Go signs are provided and located with respect to stop end of LDA.
4. All runway markings, including Displaced Threshold area, are white. All taxiways, blast pads, stopways, and unusable pavement markings are yellow.
5. Threshold/Runway End lights (number on each side)
 - a. 3 (minimum) - non-instrumented operation
 - b. 4 (minimum) - instrumented operation
6. If needed to provide visual guidance 360°, red fixtures may be installed on edge lights in the stopway area.

Figure 12. Lighting for Runway with Displaced Threshold & Stopway.

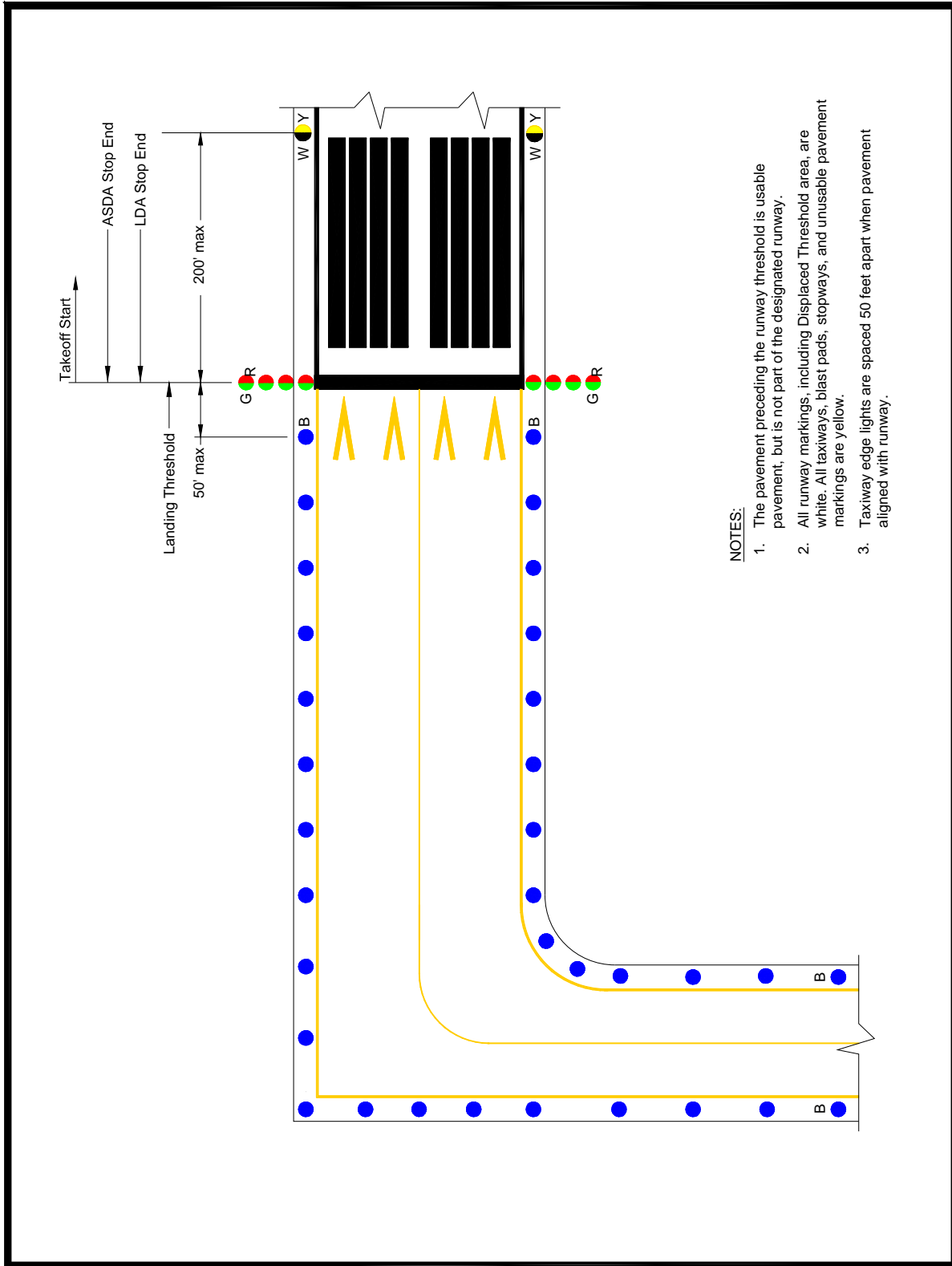

Figure 13. Runway with End Taxiway.

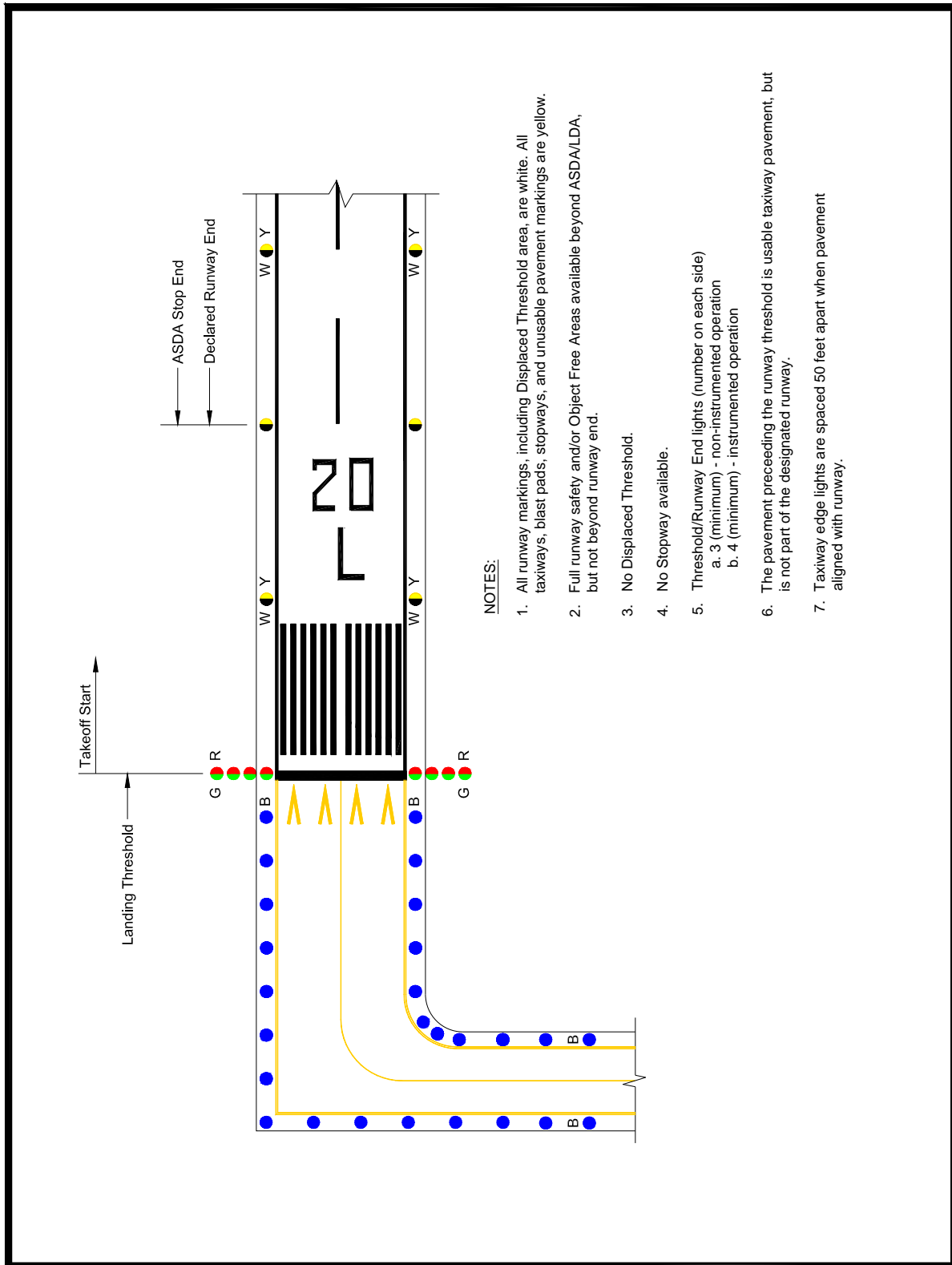

Figure 14. Lighting for Runway with End Taxiway and Shortened ASDA.

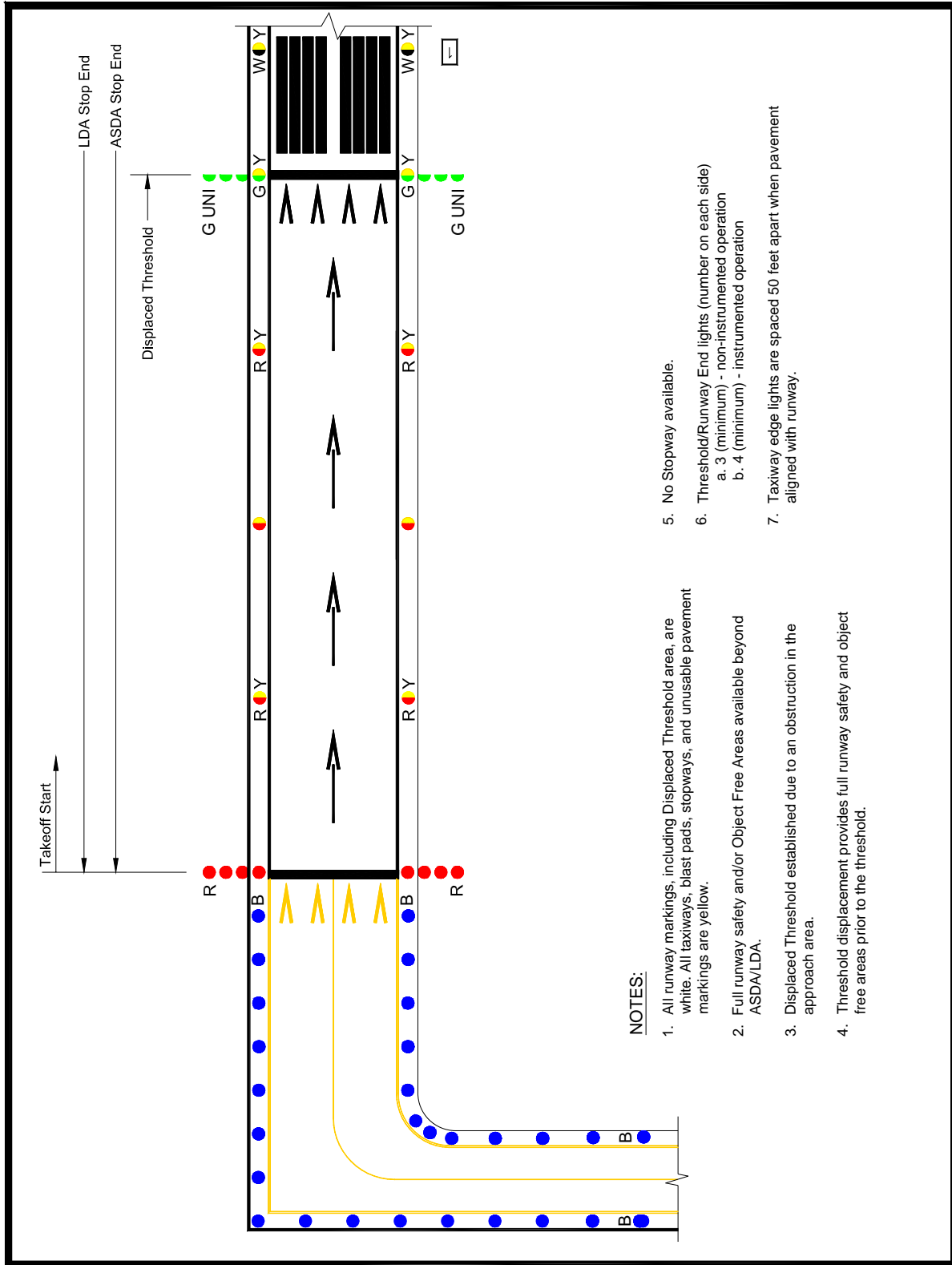

Figure 15. Lighting for Runway with End Taxiway and Displaced Threshold not Coinciding with Opposite Runway End.

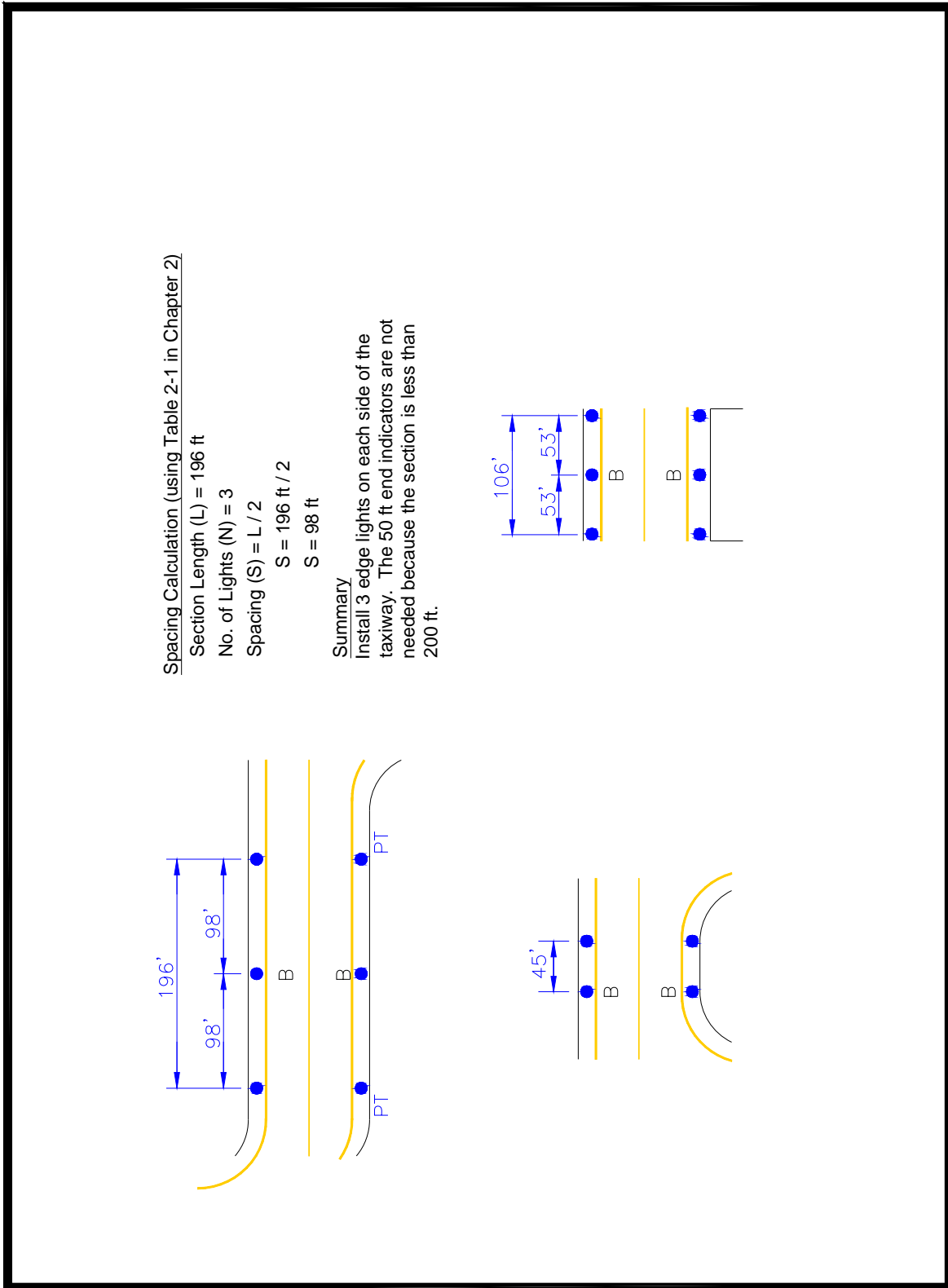
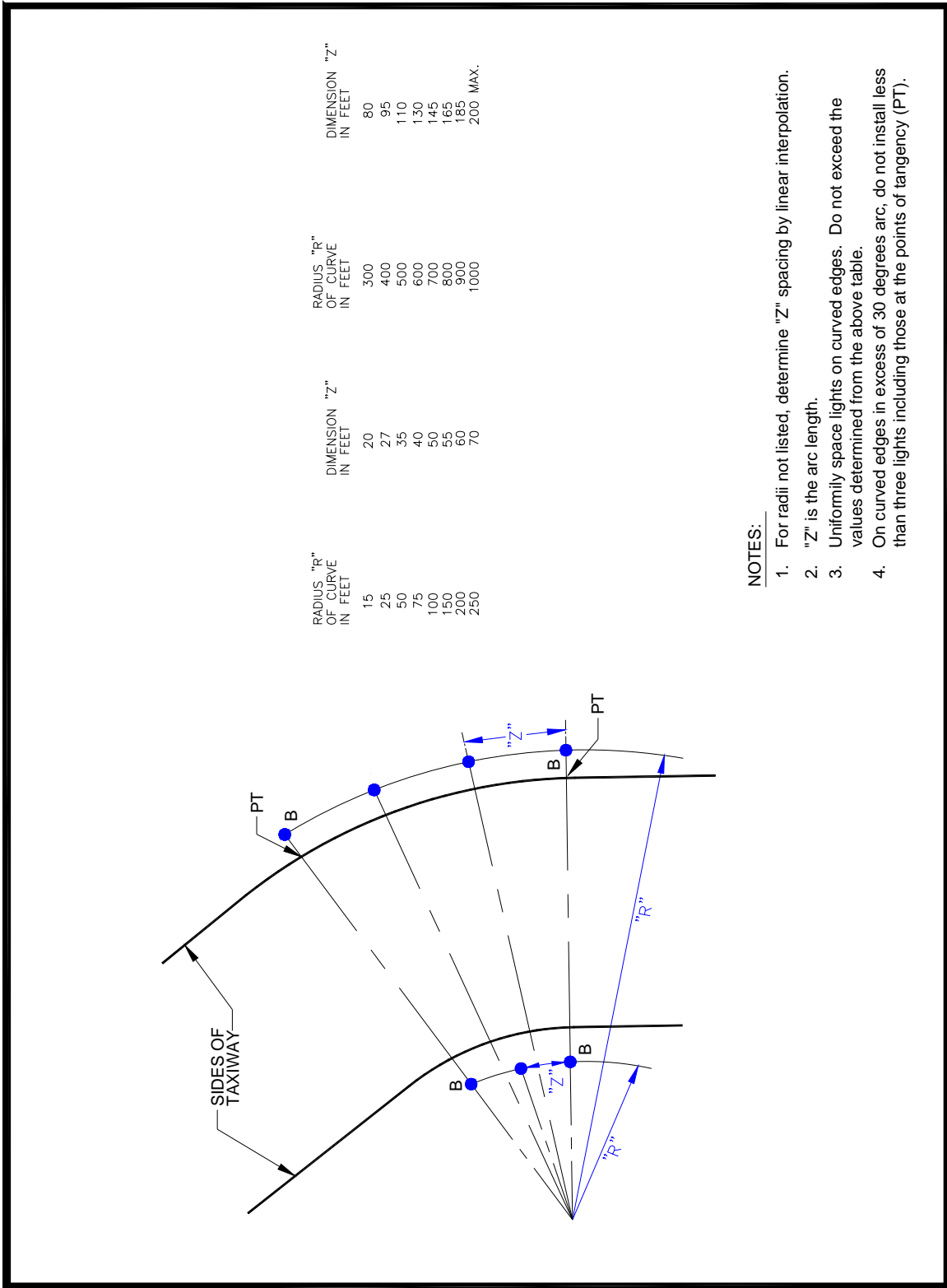

Figure 16. Typical Straight Taxiway Sections (Less Than 200 Feet (61 m)).



NOTES:

1. For radii not listed, determine "Z" spacing by linear interpolation.
2. "Z" is the arc length.
3. Uniformly space lights on curved edges. Do not exceed the values determined from the above table.
4. On curved edges in excess of 30 degrees arc, do not install less than three lights including those at the points of tangency (PT).

Figure 17. Spacing of Lights on Curved Taxiway Edges.

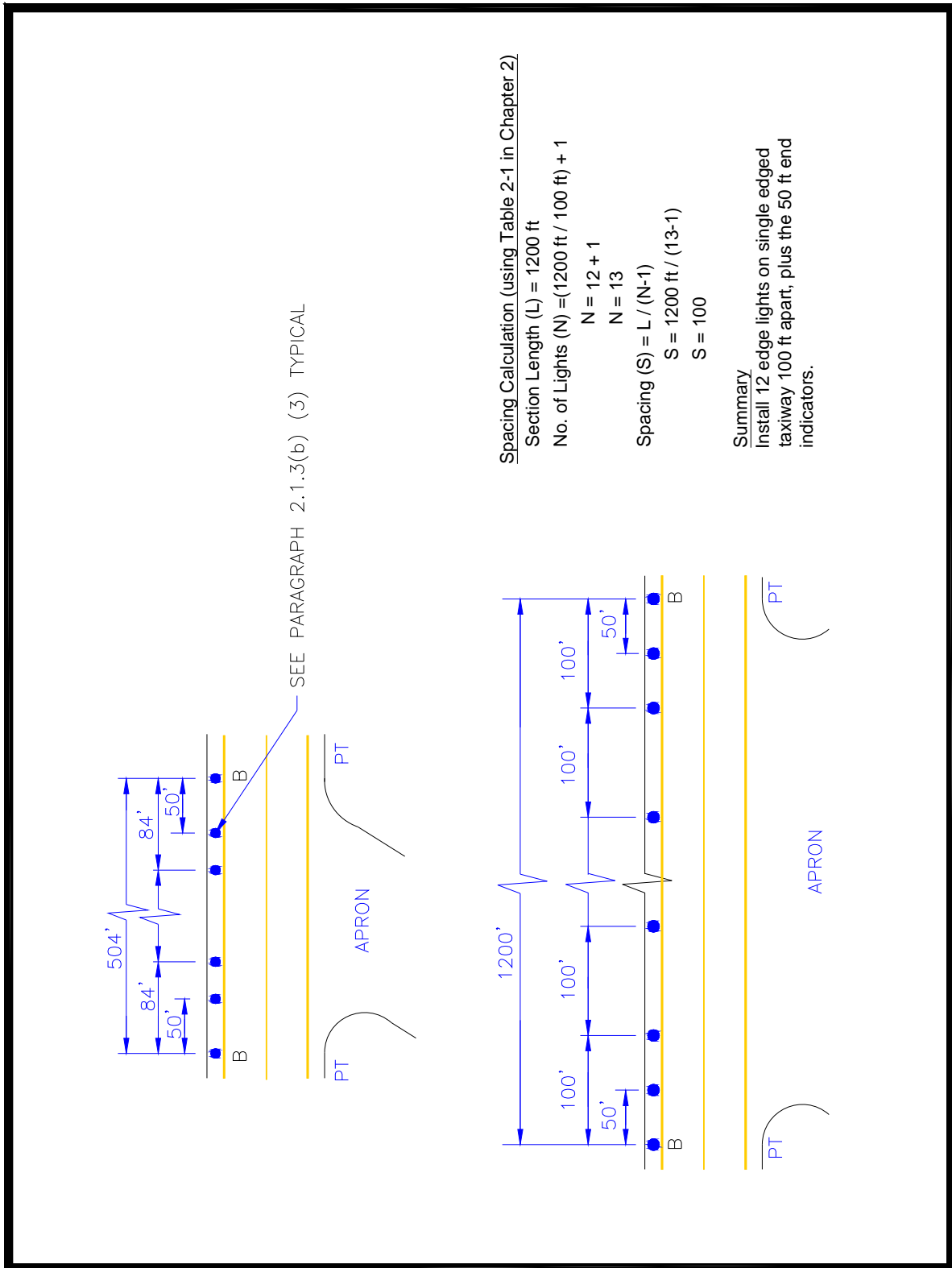

Figure 18. Typical Single Straight Taxiway Edges (More Than 200 Feet (61 m)).

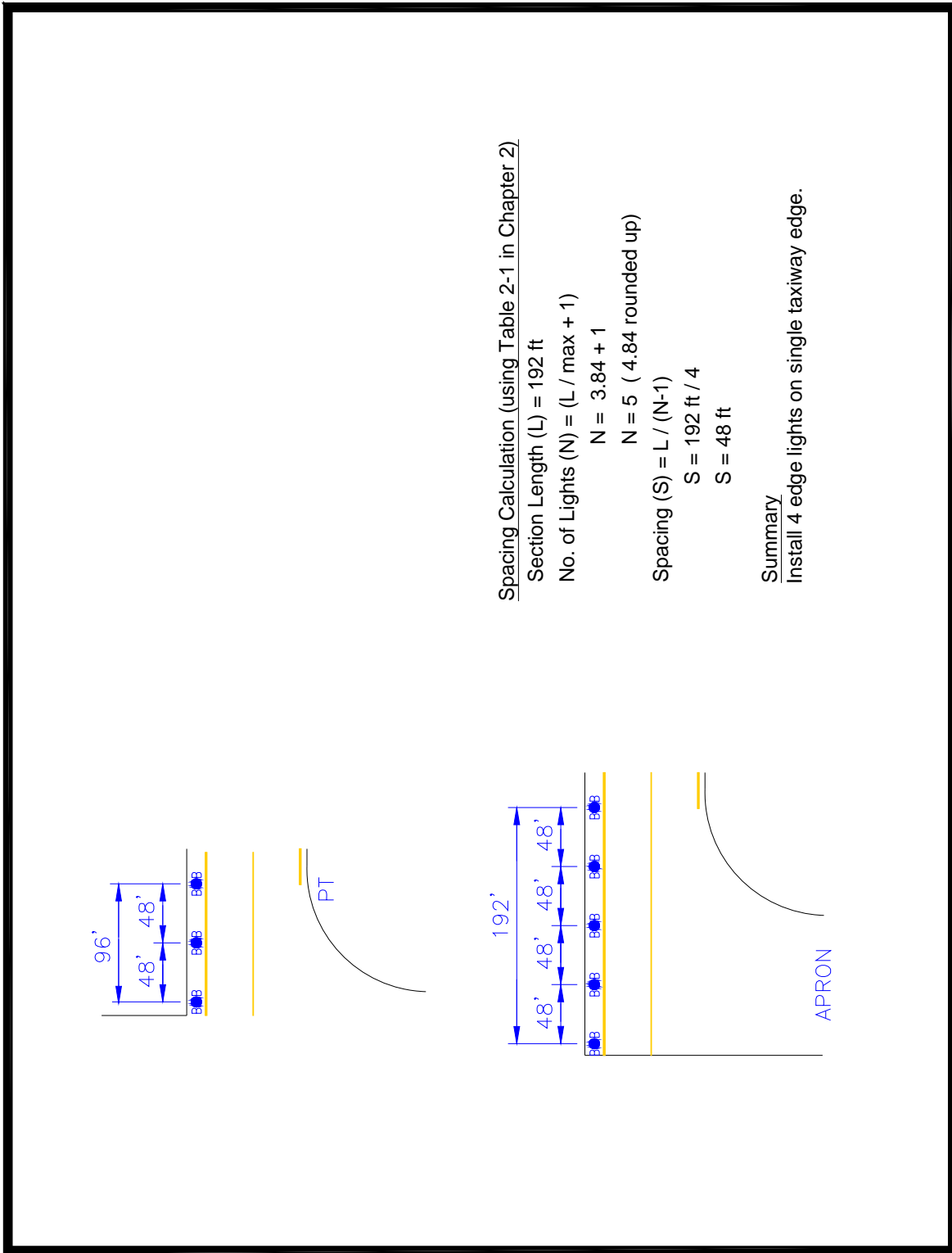

Figure 19. Typical Single Straight Taxiway Edges (Less Than 200 Feet (61 m)).

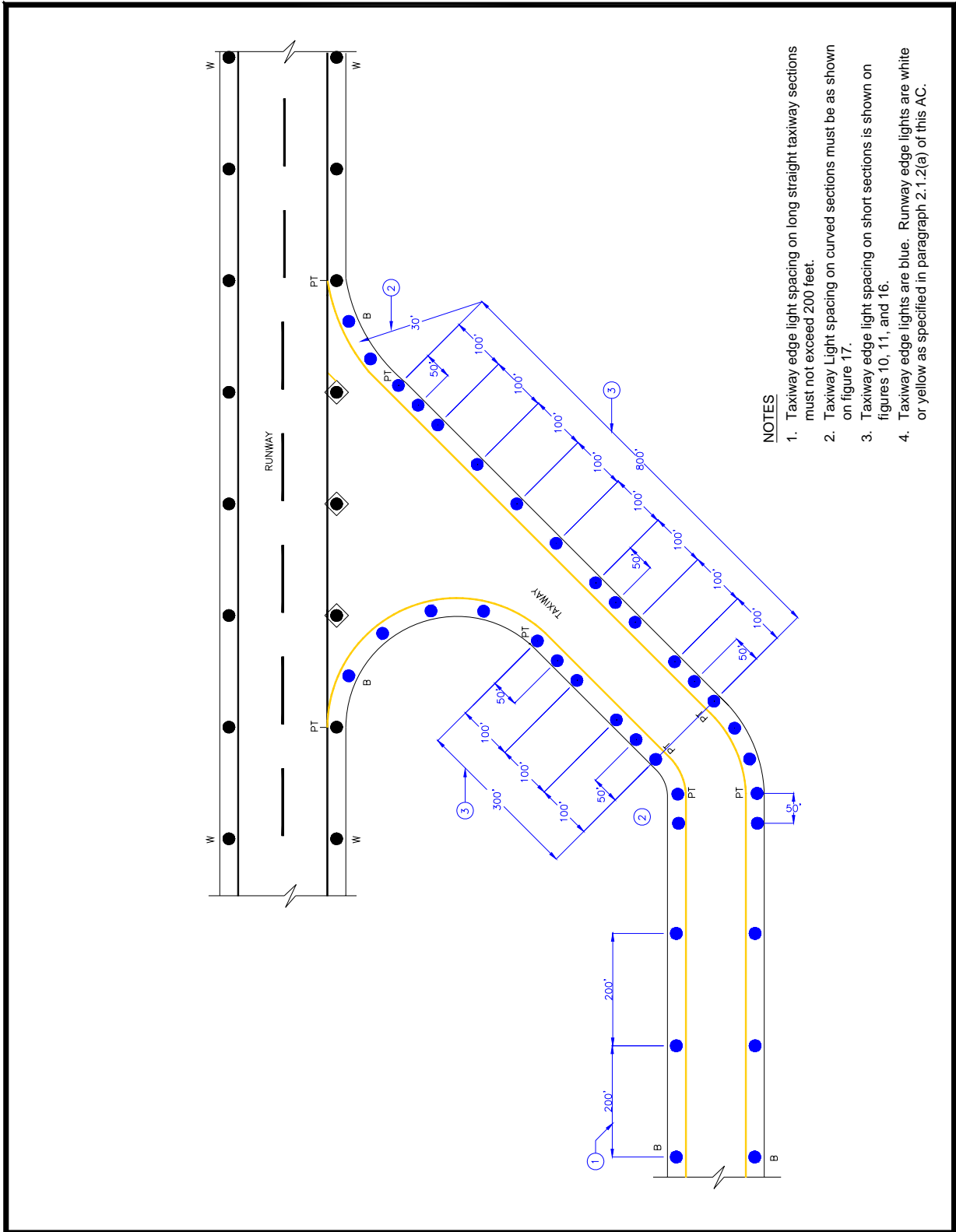

Figure 20. Typical Edge Lighting Configuration.

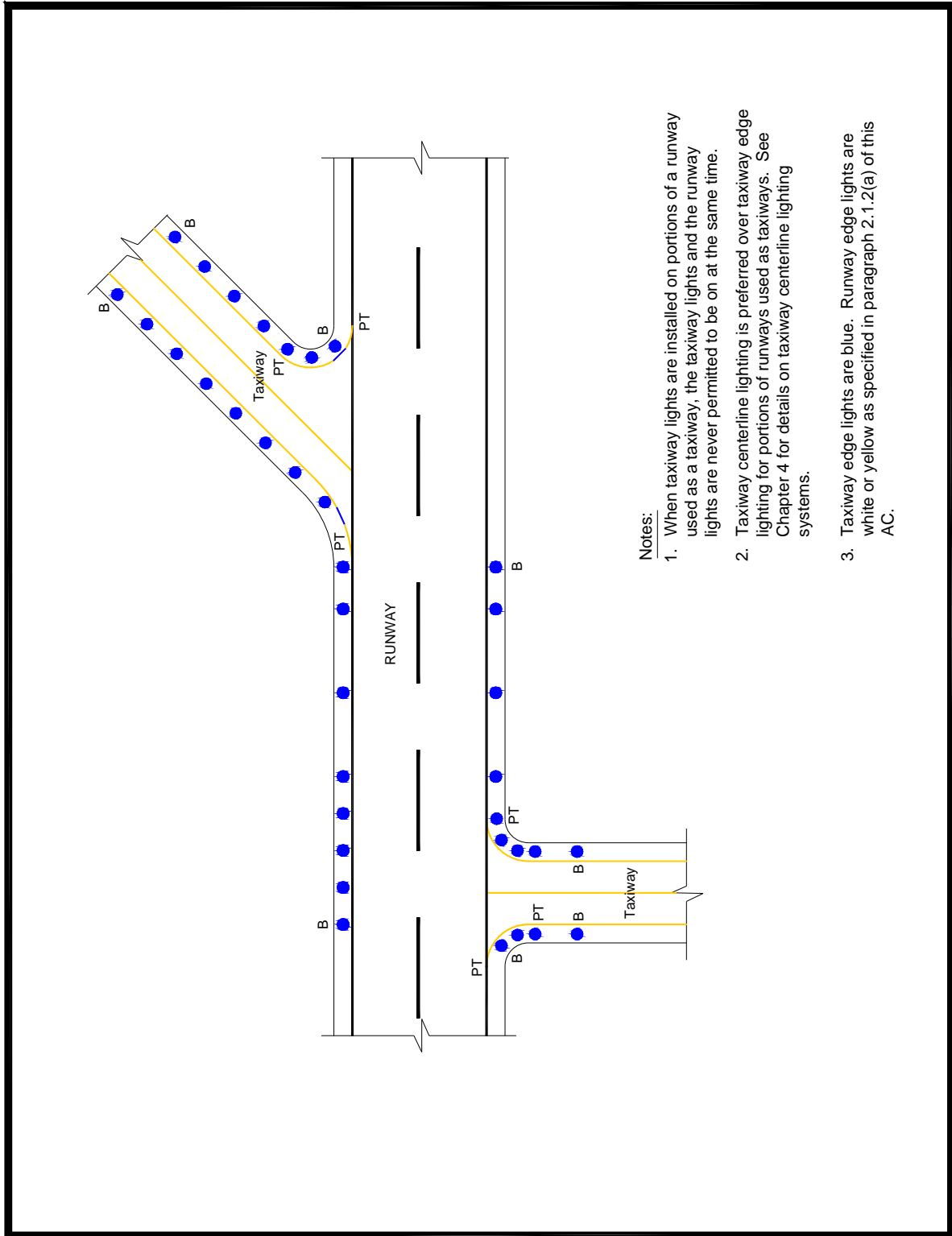
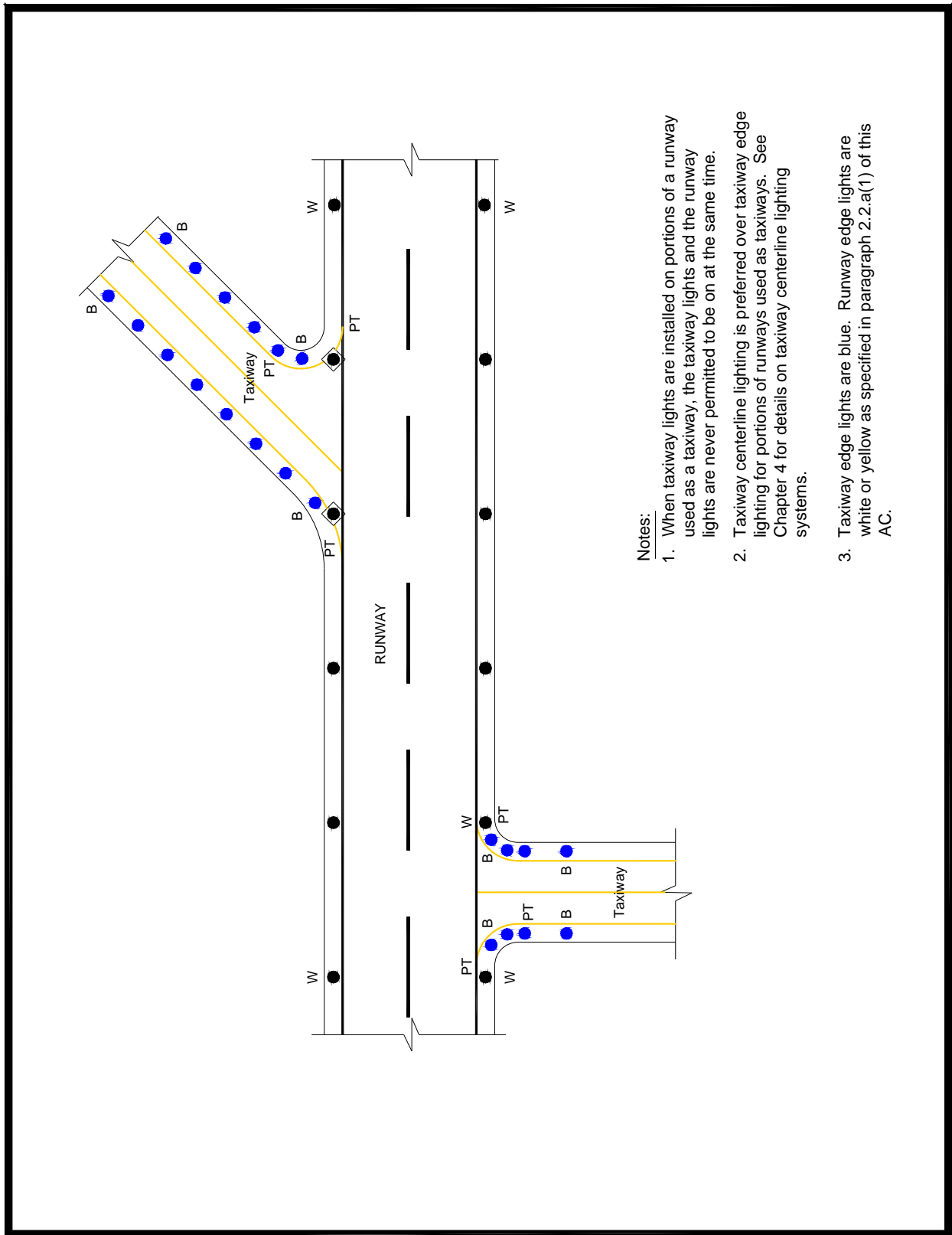

Figure 21. Typical Edge Lighting for Portions of Runways Used as Taxiway (When Taxiway Lights Are “On”).



Notes:

1. When taxiway lights are installed on portions of a runway used as a taxiway, the taxiway lights and the runway lights are never permitted to be on at the same time.
2. Taxiway centerline lighting is preferred over taxiway edge lighting for portions of runways used as taxiways. See Chapter 4 for details on taxiway centerline lighting systems.
3. Taxiway edge lights are blue. Runway edge lights are white or yellow as specified in paragraph 2.2.a(1) of this AC.

Figure 22. Typical Edge Lighting for Portions of Runways Used as Taxiway (When Runway Lights Are “On”).

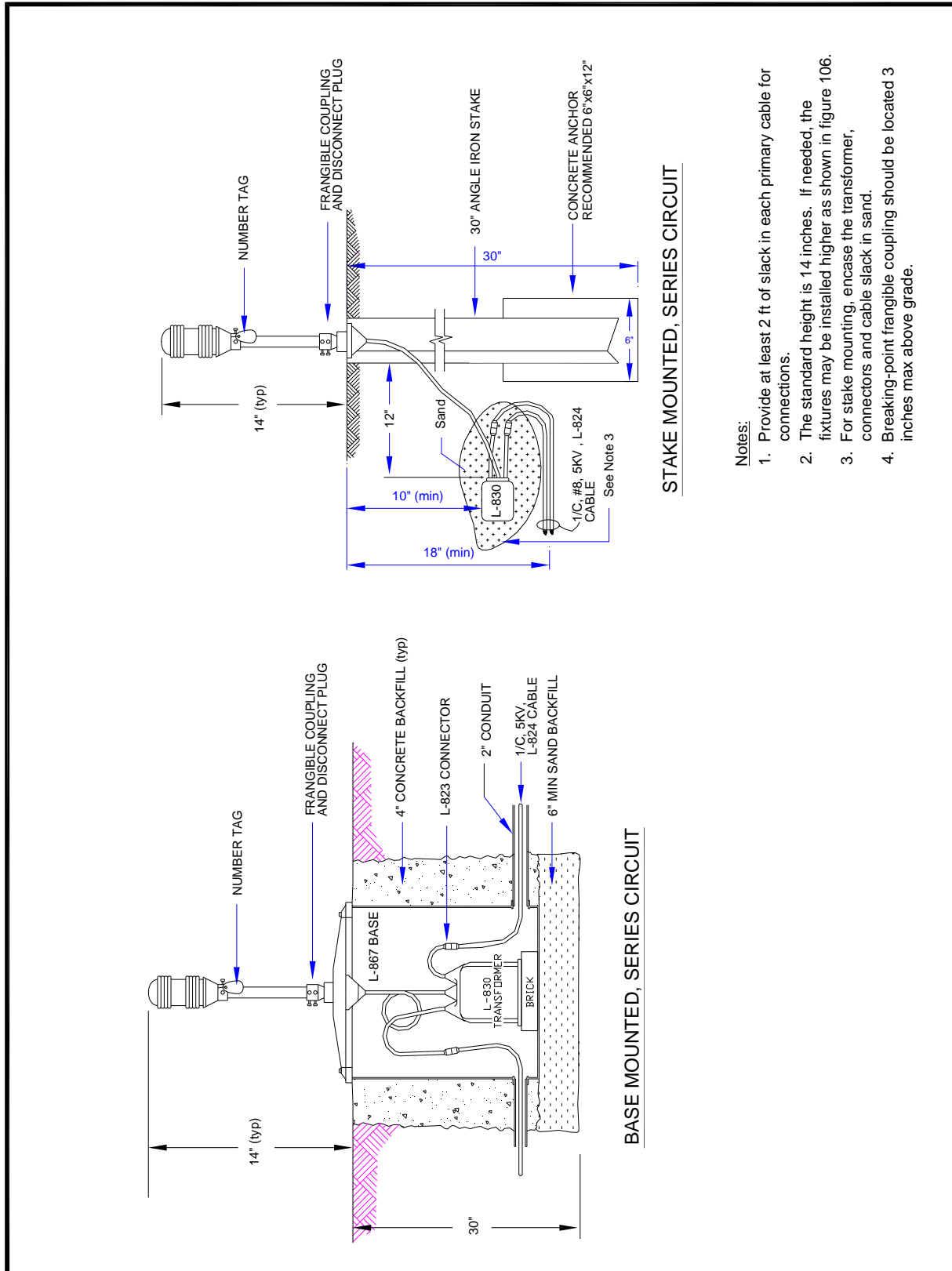
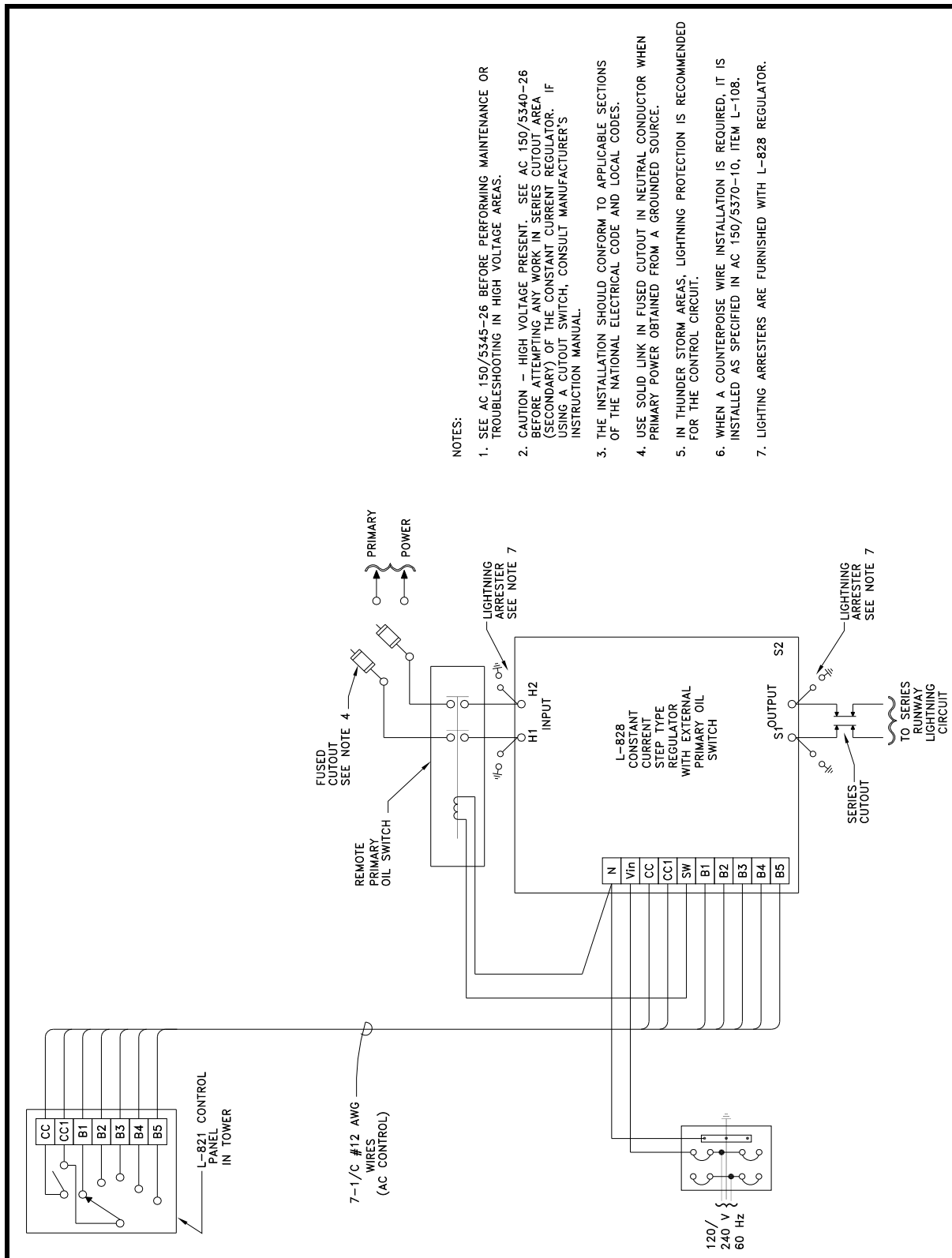

Figure 23. Light Fixture Wiring.



NOTES:

1. SEE AC 150/5345-26 BEFORE PERFORMING MAINTENANCE OR TROUBLESHOOTING IN HIGH VOLTAGE AREAS.
2. CAUTION - HIGH VOLTAGE PRESENT. SEE AC 150/5340-26 BEFORE ATTEMPTING ANY WORK IN SERIES CUTOFF AREA (SECONDARY) OF THE CONSTANT CURRENT REGULATOR. IF USING A CUTOFF SWITCH, CONSULT MANUFACTURER'S INSTRUCTION MANUAL.
3. THE INSTALLATION SHOULD CONFORM TO APPLICABLE SECTIONS OF THE NATIONAL ELECTRICAL CODE AND LOCAL CODES.
4. USE SOLID LINK IN FUSED CUTOFF IN NEUTRAL CONDUCTOR WHEN PRIMARY POWER OBTAINED FROM A GROUNDED SOURCE.
5. IN THUNDER STORM AREAS, LIGHTNING PROTECTION IS RECOMMENDED FOR THE CONTROL CIRCUIT.
6. WHEN A COUNTERPOISE WIRE INSTALLATION IS REQUIRED, IT IS INSTALLED AS SPECIFIED IN AC 150/5370-10, ITEM L-108.
7. LIGHTING ARRESTERS ARE FURNISHED WITH L-828 REGULATOR.

Figure 24. Typical Wiring Diagram Utilizing L-828 Step-type Regulator with External Remote Primary Oil Switch.

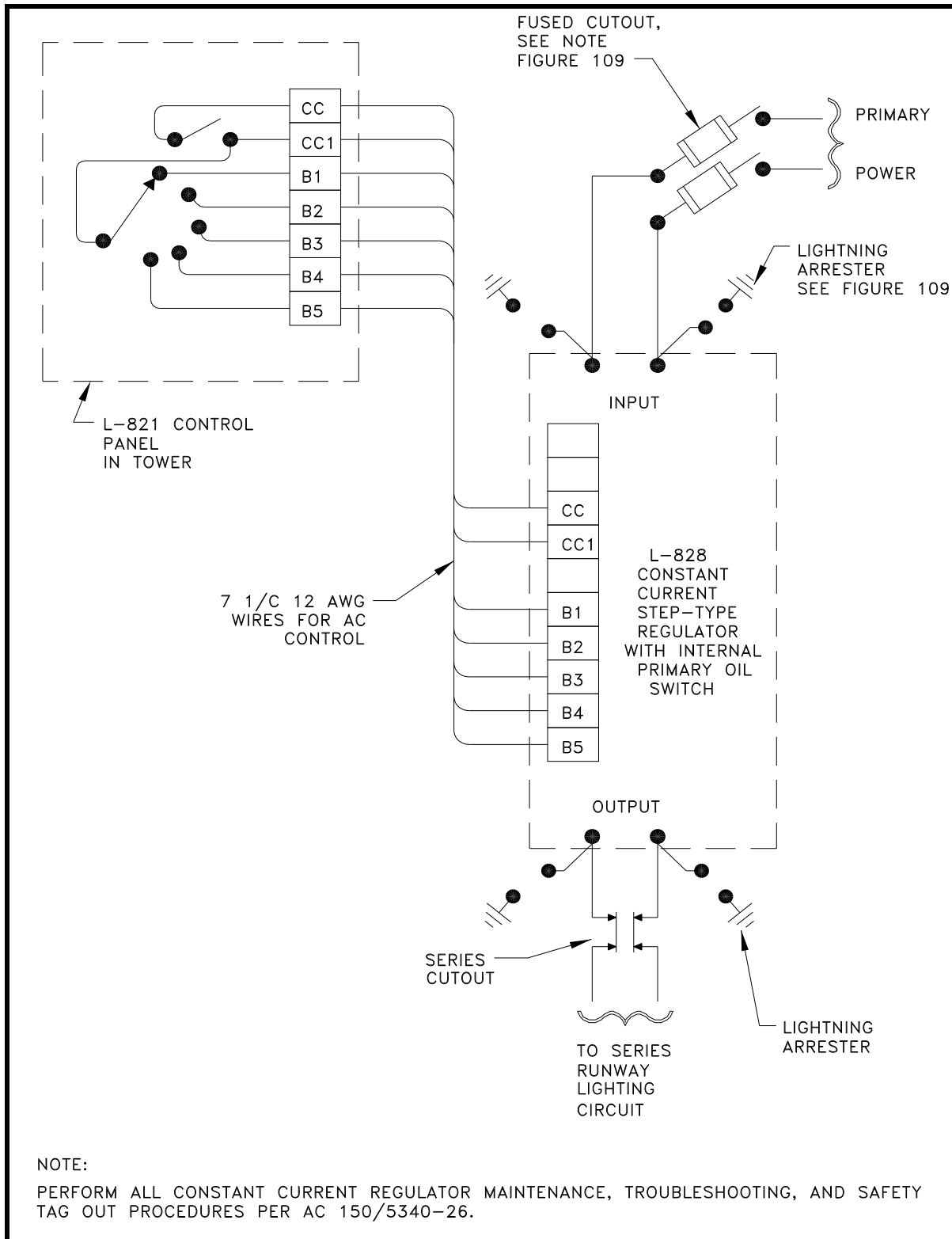

Figure 25. Typical Wiring Diagram Utilizing L-828 Step-type Regulator with Internal Control Power and Primary Oil Switch.

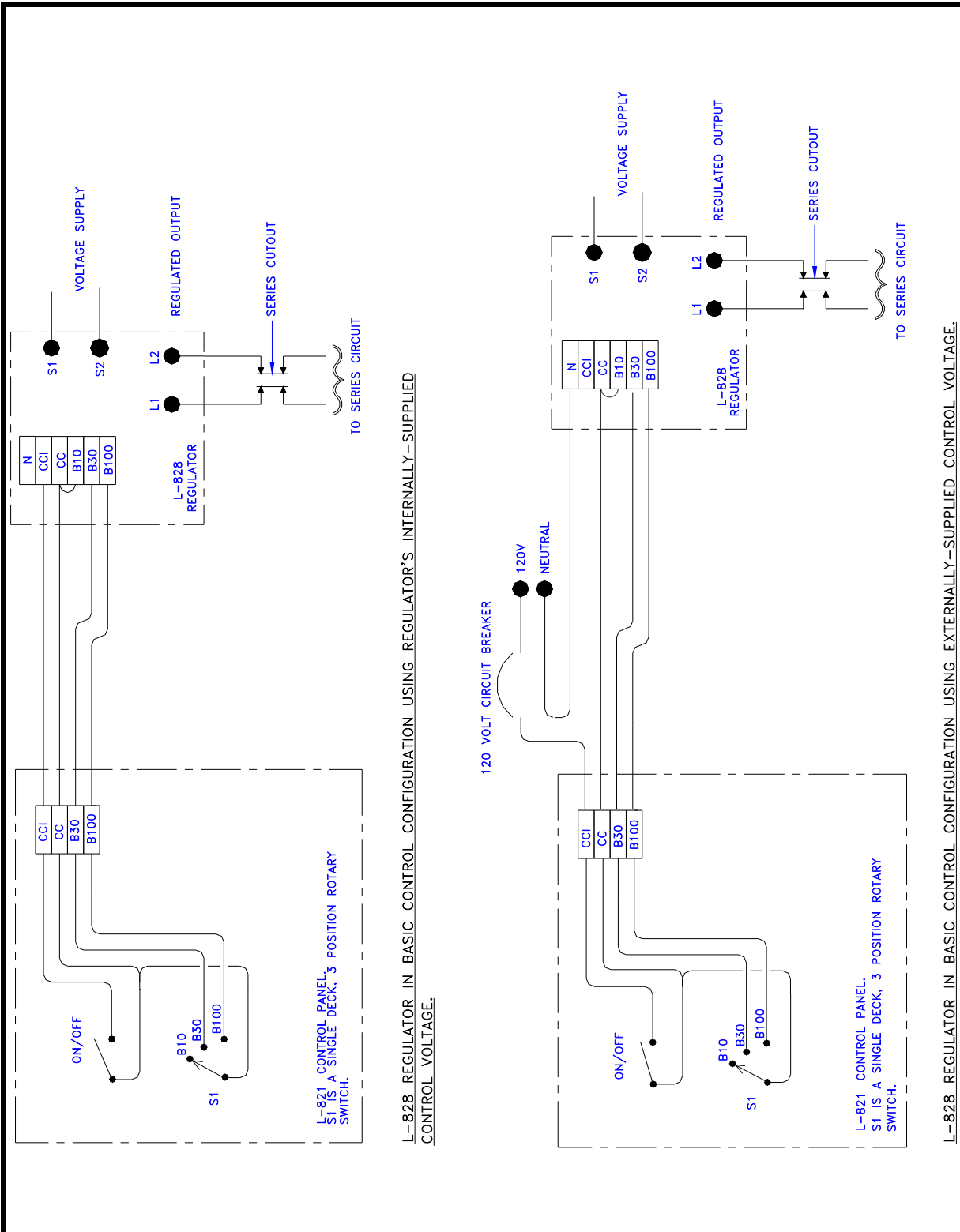

Figure 26. Typical Basic 120 VAC Remote Control System.

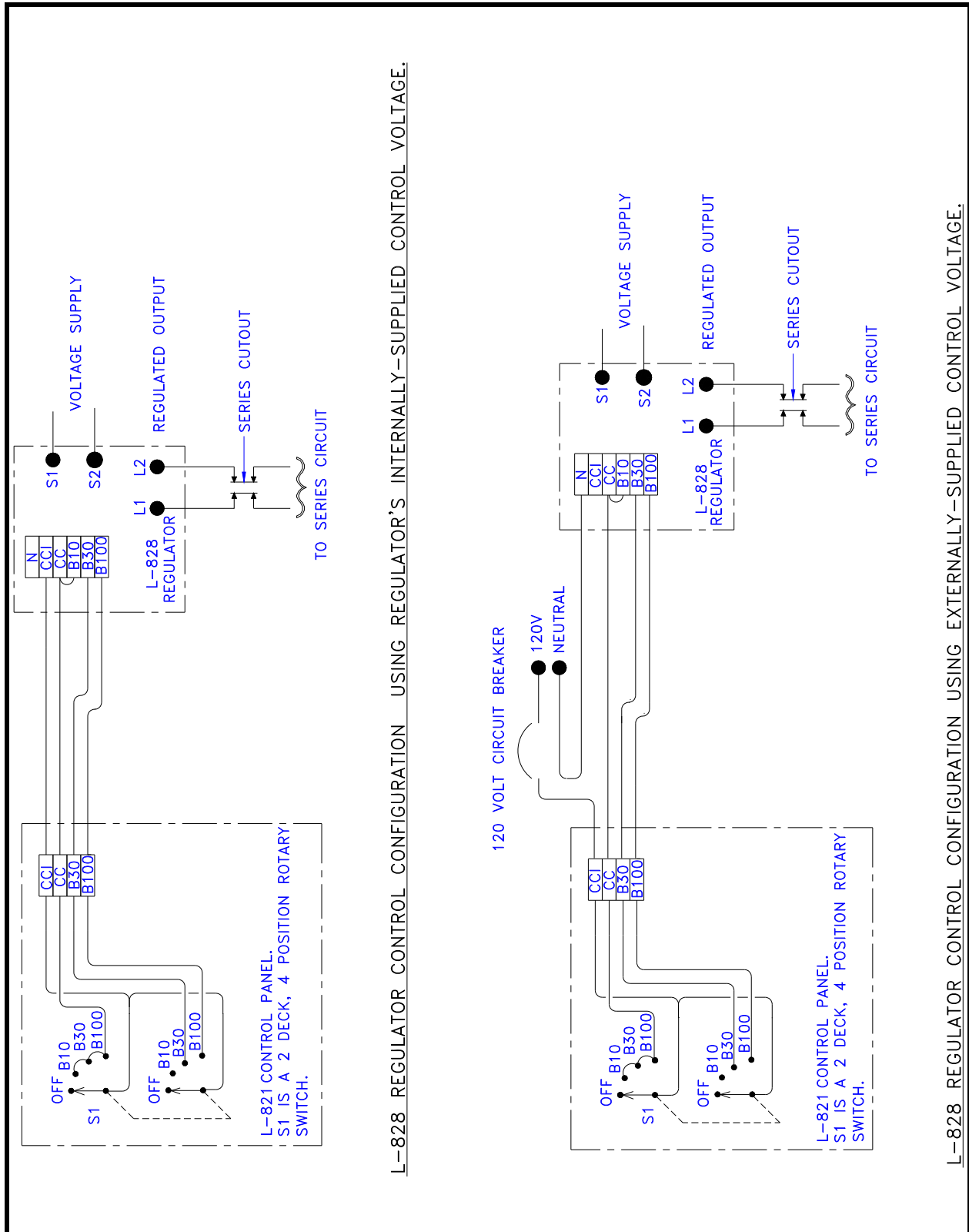

Figure 27. Alternative 120 VAC Remote Control System.

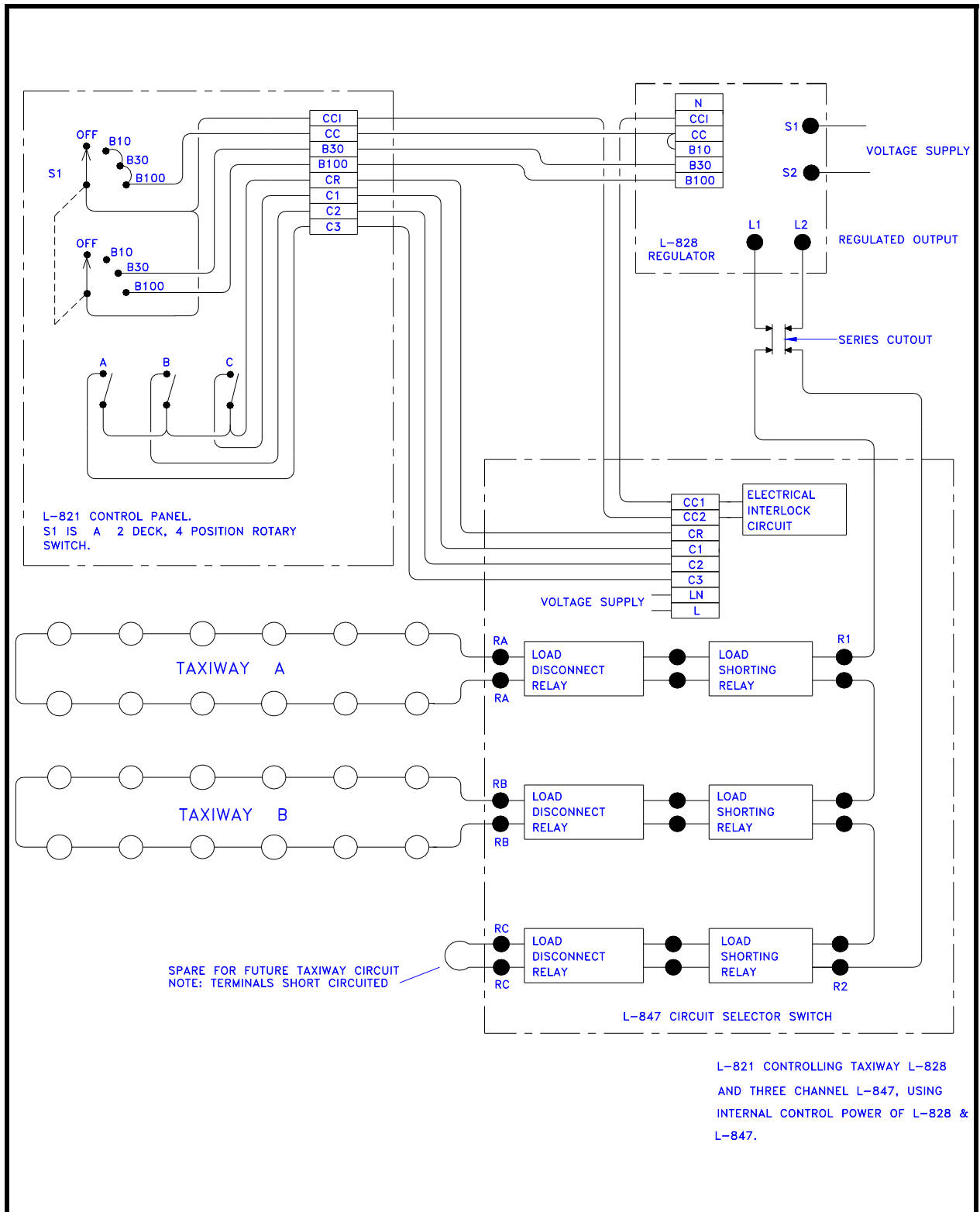

Figure 28. Typical 120 VAC Remote Control System with L-847 Circuit Selector Switch.

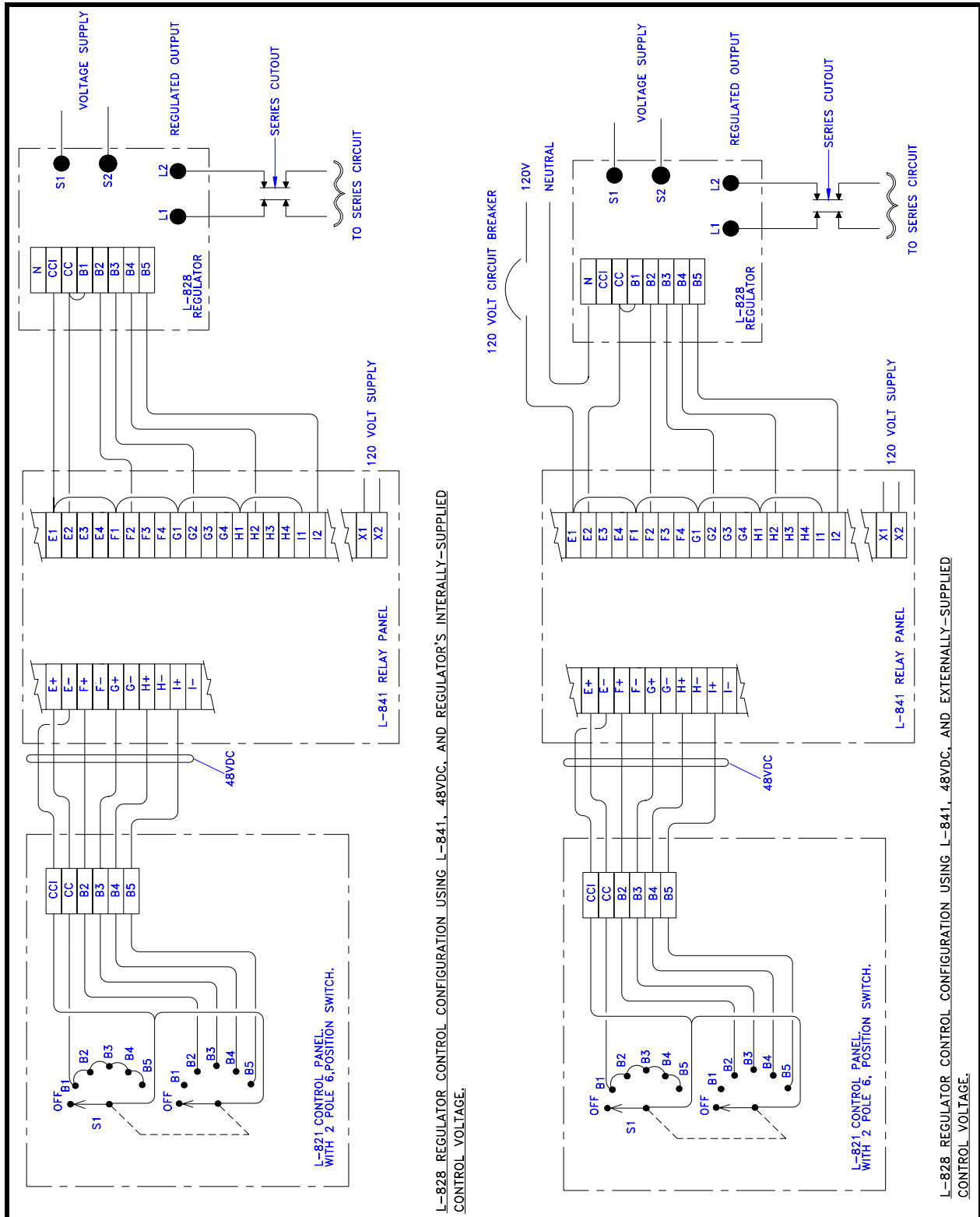

Figure 29. Typical 48 VDC Remote Control System with 5-Step Regulator and L-841 Relay Panel.

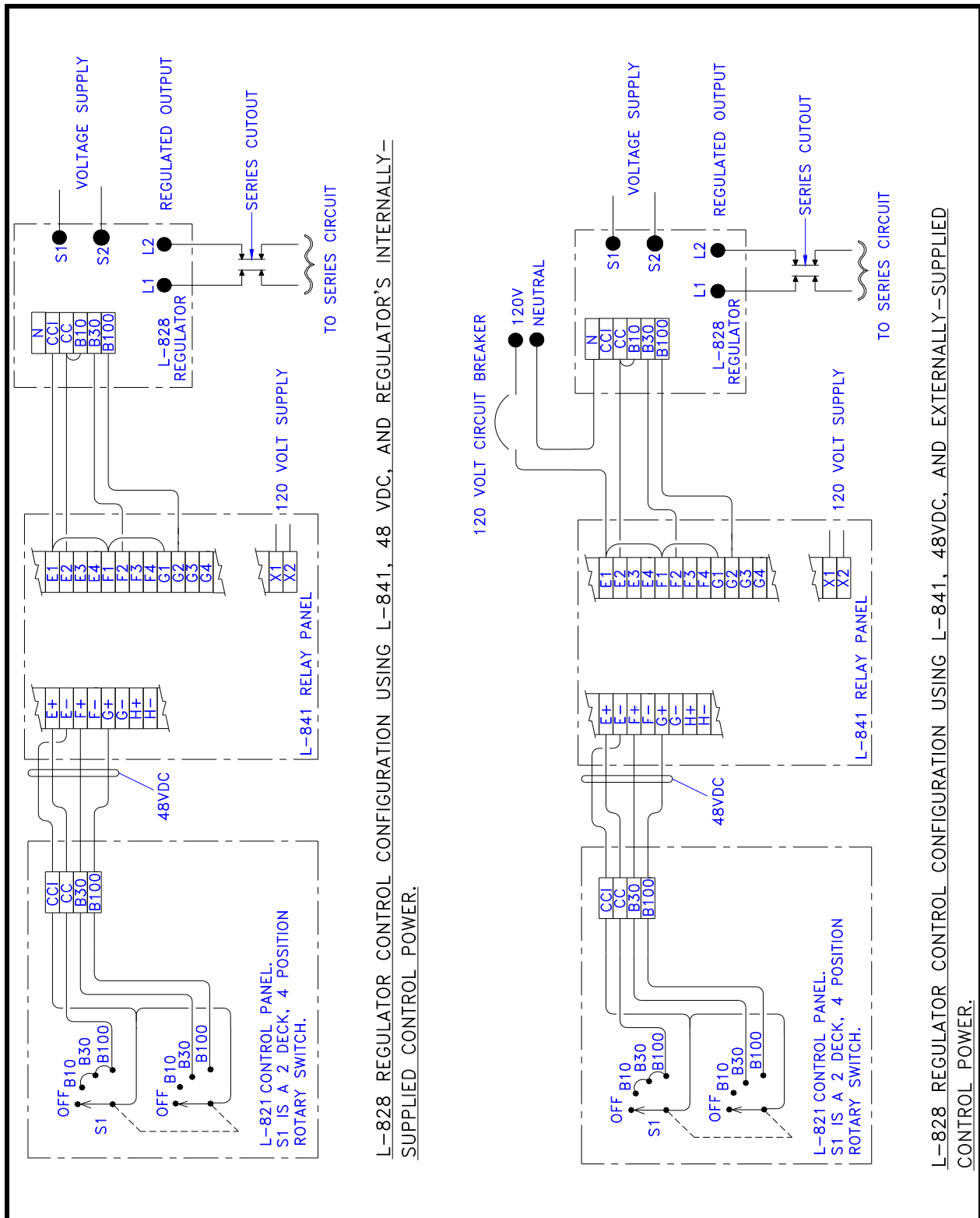

Figure 30. Typical 48 VDC Remote Control System with 3-Step Regulator and L-841 Relay Panel.

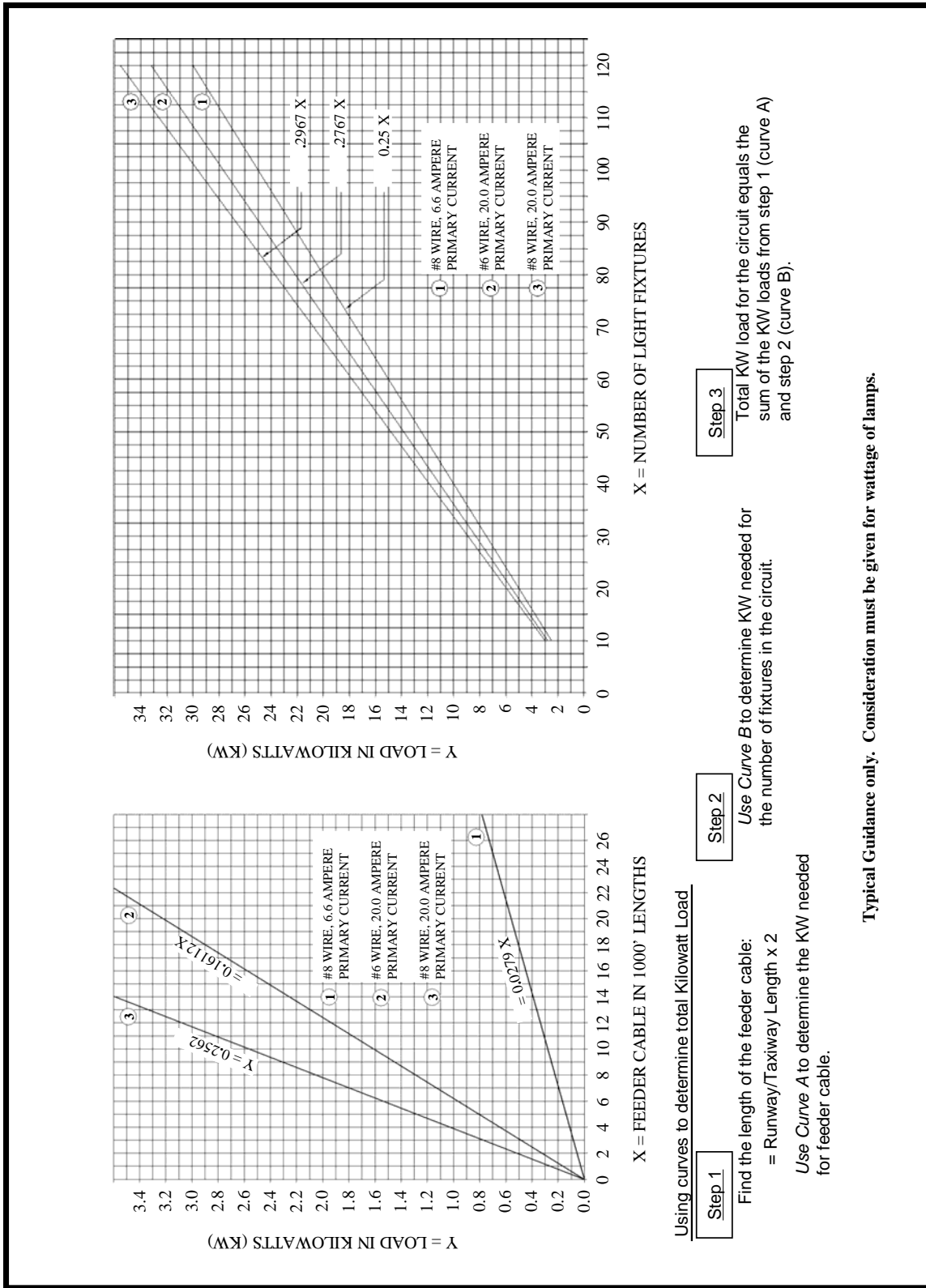
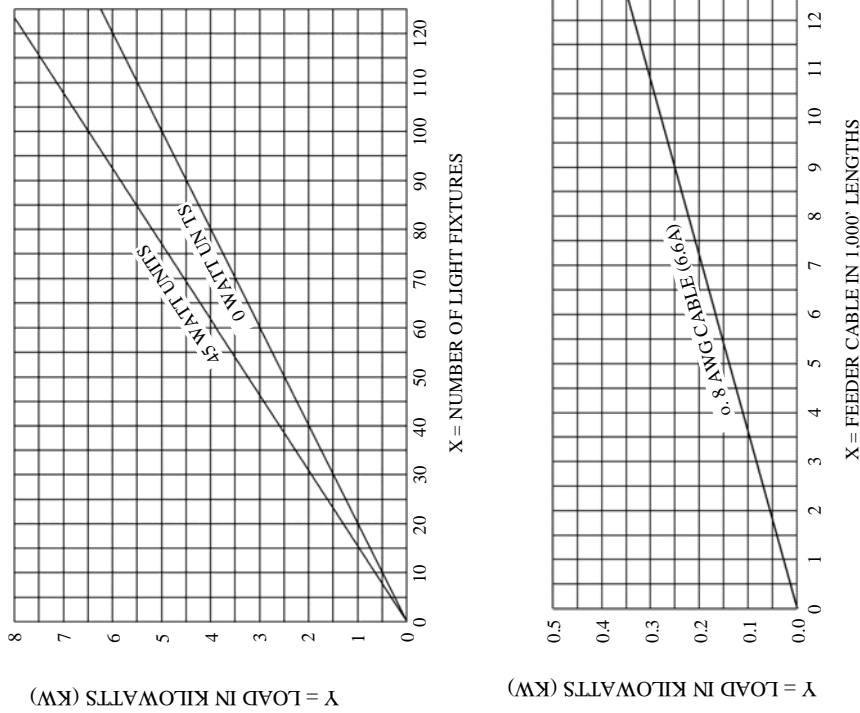

Figure 31. Curves for Estimating Loads in High Intensity Series Circuits.



Using curves to determine total Kilowatt Load

1. Computations based on actual circuit load tests.
2. In Curve A find kilowatt load (KW) for the total number of fixtures, using the applicable lines (i.e. 45 watt or 30 watt).
3. Basis for computing unit loads in Curve A:

30/45 watt transformer with 45 watt lamp	54.7 watts
Cable loss, lamp tolerance, etc.	10.3 watts
Total estimated load per 45 watt unit	65.0 watts
- 30/45 watt transformer with 30 watt lamp

Cable loss, lamp tolerance, etc.	40.4 watts
Total estimated load per 30 watt unit	50.0 watts
4. Basis for computing load per 1000 ft of No. 8 AWG cable in Curve B:

$$I^2R = (6.6A)^2 \times 0.6405 \text{ ohms}/1,000 \text{ ft} = 27.9 \text{ watts}/1000 \text{ ft}$$
5. Total KW load per circuit equal the sum of the KW loads from curve A and curve B.

Figure 32. Curves for Estimating Loads in Medium Intensity Series Circuits.

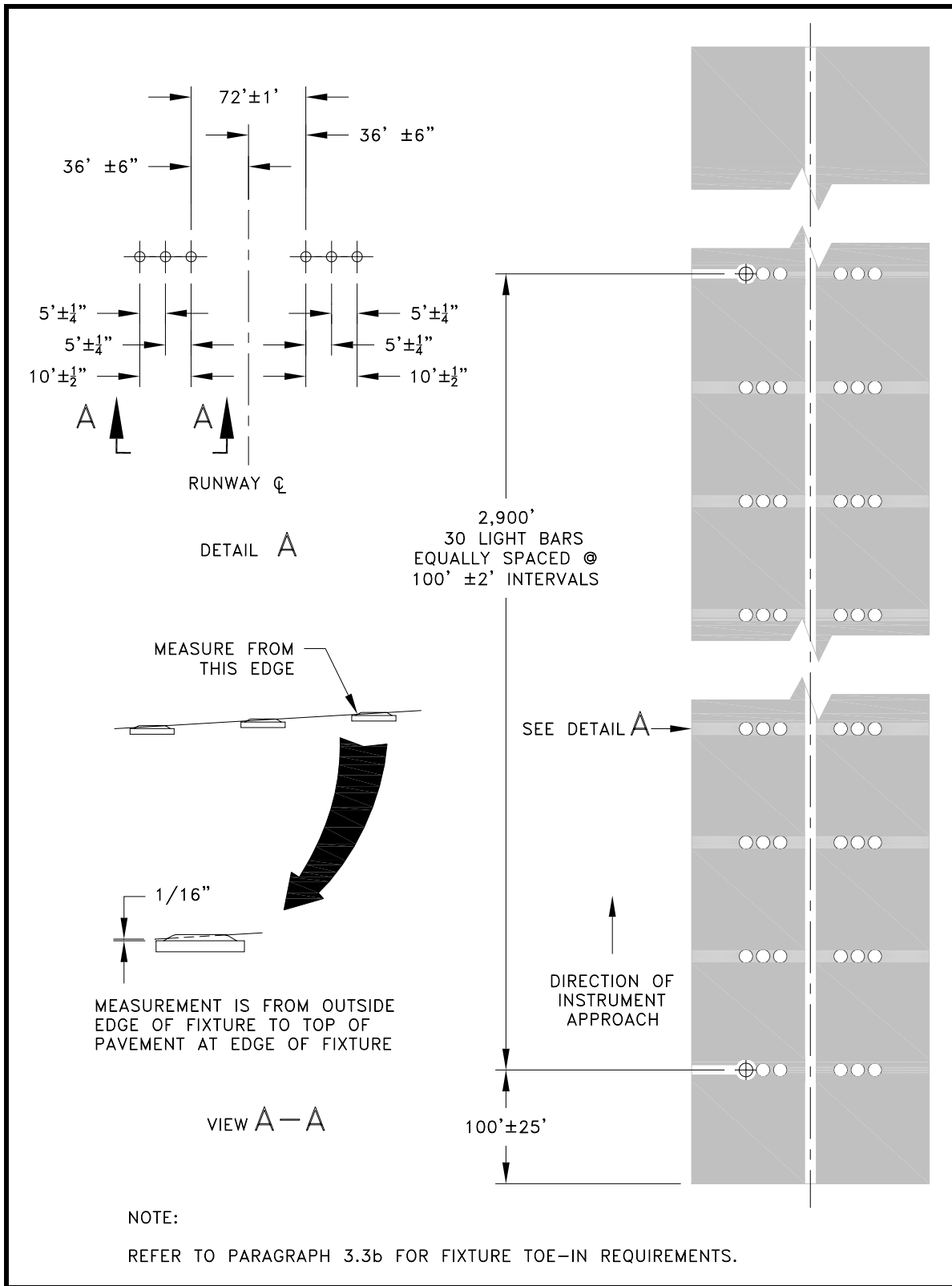
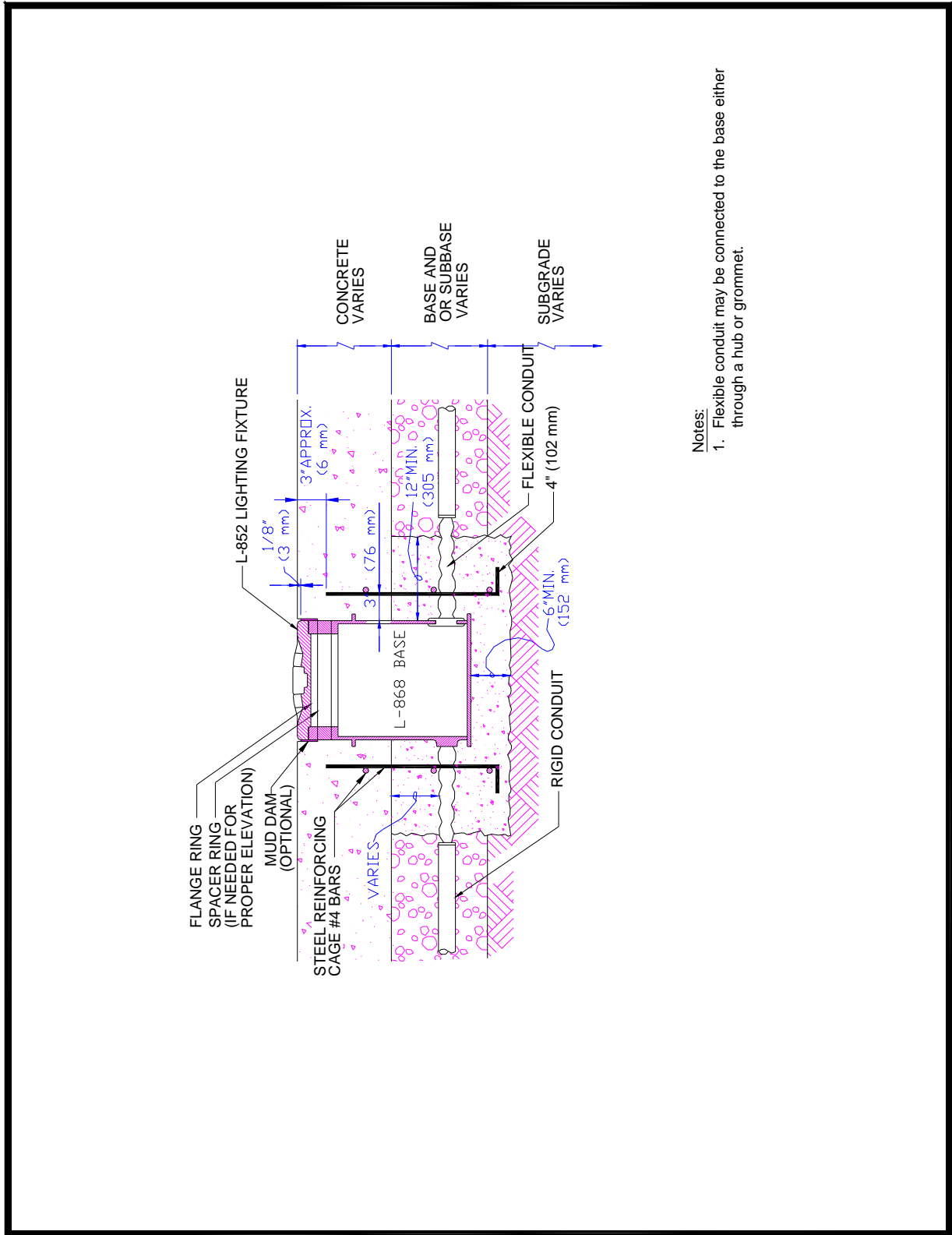

Figure 34. Touchdown Zone Lighting Layout.



- Notes:
1. Flexible conduit may be connected to the base either through a hub or grommet.

Figure 35. Section Through Non-adjustable Base and Anchor, Base and Conduit System, Rigid Pavement.

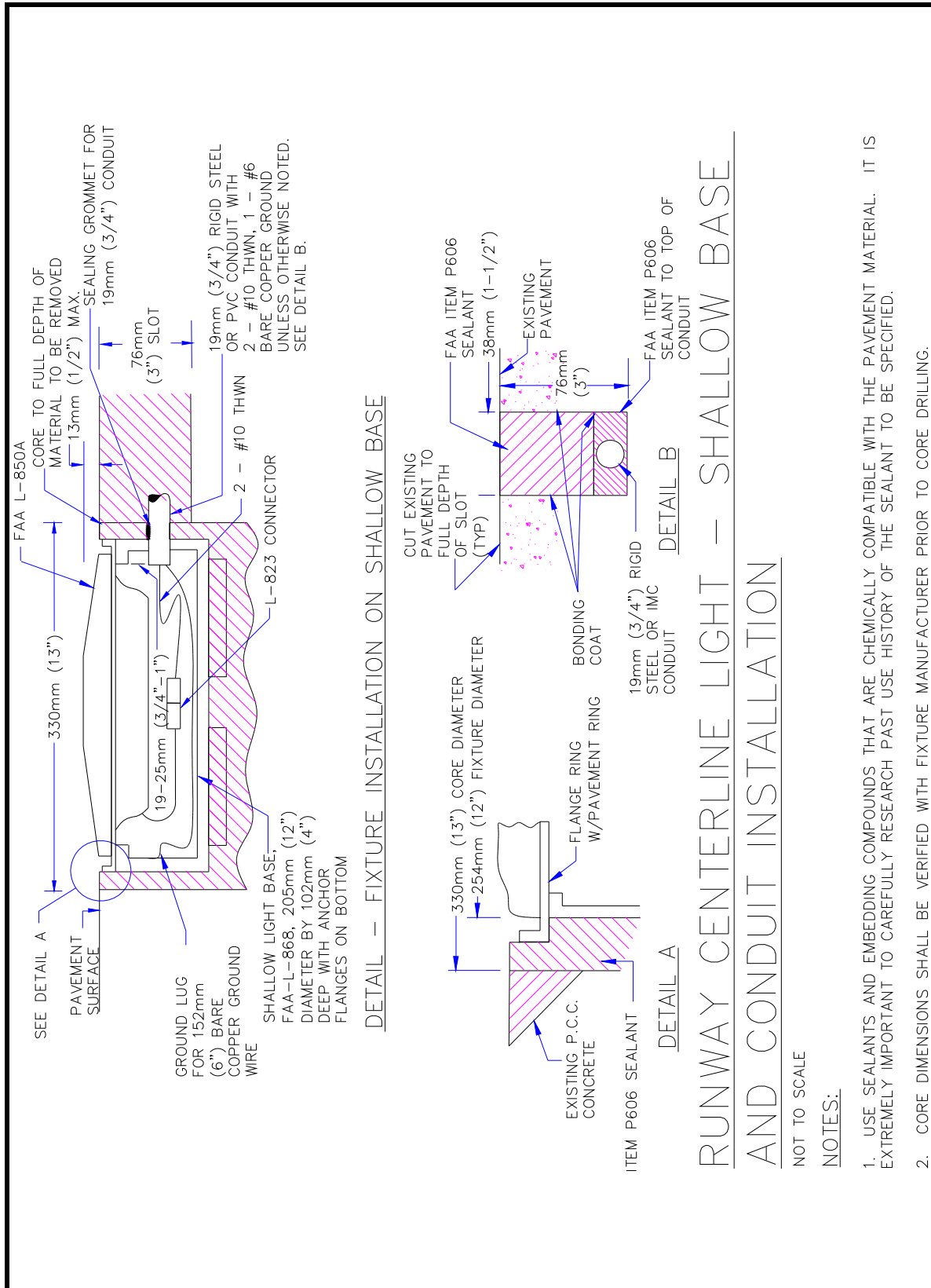

Figure 37. Runway Centerline Light – Shallow Base & Conduit Installation.

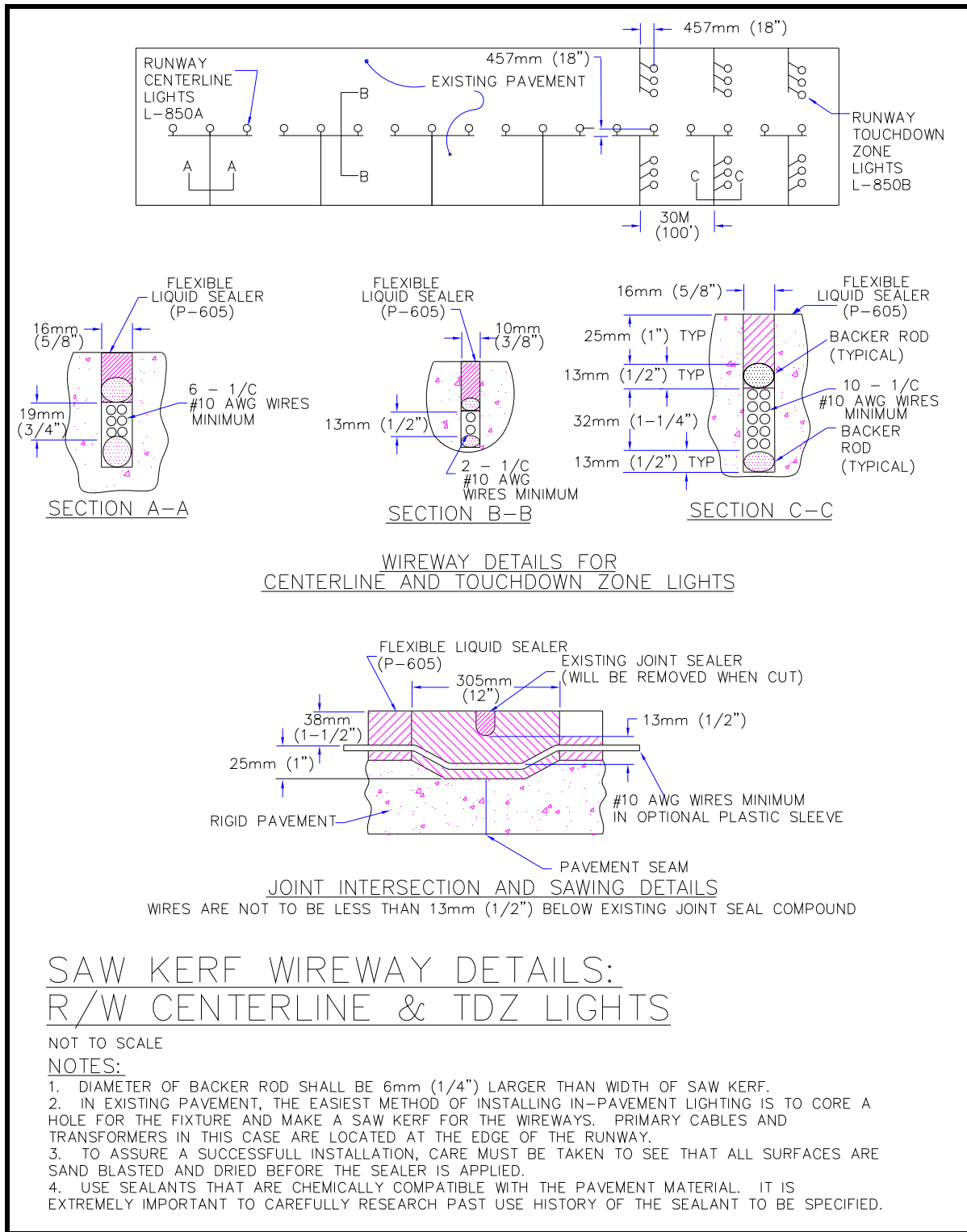

Figure 38. Saw Kerf Wireway Details.

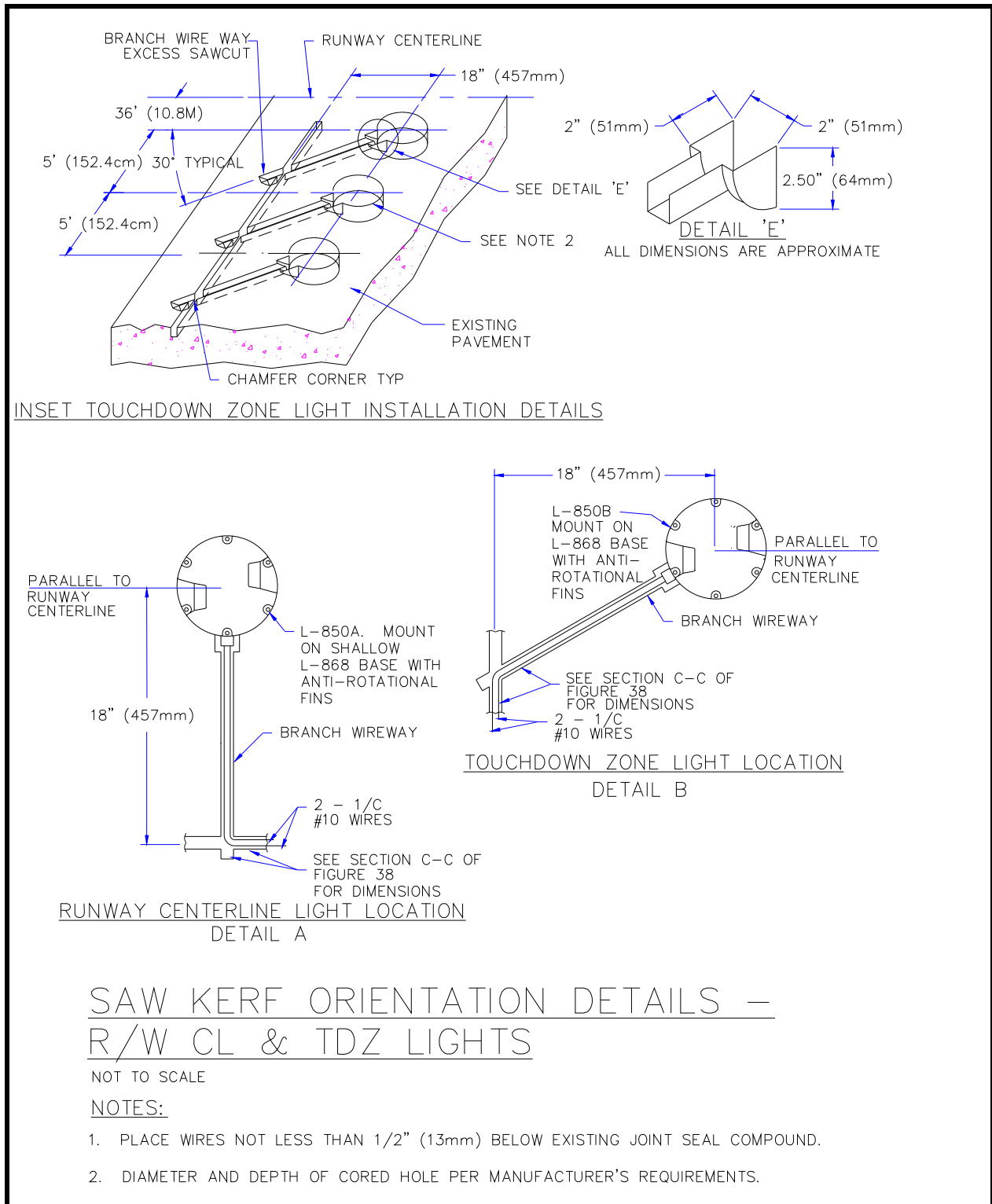

Figure 39. Saw Kerf Orientation Details – R/W Centerline and TDZ Lights.

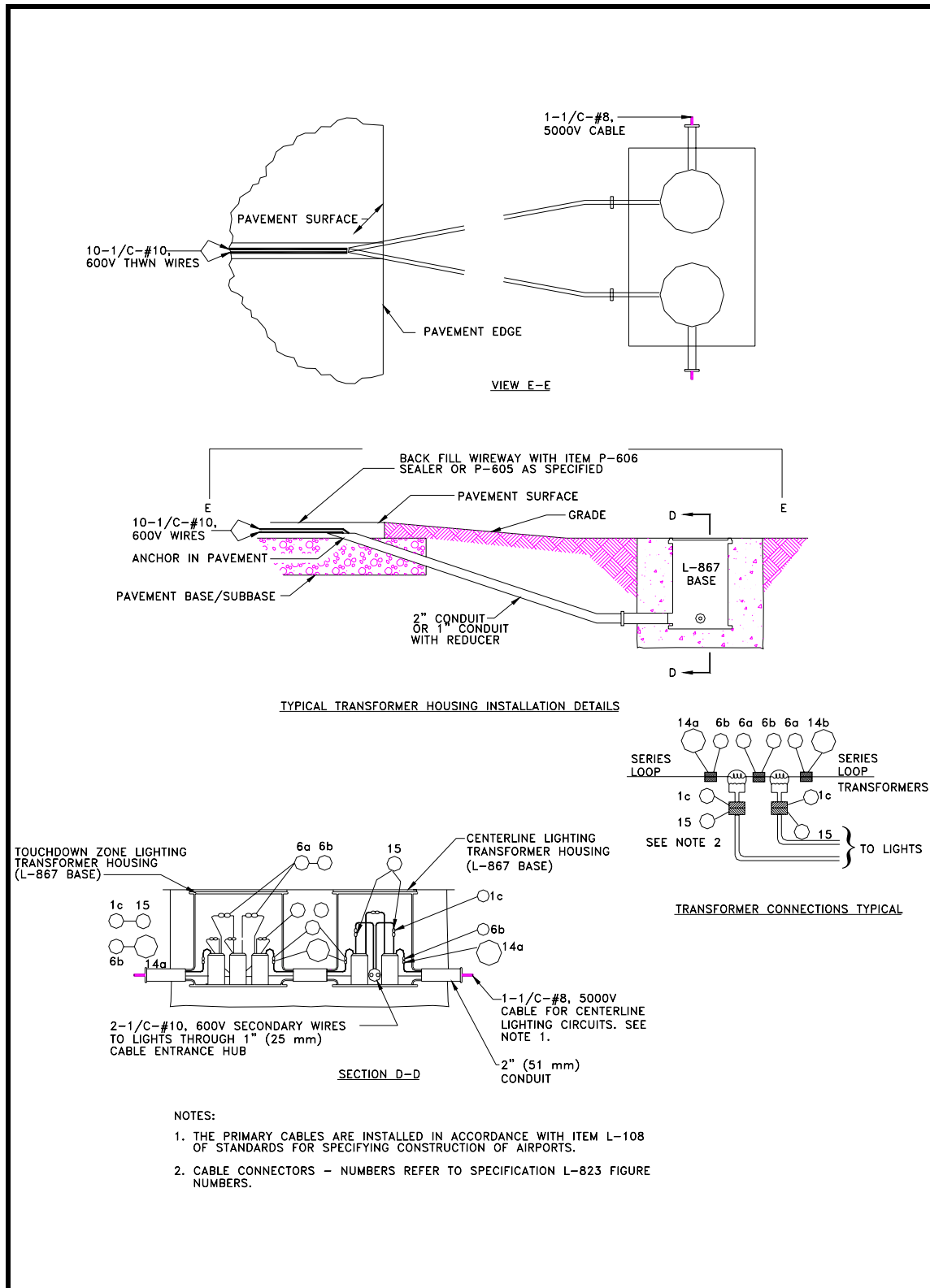

Figure 40. Transformer Housing Installation Details Inset Type Lighting Fixtures.

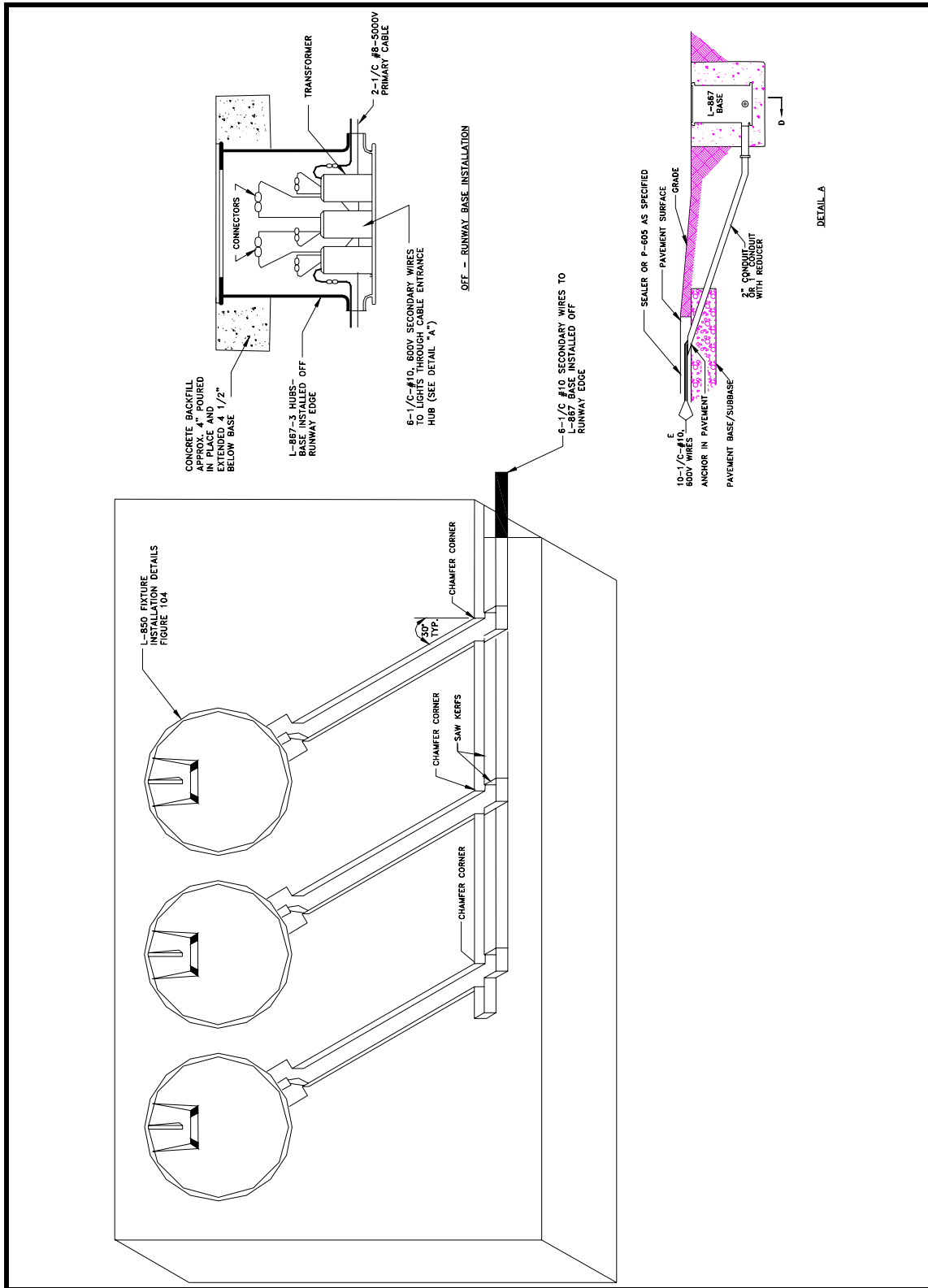

Figure 41. Typical Equipment Layout, Inset Type Lighting Fixtures.