



U.S. Department
of Transportation
Federal Aviation
Administration

AIRPORT DESIGN

/ INCORPORATES CHANGES 1 THRU 13 /

AC: 150/5300-13
Date: 9/29/89

Advisory Circular

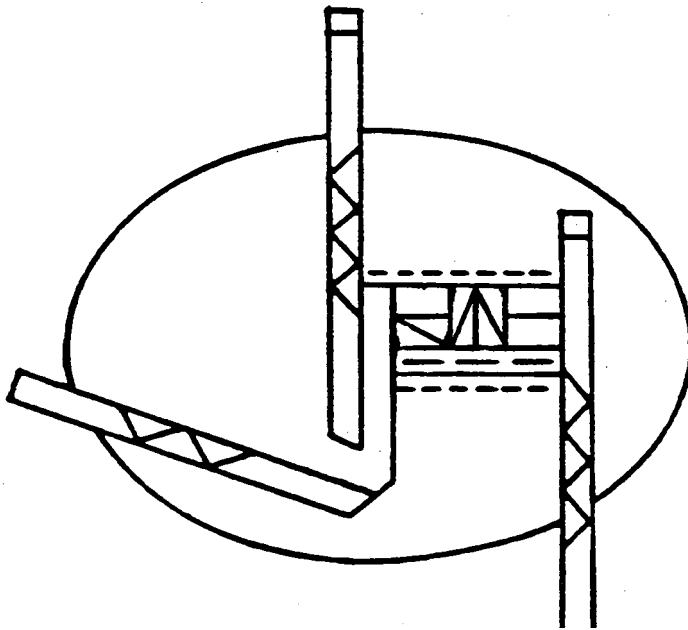



U.S. Department
of Transportation
**Federal Aviation
Administration**

Advisory Circular

Subject: AIRPORT DESIGN

Date: 9/29/89
Initiated by: AAS-110

AC No: 150/5300-13
Change:

1. **PURPOSE.** This advisory circular (AC) contains the Federal Aviation Administration's (FAA) standards and recommendations for airport design.

2. **CANCELLATION.** This (AC) cancels the following publications:

a. AC 150/5300-2D, Airport Design Standards--Site Requirements for Terminal Navigational Facilities, dated March 10, 1980.

b. AC 150/5300-4B, Utility Airports--Air Access to National Transportation, dated June 24, 1975.

c. AC 150/5300-12, Airport Design Standards--Transport Airports, dated February 28, 1983.

d. AC 150/5325-5C, Aircraft Data, dated June 29, 1987.

e. AC 150/5335-2, Airport Aprons, dated January 27, 1965.

3. **APPLICATION.** The standards and recommendations contained in this advisory circular are recommended by the Federal Aviation Administration for use in the design of civil airports. For airport projects receiving Federal grant-in-aid assistance, the use of these standards is mandatory. At certificated airports, the standards and recommendations may be used to satisfy specific requirements of Federal Aviation Regulations (FAR) Part 139, Certification and Operations: Land Airports Serving Certain Air Carriers, Subpart D.

Leonard E. Mudd

Leonard E. Mudd, Director
Office of Airport Safety and Standards

CONTENTS

Paragraph	Page
Chapter 1. REGULATORY REQUIREMENTS AND DEFINITION OF TERMS	
1. GENERAL	1
2. DEFINITIONS	1
3. RELATED/REFERENCED READING MATERIAL	3
4. AIRPORT REFERENCE CODE (ARC).....	5
5. AIRPORT LAYOUT PLAN	5
6. MODIFICATION OF AIRPORT DESIGN STANDARDS TO MEET LOCAL CONDITIONS	5
7. NOTICE TO THE FAA OF AIRPORT DEVELOPMENT	5
8. NOTICE TO THE FAA OF PROPOSED CONSTRUCTION	6
9. FAA STUDIES.....	6
10. FEDERAL ASSISTANCE	6
11. ENVIRONMENTAL ASSESSMENTS.....	6
12. STATE ROLE	6
13. LOCAL ROLE	6
14. to 199. RESERVED	6
Chapter 2. AIRPORT GEOMETRY	
200. INTRODUCTION	9
201. PRINCIPLES OF APPLICATION	9
202. RUNWAY LOCATION AND ORIENTATION	9
203. ADDITIONAL RUNWAYS	10
204. TAXIWAY SYSTEM	10
205. AIRPORT APRONS	10
206. SEPARATION STANDARDS	10
207. PARALLEL RUNWAY SEPARATION--SIMULTANEOUS VFR OPERATIONS	11
208. PARALLEL RUNWAY SEPARATION--SIMULTANEOUS IFR OPERATIONS	11
209. RUNWAY TO PARALLEL TAXIWAY AND TAXILANE SEPARATION.....	12
210. BUILDING RESTRICTION LINE (BRL)	12
211. OBJECT CLEARING CRITERIA	12
212. RUNWAY PROTECTION ZONE (RPZ).....	13
213. to 299. RESERVED	13
Chapter 3. RUNWAY DESIGN	
300. INTRODUCTION.....	21
301. RUNWAY LENGTH	21
302. RUNWAY WIDTH.....	21
303. RUNWAY SHOULDERS.....	21
304. RUNWAY BLAST PAD.....	21
305. RUNWAY SAFETY AREA (RSA).....	21
306. OBSTACLE FREE ZONE (OFZ).....	22
307. RUNWAY OBJECT FREE AREA	23
308. CLEARWAY STANDARDS.....	23
309. STOPWAY STANDARDS.....	23
310. RESCUE AND FIREFIGHTING ACCESS.....	24
311. to 399. RESERVED	24
Chapter 4. TAXIWAY AND TAXILANE DESIGN	
400. INTRODUCTION	33
401. DIMENSIONAL STANDARDS	33
402. TAXIWAY SHOULDERS.....	33
403. TAXIWAY SAFETY AREA (TSA).....	33
404. TAXIWAY AND TAXILANE OBJECT FREE AREA (OFA)	33
405. PARALLEL TAXIWAY.....	33
406. TAXIWAY INTERSECTIONS	34

407.	ENTRANCE TAXIWAYS.....	34
408.	BYPASS TAXIWAYS.....	34
409.	HOLDING BAYS.....	34
410.	TURNAROUNDS.....	34
411.	DUAL PARALLEL TAXIWAYS.....	34
412.	TAXIWAY BETWEEN PARALLEL RUNWAYS.....	35
413.	EXIT TAXIWAYS.....	35
414.	APRON TAXIWAYS AND TAXILANES.....	35
415.	END-AROUND TAXIWAYS.....	35
416. to 499.	RESERVED.....	38

Chapter 5. SURFACE GRADIENT AND LINE OF SIGHT

500.	INTRODUCTION.....	49
501.	BACKGROUND.....	49
502.	SURFACE GRADIENT STANDARDS.....	49
503.	LINE OF SIGHT STANDARDS.....	56
504. to 599.	RESERVED.....	56

Chapter 6. SITE REQUIREMENTS FOR NAVAID AND ATC FACILITIES

600.	GENERAL.....	59
601.	MICROWAVE LANDING SYSTEM.....	59
602.	INSTRUMENT LANDING SYSTEM.....	61
603.	NONDIRECTIONAL BEACON.....	63
604.	VERY HIGH FREQUENCY OMNIRANGE.....	64
605.	APPROACH LIGHTING SYSTEMS.....	64
606.	OMNIDIRECTIONAL APPROACH LIGHTING SYSTEMS.....	65
607.	LEAD-IN LIGHTING SYSTEMS.....	65
608.	AIRPORT ROTATING BEACONS.....	65
609.	AIRPORT TRAFFIC CONTROL TOWERS.....	65
610.	AIRPORT SURVEILLANCE RADAR.....	66
611.	AIRPORT SURFACE DETECTION EQUIPMENT.....	66
612.	RUNWAY VISUAL RANGE FACILITIES.....	66
613.	AUTOMATIC WEATHER OBSERVATION STATIONS (AWOS).....	66
614.	PHYSICAL SECURITY.....	67
615.	CABLE PROTECTION.....	67
616. to 699.	RESERVED.....	67

Chapter 7. RUNWAY AND TAXIWAY BRIDGES

700.	INTRODUCTION.....	69
701.	SITING PRECEPTS.....	69
702.	DIMENSIONS.....	69
703.	LOAD CONSIDERATIONS.....	69
704.	DECK DESIGN.....	69
705.	MARKING AND LIGHTING.....	69
706.	OTHER CONSIDERATIONS.....	69
707.	PASSENGER AND BAGGAGE TUNNELS.....	70
708. to 799.	RESERVED.....	70

Chapter 8. THE EFFECTS AND TREATMENT OF JET BLAST

800.	INTRODUCTION.....	77
801.	JET BLAST EFFECTS.....	77
802.	BLAST FENCES.....	77
803.	SHOULDERS AND BLAST PADS.....	78

Appendix 1. WIND ANALYSIS

1.	OBJECTIVE.....	87
2.	CROSSWINDS	87
3.	COVERAGE AND ORIENTATION OF RUNWAYS	87
4.	ASSEMBLING WIND DATA.....	87
5.	ANALYZING WIND DATA.....	88
6.	CONCLUSIONS	88
7.	ASSUMPTIONS	88
8.	COMPUTER WIND ANALYSIS.....	88

Appendix 2. RUNWAY END SITING REQUIREMENTS

1.	PURPOSE.....	100
2.	APPLICATION.....	100
3.	LIMITATIONS	100
4.	EVALUATION CONSIDERATIONS.....	100
5.	CLEARANCE REQUIREMENTS	101

Appendix 3. AIRPORT REFERENCE POINT

1.	DISCUSSION.....	109
2.	SAMPLE COMPUTATION	109
3.	ACCURACY	109

Appendix 4. COMPASS CALIBRATION PAD

1.	PURPOSE.....	111
2.	BACKGROUND.....	111
3.	APPLICATION.....	111
4.	DESIGN OF COMPASS CALIBRATION PAD.....	111
5.	LOCATION OF COMPASS CALIBRATION PAD.....	112
6.	CONSTRUCTION OF COMPASS CALIBRATION PAD.....	112
7.	VOR CHECKPOINT	113

Appendix 5. SMALL AIRPORT BUILDINGS, AIRPLANE PARKING, AND TIEDOWNS

1.	GENERAL	117
2.	TRANSIENT APRON	117
3.	APRON FOR BASED AIRPLANES	117
4.	TIEDOWNS	118
5.	OTHER CONSIDERATIONS	118
6.	HANGARS.....	118
7.	ADMINISTRATION BUILDING	118
8.	AIRPORT SURVEY	122
9.	BUILDING PLAN	122
10.	EXPANSION	122
11.	CIRCULATION.....	122
12.	WAITING ROOM.....	122
13.	MANAGER'S OFFICE	123
14.	EATING FACILITIES	123
15.	PUBLIC RESTROOMS.....	123
16.	ROADS AND AUTO PARKING	123

Appendix 6. METRIC CONVERSION AND TYPICAL AIRPORT LAYOUT PLAN

Appendix cancelled (pp. 125-130)

Appendix 7. AIRPORT LAYOUT PLAN COMPONENTS AND PREPARATION

Appendix cancelled (pp. 131-138)

Appendix 8. RUNWAY DESIGN RATIONALE

1.	SEPARATIONS	139
2.	OBSTACLE FREE ZONE (OFZ)	139
3.	RUNWAY SAFETY AREA	139
4.	RUNWAY OBJECT FREE AREA (ROFA).....	139
5.	RUNWAY SHOULDERS AND BLAST PADS	140
6.	CLEARWAY	140
7.	STOPWAY	140
8.	RUNWAY PROTECTION ZONE (RPZ).....	140

Appendix 9. TAXIWAY AND TAXILANE DESIGN RATIONALE

1.	INTRODUCTION	141
2.	BACKGROUND AND RATIONALE.....	141
3.	EXIT TAXIWAY LOCATION.....	142
4.	WINGTIP TRACE	146

Appendix 10. TAXIWAY FILLET DESIGN

1.	INTRODUCTION	149
2.	EXAMPLE NO. 1, JUDGMENTAL OVERSTEERING.....	150
3.	EXAMPLE NO. 2, MAINTAINING COCKPIT OVER CENTERLINE	150

Appendix 11. COMPUTER PROGRAM

1.	AIRPORT DESIGN (FOR MICROCOMPUTERS) VERSION 4.2	153
2.	HOW TO OBTAIN A COPY OF AIRPORT DESIGN (FOR MICROCOMPUTERS) VERSION 4.2.....	153
3.	REQUIREMENTS.....	153
4.	SETUP ON A MICROCOMPUTER.....	153
5.	RUN AIRPORT DESIGN PROGRAM.....	153
6.	HOT KEYS.....	153
7.	RUNWAY AND TAXIWAY WIDTH AND CLEARANCE STANDARD DIMENSIONS.....	154
8.	RECOMMENDED RUNWAY LENGTHS	154
9.	STANDARD WIND ANALYSIS	154
10.	TAXIWAY DESIGN.....	155
11.	AIRPORT CAPACITY AND DELAY FOR LONG RANGE PLANNING	156
12.	DECLARED DISTANCE LENGTHS	156
13.	INPUT AIRPLANE DATA AVAILABILITY	156

Appendix 12. AIRPLANE DATA

1.	BACKGROUND	165
2.	EXPLANATORY INFORMATION	166

Appendix 13. AIRPLANES ARRANGED BY AIRPLANEMANUFACTURER AND AIRPORT REFERENCE CODE

Section 1.	Alphabetical Listing (U.S. customary units).....	251
Section 2.	Alphabetical Listing (SI units).....	257
Section 3.	Listing Small Airplanes by Airport Reference Code (U.S. customary units).....	263
Section 4.	Listing Large Airplanes by Airport Reference Code (U.S. customary units).....	264
Section 5.	Listing Small Airplanes by Airport Reference Code (SI units).....	269
Section 6.	Listing Large Airplanes by Airport Reference Code (SI units).....	270

Appendix 14. DECLARED DISTANCES

1.	APPLICATION	275
2.	BACKGROUND	275
3.	FAA APPROVAL FOR APPLYING DECLARED DISTANCES IN AIRPORT DESIGN.....	275
4.	RUNWAY SAFETY AREA (RSA) AND RUNWAY OBJECT FREE AREA (ROFA) LENGTHS.....	276
5.	RUNWAY PROTECTION ZONE (RPZ) LOCATION AND SIZE	276
6.	CLEARWAY LOCATION	276
7.	NOTIFICATION	276

Appendix 15. TRANSFER OF ELECTRONIC DATA

1.	INTRODUCTION	283
2.	BACKGROUND	283
3.	DEFINITIONS	283
4.	APPLICATION	283
5.	CADD FILE DELIVERABLES.....	284
6.	DATABASES DELIVERABLES	286
7.	PHOTOGRAMMETRY DELIVERABLES	286
8.	FEATURES AND OBJECTS CODE.....	287
9.	MEDIA	289
10.	FAA POINT OF CONTACT	289

Appendix 16. NEW INSTRUMENT APPROACH PROCEDURES

1.	BACKGROUND	291
2.	INTRODUCTION	291
3.	ACTION	291
4.	DEFINITIONS	291

Appendix 17. MINIMUM DISTANCES BETWEEN CERTAIN AIRPORT FEATURES AND ANY ON-AIRPORT AGRICULTURE CROPS (1 page).

Appendix 18. ACRONYMS (1 page).

Appendix 19. INDEX (4 pages).

Table	Page
1-1. Increases in airport design standards associated with an upgrade in the first component (aircraft approach category) of the airport reference code.....	7
1-2. Increases in airport design standards to provide for lower approach visibility minimums	8
2-1. Runway separation standards for aircraft approach categories A & B.....	14
2-2. Runway separation standards for aircraft approach categories C & D.....	15
2-3. Taxiway and taxilane separation standards	16
2-4. Runway protection zone (RPZ) dimensions	19
3-1. Runway design standards for aircraft approach category A & B visual runways and runways with not lower than 3/4-statute mile (1 200 m) approach visibility minimums	25
3-2. Runway design standards for aircraft approach categories A & B runways with lower than 3/4-statute mile (1 200 m) approach visibility minimums	26
3-3. Runway design standards for aircraft approach categories C & D.....	26-1
4-1. Taxiway dimensional standards.....	38
4-2. Taxiway fillet dimensions	40
4-3. Wingtip clearance standards.....	40
4-4. Visual screen height calculation formula (same elevation as runway).....	48-5
4-5. Visual screen height calculation formula (EAT below DER elevation) for Design Group III.....	48-6
4-6. Visual screen height calculation formula (EAT below DER elevation) for Design Group IV	48-7
4-7. Visual screen height calculation formula (EAT below DER elevation) for Design Groups V and VI	48-8
4-8. Visual screen vertical height calculation tables.....	48-9
4-9. Visual screen panel wind-loading deflection allowance	48-12
4-10. CIE chromaticity coordinate limits.....	48-12
4-11. Minimum reflection levels.....	48-13
A2-1. Approach/Departure Requirements Table	103
A9-1. Exit taxiway cumulative utilization percentages	142
A16-1A. Precision instrument approach requirements.....	292
A16-1B. Approach procedure with vertical guidance (APV-RNP) approach requirements.....	293
A16-1C. Nonprecision approach requirements	294
A16-2. Survey requirements for instrument approach procedures	295
A17-1. Minimum Distances Between Certain Airport Features and Any On-Airport Agriculture Crops	296

Figure	Page
2-1. Typical airport layout	17
2-2. Parallel runway separation.....	18
2-3. Runway protection zone.....	20
3-1. Runway safety area.....	27
3-2. Obstacle free zone (OFZ) for visual runways and runways with not lower than 3/4 statute mile (1 200 m) approach visibility minimums.....	28
3-3. Obstacle free zone (OFZ) for runways serving small airplanes exclusively with lower than 3/4-statute mile (1 200 m) approach visibility minimums	29
3-4. Obstacle free zone (OFZ) for runways serving large airplanes with lower than 3/4-statute mile (1 200 m) approach visibility minimums.....	30
3-5. Obstacle free zone (OFZ) for runways serving large airplanes with lower than 3/4-statute mile (1 200 m) approach visibility minimums and displaced threshold	31
3-6. Precision object free zone.....	32
3-7. Clearway.....	32-1
3-8. Stopway.....	32-2
4-1. Taxiway intersection details	39
4-2. Maintaining cockpit over centerline	41
4-3. Judgmental oversteering.....	42
4-4. Example of pavement fillet computer program printout.....	43
4-5. Entrance taxiway	44
4-6. Bypass taxiway.....	44
4-7. Dual parallel taxiway entrance	45
4-8. Typical holding bay configurations.....	46

4-9.	Taxiway turnaround	46
4-10.	Crossover taxiway	47
4-11.	Right-angled exit taxiway	47
4-12.	Acute-angled exit taxiway	48
4-13.	Example of acute-angled exit taxiway computer layout data page 1	48-1
4-14.	Example of acute-angled exit taxiway computer layout data page 2	48-2
4-15.	Typical end-around taxiway layout	48-3
4-16.	End-around taxiway visual screen width calculations	48-4
4-17.	Visual screen width calculation formula	48-5
4-18.	Examples of mounting screen to vertical column	48-10
4-19.	Examples of panel layout for 13-foot-high screen	48-11
4-20.	Diagonal stripe orientation	48-12
4-21.	Examples of frangibility connections	48-14
5-1.	Longitudinal grade limitations for aircraft approach categories A & B	50
5-2.	Transverse grade limitations for aircraft approach categories A & B	51
5-3.	Longitudinal grade limitations for aircraft approach categories C & D	52
5-4.	Transverse grade limitations for aircraft approach categories C & D	53
5-5.	Runway safety area grade limitations beyond 200 feet (60 m) from the runway end	55
5-6.	Runway visibility zone	57
6-1.	AZ antenna siting	59
6-2.	Typical NAVAID placement	60
6-3.	AZ antenna critical area	61
6-4.	EL antenna siting	61
6-5.	EL antenna critical area	61
6-6.	ILS LOC siting and critical area	62
6-7.	GS siting and critical area	62
6-8.	Marker beacon site	63
6-9.	NDB site	63
6-10.	A TVOR installation	64
7-1.	Full width runway-taxiway bridge	71
7-2.	Cross-section full width runway-taxiway bridge	72
7-3.	Minimum width taxiway bridge with positive edge protection, O'Hare Airport, Chicago, IL	73
7-4.	Example structural deck and depressed roadway, O'Hare Airport, Chicago, IL	74
7-5.	Suggested shoulder marking of minimum width taxiway bridge	75
7-6.	Controlled use service road, Los Angeles International Airport, Los Angeles, CA	76
8-1.	Velocity distance curves, DC-8	79
8-2.	Velocity distance curves, B-727	80
8-3.	Velocity distance curves, B-747	81
8-4.	Velocity distance curves, DC-10	82
8-5.	Blast velocities of business jet airplanes	83
8-6.	Typical blast deflector fences, metal	84
8-7.	Typical blast deflector fences, concrete	85
A1-1.	Wind vector diagram	89
A1-2.	Typical environmental data service wind summary	90
A1-3.	Windrose blank showing direction and divisions	91
A1-4.	Completed windrose using figure A1-2 data	92
A1-5.	Windrose analysis	93
A1-6.	Windrose analysis--estimating area not included	94
A1-7.	Computer printout page 1	95
A1-8.	Computer printout page 2	96
A1-9.	Computer printout page 3	97
A1-10.	Lotus cell-formulas page 1	98
A1-11.	Lotus cell-formulas page 2	99
A2-1.	Approach slopes	105
A2-2.	Approach slopes—with offset approach course	106
A2-3.	Departure surface for Instrument Runways TERPS (40:1)	107
A2-4.	One-Engine Inoperative (OEI) Obstacle Identification Surface (62.5:1)	108
A3-1.	Sample layout	109

A3-2.	Sample computation - airport reference point	110
A4-1.	Marking layout and details of wheel block	114
A4-2.	Type I. compass calibration pad	115
A4-3.	Type II. compass calibration pad	116
A5-1.	Parking apron area	119
A5-2.	Tiedown layouts	120
A5-3.	T-hanger layout	121
A8-1.	Approximate distance airplanes undershoot and overrun the runway end	140
A9-1.	Wingtip clearance - parallel taxiways	143
A9-2.	Wingtip clearance from taxiway	144
A9-3.	Wingtip clearance from apron taxiway	144
A9-4.	Wingtip clearance from taxilane	145
A9-5.	Pavement edge clearance on tangent	146
A9-6.	McDonnell-Douglas MD-88 wingtip clearance trace for a 100-foot (30.5 m) radius centerline	147
A9-7.	McDonnell-Douglas MD-88 wingtip clearance trace for a 120-foot (36.5 m) radius offset centerline	147
A9-8.	Boeing 727-200 wingtip clearance trace for a 120-foot (36.5 m) radius offset centerline	148
A9-9.	Boeing 727-100 wingtip clearance trace for a 120-foot (36.5 m) radius offset centerline	148
A10-1.	Taxiway intersection details	151
A10-2.	Depiction of symbols	152
A11-1.	THIS FIGURE INTENTIONALLY LEFT BLANK	156
A11-2.	Estimated airplane data elements for input in the computer program	157
A11-3.	Example of the airport design airplane and airport data window	158
A11-4.	Example printout of width and clearance standard dimensions page 1	158
A11-5.	Example printout of width and clearance standard dimensions page 2	159
A11-6.	Example printout of wind analysis (two bi-directional runways)	160
A11-7.	Example printout of windrose (two bi-directional runways)	161
A11-8.	Example printout of wind analysis (one uni-directional runway)	162
A11-9.	Example printout of windrose (one uni-directional runway)	163
A11-10.	Nomenclature used in the taxiway design task	164
A11-11.	Nomenclature used in the declared distance task	164
A12-1.	Single engine, high wing, tailwheel airplanes 8,000 lb. (3,628 Kg) or less	167
A12-2.	Single engine, high wing, tailwheel airplanes 8,000 lb. (3,628 Kg) or less (cont'd)	168
A12-3.	Single engine, high wing, tricycle gear airplanes 8,000 lb. (3,628 Kg) or less	169
A12-4.	Single engine, low wing, tricycle gear airplanes 8,000 lb. (3,628 Kg) or less	170
A12-5.	Single engine, low wing, tricycle gear airplanes 8,000 lb. (3,628 Kg) or less (cont'd)	171
A12-6.	Twin engine, low or mid wing, tricycle gear airplanes 8,000 lb. (3,628 Kg) or less	172
A12-7.	Twin engine, low or mid wing, tricycle gear airplanes 8,000 lb. (3,628 Kg) or less (cont'd)	173
A12-8.	Twin engine, high or mid wing, tricycle gear airplanes 8,000 lb. (3,628 Kg) or less	174
A12-9.	Aérospatiale Nord 262	175
A12-10.	Aérospatiale/Sud SE-210 Caravelle	176
A12-11.	Airbus Industries A300, 310, and 320	177
A12-12.	Avions de Transport Regional ATR-42 & -72	178
A12-13.	Avions Marcel Dassault Mystère 20 (Fan Jet Falcon)	179
A12-14.	BAe 1-11	180
A12-15.	B.A.C./SNIAS Concorde	181
A12-16.	B.A.C./Vickers VC-10	182
A12-17.	B.A.C./Vickers Viscount	183
A12-18.	Beech Starship	184
A12-19.	Beechcraft Airliner	185
A12-20.	Beechcraft King Air	186
A12-21.	Beechcraft Model 18 and Conversions	187
A12-22.	Beechcraft Queen Air	188
A12-23.	Boeing B-52 Stratofortress	189
A12-24.	Boeing KC-97L	190
A12-25.	Boeing KC-135A	191
A12-26.	Boeing 707-720	192
A12-27.	Boeing 727	193
A12-28.	Boeing 737	194

A12-29. Boeing 747	195
A12-30. Boeing 757	196
A12-31. Boeing 767	197
A12-32. British Aerospace 146	198
A12-33. Canadiar CL-44	199
A12-34. Canadiar CL-66	200
A12-35. Cessna Citation	201
A12-36. Construcciones Aeronauticas CASA C-212 and 235	202
A12-37. Convair-liner and Turboprop Conversions	203
A12-38. De Havilland Canada C-7 Caribou	204
A12-39. De Havilland Canada DASH 7 & DASH 8	205
A12-40. Douglas C-124 Globemaster	206
A12-41. De Havilland Canada DHC-6 Twin Otter	207
A12-42. Dornier Gmb H	208
A12-43. Douglas DC-3	209
A12-44. Douglas DC-4/6/7	210
A12-45. Embraer EmB 110	211
A12-46. Embraer EmB 120	212
A12-47. Fairchild C-119K Flying Boxcar	213
A12-48. Fairchild C-123K Provider	214
A12-49. Fairchild F-27	215
A12-50. Fokker F-27	216
A12-51. Fokker F-28	217
A12-52. Gates Learjet	218
A12-53. General Dynamics/Convair 880/990	219
A12-54. Grumman Gulfstream I	220
A12-55. Grumman Gulfstream II	221
A12-56. Grumman G-64/G-III	222
A12-57. Grumman G-73	223
A12-58. Hamburger-Flugzeugbau HFB-320 Hansa	224
A12-59. Hawker Siddeley DH. 104 Dove	225
A12-60. Hawker Siddeley DH. 114 Heron	226
A12-61. Hawker Siddeley HS-125	227
A12-62. Hawker Siddeley HS-748	228
A12-63. Ilyushin IL-62	229
A12-64. Israel Aircraft Industries Westwind	230
A12-65. Lockheed Constellation and Super Constellation	231
A12-66. Lockheed C-5B Galaxy	232
A12-67. Lockheed C-141 Starlifter	233
A12-68. Lockheed L-188 Electra II	234
A12-69. Lockheed L-100 Hercules	235
A12-70. Lockheed L-1011 Tristar	236
A12-71. Lockheed L-1329 Jetstar	237
A12-72. Martin 404	238
A12-73. McDonnell-Douglas DC-8	239
A12-74. McDonnell-Douglas DC-9 and MD-80	240
A12-75. McDonnell-Douglas DC-10	241
A12-76. McDonnell-Douglas MD-11	242
A12-77. Mitsubishi MU-2	243
A12-78. Nihon/N.A.M.C. YS-11A	244
A12-79. Rockwell International NA-265 Sabreliner	245
A12-80. SAAB SF 340	246
A12-81. Short Brothers	247
A12-82. Shorts SC. 5/10 Belfast	248
A12-83. Swearingen Merlin	249
A12-84. Swearingen Metro	250
A14-1. Takeoff run available (TORA)	277
A14-2. Takeoff distance available (TODA)	278

A14-3. Accelerate-stop distance available (ASDA)279
A14-4. Landing distance available (LDA)280
A14-5. Example of a runway extended to 7000 feet281
A14-6. Example of a runway with threshold displaced for runway safety area282

Chapter 1. REGULATORY REQUIREMENTS AND DEFINITION OF TERMS

1. GENERAL. Section 103 of the Federal Aviation Act of 1958 states in part, “In the exercise and performance of his power and duties under this Act, the Secretary of Transportation shall consider the following, among other things, as being in the public interest: (a) The regulation of air commerce in such manner as to best promote its development and safety and fulfill the requirements of defense; (b) The promotion, encouragement, and development of civil aeronautics”

This public charge, in effect, requires the development and maintenance of a national system of safe, delay-free, and cost-effective airports. The use of the standards and recommendations contained in this publication in the design of airports supports this public charge. These standards and recommendations, however, do not limit or regulate the operations of aircraft.

2. DEFINITIONS. As used in this publication, the following terms mean:

Aircraft Approach Category. A grouping of aircraft based on 1.3 times their stall speed in their landing configuration at the certificated maximum flap setting and maximum landing weight at standard atmospheric conditions. The categories are as follows:

Category A: Speed less than 91 knots.

Category B: Speed 91 knots or more but less than 121 knots.

Category C: Speed 121 knots or more but less than 141 knots.

Category D: Speed 141 knots or more but less than 166 knots.

Category E: Speed 166 knots or more.

Airplane Design Group (ADG). A grouping of airplanes based on wingspan or tail height. Where an airplane is in two categories, the most demanding category should be used. The groups are as follows:

Group I: Up to but not including 49 feet (15 m) wingspan or tail height up to but not including 20 feet.

Group II: 49 feet (15 m) up to but not including 79 feet (24 m) wingspan or tail height from 20 up to but not including 30 feet.

Group III: 79 feet (24 m) up to but not including 118 feet (36 m) wingspan or tail height from 30 up to but not including 45 feet.

Group IV: 118 feet (36 m) up to but not including 171 feet (52 m) wingspan or tail height from 45 up to but not including 60 feet.

Group V: 171 feet (52 m) up to but not including 214 feet (65 m) wingspan or tail height from 60 up to but not including 66 feet.

Group VI: 214 feet (65 m) up to but not including 262 feet (80 m) wingspan or tail height from 66 up to but not including 80 feet.

Table 1-1. Airplane Design Groups (ADG)

Group #	Tail Height (ft)	Wingspan (ft)
I	<20	<49
II	20 - <30	49 - <79
III	30 - <45	79 - <118
IV	45 - <60	118 - <171
V	60 - <66	171 - <214
VI	66 - <80	214 - <262

Airport Elevation. The highest point on an airport's usable runway expressed in feet above mean sea level (MSL).

Airport Layout Plan (ALP). The plan of an airport showing the layout of existing and proposed airport facilities.

Airport Reference Point (ARP). The latitude and longitude of the approximate center of the airport.

Blast Fence. A barrier used to divert or dissipate jet blast or propeller wash.

Building Restriction Line (BRL). A line which identifies suitable building area locations on airports.

Clear Zone. See Runway Protection Zone.

Clearway (CWY). A defined rectangular area beyond the end of a runway cleared or suitable for use in lieu of runway to satisfy takeoff distance requirements.

Compass Calibration Pad. An airport facility used for calibrating an aircraft compass.

Declared Distances. The distances the airport owner declares available for the airplane's takeoff run, takeoff distance, accelerate-stop distance, and landing distance requirements. The distances are:

Takeoff run available (TORA). The runway length declared available and suitable for the ground run of an airplane taking off;

Takeoff distance available (TODA). The TORA plus the length of any remaining runway or clearway (CWY) beyond the far end of the TORA;

NOTE: The full length of TODA may not be usable for all takeoffs because of obstacles in the departure area. The usable TODA length is aircraft performance dependent and, as such, must be determined by the aircraft operator before each takeoff and requires knowledge of the location of each controlling obstacle in the departure area.

Accelerate-stop distance available (ASDA). The runway plus stopway (SWY) length declared available and suitable for the acceleration and deceleration of an airplane aborting a takeoff; and

Landing distance available (LDA). The runway length declared available and suitable for a landing airplane.

Fixed By Function NAVAID. An air navigation aid (NAVAID) that must be positioned in a particular location in order to provide an essential benefit for civil aviation is fixed by function. Exceptions are:

a. Equipment shelters, junction boxes, transformers, and other appurtenances that support a fixed by function NAVAID *are not* fixed by function unless operational requirements require them to be located in close proximity to the NAVAID.

b. Some NAVAIDS, such as localizers, can provide beneficial performance even when they are not located at their optimal location. These NAVAIDS are not fixed by function.

Fragible NAVAID. A navigational aid (NAVAID) which retains its structural integrity and stiffness up to a designated maximum load, but on impact from a greater load, breaks, distorts, or yields in such a manner as to present the minimum hazard to aircraft. The term NAVAID includes electrical and visual air navigational aids, lights, signs, and associated supporting equipment.

Hazard to Air Navigation. An object which, as a result of an aeronautical study, the FAA determines will have a substantial adverse effect upon the safe and efficient use of navigable airspace by aircraft, operation of air navigation facilities, or existing or potential airport capacity.

Large Airplane. An airplane of more than 12,500 pounds (5 700 kg) maximum certificated takeoff weight.

Low Impact Resistant Supports (LIRS). Supports designed to resist operational and environmental static loads and fail when subjected to a shock load such as that from a colliding aircraft.

Object. Includes, but is not limited to above ground structures, NAVAIDs, people, equipment, vehicles, natural growth, terrain, and parked aircraft.

Object Free Area (OFA). An area on the ground centered on a runway, taxiway, or taxilane centerline provided to enhance the safety of aircraft operations by having the area free of objects, except for objects that need to be located in the OFA for air navigation or aircraft ground maneuvering purposes.

Obstacle Clearance Surface (OCS). An inclined obstacle evaluation surface associated with a glidepath. The separation between this surface and the glidepath angle at any given distance from GPI defines the MINIMUM required obstruction clearance at that point.

Obstacle Free Zone (OFZ). The OFZ is the airspace below 150 feet (45 m) above the established airport elevation and along the runway and extended runway centerline that is required to be clear of all objects, except for frangible visual NAVAIDs that need to be located in the OFZ because of their function, in order to provide clearance protection for aircraft landing or taking off from the runway, and for missed approaches. The OFZ is sub-divided as follows:

Runway OFZ. The airspace above a surface centered on the runway centerline.

Inner-approach OFZ. The airspace above a surface centered on the extended runway centerline. It applies to runways with an approach lighting system.

Inner-transitional OFZ. The airspace above the surfaces located on the outer edges of the runway OFZ and the inner-approach OFZ. It applies to runways with approach visibility minimums lower than 3/4-statute mile (1 200 m).

Obstruction to Air Navigation. An object of greater height than any of the heights or surfaces presented in Subpart C of Code of Federal Regulation (14 CFR), Part 77. (Obstructions to air navigation are presumed to be hazards to air navigation until an FAA study has determined otherwise.)

Precision Approach Category I (CAT I) Runway. A runway with an instrument approach procedure which provides for approaches to a decision height (DH) of not less than 200 feet (60 m) and visibility of not less than 1/2 mile (800 m) or Runway Visual Range (RVR) 2400 (RVR 1800 with operative touchdown zone and runway centerline lights).

Precision Approach Category II (CAT II) Runway. A runway with an instrument approach procedure which provides for approaches to a minima less than CAT I to as low as a decision height (DH) of not less than 100 feet (30 m) and RVR of not less than RVR 1200.

Precision Approach Category III (CAT III) Runway. A runway with an instrument approach procedure which provides for approaches to minima less than CAT II.

Runway (RW). A defined rectangular surface on an airport prepared or suitable for the landing or takeoff of airplanes.

Runway Blast Pad. A surface adjacent to the ends of runways provided to reduce the erosive effect of jet blast and propeller wash.

Runway Protection Zone (RPZ). An area off the runway end to enhance the protection of people and property on the ground.

Runway Safety Area (RSA). A defined surface surrounding the runway prepared or suitable for reducing the risk of damage to airplanes in the event of an undershoot, overshoot, or excursion from the runway.

Shoulder. An area adjacent to the edge of paved runways, taxiways, or aprons providing a transition between the pavement and the adjacent surface; support for aircraft running off the pavement; enhanced drainage; and blast protection.

Small Airplane. An airplane of 12,500 pounds (5 700 kg) or less maximum certificated takeoff weight.

Stopway (SWY). A defined rectangular surface beyond the end of a runway prepared or suitable for use in lieu of runway to support an airplane, without causing structural damage to the airplane, during an aborted takeoff.

Taxilane (TL). The portion of the aircraft parking area used for access between taxiways and aircraft parking positions.

Taxiway (TW). A defined path established for the taxiing of aircraft from one part of an airport to another.

Taxiway Safety Area (TSA). A defined surface alongside the taxiway prepared or suitable for reducing the risk of damage to an airplane unintentionally departing the taxiway.

Threshold (TH). The beginning of that portion of the runway available for landing. In some instances, the landing threshold may be displaced.

Displaced Threshold. A threshold that is located at a point on the runway other than the designated beginning of the runway.

Visual Runway. A runway without an existing or planned straight-in instrument approach procedure.

3. RELATED/REFERENCED READING MATERIAL. The following is a listing of documents referenced in other parts of this advisory circular. Advisory Circulars 00-2 and 00-44 may be obtained by writing to: The U.S. Department of Transportation; Utilization and Storage Section, M-443.2; Washington, D.C. 20590. The most current versions of the ACs listed below are available online at www.faa.gov.

NOTE: Some of the ACs in this paragraph have been cancelled but are still referenced in the main document. They will continue to be listed here and shown as cancelled until the next complete revision of the document.

- a. AC 00-2, Advisory Circular Checklist.
- b. AC 00-44, Status of Federal Aviation Regulations.
- c. AC 20-35, Tiedown Sense.
- d. AC 70/7460-1, Obstruction Marking and Lighting.
- e. AC 70/7460-2, Proposed Construction or Alteration of Objects that May Affect the Navigable Airspace. (Cancelled)
- f. AC 107-1, Aviation Security-Airports.
- g. AC 120-29, Criteria for Approving Category I and Category II Landing Minima for FAR Part 121 Operators.
- h. AC 150/5000-3, Address List for Regional Airports Divisions and Airports District/Field Offices. (Cancelled)
- i. AC 150/5060-5, Airport Capacity and Delay.
- j. AC 150/5070-3, Planning the Airport Industrial Park. (Cancelled)
- k. AC 150/5070-6, Airport Master Plans.
- l. AC 150/5190-1, Minimum Standards for Commercial Aeronautical Activities on Public Airports. (Cancelled by AC 150/5190-5)

m. AC 150/5190-4, A Model Zoning Ordinance to Limit Height of Objects Around Airports.

n. AC 150/5190-5, Exclusive Rights and Minimum Standards for Commercial Aeronautical Activities. (Cancelled by AC 150/5190-6 and AC 150/5190-7)

o. AC 150/5190-6, Exclusive Rights at Federally-Obligated Airports

p. AC 150/5190-7, Minimum Standards for Commercial Aeronautical Activities

q. AC 150/5200-33, Hazardous Wildlife Attractants On or Near Airports.

r. AC 150/5220-16, Automated Weather Observing Systems (AWOS) for Non-Federal Applications.

s. AC 150/5230-4, Aircraft Fuel Storage, Handling, and Dispensing on Airports.

t. AC 150/5320-5, Airport Drainage.

u. AC 150/5320-6, Airport Pavement Design and Evaluation.

v. AC 150/5320-14, Airport Landscaping for Noise Control Purposes.

w. AC 150/5325-4, Runway Length Requirements for Airport Design.

x. AC 150/5340-1, Standards for Airport Marking.

y. AC 150/5340-5, Segmented Circle Marker Systems.

z. AC 150/5340-14, Economy Approach Lighting Aids. (Cancelled by AC 150/5340-30)

aa. AC 150/5340-18, Standards for Airport Sign Systems.

bb. AC 150/5340-21, Airport Miscellaneous Lighting Visual Aids. (Cancelled by AC 150/5340-30)

cc. AC 150/5340-24, Runway and Taxiway Edge Lighting System. (Cancelled by AC 150/5340-30)

dd. AC 150/5340-28, Precision Approach Path Indicator (PAPI) Systems. (Cancelled by AC 150/5340-30)

ee. AC 150/5340-30, Design and Installation Details for Airport Visual Aids

ff. AC 150/5345-52, Generic Visual Slope Indicators (GVGI).

gg. AC 150/5360-13, Planning and Design Guidelines for Airport Terminal Facilities.

hh. AC 150/5370-10, Standards for Specifying Construction of Airports.

ii. AC 150/5390-2, Heliport Design.

jj. 14 CFR Part 23, Airworthiness Standards: Normal, Utility, Acrobatic, and Commuter Category Airplanes.

kk. 14 CFR Part 25, Airworthiness Standards: Transport Category Airplanes.

ll. 14 CFR Part 77, Objects Affecting Navigable Airspace.

mm. 14 CFR Part 97, Standard Instrument Approach Procedures.

nn. 14 CFR Part 135, Operating Requirements: Commuter and On Demand Operations and Rules Governing Persons On Board Such Aircraft.

oo. 14 CFR Part 139, Certification of Airports.

pp. 14 CFR Part 151, Federal Aid to Airports.

qq. 14 CFR Part 152, Airport Aid Program.

rr. 14 CFR Part 153, Acquisition of U.S. Land for Public Airports. (Removed from Title 14)

ss. 14 CFR Part 154, Acquisition of Land for Public Airports Under the Airport and Airway Development Act of 1970. (Removed from Title 14)

tt. 14 CFR Part 157, Notice of Construction, Alteration, Activation, and Deactivation of Airports.

uu. Order 1050.1, Policies and Procedures for Considering Environmental Impacts.

vv. Order 5050.4, Airport Environmental Handbook.

ww. Order 5100.38, Airport Improvement Program (AIP) Handbook.

xx. Order 7400.2, Procedures for Handling Airspace Matters.

yy. Order 8200.1, United States Standard Flight Inspection Manual.

zz. Order 8260.3, United States Standard for Terminal Instrument Procedures (TERPS).

4. AIRPORT REFERENCE CODE (ARC). The ARC is a coding system used to relate airport design criteria to the operational and physical characteristics of the airplanes intended to operate at the airport.

a. Coding System. The airport reference code has two components relating to the airport design aircraft. The first component, depicted by a letter, is the *aircraft approach category* and relates to aircraft approach speed (operational characteristic). The second component, depicted by a Roman numeral, is the *airplane design group* and relates to airplane wingspan or tailheight (physical characteristics), whichever is the most restrictive. Generally, runways standards are related to aircraft approach speed, airplane wingspan, and designated or planned approach visibility minimums. Taxiway and taxilane standards are related to airplane design group.

b. Airport Design. Airport design first requires selecting the ARC(s), then the lowest designated or planned approach visibility minimums for each runway, and then applying the airport design criteria associated with the airport reference code and the designated or planned approach visibility minimums.

(1) An upgrade in the first component of the ARC may result in an increase in airport design standards. Table 1-1 depicts these increases.

(2) An upgrade in the second component of the ARC generally will result in a major increase in airport design standards.

(3) An airport upgrade to provide for lower approach visibility minimums may result in an increase in airport design standards. Table 1-2 depicts these increases.

(4) Operational minimums are based on current criteria, runways, airspace, and instrumentation. Unless this is taken into consideration in the development of the airport, the operational minimums may be other than proposed.

(5) For airports with two or more runways, it may be desirable to design all airport elements to meet the requirements of the most demanding ARC. However, it may be more practical to design some airport elements, e.g., a secondary runway and its associated taxiway, to standards associated with a lesser demanding ARC.

5. AIRPORT LAYOUT PLAN. An Airport Layout Plan (ALP) is a scaled drawing of existing and proposed land and facilities necessary for the operation and development of the airport. Any airport will benefit from a carefully developed plan that reflects current FAA design standards and planning criteria. For guidance on developing Airport Master Plans, refer to AC 150/5070-6, *Airport Master Plans*.

a. FAA-Approved ALP. All airport development carried out at Federally obligated airports must be done in accordance with an FAA-approved ALP. The FAA-approved

ALP, to the extent practicable, should conform to the FAA airport design standards existing at the time of its approval. Due to unique site, environmental, or other constraints, the FAA may approve an ALP not fully complying with design standards. Such approval requires an FAA study and finding that the proposed modification is safe for the specific site and conditions. When the FAA upgrades a standard, airport owners should, to the extent practicable, include the upgrade in the ALP before starting future development.

b. Guidance. AC 150/5070-6, *Airport Master Plans*, contains background information on the development of ALPs, as well as a detailed listing of the various components that constitute a well-appointed ALP.

c. Electronic Plans. The FAA recommends the development of electronic ALPs where practical.

6. MODIFICATION OF AIRPORT DESIGN STANDARDS TO MEET LOCAL CONDITIONS.

“Modification to standards” means any change to FAA design standards other than dimensional standards for runway safety areas. Unique local conditions may require modification to airport design standards for a specific airport. A modification to an airport design standard related to new construction, reconstruction, expansion, or upgrade on an airport which received Federal aid requires FAA approval. The request for modification should show that the modification will provide an acceptable level of safety, economy, durability, and workmanship. Appendixes 8 and 9 discuss the relationship between airplane physical characteristics and the design of airport elements. This rationale along with the computer program cited in appendix 11 may be used to show that the modification will provide an acceptable level of safety for the specified conditions, including the type of aircraft.

7. NOTICE TO THE FAA OF AIRPORT DEVELOPMENT.

14 CFR Part 157, *Notice of Construction, Activation, and Deactivation of Airports*, requires persons proposing to construct, activate, or deactivate an airport to give notice of their intent to the FAA. The notice applies to proposed alterations to the takeoff and landing areas, traffic patterns, and airport use, e.g., a change from private-use to public-use.

a. Notice Procedure. 14 CFR Part 157 requires airport proponents to notify the appropriate FAA Airports Regional or District Office at least 30 days before construction, alteration, deactivation, or the date of the proposed change in use. In an emergency involving essential public service, health, or safety, or when delay would result in a hardship, a proponent may notify the FAA by telephone and submit Form 7480-1, *Notice of Landing Area Proposal*, within 5 days.

b. The Notice. The notice consists of a completed FAA Form 7480-1, a layout sketch, and a location map. The layout sketch should show the airport takeoff and landing area configuration in relation to buildings, trees, fences, power lines, and other similar significant features. The preferred type of location map is the 7.5 minute U.S. Geological Survey

Quadrangle Map showing the location of the airport site. Form 7480-1 lists FAA Airports Office addresses.

c. FAA Action. The FAA evaluates the airport proposal for its impact upon the: safe and efficient use of navigable airspace; operation of air navigation facilities; existing or potential airport capacity; and safety of persons and property on the ground. The FAA notifies proponents of the results of the FAA evaluation.

d. Penalty for Failure to Provide Notice. Persons who fail to give notice are subject to civil penalty.

8. NOTICE TO THE FAA OF PROPOSED CONSTRUCTION. 14 CFR Part 77, Objects Affecting Navigable Airspace, requires persons proposing any construction or alteration described in 14 CFR Section 77.13(a) to give 30-day notice to the FAA of their intent. This includes any construction or alteration of structures more than 200 feet (61 m) in height above the ground level or at a height that penetrates defined imaginary surfaces located in the vicinity of a public-use airport.

a. Airport Data Requirements. Future airport development plans and feasibility studies on file with the FAA may influence the determinations resulting from 14 CFR Part 77 studies. To assure full consideration of future airport development in 14 CFR Part 77 studies, airport owners must have their plans on file with the FAA. The necessary plan data includes, as a minimum, planned runway end coordinates, elevation, and type of approach for any new runway or runway extension.

b. Penalty for Failure to Provide Notice. Persons who knowingly and willingly fail to give such notice are subject to criminal prosecution.

9. FAA STUDIES. The FAA studies existing and proposed objects and activities, on and in the vicinity of public-use airports. These objects and activities are not limited to obstructions to air navigation, as defined in 14 CFR Part 77. These studies focus on the efficient use of the airport and the safety of persons and property on the ground. As the result of these studies, the FAA may resist, oppose, or recommend against the presence of objects or activities in the vicinity of a public-use airport that conflict with an airport planning or design standard/recommendation. This policy is stated as a notice on page 32152 of Volume 54, No. 149, of the Federal Register, dated Friday, August 4, 1989. FAA studies conclude:

a. Whether an obstruction to air navigation is a hazard to air navigation;

b. Whether an object or activity on or in the vicinity of an airport is objectionable;

c. Whether the need to alter, remove, mark, or light an object exists;

d. Whether to approve an Airport Layout Plan;

e. Whether proposed construction, enlargement, or modification to an airport would have an adverse effect on the safe and efficient use of navigable airspace; or

f. Whether a change in an operational procedure is feasible.

10. FEDERAL ASSISTANCE. The FAA administers a grant program (per Order 5100.38, Airport Improvement Program (AIP) Handbook) which provides financial assistance for developing public-use airports. Persons interested in this program can obtain information from FAA Airports Regional or District Offices. Technical assistance in airport development is also available from these offices.

11. ENVIRONMENTAL ASSESSMENTS. Federal grant assistance in, or ALP approval of, new airport construction or major expansion normally requires an assessment of potential environmental impacts in accordance with FAA Order 5050.4B, National Environmental Policy Act (NEPA) Implementing Instructions for Airport Projects, and the National Environmental Policy Act of 1969.

12. STATE ROLE. Many State aeronautics commissions or similar departments require prior approval and, in some instances, a license for the establishment and operation of an airport. Some States administer a financial assistance program similar to the Federal program and technical advice. Proponents should contact their respective State aeronautics commissions or departments for information on licensing and assistance programs.

13. LOCAL ROLE. Most communities have zoning ordinances, building codes, and fire regulations which may affect airport development. Some have or are in the process of developing codes or ordinances regulating environmental issues such as noise and air quality. Others may have specific procedures for establishing an airport.

14. to 199. RESERVED

Table 1-1. Increases in airport design standards associated with an upgrade in the first component (aircraft approach category) of the airport reference code

ARC upgrade	Changes in airport design standards.
A-I s/ to B-I s/	No change in airport design standards.
B-I s/ to C-I	Increase in crosswind component. Refer to paragraph 203.b. Increase in runway separation standards. Refer to tables 2-1 and 2-2. Increase in RPZ dimensions. Refer to table 2-4 and appendix 14, paragraph 5.b. Increase in OFZ dimensions. Refer to paragraph 306. Increase in runway design standards. Refer to tables 3-1, 3-2, and 3-3. Increase in surface gradient standards. Refer to paragraph 502. Increase in threshold siting standards. Refer to appendix 2, paragraph 5.
A-I to B-I	No change in airport design standards.
B-I to C-I	Increase in crosswind component. Refer to paragraph 203.b. Increase in runway separation standards. Refer to tables 2-1 and 2-2. Increase in RPZ dimensions. Refer to table 2-4 and appendix 14, paragraph 5.b. Increase in runway design standards. Refer to tables 3-1, 3-2, and 3-3. Increase in surface gradient standards. Refer to paragraph 502.
C-I to D-I	Increase in RSA width. Refer to table 3-3, Note 4/.
A-II to B-II	No change in airport design standards.
B-II to C-II	Increase in crosswind component. Refer to paragraph 203.b. Increase in runway separation standards. Refer to tables 2-1 and 2-2. Increase in RPZ dimensions. Refer to table 2-4 and appendix 14, paragraph 5.b. Increase in runway design standards. Refer to tables 3-1, 3-2, and 3-3. Increase in surface gradient standards. Refer to paragraph 502.
C-II to D-II	Increase in RSA width. Refer to table 3-3, Note 4/.
A-III to B-III	No change in airport standards.
B-III to C-III	Increase in runway separation standards. Refer to tables 2-1 and 2-2. Increase in RPZ dimensions. Refer to table 2-4 and appendix 14, paragraph 5.b. Increase in runway design standards. Refer to tables 3-1, 3-2, and 3-3. Increase in surface gradient standards. Refer to paragraph 502.
C-III to D-III	Increase in RSA width. Refer to table 3-3, Note 4/.
A-IV to B-IV	No change in airport design standards.
B-IV to C-IV	Increase in RPZ dimensions. Refer to table 2-4 and appendix 14, paragraph 5.b. Increase in surface gradient standards. Refer to paragraph 502.
C-IV to D-IV	Increase in RSA width. Refer to table 3-3, Note 4/.
C-V to D-V	Increase in RSA width. Refer to table 3-3, Note 4/.
C-VI to D-VI	Increase in RSA width. Refer to table 3-3, Note 4/.

s/ These airport design standards pertain to facilities for small airplanes exclusively.

Table 1-2. Increases in airport design standards to provide for lower approach visibility minimums

Visibility minimums decrease *	Changes in airport design standards.
Visual to Not lower than 1-Mile (1 600 m)	No change in airport design standards.
Not lower than 1-Mile (1 600 m) to Not lower than 3/4-Mile (1 200 m)	Increase in RPZ dimensions. Refer to table 2-4. Increase in threshold siting standards. Refer to appendix 2, paragraph 5.
Not lower than 3/4-Mile (1 200 m) to Not lower than CAT I	For aircraft approach categories A & B runways: Increase in runway separation standards. Refer to table 2-1. Increase in RPZ dimensions. Refer to table 2-4. Increase in OFZ dimensions. Refer to paragraph 306. Increase in runway design standards. Refer to tables 3-1 and 3-2. Increase in threshold siting standards. Refer to appendix 2, paragraph 5.
	For aircraft approach categories C & D runways: Increase in runway separation standards for ADG I & II runways. Refer to table 2-2. Increase in RPZ dimensions. Refer to table 2-4. Increase in OFZ dimensions. Refer to paragraph 306. Increase in threshold siting standards. Refer to appendix 2, paragraph 5.
Not lower than CAT I to Lower than CAT I	Increase in OFZ dimensions for runways serving large airplanes. Refer to paragraph 306. Increase in threshold siting standards. Refer to appendix 2, paragraph 5.

* In addition to the changes in airport design standards as noted, providing for lower approach visibility minimums may result in an increase in the number of objects identified as obstructions to air navigation in accordance with 14 CFR Part 77. This may require object removal or marking and lighting. Refer to paragraph 211.a.(6).

Chapter 2. AIRPORT GEOMETRY

200. INTRODUCTION. This chapter presents the airport geometric design standards and recommendations to ensure the safety, economy, efficiency, and longevity of an airport.

201. PRINCIPLES OF APPLICATION.

a. Need to Plan. The significance of the interrelationship of the various airport features cannot be overemphasized. It is important that airport owners look to both the present and potential functions of the airport.

(1) Existing and planned airspace required for safe and efficient aircraft operations should be protected by acquisition of a combination of zoning, easements, property interests, and other means. AC 150/5190-4, A Model Zoning Ordinance to Limit Height of Objects Around Airports, presents guidance for controlling the height of objects around airports.

(2) All other existing and planned airport elements, including the following, should be on airport property:

(a) Object free areas;

(b) Runway protection zones;

(c) Areas under the 14 CFR Part 77 Subpart C airport imaginary surfaces out to where the surfaces obtain a height of at least 35 feet (10 m) above the primary surface; and

(d) Areas, other than those which can be adequately controlled by zoning, easements, or other means to mitigate potential incompatible land uses.

b. Airport Functions. Coordination with the FAA and users of the airport should assist in determining the airport's immediate and long range functions which will best satisfy the needs of the community and traveling public. This involves determining the following:

(1) The operating characteristics, sizes, and weights of the airplanes expected at the airport;

(2) The airport reference code (ARC) resulting from (1);

(3) The most demanding meteorological conditions in which airplanes will operate;

(4) The volume and mix of operations;

(5) The possible constraints on navigable airspace; and

(6) The environmental and compatible land-use considerations associated with topography, residential development, schools, churches, hospitals, sites of public assembly, and the like.

c. Airport Layout Plan. When developing the airport layout plan, application of the standards and recommendations in this publication to the long range functions of the airport will establish the future airport geometry. See appendices 6 and 7 for detailed information on the development of the airport layout plan.

202. RUNWAY LOCATION AND ORIENTATION. Runway location and orientation are paramount to airport safety, efficiency, economics, and environmental impact. The weight and degree of concern given to each of the following factors depend, in part, on: the airport reference code; the meteorological conditions; the surrounding environment; topography; and the volume of air traffic expected at the airport.

a. Wind. Appendix 1 provides information on wind data analysis for airport planning and design. Such an analysis considers the wind velocity and direction as related to the existing and forecasted operations during visual and instrument meteorological conditions. It may also consider wind by time of day.

b. Airspace Availability. Existing and planned instrument approach procedures, missed approach procedures, departure procedures, control zones, special use airspace, restricted airspace, and traffic patterns influence airport layouts and locations. Contact the FAA for assistance on airspace matters.

c. Environmental Factors. In developing runways to be compatible with the airport environs, conduct environmental studies which consider the impact of existing and proposed land use and noise on nearby residents, air and water quality, wildlife, and historical/archeological features.

d. Obstructions to Air Navigation. An obstruction survey should identify those objects which may affect airplane operations. Approaches free of obstructions are desirable and encouraged, but as a minimum, locate and orient runways to ensure that the

approach areas associated with the ultimate development of the airport are clear of hazards to air navigation.

e. Topography. Topography affects the amount of grading and drainage work required to construct a runway. In determining runway orientation, consider the costs of both the initial work and ultimate airport development. See chapter 5 and AC 150/5320-5 for further guidance.

f. Airport Traffic Control Tower Visibility. The location and orientation of runways and taxiways must be such that the existing (or future) airport traffic control tower (ATCT) has a clear line of sight to: all traffic patterns; the final approaches to all runways; all runway structural pavement; and, other operational surfaces controlled by ATC. A clear line of sight to taxiway centerlines is desirable. Operational surfaces not having a clear unobstructed line of sight from the ATCT are designated by ATC as uncontrolled or nonmovement areas through a local agreement with the airport owner. See chapter 6 for guidance on airport traffic control tower siting.

g. Wildlife Hazards. In orienting runways, consider the relative locations of bird sanctuaries, sanitary landfills, or other areas that may attract large numbers of birds or wildlife. Where bird hazards exist, develop and implement bird control procedures to minimize such hazards. See AC 150/5xxx-xx, *Announcement of Availability*, FAA/USDA manual *Wildlife Hazard Management at Airports*. This manual may be used to determine, on a case-by-case basis, what uses may be compatible with a particular airport environment with respect to wildlife management. Guidance is also available through local FAA Airports Offices.

203. ADDITIONAL RUNWAYS. An additional runway may be necessary to accommodate operational demands, minimize adverse wind conditions, or overcome environmental impacts.

a. Operational Demands. An additional runway, or runways, is necessary when traffic volume exceeds the existing runway's operational capability. With rare exception, capacity-justified runways are parallel to the primary runway. Refer to AC 150/5060-5 for additional discussion.

b. Wind Conditions. When a runway orientation provides less than 95 percent wind coverage for any aircraft forecasted to use the airport on a regular basis, a crosswind runway is recommended. The 95 percent wind coverage is computed on the basis of the crosswind not exceeding

10.5 knots for Airport Reference Codes A-I and B-I, 13 knots for Airport Reference Codes A-II and B-II, 16 knots for Airport Reference Codes A-III, B-III, and C-I through D-III, and 20 knots for Airport Reference Codes A-IV through D-VI. See Appendix 1 for the methodology on computing wind coverage.

c. Environmental Impact. An additional runway may be needed to divert traffic from overflying an environmentally sensitive area.

204. TAXIWAY SYSTEM. As runway traffic increases, the capacity of the taxiway system may become the limiting operational factor. Taxiways link the independent airport elements and require careful planning for optimum airport utility. The taxiway system should provide for free movement to and from the runways, terminal/cargo, and parking areas. It is desirable to maintain a smooth flow with a minimum number of points requiring a change in the airplane's taxiing speed.

a. System Composition. Through-taxiways and intersections comprise the taxiway system. It includes entrance and exit taxiways; bypass, crossover or transverse taxiways; apron taxiways and taxiways; and parallel and dual parallel taxiways. Chapter 4 discusses taxiway design.

b. Design Principles:

- (1) Provide each runway with a parallel taxiway or the capability therefore;
- (2) Build taxiways as direct as possible;
- (3) Provide bypass capability or multiple access to runway ends;
- (4) Minimize crossing runways;
- (5) Provide ample curve and fillet radii;
- (6) Provide airport traffic control tower line of sight; and
- (7) Avoid traffic bottlenecks.

205. AIRPORT APRONS. Chapter 5 contains gradient standards for airport aprons. The tables cited in paragraph 206 present separation criteria applicable to aprons. For other apron criteria, refer to AC 150/5360-13 and Appendix 5 herein.

206. SEPARATION STANDARDS. Tables 2-1, 2-2, and 2-3 present the separation standards depicted in figure 2-1. *The separation distances may need to be increased with airport elevation to meet the runway obstacle free zone (OFZ) standards.* The

computer program cited in appendix 11 may be used to determine the increase to these separation distances for elevation.

207. PARALLEL RUNWAY SEPARATION--SIMULTANEOUS VFR OPERATIONS.

a. Standard. For simultaneous landings and takeoffs using visual flight rules (VFR), the minimum separation between centerlines of parallel runways is 700 feet (214 m).

b. Recommendations. The minimum runway centerline separation distance recommended for Airplane Design Group V and VI runways is 1,200 feet (366 m). Air traffic control practices, such as holding airplanes between the runways, frequently justify greater separation distances. Runways with centerline spacings under 2,500 feet (762 m) are treated as a single runway by ATC when wake turbulence is a factor.

208. PARALLEL RUNWAY SEPARATION--SIMULTANEOUS IFR OPERATIONS.

To attain instrument flight rule (IFR) capability for simultaneous (independent) landings and takeoff on parallel runways, the longitudinal (in-trail) separation required for single runway operations is replaced, in whole or in part, by providing lateral separation between aircraft operating to parallel runways. Subparagraphs a and b identify the minimum centerline separations for parallel runways with operations under instrument flight rules (IFR). Where practical, parallel runway centerline separation of at least 5,000 feet (1 525 m) is recommended. Placing the terminal area between the parallel runways minimizes taxi operations across active runways and increases operational efficiency of the airport. Terminal area space needs may dictate greater separations than required for simultaneous IFR operations.

a. Simultaneous Approaches. Precision instrument operations require electronic navigational aids and monitoring equipment, air traffic control, and approach procedures.

(1) Dual simultaneous precision instrument approaches are normally approved on parallel runway centerline separation of 4,300 feet (1 310 m). Further on a case-by-case basis, the FAA will consider proposals utilizing separations down to a minimum of 3,000 feet (915 m) where a 4,300 foot (1 310 m) separation is impractical. This reduction of separation requires special high update radar, monitoring equipment, etc..

(2) Triple simultaneous precision instrument approaches for airports below 1,000 feet (305 m) elevation normally require parallel runway centerline separation of 5,000 feet (1 525 m) between adjacent runways. Triple simultaneous precision instrument approaches for airport elevations at and above 1,000 feet (305 m) and reduction in separation are currently under study by the FAA. In the interim, the FAA, on a case-by-case basis, will consider proposals utilizing separations down to a minimum of 4,300 feet (1 310 m) where a 5,000-foot (1 525 m) separation is impractical or the airport elevation is at or above 1,000 feet (305 m). Reduction of separation may require special radar, monitoring equipment, etc..

(3) Quadruple simultaneous precision instrument approaches are currently under study by the FAA. In the interim, the FAA, on a case-by-case basis, will consider proposals utilizing separations down to a minimum of 5,000 feet (1 525 m). Quadruples may require special radar, monitoring equipment, etc..

b. Simultaneous Departures or Approaches and Departures. Simultaneous departures do not always require radar air traffic control facilities. The following parallel runway centerline separations apply:

(1) Simultaneous Departures.

(a) Simultaneous nonradar departures require a parallel runway centerline separation of at least 3,500 feet (1 067 m).

(b) Simultaneous radar departures require a parallel runway centerline separation of at least 2,500 feet (762 m).

(2) Simultaneous Approach and Departure. Simultaneous radar-controlled approaches and departures require the following parallel runway centerline separations:

(a) When the thresholds are not staggered, at least 2,500 feet (762 m).

(b) When the thresholds are staggered and the approach is to the near threshold, the 2,500-foot (762 m) separation can be reduced by 100 feet (30 m) for each 500 feet (150 m) of threshold stagger to a minimum separation of 1,000 feet (305 m). For Airplane Design Groups V and VI runways, a separation of at least 1,200 feet (366 m) is recommended. See figure 2-2 for a description of "near" and "far" thresholds.

(c) When the thresholds are staggered and the approach is to the far threshold, the minimum 2,500-foot (762 m) separation requires an increase of 100 feet (30 m) for every 500 feet (152 m) of threshold stagger.

209. RUNWAY TO PARALLEL TAXIWAY AND TAXILANE SEPARATION.

a. **Standards.** Tables 2-1 and 2-2 present the runway centerline to parallel taxiway/taxilane centerline separation standard. This distance is such to satisfy the requirement that no part of an aircraft (tail tip, wing tip) on taxiway/taxilane centerline is within the runway safety area or penetrates the obstacle free zone (OFZ). The computer program cited in appendix 11 may be used to determine the increase to these separation distances for elevation.

b. **Recommendations.** To have room for the acute-angled exit taxiway, provide a runway centerline to parallel taxiway centerline of at least 400 feet (120 m) for Airplane Design Groups I and II, 500 feet (150 m) for Airplane Design Group III, and 600 feet (180 m) for Airplane Design Groups IV, V, and VI.

210. BUILDING RESTRICTION LINE (BRL). A BRL should be placed on an airport layout plan for identifying suitable building area locations on airports. The BRL should encompass the runway protection zones, the runway object free area, the runway visibility zone (see paragraph 503), NAVAID critical areas, areas required for terminal instrument procedures, and airport traffic control tower clear line of sight.

211. OBJECT CLEARING CRITERIA. Safe and efficient operations at an airport require that certain areas on and near the airport be clear of objects or restricted to objects with a certain function, composition, and/or height. The object clearing criteria subdivides the 14 CFR Part 77, Subpart C, airspace and the object free area (OFA) ground area by type of objects tolerated within each subdivision. Aircraft are controlled by the aircraft operating rules and not by this criteria.

a. **Standards.** Object clearance requirements are as follows:

(1) **Object Free Area (OFA).** Object free areas require clearing of objects as specified in paragraph 307, Runway Object Free Area, and paragraph 404, Taxiway and Taxilane Object Free Area (OFA).

(2) **Runway and Taxiway Safety Areas.** Runway and taxiway safety areas require clearing of objects, except for objects that need to be located in the runway or taxiway safety area because of their function. Objects higher than 3 inches (7.6 cm) above grade should be constructed on low impact resistant supports (frangible mounted structures) of the lowest practical height with the frangible point no higher than 3 inches (7.6 cm) above grade. Other objects, such as manholes, should be constructed at grade. In no case should their height exceed 3 inches (7.6 cm) above grade. Underground fuel storage facilities should not be located within runway and taxiway safety areas (see AC 150/5230-4), Aircraft Fuel Storage, Handling, and Dispensing on Airports). Tables 3-1, 3-2, 3-3, and 4-1 specify runway and taxiway safety area standard dimensions.

(3) **Obstacle Free Zone (OFZ).** Obstacle Free Zones require clearing of object penetrations, except for frangible visual NAVAIDs that need to be located in the OFZ because of their function. Paragraph 306 specifies OFZ standard dimensions.

(4) **Threshold.** The threshold obstacle clearance surfaces, defined in Appendix 2, paragraph 5, require clearing of object penetrations.

(5) **NAVAIDs.** Certain areas require clearing for the establishment and operation of NAVAIDs. These NAVAID critical areas are depicted in chapter 6.

(6) **14 CFR Part 77 Obstructions to Air Navigation.** Obstructions to air navigation must be removed unless an FAA aeronautical study, based on proposed operations, determined otherwise. To determine otherwise, the FAA must find no substantial adverse effect as defined in Order 7400.2, Procedures for Handling Airspace Matters, Chapter 7, Evaluating Aeronautical Effect, Section 1, General. The FAA, normally, limits aeronautical studies of existing objects to obstructions to air navigation which are not included in the criteria cited in paragraphs 211a(1) through (5).

(7) **Runway Protection Zone (RPZ).** The RPZ requires clearing of incompatible objects and activities as specified in paragraphs 212a(1)(a) and 212a(2).

(8) **General.** Other objects which require clearing are those which generally can have an adverse effect on the airport. These include objects in the inner part of the approach area (coinciding with the RPZ) such as fuel handling and storage facilities, smoke and dust generating activities, misleading lights, and those which may create glare or attract wildlife.

b. Recommendations. Other objects that are desirable to clear, if practicable, are objects that do not have a substantial adverse effect on the airport but, if removed, will enhance operations. These include objects in the controlled activity area and obstructions to air navigation that are not covered in paragraph 211.a, especially those penetrating an approach surface. On a paved runway, the approach surface starts 200 feet (61 m) beyond the area usable for takeoff or landing, whichever is more demanding. On an unpaved runway, the approach surface starts at the end of the area usable for takeoff or landing.

212. RUNWAY PROTECTION ZONE (RPZ). The RPZ's function is to enhance the protection of people and property on the ground. This is achieved through airport owner control over RPZs. Such control includes clearing RPZ areas (and maintaining them clear) of incompatible objects and activities. Control is preferably exercised through the acquisition of sufficient property interest in the RPZ.

a. Standards.

(1) RPZ Configuration/Location. The RPZ is trapezoidal in shape and centered about the extended runway centerline. The central portion and controlled activity area the two components of the RPZ (see Figure 2-3). The RPZ dimension for a particular runway end is a function of the type of aircraft and approach visibility minimum associated with that runway end. Table 2-4 provides standard dimensions for RPZs. Other than with a special application of declared distances, the RPZ begins 200 feet (60 m) beyond the end of the area usable for takeoff or landing. With a special application of declared distances, see Appendix 14, separate approach and departure RPZs are required for each runway end.

(a) The Central Portion of the RPZ. The central portion of the RPZ extends from the beginning to the end of the RPZ, centered on the runway centerline. Its width is equal to the width of the runway OFA (see Figure 2-3). Paragraph 307 contains the dimensional standards for the OFA.

(b) The Controlled Activity Area. The controlled activity area is the portion of the RPZ to the sides of the central portion of the RPZ.

(2) Land Use. In addition to the criteria specified in paragraph 211, the following land use criteria apply within the RPZ:

(a) While it is desirable to clear all objects from the RPZ, some uses are permitted, provided they do not attract wildlife (see paragraph 202.g., *Wildlife Hazards*, and Appendix 17 for dimensional standards), are outside of the Runway OFA, and do not interfere with navigational aids. Automobile parking facilities, although discouraged, may be permitted, provided the parking facilities and any associated appurtenances, in addition to meeting all of the preceding conditions, are located outside of the central portion of the RPZ. Fuel storage facilities may not be located in the RPZ.

(b) Land uses prohibited from the RPZ are residences and places of public assembly. (Churches, schools, hospitals, office buildings, shopping centers, and other uses with similar concentrations of persons typify places of public assembly.) Fuel storage facilities may not be located in the RPZ.

b. Recommendations. Where it is determined to be impracticable for the airport owner to acquire and plan the land uses within the entire RPZ, the RPZ land use standards have recommendation status for that portion of the RPZ not controlled by the airport owner.

c. FAA Studies of Objects and Activities in the Vicinity of Airports. The FAA policy is to protect the public investment in the national airport system. To implement this policy, the FAA studies existing and proposed objects and activities, both off and on public-use airports, with respect to their effect upon the safe and efficient use of the airports and safety of persons and property on the ground. These objects need not be obstructions to air navigation, as defined in 14 CFR Part 77. As the result of a study, the FAA may issue an advisory recommendation in opposition to the presence of any off-airport object or activity in the vicinity of a public-use airport that conflicts with an airport planning or design standard or recommendation.

213. RUNWAY HOLDING POSITION (HOLDLINE). At airports with operating airport traffic control towers, runway holding positions (holdlines) identify the location on a taxiway where a pilot is to stop when he/she does not have clearance to proceed onto the runway. At airports without operating control towers, these holdlines identify the location where a pilot should assure there is adequate separation with other aircraft before proceeding onto the runway. The holdline standards, which assume a perpendicular distance from a runway centerline to an intersecting taxiway centerline, are in Tables 2-1 and 2-2. However, these distance standards may need to be longer and placed in such a way to take into account the largest aircraft (tail, body, or wing tip) expected to use the runway from penetrating the Obstacle Free Zone.

214. to 299. RESERVED

Table 2-1. Runway Separation Standards for aircraft approach categories A & B

ITEM	DIM 1/	AIRPLANE DESIGN GROUP				
		I 2/	I	II	III	IV
Visual runways and runways with not lower than $\frac{3}{4}$ -statue mile (1200m) approach visibility minimums						
Runway Centerline to:						
Parallel Runway Centerline	H	Refer to paragraphs 207 and 208				
Holdline		125ft 7/ 38m	200ft 60m	200ft 60m	200ft 5/ 60m	250ft 75m
Taxiway/Taxilane/ Centerline 3/	D	150ft 45m	225ft 67.5m	240ft 72m	300ft 90m	400ft 120m
Aircraft Parking Area	G	125ft 37.5m	200ft 60m	250ft 75m	400ft 120m	500ft 150m
Helicopter Touchdown Pad		Refer to Advisory Circular 150/5390-2				
Runways with lower than $\frac{3}{4}$ -statue mile (1200m) approach visibility minimums 4/						
Runway Centerline to:						
Parallel Runway Centerline	H	Refer to paragraphs 207 and 208				
Holdline		175ft 7/ 53m	250ft 75m	250ft 75m	250ft 5/ 75m	250ft 6/ 75m
Taxiway/Taxilane/ Centerline 3/	D	200ft 60m	250ft 75m	300ft 90m	350ft 105m	400ft 120m
Aircraft Parking Area	G	400ft 120m	400ft 120m	400ft 120m	400ft 120m	500ft 150m
Helicopter Touchdown Pad		Refer to Advisory Circular 150/5390-2				

- 1/ Letters correspond to the dimensions on Figure 2-1.
- 2/ These dimensional standards pertain to facilities for small airplanes exclusively.
- 3/ The taxiway/taxilane centerline separation standards are for sea level. At higher elevations, an increase to these separation distances may be required to keep taxiing and holding airplanes clear of the OFZ (refer to paragraph 206).
- 4/ For approaches with visibility less than $\frac{1}{2}$ -statue miles, runway centerline to taxiway/taxilane centerline separation increases to 400 feet (120m).
- 5/ This distance is increased 1 foot for each 100 feet above 5,100 feet above sea level.
- 6/ This distance is increased 1 foot for each 100 feet above sea level.
- 7/ The holdline dimension standards pertains to facilities for small airplanes exclusively, including airplane design groups I & II

Table 2-2. Runway Separation Standards for aircraft approach categories C & D 7/

ITEM	DIM 1/	AIRPLANE DESIGN GROUP					
		I	II	III	IV	V	VI
Visual runways and runways with not lower than 3/4-statue mile (1200m) approach visibility minimums							
Runway Centerline to:							
Parallel Runway Centerline	H	Refer to paragraphs 207 and 208					
Holdline		250ft 75m	250ft 75m	250ft 75m	250ft 75m	250ft 6/ 75m	280ft 6/ 85m
Taxiway/Taxilane/ Centerline 2/	D	300ft 90m	300ft 90m	400ft 120m	400ft 120m	3/ 3/	500ft 150m
Aircraft Parking Area	G	400ft 120m	400ft 120m	500ft 150m	500ft 150m	500ft 150m	500ft 150m
Helicopter Touchdown Pad		Refer to Advisory Circular 150/5390-2					
Runways with lower than 3/4-statue mile (1200m) approach visibility minimums							
Runway Centerline to:							
Parallel Runway Centerline	H	Refer to paragraphs 207 and 208					
Holdline		250ft 75m	250ft 75m	250ft 75m	250ft 6/ 75m	280ft 6/ 85m	280ft 6/ 85m
Taxiway/Taxilane/ Centerline 2/	D	400ft 120m	400ft 120m	400ft 120m	400ft 120m	3/ 4/ 3/ 4/	5/ 5/
Aircraft Parking Area	G	500ft 150m	500ft 150m	500ft 150m	500ft 150m	500ft 150m	500ft 150m
Helicopter Touchdown Pad		Refer to Advisory Circular 150/5390-2					

- 1/ Letters correspond to the dimensions on Figure 2-1.
- 2/ The taxiway/taxilane centerline separation standards are for sea level. At higher elevations, an increase to these separation distances may be required to keep taxiing and holding airplanes clear of the OFZ (refer to paragraph 206).
- 3/ For Airplane Design Group V, the standard runway centerline to parallel taxiway centerline separation distance is 400ft (120m) for airports at or below an elevation of 1,345 feet (410m); 450feet (135m) for airports between elevations for 1,345 feet (410m) and 6,560 feet (2,000m); and 500 feet (150m) for airports above an elevation of 6,560 feet (2,000m).
- 4/ For approaches with visibility less than 1/2-statue mile, the separation distance increases to 500 feet (150m) plus required OFZ elevation adjustment.
- 5/ For approaches with visibility down to 1/2-statue mile, the separation distance increases to 500 feet (150m) plus elevation adjustment. For approaches with visibility less than 1/2-statue mile, the separation distance increases to 550 feet (168m) plus required OFZ elevation adjustment.
- 6/ This distance is increased 1 foot for each 100 feet above sea level.
- 7/ For all airplane design groups under aircraft approach category D, this distance is increased 1 foot for each 100 feet above sea level.

Table 2-3. Taxiway and taxilane separation standards

ITEM	DIM <u>1/</u>	AIRPLANE DESIGN GROUP					
		I	II	III	IV	V	VI
<i>Taxiway Centerline to:</i> Parallel Taxiway/ Taxilane Centerline	J	69 ft 21 m	105 ft 32 m	152 ft 46.5 m	215 ft 65.5 m	267 ft 81 m	324 ft 99 m
Fixed or Movable Object <u>2</u> and <u>3/</u>	K	44.5 ft 13.5 m	65.5 ft 20 m	93 ft 28.5 m	129.5 ft 39.5 m	160 ft 48.5 m	193 ft 59 m
<i>Taxilane Centerline to:</i> Parallel Taxilane Centerline		64 ft 19.5 m	97 ft 29.5 m	140 ft 42.5 m	198 ft 60 m	245 ft 74.5 m	298 ft 91 m
Fixed or Movable Object <u>2</u> and <u>3/</u>		39.5 ft 12 m	57.5 ft 17.5 m	81 ft 24.5 m	112.5 ft 34 m	138 ft 42 m	167 ft 51 m

1/ Letters correspond to the dimensions on Figure 2-1.

2/ This value also applies to the edge of service and maintenance roads.

3/ Consideration of the engine exhaust wake impacted from turning aircraft should be given to objects located near runway/taxiway/taxilane intersections.

The values obtained from the following equations may be used to show that a modification of standards will provide an acceptable level of safety. Refer to paragraph 6 for guidance on modification of standard requirements.

Taxiway centerline to parallel taxiway/taxilane centerline equals 1.2 times airplane wingspan plus 10 feet (3 m).

Taxiway centerline to fixed or movable object equals 0.7 times airplane wingspan plus 10 feet (3 m).

Taxilane centerline to parallel taxilane centerline equals 1.1 times airplane wingspan plus 10 feet (3 m).

Taxilane centerline to fixed or movable object equals 0.6 times airplane wingspan plus 10 feet (3 m).

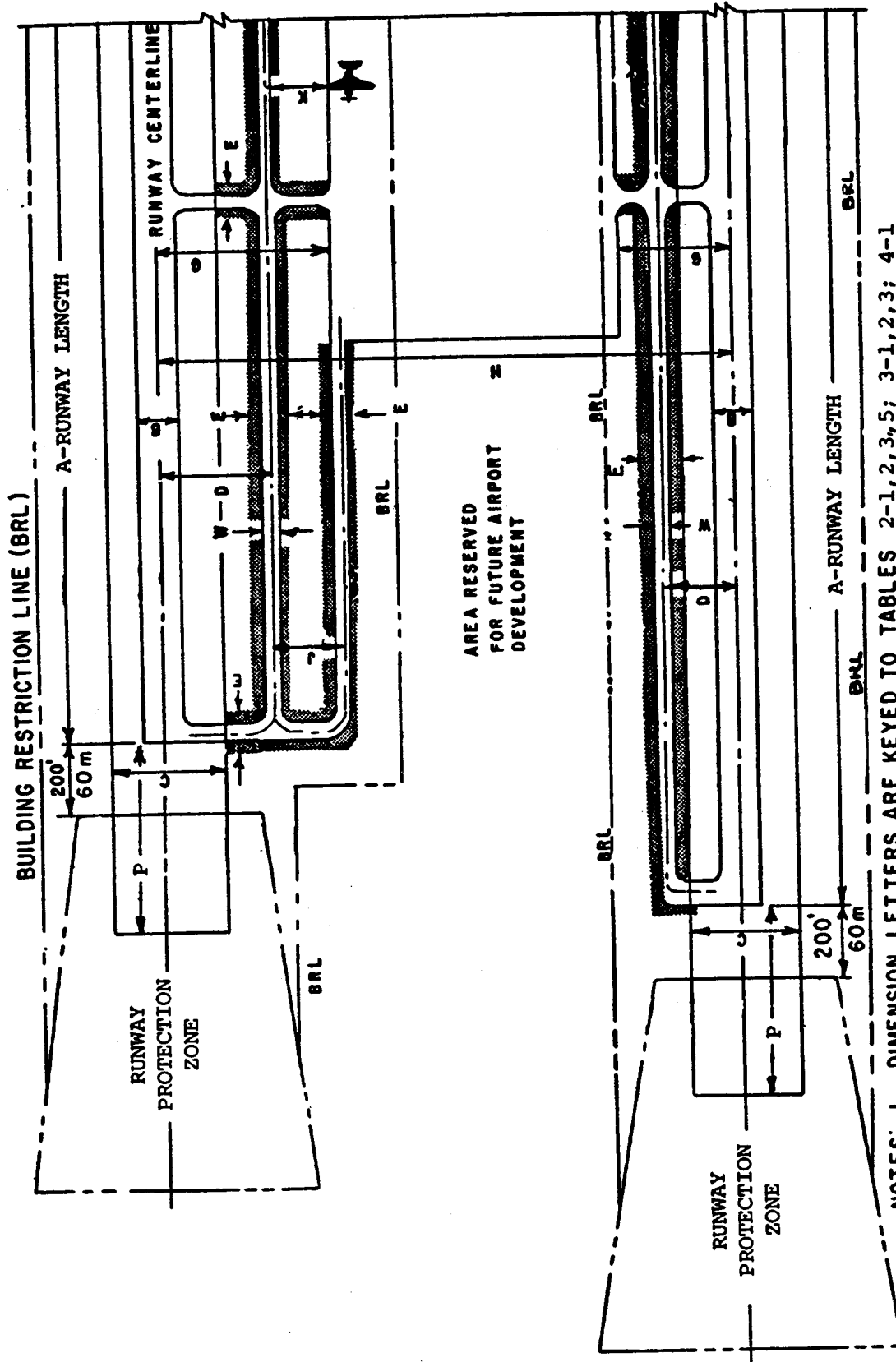

- NOTES: 1. DIMENSION LETTERS ARE KEYED TO TABLES 2-1, 2, 3, 5; 3-1, 2, 3; 4-1
2. SHADED AREA SURROUNDING TAXIWAYS DELINEATES THE LIMITS OF THE TAXIWAY SAFETY AREA.
3. PREFERRED LOCATION FOR BUILDING AND AIRPLANE PARKING AREA IS MIDPOINT OF RUNWAY. THE SIZE AND SHAPE ARE VARIABLE AS REQUIRED.

Figure 2-1. Typical airport layout

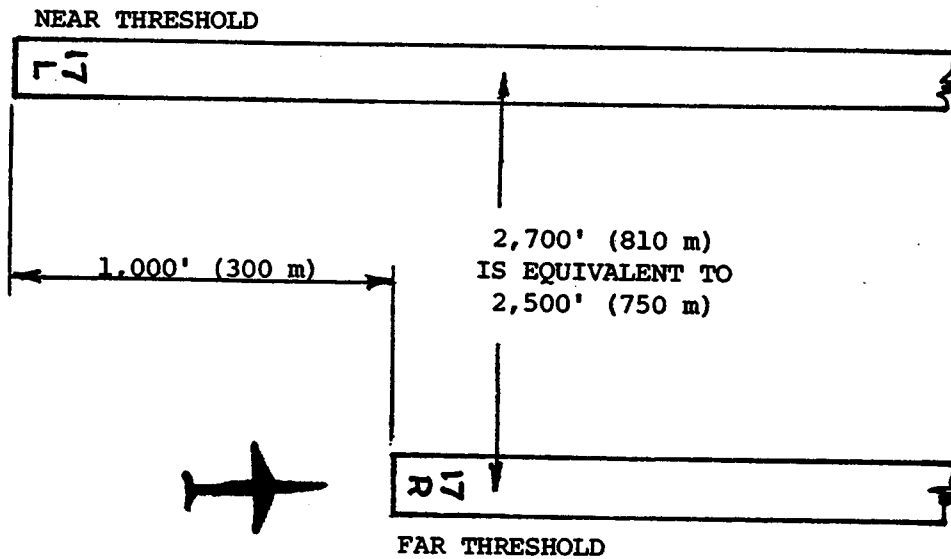
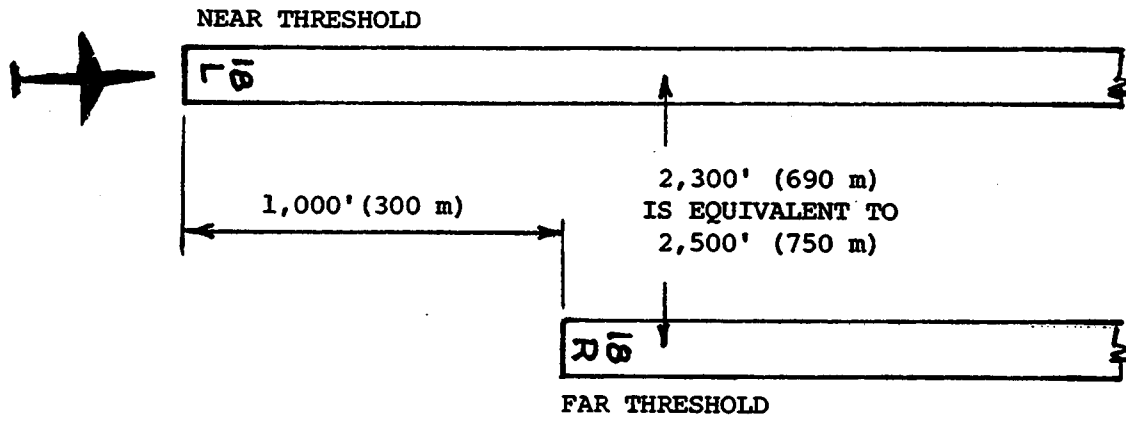
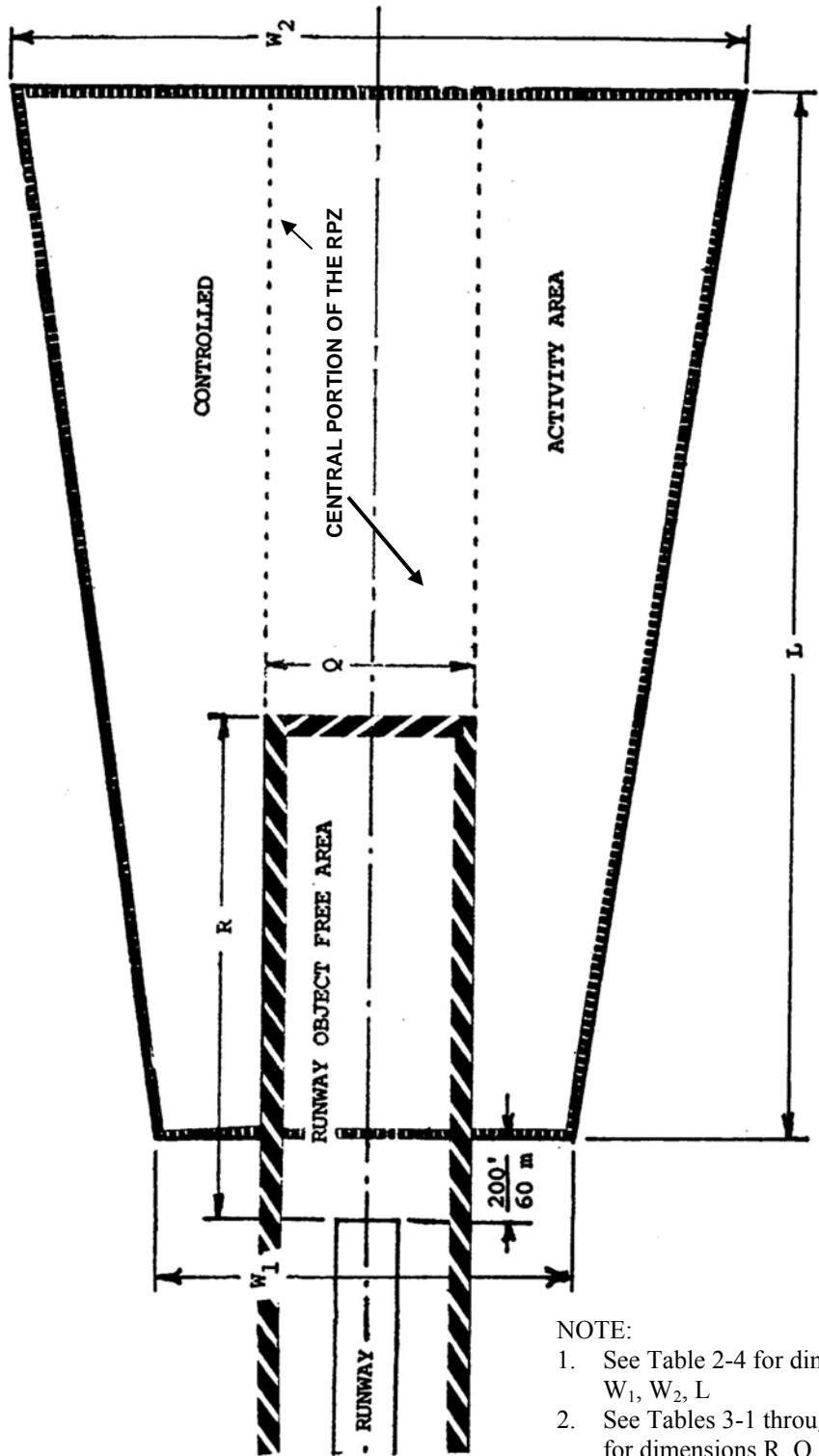

Figure 2-2. Parallel runway separation

Table 2-4. Runway protection zone (RPZ) dimensions

Approach Visibility Minimums <u>1/</u>	Facilities Expected To Serve	Dimensions			
		Length L Feet (meters)	Inner Width W ₁ feet (meters)	Outer Width W ₂ feet (meters)	RPZ acres
Visual And Not lower than 1-Mile (1 600 m)	Small Aircraft Exclusively	1,000 (300)	250 (75)	450 (135)	8.035
	Aircraft Approach Categories A & B	1,000 (300)	500 (150)	700 (210)	13.770
	Aircraft Approach Categories C & D	1,700 (510)	500 (150)	1,010 (303)	29.465
Not lower than ³ / ₄ -Mile (1 200 m)	All Aircraft	1,700 (510)	1,000 (300)	1,510 (453)	48.978
Lower than ³ / ₄ -Mile (1 200 m)	All Aircraft	2,500 (750)	1,000 (300)	1,750 (525)	78.914

1/ The RPZ dimensional standards are for the runway end with the specified approach visibility minimums. The departure RPZ dimensional standards are equal to or less than the approach RPZ dimensional standards. When a RPZ begins other than 200 feet (60 m) beyond the runway end, separate approach and departure RPZs should be provided. Refer to Appendix 14 for approach and departure RPZs.



- NOTE:
1. See Table 2-4 for dimension W_1, W_2, L
 2. See Tables 3-1 through 3-3 for dimensions R, Q

Figure 2-3. Runway protection zone

Chapter 3. RUNWAY DESIGN

300. INTRODUCTION. This chapter presents standards for runways and runway associated elements such as shoulders, blast pads, runway safety areas, obstacle free zones (OFZ), object free areas (OFA), clearways, and stopways. Tables 3-1, 3-2, and 3-3 present the standard widths and lengths for runway and runway-associated elements. Also included are design standards and recommendations for rescue and firefighting access roads. At new airports, the RSA and ROFA lengths and the RPZ location standards are tied to runway ends. At existing constrained airports, these criteria may, on a case-by-case basis, be applied with respect to declared distances ends. See appendix 14.

301. RUNWAY LENGTH. AC 150/5325-4 and airplane flight manuals provide guidance on runway lengths for airport design, including declared distance lengths. The computer program cited in appendix 11 may be used to determine the recommended runway length for airport design.

302. RUNWAY WIDTH. Tables 3-1, 3-2, and 3-3 present runway width standards that consider operations conducted during reduced visibility.

303. RUNWAY SHOULDERS. Runway shoulders provide resistance to blast erosion and accommodate the passage of maintenance and emergency equipment and the occasional passage of an airplane veering from the runway. Tables 3-1, 3-2, and 3-3 present runway shoulder width standards. A natural surface, e.g., turf, normally reduces the possibility of soil erosion and engine ingestion of foreign objects. Soil with turf not suitable for this purpose requires a stabilized or low cost paved surface. Refer to chapter 8 for further discussion. Figure 3-1 depicts runway shoulders.

304. RUNWAY BLAST PAD. Runway blast pads provide blast erosion protection beyond runway ends. Tables 3-1, 3-2, and 3-3 contain the standard length and width for blast pads for takeoff operations requiring blast erosion control. Refer to chapter 8 for further discussion. Figure 3-1 depicts runway blast pads.

305. RUNWAY SAFETY AREA (RSA). The runway safety area is centered on the runway centerline. Tables 3-1, 3-2, and 3-3 present runway safety area dimensional standards. Figure 3-1 depicts the runway safety area. Appendix 8 discusses the runway safety area's evolution.

a. Design Standards. The runway safety area shall be:

(1) cleared and graded and have no potentially hazardous ruts, humps, depressions, or other surface variations;

(2) drained by grading or storm sewers to prevent water accumulation;

(3) capable, under dry conditions, of supporting snow removal equipment, aircraft rescue and firefighting equipment, and the occasional passage of aircraft without causing structural damage to the aircraft; and

(4) free of objects, except for objects that need to be located in the runway safety area because of their function. Objects higher than 3 inches (7.6 cm) above grade should be constructed, to the extent practicable, on low impact resistant supports (frangible mounted structures) of the lowest practical height with the frangible point no higher than 3 inches (7.6 cm) above grade. Other objects, such as manholes, should be constructed at grade. In no case should their height exceed 3 inches (7.6 cm) above grade.

b. Construction Standards. Compaction of runway safety areas shall be to FAA specification P-152 found in AC 150/5370-10.

c. Sub-standard RSAs. RSA standards cannot be modified or waived like other airport design standards. The dimensional standards remain in effect regardless of the presence of natural or man-made objects or surface conditions that might create a hazard to aircraft that leave the runway surface. Facilities, including NAVAIDs, that would not normally be permitted in an RSA should not be installed inside the standard RSA dimensions even when the RSA does not meet standards in other respects. A continuous evaluation of all practicable alternatives for improving each sub-standard RSA is required until it meets all standards for grade, compaction, and object frangibility. FAA Order 5200.8, Runway Safety Area Program, explains the process for conducting this evaluation. Each FAA regional Airports division manager has a written determination of the best practicable alternative(s) for improving each RSA. Therefore, runway and RSA improvement projects must comply with the determination of the FAA regional Airports division manager.

d. Threshold Displacement. Incremental improvements that involve the displacement of a landing threshold need to be carefully planned so that they do not incur unnecessary costs or create situations that could compromise operational safety.

(1) Runway thresholds that are displaced temporarily pending the planned relocation of objects (such as Localizer antennas) should consider the extra costs associated with re-arranging the runway lights, approach lights and navigational aids.

(2) The displacement of a threshold that does not also include relocation of the lead-in taxiway can create an undesirable and confusing operating environment for the pilot. (See paragraph 204.)

e. Allowance for Navigational Aids. The RSA is intended to enhance the margin of safety for landing or departing aircraft. Accordingly, the design of an RSA must account for navigational aids that might impact the effectiveness of the RSA:

(1) RSA grades sometimes require approach lights to be mounted on massive towers that could create a hazard for aircraft. Therefore, consider any practicable RSA construction to a less demanding grade than the standard grade to avoid the need for massive structures.

(2) Instrument landing system (ILS) facilities (glide slopes and localizers) are not usually required to be located inside the RSA. However, they do require a graded area around the antenna. (See chapter 6 for more information on the siting of ILS facilities.) RSA construction that ends abruptly in a precipitous drop-off can result in design proposals where the facility is located inside the RSA. Therefore, consider any practicable RSA construction beyond the standard dimensions that could accommodate ILS facilities if and when they are installed.

306. OBSTACLE FREE ZONE (OFZ). The OFZ clearing standard precludes taxiing and parked airplanes and object penetrations, except for frangible visual NAVAIDs that need to be located in the OFZ because of their function. The runway OFZ and, when applicable, the precision OFZ, the inner-approach OFZ, and the inner-transitional OFZ comprise the obstacle free zone (OFZ). Figures 3-2, 3-3, 3-4, 3-5, and 3-6 show the OFZ.

a. Runway OFZ (ROFZ). The runway OFZ is a defined volume of airspace centered above the runway centerline. The runway OFZ is the airspace above a surface whose elevation at any point is the same as the elevation of the nearest point on the runway centerline. The runway OFZ extends 200 feet (60 m) beyond each end of the runway. Its width is as follows:

(1) For runways serving small airplanes exclusively:

(a) 300 feet (90 m) for runways with lower than 3/4-statute mile (1 200 m) approach visibility minimums.

(b) 250 feet (75 m) for other runways serving small airplanes with approach speeds of 50 knots or more.

(c) 120 feet (36 m) for other runways serving small airplanes with approach speeds of less than 50 knots.

(2) For runways serving large airplanes, 400 feet (120 m).

b. Inner-approach OFZ. The inner-approach OFZ is a defined volume of airspace centered on the approach area. It applies only to runways with an approach lighting system. The inner-approach OFZ begins 200 feet (60 m) from the runway threshold at the same elevation as the runway threshold and extends 200 feet (60 m) beyond the last light unit in the approach lighting system. Its width is the same as the runway OFZ and rises at a slope of 50 (horizontal) to 1 (vertical) from its beginning.

c. Inner-transitional OFZ. The inner-transitional OFZ is a defined volume of airspace along the sides of the runway OFZ and inner-approach OFZ. It applies only to runways with lower than 3/4-statute mile (1 200 m) approach visibility minimums.

(1) For runways serving small airplanes exclusively, the inner-transitional OFZ slopes 3 (horizontal) to 1 (vertical) out from the edges of the runway OFZ and inner-approach OFZ to a height of 150 feet (45 m) above the established airport elevation.

(2) For runways serving large airplanes, separate inner-transitional OFZ criteria apply for Category (CAT) I and CAT II/III runways.

(a) For CAT I runways, the inner-transitional OFZ begins at the edges of the runway OFZ and inner-approach OFZ, then rises vertically for a height "H", and then slopes 6 (horizontal) to 1 (vertical) out to a height of 150 feet (45 m) above the established airport elevation.

1) In U.S. customary units,

$$H_{\text{feet}} = 61 - 0.094(S_{\text{feet}}) - 0.003(E_{\text{feet}}).$$

2) In SI units,

$$H_{\text{meters}} = 18.4 - 0.094(S_{\text{meters}}) - 0.003(E_{\text{meters}}).$$

3) S is equal to the most demanding wingspan of the airplanes using the runway and E is equal to the runway threshold elevation above sea level.

(b) For CAT II/III runways, the inner-transitional OFZ begins at the edges of the runway OFZ and inner-approach OFZ, then rises vertically for a height "H", then slopes 5 (horizontal) to 1 (vertical) out to a

distance "Y" from runway centerline, and then slopes 6 (horizontal) to 1 (vertical) out to a height of 150 feet (45 m) above the established airport elevation.

- 1) In U.S. customary units,

$H_{\text{feet}} = 53 - 0.13(S_{\text{feet}}) - 0.0022(E_{\text{feet}})$ and distance

$Y_{\text{feet}} = 440 + 1.08(S_{\text{feet}}) - 0.024(E_{\text{feet}})$.

- 2) In SI units,

$H_{\text{meters}} = 16 - 0.13(S_{\text{meters}}) - 0.0022(E_{\text{meters}})$ and distance

$Y_{\text{meters}} = 132 + 1.08(S_{\text{meters}}) - 0.024(E_{\text{meters}})$.

3) S is equal to the most demanding wingspan of the airplanes using the runway and E is equal to the runway threshold elevation above sea level. Beyond the distance "Y" from runway centerline the inner-transitional CAT II/III OFZ surface is identical to that for the CAT I OFZ.

d. Precision OFZ. The Precision Obstacle Free Zone (POFZ) is defined as a volume of airspace above an area beginning at the runway threshold, at the threshold elevation, and centered on the extended runway centerline, 200 feet (60m) long by 800 feet (240m) wide. See figure 3-6.

The surface is in effect only when all of the following operational conditions are met:

- (1) Vertically guided approach
- (2) Reported ceiling below 250 feet and/or visibility less than $\frac{3}{4}$ statute mile (or RVR below 4000 feet)
- (3) An aircraft on final approach within two (2) miles of the runway threshold.

When the POFZ is in effect, a wing of an aircraft holding on a taxiway waiting for runway clearance may penetrate the POFZ; however neither the fuselage nor the tail may infringe on the POFZ.

The POFZ is applicable at all runway ends including displaced thresholds.

Note: POFZ takes effect no later than January 1, 2007 for all runway ends at which it applies.

307. OBJECT FREE AREA. The runway object free area (OFA) is centered on the runway centerline. The runway OFA clearing standard requires clearing the OFA of above ground objects protruding above the runway safety area edge elevation. Except where precluded by other clearing standards, it is acceptable to place objects that need to be located in the OFA for air navigation or aircraft ground maneuvering purposes and to taxi and hold aircraft in the OFA. Objects non-essential for air navigation or aircraft ground maneuvering purposes are not to be placed in the OFA. This includes parked airplanes

and agricultural operations. Tables 3-1, 3-2, and 3-3 specify the standard dimensions of the runway OFA. Extension of the OFA beyond the standard length to the maximum extent feasible is encouraged. See figure 2-3.

308. CLEARWAY STANDARDS. The clearway (See figure 3-7) is a clearly defined area connected to and extending beyond the runway end available for completion of the takeoff operation of turbine-powered airplanes. A clearway increases the allowable airplane operating takeoff weight without increasing runway length.

a. Dimensions. The clearway must be at least 500 feet (150 m) wide centered on the runway centerline. The practical limit for clearway length is 1,000 feet (300 m).

b. Clearway Plane Slope. The clearway plane slopes upward with a slope not greater than 1.25 percent.

c. Clearing. Except for threshold lights no higher than 26 inches (66 cm) and located off the runway sides, no object or terrain may protrude through the clearway plane. The area over which the clearway lies need not be suitable for stopping aircraft in the event of an aborted takeoff.

d. Control. An airport owner interested in providing a clearway should be aware of the requirement that the clearway be under its control, although not necessarily by direct ownership. The purpose of such control is to ensure that no fixed or movable object penetrates the clearway plane during a takeoff operation.

e. Notification. When a clearway is provided, the clearway length and the declared distances, as specified in appendix 14, paragraph 7, shall be provided in the Airport/Facility Directory (and in the Aeronautical Information Publication (AIP), for international airports) for each operational direction.

309. STOPWAY STANDARDS. A stopway is an area beyond the takeoff runway, centered on the extended runway centerline, and designated by the airport owner for use in decelerating an airplane during an aborted takeoff. It must be at least as wide as the runway and able to support an airplane during an aborted takeoff without causing structural damage to the airplane. Their limited use and high construction cost, when compared to a full-strength runway that is usable in both directions, makes their construction less cost effective. See figure 3-8. When a stopway is provided, the stopway length and the declared distances, as specified in appendix 14, paragraph 7, shall be provided in the Airport/Facility Directory (and in the Aeronautical Information Publication for international airports) for each operational direction.

310. RESCUE AND FIREFIGHTING ACCESS.

Rescue and firefighting access roads are normally needed to provide unimpeded two-way access for rescue and firefighting equipment to potential accident areas. Connecting these access roads, to the extent practical, with the operational surfaces and other roads will facilitate aircraft rescue and firefighting operations.

a. Recommendation. It is recommended that the entire runway safety area (RSA) and runway protection zone (RPZ) be accessible to rescue and firefighting vehicles so that no part of the RSA or RPZ is more than 330 feet (100 m) from either an all weather road or a paved operational surface. Where an airport is adjacent to a body of water, it is recommended that boat launch ramps with appropriate access roads be provided.

b. All Weather Capability. Rescue and firefighting access roads are all weather roads designed to

support rescue and firefighting equipment traveling at normal response speeds. Establish the widths of the access roads on a case-by-case basis considering the type(s) of rescue and firefighting equipment available and planned at the airport. The first 300 feet (90 m) adjacent to a paved operational surface should be paved. Where an access road crosses a safety area, the safety area standards for smoothness and grading control. For other design and construction features, use local highway specifications.

c. Road Usage. Rescue and firefighting access roads are special purpose roads that supplement but do not duplicate or replace sections of a multi-purpose road system. Restricting their use to rescue and firefighting access equipment precludes their being a hazard to air navigation.

311. to 399. RESERVED.

Table 3-1. Runway design standards for aircraft approach category A & B visual runways and runways with not lower than 3/4-statute mile (1,200 m) approach visibility minimums

(Refer also to Appendix 16 for the establishment of new approaches)

ITEM	DIM <u>1/</u>	AIRPLANE DESIGN GROUP				
		<u>I 2/</u>	I	II	III	IV
Runway Length	A	- Refer to paragraph 301 -				
Runway Width	B	60 ft	60 ft	75 ft	100 ft	150 ft
		18 m	18 m	23 m	30 m	45 m
Runway Shoulder Width		10 ft	10 ft	10 ft	20 ft	25 ft
		3 m	3 m	3 m	6 m	7.5 m
Runway Blast Pad Width		80 ft	80 ft	95 ft	140 ft	200 ft
		24 m	24 m	29 m	42 m	60 m
Runway Blast Pad Length		60 ft	100 ft	150 ft	200 ft	200 ft
		18 m	30 m	45 m	60 m	60 m
Runway Safety Area Width	C	120 ft	120 ft	150 ft	300 ft	500 ft
		36 m	36 m	45 m	90 m	150 m
Runway Safety Area Length Prior to Landing Threshold <u>3/</u> , <u>4/</u>		240 ft	240 ft	300 ft	600 ft	600 ft
		72 m	72 m	90 m	180 m	180 m
Runway Safety Area Length Beyond RW End <u>3/</u> , <u>4/</u>	P	240 ft	240 ft	300 ft	600 ft	1,000 ft
		72 m	72 m	90 m	180 m	300 m
Obstacle Free Zone Width and Length		- Refer to paragraph 306 -				
Runway Object Free Area Width	Q	250 ft	400 ft	500 ft	800 ft	800 ft
		75 m	120 m	150 m	240 m	240 m
Runway Object Free Area Length Beyond RW End <u>5/</u>	R	240 ft	240 ft	300 ft	600 ft	1,000 ft
		72 m	72 m	90 m	180 m	300 m

1/ Letters correspond to the dimensions on figures 2-1 and 2-3. Use this table only when both ends of the runway provide not lower than 3/4-statute mile approach visibility minimums.

2/ These dimensional standards pertain to facilities for small airplanes exclusively.

3/ The runway safety area (RSA) length begins at each runway end when a stopway is not provided. When a stopway is provided, the length begins at the stopway end.

4/ The standard RSA length beyond the runway end may be reduced to the standard RSA length prior to landing threshold if a standard Engineered Materials Arresting System (EMAS) is provided. To qualify for this reduction, the EMAS installation must provide the ability to stop the critical aircraft exiting the end of the runway at 70 knots, and the runway must provide either instrument or visual vertical guidance for approaches in the opposite direction. See AC 150/5220-22.

5/ The runway object free area length beyond the end of the runway never exceeds the standard RSA length beyond the runway end as provided by note 4 above.

Table 3-2. Runway design standards for aircraft approach category A & B runways with lower than 3/4-statute mile (1,200 m) approach visibility minimums

(Refer also to Appendix 16 for the establishment of new approaches)

ITEM	DIM <u>1/</u>	AIRPLANE DESIGN GROUP				
		<u>I 2/</u>	<u>I</u>	<u>II</u>	<u>III</u>	<u>IV</u>
Runway Length	A	- Refer to paragraph 301 -				
Runway Width	B	75 ft	100 ft	100 ft	100 ft	150 ft
		23 m	30 m	30 m	30 m	45 m
Runway Shoulder Width		10 ft	10 ft	10 ft	20 ft	25 ft
		3 m	3 m	3 m	6 m	7.5 m
Runway Blast Pad Width		95 ft	120 ft	120 ft	140 ft	200 ft
		29 m	36 m	36 m	42 m	60 m
Runway Blast Pad Length		60 ft	100 ft	150 ft	200 ft	200 ft
		18 m	30 m	45 m	60 m	60 m
Runway Safety Area Width	C	300 ft	300 ft	300 ft	400 ft	500 ft
		90 m	90 m	90 m	120 m	150 m
Runway Safety Area Length Prior to Landing Threshold <u>3/</u> , <u>4/</u>		600 ft	600 ft	600 ft	600 ft	600 ft
		180 m	180 m	180 m	180 m	180 m
Runway Safety Area Length Beyond RW End <u>3/</u>	P	600 ft	600 ft	600 ft	800 ft	1,000 ft
		180 m	180 m	180 m	240 m	300 m
Obstacle Free Zone Width and Length		- Refer to paragraph 306 -				
Runway Object Free Area Width	Q	800 ft	800 ft	800 ft	800 ft	800 ft
		240 m	240 m	240 m	240 m	240 m
Runway Object Free Area Length Beyond RW End <u>5/</u>	R	600 ft	600 ft	600 ft	800 ft	1,000 ft
		180 m	180 m	180 m	240 m	300 m

1/ Letters correspond to the dimensions on figures 2-1 and 2-3. Use this table for both ends of the runway even when one end does not have lower than 3/4-statute mile visibility minimums.

2/ These dimensional standards pertain to facilities for small airplanes exclusively.

3/ The runway safety area (RSA) length begins at each runway end when a stopway is not provided. When a stopway is provided, the length begins at the stopway end.

4/ The standard RSA length beyond the runway end may be reduced to the standard RSA length prior to landing threshold if a standard Engineered Materials Arresting System (EMAS) is provided. To qualify for this reduction, the EMAS installation must provide the ability to stop the critical aircraft exiting the end of the runway at 70 knots, and the runway must provide either instrument or visual vertical guidance for approaches in the opposite direction. See AC 150/5220-22.

5/ The runway object free area length beyond the end of the runway never exceeds the standard RSA length beyond the runway end as provided by note 4 above.

Table 3-3. Runway design standards for aircraft approach categories C & D

(Refer also to Appendix 16 for the establishment of new approaches)

ITEM	DIM <u>1/</u>	AIRPLANE DESIGN GROUP					
		I	II	III	IV	V	VI
Runway Length	A	- Refer to paragraph 301 -					
Runway Width	B	100 ft	100 ft	100 ft <u>2/</u>	150 ft	150 ft	200 ft
		30 m	30 m	30 m <u>2/</u>	45 m	45 m	60 m
Runway Shoulder Width <u>3/</u>		10 ft	10 ft	20 ft <u>2/</u>	25 ft	35 ft	40 ft
		3 m	3 m	6 m <u>2/</u>	7.5 m	10.5 m	12 m
Runway Blast Pad Width		120 ft	120 ft	140 ft <u>2/</u>	200 ft	220 ft	280 ft
		36 m	36 m	42 m <u>2/</u>	60 m	66 m	84 m
Runway Blast Pad Length		100 ft	150 ft	200 ft	200 ft	400 ft	400 ft
		30 m	45 m	60 m	60 m	120 m	120 m
Runway Safety Area Width <u>4/</u>	C	500 ft	500 ft	500 ft	500 ft	500 ft	500 ft
		150 m	150 m	150 m	150 m	150 m	150 m
Runway Safety Area Length Prior to Landing Threshold <u>5/</u> , <u>6/</u>		600 ft	600 ft	600 ft	600 ft	600 ft	600 ft
		180 m	180 m	180 m	180 m	180 m	180 m
Runway Safety Area Length Beyond RW End <u>5/</u> , <u>6/</u>	P	1,000 ft	1,000 ft	1,000 ft	1,000 ft	1,000 ft	1,000 ft
		300 m	300 m	300 m	300 m	300 m	300 m
Obstacle Free Zone Width and Length		- Refer to paragraph 306 -					
Runway Object Free Area Width	Q	800 ft	800 ft	800 ft	800 ft	800 ft	800 ft
		240 m	240 m	240 m	240 m	240 m	240 m
Runway Object Free Area Length Beyond RW End <u>7/</u>	R	1,000 ft	1,000 ft	1,000 ft	1,000 ft	1,000 ft	1,000 ft
		300 m	300 m	300 m	300 m	300 m	300 m

1/ Letters correspond to the dimensions on figures 2-1 and 2-3.

2/ For Airplane Design Group III serving airplanes with maximum certificated takeoff weight greater than 150,000 pounds (68,100 kg), the standard runway width is 150 feet (45 m), the shoulder width is 25 feet (7.5 m), and the runway blast pad width is 200 feet (60 m).

3/ Design Groups V and VI normally require stabilized or paved shoulder surfaces.

4/ For Airport Reference Code C-I and C-II, a runway safety area width of 400 feet (120 m) is permissible.

5/ The runway safety area (RSA) length begins at each runway end when a stopway is not provided. When a stopway is provided, the length begins at the stopway end.

6/ The standard RSA length beyond the runway end may be reduced to the standard RSA length prior to landing threshold if a standard Engineered Materials Arresting System (EMAS) is provided. To qualify for this reduction, the EMAS installation must provide the ability to stop the critical aircraft exiting the end of the runway at 70 knots, and the runway must provide either instrument or visual vertical guidance for approaches in the opposite direction. See AC 150/5220-22.

7/ The runway object free area length beyond the end of the runway never exceeds the standard RSA length beyond the runway end as provided by note 6 above.

This page intentionally left blank

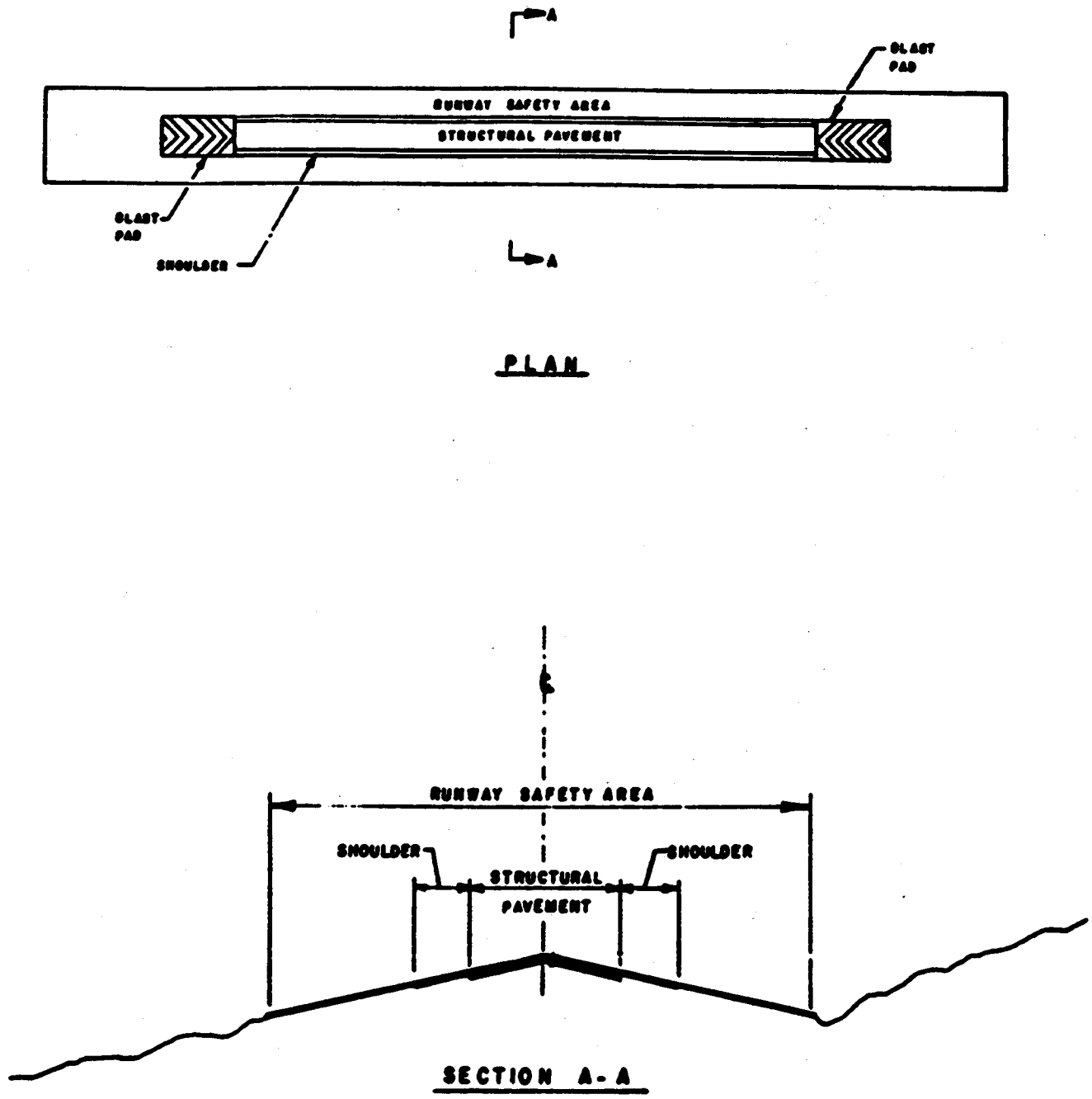

Figure 3-1. Runway safety area

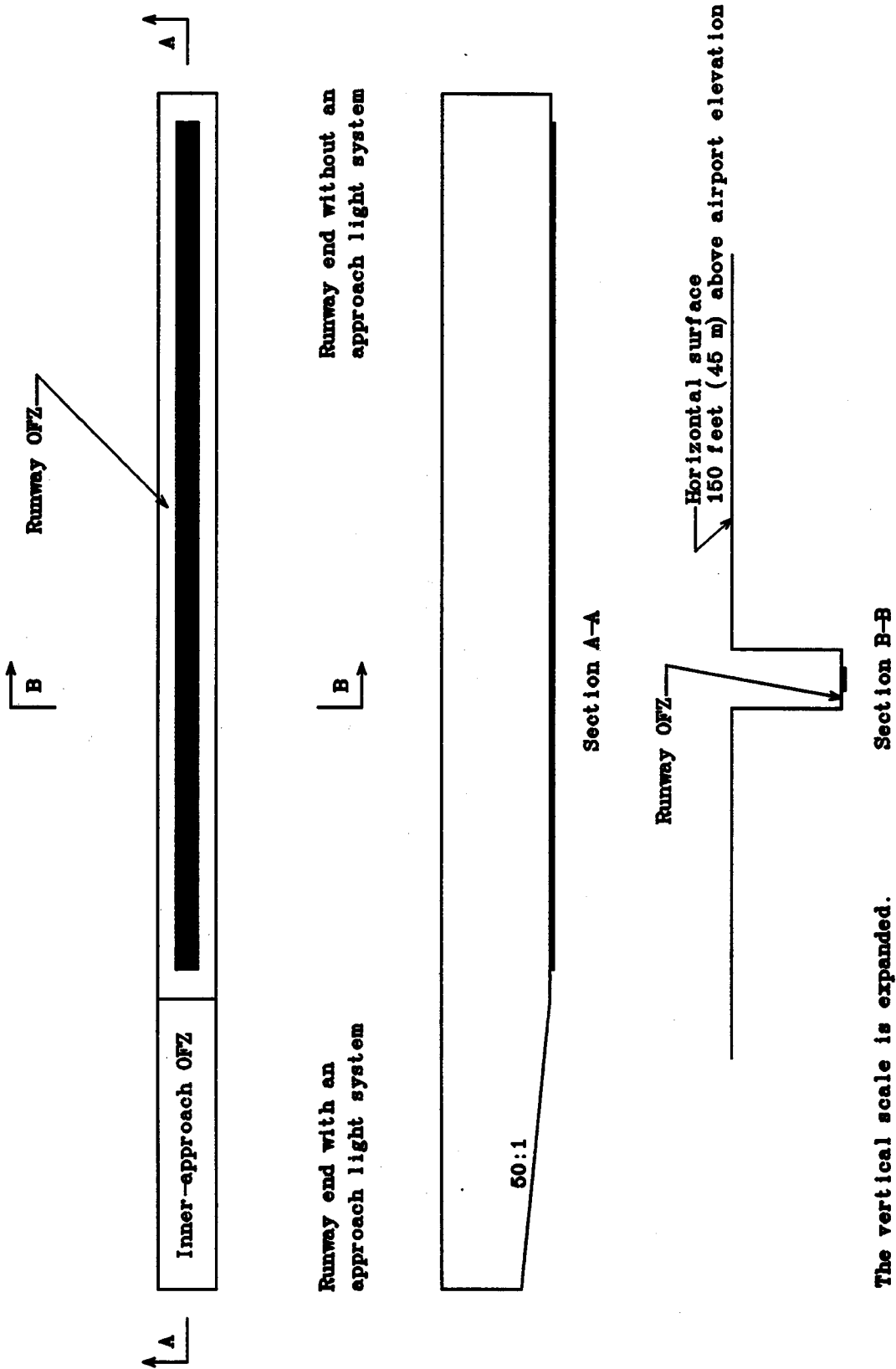

Figure 3-2. Obstacle free zone (OFZ) for visual runways and runways with not lower than 3/4-statute mile (1 200 m) approach visibility minimums

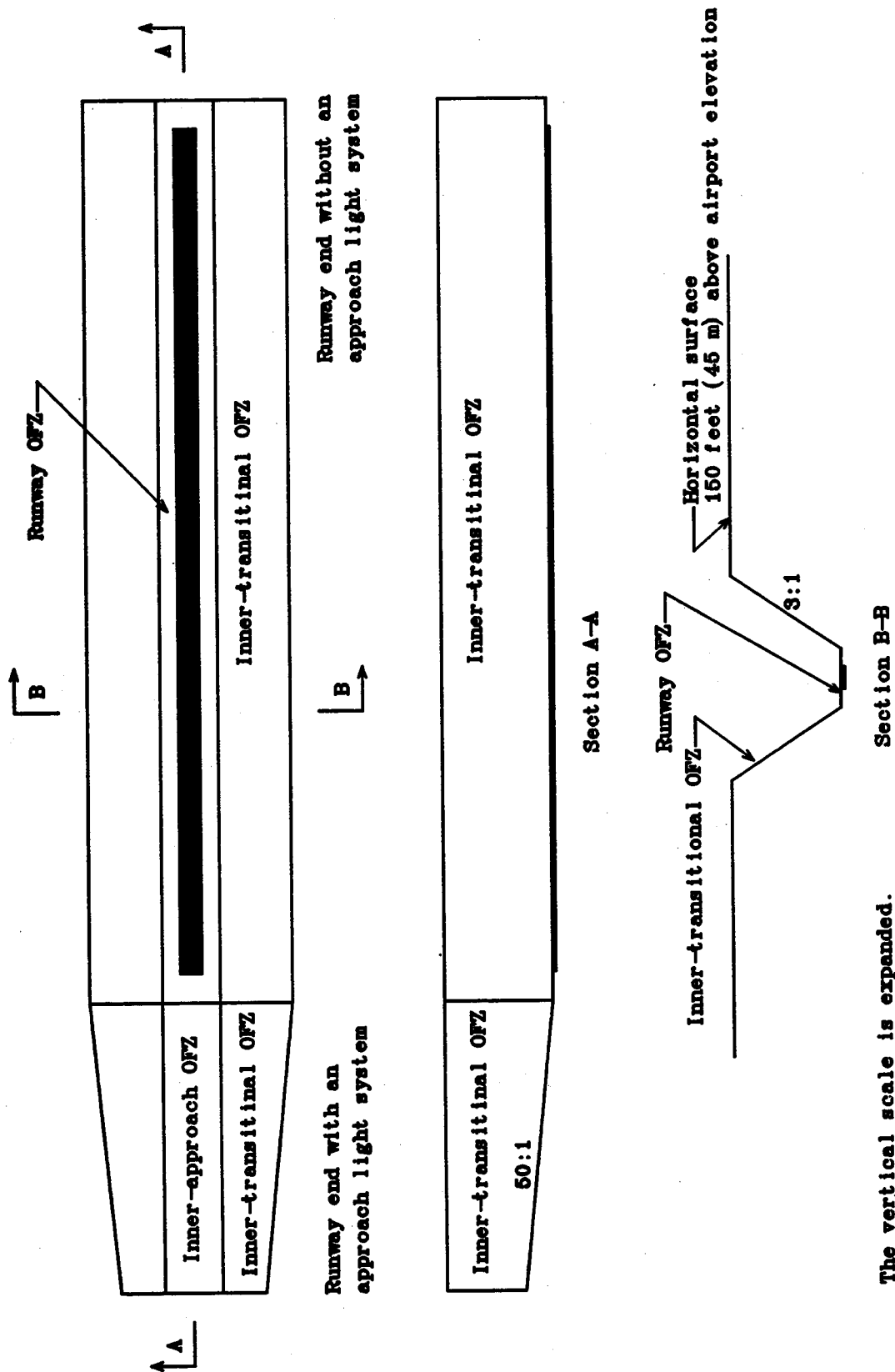

Figure 3-3. Obstacle free zone (OFZ) for runways serving small airplanes exclusively with lower than 3/4-statute mile (1 200 m) approach visibility minimums

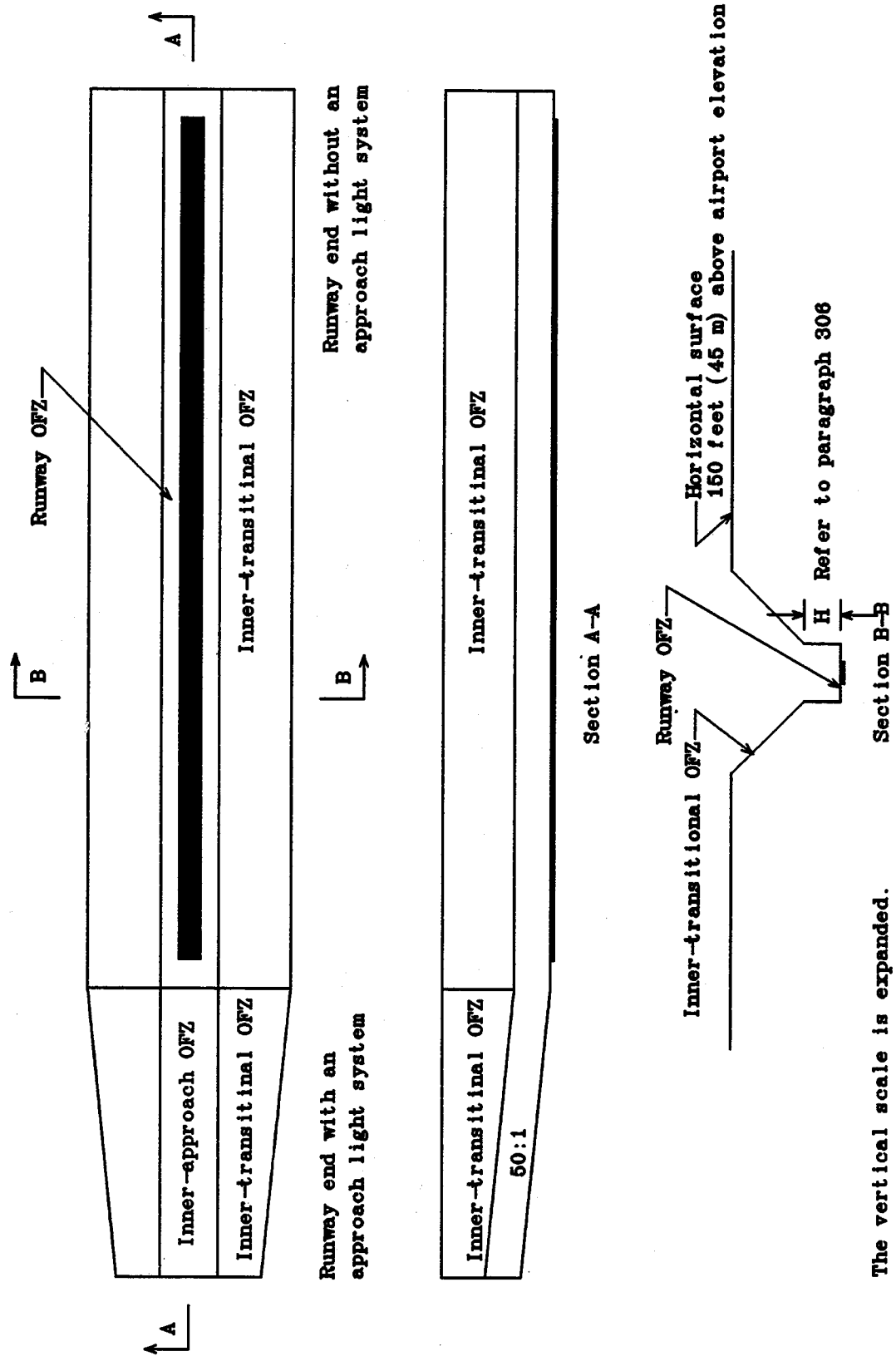

Figure 3-4. Obstacle free zone (OFZ) for runways serving large airplanes with lower than 3/4-statute mile (1 200 m) approach visibility minimums

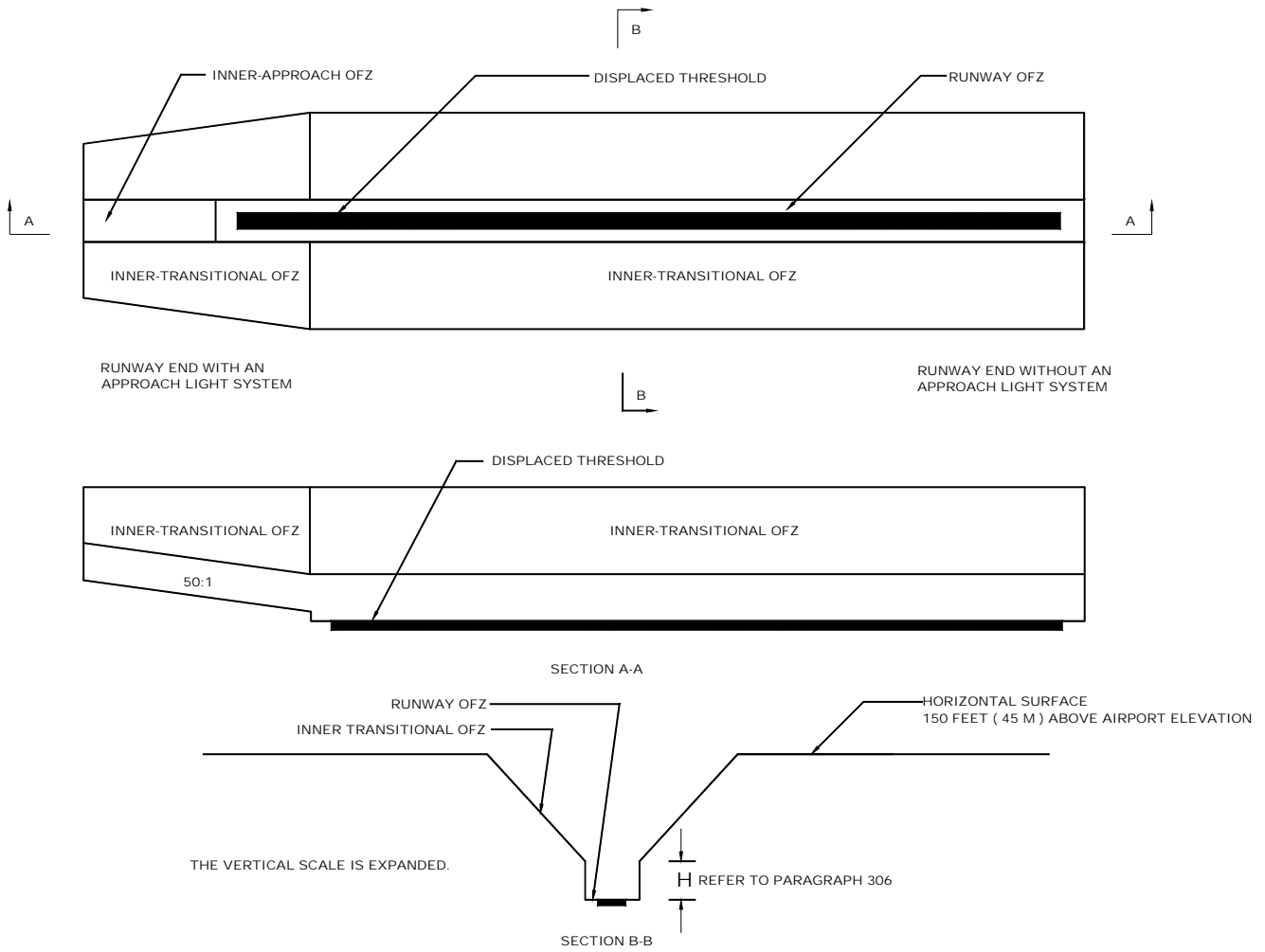

FIGURE 3-5. OBSTACLE FREE ZONE (OFZ) FOR RUNWAYS SERVING LARGE AIRPLANES WITH LOWER THAN 3/4-STATUTE MILE (1 200 M) APPROACH VISIBILITY MINMUMS AND DISPLACED THRESHOLD

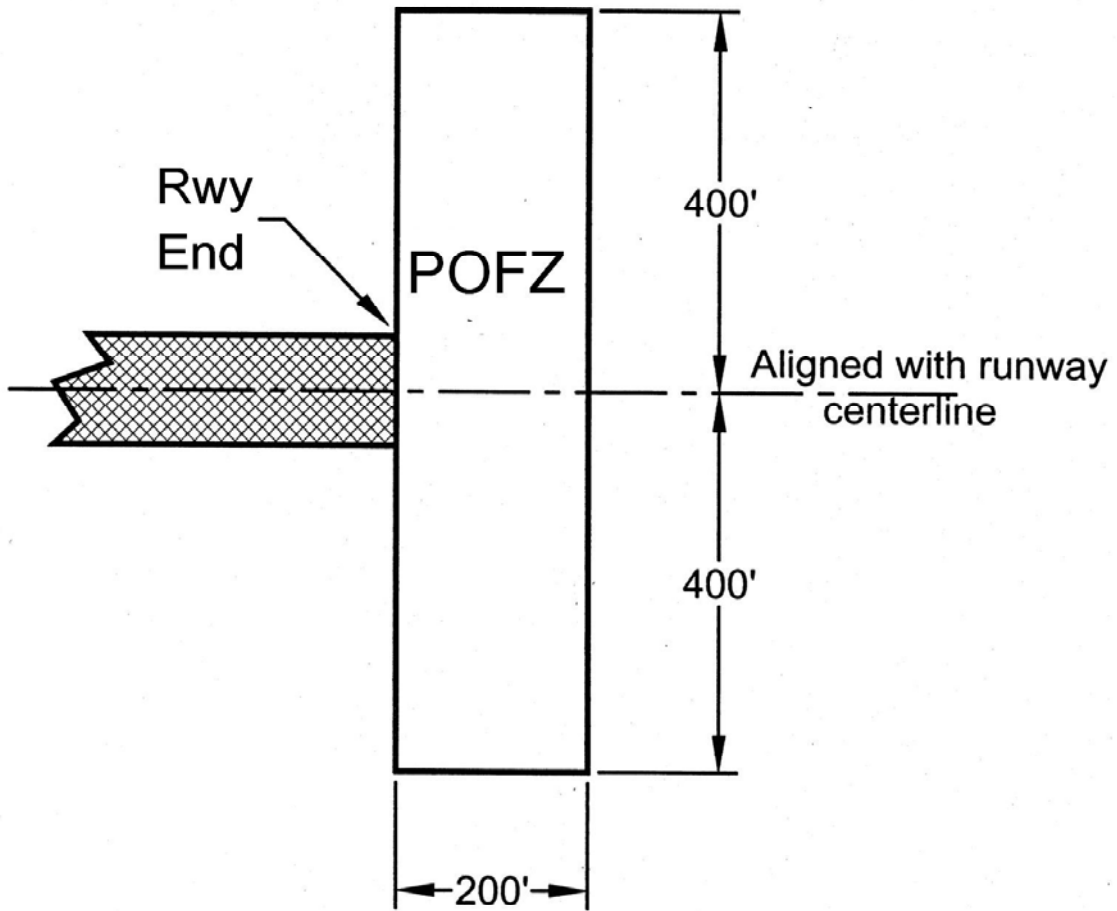

Figure 3-6. Precision Obstacle Free Zone

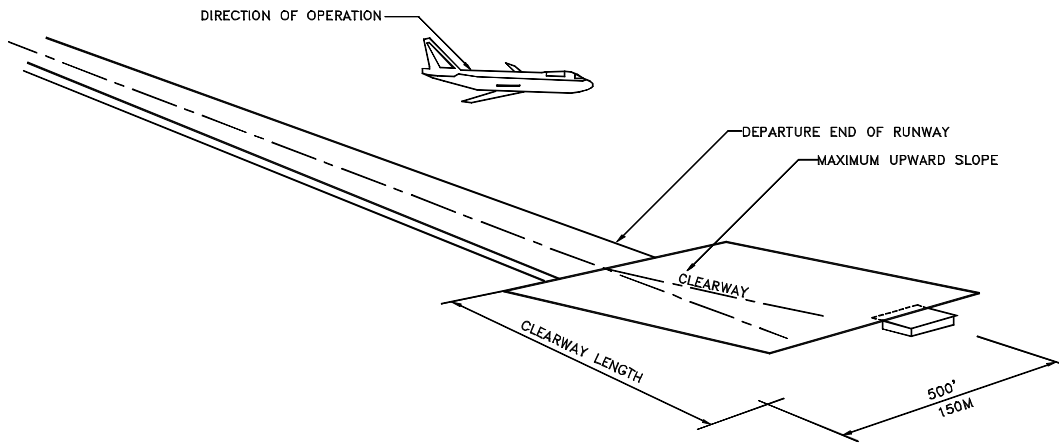

Figure 3-7. Clearway

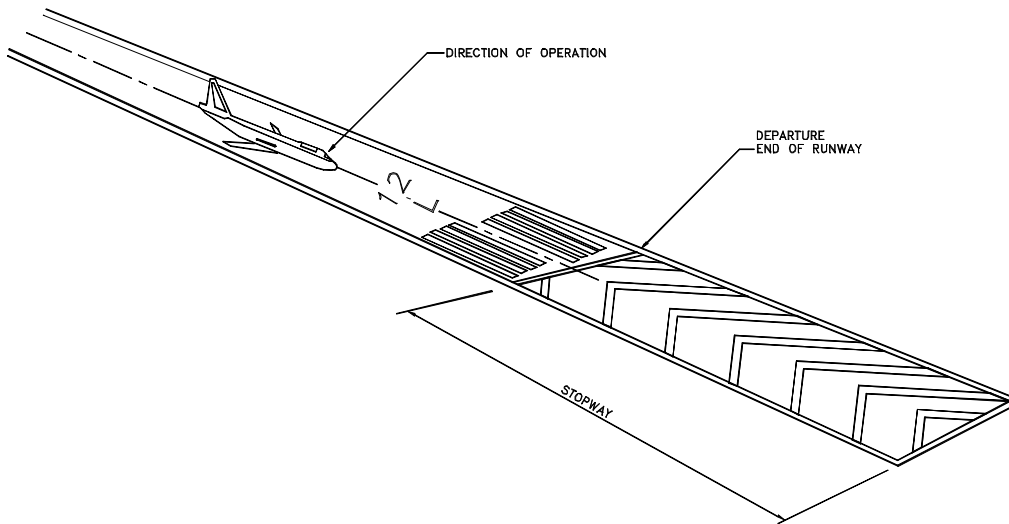

Figure 3-8. Stopway

Chapter 4. TAXIWAY AND TAXILANE DESIGN

400. INTRODUCTION. This chapter presents the design standards for taxiways, taxilanes, and associated airport elements.

401. DIMENSIONAL STANDARDS. Tables 4-1 and 4-2 present the dimensional standards for taxiway, taxilanes, and associated elements. Appendix 9 discusses the relationship between airplane physical characteristics and the design of taxiway and taxilane elements. The rationale presented there is useable, on a case-by-case basis, to adapt separation standards to meet unusual local conditions or to accommodate a specific airplane within an airplane design group.

402. TAXIWAY SHOULDERS. Provide stabilized or paved shoulders to reduce the possibility of blast erosion and engine ingestion problems associated with jet engines that overhang the edge of the taxiway pavement. Table 4-1 presents taxiway shoulder width standards. Soil with turf not suitable for this purpose requires a stabilized or low-cost paved surface. Chapter 8 contains additional information on this subject.

403. TAXIWAY SAFETY AREA (TSA). The taxiway safety area is centered on the taxiway centerline. Table 4-1 presents taxiway safety area dimensional standards.

a. Design Standards. The taxiway safety area shall be:

(1) cleared and graded and have no potentially hazardous ruts, humps, depressions, or other surface variations;

(2) drained by grading or storm sewers to prevent water accumulation;

(3) capable, under dry conditions, of supporting snow removal equipment, aircraft rescue and firefighting equipment, and the occasional passage of aircraft without causing structural damage to the aircraft, and

(4) free of objects, except for objects that need to be located in the taxiway safety area because of their function. Objects higher than 3 inches (7.6 cm) above grade should be constructed on low impact resistant supports (frangible mounted structures) of the lowest practical height with the frangible point no higher than 3 inches (7.6 cm) above grade. Other objects, such as manholes, should be constructed at grade. In no case should their height exceed 3 inches (7.6 cm) above grade.

b. Construction Standards. Compaction of taxiway safety areas shall be to FAA specification P-152 found in AC 150/5370-10.

404. TAXIWAY AND TAXILANE OBJECT FREE AREA (OFA). The taxiway and taxilane OFAs

are centered on the taxiway and taxilane centerlines as shown in figures A9-2, A9-3, and A9-4.

a. The taxiway and taxilane OFA clearing standards prohibit service vehicle roads, parked airplanes, and above ground objects, except for objects that need to be located in the OFA for air navigation or aircraft ground maneuvering purposes. Vehicles may operate within the OFA provided they give right of way to oncoming aircraft by either maintaining a safe distance ahead or behind the aircraft or by exiting the OFA to let the aircraft pass. Provide vehicular exiting areas along the outside of the OFA where required. Table 4-1 specifies the standard dimensions for OFAs.

b. OFA clearance fillets shall be provided at intersections and turns where curved taxiway or taxilane centerline pavement markings, reflectors, or lighting are provided. The OFA clearance fillets shall be configured to provide the standard wingtip clearance for the using aircraft. Appendix 9 provides guidance for finding the wingtip trace and Table 4-3 specifies the standard wingtip clearances.

c. Offset taxilane pavement markings may be used at existing facilities where it is impracticable to upgrade the facility to existing standards or as a temporary measure to assure adequate wingtip clearance until upgraded facilities meeting design standards are completed. The offset taxilane pavement markings should be located on an arc offset and parallel to the curved centerline. The radius of the offset arc should be approximately $(R^2 + d^2)^{0.5}$. R being the radius of the taxilane turn and d being a representative distance from the center of cockpit to the center of the main undercarriage of the larger wingspan aircraft. Increasing the offset radius increases the clearance inside of the curve while decreasing the clearance outside of the curve. Both clearances for each of the larger wingspan aircraft need to be examined. Where offset taxilane pavement markings are provided, centerline lighting or reflectors are required.

405. PARALLEL TAXIWAY. A basic airport consists of a runway with a full-length parallel taxiway, an apron, and connecting transverse taxiways between the runway, parallel taxiway, and the apron.

a. Separation Distance. Tables 2-1 and 2-2 show the standard separation distances between parallel taxiways and runways.

b. Centerline Profile. The centerline profile of a parallel taxiway should prevent excessive longitudinal grades on crossover or transverse taxiways. Chapter 5 provides the standards for taxiway longitudinal grades.

406. TAXIWAY INTERSECTIONS. An airplane pilot may negotiate a taxiway turn by either maintaining the cockpit over the centerline or by judgmental oversteering.

a. Cockpit Over Centerline. Taxiway intersections designed to accommodate cockpit over centerline steering require more pavement, but enable more rapid movement of traffic with minimal risk of aircraft excursions from the pavement surface. Intersections should be designed to accommodate cockpit over centerline steering to the extent practicable. Where taxiway centerline lighting or reflectors are installed, intersections shall be designed for cockpit over centerline steering.

b. Judgmental Oversteering. Taxiway intersections designed to accommodate the judgmental oversteering method of maneuvering require the least pavement widening. However, judgmental oversteering requires complex maneuvering, increases the risk of aircraft excursions from the pavement surface, and slows the flow of traffic.

c. Design. Figure 4-1 shows the most common designs of taxiway-taxiway intersections and tables 4-1 and 4-2 present associated dimensional standards. The designs also apply to taxiway-apron intersections. Adjusting these shapes to achieve more efficient construction procedures may be desirable and should be a cost basis consideration. For example, squaring the venturi areas or designing the pavement fillets, by using either the methodology presented in appendix 10 or a computer program to provide the standard taxiway edge safety margin, may produce a more cost-effective design. Figure 4-4 is a printout from such a program that is operable on an IBM PC compatible computer. Appendix 11 gives details on availability of this program.

d. Limitations. The criteria depicted in figure 4-1 apply to taxiway-taxiway intersections and taxiway-apron intersections and not to runway-taxiway intersections. Discussion and details on runway-taxiway intersections with accompanying figures are in subsequent paragraphs.

407. ENTRANCE TAXIWAYS.

a. Dual Use. An entrance taxiway also serves as the final exit taxiway on a bidirectional runway. It is normally in the form of an “L” taxiway intersection with a right angle connection to the runway.

b. Radius. The centerline radius of curvature should be as large as possible to accommodate higher speeds. The radius is dependent on the separation distance between the runway and parallel taxiway.

c. Design. The entrance design shown in figure 4-5, with a centerline radius of 200 feet (60 m), will allow entrance speeds of 20 mph (30 km per hour), the minimum design speed for the taxiway system. Larger radii will permit higher entrance speeds. The design width requires at least the taxiway edge safety margin specified in table 4-1.

408. BYPASS TAXIWAYS. Air traffic personnel at busy airports encounter occasional bottlenecks when moving airplanes ready for departure to the desired takeoff runway. Bottlenecks result when a preceding airplane is not ready for takeoff and blocks the access taxiway. Bypass taxiways provide flexibility in runway use by permitting ground maneuvering of steady streams of departing airplanes. An analysis of existing and projected traffic indicates if a bypass taxiway will enhance traffic flow.

a. Location. Bypass taxiway locations are normally at or near the runway end. They can be parallel to the main entrance taxiway serving the runway, as shown in figure 4-6, or used in combination with the dual parallel taxiways, as depicted in figure 4-7.

b. Design. Bypass taxiway widths require at least the standard taxiway edge safety margin. The separation and clearance standards are the same as for parallel taxiways.

409. HOLDING BAYS. Providing holding bays instead of bypass taxiways also enhances capacity. Holding bays provide a standing space for airplanes awaiting final air traffic control (ATC) clearance and to permit those airplanes already cleared to move to their runway takeoff position. By virtue of their size, they enhance maneuverability for holding airplanes while also permitting bypass operations. A holding bay should be provided when runway operations reach a level of 30 per hour.

a. Location. Although the most advantageous position for a holding bay is adjacent to the taxiway serving the runway end, it may be satisfactory in other locations. Place holding bays to keep airplanes out of the OFZ and the runway safety area, as well as avoiding interference with instrument landing system operations.

b. Design. Figure 4-8 shows some typical holding bay configurations. Paving the area between dual parallel taxiways may provide an acceptable holding bay.

410. TURNAROUNDS. A turnaround can serve as a combination holding bay and bypass taxiway, when it is not economically feasible to provide a parallel taxiway. The turnaround needs to extend far enough away from the runway so airplanes will be able to remain behind the hold line. Figure 4-9 shows a taxiway turnaround.

411. DUAL PARALLEL TAXIWAYS. To accommodate high-density traffic, airport planners should consider multiple access to runways. For example, to facilitate ATC handling when using directional flow releases, e.g., south departure, west departure, etc., airplanes may be selectively queued on dual (or even triple) parallel taxiways. A dual parallel taxiway need not extend the full length of runway. Crossover taxiways between dual parallel taxiways increase flexibility. See figure 4-10.

412. TAXIWAY BETWEEN PARALLEL RUNWAYS. A taxiway located between two parallel runways requires a centerline separation from each runway to meet the standard separation distance specified in table 2-1.

413. EXIT TAXIWAYS. Design and locate exit taxiways to meet the operational requirements of the airport.

a. Efficiency. Appendix 9 provides guidance on exit taxiway location utilization. AC 150/5060-5 provides guidance on the effect of exit taxiway location on runway capacity. Exit taxiways should permit free flow to the parallel taxiway or at least to a point where air traffic control considers the airplane clear of the runway.

b. Type. A decision to provide a right-angled exit taxiway or a standard acute-angled exit taxiway rests upon an analysis of the existing and contemplated traffic. The purpose of an acute-angled exit taxiway, commonly referred to as a “high speed exit,” is to enhance airport capacity. However, when the design peak hour traffic is less than 30 operations (landings and takeoffs), a properly located right-angled exit taxiway will achieve an efficient flow of traffic.

c. Separation. The type of exit taxiway influences runway and taxiway separation. The standard runway-taxiway separations specified in tables 2-1 and 2-2 are satisfactory for right-angled exit taxiways. A separation distance of at least 600 feet (180 m) is necessary for an efficient acute-angled exit taxiway, which includes a reverse curve for “double-back” operations. The runway-taxiway separations specified in tables 2-1 and 2-2 are adequate for acute-angled exits where the taxiway traffic flow is in the direction of landing.

d. Configuration. Figure 4-1 illustrates the configuration for a right-angled exit taxiway. An entrance spiral of at least 30 degrees and 300 feet (90 m) in length should be provided. Figure 4-12 illustrates the standard acute-angled exit taxiway with a 30-degree angle of intersection and a 1,400-foot (420 m) entrance spiral. When runway capacity needs justify the additional cost, high-visibility taxiway centerline lights can be added and the exit taxiway widened by doubling the taxiway edge safety margin. These design enhancements will increase pilot acceptance of an exit. Figures 4-13 and 4-14 present a computer printout of layout data for a 1,400-foot (420 m) spiral exit using a program operable on IBM compatible equipment. Appendix 11 gives details on the availability of this program.

414. APRON TAXIWAYS AND TAXILANES. Requirements often exist to provide through-taxi routes across an apron and to provide access to gate positions or other terminal areas.

a. Apron Taxiways. Apron taxiways may be located either inside or outside the movement area. Apron taxiways require the same separations as other taxiways. When the apron taxiway is along the edge of the

apron, locate its centerline inward from the apron edge at a distance equal to one-half of the width of the taxiway structural pavement. A shoulder is necessary along the outer edge in addition to the taxiway safety area and the separations specified in tables 2-1, 2-2, 2-3, and 4-1.

b. Taxilanes. Taxilanes are located outside the movement area. Taxilanes provide access from taxiways (usually an apron taxiway) to airplane parking positions and other terminal areas. When the taxilane is along the edge of the apron, locate its centerline inward from the apron edge at a distance equal to one-half of the width of the taxiway structural pavement and satisfy other apron edge taxiway criteria, i.e., a shoulder, safety area, and the separations specified in tables 2-1, 2-2, 2-3, and 4-1.

c. Visibility. Airport traffic control tower personnel require a clear line of sight to all apron taxiways under air traffic control (ATC). Although ATC is not responsible for controlling taxilane traffic, a clear line of sight to taxilanes is desirable.

415. END-AROUND TAXIWAYS. In an effort to increase operational capacity, airports have added dual and sometimes triple parallel runways, which can cause delays when outboard runway traffic has to cross active inboard runways to make its way to the terminal. To improve efficiency and provide a safe means of movement around the departure end of a runway, it might be feasible to construct a taxiway that allows aircraft to transition around the ends of the runway. This type of taxiway is called an End-Around Taxiway (EAT). Due to the safety critical nature of these operations, it is necessary for planners to work closely with the FAA prior to considering the use of an EAT. EATs should be done only to enhance safety and capacity. Before EAT projects are proposed and feasibility studies and/or design started, they must be pre-approved by the FAA Office of Airport Safety and Standards, Airport Engineering Division (AAS-100). Submission for project approval is through the local Airports District Office for coordination with the approval authority (AAS-100). See figure 4-15.

a. Design Considerations. End-around taxiways must remain outside of the standard runway safety area (RSA), which extends 1,000 feet along the centerline extended of the departure end of the runway (DER). In addition, the EAT must be entirely outside of the ILS critical area. An airspace study for each site should be performed to verify if the tail height of the critical design group aircraft operating on the EAT does not penetrate any FAA Order 8260.3 TERPS surface and meets the requirements of 14 CFR 121.189 for the net takeoff flight path to clear all obstacles either by a height of at least 35 feet vertically, or by at least 200 feet horizontally within the airport boundaries.

b. Visual Screen. The placement and configuration of EATs must take into account additional

restrictions to prevent interfering with navigational aids, approaches and departures from the runway(s) with which they are associated. In order to avoid potential issues where pilots departing from a runway with an EAT might mistake an aircraft taxiing on the EAT for one actually crossing near the departure end of the runway, a visual screen type device may be required, depending on the elevation changes at a specific location. Through a partial or complete masking effect, the visual screen will enable pilots to better discern when an aircraft is crossing the active runway versus operating on the EAT. The intent is to eliminate any false perceptions of runway incursions, which could lead to unnecessary aborted takeoffs, and alert pilots to actual incursion situations. A visual screen is required for any new EAT unless the elevation of the EAT centerline, at a point in line with the extended runway centerline, is at least 29 feet below the elevation at the DER, so the terrain creates a natural masking of the aircraft on the EAT. Research has shown that “masking” is accomplished at a height where a critical design group aircraft’s wing-mounted engine nacelle would be blocked from view, as discerned from the V-1 point during take-off. DO not locate the visual screen structure within any runway safety area, taxiway obstacle free zone, critical ILS area, or should it penetrate the inner approach OFZ, the approach light plane or other TERPS surfaces.

(1) Screen Sizing. The size of the EAT visual screen is dependent on the runway geometry, the size of the critical design group aircraft operating at that particular airport (on both the departing and EAT), and the elevation relationship between the EAT and the departing runway.

(a) Horizontal Geometry. The width of the screen should be designed to be perceived to originate and end at the taxiway/runway hold line(s) at the DER from a position on the runway equivalent to V1 (take-off decision speed under maximum conditions) for the critical design group aircraft. In order to calculate the screen width, the distance to where the screen will be located beyond the runway end must first be determined. From the runway centerline location of V1 for the design aircraft, lines are drawn through the runway hold line position closest to the DER (normally derived from the Aircraft Holding Position Location in Advisory Circular 150/5340-18) and extended until they intersect with a line perpendicular to the runway at the screen location. See figure 4-16. Use the formula in Figure 4-17 to calculate the width of the visual screen.

(b) Vertical Geometry. The vertical height of the screen must be designed so the top of the screen will mask that portion of an aircraft that extends up to where the top of a wing-mounted engine nacelle would be of a critical design group aircraft taxiing on the EAT, as viewed from the cockpit of the same design group aircraft at the typical V1 point on the departure runway. In a situation where the EAT and the

DER elevation are the same, the lower edge of the visual panels should be at the same vertical height as the centerline of the DER. The visual panels of the screen should extend from that point, up to the heights shown in table 4-4, depending on the design group aircraft. For the higher design groups, it is permissible to have the lower limit of the visual screen up to two (2) feet above the DER elevation, as shown in table 4-4. Variations in terrain at the site where the screen is to be constructed will need to be considered, and they may result in the screen being a sizeable distance off the ground. In the event the EAT and DER are at different elevations, either higher or lower, the overall screen height will have to be adjusted to ensure the same masking capability. Tables 4-5, 4-6, and 4-7 provide guidance on determining the height of the visual screen for the respective design groups if the elevation of the EAT is below the elevation of the DER. If the EAT is lower than 29 feet in elevation as compared to the centerline of the DER, a screen is not required. Table 4-8 provides guidance on determining the height of the visual screen for design groups 3 through 6 if the elevation of the EAT is above the elevation of the DER. It may be feasible to grade the site of the visual screen to allow for an additional 2-foot separation between the visual screen panels and the ground for mowing access.

(2) Screen Construction. The visual screen must be constructed to perform as designed and be durable, resistant to weather, frangible, and resistant to excessive wind speeds. The visual screen comprises foundations, frame, connection hardware, and front panels.

(a) Foundations. The foundation of the screen structure should be sufficient to hold the visual screen in position. The base of the foundation should have a sufficient mow strip around it to provide a safety buffer between mowing equipment and the screen structure.

(b) Frame. The frame structure of the screen should be constructed so it is durable, able to withstand wind loading, and frangible in construction. Figure 4-18 illustrates three methods for constructing the frame structure, depending on the overall height of the structure. The visual screen structure should be constructed to allow the front panels of the screen to be angled upward 12 ($\pm 1^\circ$) degrees from the vertical plane. All connections within the frame structure, the panels, and the foundations should be designed to break away from the structure in the event an aircraft impacts them.

(c) Front Panel. The front panel of the visual screen should be designed so it is conspicuous from the runway side of the screen. The front panel should be constructed of aluminum honeycomb material, as described in the next paragraph. The replaceable front panels should be 12 feet long and 4

feet high and attached to the frame structure so as to allow easy replacement if necessary. See figure 4-19.

(i) **Aluminum**

Honeycomb Performance Criteria. The screen panels should be constructed of aluminum honeycomb material, as described in this section. The front panel of the screen should be constructed of 4-foot-tall panels, with the remaining difference added as required. For example, three 4-foot-high panels plus one 1-foot-tall panel would be used to create a 13-foot-tall screen. These panels should be undersized by 0.50 inches to allow for thermal and deflection movements. The front and back panel faces should be specified to meet the required deflection allowance and should be a minimum 0.04 inches thick. The honeycomb material should be of sufficient thickness to meet the required deflection allowance, but should not be more than 3 inches thick. The internal aluminum honeycomb diameter should be of sufficient strength to meet the required deflection allowance, but should not be more than 0.75 inches in diameter. The panel edge closures should be of aluminum tube that is 1 inch times the thickness of the honeycomb and sealed. The deflection allowance for the screen is 0.50 inches maximum at the center of the panel when supported by four points at the corner of the panel. The panel faces should have a clear anodized finish on both front and back. The wind-loading deflection should be as specified in table 4-9.

(ii) **Pattern.** The front panel of the screen should visually depict a continuous, alternating red and white, diagonal striping of 12-foot-wide stripes set at a 45-degree angle \pm five (5) degrees, sloped either all to the left or all to the right. To provide maximum contrast, the slope of the diagonal striping on the screen should be opposite the slope of aircraft tails operating in the predominant flow on the EAT, as shown in Figure 4-20.

(iii) **Color.** The front panel of the screen should be reflective red and white. The colors of the retroreflective sheeting used to create the visual screen must conform to Chromaticity Coordinate Limits shown in table 4-10, when measured in accordance with Federal Specification FP-85, Section 718.01(a), or ASTM D 4956.

(iv) **Reflectivity.** The surface of the front panel should be reflective on the runway side of the screen. Measurements should be made in accordance with ASTM E810, *Standard Test Method for Coefficient of Retro-reflection of Retro-reflective Sheeting*. The sheeting must maintain at least 90 percent of its values, as shown in table 4-11, with water falling on the surface, when measured in accordance with the standard rainfall test of FP-85, Section 718.02(a), and Section 7.10.0 of AASHTO M 268.

(v) **Adhesion.** The screen surface material must have a pressure-sensitive adhesive,

which conforms to adhesive requirements of FP-85 (Class 1) and ASTM D 4956 (Class 1). The pressure-sensitive adhesive is recommended for application by hand or with a mechanical squeeze roller applicator. This type adhesive lends itself to large-scale rapid production of signs. Applications should be made with sheeting and substrate at temperatures above 65° F (18°C).

(3) **Environmental Performance.**

The front panel of the screen surface material and all its required components must be designed for continuous outdoor use under the following conditions:

(a) **Temperature.** Screen surface material must withstand the following ambient temperature ranges: -4 degrees to +131 degrees F (-20 degrees to +55 degrees C).

(b) **Wind Loading.** The screen must be able to sustain exposure to wind velocities of at least 90 mph or the appropriate velocity rating anticipated for the specific airport location, whichever is greater.

(c) **Rain.** The screen surface material must withstand exposure to wind-driven rain.

(d) **Sunlight.** The screen surface material must withstand exposure to direct sunlight.

(e) **Lighting.** If required, the top edge of the visual screen should be illuminated with steady burning, L-810 FAA-approved obstruction lighting, as provided in the current version of AC 150/5345-43, and positioned as specified in paragraph 58(b) of the current version of AC 70/7460-1.

(4) **Provision for Alternate Spacing of Visual Screen.** If access is needed through the area where the visual screen is constructed, various sections of the screen may be staggered up to 50 feet from each other, as measured from the runway end, so an emergency vehicle can safely navigate between the staggered sections of screen. The sections of screen must be overlapped so the screen appears to be unbroken when viewed from the runway, at the V1 takeoff position.

(5) **Frangibility.** The screen structure, including all of its components, should be of the lowest mass possible to meet the design requirements so as to minimize damage should the structure be impacted. The foundations at ground level should be designed so they will shear on impact, the vertical supports should be designed so they will give way, and the front panels should be designed so they will release from the screen structure if impacted. The vertical support posts should be tethered at the base so they will not tumble when struck. Figure 4-21 provides information on how this level of frangibility can be achieved.

(6) **Navigational Aid Consideration.** The following considerations should be given when determining

the siting and orientation of the visual screen. The visual screen may have adverse affects on navigational aids if it is not sited properly. The uniqueness and complexity of the airport siting environment requires that all installations be addressed on a case-by-case basis, so mitigations can be developed to ensure the installation of the visual screen does not significantly navigational aid performance.

(a) Approach Light Plane. No part of the visual screen may penetrate the approach light plane.

(b) Radar Interference. Research has shown that a visual screen erected on an airport equipped with Airport Surface Detection Equipment (ASDE) may reflect signals that are adverse to the ASDE operation. To avoid this, the visual screen should be tilted back/away (on the side facing the ASDE) 12 degrees ($\pm 1^\circ$). This will minimize or eliminate false radar

targets generated by reflections off the screen surface. Examples of this tilting are shown in figure 4-18.

(c) Instrument Landing System (ILS) Interference. Research has shown that the presence of visual screens on a runway instrumented with an ILS system (localizer and glide slope) will generally not affect or interfere with the operation of the system. An analysis must be performed for glide slopes, especially null reference glide slopes, prior to the installation of the screens. The uniqueness and complexity of the airport siting environment requires that all installations be addressed on a case-by-case basis, so mitigations can be developed to ensure the installation of the visual screen does not significantly impact the performance of the ILS.

416. to 499. RESERVED.

Table 4-1. Taxiway dimensional standards

ITEM	DIM 1/	AIRPLANE DESIGN GROUP					
		I	II	III	IV	V	VI
Taxiway Width	W	25 ft 7.5 m	35 ft 10.5 m	50 ft 2/ 15 m 2/	75 ft 23 m	75 ft 23 m	100 ft 30 m
Taxiway Edge Safety Margin 3/		5 ft 1.5 m	7.5 ft 2.25 m	10 ft 4/ 3 m 4/	15 ft 4.5 m	15 ft 4.5 m	20 ft 6 m
Taxiway Pavement Fillet Configuration		- Refer to Table 4-2 -					
Taxiway Shoulder Width		10 ft 3 m	10 ft 3 m	20 ft 6 m	25 ft 7.5 m	35 ft 5/ 10.5 m 5/	40 ft 5/ 12 m 5/
Taxiway Safety Area Width	E	49 ft 15 m	79 ft 24 m	118 ft 36 m	171 ft 52 m	214 ft 65 m	262 ft 80 m
Taxiway Object Free Area Width		89 ft 27 m	131 ft 40 m	186 ft 57 m	259 ft 79 m	320 ft 97 m	386 ft 118 m
Taxilane Object Free Area Width		79 ft 24 m	115 ft 35 m	162 ft 49 m	225 ft 68 m	276 ft 84 m	334 ft 102 m

1/ Letters correspond to the dimensions on figures 2-1 and 4-1.

2/ For airplanes in Airplane Design Group III with a wheelbase equal to or greater than 60 feet (18 m), the standard taxiway width is 60 feet (18 m).

3/ The taxiway edge safety margin is the minimum acceptable distance between the outside of the airplane wheels and the pavement edge.

4/ For airplanes in Airplane Design Group III with a wheelbase equal to or greater than 60 feet (18 m), the taxiway edge safety margin is 15 feet (4.5 m).

5/ Airplanes in Airplane Design Groups V and VI normally require stabilized or paved taxiway shoulder surfaces.

Consideration should be given to objects near runway/taxiway/taxilane intersections, which can be impacted by exhaust wake from a turning aircraft.

The values obtained from the following equations may be used to show that a modification of standards will provide an acceptable level of safety. Refer to paragraph 6 for guidance on modification of standards requirements.

Taxiway safety area width equals the airplane wingspan;

Taxiway OFA width equals 1.4 times airplane wingspan plus 20 feet (6 m); and

Taxilane OFA width equals 1.2 times airplane wingspan plus 20 feet (6 m).

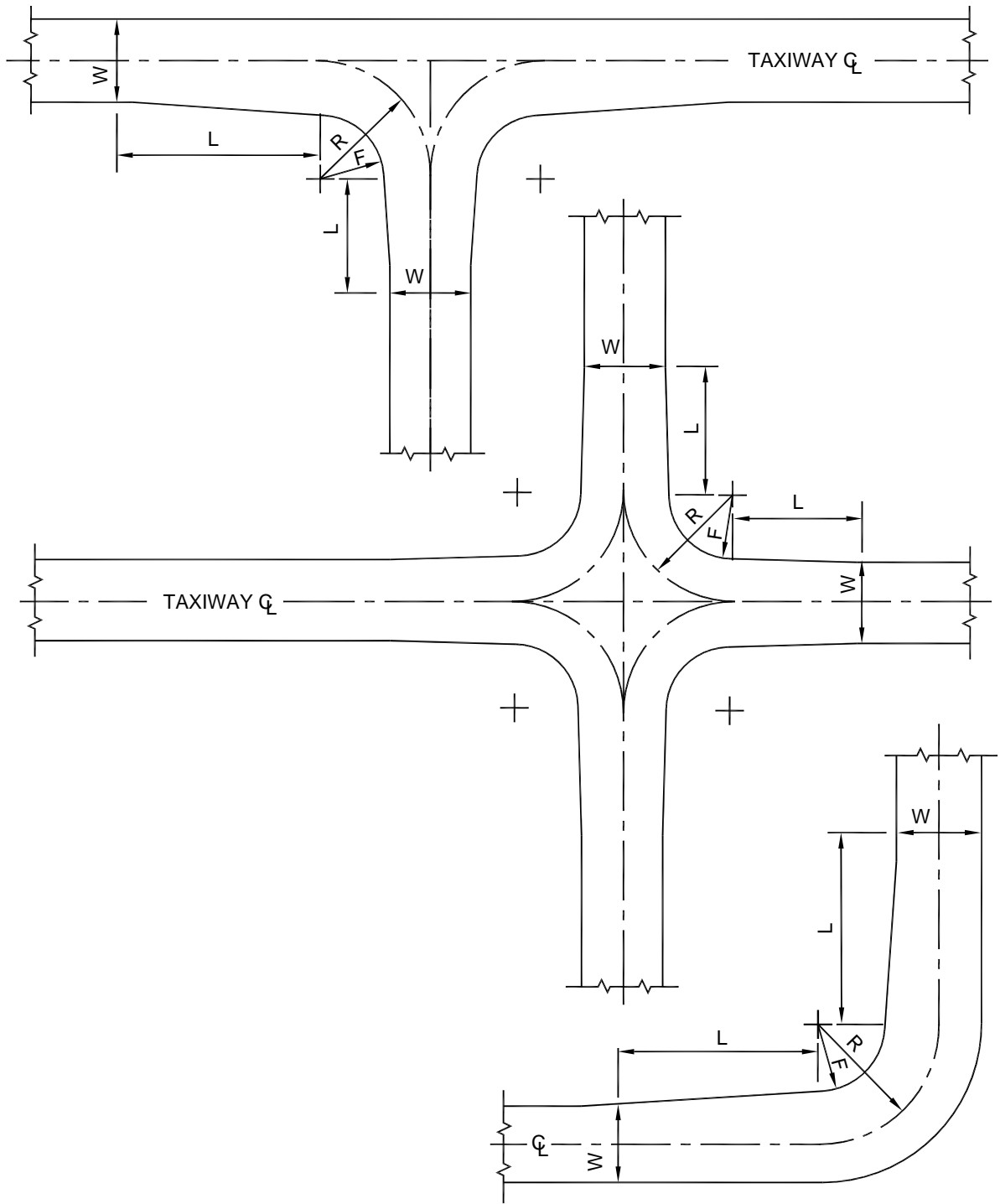

Figure 4-1. Taxiway intersection details

Table 4-2. Taxiway fillet dimensions

ITEM	DIM 1/	AIRPLANE DESIGN GROUP					
		I	II	III 2/	IV	V	VI
Radius of Taxiway Turn 3/	R	75 ft 22.5 m	75 ft 22.5 m	100 ft 30 m	150 ft 45 m	150 ft 45 m	170 ft 51 m
Length of Lead-in to Fillet	L	50 ft 15 m	50 ft 15 m	150 ft 45 m	250 ft 75 m	250 ft 75 m	250 ft 75 m
Fillet Radius for Tracking Centerline	F	60 ft 18 m	55 ft 16.5 m	55 ft 16.5 m	85 ft 25.5 m	85 ft 25.5 m	85 ft 25.5 m
Fillet Radius for Judgmental Oversteering Symmetrical Widening 4/	F	62.5 ft 18.75 m	57.5 ft 17.25 m	68 ft 20.4 m	105 ft 31.5 m	105 ft 31.5 m	110 ft 33 m
Fillet Radius for Judgmental Oversteering One Side Widening 5/	F	62.5 ft 18.75 m	57.5 ft 17.25 m	60 ft 18 m	97 ft 29 m	97 ft 29 m	100 ft 30 m

1/ Letters correspond to the dimensions on figure 4-1.

2/ Airplanes in Airplane Design Group III with a wheelbase equal to or greater than 60 feet (18 m) should use a fillet radius of 50 feet (15 m).

3/ Dimensions for taxiway fillet designs relate to the radius of taxiway turn specified. Figures 4-2 and 4-3 show taxiway fillet designs that provide the standard taxiway edge safety margin for a range of wheelbase and undercarriage width combinations. Custom-designed pavement fillet are necessary when the specified "R" or the undercarriage (also undercarriage to cockpit) dimensions fall outside of the standard taxiway edge safety margin of figures 4-2 and 4-3. The equations in appendix 10 or the use of a computer program offer this ability. Appendix 11 gives details on availability of this program.

4/ The center sketch of figure 4-1 displays pavement fillets with symmetrical taxiway widening.

5/ The lower sketch of figure 4-1 displays a pavement fillet with taxiway widening on one side.

Table 4-3. Wingtip clearance standards

ITEM	DIM	AIRPLANE DESIGN GROUP					
		I	II	III	IV	V	VI
Taxiway Wingtip Clearance		20 ft 6 m	26 ft 8 m	34 ft 10.5 m	44 ft 13.5 m	53 ft 16 m	62 ft 19 m
Taxilane Wingtip Clearance		15 ft 4.5 m	18 ft 5.5 m	22 ft 6.5 m	27 ft 8 m	31 ft 9.5 m	36 ft 11 m

The values obtained from the following equations may be used to show that a modification of standards will provide an acceptable level of safety. Refer to paragraph 6 for guidance on modification of standards requirements.

Taxiway wingtip clearance equals 0.2 times airplane wingspan plus 10 feet (3 m) and

Taxilane wingtip clearance equals 0.1 times airplane wingspan plus 10 feet (3 m).

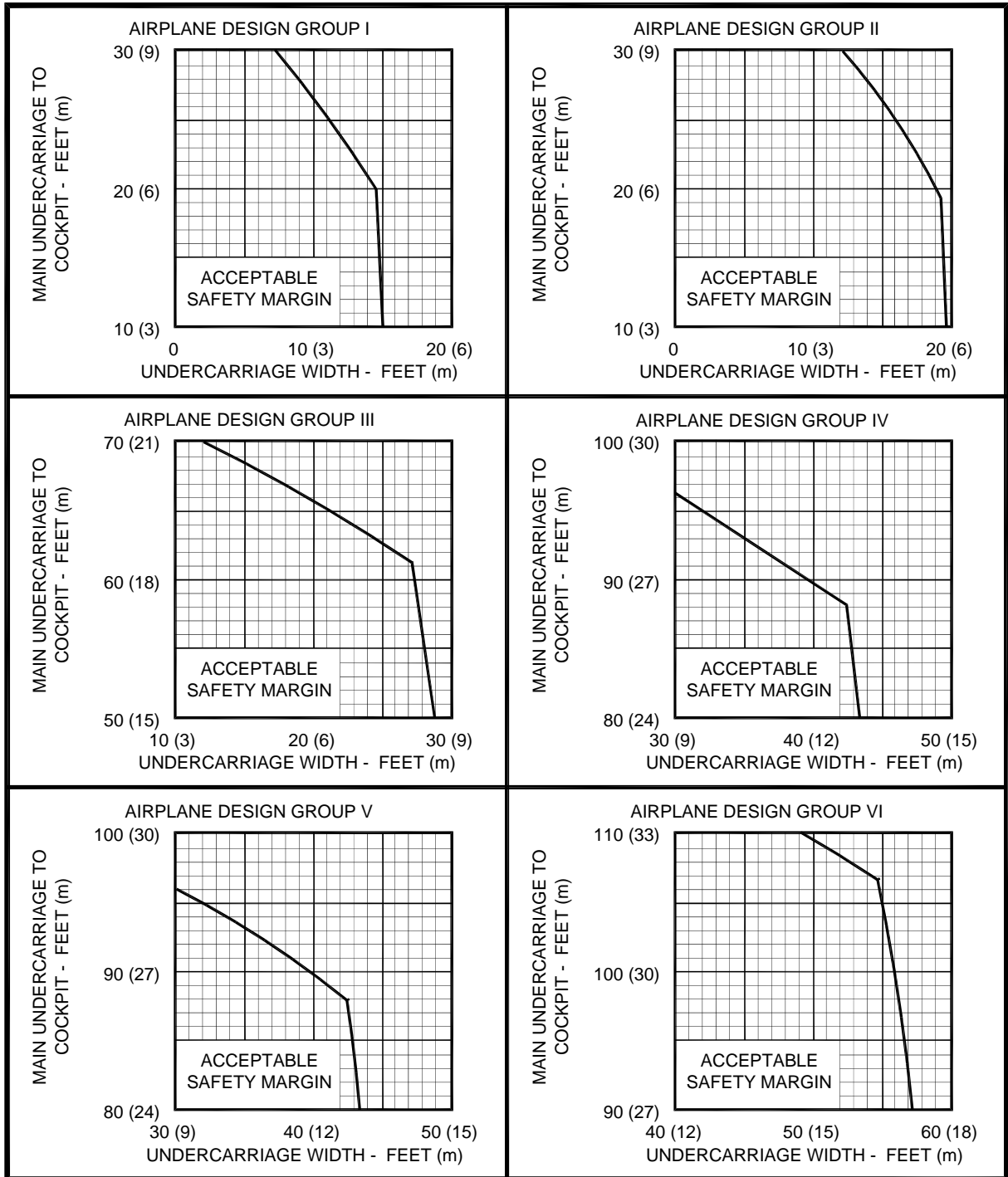

Figure 4-2. Maintaining cockpit over centerline

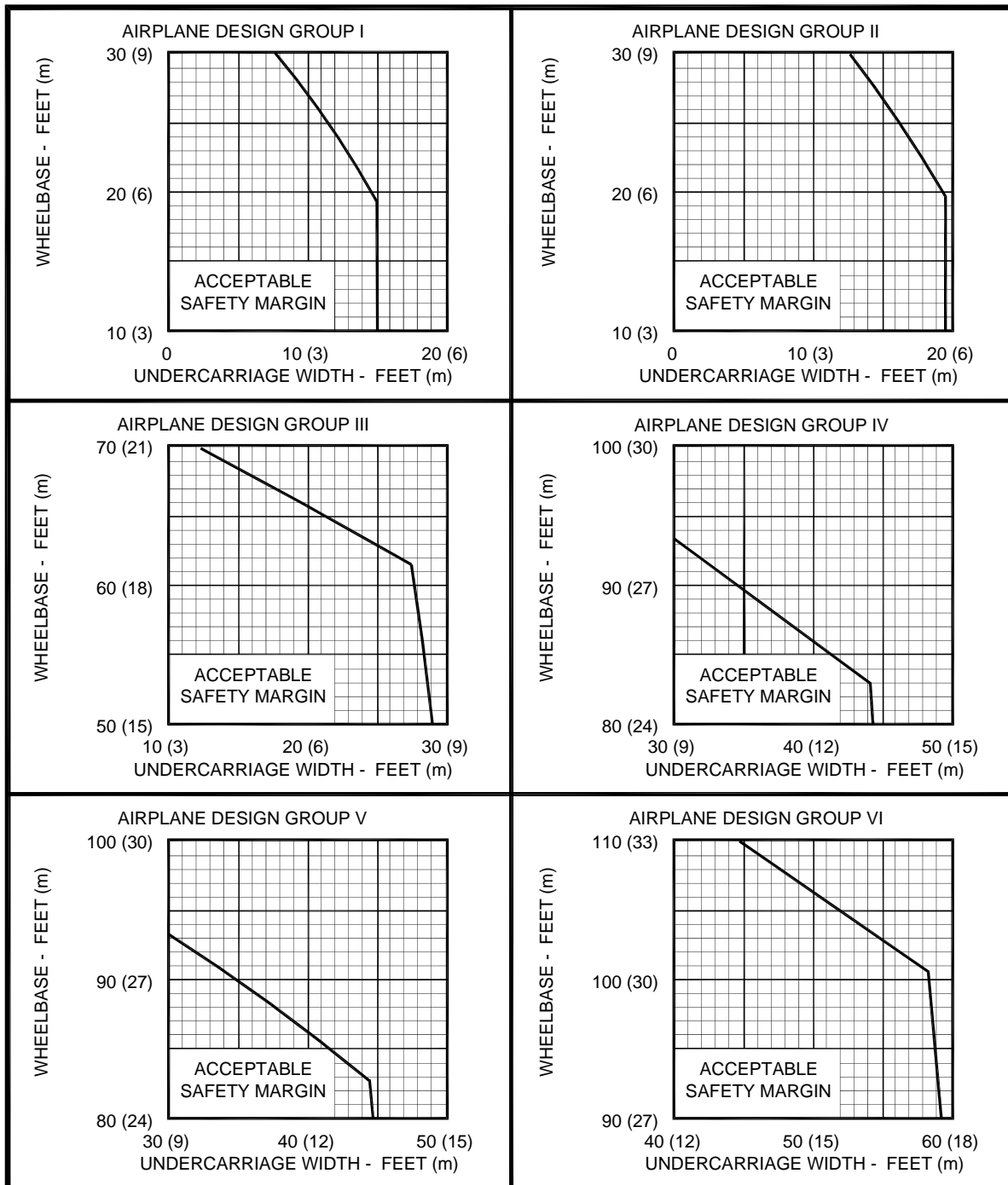

Figure 4-3. Judgmental oversteering

OFFSET DISTANCES ON A TAXIWAY INTERSECTION OR CURVE

Airplane wheelbase	84.000
Center of airplane cockpit to nosewheel	6.000
Airplane undercarriage width [1.15 x main gear track]	41.000
Taxiway edge safety margin	15.000
Taxiway width	75.000

AIRPLANE COCKPIT ON CENTERLINE

Entrance Station	0.000	Radius	150.000
Tangent Length	*****		
Intersection Angle	180.00000	Curve Length	471.239
Tangent Length	*****		
Exit Station	471.239	Radius	150.000
Entrance Station	471.239		
Tangent Length	328.761		
Exit Station	800.000		

STATION	LEFT OFFSET	RIGHT OFFSET	STEERING ANGLES	X COORDINATE	Y COORDINATE	CENTERLINE ANGLE
0.000	43.57	28.58	0.000	0.000	0.000	0.00000
50.000	51.88	19.58	14.676	49.079	8.256	19.09859
100.000	56.92	15.00	23.246	92.755	32.117	38.19718
150.000	60.05	15.00	28.382	126.221	68.955	57.29577
200.000	62.03	15.00	31.528	145.791	114.714	76.39436
250.000	63.28	15.00	33.486	149.311	164.359	95.49295
300.000	64.08	15.00	34.717	136.395	212.422	114.59153
350.000	64.59	15.00	35.496	108.463	253.614	133.69012
400.000	64.74	15.00	35.992	68.591	283.399	152.78871
450.000	61.62	15.00	36.308	21.168	298.499	171.88730
471.239	58.29	15.00	36.405	0.000	300.000	180.00000
471.239	58.29	15.00	36.405	0.000	300.000	180.00000
500.000	51.79	19.88	26.870	-28.761	300.000	180.00000
550.000	44.70	26.51	15.609	-78.761	300.000	180.00000
600.000	40.74	30.32	8.993	-128.761	300.000	180.00000
650.000	38.50	32.52	5.167	-178.761	300.000	180.00000
700.000	37.22	33.79	2.966	-228.761	300.000	180.00000
750.000	0.00	0.00	1.702	-278.761	300.000	180.00000
800.000	0.00	0.00	0.977	-328.761	300.000	180.00000

NOTE: The offset distance is a perpendicular distance measured from the taxiway centerline. The hard surface needs to be widened at stations where the offset distance extends beyond the hard surface.

REFERENCE: AC 150/5300-13, AIRPORT DESIGN.

Figure 4-4. Example of pavement fillet computer program printout

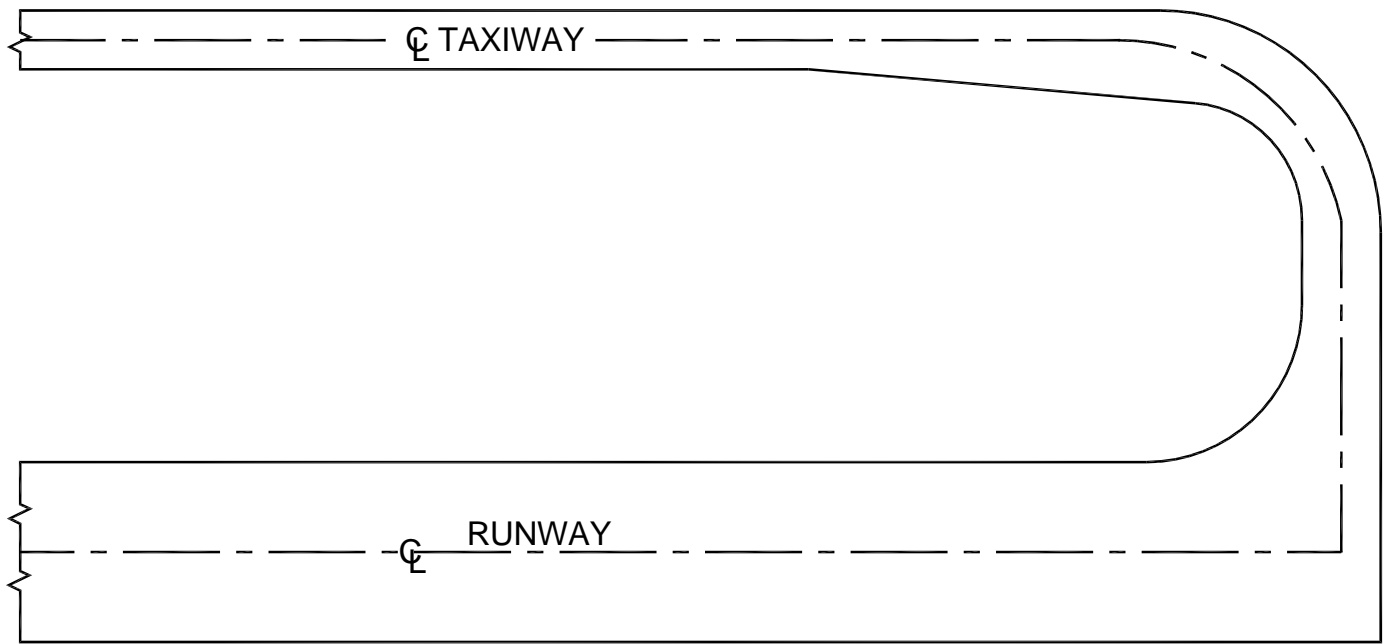

Figure 4-5. Entrance taxiway

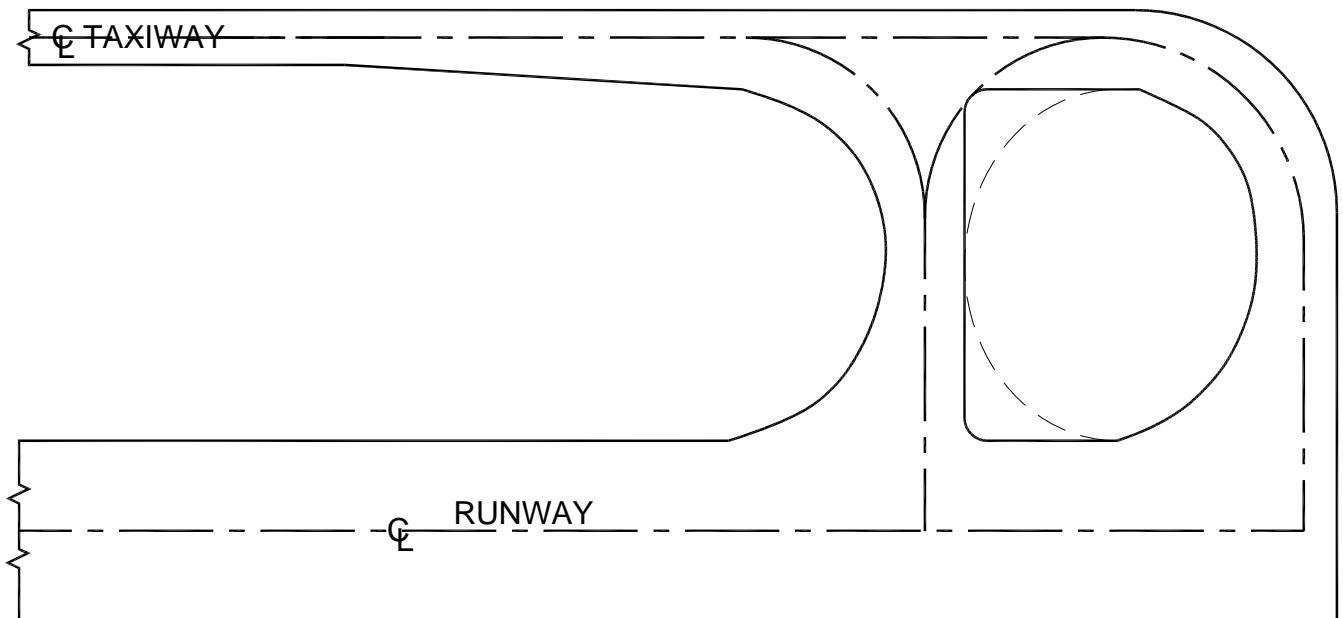

Figure 4-6. Bypass taxiway

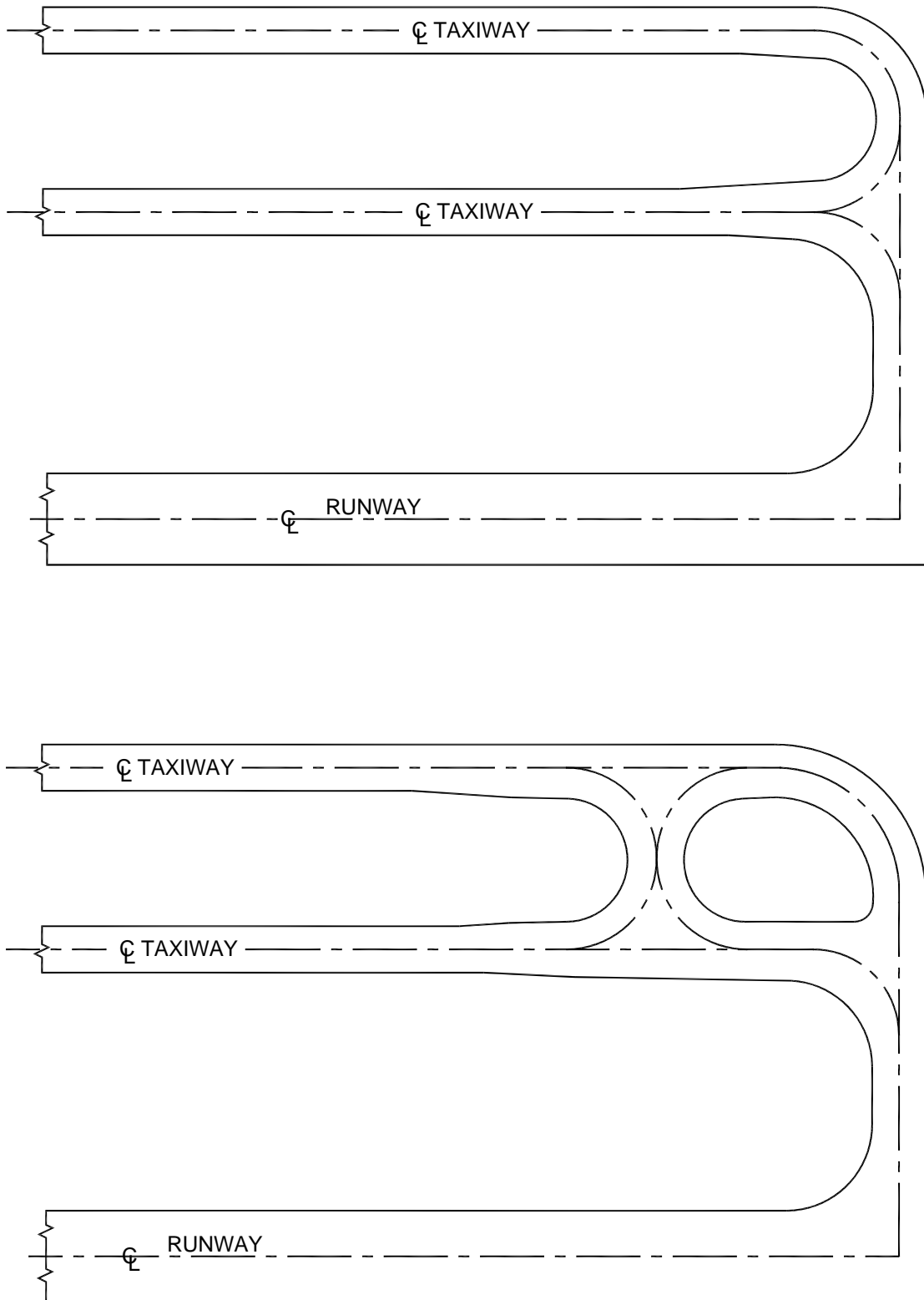

Figure 4-7. Dual parallel taxiway entrance

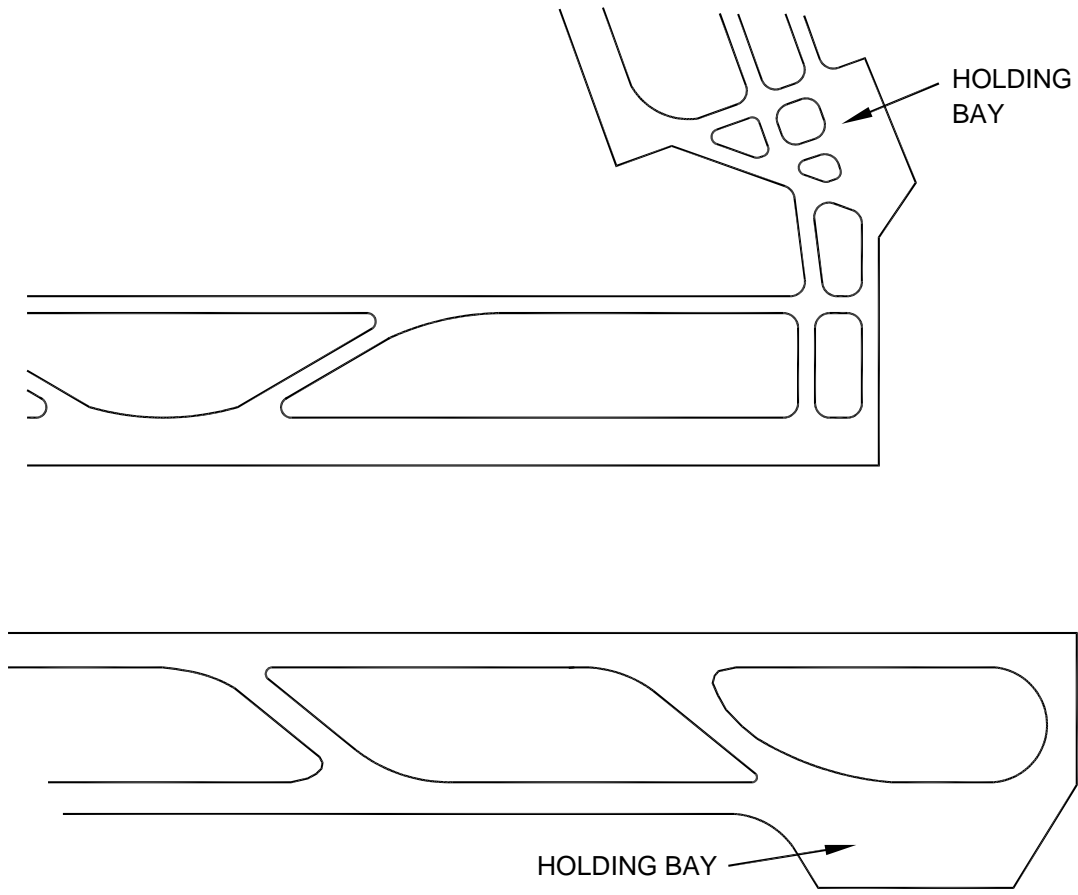

Figure 4-8. Typical holding bay configurations

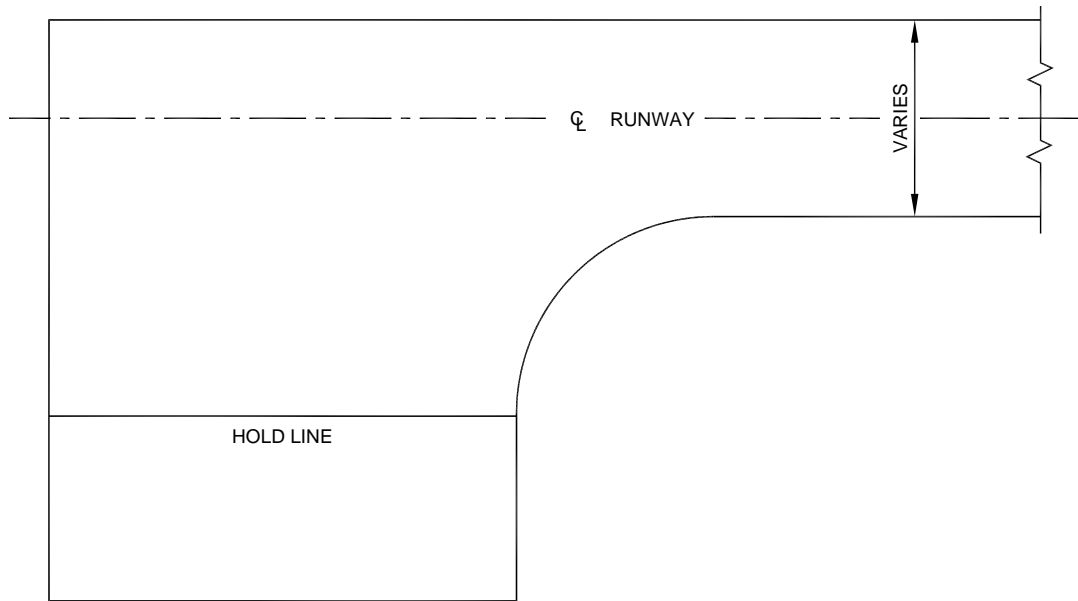

Figure 4-9. Taxiway turnaround

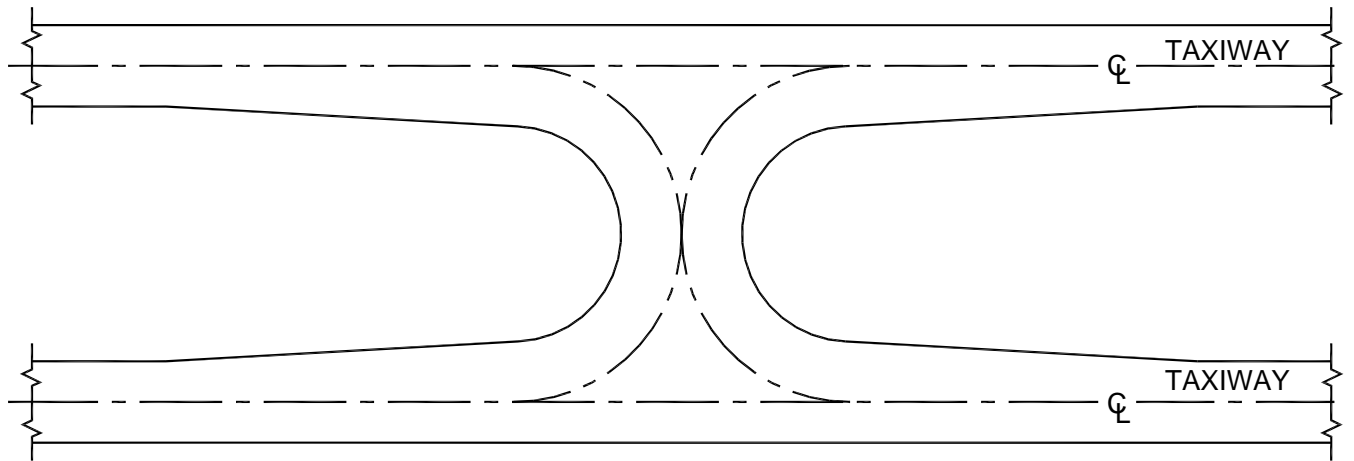

Figure 4-10. Crossover taxiway

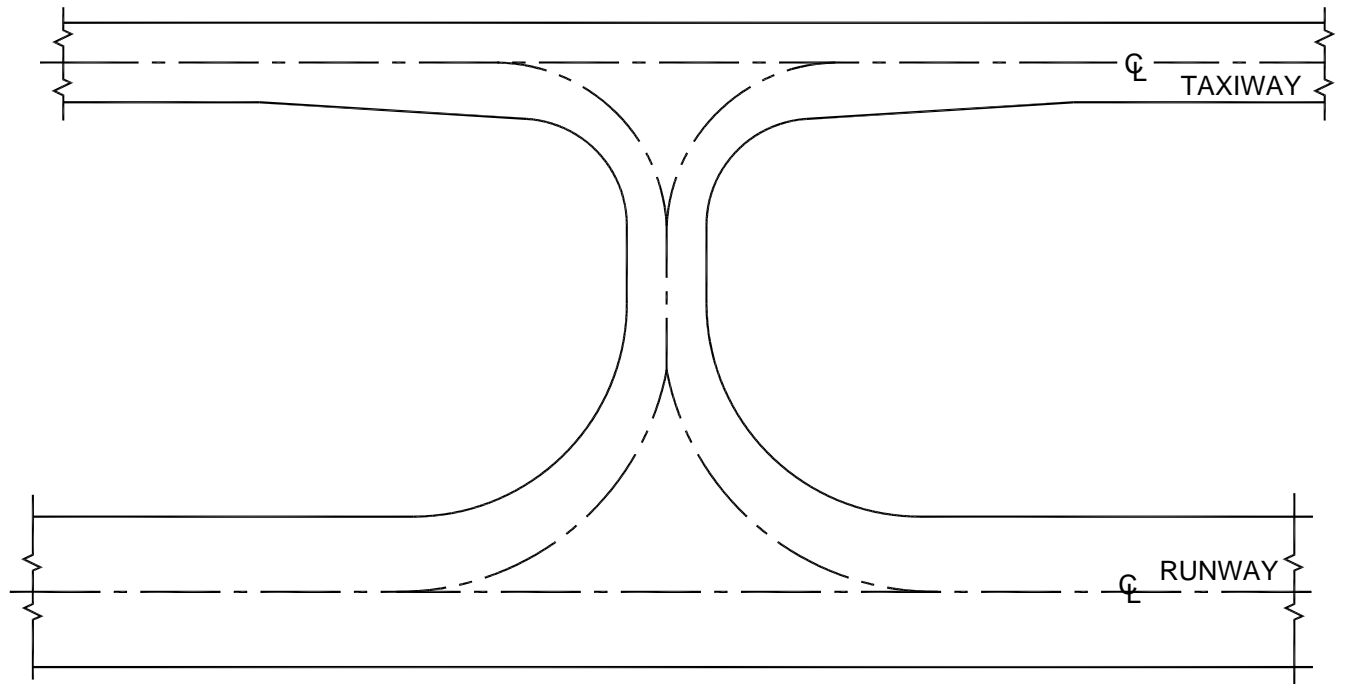

Figure 4-11. Right-angled exit taxiway

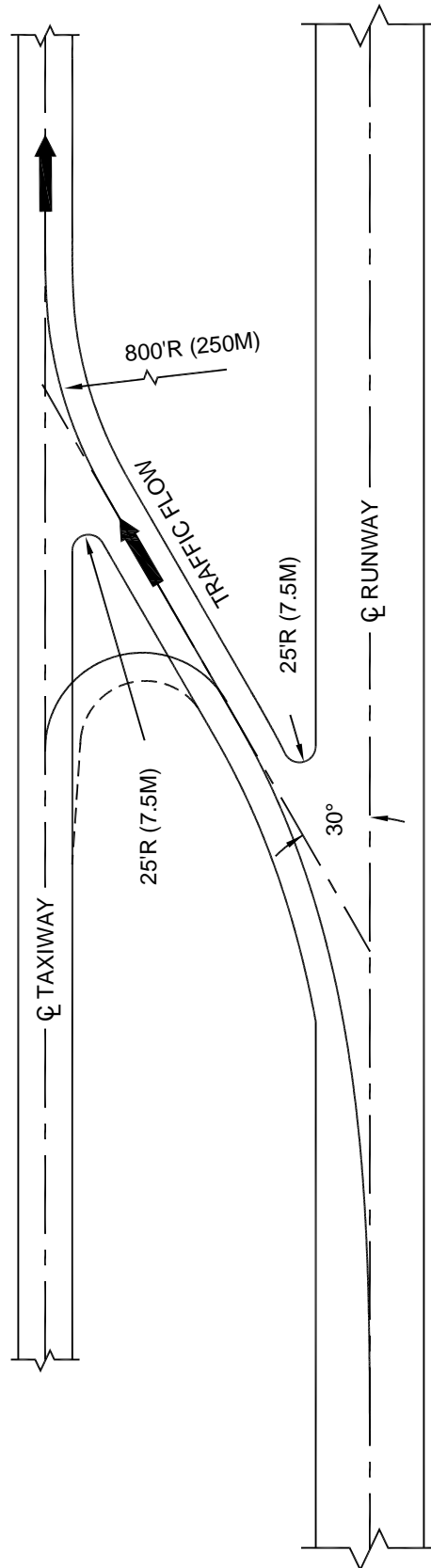

Figure 4-12. Acute-angled exit taxiway

OFFSET DISTANCES ON A RAPID RUNOFF EXIT TAXIWAY

Airplane wheelbase	84.000
Center of airplane cockpit to nosewheel	6.000
Airplane undercarriage width [1.15 x main gear track]	41.000
Taxiway edge safety margin	15.000
Taxiway width	75.000
Runway width	150.000
Runway centerline to parallel taxiway centerline	600.000

AIRPLANE COCKPIT ON CENTERLINE

Entrance Station	0.000		
Tangent Length	947.098		
Intersection Angle	30.00000	Spiral Length	1400.000
Tangent Length	479.205		
Exit Station	1400.000	Radius	1336.902
Entrance Station	1400.000		
Tangent Length	506.435		
Exit Station	1906.435		
Entrance Station	1906.435	Radius	800.000
Tangent Length	214.359		
Intersection Angle	-30.00000	Curve Length	418.879
Tangent Length	214.359		
Exit Station	2325.314	Radius	800.000
Entrance Station	2325.314		
Tangent Length	274.686		
Exit Station	2600.000		

STATION	LEFT OFFSET	RIGHT OFFSET	STEERING ANGLES	X COORDINATE	Y COORDINATE	CENTERLINE ANGLE
0.000	75.01	74.99	0.000	0.000	0.000	0.00000
50.000	75.06	74.94	0.032	50.000	0.011	0.03827
100.000	75.13	74.86	0.109	100.000	0.089	0.15306
150.000	75.20	74.76	0.212	149.999	0.301	0.34439
200.000	75.27	74.63	0.330	199.998	0.712	0.61224
250.000	75.33	74.49	0.456	249.993	1.391	0.95663
300.000	75.37	74.32	0.587	299.983	2.404	1.37755
350.000	75.38	74.12	0.721	349.963	3.818	1.87500
400.000	75.36	73.89	0.857	399.927	5.698	2.44898
450.000	75.31	73.62	0.994	449.868	8.113	3.09949
500.000	75.22	73.31	1.131	499.777	11.127	3.82653
550.000	75.09	72.96	1.268	549.641	14.808	4.63010
600.000	74.90	72.57	1.406	599.445	19.222	5.51020
650.000	74.67	72.11	1.543	649.172	24.432	6.46684
700.000	74.38	71.61	1.681	698.802	30.506	7.50000
750.000	74.02	71.04	1.819	748.308	37.506	8.60969
800.000	73.61	70.40	1.956	797.665	45.497	9.79592

Figure 4-13. Example of acute-angled exit taxiway computer layout data page 1

850.000	73.12	69.70	2.094	846.839	54.541	11.05867
900.000	72.56	68.92	2.232	895.795	64.699	12.39796
950.000	71.92	68.07	2.370	944.493	76.031	13.81378
1000.000	71.20	67.13	2.508	992.887	88.595	15.30612
1050.000	70.40	66.11	2.646	1040.928	102.447	16.87500
1100.000	69.51	65.00	2.784	1088.562	117.640	18.52041
1150.000	68.52	63.80	2.921	1135.729	134.227	20.24235
1200.000	67.45	62.51	3.059	1182.363	152.255	22.04082
1250.000	66.27	61.11	3.197	1228.396	171.768	23.91582
1300.000	64.99	59.62	3.335	1273.752	192.807	25.86735
1350.000	63.53	58.11	3.473	1318.349	215.408	27.89541
1400.000	61.32	57.15	3.611	1362.102	239.603	30.00000
1400.000	61.32	57.15	3.611	1362.102	239.603	30.00000
1450.000	58.78	56.38	2.072	1405.404	264.603	30.00000
1500.000	56.62	55.25	1.189	1448.705	289.603	30.00000
1550.000	54.68	53.89	0.682	1492.006	314.603	30.00000
1600.000	52.87	52.42	0.391	1535.307	339.603	30.00000
1650.000	51.13	50.87	0.225	1578.609	364.603	30.00000
1700.000	49.43	49.28	0.129	1621.910	389.603	30.00000
1750.000	47.75	47.66	0.074	1665.211	414.603	30.00000
1800.000	46.08	46.04	0.042	1708.512	439.603	30.00000
1850.000	44.35	44.48	0.024	1751.814	464.603	30.00000
1900.000	41.70	43.86	0.014	1795.115	489.603	30.00000
1906.435	41.24	43.91	0.013	1800.688	492.820	30.00000
1906.435	41.24	43.91	0.013	1800.688	492.820	30.00000
1950.000	38.43	43.96	-2.465	1838.991	513.565	26.87989
2000.000	36.05	43.54	-4.163	1884.266	534.763	23.29890
2050.000	34.28	42.90	-5.138	1930.776	553.092	19.71791
2100.000	32.94	42.21	-5.699	1978.341	568.480	16.13693
2150.000	31.94	41.58	-6.022	2026.774	580.867	12.55594
2200.000	31.21	41.08	-6.208	2075.886	590.205	8.97495
2250.000	30.75	40.72	-6.314	2125.485	596.457	5.39397
2300.000	31.03	40.03	-6.376	2175.378	599.599	1.81298
2325.314	31.82	39.22	-6.396	2200.688	600.000	0.00000
2325.314	31.82	39.22	-6.396	2200.688	600.000	0.00000
2350.000	32.70	38.32	-4.864	2225.374	600.000	0.00000
2400.000	33.89	37.12	-2.792	2275.374	600.000	0.00000
2450.000	34.58	36.43	-1.602	2325.374	600.000	0.00000
2500.000	34.97	36.03	-0.919	2375.374	600.000	0.00000
2550.000	0.00	0.00	-0.527	2425.374	600.000	0.00000
2600.000	0.00	0.00	-0.303	2475.374	600.000	0.00000

NOTE: The offset distance is a perpendicular distance measured from the taxiway centerline. The hard surface needs to be widened at stations where the offset distance extends beyond the hard surface.

REFERENCE: AC 150/5300-13, AIRPORT DESIGN.

Figure 4-14. Example of acute-angled exit taxiway computer layout data page 2

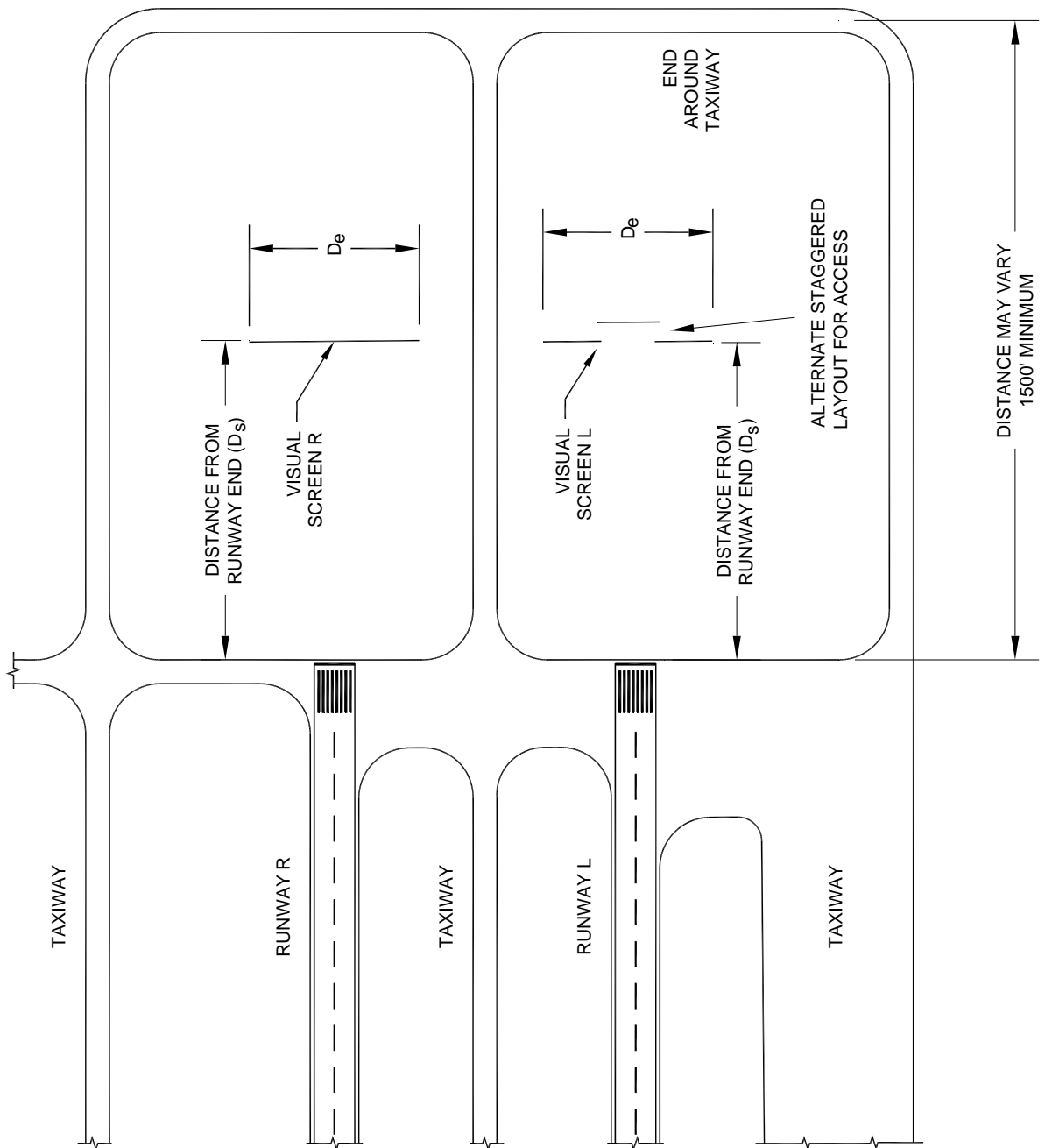

Figure 4-15. Typical end-around taxiway layout

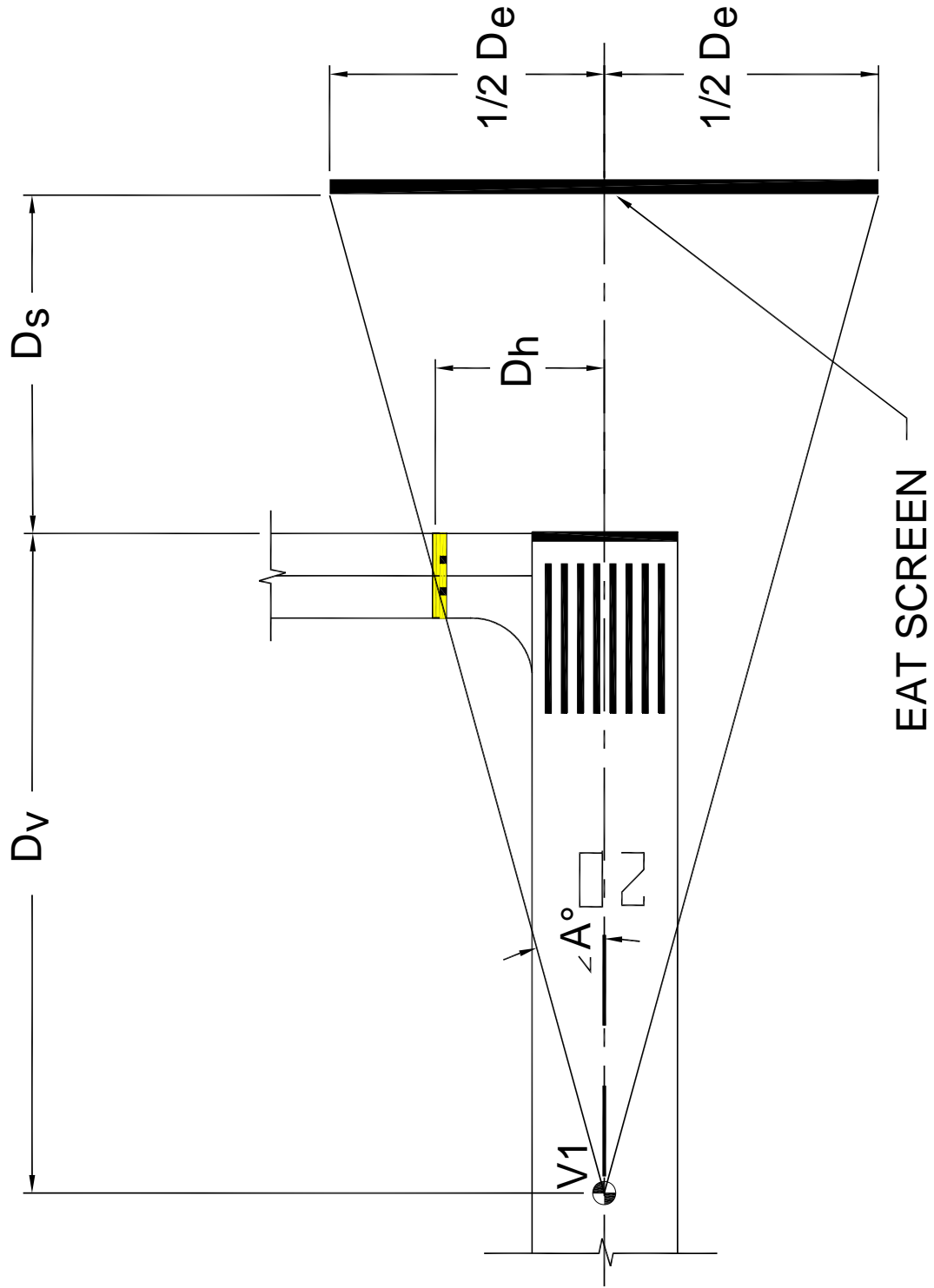

Figure 4-16. End-around taxiway visual screen width calculations

$$\angle A = \arctan \frac{D_h}{D_v}$$

$$(\tan \angle A (D_v + D_s)) = \frac{1}{2} D_e$$

Where: D_v = Distance from Average V1 location (defined in Federal Aviation Regulation 1.2 as takeoff decision speed) for Design Group aircraft to Departure Runway End.

D_s = Distance from Departure Runway End to the EAT Visual Screen Location

D_h = Distance from the Departure Runway End Centerline to the Centerline of Taxiway at Hold Position Marking

D_e = Total Width of EAT Visual Screen

Figure 4-17. Visual screen width calculation formula

Table 4-4. Visual screen height calculation formula (same elevation as runway)

EAT Visual Screen Height Calculation – EAT and Runway at Same Elevation

Design Group	Typical Design Group Engine Nacelle Height	Required Screen Surface Height	Required Height of Top Edge of Screen (Above Runway Centerline Elevation)
III	9 ft	10 ft	10 ft
IV	12 ft	13 ft	13 ft
V	18 ft	16 ft	18 ft
VI	18 ft	16 ft	18 ft

Table 4-5. Visual screen height calculation formula (EAT below DER elevation) for Design Group III

**Design Group III Aircraft
EAT Visual Screen Height Calculation –
EAT At or Below DER Elevation**

Elevation Difference (ft)	Required Screen Surface Height (ft)	Required Height of Top Edge of Screen (+ DER Centerline Elevation) (ft)
0	10	10
1	10	10
2	10	10
3	10	10
4	10	10
5	10	10
6	10	10
7	10	10
8	10	10
9	10	10
10	10	10
11	9	9
12	9	9
13	9	9
14	9	9
15	9	9
16	9	9
17	9	9
18	9	9
19	9	9
20	8	8
21	8	8
22	8	8
23	8	8
24	8	8
25	8	8
26	8	8
27	8	8
28	8	8
29+	0	0

Table 4-6. Visual screen height calculation formula (EAT below DER elevation) for Design Group IV

**Design Group IV Aircraft
EAT Visual Screen Height Calculation –
EAT At or Below DER Elevation**

Elevation Difference (ft)	Required Screen Surface Height (ft)	Required Height of Top Edge of Screen (+/- DER Centerline Elevation) (ft)
0	13	13
1	13	13
2	13	13
3	13	13
4	13	13
5	13	13
6	13	13
7	13	13
8	13	13
9	13	13
10	13	13
11	13	13
12	13	13
13	13	13
14	12	12
15	12	12
16	12	12
17	11	11
18	11	11
19	11	11
20	10	10
21	10	10
22	10	10
23	9	9
24	9	9
25	9	9
26	8	8
27	8	8
28	8	8
29+	0	0

Table 4-7. Visual screen height calculation formula (EAT below DER elevation) for Design Groups V and VI

**Design Group V and VI Aircraft
EAT Visual Screen Height Calculation –
EAT At or Below DER Elevation**

Elevation Difference (ft)	Required Screen Surface Height (ft)	Required Height of Top Edge of Screen (+/- DER Centerline Elevation) (ft)
0	13	18
1	13	18
2	13	18
3	13	18
4	13	18
5	13	17
6	13	16
7	13	15
8	13	14
9	13	13
10	13	13
11	13	13
12	13	13
13	13	13
14	12	12
15	12	12
16	12	12
17	11	11
18	11	11
19	11	11
20	10	10
21	10	10
22	10	10
23	9	9
24	9	9
25	9	9
26	8	8
27	8	8
28	8	8
29+	0	0

Table 4-8. Visual screen vertical height calculation tables

Design Group III -VI Aircraft EAT Visual Screen Height Calculation – EAT Above DER Elevation

Design Group	Required Height of Top Edge of Screen (Above Runway Centerline Elevation) (ft)	Add Elevation Difference – EAT above DER	Calculate: NEW Required Height of Top Edge of Screen (Above DER Centerline Elevation) (ft)
III	10	+ Elevation Difference	= New Required Height of Top Edge of Screen
IV	13		
V	18		
VI	18		

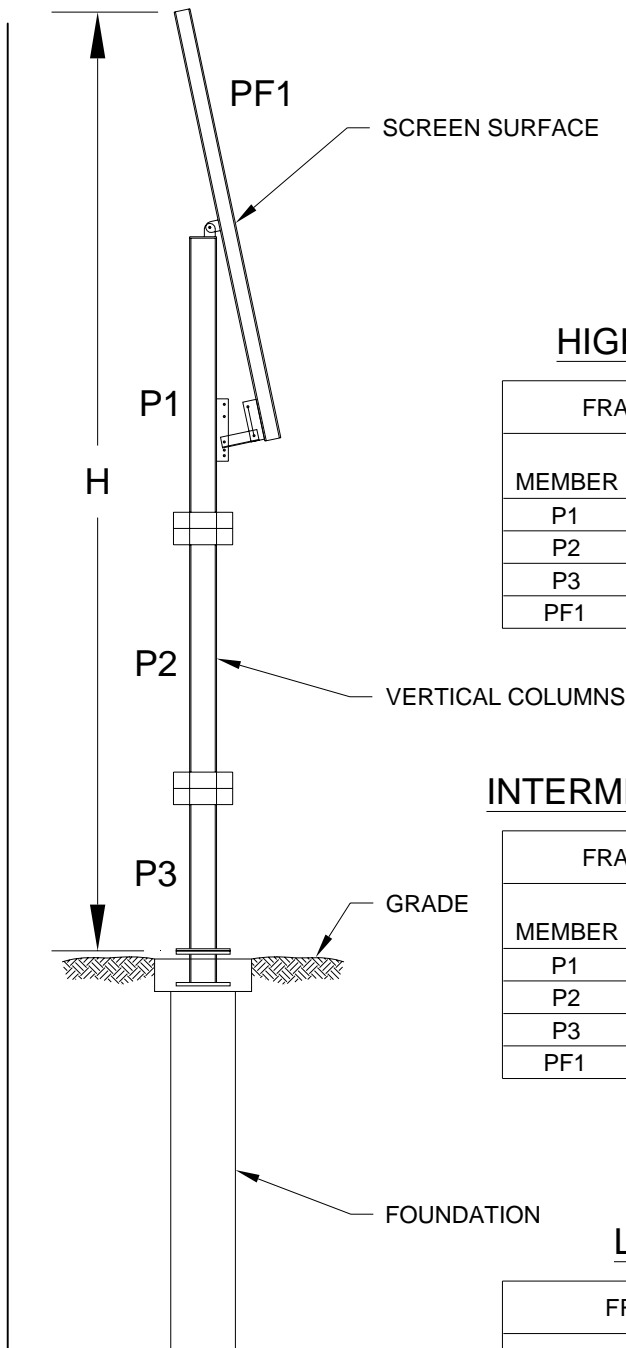

HIGH FRAME ELEV: $26' < H \leq 32'$

FRAMING SCHEDULE - VISUAL SCREEN $26' < H \leq 32'$			
MEMBER	WIND SPEED (MPH)		
	90	130	150
P1	HSS 8x6x5/16	HSS 8x8x1/2	HSS 12x8x3/8
P2	HSS 10x6x1/2	HSS 12x8x9/16	HSS 16x8x1/2
P3	HSS 12x6x1/2	HSS 16x8x1/2	HSS 20x8x1/2
PF1	HSS 6x4x3/16	HSS 6x4x5/16	HSS 6x4x5/16

INTERMEDIATE FRAME ELEV: $18' < H \leq 26'$

FRAMING SCHEDULE - VISUAL SCREEN $18' < H \leq 26'$			
MEMBER	WIND SPEED (MPH)		
	90	130	150
P1	HSS 8x6x5/16	HSS 8x8x1/2	HSS 12x8x3/8
P2	HSS 10x6x1/2	HSS 12x8x9/16	HSS 16x8x1/2
P3			
PF1	HSS 6x4x3/16	HSS 6x4x5/16	HSS 6x4x5/16

LOW FRAME ELEV: $H \leq 18'$

FRAMING SCHEDULE - VISUAL SCREEN $H \leq 18'$			
MEMBER	WIND SPEED (MPH)		
	90	130	150
P1	HSS 8x6x5/16	HSS 8x8x1/2	HSS 12x8x3/8
P2			
P3			
PF1	HSS 6x4x3/16	HSS 6x4x5/16	HSS 6x4x5/16

Figure 4-18. Examples of mounting screen to vertical column

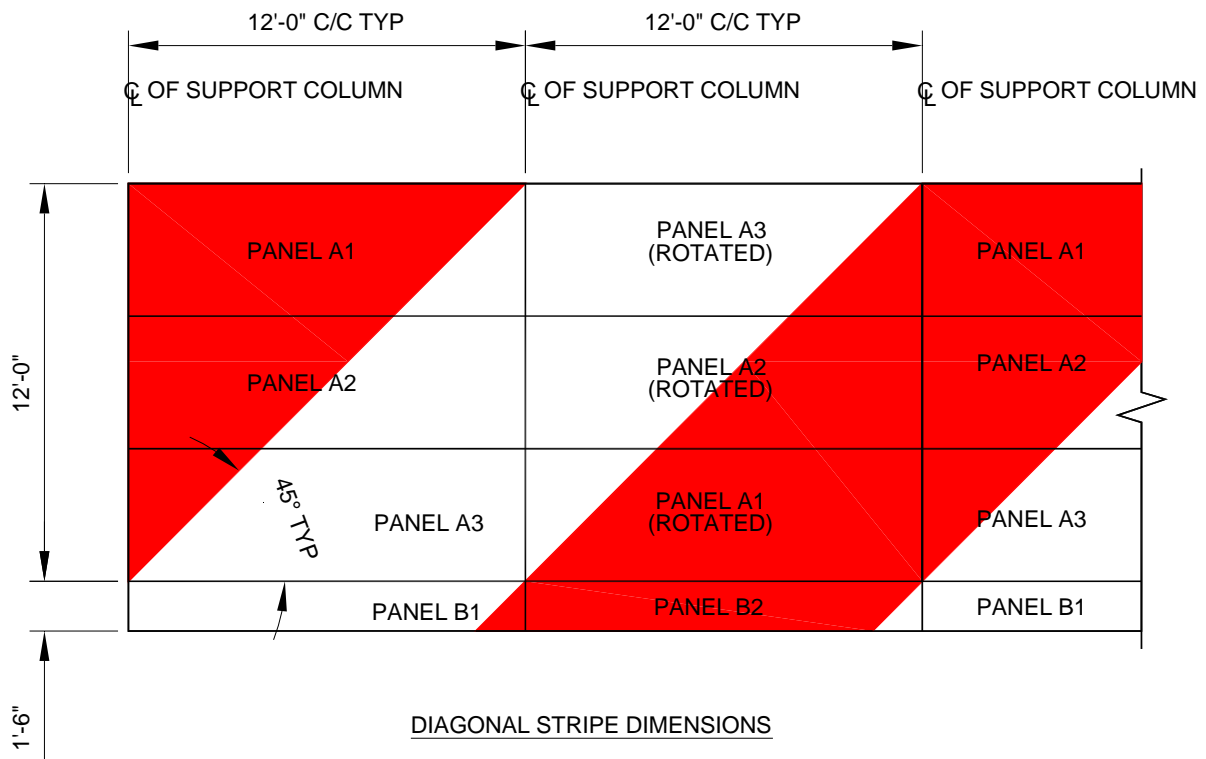
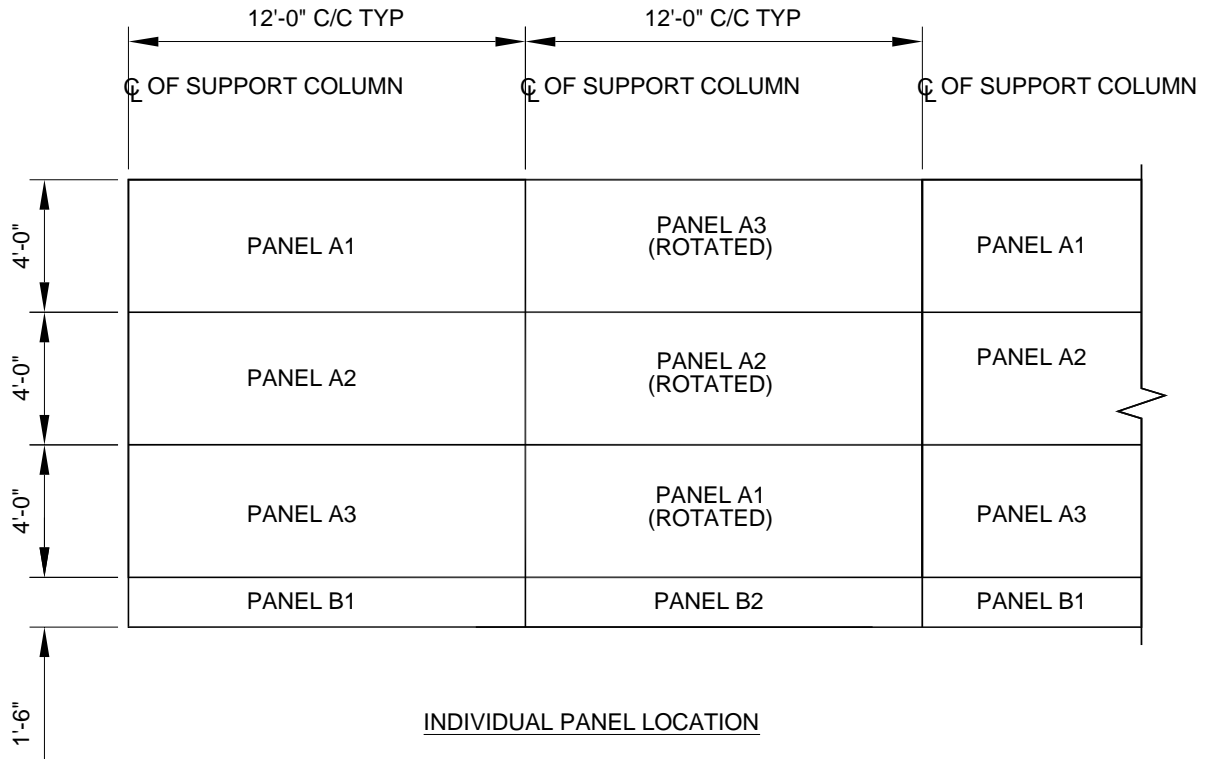

Figure 4-19. Examples of panel layout for 13-foot-high screen

Table 4-9. Visual screen panel wind-loading deflection allowance

WIND SPEED (3 SEC GUST)	DEFLECTION	STRENGTH
90 MPH	.074 PSI	.17 PSI
130 MPH	.074 PSI	.35 PSI
150 MPH	.074 PSI	.47 PSI

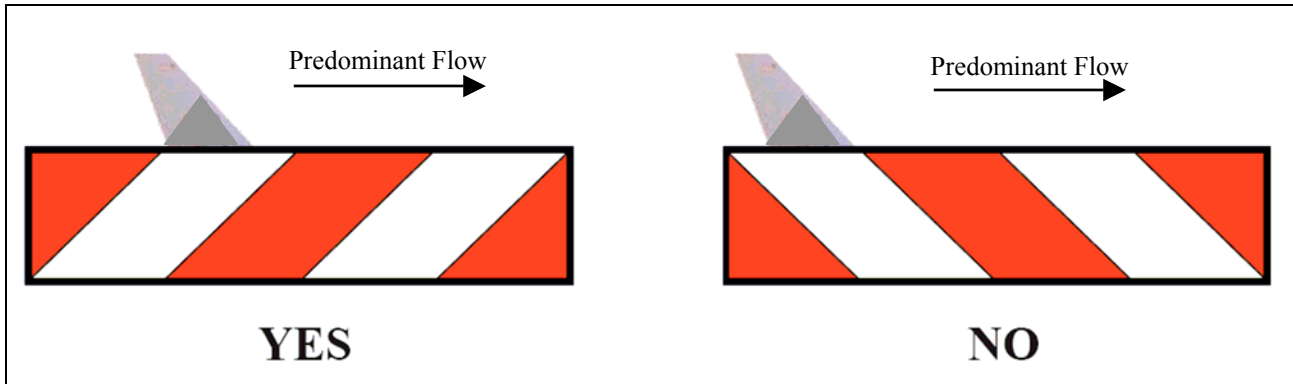

Figure 4-20. Diagonal stripe orientation

Table 4-10. CIE chromaticity coordinate limits

Color	x	y	X	Y	x	y	x	y	Min	Max	Munsell Paper
White	.303	.287	.368	.353	.340	.380	.274	.316	35.0		6.3GY 6.77/0.8
Red	.613	.297	.708	.292	.636	.364	.558	.352	8.0	12.0	8.2R 3.78/14.0

Table 4-11. Minimum reflection levels

Minimum Coefficient of Retroreflection Candelas/Foot Candle/Square Foot/Candelas/Lux/Square Meter

Observation Angle <u>1</u>/ (degrees)	Entrance Angle <u>2</u>/ (degrees)	White	Red
0.2	-4	70	14.5
0.2	+30	30	6.0
0.5	-4	30	7.5
0.5	+30	15	3.0

(Reflectivity must conform to Federal Specification FP-85 Table 718-1 and ASTM D 4956.)

- 1/ Observation (Divergence) Angle—The angle between the illumination axis and the observation axis.
- 2/ Entrance (Incidence) Angle—The angle from the illumination axis to the retroreflector axis. The retroreflector axis is an axis perpendicular to the retroreflective surface.

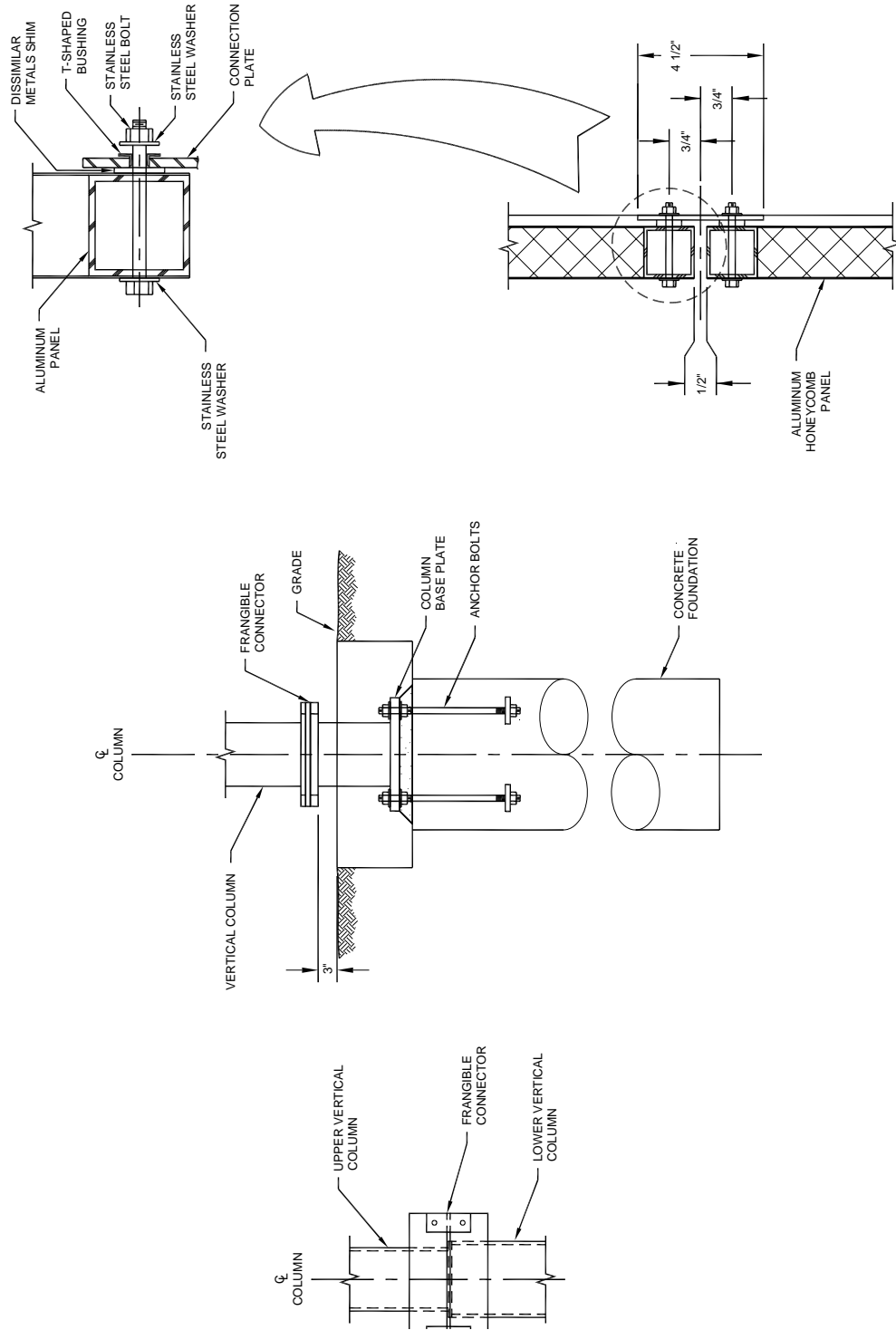

Figure 4-21. Examples of frangibility connections

FRANGIBLE CONNECTION ON PANELS

FRANGIBLE CONNECTION ON COLUMNS

FRANGIBLE CONNECTION BASE

Chapter 5. SURFACE GRADIENT AND LINE OF SIGHT

500. INTRODUCTION. This chapter presents gradient and line of sight standards. The standards apply to the design of airport surfaces required for the landing, takeoff, and ground movement of airplanes.

501. BACKGROUND. Surface gradients should allow design flexibility without adversely affecting operational safety. Line of sight standards impose additional restraints on surface gradients. It is important that the pilot and air traffic controller see the runway and taxiway surfaces to assure that the runways and taxiways are clear of aircraft, vehicles, wildlife, and other hazardous objects.

502. SURFACE GRADIENT STANDARDS.

a. Runway and Stopway.

(1) Aircraft Approach Categories A and B. The longitudinal and transverse gradient standards for runways and stopways are as follows and as illustrated in figures 5-1 and 5-2.

(a) The maximum longitudinal grade is ± 2 percent. It is desirable to keep longitudinal grades to a minimum.

(b) The maximum allowable grade change is ± 2 percent. Use longitudinal grade changes only when absolutely necessary.

(c) Vertical curves for longitudinal grade changes are parabolic. The length of the vertical curve is a minimum of 300 feet (90 m) for each 1 percent of change. No vertical curve is necessary when the grade change is less than 0.4 percent.

(d) The minimum allowable distance between the points of intersection of vertical curves is 250 feet (75 m) multiplied by the sum of the grade changes (in percent) associated with the two vertical curves.

(e) Figure 5-2 presents maximum and minimum transverse grades for runways and stopways. In all cases, keep transverse grades to a minimum, consistent with local drainage requirements.

(f) Provide a smooth transition between the intersecting pavement surfaces as well as adequate drainage of the intersection. Give precedence to the grades for the dominant runway

(e.g., higher speed, higher traffic volume, etc.) in a runway-runway situation and for the runway in a runway-taxiway situation.

(2) Aircraft Approach Categories C and D. The longitudinal and transverse gradient standards for runways and stopways are as follows and as illustrated in figures 5-3 and 5-4.

(a) The maximum longitudinal grade is ± 1.5 percent; however, longitudinal grades may not exceed ± 0.8 percent in the first and last quarter of the runway length. It is desirable to keep longitudinal grades to a minimum.

(b) The maximum allowable grade change is ± 1.5 percent. Use longitudinal grade changes only when absolutely necessary.

(c) Vertical curves for longitudinal grade changes are parabolic. The length of the vertical curve is a minimum of 1,000 feet (300 m) for each 1 percent of change.

(d) The minimum allowable distance between the points of intersection of vertical curves is 1,000 feet (300 m) multiplied by the sum of the grade changes (in percent) associated with the two vertical curves.

(e) Figure 5-4 presents maximum and minimum transverse grades for runways and stopways. In all cases, keep transverse grades to a minimum, consistent with local drainage requirements.

(f) Provide a smooth transition between intersecting pavement surfaces as well as adequate drainage of the intersection. Give precedence to the grades for the dominant runway (e.g., higher speed, higher traffic volume, etc.) in a runway-runway situation and for the runway in a runway-taxiway situation.

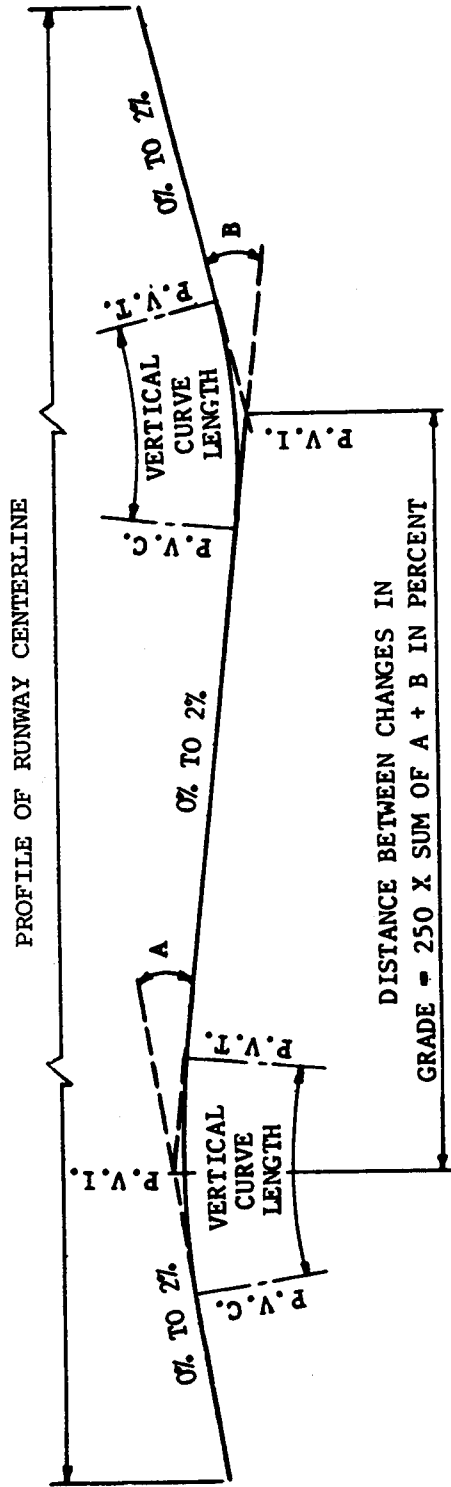

VERTICAL CURVES

LENGTH OF VERTICAL CURVES WILL NOT BE LESS THAN 300' FOR EACH 1% GRADE CHANGE, EXCEPT THAT NO VERTICAL CURVE WILL BE REQUIRED WHEN GRADE CHANGE IS LESS THAN 0.4%.

GRADE CHANGE

MAXIMUM GRADE CHANGE SUCH AS (A) OR (B) SHOULD NOT EXCEED 2%.

Figure 5-1. Longitudinal grade limitations for aircraft approach categories A & B

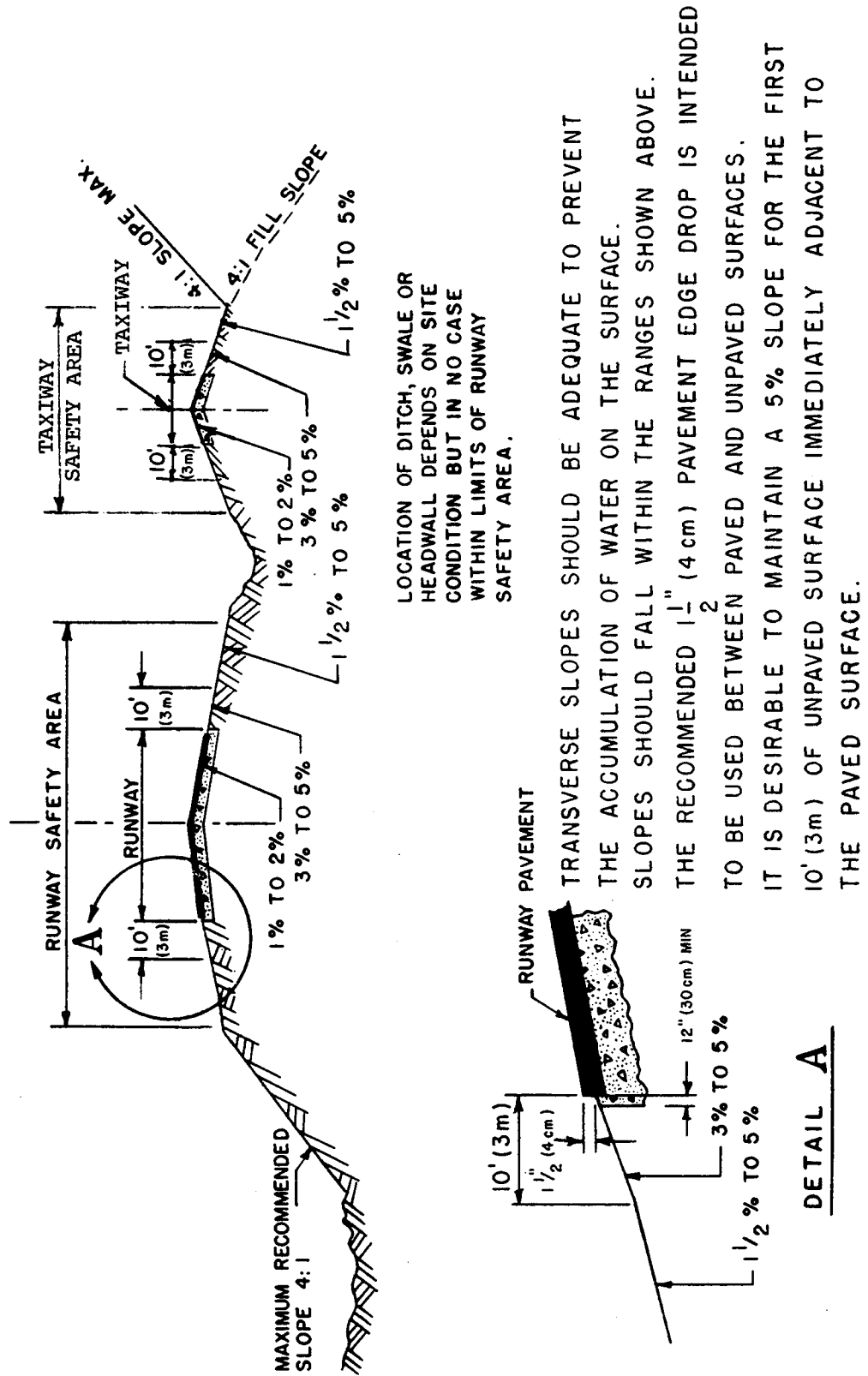

LOCATION OF DITCH, SWALE OR HEADWALL DEPENDS ON SITE CONDITION BUT IN NO CASE WITHIN LIMITS OF RUNWAY SAFETY AREA.

TRANSVERSE SLOPES SHOULD BE ADEQUATE TO PREVENT THE ACCUMULATION OF WATER ON THE SURFACE. SLOPES SHOULD FALL WITHIN THE RANGES SHOWN ABOVE. THE RECOMMENDED 1 1/2" (4 cm) PAVEMENT EDGE DROP IS INTENDED TO BE USED BETWEEN PAVED AND UNPAVED SURFACES. IT IS DESIRABLE TO MAINTAIN A 5% SLOPE FOR THE FIRST 10' (3m) OF UNPAVED SURFACE IMMEDIATELY ADJACENT TO THE PAVED SURFACE.

Figure 5-2. Transverse grade limitations for aircraft approach categories A & B

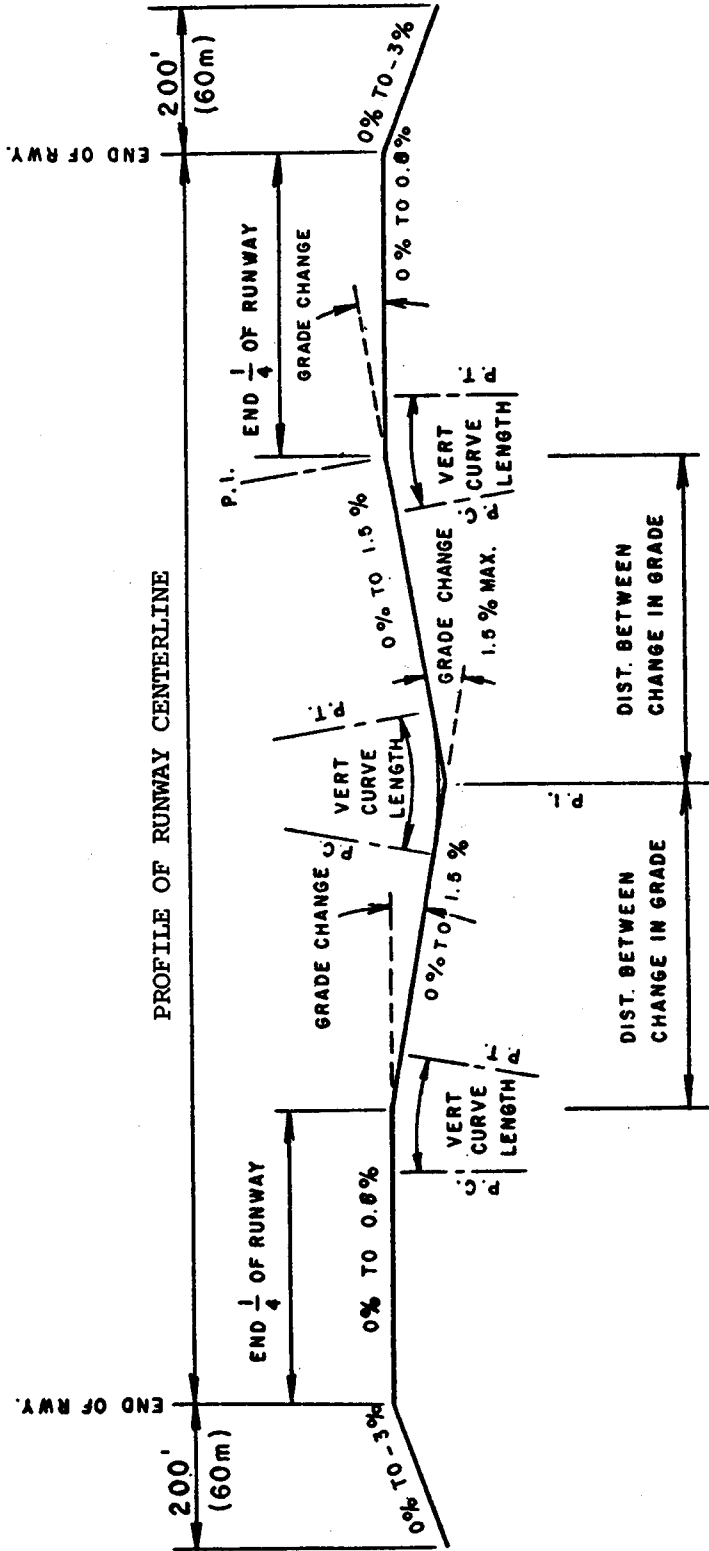

MINIMUM DISTANCE BETWEEN CHANGE IN GRADE = 1000' (300m) x SUM OF GRADE CHANGES (IN PERCENT).

MINIMUM LENGTH OF VERTICAL CURVES = 1000' (300m) x GRADE CHANGE (IN PERCENT)

Figure 5-3. Longitudinal grade limitations for aircraft approach categories C & D

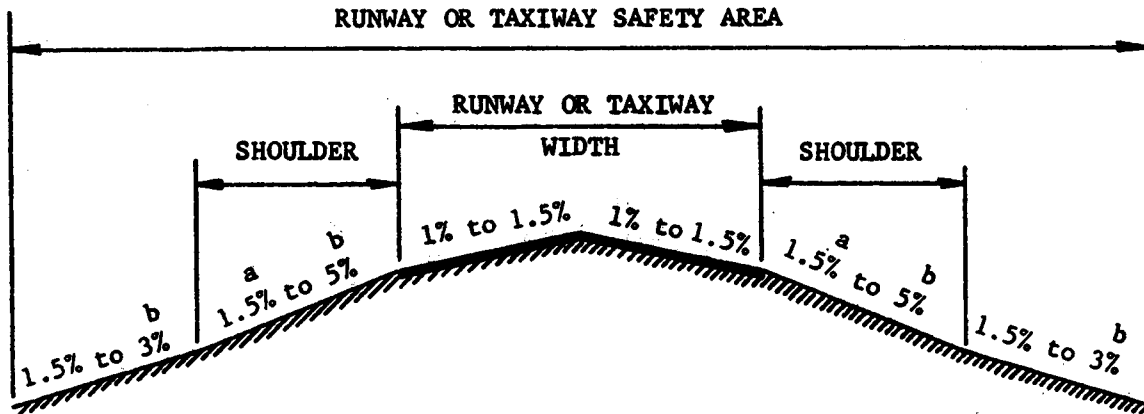

- a. 3% MINIMUM REQUIRED FOR TURF
- b. A slope of 5% is recommended for a 10-foot (3 m) width adjacent to the pavement edges to promote drainage.

GENERAL NOTES:

1. A 1.5 inch (3.8 cm) drop from paved to unpaved surfaces is recommended.
2. Drainage ditches may not be located within the safety area.

Figure 5-4. Transverse grade limitations for aircraft approach categories C & D

b. **Runway Safety Area.** The longitudinal and transverse gradient standards for runway safety areas are as follows and are illustrated in figures 5-1 through 5-5.

(1) Longitudinal grades, longitudinal grade changes, vertical curves, and distance between changes in grades for that part of the runway safety area between the runway ends are the same as the comparable standards for the runway and stopway. Exceptions are allowed when necessary because of taxiways or other runways within the area. In such cases, modify the longitudinal grades of the runway safety area by the use of smooth curves. For the first 200 feet (60 m) of the runway safety area beyond the runway ends, the longitudinal grade is between 0 and 3 percent, with any slope being downward from the ends. For the remainder of the safety area (figure 5-5), the maximum longitudinal grade is such that no part of the runway safety area penetrates the approach surface or clearway plane. The maximum allowable negative grade is 5 percent. Limitations on longitudinal grade changes are plus or minus 2 percent per 100 feet (30 m). Use parabolic vertical curves where practical.

(2) Figure 5-2 and 5-4 show the maximum and minimum transverse grades for paved shoulders and for the runway safety area along the runway up to 200 feet (60 m) beyond the runway end. In all cases, keep transverse grades to a minimum, consistent with local drainage requirements. Figure 5-5 illustrates the criteria for the transverse grade beginning 200 feet (60 m) beyond the runway end.

(3) Elevation of the concrete bases for NAVAIDs located in the runway safety area should not be higher than a maximum of 3 inches (7.6 cm) above the finished grade. Other grading requirements for NAVAIDs located in the runway safety area are, in most cases, more stringent than those stated above. See chapter 6.

c. **Runway Blast Pad.** For blast pads, follow the same longitudinal and transverse grades as the respective grades of the associated safety area.

d. **Taxiways and Taxiway Safety Areas.** Figures 5-2 and 5-4 illustrate the transverse gradient standards. The longitudinal and transverse gradient standards for taxiways and taxiway safety areas are as follows:

(1) The maximum longitudinal grade is 2 percent for Aircraft Approach Categories A and B and 1.5 percent for Aircraft Approach Categories C and D. Minimum longitudinal grades are desirable.

(2) Avoid changes in longitudinal grades unless no other reasonable alternative is available. The maximum longitudinal grade change is 3 percent.

(3) When longitudinal grade changes are necessary, the vertical curves are parabolic. The minimum length of the vertical curve is 100 feet (30 m) for each 1 percent of change.

(4) The minimum distance between points of intersection of vertical curves is 100 feet (30 m) multiplied by the sum of the grade changes (in percent) associated with the two vertical curves.

(5) At any point on a taxiway centerline, the allowable difference in elevation between the taxiway and the corresponding point on the associated parallel runway, taxiway, or apron edge is 1.5 percent of the shortest distance between the points. For the purposes of this item, a parallel taxiway is any taxiway functioning as a parallel taxiway whether it is exactly parallel or not. This will allow the subsequent placement of a stub taxiway at any point to satisfy capacity requirements.

(6) Figures 5-2 and 5-4 show the maximum and minimum transverse grades for taxiways and taxiway safety areas. In all cases, the transverse grades should be at a minimum, consistent with local drainage requirements.

(7) Elevation of the concrete bases for NAVAIDs located in the taxiway safety area should not be higher than a maximum of 3 inches (7.6 cm) above the finished grade. Other grading requirements for NAVAIDs located in the taxiway safety area are, in most cases, more stringent than those stated above. See chapter 6.

e. **Aprons.** To ease aircraft towing and taxiing, apron grades should be at a minimum, consistent with local drainage requirements. The maximum allowable grade in any direction is 2 percent for Aircraft Approach Categories A and B and 1 percent for Aircraft Approach Categories C and D. Where possible, design apron grades to direct drainage away from the any building, especially in fueling areas.

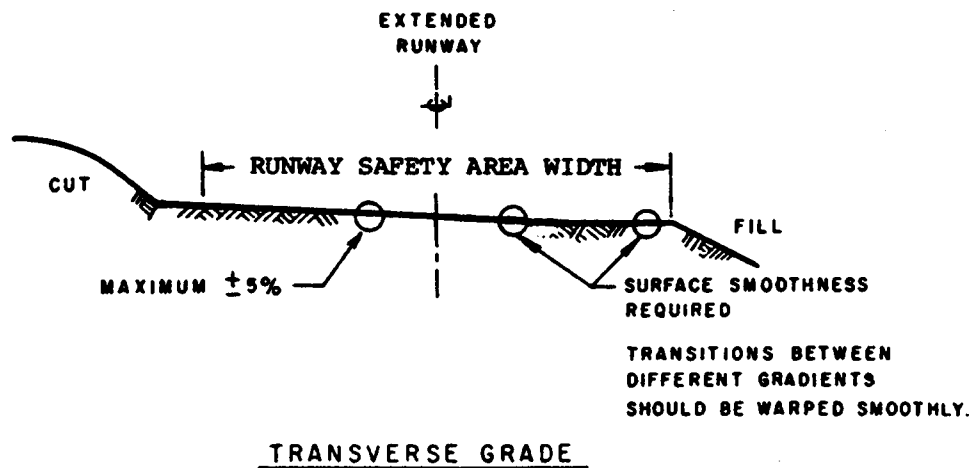
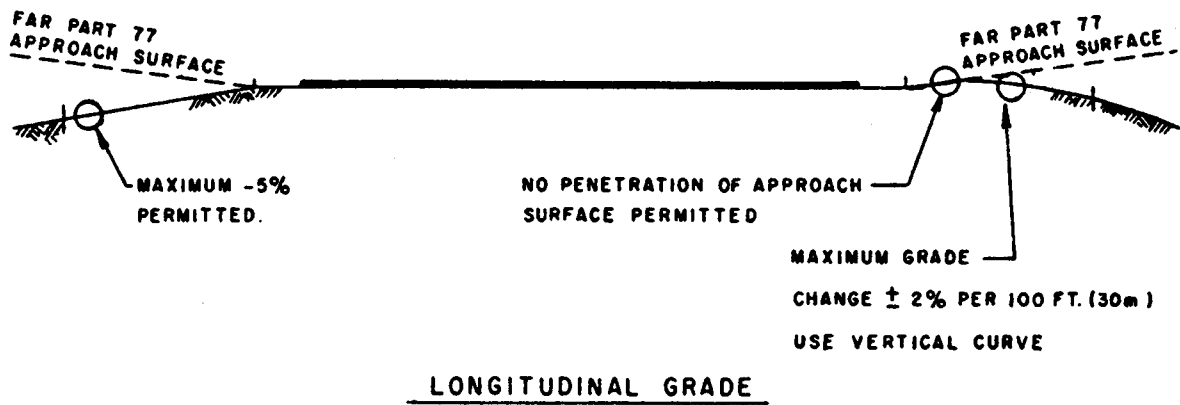

Figure 5-5. Runway safety area grade limitations beyond 200 feet (60 m) from the runway end

503. LINE OF SIGHT STANDARDS. The following standards provide the minimum line of sight:

a. Along Individual Runways. An acceptable runway profile permits any two points five feet (1.5 m) above the runway centerline to be mutually visible for the entire runway length. However, if the runway has a full length parallel taxiway, the runway profile may be such that an unobstructed line of sight will exist from any point five feet (1.5 m) above the runway centerline to any other point five feet (1.5 m) above the runway centerline for one-half the runway length.

b. Between Intersecting Runways. A clear line of site between the ends of intersecting runways is recommended. Terrain needs to be graded and permanent objects need to be designed or sited so that there will be an unobstructed line of sight from any point five feet (1.5 m) above one runway centerline to any point five feet (1.5 m) above an intersecting centerline, within the runway visibility zone. The runway visibility zone is an area formed by imaginary lines connecting the two runways' visibility points, as shown in figure 5-6. Determine the location of each runway's visibility point as follows:

(1) If the distance from the intersection of two runway centerlines to a runway end is 750 feet (250 m) or less, the visibility point is on the centerline of the runway end.

(2) If the distance from the intersection of two runway centerlines to a runway end is greater than 750 feet (250 m) but less than 1,500 feet (500 m), the visibility point is on the centerline, 750 feet (250 m) from the intersection of the runway centerlines.

(3) If the distance from the intersection of two runway centerlines to a runway end is equal to or greater than 1,500 feet (500 m), the visibility point is on the centerline equidistant from the runway end and the intersection of the centerlines.

c. Taxiways. There are no line of sight requirements for taxiways. However, the sight distance along a runway from an intersecting taxiway needs to be sufficient to allow a taxiing aircraft to enter safely or cross the runway.

504. to 599. RESERVED.

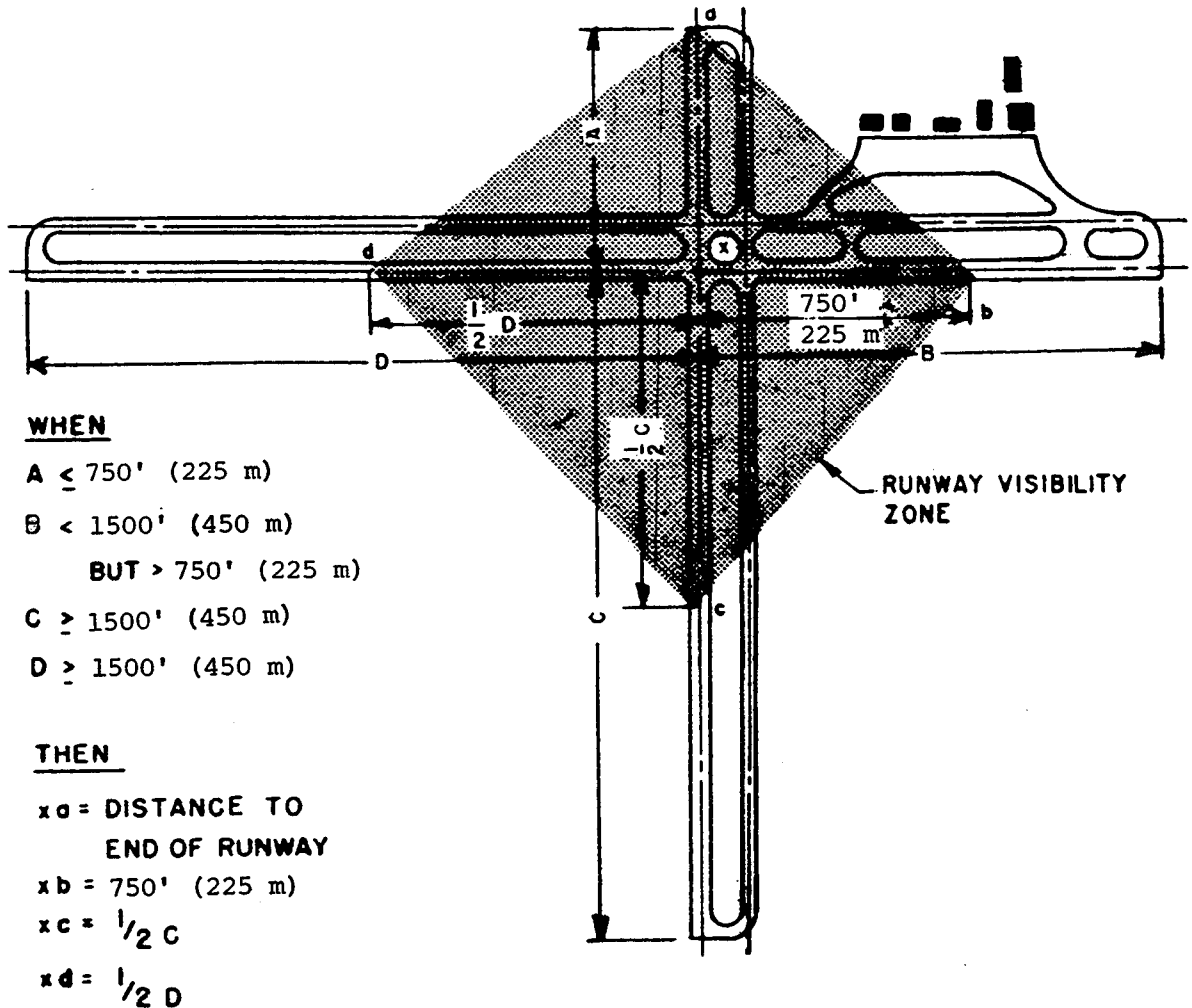

Figure 5-6. Runway visibility zone

Chapter 6. SITE REQUIREMENTS FOR NAVAID AND ATC FACILITIES

600. GENERAL. This chapter presents siting and clearing requirements for the navigational aids (NAVAID) and air traffic control (ATC) facilities which influence airport planning. The information is not readily available in other FAA Advisory Circulars. It is provided to minimize conflicts between NAVAIDs and ATC facilities and other airport developments. Figure 6-2 depicts the usual location of these NAVAIDs and ATC facilities on a typical airport.

CAUTION: The guidance herein is not in sufficient detail to be used to design or install a NAVAID or ATC facility.

a. **Limitations.** Siting and clearing criteria is representative of the ideal situation. It is advisable to contact the appropriate FAA regional office before planning any NAVAID or ATC facility.

b. **Federal NAVAID and ATC Programs.** Information on eligibility for FAA-installed NAVAIDs and ATC facilities or other FAA assistance programs can be obtained from an FAA regional office. FAA policy governing NAVAID and ATC facility relocations is found in AC 6030.1, FAA Policy on Facility Relocations Occasioned by Airport Improvements or Changes.

c. **Non-Federal NAVAIDs.** FAA policy concerning the establishment of instrument procedures using non-Federal NAVAIDs is found in FAR Part 171, Non-Federal Navigation Facilities.

d. **Jet Blast/Exhaust.** NAVAIDs, monitoring devices, and equipment shelters should be located at least 300 feet (90 m) behind the source of jet blast to minimize the accumulation of exhaust deposits on antennas.

601. MICROWAVE LANDING SYSTEM. The microwave landing system (MLS) provides the pilot of a properly equipped aircraft with electronic guidance to control the aircraft's alignment and descent until the runway environment is in sight. MLS is also used to define a missed approach course or a departure course. Figure 6-2 illustrates MLS component locations.

a. **General.** MLS operates on the direct signal from the transmitting antenna on the ground to the receiving antenna on the aircraft.

(1) MLS is not particularly susceptible to signal interference as a result of buildings, trees, power lines, metal fences, and other large objects. However, when these objects are in the coverage area, they may cause multipath (signal reflection) or shadowing (signal blockage) problems.

(2) MLS antenna systems do not use the ground to form the desired signal. Grading for MLS installations is usually limited to that needed for the antenna and monitors, a service road, and a vehicle parking area.

b. **Azimuth Antenna.** Alignment guidance is provided by the azimuth (AZ) antenna. The signal coverage area extends 40 degrees either side of the intended course (runway centerline).

(1) The AZ antenna is located on the extended runway centerline at a distance of 1,000 to 1,500 feet (300 to 450 m) beyond the stop end of the runway. AZ antennas are 8 feet (2.4 m) in height and are mounted on low impact resistant supports. AZ antennas should not violate any airport design or approach surface. Figure 6-1 illustrates AZ antenna siting.

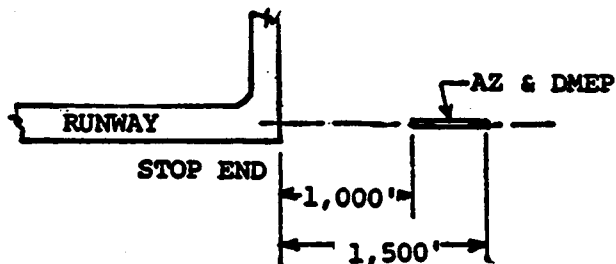

Figure 6-1. AZ antenna siting

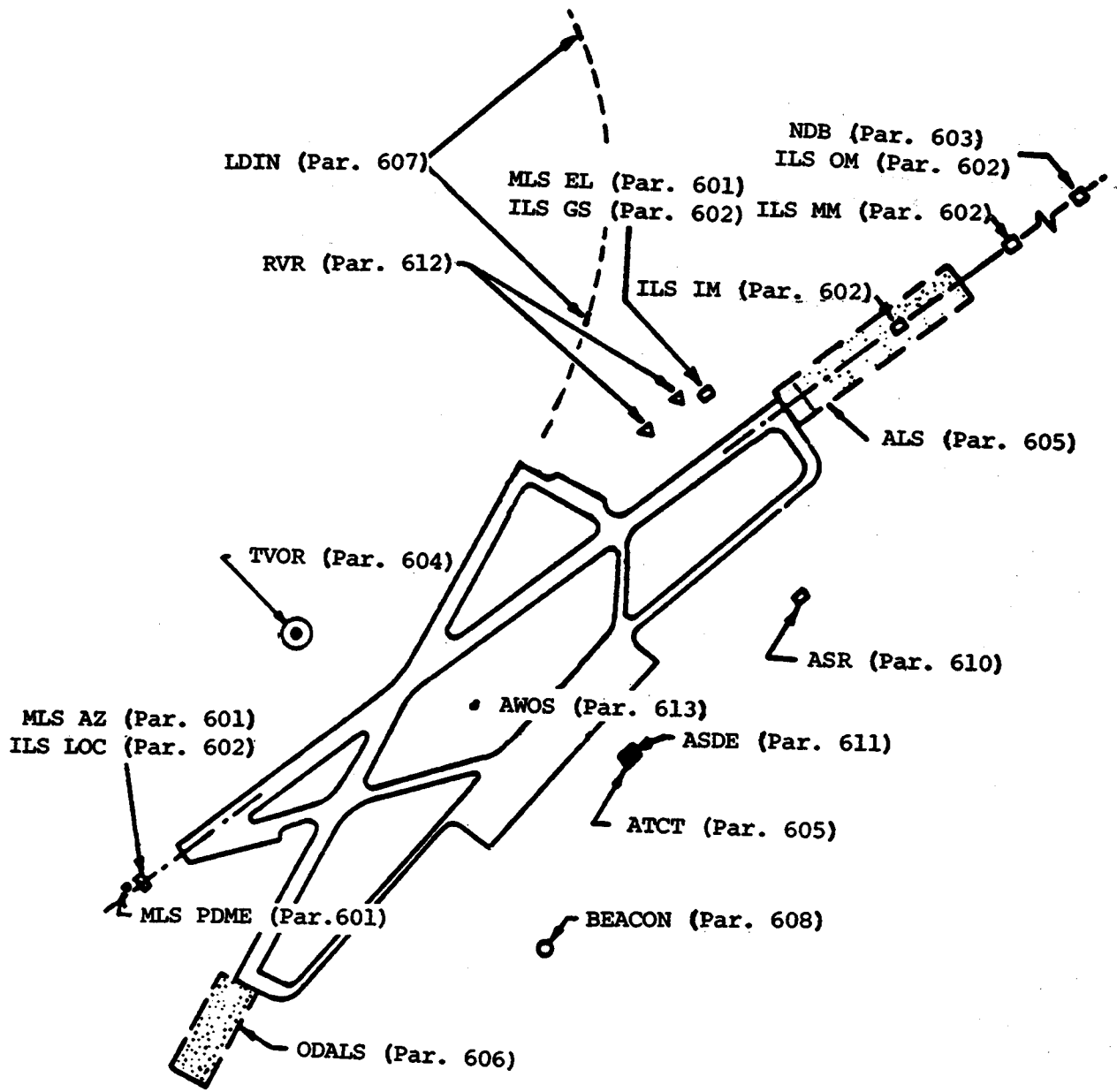

Figure 6-2. Typical NAVAID placement

(2) AZ antennas require the area between the antenna and the stop end of the runway be cleared of objects that could reflect or block the signal. Figure 6-3 illustrates this area.

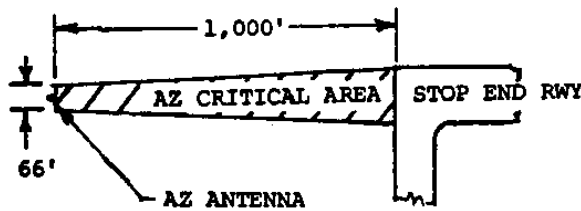

Figure 6-3. AZ antenna critical area

a. **Elevation Antenna.** Descent guidance is provided by the elevation (EL) antenna. The signal area extends from the horizon to 30 degrees above the horizon. The EL antenna height depends upon the beam width but would not exceed 18.6 feet (5.7 m).

(1) The EL antenna site is at least 400 feet (120 m) from the runway centerline and 800 to 1,000 feet (240 to 300 m) from the runway threshold and should provide a threshold crossing height of 50 feet (15 m). Figure 6-4 illustrates EL antenna siting.

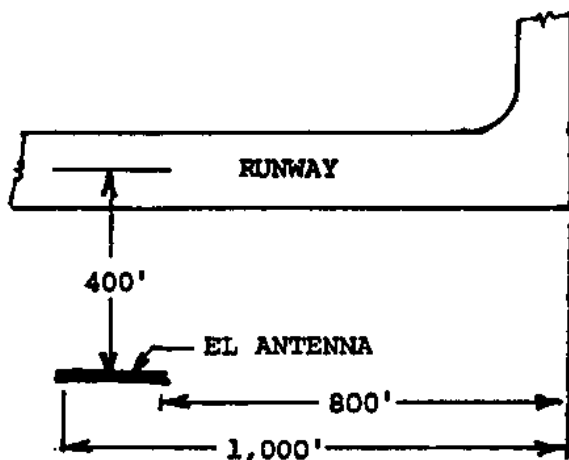

Figure 6-4. EL antenna siting

(2) EL antenna critical areas begin at the runway near edge and extend to 33 feet (10 m) outboard of the antenna site. They are 1,000 feet (300 m) in length, measured from the antenna toward the approaching aircraft. These areas should be clear of objects that could reflect or block the signal. Figure 6-5 illustrates this area.

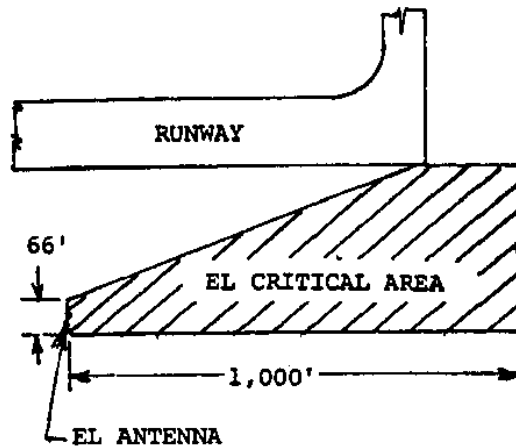

Figure 6-5. EL antenna critical area

b. **Distance Measuring Equipment.** Range information is provided by distance measuring equipment (DME). DME antennas are 22 feet (6.7 m) in height and normally are collocated with the AZ antenna. To preclude penetration of an approach surface, the collocated AZ/DME antennas should be placed 1,300 feet (390 m) from the runway end.

602. INSTRUMENT LANDING SYSTEM. The instrument landing system (ILS) provides pilots with electronic guidance for aircraft alignment, descent gradient, and position until visual contact confirms the runway alignment and location. Figure 6-2 illustrated ILS component locations.

a. **General.** The ILS uses a line-of-sight signal from the localizer antenna and marker beacons and a reflected signal from the ground plane in front of the glide slope antenna.

(1) ILS antenna systems are susceptible to signal interference sources such as power lines, fences, metal buildings, etc.

(2) Since ILS uses the ground in front of the glide slope antenna to develop the signal, this area should be graded to remove surface irregularities.

(3) ILS equipment shelters are located near but are not a physical part of the antenna installation.

b. **Localizer Antenna.** The localizer (LOC) signal is used to establish and maintain the aircraft's horizontal position until visual contact confirms the runway alignment and location.

(1) The LOC antenna is usually sited on the extended runway centerline outside the runway safety area between 1,000 to 2,000 feet (300 to 600 m) beyond the stop end of the runway. Where it is not practicable to locate the antenna beyond the end of the RSA, consult with the FAA Terminal Procedures Specialist (TERPS) and consider offsetting the localizer to the side to keep it clear of the RSA and to minimize the potential hazard to aircraft (See paragraph 305). The localizer critical area is illustrated in Figure 6-6.

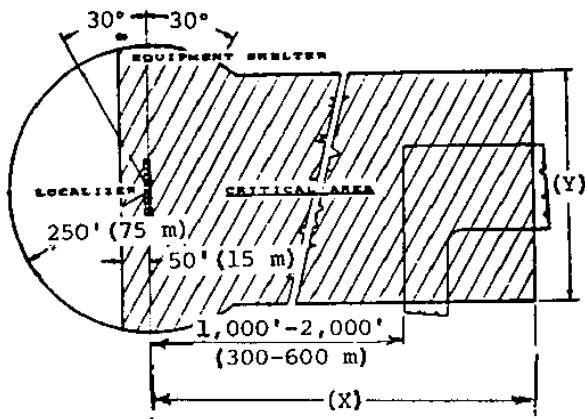

NOTE: The X and Y dimensions vary depending on the system used.

X varies from 2,000 feet (600 m) to 7,000 feet (2100 m).

Y varies from 400 feet (120 m) to 600 feet (180 m).

Figure 6-6. ILS LOC siting and critical area

(2) The critical area depicted in figure 6-6 surrounding the LOC antenna and extending toward and overlying the stop end of the runway should be clear of objects.

(3) The critical area should be smoothly graded. A constant +1 percent to -1.5 percent longitudinal grade is recommended. Transverse grades

should range from +1.0 percent to -3.0 percent, with smooth transitions between grade changes. Antenna supports shall be frangible and foundations should be flush with the ground.

(4) The LOC equipment shelter is placed at least 250 feet (75 m) to either side of the antenna array and within 30 degrees of the extended longitudinal axis of the antenna array.

c. **Glide Slope Antenna.** The glide slope (GS) signal is used to establish and maintain the aircraft's descent rate until visual contact confirms the runway alignment and location. A GS differentiates precision from nonprecision approaches.

(1) The GS antenna may be located on either side of the runway. The most reliable operation is obtained when the GS is located on the side of the runway offering the least possibility of signal reflections from buildings, power lines, vehicles, aircraft, etc. The glide slope critical area is illustrated in Figure 6-7.

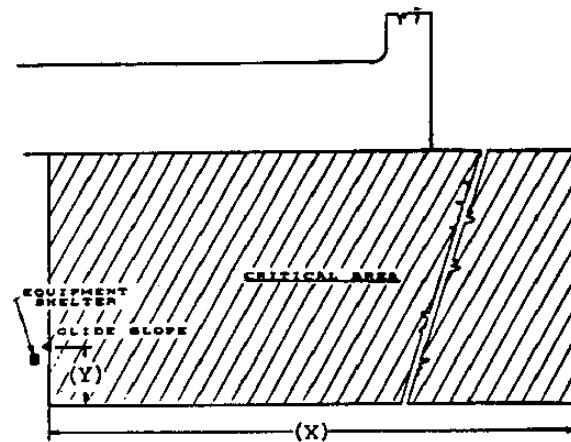

NOTE: The X and Y dimensions vary depending on the system used.

X varies from 800 feet (240 m) to 3,200 feet (960 m).

Y varies from 100 feet (30 m) to 200 feet (60 m).

Figure 6-7. GS siting and critical area

(2) Signal quality is dependent upon the type of antenna used and the extent of reasonably level ground immediately in front of the antenna.

(3) The GS equipment shelter is located 10 feet (3 m) behind the antenna and a minimum of 400 feet (120 m) from the runway centerline.

a. Marker Beacons. Marker beacons radiate cone or fan shaped signals vertically to activate aural and visual indicators in the cockpit marking specific points in the ILS approach.

(1) Marker beacons are located on the extended runway centerline at key points in the approach as noted below. Figure 6-2 illustrates the placement of marker beacons for an ILS. Figure 6-8 illustrates typical marker beacon installation.

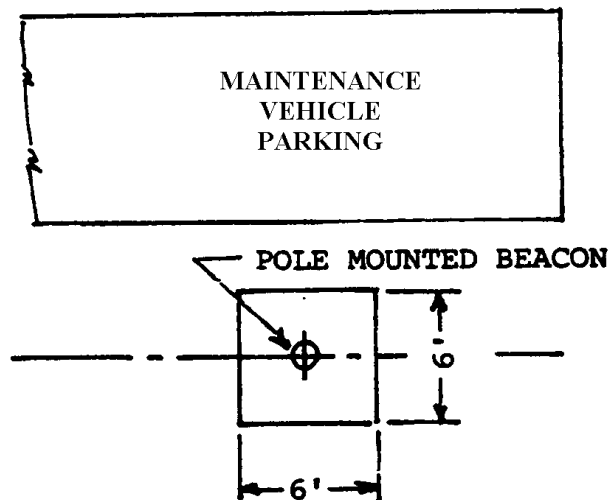

Figure 6-8. Marker beacon site

(a) The outer marker (OM) beacon is located 4 to 7 nautical miles (7.4 to 13 km) from the ILS runway threshold to mark the point at which glide slope altitude is verified or at which descent without glide slope is initiated.

(b) A middle marker (MM) beacon is located 2,000 to 6,000 feet (600 to 1 800 m) from the ILS runway threshold. It marks (approximately) the decision point of a CAT I ILS approach.

(c) An inner marker (IM) beacon may be located to mark the decision point of a CAT II or CAT III ILS approach. Inner marker beacons are not used for CAT I ILS's.

(d) A "back course" marker beacon (comparable to an outer marker beacon) may be located to the rear of a bidirectional localizer facility to permit development of a nonprecision approach.

(2) Off airport marker beacons are located in a fenced 6-foot by 6-foot (2 m by 2 m) tract situated on the extended runway centerline. Interference sources such as metal buildings, power lines, trees, etc., shall be avoided within 100 feet (30 m) of the antenna. A vehicle access and parking area is required at the site.

(3) Marker beacon sites should be smooth, level, and well drained.

603. NONDIRECTIONAL BEACON. The non-directional beacon (NDB) radiates a signal which provides directional guidance to and from the transmitting antenna. An NDB is normally mounted on a 35 foot (11 m) pole. Figure 6-9 illustrates an NDB antenna.

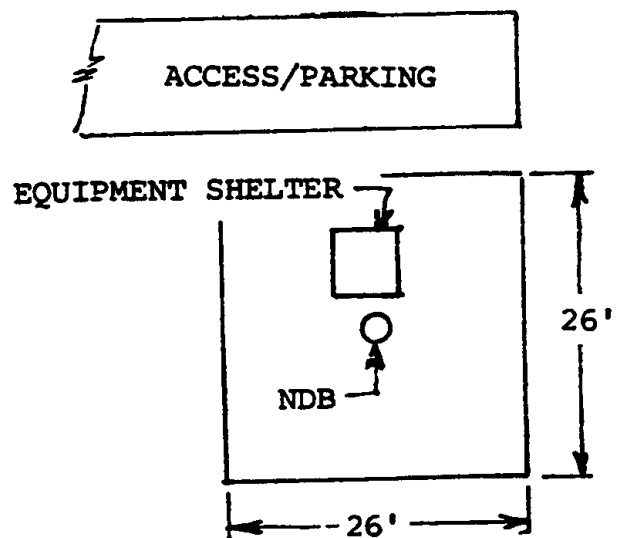

Figure 6-9. NDB site

a. Location. A NDB may be located on or adjacent to the airport. Metal buildings, power lines, or metal fences should be kept 100 feet (30 m) from a NDB antenna.

b. Grading. The NDB site should be smooth, level, and well drained.

c. Equipment Shelter. Electronic equipment is housed in a small collocated shelter.

604. VERY HIGH FREQUENCY OMNIRANGE.

The standard very high frequency omnirange (VOR) located on an airport is known as a TVOR. TVORs radiate azimuth information for nonprecision instrument approach procedures. Figure 6-10 illustrates a typical TVOR installation.

a. Location. If the airport has intersecting runways, TVORs should be located adjacent to the intersection to provide approach guidance to both. TVORs should be located at least 500 feet (150 m) from the centerline of any runway and 250 feet (75 m) from the centerline of any taxiway.

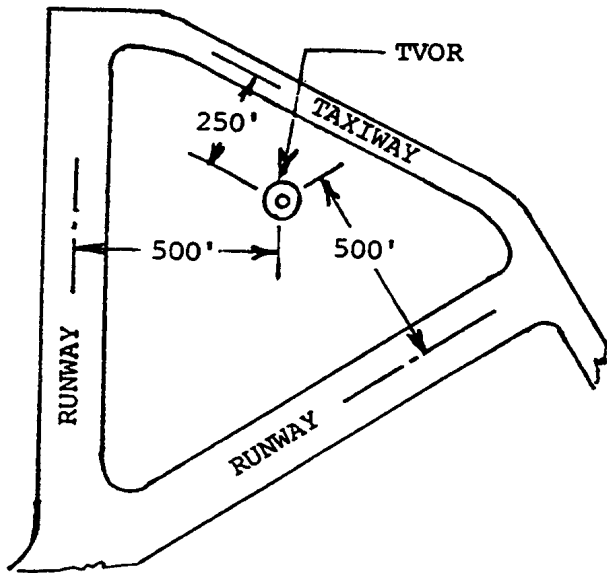

Figure 6-10. A TVOR installation

b. Clearances. TVOR signals are susceptible to distortion caused by reflections. Structures should be at least 1,000 feet (300 m) from the antenna. Metal structures beyond 1,000 feet (300 m) should not penetrate a 1.2 degree angle measured from the antenna base. Nonmetal structures beyond 1,000 feet (300 m) should not penetrate a 2.5 degree angle measured from the antenna base. Metal fences should be at least 500 feet (150 m) from the antenna and overhead power and telephone lines at least 1,200 feet (360 m) from the antenna. While trees should be at least 1,000 feet (300 m) from the antenna, a single tree may be tolerated if it is at least 500 feet (150 m) from the antenna. Beyond a 1,000 feet trees should not penetrate a 2.0 degree angle measured from the antenna.

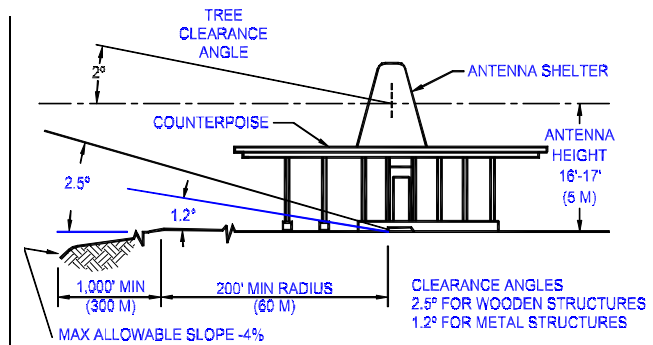

Figure 6-11, TVOR Clearances

c. Grading. TVOR sites should be level within 1000 feet (300 m) of the antenna. However, a downward slope of as much as 4 percent is permitted between 200 feet (60 m) and 1,000 feet (300 m) of the antenna. Surfaces should be cleared and smooth with no major irregularities.

d. Equipment Shelter. All necessary electronic equipment is located within the structure.

605. APPROACH LIGHTING SYSTEMS. All approach lighting systems (ALS) are configurations of lights positioned symmetrically along the extended runway centerline. They begin at the runway threshold and extend towards the approach. An ALS augments the electronic navigational aids. Guidance on ALS systems is found in AC 150/5340-14.

a. ALS Configurations. The FAA recognizes four ALS configurations to meet visual requirements for precision and nonprecision approaches.

(1) An ALSF-2 is a 2,400 foot (720 m) high intensity ALS with sequenced flashing lights. It is required for CAT II and CAT III precision approaches.

(2) A MALSR is a 2,400 foot (720 m) medium intensity ALS with runway alignment indicator lights (RAILs). It is an economy ALS system approved for CAT I precision approaches. The MALS portion of the system is 1,400 feet (420 m) in length. The RAIL portion extends outward an additional 1,000 feet (300 m).

(3) A MALS is a 1,400 foot (420 m) medium intensity ALS. It enhances nonprecision instrument and night visual approaches.

(4) A MALSF is a medium intensity ALS identical to the MALS above except that sequenced flashing lights are added to the outer three light bars. The sequenced flashing lights improve pilot recognition of the ALS when there are distracting lights in the airport vicinity.

b. Land Requirements. An ALS requires a site centered on the extended runway centerline. It is 400 feet (120 m) wide. It starts at the threshold and extends 200 feet (60 m) beyond the outermost light of the ALS.

c. Clearance Requirements. A clear line of sight is required between approaching aircraft and all lights in an ALS.

606. OMNIDIRECTIONAL APPROACH LIGHTING SYSTEMS. An omnidirectional approach lighting system (ODALS) may be installed on a runway with a nonprecision approach or on a runway that is difficult to identify due to an excessive number of lights in the area.

a. ODALS Configuration. ODALS consists of seven capacitor discharge lights. Five of the seven lights are sequence flashing omnidirectional lights. These five are located on the extended runway centerline, beginning 300 feet (90 m) from the runway threshold and spaced at 300-foot (90 m) intervals. The remaining two lights are located on either side of the runway threshold.

b. Land Requirements. ODALS require a site centered on the extended runway centerline. It is 400 feet (120 m) wide. It starts at the threshold and extends 1,700 feet (510 m).

c. Clearance Requirements. A clear line of sight is required between approaching aircraft and all lights in an ODALS.

607. LEAD-IN LIGHTING SYSTEMS. Lead-in lights (LDIN) consist of at least three flashing lights installed at or near ground level to define the desired course to an ALS or to a runway threshold.

a. LDIN Configuration. Each LDIN installation is unique. An LDIN is designed to overcome problems associated with hazardous terrain, obstructions, noise sensitive areas, etc. LDIN systems may be curved, straight, or a combination thereof. The lights are placed on the desired approach path, beginning at a point within visual range of the final approach. Generally the lights are spaced at 3,000-foot (900 m) intervals.

b. Land Requirements. Sufficient land or property interest to permit installation and operation of the lights, together with the right to keep the lights visible to approaching aircraft, is required.

c. Clearance Requirements. A clear line of sight is required between approaching aircraft and the next light ahead of the aircraft.

608. AIRPORT ROTATING BEACONS. Airport rotating beacons indicate the location of an airport by

projecting beams of light spaced 180 degrees apart. Alternating white/green flashes identify a lighted civil airport; white/white flashes an unlighted civil airport.

a. Location. The beacon shall be located to preclude interference with pilot or controller vision. Beacons should be within 5,000 feet (1 500 m) of a runway.

b. Land Requirements. Most beacons are located on airport property. When located off the airport, sufficient land or property interest to permit installation and operation of the beacon, together with the right to keep the beacon visible to approaching aircraft, is required.

c. Clearance Requirements. A beacon should be mounted high enough above the surface so that the beam sweep, aimed 2 degrees or more above the horizon, is not blocked by any natural or manmade object.

609. AIRPORT TRAFFIC CONTROL TOWERS. From airport traffic control towers (ATCTs), ATC personnel control flight operations within the airport's designated airspace and the operation of aircraft and vehicles on the movement area. A site should be reserved for an ATCT after consulting with the appropriate FAA regional office.

a. Land Requirements. A typical ATCT site will range from 1 to 4 acres (0.4 to 1.6 hectares). Additional land may be needed for combined flight service stations/towers.

b. Clearance Requirements. ATCT sites must meet these requirements:

(1) There must be maximum visibility of the airport's traffic patterns.

(2) There must be a clear, unobstructed, and direct line of sight to the approaches, to all runways or landing areas, and to all runway and taxiway surfaces.

(3) Most ATCTs penetrate an 14 CFR Part 77 surface. A tower penetrating an 14 CFR Part 77 surface is an obstruction to air navigation. As such, it is presumed to be a hazard to air navigation until an FAA study determines otherwise.

(4) The ATCT must not derogate the signal generated by any existing or planned electronic NAVAID or an ATC facility.

(5) The proposed site must be large enough to accommodate current and future building needs, including employee parking spaces.

610. AIRPORT SURVEILLANCE RADAR. Airport surveillance radars (ASR) are used to control air traffic. ASR antennas scan through 360 degrees to present the controller with the location of all aircraft within 60 nautical miles of the airport. The site for the ASR antenna is flexible, subject to the following guidelines:

a. Location. The ASR antenna should be located as close to the ATCT control room as practical. ASR-4, -5, -6, and -7 antennas should be within 12,000 feet (3 600 m) of the control room. ASR-8 antennas should be within 20,000 feet (6 000 m) of the control room. ASR-9 antennas may be located over 20,000 feet (6 000 m) from the control room.

b. Clearances. Antennas should be located at least 1,500 feet (450 m) from any building or object that might cause signal reflections and at least one-half mile (.8 km) from other electronic equipment. ASR antennas may be elevated to obtain line-of-sight clearance. Typical ASRs heights range from 25 to 85 feet (7.5 to 25.5 m) above ground.

611. AIRPORT SURFACE DETECTION EQUIPMENT. Airport surface detection equipment (ASDE) compensates for the loss of line of sight to surface traffic during periods of reduced visibility. ASDE should be sited to provide line-of-sight coverage of the entire aircraft movement area. While the ideal location for the ASDE antenna is on the ATCT cab roof, the antenna may be placed on a freestanding tower up to 100 feet (30 m) tall located within 6,000 feet (1 800 m) of the ATCT cab.

612. RUNWAY VISUAL RANGE FACILITIES. Runway visual range facilities provided a measurement of horizontal visibility, i.e., how far ahead the pilot of an aircraft should be able to see high intensity runway edge lights or contrasting objects. RVR installations consist of a projector and a receiver. Existing systems will be replaced by single-point systems in the 1990-1998 time frame.

a. Number. The number of RVRs required depends upon the runway approach category and physical length.

(1) CAT I runways require only a touchdown RVR.

(2) CAT II runways with authorized visibility minimums down to 1,600 RVR require only a touchdown RVR. Minimums below 1,600 RVR require touchdown and rollout RVRs. CAT II runways more than 8,000 feet (2 400 m) in length require touchdown, roll-out, and midpoint RVRs.

(3) CAT III runways with visibility minimums below 1,200 RVR require touchdown, midpoint, and rollout RVRs.

b. Longitudinal Location.

(1) Touchdown RVRs are located 750 to 1,000 feet (225 to 300 m) from the runway threshold, normally behind the MLS elevation antenna or ILS glide slope antenna.

(2) Rollout RVRs are located 750 to 1,000 feet (225 to 300 m) from the rollout end of the runway.

(3) Mid-point RVRs are located within 250 feet (75 m) of the runway's center longitudinally.

c. Lateral Location. RVR installations are located adjacent to the instrument runway.

(1) Single-point visibility sensor installations are located at least 400 feet (120 m) from the runway centerline and 150 feet (45 m) from a taxiway centerline.

(2) Transmissometer projectors are located at least 400 feet (120 m) from the runway centerline and 150 feet (45 m) from a taxiway centerline. Receivers are located between 250 feet (75 m) and 1,000 feet (300 m) from the runway centerline. The light beam between the projector and receiver should be at an angle of 5 to 14.5 degrees to the runway centerline. The light beam may be parallel to the runway centerlines when installations are between parallel runways.

613. AUTOMATIC WEATHER OBSERVATION STATIONS (AWOS). Automatic recording instruments have been developed for measuring cloud height, visibility, wind speed and direction, temperature, dewpoint, etc.. The U.S. Department of Commerce's National Oceanic and Atmospheric Administration publication "Federal Standard for Siting Meteorological Sensors at Airports" addresses siting of sensors. AC 150/5220-16, Automated Weather Observing Systems (AWOS) for Non-Federal Applications provides additional guidance.

614. PHYSICAL SECURITY. Airport facilities require protection from acts of vandalism. To provide a measure of protection, unauthorized persons must be precluded from having access to NAVAIDs and ATC facilities. Perimeter fencing should be installed to preclude inadvertent entry of people or animals onto the airport. In addition to airport perimeter fencing, the following security measures are recommended:

a. **Off-Airport Facilities.** Navigational and ATC facilities located off an airport, and in a location that is accessible to animals or the public, shall have a security perimeter fence installed at the time of construction.

b. **On-Airport Facilities.** Navigational and ATC facilities located on the airport have at least the protection of the operational areas. Any protection device, e.g., a guard rail or security fence, which penetrates an FAR Part 77 surface is an obstruction to air navigation. As such, it is presumed to be a hazard to air navigation until an FAA study determines otherwise.

615. CABLE PROTECTION. Most NAVAID and ATC facilities discussed in this chapter are served by buried power and control cables. FAA cables are typically buried approximately 24 inches (.6 m) below ground. They should be installed in conduit or duct beneath runways and taxiways, and in duct and manhole systems under aprons and paved parking areas. Information regarding the location of FAA cables and ducts may be obtained from the Manager of the Airways Facilities Maintenance Office serving the NAVAID or ATC facility. Questions relative to protecting or relocating cables can be obtained from the FAA Regional Airways Facilities Division Office.

616. to 699. RESERVED

Chapter 7. RUNWAY AND TAXIWAY BRIDGES

700. INTRODUCTION. Efforts to extend a runway are in many cases complicated by an existing or proposed street, highway, or railroad which is important to the community. When the closing or rerouting of an existing surface transportation mode is not practical, consider bridging the runway/taxiway over the impediment. This chapter presents guidance for this consideration.

701. SITING PRECEPTS. Minimize the extent of the required structure(s) by selection of:

a. **Route.** Achievement of the least number of required runway or taxiway bridges is possible through routing or rerouting of surface modes.

b. **Alignment.** A single bridge structure should handle all surface modes, including utilities, through proper routing or alignment.

c. **Locations.** Locations of bridges should be on straight portions of taxiways and away from taxiway intersections or angled taxiway exits. Such airport features as drainage systems, utility service lines, runway and taxiway lighting circuits, ILSs, and approach lighting systems (ALS), may also affect bridge location and design.

702. DIMENSIONS.

a. **Length.** Bridge length is parallel with the runway or taxiway centerline.

b. **Width.** Bridge width is perpendicular to the runway or taxiway centerline. The recommended bridge width (full strength structure) is the width of the runway or taxiway plus safety areas. It is recommended that bridges for a runway and parallel taxiway be continuous full-width, full-strength structures as illustrated in figures 7-1 and 7-2. In unusual situations, site conditions may limit taxiway bridges to a width of the taxiway plus shoulders. A minimum width taxiway bridge requires: positive edge protection; underwing engine clearance; adequate blast protection for vehicles or personnel crossing under the bridge; sufficient width for maneuvering rescue and firefighting equipment; and sufficient width to accommodate aircraft evacuation slides. Figure 7-3 illustrates a minimum width taxiway bridge.

c. **Height.** Bridge height is the vertical clearance provided over the crossed surface.

d. **Clearance.** Except for positive edge restraints on minimum width taxiway bridges, no structural members should project above the runway or taxiway surface.

703. LOAD CONSIDERATIONS. Runway and taxiway bridges must support both static and dynamic loads imposed by the heaviest airplane expected to use the structures. Airport authorities should evaluate the potential need to accommodate heavier airplanes and construct any runway or taxiway bridge accordingly. Overdesign is preferable to the cost and operational penalties of replacing or strengthening an underdesigned structure at a later date. Airplanes weighing up to 873,000 pounds (395 985 kg) are in use today. Airplanes weighing 1,000,000 pounds (453 600 kg) or more may exist by the turn of the century.

704. DECK DESIGN. Bridges should be designed to incorporate a layer of select earth between the bridge deck and the runway or taxiway pavement. The earth acts as an insulator to reduce the probability of ice forming on the bridge before the adjacent pavement freezes. Where bridge height is limited, the bridge's structural deck may be the runway or taxiway surface.

705. MARKING AND LIGHTING. The following marking and lighting is in addition to the standard marking and lighting specified in advisory circulars of the 150/5340 series. Figure 7-5 illustrates shoulder marking for minimum width taxiways.

a. Three equally-spaced L-810 obstruction lights on each side of the bridge.

b. Chevrons spaced 25 feet (7.5 m) apart on runway and taxiway shoulders.

c. Taxiway centerline lights or centerline reflectors.

d. Taxiway edge lights or edge reflectors.

e. Taxiway edge markings.

706. OTHER CONSIDERATIONS. The preceding paragraphs cover design requirements applicable to all runway and taxiway bridges. The following identify additional design features which may be necessary as part of a specific runway or taxiway bridge project.

a. Curbs. On minimum width taxiway bridges and where icing conditions may exist, a curb designed to hold the largest expected aircraft should be added to prevent aircraft from being blown from the bridges. Figure 7-3 shows a double-curb installation.

b. Security Fences. Security fences should be provided adjacent to the bridge-tunnel to prevent inadvertent entry of persons, vehicles, or animals into operational areas. AC 107-1 furnishes additional guidance on the subject.

c. Pavement Heating. Where freezing is a problem, in-pavement heating may be desirable on bridges which do not have sufficient earth cover to provide insulation. Accordingly, the drainage system needs to be capable of accepting melted runoff without refreezing or flooding the bridged surface.

d. Service Roads. Airport maintenance and service equipment may use a runway or taxiway bridge if its presence does not interfere with airplane operations. There should be a separate bridge if there is more than occasional use by these vehicles. Figure 7-6 illustrates a multi-use bridge over a public roadway.

e. Blast Protection. Minimum width taxiway bridges require special features to protect the surface from jet blast. One alternative is nonload-bearing decks beyond the limits of the load-bearing shoulders.

f. Approach Aprons. Aprons, similar to those used in highway construction, are recommended to minimize the effects of differential settlement between the bridge proper and its approaches.

g. Tunnel Ventilation. The need for mechanical ventilation will depend upon its length. When mechanical ventilation is necessary, all aboveground components need to be located so that they are not a hazard to aeronautical operations.

h. Tunnel Lighting. The need for artificial lighting of the tunnel depends on its length. Emergency lighting and lane-control signals may also be necessary. The American Association of State Highway Officials publication "Informational Guide for Roadway Lighting" contains a section on lighting tunnels and underpasses. Copies of this publication are available through state highway offices. Light poles shall not penetrate an FAR Part 77 surface unless an FAA aeronautical study determines they will not be hazards. Light from the fixtures shall not cause

glare or distract pilots or control tower personnel. Figure 7-4 illustrate roadway lighting applications.

i. Drainage. Tunnels which pass under a runway or taxiway, may require automatic, self-priming pumps.

707. PASSENGER AND BAGGAGE TUNNELS.

Passenger and baggage tunnels connect main and satellite terminals. In essence, they are merely smaller versions of runway and taxiway bridges and have similar design considerations. Tunnels house walkways, baggage conveyers, subway-type people-mover systems, or a combination of these.

708. to 799. RESERVED.



Figure 7-1. Full width runway-taxiway bridge

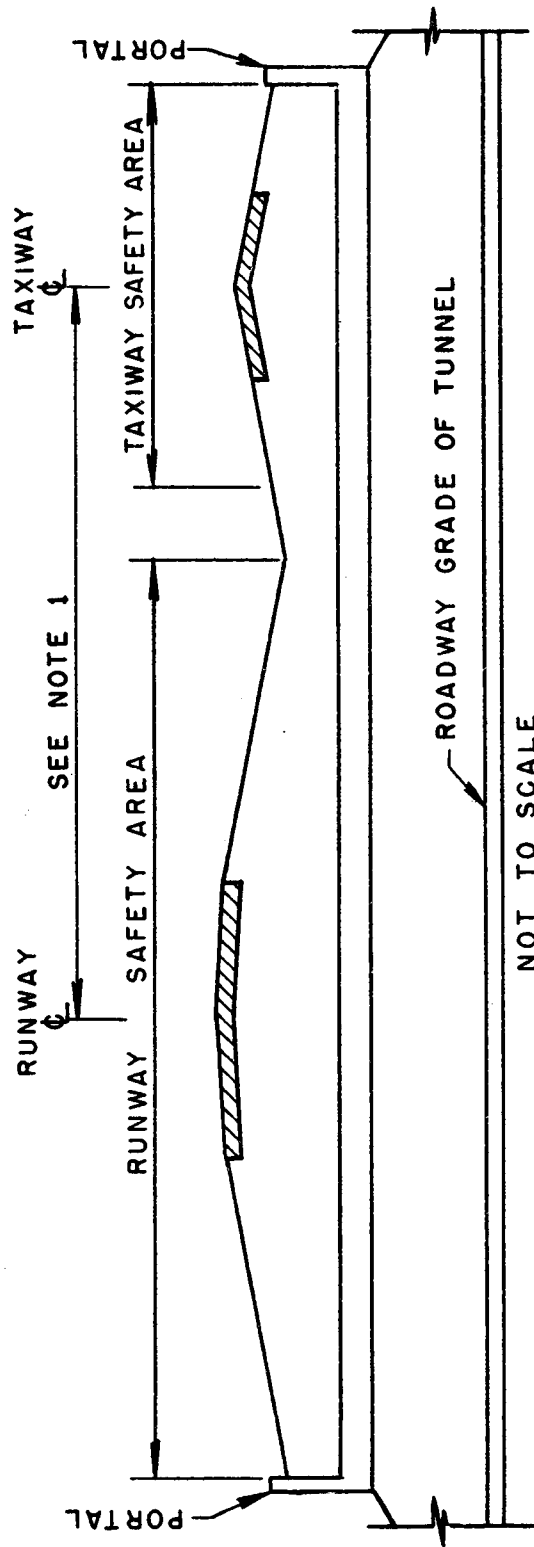

NOTES:

1. WIDTH OF TAXIWAY SAFETY AREA AND RUNWAY / TAXIWAY SEPARATION DISTANCE VARY DEPENDING ON AIRPLANE / TAXIWAY DESIGN GROUP.
2. ROADWAY TUNNEL NORMALLY HAS SLIGHT LONGITUDINAL GRADIENT AND SOME TYPE OF RETAINING WALL AT PORTALS
3. UNIFORM TUNNEL CROSS SECTION IS NORMALLY USED; AND A CONTINUOUS STRUCTURE WITHOUT OPEN SECTION IN INFIELD AREA IS PREFERRED AND RECOMMENDED WHEREVER FEASIBLE

Figure 7-2. Cross-section full width runway-taxiway bridge



Figure 7-3. Minimum width taxiway bridge with positive edge protection, O'Hare Airport, Chicago, IL

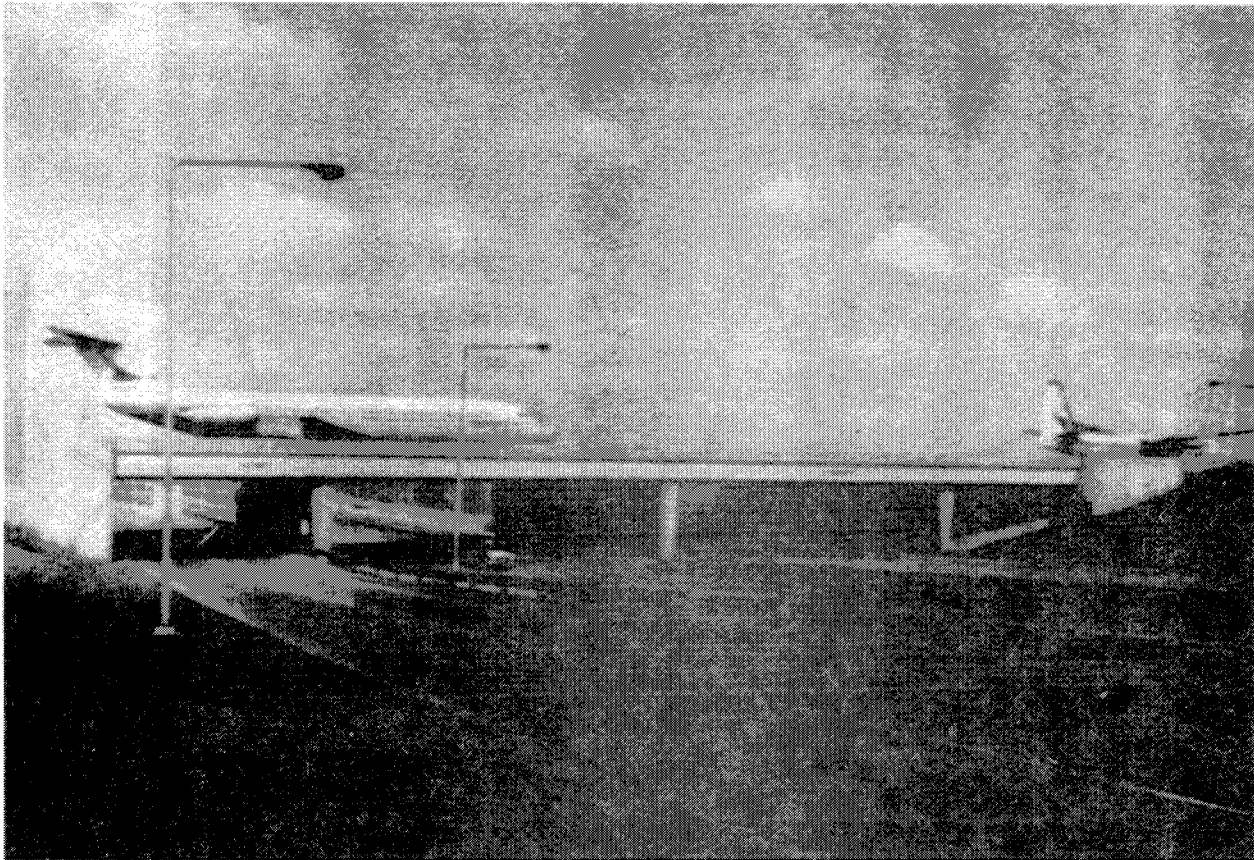

Figure 7-4. Example structural deck and depressed roadway, O'Hare Airport, Chicago, IL

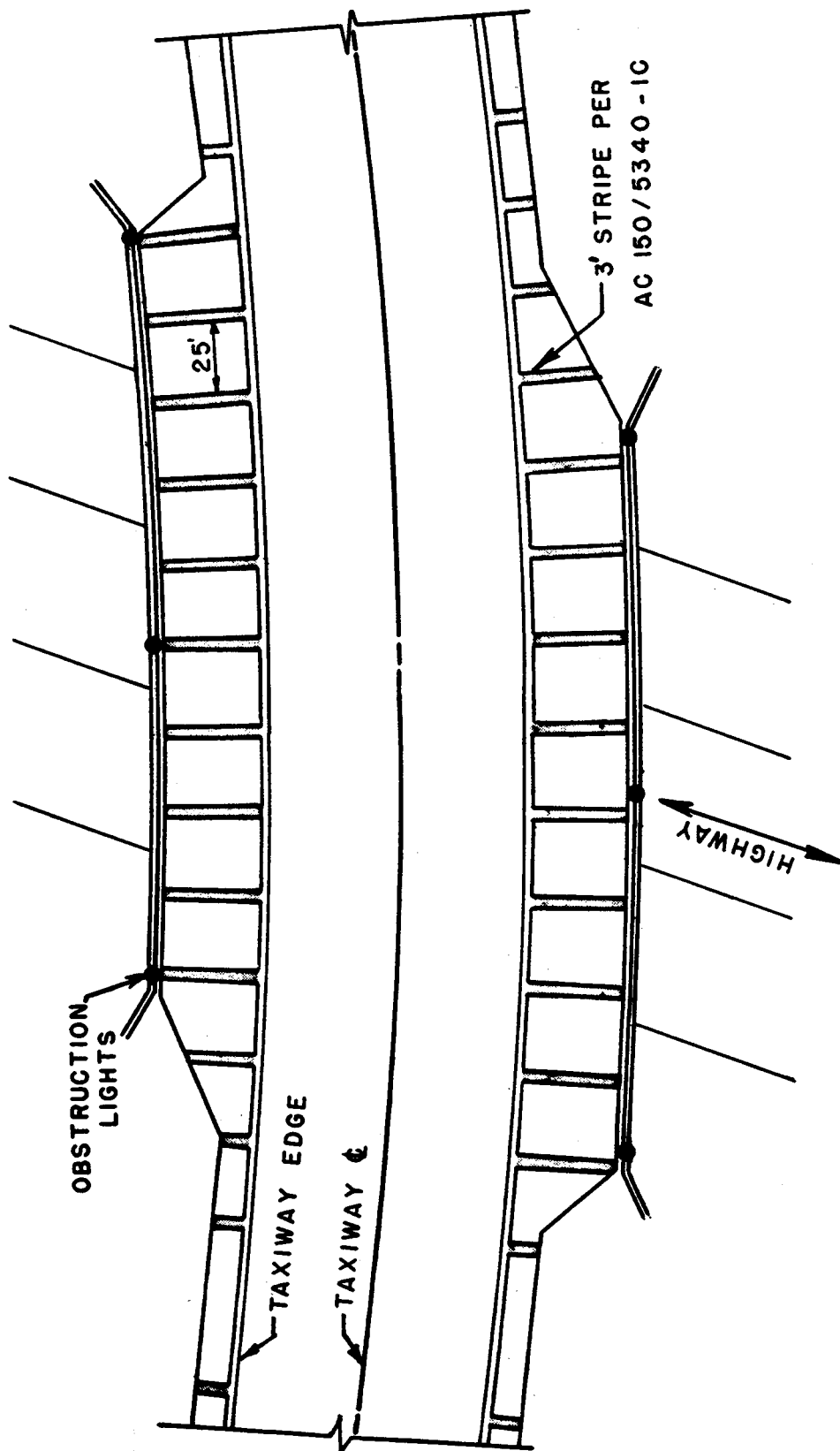

Figure 7-5. Suggested shoulder marking of minimum width taxiway bridge

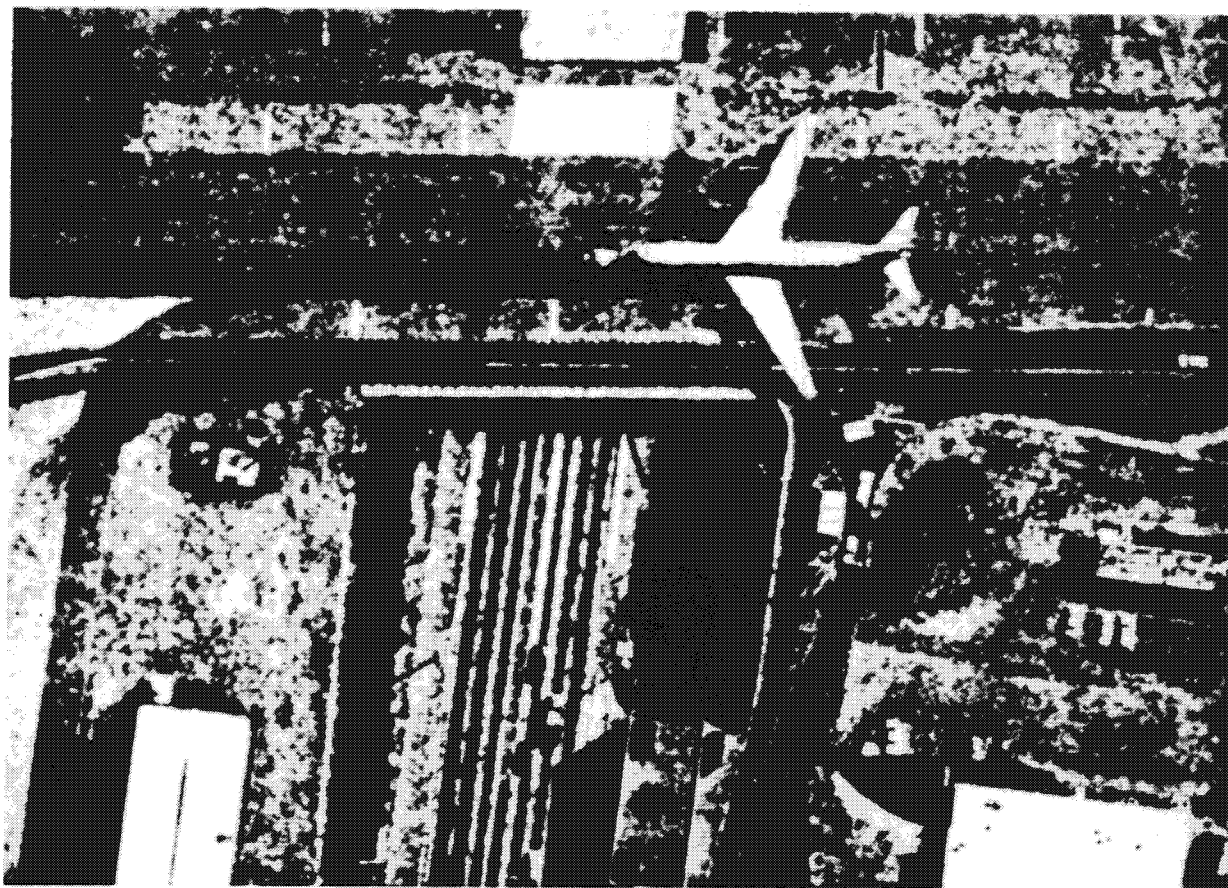

Figure 7-6. Controlled use service road, Los Angeles International Airport, Los Angeles, CA

Chapter 8. THE EFFECTS AND TREATMENT OF JET BLAST

800. INTRODUCTION. The forces of jet exhaust (jet blast) far exceed the forces of propwash from the most powerful propeller airplane. These high velocities are capable of causing bodily injury to personnel and damage to airport equipment or facilities. This chapter suggests means to minimize the effects of jet blast.

801. JET BLAST EFFECTS. Jet blast affects all operational areas of the airport. In terminal, maintenance, and cargo areas, personnel safety is the overriding consideration. Blast velocities greater than 30 m.p.h. (48 km/hr) can cause loose objects on the pavement to become missiles capable of causing injury to personnel who may be at a considerable distance behind the airplane. In other operational areas, sudden gusts averaging more than 20 m.p.h. (31 km/hr) are hazardous, and when striking moving vehicles or airplanes, are more dangerous than continuous velocities of the same magnitude. Velocities of this magnitude can occur over 2,000 feet (600 m) to the rear of certain airplanes when their engines are operating at takeoff thrust.

a. Jet Blast Pressures. Jet exhaust velocities are irregular and turbulent. The vibrations they induce over small areas should be considerations in designing a building or structure subjected to jet blast. Over areas of 10 to 15 square feet (3 to 5 m²), the velocities may be assumed to be periodic with peaks occurring 2 to 6 times per second. These peaks are not continuous laterally or vertically. The following equation computes the pressure produced on a surface perpendicular to the exhaust stream:

$$P = 0.00256 V^2, \text{ where:}$$

P = pressure in pounds per square foot; and
V = velocity in miles per hour.

$$P = 0.04733 V^2, \text{ where:}$$

P = pressure in pascals; and
V = velocity in kilometers per hour.

b. Blast Velocity Distances. The drag and uplift forces produced by jet engines are capable of moving large boulders. A jet engine operating at maximum thrust is capable of lifting a 2-foot (0.6 m) boulder 35 feet (10 m) behind the airplane completely off the ground. Fortunately, these forces which cause severe erosion decrease rapidly with distance so that beyond 1,200 feet (365 m) behind a jet airplane only sand and cohesionless soils are affected. Figures 8-1

through 8-5 illustrate the velocity versus distance plots for representative airplanes. The velocities shown represent maximum values, particularly for breakaway from a parked position. For site specific conditions, include manufacturers' jet blast data for the most demanding airplane in the analysis. The distances shown are measured from the rear of the airplane and the velocities are for takeoff, breakaway, and idle thrust power settings. Similar data for other airplanes, including lateral and vertical velocity contours, as well as site specific blast loads on structures, may be obtained from the engine manufacturers.

c. Heat Effects. High temperatures are also associated with jet exhaust; but the affected area is smaller than the area subject to hazardous jet blast velocities. Contours showing the level of heat at varying distances from jet engines are obtainable from airplane manufacturers.

802. BLAST FENCES. Properly designed blast fences can substantially reduce or eliminate the damaging effects of jet blast, as well as the related fumes and noise which accompany jet engine operation. Fences are permissible near apron areas to protect personnel, equipment, or facilities from the jet blast of airplanes moving into or out of parking positions. In addition, blast fences may be necessary near runway ends, run-up pads, etc., to shield off-airport, as well as, airport pedestrian or vehicular traffic.

a. Location. Generally, the closer the fence is to the source of blast, the better it performs, provided that the centerline of the exhaust stream falls below the top of the fence. To the extent practicable, blast fences should be located outside of the runway object free area.

b. Design. Figures 8-6 and 8-7 illustrate several types of blast fence design which are readily available from various manufacturers. Blast fences located inside the runway object free area should be as frangible as practicable.

c. Other Types of Blast Protection. Although blast fences are the most effective means of blast protection, other methods may achieve satisfactory results. Any surface, whether natural or manmade, located between the jet engine and the area to be protected will afford some measure of blast protection.

803. SHOULDERS AND BLAST PADS. Unprotected soils adjacent to runways and taxiways are susceptible to erosion. A dense, well-rooted turf cover can prevent erosion and support the occasional passage of aircraft, maintenance equipment, or emergency equipment under dry conditions. Paved shoulders are recommended for runways, taxiways, and aprons which will accommodate Group III and higher aircraft. Turf, aggregate-turf, soil cement, lime or bituminous stabilized soil are recommended adjacent to paved surfaces provided for Group I and II aircraft.

a. Shoulder and Blast Pad Dimensions. Paved shoulders should run the full length of the runway(s) and taxiway(s). Blast pads at runway ends should extend across the full width of the runway plus the shoulders. Table 3-1, 3-2, and 3-3 specify the standard blast pad dimensions and runway shoulder widths. Table 4-1 specifies the standard taxiway shoulder widths. Increases to these standard dimensions are permissible for unusual local conditions.

b. Pavement Strength. Shoulder and blast pad pavement needs to support the occasional passage of the most demanding airplane as well as the heaviest existing or future emergency or maintenance vehicle for the design life of the full strength pavement. These pavements may be constructed of bituminous or Portland Cement concrete materials. Specifications for materials and constructions standards for these pavements should be based on state highway requirements.

(1) For Airplane Design Groups III and IV, the minimum bituminous concrete surface thickness, constructed on an aggregate base, is 2 inches (51 mm) for shoulders and 3 inches (76 mm) for blast pads. These thicknesses should be increased by 1 inch (25 mm) for Airplane Design Groups V and VI. Aggregate base and subbase thicknesses should be determined using state highway design standards.

(2) The thickness of shoulders and blast pads constructed of Portland Cement concrete should be based on state highway standards. The minimum thickness of these pavements, as recommended in AC 150/5320-6, is 5 inches (127 mm).

(3) Shoulders and blast pads may have stabilized subbase and base. The stabilized subbase and base thicknesses should be determined using the equivalency factors in AC 150/5320-6 for converting aggregate subbase and base to stabilized subbase and base.

c. Drainage. Surface drainage should be maintained or improved in the shoulder and blast pad areas. Where a paved shoulder or blast pad abuts the runway, the joint should be flush, however, the shoulder may retain a 5 percent transverse slope. A 1.5 inch (3.8 cm) step is the standard at the edge of paved shoulders and blast pads to enhance drainage and to prevent fine graded debris from accumulating on the pavement. Base and subbase courses shall be of sufficient depth to maintain the drainage properties of granular base or subbase courses under the runway, taxiway, or apron pavement. An alternative is to provide a subdrain system with sufficient manholes to permit observation and flushing of the system.

d. Marking and Lighting. AC 150/5340-1 provides guidance for marking shoulders and blast pads. New construction should provide for edge lights to be base mounted and for the installation of any cable under the shoulder or blast pad pavement to be in conduit. When adding shoulders or blast pads to existing runways or taxiways, the existing runway or taxiway edge lighting circuitry, if not suitable, should be updated/modified prior to shoulder or blast pad paving.

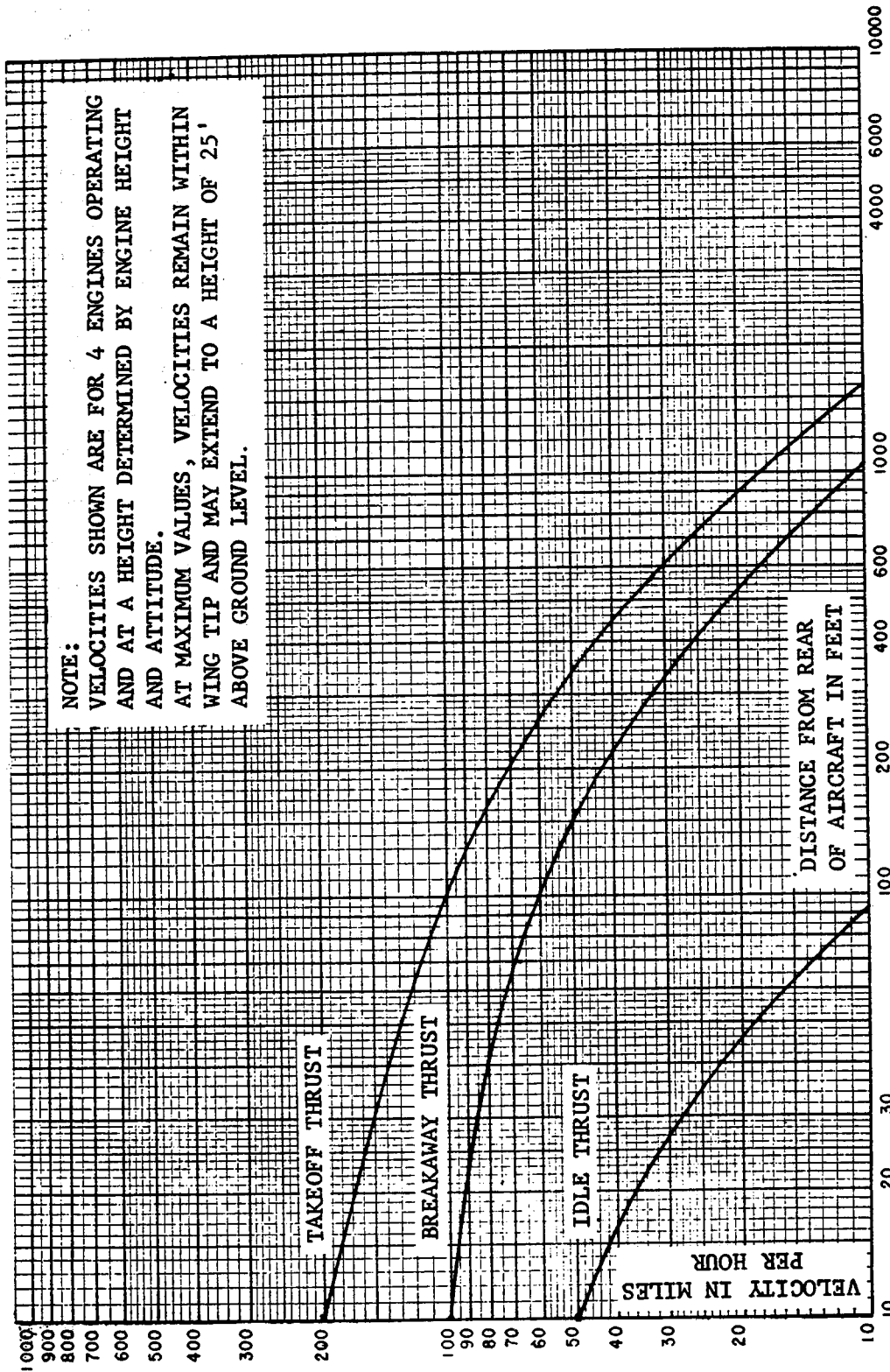

Figure 8-1. Velocity distance curves, DC-8

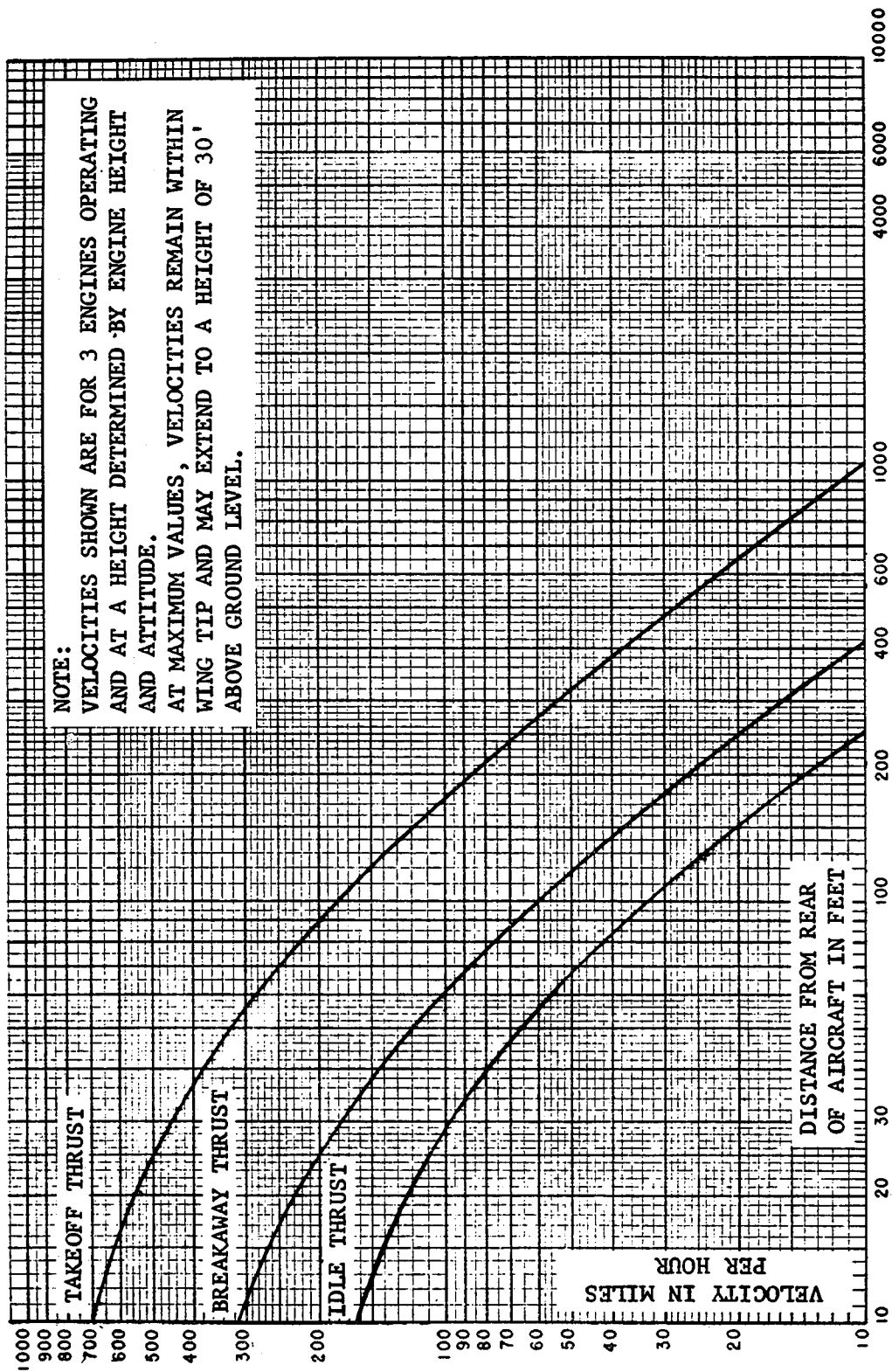

Figure 8-2. Velocity distance curves, B-727

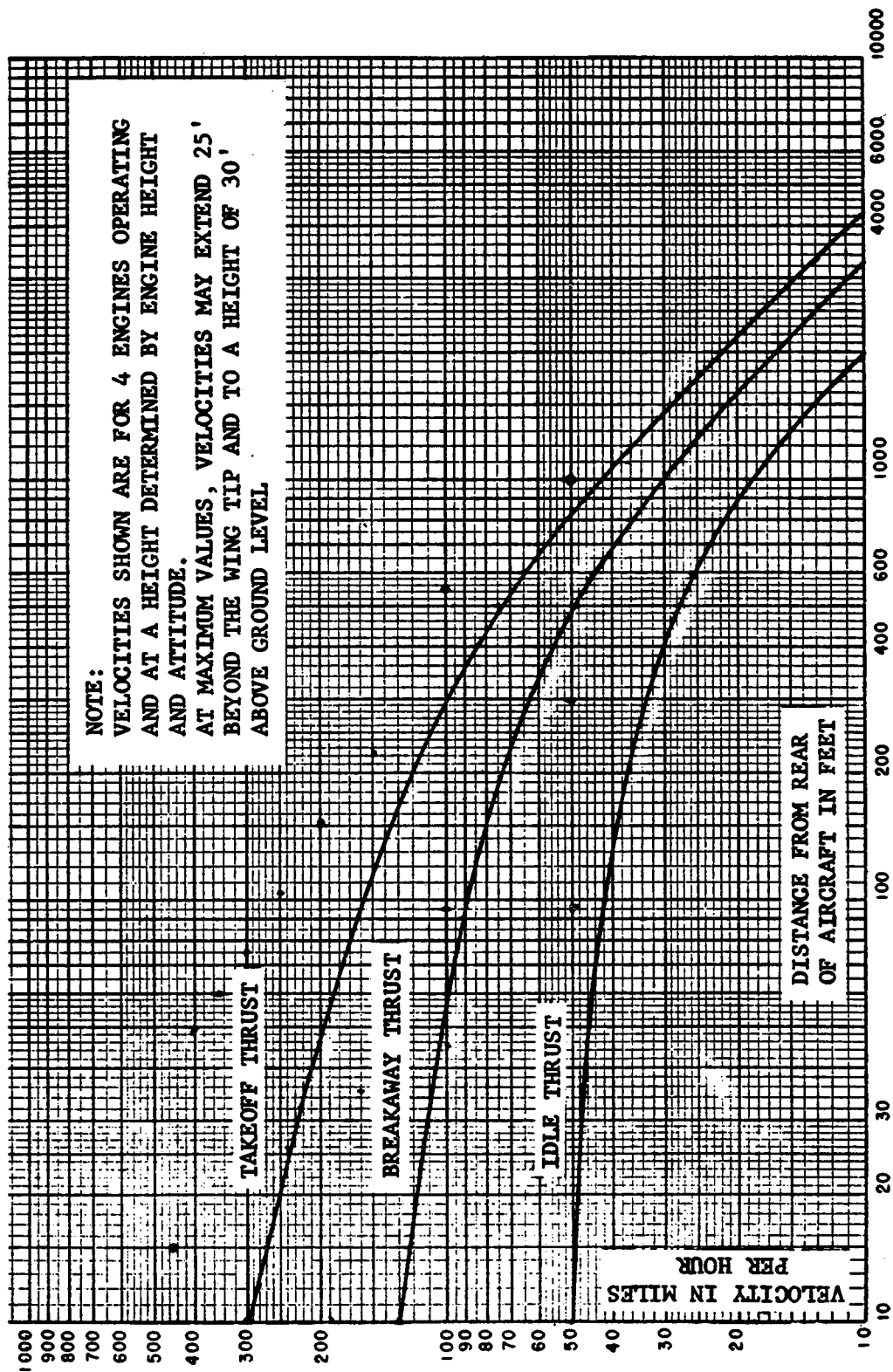

Figure 8-3. Velocity distance curves, B-747

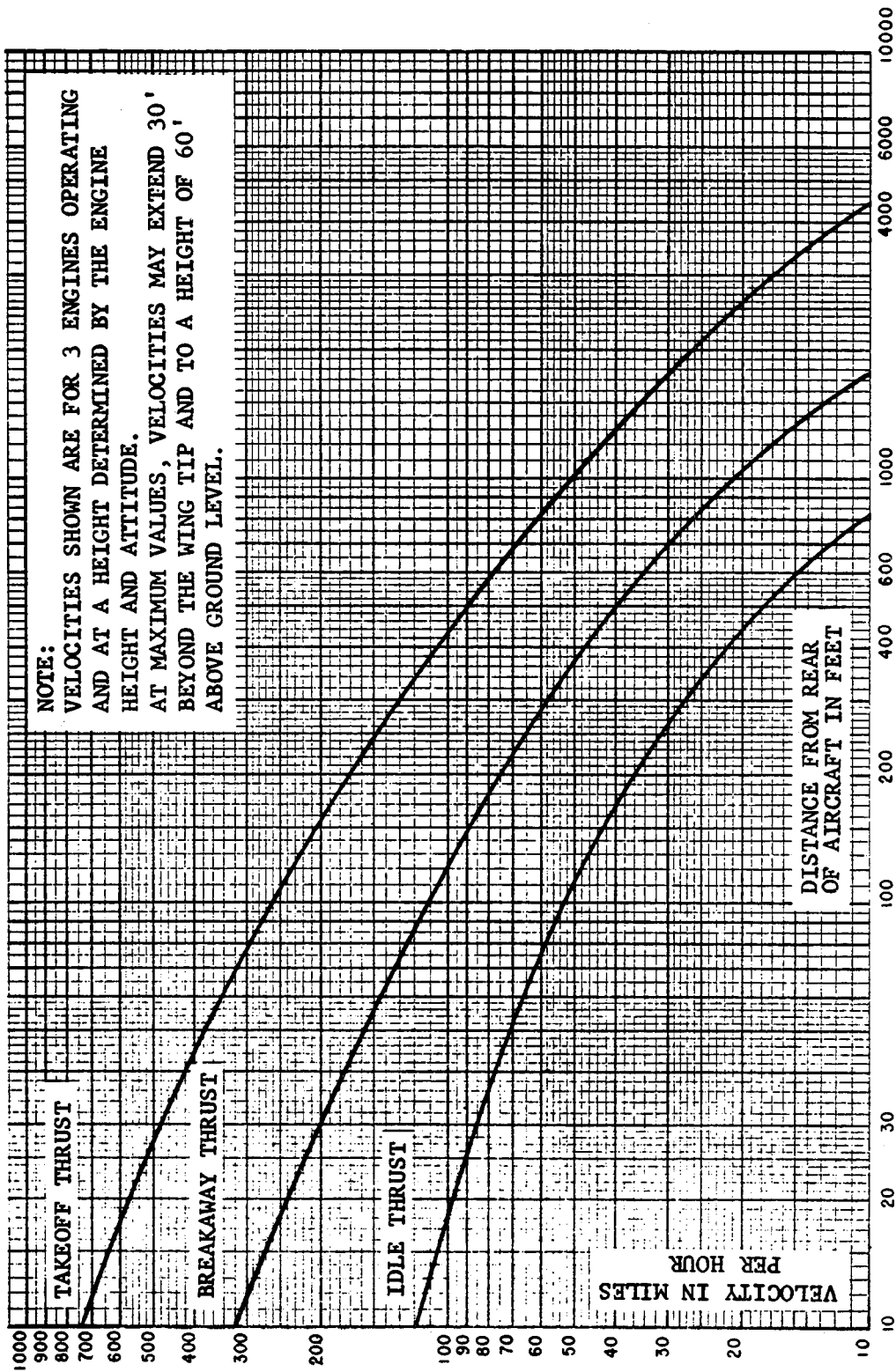

Figure 8-4. Velocity distance curves, DC-10

VELOCITY IN MILES/HOUR (KILOMETERS/HOUR)

Distance Behind Engine Aircraft	20' (6 m)	40' (12 m)	60' (18 m)	80' (24 m)	100' (30 m)
Fan Jet Falcon					
Idle	82(132)	36(58)	25(40)	22(35)	18(29)
Breakaway ^{1/}	150(241)	68(109)	46(74)	33(53)	27(43)
Takeoff	341(549)	155(249)	106(171)	75(121)	62(100)
Jet Commander, Lear Jet, & Hansa					
Idle	54(87)	24(39)	15(24)	11(18)	9(14)
Breakaway	114(183)	50(80)	31(50)	22(35)	18(29)
Takeoff	259(417)	114(183)	68(109)	52(84)	42(68)
Jet Star & Sabreliner					
Idle	92(148)	41(66)	25(40)	18(29)	15(24)
Breakaway	195(314)	85(137)	52(84)	39(63)	31(50)
Takeoff	443(713)	194(312)	119(192)	89(143)	72(116)
Gulfstream II					
Idle	153(246)	75(121)	48(77)	41(66)	34(55)
Breakaway	330(531)	150(241)	102(164)	72(116)	60(97)
Takeoff	750(1207)	341(549)	232(373)	164(264)	136(219)

^{1/} "Breakaway" is that percentage of power required to start airplanes moving and usually is approximately 55 percent of maximum continuous thrust.

Figure 8-5. Blast velocities of business jet airplanes

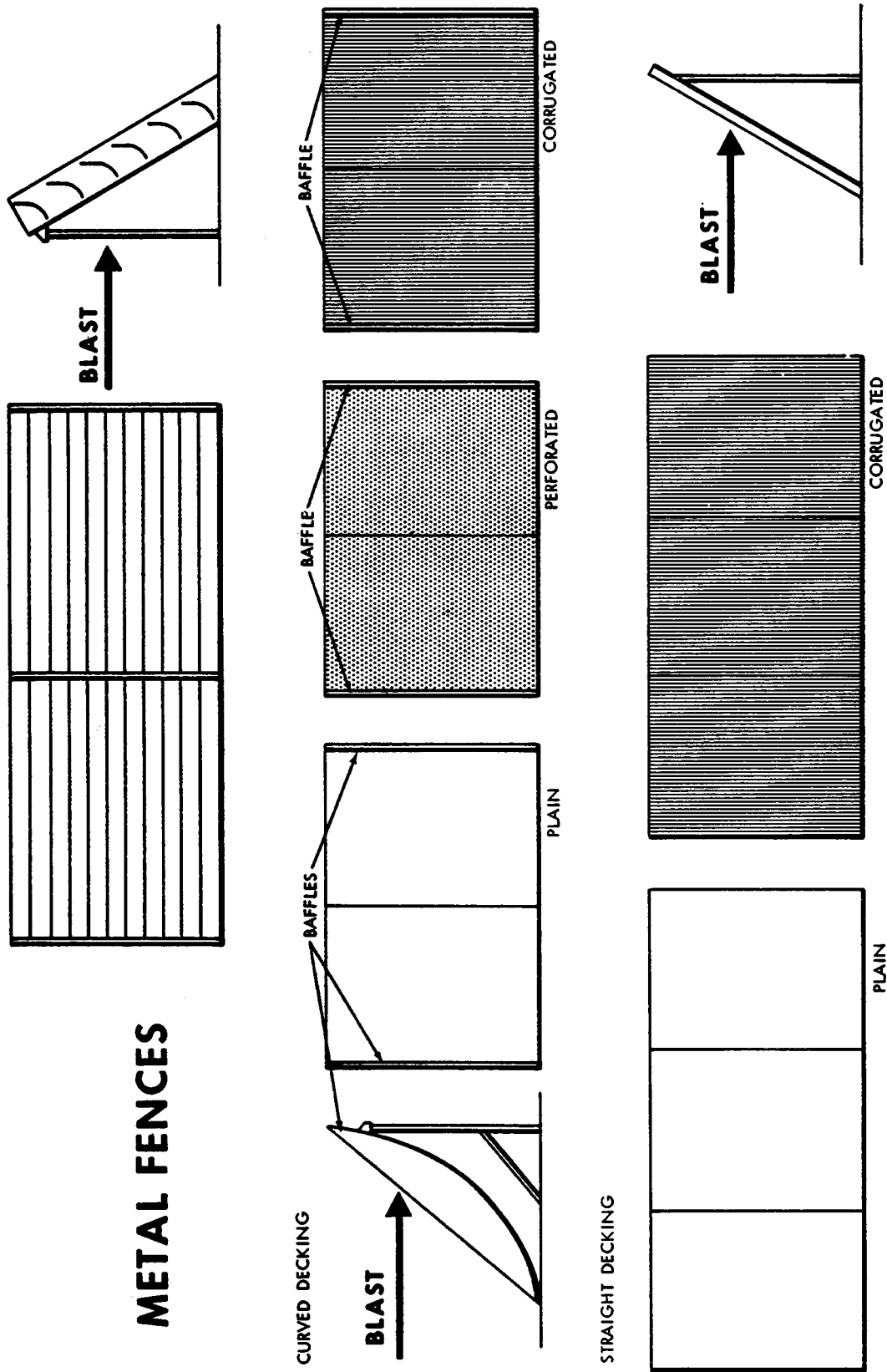

Figure 8-6. Typical blast deflector fences, metal

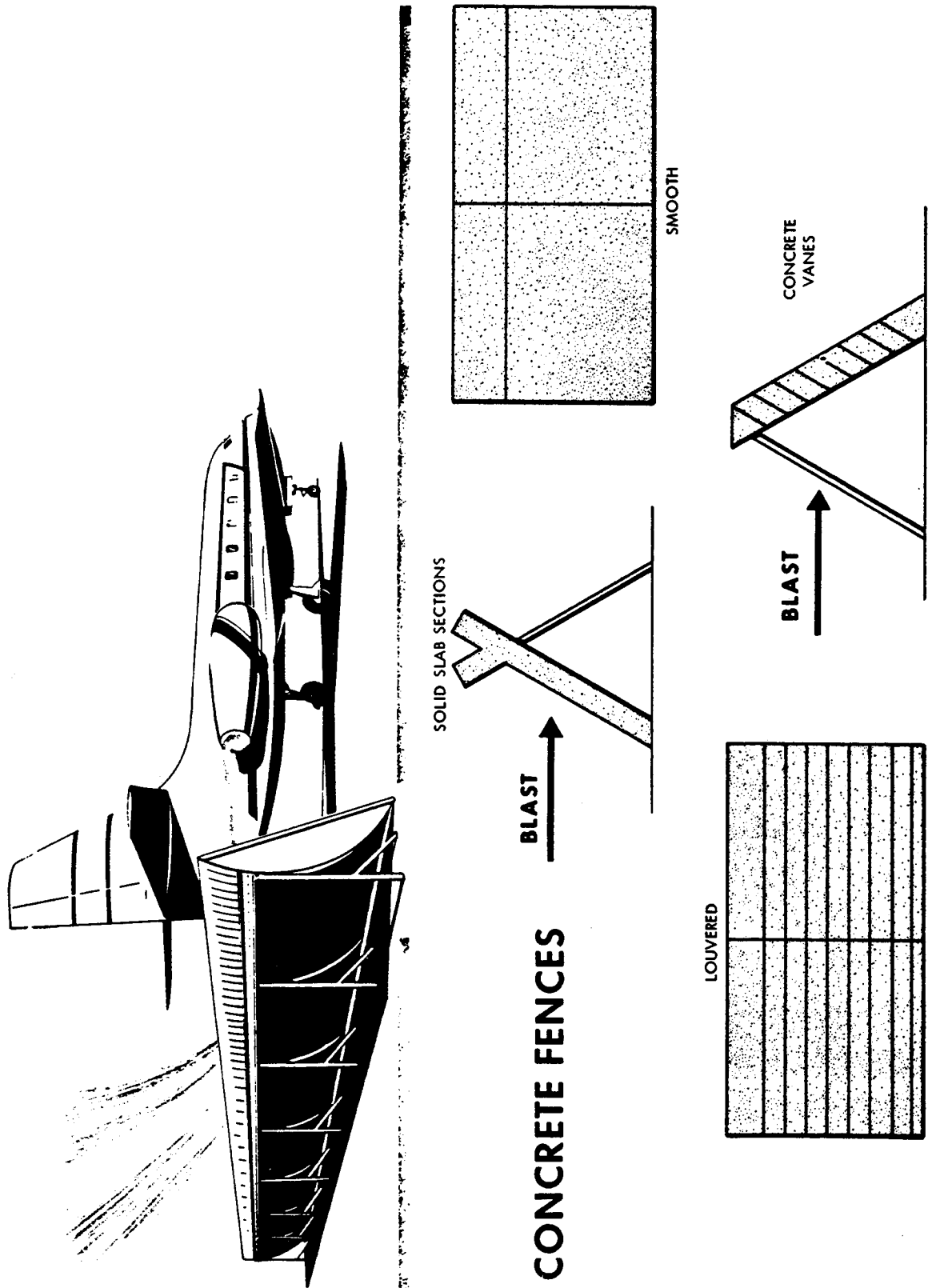

Figure 8-7. Typical blast deflector fences, concrete

