



U.S. Department
of Transportation
**Federal Aviation
Administration**

Advisory Circular

Subject: SPECIFICATION FOR L-821, PANELS
FOR THE CONTROL OF AIRPORT LIGHTING

Date: 9/28/2007

AC No.: 150/5345-3F

Initiated by: AAS-100

Change:

1. PURPOSE. This advisory circular (AC) provides the specified manufacturing requirements for panels used for remote control of airport lighting and auxiliary systems.

2. EFFECTIVE DATE. Effective six months after the issue date of this AC, only that equipment qualified in accordance with the specifications herein will be listed in accordance with AC 150/5345-53, *Airport Lighting Equipment Certification Program*.

3. CANCELLATION. AC 150/5345-3E, *Specification for L-821 Panels for Remote Control of Airport Lighting*, dated September 1, 1998, is canceled.

4. APPLICATION. The FAA recommends the guidelines and standards in this AC for L-821 Airport Lighting Panels. This AC does not constitute a regulation and in general is not mandatory. However, use of these guidelines is mandatory for L-821 Airport Lighting Panels funded under the Airport Improvement Program (AIP) or Passenger Facility Charge (PFC) Programs. Mandatory terms such as “must” apply only to those who purchase L-821 Airport Lighting Panels using AIP or PFC funds and/or to those who intend to meet this specification for any other reason.

5. PRINCIPAL CHANGES. The following principal changes have been incorporated into this AC:

- Updated “Referenced Documents” section.

6. METRIC UNITS. To promote an orderly transition to metric units, this AC includes both English and metric dimensions. The metric conversions may not be exact equivalents, and until there is an official changeover to the metric system, the English dimensions will govern.

DAVID L. BENNETT
Director of Airport Safety and Standards

This page intentionally blank.

**FAA SPECIFICATION FOR L-821 PANELS
FOR THE CONTROL OF AIRPORT LIGHTING**

1. SCOPE AND CLASSIFICATION.

1.1 Scope. This specification sets forth the manufacturing requirements for panels to be used to control various airport lighting and auxiliary systems.

1.2 Equipment Classification. Two types, three classes, two styles, and three modes of panels are covered by this specification.

1.2.1 Type. Panels of the following types are covered by this specification:

Type	Description
I	Conventional panels. (See illustrations in Appendix IV, Figures 2, 3, 4, 5, and 6A).
II	Facsimile panels. (See illustrations in Appendix IV, Figures 6B and 7).

1.2.2 Class. Panels of the following classes are covered by this specification:

Class	Description
F	Flush mounted panels. Class F panels consist of a top plate attached to a case which is installed in a console in the airport control station (desk, counter, etc.) with the top plate flush with the surface of the control station. A typical case is shown in Appendix IV, Figure 8.
S	Surface mounted panels. Class S panels consist of a top plate and case for installation on an airport control station (desk, counter, etc.). A typical case is shown in Appendix IV, Figure 8.
W	Wall or surface mounted panels. Class W panels consist of a top plate and a commercial outlet or pull box for mounting in an electrical vault or other convenient control point at a small airport. A typical panel top plate is shown in Appendix IV, Figure 4.

1.2.3 Style. Panels of the following styles are covered by this specification:

Style	Description
1	Unlighted.
2	Backlighted.

1.2.4 Mode. Panels of the following modes are covered by this specification:

Mode	Description
1	Generic Panel. I.e. main lighting control panel. (See sample panels in Appendix IV, Figures 2 through 7).
2	Land and Hold Short Operations (LAHSO) Control Panel. (See illustration in Appendix IV, Figure 11).
3	Stop Bar Control Panel. (See illustration in Appendix IV, Figure 12).

2. REFERENCED DOCUMENTS.

2.1 General. The following is a listing of documents referenced in this AC.

2.2 FAA Advisory Circulars.

AC 150/5340-30C	<i>Design and Installation Details for Airport Visual Aids</i>
AC 150/5345-53	<i>Airport Lighting Equipment Certification Program</i>
AC 120-57A	<i>Surface Movement Guidance and Control Systems</i>

Notes: Electronic copies of FAA Advisory Circulars may be obtained from:

www.faa.gov/airports_airtraffic/airports/resources/advisory_circulars/

or all FAA documents by standard mail from:

U.S. Department of Transportation
 Subsequent Distribution Office
 Ardmore East Business Center
 3341Q 75th Avenue
 Landover, MD 20785

Phone: (301) 322-4961

FAX: (301) 386-5394

2.3 Federal Standards.

FED-STD-595	<i>Colors</i>
-------------	---------------

Notes: Electronic copies of Federal standards and specifications may be obtained from:

www.gsa.gov/fss

2.4 Military Standards.

MIL-STD-810F *Environmental Engineering Considerations and Laboratory Tests*

Notes: Copies of Military Standards may be obtained from:

dodssp.daps.dla.mil/

or compact discs (CDs) on website order form by standard mail from:

DAPS / DODSSP
 Building 4/Section D
 700 Robbins Ave.
 Philadelphia, PA 19111-5094

3. GENERAL EQUIPMENT REQUIREMENTS.

3.1 General Requirements. The panels specified herein are intended for use in controlling various lighting and auxiliary systems as described in the documents listed in paragraph 2.2.

3.2 Location. The panels are generally installed in airport traffic control towers (ATCT). Airports without ATCTs should install panels at a convenient control location such as a hangar, office, or electrical vault.

3.3 Panel Configurations. Each control panel layout must clearly identify the “ON” and “OFF” position of each switch or push button, the system each switch or push buttons controls, and, where appropriate, the intensity of the lighting system. Panel layouts are airport specific and must be configured to accommodate unique user requirements at a particular airport. Panel lighting, including panel backlighting and illuminated switches, must be illuminated such that they are visible when direct sunlight falls on the panel. Some examples of typical panel layouts using different switches and arrangements are shown in Appendix IV of this specification. The figures are provided to show examples; physical conformance to the figures may not ensure that the panels comply with all applicable portions of this specification.

3.2.1 Type I, Conventional Panels. Switching of airport lighting and auxiliary systems may be accomplished in several ways. Figures are provided in Appendix IV of this AC to show some typical control panels. Other panel configurations will comply with this specification. The following table includes a description of the sample control panels illustrated in this AC:

Figure	Description
2 and 6A	Panel layouts with toggle switches for system controls with the exception of some intensity setting controls. Some of the system intensity settings are controlled with the five-position rotary switches.
3 and 4	Panel layouts with rotary switches for runway and/or taxiway lighting systems controls, including intensity settings, and toggle switches for other system controls.
5	Panel layout with all push button switches for system controls.

3.2.2 Type II, Facsimile Panels. Type II panels will primarily be Class F (flush mounted) panels. The layout of airport operating surface being controlled must be engraved, painted, or overlaid by decal on the panel. Such surfaces include, but are not limited to, runways and taxiways. Other methods of labeling panel plates may be acceptable but must be approved by the FAA or the third party certification bodies listed in AC 150/5345-53 providing certification of the particular panel. (Approval method is described in Appendix III). Type II, Style 2, panel plates must have appropriate facsimile sections of the airport surface back-lighted as the switch that controls a particular system is activated (turned “ON”). When the system is de-activated (turned “OFF”) the backlighting must not be illuminated. Individual lighting sections controlled by various switches must be color coded. Appendix IV, Figures 6A and 7 illustrate examples of the Type II, Style 2 panels. The shaded taxiways would appear in various colors and illuminate when the associated lighting circuit is activated.

3.3 Panel Components.

3.3.1 Panel Plate. Class F and S panel plates must be made of 0.094-inch (2.5 mm) steel or of other material of thickness or design that will provide like stiffness. The plate is to be attached to the case with a continuous hinge along its top edge. A latch must be mounted inside the case to provide support when the panel plate is open and at a near vertical position. No part of the plate or its attachments should project behind the plane of the back of the case during opening or closing. The panel plate for Class W panels may be a commercially available utility or outlet box cover that is usually attached to the case or box with screws. Therefore, for Class W, panels a latch and/or hinge is not required.

3.3.2 Case or Box. Class F and S panels must have a suitable case made of not less than 0.078-inch (2 mm) (nominal) sheet steel or aluminum of equal rigidity (see Figure 8 for examples). Commercially available outlets or pull boxes may be provided in lieu of a manufactured case for Class W panel plates. A grounding lug, capable of handling no. 12 AWG or larger conductor, must be supplied in each case or box.

3.3.3 Switches. Switches are used to turn “ON” and “OFF” airport lighting regulators, beacons, obstruction lights, lighted wind indicators, apron lights, emergency power generators, and various lighting systems. Additionally, switches are used to control the intensity of intensity controlled lighting systems. The switches may be wired, programmed, or ganged for simultaneous operation of several lighting system circuits. Switches must have a contact rating of 125% of the load current and must be rated to meet the circuit voltage requirements. The life expectancy of the switches, at rated load, must be at least 25,000 operations. Switches must have screw, solder, or push-on type terminals. Typical switches are shown on panel layouts in Figures 2 through 7 and Figures 11 and 12.

3.3.3.1 Toggle Switches. Toggle switches must have either two or three positions and, for most applications, be detented to provide positive-feel switching. Switches must be mounted to operate left to right and wired such that when the switch is in the far left position the lighting system is either “OFF” or “ON” with the intensity set to the lowest available intensity. Switches must be mounted on the panel plate with a hexagonal nut above and below the panel plate using an internal-tooth lock-washer and a locking ring or keyed punched panel to assure permanent mounting.

3.3.3.2 Rotary Switches. Rotary switches, used for the control of lighting systems, must have three to six distinct positions with the appropriate number of poles to control the lighting system intensity. If required by the user, the rotary switch must provide a pole to turn the systems “OFF.” The switches must have a minimum angular throw of 30 degrees between detents and be equipped with a stop to prevent rotation past the last position. The switches must rotate between detents in either direction without stopping.

3.3.3.3 Push Button Switches. Momentary or alternate action push button switches may be used to control any or all functions of airport lighting and auxiliary systems. The use of push button switches for intensity control will require auxiliary relays or non-radio interference solid state circuitry. Switches must be wired so that when initially energized, the intensity setting of an intensity controlled lighting system is the lowest available intensity. When an intensity controlled lighting system is de-energizing, the intensity setting must automatically return to the lowest intensity available. Illuminated push buttons should be softly backlit in an “OFF” position, and glow noticeably brighter in the “ON” position. A sample panel illustrating push button controls is shown in Appendix IV, Figure 5.

3.3.4 Backlighting. Backlighting of facsimile panels, switches, or switch designations must be made with light sources with a life expectancy of at least 10,000 hours. A control to reduce the brightness of the panel backlighting up to 90 percent must be provided. This brightness control must not cause radio interference. A control must be provided on each panel to test the panel lamps and illuminated switches.

3.3.5 Emergency Generator Control. Airport main lighting control panels must include an emergency generator control switch that will transfer the power load from the main power supply to the emergency generator and a red pilot light that illuminates when the power load has been switched to the emergency generator.

3.3.6 Wire and Wiring. The wire must have stranded copper conductors with adequate current capacity and a minimum rated insulation of 90° C. The wire size and insulation voltage rating must be suitable for the design voltage and load. For identification purposes, all wires must be either color coded or identified with wire markers. Wire markers must be fixed such that they can not be accidentally removed and that they remain legible under normal conditions. All leads must be properly strained and long enough to allow the plate to be raised to the extent permitted by the latch. All panels must be wired with terminal connections in accordance with the applicable combination of components. Figure 9 shows the wiring diagram of the sample panel shown in Figure 2.

3.3.7 Terminal Blocks. Terminal blocks must be pressure type terminal blocks and have a minimum rating equal to or greater than the rating of the wire. Each individual terminal must be identified with permanent marks in accordance with the wiring diagram furnished with the unit. Terminal blocks may be omitted in Class W panels.

3.3.8 Marking. Switch designations must be marked in characters not less than 3/16 inch (0.5 cm) and not over 5/16 inch (0.8 cm) high, formed by engraving, etching, or stamping. Unlighted characters must

be permanently marked. Markings must be a contrasting color from the marked surface, i.e. white surface with black marking, or black surface with white marking. Markings must be placed either on the panel or on a small separate plate securely fastened to the panel. When push button switches are used, the marking may be on the switch itself but must be visible when the push button is in the “ON” or “OFF” position.

3.3.9 Painting. For Type F and S panels, the color and gloss of the case and panel plate must conform to Federal Standard 595, brown No. 30372. Apply a hard, paint finish having a smooth texture, i.e. powder coating, baked epoxy, etc. The finished surface of the panel must be suitable for indoor use and provide protection against circulating dust, falling dirt, and dripping non-corrosive liquids. An acceptable finish surface must be free of runs, sags, etc. For Class W panels, the commercially applied finish to the utility box and cover will be acceptable.

3.3.10 Wiring Diagram. The manufacturer must supply three copies of a wiring diagram with each panel. The wiring diagram must show the color code or number identification of each wire and the proper connections.

3.3.11 Parts List and Installation Instructions. A component parts list and installation instructions must be furnished with each control panel along with sufficient drawings or illustrations to indicate clearly the method of installation.

3.3.12 Nameplate. A nameplate showing the following information must be attached to each panel:

- a. Airport Lighting Control Panel.
- b. Identification: FAA L-821.
- c. Type ____, Class ____, Style ____, Mode ____.
- d. Manufacturer's Part no. ____.
- e. Manufacturer's name or trademark.
- f. Date manufactured ____.

4. MODE 2, LAND AND HOLD SHORT OPERATIONS (LAHSO) CONTROL PANELS.

4.1 LAHSO Lighting Systems. Land and hold short lighting systems are lights used to provide visual reference to pilots during LAHSO. The details of the lighting system are in AC 150/5340-30. Control panels for the control of LAHSO lighting systems must comply with the applicable requirements in paragraph 4.1 through 4.4 in addition to the other details in this AC which are not related to a specific panel.

4.2 General Requirements. The control panel must be located in the ATCT. The panel must contain an "ON/OFF" push button and a red fault indicator lamp for each LAHSO lighting system controlled at the panel. The LAHSO controls may be located on the airport's main lighting control panel. The fault light must illuminate if any one of the faults defined in AC 150/5340-30 occurs. If the LAHSO panel is a dedicated panel separate from the main lighting control panel, panel backlighting must comply with paragraph 3.3.4 of this AC and lighting system intensity controls must not be provided on the LAHSO panel.

4.3 Multiple LAHSO Systems on Separate Runways. A control panel used to control multiple LAHSO lighting systems installed on separate runways must provide one push button on the control panel for each system. A typical panel layout for this configuration is shown in Appendix IV, Figure 11A.

4.4 Multiple LAHSO Systems on the Same Runway. A control panel used to control multiple LAHSO lighting systems installed on the same runway must provide one push button for each system and a master switch. The master switch must be a separate "ON/OFF" push button which turns the LAHSO control panel "ON" and "OFF". When the master switch is "ON", push buttons controlling the systems must be energized, and when the master switch is "OFF", push buttons controlling the systems must be de-energized. The push buttons used to activate the LAHSO lighting systems must be interlocked allowing only one LAHSO lighting systems to be operating at any given time. The interlock design must not allow simultaneous operations of controlled LAHSO lighting systems controlled from the same panel. Thus, when a push button for a LAHSO lighting system on a control panel is pressed and locked in the "ON" position the associated system is activated, all other LAHSO lighting system controlled from the same panel must become inactive. However, the interlock must not de-activate a lighting system when another system push button has been partially depressed and released prior to locking in the "ON" position. A typical panel layout for this configuration is shown in Appendix IV, Figure 11B.

5. MODE 3, STOP BAR CONTROL PANELS. Control panels for the control of stop bar lighting systems must comply with the applicable requirements in 5.1 through 5.3.4.3 in addition to the other details in this AC which are not related to a specific panel.

5.1 General Requirements. The control panel must be located in the ATCT. The stop bar control panel must be a dedicated panel separate from the main airport lighting control panel. The panel must include an “ON/OFF” switch for each stop bar to be controlled from the panel. Each switch on the panel must be clearly labeled to indicate the function of the switch. The panel must be activated and de-activated with a master control switch specified in 5.1.1.

5.1.1 Master Controls. A master control switch must be located on the main lighting control panel to transition the applicable taxiway centerline lights, taxiway edge lights, runway guard lights, clearance bars, and stop bars to the appropriate SMCGS settings for low visibility operations. (See Surface Movement Guidance and Control System (SMCGS) operations in Appendix II for more information on low visibility operations). The master control switch must also activate the associated stop bar control panels. If the airport is approved for low visibility operations that do not require stop bars, it is recommended that the master switch be installed. The master switch must various transition the applicable taxiway centerline lights, taxiway edge lights, runway guard lights, clearance bars, and stop bars to the appropriate SMCGS settings when switched. For example, the switch settings may be “No SMCGS”, “Below 1200 RVR”, and/or “Below 600 RVR”. When the switch is in the “No SMCGS” position, the applicable taxiway centerline lights, taxiway edge lights, runway guard lights, clearance bars, and stop bars must conform to the setting on the main lighting control panel, and all associated stop bars and stop bar control panels must be de-energized. The appropriate SMCGS setting for the applicable lighting systems should be outlined in the airport’s SMCGS plan.

5.1.2 Stop Bar Controls. The stop bar control panel must have a separate stop bar control switch to activate or de-activate each controlled stop bar on the airfield. A single stop bar control switch must be for each runway on the panel to temporarily de-activate the uncontrolled stop bars on the applicable runway. The stop bar control switches must be push buttons that comply with paragraph 5.3.1 of this AC.

5.2 Stop Bar Panel Configuration.

5.2.1 Dimensions. The minimum dimensions for the panel must be 4 inches x 12 inches (100 mm x 300 mm) and the maximum dimensions must be 12 inches x 16 inches (300 mm x 400 mm).

5.2.2 Location. The exact location of control panels are site specific with respect to operations, space, etc. The local air traffic facility should be consulted about the appropriate location for the control panel.

5.2.3 Display. The stop bar control panel must include a diagram of the airport where the stop bars are located. The diagram must be limited to relevant portions of the airport surface movement area; runways and associated taxiways must be included. Where appropriate, designated taxi routes for low visibility operations should be included on the diagram. The diagram should allow for inclusion of additional stop bar controls and displays, if possible. Each stop bar position should be represented on the panel by three lights (per paragraph 5.3.2) which will indicate the “ON/OFF” status of the actual stop bar. A time delay may exist between actual status of airfield lights and panel lights in accordance with control methods described in AC 150/5340-30. The panel must also include an alert control in the upper right hand corner. The alert control must be a single push button, backlit red. Where applicable, lead-on lights will be represented by one green panel light located on the diagram for each segment of lead-on lights in a position relative to their position on the airfield. A typical panel is shown in Appendix IV, Figure 11 and the panel push button functions are described in Appendix I, Table 1.

5.3 Stop Bar Control Panel Design.

5.3.1 Push Buttons. Push buttons must be used to control stop bar lighting systems and must be located on the stop bar control panel. The push buttons should be softly backlit in an “OFF” position and glow

noticeably brighter in the “ON” position. All push buttons, with the exception of “ALERT”, “SENSOR OVERRIDE”, “UC STOPBARS”, and “LAMP TEST”, must be alternate action push buttons with tactile feedback. The “ALERT”, “SENSOR OVERRIDE”, “UC STOPBARS”, and “LAMP TEST” push buttons must be momentary action push buttons with tactile feedback. The push button controls and the panel layout should be designed to minimize the possibility of inadvertent activation; protective raised edges on at least two opposite sides, such that the push button will not be activated if a flat object weighing 2 pounds is dropped on it from a height of 3 inches. The ranges below are general guidelines for such controls; however, actual values to be used in a particular control tower are to be determined by the system designer/engineer. Air Traffic Control (ATC) personnel at the airport must be consulted prior to final design and installation to verify that the control panel will meet the ATC requirements identified at that particular airport. The ranges are as follows:

Push Button Dimensions:	Minimum 3/8 inch (9.5 mm) - Maximum 1 inch (25 mm).
Lamp to Button Separation:	Minimum 1/2 inch (13 mm) - Maximum 2 inches (50 mm).
Button to Button Separation:	Minimum 1/2 inch (13 mm)
Resistance:	Minimum 10 oz. (2.8 N) - Maximum 40 oz. (11 N).
Displacement Height:	Minimum 5/64 inch (2 mm) - Maximum 1/4 inch (16 mm).

5.3.2 Panel Illumination. All panel lights must be light emitting diodes (LED) or lamps with a minimum lamp life of 5,000 hours. The intensity must provide a noticeable difference between “ON” and “OFF” under typical ATCT lighting conditions and when viewed between 0 degrees and 45 degrees from vertical. When the panel is activated, diagrams, indicator lamps, and push buttons must be backlit. Backlighting must not be more than 30% of the panel full lighting intensity. A panel lighting intensity switch must be provided to vary the panel intensity between 50% and 100% intensity.

5.3.3 Labeling. The panel labels must be in a simple, unadorned font and must be located in consistent locations relative to each control/display. The relationship between the label and its associated control/display should be clear by virtue of their relative locations. All movement areas represented on the panel must be labeled according to the airport nomenclature on the airport layout charts and signs. If necessary, to clarify the relationship between controls and displays, a line can be drawn around each associated pair of controls and stop bar indicators in a contrasting, neutral color. The stop bar alert control will be clearly labeled. The minimum character height is to be 0.18 inch (.7 mm). All characters should be capital letters and clearly viewed from 19.7 inches (.5 m) - 39.4 inches (1 m).

5.3.4 Panel Functions. Control push buttons on the stop bar control panel must comply with the applicable functional descriptions in this section and Table 1, Stop Bar Panel Push Button Descriptions, in Appendix I.

5.3.4.1 Controlled Stop Bars. Panel functions of the panel buttons and status indicator lights are described in Appendix I, Table 1. AC 150/5340-30 contains more information on the normal operations of stop bars and the performance of the stop bar sensors.

5.3.4.2 Uncontrolled Stop Bars. When the panel is initially energized, the uncontrolled stop bars must be energized. The uncontrolled stop bars must be de-energized when the “UC STOP BARS” push button is pushed and must become re-energized automatically in 30 seconds. If the push button is pushed again before the 30 second delay has expired, the uncontrolled stop bars must become re-energized. The uncontrolled stop bars must be electronically monitored if the status of uncontrolled stop bars is indicated with panel lights on the control panel (as shown in Figure 11).

5.3.4.3 Alert. Each stop bar control panel must have an alert function, which indicates system malfunctions as described in the section of AC 120-57 that specifies the monitoring and visual inspection

of lighting aids. This function must be a red push button. To signal an alert condition is present, the alert push button must be lighted and blinking, the appropriate red (stop bar) or green (lead-on) panel lights must be blinking, and an audible tone must sound. If the monitoring system is unable to detect and/or indicate which particular stop bar is malfunctioning, the alert push button must be lighted and blinking, and an audible tone must sound. A depression of this push button will indicate acknowledgement of the alert, and the push button will stop blinking and remain lighted and the tone must cease. When the problem is corrected, the alert push button along with the stop bar and lead-on panel lights must return to normal status.

6. EQUIPMENT QUALIFICATION REQUIREMENTS.

6.1 Qualification Procedures. Procedures for qualifying equipment to be furnished under the Federal grant assistance program for airports are contained in AC 150/5345-53.

6.2 Qualification Tests. The following tests must be conducted on each panel to be qualified.

6.2.1 Examination. In this examination, use a check list to certify that the material used, dimensions, component parts, calibration, quantities, etc., are in accordance with the requirements of this specification as it applies.

6.2.2 Operation. Connect the panel to a test board consisting of pilot lights to check each component and switch for proper operation. Panels must demonstrate compliance to all applicable operational requirements.

6.2.3 Dielectric. Subject all terminals on the terminal block to a potential of at least 500 volts rms, 60 Hz, applied between the terminal and the grounded case for a period of one minute. Any breakdown of the insulation will be cause for rejection.

6.2.4 Humidity. Subject all panels to a humidity test in accordance with MIL-STD-810E, Method 507.3, Procedure I. The equipment must be subjected to three cycles (72 hours) according to Table 507.3-I, except the maximum temperature at cycle 1 must be +130°F ($\pm 5^\circ$) (+55°C). Failure of the equipment to operate as specified or any deterioration in material must be cause for failure.

7. PRODUCTION TEST REQUIREMENTS.

7.1 Production Tests. The following tests must be conducted on each production panel.

7.1.1 Examination. In this examination, use a check list to certify that the material used, dimensions, component parts, calibration, quantities, etc., are in accordance with the detail requirements of this specification, as it applies, and the purchase order.

7.1.2 Operation. Connect the panel to a test board consisting of pilot lights to check each component and switch for proper operation. Panels must demonstrate compliance with all applicable operational requirements.

7.1.3 Dielectric. Subject all terminals on the terminal block to a potential of at least 500 volts rms, 60 Hz, applied for a period of one minute between the terminal and the grounded case. No breakdown of the insulation will be acceptable.

This page intentionally blank.

APPENDIX 1. TABLE.

Table 1. Stop Bar Panel Push Button Descriptions.

The following table describes the functions and characteristics of the controls shown on the typical stop bar control panel shown in Figure 12. The table also describes the system and panel status operations associated with the system sensors. The sensors are described in detail in AC 150/5345-28.

Activation or DE-ACTIVATION ¹	Appearance	Function	Airfield Lighting and Panel Light Status ^{2,3}
ALERT⁴ (Red)			
Automatic	Blinking	Indicates the system is malfunctioning. Malfunctions are defined in AC 120-57.	<i>Related Stop Bar – Blinking Related Lead On – Blinking</i>
MANUAL	Illuminated	Indicates acknowledgment of the malfunction.	<i>Related Stop Bar – Blinking Related Lead On – Blinking</i>
AUTOMATIC	Un-Illuminated	Indicates the system malfunctions have been corrected.	<i>Related Stop Bar – Blinking Related Lead On – Blinking</i>
GO (Green)			
Manual	Back-lighted	Turns “OFF” associated Stop Bar	<i>Stop Bar - “OFF” Lead On (segment 1) - “ON” Lead On (segment 2) - “ON”</i>
AUTOMATIC (sensor) Or MANUAL	Illuminated	Turns “ON” associated Stop Bar	<i>Stop Bar - “ON” Lead On (segment 1) - “OFF” Lead On (segment 2) - “ON” Lead On (segment 2) - “OFF” when aircraft clears sensor #2 Stop Bar - “ON” Lead On (segment 1) - “OFF” Lead On (segment 2) - “OFF”</i>
LAMP TEST³ (White)			
Manual	Illuminated	Illuminates all push buttons and indicator lights on the panel to full intensity.	Airfield Lighting - unchanged Panel lights - full intensity

¹ First letter CAPITAL indicates Activation and ALL CAPITAL LETTERS indicate De-activation.

² Italics indicate a change in lighting status.

³ A time delay may exist between airfield lighting changes and panel indicator changes, per AC 150/5340-30.

⁴ Momentary action push buttons.

Table 1. Stop Bar Panel Push Button Descriptions (continued).

Activation or DE-ACTIVATION¹	Appearance	Function	Airfield Lighting and Panel Light Status^{2,3}
SENSOR OVERRIDE ³ (White)			
Manual	Illuminated	Overrides sensor commands when pressed along with the GO push button.	<i>Stop Bar - "OFF"</i> <i>Lead On (segment 1) - "ON"</i> <i>Lead On (segment 2) - "ON"</i>
MANUAL Or AUTOMATIC (timed)	Back-lighted	Resets the associated Stop Bar.	<i>Stop Bar - "ON"</i> <i>Lead On (segment 1) - "OFF"</i> <i>Lead On (segment 2) - "OFF"</i>
UC STOPBARS (Yellow)			
Manual	Illuminated	All associated uncontrolled stop bars turned "OFF".	<u>Controlled Stop Bars</u> Stop Bars – unchanged Lead On (all) – unchanged <u>Uncontrolled Stop Bars</u> Stop Bar - "OFF" Lead On (segment 1) - "ON" Lead On (segment 2) - "ON"
AUTOMATIC (timed) or MANUAL	Back-lighted	All associated uncontrolled stop bars turned "ON".	<u>Uncontrolled Stop Bars</u> Stop Bars - "ON" <u>Uncontrolled Stop Bars</u> Stop Bar - "ON" Lead On (all) – unchanged Sensor #1
Sensor #1			
Aircraft Crossing		Turns "OFF" segment 1 of Lead on lights.	Stop Bar - "ON" Lead On (segment 1) - "OFF" Lead On (segment 2) - "ON" Sensor #2
Sensor #2			
Aircraft Crossing		Turns "OFF" segment 2 of Lead on lights.	Stop Bar - "ON" Lead On (segment 1) - "OFF" Lead On (segment 2) - "OFF"

¹ First letter CAPITAL indicates Activation and ALL CAPITAL LETTERS indicate De-activation.

² Italics indicate a change in lighting status.

³ A time delay may exist between airfield lighting changes and panel indicator changes, per AC 150/5340-30.

⁴ Momentary action push buttons

APPENDIX 2. TERMS.

- A. Airport Grant Assistance Program. Programs that provide funding for airport planning and development projects at airports in the National Plan of Integrated Airport Systems (NPIAS).
- B. Alert Control. A single red back-lighted push button control, that when pressed indicates that the controller has acknowledged the “ALERT” and is aware that a malfunction has occurred.
- C. Alternate Action (push buttons or toggle switches). When pushed in (push buttons) or toggled (toggle switches), the circuit locks in position. An additional push or toggle locks the circuit in the alternate position.
- D. Controlled Stop Bars. Stop Bars controlled individually by controls located on the stop bar control panel.
- E. Conventional Panel. Panels with switches and characters identifying the lighting system each switch controls.
- F. Facsimile Panel. Panels that include a graphic layout of the airport surface for the lighting systems controlled from the panel.
- G. Main Lighting Control Panel. The lighting control panel usually located in the airport traffic control tower which controls the airport lighting systems that do not require a dedicated panel.
- H. Momentary Push Button. Push buttons which close the circuit and turn “ON” the system simultaneous with the manual push of the button.
- I. RVR. Runway Visual Range
- J. Stop Bar. Stop bar lights consist of elevated and in-pavement red fixtures that are installed at the runway holding position or ILS critical area holding position marking. Stop bars may be controllable by ATC and will include a system of in-pavement green taxiway centerline/lead-on lights at locations where aircraft will enter or cross a runway.
- K. Surface Movement Guidance and Control System (SMCGS). A SMCGS system consists of the provision of guidance to, and control or regulation of, all aircraft, ground vehicles and personnel on the movement area of an aerodrome. Guidance relates to facilities, information and advice necessary to enable the pilots of aircraft, or the drivers of ground vehicles to find their way on the aerodrome, and to keep the aircraft or vehicles on the surfaces or within the areas intended for their use. Control or regulation means the measures necessary to prevent collisions and to ensure that the traffic flows smooth and freely.
- L. Tactile Feedback. Providing a tangible reaction as a result of action, for example a “click” feel.
- M. Uncontrolled Stop Bars. Stop bars designated by the SMCGS plan to remain “ON” during SMCGS operation below 1200 RVR which are not individually controlled by ATC. Uncontrolled stop bars are turned “ON” and “OFF” by the SMCGS Master switch, located on the main lighting control panel, and may be temporally turned “OFF” from the stop bar control panel when a special need arises.

This page intentionally blank.

APPENDIX 3. APPROVAL OF ALTERNATIVE PANEL LABELING.

The manufacturer must submit to the Federal Aviation Administration, Airport Engineering Division, AAS-100, 800 Independence Avenue SW, Washington, DC 20591 and, if applicable, the certification body providing the initial qualification of the panel, a request for approval of the alternative panel labeling method not mentioned in this specification. Requests must include a complete description of the labeling method, typical drawings, and other detailed information. The third party certification body will then evaluate the alternative labeling, with the necessary input from the FAA, to determine if it is acceptable. All alternate methods receiving approval will be shared with each of the approved third party certification bodies.



This page intentionally blank.

APPENDIX 4. FIGURES.

ABBREVIATIONS

16 R	Runway 16 Right
34 L	Runway 34 Left
TDZ	Touch Down Zone Lights
RWY or RW	Runway
CNTR LINE	Centerline
LAHSO	Land and Hold Short Operations

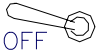
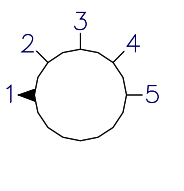
LEGEND

16L/34R EDGE LIGHTS  OFF ON	Toggle Switch		Runways
	Rotary Switch		Taxiways
TDZ	Pushbutton Switch	<div style="border: 1px solid gray; width: 15px; height: 15px;"></div> <div style="border: 1px solid gray; width: 15px; height: 15px;"></div> <div style="border: 1px solid gray; width: 15px; height: 15px;"></div> <div style="border: 1px solid gray; width: 15px; height: 15px;"></div> <div style="border: 1px solid gray; width: 15px; height: 15px;"></div>	Terminal Block
			Red Light
			Green Light

LIGHTING SYSTEM BRIGHTNESS STEPS

Two Step Brightness	Three Step Brightness	Five Step Brightness
Step 1 – 30%	Step 1 – 10%	Step 1 –
Step 2 – 100%	Step 2 – 30%	Step 2 –
	Step 3 – 100%	Step 3 –
		Step 4 –
		Step 5 –

Figure 1. Abbreviations, Legend and Brightness Steps

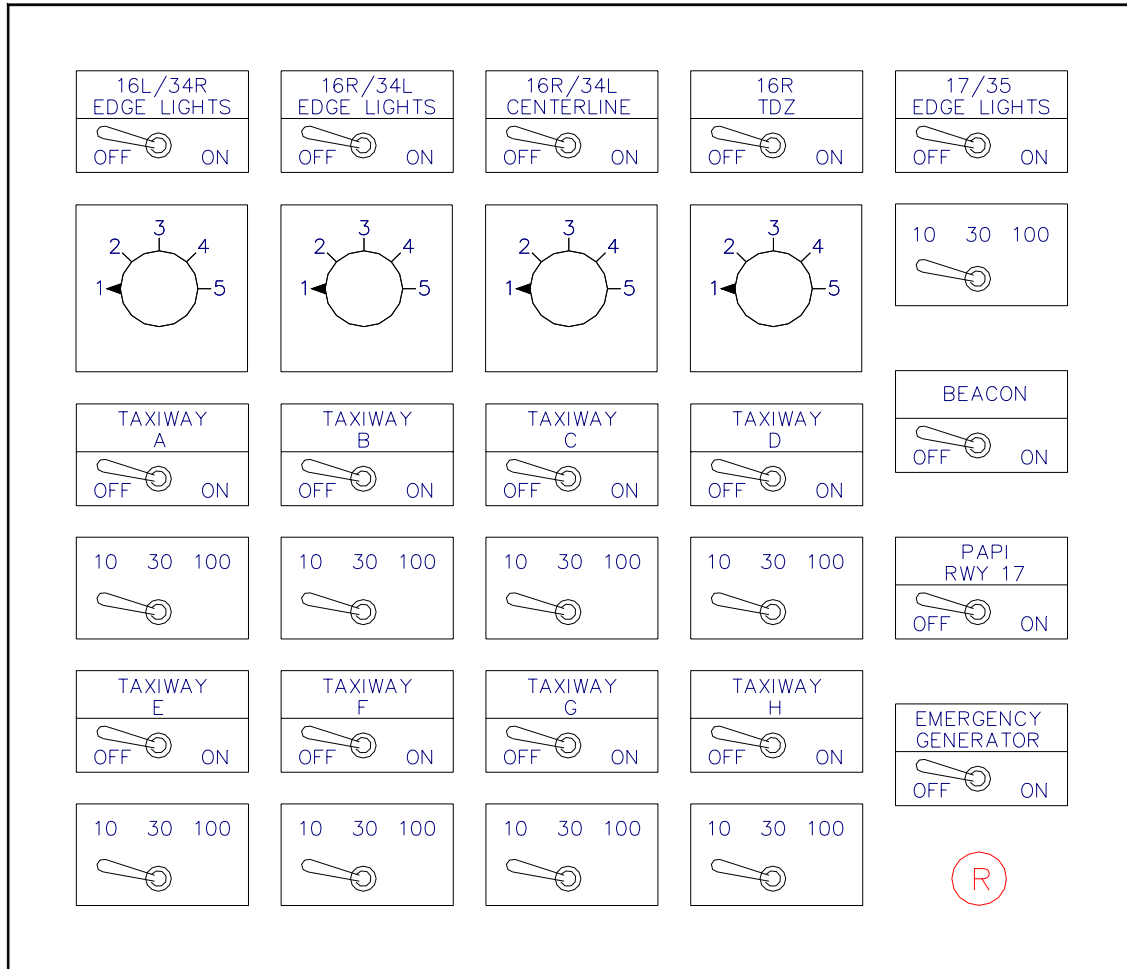

Figure 2. Typical Conventional Lighting Control Panel Layout I

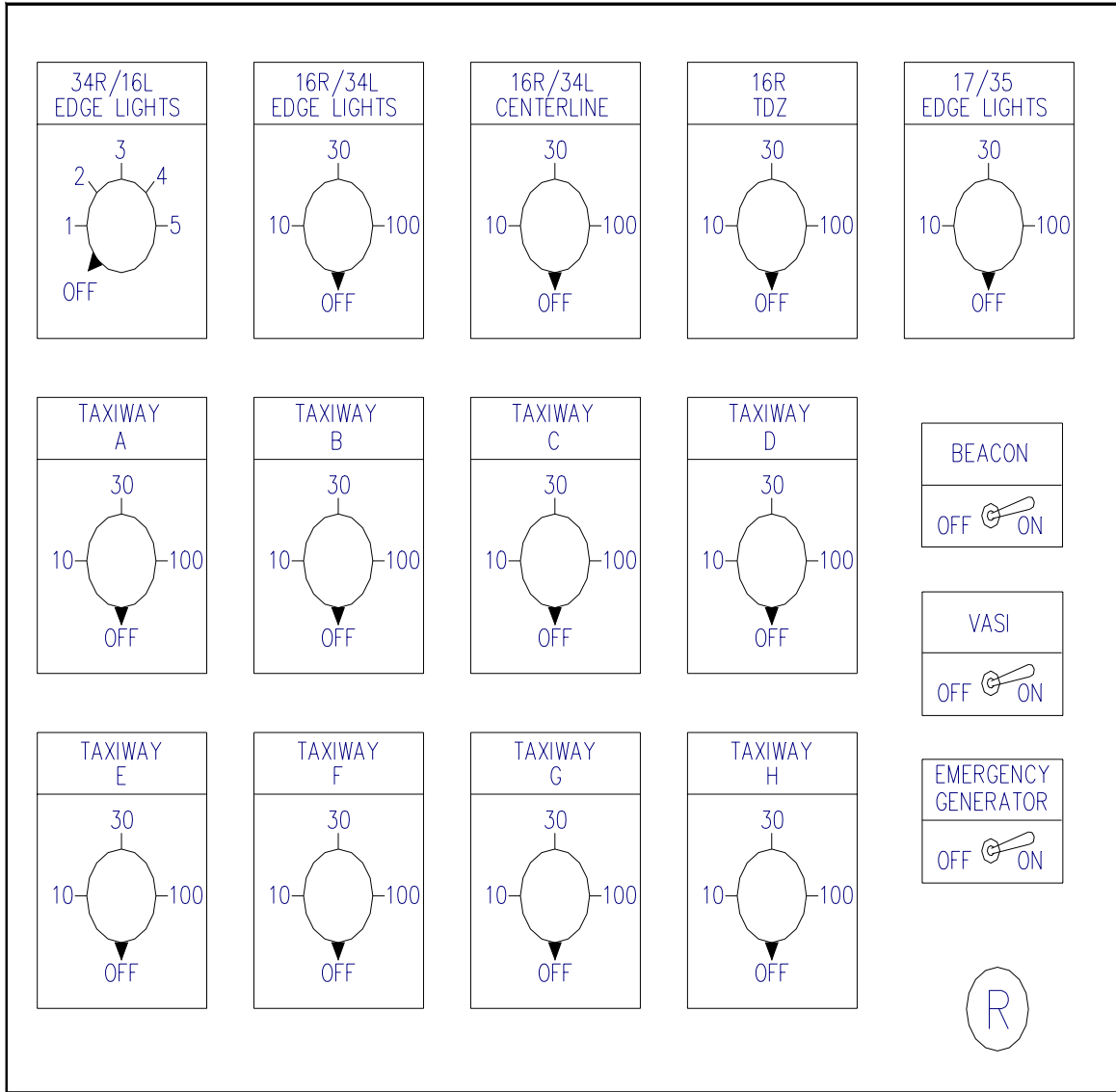

Figure 3. Typical Conventional Lighting Control Panel Layout II

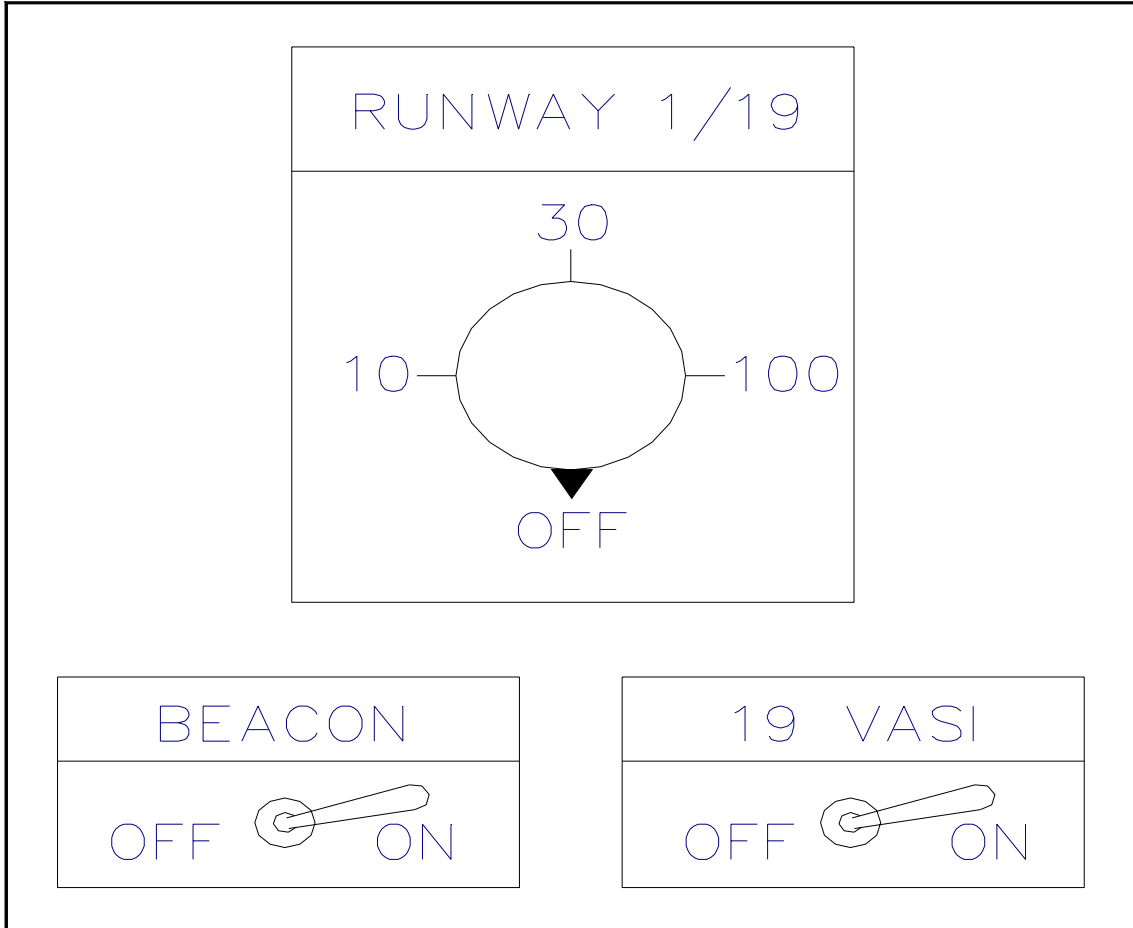

Figure 4. Sample Class W Control Panel Layout

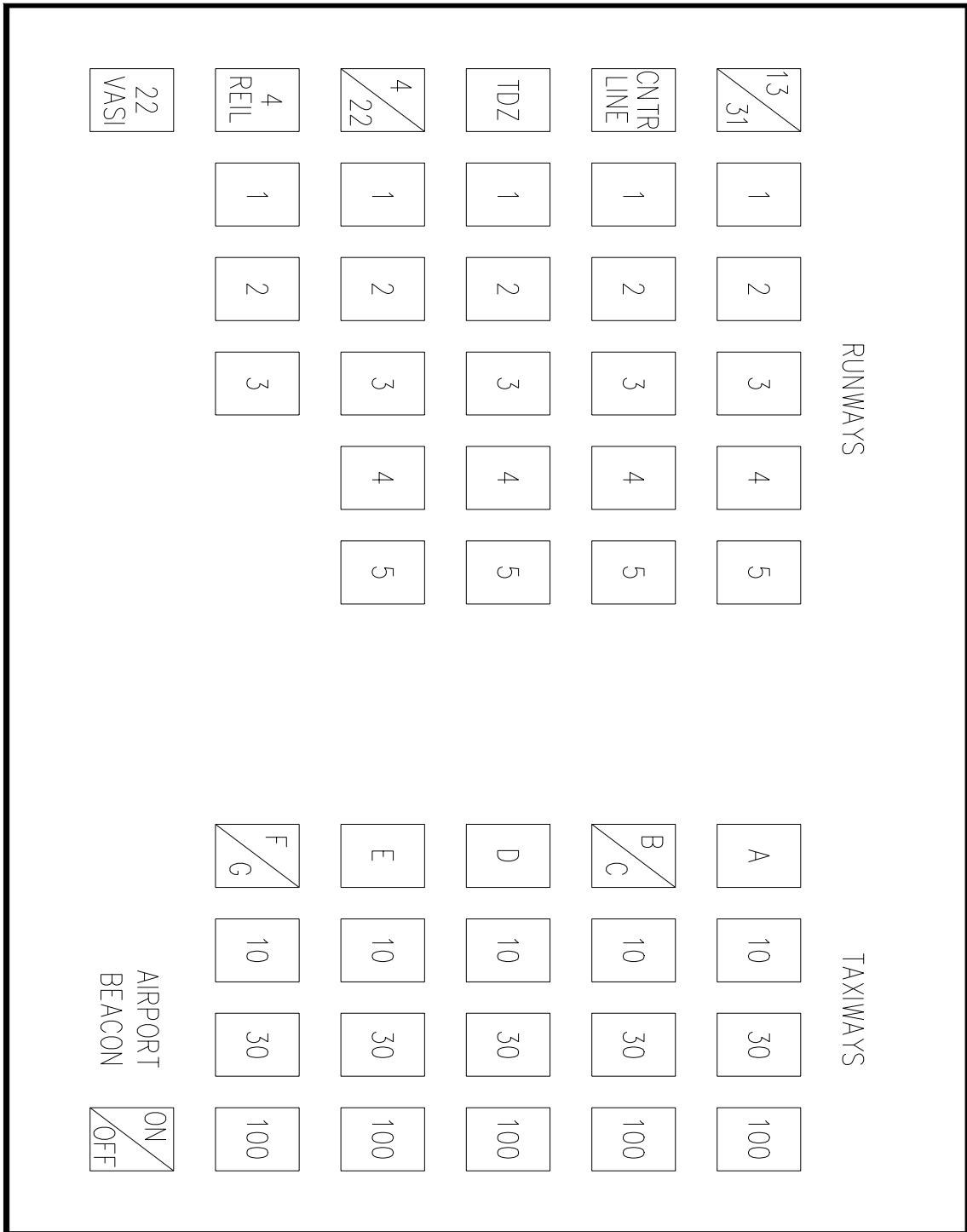
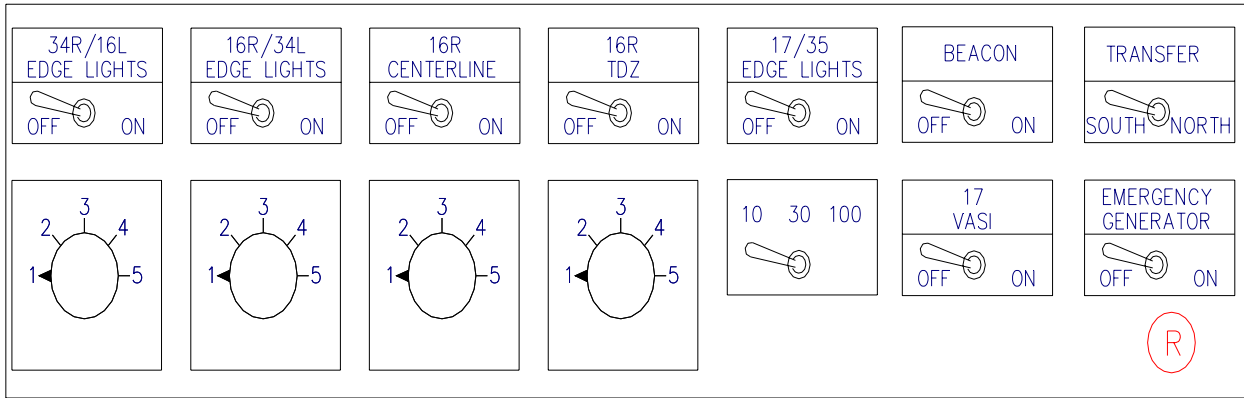
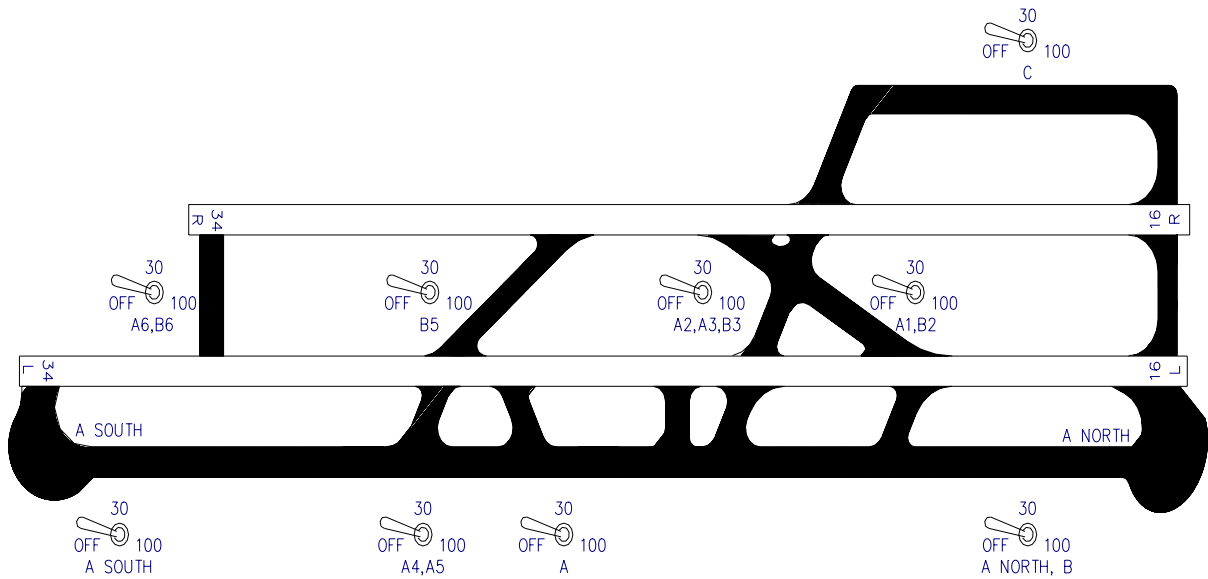

Figure 5. Sample Control Panel with Push Button Switches



A. Sample Conventional Panel – (Runway Lights)



B. Sample Facsimile Panel – (Taxiway Lights)

Figure 6. Sample Customized Lighting Control Panels

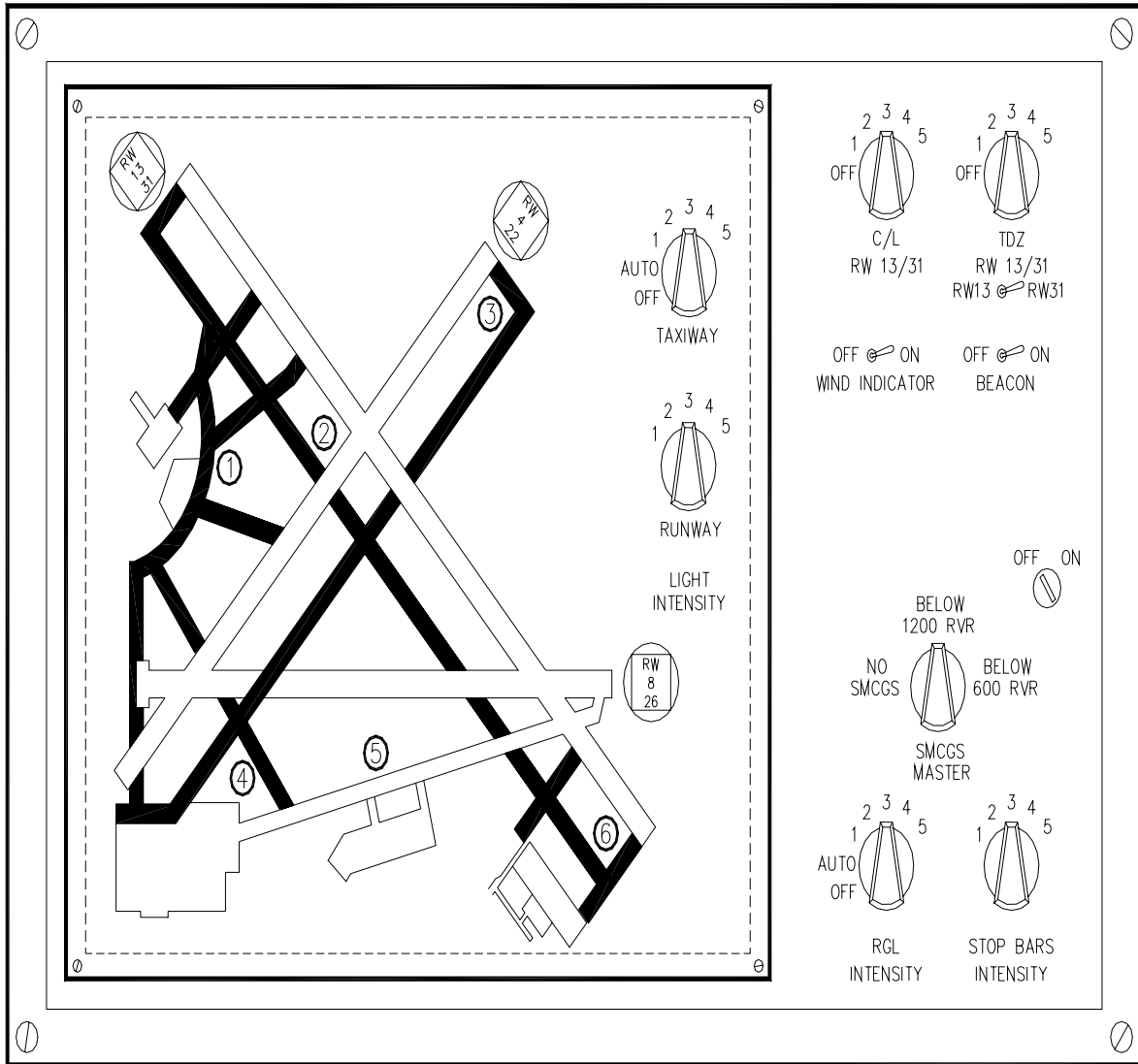
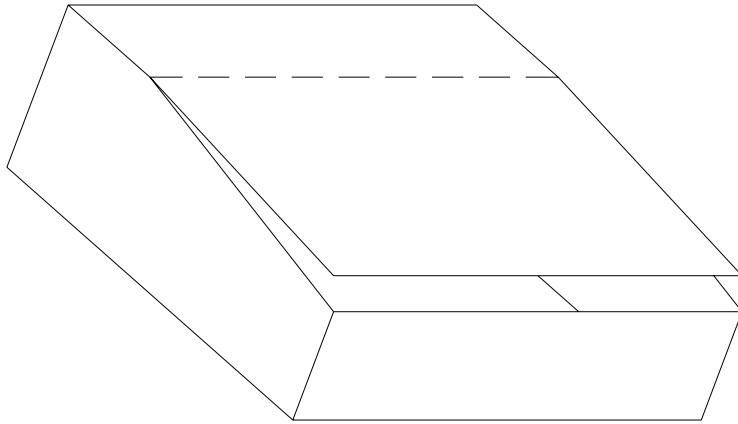
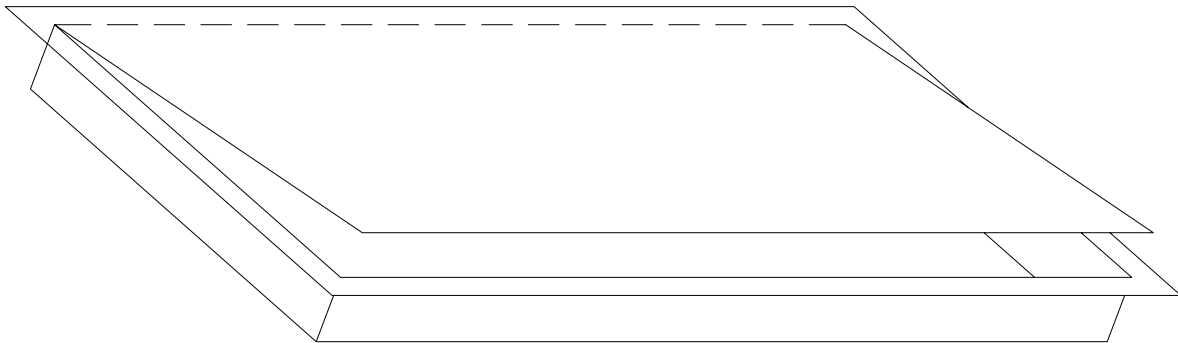

Figure 7. Sample Back-lighted Facsimile Lighting Control Panel



Type "S" – Surface Mounted Case



Type "F" – Flush Mounted Case

Figure 8. Typical Case Layouts

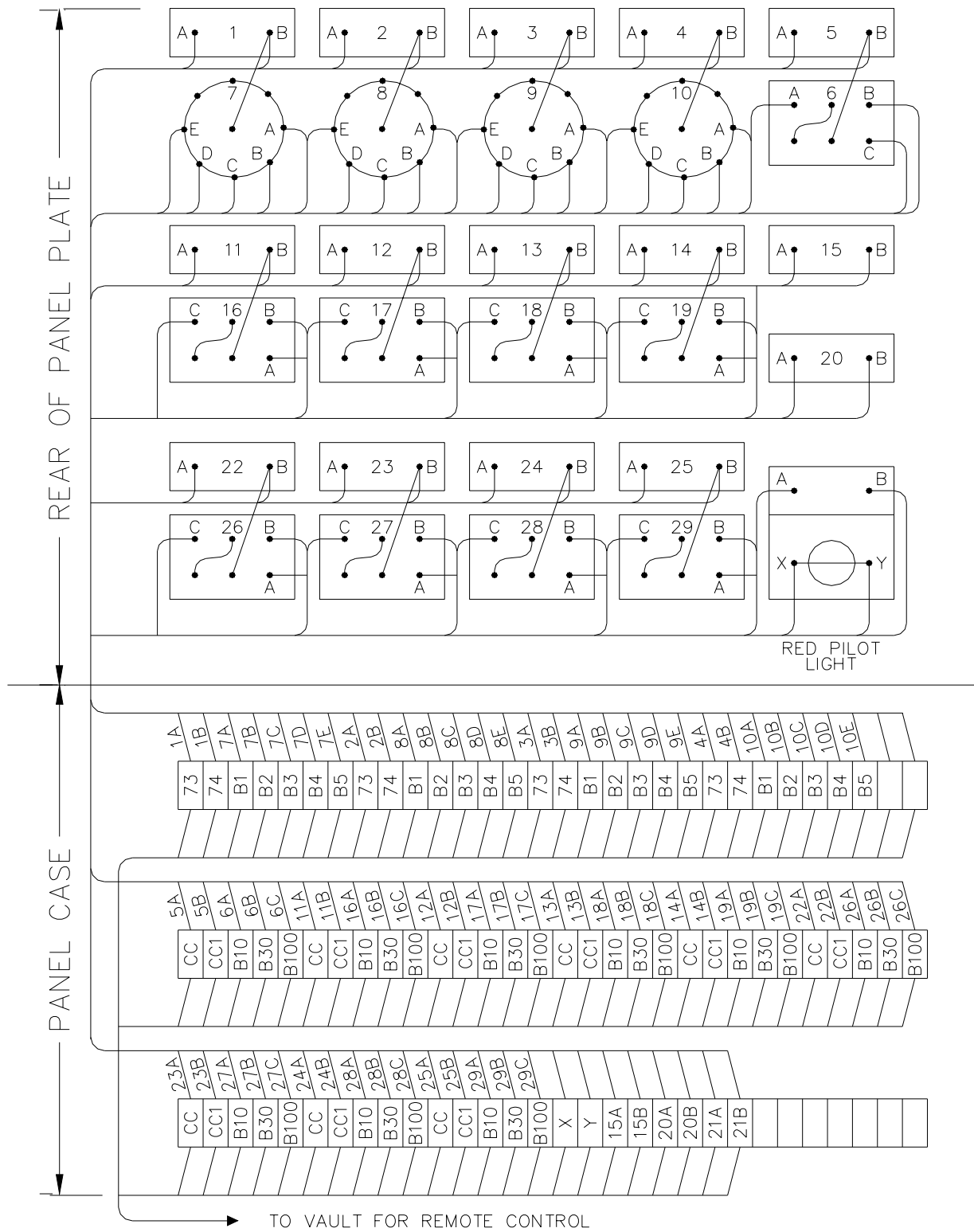
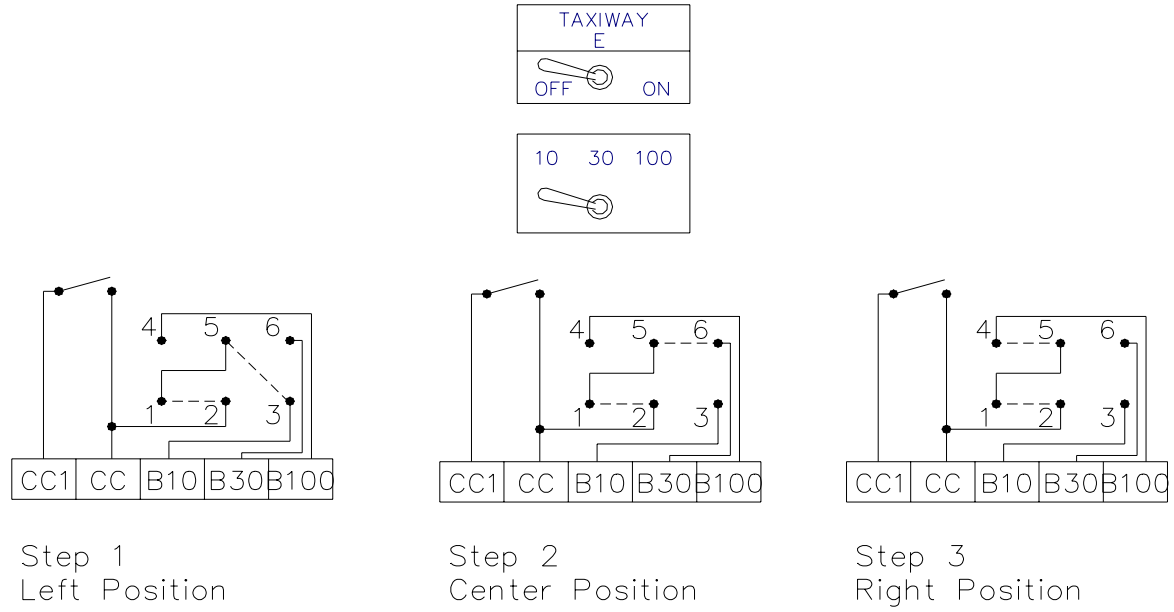

Figure 9. Typical Wiring Diagram for Conventional Lighting Control Panels

A. Toggle Switch – Three Step Brightness



B. Toggle Switch – Two Step Brightness

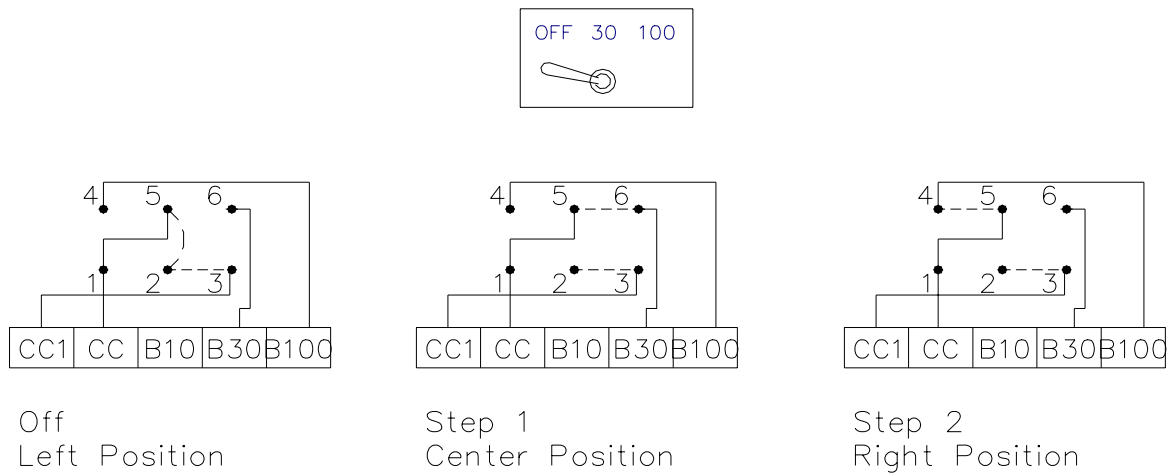
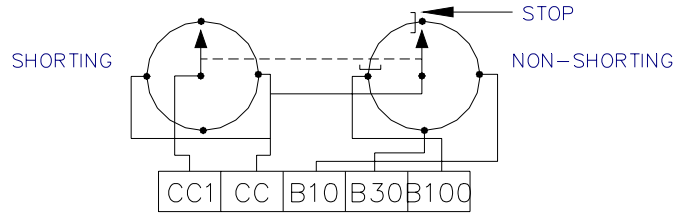
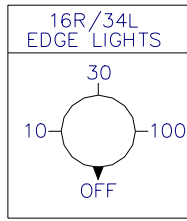
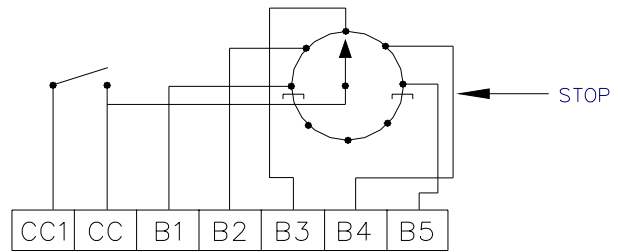
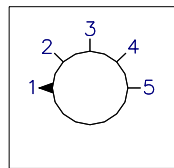
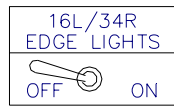

Figure 10A. Typical Switch Connections for Lighting Control Panels

C. Rotary Switch – Three Step Brightness



D. Toggle/Rotary Combination Five Step Brightness



E. Rotary Switch – Five Step Brightness

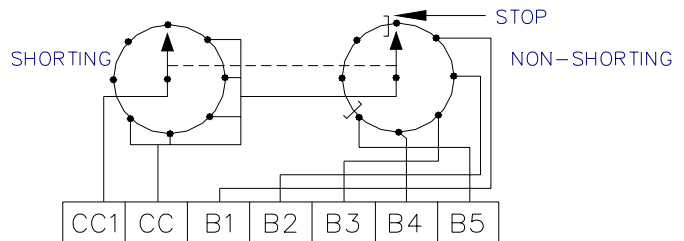
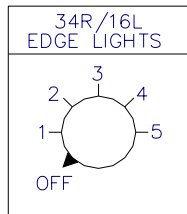

F. Standby Power Control & Indicator

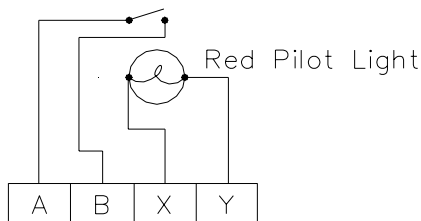
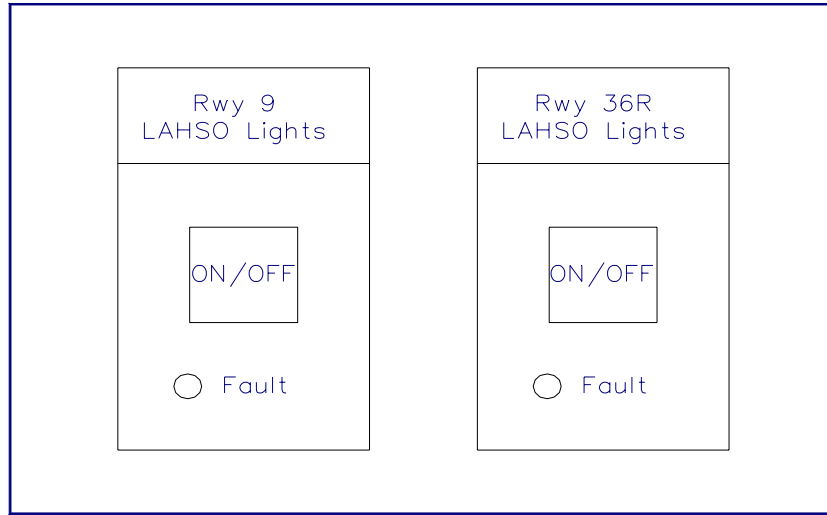
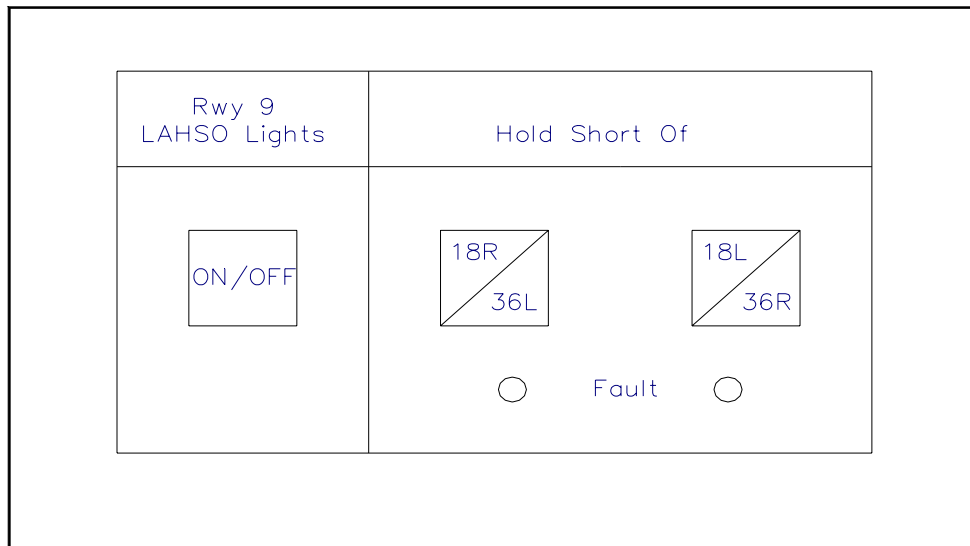

Figure 10B. Typical Switch Connections for Lighting Control Panels (cont.)



A. Control Panel with one set of LAHSO lights per runway



B. Control Panel with multiple sets of LAHSO lights on the same runway

Figure 11. Typical Land and Hold Short Lighting Control Panel

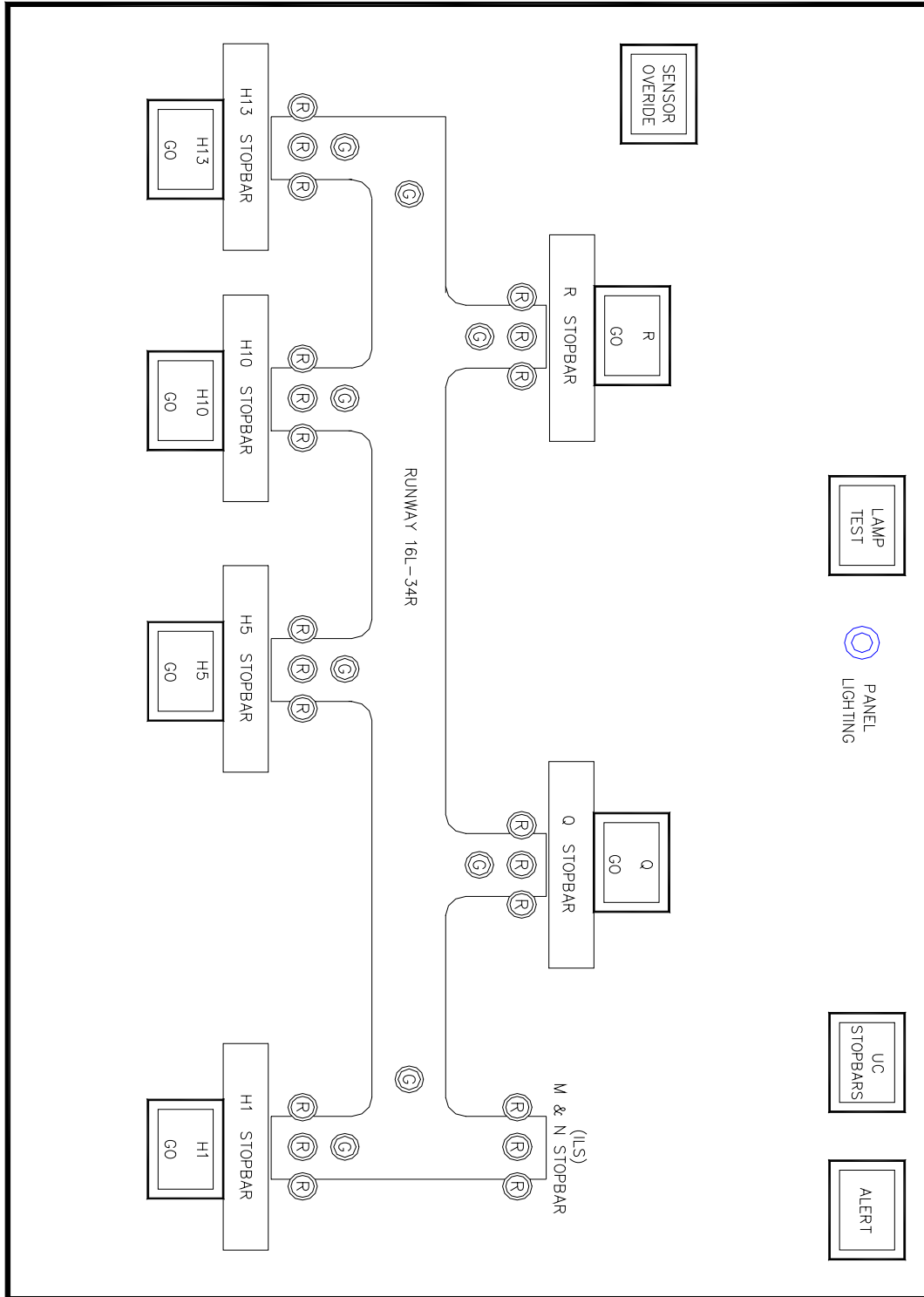

Figure 12. Typical Stop Bar Control Panel