

National Health
and Nutrition
Examination Survey

VISION
PROCEDURES
MANUAL

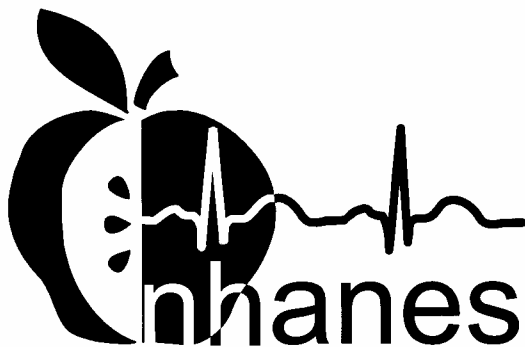

(Revised January 2004)

TABLE OF CONTENTS

<u>Chapter</u>		<u>Page</u>
1	INTRODUCTION	1-1
	1.1 Overview of Vision Exam Component.....	1-1
	1.2 General Overview of Procedures	1-1
2	EQUIPMENT	2-1
	2.1 Description of Exam Room in the MEC.....	2-1
	2.2 Description of Equipment and Supplies	2-1
	2.2.1 The Lensmeter.....	2-2
	2.2.2 The Autorefractor/Keratometer.....	2-2
	2.3 Equipment Set Up Procedures	2-2
	2.3.1 Start of Stand Procedures	2-2
	2.3.2 Calibration – Lensmeter	2-3
	2.3.3 Calibration – Autorefractor	2-9
	2.3.4 Tolerance.....	2-11
	2.4 Recording in ISIS.....	2-11
	2.4.1 Start of Stand Quality Control.....	2-11
	2.4.2 Daily Quality Control.....	2-14
	2.4.3 End of Session Quality Control.....	2-15
	2.4.4 Weekly Quality Control	2-15
	2.5 Care and Maintenance	2-16
	2.5.1 Cleaning of Equipment	2-16
	2.5.2 Maintenance	2-17
	2.5.3 Malfunctions and Troubleshooting	2-17
	2.6 End of Stand Procedures.....	2-18
3	EXAMINATION PROTOCOL.....	3-1
	3.1 Eligibility Criteria	3-1
	3.2 Pre-examination Procedures	3-1
	3.2.1 Answering SP Questions.....	3-2
	3.2.2 Medical Exclusions	3-3

TABLE OF CONTENTS (continued)

<u>Chapter</u>		<u>Page</u>
3.3	Procedures.....	3-3
	3.3.1 Overview of Procedures.....	3-3
	3.3.2 Overview of the Exam Guide Screen.....	3-5
	3.3.3 Near Card Vision Test.....	3-6
	3.3.4 Begin Vision Exam.....	3-10
	3.3.5 Measuring Prescription of Eye Glasses.....	3-12
	3.3.6 Automated Refraction and Visual Acuity Measurements...	3-17
3.4	Examining SPs with Physical Limitations.....	3-27
3.5	Recording the Results.....	3-28
3.6	Post-examination Procedures.....	3-28
3.7	Report of Findings.....	3-29
4	ISIS DATA ENTRY.....	4-1
	4.1 Vision Examination Screens.....	4-1
	4.1.1 General Screen Information.....	4-1
	4.1.2 Medical Exclusion Screen.....	4-4
	4.1.3 Near Card Screen.....	4-5
	4.1.4 Exam Guide Questions.....	4-6
	4.1.5 Exam Guide Screen.....	4-7
	4.1.6 Objective Refraction Manual Entry.....	4-11
	4.1.7 Pop-up Messages and Comments Options.....	4-12
	4.1.8 Vision Component Status Screen.....	4-13
5	QUALITY CONTROL.....	5-1
	5.1 Observation.....	5-1
	5.2 Replication.....	5-1
	5.3 Refresher Sessions.....	5-1
6	SAFETY ISSUES.....	6-1

TABLE OF CONTENTS (continued)

List of Appendixes

<u>Appendix</u>		<u>Page</u>
A	Examples of Eye Infections	A-1
B	Example of Data Items Captured	B-1
C	Vision Report of Findings.....	C-1
D	Standard Glasses Rx	D-1
E	Vision Equipment Log	E-1
F	Overview of Vision Procedures with Scripts.....	F-1

List of Tables

<u>Table</u>		
2-1	Standard glasses Rx	2-8

List of Figures

<u>Figure</u>		
2-1	Nidek Lensmeter LM 990-A.....	2-4
2-2	Setting the lens.....	2-5
2-3	Measuring the lens	2-7
2-4	Example of printed tapes from autorefractor	2-13
3-1	Nidek Lensmeter LM990-A.....	3-13
3-2	Setting the lens.....	3-14
3-3	Measuring the lens	3-16
3-4	Autorefractor ARK760	3-18

TABLE OF CONTENTS (continued)

List of Figures (continued)

<u>Figure</u>		<u>Page</u>
3-5	Focusing the SP's eye.....	3-20
3-6	VA chart button	3-22

List of Exhibits

<u>Exhibit</u>		
3-1	Medical Exclusion screen	3-4
3-2	Exam Guide screen	3-5
3-3	Near Card screen.....	3-8
3-4	Near Card.....	3-8
3-5	Tumbling E Card	3-9
3-6	Exam Guide Questions screen	3-11
3-7	SP with Glasses Exam Guide screen	3-12

1. INTRODUCTION

1.1 Overview of Vision Examination Component

The vision examination is designed to test distance vision, measure refractive error, measure the shape of the cornea and, if applicable, measure the distance eyeglass prescription in SP's aged 12 years and older. Near vision will be tested in SPs over 50 years of age.

Vision loss is common in adults and prevalence increases with advancing age. Approximately 13 percent of individuals 65 years of age or older and 28 percent of those over 85 years of age report some degree of visual impairment. In children, refractive errors are the most common vision disorders, occurring in 20 percent by 16 years of age. More than 90 percent of older people require the use of corrective lenses at some time. Visual disorders in older adults frequently lead to trauma from falls, automobile crashes, and other types of unintentional injuries. Many adults are unaware of decreases in their visual acuity, and up to 25 percent may have incorrect corrective lens prescriptions.

1.2 General Overview of Procedures

All participants aged 12 years and older will be asked to participate in this component which is estimated to take 7 minutes to administer.

The MEC examination will consist of several tests. For SPs aged 50 years or older, the exam will begin with a Near Card test, which tests for near vision. Additionally, all SPs will be administered two other tests which require automated vision equipment: a Visual Acuity test, which tests for distance vision, and an Objective Refraction/Keratometric evaluation, which measures the SP's refractive error and corneal curvature.

2. EQUIPMENT

2.1 Description of Exam Room in the MEC

The vision examination room is located in trailer #1 of the MEC. A sink is located in the nearby hallway for SPs to wash hands and to use when reinserting contact lenses.

2.2 Description of Equipment and Supplies

Nonconsumable items include:

- Nidek Autorefractor/Keratometer (model ARK-760A)
- Nidek Auto Lensmeter (model LM-990A)
- Tape measure
- Near Card
- Penlight
- Blower brush

Consumable supplies include:

- Unisol 4 saline solution – **NOTE: You must write the date opened on the bottle in the space provided. The bottle should be discarded 30 days after opening.**
- Clarity lens cleaner
- Contact lens cases
- Alcohol wipes
- Chin rest tissue
- ARK printer paper
- Lensmeter printer paper
- Lint free Kimwipes
- Absorbond lens wipers

- Cotton tipped applicators

2.2.1 The Lensmeter

The lensmeter allows you to measure the SP's prescription of single vision lenses, bifocal (trifocal) lenses, and progressive power lenses (PPL).

2.2.2 The Autorefractor/Keratometer

This instrument contains both a refractometer and a keratometer in one unit. The refractometer uses infrared rays to measure objectively the refractive power of the SP's eyes and built-in charts and a cross cylinder lens for subjective measurements. It obtains the spherical, cylindrical powers, and cylindrical axis of the lens, which may correct the SP's refractive error. The keratometer measures the corneal curvature, angle of corneal meridia, and corneal cylindrical power of the SP's eyes.

The SP's visual acuity is also checked with this instrument. This is initially performed aided by the SP's usual correction, if any, whether it is glasses or contact lenses. For some SPs, you will measure the visual acuity with the objective refraction measurements to determine whether the SP's usual acuity can be improved.

2.3 Equipment Procedures

2.3.1 Set-up Procedures

At the beginning of the stand, usually on set-up day, these procedures are followed in order to prepare the equipment for use. The data manager will connect the computer, keyboard, mouse, and bar code wand. Additionally, the data manager will connect the lensmeter and refractor to the computer.

1. Remove Velcro fasteners from cabinet doors and keep them in the cabinets; do not throw them away. Make certain when performing equipment set-up procedures that you are careful when opening cabinets; contents may have shifted during the move.
2. Remove cargo tie-down fastener from around the lensmeter box, refractor box, and table. Store the tie-down in the cabinets.
3. Remove lensmeter and refractor from storage boxes.

4. Remove supplies from storage box.
5. Replace small supply shelf and brackets on wall beneath the counter.
6. Unlock the door and place the two stools in upright position.

2.3.2 Calibration – Lensmeter

Calibration checks are performed on a regular basis to confirm that the lensmeter is working properly. A record of these checks is kept as part of the Quality Control procedures. Follow the procedures outlined below to check the calibration of the lensmeter.

2.3.2.1 Lensmeter Calibration Frequency

The lensmeter will be calibrated weekly and at the start of each stand.

On a daily basis, inspect the lensmeter with the penlight. If any debris is detected, use a puff of air from the blower brush to clean the lens. If necessary, use an Absorbond lens wiper to clean the lens and the screen.

2.3.1.1 Lensmeter Calibration Procedures

Items needed for the calibration procedures:

- Four pairs of calibration glasses of known prescription (8 total prescriptions)
- Nidek Lensmeter LM-990A (Figure 2-1)
- Lens Cleaner Spray
- Lint-free Kimwipes

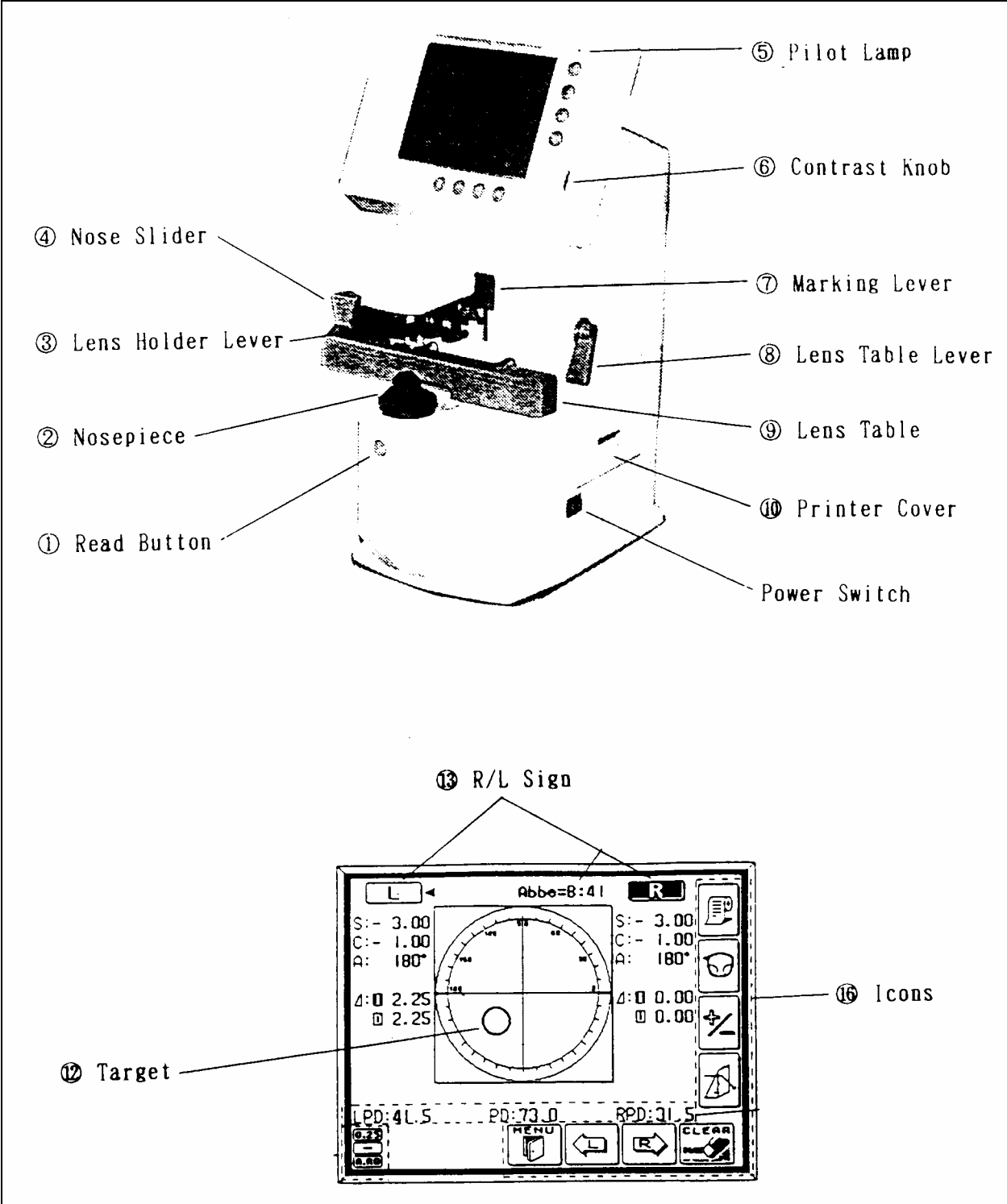

Figure 2-1. Nidek Lensmeter LM 990-A

Measuring Prescription of Eye Glasses

Follow the procedures outlined below for measuring the prescription of each pair of calibration glasses. Refer to the Nidek Auto Lensmeter Model LM-990A Operator's Manual for more detailed specifications if necessary. Print the lensmeter readings to compare to the known values. See the table of the standardized eye glasses prescriptions and the tolerance ranges allowed in Section 2.3.1.2. Keep the lensmeter printouts in the QC Folder and record the results in ISIS. (See Section 2.4.)

1. Inspect the lenses. If they are exceptionally dirty, clean them with lens cleaner and dry them with the Kimwipes available. Do not use paper towels, tissues, or other cloths to dry the glasses since they are not lint-free.
2. Be sure the lensmeter is turned on before you place the glasses on the nosepiece; otherwise, you will receive an "Init Err" message because the lensmeter will not calibrate properly. If this occurs shut the machine off and turn it on again once the glasses are removed.
3. Set the nose slider on the lens table by pulling down on it. It will lower into place in front of the lens table. Place the nose slider to the left of the nosepiece. This will allow you to test the right lens first.

Place the eyeglass frame on the nose slider with the top of the glass frame facing you and the bottom of the glass frame against the platform. This will position the glasses so that the right lens is held in your right hand and the left lens is held in your left hand (similar to holding glasses upside down). See Figure 2-2. Because the lensmeter will automatically detect the position of the slider, you do not need to "tell" the lensmeter which lens you are reading; it should indicate that you are testing the right lens.

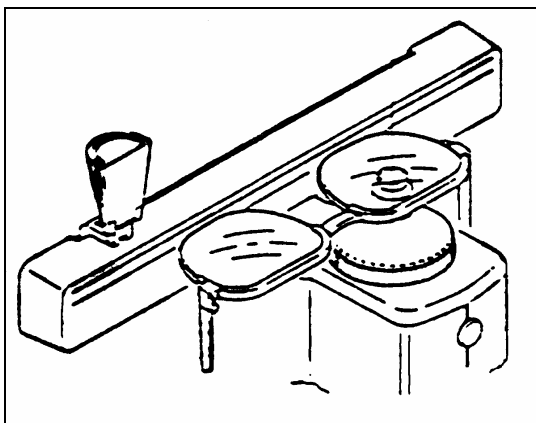

Figure 2-2. Setting the lens

4. Move the lens table forward until the bottom edges of both lenses touch.
5. “Fix” the lens by first raising the lens holder lever to its uppermost position and then lowering it slowly until it makes contact with the lens.

Some points to remember:

- Keep the eyeglass frames horizontally flush against the platform. (Otherwise, the axis measurements may be skewed.)
- Use the lens holder to avoid tilting the lenses. (Otherwise, the cylinder measurements may be skewed.)

Measuring the Lens

Progressive power eyeglasses have gradually increasing strength as you go from the middle to the bottom of the lens. Because you cannot readily see the different lens areas, the eyeglasses appear to be single vision lenses. Bifocal and seamless bifocals have both a distance portion and near portion on the lenses. The lensmeter has the capability to measure these in separate modes. However, all lenses may be measured in Progressive Power Lens (PPL) mode. Thus, for simplicity and to save time, **you will read the lenses in the Progressive Power Lens mode.**

1. Press the PPL mode button (the second button on the right hand side of the display screen). Four lens graphics will appear on the bottom left hand side of the LED screen to indicate that you are now in the PPL mode (Figure 2-3).
2. Set the lens as described above.
3. Place the upper third part of the lens on the nosepiece in order to position the distance portion properly.
4. Align the target (vertical line) by moving the lens sideways so that the target is brought to the middle of the guide (horizontal line) (Figure 2-3).
5. When the target is within an acceptable range, the “PUSH” sign with an up arrow will appear and the target line will disappear (Figure 2-3).
6. Push the lens forward slowly until the target changes to a plus sign (Figure 2-3).
7. When the distance value is stable, a small beep sounds and the “PULL” sign with a down arrow appears (see Figure 2-3).
8. Lift the lens holder off the lens. Remove the glasses and move the nose slider to the right. Place the glasses so that the left lens is in position under the lens holder. Remember to start with the distance third of the eyeglasses so that you are measuring the distance portion.

9. When moving from side to side, pull the table closer to you slightly and repeat steps 1-7 for the left lens.

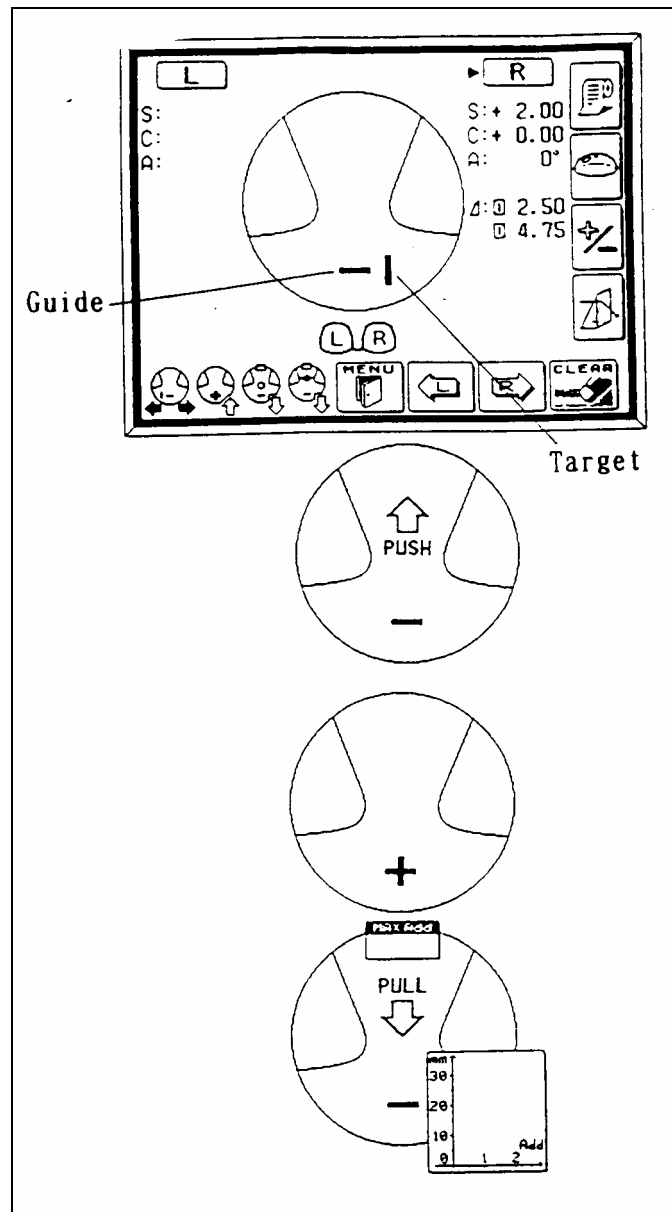

Figure 2-3. Measuring the lens

Some points to remember:

- If you forget the order of the steps, follow the lens graphics on the bottom left hand side of the screen.
- Always remember to start in the top distance portion of the lens, especially when switching to the left lens.
- If the plus sign never appears in Step 6 and the PUSH sign appears all the way to the top of the frame, remove the glasses and start a little bit lower in the lens.
- If the plus sign still does not appear after trying a second time, the prescription may not have a sphere component. In this case, measure the distance portion approximately 5 mm below the top of the frame, centering the lens as best as possible.

IMPORTANT NOTE FOR MEASURING ANY LENS

If the sphere is equal to or greater than $\pm 5D$ / for any lens type, use the auto-Abbe compensation when “reading” the lens as follows: Align the lens as described in this section. When pressing the “Read” button, depress it for a count of 2 seconds. This reduces error of high power lens measurements.

2.3.1.2 Table of Standardized Eye Glasses Prescriptions

See Table 2.1 below for the prescriptions of the standardized eye glasses and the tolerance range for the sphere, cylinder and axis.

Table 2.1. Standard glasses Rx

	Right lens			Left lens		
	Sphere	Cyl.	Axis	Sphere	Cyl.	Axis
Pair #1	+1.50	+1.00	90	-2.50	+1.00	90
Pair #2	+1.50	+3.50	45	-5.00	+3.50	45
Pair #3	+3.00	+1.00	180	-4.00	+1.00	180
Pair #4	+3.00	+3.50	125	-6.50	+3.50	125

Tolerance range for Sphere and Cylinder is + or - .25 D

Tolerance range for Axis is + or - 3 degrees

2.3.3 Calibration – Autorefractor

Calibration checks are performed on a regular basis to confirm that the autorefractor is working properly. A record of these checks is kept as part of the Quality Control procedures. Follow the procedures outlined below to check the calibration of the autorefractor.

2.3.3.1 Autorefractor Calibration Frequency

The autorefractor will be calibrated with both the test eyes and steel balls at the **start of each stand**. Calibration with the test eyes only will be done **weekly**. If the test eyes are switched during a stand, the known values must be entered in ISIS the first day the new eyes are used. (See Section 2.4.3.)

On a **daily** basis, inspect the refractor's measuring window with the penlight. If any debris is detected, clean the window from the center outward using Absorbond lens wipers wrapped around a cotton tipped applicator. If necessary, moisten the wrapped tip with an alcohol wipe. Dry the window using a cotton tipped applicator wrapped with a lens wiper. Check again with the penlight; if streaks exist, repeat the steps above.

NOTE: Before using a cotton-tipped applicator to clean the window, wrap it in a lens wiper. Otherwise the cotton fibers will stick to the window.

2.3.3.2 Autorefractor Calibration Procedures

Measurement with Test Eyes

1. Install the test eyes and steel balls to the chin rest. To align, they must be set high—near the top of the chin rest.
2. Turn the power ON and set to <OBJ.MEAS> mode by pressing the R/K button.
3. Set the parameter 1: STEP to 0.01 from the default setting of 0.25. To do this, open up the trap door, press the solar system button and then use the down arrow to set to 0.01. Press the solar system button again.

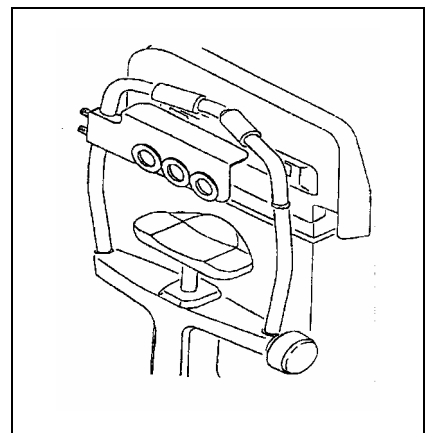

4. Aim accurately and measure the test eyes. Keep the Autofocus on to focus correctly. Then take off the Autofocus to fire manually by pressing the joystick button. Measure

the right and left eye first and print these readings. Then measure the center eye and print the readings. Keep the printout in the QC Folder.

- NOTE: A slightly incorrect alignment will affect the measured value especially when the test eyes of +10D and -10D are used. Errors of the order of -0.1D to +0.1D will be caused in measurement like that. Be sure to make the alignment as accurate as possible.
5. Return to the default setting of 0.25 by setting the parameter 1: STEP to 0.25. (See #3 above.)

Tolerance of AR Measured Data

1. See the table on the right side. Compare the SE value on the printout with these values.
2. Also weekly, verify that the VD (vertex distance) value on the printout is 13.75 mm.

	TOLERANCE	
	SPHERE	CYLINDER
+10D	± 0.25D	± 0.25D
0D	± 0.25D	± 0.25D
-10D	± 0.25D	± 0.25D

NOTE: The SPH values table is stuck on each of the test eyes. Check the tolerance in measurement comparing the measured value to the reference data in the table. Use the values corresponding to the line where VD = 13.75 mm. The cylinder value should be zero.

VD = 13.75 mm
+9.78D
+0.00D
+10.49D

SAMPLE

Measurement with Steel Balls

1. At the beginning of each stand, install the test eyes and steel balls to the chin rest.
2. Turn the power ON and set to <K> mode.
3. Aim accurately and measure the steel balls.

NOTE: The slightly incorrect alignment will affect the measured value. Errors of the order of -0.02 mm to +0.02 mm will be caused in measurement like that. Be sure to make the correct alignment as accurate as possible.

Tolerance of KM Measured Data

1. See the table on the right side. Compare the printout with these values. After you have checked to determine if the refractor is within tolerance, make sure to

	TOLERANCE	
	AVE	R1-R2
R5.95	± 0.02 mm	± 0.04 mm
R7.94	± 0.02 mm	± 0.04 mm
R9.13	± 0.02 mm	± 0.04 mm

return to the <K/M> mode by pressing the R/K button.

2.3.4 Tolerance

If any piece of equipment is out of tolerance, first repeat the measurement yourself. Then have another technician attempt the measurement. Next, if the problem is with the refractor, measure another technician's eyes and compare them with their refractive errors on file in the QC folder. If the problem still exists, call the MEC manager. The MEC manager will call MARCO to determine whether the equipment will need to be sent back. If so, Westat will send a backup piece of equipment.

2.4 Recording in ISIS

Quality control values are entered in ISIS at the following intervals: Start of Stand; Daily; End of Session; and Weekly.

2.4.1 Start of Stand Quality Control

Start of Stand entry includes the following for the steel balls:

- Known values for the steel balls;
- Result 1 for the steel balls (R1 on the tape);
- Result 2 for the steel balls (R2 on the tape); and
- Average result for the steel balls (AVE on the tape).

The tape from the refractor will have 4 sets of values for the steel balls listed. Only enter the set of values (R1, R2, AVE) that are between the carets (<>). The known values are listed above the steel balls.

Start of Stand entry for the test eyes includes the following (right, left, and center):

- Known values for the sphere;
- Sphere result; and
- Cylinder result.

The results that should be entered in ISIS are in the carets (< >). Known values are listed on the test eyes.

Start of Stand entry includes the following for the lensmeter:

- Lens sphere results (4 pairs of glasses);
- Lens cylinder results (4 pairs of glasses); and
- Lens axis results (4 pairs of glasses).

The known values are prerecorded in ISIS for the glasses. The health technician must put a check in the done box to complete the QC program, but no values need to be entered.

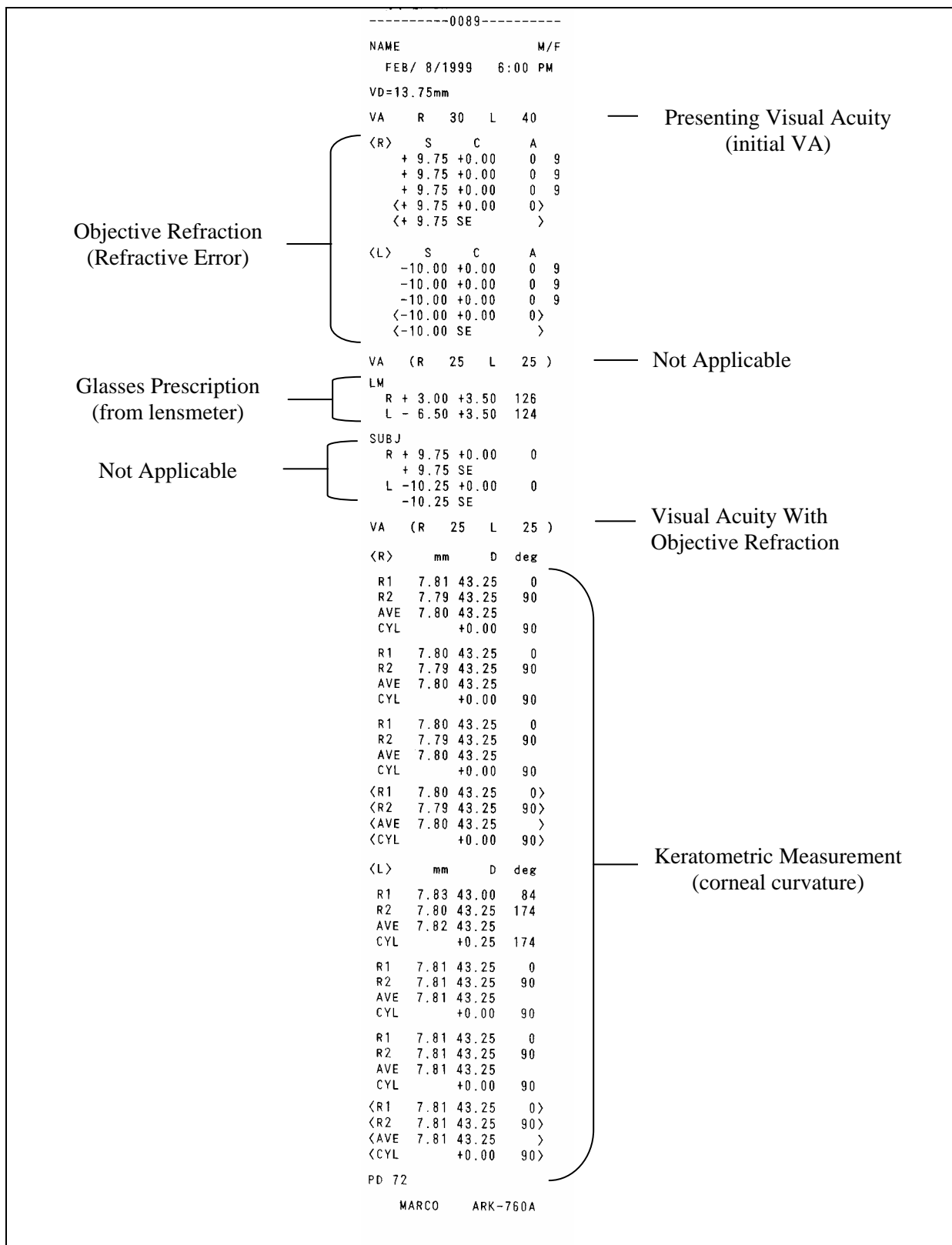
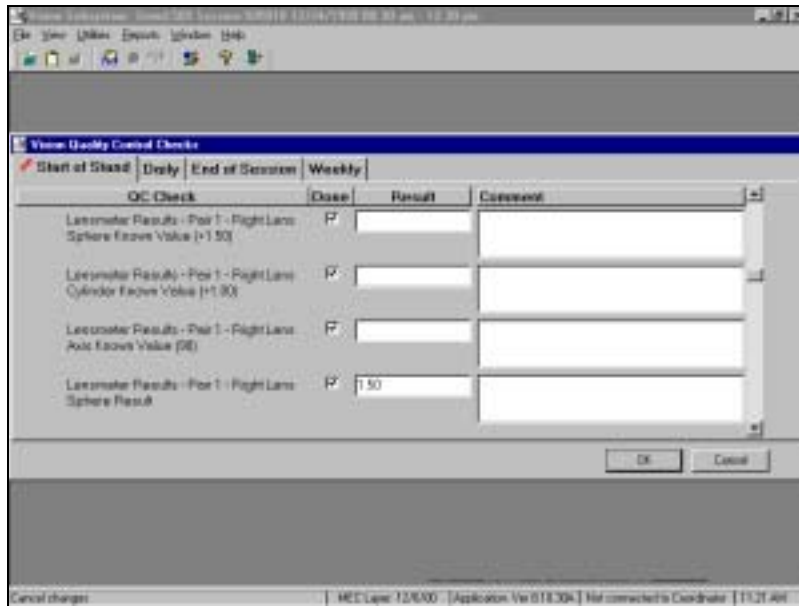
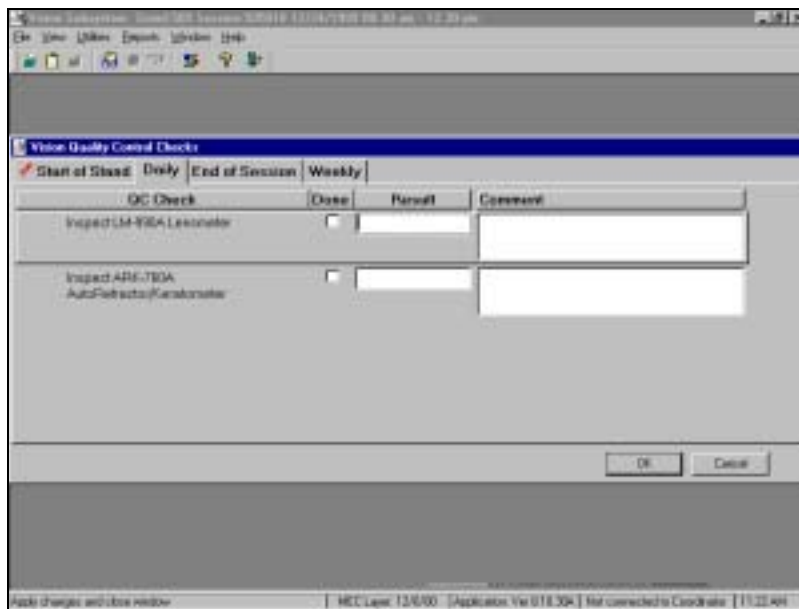

Figure 2-5. Example of printed tapes from autorefractor



2.4.2 Daily Quality Control

The lensmeter and refractor must be checked daily. This must be checked off in ISIS.



2.4.3 End of Session Quality Control

This tab is only used for entry if the test eyes are switched during a stand. Known values must be entered here the first day the new test eyes are used.

QC Check	Date	Result	Comment
Right Test Eyes - Sphere - Know Value if changed			
Left Test Eyes - Sphere - Know Value if changed			
Center Test Eyes - Sphere - Focus Value if changed			

2.4.4 Weekly Quality Control

The Weekly QC procedures are the same as the Start of Stand QC, except the steel balls are not used. The test eyes and the eyeglasses are used for the Weekly QC.

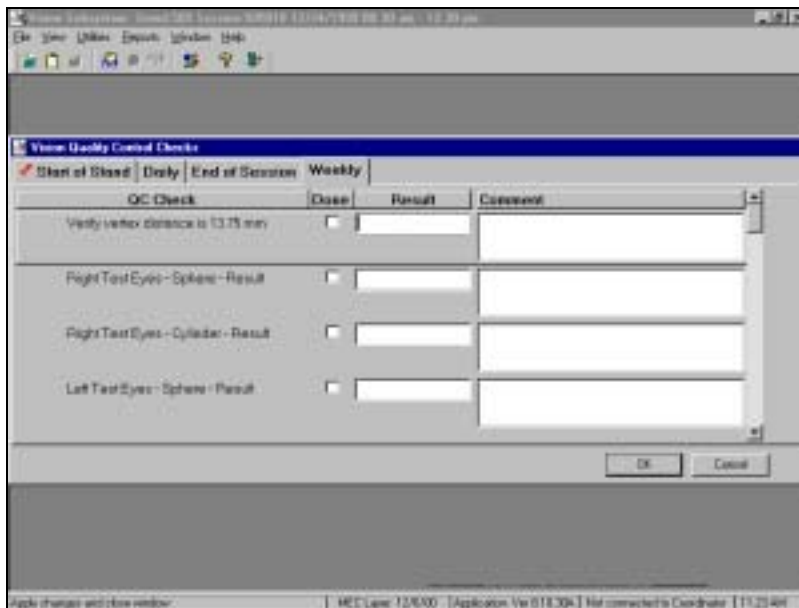

2.5 Care and Maintenance

2.5.1 Cleaning of Equipment

The following procedures should be followed when cleaning the **Lensmeter**:

1. Lift up the nosepiece and remove it.
2. Clean the protective glass by blowing off dust with the blower brush.
3. If the lens is still dirty, wipe gently with Absorbond Lens wipes.
4. If the exterior of the instrument becomes dirty, wipe with an alcohol wipe.

The following procedures should be followed when cleaning the **Autorefractor**:

1. Wipe the forehead rest and other external parts with an alcohol wipe.
2. Clean the measuring window and TV monitor with Absorbond lens wipes.
3. Ensure that the chin rest has a fresh layer of tissue.

2.5.2 Maintenance

There is no routine maintenance for the equipment.

2.5.3 Malfunctions and Troubleshooting

Because there is no routine maintenance for the equipment, any malfunction will need to be investigated by MEC health technician staff. If trouble-shooting tests cannot diagnose the malfunction, the MEC manager will report to NCHS and call the appropriate Marco representative. The following are solutions to common problems that may occur with the equipment:

Lensmeter

Problem	Solution
The display disappears suddenly.	The auto-OFF function has been executed. Press any button to recall the ON state.
The display is unclear.	Adjust the contrast knob.
“Data Err” appears.	Clean the protective glass and the measuring lens.

Refractor

Problem	Solution
The TV monitor display disappears suddenly.	The auto-OFF function may have been executed. To recover the ON condition, press any button.
The main body cannot be moved laterally.	The locking knob may be fixing the main body. Loosen the locking knob, which is beside the joystick.
The instrument does not print.	Check the printer paper. If the paper is out, set in a new printer roll. Also the printer roll may be set with the wrong side up. Set up with the correct side up.

2.6 End of Stand Procedures

The following procedures must be done when packing up at the end of the stand.

Lensmeter

1. Pack the instrument in its original box. To do this, first unplug the two cables from the base of the instrument. (The power cable is black, and the one that connects to the refractor is white.)
2. Be sure the instrument is not stored in a wet or humid environment.
3. Store the instrument in a place away from direct sunlight and with an environmental temperature of 50-104 degrees Fahrenheit.
4. Make sure the power cord is not crushed.

Refractor

1. Place the refractor in the locked position. Pack the instrument in its original box. To do this, first unplug the three cables from the base of the instrument. (The power cable is dark gray, the connector to the computer is light gray, and the cable to the lensmeter is white.)
2. Do not store the instrument in a place where it may get wet or where poisonous gas or liquid is stored.
3. Store the instrument in conditions with a temperature of between 50-104 degrees Fahrenheit.

Room

1. Lower the table to its lowest position and move it to the corner against the counter and the wall closest to the coordinator's area.
2. Remove the small supply shelf and brackets located in front of the computer and place the lensmeter box against the back wall (in front of the computer) under the counter.
3. Place the refractor box next to the lensmeter box, and in front of and against the table (the three pieces will almost form a square in the corner).
4. Secure the refractor and lensmeter boxes and the table with the cargo tie-down fasteners that attach from the wall beneath the shelf to the wall closest to the coordinator's area.
5. Place all shelf stable supplies in the overhead cabinets. Place all liquid supplies in the room-designated storage box. The opened bottle of Unisol saline solution should be discarded. This box will remain on the floor in the room.
6. Remove the contents of the file folder attached to the wall above the lensmeter and place them in the room-designed box. The small supply shelf and brackets should also

be placed in this box. Additionally, the phone, handset, and mouse may be placed in the box.

7. Use the Velcro fasteners to secure the cabinet doors. Secure the door open with the latch at the top of the door. The two stools should remain in the room, but be placed on their sides so they won't shift during the move.
8. Tear down of the computer equipment (keyboard, monitor, mouse, bar code wand, etc.), and the lensmeter and refractor connections/cables will be the responsibility of the data manager.

3. EXAMINATION PROTOCOL

3.1 Eligibility Criteria

All SPs aged 12 years and older are eligible for the vision examination. SPs aged 50 years and older are eligible for all three parts of the examination: (a) Near Card visual acuity test, (b) eye glasses prescription determination when appropriate, and (c) automated distance visual acuity and refraction measurements. SPs aged 12 to 49 years are eligible for the last two parts (b and c), the eye glasses prescription determination as appropriate, and the automated distance visual acuity and refraction measurements.

SPs are asked two questions related to vision problems in the Household Interview. These questions are:

1. With both eyes open, can you see light?
2. With both eyes open and when wearing your glasses or contacts if you wear any, can you count the fingers of a hand held 2 feet in front of your face?

Based on the response to the first question, the SP will be excluded from the Vision component if he/she is unable to see light with both eyes open. This exclusion will be made by the Coordinator system when the Household Interview questions are uploaded at the beginning of each session. The SP will not be sent to the vision room for the examination and the status will be coded as Not Done due to physical limitation. The response to the second question does not exclude the SP from vision.

SPs with severe eye infections in both eyes are excluded from this exam for medical safety reasons and therefore there are a few screening questions to be answered.

3.2 Pre-examination Procedures

1. Select the Vision Examination icon from the introductory window on the automated system.
2. Enter your tech password into the system when prompted.
3. Open a new examination.

4. Wand the SP's identification bracelet. Verify the SP's name and identification number displayed on the screen.
5. Explain the process to the SP in your own words but be sure to include the following facts:
 - This vision exam is not a substitute for eye examinations performed by the SP's eye doctor.
 - Some but not all results will be provided to the SP when he/she leaves the MEC (distance visual acuity).
 - The exam consists of several tests, one of which requires a near vision card (if age 50 or older) and two of which require the automated vision equipment.
 - SPs may be asked to remove their glasses and/or contact lenses during the course of the examination. A sink is available for SPs who want to wash their hands before removing their contact lenses.
 - If you wish you may clear the Lensmeter and Refractor, although you will be prompted to do so by ISIS later.

3.2.1 Answering SP Questions

Although your introduction to the component will answer most of the SP's questions regarding the vision examination, some SPs may express additional concerns. Below is some suggested wording for dealing with these questions.

What exactly are you testing for?

12-49 years: We are interested in how well you can see far away. We are also interested in the shape of your eyes. Finally, we would like to test your glasses, if you have them, to learn more about your prescription.

50+ years: We are interested in learning how well you can see close up and how well you can see far away. We are also interested in the shape of your eyes. Finally, we would like to test your glasses, if you have them, to learn more about your prescription.

Will you give me a prescription for new glasses?

No, we will not be able to give you a prescription for new glasses today. Today's exam is not a substitute for your regular eye exam. You should see an eye doctor if you are concerned about your current prescription.

Will the examination hurt?

No, the examination should not hurt. First, you may be asked to read some numbers on a card. Second, you will be asked to look into a machine and read the numbers and letters that are shown. (If asked: Unlike other vision examinations you may have experienced, the machine will not puff air onto your eyes.)

Will you check for glaucoma? (Will you check my eye pressure?)

No, we will not be checking for glaucoma today. Today's exam is not a substitute for your regular eye exam. You should see an eye doctor if you are concerned about this.

Are you an eye doctor/optamologist/optometrist?

No I am not. I am a health technician specially trained to perform this examination.

Do I have to take my contact lenses out?

Some of the tests will not be accurate if you decide to leave your contact lenses in. As with other parts of this examination, you may agree to some parts of the examination and not to others. (If asked: You may use our saline solution which is preservative-free and safe for both hard and soft lenses or if you prefer, you may use your own.)

3.2.2 Medical Exclusions

The first screen that appears after the SP verification step is the Medical Exclusion screen (Exhibit 3-1). Displayed on the screen are two questions for the tech to answer by observation.

Does SP appear to have a severe eye infection in one or both eyes?

Observe the SP's eyes for possible infection using the following guidelines: redness, inflammation, discharge, or pain. If the answer to this question is "Yes," you will be prompted to record which eye(s) is/are affected. If either eye has sign of an infection, the SP will be excluded from the vision component. Presence of subconjunctival hemorrhage (area of blood covering the white of an eye, sometimes taking up the whole side to the left or right of the iris) is NOT a reason to exclude a participant. Refer to the color pictures if necessary (Appendix A).

Is SP wearing an eye patch?

Observe the SP's eye for presence of an eye patch. If the answer to this question is "Yes," you will be prompted to record which eye(s) is/are affected. Although the SP is not excluded from the vision examination because he/she wears an eye patch, you will not conduct the examination on the affected eye.

3.3 Procedures

3.3.1 Overview of Procedures

As mentioned earlier, there are three parts to the examination:

- **Near Vision Card** - ages 50 years and older (Section 3.3.2)
- **Eye Glasses Prescription** - ages 12 years and older when glasses are available (Section 3.3.4)

Exhibit 3-1. Medical Exclusion screen

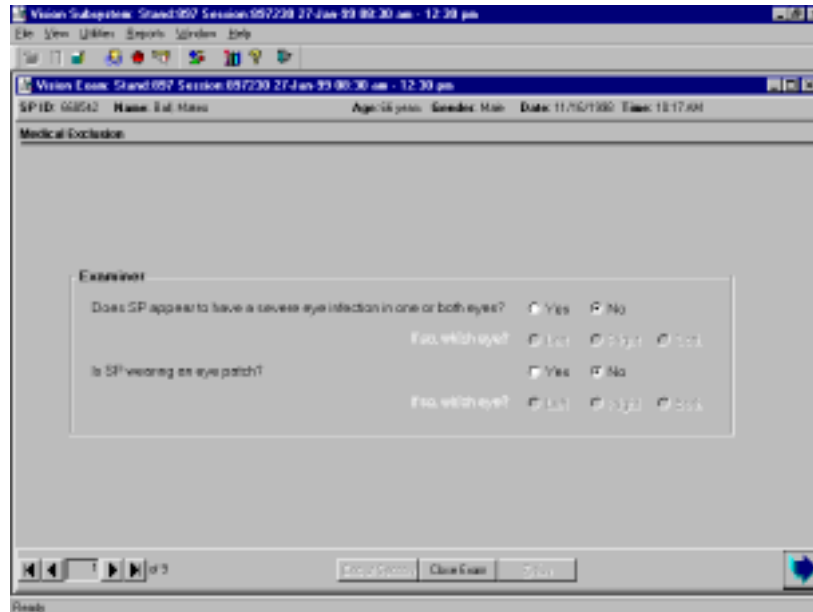

- **Distance Visual Acuity and Refraction Measurements** - ages 12 years and older (Section 3.3.5)

There are four different examination screen variations to accommodate the variety of SP conditions as follows:

- SPs with No Glasses (to examine those SPs who do not wear distance glasses or contact lenses as well as those SPs who do but did not bring their distance glasses or contacts to the MEC);
- SPs with Distance Glasses (to examine those SPs who brought distance glasses to the MEC);
- SPs with Contact Lenses (to examine those SPs who brought contact lenses to the MEC); and
- SPs with Contact Lenses and Glasses (to examine those SPs who brought both their contact lenses and distance glasses to the MEC).

3.3.2 Overview of the Exam Guide Screen

As mentioned above, there are a variety of different paths the vision examination can take and that path is dependent on the types of correction an SP has as well as results of each vision test as they are conducted. The Exam Guide screen (Exhibit 3-2) is designed to help you navigate the order of the examination for each SP. The screen is divided into two sections that are enabled in sequence as you come to them. If a portion of the screen is not enabled, then do not conduct that test unless prompted to do so through a message box. The two sections are as follows:

- **Visual Acuity (with usual correction):** All SPs will receive this test which is an initial visual acuity with whatever distance correction, if any, the SP usually wears (see Section 3.3.6.1).
- **Visual Acuity with Objective Refraction:** Certain SPs will receive this test which consists of a visual acuity check using the objective refraction measurements as the “correction factor” for the SP. Again SPs do not wear their distance correction since the autorefractor is providing the correction it deems appropriate. SPs will receive this test whenever the Visual Acuity with their usual correction is worse than 20/25 (see Section 3.3.6.3).

Exhibit 3-2. Exam Guide screen

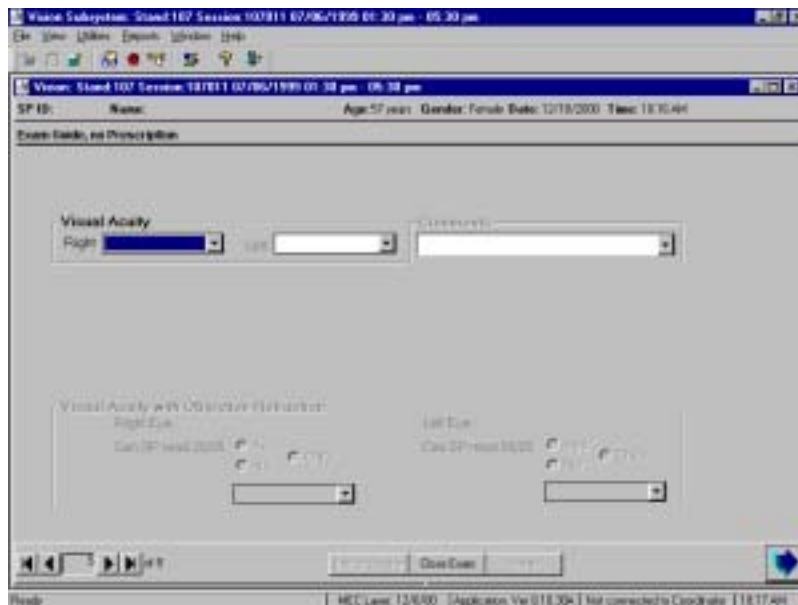

In order for the Exam Guide to work properly, it is essential that all data entered on this screen are accurate. Otherwise, incorrect skip patterns may be initiated and the SP and/or you will experience problems during the examination. Additionally, the screen enables an “Examiner Reminder” as you proceed through the exam. This will serve as a guide to assist you with the next protocol steps.

Procedures for each of these tests are provided in the remaining sections of this chapter. Instructions for entering data are provided in Chapter 4.

3.3.3 Near Card Vision Test

If the SP is 50 years of age or older, the examination begins with the Near Card vision test. The supplies required for this test are:

- Near Card;
- Tumbling E Near Card;
- Measuring Tape;
- Near Card Guide;
- Tumbling E Near Card Guide; and
- Laminated E.

3.3.3.1 Begin Near Card Test

For SPs aged 50 years and older, the first examination screen that appears after entering the SP ID is the Near Card screen (Exhibit 3-3). Displayed on the screen are three questions, one that is asked of the SP and two that are answered by the examiner.

Do you wear glasses or contact lenses for reading or near work?

This question is asked directly of the SP exactly as it is worded here. NOTE: We are only interested in correction that is used for close up work because we are testing near vision in this step. The SP may use correction that is nonprescription (glasses from a drug store, magnifiers). Do answer “Yes” to the question for these situations. We will collect information on the types of correction used for distance later in the examination.

Are glasses and/or contacts being used for this test?

This question is displayed only if the SP stated in the previous question that he/she does wear correction for close up work. After this statement, you are to record whether glasses, contacts, or a combination of glasses and/or contacts are being used for this test. You can obtain this information by asking: **“Do you have the glasses and/or contacts you use for near vision with you today? If so, please wear them for this test.”** (These must be easily accessible; use your own judgment.)

If the SP wears correction for near vision but does not have them at the time of the test, be sure to answer “No” to this question.

Is the Tumbling E card being used for this test?

The default is **No**. The examiner will only change the answer to **YES** if the SP says they cannot read numbers, and the tumbling E card is used for the Near Vision exam.

Once these three questions are answered, conduct the Near Card vision test as follows:

1. The test is to be conducted with the SP’s correction for near vision on. Therefore ask the SP to wear their correction. If this correction consists of bifocals or trifocals, remind the SP to look through the portion which is used to see near objects.
2. Have the SP place the Near Card (Exhibit 3-4) at a comfortable reading distance. Use the measuring tape provided to determine the distance of the card. Measure the distance from the center of the card to the SP’s brow with the measuring tape and record the answer to the nearest inch in the field provided on the screen. (Rounding rule: Numbers less than 0.5, round down (example: $16 \frac{1}{4} = 16$) and numbers equal to or greater than 0.5, round up ($13 \frac{1}{2} = 14$, $21 \frac{3}{4} = 22$.) Ask the SP to hold the card at this distance.
3. Make sure the SP has both eyes open during the test and **keeps the card at the measured distance**. Do not allow the SP to squint, close one eye, or move his/her head backwards or forwards in order to improve his/her vision.
4. Read the following statement to the SP: **“Please read the numbers on this chart, starting with the top row from left to right.”**
5. The SP must read the entire line in order for you to score it. If he/she stops in the middle of the line, prompt him/her to continue with a best guess. Caution SPs to read slowly to avoid misstatements.
6. You may focus the SP on the correct line by telling him/her where the line is in relation to the single or double line printed on the card. You may not point to individual numbers to help him/her focus. For example, the SP has read the first two lines and has asked where to read next. An acceptable answer would be: “Please read the line just below the double black line printed on the card.”

7. The Near Card Guide is a hard-copy version of the Near Card so you can “score” SPs without having to look over their shoulder during the test. There is a Guide attached to the top of the Refractor as well as Guides attached to a clipboard. Use whichever is the most comfortable for you. The SP is allowed to miss up to one number on any one line to continue. Therefore, the SP may proceed to the next line whenever he/she reads 4 or 5 numbers correctly on a line.
8. If the SP corrects himself/herself immediately after a miss, accept the correction. If the SP proceeds to the next number and wants to change the reading of a previously read number, do not accept the correction.

Exhibit 3-3. Near Card screen

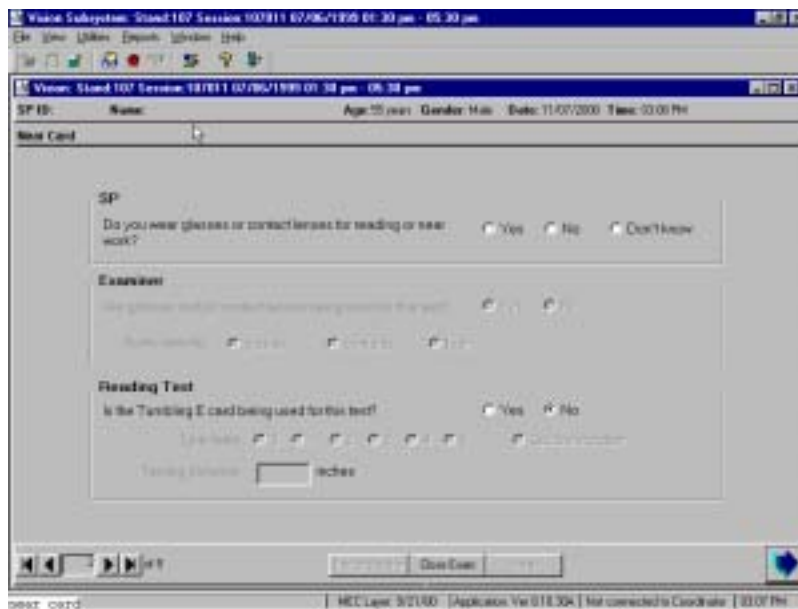

Exhibit 3-4. Near Card

NHANES	
9 6 8 5 9	(20/400)
6 5 9 6 8 <u> </u>	(20/200)
8 5 6 9 5	(20/63)
5 9 8 6 8 <u>—————</u>	(20/40)
*****	(20/25)

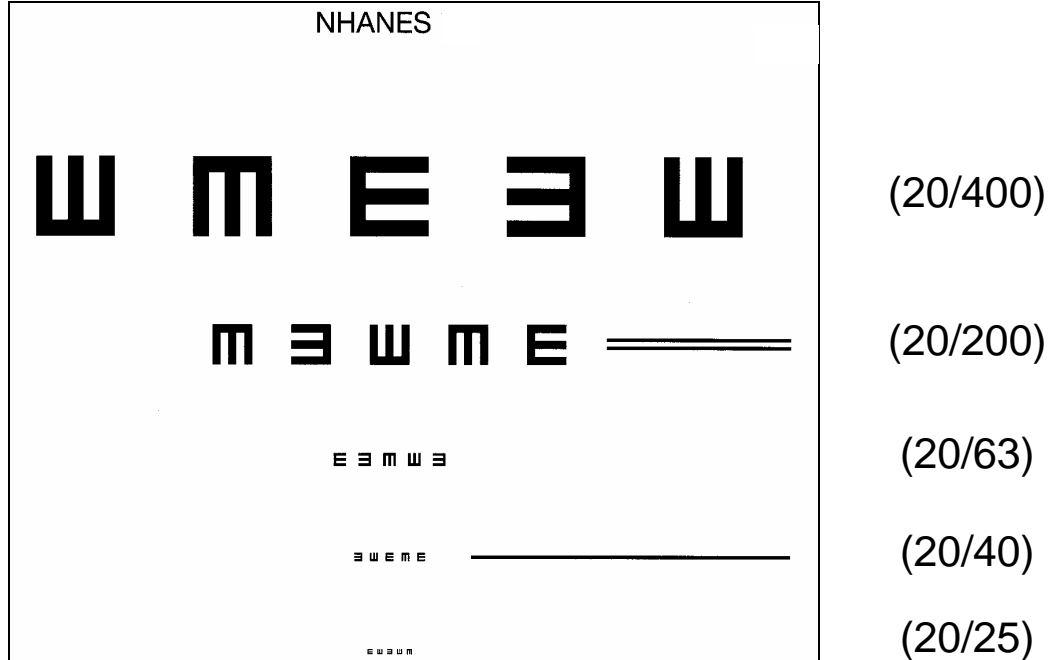

Exhibit 3-5. Tumbling E Card

9. After the SP reads the line, continue as follows:
 - If the SP reads the line correctly, that is with one or fewer misses, ask the SP to read the next line down. If the SP reads this line correctly, proceed down the chart one line at a time.
 - If the SP cannot read the line correctly, you must “verify the miss.” To do this, ask the SP to read the next lowest line.
 - If the SP misses more than one number in this “verification” line, end the test.
 - If the SP misses no more than one number on the line (that is he/she “passes”), continue down the chart until the next time the SP misses more than one number or he/she reads the last line correctly.

10. Stop the test under the following circumstances:
 - The SP has read all five lines with fewer than two misses on the lowest line; or
 - The SP has missed two or more numbers on a line two lines in a row.

11. Enter the number of the last line the SP read with one or fewer misses, that is the number of the last line where the SP read at least four out of the five numbers correctly.

Some points to remember:

- If the SP misses more than one item on the last line during the Near Card test, you will not be able to “verify the miss.” In these instances, enter line “4” as the last line read correctly by the SP.
- If the SP cannot read the first line, enter line “0” in ISIS.

3.3.3.2 Tumbling E Near Card

If the SP tells the health technician or the coordinator they cannot read numbers, conduct the Near Card vision test using the Tumbling E protocol. This will only be used if the examiner knows at the beginning of the exam. If the SP does not say anything, the examiner will use the Near Card with numbers. When using the Tumbling E card, follow all the same procedures as for the Near Card with numbers, except the following:

1. Read the following statement to the SP (instead of #4 in Section 3.3.3.1):
“Please tell me the direction the open part of the “E” is facing, starting on the top row and moving from left to right”.
2. The home examiner will demonstrate what is meant by Up, Down, Left, Right by rotating the large laminated E card slowly, clockwise from Right, Up, Left, Down. Then the examiner will ask if the SP understands. If the SP says **yes**, proceed. If the SP says **no**, demonstrate again, slowly, and then proceed.
3. Measure and score the response in the same fashion as with the Near Card with numbers.
4. Change the answer on the ISIS screen for “Is the tumbling E card being used for this test?” to **yes**.

3.3.4 Begin Vision Exam

Before the eye glasses prescription is measured and/or the automated refraction is conducted, the Exam Guide questions (Exhibit 3-6) must be answered. Some of these questions are asked of the SP while some are answered by the examiner.

Exhibit 3-6. Exam Guide Questions screen

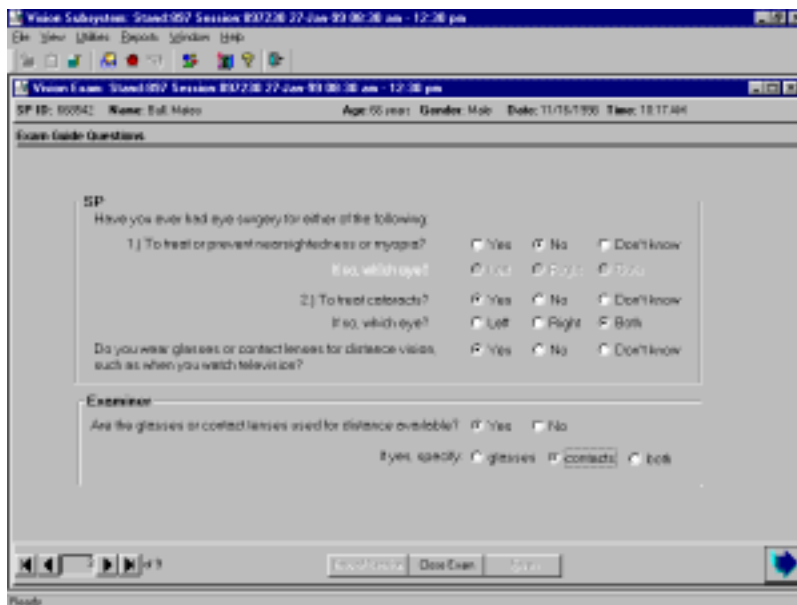

Have you ever had eye surgery for either of the following: (1) to treat or prevent nearsightedness or myopia or (2) to treat cataracts?

This question is asked directly of the SP exactly as it is worded here. **NOTE:** We are only interested in laser or radial keratotomy (RK) surgeries used to improve nearsightedness. Some other terms to describe this surgery include: PRK, RK, Lasik, Eximer, or Refractive surgery. You may need to probe a response of “laser surgery,” since this may possibly be for another reason. We are also interested in eye surgery for cataracts. If the answer is “Yes,” you will be prompted to record which eye(s) was/were operated on.

Do you wear glasses or contact lenses for distance vision, such as when you watch television?

This question is asked directly of the SP exactly as it is worded here. **NOTE:** We are only interested in correction that was used for distance because we are testing distance vision during both the eyeglass prescription and automated refraction steps. Information on the types of correction used for near vision was collected earlier in the examination.

Are glasses and/or contacts used for distance available?

This question is only asked if the SP stated in the previous question that he/she does wear correction for distance vision. The lens prescription test can only be conducted if distance glasses are available and the visual acuity test is to be conducted with the correction on. If you record a positive answer, you are prompted to record whether glasses, contacts, or a combination of glasses and contacts are available to be tested. You can obtain this

information by asking: **“Do you have the glasses and/or contacts you use for distance vision with you today? If so, please wear them for this test.”**

If the SP wears correction for distance vision but does not have them at the time of the test, be sure to answer “No” to this question.

3.3.5 Measuring Prescription of Eye Glasses

This test is conducted for all SPs aged 12 years and older who brought their distance glasses to the MEC. The procedures for conducting the test with the Nidek Lensmeter are provided below. Refer to the Nidek Auto Lensmeter Model LM-990A Operator’s Manual for more detailed specifications if necessary. If the SP has reported that he/she wears glasses for distance vision and has them available for testing, the SP with Glasses Exam Guide screen (Exhibit 3-7) is displayed. The supplies required for the test are as follows:

- Nidek Lensmeter LM-990A (Figure 3-1)
- Lens Cleaner Spray
- Lint-free Kimwipes

Exhibit 3-7. SP with Glasses Exam Guide screen

Visual Subsystem: Stand 505 Session 505818 12/24/1999 08:38 am - 12:30 pm

Visual Subsystem: Stand 505 Session 505818 12/24/1999 08:38 am - 12:30 pm

SP ID: Name: Age: 15 year Gender: Male Date: 12/19/2000 Time: 11:05:46

Examiner: Did you get the glasses prescription? Yes No

Visual Acuity (with correction)

Right: 20/30 Left: 20/30 Comments:

Examiner Reminder

ask the SP to remove their glasses or contacts
Please proceed with Objective Refraction on BOTH eyes.
Begin the Objective Refraction with LEFT eye

Visual Acuity with Objective Refraction

Right Eye: Can SP read 20/25? Yes NO

Left Eye: Can SP read 20/25? Yes NO

Ready | MEC Laser 12/24/00: [Application: Ver 018.304] Not connected to Coordinator | 11:00 AM

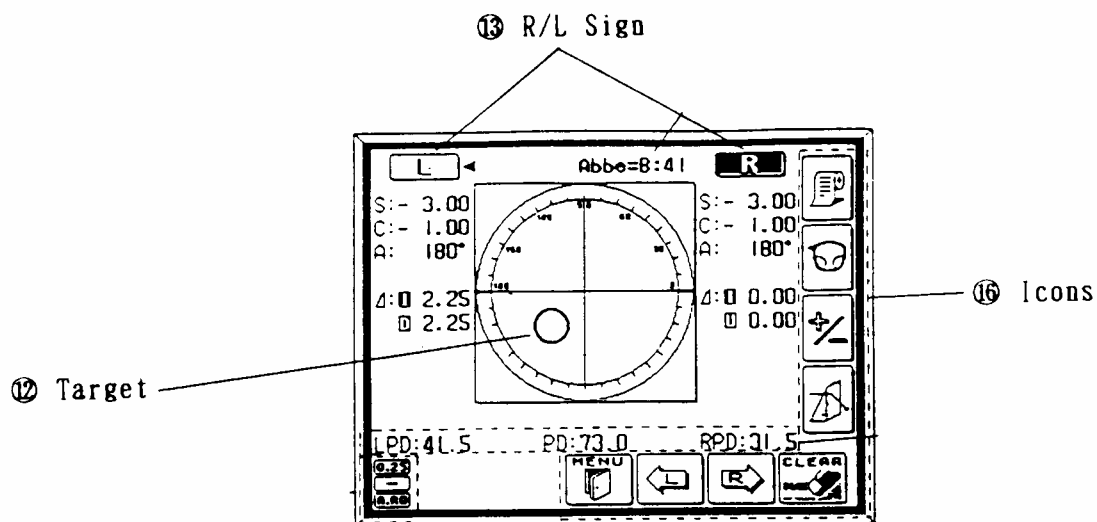
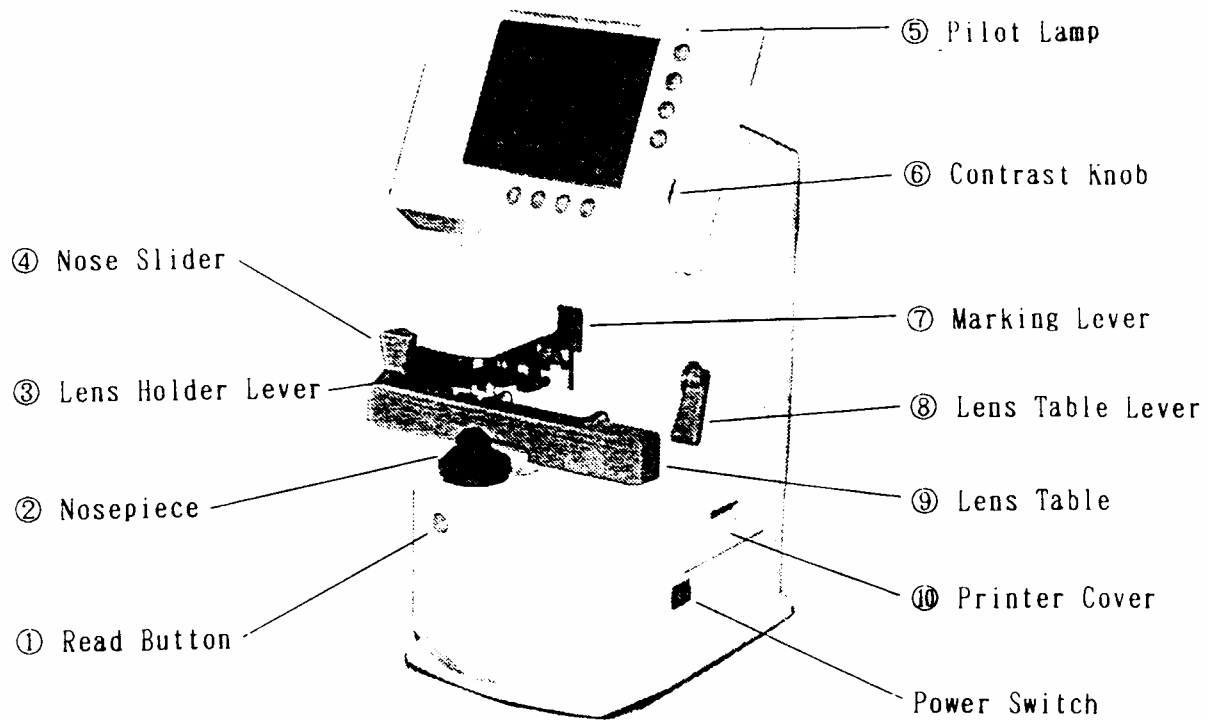

Figure 3-1. Nidek Lensmeter LM 990-A

Pre-examination Procedures

1. Ask the SP to hand you the eyeglasses he/she wears to see distant objects.
2. Inspect the lenses. If they are exceptionally dirty, clean them with lens cleaner and dry them with the Kimwipes available. Do not use paper towels, tissues, or other cloths to dry the glasses since they are not lint-free.

Setting the Lens

1. Be sure the lensmeter is turned on before you place the glasses on the nosepiece; otherwise, you will receive an “Init Err” message because the lensmeter will not calibrate properly. If this occurs shut the machine off and turn it on again once the glasses are removed.
2. Set the nose slider on the lens table by pulling down on it. It will lower into place in front of the lens table. Place the nose slider to the left of the nosepiece. This will allow you to test the right lens first.
3. Place the eyeglass frame on the nose slider with the top of the glasses frame facing you and the bottom of the glasses frame against the platform. This will position the glasses so that the right lens is held in your right hand and the left lens is held in your left hand (similar to holding glasses upside down). See Figure 3-2. Because the lensmeter will automatically detect the position of the slider, you do not need to “tell” the lensmeter which lens you are reading; it should indicate that you are testing the right lens.

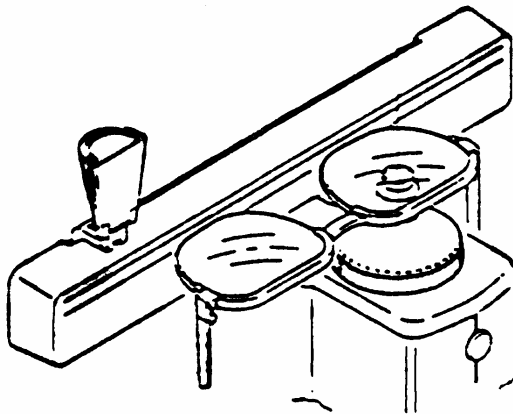

Figure 3-2. Setting the lens

4. Move the lens table forward until the bottom edges of both lenses touch.
5. “Fix” the lens by first raising the lens holder lever to its uppermost position and then lowering it slowly until it makes contact with the lens.

Some points to remember:

- Keep the eyeglass frames horizontally flush against the platform. (Otherwise, the axis measurements may be skewed.)
- Use the lens holder to avoid tilting the lenses. (Otherwise, the cylinder measurements may be skewed.)

Measuring the Lens

Progressive power eyeglasses have gradually increasing strength as you go from the middle to the bottom of the lens. Because you cannot readily see the different lens areas, the eyeglasses appear to be single vision lenses. Bifocal and seamless bifocals have both a distance portion and near portion on the lenses. The lensmeter has the capability to measure these in separate modes. However, all lenses may be measured in Progressive Power Lens (PPL) mode. Thus, for simplicity and to save time, **you will read the lenses in the Progressive Power Lens mode.**

1. Press the PPL mode button (the second button on the right hand side of the display screen). Four lens graphics will appear on the bottom left hand side of the LED screen to indicate that you are now in the PPL mode (Figure 3-3).
2. Set the lens as described above.
3. Place the upper third part of the lens on the nosepiece in order to position the distance portion properly.
4. Align the target (vertical line) by moving the lens sideways so that the target is brought to the middle of the guide (horizontal line) (Figure 3-3).
5. When the target is within an acceptable range, the “PUSH” sign with an up arrow will appear and the target line will disappear (Figure 3-3).
6. Push the lens forward slowly until the target changes to a plus sign (Figure 3-3).
7. When the distance value is stable, a small beep sounds and the “PULL” sign with a down arrow appears (see Figure 3-3).
8. Lift the lens holder off the lens. Remove the glasses and move the nose slider to the right. Place the glasses so that the left lens is in position under the lens holder. Remember to start with the distance third of the eyeglasses so that you are measuring the distance portion.
9. When moving from side to side, pull the table closer to you slightly and repeat steps 1-7 for the left lens.

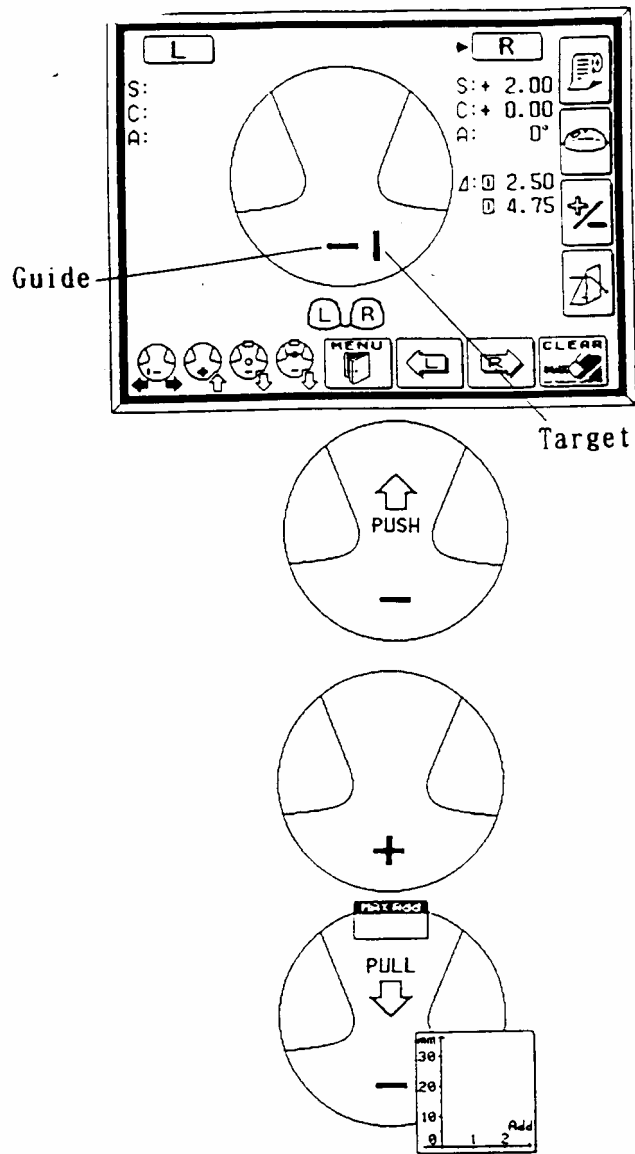

Figure 3-3. Measuring the lens

Some points to remember:

- If you forget the order of the steps, follow the lens graphics on the bottom left hand side of the screen.
- Always remember to start in the top distance portion of the lens, especially when switching to the left lens.
- If the plus sign never appears in Step 6 and the PUSH sign appears all the way to the top of the frame, remove the glasses and start a little bit lower in the lens.
- If the plus sign still does not appear after trying a second time, the prescription may not have a sphere component. In this case, measure the distance portion approximately 5 mm below the top of the frame, centering the lens as best as possible.

IMPORTANT NOTE FOR MEASURING ANY LENS

If the sphere is equal to or greater than $\pm 5D$ for any lens type, use the auto-Abbe compensation when “reading” the lens as follows: Align the lens as described in this section. When pressing the “Read” button, depress it for a count of 2 seconds. This reduces error of high power lens measurements.

3.3.6 Automated Refraction and Visual Acuity Measurements

These tests are conducted for all SPs aged 12 years and older regardless of whether they wear eyeglasses or contacts. The procedures for conducting the tests with the Nidek Auto Refractor ARK 760 are provided below. Refer to the Nidek Auto Refractor Model ARK-760 Operator’s Manual for more detailed specifications if necessary. The supplies required for the tests are as follows:

- Nidek Refractor ARK-760 (Figure 3-4)
- Disposable contact lens cases
- Unisol 4 contact lens solution (for rinsing and wetting)
- Lens cleaner spray

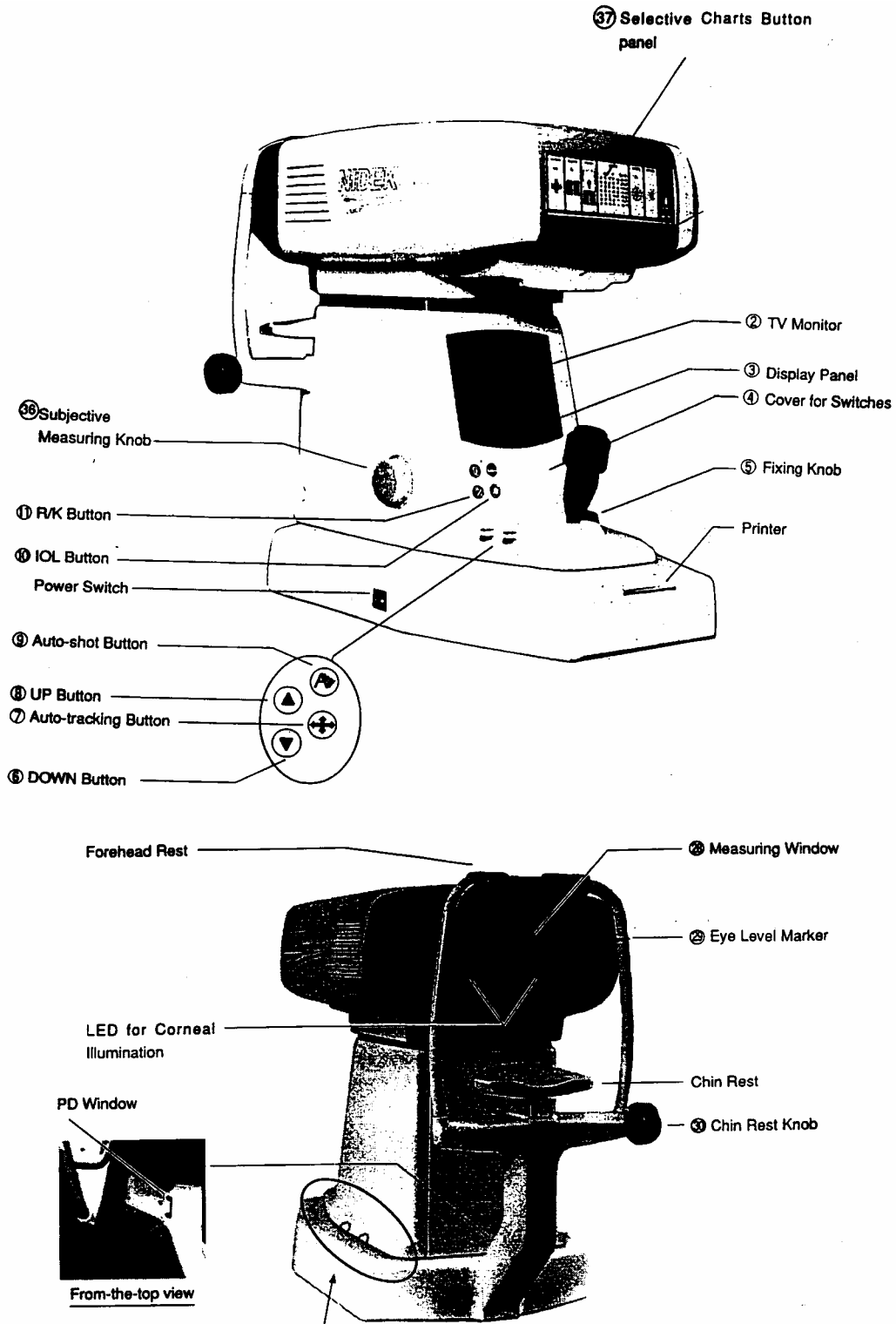

Figure 3-4. Autorefractor ARK760

- Kimwipes
- Alcohol swabs

Positioning the SP

- Make sure that the moveable top portion of the autorefractor is positioned closest to you and not the SP.
- Ask the SP to remain seated in the chair and lean forward to place his/her chin in the chinrest and his/her forehead against the forehead rest.
- Adjust the height of the table using the foot controls so that the SP is comfortable.
- Align the center of the SP's eye with the eye level marker (red band) by using the chin rest knob.

Some points to remember:

- Always make sure that the SP keeps his/her forehead on the forehead rest or you will be unable to focus the eye for any of the upcoming tests.

Focusing the SP's Eye

- Move the autorefractor to the appropriate eye as specified on the ISIS Vision screen. A red "R" or "L" will appear at the edges of the autorefractor when you have moved the unit far enough to measure the eye. These letters are also used to remind you which eye is currently being measured.
- Use the focusing indicator, called a mire ring, to focus on the center of the eye. Move the top portion of the unit forward slowly. A series of lines will appear to the left and right of the mire ring (Figure 3-5).

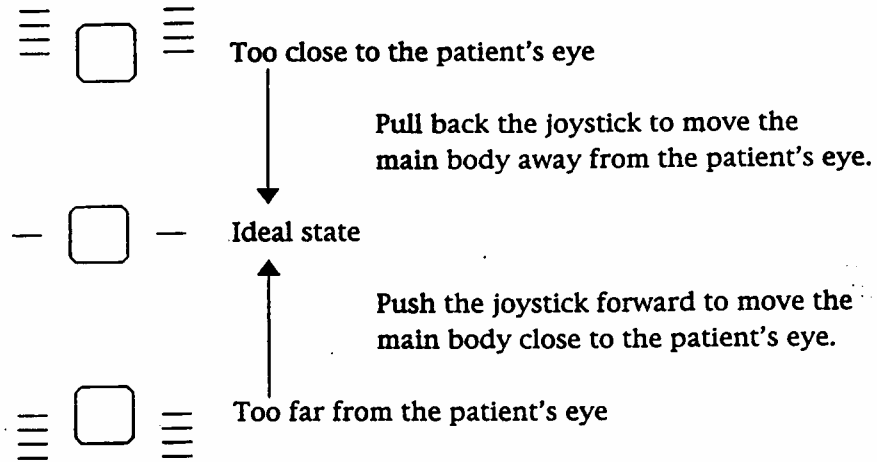

Figure 3-5. Focusing the SP's eye

- When one line appears on either side of the ring, the autorefractor is in position to focus the eye.
- If one or more lines appear below this center line, the unit is too far from the SP's eye. Move the unit closer to the SP.
- If one or more lines appear above this center line, the unit is too close to the SP's eye. Move the unit away from the SP.
- Use the joystick to raise or lower the unit as necessary to raise or lower the mire ring in order to focus on the SP's eye.
- If the <LIMIT> message appears on the LED screen, move the joystick and/or the chin rest in the direction indicated by the arrows on the screen.

3.3.6.1 Visual Acuity Measurement with Distance Correction

Pre-examination Procedures

- Ask the SP to wear the glasses or contacts they use for distance vision. For SPs who wear glasses, lens cleaner spray and Kimwipes are available if they ask to clean their glasses.

Measuring Visual Acuity with Distance Correction

1. Move the autorefractor to the start eye as specified on the Vision ISIS screen.
2. Begin by pressing the Visual Acuity (VA) Chart Button on the Selective Chart Buttons Panel. Note that the LED screen tells you that the whole VA chart is displayed.
3. Use the arrow buttons on the base of the autorefractor to change the whole VA chart to the 20/50 line.
4. Introduce this test as you proceed with steps 1-3 with a statement similar to the following: **The screen will appear blurry for a few moments. Then I will ask you to read it to me as best as you can. Please note that there may be numbers and letters on the screen.**
5. Focus the eye as specified in the previous section.
6. Ask the SP to read the line: **Please read the numbers and/or letters on this chart slowly, starting from left to right (see Figure 3-6).**
7. The SP must read the entire line in order for you to score it. If he/she stops in the middle of the line, prompt him/her to continue with a best guess. Caution SPs to read slowly to avoid misstatements.
8. The SP is allowed to miss one number/letter on any one line to continue. Therefore, the SP may proceed to the next line whenever he/she reads 4 or 5 items correctly.
9. If the SP corrects himself/herself immediately after a miss, accept the correction. If the SP proceeds to the next item and wants to change the reading of a previously read item, do not accept the correction.
10. After the SP reads the 20/50 line, continue as follows:
 - If the SP reads the 20/50 line correctly, that is with one or fewer misses, press the down arrow key once. The 20/40 line is displayed. Repeat steps 6-9. If the SP reads this line correctly, proceed down the visual acuity chart one line at a time using the down arrow key.
 - If the SP cannot read the 20/50 line correctly, restart at the 20/200 line and proceed down the chart using the rules in Steps 6-9. Use the up arrow key to move to the 20/200 line. (If the SP cannot see to read the 20/200 line, check “20/200+” in ISIS for that eye and leave the chart line in the Refractor at 20/200. For any situations where the SP was not able to read the 20/200 line that is NOT related to poor or impaired vision, check “CNO” for that eye. Examples would be no time, or lack of cooperation.)

Figure 3-6. VA chart button

VA Chart Button



	6		F		20/200
2	5	0	P	H	20/80
8	2	V	D	F	20/60
7	6	K	R	H	20/50
5	8	P	O	E	20/40
6	2	C	N	K	20/30
8	7	R	P	O	20/25
2	5	D	H	V	20/20

11. Whenever the SP misses more than one item on a line, you must “verify the miss.” To do this, present the next lowest line on the chart and ask the SP to continue.
 - If the SP misses more than one item on this “verification” line, end the test.
 - If the SP misses no more than one item on the line (that is he/she “passes”), continue down the chart until the next time the SP misses more than 1 item or he/she reads the 20/20 line correctly.
12. Stop the test under the following circumstances:
 - The SP reads the 20/20 line correctly; or
 - The SP has missed more than 1 item on a line two lines in a row.
13. **Make sure that the visual acuity line shown on the LED screen matches the last visual acuity line correctly read by the SP.** For example, for those SPs who missed more than one item on a line and failed the verification step on the next lowest line, you must press the up arrow key twice to return to the last VA line the SP read correctly.
14. Move the autorefractor to the second eye and repeat steps 3-13.
15. Make sure that you select the appropriate acuity line in ISIS which reflects the acuity chart line in the Refractor.

Some points to remember:

- Make sure the SP does not squint while reading the VA chart. You will actually see the eyes close on the LED screen when this occurs.
- Make sure that SP understands that there are letters and numbers on the chart.
- You will not be able to “verify a miss” when the SP misses more than one item on the last line (20/20). In this instance, enter “20/25” as the last line the SP read correctly.
- Make sure to move the VA screen back to the last line read correctly.

3.3.6.2 Automated Objective Refraction Measurements

Pre-Examination Procedures

- Ask the SP to remove his/her glasses or contacts. For SPs who wear contact lenses, contact lens solution which is safe for all contact lenses will be available in the vision room. Direct SPs who wish to wash their hands before removing their contacts to the sink in the hallway. Offer the disposable contact lens case for SPs who do not have a lens case of their own. If the SP refuses to remove his/her lenses or cannot, proceed

with the lenses in. **SPs with cataracts are to leave their lenses in.** If the SP leaves their contact lenses in during the OR, select “Contact Lenses worn for OR” from the comment drop down screen.

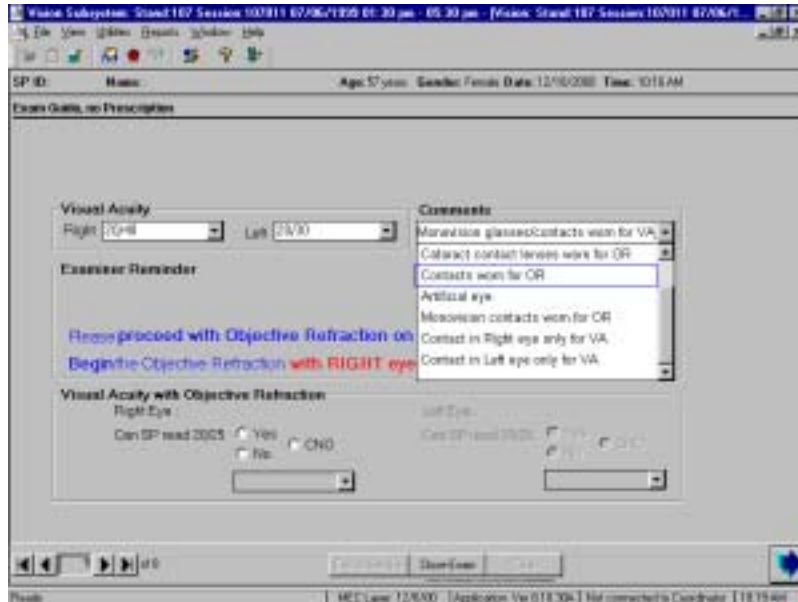

- Ask the SP to reposition himself/herself in the autorefractor.

Measuring Objective Refraction (with No Correction)

1. Move the autorefractor to the same start eye as specified for visual acuity on the Vision ISIS screen.
2. Begin by pressing the Scenery Chart Button on the Selective Chart Buttons Panel. Note that the LED screen displays the <R/K> symbol and space for several readings.
3. Introduce this test while completing steps 1-2 with a statement similar to the following: **The screen will appear blurry for a few moments. Once it is in focus, you will see a hot air balloon on the screen. I'd like you to focus on the balloon. Please blink a few times for me while I focus on your eye. When you hear a beep, the test will begin; try not to blink for me at that time.**
4. Focus the eye.
5. Once focused, the autorefractor will automatically take the required readings. You will hear a series of three quick beeps and then a series of three longer beeps. The first three beeps indicate that the autorefractor is taking three keratometry readings. The three longer beeps indicate that the autorefractor is taking three refraction readings.
6. The word <FINISH> will appear when the test is done.
7. Move the autorefractor to the next eye and repeat steps 3-6.

Some points to remember:

- If the SP cannot see the red hot air balloon, ask him/her to focus on the red blur. If the SP cannot see a red blur, ask him/her to focus on where your voice is coming from and look straight through the eyepiece.
- Make sure the SP does not blink or squint during step 5 or the autorefractor will be unable to take the required readings. For SPs with baggy or limp eye lids, ask the SP to hold the upper lid up with his/her finger, making sure that he/she continues to hold his/her forehead against the forehead rest.
- NOTE: The SP's pupil must be a certain size in order for the readings to be completed. Some medications may cause the pupil to contract. If the pupil does not fill the mire ring, you will be unable to take these readings. Make a note of this in the ISIS system as described in Section 4.
- If the autorefractor is unable to take any of the three required readings in step 5, it will automatically switch to the IOL mode and try again. If the readings are not obtained at this step, you will attempt to take the readings manually.
 - Press the auto-tracking button () once to switch to the manual mode.
 - Focus on the eye and press and hold the button on top of the joystick until three keratometry and three refraction measurements are taken.
 - There are some eye conditions which cause problems in one area of the eye but not in another. Therefore, if you are having trouble taking manual readings from the center of the eye, move the joystick in a circle while pressing the button in order to “walk” around the box. You may be able to obtain the readings off-center.
 - Remember to press the auto-tracking button once more in order to return to the auto-tracking mode for the next SP.
- If the autorefractor is unable to take all of the required readings, in step 5 the readings which were taken will flash on the screen. (Sometimes you will see the <KM?> indicator flash as well.) You will not see the <FINISH> indicator. If all the readings are not obtained, press the button on top of the joystick and the autorefractor will make another attempt at the readings. If you are still having difficulty, you may want to ask the SP if they had cataract surgery. However, make only one attempt after getting the <KM?> indicator. Additionally, if you have no reading under the R (i.e., 0:3), try once more.
- If you are unable to get KM data the unit will not go to the automatic 20/25 line with the sphere flashing. To get to that screen, press VA Chart, and then press the IOL button (next).
- If the SP wears contacts for the OR portion of the exam, make sure to comment in ISIS.
- If the SP wears glasses and you got the prescription on the lensmeter you will hear a beep during the OR measurement indicating the data transferred.

3.3.6.3 Visual Acuity with Objective Refraction Measurements

The Visual Acuity with Objective Refraction test is only done if prompted by the Vision ISIS program as described in Section 3.3.2. Please note that you may be asked to conduct this test for one or both eyes as appropriate. The SP should **not** wear his/her distance correction for this test.

The only equipment/supply needed for this test is the autorefractor.

Conducting the Measurement

1. Immediately after conducting the Objective Refraction measurement, position the autorefractor on the eye indicated by the Vision ISIS system. Note that the 20/25 Visual Acuity line is displayed.
2. Focus the eye.
3. Ask the SP to read the line for you: **Now please read this line slowly and from left to right for me. Remember that you may see both numbers and letters on the screen.**
4. Enter the results on the Vision ISIS screen. Please note that guidelines specified in Section 3.3.6.1 apply here. The SP may miss one or fewer items to “pass;” however, it is not necessary to “verify a miss” during this test.
 - If you have no objective refraction measurements for an eye, you cannot assess the VA with OR. Answer “CNO” to the question “Can the SP read 20/25?”
 - If the refractor was able to get only one of 3 readings you will need to manually bring up the 20/25 line by pressing the VA chart, and then the IOL button.
 - If the SP can read the 20/25 line, you will answer: “Yes” to the question “Can the SP read the 20/25 line?”
 - If the SP cannot read the 20/25 line, you must change the chart line to the 20/50 visual acuity line. In ISIS, answer “No” to the question “Can the SP read the 20/25 line?” A pop-up will remind you to go to this line and begin the acuity check.

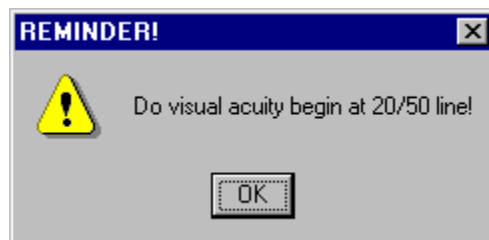

5. Using the up arrow keys, change the visual acuity chart to the 20/50 line.
6. Ask the SP to read the line: **Now please read this line slowly and from left to right for me. Remember that you may see both numbers and letters on the screen.**
 - If the SP can read the line, you will move down the chart one line at a time, asking the SP to read each line. Continue down the chart until the SP fails to read the line by missing two or more numbers or letters on the line or you reach the 20/25 line, whichever occurs first.
 - **Make sure that the final visual acuity line on the LED screen matches the last visual acuity line correctly read by the SP.** For example, if the SP missed more than one item on a line, you must press the up arrow key once to return to the last VA line the SP read correctly.
 - Some SPs may fail to read the 20/25 line initially. Yet, when you go to the 20/50 line and work down they may then pass the 20/25 line. In these instances, **do not** change the answer to the question ‘Can SP read 20/25’ to ‘Yes’. This answer should remain ‘No’, and you should leave the 20/25 line in the Refractor and in ISIS as the last line read correctly.
 - Do not go below the 20/25 line, to the 20/20 line.
 - If the SP cannot read the line (20/50) move the chart line up to the 20/200 line.

Follow the steps above, moving down the chart until the SP fails to read the line. If the SP cannot see to read the 20/200 line, enter “20/200+” in ISIS for that eye and leave the chart line in the Refractor at 20/200.
7. Repeat Steps 1-6 for the second eye, if prompted by the Vision ISIS system to do so.
8. Make sure that you select the appropriate acuity line in ISIS which reflects the acuity chart line in the Refractor.

3.4 Examining SPs with Physical Limitations

As stated above, SPs with severe eye infections are excluded from the exam. The only physical limitation that would prohibit someone from taking this test is if he/she is completely blind, that is he/she cannot see light with both eyes open. Other physical limitations, such as limited upper mobility, may restrict how well the SP can position himself/herself at the autorefractor.

3.5 Recording the Results

All results will be recorded into the automated system using the Vision Examination Form. This form is accessed from the introductory window menu by selecting the vision icon. There are 8 separate screens as follows:

1. The first screen directs you to confirm the SP's name, NCHS identification number, age and sex.
2. Once verified, the program moves to the second screen, which prompts you to ask the medical exclusion questions.
3. The third screen prompts you to begin the Near Card Exam for SPs 50 years and older by answering a series of questions.
4. The fourth screen prompts you to begin the Vision Exam by answering a series of questions. (**NOTE:** This is the third screen for SPs 12-49 years of age.)
5. The fifth screen provides you with a guide for conducting the exams. As discussed in Section 3.3.2, the system will prompt you to conduct certain tests based on the data you enter during the course of the examination.
6. After you have completed all portions of the exam, the data will be automatically captured and transferred to the database. Appendix B shows an example of items that are captured.
7. The last screen, the Component Status Screen, prompts you for the results of the examination. Final result options include "complete," "partial complete," and "not done."

The actual screens and detailed instructions for use are provided in Chapter 4.

3.6 Post-examination Procedures

1. Complete the Vision Examination Screens.
2. Make sure the SP has his or her correction (eyeglasses or contact lenses) before leaving the room. Remind SPs who wear contact lenses that they may use the sink in the hall when putting their contact lenses back in.
3. Return the SP to the coordinator for assignment to another component.

4. Change the chin rest tissue and wipe the head rest with alcohol wipes.
5. Wash your hands.

3.7 Report of Findings

All examined persons with a “complete” vision exam will receive a report of findings from the coordinator. Appendix C shows an example of this report.

4. ISIS DATA ENTRY

4.1 Vision Examination Screens

Once the coordinator has assigned an SP to the vision room, a communication dialog box from the coordinator will appear to let you know that an SP has been assigned to vision. Click on the Close button to remove the dialog box from the screen.

Move the mouse pointer to the first icon on the left in the Standard toolbar. This is the “Logon SP” icon. Click on this button to begin the examination. A dialog box will appear which will ask you for your name and password. Wand the bar code on the SP’s plastic bracelet to enter the ID. This will activate a dialog box containing descriptive information about the SP (i.e., name, SP ID, age, etc.). Confirm the name and check the age and sex to ensure you have the correct SP. Click OK to proceed with the exam.

4.1.1 General Screen Information

All the component screens have similar characteristics. As shown below, at the very top of the screen is a Title bar, with the component name (Vision Subsystem), the Stand number, Session number, and the date and Session times. The Menu bar is just below the title bar, and the Standard toolbar icons are below the Menu bar. The Standard toolbar contains a row of buttons that provide shortcuts to menu commands as well as some other features. The Menu and Standard toolbars are described in the MEC Subsystem Overview.

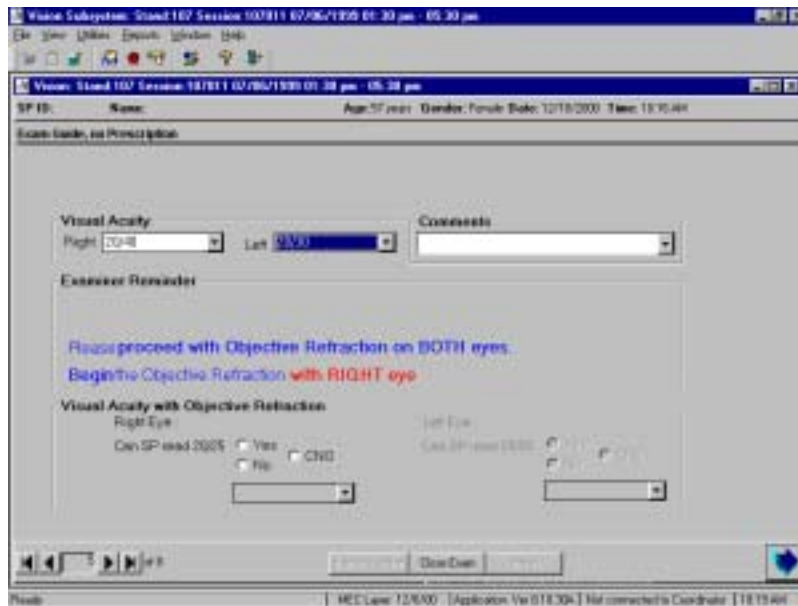

Just below the Standard toolbar is a second Title bar. This Title bar identifies the exam (Vision Exam). Below the Title bar is the SP ID, name, age, gender, and the current date and time. Below this bar, at the top left of the main area of the window is the screen name.

At the bottom left side of the screen is a screen number with a set of VCR arrow buttons on each side. These buttons help you navigate through the screens. The button on the far left moves you to the first screen. Likewise, the button on the far right moves you to the last screen. The button directly to the left of the screen number moves you to the previous screen, and the button directly to the right moves you to the next screen. Clicking on the arrow button will move you through the screens. At the bottom of the screen in the middle are two buttons, “Close” and “Finish,” and to the far right is a large arrow. Clicking on the large arrow will move you to the next screen.

The very first message you will get after logging in an SP is the **QC Checks not done** box.

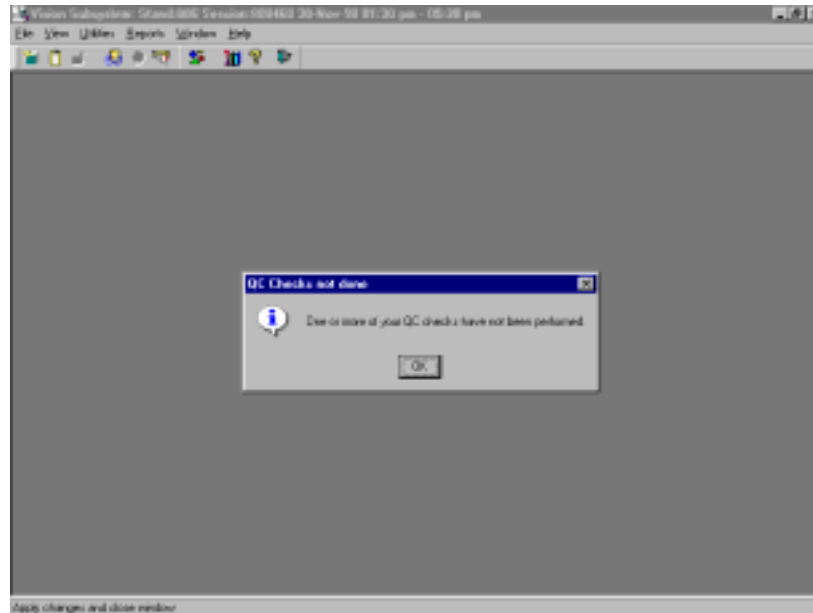

This box will continue to appear each time until the QC checks are completed in the automated ISIS system.

4.1.2 Medical Exclusion Screen

The **Medical Exclusion** screen is always the first data entry screen that will appear. There are two questions for the examiner.

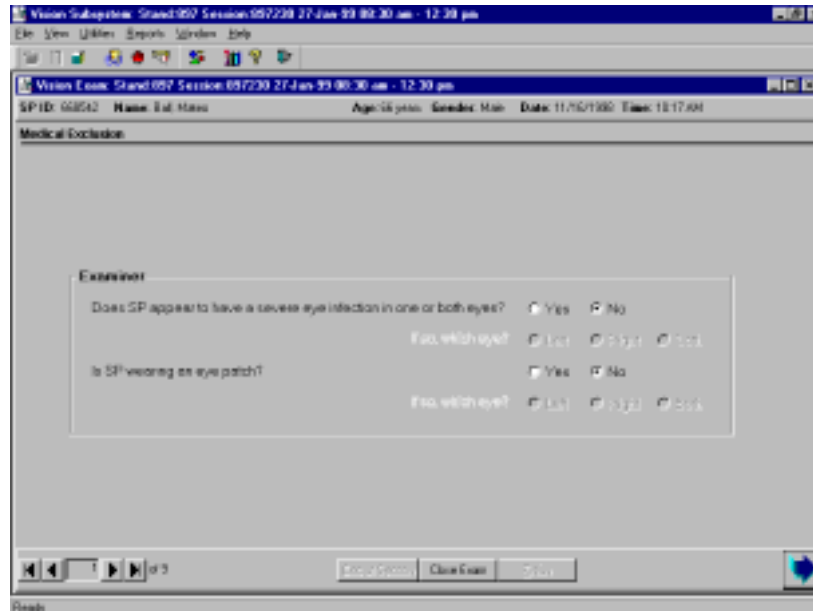

After you assess the possibility of an eye infection and indicate which eye, if any, answer the second question regarding whether the SP is wearing an eye patch. After the questions are answered, move the pointer to the large arrow and click to move to the next page.

4.1.3 Near Card Screen

For SPs aged 50 years and older, the **Near Card** screen is the next to appear. You have two questions to answer. The first question is asked directly of the SP; the second question you must assess (see Chapter 3 for details). After answering these questions, the Near Card measurement may be ascertained.

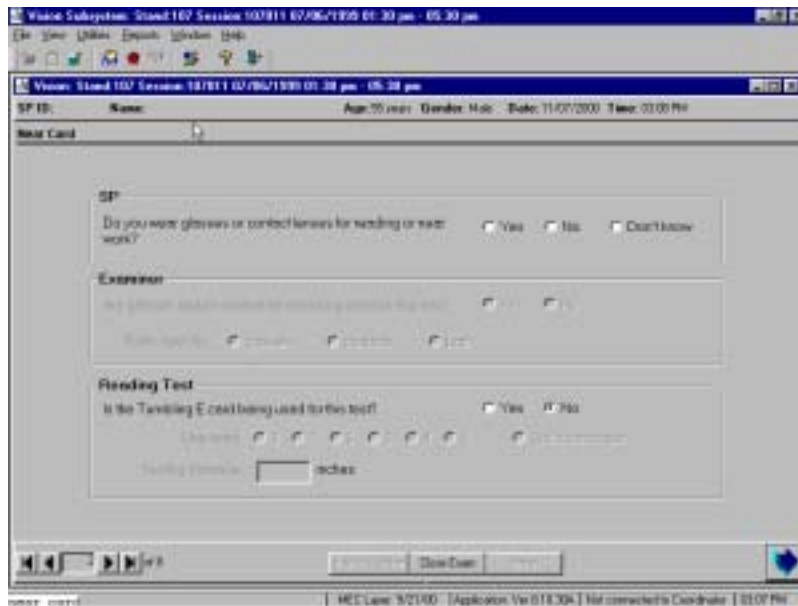

After conducting the Near Card test as specified in Chapter 3 (3.3.3), record whether or not the tumbling E card was used, click on the appropriate line read, and record the testing distance. If applicable, there is a ‘Could not obtain’ option.

This “CNO” option is for situations where the SP could not read the Near Card at any held distance, versus an SP who holds the card, at 16 inches, and “fails” to read line 1 (coded as “0” and “16 in”).

4.1.4 Exam Guide Questions

The **Exam Guide Questions** screen appears next, and is the second screen for SPs under 50 years of age (SPs <50 years are excluded from the Near Card exam). There are two boxes which contain questions. In the first box are questions asked of the SP, while the examiner must answer the question in the second box.

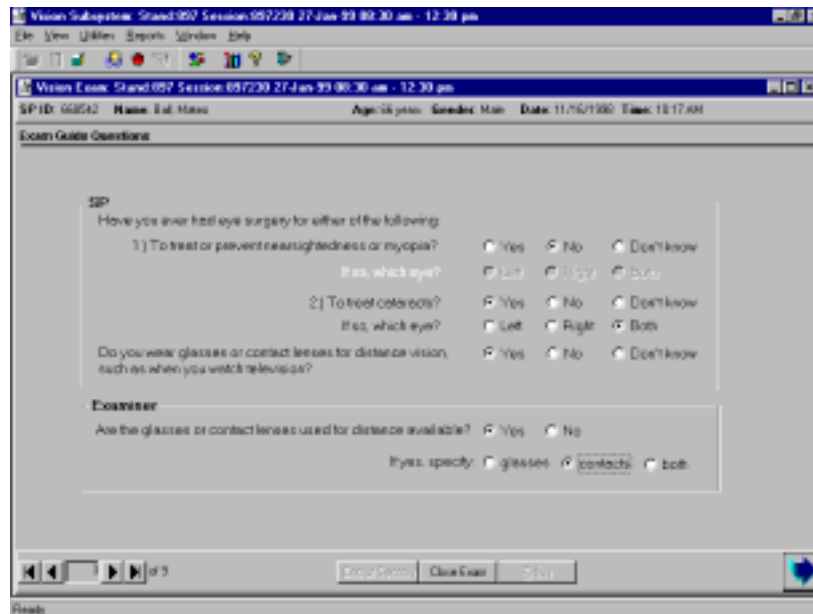

When you click the arrow key to move to the next screen you will see the following reminder:

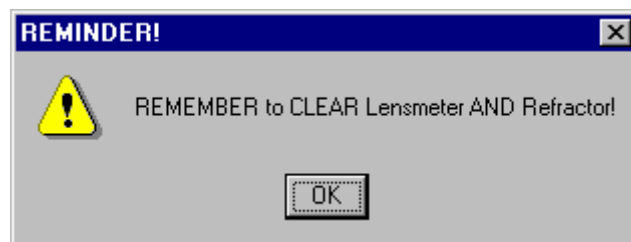

Click “OK” after you have cleared each instrument. To clear the lensmeter, press the clear button. To clear the refractor, turn the unit off, wait 5 seconds and turn it back on.

4.1.5 Exam Guide Screen

The next screen is dependent on what the SP has answered for the Exam Guide Questions. There are four possibilities: **Exam Guide, no Prescription, Exam Guide with Glasses, Exam Guide, with Contacts**, and **Exam Guide with Glasses and Contacts**. All these screens are similar; however, they follow different skip patterns.

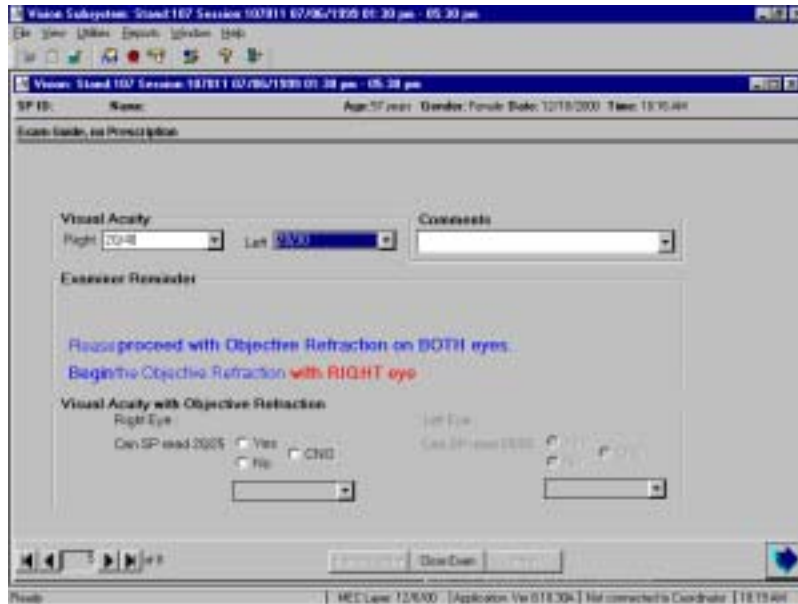

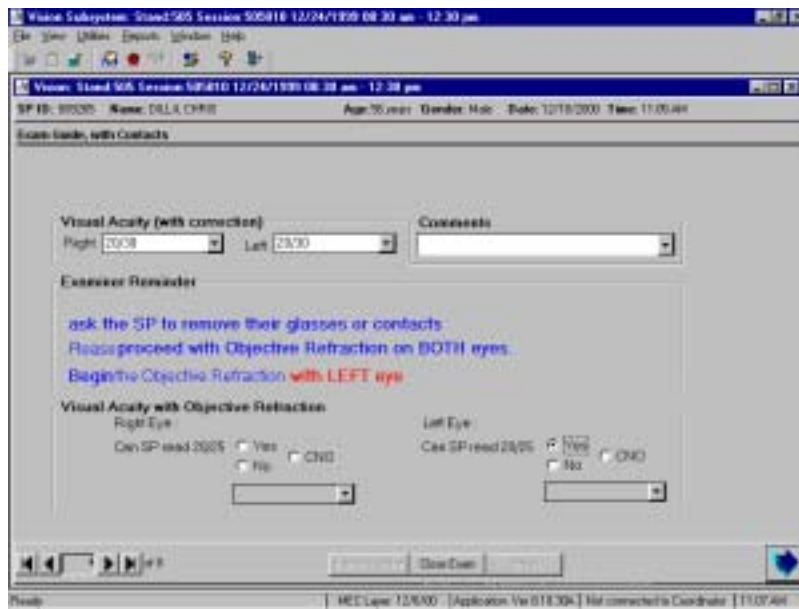
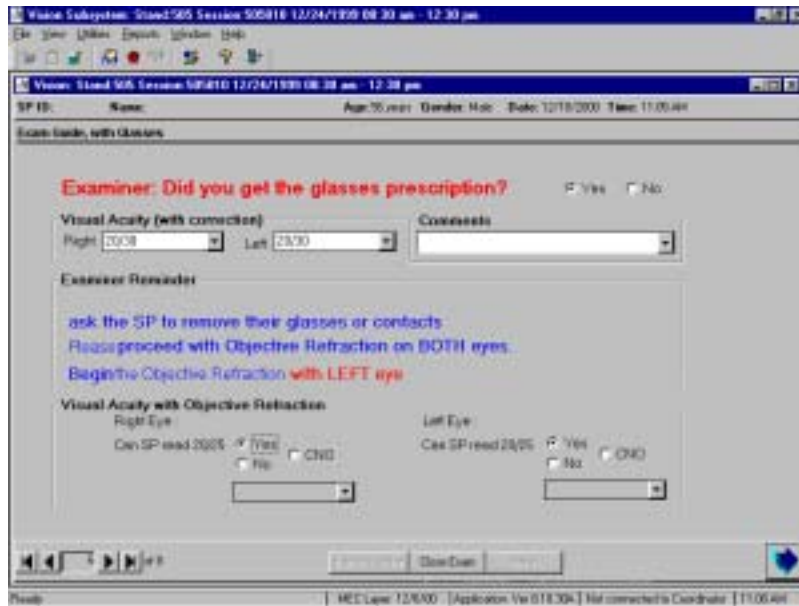



Note that this screen provides you with a guide for conducting the exam. It simply prompts you to conduct certain tests based on the data you enter during the course of the exam. Since the refractor is able to capture most of the necessary data, this screen is not designed strictly for data entry purposes.

After you have completed all portions of the exam, click on the arrow key to proceed with capturing the data. The following message will appear:

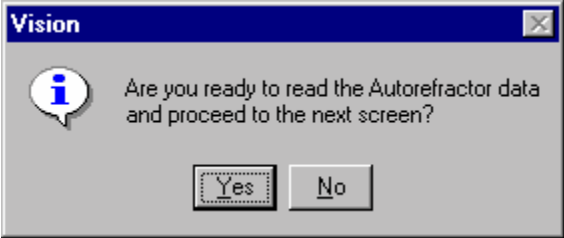

Click "Yes" to transfer the data.

Once the data has successfully transferred you will see the following:

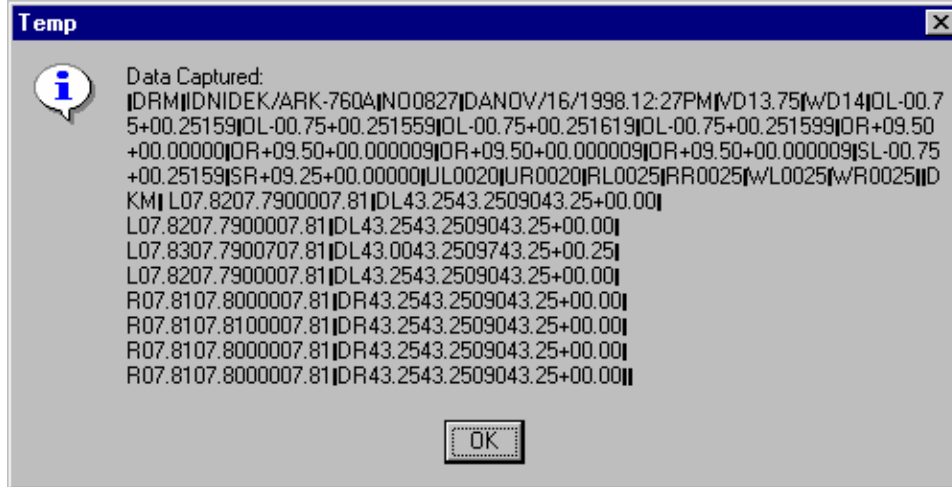

Click "OK" to move on.

4.1.6 Objective Refraction Manual Entry

If the refractor is not correctly sending data to be captured by the computer, a pop-up message will appear asking if you would like to try again. Click on “Yes,” and make a second attempt. If the data still does not capture, you will receive another pop-up message telling you to print the tape from the refractor. If you used the lensmeter and that data is not on the refractor tape, print the lensmeter tape as well.

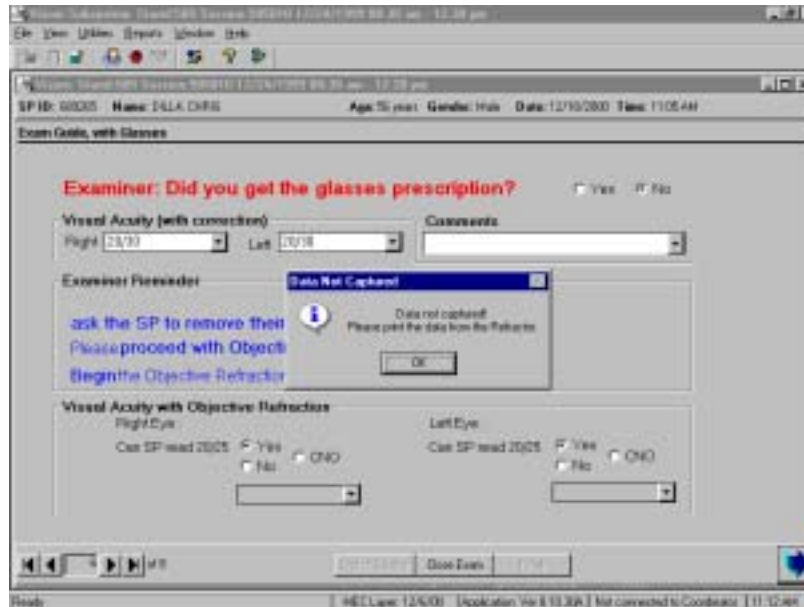
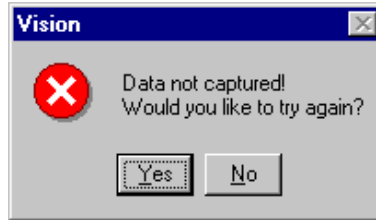

4.1.7 Pop-up Messages and Comments Options

If you fail to answer a question or complete part of the exam, a pop-up message will remind you to answer the question or finish the slide.

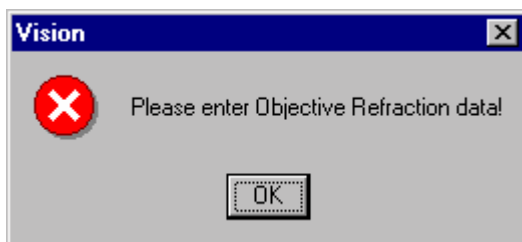
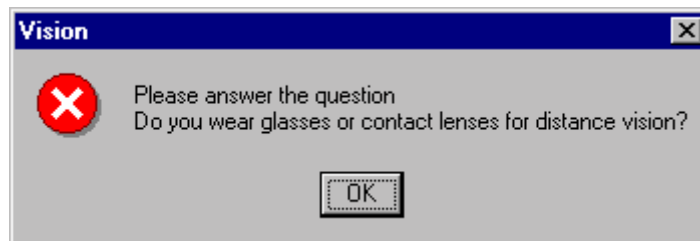
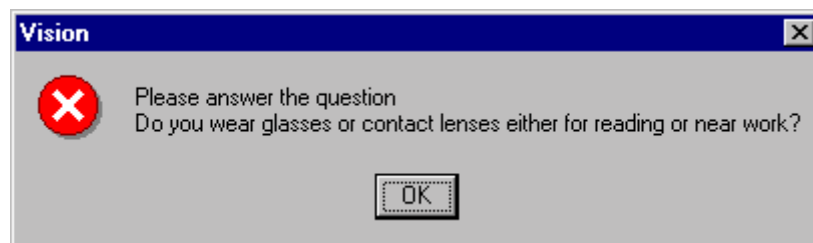
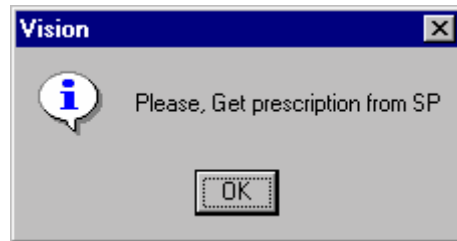

Also note that on the Exam Guide screens you may choose one of the following comments: Monovision glasses/contacts worn for VA; Cataract contact lenses worn for OR; Contacts worn for OR; Artificial eye; Monovision contacts worn for OR; Contact in right eye only for VA; or Contact in left eye only for VA.

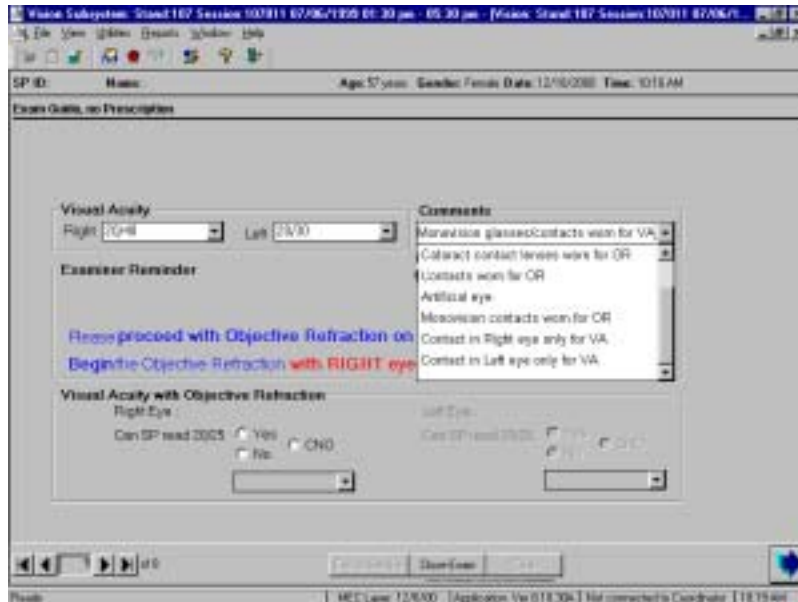

If the SP has monovision glasses or contacts (one lens for distance and one for near), please select that comment. Additionally, if an SP wears contacts after cataract surgery, they should be left in for the OR measurement, and the appropriate comment selected. If an SP is unable or unwilling to remove their contact or monovision lenses for the OR measurement, please select the appropriate comment. If an SP has a glass or artificial eye the Visual Acuity will be ‘could not obtain’ and the appropriate comment ‘artificial eye’ selected. Lastly, if an SP is wearing a contact lens in only one eye for the visual acuity, please select the appropriate comment to indicate which eye.

4.1.8 Vision Component Status Screen

The last screen displayed is **Vision Component Status**. This screen has three options: Complete, Partial, and Not Done. Additionally, there is a Comments box. If the exam is partial or not done, you are required to comment. Click on the down arrow to the right of the Comments box to make a selection. There are nine comments to choose from: safety exclusion, SP refusal, no time, physical limitation, eye specific limitation, communication problem, equipment failure, SP ill/emergency, or interrupted. Use the ‘eye specific limitation’ comment to reflect situations where you were unable to get OR data. You may also select the “Other, specify” comment. If you choose the “Other, specify” comment

you must enter text into the “Other text” field to describe the comment. The nine comments in the comment box should cover most of the comments you need to make. Note that “Eye Specific Limitation” is a comment designed only for this component. Examples include artificial eye(s), and cataracts. Only use the “Other, specify” comment if your comment does not fit into one of the defined comments. Be as **brief** as possible when you type your comment in the “Other text” field.

NOTE: Please make a printout of both the lensmeter and refractor data if the examination is Partial.

When you have completed this screen, click on **Finish** to close the exam. Then escort the SP to the next exam or to the coordinator.

Vision Exam: Stand: 097 Session: 097230 27-Jan-09 09:36 am - 12:30 pm

SP ID: 12870 Name: Douglas, Only Age: 55 years Gender: Female Date: 11/16/1990 Time: 11:15 AM

Vision Component Status

Status

Complete

Partial

Not Done

Comments

Other text

Previous Next Finish

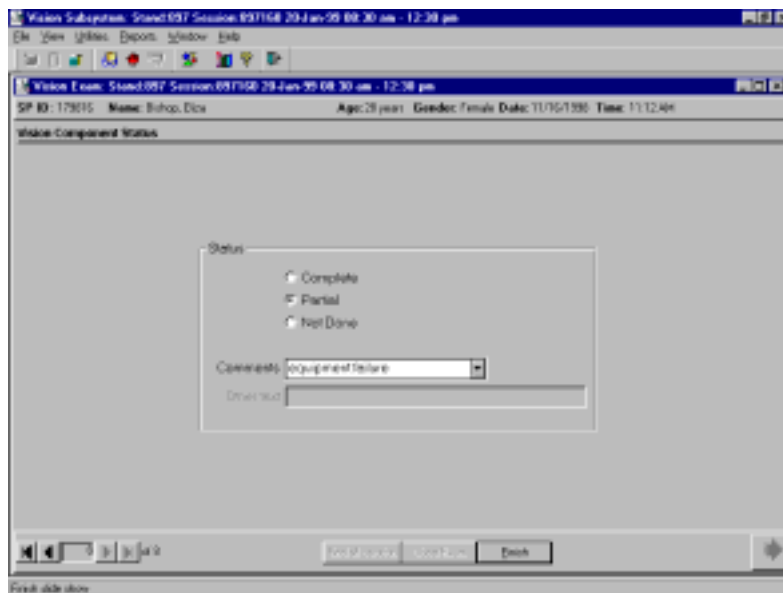

6. SAFETY ISSUES

SPs who are unable to see light with both eyes open or have severe eye infections are excluded from this exam. SPs who are unable to sit up for the examination may also be an issue. Notify the coordinator or MEC manager if this situation occurs.

Appendix A

Examples of Eye Infections



(1) Acute conjunctival chemosis.
Excluded from vision exam.



(2) Acute anterior cellulitis.
Excluded from vision exam.

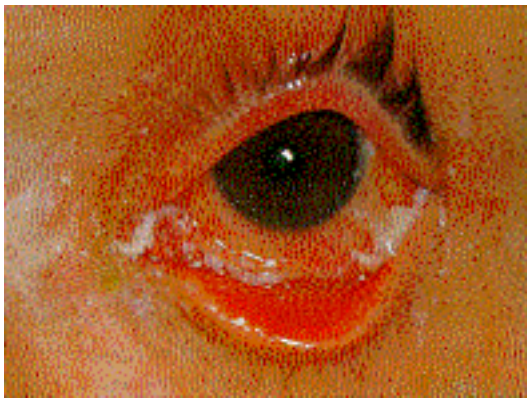

(3) Acute conjunctivitis.
Excluded from vision exam.



(4) Acute chalazion of the upper eyelid and an associated *preauricular adenopathy*.
Included in vision exam.

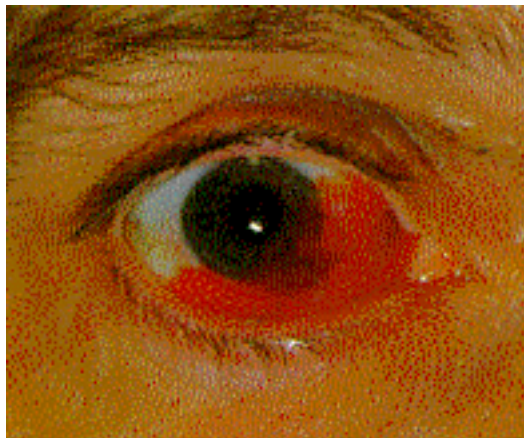

(5) Subconjunctival hemorrhage. Most are spontaneous and require no treatment or diagnostic studies.
Included in vision exam.

St. Louis, Missouri

Appendix B

Example of Data Items Captured

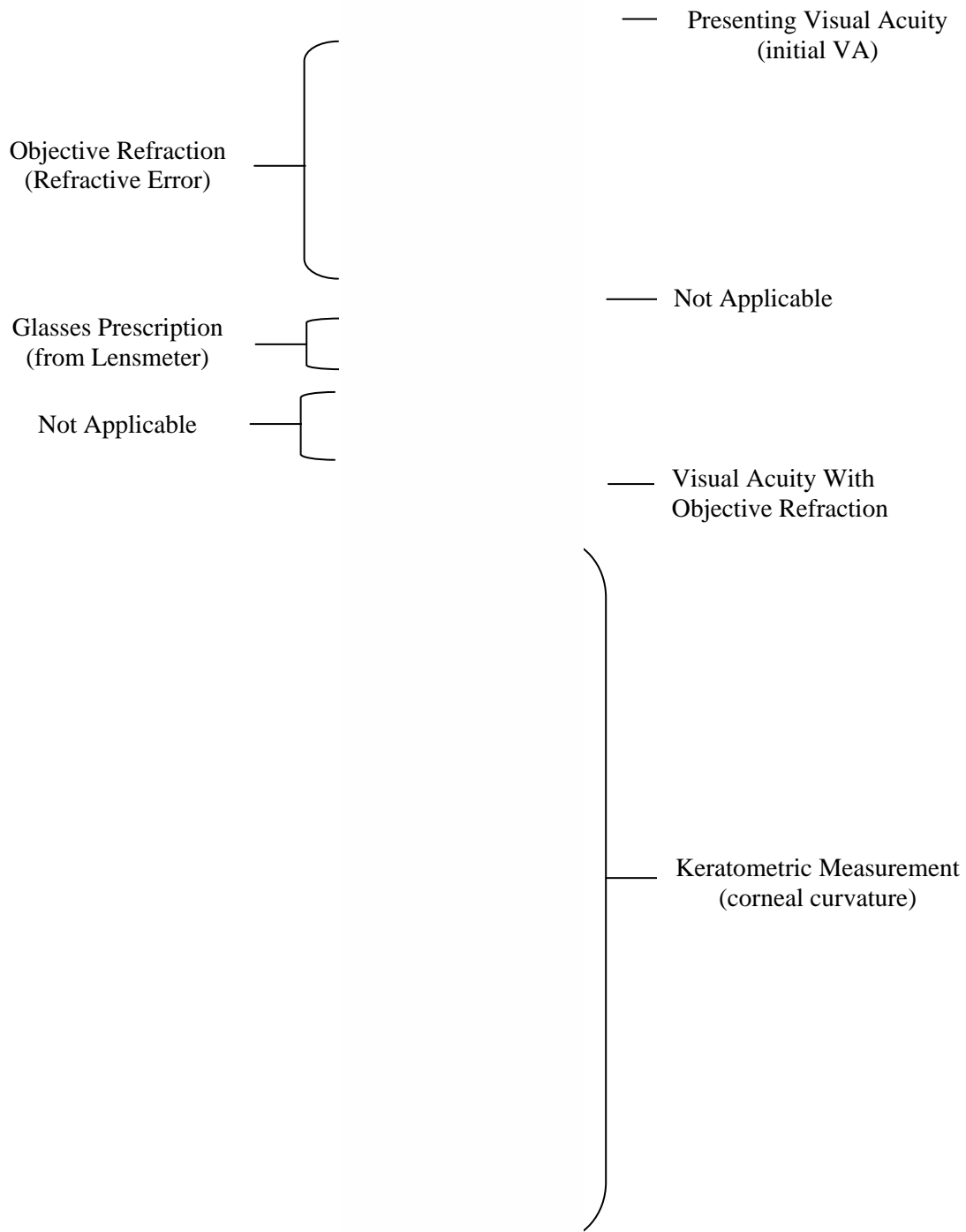

Appendix C

Vision Report of Findings



National Health and Nutrition Examination Survey

Final Report of Findings

Vision

We have done a quick check of your vision today. Our exam is not as precise as an eye exam done by an eye doctor. These values may differ from a vision exam you may have by an ophthalmologist, optometrist, or optician.

With glasses:

In your right eye your distance vision is **20/25**.

If your left eye your distance vision is **20/20**.

This is a good level of vision. We have not done a full eye examination, so you should continue your usual schedule of periodic examinations by your eye doctor.



National Health and Nutrition Examination Survey

Final Report of Findings

Vision

We have done a quick check of your vision today. Our exam is not as precise as an eye exam done by an eye doctor. These values may differ from a vision exam you may have by an ophthalmologist, optometrist, or optician.

Without glasses:

In your right eye your distance vision is **20/50**.

If your left eye your distance vision is **20/80**.

This level of vision is not as good as most people's. If you were not already aware of this, you should see an eye doctor to see if he/she can improve your vision. Your eye doctor can also provide you with a full eye examination.

Appendix D

Standard Glasses Rx

STANDARD GLASSES R_x

	Right lens			Left lens		
	Sphere	Cyl.	Axis	Sphere	Cyl.	Axis
Pair #1	+1.50	+1.00	90	-2.50	+1.00	90
Pair #2	+1.50	+3.50	45	-5.00	+3.50	45
Pair #3	+3.00	+1.00	180	-4.00	+1.00	180
Pair #4	+3.00	+3.50	125	-6.50	+3.50	125

Tolerance range for Sphere and Cylinder is + or - .25 D

Tolerance range for Axis is + or - 3 degrees

Appendix E

Vision Equipment Log

VISION EQUIPMENT LOG

MEC #1

Equipment	Serial #	Govt. #	Color Code
Refractor	30006	046687	Red
Lensmeter	22094	046038	Red
Table	-----	046681	Red
Test eyes	231	088245	Red
Test glasses	None	None	Red
Tape measure	None	None	Red
Near Card	None	None	Red
Penlight	None	None	Red
Blower Brush	None	None	Red

MEC #2

Equipment	Serial #	Govt. #	Color Code
Refractor	30103	046676	Blue
Lensmeter	23002	046680	Blue
Table	-----	046682	Blue
Test eyes	219	046665	Blue
Test glasses	None	None	Blue
Tape measure	None	None	Blue
Near Card	None	None	Blue
Penlight	None	None	Blue
Blower Brush	None	None	Blue

MEC #3

Equipment	Serial #	Govt. #	Color Code
Refractor	30102	046677	Yellow
Lensmeter	22419	046679	Yellow
Table	-----	046683	Yellow
Test eyes	233	088244	Yellow
Test glasses	None	None	Yellow
Tape measure	None	None	Yellow
Near Card	None	None	Yellow
Penlight	None	None	Yellow
Blower Brush	None	None	Yellow

Warehouse Set

Equipment	Serial #	Govt. #	Color Code
Refractor	30104	046675	Green
Lensmeter	23001	046678	Green
Table	1064	046039	Green
Test eyes	218	046666	Green
Test glasses	None	None	Green
Tape measure	None	None	Green
Near Card	None	None	Green
Penlight	None	None	Green
Blower Brush	None	None	Green

Appendix F

Overview of Vision Procedures with Scripts

OVERVIEW OF VISION PROCEDURES WITH SCRIPTS

(ENGLISH VERSION)

1. Log in to Component and Wand SP into ISIS.

2. Introduction to Component

There is no standard script. The introduction should include the information in the suggested scripts below. See Section 3.2.1 for more details and responses to possible questions from SPs. Remember that this is not a substitute for an eye examination performed by an ophthalmologist and the exam does not check for glaucoma.

Suggested introduction for SPs 12 -49 years:

“For this component we are interested in how well you can see far away. We are also interested in the shape of your eyes. Additionally, we would like to test your glasses, if you have them, to learn more about your prescription.”

Suggested introduction for SPs 50 years and older:

“For this component we are interested in learning how well you can see close up and how well you see far away. We are also interested in the shape of your eyes. Additionally, we would like to test your glasses, if you have them, to learn more about your prescription.”

3. Equipment Set-up

Clear Lensmeter & Auto-refractor.

Press VA Chart button.

Set whole VA chart to 20/50 line for both right and left eye.

4. Medical Exclusion Questions

Eye infection or eye patch

5. Vision test for near vision (reading) ***** SPs 50 years and over only:***

Near Card

Suggested script for SPs 50 years and older:

“Do you have the glasses and/or contacts you use for near vision with you today? If so please wear them for this test.”

To perform the near vision test the tech says:

“Please hold this card at a comfortable distance where you can read it. I am going to measure this distance with this tape measure.”

a. If using the near card, say:

“Keeping the card at this distance, please read the numbers on this chart starting with the top row from left to right, slowly. Try to keep both eyes open and do not squint.”

b. If using the tumbling E card say:

“Please tell me the direction the open part of the “E” is facing, starting on the top row and moving from left to right.”

6. Exam Guide Questions

Determine if SP has had eye surgery for myopia (nearsightedness) or cataracts.

Determine if SP wears glasses or contacts for distance vision.

Determine if glasses or contacts are available for this test.

OVERVIEW OF VISION PROCEDURES WITH SCRIPTS (ENGLISH VERSION)

7. Measure prescription of glasses (used for distance vision)

Get lensmeter readings.

Suggested script (if applicable):

“I would like to get your glasses prescription. May I have your glasses for a moment?”

8. Visual Acuity Measurement with Distance Correction (with glasses or lenses)

Enter VA in ISIS.

Leave Auto-Refractor at correct VA setting.

(ISIS VA entry and setting on Auto-refractor should be the same).

Select appropriate comment if needed (See Section 4.1.7).

If the SP stated that he or she wears correction for distance vision, the tech asks:

“Do you have the glasses and/or contact lenses you use for distance vision with you today? If so, please wear them for this test.”

To perform the visual acuity test the tech says,

“Let’s check your visual acuity. Please place your chin on the chin rest with your forehead touching the bar or forehead rest. Keep both eyes open and do not squint. The screen may appear blurry for a few moments. Then I will ask you to read it to me as best you can. Please note that there may be numbers and letters on the screen.”

“Please read the numbers and/or letters on this chart slowly, starting from left to right.”

As the tech moves down the chart line by line they say:

“And this line please?”

9. Automated Objective Refraction Measurements

Have SP remove glasses or contact lenses.

Move Auto-refractor to same start eye as specified for VA on ISIS screen.

Press Scenery Chart Button.

If the SP has glasses or contacts for distance vision only (not for cataracts) the tech says,

“For this next part of the exam, please remove your glasses/contacts (which ever applies).”

The SP can remove the lenses in the vision room or at the sink in the hallway. They may also wish to wash their hands in the sink in the hallway before removing their lenses. Additionally, we have disposable contact lens cases as well as saline solution for the SPs. The SP is asked,

“Now I’d like to measure the shape of your eyes. Again, please place your chin on the chin rest with your forehead touching the bar or forehead rest. The screen may appear blurry for a few moments. Once it is in focus you will see a hot air balloon on the screen. I’d like you to focus on the balloon. Please blink a few times for me while I focus your eye. When you hear a beep the test will begin; try not to blink for me at that time.”

OVERVIEW OF VISION PROCEDURES WITH SCRIPTS

(ENGLISH VERSION)

10. Visual Acuity with Objective Refraction

Done on SPs if visual acuity with correction is worse than 20/25.
SP should remove glasses or contact lenses (if willing).

Suggested script:

“Please read this line slowly from left to right. Remember that you may see both numbers and letters on the screen.”

11. Component Status

12. Clean headpiece & chin rest with alcohol swab while waiting for SP to be assigned to next component.

OVERVIEW OF VISION PROCEDURES WITH SCRIPTS

(SPANISH VERSION)

1. Log in to Component and Wand SP into ISIS.

2. Introduction to Component

There is no standard script. The introduction should include the information in the suggested scripts below. See Section 3.2.1 for more details and responses to possible questions from SPs.. Remember that this is not a substitute for an eye examination performed by an ophthalmologist and the exam does not check for glaucoma.

Suggested introduction for SPs 12 -49 years:

“Para este componente estamos interesados en saber qué tan bien puede ver usted de lejos. También estamos interesados en la forma de sus ojos. Adicionalmente, quisiéramos examinar sus lentes, si usted los tiene aquí, para saber más acerca de su receta”.

Suggested introduction for SPs 50 years and older:

“Para este componente estamos interesados en saber qué tan bien puede ver usted de cerca y qué tan bien puede ver de lejos. También estamos interesados en la forma de sus ojos. Adicionalmente, quisiéramos examinar sus lentes, si usted los tiene aquí, para saber más acerca de su receta.”

3. Equipment Set-up

Clear Lensmeter & Auto-refractor.

Press VA Chart button.

Set whole VA chart to 20/50 line for both right and left eye.

4. Medical Exclusion Questions

Eye infection or Eye patch

5. Vision test for near vision (reading) ***** SPs 50 years and over only*****

Near Card

Suggested script for SPs 50 years and older:

“¿Tiene usted aquí los (anteojos/lentes/espeuelos) y/o los lentes de contacto que usa para ver de cerca? Si es así, por favor póngaselos para esta prueba.”

To perform the near vision test the tech says:

“Por favor sostenga esta tarjeta a una distancia confortable donde usted la pueda leer. Yo voy a medir esta distancia con esta cinta de medir.”

a. If using the near card, say:

“Manteniendo la tarjeta a esta distancia, por favor lea lentamente los números que hay en este diagrama empezando en la línea de arriba de izquierda a derecha. Trate de mantener ambos ojos abiertos y no los entrecierre.”

b. If using the tumbling E card say:

“Por favor dígame hacia dónde está la parte abierta de la “E”, empezando en la línea de arriba y moviéndose de izquierda a derecha.”

6. Exam Guide Questions

Determine if SP has had eye surgery for myopia (nearsightedness) or cataracts.

Determine if SP wears glasses or contacts for distance vision.

Determine if glasses or contacts are available for this test.

OVERVIEW OF VISION PROCEDURES WITH SCRIPTS (SPANISH VERSION)

7. Measure prescription of glasses (used for distance vision)

Get lensmeter readings.

Suggested script (if applicable):

“Quisiera ver la receta de sus (anteojos/lentes/espejuelos). ¿Podría darme sus anteojos por un momento?”

8. Visual Acuity Measurement with Distance Correction (with glasses or lenses)

Enter VA in ISIS.

Leave Auto-Refractor at correct VA setting.

(ISIS VA entry and setting on Auto-refractor should be the same).

Select appropriate comment if needed (See Section 4.1.7).

If the SP stated that he/she wears correction for distance vision the tech asks:

“¿Tiene usted aquí los (anteojos/lentes/espejuelos) y/o los lentes de contacto que usa para ver de lejos? Si es así, por favor póngaselos para esta prueba.”

To perform the visual acuity test the tech says,

“Permítame revisar su agudeza visual. Por favor ponga el mentón en el lugar indicado con la frente tocando la barra. Mantenga los dos ojos abiertos y no los entrecierre. La pantalla posiblemente se verá borrosa por unos pocos momentos. Luego le pediré que me la lea lo mejor que usted pueda. Por favor fíjese que puede haber números y letras en la pantalla.”

“Por favor lea los números lentamente y/o las letras en este diagrama, empezando de izquierda a derecha.”

As the tech moves down the chart line by line they say:

“¿Y esta línea por favor?”

9. Automated Objective Refraction Measurements

Have SP remove glasses or contact lenses

Move Auto-refractor to same start eye as specified for VA on ISIS screen

Press Scenery Chart Button

If the SP has glasses or contacts for distance vision only (not for cataracts) the tech says,

“Para esta siguiente parte del examen, por favor sáquese los (anteojos/lentes/espejuelos)/lentes de contacto (which ever applies).”

The SP can remove the lenses in the vision room or at the sink in the hallway. They may also wish to wash their hands in the sink in the hallway before removing their lenses. Additionally, we have disposable contact lens cases as well as saline solution for the SPs. The SP is asked,

“Ahora quisiera medir la forma de sus ojos. Nuevamente, por favor ponga el mentón en el lugar indicado con la frente tocando la barra. La pantalla posiblemente se verá borrosa por unos pocos momentos. Una vez que esté enfocada usted verá un globo de aire caliente en la pantalla. Quiero que se concentre en el globo. Por favor pestañee unas cuantas veces mientras enfoco sus ojos. Cuando oiga un sonido empezará la prueba; trate de no pestañear en ese momento”.

10. Visual Acuity with Objective Refraction

Done on SPs if visual acuity with correction is worse than 20/25.
SP should remove glasses or contact lenses (if willing).

Suggested script:

“Por favor lea esta línea lentamente de izquierda a derecha. Recuerde que puede que vea tanto números como letras en la pantalla.”

11. Component Status

12. Clean headpiece & chin rest with alcohol swab while waiting for SP to be assigned to next component.

5. QUALITY CONTROL

A variety of quality control procedures have been chosen to ensure the accurate collection and documentation of reliable data. Quality control procedures for the vision component are described in this chapter.

5.1 Observation

At regular intervals, consultants from the review center will observe a sample of the vision examinations conducted in the MEC. They will observe whether the appropriate procedures and techniques are followed. Deviations from the standard procedures will be noted. Again this information will be used by the Director of MEC Operations to determine whether retraining is necessary.

5.2 Replication

A small percentage of SPs in each stand are asked to volunteer for complete replications of the entire MEC examination, in which case the vision examination will be repeated. Vision examinations will not be repeated as a separate quality control measure.

5.3 Refresher Sessions

Periodically, refresher sessions will be scheduled for all MEC staff to provide an opportunity for review of procedures as well as to confirm the consistency of procedures performed in the field.