

ADD CHP

Accelerated Development and Deployment of Federal Combined Heat and Power Projects

Keith Kline



**Oak Ridge National Laboratory
DOE Federal Energy Management Program
ACEEE Summer Study on Energy Efficiency in Buildings
August 20, 2002**

Presentation Outline

- **FEMP?**
- **Why CHP in Federal Sector**
- **Federal Market Assessment for CHP**
- **FEMP Services– ADD CHP**
- **Screening for CHP potential**
- **Partnering for Success**



OAK RIDGE NATIONAL LABORATORY
U. S. DEPARTMENT OF ENERGY



Department of Energy, Federal Energy Management Program (DOE FEMP)

- **Mission: help agencies meet their mandates to reduce energy and water use.**

“To reduce the cost and environmental impact of the government by advancing energy efficiency and water conservation, promoting the use of renewable and distributed energy, and improving utility management decisions at Federal sites.”

Federal Agencies (in Aggregate) are on Track to Meet Their Site Energy Intensity Goals

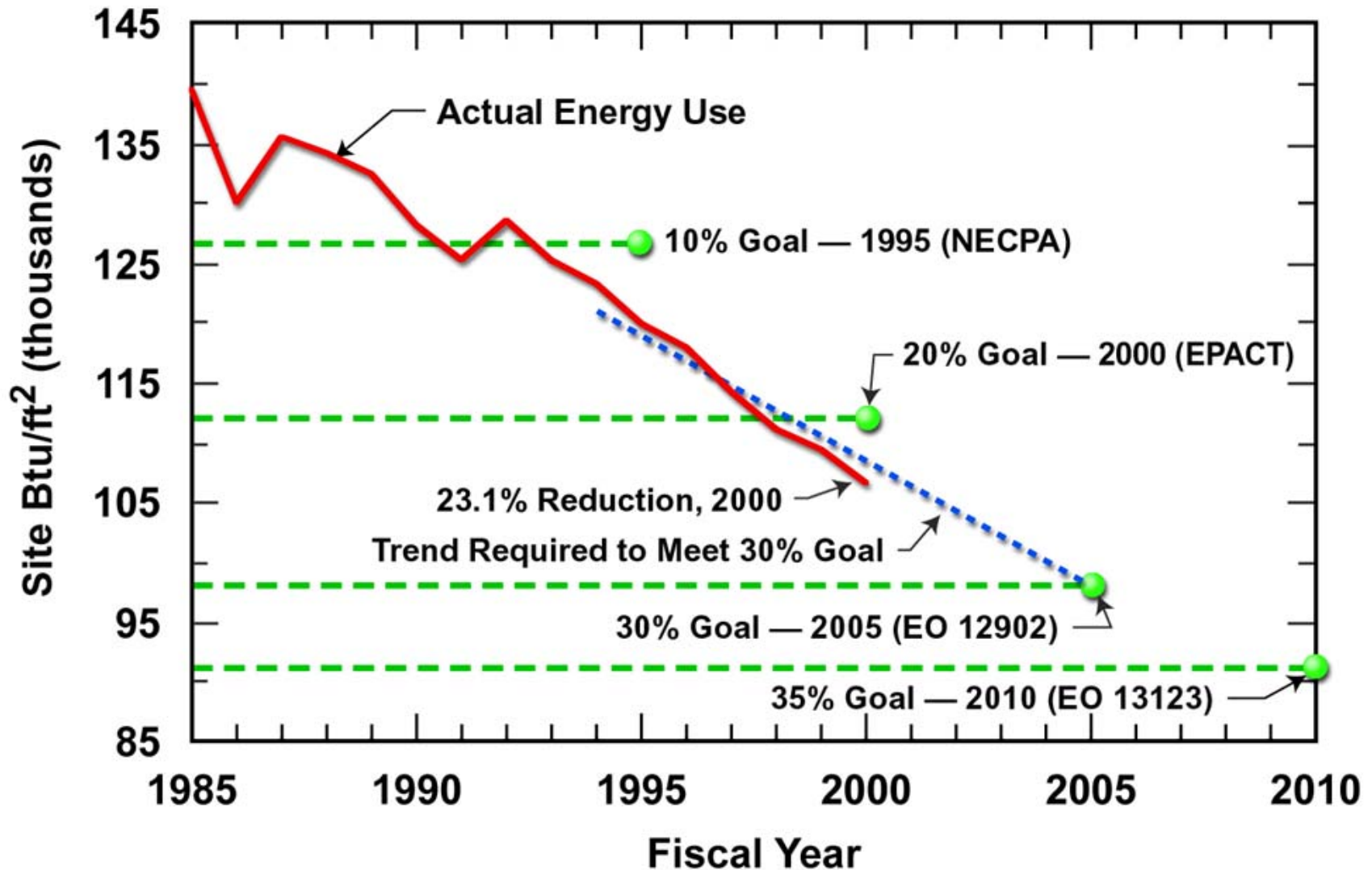

Why Distributed Energy?

- **Support Multiple Federal Goals**
 - **Increase Efficiency and Reliability**
 - **Reduce Costs & Emissions**
- **“Leadership by Example”**
 - **Establish Physical Infrastructure for Clean Technologies of Tomorrow (Hydrogen, Fuel Cells)**
 - **Increase Knowledge, Experience and Institutional Capability to Procure and Manage On-Site Power Systems**

What is CHP? Producing electricity on-site and using waste heat for productive purposes.

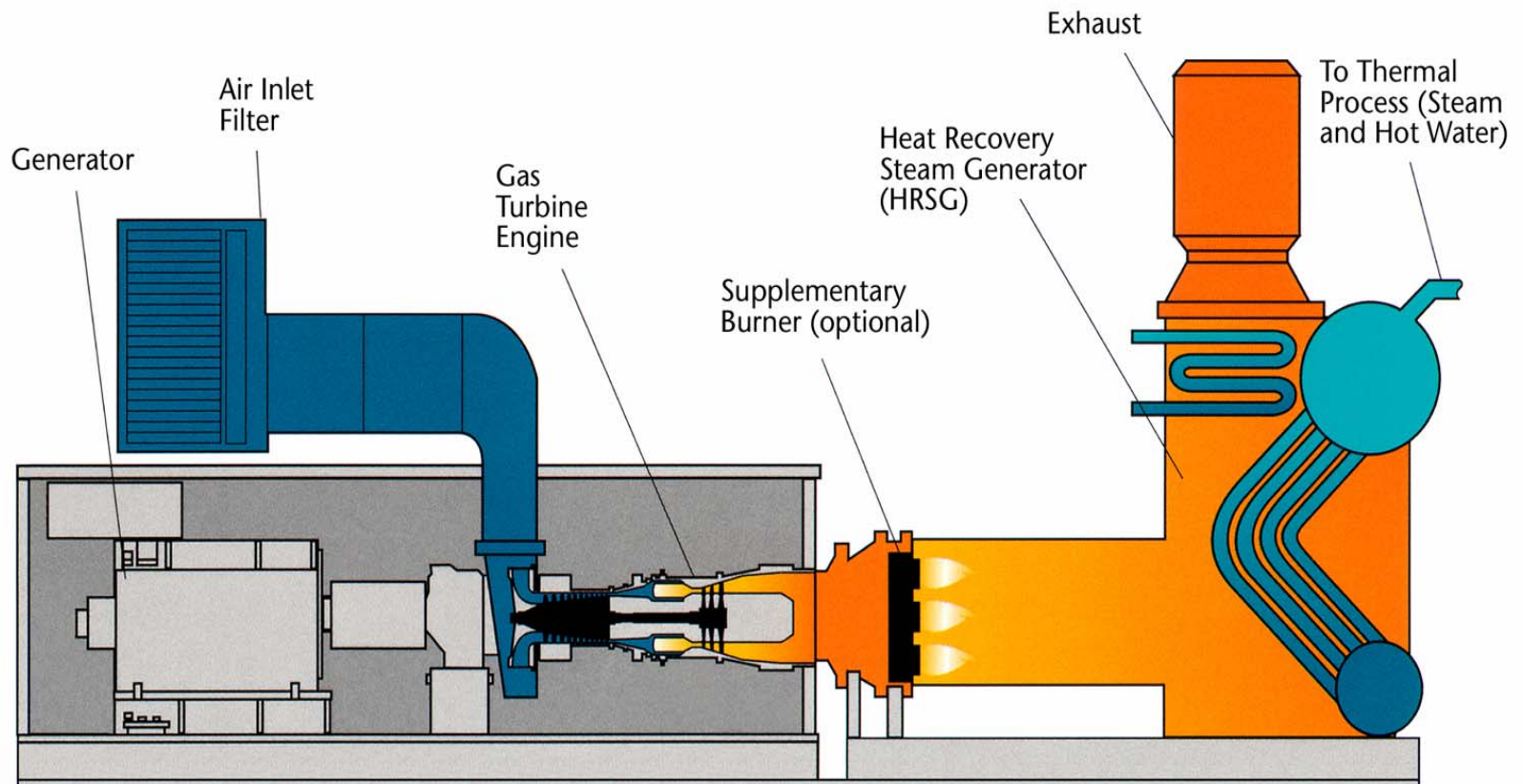

Why CHP?

- **More efficient form of DG-DER**
- **Commercially available today**
- **Proven but underutilized technologies**
- **Increase energy security**
- **Agencies interested— but process is not easy**

What is Federal CHP Potential?

- **Market Assessment of CHP at Federal sites (2002)**
 - Reports on FEMP & ORNL web sites
 - Full analysis online at www.ornl.gov/femp/pdfs/chp_market_assess.pdf
- **Base Case: Sites with simple payback in less than 10 years = 1500-1600 MW (gas Recip-ICE or Gas Combustion Turbine)**

CHP Potential--DOE Regions

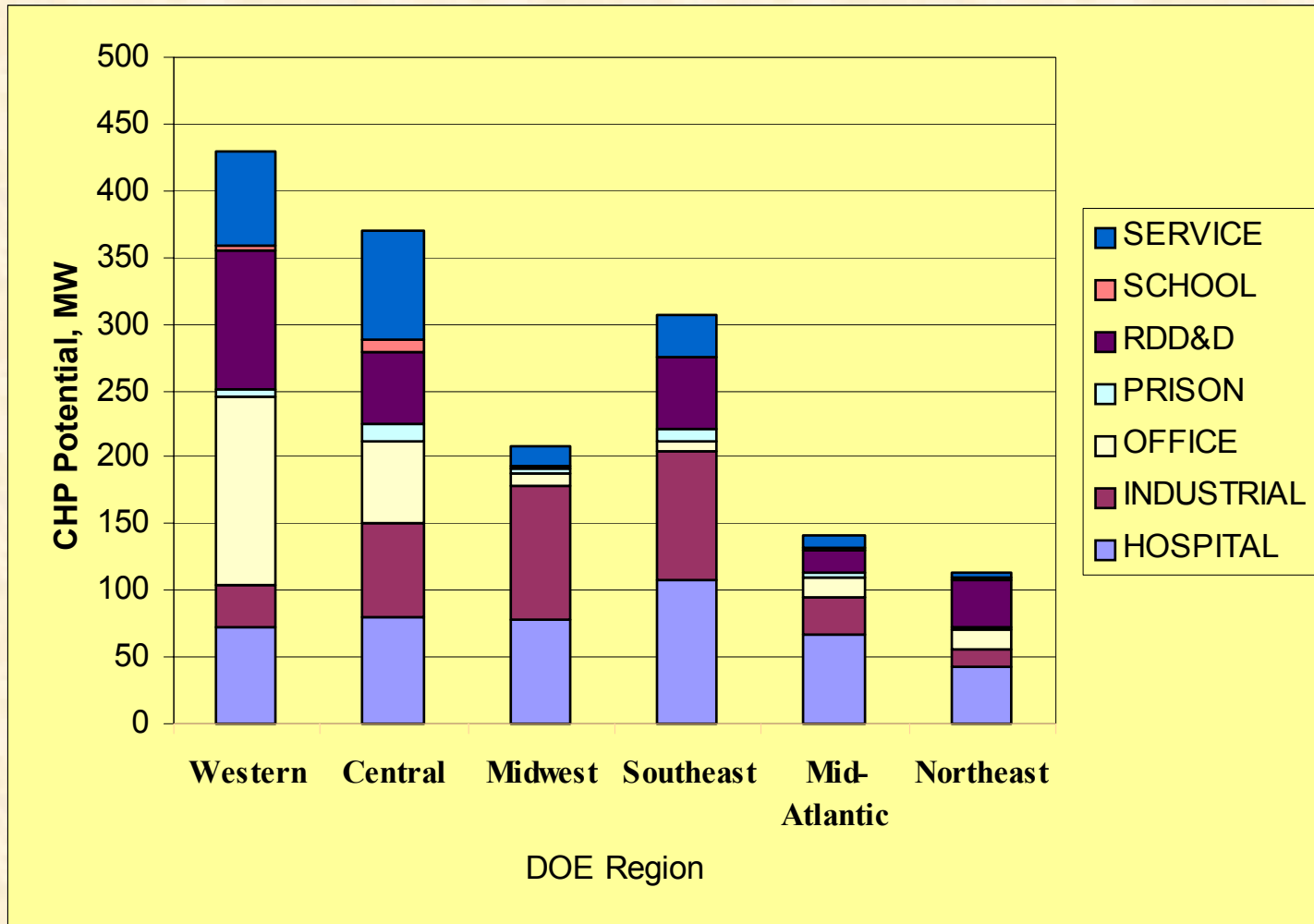

Assessment: 1570 MW of Federal CHP Offers:

- ✓ \$170 million/year in energy cost savings
 - ✓ Avg. return on investment <8 years
 - ✓ 50 trillion Btu/yr of source energy savings
 - ✓ 4 million metric tons/yr of avoided CO2
 - ✓ Increase reliability/security representing 13% of total federal electricity purchased for buildings (in fy 2000)
- e.g. this is significant!**



Factors Favoring CHP

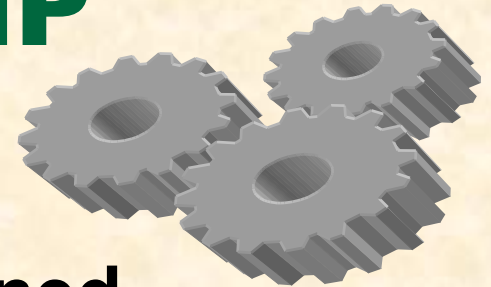

- **High electric rates**
- **Energy security upgrades planned**
- **Gas/alternate fuel available**
- **Thermal demand on site, follows electric load**
- **Compatible infrastructure (central heat and cooling systems)**
- **Large, steady thermal and electric loads**

Rules of thumb and Market Assessments –versus– How the market *really* works....

- **CHP project potential and development process is very *site-specific***
- **Agencies need financing but CHP is relatively new in the Federal financed-project market**
- **Partnering is vital for success**

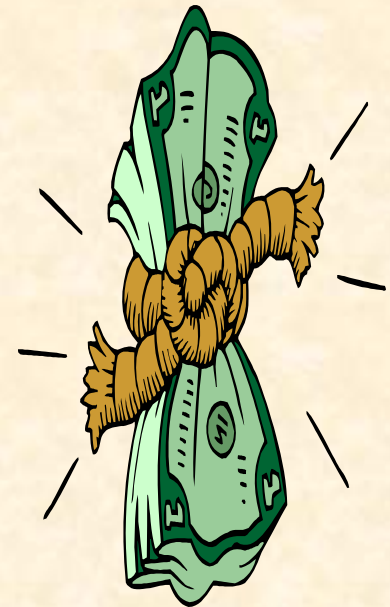

Federal Hurdles to DER-CHP

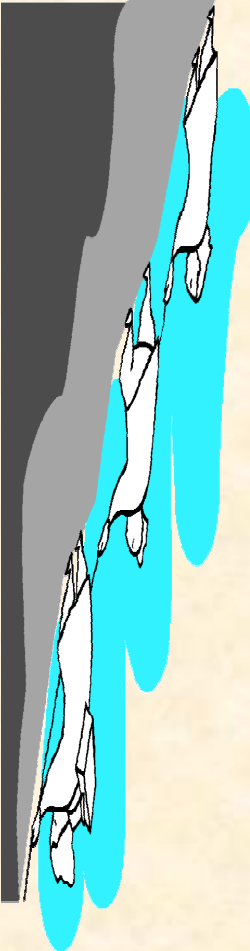
- 
- **Lack of reliable information on performance and costs**
 - **Uncertainties about rates; inter-connection and other costs**
 - **Large, complex projects involve many actors; require custom design**
 - **Permitting, siting, local red-tape**
 - **Staff turnover and budgets limit large, long-term projects**
 - **Prefer to avoid responsibilities of power business; concerns about O&M**

FEMP – “ADD CHP”

- **Accelerated Development and Deployment of Combined Heat and Power (CHP)**
- **Make proven CHP technology more accessible to the federal sector**



OAK RIDGE NATIONAL LABORATORY
U. S. DEPARTMENT OF ENERGY



FEMP CHP Strategy

- **Target assistance to address hurdles in federal sector**
 - **Build partnerships**
 - **Focus on markets with highest potential for success**
 - **Help interested agencies make informed DER-CHP decisions**
- ...move good projects to deployment**

Example: Outreach FEMP DER Workshops

- **Distributed Energy Workshops**
 - Case studies from federal sites:
all parties participate
 - Team federal energy managers with
potential private partners
- **Upcoming FEMP Workshops:**
 - Boston, October 23-25 with USCHPA
 - Los Angeles, Spring 2003
 - Orlando, Aug 17-20: Energy Security,
DG & CHP Track at Energy 2003



Other examples of ADD CHP Support to Federal Sites—

- Need estimate of CHP potential?
 - Quick Screening Service
- Need information on options and performance?
 - TA to agencies and project facilitators
- Need financing?
 - Assistance to identify potential partners



Free CHP Screening for Federal Sites

- **Site completes short excel data form**
 - Basic information on energy costs, use and existing equipment
- **FEMP sends report to site summarizing results of screening analysis**
 - CHP metrics, favorable and unfavorable
 - If/when is further study merited?



OAK RIDGE NATIONAL LABORATORY
U. S. DEPARTMENT OF ENERGY



Reports to agencies include graphic feedback

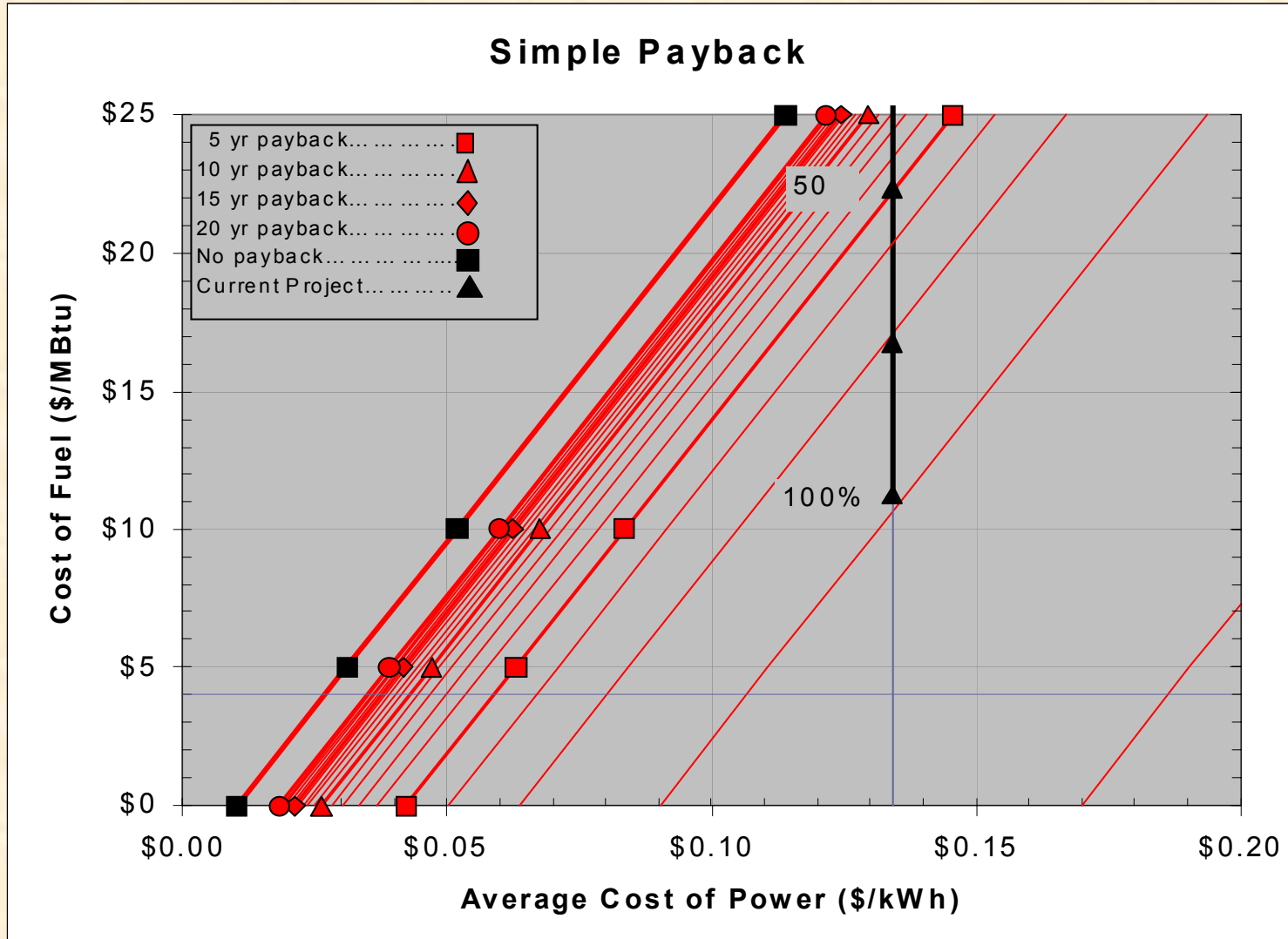

CHP Screening: Simple Payback Period for 96 Projects

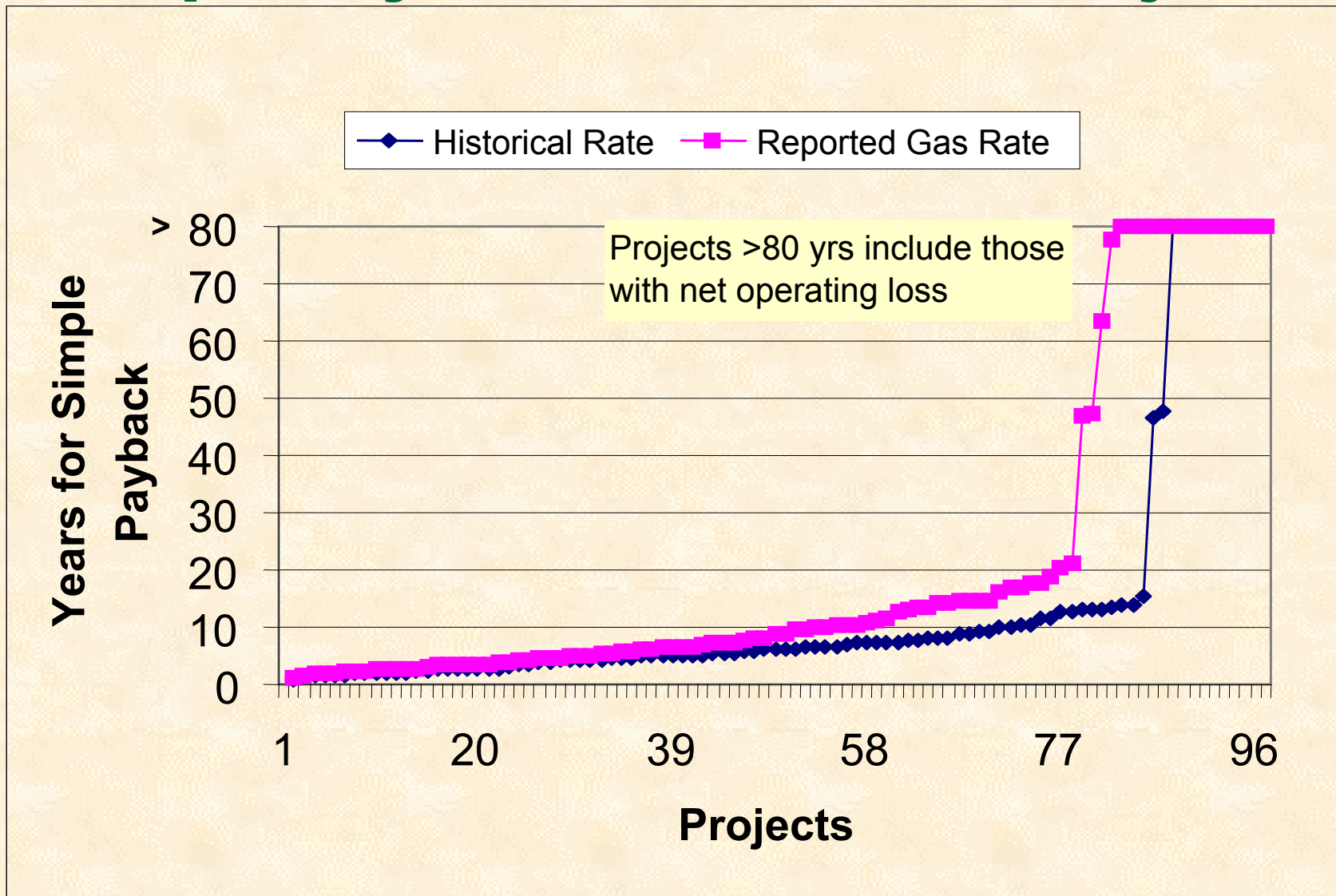

CHP Screening: Simple Payback Period for 96 Projects

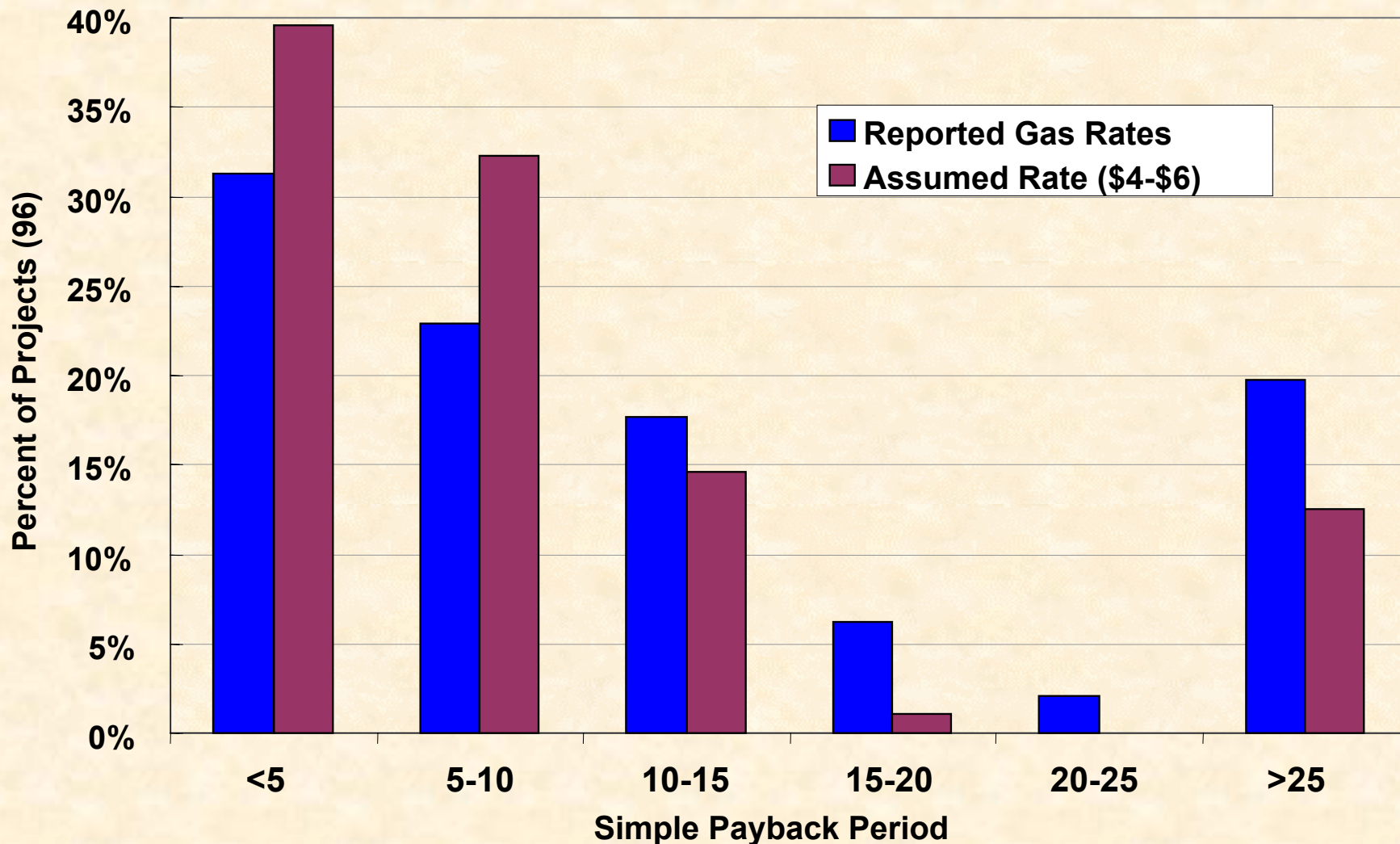

CHP Economics: Sensitive to Waste Heat Use

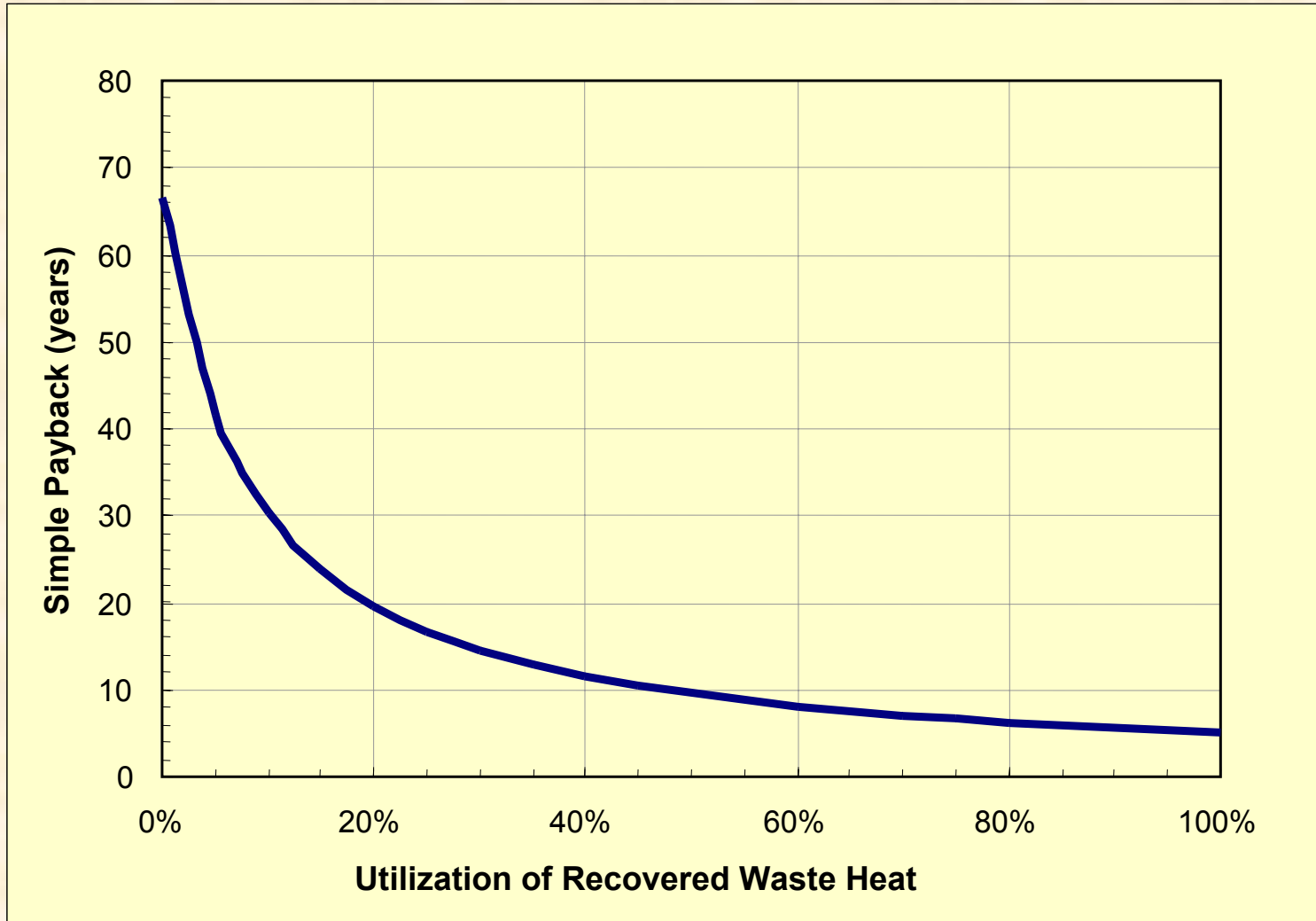

Screening Results:

- **Need to maximize use of waste heat**
- **Best opportunities are in large, energy intensive sites, hospitals, military bases**
- **Energy security/other upgrades improve economics**
- **Many Hurdles...**
- **Need partners to support next steps**

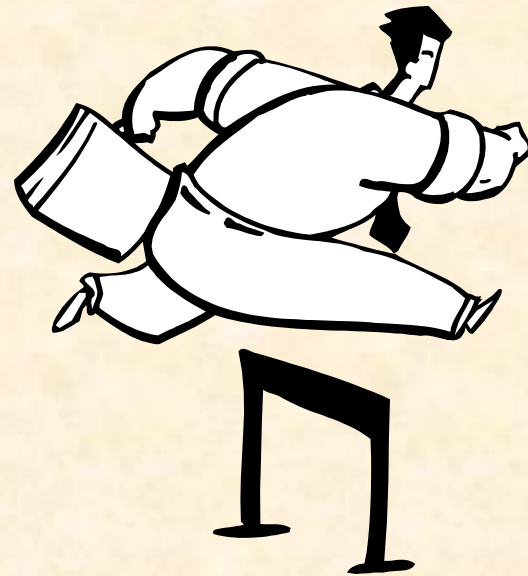

How Does Partnering Work?

- **Private partners are essential--**
promote, market, sell, finance,
implement
 - ESCOs and Utilities
 - CHP industry & associations (USCHPA, AGCC, IDEA, etc.)
- **FEMP**
 - provides assistance to identify and catalyze projects;
 - offers federal agencies unbiased technical assistance on equipment, design and financing to help agencies secure best-value projects

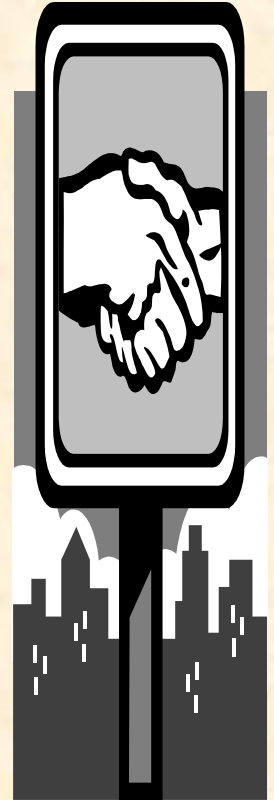

Federal Agencies Are Embracing CHP As Never Before

- *90 federal sites are studying, requesting assistance for, or actively developing CHP projects*
 - Secure, reliable power for mission support
 - Mitigate electric rate increases
 - Achieve energy/emission reduction mandates



Federal Agencies Where The CHP Action Is

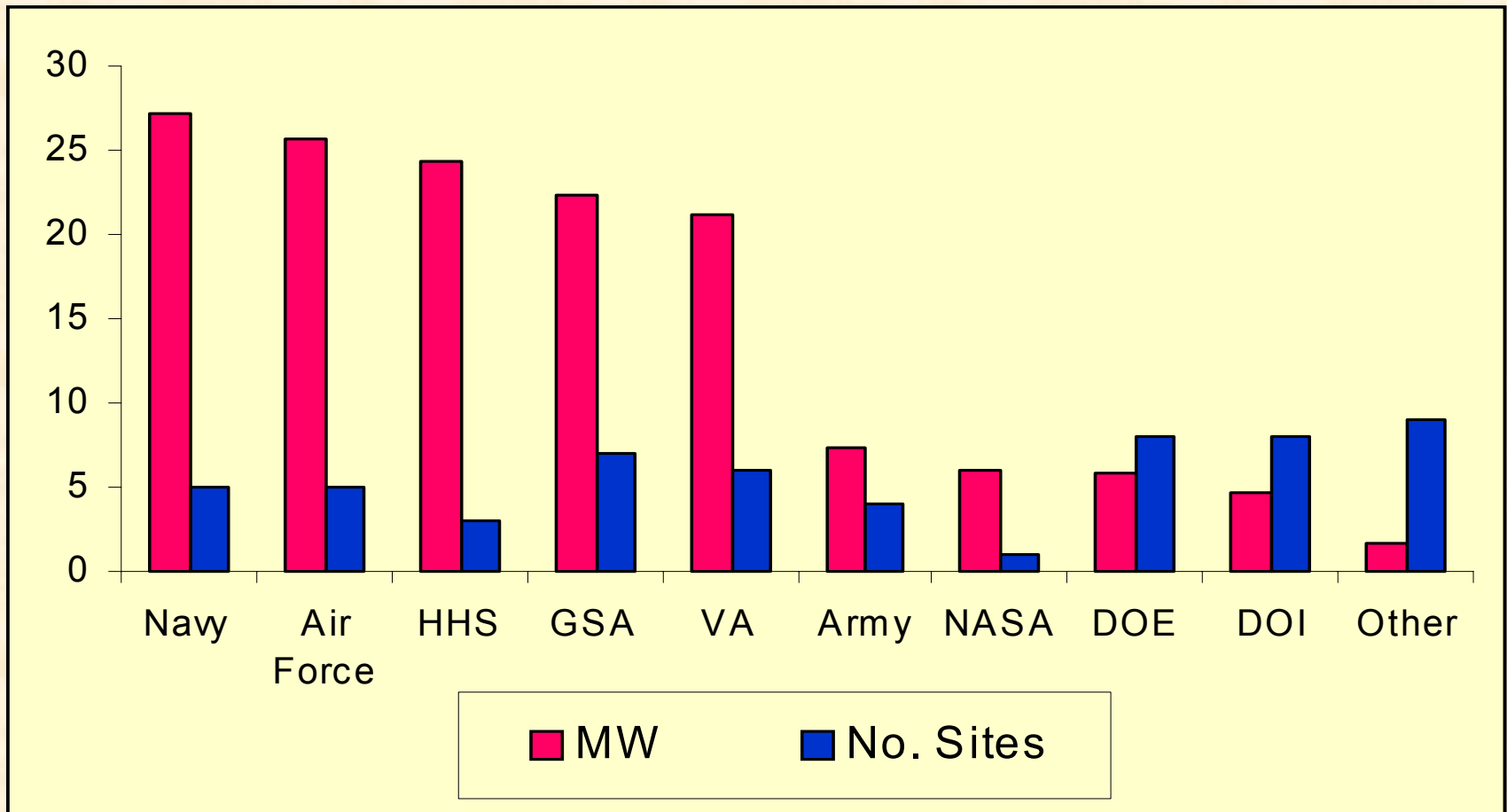

Summary: Partnerships and Financing Make CHP Projects Happen

FEMP's Team can help

- Determine if sites have CHP potential
- Identify private partners
- Understand technology options
- Ensure best-value configurations
- Avoid surprises

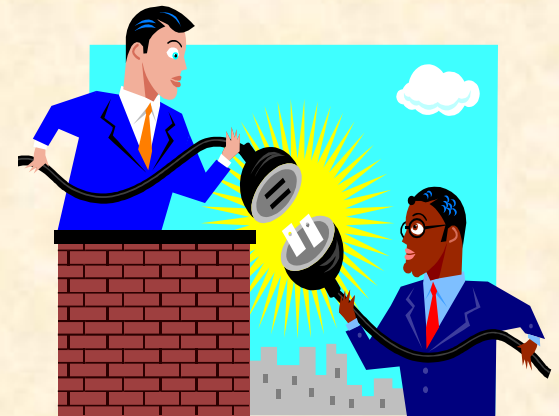

OAK RIDGE NATIONAL LABORATORY
U. S. DEPARTMENT OF ENERGY



Federal Support for CHP on the Web:

- Funding opportunities, Workshops, Case studies: http://www.eren.doe.gov/femp/techassist/der_resources.html
- CHP Screening form, “Analysis of CHP Potential at Federal Sites” (Market Assessment), etc at www.ornl.gov/femp/ or at
- DOE Websites-FEMP <http://www.eren.doe.gov/femp/>
Integrated Power Technologies and links: <http://www.eren.doe.gov/power/>



OAK RIDGE NATIONAL LABORATORY
U. S. DEPARTMENT OF ENERGY



FEMP CHP Contacts

- Regional DOE Offices:
http://www.eren.doe.gov/femp/financing/femp_services_who.html
- DER/CHP Programs at FEMP HQ:
Shawn.Herrera@ee.doe.gov (202) 586-1511
- Keith Kline, ORNL-FEMP “ADD CHP”
Coordinator, (865) 574-4230 Klinekl@ornl.gov