

EFFICACY OF ULTRAVIOLET IRRADIATION IN CONTROLLING THE SPREAD OF TUBERCULOSIS

Submitted to:

Centers for Disease Control and Prevention
National Institute for Occupational Safety and Health

PRINCIPLE INVESTIGATOR:

Shelly L. Miller^a

CO-INVESTIGATORS:

Mark Hernandez^b, Kevin Fennelly^c, John Martyny^d, Janet Macher^e

RESEARCH STAFF:

Elmira Kujundzic^b, Peng Xu^b, Patricia Fabian^b, Jordan Peccia^b, Cody Howard^a

REPORT DATE:

October 19, 2002

NIOSH CONTRACT NO.:

200-97-2602

^a Department of Mechanical Engineering, 427 UCB, University of Colorado, Boulder, CO 80309

^b Department of Civil, Environmental, and Architectural Engineering, 428 UCB, University of Colorado, Boulder, CO 80309

^c Division of Pulmonary Medicine, National Jewish Medical and Research Center, 1400 Jackson St., Denver, CO 80206

^d Tri-County Health Department, 4301 East 72nd Ave., Commerce City, CO 80022

^e Environmental Health Laboratory Branch, California Department of Health Services, 2151 Berkeley Way, Berkeley CA 94704

Acknowledgements

This research was supported by funds provided by the Centers for Disease Control and Prevention, National Institute of Occupational Safety and Health, contract # 200-97-2602, and the National Science Foundation, Grant # BES 00-734-1505.

We thank Dr. Janet Macher and Dr. Millie Schafer for guidance during this project. Dr. Ronald Rahn was instrumental in the characterization of UV irradiance levels in our test room. We thank Clyde Moss for helpful discussions as well as assistance with the selection and installation of the UVGI system. Adam Barker facilitated the *M. bovis* BCG experiments. We appreciate Charlie Dunn for assistance with the lamp installation and for his expertise in UVGI system design and manufacturing. The Joint Center for Energy Management provided essential equipment and operated the test facility.

Table of Contents

Acknowledgements	i
Table of Contents	ii
List of Figures	iii
List of Tables	iv
Executive Summary	v
Background	v
Objectives	v
Methods	vi
Results	vii
Conclusions	viii
1. Introduction	1
2. Materials and Methods	5
2.1 Culture Preparations	5
2.2 Test Facility	6
2.3 UVGI System and Photoreactivation Lamps	7
2.4 Airborne Bacteria Generation and Collection	10
2.5 Enumeration by Culturing and Epifluorescent Microscopy	10
2.6 UV Irradiance Measurement	11
2.7 Constant Generation Method Protocol	12
2.8 Decay Method Protocol	13
2.9 Experimental Scenarios	15
2.9.1 Constant Generation and Decay Experiments	15
2.9.2 Relative Humidity Experiments	15
2.9.3 UV Irradiance Experiments	17
2.9.4 Photoreactivation Experiments	18
2.9.5 Incomplete Mixing Experiments	18
2.10 Statistical Analysis and Error Propagation	19
3. Results	20
3.1 UV Irradiance Levels	20
3.2 Cell Concentration and Particle Size for Well-Mixed Conditions	23
3.3 Effectiveness of UVGI	24
3.4 UVGI Inactivation Rate (ACH_{UV})	25
3.6 Effectiveness of UVGI for Various RH Conditions	28
3.7 UVGI Inactivation Rate (ACH_{UV}) for Various RH Conditions	29
3.8 UVGI Inactivation Rate (ACH_{UV}) for Unevenly Distributed Irradiance	30
3.9 UVGI Inactivation Rate (ACH_{UV}) for Elevated levels of UV Irradiance	31
3.10 Effectiveness of UVGI under Photoreactivation Conditions	32
3.11 Effectiveness of UVGI for Incomplete Mixing Conditions	33
4. Discussion and Conclusions	34
5. References	40
6. Appendix I	A - 1
7. Appendix II	A - 8
7.1 Error Propagation for UVGI Equivalent Air-Exchange Rates	A - 8
7.2 Error Propagation for UVGI Effectiveness	A - 8
7.3 Error Propagation for Averaging Parameters	A - 9

List of Figures

Figure 1.	Configuration of 89 m ³ test room (plan view).....	8
Figure 2.	UVGI lamp output spectral distribution.....	9
Figure 3.	Spectral power distribution for lamps used in photoreactivation experiments	9
Figure 4.	Spatial distribution of ultraviolet irradiance measured using actinometry.....	22
Figure 5.	Vertical distribution of UV irradiance.....	22
Figure 6.	Effectiveness of UVGI-induced microbial inactivation.....	25
Figure 7.	Data from decay method experiments used to determine inactivation rates with ventilation rate of 0 air changes per hour.....	26
Figure 8.	Data from decay method experiments used to determine inactivation rates with ventilation rate of 3 air changes per hour.....	26
Figure 9.	Data from decay method experiments used to determine inactivation rates with ventilation rate of 6 air changes per hour.....	27
Figure 10.	UVGI-induced inactivation rate as a function of effective UVGI irradiance for 54 W to 216 W lamp power	27
Figure 11.	Effectiveness of UVGI-induced microbial inactivation varying RH	28
Figure 12.	Data from decay method experiments used to determine inactivation rates at 20, 50, and 90% relative humidity	30
Figure 13.	Data from decay method experiments used to determine inactivation rates induced by UVGI for unevenly distributed UV irradiance	31
Figure 14.	Data from decay method experiments used to determine inactivation rates induced by UVGI for elevated levels of UV irradiance	32
Figure 15.	Effectiveness of UVGI-induced microbial inactivation under different room air mixing conditions	34
Figure 16.	UVGI-induced inactivation rate as a function of effective UVGI irradiance for 54 W to 504 W lamp power	37

List of Tables

Table 1. Summary of Key Parameters and Methods for this Study.....	vi
Table 2. Experimental Scenarios for Well-Mixed Conditions.....	16
Table 3. Experimental Scenarios for Varying RH Conditions	17
Table 4. Experimental scenarios for Elevated UV Irradiance and Unevenly Distributed Irradiance	18
Table 5. Experimental Scenarios for Photoreactivation	18
Table 6. Experimental Scenarios for Incomplete Mixing Conditions	19
Table 7. Average \pm SD UV Irradiance Measured in the Upper Zone of the Room by Actinometry for Tests with Different Lamp Power.....	21
Table 8. Horizontal Distribution of UV Irradiance Measured in the Upper Zone of the Room by Actinometry for the Louvered (Unlouvered) NW Corner Lamp.....	23
Table 9. Total and Culturable Count Average (Standard Deviation) Concentrations for Constant Generation Method Experiments under Well-Mixed Conditions.....	24
Table 10. Hypothesis Tests for Effectiveness at Varying Relative Humidity	29
Table 11. Results for Photoreactivating Conditions and 40% Relative Humidity	33
Table 12. Results for Photoreactivating Conditions and 100% Relative Humidity	33

Executive Summary

Background

Airborne transmission of *Mycobacterium tuberculosis* and other infectious agents within indoor environments has been a recognized hazard for decades. Engineering controls such as ventilation and negative pressure have been helpful for control of tuberculosis (TB) transmission in high-risk settings such as hospital isolation rooms. Increasing costs associated with providing ventilation has prompted renewed interest in other means to remove airborne infectious agents from room air, such as the application of ultraviolet germicidal irradiation (UVGI). One application of UVGI is to irradiate the upper part of a room while minimizing radiation exposure to persons in the lower part of the room. Data has been available showing that UVGI has the potential to be a useful engineering control for TB. The 1994 CDC TB Guidelines (Centers for Disease Control and Prevention, 1994) relied primarily on upper-room air UVGI studies over 30 years old when guidelines were written for its use as an engineering control measure to mitigate the transmission of airborne *M. tuberculosis*. Knowledge gaps still remained in regard to the impacts of environmental factors such as air mixing, relative humidity and various other parameters on the efficacy of upper-room air UVGI. In addition, no room studies had been conducted using modern UVGI fixtures and bulbs. Thus questions still remain on the best approach to install UVGI in real settings. The aim of our study was to systematically investigate the conditions under which UVGI can be expected to mitigate the spread of tuberculosis. Completion of this work has significantly improved our fundamental understanding of the efficacy of upper-room air UVGI systems and will facilitate their design, optimization and implementation on a practical scale.

Objectives

The efficacy of killing or inactivating airborne bacteria using upper-room air UVGI from a modern UVGI system was investigated in realistic physical scenarios under carefully controlled laboratory conditions. Table 1 summarizes the parameters studied in this work, as well as the methods used to accomplish our research objectives. The research objectives pursued in this project are detailed below.

1. Establishment of a full-scale test room that simulated a typical health-care facility isolation room with a modern UVGI system.
2. Characterize the irradiance provided to the test room by the UVGI system.
3. Estimate the effectiveness of UVGI for three microorganisms (*Mycobacterium parafortuitum*, *Bacillus subtilis* spores, and *Mycobacterium bovis* BCG) for two room ventilation rates, 0 and 6 air changes per hour.
4. Measure the inactivation rate as a function of UVGI and calculate the Z value due to UVGI for *M. parafortuitum*.
5. Evaluate the impact of varying relative humidity on the UVGI effectiveness and inactivation rate.
6. Quantify how different levels, and spatial distributions, of UVGI, impact the inactivation rate.
7. Determine whether photoreactivation is a concern for real applications of UVGI.
8. Establish whether the air mixing in a room will change the performance of a UVGI system.

Table 1. Summary of Key Parameters and Methods for this Study

Parameters Studied	Methods Used
Effectiveness of UVGI	Air sampling with glass impingers
Inactivation rates for UVGI	Culturing of colony forming units
Z value	Direct epifluorescent microscopy
Microorganism species	Constant generation protocol
Ventilation (ACH)	Decay protocol
Relative humidity	Least-squares linear estimation
Ultraviolet germicidal irradiance levels	Statistical hypothesis testing
UVGI distribution patterns	
Photoreactivation	
Mixing of room air	

Methods

The efficacy of UVGI for inactivating airborne bacteria was evaluated in a full-scale test room (87 m³), fitted with a modern UVGI system consisting of 9 louvered fixtures, one in each corner, one on each wall, and one hung in the center (504 W all lamps operating). This installation created a band of UVGI in the upper level of the room, with an average depth of approximately 30 cm. The test room was operated at 24 °C, between 25–100% relative humidity, and at three ventilation rates (0, 3, and 6 air changes per hour). Air within the room was well mixed with box fans for most experiments. The room was configured so that the bioaerosol source was located in the center of the room between the ventilation ceiling exhaust and ceiling supply, in accordance with the Center for Disease Control and Prevention’s recommendation that clean air first flow to less contaminated areas, then flow across the infectious source and into the exhaust.

Two experimental protocols were used: constant generation and decay. Using the constant generation protocol, *Bacillus subtilis* (spores), *Mycobacterium parafortuitum*, and *Mycobacterium bovis* BCG cells were aerosolized continuously into the room such that their numbers and physiologic state were comparable both with and without the UVGI and ventilation system operating. Triplicate air samples were collected using glass impingers at 5–9 breathing-zone locations within the room. Collected bacteria were quantified using direct microscopy and standard culturing assays.

Using the decay protocol, *Mycobacterium parafortuitum* cells were aerosolized only until the concentration in the room reached a detectable level and then stopped and the concentration was allowed to decay. Duplicate air samples were collected using glass impingers at one breathing-zone location within the room. Collected bacteria were quantified using standard culturing assays.

Duplicate or triplicate experiments were conducted to provide repeatable data. Key uncertainties in the results were quantified and statistical hypothesis testing was applied to the data to determine significance of these results.

Results

Measurements of UVGI by spherical chemical actinometry in the upper zone of the room revealed average irradiance levels of 12, 20, 33, 42, and 87 $\mu\text{W cm}^{-2}$ for lamp power levels of 54, 108, 162, 216, and 504 W respectively. At breathing zone height (1.5 m above floor) with 216 W lamp power, the average irradiance was 0.08 $\mu\text{W cm}^{-2}$. Measurements of UVGI by six-directional radiometry agreed with those using actinometry.

Constant generation experiments showed that the UVGI system (corner plus center fixtures operating, 216 W) reduced the room-average concentration of culturable airborne bacteria between 46–80% for *B. subtilis* spores, between 83–98% for *M. parafortuitum*, and 96–97% for *M. bovis* BCG cells at 50% RH, depending on the ventilation rate. Effectiveness was shown to be statistically equivalent for *M. parafortuitum* and *M. bovis* BCG. Although increasing the ventilation rate from 0 to 6 air changes per hour (ACH, or h^{-1}) appeared to decrease the effectiveness of UVGI-induced microbial inactivation for *M. parafortuitum* and *B. subtilis* spores, these decreases were not statistically significant.

Decay experiments showed that the UVGI system operating at 216 W (corner plus center fixtures) was capable of inactivating *M. parafortuitum* at an average rate of 16 ± 1.2 ACH. The UVGI system operating at 108 W (each corner fixture plus center fixture at half power) inactivated *M. parafortuitum* at an average rate of 6.1 ± 0.76 ACH. Normalizing these inactivation rates by the UVGI levels provides an index of the dose-response relationship of different organisms and is solely dependent on the microorganism physiology. This index has been traditionally termed the Z value. The Z value was estimated to be $1.2 \pm 0.15 \times 10^{-3} \text{ cm}^2 \mu\text{W}^{-1} \text{ s}^{-1}$ for aerosolized *M. parafortuitum* at 50% relative humidity.

Varying the relative humidity from 25% to 100% showed that the effectiveness as determined from constant generation experiments with *M. parafortuitum* decreased by approximately 20–40% above 75% RH. Decay experiments also showed that inactivation rates decreased by a factor of 2 when the relative humidity was increased from 50% to 90% RH.

Changing the irradiance distribution within the upper zone of the test room from a more even distribution throughout the room to one in which the UV irradiance was concentrated along one side of the wall decreased the inactivation rate by 25%. Increasing the total lamp power provided to the room by the UVGI system by 60%, from 216 W to 504 W (lamps were evenly distributing throughout the upper zone), resulted in an increase of the inactivation rate by only 19%. These results are for *M. parafortuitum*.

Photoreactivation was not seen in constant generation experiments with *M. parafortuitum* at relative humidity of 40%. At 100% RH, however, the results were inconclusive; one of our experiments suggested that photoreactivation had occurred and decreased effectiveness by an average of 17%. More experiments need to be conducted to confirm that photoreactivation under the conditions of high RH occurs.

The effectiveness of the UVGI system was substantially decreased from an average of 89% to 9% when the mixing fans were turned off and wintertime ventilation conditions were established (ventilation supply air was elevated at 34 °C compared to room temperature at 24 °C) for *M. parafortuitum*. For the ventilation configuration of our room and the location of bioaerosol generation, turning off the mixing fans did not have very much impact provided the temperature distribution was uniform.

Conclusions

This study quantifies the impact of environmental factors on the response of airborne bacteria to UVGI in a full-scale room. Unique aspects of the study include:

- (a) Experiments were conducted at full scale.
- (b) Details of the test room were well characterized, including the UVGI system and room air mixing.
- (c) The temperature and relative humidity were well controlled.
- (d) Experiments were replicated and duplicate or triplicate sampling was used.
- (e) An *M. tb* surrogate was tested that is easy to work with and not considered to be a biosafety hazard.
- (f) Novel bioassays were applied.

Overall, UVGI was very effective at inactivating airborne bacteria at the levels provided to our test room. We recommend that the UV irradiance in the upper zone of the room be approximately 40-50 $\mu\text{W cm}^{-2}$ to obtain an inactivation rate of 16 ACH for *M. tb* surrogates and to reduce airborne concentrations within the room by 90%. Moderate levels of ventilation (0–6 ACH) do not have an impact on the effectiveness of UVGI. Higher levels of UVGI than the levels we tested in our room may be advantageous, although we did find that there are diminishing returns from increasing UVGI above a certain threshold. We found that this threshold was between a total of 216 W and 504 W of lamp power for our test chamber. The distribution of UVGI within the room should be as uniform as possible and the air within the room well mixed. If the UVGI system will be operated at relative humidity higher than 75% RH, the irradiance provided to the room must be increased accordingly as the UVGI effectiveness decreases at high RH. Similarly, our data suggest that at low relative humidity, irradiance levels may also need to be increased – more studies at low RH should be conducted to verify. Photoreactivation is not an issue at moderate relative humidity but there is insufficient data to conclude yet whether it will be an issue at higher relative humidity.

The information generated by this research will help the CDC identify effective mitigation control measures, and the relative importance of UVGI as compared to other controls, for reducing the public health risks from TB and other airborne infectious disease. This information can be used in conjunction with other available data to design and install UVGI systems in high-risk settings that are effective at controlling exposure to airborne bacteria.

1. Introduction

Airborne transmission of *Mycobacterium tuberculosis* and other infectious agents within indoor environments has been a recognized hazard for decades (Blumberg et al. 1995; Center for Disease Control and Prevention 1994; Ikeda et al. 1995; Kearns et al. 2000; Riley et al. 1962). Recent outbreaks of multidrug-resistant strains of *M. tuberculosis* in healthcare and correctional facilities have heightened the concern and need to prevent transmission (Fackelmann 1998; Kearns et al. 2000; Nivin et al. 1998). Although resurgence of tuberculosis (TB) in the United States has halted and the incidence is once again falling, there is a global epidemic of TB fueled in part by the epidemic of HIV-AIDs (Frankel 1995; Morbidity and Mortality Weekly Report 2002; World Health Organization 2000). The World Health Organization estimates that between 2000 and 2020, nearly one billion people will be newly infected with TB, 200 million people will get sick, and 35 million will die from TB if control is not further strengthened (World Health Organization 2000).

For control of TB transmission in hospital isolation rooms, the Centers for Disease Control and Prevention (CDC) recommends ventilating the room with clean, outside air at a rate of six to twelve air changes per hour (ACH, h⁻¹) and maintaining the room under negative pressure relative to adjacent areas (Centers for Disease Control and Prevention 1994). Many isolation rooms currently receive less than the recommended 6 ACH (Blumberg et al. 1995; Ikeda et al. 1995), and renovating facilities to achieve ventilation rates between 6–12 ACH can be expensive. Thus, there has been renewed interest in other means to remove airborne infectious agents from room air, such as the use of high-efficiency-particle-air (HEPA) filters or the application of ultraviolet germicidal irradiation (UVGI) (Centers for Disease Control and Prevention 1994; Nagin et al. 1994; Nardell 1995).

UVGI is mainly used to disinfect air in two configurations: ventilation duct irradiation and upper-room air irradiation (Nagin et al. 1994).¹ Animal studies compellingly demonstrated that ventilation duct irradiation prevented the transmission of TB from hospitalized tuberculosis patients to guinea pig colonies (Riley et al. 1957; Riley et al. 1962). Initial observations of the efficacy of upper-room air irradiation to control airborne infection were reported in the early 1900s by Wells (Wells 1935; Wells 1955). For upper-room air irradiation, germicidal lamps are suspended from the ceiling or attached to the walls; the bottom of the lamp is usually shielded or louvered to direct radiation upward above a predetermined height. The objective of this configuration is to inactivate airborne infectious agents in the upper part of the room, while minimizing radiation exposure to persons in the lower part of the room. In the remainder of this report, the term *UVGI* is used to mean upper-room air UVGI. *Inactivation* in this context means the loss of the ability to replicate and form colonies. Commercially available germicidal lamps

¹UVGI is used in many applications, such as for water sterilization and food processing (Summer, 1962).

² This normalization is used in many of these studies and is applied in this research.

contain mercury vapors under low pressure that emit energy in the UV-C wavelength range, 100–290 nm, with about 90% of the total spectral power emitted at 254 nm (International Light 2002; Summer 1962; Macher 1993). These lamps also produce some visible violet-blue light.

Airborne microorganisms that are exposed to UVGI may be damaged, the effect depending on the UVGI dose cells receive, and the lethal dose for each microorganism. The lethal effect of UVGI is primarily due to the structural defects (formation of pyrimidine dimers) it produces in the cell's DNA (Setlow and Carrier 1966). Microbial susceptibility to inactivation by UVGI varies widely. David (1973) reports that the response to ultraviolet light of microorganisms is correlated with the size of the bacterial genome, the cellular concentration of carotenoids, and the repair efficiency. UVGI dose is calculated from exposure duration and the average irradiance level delivered to a cell. Often a dose is defined in terms of the amount of cells inactivated. For example, Riley et al. (1976) estimated the UVGI dose required to inactivate 90% of aerosolized *Mycobacterium tuberculosis* (*M. tuberculosis*) Erdman strain to be approximately $700 \mu\text{W s cm}^{-2}$.

A handful of research studies have investigated the efficacy of upper-room air UVGI. Kethley and Branch (1972) reported that with two 30-W lamps suspended from the ceiling and 6 ACH ventilation, airborne *Serratia marcescens* concentrations were reduced by 76% for a $5.2 \mu\text{m}$ count median diameter (CMD) aerosol and by 95% for a $2.7 \mu\text{m}$ CMD aerosol. *S. marcescens* was suspended in beef broth, which may have been the reason for UVGI effectiveness to decrease with increasing particle size. Beef broth has high turbidity and may have inhibited UVGI from efficiently reaching the cells. Kethley and Branch also measured directly the inactivation rate for *S. marcescens* as 19 ACH. Riley et al. (1976) reports on one of a few studies to directly measure and report inactivation rates for *Mycobacterium bovis* (*M. bovis*) BCG, a surrogate for *M. tuberculosis*. Rates of 10 h^{-1} with one unlowered 17-W ceiling lamp and $19\text{--}33 \text{ h}^{-1}$ with two unlowered ceiling fixtures (46-W total) were measured in a 64-m^3 room (18.4 m^2 of floor area). Miller and Macher (2000) showed that UVGI (one unlowered 15-W wall lamp) and 2 ACH ventilation reduced airborne bacteria concentrations in the breathing zone of a 36-m^3 test chamber by approximately 50% for *Bacillus subtilis* spores and *Micrococcus luteus*. For *Escherichia coli*, the reduction was close to 100% – bacteria were only cultured from samples nearest the source with the UV lamps operating. Miller and Macher (2000) measured an inactivation rate for *B. subtilis* spores of 4 h^{-1} . Ko et al. (2002) showed in a 45-m^3 test chamber that two fixtures, 72-W total, reduced airborne *Serratia marcescens* concentrations by 29–88%, depending on ventilation rates and mixing conditions. All of the above mentioned studies did not promote mixing during their experiments, possibly resulting in unevenly distributed airborne bacteria and which would impact the interpretation of inactivation rates.

Measurements of UVGI effects in real-life settings are limited. Macher et al. (1992, 1994) saw a 14–19% reduction in the concentration of viable, ambient bacteria in a well-ventilated hospital waiting room equipped with wall-mounted lamps. Epidemiological studies have shown that UVGI can reduce transmission of airborne infectious diseases in hospitals (McLean, 1961) and military housing (Willmon et al., 1948).

Many environmental factors affect the efficacy of upper-room air UVGI. These factors include room airflow patterns, room relative humidity (RH), UV irradiance levels, UV irradiance distribution patterns, and background fluorescent or daylight levels. Upper-room air UVGI only

irradiates the upper parts of a room, thus the room airflow pattern has a strong impact on UVGI efficacy. Air from the lower part of the room must be moved into the upper part of the room to be irradiated. Theoretically, upper-room air UVGI will perform better in a well-mixed room compared to a poorly mixed room, because there is a higher probability that airborne microorganisms in the lower portions of the room will be circulated through the irradiance zone in the upper portions. Airflow patterns are influenced by many factors, including room furnishings, ventilation supply/exhaust locations, and air temperatures. The impact of room airflow patterns on the efficacy of upper-room air UVGI systems is not well understood. Previous studies of UVGI efficacy were either done in environments where the mixing conditions were uncontrolled or unknown (Riley et al. 1976; Macher et al. 1992, 1994; Miller and Macher 2000), or in a room in which the air was well mixed using fans (Xu, et al., 2002). To provide important data needed to understand the impact of airflow patterns on UVGI, in the present study we investigated both mixed and unmixed conditions, as well as room temperature gradients.

The response of airborne microorganisms to UVGI exposure is impacted by relative humidity as it has a critical effect on bacterial survival and replication. Although RH has long been recognized as a key factor in bioaerosol activity, the biomedical engineering and industrial hygiene literature reporting on RH-bioaerosol interactions is limited. Relative humidity of 40 to 60% was reported to be more lethal than either lower or higher RH to airborne bacteria, such as *E. coli* (Hatch and Wolochow 1969). Wells and Wells (1936) found that UVGI efficacy for airborne *E. coli* decreased with increasing RH level in a small chamber. Whisler (1940) found that the vulnerability of *E. coli* to UVGI declined sharply between 60 and 70% RH. Damage to ion-retention mechanisms of airborne *E. coli*, which may decrease viability, is minimized at RH above 70% (Anderson et al. 1968). Riley and Kaufman (1972) reported that the fraction of airborne *S. marcescens* inactivated by UVGI declined sharply at RH above 80%, using a small plug-flow test reactor. Recently, Peccia et al. (2001) conducted decay experiments in a small-scale aerosol reactor (0.8 m³) to determine the impact of RH. They derived the irradiance-normalized inactivation rates at multiple RH levels for three bacteria. Inactivation rates were sensitive to changes in RH, and were a minimum near saturation (95%) and maximum near 50% RH. In this study we investigate the impacts of RH between 25 and near 100%, providing new data under full-scale conditions.

Other factors that change the UVGI efficacy are levels of UV irradiance and its distribution pattern. The rate of inactivation increases as the UV irradiance increases; the range, however, over which such relationship exists is not known. There may be some threshold above where it is not linearly related and some lower limit below which there is no effect. The UVGI distribution pattern can also potentially change UVGI efficacy. Historically, when installing UVGI in a facility, a single UV lamp fixture was hung on one side of an upper wall of a room or from the ceiling. The UV irradiance was then highest on one side of the room nearest the wall fixture or highest near the ceiling fixture. Was this an efficient or optimal use of upper air UVGI? Whether or not the upper room air UVGI distribution should be uniform remains to be studied. In this work we addressed the knowledge gap with respect to UVGI distribution and optimal levels. These data will be useful for better understanding how to best install UVGI systems recognizing that uniform UVGI may be difficult to achieve.

The last factor addressed in this research is photoreactivation (PR), which refers to the potential for UVGI-damaged airborne bacteria to recover, this recovery being facilitated by light-activated DNA photolyase enzymes that repair cyclobutane thymine dimer DNA lesions. PR may affect UVGI systems adversely in environments with incandescent light, fluorescent light, or sunlight. It has been suggested that short wavelength visible light, in the range 300–400 nm, is the main factor inducing photoreactivation (Nicholson 1995). Previous studies on bacteria suspended in liquid or on agar plate surfaces have been conducted showing that PR occurs in mycobacteria (David et al. 1971), and that the length of exposure to photoreactivating light is an important factor affecting the extent of PR (Liltved and Landfald 1996). More recently, Oguma et al (2001) demonstrated that in liquid suspensions of *E. coli* and *Cryptosporidium parvum* the number of pyrimidine dimers induced in the DNA was highly correlated with the dose of UV used, and that the pyrimidine dimers induced in the DNA by UVGI were continuously repaired during exposure to fluorescent light. Interestingly, Oguma et al. also found that for *C. parvum* the animal infectivity did not recover by PR. These studies, however, may not reflect accurately the PR behavior of airborne microorganisms because the hydration states experienced by airborne bacteria are much different than those in liquid environments or under culturing conditions. A recent study reports the relationship between RH and PR for airborne microorganisms (Peccia 2001). Peccia showed in a small-scale aerosol reactor (0.8 m³) that PR rates of airborne organisms increased with increasing RH and decreasing UVGI dose. Interestingly, results also showed that when irradiated in the absence of photoreactivating light, cyclobutane thymine dimers are not the most significant form of UVGI-induced DNA damage incurred by airborne bacteria, suggesting that other mechanisms of damage are more important. In the present work we conducted a limited number of tests to determine whether PR was a concern at full-scale conditions and at different relative humidity for airborne bacteria.

To expand the limited experimental data on the effects of environmental factors on irradiating airborne bacteria, the UVGI response of a modern UVGI system was investigated in realistic physical scenarios under carefully controlled laboratory conditions. This study was based on a previously developed and tested design for evaluating UVGI effects (Miller and Macher 2000; Xu et al., 2002). The UVGI response of two mycobacterium species was investigated—*Mycobacterium parafortuitum* and *Mycobacterium bovis* BCG, a *M. tuberculosis* surrogate—and compared to that of airborne *Bacillus subtilis* spores. Airborne bacteria concentrations were generated that allowed for concurrent enumeration using direct epifluorescent microscopy techniques and standard plate counts. Air samples were collected at a large number of locations within a full-scale test room with replicates. The UV irradiance distribution within the room was characterized with radiometry and a newly developed actinometry technique. Experiments using two methodologies were conducted, constant generation and decay. In the constant generation method, UVGI efficacy was determined by comparing measurements of the concentration of culturable airborne bacteria with and without exposure to UVGI. In the decay method, UVGI efficacy was determined by the rate at which airborne microorganisms were inactivated. Experiments were conducted under various air mixing conditions by changing ventilation parameters, such as supply air temperatures and ventilation rates. UVGI efficacy was evaluated under various RH levels controlled by a mechanical ventilation and humidification system. Experiments were also conducted under various UV irradiance levels and distribution patterns by changing UVGI fixture locations and number of operating lamps. UVGI efficacy was also assessed in the presence of photoreactivating light.

2. Materials And Methods

2.1 Culture Preparations

The American Type Culture Collection (ATCC) supplied all cultures used in this study. Three bacteria were aerosolized during the experiments: *B. subtilis* (ATCC #090287), *M. parafortuitum* (ATCC #19689), a rapid-growing, rod-shaped mycobacterium that yields pale yellow colonies, and *M. bovis* Bacillus Calmette-Gueren (BCG), Pasteur strain, ATCC #35734 (Trudeau Mycobacteriology Collection #1011), an attenuated strain of *M. bovis* used in human tuberculosis vaccination. *M. bovis* BCG is closely related phenotypically and genotypically to *M. tuberculosis* and has, therefore, been used as its surrogate in bioaerosol studies (Riley et al. 1976). *M. parafortuitum* was chosen because both it and *M. bovis* BCG are related mycobacteria and *M. bovis* BCG has been reported to be very sensitive to UVGI (David 1973; Hollander 1942; Riley et al. 1976). Compared with *M. bovis* BCG, *M. parafortuitum* is easier to work with because it grows faster (3 days compared to ~ 4 weeks) and is considered a lower-level hazard by the CDC (Centers for Disease Control and Prevention and National Institutes of Health 1999).

These three bacteria were selected to represent a range of UVGI susceptibilities (Collins 1971; David 1973; Hollander 1942; Miller and Macher 2000; Riley et al 1976; Wells 1955). Wells (1955) determined the lethal power of UVGI on select aerosolized bacteria. The vulnerability of *B. subtilis* (spore) was 0.22 and *M. tuberculosis* was 0.84, relative to *E. coli* (*E. coli* – 1.0). David (1973) found that the relative UV sensitivity of liquid suspensions of *M. tuberculosis* was 0.40 relative to *E. coli* (1.0). David (1973) also reports that the differences in response to ultraviolet light of members of the mycobacteria are small and are correlated with the size of the bacterial genome, the cellular concentration of carotenoids, and the repair efficiency. UV susceptibility was shown to be similar for *M. tuberculosis* and *M. bovis* BCG (Collins 1971 (agar plate surfaces), Riley et al. 1976 (airborne bacteria)). Collins (1971) reports that compared with mycobacteria, all of the gram-negative bacteria (including *E. coli* and *S. marcescens*) tested were twice as sensitive to UV inactivation. Peccia and colleagues (Peccia 2000; Peccia and Hernandez 2002) measured in a small-scale aerosol reactor statistically similar UV inactivation rates for *M. parafortuitum* and *M. bovis* BCG.

M. parafortuitum was grown on Soybean-Casein Digest Agar (SCDA) (Difco Laboratories, Detroit, MI) at 37°C and incubated for 60 hours. *M. bovis* BCG was grown in Proskauer-Beck broth (Difco Laboratories, Detroit, MI) amended with 0.5% Tween 80 (Sigma Chemical, St. Louis, MO). *M. bovis* BCG cultures were grown for 21 days at 37°C under constant mixing using a Teflon®-coated magnetic stir bar and magnetic stir plate. Sporulating *B. subtilis* cultures were grown on agar plates (8.5 g L⁻¹ nutrient agar with 0.002% MnCl₂·6H₂O) at 37°C.

After 5 days, *B. subtilis* spores and cells were removed from the agar surface by scraping the plates with a sterile glass rod, and then suspending in sterile deionized water. Spores were separated from remaining vegetative cells by repeated centrifugation and decanting vegetative cell-containing supernatant. Using Shaeffer-Fulton stains *B. subtilis* spore purity was confirmed in the range 94–100% immediately prior to their aerosolization. Spores were stored at 4°C in sterile deionized water for up to 24 h prior to use, and were not pasteurized as this step was found to

increase the germination potential of spores before UV exposure and during impinger collection (Peccia 2000).

Fresh *M. parafortuitum* cultures were removed from agar plate surfaces by scraping, and were suspended in sterile deionized water immediately prior to aerosolization. *M. bovis* BCG was aerosolized directly from its liquid broth culture (Proskauer-Beck). Immediately before aerosolization, cell concentrations (except *M. bovis* BCG) and spore solutions were diluted to a concentration of approximately 1×10^9 cells ml^{-1} as determined by direct microscopy.

Stock cultures of *B. subtilis* vegetative cells and *M. parafortuitum* were maintained on SCDA at 4°C for short-term storage (< 4 weeks). For storage longer than four weeks, all cultures, including *M. bovis* BCG, were stored at -20°C in sterile deionizing water containing 40% (vol/vol) glycerol.

2.2 Test Facility

A simulated, health-care test room was established at the Joint Center for Energy Management's Larson Building Systems Laboratory, University of Colorado at Boulder. An 87-m³ room housed inside the laboratory was used for testing. The room has an infiltration rate between 0.1–0.3 ACH. The floor-to-ceiling height is 2.5 m and contains 35 m² of clear floor area (8.1 ft × 19 ft × 20 ft). The room has insulated walls, raised floor, plenum ceiling, one door and no windows. Figure 11 is a schematic of the test room.

The test room is equipped with a computer-controlled ventilation system that delivered from 2 to 8 ACH of HEPA-filtered outside air through two circular diffusers located in the ceiling. Air is exhausted through two outlets also located in the ceiling. To minimize airborne bacteria exiting the test room, HEPA filters were installed within the exhaust ducting. The ventilation system was operated during testing to maintain a slight negative pressure (12 Pa) within the room relative to the surrounding laboratory (Centers for Disease Control and Prevention 1994). The ventilation rate was measured and controlled by airflow sensors (Eliminator 3000, Ebtron Inc., CA) installed in the ducts. This rate was verified with tracer gas (72% SF₆ and 18% H₂) tests.

The room air was mixed with two box fans (48-cm diameter, MODEL 3723, Lasko Inc., TX) operated on both sides of the room. The room air mixing was characterized using the age-of-air method both by using a gas and particle tracer (Xu and Miller 1999). The room air was well mixed for particles, both with and without the box fans operating, provided the supply air was at the same temperature as the room air. Mixing was somewhat better when the ventilation was at 0 or 3 ACH compared to 6 ACH. Particle concentrations were higher by 20-30% in the lower zone compared to the upper zone for 3 and 6 ACH ventilation. Particle concentrations in the lower and upper zones were comparable at 0 ACH. When the supply air was warmer than the room air, the air was poorly mixed with no fans on, and the lower zone concentration was 75% higher than the upper zone concentration. The paper summarizing these results, Xu and Miller 1999, is included in Appendix I.

The temperature and relative humidity in the room are controlled by two feedback-control loops linked with cooling coil and steam-injection humidifiers. The room is capable of maintaining a temperature in the range between 15–35°C and a relative humidity in the range between 50–100%.

2.3 UVGI System and Photoreactivation L amps

The UVGI system (Lumalier, Memphis, TN) consists of nine fixtures, four mounted in each of the corners of the room, four mounted on each of the walls, and one hung from the center of the ceiling Figure 1. The manufacturer rated the lamps within the fixtures at 18 W. The center fixture is rated at a total of 72 W, consisting of four lamps. The corner fixtures are rated at 36 W each containing two lamps installed with parabolic aluminum reflectors on the back of the fixtures. The wall fixtures are rated at 72 W each containing four lamps installed with parabolic aluminum reflectors on the back of the fixtures. Each fixture is equipped with concentric black louvers of 1.9-cm spacing. The height of the fixtures is approximately 25 cm and they were installed so that the lower edge was located 2.1 m above the floor and the top was 10 cm below the ceiling. This placement created a band of UVGI in the upper level of the room, with an average depth of approximately 30 cm. The depth of the band varied throughout the room, with the narrowest dimensions being right next to the lamps at 18 cm and the widest dimensions being in between fixtures.

The number of UVGI fixtures that a room needs will depend on a number of factors, the most important being its size and the amount of UVGI needed. A general rule of thumb has been suggested: one 30-W fixture for every 18 m² (200 ft²) of floor area (1.67 W m⁻²), or for every seven people in a room, whichever is greater (Macher 1993, Riley 1988). This rule is not very helpful because it does not specify the amount of UVGI (or UV-C, 254 nm wavelength) needed per floor area, only the lamp power. Depending on the fixture design, the UVGI provided by a fixture could be quite high if there are no louvers, or it could be quite low if it is louvered, as many louvers severely attenuate the UVGI (Miller and Macher 2000). The “power distribution” for our room is much higher than the recommendation cited above: 504 W / 35 m² = 14.4 W m⁻².

The spectral distribution of the UV lamps was measured at the National Renewable Energy Laboratory in Golden, CO. After warming up the lamps for 30 min, the spectral output of these lamps was measured three times in the dark by a Spectralink Scanning Radiometer (model ISADHL, ISA Systems Analysis, Inc., VA) at wavelengths between 200 and 300 nm. The UV lamp spectral distribution is shown in Figure 2. The data presented are the average of the triplicate measurements. The UV output peaked between 254-256 nm and most of the radiation energy emitted by these lamps was concentrated in this area. There was also a small band of irradiance peaking at 298 nm, but the band had approximately 80% lower output than the 254-256 nm peak.

For the well-mixed, incomplete mixing, varying RH, and photoreactivation experiments, only the four corner UV fixtures and the one center fixture were turned on. For the experiments that explored various UV irradiance levels and distributions, the UV fixtures were operated based on the test requirements.

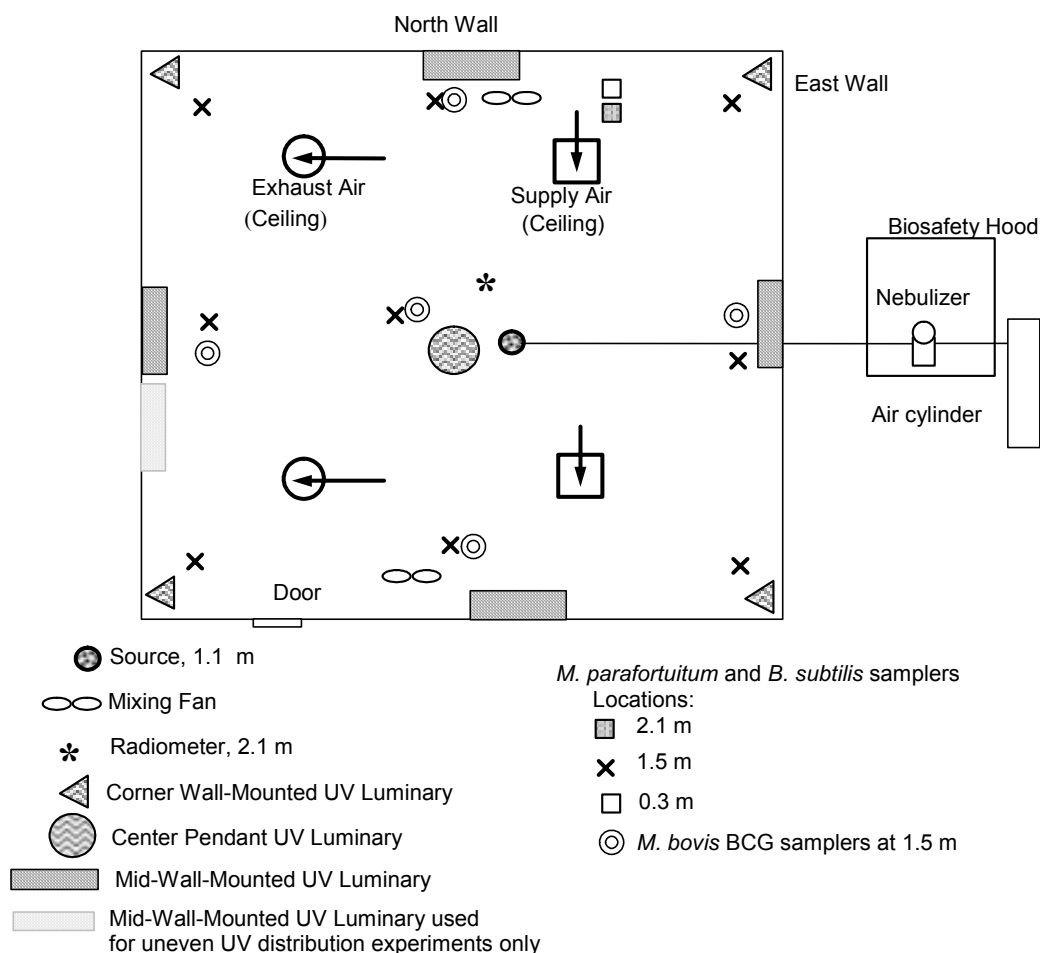

Figure 1. Configuration of 89 m³ test room (plan view). Heights above the floor are given. Biosafety hood contains the bioaerosol generation system. Test room was sealed and under slight negative pressure during experiments.

The UVGI system was operated for 100 h before experiments were conducted. A logbook was used to document the number of hours the lamps were operated. The UV fixtures were rated “ozone free” and negligible ozone levels were verified in the test room during UVGI operation using a portable ozone monitor (Black et al. 2000).

For the photoreactivation experiments, full spectrum fluorescent lamps (F40T12SUN, Verilux, Inc., Stamford, CT) were installed in test room, because it was suggested that the short wavelength light (~300-400 nm) was the main factor inducing photoreactivation. These lamps have a spectral power distribution representing noon sunlight on an overcast June day for the US mid-latitudes (27 degrees), as shown in Figure 3 (Verilux 2002). Each 48-inch lamp provided 40 watts of power and 12 lamps were installed in the test room ceiling-recessed light fixtures.

The fluorescent power distribution was $40 \text{ W} \times 12 / 35 \text{ m}^2 = 13.7 \text{ W m}^{-2}$. All the other experiments except those involving photoreactivation were conducted in the dark.

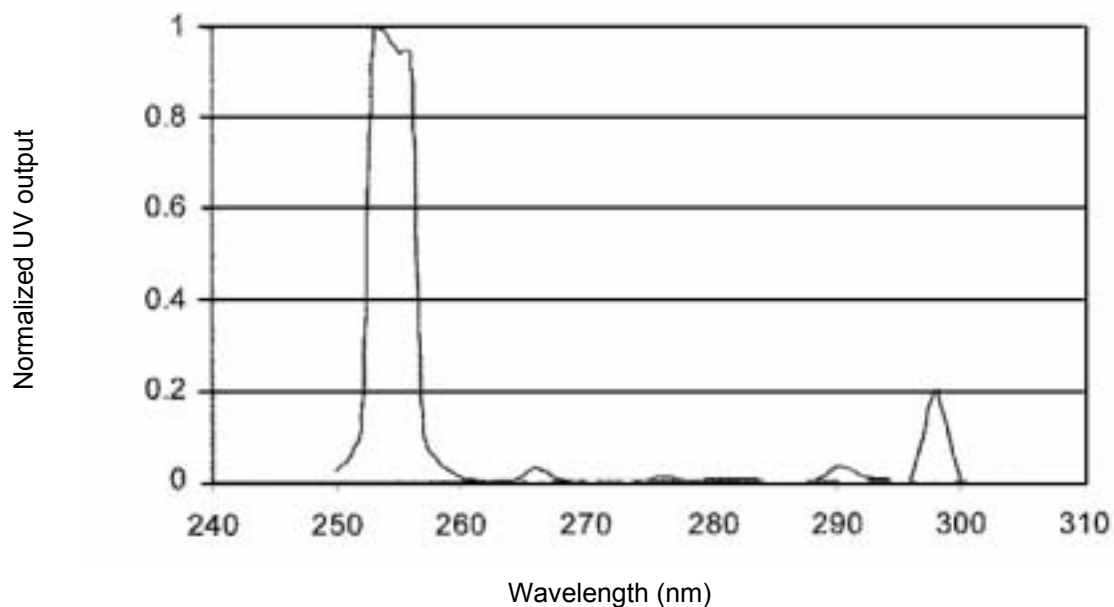

Figure 2. UVGI lamp output spectral distribution.

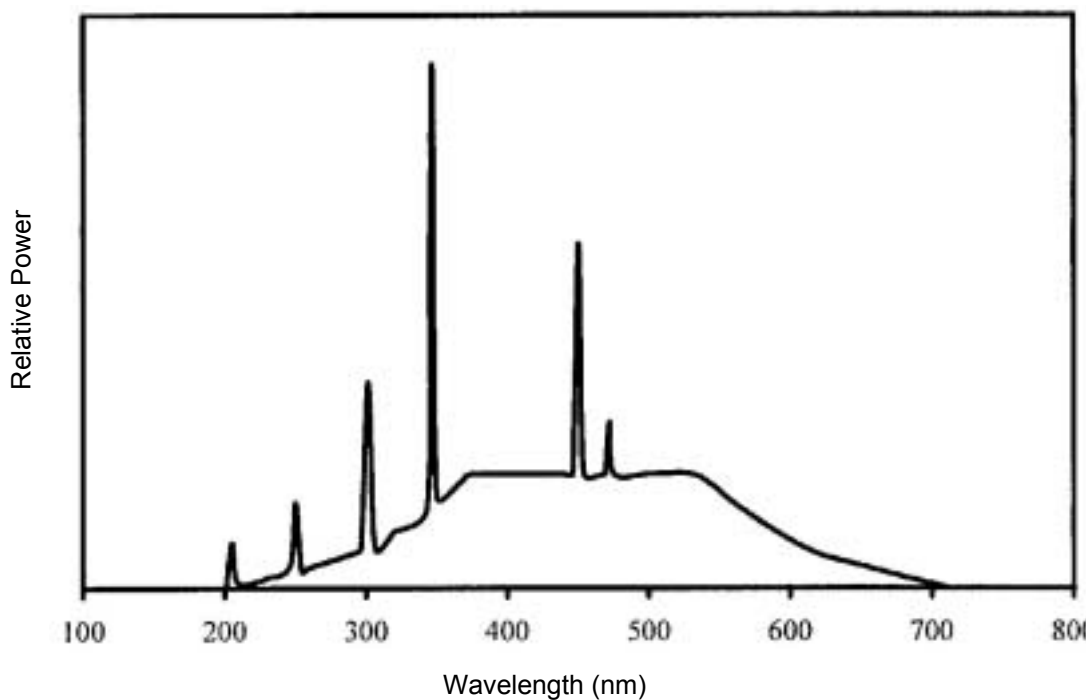

Figure 3. Spectral power distribution (SPD) for lamps used in photoreactivation experiments. SPD from Verilux Inc. technical information (Verilux 2002).

2.4 Airborne Bacteria Generation and Collection

The test bioaerosols were generated using a six-jet Collison nebulizer with a large reservoir (CN 25, BGI Inc., MA). The nebulizer was located outside of the test room, within a biosafety cabinet (Nuair Inc., MN) in an adjacent room housed within the laboratory. The CN reservoir was filled with 50 ml of suspension. The bioaerosol was delivered from the CN discharge port into the test room through 3 meters of plastic tubing (1.9-cm inner diameter). The nebulizer was operated at 137 kPa (20 psia), generated by a compressed air cylinder in series with an air supply system that included a dehumidifier, a HEPA filter, and a pressure regulator (Model 3074, TSI, Inc. MN). To ensure a stable particle size distribution, and a consistent airborne bacteria concentration over the course of the experiments, the cell suspension was replenished every 30 minutes. This was accomplished by turning off the system temporarily and either (1) emptying the CN reservoir and refilling with 50 ml of fresh suspension or (2) removing the CN reservoir with the used suspension and attaching a new reservoir containing 50 ml of fresh suspension. The test bioaerosol was released near a heated mannequin's head, approximately 1.0 m above the floor. The heated mannequin, equipped with 108 W heating tape, was seated in a chair in the middle of the room to simulate a person. The mannequin generated a thermal plume similar to that of a human body, which influenced air mixing near the bioaerosol source. The mannequin and bioaerosol source were located in the room between the ventilation exhaust and supply (Figure 1), in accordance with the CDC's recommendation that clean air first flow to less contaminated areas, then flow across the infectious source and into the exhaust (Centers for Disease Control and Prevention 1994; Miller-Leiden et al. 1996).

Airborne microorganisms were sampled using AGI-30 impingers (AGI-30, ACE Glass Inc., NJ) at 12 L min⁻¹ through tubing connected to a manifold in series with a high-flow sampling pump (Model 1023-101Q, Gast Manufacturing Inc., MI) regulated by rotameters (Model 7400, King Instrument Inc., CA). The impingers concentrated the bacteria into 30 ml of sterile, phosphate buffer (150 mM NaCl, pH 7.2) with minimal damage to the microorganisms. Before each experiment, the pump and rotameters were calibrated using a bubble meter (Gillibrator, Scientific Industries, FL).

2.5 Enumeration by Culturing and Epifluorescent Microscopy

Following collection, the impingers' contents were mixed and divided into equal aliquots for two types of analysis: culturing of colony-forming units (CFU) and direct counting using epifluorescent microscopy. A modification of the standard plate count method was used to enumerate culturable bacteria. Within 2 hours after collection, samples from liquid impingers were diluted (usually 1:10) in 50 mM phosphate-buffer saline (PBS) solution (150 mM NaCl, pH 7.2) and cultured using a spiral plating method (Spiral Biotech, Inc., MD) according to manufacturer's recommendations. At least three replicates of each sample were plated. *B. subtilis* spores were incubated at 37 °C for 24 h, *M. parafortuitum* was incubated for 60 h, and *M. bovis* BCG was incubated for 21–35 days. All organisms were plated on SCDA agar except *M. bovis* BCG, which was plated on 7H11 media (Dubos and Middlebrook 1947). A comparison of cultured bacteria counts using the spiral plater with standard spread plate methods showed no significant differences (independent t test, $\alpha=0.05$). The variability of the spiral plater method was lower than that of the spread plate method (coefficient of variance 5% lower for the spiral

plating method, n=10). All plating was performed in indirect dimmed light (minimal light fixtures were turned on in the laboratory and none of the fixtures that were on were directly overhead). All experiments and incubations were carried out in the dark to control for photoreactivation.

Epifluorescent microscopy was used to directly measure the total number of airborne microorganisms. Total numbers were used to judge whether the number of organisms aerosolized was identical between UV-on and UV-off experiments. Vegetative cells were stained with 4'-6-diamidino-2-phenylindole (DAPI) (Sigma Chemicals, MO), a DNA-binding fluorescent stain (Ward et al. 1965), and spores were stained with a nonspecific fluorescein derivative (5-[4,6-dichlorotriazin-2-yl] aminofluorescein (DTAF), in accordance with previously described methods (Hernandez et al. 1999). Samples were stained at a final concentration of 0.5–1.0 $\mu\text{g DAPI ml}^{-1}$ and 200 $\mu\text{g DTAF ml}^{-1}$ at pH 9.0 respectively. Vegetative cells were incubated in DAPI for 1 min at room temperature and spores in DTAF solution were incubated for 30 min at 37 °C in the dark. Vegetative cell and spores were then filtered through 25-mm diameter, 0.2 μm , black polycarbonate filters (Poretics Inc., CA) with the exception that DTAF-stained spores were rinsed with 50 mM sodium carbonate buffer at pH 9.0. Mounted filters were examined under 1100 \times magnification using a Nikon Eclipse E400 epifluorescent microscope fitted with a mercury lamp and polarizing filters (Chroma Tech. Corp., VT). At least 10 random fields, and greater than 200 total cells, were counted per slide. All direct counts were reported as the average of 10 fields. Direct counts from aliquots having coefficient of variance of greater than 30% were discarded and new sample aliquots were stained and counted until a uniform distribution was observed (Hernandez et al. 1999).

In addition, the particle size distribution of culturable airborne bacteria was measured using a six-stage, multiple-hole impactor (Grasby Andersen, Andersen Instruments GA). This impactor sampled at 28.3 L min^{-1} and had d_{50} (diameter with 50% collection efficiency) cut points of 7, 4.7, 3.3, 2.1, 1.1, and 0.65 μm for the six stages. A modification to the standard impactor operation was implemented allowing for longer, more accurate, sample collection without concerns about overloading the plates. Plain gelatin with glycerin and water was used as the impactor plate media for *B. subtilis* spores and *M. parafortuitum* (Blomquist et al. 1984), and 7H11 agar media was used for *M. bovis* BCG, instead of the usual agar medium.

2.6 UV Irradiance Measurement

Spherical actinometers were used to characterize the UVGI distribution in the room according to Rahn et al. (1999). These spherical actinometers measured 3-dimensional irradiance, which is suitable for this study since multiple UVGI fixtures were installed at different locations within the room. Spherical glass irradiation cells (1-cm diameter) were filled with an actinometric solution of 0.6 M KI and 0.1 M KIO_3 in 0.01 M borate, pH 9.25. The cells were then exposed to irradiation for a designated time period. The absorptivity of the solutions was measured by a spectrophotometer before and after UVGI exposure and comparisons of these absorptivities were used to calculate irradiance.

To measure the irradiance in the upper zone of the room, cells were suspended at 20 evenly spaced locations 2.3 m from the floor and exposed to UVGI for 30 and 90 minutes.

The actinometric method was also used to measure UVGI in the breathing zone (1.5 m above the floor) by filling the glass cells with the actinometric solution, hanging them at 20 locations, and exposing them for 12 hours.

The characteristic of one corner lamp was also investigated. We measured the vertical distribution of UV irradiance from the NW corner lamp (Figure 1) by hanging cells at different heights, 8 ft away from the centerline of the lamp. The horizontal distribution for this same lamp was also measured at 2.3 m above the floor, 4 ft, 6 ft, and 8 ft away from the lamp along the centerline, and directly along the north and west walls. Measurements were conducted for the lamp, louvered and unlouvered.

Actinometer irradiance measurements were made for all fixtures (9 fixtures, 504 W total) and for the corner plus center fixtures (5 fixtures, 216 W) operating. We also measured the irradiance for: (a) two lamps in three of the corner fixtures, one in the other corner fixture, and two in the center fixture operating (162 W); (b) one lamp in each of the corner fixtures and two lamps in the center fixture operating (108 W); (c) a lamp in each of three corner fixtures operating (54 W); and (d) two wall fixtures and two corner fixtures along the west wall operating (216 W), for uneven UV distributed irradiance (an extra wall fixture was installed for this test; see (Figure 1). A factory calibrated model 1400 International Light radiometer (International Light Inc., Newburyport, MA) was also used to measure UV irradiance. The radiometer was calibrated every year. In the upper zone of the room, along a 0.6-m × 0.6-m grid, the UV irradiance at 113 points was measured 2.3 m above the floor (measurements nearest lamps were made 4 ft away). Since airborne bacteria were exposed to UVGI from all directions, at each point in the room, the UV irradiance was measured in six directions. Assuming that the point of measurement is a cube, these directions are normal to the front, back, top, bottom, left, and right faces of the cube. These directions were oriented within the room along the room's wall surfaces, that is, towards the N, W, E and S walls and also the ceiling and floor. The sum of the irradiance measured in these six directions was a reasonable estimation of UV irradiance at that point (Rahn et al. 1999). The radiometer was also used to track the UVGI irradiance between experiments to make sure it did not vary between runs. The UVGI lamps were warmed up for at least 30 minutes before all measurements.

2.7 Constant Generation Method Protocol

UVGI efficacy can be characterized in terms of the percentage of airborne bacteria that cannot be cultured when exposed to UVGI during constant generation, or continuous aerosolization of bacteria. This experimental protocol represents the scenario in which an infectious person has been present in a room for an extended period and remains in the room after a susceptible person enters. The infectious aerosol concentration is essentially constant while the susceptible person is present, as determined by a balance between the rates of airborne bacteria generation and removal.

After cleaning the test room by supplying HEPA-filtered outside air via the ventilation system, the negative pressure in the room and the ventilation rate were established. The box fans were turned on to ensure room air mixing. The test room door was closed and sealed to reduce infiltration. All fixtures (both UV and overhead fluorescent) were turned off for all experiments,

except during the UV on experiment, in which only the UVGI system was operated. Bacteria aerosolization was started and then maintained for 90 min. During the last 30 min of generation, samples were collected using AGI-30 impingers clustered in triplicate at from five to eleven room locations for *M. parafortuitum* and *B. subtilis* spore tests, and five locations for *M. bovis* BCG tests. The impingers were positioned at each sampling location such that their intake nozzles were at 60° angles to each other, thereby eliminating flow bias to any single impinger. All of the sampling locations were positioned in the breathing zone, 1.5 m above the floor. In a few of the experiments, an additional set of impingers was located near the ceiling (2.4 m above the floor) and near the floor (30 cm above the floor) to investigate vertical stratification (e.g., whether the bacteria concentration was elevated nearer to the breathing zone compared to the ceiling or floor). When the experiment was completed, the test room was cleared of all airborne bacteria by operating the ventilation system at 8 ACH for at least one hour. Each test consisted of otherwise identical experiments conducted with the UVGI system on and off.

UVGI effectiveness, E, quantifies the impact of UVGI on room bioaerosol concentrations and is estimated by comparing the measured culturable airborne bacteria concentration with the UVGI system on, $C_{UV\ on}$ (CFU m⁻³), to the airborne culturable bacteria concentration without UVGI, $C_{UV\ off}$ (CFU m⁻³). Although the aim was to reproduce the same generation rate of airborne bacteria for both UV on and UV off experiments, there was some variability in total bacteria concentration in the room. Therefore, in calculating effectiveness, the culturable airborne bacteria concentrations were normalized by the total bacteria concentration as determined by total direct counts. The effectiveness, E, of the UVGI system is given by:

$$E = 1 - \frac{C_{UV\ on}}{C_{UV\ off}} \times \frac{D_{UV\ off}}{D_{UV\ on}}, \quad (1)$$

where $D_{UV\ off}$ and $D_{UV\ on}$ (# m⁻³) are the total airborne bacteria concentrations measured by direct counts for UVGI off and on.

2.8 Decay Method Protocol

UVGI efficacy can also be characterized in terms of the rate in which it inactivates microorganisms. This experimental protocol represents a scenario in which an infectious person has been present in a room for a time but departs before a susceptible person enters. The infectious aerosol concentration decreases with time once the infectious person leaves the room. Another scenario would be one in which an infectious person enters a room for a short moment where susceptibles are present and then leaves again, generating a spike of aerosol, that can then decay with time.

After cleaning the test room by supplying HEPA-filtered outside air, airborne bacteria were generated continuously to raise the concentration in the room to a suitable level for detection. No ventilation was provided during this period, the box fans were turned on to ensure mixing, and the lights including the UVGI system were off. After 30 min, aerosolization was stopped and the ventilation rate and negative pressure was established and the UVGI system was turned on. Airborne bacteria were sampled five times at approximately 3 to 4-min intervals as the concentration decayed over 15-20 min with duplicate impingers. Thus in total, 10 samples were

collected over the decay period. The impingers were positioned at one location underneath the ventilation exhaust in the breathing zone, 1.5 m above the floor. The impingers were positioned such that their intake nozzles were at 180° angles to each other, thereby eliminating flow bias to any single impinger. Additional decay experiments were conducted without the UVGI system operating to measure removal by ventilation and natural die-off.

A completely-mixed room (CMR) model is needed to evaluate UVGI inactivation rates. The model is based on the assumption of perfect mixing, which results in uniform airborne bacteria concentrations throughout the volume of the room. A material balance is applied to airborne culturable bacteria within a room with volume V (m^3). Culturable bacteria are emitted from a source at a generation rate G (colony-forming units (CFU) h^{-1}). Ventilation air flows through the room removing airborne bacteria, reducing the indoor culturable bacteria concentration. The ventilation rate is expressed as the volumetric airflow rate through the room divided by the volume of the room (ACH, h^{-1}). In addition, the UVGI system inactivates airborne bacteria when operated. This inactivation rate can be approximated with a first order model, denoted ACH_{UV} (h^{-1}). Gravitational settling, natural die-off, and other natural decay mechanisms for bacteria are denoted ACH_N (h^{-1}).

The rate of change of the indoor airborne culturable bacteria concentration with the UVGI system on, $C_{UV\ on}(t)$ (CFU m^{-3}), is given by:

$$\frac{dC_{UV\ on}(t)}{dt} = \frac{G}{V} - (ACH + ACH_{UV} + ACH_N)C_{UV\ on}(t). \quad (2)$$

Rates for UVGI inactivation can be determined by interpreting the airborne bacteria concentration data collected during decay method experiments using the CMR model. From Equation 2, the rate of change of the culturable airborne bacteria concentration with time during the decay period is given by the relationship:

$$C_{UV\ on}(t) = C_o e^{-(ACH + ACH_{UV} + ACH_N)t}. \quad (3)$$

A similar expression can be written for the culturable airborne bacteria concentration without UVGI, $C_{UV\ off}(t)$.

To derive the overall removal rate, $ACH + ACH_{UV} + ACH_N$, the natural-log form of Equation 3 is linearly fit to data (natural-log transformed) collected during experiments with the UVGI system operating using a least-squares method:

$$\ln[C_{UV\ on}(t)] = \ln C_o - (ACH + ACH_{UV} + ACH_N) t. \quad (4)$$

The slope of the line is equal to the overall removal rate.

Similarly, data from experiments without the UVGI system operating is linearly fit to derive the removal rate due to ventilation and natural decay only, $ACH + ACH_N$:

$$\ln[C_{UV\ on}(t)] = \ln C_o - (ACH + ACH_N) t. \quad (5)$$

The slope of the line is equal to the removal rate due to ventilation and natural decay.

ACH_{UV} is ultimately determined by calculating the difference between the two rates derived from Equations 4 and 5.

2.9 Experimental Scenarios

All of our experiments were conducted under well-controlled temperature and RH conditions. The temperature and relative humidity were maintained at $24^{\circ}\text{C} \pm 1^{\circ}\text{C}$, and $50\% \pm 5\%$. A subset of experiments also controlled the relative humidity to 25%, 40%, and 100% RH. In addition, all but a couple of experiments were conducted under well-mixed conditions. Mixing was assured by turning on the mixing fans within the room; the room air was completely mixed when both mixing fans were on (Xu and Miller 1999). Similarly, ventilation rates were controlled to 0, 3, or 6 ACH.

2.9.1 Constant Generation and Decay Experiments

Ten experiments (Table 2), each conducted two times to estimate repeatability, were conducted using the constant generation method under well-mixed conditions. Experiments using the constant generation protocol were performed at two ventilation rates, 0 ACH and 6 ACH. 11 sampling locations were used for *B. subtilis* and *M. parafortuitum*; 5 sampling locations were used for *M. bovis* BCG. Negative pressure was maintained so that there was some leakage, and it was determined that this resulted in an air-exchange rate of 0.2–0.3 ACH.

Eleven experiments (Table 2) were conducted by the decay method using *M. parafortuitum*. Each was conducted two times to estimate repeatability. Experiments were performed under well-mixed conditions at three ventilation rates: 0, 3, and 6 ACH. Two to four UV irradiance levels were tested (the UV irradiance was varied by switching on/off some of the UVGI lamps) to determine the relationship between the inactivation rate of UVGI system and UV irradiance, in terms of Z value. Z value is the UVGI inactivation rate expressed in s^{-1} normalized to UV irradiance. It is an index used to express the dose-response relationship of different organisms and is solely dependent on the microorganism physiology. The higher the Z value, the more quickly the targeted microorganism is being inactivated by UVGI.

2.9.2 Relative Humidity Experiments

Both the constant generation and the decay method were used in these studies to test the effects of RH on UVGI efficacy. Mixing fans were operated during all experiments to ensure well-mixed conditions. For the constant generation method, the experiments were conducted at 25%, 50%, 75%, and 100% RH respectively. The test facility's steam injection system was used for RH control. Dry steam was injected into the supply air and a feed-back control device connected with a room RH sensor controlled the steam injection flow rate. This provided an accurate control on RH and reduced the potential for contamination. The RH value was very stable throughout the test, ranging $\pm 5\%$ of the target value for all tests. Room air temperature was

24°C for all experiments. To better represent real applications, the room was ventilated at 6 ACH during the experiments. The CDC guidelines suggest TB isolation rooms be ventilated at least at 6 ACH (CDC 1994). Although the ventilation rate was set at 6 ACH, we were still able to reach 100% RH with this steam injection system. Also, since only dry steam was introduced into the room, no fog or visible water droplets were observed throughout the test. Five sampling locations were used for these tests, each in the breathing zone.

Table 3 details the four experimental scenarios that were conducted with *M. parafortuitum* (each scenario consisted of a test with the UV lamps on and a test with the lamps off). We repeated each of these scenarios to estimate variability the following number of times: three for 100% RH and two for 75%, 50% and 25% RH.

Table 2. Experimental Scenarios for Well-Mixed Conditions¹

Test Organism	Ventilation Configuration	Methodology	Lamp Power (W)
<i>B. subtilis</i> spores	0 ACH	Constant generation	216
<i>B. subtilis</i> spores	0 ACH	Constant generation	0
<i>B. subtilis</i> spores	6 ACH	Constant generation	216
<i>B. subtilis</i> spores	6 ACH	Constant generation	0
<i>M. parafortuitum</i>	0 ACH	Constant generation	216
<i>M. parafortuitum</i>	0 ACH	Constant generation	0
<i>M. parafortuitum</i>	6 ACH	Constant generation	216
<i>M. parafortuitum</i>	6 ACH	Constant generation	0
<i>M. bovis</i> BCG	0 ACH	Constant generation	216
<i>M. bovis</i> BCG	0 ACH	Constant generation	0
<i>M. parafortuitum</i>	0 ACH	Decay	216
<i>M. parafortuitum</i>	0 ACH	Decay	108
<i>M. parafortuitum</i>	0 ACH	Decay	0
<i>M. parafortuitum</i>	3 ACH	Decay	216
<i>M. parafortuitum</i>	3 ACH	Decay	162
<i>M. parafortuitum</i>	3 ACH	Decay	108
<i>M. parafortuitum</i>	3 ACH	Decay	54
<i>M. parafortuitum</i>	3 ACH	Decay	0
<i>M. parafortuitum</i>	6 ACH	Decay	216
<i>M. parafortuitum</i>	6 ACH	Decay	108
<i>M. parafortuitum</i>	6 ACH	Decay	0

¹ All experiments repeated two times

For the decay method, experiments were performed under no-ventilation conditions. Because there was no ventilation, the mechanical ventilation's dry steam injector could not be used. Four portable humidifiers were placed in the room to control humidity, two on the north and two on the south side of the chamber (Duracraft DH910, Southborough MA). Using the humidifiers, the maximum humidity in the room was 90% RH without any notable condensation on room surfaces. The decay experiments were conducted at three RH levels with *M. parafortuitum* (Table 3): 20% RH, 50% RH, and 90% RH. Each experimental scenario was conducted two times.

Table 3. Experimental Scenarios for Varying RH Conditions

Ventilation Configuration	Relative humidity (%)	Methodology	Lamp Power (W)
6 ACH	100	Constant generation	216
6 ACH	100	Constant generation	0
6 ACH	75	Constant generation	216
6 ACH	75	Constant generation	0
6 ACH	50	Constant generation	216
6 ACH	50	Constant generation	0
6 ACH	25	Constant generation	216
6 ACH	25	Constant generation	0
0 ACH	90	Decay	216
0 ACH	90	Decay	0
0 ACH	50	Decay	216
0 ACH	50	Decay	0
0 ACH	20	Decay	216
0 ACH	20	Decay	0

2.9.3 UV Irradiance Experiments

To understand the effect of differing levels of UV irradiance and its distribution within the room, we conducted two sets of experiments. The first set of experiments was designed to determine the effectiveness of UVGI when the UV irradiance is unevenly distributed, and the second set of experiments was to determine the effectiveness of UVGI when the UV irradiance level is very high. The decay protocol was used in all experiments, with mixing fans on and 0 ACH ventilation. The UV irradiance was measured for each UVGI configuration. All tests were conducted with *M. parafortuitum*.

To simulate a scenario in which the UV irradiance is unevenly distributed spatially within the room, an additional wall fixture (4 lamps, 72 W total) was installed on the west wall next to the wall fixture already installed. These two wall fixtures were turned on in combination with two corner fixtures on the west wall (Figure 1). This created a UV irradiated zone that was highest nearest one side of the room (west) and decreased across the room (east). The total wattage of the operated UV lamps was 216 W. Triplicate experiments were conducted (Table 4).

To determine the UVGI performance under very high UV irradiance levels, all fixtures installed in the room were operated, which included the four wall and four corner fixtures as well as the center fixture. Total wattage of the operated UV lamps was 504 W. The decay protocol was used for the experiments, conducted in triplicate, except that the bioaerosol was sampled every 2 minutes instead of 4 minutes because the culturable bacteria concentrations were assumed to decay twice as fast. The sampling time for impingers was changed to 1 minute correspondingly.

Table 4. Experimental Scenarios for Elevated UV Irradiance and Unevenly Distributed Irradiance

Fixture Configuration	Lamp Power (W)
4 fixtures, west wall only	216
4 fixtures, west wall only	0
All fixtures ¹	504
All fixtures	0

¹Four wall, four corner, and one center fixture

2.9.4 Photoreactivation Experiments

The objectives of these experiments were to investigate the effect of photoreactivation on UVGI efficacy at 40% and 100% RH. We tried initially to conduct the lower RH experiments at 50% RH, which is the level at which most other experiments had been conducted, but the laboratory dry steam-injection humidification system was not working and we could only achieve 40% RH using the portable humidifiers. 100% RH has been shown to produce the most photoreactivation effects for airborne *M. parafortuitum* (Peccia 2001). Constant generation methods (with mixing fans on) and *M. parafortuitum* was used for all tests, conducted twice for both 40% RH and 100% RH. Mechanical ventilation was provided at 3 ACH for all tests. Five sampling locations were used for these tests, each in the breathing zone.

To determine the effects of photoreactivation for each RH, three tests were conducted (Table 5): (1) UVGI off and full spectrum fluorescent lights off, (2) UVGI on and fluorescent off, and (3) UVGI on and fluorescent on. The data analysis comparing the first two tests provided the UVGI effectiveness under a dark environment. The data analysis comparing the second to the third test provided the UVGI efficacy under photoreactivation conditions.

Table 5. Experimental Scenarios for Photoreactivation

Relative Humidity (%)	Fixture Configuration	Lamp Power (W)
40	UV off/fluorescent off	0
40	UV on/fluorescent off	216
40	UV on/fluorescent on	216 (UV) + 480 (visible)
100	UV off/fluorescent off	0
100	UV on/fluorescent off	216
100	UV on/fluorescent on	216 (UV) + 480 (visible)

2.9.5 Incomplete Mixing Experiments

UVGI effectiveness was tested under various air mixing conditions using the constant generation method. Two experimental scenarios, each conducted two times to estimate variability, were conducted with *M. parafortuitum* using the constant generation method (Table 6). Two mixing and ventilation conditions were observed: (1) mixing fans off to simulate incomplete mixing with no ventilation (~0.3 ACH due to infiltration, negative pressure) and (2) mixing fans off to

simulate incomplete mixing with 6 ACH ventilation simulating wintertime conditions. Incomplete mixing of the room could occur under wintertime conditions if the buoyancy of the warmer supply air (warmer than the room air) creates a short circuit between the supply inlet and the exhaust outlet, for ceiling supply and ceiling return systems.

Most of the experiments were conducted at 24 ± 1 °C (supply and room air temperature). In the experiments designed to simulate wintertime conditions, the supply air was elevated at 34 ± 1 °C, resulting in an upper zone temperature of 29 ± 1 °C and a lower zone temperature of 24 ± 1 °C. The relative humidity for all experiments was $50 \pm 5\%$. For most experiments, five sampling locations were used, each in the breathing zone. For one of the 6ACH wintertime ventilation experiments, samples were also collected at the ceiling and floor to investigate possible vertical stratification. The room air mixing was characterized using the age-of-air method both by using a gas tracer and a particle tracer (Xu and Miller 1999; Appendix I).

Table 6. Experimental Scenarios for Incomplete Mixing Conditions

Ventilation Configuration	Mixing Configuration	Room/Supply Air Temperature (°C)	Lamp Power (W)
0 ACH	Mixing Fans Off	N/A	216
0 ACH	Mixing Fans Off	N/A	0
6 ACH	Mixing Fans Off	24/34	216
6 ACH	Mixing Fans Off	24/34	0

2.10 Statistical Analysis and Error Propagation

Statistical hypothesis testing was applied to our data. In this analysis, a statistical hypothesis is first made about the data, which is a statement about one or more parameters we are considering (Petrucci et al. 1999). There are two types of hypotheses, a null, H_0 , and an alternative hypothesis, H_a . Typically, our null hypothesis was that the arithmetic mean concentration measured in one set of experiments equaled the mean from another set of experiments ($H_0: \mu_1 = \mu_2$). Our alternative hypothesis was that either the mean concentration from one set of experiments was greater than the mean from another set of experiments ($H_a: \mu_1 > \mu_2$), or that the means were not equal ($H_a: \mu_1 \neq \mu_2$). To decide between the null and alternative hypotheses, we used the t test statistic. The test is conducted by assuming at the outset that H_0 is true. The observed value of the t test statistic is then examined to see if it is consistent with H_0 and a p-value quantifies how consistent it is.

All of our experiments can be considered to be independent and the variances in the experiments are unknown. Thus we conducted our hypothesis tests (called tests for the remainder of the report) for independent populations with unknown variances. We tested for reasonably strong 95% confidence ($\alpha = 0.05$), which means that to reject the null hypothesis, the p-value needed to be less than 0.05.

Simple linear regression was used in our data analyses to quantify the relationship between two variables, one of which is the dependent variable and the other is the independent variable

(Petrucci 1999). The simple linear regression model can be described by $Y = mX + b$, where Y is the dependent variable, X is the independent variable, and m and b are the unknown model parameters that we are estimating. We estimated the parameters m and b using a least squares method, in which the sum of squares error is minimized. The F test was used to determine whether the derived linear relation between the dependent and independent variables was significant. In this test, the null hypothesis is that there is no relation between the variables ($H_0: m = b = 0$). The alternative hypothesis is that H_0 is not true ($H_a: m$ and/or b is not 0). The test statistic used for testing these hypotheses is called the F test statistic.

Random errors for each measurement in this study were estimated. Errors were minimized by using duplicate or triplicate sampling as well as by repeating our experiments two or more times. The effects of these errors were then propagated in test results calculated from several measurements (Dieck, 1997). Results calculated from several measurements include the UVGI effectiveness and the equivalent air-exchange rate. The method used in this study for error propagation is the Taylor's Series approximation. Briefly, this approach proceeds as follows: Given the function $R = F(X, Y)$, the Taylor's Series equation for propagating the effects of error in X and Y on the result R for independent error sources is:

$$U_R = \sqrt{\left(\frac{\partial R}{\partial X} U_X\right)^2 + \left(\frac{\partial R}{\partial Y} U_Y\right)^2}, \quad (6)$$

where U_R is the error in the result, U_X and U_Y are the errors in the measured parameters X and Y , $\partial R / \partial X$ expresses the influence an error in X will have on result R , and $\partial R / \partial Y$ expresses the influence an error in Y will have on result R . Using equation 6, the effects of an error in either X or Y may be impressed upon result R . Appendix II details the exact error propagation equations used in this study.

3. Results

3.1 UV Irradiance Levels

For the well-mixed, incomplete mixing, varying RH, and photoreactivation experiments, only the four corner UV fixtures and the one center fixture were turned on (5 fixtures, 216 W total lamp power). The results of the actinometer measurements for this configuration are presented in Figure 4 and Table 7. The UV spherical irradiance peaked in the region closest to the fixtures, and the area along the diagonals of the room. For the 30-min exposure test, the spatial average value \pm standard deviation was $42 \pm 19 \mu\text{W cm}^{-2}$. The maximum value was $81 \mu\text{W cm}^{-2}$, and the minimum was $25 \mu\text{W cm}^{-2}$. For the 90-min exposure test, the spatial average value was $44 \pm 20 \mu\text{W cm}^{-2}$. The maximum and minimum values were 87 and $23 \mu\text{W cm}^{-2}$ respectively. The results from the 30-min and 90-min tests were statistically equivalent (independent t test, $\alpha = 0.05$), which indicated that the response of the system was linear over the dose range and the test was repeatable. The average UV spherical irradiance at a height of 1.5 m was $0.08 \pm 0.02 \mu\text{W cm}^{-2}$ for 216 W (four corner and center fixtures operating).

Table 7. Average \pm SD UV Irradiance Measured in the upper Zone of the Room by Actinometry for Tests with Different Lamp Power

UV Irradiance ($\mu\text{W cm}^{-2}$)	Fixture Configuration	Lamp Power (W)
12 \pm 8.8	3 corner with 1 lamp operating in each	54
20 \pm 8.1	4 corner with 1 lamp operating in each, center with 2 lamps operating	108
33 \pm 18	3 corner with 2 lamps operating in each, 1 corner with 1 lamp operating, center with 2 lamps operating	162
42 \pm 19 ¹	4 corner, center ²	216
44 \pm 55	2 corner and 2 wall along west wall ²	216
87 \pm 49	4 corner, 4 wall, center ²	504

¹30-min exposure test

²All lamps in fixtures operating

Radiometry measurements were also done for the UVGI system configured such that four corner UV fixtures and the one center fixture were operating. The results of the radiometer measurements agreed with those using actinometry (independent t test, $\alpha=0.05$). The spatial average value in the upper zone was $54 \pm 20 \mu\text{W cm}^{-2}$. The maximum value was $131 \mu\text{W cm}^{-2}$, and the minimum was $22 \mu\text{W cm}^{-2}$. The UV irradiance at the height of 1.5 m was two orders of magnitude less than that measured in the upper zone—the spatial average value was $0.2 \pm 0.04 \mu\text{W cm}^{-2}$.

For the experiments that explored various UV irradiance levels and distributions, the UV fixtures were operated based on the test requirements. The average UV spherical irradiance with partial UVGI lamps operating was measured and is summarized in Table 7.

Actinometry measurements in which four UV fixtures along the west side of the room were operated (216 W), imposing a significant UV irradiance gradient from west to east wall, showed that the UV irradiance near one side of the room was as high as $140\text{-}160 \mu\text{W cm}^{-2}$, while on the other side of the room is as low as $2\text{-}10 \mu\text{W cm}^{-2}$. The average UV irradiance is $44 \pm 55 \mu\text{W cm}^{-2}$, as summarized in Table 7.

The vertical distribution of irradiance 8 ft away from the NW corner lamp along the centerline as measured by actinometry is shown in Figure 5. For the louvered configuration, the delineation between the upper UVGI zone and the lower zone can be clearly seen at this location: the irradiance decreases from $9 \mu\text{W cm}^{-2}$ at a height of 1.8 m above the ground to $3 \mu\text{W cm}^{-2}$ at a height of 1.6 m. For the unlouvered configuration, however, the irradiance is higher and more variable, decreasing steadily with height; the largest decrease occurs at 0.4 m above the ground. Table 8 summarizes the horizontal distribution of irradiance for this same corner lamp in the upper zone at 2.3 m above the floor. Results are presented for the lamp, both louvered and unlouvered. Louvering the lamp decreases the irradiance by two to four times. The irradiance along the N wall is comparable to that along the W wall, indicating that the output is fairly symmetrical. The irradiance is highest along the centerline. The lamps were operated limited hours during the experiments and the UVGI output remained steady during the study.

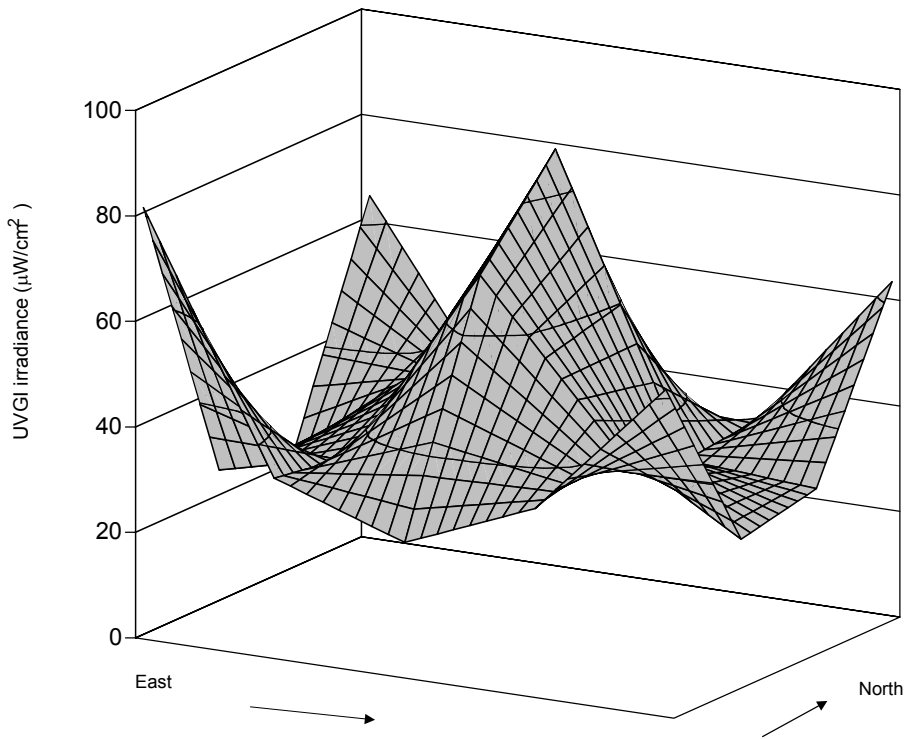

Figure 4. Spatial distribution of ultraviolet irradiance measured using actinometry in the upper-room zone with the four corner luminaries and one center luminary operating (216 W total lamp power). Spatially averaged value and standard deviation was $42 \pm 19 \mu\text{W cm}^{-2}$. The maximum value was $81 \mu\text{W cm}^{-2}$, and the minimum value was $25 \mu\text{W cm}^{-2}$.

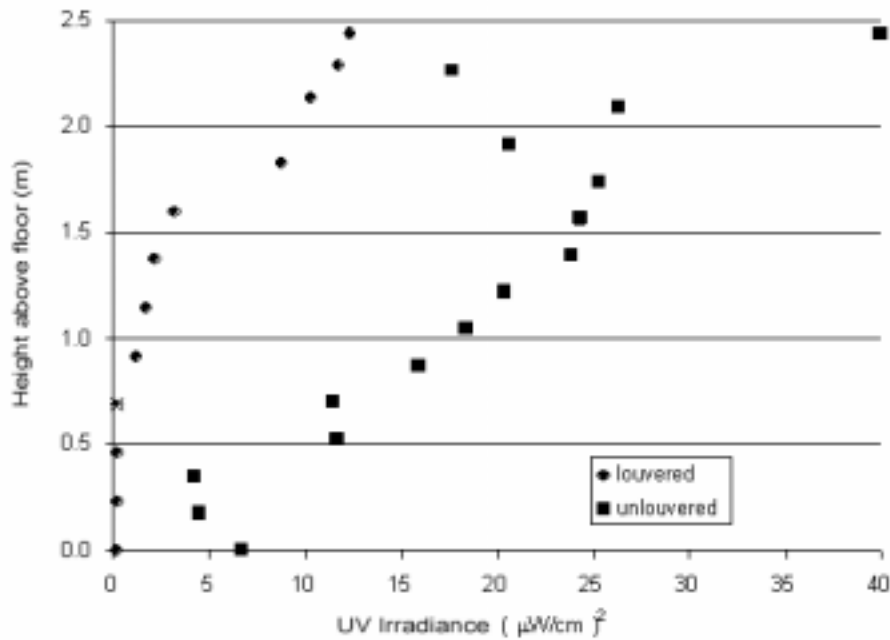

Figure 5. Vertical distribution of UV irradiance 8 ft away from the NW corner lamp (louvered and unlouvered) along the centerline as measured by chemical actinometry.

Table 8. Horizontal Distribution of UV Irradiance ($\mu\text{W cm}^{-2}$) Measured in the Upper Zone of the Room by Actinometry for the Louvered (Unlouvered) NW Corner Lamp

		Along N Wall \longrightarrow			
Along W Wall \downarrow	Centerline	4 ft away	6 ft away	8 ft away	
			18 (77)	13 (59)	7.8 (44)
	4 ft away	24 (74)	64 (121)		
	6 ft away	14 (51)	27 (83)		
	8 ft away	7.8 (36)		10 (40)	

3.2 Cell Concentration and Particle Size for Well-Mixed Conditions

The airborne bacteria total and culturable room-average (standard deviation) concentrations in the breathing zone for each constant generation method test under well-mixed conditions are listed on Table 9. *B. subtilis* spores and *M. parafortuitum* were tested at both 0 and 6 ACH. *M. bovis* BCG was tested at 0 ACH successfully. At 6 ACH, however, its culturability was below the detection limit. During the 0 ACH experiments, airborne bacteria concentrations continuously changed with time. During the 6 ACH experiments, concentrations approached equilibrium after 30 min.

The total number of bacteria aerosolized (as measured by direct counts) was statistically equivalent for all experiments in Table 9 comparing UVGI on and off (independent t test, $\alpha = 0.05$). The concentration of culturable airborne bacteria was less than the concentration of total airborne bacteria by up to an order of magnitude, depending on the type of microorganism, suggesting that the bacteria were stressed through the aerosolization process or lost culturability while airborne.

Based on culturable concentrations recovered from the impingers, the vertical and horizontal spatial concentration distribution within the room was relatively uniform. There was no statistically significant difference in the concentrations of airborne bacteria collected at all 11 locations (9 in the breathing zone, 1 at the ceiling, 1 at the floor; (Figure 1) as judged by independent t tests ($\alpha = 0.05$). This result supports the conclusion that the room air was well mixed.

Impactor data demonstrated that most of the collected airborne bacteria aerodynamic diameters were between 0.65 and 2.1 μm (d_{50} 's for impactor stages 4 through 6), with a geometric mean of 1.6 μm (geometric standard deviation = 1.2). No significant difference in size distribution was observed among the different microorganisms aerosolized (independent t test, $\alpha = 0.05$).

Table 9. Total and Culturable Count Room-Average (Standard Deviation) Concentrations for Constant Generation Method Experiments Under Well-Mixed Conditions¹

	Ventilation Configuration	Lamp Power (W)	Total Count Concentration (# m ⁻³)	Culturable Count Concentration (CFU m ⁻³)
<i>B. subtilis</i> spores	0 ACH	216 W	1.06 (0.13) × 10 ⁸	1.12 (0.32) × 10 ⁵
		0	8.59 (0.18) × 10 ⁷	4.64 (0.59) × 10 ⁵
	0 ACH	216	4.39 (0.19) × 10 ⁷	3.38 (0.72) × 10 ⁶
		0	4.13 (0.31) × 10 ⁷	1.41 (0.08) × 10 ⁷
	6 ACH	216	4.93 (0.35) × 10 ⁶	4.78 (2.10) × 10 ⁵
		0	5.56 (0.63) × 10 ⁶	1.38 (0.02) × 10 ⁶
6 ACH	216	8.66 (1.72) × 10 ⁶	5.51 (0.50) × 10 ⁵	
	0	7.36 (1.54) × 10 ⁶	8.73 (1.37) × 10 ⁵	
<i>M. parafortuitum</i>	0 ACH	216	2.10 (0.43) × 10 ⁸	6.12 (5.80) × 10 ⁵
		0	1.60 (0.54) × 10 ⁸	2.20 (0.62) × 10 ⁷
	0 ACH ²	216	N/A	1.33 (1.47) × 10 ⁴
		0	N/A	1.92 (0.85) × 10 ⁵
	6 ACH	216	1.58 (0.21) × 10 ⁸	1.31 (0.29) × 10 ⁷
		0	1.51 (0.22) × 10 ⁸	2.57 (0.23) × 10 ⁸
	6 ACH	216	7.45 (0.77) × 10 ⁷	2.34 (0.35) × 10 ⁷
		0	7.84 (0.18) × 10 ⁷	1.44 (0.20) × 10 ⁸
<i>M. bovis</i> BCG	0 ACH	216	6.80 (0.51) × 10 ⁵	1.01 (0.12) × 10 ³
		0	6.64 (0.48) × 10 ⁵	3.71 (0.22) × 10 ⁴
	0 ACH	216	6.14 (1.50) × 10 ⁵	5.51 (0.76) × 10 ³
		0	3.49 (1.60) × 10 ⁵	7.67 (4.43) × 10 ⁴

¹ Room-average ± standard deviation calculated using measurements from 9 breathing zone locations.

² Room-average ± standard deviation calculated using culturable counts only; total counts were not available, data was lost.

3.3 Effectiveness of UVGI

As shown in Figure 6, the UVGI system (corner plus center fixtures operating, 216 W) reduced the room-average concentration of culturable airborne bacteria. The effectiveness of UVGI was between 46–80% for *B. subtilis* spores, between 83–98% for *M. parafortuitum*, and 96–97% for *M. bovis* BCG at 50% relative humidity and well-mixed conditions, depending on the ventilation rate (Equation 1).

For 0 ACH ventilation, the average effectiveness based on duplicate experiments is: *B. subtilis* – 79%; *M. parafortuitum* – 96%; *M. bovis* BCG – 97%. Effectiveness was not statistically different for *M. parafortuitum* and *M. bovis* BCG at 0 ACH ventilation rate (independent t test, $\alpha = 0.05$). For 6 ACH ventilation, the average effectiveness based on duplicate experiments is: *B. subtilis* – 54%; *M. parafortuitum* – 89%. *B. subtilis* spores were more resistant to inactivation by UVGI than either mycobacteria cultures tested

While increasing the ventilation rate from 0 to 6 ACH appeared to decrease the effectiveness of UVGI-induced microbial inactivation by an average of 25% for *B. subtilis* spores and 7% for *M. parafortuitum*, these decreases were not statistically significant (independent test, $\alpha = 0.05$).

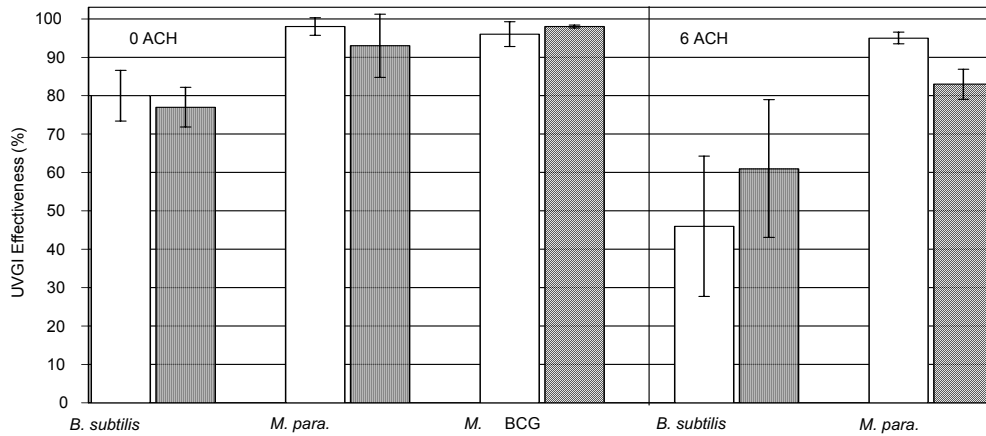

Figure 6. Effectiveness of UVGI-induced microbial inactivation for constant-generation method experiments under well-mixed conditions with 50% RH and 0 or 6 air changes per hour (ACH) ventilation rate for *B. subtilis* spores, *M. parafortuitum*, and *M. bovis* BCG. Error bars represent the standard deviation. Experiments were repeated: indicates experiment 1, indicates experiment 2.

3.4 UVGI Inactivation Rate (ACH_{UV})

Decay experiment data used to determine inactivation rates induced by UVGI are presented in Figure 7–9. All data is for well-mixed conditions and 50% RH. The least-squares method was used to fit lines to the data and inactivation rates were inferred by subtracting the slope of the lines for the no-UV experiments from those with UVGI (Equations 4 and 5). The figures are plots of normalized CFU concentration versus time. Normalized CFU concentration was calculated by dividing the data for each experiment by the maximum concentration measured during the experiment. Standard deviations of the regression lines are reported and propagation of errors was applied to determine the uncertainty in the inactivation rates (see Appendix 1 for propagation of errors). All slopes were statistically significant (F tests, $\alpha = 0.05$).

At 0 ACH ventilation rate, the inactivation rate (\pm standard deviation) with 9 fixtures (216 W) operating was $16 \pm 1.8 \text{ h}^{-1}$ (Figure 7). When the lamp power was decreased to 108 W, *M. parafortuitum* responded to the UVGI system with an inactivation rate of $5.6 \pm 0.69 \text{ h}^{-1}$. Experiments conducted at 3 ACH ventilation rate, and for lamp powers of 54, 108, 162 and 216 watts (Figure 8), resulted in ACH_{UV} values of $1.2 \pm 1.1 \text{ h}^{-1}$, $7.7 \pm 0.57 \text{ h}^{-1}$, $14 \pm 3.1 \text{ h}^{-1}$, and $17 \pm 2.4 \text{ h}^{-1}$ respectively.

Experiments conducted at 6 ACH ventilation rate (Figure 9), for 108 and 216 W lamp power, resulted in ACH_{UV} values of $5.1 \pm 2.1 \text{ h}^{-1}$ and $13 \pm 1.9 \text{ h}^{-1}$ respectively.

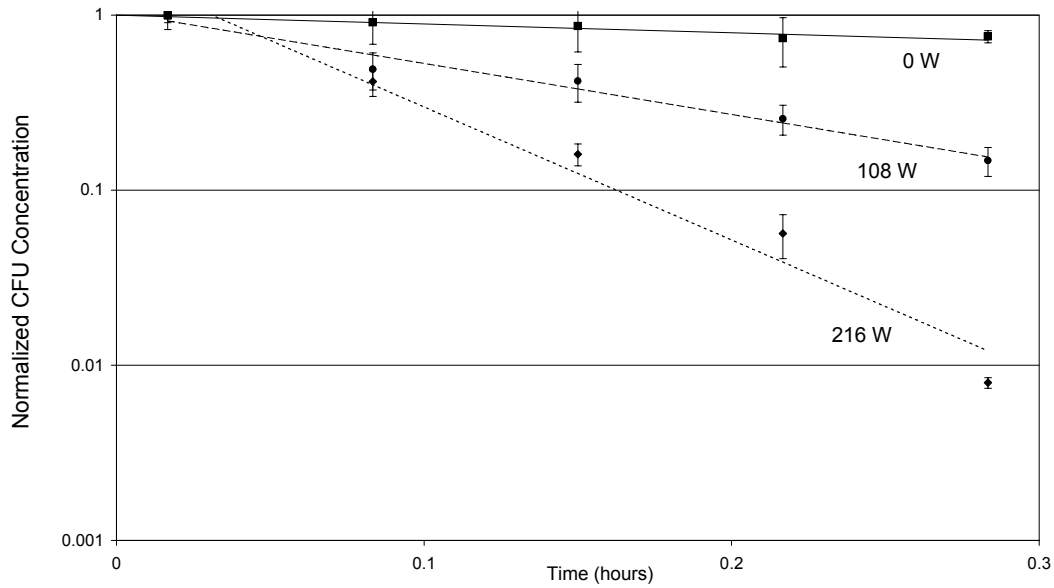

Figure 7. Data from decay method experiments used to determine inactivation rates for *M. parafortuitum* induced by UVGI under well-mixed conditions with ventilation rate of 0 air changes per hour, 50% RH, and UVGI at 216 W, 108 W and 0 W total lamp power. UVGI inactivation rates are the difference between the slopes of the lines with UVGI on and off. Slopes of lines \pm standard deviation of the lines are $-0\text{ W: } -1.2 \pm 0.21\text{ h}^{-1}$, $108\text{ W UV: } -6.7 \pm 0.66\text{ h}^{-1}$, $216\text{ W UV: } -17.5 \pm 1.8\text{ h}^{-1}$. All slopes were statistically significant as judged by F tests, $\alpha = 0.05$.

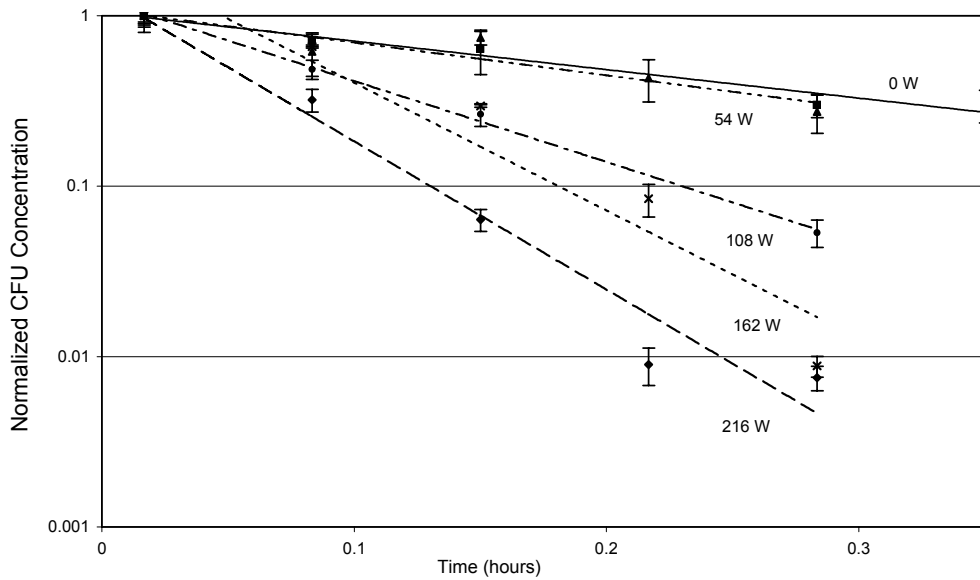

Figure 8. Data from decay method experiments used to determine inactivation rates for *M. parafortuitum* induced by UVGI under well-mixed conditions with ventilation rate of 3 air changes per hour, 50% RH, and UVGI at 216 W, 162 W, 108 W, 54 W, and 0 W total lamp power. UVGI inactivation rates are the difference between the slopes of the lines with UVGI on and off. Slopes of lines \pm standard deviation of the lines are $-0\text{ W: } -3.2 \pm 0.40\text{ h}^{-1}$, $54\text{ W: } -4.4 \pm 1.0\text{ h}^{-1}$, $108\text{ W: } -10.9 \pm 0.40\text{ h}^{-1}$, $162\text{ W: } -17.3 \pm 3.1\text{ h}^{-1}$, $216\text{ W: } -20.0 \pm 2.4\text{ h}^{-1}$. All slopes were statistically significant as judged by F tests, $\alpha = 0.05$.

The average inactivation rate of the UVGI system from experiments under different ventilation rates in our study for *M. parafortuitum* was $16 \pm 1.2 \text{ h}^{-1}$ for 216 W, and $6.1 \pm 0.76 \text{ h}^{-1}$ for 108 W.

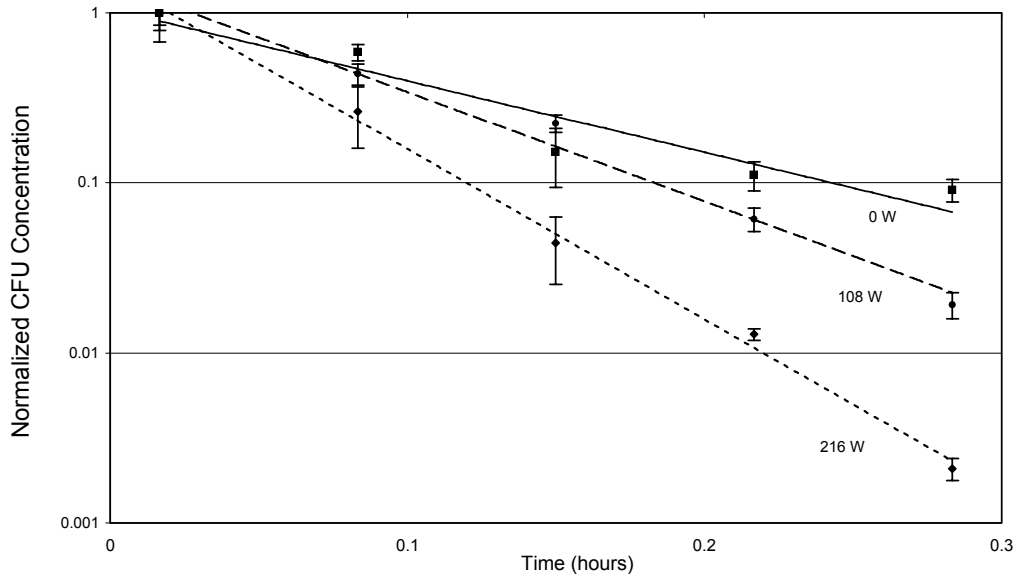

Figure 9. Data from decay method experiments used to determine inactivation rates for *M. parafortuitum* induced by UVGI under well-mixed conditions with ventilation rate of 6 air changes per hour, 50% RH, and UVGI at 216 W, 108 W and 0 W total lamp power. UVGI inactivation rates are the difference between the slopes of the lines with UVGI on and off. Slopes of lines \pm standard deviation of the lines are – 0 W: $-9.7 \pm 1.8 \text{ h}^{-1}$, 108 W: $-14.8 \pm 1.1 \text{ h}^{-1}$, 216 W: $-23.1 \pm 0.78 \text{ h}^{-1}$. All slopes were statistically significant as judged by F tests, $\alpha = 0.05$.

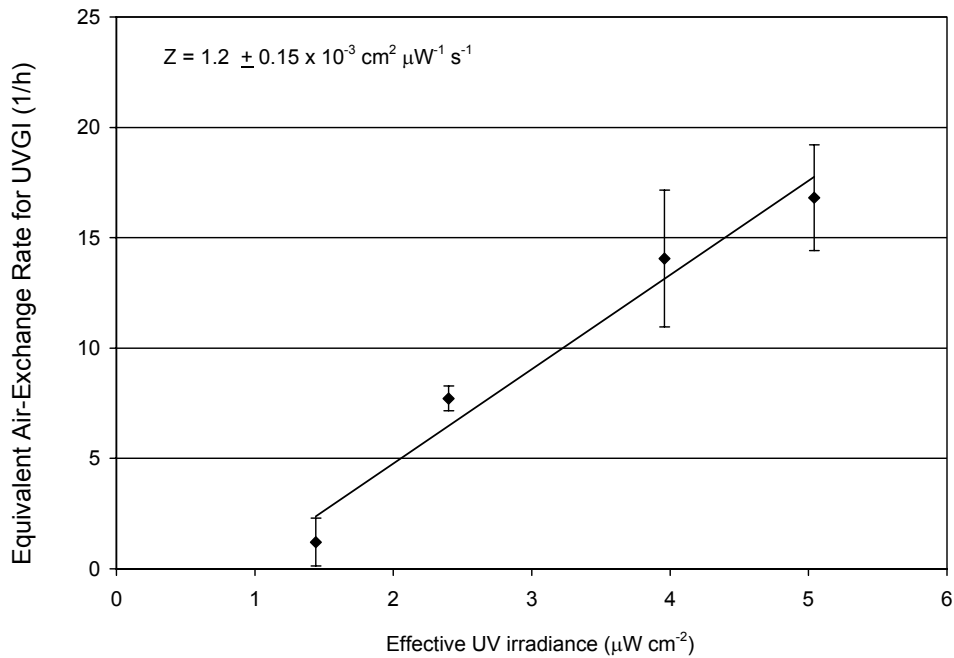

Figure 10. UVGI-induced inactivation rate as a function of effective UVGI irradiance for *M. parafortuitum* under well-mixed conditions for 54 W to 216 W lamp power. Effective UVGI irradiance is the irradiance measured in the upper-room zone only normalized to the fraction of room volume irradiated by UV (0.3 m / 2.5 m). Tests conducted at 50% RH.

3.6 Effectiveness of UVGI for Various RH Conditions

Figure 6 summarizes the effectiveness of the UVGI system (corner plus center fixtures operating, 216 W) for different relative humidity under well-mixed conditions with 6 ACH ventilation. For 100% RH, the effectiveness of the UVGI system ranged from 42–67%, with an average effectiveness of 55% and propagated standard deviation of 7.3%. At 75% RH, the effectiveness was 47 and 53% with an average of 50%. At 25% RH, the effectiveness was 62 and 77%, with an average of 70%. Previous experiments conducted at 50% RH and at 6 ACH ventilation showed that UVGI effectiveness was 95% and 83% (Section 4.3, Figure 6), with an average efficacy of 89%.

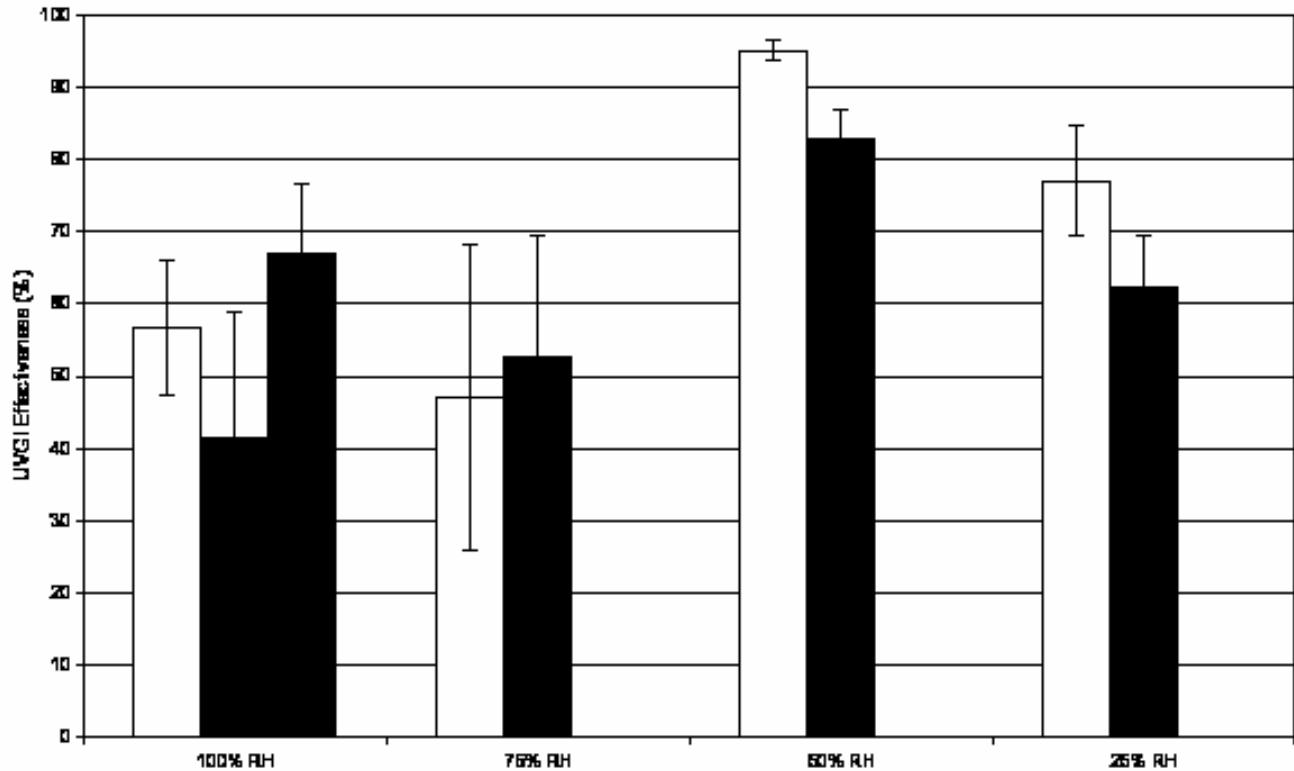

Figure 11. Effectiveness of UVGI-induced microbial inactivation for constant-generation method experiments under well-mixed conditions and varying RH with 6 air changes per hour (ACH) ventilation rate for *M. parafortuitum*. Error bars represent the standard deviation. Experiments were repeated: indicates experiment 1, indicates experiment 2, and indicates experiment 3.

Table 10 details the results of independent, unequal variance t tests (one tail, $\alpha = 0.05$). These hypothesis tests were conducted on the average effectiveness derived from repeat experiments and compare effectiveness values to another to see if there is any difference (see section 3.10). The hypothesis tests showed that the effectiveness measured at 50 and 100% RH, and at 75 and 50% RH, were statistically significantly different. Because the effectiveness for 75 and 100% is lower compared to the effectiveness at 50% RH, we can say that the effectiveness of UVGI is significantly decreased for RH at 75% or above.

Other comparisons noted in Table 10 were not statistically significantly different. The effectiveness at 100 and 75% RH, 100 and 25% RH, 75 and 25% RH were not different. The hypothesis tests also indicate that the effectiveness at 50 and 25% RH were not different, but the test is fairly weak and if α is increased from 0.05 to 0.09 (confidence is decreased from 95% to 91%), then the effectiveness would be shown to be different. This suggests then that effectiveness is also significantly decreased for RH below 25% compared to the effectiveness at 50% RH. In summary, our results show effectiveness decreases by 40% for relative humidity above 75% RH and decreases by 20% below 25% RH for $\alpha = 0.09$. More experiments need to be conducted at RH below 50% to state with greater statistical confidence that effectiveness decreases at lower RH.

Table 10. Detailed Results of Hypothesis Tests for Effectiveness at Varying Relative Humidity¹

RH 1 and RH 2 to be tested for difference	Average Effectiveness (%) for RH 1	Average Effectiveness (%) for RH 2	T test statistic	P value (one tail)
100% vs. 75%	55	50	0.66	0.28
100% vs. 50%	55	89	-3.5	0.019
100% vs. 25%	55	70	-1.4	0.13
75% vs. 50%	50	89	-5.8	0.054
75% vs. 25%	50	70	-2.5	0.12
50% vs. 25%	89	70	2.0	0.090

¹ Bold indicates effectiveness for RH1 and RH2 are statistically significantly different at the 0.05 level.

3.7 UVGI Inactivation Rate (ACH_{UV}) for Various RH Conditions

Decay experiment data used to determine inactivation rates induced by UVGI for various RH conditions are presented in Figure 12. The least-squares method was used to fit lines to the data and inactivation rates were inferred by subtracting the slope of the lines for the no-UV experiments from those with UVGI. Standard deviations of the regression lines are reported and propagation of errors was applied. All slopes were statistically significant as judged by F tests ($\alpha = 0.05$).

The equivalent air-exchange rate of the UVGI system (4 corner fixtures and one center fixture, 216 W) under well-mixed conditions, ACH_{UV} (\pm propagated standard deviation), was $8.8 \pm 1.5 \text{ h}^{-1}$ for 90% RH, $18 \pm 2.0 \text{ h}^{-1}$ for 50% RH and $21 \pm 1.8 \text{ h}^{-1}$ for 20% RH. Increasing RH from 50 to 90% decreased the equivalent air-exchange rate by half. Increasing the RH from 20 to 50% did not have as dramatic an effect: the equivalent air-exchange rate decreased by 15%. This difference between 20 and 50% RH can not be considered substantial given that the standard deviations overlap (upper bound on 50% RH is $18 + 2.0 = 20 \text{ h}^{-1}$ and lower bound on 20% RH is $21 - 1.8 = 19 \text{ h}^{-1}$). The equivalent air-exchange rate derived in these experiments for 50% RH agrees with the average rate derived during the well-mixed conditions experiments ($16 \pm 1.2 \text{ h}^{-1}$).

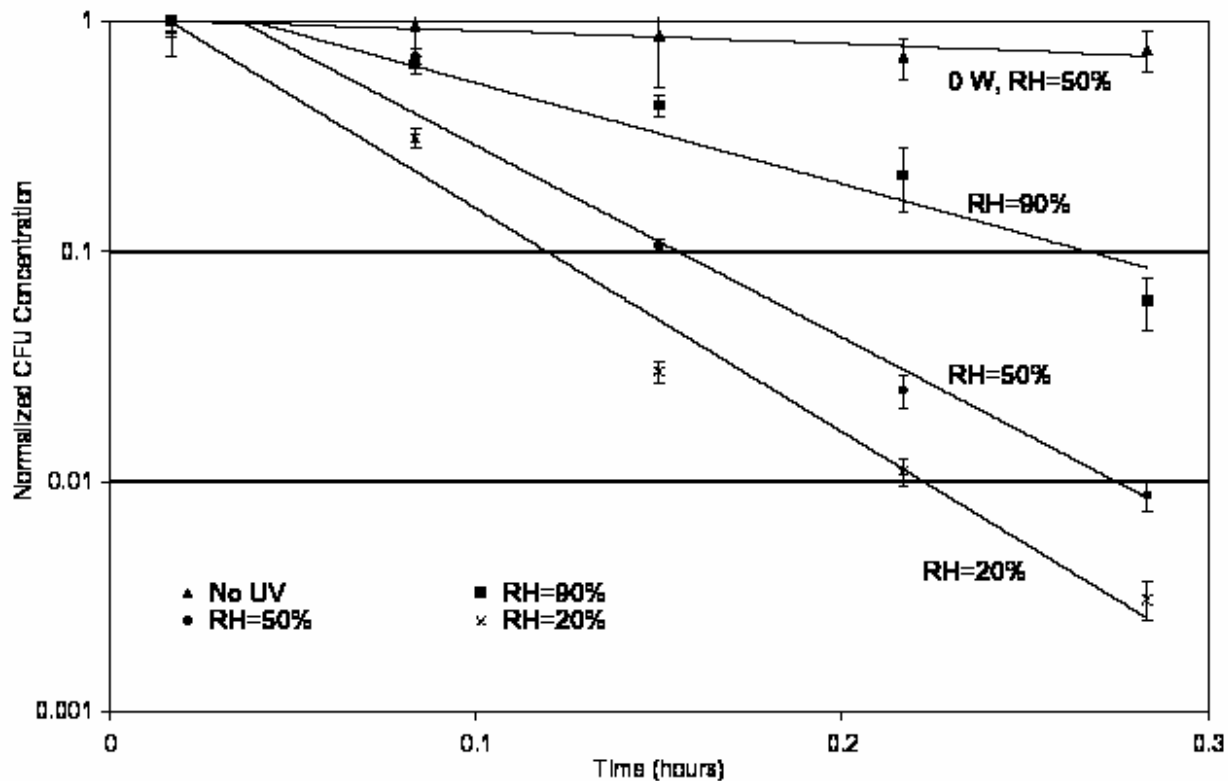

Figure 12. Data from decay method experiments used to determine inactivation rates at 20, 50, and 90% relative humidity for *M. parafortuitum* induced by UVGI under well-mixed conditions with 0 ACH ventilation and UVGI at 216 W. UVGI inactivation rates are the difference between the slopes of the lines with UVGI on and off. Slopes of lines \pm standard deviation of the lines are – 0 W, 50% RH: $-1.3 \pm 0.35 \text{ h}^{-1}$, 90% RH: $-10 \pm 1.5 \text{ h}^{-1}$, 50% RH: $-19 \pm 1.9 \text{ h}^{-1}$, 20% RH: $-22 \pm 1.7 \text{ h}^{-1}$. All slopes were statistically significant as judged by F tests, $\alpha = 0.05$.

3.8 UVGI Inactivation Rate (ACH_{UV}) for Unevenly Distributed Irradiance

Figure 13 shows the data for the decay experiments used to determine inactivation rates induced by UVGI for unevenly distributed irradiance within the upper portion of the room. For the three repeat tests we conducted, the UVGI equivalent air-exchange rates (2 corner fixtures and 2 wall fixtures, along west wall, 216 W) under well-mixed conditions were 10 ± 0.86 , 11 ± 1.3 , and $14 \pm 1.7 \text{ h}^{-1}$ respectively. All slopes were statistically significant as judged by F tests ($\alpha = 0.05$). The average equivalent air-exchange rate for unevenly distributed UVGI was $12 \pm 1.3 \text{ h}^{-1}$. Compared with the average equivalent air-exchange rate ($16 \pm 1.2 \text{ h}^{-1}$) from similar decay experiments under the more uniform irradiance distribution achieved by 4 corner fixtures and one center fixture (216 W), the air-exchange rate decreased by 25%.

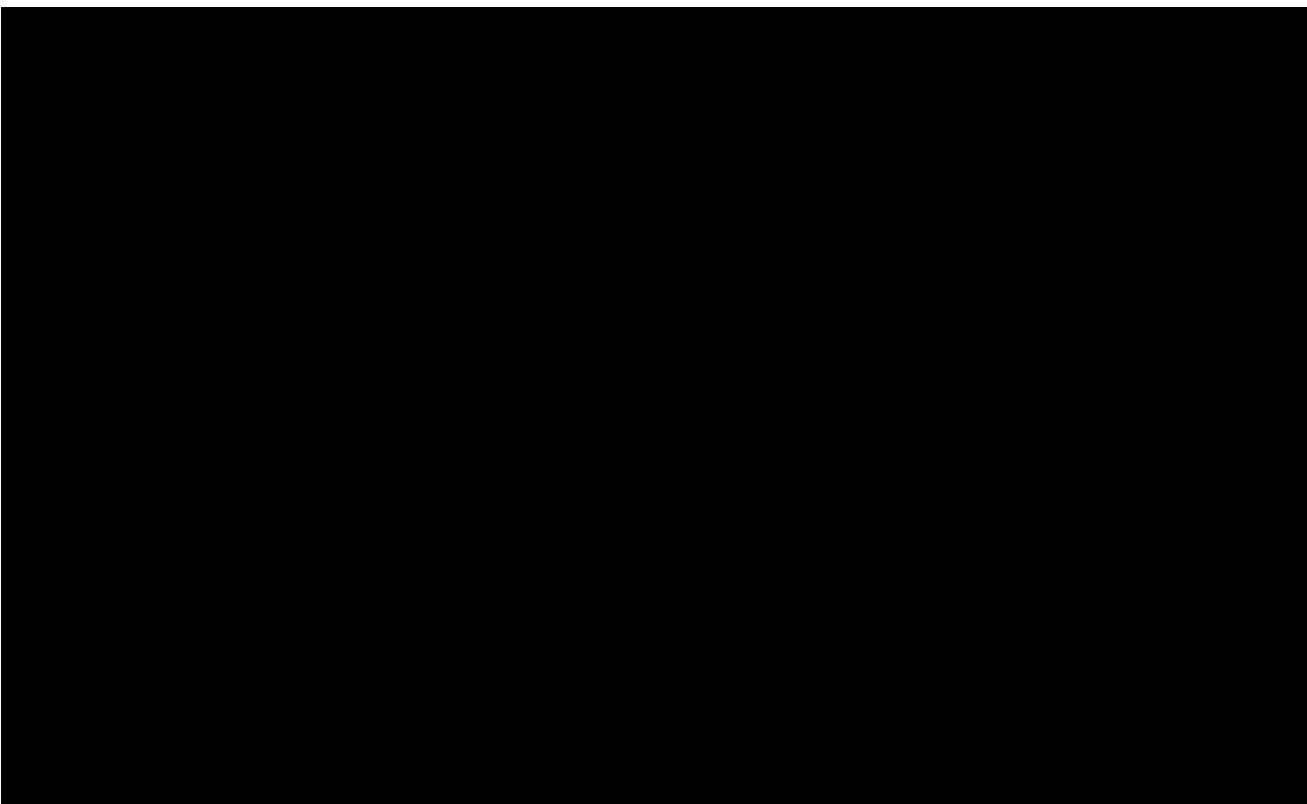

Figure 13. Data from decay method experiments used to determine inactivation rates induced by UVGI for unevenly distributed UV irradiance (all luminaries along west wall, 216 W) for *M. parafortuitum* under well-mixed conditions with 0 ACH ventilation. Data are shown for three repeat experiments. UVGI inactivation rates are the difference between the slopes of the lines with UVGI on and off. Slopes of lines \pm standard deviation of the lines are – 0 W: $-0.17 \pm 0.29 \text{ h}^{-1}$, experiment 1: $-11 \pm 1.3 \text{ h}^{-1}$, experiment 2: $-10 \pm 0.80 \text{ h}^{-1}$, experiment 3: $-14 \pm 1.7 \text{ h}^{-1}$. All slopes were statistically significant as judged by F tests, $\alpha = 0.05$.

3.9 UVGI Inactivation Rate (ACH_{UV}) for Elevated levels of UV Irradiance

Figure 14 shows the data for the decay experiments used to determine inactivation rates induced by UVGI for elevated levels of UV irradiance. For these experiments 9 fixtures were operated (four corner, four wall and one center fixture, Figure 1) resulting in 504 W total lamp power. Only two of the three repeat experiments were successful. UVGI equivalent air-exchange rates are 19 ± 2.9 and $19 \pm 2.4 \text{ h}^{-1}$ for the two tests respectively, and the average is $19 \pm 1.9 \text{ h}^{-1}$. Compared with the equivalent air-exchange rate ($16 \pm 1.2 \text{ h}^{-1}$) from similar decay experiments under 216 W total lamp power, the air-exchange rate did not more than double as might be expected, but increased by only 19%.

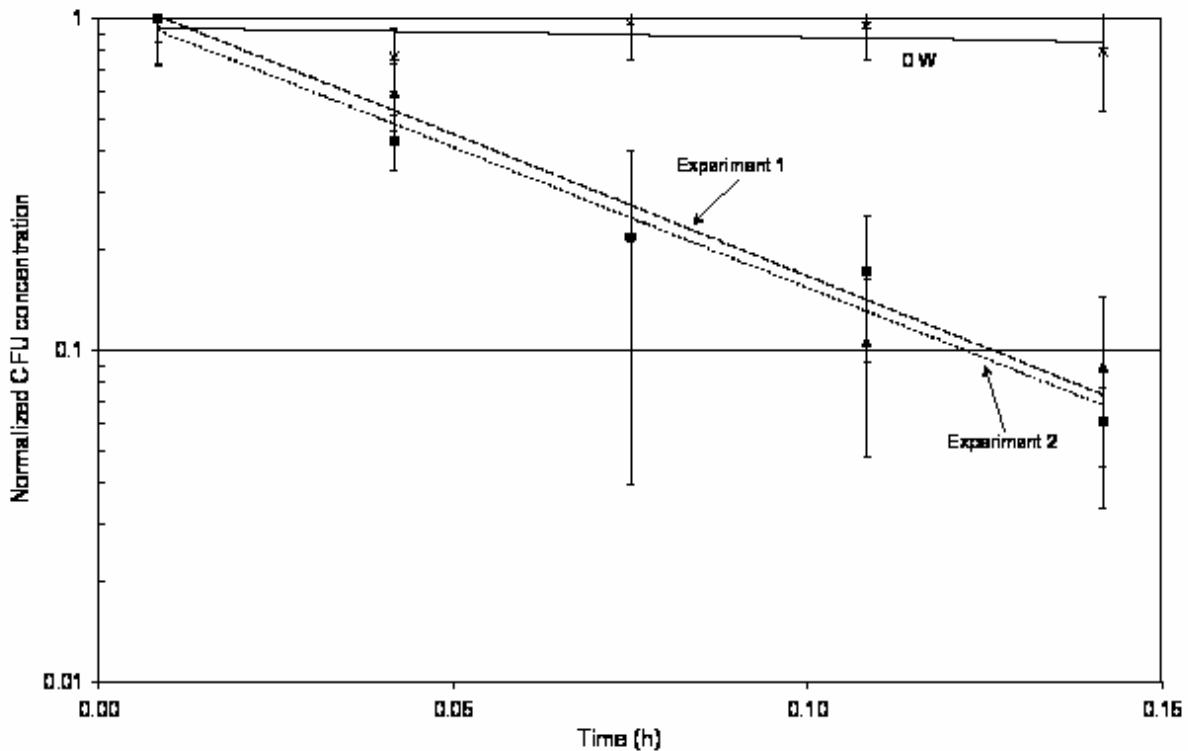

Figure 14. Data from decay method experiments used to determine inactivation rates induced by UVGI for elevated levels of UV irradiance (9 luminaries operated, 504 W) for *M. parafortuitum* under well-mixed conditions with 0 ACH ventilation. Data are shown for two repeat experiments. UVGI inactivation rates are the difference between the slopes of the lines with UVGI on and off. Slopes of lines \pm standard deviation of the lines are $-0\text{ W: }-0.72 \pm 1.3\text{ h}^{-1}$, experiment 1: $-19.5 \pm 2.0\text{ h}^{-1}$, experiment 2: $-19.7 \pm 2.5\text{ h}^{-1}$. All slopes were statistically significant as judged by F tests, $\alpha = 0.05$.

3.10 Effectiveness of UVGI under Photoreactivation Conditions

Photoreactivation occurring within airborne bacteria was not confirmed by concurrent exposure of airborne bacteria and visible light at 40% RH. Table 11 lists the experimental results of two repeat experiments that were conducted at 40% RH, complete-mixing conditions, and 3 ACH ventilation for *M. parafortuitum*. Under the column labeled “Effectiveness”, the estimate of 85% for both experiments 1 and 2 is the effectiveness of the system without photoreactivation, determined by comparing experiments with *UV off/fluorescent off* to *UV on/fluorescent off* (Equation 1). This effectiveness is comparable to that found in the complete-mixing experiments conducted at 50% RH, which ranged between 83–98% for *M. parafortuitum*, depending on ventilation conditions (Figure 6). Comparing *UV off/fluorescent off* to *UV on/fluorescent on* derives the effectiveness of the system with photoreactivation, 83% for experiment 1 and 81% for experiment 2. While the % decrease in effectiveness due to photoreactivation can be calculated, and is 1.4% for experiment 1 and 4.1% for experiment 2, the % decrease in effectiveness due to photoreactivation is not different from zero due to the large propagated error in the result. Comparing the effectiveness values for *UV on/fluorescent off* to those derived for *UV on/fluorescent on*, an independent t test indicates that the differences are not statistically significant ($\alpha = 0.05$).

Table 11. Results for Photoreactivating Conditions and 40% Relative Humidity¹

Exp. #	Fixture Configuration	Total Count Concentration (# m ⁻³)	Culturable Count Concentration (CFU m ⁻³)	Effectiveness (%)	% Decrease in Effectiveness due to PR
1	UV off/fluorescent off	1.22 (0.35) × 10 ⁷	1.30 (0.20) × 10 ⁶		
	UV on/fluorescent off	1.35 (0.23) × 10 ⁷	2.22 (0.27) × 10 ⁵	85 ± 5.9	
	UV on/fluorescent on	1.46 (0.13) × 10 ⁷	2.61 (1.50) × 10 ⁵	83 ± 11	1.4 ± 13
2	UV off/fluorescent off	8.83 (0.29) × 10 ⁷	1.16 (0.25) × 10 ⁶		
	UV on/fluorescent off	1.01 (0.06) × 10 ⁸	1.95 (0.58) × 10 ⁵	85 ± 5.5	
	UV on/fluorescent on	1.00 (0.03) × 10 ⁸	2.47 (1.30) × 10 ⁵	81 ± 11	4.1 ± 12

¹ Average ± standard deviation was calculated using measurements from 5 breathing zone locations within the room.

Experiments of concurrent exposure of airborne bacteria and visible light at 100% RH were inconclusive. Table 12 details results of two repeat experiments that were conducted with *M. parafortuitum* at 100% RH, complete-mixing conditions, and 3 ACH ventilation. For experiments 1 and 2, the effectiveness of UVGI is 42% and 60% respectively when fluorescent light is off. These effectiveness values are comparable to those found in the complete-mixing experiments conducted at 100% RH, which ranged between 41–67% for *M. parafortuitum*, with 6 ACH ventilation (Figure 11). When the fluorescent light is on, the effectiveness decreases; only experiment 2, however, shows a result for % decrease in effectiveness due to photoreactivation that is significantly different from zero. Experiment 1 indicates that no photoreactivation occurred, while experiment 2 indicates that some photoreactivation occurred. However, comparing the effectiveness values for UV on/fluorescent off to those derived for UV on/fluorescent on, an independent t test indicates that the differences are not statistically significant ($\alpha = 0.05$). More experiments need to be conducted to confirm that photoreactivation under the conditions of these experiments occurs.

Table 12. Results for Photoreactivating Conditions and 100% Relative Humidity¹

Exp. #	Fixture Configuration	Total Count Concentration (# m ⁻³)	Culturable Count Concentration (CFU m ⁻³)	Effectiveness (%)	% Decrease in Effectiveness due to PR
1	UV off/fluorescent off	4.08 (0.22) × 10 ⁷	4.39 (0.33) × 10 ⁶		
	UV on/fluorescent off	2.68 (0.14) × 10 ⁷	1.67 (0.11) × 10 ⁶	42 ± 7.4	
	UV on/fluorescent on	4.48 (0.34) × 10 ⁷	2.89 (0.17) × 10 ⁶	40 ± 8.0	2.0 ± 11
2	UV off/fluorescent off	5.87 (0.26) × 10 ⁷	2.30 (0.09) × 10 ⁷		
	UV on/fluorescent off	6.48 (0.17) × 10 ⁷	1.02 (0.09) × 10 ⁷	60 ± 12	
	UV on/fluorescent on	5.89 (0.37) × 10 ⁷	1.32 (0.09) × 10 ⁷	43 ± 6.5	17 ± 13

¹ Average ± standard deviation was calculated using measurements from 5 breathing zone locations within the room.

3.11 Effectiveness of UVGI for Incomplete Mixing Conditions

The effectiveness of the UVGI system (corner plus center fixtures operating, 216 W) under incomplete mixing conditions is shown in Figure 15. For comparison purposes, results from the completely mixed experiments are also presented (see Figure 6). For our test room configuration, UVGI efficacy under 0 ACH ventilation was not affected when the mixing fans were turned off compared to when the fans were on (independent t-test, $\alpha = 0.05$). Note that one of our duplicate experiments under this configuration was not successful.

For 6 ACH, the UVGI efficacy decreased substantially from an average of 89% to 12% when the mixing fans were turned off and wintertime ventilation conditions were established (ventilation supply air was elevated at 34 °C compared to room temperature at 24 °C). This decrease was statistically significant (independent t- test, $\alpha = 0.05$). The propagated standard deviation for effectiveness under winter conditions is very large, indicating a high degree of variability in culturable bacteria concentrations at breathing zone height within the room. In addition, we observed a vertical stratification in concentrations during experiment 1 in which additional air samples were collected at the ceiling and floor. The breathing zone concentration (3.96×10^3 CFU m⁻³) was statistically significantly higher than both the ceiling (2.50×10^3 CFU m⁻³) and the floor (3.13×10^3 CFU m⁻³) concentrations (independent t-test, $\alpha = 0.05$).

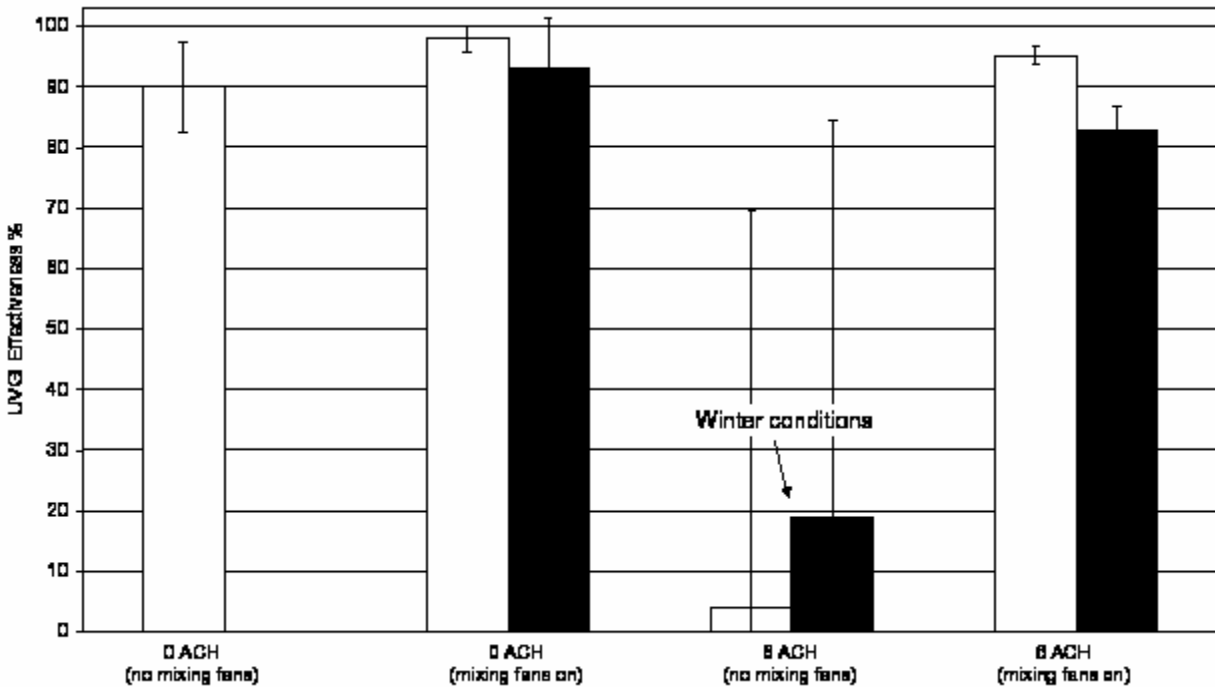

Figure 15. Effectiveness of UVGI-induced microbial inactivation for constant-generation method experiments under different room air mixing conditions for 50% RH with 0 or 6 air changes per hour (ACH) ventilation rate for *M. parafortuitum*. Experiments were repeated: indicates experiment 1 and indicates experiment 2.

4. Discussion and Conclusions

Overall, our data demonstrate that the upper room-air UVGI system tested was able to inactivate airborne bacteria spores and mycobacteria and significantly decrease their culturable airborne cell concentrations. This report addresses the effects of the following factors influencing the efficacy of upper-room air UVGI: bacterial physiology and species, room ventilation rates, UV irradiance levels and distribution, airflow patterns, relative humidity (RH), and photoreactivation.

In our study, we used two indices to describe the impact of UVGI on airborne bacteria. One is the *effectiveness*, E (Equation 1). The other is the *inactivation rate*, ACH_{UV} (Equations 4 and 5). The effectiveness was applied in this research to constant-generation method experiments. It

provides a clear picture of the decrease in culturable airborne bacteria concentrations that can be achieved under given environmental conditions. Also, it is not based on assuming the room air is well mixed. The disadvantage of effectiveness is that it is not an intrinsic parameter of UVGI itself; it is a relative parameter depending on factors such as the ventilation rate, air mixing conditions, and room configuration. In our data we observed that increasing the ventilation rate from 0 to 6 ACH decreased the effectiveness for *B. subtilis* spores. This decrease was not statistically significant as judged by an independent t test at the $\alpha = 0.05$ level, although it was significant at the $\alpha = 0.09$ level. Increasing the ventilation rate did not statistically decrease the effectiveness for *M. parafortuitum* ($\alpha = 0.2$). Our data suggests that modifying the ventilation rate in an environment in which UVGI is applied may change its effectiveness, however our data is by no means conclusive. Theoretically one can argue that increasing the ventilation rate will result in a higher overall removal of airborne contaminants and it will lessen the relative effectiveness of the UVGI system since the average residence time of the bacteria within the room will be reduced and the bacteria will not receive as much exposure. More studies on the impact of ventilation on effectiveness need to be conducted to conclusively determine if ventilation reduces the relative influence of UVGI and at what level.

The inactivation rate is another parameter used to describe the impact of UVGI on airborne bacteria. We applied the inactivation rate to decay method experiments. It is unrelated to the ventilation rate and provides a direct measure of the removal rate of airborne bacteria due to UVGI. It is, however, based on the assumption of complete mixing. If mixing is not consistent, the ACH_{UV} can not be interpreted nor will it be reproducible. Inactivation rates can only be derived accurately with time dependent data, although other researchers have attempted to use the equation for effectiveness (equation 1) and the assumption of well-mixed conditions to estimate inactivation rates indirectly (Ko et al., 2002; Kethley et al., 1972). This method of estimating inactivation rates is prone to large errors if there is some variation in the data. Our results demonstrate that the UVGI system under well-mixed conditions achieved reductions of culturable airborne bacteria with effectiveness ranging between 46 to 98%, depending on the ventilation rate and bacteria. Previous researchers have also found UVGI effectiveness to be near this range. Goldner et al. measured approximately half the concentration of culturable, ambient airborne bacteria in two operating rooms when ceiling-mounted UVGI lamps were operated (Goldner et al. 1980). An investigation of a hospital waiting room in which four (15 W) louvered UVGI fixtures were installed demonstrated effectiveness ranging between 14–19% for ambient airborne bacteria (Macher et al. 1992, 1994). Macher and colleagues found that UVGI reduced the concentration of gram-positive cocci, which were the most prominent group of bacteria present (~70%), but did not affect the concentrations of gram-positive rod-shaped bacteria (~20%), gram-negative rods (7%), or gram-negative cocci (~1%). Miller and Macher determined in a series of 36-m³ room experiments that the effectiveness of one wall-mounted germicidal fixture (15 W) and 2 ACH ventilation was approximately 50% for *B. subtilis* spores and *Micrococcus luteus*. For *Escherichia coli*, effectiveness was close to 100% (Miller and Macher 2000). Ko et al. (2002) found for ceiling- and wall-mounted fixtures (59 W total), effectiveness under mixed conditions ranged between 53–88% with 6 ACH ventilation and 62% with 2 ACH ventilation. Note that our calculations of effectiveness include normalization by the total bacterial counts, to account for the possible variability in bioaerosol generated between experiments (Equation 1). All of the other studies cited above did not account for how much bacteria was aerosolized, and instead assumed that it was the same, which could lead to errors in

the estimation of effectiveness if the amount of bioaerosol released was different between experiments.

Previous research has suggested that *M. bovis* BCG has similar responses to irradiation as virulent forms of *M. tb* (Riley et al. 1976). We observed statistically similar UVGI effectiveness between *M. parafortuitum* and *M. bovis* BCG, suggesting that under certain full-scale environmental conditions, *M. parafortuitum* behaves similarly to *M. bovis* BCG in terms of its inactivation response as judged by effectiveness.

With the room air well mixed, the UVGI system (216 W) provided an average 16 h^{-1} as an UVGI-induced inactivation rate for *M. parafortuitum*. Riley et al. (1976) reports inactivation rates of $10\text{--}33 \text{ h}^{-1}$, depending on the total power of the UVGI lamps, for *M. bovis* BCG. This study was conducted in a smaller room (64 m^3 with 18.4 m^2 floor area) using 17 W and 46 W ceiling mounted unlouvered lamps. No UV irradiance measurements were made. Miller and Macher (2000) measured in a 36-m^3 room (14.7 m^2 floor area) with one unlouvered 15-W wall lamp an inactivation rate for *B. subtilis* spores of 4 h^{-1} .

A linear relationship was observed between the UVGI inactivation rate, ACH_{UV} , and the level of UV irradiance. Our data shows that this relationship holds up until the effective UV irradiance of $5.0 \mu\text{W cm}^{-2}$ that was derived from 216 W of total lamp power. We obtained only one more data point above this level. Figure 16 shows the linear relationship up until $5.0 \mu\text{W cm}^{-2}$ effective irradiance and also shows the additional data point for an effective UV irradiance of $10.4 \mu\text{W cm}^{-2}$ derived from 504 of total lamp power. At the highest effective irradiance that we studied, the relationship between ACH_{UV} and the level of UV irradiance is no longer linear and in fact rolls off. This finding implies that in general higher irradiance from a UVGI system provides better inactivation of airborne bacteria only up to a certain point. There is an upper threshold at which adding more UVGI will not achieve similar additional inactivation. While more data is needed to determine the exact upper threshold level of effective irradiance for our UVGI system with *M. parafortuitum*, we can estimate that it probably lies somewhere between 5 and $10 \mu\text{W cm}^{-2}$.

We also found that at UV irradiance levels below an effective UV irradiance of $1.5 \mu\text{W cm}^{-2}$ minimal inactivation effects were observed against *M. parafortuitum*. Such low UV irradiance levels only provided 1.2 h^{-1} inactivation under well-mixed conditions.

Using this linear relationship between UVGI inactivation rates and irradiance, we derived a Z value of $1.2 \pm 0.15 \times 10^{-3} \text{ cm}^2 \mu\text{W}^{-1} \text{ s}^{-1}$ for aerosolized *M. parafortuitum*. In our opinion, the Z value is one of the best methods to parameterize the impact of UVGI on microorganisms, as it indicates microorganism susceptibility to UVGI and it is only dependent on microorganism physiology. For airborne microorganisms, Z values should be derived specifically using aerosolized microorganisms. Only a handful of previous studies have measured UVGI susceptibility or Z value in this manner. Many more studies have used liquid suspensions or agar media in experiments to estimate UVGI susceptibility. The results of these studies may not be applicable to bioaerosols due to the effects of aerosolization on suspended microorganisms. For example, Anderson and Dark (1967) showed that ion-retention mechanisms were damaged

during aerosolization of *E. coli*, possibly contributing to decreased viability of organisms recovered from bioaerosols.

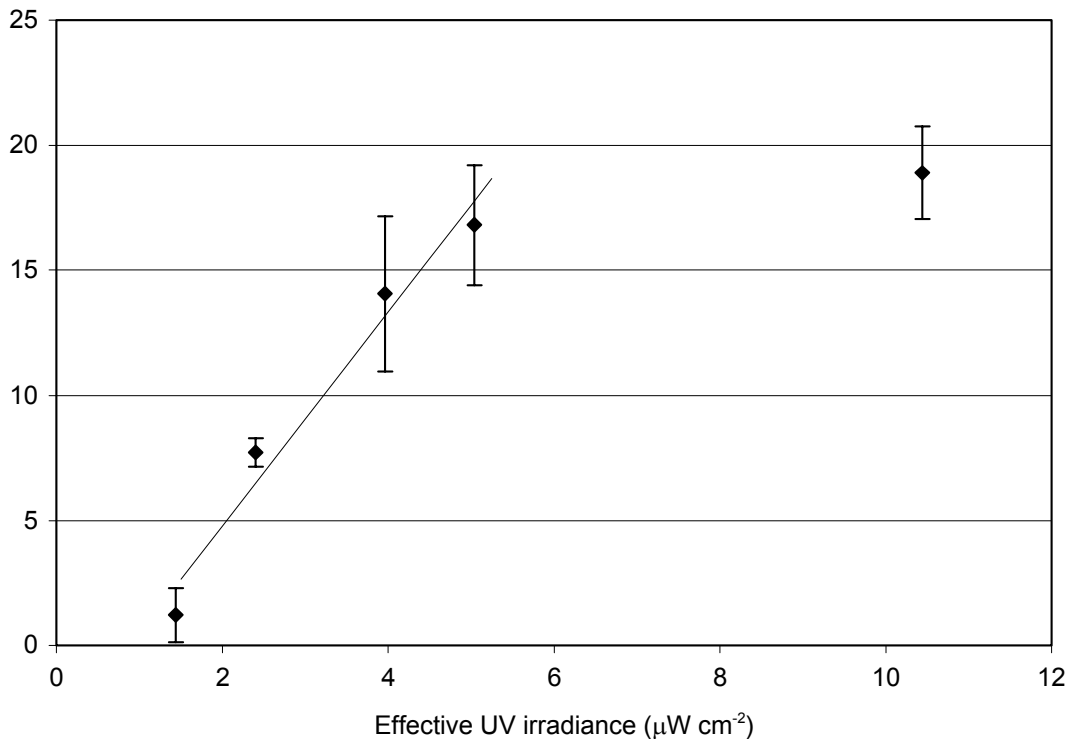

Figure 16. UVGI-induced inactivation rate as a function of effective UVGI irradiance for *M. parafortuitum* under well-mixed conditions for 54 W to 504 W lamp power. Effective UVGI irradiance is the irradiance measured in the upper-room zone only normalized to the fraction of room volume irradiated by UV (0.3 m / 2.5 m). Tests conducted at 50% RH.

A separate study was carried out in a small-scale aerosol reactor (0.8 m^3) at the University of Colorado parallel to the studies reported here (Peccia 2000; Peccia et al. 2001; Peccia and Hernandez 2001). The entire reactor was irradiated and the UV irradiance was scalable to our tests. Under the same environmental conditions, Z values determined for aerosolized bacteria were $1.9 \times 10^{-3} \text{ cm}^2 \mu\text{W}^{-1}\cdot\text{s}^{-1}$ for *M. bovis* BCG and $1.6 \times 10^{-3} \text{ cm}^2 \mu\text{W}^{-1}\cdot\text{s}^{-1}$ for *M. parafortuitum*, agreeing with our value for *M. parafortuitum*. The Z values determined by Riley et al. (1976) are $2.3\text{--}3.9 \times 10^{-3} \text{ cm}^2 \mu\text{W}^{-1}\cdot\text{s}^{-1}$ for aerosolized *M. bovis* BCG, comparable at the lower end to Peccia's results, and $2.3\text{--}4.2 \times 10^{-3} \text{ cm}^2 \mu\text{W}^{-1}\cdot\text{s}^{-1}$ for aerosolized *M. tuberculosis* (Erdman strain). An important factor affecting upper-room UVGI systems is the airflow pattern within the room. Air mixing impacts have been studied previously (Riley et al. 1971a,b). The results of our experiments indicate that poor air mixing can decrease UVGI effectiveness by almost 80% under wintertime ventilation conditions ($34 \text{ }^\circ\text{C}$ supply air temperature and $24 \text{ }^\circ\text{C}$ room air temperature). Riley et al. (1971a) found similarly that hot supply air without a mixing fan decreased the UVGI-induced inactivation rate by 60% compared to conditions of hot supply air with a mixing fan. High relative humidity has been shown to significantly impact the effects of UVGI. Our results showed that for *M. parafortuitum* the effectiveness decreased by 40% when the RH was

increased above 75% and the equivalent air-exchange rate decreased by half when the RH was increased from 50 to 90%. Peccia et al. (2001) also showed in bench-scale studies that the Z value for *M. parafortuitum* decreased by around 40% when the RH increased from 50 to 95% RH. Riley and Kaufman (1972) also showed that the inactivation of *Serratia marcescens* decreased dramatically with increase in RH above 60-70%. Our results also suggest that effectiveness most likely decreases below relative humidity of 25%; more work, however needs to be done to confirm this affect with greater statistical confidence. Both Peccia et al. (2001) and Riley and Kaufman (1972) also show decreases in Z value at low RH levels.

We found that the distribution of UVGI within a room can have an impact on how effective the system is. While these impacts are not as drastic as those from elevated RH or poor room air mixing, we found, even with the mixing fans on, a skewed UVGI distribution did decrease h UVGI equivalent air exchange rate as much as 30% compared with a more uniformly distributed system with the same wattage.

In 1971 the first study was reported showing that liquid cultures of *M. tb* could be photoreactivated (David et al. 1971). Our studies reported here are the first to present data on photoreactivation for bacterial aerosols under full-scale environmental conditions. We found that at 40% RH, no photoreactivation could be detected. This result is consistent with a previous study of photoreactivation in a small-scale aerosol reactor that found conclusive evidence that photoreactivation does not occur below 50–65% RH (Peccia and Hernandez 2001). Interestingly, Peccia and Hernandez suggest that photoreactivation may not occur with the relative humidity below 50% because the "A" form of DNA occurs in the cell, and this form of DNA does not contain cyclobutane thymine dimers that can help in reparation of this nucleic acid. Transition to the "B" form of DNA, begins in the RH range between 50% and 65%, and is completed above the relative humidity of 75%. Previous studies on dehydrated DNA and in aerosolized bacterial cells irradiated with UVGI at low RH, contained no or small amounts of cyclobutane thymine dimers. Differential UVGI-inactivation, and increase in photoreactivation activity, may therefore result at higher relative humidity (Peccia, 2000). Oguma et al. (2001) reports that for fully hydrated, liquid cultures, the number of pyrimidine dimers induced in the DNA is highly correlated with the UVGI dose, and that these dimers are continuously repaired during fluorescent light exposure. Peccia and Hernandez (2001) found that visible light decreased Z value response by approximately 60% at 95% RH. We found under full-scale environmental conditions inconclusive evidence that photoreactivation occurs at 100% RH. Only one of our two experiments showed some photoreactivation occurring, decreasing effectiveness by 17%. A possible reason for our inconclusive results at 100% RH is that the amount photoreactivation that can be observed depends on the volume of air that is irradiated. In our studies, only the upper room volume was irradiated with UVGI compared to Peccia and Hernandez' studies in which the entire volume of the small-scale reactor was irradiated. In other words, Peccia was simulating the UV zone only, thus all bacteria were irradiated and also all bacteria were exposed to the photoreactivating light. In our case, only the bacteria in the upper 8th of the room were irradiated and also only these bacteria in the upper part of the room were exposed to photoreactivating light. Our air samples represent what is happening in the entire room, so what we measured was a lesser photoreactivating effect due to only a portion of our room being inactivated and subsequently repaired. Because the possibility of photoreactivation at very high RH has profound

implications for how UVGI is implemented under some environmental conditions, we recommend that more full-scale studies be conducted.

The UVGI fixtures installed in the test room were positioned at different locations around the room. Consequently the irradiation at a given point in the room was from all directions. To characterize the distribution of UV irradiance, 3-dimensional measurements were needed. The actinometric measurement technique was useful because the spherical actinometers that were employed are able to evaluate a 3-dimensional UV irradiance field. Traditional radiometer measurements detect surface UV irradiance from one direction. Any UV measurement technique should be altered to account for UV irradiance from many directions, as was done in our evaluation. We found that a 3-dimensional measurement could be approximated adequately using a radiometer by measuring the irradiance in six different directions (up, down, and all four horizontal directions) and summing (Rahn et al. 1999).

5. References

Anderson, J.D., Dark, F.A., 1967. Studies on the effects of aerosolization on the rates of efflux of ions from populations of *Escherichia coli* Strain B. *Journal of General Microbiology* 46, 95-105.

Black, D.R., Harley, R.A., Hering, S.V., Stolzenburg, M.R., 2000. A new, portable, real-time ozone monitor. *Environmental Science & Technology* 34, 3031-3040.

Blomquist, G., Palmgren, U., Ström, G., 1984. Improved techniques for sampling airborne fungal particles in highly contaminated environments. *Scandinavian Journal of Work and Environmental Health* 10, 253–258.

Blumberg, H.M., Watkins, D.L., Berschling, J.D., Antle, A., Moore, P., White, N., Hunter, M., Green, B., Ray, S.M., McGowan, Jr., J.E., 1995. Preventing the nosocomial transmission of tuberculosis. *Annals of Internal Medicine* 122, 658-663.

Centers for Disease Control and Prevention, 1994. Guidelines for preventing the transmission of *Mycobacterium tuberculosis* in health-care facilities. *Morbidity and Mortality Weekly Report* 43(RR-13), 1-132.

Centers for Disease Control and Prevention and National Institutes of Health, 1999. Biosafety in microbiological and biomedical laboratories. DHHS Publication No (CDC) 93-8395, PHS, US Government Printing Office, Washington DC.

Collins, F.M., 1971. Relative susceptibility of acid-fast and non-acid-fast bacteria to ultraviolet light. *Applied Microbiology* 21, 411-413.

David, H.L., 1973. Response of mycobacteria to ultraviolet light radiation. *American Review of Respiratory Disease* 180, 1175–1185.

David, H.L., Jones, W.D., Newman, C.M., 1971. Ultraviolet light inactivation and photoreactivation in the mycobacteria. *Infection and Immunity* 4, 318-319.

Dieck, R.H., 1997. *Measurement Uncertainty: Methods and Applications*. 2nd edition. Instrument Society of America, NC., pp. 97-90.

Dubos, R.J., Middlebrook, G., 1947. Media for Tubercle bacilli. *American Review of Tuberculosis* 56, 334–345.

Fackelmann K., 1998. Tuberculosis outbreak. *Science News* 153, 73-78.

Frankel, D.H., 1995. Tuberculosis falling in LA. *Lancet* 345, 1565.

Goldner, J.L., Moggio, M., Beissinger, S.F., McCollum, D.E., 1980. Ultraviolet light for the control of airborne bacteria in the operating room, p. 271–284. In: Airborne Contagion. R. B. Kundsinn, Ed. New York Academy of Sciences, New York.

Hatch, M.T., Wolochow, H., 1969. Bacterial survival: consequences of the airborne state. In: An Introduction to Experimental Aerobiology. R. L. Dimick and A. B. Akers, Eds. John Wiley and Sons, New York.

Hollander, A., 1942. Abiotic and sublethal effects of ultraviolet radiation in microorganisms. In: Aerobiology, Publ. No. 17, American Association for the Advancement of Science. F. R. Moulton, Ed. The Science Press Printing Co., Lancaster, PA.

Hernandez, M., Miller, S.L., Landfear, D.W., Macher, J.M., 1999. A combined fluorochrome method for quantification of metabolically active and inactive airborne bacteria. *Aerosol Science and Technology* 30, 145–160.

Ikeda, R.M., Birkhead, J.A., DiFerdinando, G.T., Bornstein, D.L., Dooley, S.W., Kubica, G.P., Morse, D.L., 1995. Nosocomial tuberculosis: An outbreak of a strain resistant to seven drugs. *Infection Control and Hospital Epidemiology* 16, 152-159.

International Light, 2002. <http://www.intl-light.com/handbook/ch01.html>, Accessed Jul 2002.

Kearns A.M., Barrett, A., Marshall, C., Freeman, R., Magee, J.G., Bourke, S.J., Steward, M., 2000. Epidemiology and molecular typing of an outbreak of tuberculosis in a hostel for homeless men. *Journal of Clinical Pathology* 53, 122-124.

Kethley, T.W., Branch, K., 1972. Ultraviolet lamps for room air disinfection. *Archives of Environmental Health* 25, 205-214.

Ko, G., First, M. W., Burge, H. A., 2002. The characterization of upper-room ultraviolet germicidal irradiation in inactivating airborne microorganisms. *Environmental Health Perspectives* 110, 95-101.

Liltved, H., Landfald, B., 1996. Influence of liquid holding recover and photoreactivation on survival of ultraviolet-irradiated fish pathogenic bacteria. *Water Research* 30, 1109-1114.

Morbidity and Mortality Weekly Report, 2002. Tuberculosis Morbidity among U.S.-born and foreign-born populations --- United States, 2000. *MMWR* 51(05), 101-104.

Macher, J.M., 1993. The use of germicidal lamps to control tuberculosis in healthcare facilities. *Infection Control and Hospital Epidemiology* 14, 723-729.

- Macher, J.M., Alevantis, L.E., Chang, Y.-L., Liu, K.-S., 1992. Effect of ultraviolet germicidal lamps on airborne microorganisms in an outpatient waiting room. *Applied Occupational and Environmental Hygiene* 7, 505–513.
- Macher, J.M., Alevantis, L.E., Chang, Y.-L., Liu, K.-S., 1994. *Applied Occupational and Environmental Hygiene* 9, 462 (letter).
- McLean, R. L., 1961. The effect of ultraviolet radiation upon the transmission of epidemic influenza in long-term hospital patients. *American Review of Respiratory Disease* 83, 36 (Feb., Part 2).
- Miller, S.L., Macher, J.M., 2000. Evaluation of a methodology for quantifying the effect of room air ultraviolet germicidal irradiation on airborne bacteria. *Aerosol Science and Technology* 33, 274–295.
- Miller-Leiden, S., Lobascio, C., Nazaroff, W.W., Macher, J.M., 1996. Effectiveness of in-room air filtration and dilution ventilation for tuberculosis infection control. *Journal of the Air and Waste Management Association* 46, 869–882.
- Nagin, D., Pavelchak, N., London, M., DePersis, R.P., Melius, J., 1994. Control of tuberculosis in the workplace – engineering controls. *Occupational Medicine: State of the Art Reviews* 9, 609–630.
- Nardell, E.A., 1995. Interrupting transmission from patients with unsuspected tuberculosis: A unique role for upper-room ultraviolet air disinfection. *American Journal of Infection Control* 23, 156–164.
- Nicholson, W., 1995. Photoreactivation in the genus *Bacillus*. *Current Microbiology* 31, 361-364.
- Nivin, B., Nicholas, P., Gayer, M., Frieden, T.R., Fujiwara, P.I., 1998. A continuing outbreak of multidrug-resistant tuberculosis, with transmission in a hospital nursery. *Clinical Infectious Diseases*, 26, 303-307.
- Oguma, K., Katayama, H., Mitani, H., Morita, S., Hirata, T., Ohgaki, S., 2001. Determination of pyrimidine dimers in *Escherichia coli* and *Cryptosporidium parvum* during UV light inactivation, photoreactivation, and dark repair. *Applied and Environmental Microbiology* 67, 4630-4637.
- Peccia, J. 2000. Ph.D. Thesis. University of Colorado, Boulder.
- Peccia, J., Hernandez, M., 2001. Photoreactivation in Airborne *Mycobacteria parafortuitum*. *Applied and Environmental Microbiology* 67, 4225-4232.

Peccia, J., Hernandez, M., 2002. UV inactivation rates in airborne *Mycobacterium bovis* BCG. submitted.

Peccia, J., Werth, H., Miller, S.L., Hernandez, M., 2001. The effects of relative humidity on the ultraviolet induced inactivation of airborne bacteria. *Aerosol Science and Technology* 35, 728-740.

Petruccelli, J.D., Nandram, B., Chen, M., 1999. *Applied Statistics for Engineers and Scientists*. Prentice-Hall, Inc., NJ, pp. 298-322; 368-374; 477-479.

Rahn, R.O., Xu, P., Miller, S.L., 1999. Dosimetry of room-air germicidal irradiation using spherical actinometry. *Photochemistry and Photobiology* 70, 314–318.

Riley, R.L. 1988. Ultraviolet air disinfection for control of respiratory contagion. In: R. Kundsinn, ed. *Architectural Design and Indoor Microbial Pollution*. Oxford University Press, NY, pp. 172-197.

Riley, R.L., Kaufman, J.E. 1972. Effect of relative humidity on the inactivation of airborne *Serratia marcescense* by ultraviolet radiation. *Applied Microbiology* 23, 1113-1120.

Riley, R.L., Wells, W.F., Mills, C.C., Nyka, W., McLean, R.L., 1957. Air hygiene in tuberculosis: Quantitative studies of infectivity and control in a pilot ward. *American Review of Tuberculosis and Pulmonary Disease* 75, 420–431.

Riley, R.L., Mills, C.C., O’Grady, F., Sultan, L.U., Wittstadt, F., Shivpuri, D.N., 1962. Infectiousness of air from a tuberculosis ward. Ultraviolet irradiation of infected air: Comparative infectiousness of different patients. *American Review of Respiratory Disease* 85, 511–525.

Riley, R.L., Permutt, S., Kaufman, J.E. 1971a. Convection, air mixing, and ultraviolet air disinfection in rooms. *Archives of Environmental Health* 22, 200-207.

Riley, R.L., Permutt, S., Kaufman, J.E. 1971b. Room air disinfection by ultraviolet irradiation of upper air. Further analysis of convective air exchange. *Archives of Environmental Health* 23, 35-39.

Riley, R.L., Knight, M., Middlebrook, G., 1976. Ultraviolet susceptibility of BCG and virulent tubercle bacilli. *American Review of Respiratory Disease* 113, 413–418.

Setlow, R.B., Carrier, W.L., 1966. Pyrimidine dimers in ultraviolet-irradiated DNA’s. *Journal of Molecular Biology* 17, 237.

Summer, W., 1962. *Ultra-Violet and Infra-Red Engineering*. Interscience Publishers, Inc., New York NY, pp. 177-190, 211-215.

Verilux, 2002. <http://www.verilux.net/defaultpage.htm>. Accessed Aug 2002.

- Ward, D.C., Reich, E., Goldeberg, I.H., 1965. Base specificity in the interaction polynucleotides with antibiotic drugs. *Science* 149, 1259–1263.
- Wells, W.F., 1955. *Airborne Contagion and Air Hygiene*. Harvard University Press, Cambridge, MA, pp. 59, 72-75.
- Wells, W.F., Fair, G.M., 1935. Viability of *B. coli* exposed to ultraviolet radiation in air, *Science* 82, 280-281.
- Wells, W.F., Wells, M.W., 1936. Air-borne infection sanitary control, *Journal of the American Medical Association* 107, 1805-1809.
- Willmon, T. L., Hollander, A., Langmuir, A. D., 1948. Studies of the control of acute respiratory diseases among naval recruits. I. A review of a four-year experience with ultraviolet irradiation and dust suppressive measures, 1943 to 1947, *American Journal of Hygiene* 48, 227–232.
- Whisler, B.A., 1940. The efficacy of ultra-violet light sources in killing bacteria suspended in air. *Journal of Science, Iowa State College* 14, 215.
- World Health Organization, 2000. Global tuberculosis control. WHO Report 2000. WHO, Geneva, Switzerland, WHO/CDS/TB/2000.275. Accessed via the world-wide web: <http://www.who.int/gtb/publications/globrep00/index.html>.
- Xu, P., Miller, S.L., 1999. Factors influencing effectiveness of ultraviolet germicidal irradiation for inactivating airborne bacteria: Air mixing and ventilation efficiency, p. 393–398. In: *Indoor Air '99: Proceedings of the 8th International Conference on Indoor Air Quality and Climate, Vol. 2*. G. Raw, C. Aizlewood, and P. Warren, Ed. Edinburgh, Scotland.

6. Appendix I

FACTORS INFLUENCING EFFECTIVENESS OF ULTRAVIOLET GERMICIDAL IRRADIATION FOR INACTIVATING AIRBORNE BACTERIA: AIR MIXING AND VENTILATION EFFICIENCY

Peng Xu¹ and Shelly L. Miller²

¹ Department of Civil, Environmental, Architecture Engineering, University of Colorado, Boulder, USA

² Department of Mechanical Engineering, University of Colorado, Boulder, USA

ABSTRACT

As a result of the recent resurgence in tuberculosis incidence, there has been increased interest in using ultraviolet germicidal irradiation (UVGI) of room air to reduce exposures to infectious agents. This paper presents results of experimental studies investigating how air mixing and ventilation influences the efficacy of UVGI for inactivating airborne bacteria. Tracer gas—SF₆—and tracer particles generated by nebulization of a salt solution were injected into a full-scale room. The particles simulate an aerosol carrying an infectious agent generated by persons coughing or sneezing. The tracer gas was used to study the room airflow patterns. The concentration of the gas and particles was measured over time with a gas chromatograph and an optical particle counter. Using these data, the air mixing and ventilation efficiency were characterized. The results showed that the room air was not necessarily well mixed and the ventilation efficiency were not necessarily close to unity under higher air-exchange rates (6 air changes per hour), depending on the thermal conditions within the room.

INTRODUCTION

The transmission of tuberculosis (TB) in healthcare settings is a recognized hazard, and recent outbreaks involving multidrug-resistant strains of *Mycobacterium tuberculosis* has heightened concern [1]. In response, the Centers for Disease Control and Prevention (CDC) issued comprehensive guidelines for controlling TB transmission in health-care facilities [1]. The CDC recommended that at least 6 air changes per hour (ACH, h⁻¹) be provided for existing TB isolation rooms and, where feasible, this air flow rate should be increased to greater than 12 ACH. This increase in air-exchange rate could be accomplished by adjusting or modifying the ventilation system or by using auxiliary controls. One auxiliary engineering control method proposed by the CDC is ultraviolet germicidal irradiation (UVGI) of room air [1].

Irradiation is accomplished by mounting germicidal lamps to walls or suspending them from ceilings above the people inhabiting the rooms. This arrangement is designed to protect people from over-exposure to the UV radiation while providing enough exposure to airborne microorganism in rooms. These germicidal lamps emit UV-C radiation at a predominant wavelength of 254 nm.

In 1954, the use of UV radiation in classrooms to prevent measles was studied. Results showed that UV radiation was efficient in preventing measles from spreading where children were exposed [2]. Riley et al. conducted decay experiments in a full-sized room to determine the equivalent air-exchange rate of room air UV irradiation on *Mycobacterium bovis BCG* [3].

Results showed that the bacteria were inactivated at an exponential rather than linear rate under the UV exposure.

Despite the fact that ventilation is a primary engineering control technique and that UVGI is being recommended and used for controlling TB transmission, little is known about the efficacy of combining ventilation and UVGI. Our research group is experimentally investigating the effectiveness of UVGI of room air for inactivating airborne bacteria. To better understand some of the many factors that influence UVGI effectiveness, including ventilation rate, we conducted a study to characterize the mixing and ventilation efficiency of the test room in which the UVGI experiments are underway. These experiments were designed to investigate the following:

- Is the room well-mixed under different ventilation rates?
- How efficiently are airborne microorganisms removed by ventilation?
- What is the vertical concentration gradient within the test room?

To study the room airflow patterns, tracer gas was injected into the test room. Tracer gas, however, may not exactly represent airborne microorganisms, such as *Mycobacterium parafortuitum* aerosolized during our UVGI experiments, or *Mycobacterium tuberculosis* emitted by an infectious patient in a TB isolation room. Riffat & Cheong [4] showed that there was a difference between the distribution of particle and gas-phase concentrations in a room. Thus, tracer particles were generated to simulate airborne microorganisms. Time-averaged tracer gas and particle concentrations were measured at many points. Mixing and ventilation efficiency were determined by calculating the parameters air change effectiveness and pollutant removal effectiveness respectively. The vertical concentration gradient was characterized by comparing the measured concentrations in the upper and lower portions of the room.

METHODS

Test facility. Experiments were conducted in a full-size, simulated healthcare room at the Joint Center for Energy Management's Larson Building System Laboratory, University of Colorado (Figure 1). The test facility is a 90-m³ chamber located inside the laboratory with a floor to ceiling height of 2.4 m and a clear floor area of 6x6 m. The room is ventilated by a computer controlled air handling system, which can vary the air-exchange rate in the room from 0 to 8 ACH. Two high efficiency particulate air (HEPA) filters were installed in both supply and exhaust ducts. Two supply air diffusers are located on one side of ceiling and two exhaust outlets were located on the opposite side of the ceiling. There were two box fans (40 W) positioned near the walls to promote mixing.

The germicidal lamp system (Lumalier, Memphis, TN) consists of five luminaries: four mounted in each of the corners of the room and one hung from the center of the ceiling. The UV lamps generate a band of UV radiation with a width of 30 cm in the upper level of the room.

To characterize the distribution of tracer gas and particles in the upper and lower portions of the room, samples were collected at 5 locations. One sample (A) was collected near the source. Four samples were evenly distributed in the room, two in the upper zone (B, D) measuring the concentration in the upper level and at the exhaust, and two in the lower level of the room (C, E) measuring the concentration at breathing level (1.3 m).

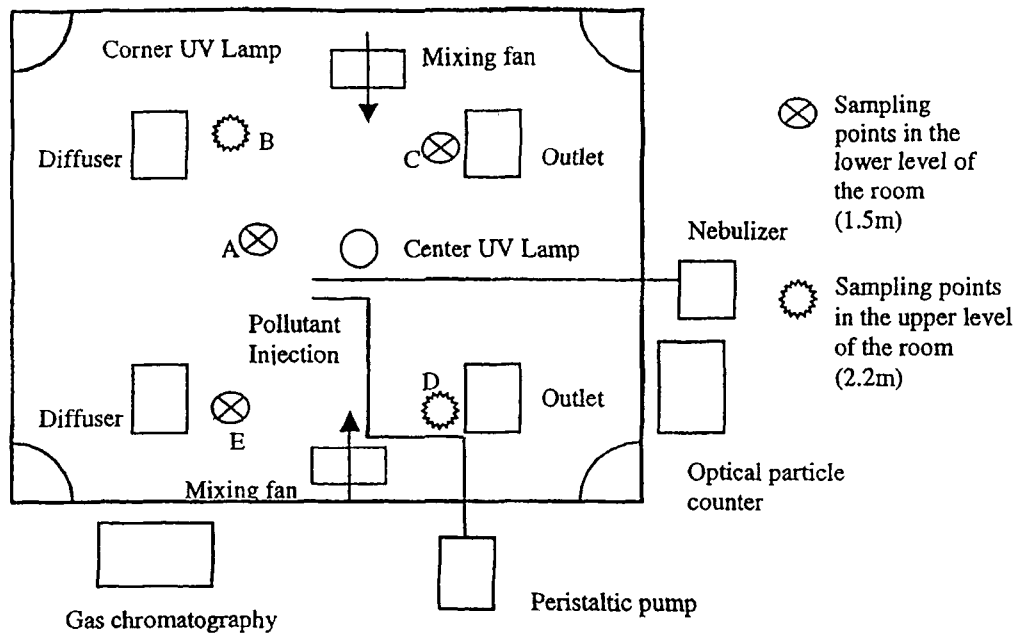

Figure 1. Layout of the test chamber and equipment

Tracer gas (17.6% SF₆ in He) was delivered into the room from a bag connected to a peristaltic pump (Cole-Parmer, IL). Tracer gas concentrations were measured by gas chromatography (Model 101, Lagus Applied Technology, CA). Tracer particles were generated from 2% salt solution using a six-jet Collison nebulizer (CN 25 BGI, Inc., MA). The particle concentrations were measured with a laser optical particle counter (Particle Measurement System Inc., CO). To measure multiple concentrations at five locations, a solenoid valve was put in line with the particle counter to automatically switch sampling every three minutes.

Test conditions and procedures. To investigate the airflow patterns, experiments were conducted varying with airflow rate, supply air temperature, and use of the mixing fans. Test conditions are summarized in Table 1. Experiment 6 is labeled as “summer conditions” because the supply air is cooler than room air. Similarly, experiment 7 is called “winter conditions”.

Table 1. Experimental conditions of tests

No.	0 ACH		3 ACH	6 ACH			
	1	2	3	4	5	6	7
Mixing fan	on	off	off	on	off	off	off
Room Temp. °C	21	21	21	21	21	21	21
Supply air Temp. °C	N/A	N/A	21	21	21	12	32

Before starting every experiment, the ventilation system was turned on, purging the room with HEPA-filtered air, and conditioning the room air to 21 °C. When the ventilation rate, system supply air, and room air temperature were stable, the tracer gas injection pump and the nebulizer were turned on. Each experiment lasted five hours after the injections were started, measuring the concentration profile from zero to steady state. After five hours, the injections were turned off and decay process was measured for another hour.

DATA ANALYSIS

Pollutant removal efficiency (PRE) [5]. Pollutant removal efficiency expresses the effectiveness of ventilation in removing the contaminants generated in a room. Since HEPA filters were installed in the supply air ducts, the particle concentration entering the room with the ventilation was assumed to be zero. Likewise, the outside concentration of tracer gas was treated as zero. The efficiency for both particles and gas was determined by:

$$PRE = C_e / C_i \quad (1)$$

where PRE is the pollutant removal efficiency at the location of interest, C_e is the pollutant concentration measured in the exhaust air (D), and C_i is the room-averaged pollutant concentration measured in the four evenly distributed sampling points (B, C, D, E). The room ventilation more efficiently removes pollutants if the value of the PRE is higher. PRE is equal to one when the room is completely mixed.

Air change effectiveness (ACE) [5]. To characterize mixing within the room, we use another index, called air change effectiveness, or air change efficiency. Air change effectiveness was determined by:

$$ACE = \tau_{\text{exhaust}} / \tau_{\text{room}} \quad (2)$$

where τ_{exhaust} is the age of the exhaust air, τ_{room} is the average air age of the four evenly distributed sampling points in the room. The age of air of these points was determined by a tracer gas decay method:

$$\tau = \int_0^{\infty} t \cdot C(t) / \int_0^{\infty} C(t) \quad (3)$$

where $C(t)$ is the concentration measured during the decay period. The higher the air change effectiveness, the better the room air is mixed. Air change effectiveness is equal to unity for completely mixed room and its maximum value is 2.

RESULTS

Using the analysis method described above, the air change effectiveness and pollutant removal efficiency for each test was calculated (Tables 2 and 3). PRE was not calculated for experiments 1-2 since steady state was never reached for these tests.

Table 2. Data analysis for tracer gas tests

Experiment No.	1	2	3	4	5	6	7
Mean concentration in upper zone (ppm)	119	112	82.4	36.0	35.0	24.0	19.0
Mean concentration in lower zone (ppm)	152	162	115	52.0	49.0	27.0	24.9
Air change effectiveness	0.92	0.86	1.0	1.1	1.0	1.2	0.33
Pollutant removal efficiency	N/A	N/A	0.95	0.79	0.88	0.81	0.14

Table 3. Data analysis for tracer particle tests.

Experiments No.	1	2	3	4	5	6	7
Mean concentration in upper zone ($\times 10^6/\text{m}^3$)	98.8	96.1	445	161	185	200	83.5
Mean concentration in lower zone ($\times 10^6/\text{m}^3$)	100	98.4	617	255	229	247	336
Air change effectiveness	1.2	1.1	0.94	0.81	0.85	0.95	0.31
Pollutant removal efficiency	N/A	N/A	0.95	0.79	0.88	0.60	0.24

Tracer gas results. The concentrations presented in Tables 2 and 3 are time-weighted average (TWA) concentrations from the 2nd to the 5th hour (steady state for experiments 3-7). The TWA tracer gas concentration in the lower zone was always higher than in the upper zone. This is reasonable since the injection was located in the lower zone. For experiments 1-6, in which mixing was relatively good, the largest difference between the upper and lower zone occurred during the experiment 2 (0 ACH without fan), which is about 50%. There is a significant difference for experiment 7 (6 ACH winter condition); the concentration in the lower zone is about 20 times higher than that in upper zone, which indicates a large vertical concentration gradient.

Generally speaking, the room was well mixed in most cases. The air change effectiveness is close to unity, from 0.86 to 1.19 in tests 1-6 and is still 0.86 even when there was no ventilation and no mixing fans. The pollutant removal efficiency is also close to unity for tests 1-6. For experiment 7, both the air change effectiveness and PRE are low, only 0.3 and 0.1 respectively.

Comparison of tracer particles and tracer gas. The optical particle counter counts particle diameters from 0.1 to 10 μm . We used the 0.4 μm particle counts to calculate all the parameters in Table 2, since the majority of the particles generated by the nebulizer are around this size [6]. The results from the particle and tracer gas tests were generally comparable. The air change effectiveness and pollutant removal efficiency varied similarly for the different test conditions. For example, the mixing for the winter condition was poor, determined by the low air change effectiveness in both the tracer gas and particle test.

For 0 ACH, the percent difference in TWA concentrations between the upper and lower zones was 50% for the tracer gas test compared to only 2% for particle test, suggesting that the particles and tracer gas were distributed differently. But for the 3 ACH and 6 ACH tests, the percent difference was smaller. It was likely that when the air-exchange rate was low, diffusion and natural convection were the dominant pollutant transport mechanisms. Therefore, particles behaved differently when compared with the gas phase pollutants.

DISCUSSION

A primary objective of this study was to determine the mixing conditions and ventilation efficiency of the test chamber we are using to evaluate the efficiency of germicidal lamp systems. In our full-size simulated healthcare room, the mixing and ventilation efficiency were good when the room was mechanically ventilated, except under winter conditions when

the buoyancy effects most likely caused the supply air to short circuit directly to the exhaust. Similar results have been shown in previous studies by Fisk et al [7] and Olesen and Seeler [8] in which rooms were mostly completely mixed when the supply air was either cooler or close to room air temperature. Therefore, in wintertime, when mixing can worsen, special techniques should be applied to enhance mixing and ensure the effectiveness of UVGI.

The concentration in the lower portion of the room was higher than the upper portion of the room, where germicidal lamps are installed in our chamber and the UVGI is concentrated. Although the room was approximately well mixed, based on the value of the air change effectiveness from tests 1-6, the difference between the two concentrations was 10-20%. Future investigations will be undertaken to address whether such a room is sufficiently mixed to inactivate airborne bacteria with UVGI when the air change effectiveness is close to one and a small vertical concentration gradient exists.

ACKNOWLEDGMENTS

We appreciate the assistance of John Martyny for providing technical advice and the tracer gas measurement equipment. We also thank Erik Jeannette for technical help in setting up the experiments. This work was supported by the Centers for Disease Control and Prevention.

REFERENCES

1. Centers for Disease Control and Prevention. 1994. Guidelines for preventing the transmission of Mycobacterium tuberculosis in health-care facilities. *Morbidity and Mortality Weekly Reports*, Vol. 43(RR-13), pp. 1-132.
2. Medical Research Council. 1954. *Special report series no.283. Disinfection with Ultraviolet Irradiation of Classrooms: Its Effects on Illness in School-Children*. London: Medical research Council.
3. Riley R L, Knight M, and Middlebrook G. 1976. Ultraviolet susceptibility of BCG and Virulent Tubercle Bacilli. *American Review of Respiratory Diseases*. Vol. 115, pp. 413-418.
4. Riffat S B and Cheong K W. 1993. Measurement of ventilation and aerosol particles in buildings. *International Journal of Energy Research*. Vol. 17, pp. 45-55.
5. Claude A R and Luk V. 1991. Airflow Patterns Within Buildings - Measurement Techniques. . *International Energy Agency*. pp. IV.4.
6. Miller-Leiden S, Lobascio C, Nazaroff W W and Macher J M. 1996. Effectiveness of in-room air filtration and dilution ventilation for tuberculosis infection control. *Journal of the Air & Waste Management Association*. Vol. 46, pp. 869-882.
7. Fisk W J, Faulkner D, Pih D, McNeel PJ, Bauman F S and Arens E A. 1991. Indoor air flow and pollutant removal in a room with task ventilation. *Indoor Air*. Vol. 1(3), pp. 247-262.
8. Olesen B W. and Seelen J. 1992. Field measurements of air changer effectiveness using tracer gas techniques, *Proceedings of IAQ '92: Environment for People*. Atlanta, GA, American Society of Heating, Refrigerating, and Air conditioning Engineers. pp. 301-308.

7. Appendix II

7.1 Error Propagation for UVGI Equivalent Air-Exchange Rates

To estimate the equivalent air-exchange rate for upper-room UVGI, at least two experiments are conducted in parallel using the decay method protocol (see section 3.8). One experiment consists of aerosolizing bacteria into the test chamber and allowing it to decay without the UVGI system operating. The 2nd experiment is a repeat of the first except that the UVGI system was turned on and operated throughout the decay period. To estimate the equivalent air-exchange rate, linear regression is performed on data from both experiments according to equations 4 and 5. The UV equivalent air-exchange rate (ACH_{UV}) is the difference between the rate derived with ($ACH_{UV\ On} = ACH + ACH_N + ACH_{UV}$) and without ($ACH_{UV\ Off} = ACH + ACH_N$) the UVGI system operating. ACH denotes the ventilation rate expressed in air-changes per hour (volumetric airflow rate through the room divided by the volume of the room) and ACH_N denotes the rate of gravitational settling, natural die-off, and other natural decay mechanisms for bacteria (see section 3.8).

$$ACH_{UV} = ACH_{UV\ On} - ACH_{UV\ Off} \quad (A1)$$

Each rate estimated by linear regression has its own uncertainty (U), or random error, associated with it. This uncertainty is the standard error in the regression coefficient. To find the overall uncertainty in ACH_{UV} , we propagate the uncertainties in the rates used to calculate ACH_{UV} :

$$U_{ACH_{UV}} = \sqrt{\left(\frac{\partial ACH_{UV}}{\partial ACH_{UV\ On}} U_{UV\ PAC\ On}\right)^2 + \left(\frac{\partial ACH_{UV}}{\partial ACH_{UV\ Off}} U_{ACH_{UV\ Off}}\right)^2} \quad (A2)$$

Substituting in the partial derivatives we find the uncertainty in the UV equivalent air-exchange rate is:

$$U_{ACH_{UV}} = \sqrt{U_{ACH_{UV\ On}}^2 + U_{ACH_{UV\ Off}}^2} \quad (A3)$$

7.2 Error Propagation for UVGI Effectiveness

To estimate the effectiveness for upper-room UVGI, two experiments are conducted in parallel using the constant generation method protocol (see section 3.7). One experiment consists of aerosolizing bacteria into the test chamber continuously without the UVGI system operating. The 2nd experiment is a repeat of the first except that the UVGI system is turned on and operated throughout the experimental period. Air samples from these experiments are assayed for culturable bacteria using plate counts and for total bacteria using total direct counts (see section 3.5). Effectiveness is calculated using the following equation:

$$E = 1 - \frac{C_{UV\ on}}{C_{UV\ off}} \times \frac{D_{UV\ off}}{D_{UV\ on}} \quad (A4)$$

$D_{UV\ off}$ and $D_{UV\ on}$ ($\# m^{-3}$) are the total airborne bacteria concentrations measured by direct counts for UVGI off and on, and $C_{UV\ off}$ and $C_{UV\ on}$ ($CFU m^{-3}$) are the culturable airborne bacteria concentrations measured by plate counts for UVGI off and on..

During these experiments, air samples are collected at 5-9 locations at breathing zone height. The room-average concentration of both culturable and total bacteria is calculated by averaging together all breathing zone concentrations. These room-average concentrations are used in equation A4 to calculate E. These room-average concentrations also have an uncertainty (U) and the standard deviation of all breathing zone concentrations is also calculated and used for U in the following propagation of errors to estimate the uncertainty in effectiveness.

$$U_E = \sqrt{\left(\frac{\partial E}{\partial C_{UVon}} U_{C_{UVon}}\right)^2 + \left(\frac{\partial E}{\partial C_{UVoff}} U_{C_{UVoff}}\right)^2 + \left(\frac{\partial E}{\partial D_{UVon}} U_{D_{UVon}}\right)^2 + \left(\frac{\partial E}{\partial D_{UVoff}} U_{D_{UVoff}}\right)^2} \quad (A5)$$

Substituting in the partial derivatives we find the uncertainty in the UV effectiveness is:

$$U_E = \sqrt{\left(\frac{D_{UVoff}}{C_{UVoff} D_{UVon}} U_{C_{UVon}}\right)^2 + \left(\frac{C_{UVon} D_{UVoff}}{C_{UVoff}^2 D_{UVon}} U_{C_{UVoff}}\right)^2 + \left(\frac{C_{UVon} D_{UVoff}}{C_{UVoff} D_{UVon}^2} U_{D_{UVon}}\right)^2 + \left(\frac{C_{UVon}}{C_{UVoff} D_{UVon}} U_{D_{UVoff}}\right)^2} \quad (A6)$$

7.3 Error Propagation for Averaging Parameters

All experiments were repeated, two or three times, to get an idea of the repeatability of the estimated parameters, including the parameters UVGI effectiveness and equivalent air-exchange rate. Average parameters were calculated from the results of the repeated experiments and errors were propagated according to the following method. Denote X_i as the value of the parameter derived from experiment i (e.g. the effectiveness). Then the average of all the parameters from N experiments is:

$$AVG = \frac{X_1 + X_2 + \dots + X_N}{N} \quad (A7)$$

$$AVG = \frac{1}{N} X_1 + \frac{1}{N} X_2 + \dots + \frac{1}{N} X_N$$

The uncertainty in the average is calculated using propagation of errors:

$$U_{AVG} = \sqrt{\left(\frac{\partial AVG}{\partial X_1} U_{X_1}\right)^2 + \dots + \left(\frac{\partial AVG}{\partial X_N} U_{X_N}\right)^2} \quad (A8)$$

Substituting in the partial derivatives we find the uncertainty in the average is:

$$U_{AVG} = \sqrt{\left(\frac{1}{N} U_{X_1}\right)^2 + \dots + \left(\frac{1}{N} U_{X_N}\right)^2} \quad (A9)$$