

Solar Terrestrial Relations Observatory (STEREO)

Press Kit / October 2006



Contents:

NASA Press Release	3
Media Services Information	5
STEREO Quick Facts	7
STEREO Mission/Science Overview	8
- What is space weather?	
- What are coronal mass ejections?	
- What are solar flares?	
- What will the 3-D solar images look like?	
- How does the solar cycle affect STEREO?	
STEREO & Solar Terrestrial Probes (STP) Program Themes	10
STEREO Instruments	11
- Sun Earth Connection Coronal and Heliospheric Investigation (SECCHI)	
- STEREO/WAVES (S/WAVES)	
- In-situ Measurements of PArticles and CME Transients (IMPACT)	
- PLASMA and SupraThermal Ion and Composition (PLASTIC)	
STEREO Ground & Mission Operations	12
STEREO Orbit Information	13
STEREO Observatory	14
Launch Vehicle Configuration	15
Launch & Injection into Orbit / Spacecraft Separation	16
STEREO Mission Participants: Institutional Responsibilities	17
Key Personnel.....	18
STEREO Biographies	20

Public Affairs Points of Contact

Erica Hupp NASA Headquarters	NASA Science Mission Directorate	202 358-1237
Rani Gran Goddard Space Flight Center	STEREO Mission	301-286-2483 / 286-8955
George Diller Kennedy Space Center	Launch Operations	321-867-2468
Kristi Marren JHU Applied Physics Lab	Mission Operations	240-228-6268
Janice Schultz Naval Research Lab	SECCHI Instrument	202-767-2856
Bob Sanders UC Berkeley	IMAGE Instrument	510-643-6998
Carmeyia Gillis NOAA Space Env. Center	Space Weather Forecasting	301-763-8000 x7163

NASA News

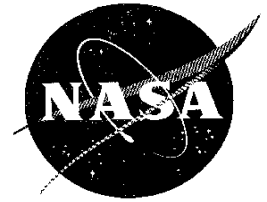

National Aeronautics and
Space Administration

Goddard Space Flight Center
Office of Public Affairs
Greenbelt, Md. 20771
(301) 286-8955

For Release:
Oct. 18, 2006

Erica Hupp/Dwayne Brown
Headquarters, Washington
202-358-1237/1726

Rani Gran /Lynn Chandler
Goddard Space Flight Center, Greenbelt, Md.
301-286-2483/2806

RELEASE: 06-90

NASA SATELLITES WILL IMPROVE UNDERSTANDING OF THE SUN

NASA's Solar Terrestrial Relations Observatory mission will dramatically improve understanding of the powerful solar eruptions that can send more than a billion tons of the sun's outer atmosphere hurtling into space.

The STEREO mission comprises two nearly identical spacecraft the size of golf carts, which are scheduled to launch on Oct. 25 aboard a Delta II rocket from Cape Canaveral Air Force Station, Fla. Their observations will enable scientists to construct the first-ever three-dimensional views of the sun. These images will show the sun's stormy environment and its effect on the inner solar system. The data are vital for understanding how the sun creates space weather.

During the two-year mission, the two spacecraft will explore the origin, evolution and interplanetary consequences of coronal mass ejections, some of the most violent explosions in our solar system. When directed at Earth, these billion-ton eruptions can produce spectacular aurora and disrupt satellites, radio communications and power systems. Energetic particles associated with these solar eruptions permeate the entire solar system and may be hazardous to spacecraft and astronauts.

"In terms of space-weather forecasting, we're where weather forecasters were in the 1950s," said Michael Kaiser, STEREO project scientist at NASA's Goddard Space Flight Center in Greenbelt, Md. "They didn't see hurricanes until the rain clouds were right above them. In our case, we can see storms leaving the sun, but we have to make guesses and use models to figure out if and when they will impact Earth."

To obtain their unique stereo view of the sun, the two observatories must be placed in different orbits, where they are offset from each other and Earth. Spacecraft "A" will be in an orbit moving ahead of Earth, and "B" will lag behind, as the planet orbits the sun.

Just as the slight offset between eyes provides depth perception, this placement will allow the STEREO observatories to obtain 3-D images of the sun. The arrangement also allows the spacecraft to take local particle and magnetic field measurements of the solar wind as it flows by the spacecraft.

STEREO is the first NASA mission to use separate lunar swingbys to place two observatories into vastly different orbits around the sun. The observatories will fly in an orbit from a point close to Earth to one that extends just beyond the moon.

Approximately two months after launch, mission operations personnel at the Johns Hopkins University Applied Physics Laboratory, Laurel, Md., will use a close flyby of the moon to modify the orbits. The moon's gravity will be used to direct one observatory to its position ahead of the Earth. Approximately one month later, the second observatory will be redirected after another lunar swingby to its position trailing the Earth. These maneuvers will enable the spacecraft to take permanent orbits around the sun.

Each STEREO observatory has 16 instruments. The observatories have imaging telescopes and equipment to measure solar wind particles and to perform radio astronomy.

"STEREO is charting new territory for science research and the building of spacecraft. The simultaneous assembly, integration and launch of nearly identical observatories have been an extraordinary challenge," said Nick Chrissotimos, STEREO project manager at Goddard.

The STEREO mission is managed by Goddard. The Applied Physics Laboratory designed and built the spacecraft. The laboratory will maintain command and control of the observatories throughout the mission, while NASA tracks and receives the data, determines the orbit of the satellites, and coordinates the science results.

For more information about STEREO, visit:

<http://www.nasa.gov/stereo>

For more information about NASA and agency programs, visit:

<http://www.nasa.gov/home>

-end-

Media Services Information

NASA Television Information

Video news releases are available on NASA TV on the Web (see <http://www.nasa.gov/ntv>) and daily at 12 pm ET with replays at 5 and 10 pm and 6 am. In the continental United States, NASA Television's Public, Education and Media channels are carried by MPEG-2 digital C-band signal on AMC-6, at 72 degrees west longitude, Transponder 17C, 4040 MHz, vertical polarization. They're available in Alaska and Hawaii on an MPEG-2 digital C-band signal accessed via satellite AMC-7, transponder 18C, 137 degrees west longitude, 4060 MHz, vertical polarization. A Digital Video Broadcast compliant Integrated Receiver Decoder is required for reception. Analog NASA TV is no longer available.

For NASA TV information and schedules, visit: <http://www.nasa.gov/ntv>

Audio

NASA TV Audio only will be available on the V circuits that may be reached by dialing: 321-867-1220, -1240, -1260. Launch conductor audio 7135.

Briefings

A prelaunch media teleconference was held on August 17 at 2PM EDT. Participants for this briefing were:

- Dr. Madhulika Guhathakurta, STEREO Program Scientist, NASA HQ, Washington, D.C.
- Michael Kaiser, STEREO Project Scientist, Goddard Space Flight Center, Greenbelt, Md.
- Nicholas Chrissotimos, STEREO Project Manager, Goddard Space Flight Center, Greenbelt, Md.
- Ed Reynolds, STEREO Project Manager, Johns Hopkins University Applied Physics Laboratory, Laurel, Md.

A NASA Kennedy Space Center (KSC) L-1 pre-launch press briefing is scheduled for L-1 to discuss launch, spacecraft readiness and weather. Panelists are include:

- Omar Baez, NASA Launch Director / NASA Launch Manger, KSC
- Kris Walsh, Director of NASA Programs, Boeing Expendable Launch Systems, Huntington Beach, Calif.
- Nicholas Chrissotimos, STEREO Project Manager, Goddard Space Flight Center, Greenbelt, Md.
- Ed Reynolds, STEREO Project Manager, Johns Hopkins University Applied Physics Laboratory, Laurel, Md.
- Joel Tumbiolo, U.S. Air Force Delta II Launch Weather Officer
45th Weather Squadron, Cape Canaveral Air Force Station.

A science briefing will immediately follow the L-1 pre-launch briefing. Panelists include

- Dr. Madhulika Guhathakurta, STEREO Program Scientist, NASA HQ, Washington, D.C.
- Michael Kaiser, STEREO Project Scientist, NASA GSFC
- Russ Howard, SECCHI Principal Investigator, Naval Research Laboratory (NRL)
- Janet Luhmann, IMPACT Principal Investigator, University of Calif., Berkeley

All L-1 briefings will be carried live on NASA Television and the V circuits.

News Center / Status Reports

The STEREO News Center at KSC will open on L-2 and may be reached at 321-867-2468. Recorded status reports will be available beginning L-2 at 321-867-2525 and 301-286-NEWS.

Launch Media Credentials

National media desiring launch accreditation should contact the KSC Newsroom by close of business on L-3. Foreign nationals must have their accreditation paperwork in **30 days before launch**. All paperwork should be sent to:

Mandi Falconer, Office of Public Affairs
KSC Media Accreditation Officer
STEREO Launch Accreditation
NASA XA-E1
NASA Kennedy Space Center
Kennedy Space Center, Fla. 32899
Telephone: 321-867-2497
Fax: 321-861-5942

Requests must be on the letterhead of the news organization and must specify the editor making the assignment to cover the launch.

Internet Information

More information on NASA's STEREO mission, including an electronic copy of this press kit, press releases, fact sheets, status reports, animations, and photos can be found at:

<http://www.nasa.gov/stereo>

STEREO Quick Facts

Mass:

1,364 pounds (620 kg) each

Data Downlink:

720 kilobits per second

Power Consumption:

596 watts (average)

Memory:

1 gigabyte

Spacecraft Dimensions:

3.6 feet (1.1 meters) high X 6.6 feet (2.0 meters) deep X 3.9 feet (1.2 meters) wide
About the size of a golf cart

Spacecraft Dimensions with Solar Arrays Deployed:

3.6 feet (1.1 meters) high X 6.6 feet (2.0 meters) wide X 21.3 feet (6.5 meters) wide
Similar in length to a soccer net

Cost:

About \$550 million including delays, European contributions, all development costs, launch costs, two years of operations and three years of data analysis.

Expendable Launch Vehicle:

Delta II 7925-10L rocket

Orbit:

One observatory will be placed ahead of Earth in its orbit ("A") and the other behind ("B"), nearly in Earth's orbit; one is a little closer to the sun, and the other a little further from the sun. Spacecraft "A" orbits the sun every 346 days while "B" orbits every 388 days. From the perspective of the sun, the observatories separate by 45 degrees every year and will eventually find themselves behind the sun.

Mission Duration:

Two years

Lead Institutions Include:

Goddard Space Flight Center, Greenbelt, Md, Naval Research Laboratory, Washington, D.C.; Applied Physics Laboratory, Laurel, Md.; Paris-Meudon Observatory, Paris; University of California, Berkeley, Calif.; University of New Hampshire, Durham, NH.

First Acquisition of Signal:

Canberra Ground Station contact for "A" spacecraft is 9 minutes after the spacecraft separates; for "B" spacecraft it's 14 minutes.

In-orbit Check-out:

About 90 days

Mission Management and STEREO Science Center:

NASA Goddard Space Flight Center, Greenbelt, Md.

Mission Operations:

Johns Hopkins University Applied Physics Laboratory (APL), Laurel, Md.

STEREO Mission Overview

The Solar TERrestrial RELations Observatory (STEREO) is scheduled for launch October 25, 2006, aboard a Delta II launch vehicle from Cape Canaveral Air Force Station (CCAFS), Fla. The STEREO two-year mission consists of two nearly identical space-based observatories that will provide revolutionary views of the Sun-Earth system. STEREO is designed to:

- Trace the flow of energy and matter from the sun to Earth
- Reveal the true 3-D structure of coronal mass ejections, also known as CMEs (enormous eruptions of matter from the sun)
- Understand why CMEs occur

STEREO is also designed to provide unique alerts for Earth-directed CMEs and new information regarding their propagation and associated phenomena throughout the solar system. The mission will provide a new perspective on solar eruptions by imaging CMEs and background events from the two observatories simultaneously. The first spacecraft will lead and the second will fly behind the Earth in its orbit.

For the first three months after launch, the observatories will fly in an orbit from a point close to Earth to one that extends just beyond the moon. STEREO mission operations personnel at The Johns Hopkins University Applied Physics Laboratory (JHU/APL), in Laurel, Md., will synchronize spacecraft orbits so that about two months after launch they encounter the moon, at which time one of them is close enough to use the moon's gravity to redirect it to a position ahead of the Earth. Approximately one month later, the second observatory will encounter the moon again and be redirected to its orbit trailing the Earth. When combined with data from observatories on the ground or in low-Earth orbit, STEREO's data will allow scientists to track the buildup and lift-off of magnetic energy from the sun and the trajectory of Earth-bound CMEs in 3-D.

NASA Goddard Space Flight Center's Solar Terrestrial Probes (STP) Program Office in Greenbelt, Md., manages the STEREO mission, instruments and its science center. The Johns Hopkins University Applied Physics Laboratory (JHU/APL) designed, built, and will operate the twin observatories for NASA during the two-year mission.

What exactly is space weather?

"Space weather" describes changes in the solar system environment caused by variations in the sun and solar wind. These include CMEs and solar flares and changes in the interplanetary magnetic field due to solar surface features like coronal holes. Solar flares and coronal mass ejections (CMEs) originate at the sun and can cause disturbances near Earth and throughout the solar system. Space weather can have a number of different effects. Dangerous radiation, especially in the form of high-speed particles can present a hazard to astronauts. Space weather can also lead to problems with spacecraft, communications, and power systems. In addition, interaction of space weather with the Earth's magnetic field causes the beautiful aurora (northern and southern lights).

What are coronal mass ejections (CMEs) and why study them?

CMEs are powerful eruptions that can eject a small part of the sun's atmosphere into interplanetary space. Typically, CMEs eject about one billion tons of solar particles into space and travel at about one million miles per hour. They can create major disturbances in the interplanetary medium (dust, gas and plasma in the space between the planets), and if they reach Earth, trigger severe magnetic storms that affect satellites, communications, power grids and airlines. CME-driven shocks also play a significant role in accelerating solar energetic particles that can damage spacecraft and harm astronauts. Despite their importance, scientists

don't fully understand the origin and evolution of CMEs; STEREO's unique 3-D measurements should help with those answers.

Understanding what causes CMEs and how they move through the solar system is one of the chief goals of the STEREO mission. The different telescopes in the SECCHI instrument suite image the CMEs. The actual material in CMEs is measured as they pass the spacecraft using the IMPACT and PLASTIC instruments, and IMPACT measures their magnetic fields. The SWAVES instruments observe radio signals produced by shock waves formed as the CMEs plow through the solar wind.

What are solar flares?

Solar flares are bright, explosive events that take place in the sun's lower corona (the sun's hot, thin outer atmosphere). They can be associated with CMEs, but are not the same thing. Scientists will use the SECCHI imaging instruments aboard STEREO to improve our understanding of how flares are related to CMEs.

Although most of what is called a solar flare occurs relatively low in the sun's atmosphere, flares do release charged particles that travel along the magnetic field lines of the interplanetary magnetic field (IMF). Electrons emitted this way by flares produce radio waves detected by the SWAVES instruments and allow researchers to map the IMF.

Sometimes these charged particles may be high enough in energy to qualify as solar energetic particles (SEPs). SEPs, along with the X-rays and gamma-rays produced by flares, can be very harmful to astronauts.

What will the 3-D images look like?

The 3D images will be constructed using data from the STEREO/SECCHI suite's Extreme Ultraviolet Imaging Telescope. These will be similar to images from the Extreme Ultraviolet Imaging Telescope (EIT) on the Solar and Heliospheric Observatory (SOHO), but with significantly greater resolution (2k) and frequency (one image every few minutes). The EIT instrument takes images approximately every 12 minutes.

How does the solar cycle influence STEREO's mission?

The sun has an 11-year cycle of activity determined by the reversal of its magnetic poles. During the solar minimum, the sun may churn out a strong CME every two or three days; that's approximately 180 CMEs per year, though only about 10-15 CMEs are directed at Earth. During solar maximum, the sun averages five CMEs daily, and sends about 100 Earthward per year. The last solar maximum was approximately 2000-2001.

STEREO will track these disturbances from their onset at the sun's surface to beyond Earth's orbit, measure energetic particles generated by CMEs and flares, and sample fields and particles in the disturbances as they pass near Earth. The STEREO scientific program does not depend on the phase of the solar cycle because CMEs and other phenomena to be studied are common to all phases of the cycle. Although the CME rate varies with the solar cycle, assuming a CME rate consistent with the minimum of the solar magnetic activity cycle, STEREO expects to observe at least 60 CMEs in remote sensing instruments and at least 24 interplanetary events in-situ.

STEREO and STP Mission Themes

STEREO is one of six missions within the Solar Terrestrial Probes (STP) program, part of NASA's Heliophysics Division within the Science Mission Directorate. The primary goal of this program is to understand our changing sun and its effects on the solar system, life and society. The STP program constitutes an ambitious in-depth look at space weather and solar science with implications for improving life on Earth, increasing the safety of space exploration and vastly enhancing our understanding of star system processes.

The four primary questions for the program are:

- Why does the sun vary?
- How do the planets respond to solar variability?
- How do the sun and galaxy interact?
- How does solar variability affect life and society?

The coordinated sequence of projects within the STP program responds to these questions by focusing on the study of the sun and the Earth as an integrated system.

Heliospheric Science Objectives

- Understand how interplanetary space and the Earth's environment respond to solar variability with the ultimate goal of a reliable predictive capability
- Obtain scientific knowledge relevant to mitigation or accommodation of undesirable effects of space weather on humans and human technology on the ground and in space
- Understand how space weather affects hardware performance and operation in space

Consequences of Space Weather

Aeronautics:

- High altitude aircraft exposure to radiation, especially near the poles
- Navigational and GPS interference

Astronautics:

- Threat of sporadic radiation to astronauts
- Potential damage to spacecraft electronics

Science:

- Understand how the sun works
- Understand how geospace responds to solar and heliospheric variations

Technology Infrastructure:

- Disruption/failure of communications satellites
- Power grid disruption problems / equipment failure

Climate Change:

- Global temperature variations
- Predictive capability for climatic changes

STEREO Instruments

The STEREO science payload consists of four measurement packages, each of which has several components. Together, this suite of instruments will characterize the CME plasma from the solar surface to Earth's orbit. Using remote and local sensors to measure the physical characteristics of CMEs, they will determine the solar origins of CMEs, their propagation into the interplanetary medium, and their ultimate effects on Earth's magnetic field.

The science payload consists of the minimum set of instruments necessary to achieve the highest priority STEREO science. The payload will, for the first time, allow scientists to:

- Image the solar atmosphere and heliosphere from two perspectives simultaneously.
- Track disturbances in three dimensions from their onset at the Sun to beyond the Earth's orbit.
- Provide stereoscopic images of multi-point CMEs and coronal features.
- Provide multi-point remote and in-situ observations of a single event.
- Measure energetic particles generated by the multi-point CME disturbances.
- Sample fields and particles in the disturbances as they pass near the Earth and provide imaging for Earth-directed events.

The STEREO observatory carries a complement of four scientific instruments (two instruments and two instrument suites, with a total of 13 instruments per observatory) as follows:

Sun Earth Connection Coronal and Heliospheric Investigation (SECCHI) has four instruments: an Extreme UltraViolet Imager, two White-light Coronagraphs and two Heliospheric Imagers. SECCHI's integrated instruments will study the 3-D evolution of CMEs from birth at the sun's surface through the corona and interplanetary medium to their eventual impact at Earth. Principal Investigator: Russell Howard of the Naval Research Laboratory in Washington.

STEREO/WAVES (S/WAVES) is an interplanetary radio burst tracker for STEREO that will track the generation and evolution of traveling radio disturbances from the sun to Earth. Principal Investigator: Jean-Louis Bougeret of the Paris Observatory, Meudon, France

In situ Measurements of PArticles and CME Transients (IMPACT) will sample the 3-D distribution and provide plasma characteristics of solar energetic particles and the local vector magnetic field. Principal investigator: Janet Luhmann of the University of California, Berkeley

PLAsma and SupraThermal Ion and Composition (PLASTIC) experiment will provide plasma characteristics of protons, alpha particles and heavy ions. This experiment will provide key diagnostic measurements of the form of mass and charge state composition of heavy ions and characterize the CME plasma from ambient coronal plasma. Principal Investigator: Antoinette Galvin of the University of New Hampshire, Durham

STEREO Ground Operations

The Deep Space Network (DSN) ground stations provide space-to-ground services for transmitting commands and telemetry/tracking data, as well as signal processing and science data handling during the mission.

STEREO Mission Operations

The Mission Operations Center (MOC), located at JHU/APL, serves as the focal point for the STEREO on-orbit operations control. It provides the hardware and software necessary for the successful conduct of operations activities.

STEREO Orbit Determination

The Flight Dynamics Facility (FDF) will be responsible for collecting and processing tracking data (range and doppler) from the DSN tracking stations. Orbit determination will be performed on a bi-weekly basis using the Goddard Trajectory Determination Software (GTDS). The orbit determination solutions will be used to produce definitive and predictive ephemeris files that will be delivered to the STEREO MOC for science data processing and mission planning.

STEREO Science Center

The STEREO Science Center (SSC) serves as the central facility responsible for telemetry distribution, archiving, and other central functions, such as long-term science planning and coordination with the science teams. The SSC is also responsible for the receipt and processing of the real-time Space Weather data. The SSC is the principal interface with the scientific community and the public at large. (<http://stereo.gsfc.nasa.gov/>)

**OVERLAP OF FIELDS OF VIEW
FROM 'AHEAD' AND 'BEHIND' SPACECRAFT**

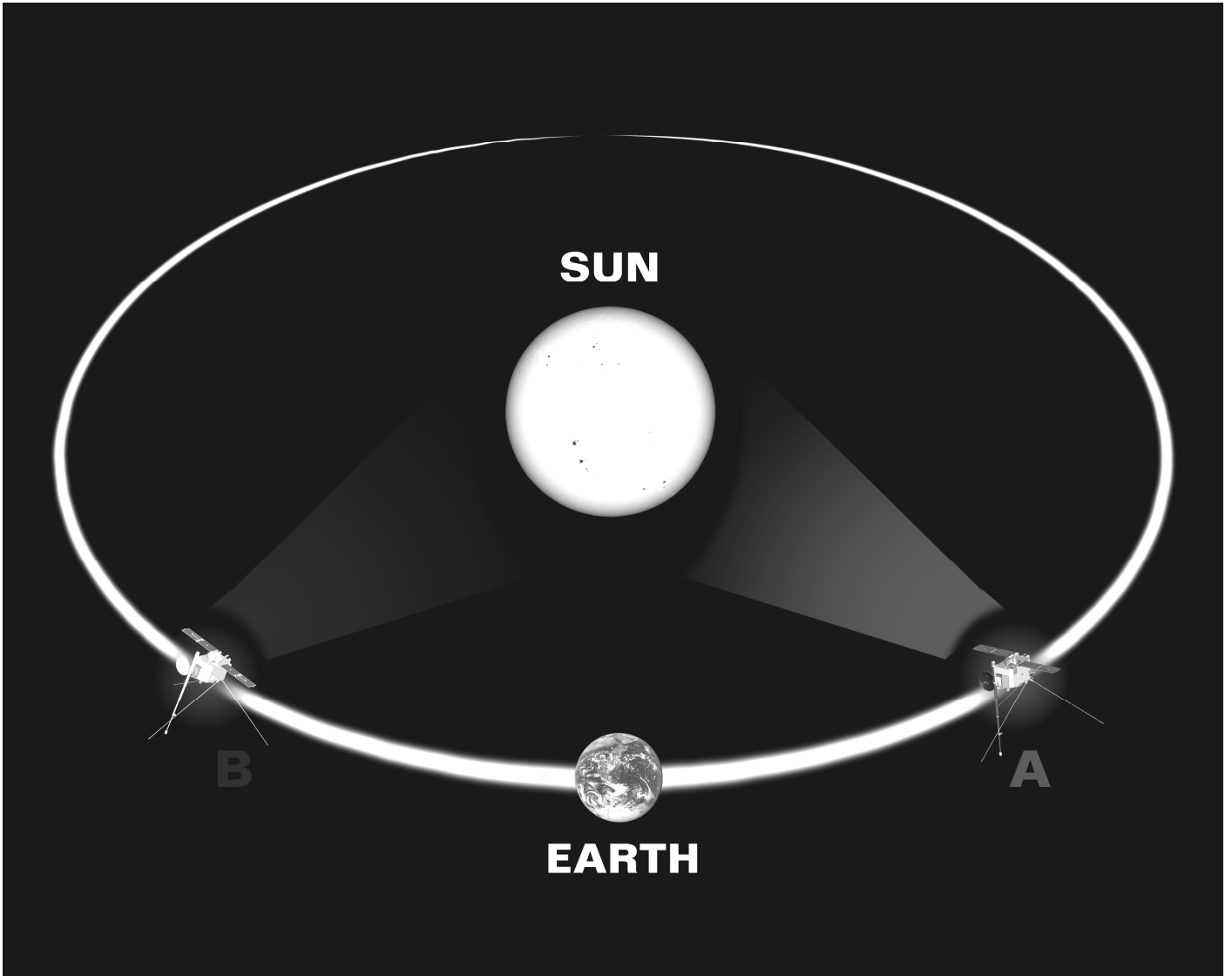

The STEREO observatories will orbit the Sun in a heliocentric orbit at ~1 Astronomical Unit (AU), with one leading Earth and one lagging.

To obtain unprecedented, three-dimensional measurements of the Sun, the twin observatories will be placed into a challenging orbit where they will be offset from one another. One observatory will be placed “ahead” of the Earth in its orbit and the other, “behind” using a series of lunar swing-bys. Although lunar gravity has previously been used to manipulate the orbit of a single spacecraft, the STEREO mission is the first ever to use lunar swing-bys for more than one spacecraft. Using this technique allows multiple payloads to be launched aboard a single launch vehicle, resulting in significant cost savings.

STEREO Observatory

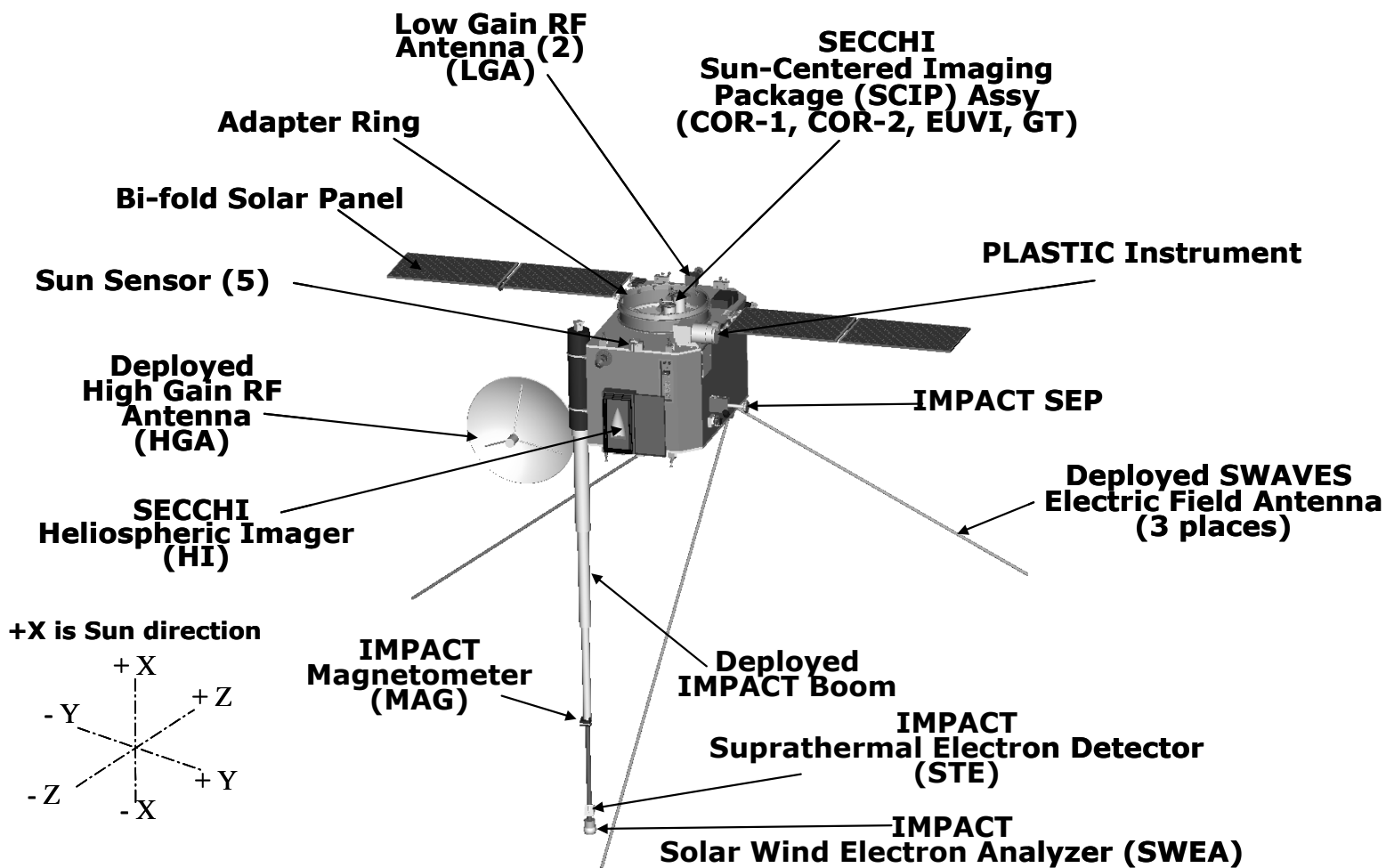

Launch Vehicle Configuration

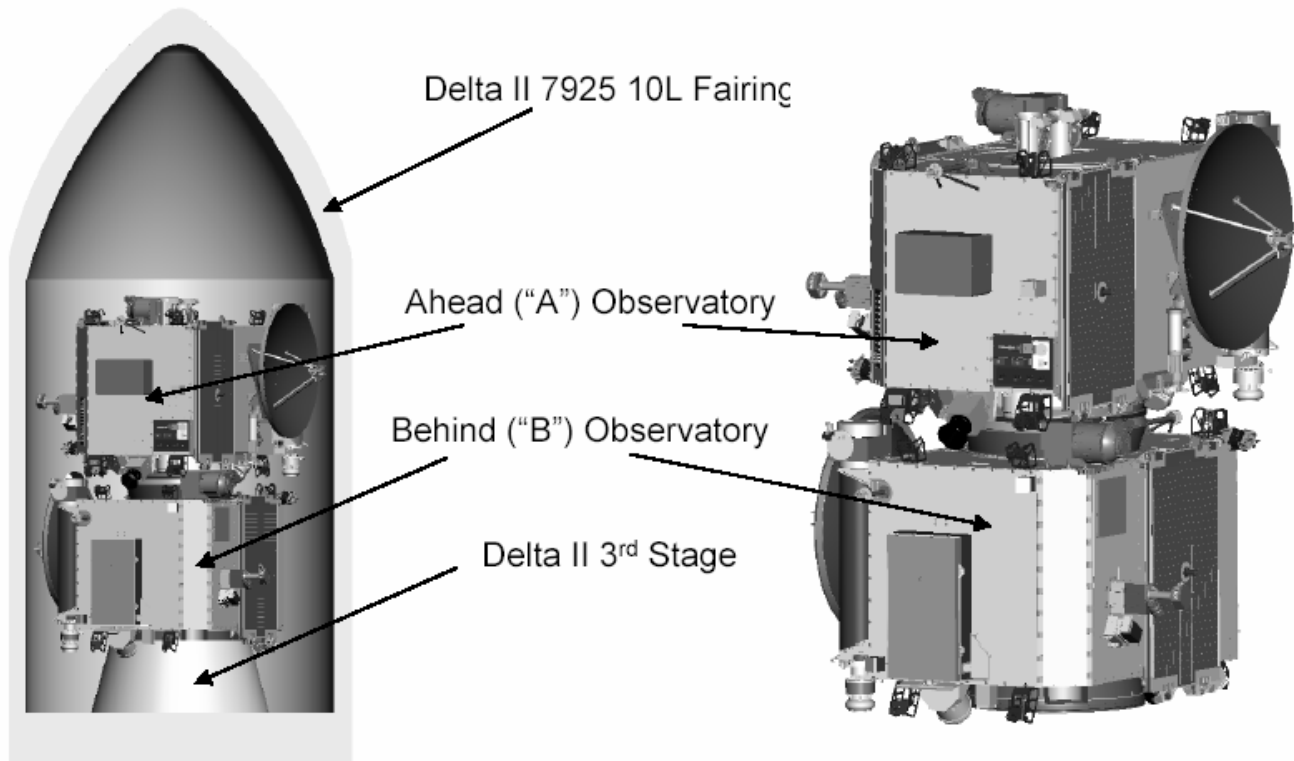

- Vehicle Configuration: 7925-10L
- Launch Site: SLC-17B at CCAFS
- Launch Period: 25 October - 02 November 2006
- Launch Window: 15 Minutes
- Unique Mission Requirements:
 - 3712A Payload Attach Fitting
 - Third Stage Motor Dome Blanket
 - Nutation Control System With Despin System (37 Lbf Reaction Engine Assembly)
 - Third-stage Ballast (10 ± 10 pounds)
 - Two 61-pin Fairing Umbilicals
 - 2 Separation Switch Pads
 - Mission-specific Access Doors: 2 (24" diameter)

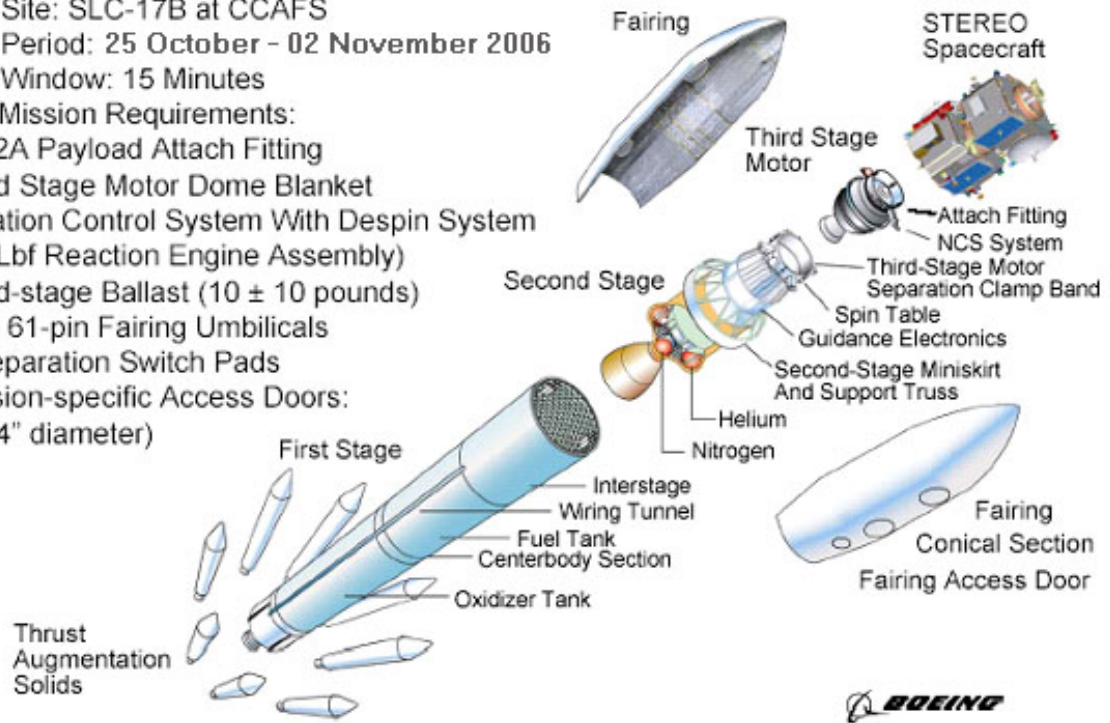

Launch & Injection into Orbit / Spacecraft Separation

STEREO Boost Profile

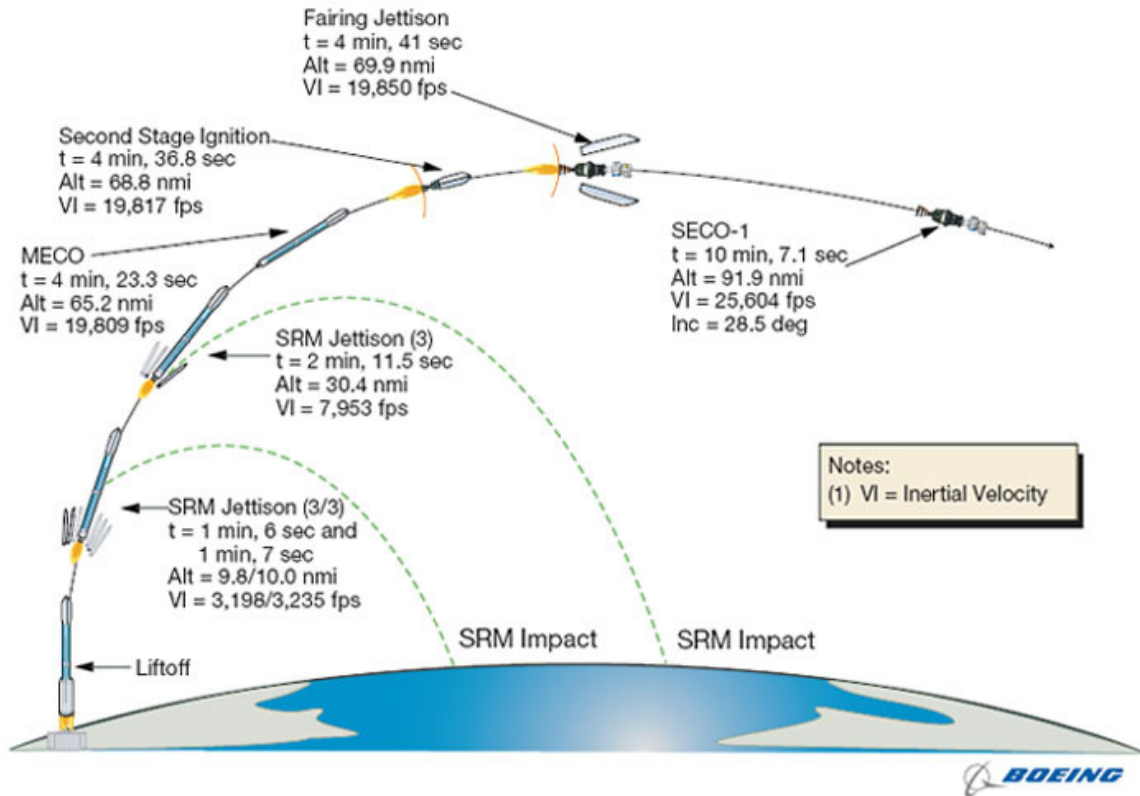

STEREO – Second and Third Stage Sequence of Events for 25 October 2006

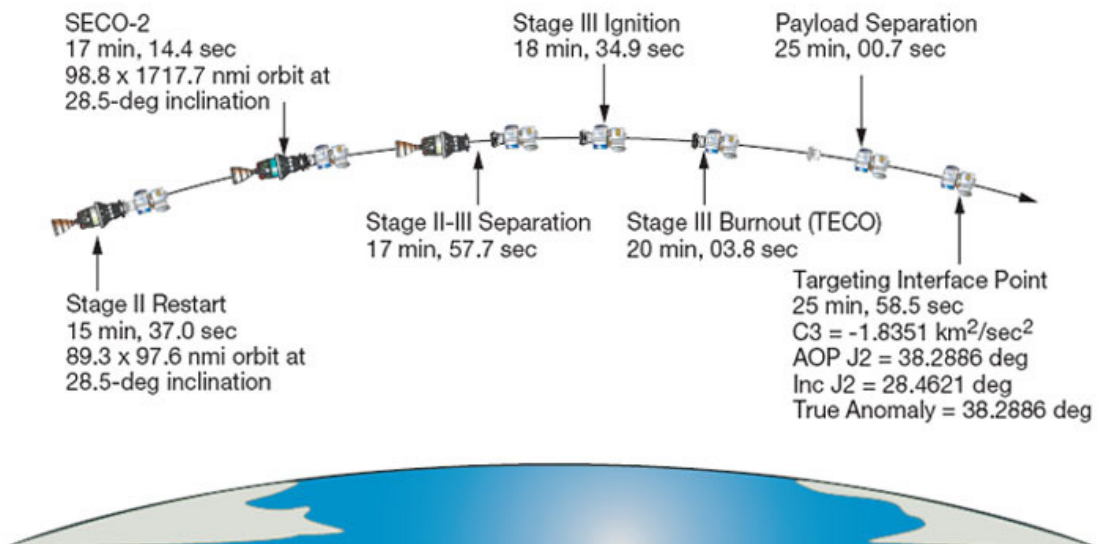

STEREO Mission Participants: Institutional Responsibilities

<i>Science Operations</i>	<i>Lead Institution</i>
STEREO Science Center (SSC) Archiving, Space Weather	Goddard Space Flight Center (GSFC)
SECCHI instrument	Naval Research Lab (NRL)
IMPACT Instrument	University of California, Berkeley (UCB) California Institute of Technology (CalTech)
PLASTIC Instrument	University of New Hampshire (UNH)
S/WAVES Instrument	Paris Observatory, Meudon, France University of Minnesota (UMN)
<i>Mission Operations</i>	<i>Lead Institution</i>
Mission Operations Center	JHU Applied Physics Laboratory (APL)
Ground System Management	Goddard Space Flight Center
Space Weather Forecasting	NOAA Space Environment Center

STEREO Mission Participants: Key Personnel

Division Director: Richard Fisher (HQ)
Phone: 202-358-1674
Email: Richard.R.Fisher@nasa.gov

Program Scientist: Madhulika Guhathakurta (HQ)
Phone: 202-358-1992
Email: Madhulika.Guhathakurta@nasa.gov

Program Executive: Victoria Elsbernd (HQ)
Phone: 202-358-3987
Email: Victoria.H.Elsbernd@nasa.gov

Program Manager: Gilberto Colón (GSFC)
Phone: 301-286-2113
Email: Gilberto.Colon-1@nasa.gov

Project Scientist: Mike Kaiser (GSFC)
Phone: 301-286-5461
Email: Michael.Kaiser@nasa.gov

Project Manager: Nicholas Chrissotimos (GSFC)
Phone: 301-286-5108
Email: Nicholas.G.Chrissotimos@nasa.gov

Deputy Project Scientist: Therese Kucera (GSFC)
Phone: 301-286-0829
Email: Terry.Kucera@nasa.gov

Mission Operations Lead: Ed Reynolds (APL)
Phone: 240-228-5101
Email: Ed.Reynolds@jhuapl.edu

Science Center Lead: Bill Thompson (GSFC)
Phone: 301-286-2040
Email: William.t.Thompson.1@gsfc.nasa.gov

IMPACT Principal Investigator: Janet Luhmann (UCB)
Phone: 510-642-2545
Email: jgluhman@ssl.berkeley.edu

SECCHI Principal Investigator: Russell Howard (NRL)
Phone: 202-767-3137
Email: russell.howard@nrl.navy.mil

PLASTIC Principal Investigator: Antoinette Galvin (UNH)
Phone: 603-862-3511
Email: toni.galvin@unh.edu

S/WAVES Principal Investigator: Jean-Louis Bougeret (Paris)
Email: Jean-Louis.bougeret@obspm.fr

STEREO Public Affairs Contacts:

NASA Headquarters
Grey Hautaluoma / Erica Hupp
202-358-0668 / 202-358-1237
Grey.Hautaluoma-1@nasa.gov / Erica.Hupp-1@nasa.gov

Goddard Space Flight Center
Rani Gran / Lynn Chandler
301-286-2483 / 301-286-2806
Rani.C.Gran@nasa.gov / Lynn.Chandler-1@nasa.gov

George Diller, Kennedy Space Center
George.H.Diller@nasa.gov / 321-867-2468

Kristi Marren, JHU Applied Physics Laboratory
Kristi.Marren@jhuapl.edu / 240-228-6268

Janice Schultz, Naval Research Laboratory
janice.schultz@nrl.navy.mil / 202-767-2856

Paula Shawa, The Boeing Company
Paula.R.Shawa@boeing.com / 714-372-1694

Bob Sanders, UC Berkley
rsanders@berkeley.edu / 510-643-6998

Biographies

Nicholas G. Chrissotimos, STEREO Project Manager NASA Goddard Space Flight Center

Mr. Chrissotimos has 24 years of project/program management experience at the Goddard Space Flight Center (GSFC). He is currently the Deputy Program Manager for the Sun Earth Connection (SEC) Programs. In addition, he is currently the Project Manager for the STEREO mission.

Mr. Chrissotimos joined GSFC full-time in 1974 after receiving a BSEE from Pratt Institute. He also has a MSEE from the University of Maryland. He first developed Ground Systems hardware for the NASA STDN tracking stations. Then designed and developed spaceflight hardware while supporting flight projects including, LANDSAT, SARSAT, SEASAT and COBE.

He served on the TDRS Project for eight years as Payload Manager, Spacecraft Manager, and Assistant Project Manager leading to the successful development and launches of TDRS 3 – 7. He later served as the TDRS H,I,J SEB Chairman, while he was the Deputy Project Manager on the EOS Chemistry and Special Flights Project.

As the Earth Systems Science Pathfinder (ESSP) Project Manager he led the definition and development of the program. As the Earth Explorers Program Manager he managed the development, launch and operations of ESSP and explorer missions; QuickScat, GRACE, SORCE, QuikTOMS, CALIPSO and CloudSat.

Mr. Chrissotimos is a recipient of the NASA Medal for Outstanding Leadership and Goddard's Exceptional Achievement Award.

Edward Reynolds, STEREO Project Manager The Johns Hopkins University Applied Physics Laboratory (APL) Laurel, Maryland

As APL's project manager for the STEREO mission, Ed Reynolds oversees the project's overall development and operation.

Mr. Reynolds has a bachelor's degree in electrical engineering from Virginia Tech. He has an extensive background in spacecraft system engineering, which stems from his experience in spacecraft integration and test.

Prior to the STEREO mission, Mr. Reynolds played key engineering roles in several projects, including the Comet Nucleus Tour (CONTOUR) and the Near Earth Asteroid Rendezvous (NEAR), the first mission in NASA's Discovery Program, that orbited and eventually landed on the asteroid Eros.

Additionally, he has worked on a number of assignments involving satellites, and sounding rockets with engineers from Russia.

Mr. Reynolds has received an Outstanding Achievement Quality Award at APL, and has authored or co-authored several technical papers. He is a member of the Project Management Institute.

**Michael Kaiser, STEREO Project Scientist
NASA Goddard Space Flight Center**

Mr. Michael L. Kaiser is a research scientist with the Solar System Exploration Division at NASA Goddard Space Flight Center. He is the Project Scientist for the STEREO Mission and is also the Deputy Principal Investigator of the STEREO WAVES investigation. In addition, he is the Principal Investigator of the WAVES experiment on the NASA Wind spacecraft and on the Voyager Planetary Radio Astronomy (PRA) experiment performed during Voyager's interstellar mission (1989-present). He is a co-investigator on the Ulysses Unified Radio And Plasma Wave experiment (UARP) and the Cassini Radio and Plasma Wave Science (RPWS) team.

Kaiser received his M.S. degree in Astronomy from the University of Maryland in 1971. His research interests include low frequency radio astronomy with particular emphasis on planetary and solar emissions. He is an author on approximately 225 scientific publications and has received the NASA Exceptional Scientific Achievement medal and numerous group achievement awards. He is a member of the American Geophysical Union (AGU), International Union of Radio Science (URSI), European Geophysical Union (EGU), American Astronomical Society/Solar Physics Division and the Institute of Electrical and Electronics Engineers, Inc.

**Dr. Theresa Kucera, STEREO Deputy Project Scientist
NASA Goddard Space Flight Center**

Therese Kucera is a research scientist in the Laboratory for Solar and Space Physics at NASA Goddard Space Center. She is the Deputy Project Scientist for STEREO and the US Deputy Project Scientist for the SOHO mission. She has served on the science operations teams of the SOHO/CDS and SUMER instruments. Her main research focus is the solar atmosphere, including investigations into solar prominences, active regions, and flares. She received her Ph.D. from the University of Colorado, Boulder in 1993.

**Jim Adams, STEREO Deputy Project Manager
NASA Goddard Space Flight Center**

With 28 years of aerospace experience, Jim Adams is the Deputy Project Manager for the STEREO Project at NASA's Goddard Space Flight Center. Previously he has served as the Project Formulation Manager for the Global Precipitation Measurement (GPM) mission, Chief of Goddard's Rapid Spacecraft Development Office and as Observatory Manager for the EOS Chemistry mission and the Global Geospace Science WIND and POLAR missions. Jim holds a BS in Physics from Westminster College and a MSEE from Villanova University.

**Dr. Madhulika Guhathakurta, STEREO Program Scientist
NASA Headquarters**

As a NASA astrophysicist, Dr. Madhulika Guhathakurta (also known as Lika) has had the opportunity to work as a scientist, mission designer, instrument builder, directing and managing science programs and teacher and spokesperson for NASA's mission and vision in the Heliophysics Division. Occasionally, she performs all of these roles in a single day.

Before joining NASA Headquarters in December of 1998, her career has focused on studying the importance of the scientific exploration of space in particular understanding the Sun as a star and its influence on the planet Earth, with research focus on understanding the magneto hydrodynamics of the Sun's outermost layer, the solar corona. She has been a Co-Investigator

on five Spartan 201 missions on aboard space shuttles to study the solar corona in white-light and UV radiation and has authored over 70 publications.

Dr. Guhathakurta is the Lead Program Scientist for NASA's initiative called "Living With a Star" (LWS) which focuses on understanding and ultimately predicting solar variability and its diverse effects on Earth, human technology and astronauts in space. The systems science behind this new kind of weather outside of Earth's terrestrial atmosphere is known as "Space Weather". She is also the Program Scientist for "Solar TERrestrial RELations Observatory" (STEREO), scheduled to launch in July 2006. STEREO is a two-year mission which will employ two nearly identical space-based observatories - one ahead of Earth in its orbit, the other trailing behind - to provide the first-ever stereoscopic measurements to study the Sun and the nature of its coronal mass ejections, or CMEs and their impact on space-weather.

She is presently leading two science definition teams for future missions in the LWS Program, "Solar Probe" and "Solar Sentinels" and involved in a mission in formulation "Radiation Belt Storm Probes (RBSP)". Solar Probe will be a historic mission, flying into one of the last unexplored regions of the solar system, the Sun's atmosphere or corona, for the first time. Approaching as close as 3 RS above the Sun's surface, Solar Probe will employ a combination of in-situ measurements and imaging to achieve the mission's primary scientific goal: to understand how the Sun's corona is heated and how the solar wind is accelerated. Solar Sentinels, an important mission for NASA's Vision for exploration will help in the understanding and prediction of Solar Energetic Particle (SEPs) and solar eruptive events, and their effects on the interplanetary environments, planets, and other solar system bodies. RBSP's science objectives are to provide understanding of how populations of relativistic electrons and ions in space are formed or changed in response to solar variations. In addition to leading science missions for the LWS program, Dr Guhathakurta also manages a theory, modeling and data analysis program to integrate scientific output, data, and models to generate a comprehensive, systems understanding of Sun-Heliosphere-Planets coupling.

Dr. Guhathakurta is leading an effort in an international initiative known as the "International Living With a Star" (ILWS) consisting of all the space agencies of the world to contribute towards the scientific goal for Space Weather understanding.

A native of India, Dr. Guhathakurta received her Masters in Astrophysics from University of Delhi and Ph.D. in Physics from University of Denver and University of Colorado at Boulder.

