

Techniques of Water-Resources Investigations of the U.S. Geological Survey

**Book 3, Applications of Hydraulics
Chapter C2**

Field Methods for Measurement of Fluvial Sediment

By Thomas K. Edwards and G. Douglas Glysson

This manual is a revision of “Field Methods for Measurement of Fluvial Sediment,” by Harold P. Guy and Vernon W. Norman, U.S. Geological Survey Techniques of Water-Resources Investigations, Book 3, Chapter C2, published in 1970.



U.S. DEPARTMENT OF THE INTERIOR

BRUCE BABBITT, *Secretary*

U.S. GEOLOGICAL SURVEY

Charles G. Groat, *Director*

UNITED STATES GOVERNMENT PRINTING OFFICE : 1998

ISBN 0-607-89738-4

For sale by U.S. Geological Survey, Information Services
Box 25286, Federal Center
Denver, CO 80225

TECHNIQUES OF WATER-RESOURCES INVESTIGATIONS OF THE U.S. GEOLOGICAL SURVEY

The U.S. Geological Survey publishes a series of manuals describing procedures for planning and conducting specialized work in water-resources investigations. The material is grouped under major subject headings called books and is further divided into sections and chapters. For example, Section A of Book 3 (Applications of Hydraulics) pertains to surface water. The chapter, the unit of publication, is limited to a narrow field of subject matter. This format permits flexibility in revision and publication as the need arises.

The reports listed below are for sale by the **U.S. Geological Survey, Information Services, Box 25286, Federal Center, Denver, Colorado 80225** (authorized agent of the Superintendent of Documents, Government Printing Office). Prepayment is required. Remittance should be sent by check or money order payable to the U.S. Geological Survey. Prices are not included because they are subject to change. **Current prices can be obtained by writing to the above address.** When ordering or inquiring about prices for any of these publications, please give the title, book number, chapter number, and "U.S. Geological Survey Techniques of Water-Resources Investigations."

- TWRI 1-D1. Water temperature—Influential factors, field measurement, and data presentation, by H.H. Stevens, Jr., J.F. Ficke, and G.F. Smoot. 1975. 65 pages.
- TWRI 1-D2. Guidelines for collection and field analysis of ground-water samples/for selected unstable constituents, by W.W. Wood. 1976. 24 pages. Reprint.
- TWRI 2-D1. Application of surface geophysics to ground-water investigations, by A.A.R. Zohdy, G.P. Eaton, and D.R. Mabey. 1974. 116 pages.
- TWRI 2-D2. Application of seismic-refraction techniques to hydrologic studies, by F.P. Haeni. 1988. 86 pages.
- TWRI 2-E1. Application of borehole geophysics to water-resources investigations, by W.S. Keys and L.M. MacCary. 1971. 126 pages.
- TWRI 2-E2. Borehole geophysics applied to ground-water investigations, by W.S. Keys. 1990. 150 pages.
- TWRI 2-F1. Application of drilling, coring, and sampling techniques to test holes and wells, by Eugene Shuter and Warren E. Teasdale. 1989. 97 pages.
- TWRI 3-A1. General field and office procedures for indirect discharge measurements, by M.A. Benson and Tate Dalrymple. 1967. 30 pages.
- TWRI 3-A2. Measurement of peak discharge by the slope-area method, by Tate Dalrymple and M.A. Benson. 1967. 12 pages.
- TWRI 3-A3. Measurement of peak discharge at culverts by indirect methods, by G.L. Bodhaine. 1968. 60 pages.
- TWRI 3-A4. Measurement of peak discharge at width contractions by indirect methods, by H.F. Matthai. 1967. 44 pages.
- TWRI 3-A5. Measurement of peak discharge at dams by indirect methods, by Harry Hulsing. 1967. 29 pages.
- TWRI 3-A6. General procedure for gaging streams, by R.W. Carter and Jacob Davidian. 1968. 13 pages.
- TWRI 3-A7. Stage measurements at gaging stations, by T.J. Buchanan and W.P. Somers. 1968. 28 pages.
- TWRI 3-A8. Discharge measurements at gaging stations, by T.J. Buchanan and W.P. Somers. 1969. 65 pages.
- TWRI 3-A9.¹ Measurement of time of travel and dispersion in streams by dye tracing, by E.P. Hubbard, F.A. Kilpatrick, L.A. Martens, and J.R. Wilson, Jr. 1982. 44 pages.
- TWRI 3-A10. Discharge ratings at gaging stations, by E.J. Kennedy. 1984. 59 pages.
- TWRI 3-A11. Measurement of discharge by moving-boat method, by G.F. Smoot and C.E. Novak. 22 pages.
- TWRI 3-A12. Fluorometric procedures for dye tracing, Revised, by J.F. Wilson, Jr., E.D. Cobb, and F.A. Kilpatrick. 1986. 41 pages.
- TWRI 3-A13. Computation of continuous records of streamflow, by E.J. Kennedy. 1983. 53 pages.
- TWRI 3-A14. Use of flumes in measuring discharge, by F.A. Kilpatrick and V.R. Schneider. 1983. 46 pages.
- TWRI 3-A15. Computation of water-surface profiles in open channels, by Jacob Davidian. 1984. 48 pages.
- TWRI 3-A16. Measurement of discharge using tracers, by F.A. Kilpatrick and E.D. Cobb. 1985. 52 pages.
- TWRI 3-A17. Acoustic velocity meter systems, by Antonius Laenen. 1985. 38 pages.
- TWRI 3-A18. Determination of stream reaeration coefficients by use of tracers, by F.A. Kilpatrick, R.E. Rathbun, Nobuhiro Yotsukura, G.W. Parker, and L.L. DeLong. 1989. 52 pages.
- TWRI 3-A19. Levels of streamflow gaging stations, by E.J. Kennedy. 1990. 27 pages.
- TWRI 3-A20. Simulation of soluble waste transport and buildup in surface waters using tracers, by F.A. Kilpatrick. 1993. 38 pages.
- TWRI 3-A21. Stream-gaging cableways, by C. Russell Wagner. 1995. 56 pages.
- TWRI 3-B1. Aquifer-test design, observation, and data analysis, by R.W. Stallman. 1971. 26 pages.
- TWRI 3-B2.² Introduction to ground-water hydraulics, a programmed text for self-instruction, by G.D. Bennett. 1976. 172 pages.
- TWRI 3-B3. Type curves for selected problems of flow to wells in confined aquifers, by J.E. Reed. 1980. 106 pages.

- TWRI 3-B4. Regression modeling of ground-water flow, by Richard L. Cooley and Richard L. Naff. 1990. 232 pages.
- TWRI 3-B4. Regression modeling of ground-water flow—Modifications to the computer code for nonlinear regression solution of steady-state
Supplement 1. ground-water flow problems, by R.L. Cooley. 1993. 8 pages.
- TWRI 3-B5. Definition of boundary and initial conditions in the analysis of saturated ground-water flow systems—An introduction, by
O. Lehn Franke, Thomas E. Reilly, and Gordon D. Bennett. 1987. 15 pages.
- TWRI 3-B6. The principle of superposition and its application in ground-water hydraulics, by Thomas E. Reilly, O. Lehn Franke, and
Gordon D. Bennett. 1987. 28 pages.
- TWRI 3-B7. Analytical solutions for one-, two-, and three-dimensional solute transport in ground-water systems with uniform flow, by
Eliezer J. Wexler. 1992. 190 pages.
- TWRI 3-C1. Fluvial sediment concepts, by H.P. Guy. 1970. 55 pages.
- TWRI 3-C2.³ Field methods for measurement of fluvial sediment, by Thomas K. Edwards and G. Douglas Glysson. 1998. 89 pages.
- TWRI 3-C3. Computation of fluvial-sediment discharge, by George Porterfield. 1972. 66 pages.
- TWRI 4-A1. Some statistical tools in hydrology, by H.C. Riggs. 1968. 39 pages.
- TWRI 4-A2. Frequency curves, by H.C. Riggs. 1968. 15 pages.
- TWRI 4-B1. Low-flow investigations, by H.C. Riggs. 1972. 18 pages.
- TWRI 4-B2. Storage analyses for water supply, by H.C. Riggs and C.H. Hardison. 1973. 20 pages.
- TWRI 4-B3. Regional analyses of streamflow characteristics, by H.C. Riggs. 1973. 15 pages.
- TWRI 4-D1. Computation of rate and volume of stream depletion by wells, by C.T. Jenkins. 1970. 17 pages.
- TWRI 5-A1. Methods for determination of inorganic substances in water and fluvial sediments, by Marvin J. Fishman and Linda C. Friedman,
editors. 1978. 545 pages.
- TWRI 5-A2. Determination of minor elements in water by emission spectroscopy, by P.R. Barnett and E.C. Mallory, Jr. 1971. 31 pages.
- TWRI 5-A3.⁴ Methods for the determination of organic substances in water and fluvial sediments, edited by R.L. Wershaw, M.J. Fishman,
R.R. Grabbe, and L.E. Lowe. 1987. 80 pages.
- TWRI 5-A4.⁵ Methods for collection and analysis of aquatic biological and microbiological samples, by L.J. Britton and P.E. Greeson, editors.
1987. 363 pages.
- TWRI 5-A5. Methods for determination of radioactive substances in water and fluvial sediments, by L.L. Thatcher, V.J. Janzer, and
K.W. Edwards. 1977. 95 pages.
- TWRI 5-A6. Quality assurance practices for the chemical and biological analyses of water and fluvial sediments, by L.C. Friedman and
D.E. Erdmann. 1982. 181 pages.
- TWRI 5-C1. Laboratory theory and methods for sediment analysis, by H.P. Guy. 1969. 58 pages.
- TWRI 6-A1. A modular three-dimensional finite-difference ground-water flow model, by Michael G. McDonald and Arlen W. Harbaugh.
1988. 586 pages.
- TWRI 6-A2. Documentation of a computer program to simulate aquifer-system compaction using the modular finite-difference ground-water
flow model, by S.A. Leake and D.E. Prudic. 1991. 68 pages.
- TWRI 6-A3. A modular finite-element model (MODFE) for areal and axisymmetric ground-water-flow problems, Part 1: Model description
and user's manual, by L.J. Torak. 1993. 136 pages.
- TWRI 6-A4. A modular finite-element model (MODFE) for areal and axisymmetric ground-water-flow problems, Part 2: Derivation of finite-
element equations and comparisons with analytical solutions, by R.L. Cooley. 1992. 108 pages.
- TWRI 6-A5. A modular finite-element model (MODFE) for areal and axisymmetric ground-water-flow problems, Part 3: Design philosophy
and programming details, by L.J. Torak. 1993. 243 pages.
- TWRI 7-C1. Finite difference model for aquifer simulation in two dimensions with results of numerical experiments, by P.C. Trescott,
G.F. Pinder, and S.P. Larson. 1976. 116 pages.
- TWRI 7-C2. Computer model of two-dimensional solute transport and dispersion in ground water, by L.F. Konikow and J.D. Bredehoeft.
1978. 90 pages.
- TWRI 7-C3. A model for simulation of flow in singular and interconnected channels, by R.W. Schaffranek, R.A. Baltzer, and D.E. Goldberg.
1981. 110 pages.
- TWRI 8-A1. Methods of measuring water levels in deep wells, by M.S. Garber and F.C. Koopman. 1968. 23 pages.
- TWRI 8-A2. Installation and service manual for U.S. Geological Survey manometers, by J.D. Craig. 1983. 57 pages.
- TWRI 8-B2. Calibration and maintenance of vertical-axis type current meters, by G.F. Smoot and C.E. Novak. 1968. 15 pages.

¹This manual is a revision of "Measurement of Time of Travel and Dispersion in Streams by Dye Tracing," by E.F. Hubbard, F.A. Kilpatrick,
L.A. Martens, and J.F. Wilson, Jr., Book 3, Chapter A9, published in 1982.

²Spanish translation also available.

³This manual is a revision of "Field Methods for Measurement of Fluvial Sediment," by Harold P. Guy and Vernon W. Norman, Book 3, Chapter C2,
published in 1970.

⁴This manual is a revision of TWRI 5-A3, "Methods of Analysis of Organic Substances in Water," by Donald F. Goerlitz and Eugene Brown, published
in 1972.

⁵This manual supersedes TWRI 5-A4, "Methods for Collection and Analysis of Aquatic Biological and Microbiological Samples," edited by
P.E. Greeson and others, published in 1977.

CONTENTS

	Page		Page
Abstract	1	Site selection	35
Introduction	1	Equipment selection and maintenance	36
Perspective	1	Suspended-sediment sampling methods	38
Sediment characteristics, source, and transport	2	Sediment-discharge measurements	38
Data needs	3	Single vertical	39
Sediment-sampling equipment	4	Surface and dip sampling	41
General	4	Multivertical	42
Suspended-sediment samplers	5	The equal-discharge-increment method	42
Depth- and point-integrating samplers	6	The equal-width-increment method	48
Hand-held samplers—US DH-81, US DH-75, US DH-48, US DH-59, and US DH-76	7	Advantages and disadvantages of equal-discharge-increment and equal-width-increment methods	49
Cable-and-reel samplers—US D-74, US D-77, US P-61, US P-63, and US P-72	8	Point samples	51
Sampler accessories	14	Number of verticals	52
Nozzles	14	Transit rates for suspended-sediment sampling	53
Gaskets	16	Observer samples	60
Bottles	16	Sampling frequency, sediment quantity, sample integrity, and identification	61
Single-stage samplers	17	Sampling frequency	61
Bed-material samplers	19	Sediment quantity	62
Limitations	19	Sample integrity	63
Hand-held samplers—US BMH-53, US BMH-60, and US BMH-80	20	Sample identification	64
Cable-and-reel sampler—US BM-54	23	Sediment-related data	64
Bedload samplers	24	Water temperature	64
Automatic pumping-type samplers	26	Stream stage	66
Development and design	26	Cold-weather sampling	66
Installation and use criteria	26	Bed-material sampling	68
Placement of sampler intake	27	Materials finer than medium gravel	68
Sampler advantages and disadvantages	28	Materials coarser than medium gravel	69
Intake orientation	28	Location and number of sampling verticals	69
Data analysis	28	Sample inspection and labeling	70
Intake efficiency	31	Bedload sampling technique	70
Cross-section coefficient	31	Computation of bedload-discharge measurements	78
Description of automatic pumping-type samplers— US PS-69, US CS-77, US PS-82, Manning S-4050, and ISCO 1680	31	Measurements for total sediment discharge	82
Support equipment	34	Reservoir-trap efficiency	84
Sediment-sampling techniques	35	Inflow measurements	84
		Outflow measurements	84
		Sediment accumulation	85
		Other sediment data-collection considerations	86
		Selected references	87

ILLUSTRATIONS

	Page
1. Diagram showing sampled and unsampled zones in a stream sampling vertical, with respect to velocity of flow and sediment concentration	3
2–10. Photographs showing:	
2. US DH-81 suspended-sediment sampler shown with a US DH-81A adapter, D-77 cap and nozzle, wading rod handle, and quart glass bottle	7
3. US DH-75 (P and Q) suspended-sediment samplers with sample containers and wading rod	9
4. US DH-48 suspended-sediment sampler	9

5.	US DH-59 suspended-sediment sampler	10
6.	US DH-76 suspended-sediment sampler	10
7.	US D-74 suspended-sediment sampler	11
8.	US D-77 suspended-sediment sampler	12
9.	US P-61 point-integrating suspended-sediment sampler	13
10.	US P-63 point-integrating suspended-sediment sampler	13
11.	Diagram showing relation between intake velocity and sample concentration for (A) isokinetic and (B, C) non-isokinetic sample collection of particles greater than 0.062 mm	14
12.	Photograph showing sample containers to fit PS-69 pumping sampler	16
13.	Sketch of US U-59 single-stage suspended-sediment sampler	17
14-19.	Photographs showing:	
14.	US U-73 single-stage suspended-sediment sampler	19
15.	US BMH-53 bed-material sampler	20
16.	US BMH-60 bed-material sampler	21
17.	US BMH-80 rotary-scoop bed-material sampler	22
18.	US BM-54 bed-material sampler	23
19.	Vibra-core sampler prepared for coring	24
20.	Sketch of Helley-Smith bedload sampler	25
21.	Diagram showing examples of pumping-sampler intake orientations	29
22.	Diagram showing pumping effect on sediment streamlines within the zone (cone) of influence and velocity changes with distance from intake	30
23-25.	Photographs showing:	
23.	US PS-69 pumping sampler	32
24.	US CS-77 (Chickasha) pumping sampler	33
25.	US PS-82 pumping sampler	33
26-29.	Diagrams showing:	
26.	Examples of natural and artificially induced streamflow constrictions encountered at sediment-measurement sites	37
27.	Sample bottle showing desired water levels for sampling methods indicated and essential record information applicable to all sampling methods	40
28.	Uses of point-integrating sampler for depth integration of deep streams	42
29.	Example of equal-discharge-increment sampling technique	43
30.	Record of discharge measurement for Nehalem River near Foss, Oregon	44
31.	Discharge-measurement notes used to estimate the equal-discharge-increment centroid locations	45
32-34.	Plots showing:	
32.	Cumulative discharge versus sample-station widths for determining equal-discharge-increment centroid locations	46
33.	Cumulative discharge versus sample-station widths for determining equal-discharge-increment centroid locations	47
34.	Cumulative percent of discharge versus sample-station widths for determining equal-discharge-increment centroid locations	47
35-37.	Diagrams showing:	
35.	Vertical transit rate relative to sample volume collected at each equal-discharge-increment centroid	48
36.	Equal-width-increment sampling technique	50
37.	Equal-width-increment vertical transit rate relative to sample volume, which is proportional to water discharge at each vertical	50
38.	Nomograph to determine number of sampling verticals required to obtain results within an acceptable relative standard error	53
39-41.	Graphs showing:	
39.	Variation of range of transit rate to mean velocity ratio versus depth relative to nozzle size for pint-size sample container	54
40.	Variation of range of transit rate to mean velocity ratio versus depth relative to nozzle size for quart-size sample container	56
41.	Range of transit rate to mean velocity ratio versus depth for 5/16-inch nozzle on a 3-liter sample bottle	58
42.	Diagram showing construction of a transit-rate determination graph	58
43.	Diagram showing example of transit rate determination using graph developed for 3/16-inch nozzle and a 1-pint sample container	59
44.	Graphs showing minimum number of bottles containing optimum sample volume needed to yield sufficient sediment for size analysis	63
45.	Example of inspection sheet for use by field person to record the kinds of measurements made and the stream conditions observed during a visit to a sediment-measurement site	65

	Page
46–49. Graphs showing:	
46. Temporal variation of bedload transport rates for 120 consecutive bedload samples from a stream with constant water discharge	71
47. Comparison of cumulative probability distributions of bedload transport rates predicted by Einstein (1937) and Hamamori (1962)	72
48. Examples of possible distribution of mean bedload transport rates in a cross section	73
49. Percent error due to computing total sediment discharge of a size range by summing the measured suspended-sediment discharge and the discharge measured with a Helley-Smith sampler	74
50–52. Diagrams showing:	
50. Single equal-width-increment bedload-sampling method	75
51. Multiple equal-width-increment bedload-sampling method	76
52. Unequal-width-increment bedload-sampling method	76
53. Graph showing variation in maximum probable errors with number of sampling traverses at 4 and 20 equally spaced verticals at cross sections with different bedload transport rates	77
54–56. Diagrams showing:	
54. Total cross-section method for computing bedload discharge from samples collected with a Helley-Smith bedload sampler	79
55. Midsection method for computing bedload discharge from samples collected with a Helley-Smith bedload sampler	80
56. Mean-section method for computing bedload discharge from samples collected with a Helley-Smith bedload sampler	81
57. Zones sampled by suspended-sediment and bedload samplers and the unmeasured zone	83

TABLES

	Page
1. Sampler designations and characteristics	6
2. Automatic pumping-type sampler evaluation	32
3. The desired quantity of suspended sediment required for various sediment analyses	63
4. Initial dry unit volume-mass and <i>K</i> factors for computing dry unit volume-mass of sediment deposits	86

UNIT CONVERSION

<i>Multiply inch-pound unit</i>	<i>By</i>	<i>To obtain SI unit</i>
<i>Length</i>		
inch (in.)	25.40	millimeter (mm)
foot (ft)	0.3048	meter (m)
<i>Area</i>		
square inch (in. ²)	6.452	square centimeter (cm ²)
square foot (ft ²)	929.0	square centimeter (cm ²)
<i>Volume</i>		
U.S. liquid pint (pt)	0.4732	liter (L)
U.S. liquid quart (qt)	0.9464	liter (L)
U.S. liquid gallon (gal)	3.785	liter (L)
U.S. liquid gallon (gal)	3,785	milliliter (mL)
U.S. liquid gallon (gal)	0.003785	cubic meter (m ³)
cubic foot (ft ³)	28,317	cubic centimeter (cm ³)
<i>Flow rate</i>		
foot per second (ft/s)	0.3048	meter per second (m/s)
cubic foot per second (ft ³ /s)	0.02832	cubic meter per second (m ³ /s)

<i>Multiply inch-pound unit</i>	<i>By</i>	<i>To obtain SI unit</i>
<i>Mass</i>		
ounce, avoirdupois (oz)	28.35	gram (g)
ounce, avoirdupois (oz)	28,350	milligram (mg)
pound, avoirdupois (lb)	453.6	gram (g)
ton, short	0.9072	megagram (Mg)
<i>Temperature</i>		
degree Fahrenheit (°F)	$^{\circ}\text{C} = 5/9 (^{\circ}\text{F} - 32)$	degree Celsius (°C)
<i>Pressure</i>		
pound per square inch (lb/in. ²)	6.895	kilopascal (kPa)
<i>Concentration (Mass/Volume)</i>		
parts per million (ppm) ¹	1.0	milligrams per liter (mg/L)
ounces per quart (oz/qt)	29,955	milligrams per liter (mg/L)
pounds per cubic foot (lb/ft ³)	16,017	grams per cubic meter (g/m ³)

¹This conversion is true for

$$\text{mg/L} = c(\text{ppm}) = c$$

when the ratio of weight of sediment to weight of water-sediment mixture is between 0 and 15,900. If this ratio is greater than 15,900, the investigator is referred to Guy (1969, table 1, p. 4) for the correct conversion factor to be used in the formula.

FIELD METHODS FOR MEASUREMENT OF FLUVIAL SEDIMENT

By Thomas K. Edwards and G. Douglas Glysson

Abstract

This chapter describes equipment and procedures for collection and measurement of fluvial sediment. The complexity of the hydrologic and physical environments and man's ever-increasing data needs make it essential for those responsible for the collection of sediment data to be aware of basic concepts involved in processes of erosion, transport, deposition of sediment, and equipment and procedures necessary to representatively collect sediment data.

In addition to an introduction, the chapter has two major sections. The "Sediment-Sampling Equipment" section encompasses discussions of characteristics and limitations of various models of depth- and point-integrating samplers, single-stage samplers, bed-material samplers, bedload samplers, automatic pumping samplers, and support equipment. The "Sediment-Sampling Techniques" section includes discussions of representative sampling criteria, characteristics of sampling sites, equipment selection relative to the sampling conditions and needs, depth- and point-integration techniques, surface and dip sampling, determination of transit rates, sampling programs and related data, cold-weather sampling, bed-material and bedload sampling, measuring total sediment discharge, and measuring reservoir sedimentation rates.

INTRODUCTION

Perspective

Knowledge of the erosion, transport, and deposition of sediment relative to land surface, streams, reservoirs, and other bodies of water is important to those involved directly or indirectly in the development and management of water and land resources. It also is becoming more important that such development and management be carried out in a manner that yields or conforms to a socially acceptable environment. The need for a clear understanding of hydrogeomorphologic processes associated with sediment requires the measurement of suspended and bed sediments for a wide range of hydrologic environ-

ments. The complex phenomena of fluvial sedimentation cause the required measurements and related analyses of sediment data to be relatively expensive in comparison with other kinds of hydrologic data. Accordingly, the purpose of this manual is to help standardize and improve efficiency in the techniques used to obtain sediment data, so the quantity and quality of the data can be maximized for a given investment of labor and resource.

Sediment data needs are of practical concern. Some of the general categories include:

1. The evaluation of sediment yield with respect to different natural environmental conditions—geology, soils, climate, runoff, topography, ground cover, and size of drainage area.
2. The evaluation of sediment yield with respect to different kinds of land use.
3. The time distribution of sediment concentration and transport rate in streams.
4. The evaluation of erosion and deposition in channel systems.
5. The amount and size characteristics of sediment delivered to a body of water.
6. The characteristics of sediment deposits as related to particle size and flow conditions.
7. The relations between sediment chemistry, water quality, and biota.

The scope of these requirements indicates that a wide variety of measurements are needed on streams and other bodies of water, ranging from large river basins to very small tributaries that drain areas such as parcels of land under urban development.

The equipment and methods discussed in this report for the collection of a suspended-sediment sample are designed to yield a representative sample of the water

sediment mixture. This representative sample may be analyzed for sediment concentration, particle-size distribution, or, if collected with the proper type sampler, any other dissolved, suspended, or total water-quality constituent. Therefore, the equipment and methods described in this report should be used to collect a representative sample for water-quality analysis.

Sediment Characteristics, Source, and Transport

Sediment is fragmental material transported by, suspended in, or deposited by water or air, or accumulated in beds by other natural agents. Sediment particles range in size from large boulders to colloidal-size fragments and vary in shape from rounded to angular. They also vary in mineral composition and specific gravity, the predominant mineral being quartz and the representative specific gravity being 2.65.

Sediment is derived from any parent material subjected to erosional processes by which particles are detached and transported by gravity, wind, water, or a combination of these agents. When the transporting agent is water, the sediment is termed "fluvial sediment." The U.S. Geological Survey (USGS) defines fluvial sediment as fragmentary material that originates mostly from weathering of rocks and is transported by, suspended in, or deposited from water (Federal Inter-Agency Sedimentation Project, 1963b); it includes chemical and biological precipitates and decomposed organic material, such as humus.

Erosion by water is classified as either sheet or channel erosion, with no distinct division between the two. Sheet erosion occurs when sediments are removed from a surface in a sheet of relatively uniform thickness by raindrop splash and sheet flow. Sediment-particle movement and the energy of the raindrops compact and partially seal the soil surface, effectively decreasing the infiltration rate and increasing the amount of flow available to erode and transport the sediment. The amount of material removed by sheet erosion is a function of surface slope, erodibility, and precipitation intensity and drop size.

Land-surface irregularities inhibit continuous sheet flow over large areas. This inhibition serves to concentrate the flow into small rills or channels and streams, which increase in size as they join together

downstream. Within these channels, eroded material from the banks or bed of the stream is contributed to the flow until, in theory, the stream is transporting as much sediment as the energy of the stream will allow. Such channel erosion may be general or local along the stream but is primarily local in nature.

Some sediment is carried to streams by wind, but direct contribution to the stream channel by this conveyance usually accounts for only a small part of the total fluvial sediments. Aside from bank caving as a result of stream erosion or processes of mass wasting (Thornbury, 1969), gravitational transfer of sediments occurs toward and into streams. Conveyance by gravitational means ranges from slow creep to rapid landslide. Other significant sources of local sediments are glacial-melt outwash, volcanic activity, mining, earth movement, construction, or additional land-disturbance activities by man.

The stream usually transports sediment by maintaining the finer particles in suspension with turbulent currents and by rolling or skipping the coarser particles along the streambed. Generally, the finer sediments move downstream at about the same velocity as the water, whereas the coarsest sediments may move only occasionally and remain at rest much of the time.

Vertical distributions of suspended-sediment particle sizes may vary among streams and among cross sections within a stream. However, as a general rule, the finer particles are uniformly distributed throughout the vertical, and the coarser particles are concentrated near the streambed. Occasionally, coarse particles may reach the water surface, generally carried by turbulent flow or as a result of dispersive grain stress (Leopold and others, 1964). Thus, with use of the depth- or point-integrating suspended-sediment samplers described here, the sample obtained generally contains a range of particle sizes representative of the suspended-sediment discharge at the sampled vertical. The vertical is divided into two zones, as illustrated by figure 1. This separation is due to the design of the sampler, which limits the effective sampled depth. Sampling the entire depth is not possible because the physical location of the sampler nozzle relative to the bottom of the sampler prevents the nozzle from passing through the zone close to the bed. This portion of the depth is termed the unsampled zone and characteristically carries the higher concentration and coarser particles. The unsampled suspended sediment moving within this zone may or

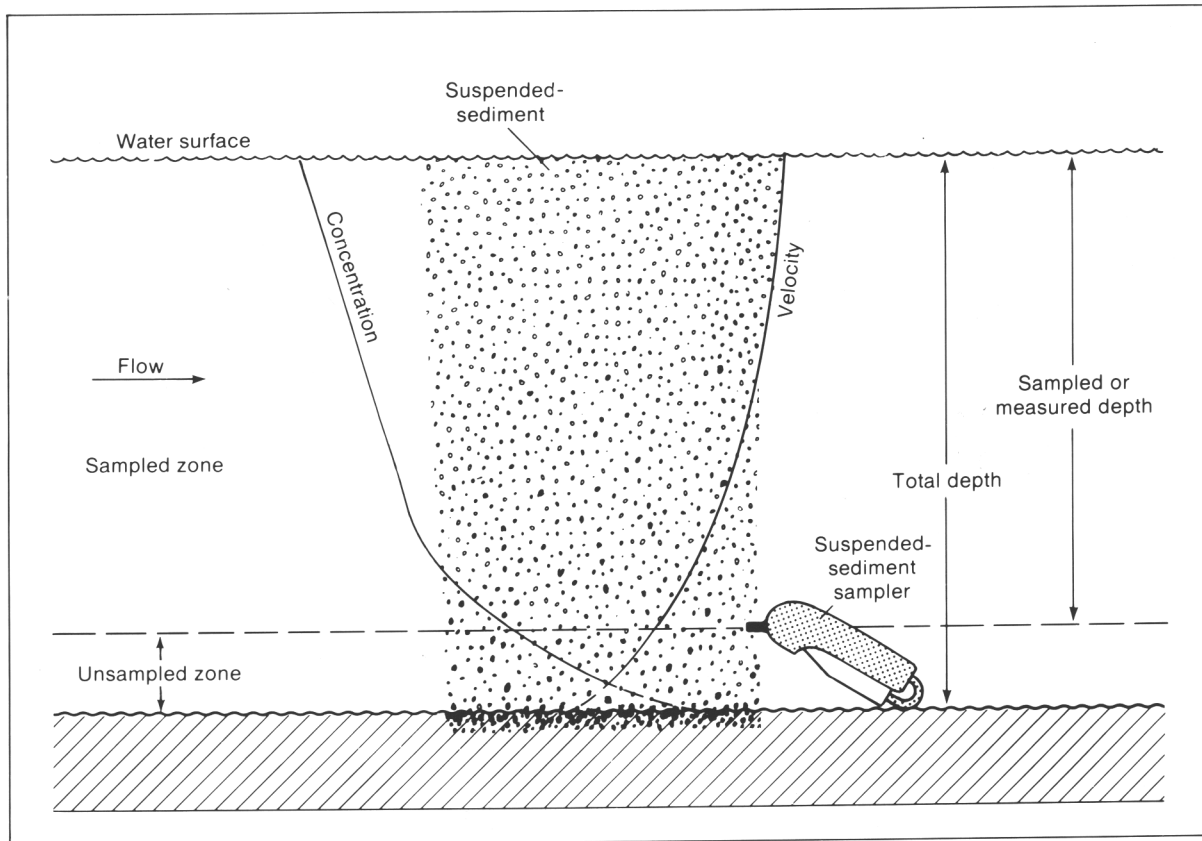

Figure 1. Sampled and unsampled zones in a stream sampling vertical, with respect to velocity of flow and sediment concentration.

may not account for a large part of the total suspended sediment, depending upon the depth, velocity, and turbulence of the flow through the vertical. The measured sediment discharge is nearly equal to the total sediment discharge if the velocity and turbulence conditions within the sampled vertical overcome the tractive force transporting the bedload in the unmeasured zone and effectively disperse all of the sediment being transported into suspension throughout the total depth.

The preceding discussion illustrates the complexity of the study of fluvial sediment transport and some of the many variables involved. The interested reader is directed to more detailed works concerning fluvial-sediment concepts and geomorphic processes, such as the contributions by Colby (1963), Leopold and others (1964), Guy (1970), and Vanoni (1975). The investigator also can obtain pertinent information on the subject by contacting the Federal Inter-Agency Sedimentation Project (F.I.S.P.), Waterways Experiment Station, Vicksburg, Mississippi.

Data Needs

No matter how precise the theoretical prediction of sedimentation processes becomes, it is inevitable that man's activities will continue to cause changes in the many variables affecting sediment erosion, transportation, and deposition; thus, there will be an increasing need for direct and indirect measurement of fluvial-sediment movement and its characteristics. Because of the rapid advances in technology, it seems of little value to list the many specific kinds of sediment problems and the kinds of sediment data required to solve such problems. However, some general areas of concern may be of interest. Sediment data are useful in coping with problems and goals related to water utilization. Many industries require sediment-free water in their processes. A knowledge of the amount and characteristics of sediment in the water resource is needed so that the sediment may be removed as economically as possible before the water is allowed to enter a distribution system. Information on sediment

movement and particle-size characteristics is needed in the design of hydraulic structures, such as dams, canals, and irrigation works. Streams and reservoirs that are free of sediment are highly regarded for recreation. Data on sediment movement and particle characteristics are needed to determine and understand how radionuclides, pesticides, and many organic materials are absorbed and concentrated by sediments, thus causing potential health hazards in some streams, estuaries, and water-storage areas. Knowledge concerning the effect of natural and man-made changes in drainage basins on the amount and characteristics of sediment yielded from the drainage basins is useful in helping to predict the stream environment when future basin changes are made. Knowledge about present fluvial-sediment conditions is being used to help establish criteria for water-quality standards and goals.

These data needs require sediment programs that will provide (1) comprehensive information on a national network basis, (2) special information about specific problem areas for water management, and (3) a description and understanding of the relations between water, sediment, and the environment (basic research). The reader is referred to Book 3, Chapter C1 of this series (Guy, 1970, p. 47) for a description of the kinds of sediment records commonly obtained at stream sites. Briefly, the records are of (1) the continuous or daily-record type, where sampling is sufficiently comprehensive to permit computation of daily loads, (2) the partial-record type, where a daily record is obtained for only a part of the year, and (3) the periodic-record type, where samples are taken periodically or intermittently. Usually a series of reconnaissance measurements is made prior to implementing any of these three programs. Even after a specific program is started, it is possible that adjustments may be necessary with respect to equipment, sample timing, or even measurement location. Realignment of efforts in this manner can be avoided in many instances by carefully applying design criteria to adequately meet the objectives of the project.

SEDIMENT-SAMPLING EQUIPMENT

General

In the early days of fluvial-sediment investigations, each investigator, or at least each agency concerned with sediment, developed methods and equipment individually as needed. It soon became apparent that consistent data could not be obtained unless equipment, data collection, and analytical methods were standardized. To overcome this difficulty, representatives of several Federal agencies (the Corps of Engineers of the Department of the Army, the Flood Control Coordinating Committee of the Department of Agriculture, the U.S. Geological Survey, the Bureau of Reclamation, the Office of Indian Affairs of the Department of the Interior, and the Tennessee Valley Authority) met in 1939 to form an interdepartmental committee, with the expressed purpose of standardizing sediment data-collection equipment, methods, and analytical techniques. The test facility for this work was initially located at the Iowa University Hydraulics Laboratory, in Iowa City, Iowa, and remained there for 9 years. In 1946, the committee became known as the Subcommittee on Sedimentation of the Federal Inter-Agency River Basin Committee. In 1948, the subcommittee moved the test facility to the St. Anthony Falls Hydraulic Laboratory, University of Minnesota, in Minneapolis, Minnesota. The subcommittee reorganized the project in 1956 to its present structure as the Federal Inter-Agency Sedimentation Project (F.I.S.P.). In 1992, F.I.S.P. was moved to its present location at the Waterways Experiment Station in Vicksburg, Mississippi. The project is sponsored by a technical committee composed of representatives of the U.S. Army Corps of Engineers, U.S. Geological Survey, Bureau of Reclamation, Agricultural Research Service, U.S. Forest Service, and Bureau of Land Management, working under a formal Guidance Memorandum describing the project's objectives and organization. The F.I.S.P. is overseen by the Technical Committee of the Subcommittee on Sedimentation of the Interagency Advisory Committee on Water Data.

Since its initiation in 1939, approximately 50 reports, dealing with nearly all aspects of measurement and analysis of fluvial sediment movement, have been published by F.I.S.P. The intent of this chapter is not to replace the Inter-Agency Project reports, but to condense and combine their information regarding sediment measurements. The interested reader should contact F.I.S.P. for a listing of individual reports presenting further background material and details on the standard samplers. Sampling equipment is available for purchase by any interested investigator from the F.I.S.P., 3909 Halls Ferry Road, Vicksburg, MS 39180-6199.

The samplers developed by the F.I.S.P. are designated by the following codes: US, United States standard sampler. (In the following discussions this code will appear in the initial reference but will be dropped from succeeding references to the sampler designations.)

D, depth integrating

P, point integrating

H, hand-held by rod or line. (This code is placed after the primary letter designation and is omitted when referring to cable- and reel-suspended samplers.)

BM, bed material

BP, battery pack

BL, bedload sampler

U or SS, single stage

PS or CS, pumping-type sampler

Year, last two digits of the year in which the sampler was developed.

Sediment samplers available from F.I.S.P. or Hydrologic Instrumentation Facility (HIF) include suites of depth-integrating suspended-sediment samplers, point-integrating suspended-sediment samplers, pumping samplers, bed-material samplers, and a bedload sampler. In addition, an array of instruments has been developed to fulfill the need for collecting samples during unpredictable high-flow events. One sampler of particular interest for use in the future is a suspended-sediment sampler that utilizes bags as sample containers to overcome the depth limits of standard samplers due to container size, nozzle diameter, and stream velocity (Federal Inter-Agency Sedimentation Project, 1982b).

Suspended-Sediment Samplers

The purpose of a suspended-sediment sampler is to obtain a representative sample of the water-sediment mixture moving in the stream in the vicinity of the sampler. The F.I.S.P. committee set up several criteria for the design and construction of suspended-sediment samplers:

1. To allow water to enter the nozzle isokinetically. (In isokinetic sampling, water approaching the nozzle undergoes no change in speed or direction as it enters the orifice.)
2. To permit the sampler nozzle to reach a point as close to the streambed as physically possible. (This varies from 3 to 7 inches, depending on the sampler.)
3. To minimize disturbance to the flow pattern of the stream, especially at the nozzle.
4. To be adaptable to support equipment already in use for streamflow measurement.
5. To be as simple and maintenance-free as possible.
6. To accommodate a standard bottle size [that is, 1-pint (473 mL) glass milk bottle, 1-quart (946 mL) glass, 1-liter (1,000 mL) plastic, 2-liter (2,000 mL) plastic, or 3-liter (3,000 mL) plastic, as listed in table 1].

When a suspended-sediment sampler is submerged with the nozzle pointing directly into the flow, a part of the streamflow enters the sampler container through the nozzle as air in the container exhausts under the combined effect of three forces:

1. The positive dynamic head at the nozzle entrance, due to the flow.
2. A negative head at the end of the air-exhaust tube, due to flow separation.
3. A positive pressure due to a difference in elevation between the nozzle entrance and the air-exhaust tube.

When the sample in the container reaches the level of the air exhaust, the flow rate drops, and circulation of the streamflow in through the nozzle and out through the air-exhaust tube occurs. Because the velocity of the water flowing through the bottle is less than the stream velocity, the coarser particles settle out, causing the concentration of coarse particles in the bottle to gradually increase.

Table 1. Sampler designations and characteristics

[Epoxy-coated versions of all samplers are available for collecting trace metal samples; US, United States; in., inches; lbs., pounds; ft/s, feet per second; cd, cadmium, do., ditto; X, type of sampler container size used; --, type of sampler container size not used]

Sampler designation (US)	Construction material	Sampler dimensions			Nozzle distance from bottom (in.)	Suspension type	Maximum velocity (ft/s)	Maximum depth (ft)	Sampler container size		Intake size (in.)	Nozzle color
		Length (in.)	Width (in.)	Weight (lbs.)					Pint	Quart		
DH-48	aluminum	13	3.2	4.5	3.5	rod	8.9	8.9	X	--	1/4	yellow
DH-75P ¹	cd-plated	9.25	4.25	1.5	3.27	do.	6.6	15	X	--	3/16	white
DH-75Q ¹	do.	9.25	4.25	1.5	4.49	do.	6.6	15	--	X	3/16	white
DH-75H ¹	do.	9.25	4.25	1.5	--	do.	6.6	15	(2 liter)		3/16	white
DH-59	bronze	15	3.5	22	4.49	handline	5.0	15	X	--	1/8	red
DH-59	do.	15	3.5	22	4.49	do.	5.0	15	X	--	3/16	red
DH-59	do.	15	3.5	22	4.49	do.	5.0	9	X	--	1/4	red
DH-76	do.	17	4.5	22	3.15	do.	6.6	15	--	X	1/8	red
DH-76	do.	17	4.5	22	3.15	do.	6.6	15	--	X	3/16	red
DH-76	do.	17	4.5	22	3.15	do.	6.6	15	--	X	1/4	red
DH-81	plastic	7.5	4.0	.5	(²)	rod	8.9	9	(⁷)	--	3/16	white
DH-81	do.	7.5	4.0	.5	(²)	do.	8.9	9	(⁷)	--	1/4	white
DH-81	do.	7.5	4.0	.5	(²)	do.	8.9	9	(⁷)	--	5/16	white
D-49	bronze	24	5.25	62	4.00	cable reel	6.6	15	X	--	1/8	green
D-49	do.	24	5.25	62	4.00	do.	6.6	15	X	--	3/16	green
D-49	do.	24	5.25	62	4.00	do.	6.6	9	X	--	1/4	green
D-74	do.	24	5.25	62	4.06	do.	6.6	15	X ⁸	X	1/8	green
D-74	do.	24	5.25	62	4.06	do.	6.6	15	X ⁸	X	3/16	green
D-74	do.	24	5.25	62	4.06	do.	6.6	³ 9, ⁴ 15	X ⁸	X	1/4	green
D-74AL	aluminum	24	5.25	42	4.06	do.	5.9	15	X ⁸	X	1/8	green
D-74AL	do.	24	5.25	42	4.06	do.	5.9	15	X ⁸	X	3/16	green
D-74AL	do.	24	5.25	42	4.06	do.	5.9	³ 9, ⁴ 15	X ⁸	X	1/4	green
D-77	bronze	29	9.0	75	7.0	do.	8.0	15	(3 liter)		5/16	white
P-61	do.	28	7.34	105	4.29	do.	6.6	⁵ 180, ⁶ 120	X ⁸	X	3/16	blue
P-63	do.	37	9.0	200	5.91	do.	6.6	⁵ 180, ⁶ 120	X ⁸	X	3/16	blue
P-72	aluminum	28	7.34	41	4.29	do.	5.3	⁵ 72.2, ⁶ 50.9	X ⁸	X	3/16	blue

¹Without sample bottle attached.

²Depends on bottle size used. Calibrated brass nozzles no longer available.

³Depth using pint sample container.

⁴Depth using quart sample container.

⁵Depth using pint sample container to transit in 15 to 30 foot increments until entire traverse is completed.

⁶Depth using quart sample container to transit in 15 to 30 foot increments until entire traverse is completed.

⁷Any size bottle with standard mason jar treads.

⁸Pint milk bottle can be used with adapter sleeve.

Depth- and Point-Integrating Samplers

A depth-integrating sampler is designed to isokinetically and continuously accumulate a representative sample from a stream vertical while transiting the vertical at a uniform rate (Federal Inter-Agency Sedimentation Project, 1952, p. 22). The simple depth-integrating sampler collects and accumulates a velocity or discharge-weighted sample as it is lowered to the bottom of the stream and raised back to the surface.

The point-integrating sampler, on the other hand, uses an electrically activated valve, enabling the operator to isokinetically sample points or portions of a given vertical. For stream cross sections less than 30 feet deep, the full depth can be traversed in one direction at a time by opening the valve and depth integrating either from surface to bottom or vice versa. Stream cross sections deeper than 30 feet can be integrated in segments of 30 feet or less by collecting integrated-sample pairs consisting of a downward

integration and a corresponding upward integration in separate containers.

To eliminate confusion and more adequately differentiate between depth- and point-integrating samplers, a direct reference to Inter-Agency Report 14 (Federal Inter-Agency Sedimentation Project, 1963b, p. 60) is presented here to describe the characteristics of the point-integrating samplers that make them useful in conditions beyond the limits of the simpler depth-integrating samplers.

Point-integrating samplers are more versatile than the simpler depth-integrating types. They can be used to collect a suspended-sediment sample representing the mean sediment concentration at any point from the surface of a stream to within a few inches of the bed, as well as to integrate over a range in depth. These samplers were designed for depth integration of streams too deep (or too swift) to be sampled in a continuous round-trip integration. When depth integrating, sampling can begin at any depth and proceed either upward or downward from that initial point through a maximum vertical distance of 30 feet.

A point-integrating sampler uses a 3/16-inch nozzle oriented parallel to the streamflow with the cross-sectional area exposed to approaching particles. The air is exhausted from the sample container and directed downstream away from the nozzle area as the sample enters. The intake and exhaust passages are controlled by a valve that can be activated on demand. When the valve is activated (opened to the sampling

position), the sampling procedure is identical to that used for depth-integrating samplers. The increased effective depth to which a point-integrating sampler can be used, as compared to the maximum sampling depth to which a depth-integrating sampler is limited, is made possible by a pressure-equalizing chamber (diving-bell principle) enclosed in the sampler body. This chamber equalizes the air pressure in the sample container with the external hydrostatic head near the intake nozzle at all depths to alleviate the inrush of sample water, which would otherwise occur when the intake and air exhaust are opened at depth.

Hand-held samplers—US DH-81, US DH-75, US DH-48, US DH-59, and US DH-76

Where streams are wadable or access can be obtained from a low bridge span or cableway, a choice of five lightweight samplers can be used to obtain suspended-sediment samples via a wading rod or handline.

The DH-81 (fig. 2) consists of a DH-81A adapter and D-77 cap and nozzle. All parts are autoclavable. This construction enables the sampler to be used for collection of depth-integrated samples for bacterial analysis. The DH-81 can be used with 1/8-inch, 3/16-inch, or 1/4-inch nozzles and is suspended from a rod. Any bottle having standard mason jar threads can be used with this sampler. Obviously, the height of the unmeasured zone will vary depending on the size of



Figure 2. US DH-81 suspended-sediment sampler shown with a US DH-81A adapter, D-77 cap and nozzle, wading rod handle, and quart glass bottle.

bottle used. The DH-81 should be useful for sampling during cold weather because the plastic sampler head and nozzle attach directly to the bottle, eliminating a metal body (which would more rapidly conduct heat away from the nozzle, air exhaust, and bottle and create a more severe sampler-freezeup condition).

The DH-75 (fig. 3) weighs 0.9 pound and is available in two versions, the DH-75P and DH-75Q, which accept plastic containers of pint and quart volumes, respectively. The sampler consists of a cadmium-plated sheet-steel body 9 1/4 inches long, excluding the nozzle and sample container, with a retainer piece and shock cord assembly to hold the sample container against a cast silicone stopper through which the 3/16-inch nozzle and 180-degree air-exhaust tube pass to the mouth of the bottle. The DH-75 was developed as a freeze-resistant sampler. This sampler is not recommended for use as a general purpose depth-integrating suspended-sediment sampler.

The DH-48 sampler (fig. 4) features a streamlined aluminum casting 13 inches long that partly encloses the sample container. The container, usually a round pint glass milk bottle, is sealed against a gasket recessed in the head cavity of the sampler by a hand-operated spring-tensioned pull-rod assembly at the tail of the sampler. A modified version of this sampler is available to accommodate square pint milk bottles also. The sample enters the container through the intake nozzle as the air from the container is displaced and exhausted downstream through the air exhaust. The sampler, including container, weighs 4 1/2 pounds and can sample to within 3 1/2 inches of the streambed. This instrument is calibrated with an intake nozzle 1/4 inch in diameter, but may be used with a 3/16-inch nozzle in high-flow velocity situations (Federal Inter-Agency Sedimentation Project, 1963b, p. 57–60).

Two lightweight (24 and 25 pounds) handline samplers designated “DH-59” and “DH-76” (figs. 5 and 6) are designed for use in shallow unwadable streams with flow velocities up to 5 ft/s (feet per second). These samplers feature streamlined bronze castings 15 and 17 inches in length for the DH-59 and DH-76, respectively. The DH-59 accommodates a round pint sample bottle, while the DH-76, a more recent version of the sampler, is designed to take a quart container. The tail assembly extends below the body of the casting to ensure sampler alignment parallel to the flow direction with the intake nozzle

entrance oriented upstream. Intake nozzles of 1/8-inch, 3/16-inch, and 1/4-inch diameters are calibrated for use with these samplers and may be interchanged as necessary when varying flow conditions are encountered from stream to stream. Suspended sediment can be collected to within 4 1/2 inches of the streambed with the DH-59, while the DH-76 can sample to within about 3 inches from the bottom.

These lightweight hand samplers are the most commonly used for sediment sampling during normal flow in small- and, perhaps, intermediate-sized streams. Because they are small, light, durable, and adaptable, they are preferred by hired observers and field people on routine or reconnaissance measurement trips. At many locations, a heavier sampler will be needed only for high-flow periods. It is often desirable, however, to require the observer to use a heavier sampler installed at a fixed location. The small size of the hand samplers also enables the person taking a sample in cold weather to warm the sampler readily if water freezes in the nozzle or air exhaust.

**Cable-and-Reel Samplers—US D-74, US D-77, US P-61,
US P-63, and US P-72**

When streams cannot be waded, but are shallower than about 15 feet, depth-integrating samplers designated “D-74” and “D-77” can be used to obtain suspended-sediment samples. Forerunners of these samplers were the US D-43 and US D-49 samplers, both of which are no longer manufactured. These latter two are only mentioned here because many of these earlier designed instruments are still used at some locations. Sampling techniques for using the older samplers are identical to those presented later in this text relative to operation of the newer D-74 and D-77 samplers.

The D-74 (fig. 7) is a 62-pound sampler (approximately 40 pounds for the aluminum version) designed to be suspended from a bridge crane or cableway by means of a standard hanger bar and cable-and-reel system. This sampler replaces the earlier D-49, which replaced the D-43 for general use. The D-74 has a streamlined cast bronze (or aluminum) body 24 inches long that completely encloses the sample container. This sampler accommodates a round quart bottle, or with addition of an adapter sleeve, a standard pint milk bottle may be used. The sampler head is hinged at the bottom and swings downward to provide access to the sample-container chamber. In this manner, sample containers can be changed during the normal sampling



Figure 3. US DH-75 (P and Q) suspended-sediment samplers with sample containers and wading rod.

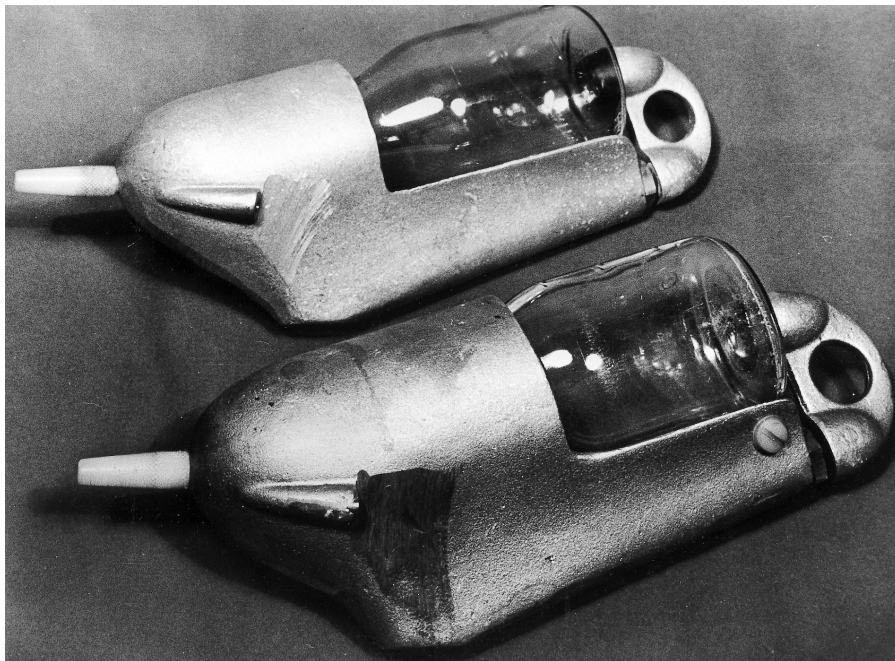

Figure 4. US DH-48 suspended-sediment sampler.

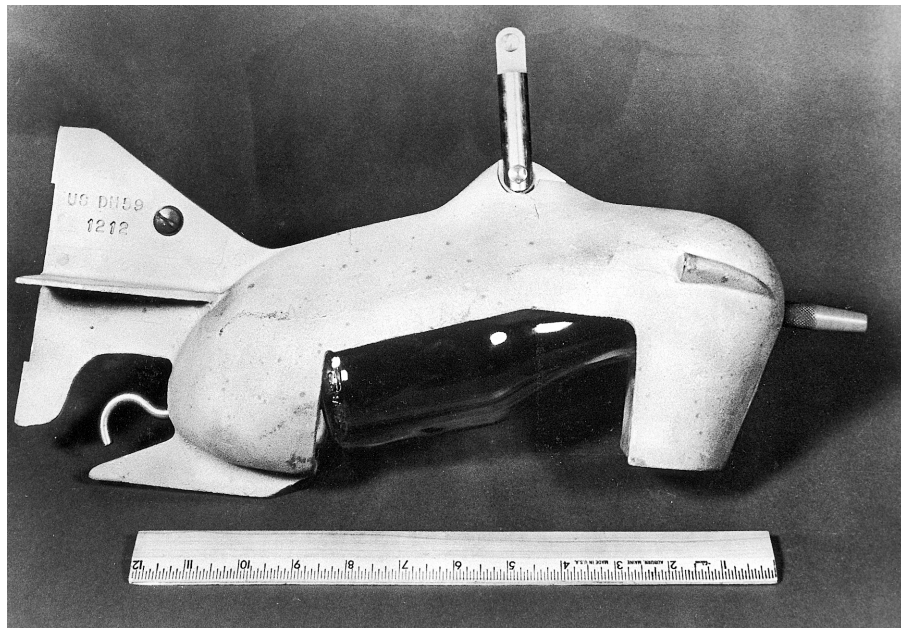

Figure 5. US DH-59 suspended-sediment sampler.

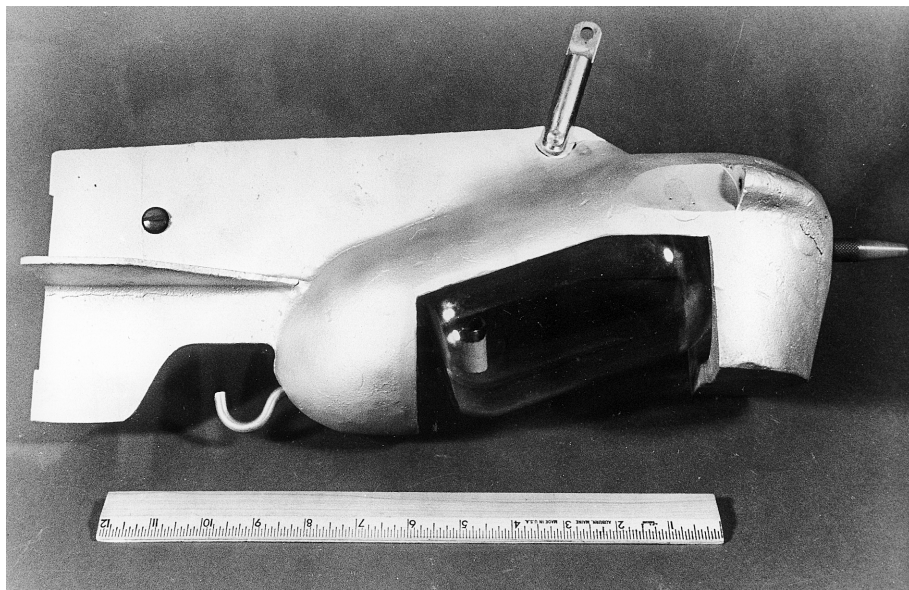

Figure 6. US DH-76 suspended-sediment sampler.

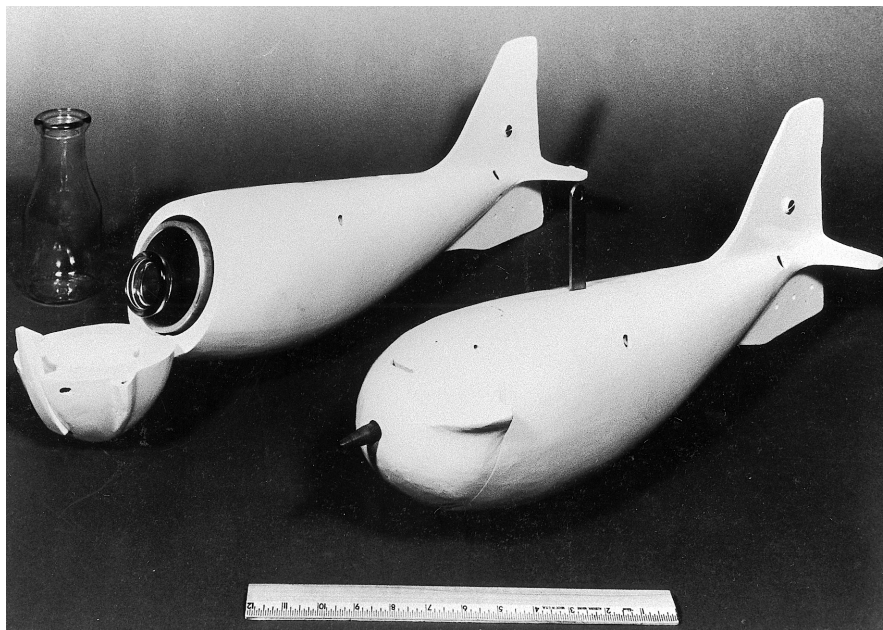

Figure 7. US D-74 suspended-sediment sampler.

routine. The body includes tail vanes that serve to align the sampler and the intake nozzle with the flow. Intake nozzles of 1/8-inch, 3/16-inch, and 1/4-inch diameters are available for use with the sampler and can be interchanged as varying flow conditions dictate. The sample container fills as a filament of water passes through the intake nozzle and displaces air from the container. The air is expelled in the downstream direction through an air-exhaust port in the side of the sampler head. The intake nozzle can be lowered to within about 4 inches of the streambed during sampling (approximately 4 1/3 inches for the aluminum version).

The D-77 is a dramatically different design (fig. 8) as compared to the design configuration of the D-74 and its predecessors. The sampler is 29 inches long and weighs 75 pounds; it has a bronze casting attached to a tail cone with four sheet-metal vanes welded in place to provide a means of orienting the intake nozzle into the flow. The casting is structured to accommodate a 3-liter autoclavable sample container that slides into the sample container chamber and is held in place by means of a spring clip on the bottom of the chamber. This sampler is constructed without a head assembly to cover the mouth of the container and facilitate attachment of the intake nozzle. Instead, a cap, nozzle, and air-exhaust assembly, constructed of autoclavable plastic, is screwed onto the mouth of the sample container, which is entirely exposed at the

front of the sampler. This configuration was purposely chosen to allow collection of a large volume (2,700 mL), depth-integrated biological or chemical sample at near- or below-freezing temperatures. Although 1/8-inch, 1/4-inch, 3/16-inch, and 5/16-inch nozzles are available, only 5/16-inch nozzles are recommended for use with this sampler. The distance between the nozzle and sampler bottom is 7 inches.

A version of the D-77 sampler was tested by F.I.S.P. to eliminate the depth-range limit dictated by sample container size, nozzle size, and stream velocity (Federal Inter-Agency Sedimentation Project, 1982b). This version, commonly referred to as a "bag sampler," incorporates a sample bag inside a special rigid container. Information about this sampler and other bag samplers can be obtained from F.I.S.P.

Point-integrating samplers currently manufactured and widely used are the P-61, P-63, and P-72. Forerunners of these samplers were the P-46 and P-50 samplers, which are no longer manufactured but are mentioned here because several of these instruments are still used. The sampling techniques used for obtaining a sample with these older samplers are the same as for the newer samplers. The primary differences between these old and new versions are valve mechanisms and cost. The new versions have a simpler valve and are less expensive.

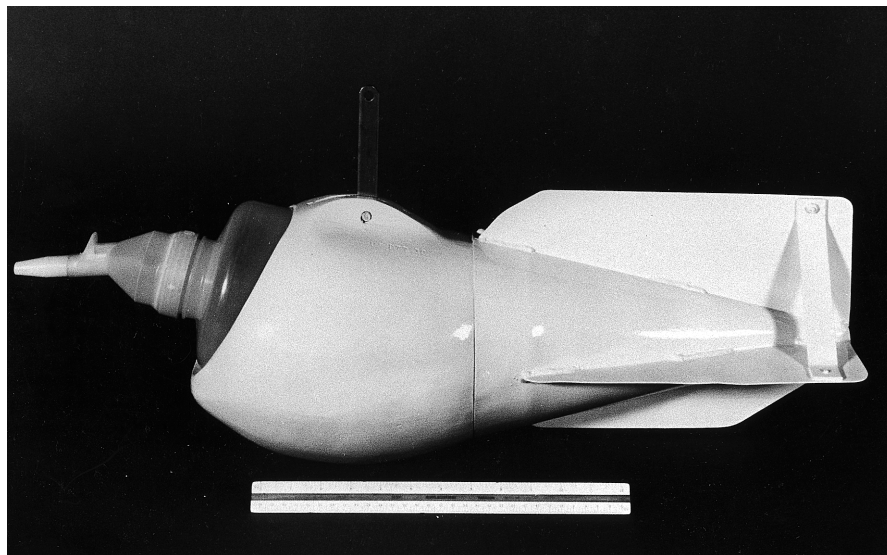

Figure 8. US D-77 suspended-sediment sampler.

The 105-pound P-61 (fig. 9) can be used for depth integration as well as for point integration to a maximum stream depth of 180 feet. The sampler valve for the P-61 has two positions. When the solenoid is not energized, the valve is in the nonsampling position, in which the intake and air-exhaust passages are closed, the air chamber in the body is connected to the cavity in the sampler head, and the head cavity is connected through the valve to the sample container. When the solenoid is energized, the valve is in the sampling position, in which the intake and air exhaust are open, and the connection from the sample container to the head cavity is closed. A P-61 sampler that has been modified to accommodate a quart bottle is illustrated in figure 9. When the ordinary pint bottle is used, the cylindrical adapter must be inserted into the bottle cavity. The maximum sampling depth is about 120 feet when the quart container is used.

The P-63 (fig. 10) is a 200-pound point-integrating suspended-sediment sampler and is better adapted to high velocities. The solenoid head is basically the same as that on the P-61. The P-63 differs from the P-61 mainly in size and weight. The P-63 is cast bronze, is 34 inches long, and has the capacity for a quart-sized round mayonnaise bottle. An adapter is furnished so that a round pint-sized milk bottle can be used. The maximum sampling depth is the same as for the P-61, about 180 feet with a pint sample container and about 120 feet with a quart container.

The 41-pound P-72 is a light-weight version of the P-61. It features a streamlined cast-aluminum shell rather than the bronze used to construct the P-61. The outward appearance of the P-72, the 3/16-inch intake nozzle, the solenoid head, and the accommodation for pint- and quart-sized containers are similar to the P-61. However, the listed maximum stream velocity at which the P-72 is recommended for use is 5.3 ft/s, as opposed to 6.6 ft/s for the P-61, and the depth limit to which this sampler should be used is about 72 feet using the pint container and 51 feet with the quart container. These depths are less than one-half of the maximum usable depths for the P-61 with the same container sizes.

All the point samplers are designed for suspension with a steel cable having an insulated inner conductor core. By pressing a switch located at the operator's station, the operating current may be supplied through the cable to the solenoid in the sampler head by storage batteries connected in series to produce 24 to 48 volts. If the suspension cable is longer than 100 feet, a higher voltage may be desirable. The US BP-76 battery pack has been designed as a portable power source for activating the P-61, P-63, and P-72 samplers and is available from the F.I.S.P. and HIF.

Because of the complex nature of point-integrating samplers, the user may find it necessary to seek additional information given in the Inter-Agency reports (Federal Inter-Agency Sedimentation Project, 1952, 1963b, and 1966).

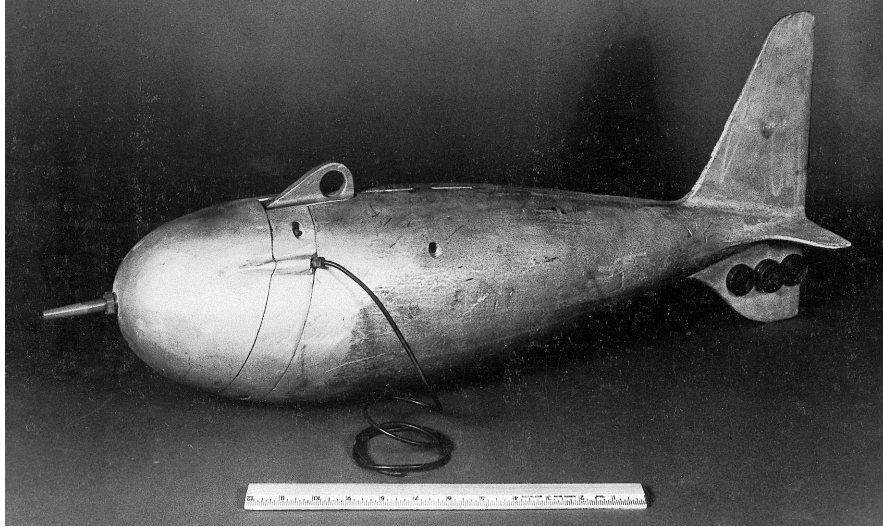

Figure 9. US P-61 point-integrating suspended-sediment sampler.

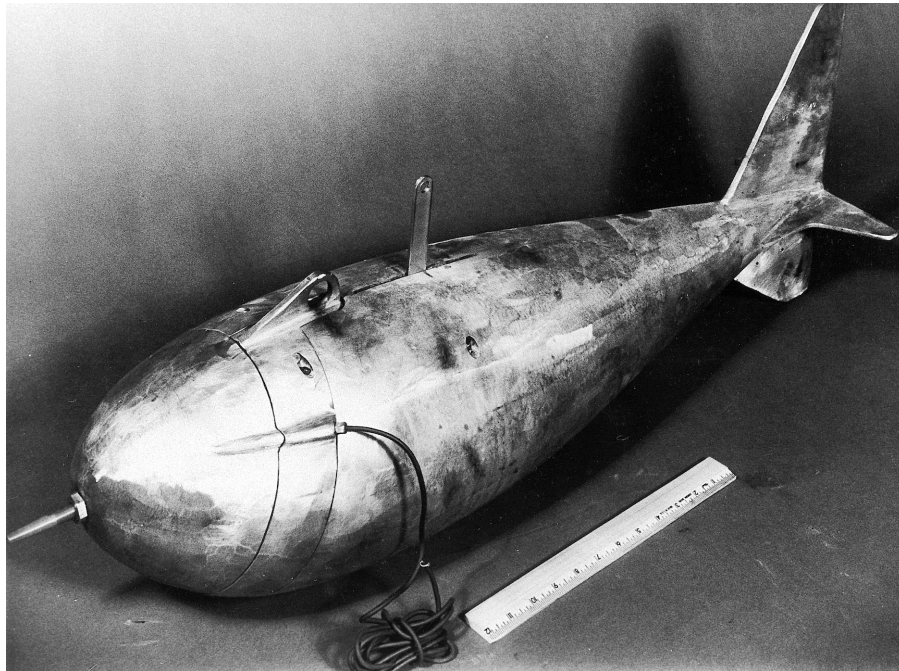

Figure 10. US P-63 point-integrating suspended-sediment sampler.

Sampler Accessories

Nozzles

Each suspended-sediment sampler is equipped with a set of nozzles specifically designed for the particular sampler. These nozzles are cut and shaped externally and internally to ensure that the velocity of water after entering the nozzle is within 8 percent of the ambient stream velocity when the stream velocity is greater than 1 ft/s. It has been found that a deviation in intake velocity from the stream velocity at the sampling point

causes an error in the sediment concentration of the sample, especially for sand-sized particles. For example, a plus-10-percent error in sediment concentration is likely for particles of sediment 0.45 mm in diameter, when the intake velocity is 0.75 of the stream velocity (Federal Inter-Agency Sedimentation Project, 1941, p. 38–41). The relation between intake-velocity deviation and errors in concentration resulting from collecting a sample enriched or deficient in sand-size particles (greater than 0.062 mm) is illustrated by figure 11. When sand-size particles are entrained in the

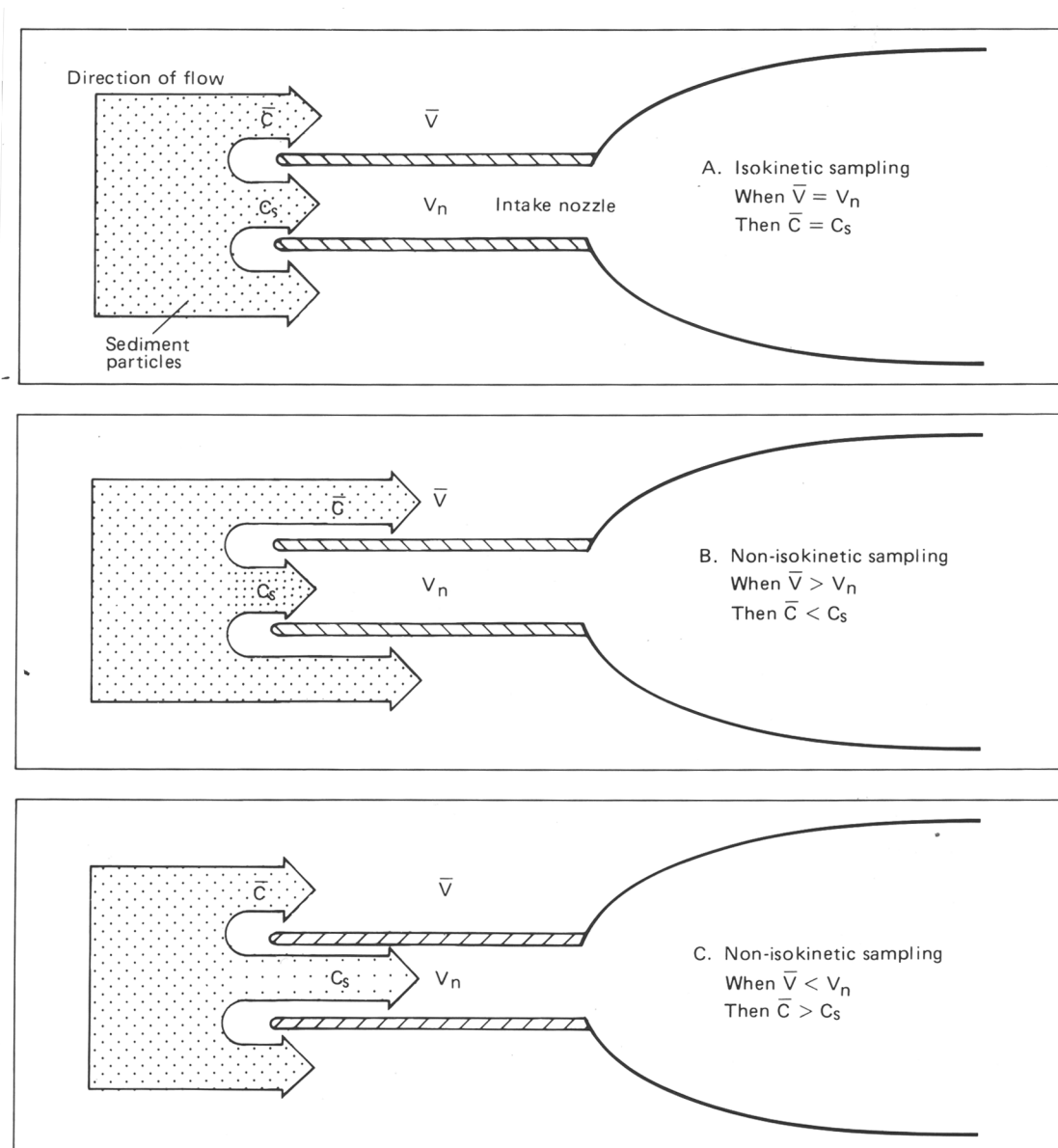

Figure 11. Relation between intake velocity and sample concentration for (A) isokinetic and (B, C) non-isokinetic sample collection of particles greater than 0.062 mm. When \bar{V} = mean stream velocity, V_n = velocity in the sampler nozzle, \bar{C} = mean sediment concentration in the stream, and C_s = sample sediment concentration.

flow, the intake velocity within the sampler nozzle must be equal to the ambient stream velocity (isokinetic), in order to collect a sample representative of the mean discharge-weighted sediment concentration (fig. 11A). The resulting sediment concentration of the sample will be equal to the average discharge-weighted sediment concentration of the approaching flow. However, when the velocity in the nozzle is less than the stream velocity (non-isokinetic, fig. 11B), some water that should flow into the nozzle now curves to the side and flows around it. Inertia resists the curving flow and forces the approaching particles (greater than 0.062 mm) to follow straight-line paths into the nozzle. This combination of curved and straight-line movement increases the concentration of coarse particles in the sample. As a result, the sediment concentration in the sample is greater than the concentration in the approaching flow. Likewise, when the velocity in the nozzle is greater than the stream velocity (non-isokinetic, fig. 11C), some water that should flow past the nozzle curves to the side and flows into it. Again, inertia resists the curving flow and forces the particles (greater than 0.062 mm) to follow straight-line paths and flow past the nozzle. The result of this combination of curved and straight-line movement is a decrease in the sample concentration relative to the concentration of the approaching flow.

Because, in general, each sampler nozzle is designed for a particular series of samplers, it must be emphasized that a nozzle for one series of samplers should not be used in another series of samplers. However, there are two exceptions to this rule—the same nozzle can be used in the P-61, P-63, and P-72 series, and a nozzle can be interchanged between the D-49 and D-74. To ensure against incorrectly matching samplers and nozzles, all nozzles are color coded to specific sampler designs (table 1).

The reasons for the differences between the nozzles of different series are that (1) the length of flow paths for water and air are different, resulting in differences of flow resistance; and (2) the differential heads between the nozzle entrance and the air exhaust are different. Thus, interchanging nozzles among samplers of various series results generally in an incorrect intake velocity and, thus, incorrect sediment concentration and particle-size distribution in the sample. Therefore, when a nozzle is bent or broken, be certain to use a correct replacement nozzle.

If extra nozzles are needed for a sampler, they can be ordered from the F.I.S.P. at the address in the latest Inter-Agency report. The order must indicate the sampler series. If the exhaust tubes, tail fins, or any other part of a sampler are damaged, the entire sampler should be sent to the F.I.S.P. for repair and recalibration.

Three nozzle diameters—1/4 inch, 3/16 inch, and 1/8 inch—are available for use with all depth-integrating samplers, except for the DH-48, DH-75, D-77, and the point-integrating samplers. The D-77 sampler is the only depth-integrating sampler that uses a 5/16-inch nozzle. Although a nozzle may physically fit a sampler, the match may not be correct. For example, it is possible, but incorrect, to interchange any one of the 1/4-inch, 3/16-inch, and 1/8-inch nozzles listed in table 1 among the depth-integrating or point-integrating samplers. For instance, it is possible, but incorrect, to put DH-48 nozzles in DH-59 samplers. One exception is the D-77, which will not accept any nozzle other than the correct one. To help prevent the incorrect interchange of color-coded nozzles among samplers, new samplers ordered from F.I.S.P. are delivered with a color-coded plastic screw in the tail vane assembly, which indicates the correct color of nozzle to be used with the sampler (for example, DH-59 has a red screw and uses a red nozzle).

The reason for different size nozzles is that stream velocities and depths occur that will cause the sample bottle to overflow for a specific transit rate when using the largest nozzle. More specifically, for depth-integrating samplers with a pint bottle, the maximum theoretical sampling depths for round-trip integration are about 9 feet for the 1/4-inch, and 15 feet with both the 3/16-inch, and 1/8-inch nozzles. Therefore, to reduce the quantity of sample entering the bottle at depths over 9 feet, use a smaller bore nozzle in combination with a pint sample bottle. For a given situation, the largest nozzle should be used to reduce the chance of excluding large sand particles that may be in suspension.

Possible errors caused by using too small a nozzle are usually minor when dealing with fine material (less than 0.062 mm), but tend to increase in importance with increasing particle size. Small nozzles also are more likely than large ones to plug with organic material, sediment, and ice particles. This means that problems with nozzles can exist even when sampling streams transporting mostly fine material.

Point-integrating samplers are supplied only with a 3/16-inch nozzle to match the opening through the valve mechanism.

Gaskets

Of equal importance to using the correct nozzle in the instrument is the necessity for using the proper gasket to seal the bottle mouth sufficiently. Gaskets for this purpose are made of a sponge-like neoprene that deteriorates somewhat with use and time. When samples are being collected for water quality, such as for trace metal analysis, the gasket should be made of silicone rubber to avoid biasing the sample chemistry.

To check the gasket for adequate seal, insert a bottle in the proper position in the sampler; then block the air-exhaust port and force air into the sampler nozzle.

CAUTION: A field person should never force air into the sampler by placing the mouth directly in contact with the nozzle—due to the possibility of questionable water quality at the site or the likelihood of receiving an electrical shock (if a brass nozzle is in use) upon activating the solenoid of a point-integrating sampler when opening the intake. A safe procedure to perform this check would be to block the air exhaust with a finger and place a short length of clean plastic or rubber tubing snugly over the nozzle and then apply

air pressure by blowing into the tubing to force air through the nozzle. If air escapes around the bottle mouth, replace the gasket. If the problem persists, check the spring that pushes the bottle against the gasket. Each sampler series uses a different size or shape of gasket, so it is necessary to have spares for each series in use. Appropriate gaskets may be obtained from the F.I.S.P. (address can be obtained from the latest Inter-Agency report). Gaskets in the “P” series samplers also may be tested by lowering the sampler, with sample bottle in place, into the stream without opening the solenoid. After a minute or so, raise the sampler to the surface and inspect the sample bottle. If the gasket is sealing properly, less than a few milliliters of water should be present in the bottle.

Bottles

Depth- and point-integrating samplers accommodate different bottle sizes and types (fig. 12). Many field people still use pint glass milk bottles, which have been used for many years and can be adapted to every sampler series with the exception of the DH-81 and D-77. Quart-sized glass mayonnaise bottles (Owens-Illinois #6762) are increasing in general use because versions of all samplers, except the DH-48 and D-77, use this size sample container. The D-77



Figure 12. Sample containers to fit PS-69 pumping sampler (left to right): pint glass milk bottle, quart glass mayonnaise bottle, and quart plastic container to fit the PS-69 pumping sampler.

sampler holds a 3-liter plastic autoclavable bottle with standard mason jar threads (Nalge 2115-3000); the DH-81 holds any bottle with standard mason jar threads; and the DH-75 holds a plastic bottle (Bel-Art #F-10906, 1,000 mL) and a variety of other quart/liter bottles. Ideally, each type of glass bottle should have an etched surface to provide a labeling area to accommodate a record of pertinent information concerning each sample. Hydrofluoric acid has been used for this purpose, but care must be exercised when handling and storing this substance. In the past, commercial etching agents have been available for general use. However, the authors do not know of any such agent that is available at this time. This etched labeling surface should easily accept medium-soft blue or black pencil markings of sufficient durability to withstand handling and yet be easily removed during cleaning. Plastic bottles also require an area for labeling. However, this is less of a problem because a grease pencil or other marker that is not readily soluble in water, but that can be removed using a solvent, can be used to write on the side of the bottle.

The practice of using plain bottles with attached tags or marked caps for recording purposes should be avoided whenever possible. These labeling areas are generally small and provide little writing space. Additionally, the use of these labeling devices can result in tags being torn off during transport or in bottles being mislabeled by interchanging caps.

Plastic and teflon bottles are increasing in use throughout the Water Resources Division of the USGS. Several samplers have been designed to use plastic sample containers (the DH-75 series, the DH-81 and D-77 samplers). Compared to glass, these bottles are lightweight, strong, and useful when sampling for certain chemicals.

During depth integration, a collapsible bottle or bag would be the ideal arrangement to eliminate the problem of depth limitation due to the size of the sample container. Depth-integrating samplers incorporating this collapsible sample bag/bottle concept, are currently under development by F.I.S.P.

Bottles are usually stored and transported in wire, wooden, fiberboard, or plastic cases holding 12 to 30 bottles each. In the field, a small bottle carrier, which holds 6, 8, or 10 bottles, is more convenient; eliminates the need to handle the heavier 12- to 30-bottle cases while making a measurement; and provides a neat, convenient, and relatively safe place to set the bottles. When making wading measure-

ments, both hands can be free to operate the sampler if the bottle carrier is suspended from the shoulder with a strap or rope.

Single-Stage Samplers

The single-stage samplers, US U-59 (fig. 13), also designated US SS-59, and US U-73, were designed and tested by the F.I.S.P. to meet the needs for instruments useful in obtaining sediment data on streams where remoteness of site location and rapid changes in stage make it impractical to use a conventional depth-integrating sampler.

The U-59 (SS-59) consists of a pint milk bottle or other sample container, a 3/16-inch inside diameter air exhaust, and 3/16-inch or 1/4-inch inside diameter intake constructed of copper tubing. Each tube is bent to an appropriate shape and inserted through a stopper

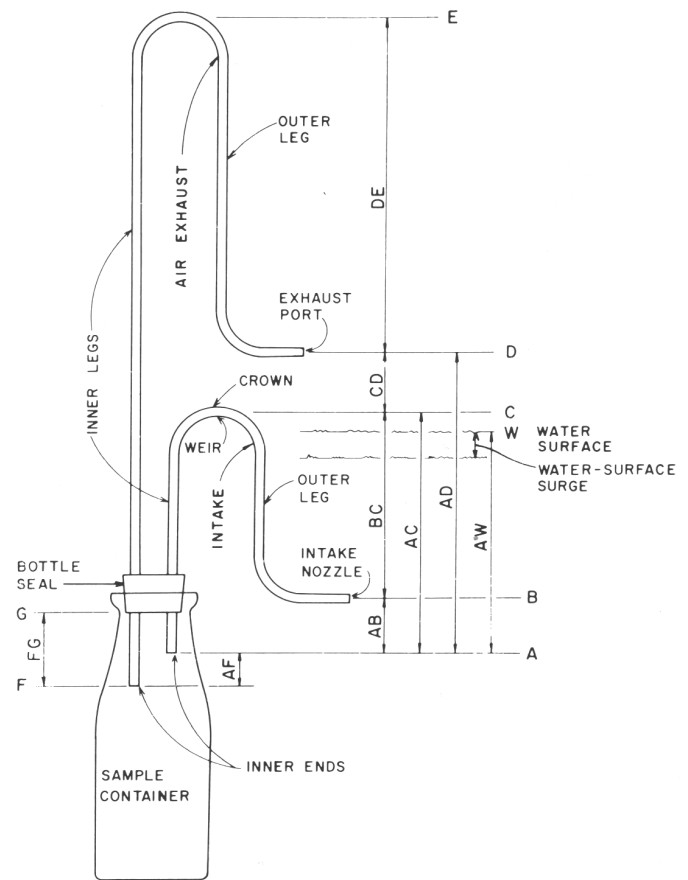

Figure 13. US U-59 single-stage suspended-sediment sampler. Sampling operation using designated letters is described in text (see also Federal Inter-Agency Sedimentation Project, 1961).

sized to fit and seal the mouth of the sample container. There are two general types of this sampler, one with a vertical intake and the other with a horizontal intake. The horizontal-intake type is further divided into three versions, each distinguished from the others by the height of the intake and air-exhaust tubes. Under some conditions either type could be used, but the two are not always interchangeable.

The vertical-intake sampler is used to sample streams carrying sediments finer than 0.062 mm. The vertical-intake sampler has the advantage of somewhat less tendency to fouling by debris and deposits of sediment in the intake nozzle than does the horizontal type of intake. Conversely, the horizontal-intake sampler should be used to sample streams carrying a considerable amount of sediment coarser than 0.062 mm.

The basic sampling operation of the instrument when velocities and turbulences are small is described by F.I.S.P. (1961, p. 17):

When the stream surface rises to B, the elevation of the intake nozzle, the water-sediment mixture enters; and as the water surface continues to rise in the stream, it also rises in the intake. (The general elevation and dimensions are expressed without regard to the inside diameter of the tube or without distinction between the weir and the crown of the siphon.) When the water-surface elevation W reaches C, flow starts over the weir of the siphon, primes the siphon, and begins to fill the sample bottle under the head AC.

Filling continues until the sample rises to F in the bottle, and water is forced up the air exhaust to the elevation W. Actually the momentum of flow in the tubes causes a momentary rise above W in the air exhaust. Water drains out of the inner leg of the intake. When the stream rises to D, air is trapped in the air exhaust. As long as sufficient air remains in the tubes, no flow can pass through to alter the original sample unless a differential head that exceeds the height of invert is built up. (If the legs of an invert are not symmetrical, the inverts have different effective air-trap heights resisting flow into and out of the bottle.) For conditions without significant surge and velocity effects at the intake nozzle or exhaust port, the heights BC and DE may be small.

If, after the normal time of sampling, the depth of submergence over the sample bottle increases, the air in the bottle is compressed, and a small additional sample enters the bottle. This additional sample will enter through the tube having the smallest height of invert. Under variable submergence, the entrance of water will compress the air in the bottle on rising stages, and some expanding air will escape on falling stages; thus the quantity of air in the bottle becomes less and less, and the water rises in the bottle.

The sampling operation just described is somewhat idealistic because, in reality, the operation is affected by the flow velocity and turbulence, which alter the effective pressure at the nozzle entrance.

The U-59 has many limitations with respect to good sampling objectives. It must be considered a type of point sampler because it samples a single point in the stream at whatever stage the intake nozzle is positioned before a flow event occurs. Its primary purpose is to collect a sample automatically, and it is used at stations on flashy streams or other locations where extreme difficulty is encountered in trying to reach a station to manually collect samples. Besides being automatic, it is inexpensive; a "battery" of them can be used to obtain a sample at several elevations or times during the rising hydrograph. However, despite these seemingly important advantages, the U-59 has many limitations. Following are the most important:

1. Samples are collected at or near the stream surface, so that, in the analysis of the data, theoretical adjustments for vertical distribution of sediment concentration or size are necessary.
2. Samples are usually obtained near the edge of the stream or near a pier or abutment; therefore, theoretical adjustments for lateral variations in sediment distribution are required.
3. Even though several combinations of size, shape, and orientation of intake and air-exhaust tubes are available, the installed system may not result in intake ratios sufficiently close to unity to sample sands accurately for a specific runoff event.
4. Covers or other protection from trash, drift, and vandalism often create unnatural flow lines at the point of sampling.
5. Water from condensation may accumulate in the sample container prior to sampling.
6. Sometimes the sediment content of the sample changes during subsequent submergence.
7. The device is not adapted to sampling on falling stages or on secondary rises.
8. No specific sampler design is best for all stream conditions.
9. The time and gage height at which a sample was taken may be uncertain.
10. Under high velocities, circulation of flow into the intake nozzle and out the air exhaust can occur. This will increase the concentration of coarse material in the sample and can make the sample concentration several orders of magnitude higher than stream concentration.

To cover a wide range of operating conditions, four “standard” models of the U-59 are available. The many specific details of these are further described in F.I.S.P. (1961).

Before a bank of the U-59 samplers can be designed and installed, it is necessary to have some knowledge of the seasonal stage characteristics of the stream so that several samples can be obtained for a given storm event and throughout the season. The stream stage and flow-velocity characteristics not only affect the design with respect to the vertical spacing of the samplers, but also the support necessary for the bank of samplers.

The U-73 (fig. 14) is a more sophisticated single-stage sampling device. The sampler’s design configuration solves several of the problems characteristic of the U-59. Specifically, this sampler (1) can be used to sample either a rising or falling stage, (2) has no problem of condensation in the sample container before the spring-loaded stoppers are tripped, and (3) features an exterior design that allows for a degree

of protection from trash or drift without additional covers or deflection shields. Aside from these few advantages, the U-73 has the same limitations and should be used under the same conditions as the U-59.

The investigator using either the U-59 or U-73 may find protective measures necessary to avoid blockage of intakes or air exhausts due to nesting insects. In freezing climates, precaution may be warranted against sample-container breakage due to expansion of a freezing sample. Samples for water-quality analysis can be collected using the U-73-TM version of the U-73. However, do not use insecticides or antifreeze solutions if samples are to be analyzed for water quality because these will obviously contaminate the sample.

Bed-Material Samplers

Limitations

To properly sample bed material for interpretation, it is first necessary to establish what constitutes bed material and understand its relation to transported load, especially to bedload. Bedload is best defined as sediment that moves by sliding, rolling, or bouncing along on or near the streambed (Hubbell, 1964; Leopold and others, 1964; Emmett, 1980a). Bed material, on the other hand, is best defined in the Office of Water Data Coordination (1978) National Handbook, chapter 3, p. 3–5, which describes bed material as “the sediment mixture of which the bed is composed.” In alluvial streams, bed-material particles are likely to be moved at any moment or during some future flow conditions. From the perspective of Leopold and others (1964), the streambed is composed of two elements, distinguished one from the other by particle size and their reaction to stream velocity. The first element consists of particles frequently transported as part of the suspended load or bedload, but considered as bed material when at rest. The second element consists of particles and aggregates of particles that compose definite structures on the streambed and reside there indefinitely or at least for long periods of time. The size fractions comprising the second element may only be moved by the most extreme flow events during which streambed erosion and scour occur.

The samplers described in this section can only accommodate bed material consisting of particles finer

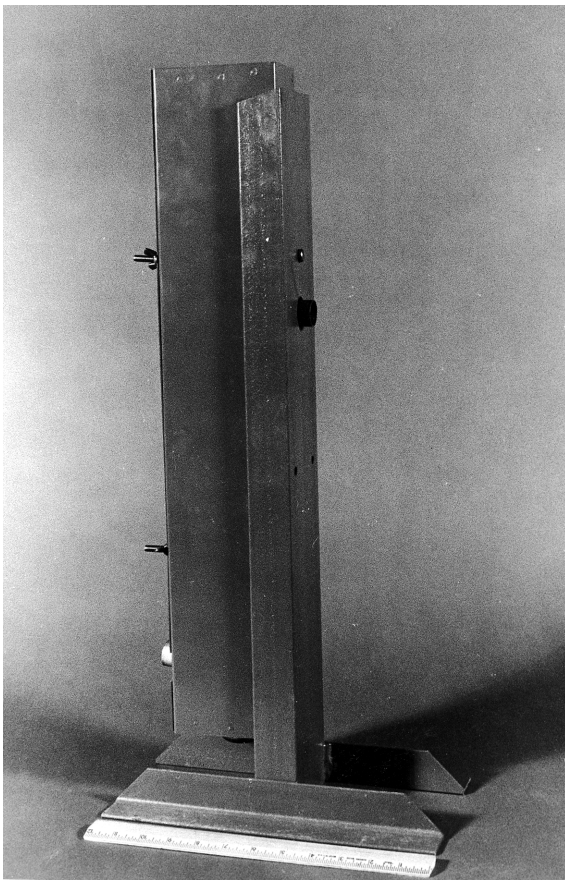

Figure 14. US U-73 single-stage suspended-sediment sampler.

than about 30 or 40 mm in diameter. These bed-material samplers cannot accurately collect representative samples of particles larger than 16 mm, however. As noted in the description of individual samplers, there also may be limitations with respect to some very fine sediments because of poor sealing of the sampler after collection. This limits bed-material sampling, with standard US type samplers, to fine material that might be transported in suspension or as bedload at higher flows. The collection and analysis of material larger than coarse gravel are more difficult and costly because other techniques are required to handle heavy samples. Due to this difficulty in collecting large particle sizes, little information regarding bed-material size distribution is available for streams having gravel, cobble, and boulder beds. Therefore, much of the equipment for measurement of large bed material is of an experimental nature, and standard equipment for sampling large particles is unavailable. The interested investigator is directed to several references on direct and indirect methods of sampling and analysis of coarse bed materials, however, and is encouraged to contact Chief, Office of Surface Water, Reston, Virginia, or the F.I.S.P. for information (Lane and Carlson, 1953; Kellerhals, 1967; Wolman, 1954).

Hand-Held Samplers—US BMH-53, US BMH-60, and US BMH-80

Three types of instruments for hand sampling of bed material finer than medium gravel have been developed for general use. The BMH-53 (fig. 15) is designed to sample bed material in wadable streams. The instrument is 46 inches long and is made of corrosion-resistant materials. The sample container is a stainless-steel thin-walled cylinder 2 inches in diameter and 8 inches long with a tight-fitting brass piston. The piston is held in position by a rod that passes through the handle to the opposite end. The piston creates a partial vacuum above the material being sampled. This vacuum aids in overcoming the frictional resistance required to force the sampler into the bed. When sampling fine-grained material, this partial vacuum also aids in retaining the shallow core in the cylinder when the sampler is removed from the bed. The piston then serves to remove the sample from the cylinder by forcing it downward toward the bottom of the cylinder. In soft cohesive beds, this technique generally provides shallow cores with a minimum of distortion, from which sediment variations with depth and subsamples can be obtained. (See Federal Inter-Agency Sedimentation Project, 1963b and 1966, for more detailed information.) A version of this sampler, developed by the F.I.S.P. incorporates a "core catcher"

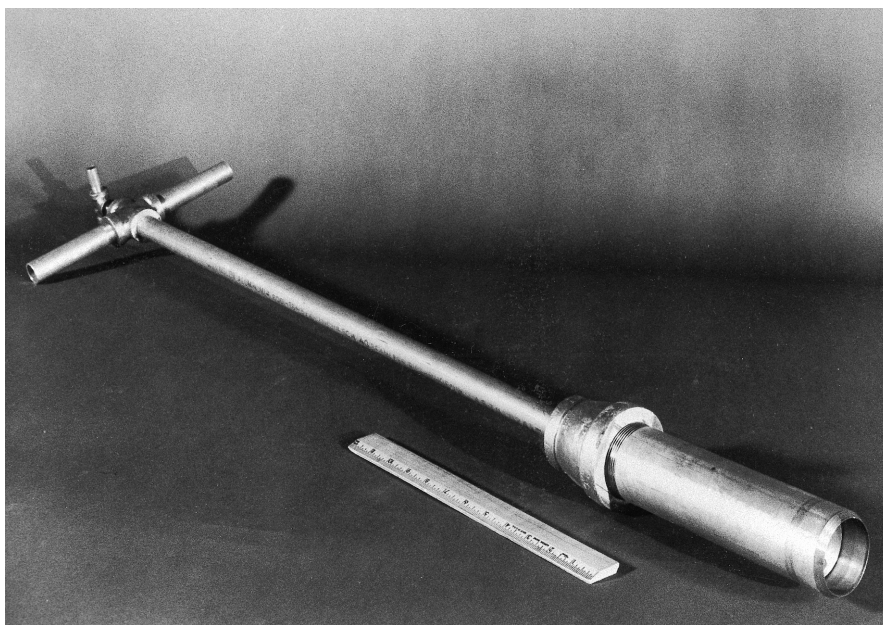

Figure 15. US BMH-53 bed-material sampler.

mechanism in the cylinder to retain samples containing a high percentage of sand.

The bed material of some wadable streams or lakes can be sampled with the US BMH-60 (fig. 16). This handline sampler is about 22 inches long, is made of cast aluminum, and weighs 30 pounds. Because of its light weight, it is useful only in streams of moderate depths and velocities. The bed material must be moderately firm and contain little or no gravel.

The sampler mechanism of the US BMH-60 consists of a scoop or bucket driven by a constant-torque spring that rotates the bucket from front to back. The scoop, when activated by release of tension on the hanger rod, can penetrate into the bed about 1.7 inches and can hold approximately 175 cubic centimeters of material. The scoop is aided in penetration of the bed by extra weight in the sampler nose. To cock the bucket into an open position for sampling (that is, retract it into the body), the sampler must first be supported by the handline, then the bucket can be rotated (back to front) with an allen wrench to an open cocked position.

The hanger rod to which the handline is attached is grooved so that a safety yoke can be placed in position to maintain tension on the hanger rod assembly. **CAUTION:** At no time should the hand or fingers be placed in the bucket opening because the bucket may

accidentally close with sufficient force to cause permanent injury! A piece of wood or a brush can be used to remove any material adhering to the inside of the sample bucket. (See Federal Inter-Agency Sedimentation Project, 1963b and 1966, for more detailed information.)

After the safety yoke is removed, the bucket closes when tension on the handline is released, which occurs as the sampler strikes the streambed. A gasket on the closure plate prevents sampled material from being contaminated or being washed from the bucket.

Another bed-material hand-sampling instrument available for general use is designated BMH-80 (fig. 17). This sampler is 56 inches in total length and is used to sample the bed of wadable streams. The sampling mechanism is a semi-cylindrical bucket, resembling the BMH-60 bucket assembly, which is operated by positioning the lever on the handle to open or close the bucket. When the bucket is closed and a sample volume of approximately 175 cubic centimeters of bed material is captured, the closure is sufficiently sealed to prevent erosion of the sample while the instrument is lifted through the water column.

An additional handline sampler, used successfully for bed-material chemistry sampling on the Willamette and Columbia Rivers in Oregon, is the Ponar sampler.

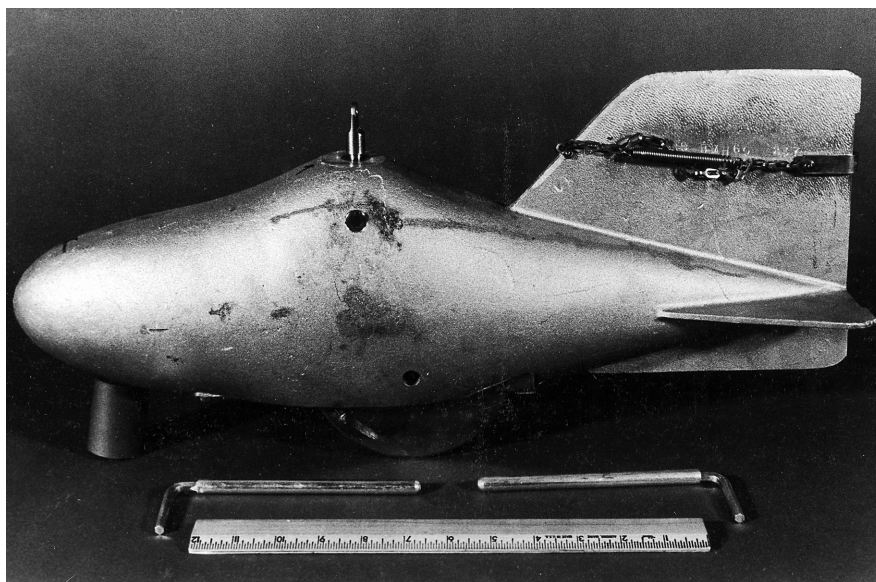
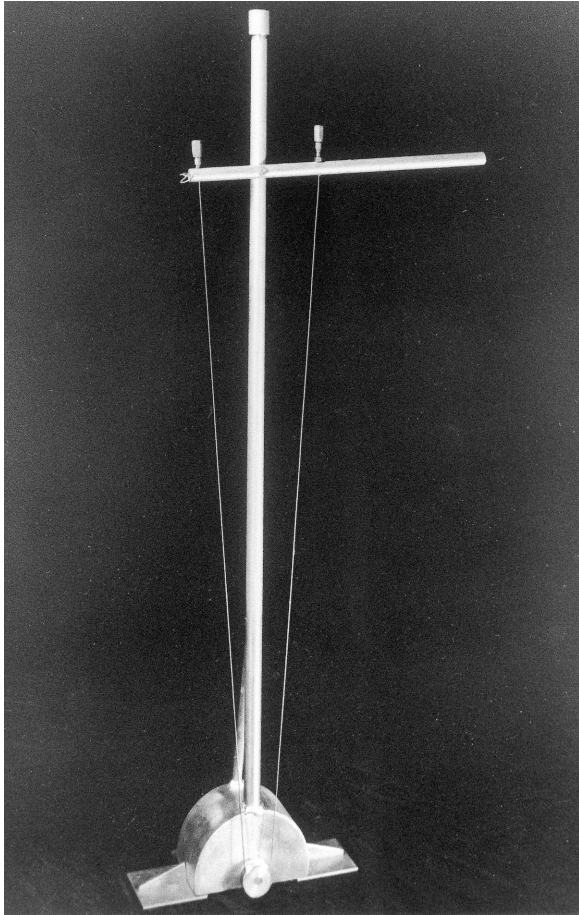
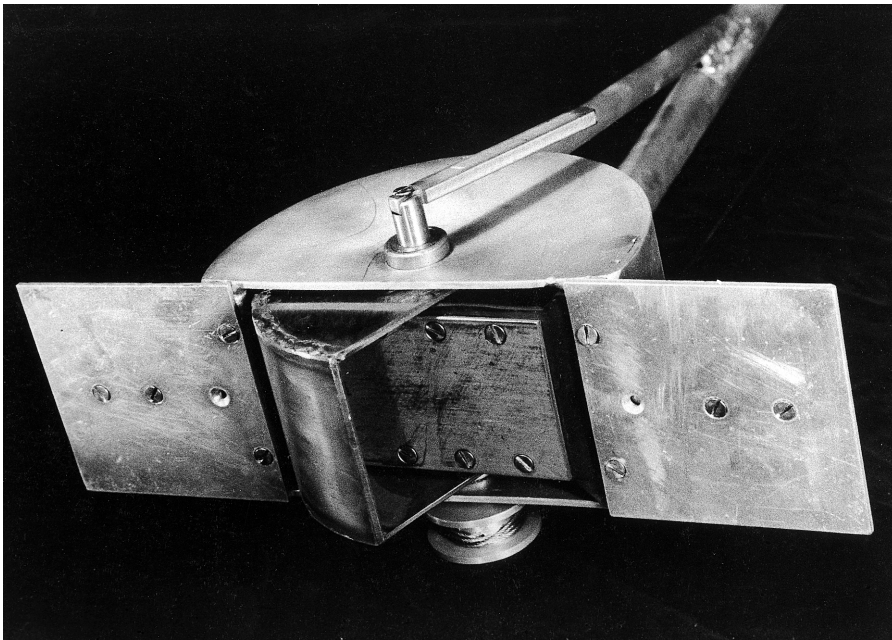

Figure 16. US BMH-60 bed-material sampler.



A This is a clam-shell type sampler, consisting of two quarter-cylinder sections hinged together at the top. The sampler, which is constructed of galvanized or stainless steel, weighs about 25 pounds and can be suspended on a handline. The jaws of the instrument are held in the open position by a system of solid-notched bars and by the downward force created by the weight of the sampler on the suspension line. Gravity provides the necessary force for bottom penetration during sampling. The solid-notched bars holding the sampler jaws open are released when the downward force of the sampler's weight is released from the suspension line as the sampler strikes the bed. The sampler then closes as an upward force is applied to lift the sampler with the captured sediment. This sampler is particularly effective where bottom sediments consist of unconsolidated fines with no armoring present. Under these conditions, bottom penetration is 6 to 8 inches, resulting in a sample volume range of 8,000 cubic centimeters to 10,000 cubic centimeters of material. Some protection against erosion of the captured sediment is provided by an overlapping lip on the bottom and sides. However, a watertight seal does not exist, so care must be exercised when raising the sampler to the surface.



B

Figure 17. US BMH-80 rotary-scoop bed-material sampler. *A*, complete hand-sampling instrument (approximately 5 feet tall). *B*, Rotary-scoop assembly (approximately 12 inches long).

Cable-and-Reel Sampler—US BM-54

The 100-pound cable-and-reel suspended BM-54 sampler (fig. 18) can be used for sampling bed material of streams and lakes of any reasonable depth, except for streams with extremely high velocities. The body of the BM-54 is cast steel. Its physical configuration is similar to the cast aluminum BMH-60, 22 inches long and with tail vanes. Its operation also is similar to the BMH-60 in that it takes a sample when tension on the cable is released as the sampler touches the bed. The sampling mechanism externally looks similar to that of the BMH-60, but its operation is somewhat different.

The driving force of the bucket comes not from a constant-torque spring, but rather from a conventional coil-type spring. The tension on the spring is adjusted by the nut-and-bolt assembly protruding from the front of the sampler. The spring is powerful enough to obtain a sample from a bed of very compacted sand. It is suggested that the tension on the spring be released during extended periods of idleness even though the bucket is closed. Maximum tension need be used only when the streambed is very firm. Unlike the BMH-60, the spring and cable assembly rotates the bucket from the back to the front of the sampler. The trapped sample is kept from washing out by a rubber gasket. (See Federal Inter-Agency Sedimentation Project,

1963b, 1964, and 1966, for more complete description and details.)

BM-54 samplers obtained after 1956 are equipped with a safety mechanism similar to the safety yoke used on the BMH-60. This safety bar can be rotated over the cutting edge of the sample bucket when cocked into the open position. The bar keeps the bucket open when in the safety position, even if there is no tension on the hanger bar. As with the BMH-60, the cable tension on the catch mechanism holds the bucket open while the sampler is lowered. Safety bars can be obtained from F.I.S.P. and should be installed on any unit that does not have one. Again, personnel operating these samplers are cautioned to **KEEP ONE'S HANDS AWAY FROM THE BUCKET CAVITY EVEN IF A SAFETY BAR IS IN USE**. The power of the bucket is demonstrated by the fact that upon release, it has been observed to lift the 100-pound sampler from a hard surface.

A bed-material sampler incorporating the heavy streamlined body of the P-61 sampler and the spring-driven bucket of the BM-54 has been developed (C.W. O'Neal, Federal Inter-Agency Sedimentation Project, written commun., 1998). This sampler, the BM-84, is intended for use in large, swift rivers.

Prych and Hubbell (1966) developed a core sampler for use in deep flowing water in studies of the Columbia River estuary. This cable-suspended

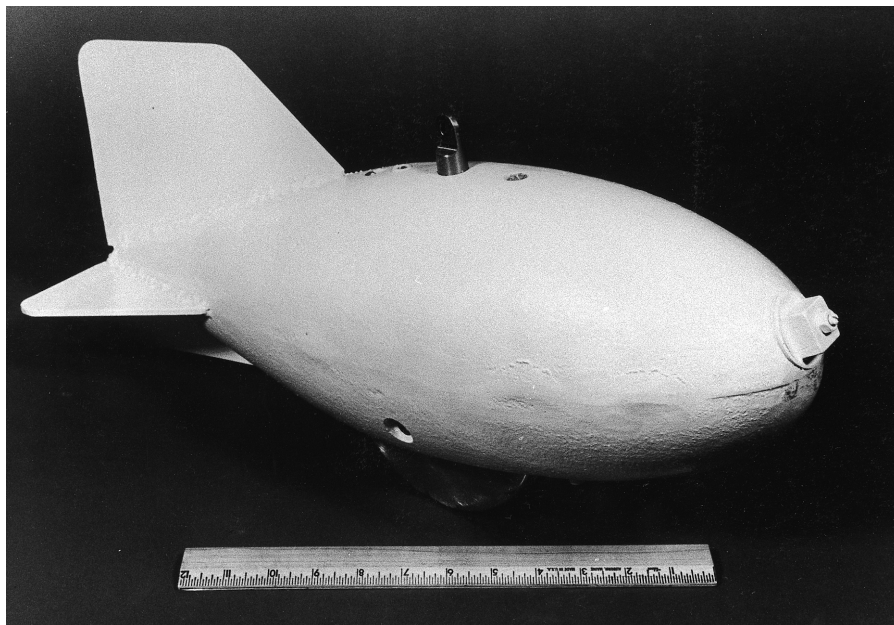

Figure 18. US BM-54 bed-material sampler.

sampler (fig. 19) is used to collect a 1 7/8-inch diameter by 6-foot-long core, by means of the combined action of vibration, suction, and an axial force derived through cables connected to a 250-pound streamlined stabilizing weight that rests on the streambed.

Smaller estuaries along the Oregon coast and other places have been successfully sampled using the Gravity Corer available from Benthos, Inc. This sampler is allowed to plunge to the bottom where, under the force of the gravitational pull on the sampler coupled with the momentum of its 250-pound total weight, it can penetrate up to 5 feet deep in soft bed material. However, much less penetration can be expected if the bed material consists of sand or gravel. The sampler is retrieved from the bed using a cable-reel boom assembly. The 2 5/8-inch diameter by 5-foot long core is retained in a core liner held in place by a core catcher at the bottom and protected against

sample washout by a watertight valve at the top. The length of core and depth of penetration depend upon the degree of hardness of the bed being sampled. Other slightly more crude devices have been used with some success to sample bed material and thus deserve mention here. The two most notable of these devices are (1) the pipe dredge, which is lowered to the streambed and dragged a short distance to collect a sample; and (2) the "can on a stick" sampler, consisting of a rod with a scoop connected to the end, which can be used in wadable streams by lowering it to the streambed and scooping bed material from the bottom.

Bedload Samplers

At this time, the reader should note the difference between bedload and unmeasured sediment. Remember from the bed-material section that bedload is the sediment that moves by sliding, rolling, or bouncing along on or very near the streambed. Unsampled sediment is comprised of bedload particles and particles in suspension in the flow below the sampling zone of the suspended-sediment samplers (fig. 1).

Bedload is difficult to measure for several reasons. Any device placed on or near the bed may disturb the flow and rate of bedload movement. More importantly, bedload transport rate and the velocity of water close to the bed vary considerably with respect to both space and time. Therefore, any sample obtained at a given point may not be representative of the mean transport rate for a reasonable interval of time because the bed particles move intermittently at a mean velocity much less than that of the water. Thus, a bedload sampler must be able to representatively sample, directly or indirectly, the mass or volume of particles moving along the bed through a given width in a specified period of time if bedload discharge is to be accurately determined.

Prior to 1940, most bedload was measured using some type of direct-collecting sampler. Bedload samplers developed during this era can be grouped into four categories: (1) box or basket, (2) pan or tray, (3) pressure difference, and (4) slot or pit samplers (Hubbell, 1964). Essentially, box or basket samplers consist of a heavy open-front box or basket apparatus, which is lowered to the streambed and positioned to allow collection of bedload particles as they migrate

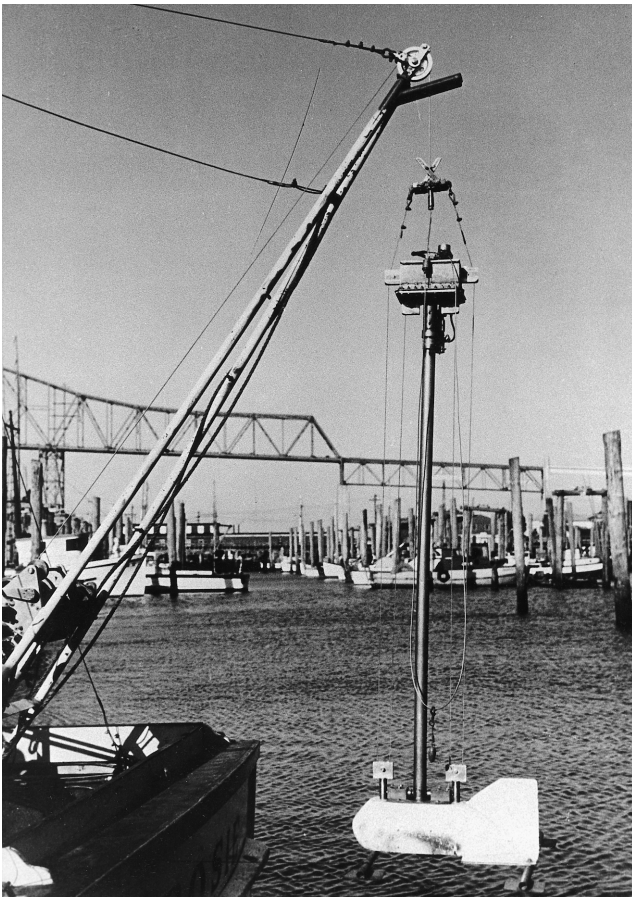

Figure 19. Vibra-core sampler prepared for coring (barrel approximately 5 feet long). From Prych and Hubbell (1966, plate 1).

downstream. The basket type, displaying various sampling efficiencies, has been used preferentially over box types. Pan or tray samplers consist of an entrance ramp leading to a slotted or partitioned box. These samplers also have varying sampling efficiencies. Pressure-difference samplers are designed to create a pressure drop at the sampler's exit and thus maintain entrance velocities approximately equal to the ambient stream velocity. Sampling efficiencies may be higher with this type of sampler than with others, and the deposition of sediments at the sampler entrance, inherent with basket or tray samplers, is eliminated. The best known early pressure-difference sampler is probably the Arnhem or Dutch sampler, after which the Helley-Smith bedload sampler is designed. Ideally, the best measurement of bedload would occur when all of the bedload moving through a given width during a specific time period was measured. The category of samplers that most closely meet this ideal is the slot or pit sampler. This type of sampler has efficiencies close to 100 percent. The slot openings of these pits are 100- to 200-grain diameters wide to ensure the high sampling efficiency. However, samples collected in the pits are removed only with great difficulty or by use of an elaborate conveyor device. A variation of this technique, consisting of a collection trough accessed by a series of hydraulically operated gates, extends from bank to bank at a site on the East Fork River, near Pinedale, Wyoming (Emmett, 1980a). Sediment trapped in the trough during sampling is removed by means of a continuous conveyor belt, which carries the sample to a weighing station on the stream bank.

The original Helley-Smith bedload sampler, introduced in 1971, was a variation of the Arnhem pressure-difference sampler. This sampler consists of an expanding nozzle, sample bag, and frame (fig. 20). The sampler design enables collection of particle sizes less than 76 mm at mean velocities to 9.8 ft/s. The sampler has a 3-inch by 3-inch square entrance nozzle, an area ratio (ratio of nozzle exit to entrance area) of 3.22, and a 295-square-inch polyester mesh sample bag that is 18 inches long with mesh openings of varying sizes (0.25 mm most commonly used), attached to the rear of the nozzle assembly with a rubber "O" ring. The total weight of the original sampler design is 66 pounds, requiring the use of a cable-reel suspension system. However, a lighter version incorporating a wading rod assembly also is available. Heavier versions weighing 99 pounds, 165 pounds, and 550 pounds (used on the Amazon

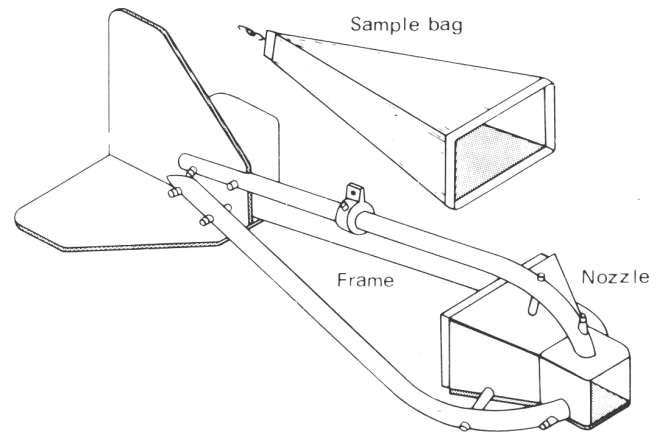

Figure 20. Helley-Smith bedload sampler. From Emmett (1980a, p. 2).

River) have been used by USGS personnel (Emmett, 1980a). A scaled-up version of the sampler having a 6-inch by 6-inch square entrance has been used to sample streams with large particle sizes.

The standard 3-inch by 3-inch sampler has been calibrated in two different laboratory studies and in an extensive field study. Results of one laboratory study (Helley and Smith, 1971) indicated an average sampling efficiency of about 160 percent. Emmett (1980a) concluded from his field study that the overall sampling efficiency was close to 100 percent. A laboratory investigation (Hubbell and others, 1985) of varying bed materials and a range of transport rates indicates that the sampling efficiency of the standard 3-inch by 3-inch sampler varies with particle size and transport rate, displaying an approximate efficiency of 150 percent for sand and small gravel and close to 100 percent for coarse gravel. The standard 6-inch by 6-inch sampler had generally higher efficiencies. Tests of a Helley-Smith type sampler, which has a 3-inch by 3-inch nozzle with less expansion than the standard nozzle (an area ratio of 1.40), resulted in fairly constant efficiencies close to 100 percent for all transport rates and particle sizes. In May 1985, the 1.40 nozzle was approved by the Technical Committee on Sediment as a provisional standard sampler for use by U.S. Federal agencies. After some modifications to the frame, the 3-inch by 3-inch nozzle with 1.40-area-expansion ratio was designated the BL-84 sampler. The Water Resources Division of the USGS endorses the use of this new sampler with the 1.40-area-ratio nozzle; however, until additional testing is done, data obtained using the original 3.22-area-ratio Helley-Smith sampler will continue to be accepted.

Automatic Pumping-Type Samplers

Development and Design

Some sediment studies require frequent collection of suspended sediment at a site. Site location, flow conditions, frequency of collection, and operational costs frequently make collection of sediment data by manual methods impractical. For these reasons, F.I.S.P. and USGS personnel have developed and evaluated several models of automatic pumping-type samplers. The US PS-69 sampler is probably the best known of these samplers to be designed, tested, and used by USGS personnel. The US CS-77 (designed and tested by the Agricultural Research Service in Durant, Oklahoma) and the US PS-82 (Federal Inter-Agency Sedimentation Project, 1983) have been used. A number of automatic pumping-type samplers also have been designed by and are available through commercial sources. The Manning S-4050 and the ISCO 1680 are common commercially used samplers. (Manning Corp. is no longer in business.)

Automatic pumping-type samplers generally consist of (1) a pump to draw a suspended-sediment sample from the streamflow and, in some cases, to provide a back flush to clear the sampler plumbing before or after each sampling cycle; (2) a sample-container unit to hold sample bottles in position for filling; (3) a sample distribution system to divert a pumped sample to the correct bottle; (4) an activation system that starts and stops the sampling cycle, either at some regular time interval or in response to a rise or fall in streamflow (gage height); and (5) an intake system through which samples are drawn from a point in the sampled cross section. Ideally, this combination of components should be designed to meet the 17 optimum criteria as set forth by W.F. Curtis and C.A. Onions (U.S. Geological Survey, written commun., 1982).

1. Stream velocity and sampler intake velocity should be equal to allow for isokinetic sample collection if the intake is aligned with the approaching flow.
2. A suspended-sediment sample should be delivered from stream to sample container without a

change in sediment concentration and particle-size distribution.

3. Cross contamination of sample caused by sediment carryover in the system between sample-collection periods should be prevented.
4. The sampler should be capable of sediment collection when concentrations approach 50,000 milligrams per liter and particle diameters reach 0.250 millimeter.
5. Sample-container volumes should be at least 350 milliliters.
6. The intake inside diameter should be 3/8 or 3/4 inch, depending upon the size of the sampler used.
7. The mean velocity within the sampler plumbing should be great enough to exceed the fall velocity of the largest particle sampled.
8. The sampler should be capable of vertical pumping lifts to 35 feet from intake to sample container.
9. The sampler should be capable of collecting a reasonable number of samples, dependent upon the purpose of sample collection and the flow conditions.
10. Some provision should be made for protection against freezing, evaporation, and dust contamination.
11. The sample-container unit should be constructed to facilitate removal and transport as a unit.
12. The sampling cycle should be initiated in response to a timing device or stage change.
13. The capability of recording the sample-collection date and time should exist.
14. The provision for operation using DC battery power or 110-volt AC power should exist.
15. The weight of the entire sampler or any one of its principal components should not exceed 100 pounds.
16. The maximum dimensions of the entire sampler or any one of its components should not exceed 35 inches in width or 79 inches in height.
17. The required floor area for the fully assembled sampler should not exceed 9 square feet (3 feet by 3 feet).

Installation and Use Criteria

The decision to use a pumping sampler for collection of sediment samples is usually based on both physical and fiscal criteria. These are real considerations; yet it should be understood that automatic

pumping samplers can be as labor intensive and costly as the manual sediment-data collection they were designed to supplement. Installation of an automatic pumping sampler requires intensive planning before installation, including careful selection of the sampler-site location and detailed background data, to ensure the collection of useful pumped sample data.

Before installation of an automatic pumping-type sampler, many of the problems associated with installing stream-gaging equipment must be dealt with. In addition, much data concerning the sediment-transport characteristics at the proposed sampling site must be obtained and evaluated prior to emplacement of the sampler and location of the intake within the streamflow. Logistically, the sample site must be evaluated as to ease of access, availability of electrical power, location of a bridge or cableway relative to the site, normal range of ambient air temperatures inherent with local weather conditions, and the availability of a local observer to collect periodic reference samples. The sediment-transport characteristics should include detailed information on the distribution of concentrations and particle sizes throughout the sampled cross section over a range of discharges.

Placement of Sampler Intake

The primary concept to consider when placing a sampler intake in the streamflow at a sample cross section is that only one point in the flow is being sampled. Therefore, to yield reliable and representative data, the intake should be placed at the point where the concentration approximates the mean sediment concentration for the cross section across the full range of flows. This idealistic concept has great merit, but the mean cross-section concentration almost never exists at the same point under varying streamflow conditions. It is even less likely that specific guidelines for locating an intake under given stream conditions at one stage would produce the same intake location relative to the flow conditions at a different stage. These guidelines would have even less transfer value from cross section to cross section and stream to stream. For these reasons, some very generalized guidelines presented by W.F. Curtis and C.A. Onions (written commun., 1982) are outlined here and should be considered on a case-by-case basis when placing a sampler intake in the streamflow at any given cross section.

1. Select a stable cross section of reasonably uniform depth and width to maximize the stability of the

relation between sediment concentration at a point and the mean sediment concentration in the cross section. This guideline is of primary importance in the decision to use a pumping sampler in a given situation; if a reasonably stable relation between the sample-point concentration and mean cross-section concentration cannot be attained by the following outlined steps, the sampler should not be installed and an alternate location considered.

2. Consider only the part of the vertical that could be sampled using a standard US depth- or point-integrating suspended-sediment sampler, excluding the unsampled zone, because data collected with a depth- or point-integrating sampler will be used to calibrate the pumping sampler.
3. Determine, if possible, the depth of the point of mean sediment concentration in each vertical for each size class of particles finer than 0.250 mm, from a series of carefully collected point-integrated samples.
4. Determine, if possible, the mean depth of occurrence of the mean sediment concentration in each vertical for all particles finer than 0.250 mm.
5. Use the mean depth of occurrence of the mean sediment concentration in the cross section as a reference depth for placement of the intake.
6. Adjust the depth location of the intake to avoid interference by dune migration or contamination by bed material.
7. Adjust the depth location of the intake to ensure submergence at all times.
8. Locate the intake laterally in the flow at a distance far enough from the bank to eliminate any possible bank effects.
9. Place the intake in a zone of high velocity and turbulence to improve sediment distribution by mixing, reduce possible deposition on or near the intake, and provide for rapid removal of any particles disturbed during the purge cycle.

Because of the generalized nature of these guidelines, it will often be impossible to satisfy them all when placing a pumping sampler intake into naturally occurring streamflows. The investigator is encouraged, however, to try to satisfy these guidelines or, at the very least, to satisfy as many as possible and to minimize the effects of those not satisfied.

Sampler Advantages and Disadvantages

Automatic pumping-type samplers are very useful for collecting suspended-sediment samples during periods of rapid stage changes caused by storm-runoff events and in reducing the manpower necessary to carry out intensive sediment-collection programs (Federal Inter-Agency Sedimentation Project, 1981b). However, it should be noted that pumping samplers quite often require more man-hours and cost more to operate than a conventional, observer-sampled type of station. Pumping samplers, because of their mechanical complexity, power requirements, and limited sample capacity, quite often require more frequent site visits by the field personnel than would be required at the conventional observer station. In addition, problems associated with collecting high-flow, cross-section samples are still present.

In streams with significant amounts of suspended-sand loads, the problems associated with using a pumping sampler are so great that two records may have to be calculated, one for the silt-clay size fraction load and one for the sand-size fraction load. This requires that most of the samples collected with the pumping sampler, as well as the samples collected manually, be subjected to a full particle-size analysis. Extensive laboratory work of this type increases the cost of analysis and computation of the sediment-discharge record. Another disadvantage is that the pumping lift for most samplers is relatively small and may be less than the normal fluctuations in stage at some sites. This is especially true on western rivers, where stage ranges may exceed 50 feet, making it necessary to locate the pump outside of the sampler's shelter in order to maintain a manageable pumping lift.

Intake Orientation

The orientation of the pumping sampler intake nozzle can drastically affect sampling efficiency. There are five ways in which an intake could be oriented to the flow (fig. 21): (1) normal and pointing directly upstream (fig. 21A), (2) normal and horizontal to flow (fig. 21B), (3) normal and vertical with the orifice up (fig. 21C), (4) normal and vertical with the orifice down (fig. 21D), and (5) normal and pointing directly downstream (fig. 21E). Of these five orientations, 1, 3, and 4 should be avoided because of high sampling errors and trash collection problems. Orientation 2, with the nozzle positioned normal and horizontal to the flow, is the most common alternative

used. The major problem with this orientation is that sand-size particles may not be adequately sampled (see the following section on pumped-sample data analysis). Orientation 5, pointing directly downstream, appears to have an advantage over orientation 2 (Winterstein and Stefan, 1983). When the intake is pointing downstream, a small eddy is formed at the intake, which envelops the sand particles and thus allows the sampler to collect a more representative sample of the coarse load. Winterstein and Stefan (1983) also have demonstrated that nozzle orientations at angles to the flow other than those illustrated in figure 21 do not improve the resultant sample and, therefore, do not represent any useful advantage.

Data Analysis

A major concern when evaluating sediment data collected by automatic pumping-type samplers is the relation between the data and the true mean suspended-sediment concentration in transport at the time of sample collection. In order to determine this relation, concentrations determined from the pumping sampler must be compared with the corresponding concentrations determined from a complete depth-integrated cross-section sample over the full range of flow. This relation then is used to adjust the pumped sample data.

It must be remembered that samples collected by pumping samplers are taken from a single point in the flow. Although attempts are made to ensure that cross-sectional mean sediment concentrations are obtained, in reality this rarely happens. However, if a stable relation between the concentration at the sample point and the mean concentration in the cross section exists, the sample can be considered as representative as possible. In addition, pumping samplers do not collect samples isokinetically (as do standard US depth- or point-integrating samplers), due to the pumping rate and the orientation of the intake orifice. Not sampling isokinetically introduces concentration errors, particularly for particles greater than 0.062 mm.

Pumping samplers rely on pump speed to create a velocity in the intake tube greater than the settling velocity of particles in suspension. This higher velocity is necessary to deliver the sample to the sample container without reducing the concentration of coarser particles by depositing them within the sampler's plumbing. The pumping action at the intake orifice bends the streamlines of sediment-laden flow

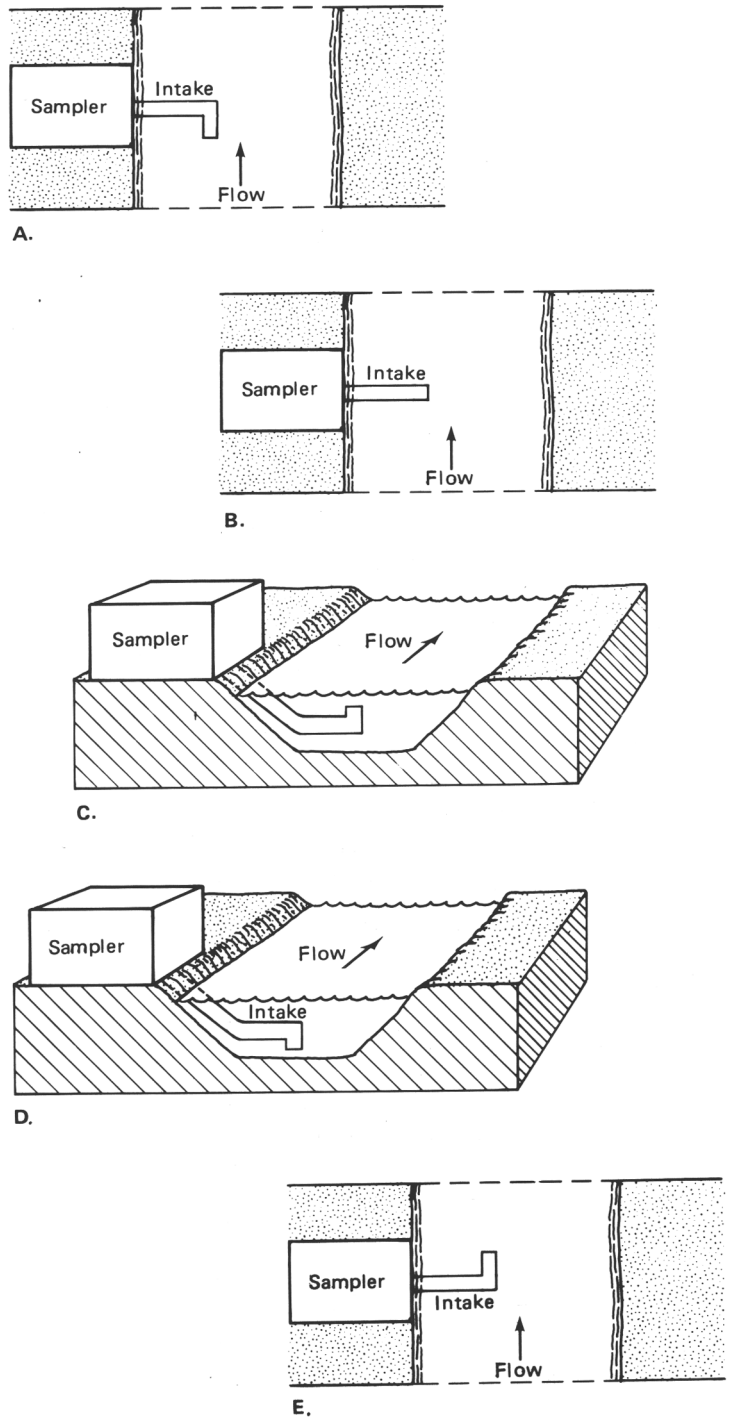

Figure 21. Examples of pumping-sampler intake orientations. *A*, Normal and pointing directly upstream. *B*, Normal and horizontal to flow. *C*, Normal and vertical with the orifice up. *D*, Normal and vertical with the orifice down. *E*, Normal and pointing directly downstream.

as a sample is drawn into the intake and as particles are propelled through the sampler to the sample container. This force acts on particles carried past the orifice with varying results, dependent upon particle size and velocity (Federal Inter-Agency Sedimentation Project, 1941). That is, the pumping force attempts to pull particles laterally from their streamlines and accelerate them in the direction of the intake. At low stream velocities, when only fine silts and clays are being transported, this is not a problem. However, as stream velocity increases and particles larger than 0.062 mm begin to move in suspension, the pumping force must overcome the momentum of these larger particles, due to their mass and acceleration in the downstream direction, in order for a representative

sample to be obtained. A decrease in sampling efficiency can result in a biased sample because fewer and fewer large particles are drawn into the intake as the distance from the intake increases (fig. 22). This figure shows that only those sediment particles passing directly in front of the intake, a short distance away, are greatly affected and subject to capture. It also should be realized that the zone (cone) of influence is an idealized concept, and pumping influence is much greater on sediments approaching the intake from upstream than on those sediments that have passed to the downstream side. As mentioned previously, this problem may be relieved somewhat by orienting the intake directly downstream.

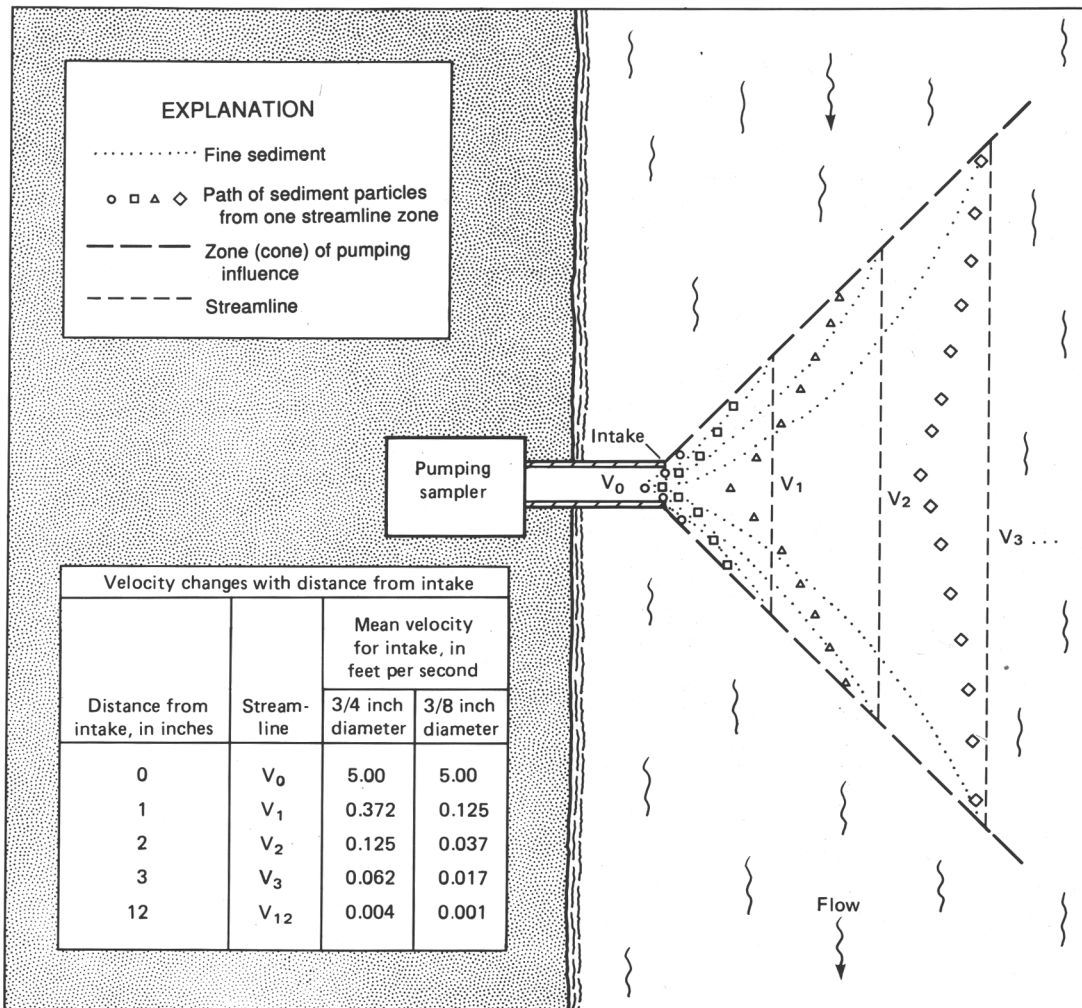

Figure 22. Pumping effect on sediment streamlines within the zone (cone) of influence and velocity changes with distance from intake (cone) of influence and velocity changes with distance from the intake oriented normal and horizontal to the flow for 3/4-inch and 3/8-inch diameter intakes with pumped velocity of 5 feet per second (from Federal Inter-Agency Sedimentation Project, 1966; W.F. Curtis and C.A. Onions, written commun., 1982).

Intake Efficiency

To facilitate accurate interpretation of data collected by automatic pumping-type samplers, some comparison between sediment concentration of the pumped sample (C_p) and mean sediment concentration of the streamflow (C_s) must be made. This comparison is made in terms of intake efficiency, which is the ratio of the pumped-sample sediment concentration to the mean concentration of the stream at the intake sampling point (Federal Inter-Agency Sedimentation Project, 1966), or:

$$\frac{C_p}{C_s}(100) = \text{intake efficiency.}$$

In reality, this relation is based on comparison of the pumped sample to sediment concentration of a point sample collected as close to the intake sampling point as possible, using a standard US depth- or point-integrating sampler.

Intake efficiencies should be determined for pumping samplers as soon as possible after installation-related sediment disturbances have stabilized. Additional efficiency values should be established over a broad range of flow conditions to determine actual effects of variations in particle sizes at a given sample site. These data then can be used to evaluate the sediment concentration of pumped samples and check their credibility.

Cross-Section Coefficient

Determining the degree of efficiency with which a pumping sampler obtains a representative sample is one step in the interpretation of suspended-sediment concentration data. These data should be further assessed relative to the cross-sectional mean suspended-sediment concentration. A coefficient should be determined based on how well the pumping sampler's data represents the cross-sectional mean, and this coefficient should be applied to the pumping sampler data.

From previous discussion, it should be evident that sediment samples taken at a single point of flow within a cross section seldom represent the mean sediment concentration. Therefore, cross-section coefficients must be determined to relate pumped-sample sediment concentration to the mean sediment concentration in the cross section. Because no theoret-

ical relation exists between these parameters, an empirical comparison must be made between concentrations obtained from pumped samples and concentrations obtained from depth-integrated, cross-sectional samples collected at the same time. Obviously, it is impossible to collect an entire cross-sectional sample in the length of time it takes to cycle the pumping sampler to collect a single sample. Therefore, it is recommended that a sample collected with the pumping sampler be taken immediately before and after the cross-section sample. This procedure will help bracket any changes in concentration that might occur during the time period necessary to collect the cross-section sample. If it is suspected that the concentration is changing rapidly during the collection of the cross-section sample, try to collect one or more samples with the pumping sampler during the time that the cross-section sample is being collected. These data will help in the development of the cross-section coefficient. Collection and comparison of these check samples should be repeated during each station visit, as well as during rising and falling stages, and at peak flows for all seasonal periods (snowmelt runoff, thunderstorms, and so on). A more detailed discussion on development of cross-section coefficients is available to the interested reader in Guy (1970) and Porterfield (1972).

Description of Automatic Pumping-Type Samplers—US PS-69, US CS-77, US PS-82, Manning S-4050, and ISCO 1680

The US PS-69 pumping sampler (fig. 23) is a time- or stage-activated, electrically driven, suspended-sediment sampler capable of collecting up to 72 samples at volumes to 1,000 mL. Standard pumping lifts are to 17 feet vertically, but repositioning the pump or using multiple pumps in series can increase lift capabilities for extreme situations. This sampler must be placed in a shelter and protected against inclement weather and temperature extremes.

Particle sizes sampled range to 0.250 millimeter with some decrease in sampling efficiency for the larger particles. Sediment concentrations to 160,000 milligrams per liter have been sampled by USGS personnel in New Mexico, using an air-driven pump with the PS-69 (J.V. Skinner, written commun., 1985); extremely high concentrations also have been sampled in the vicinity of the Mount St. Helens volcano in Washington.

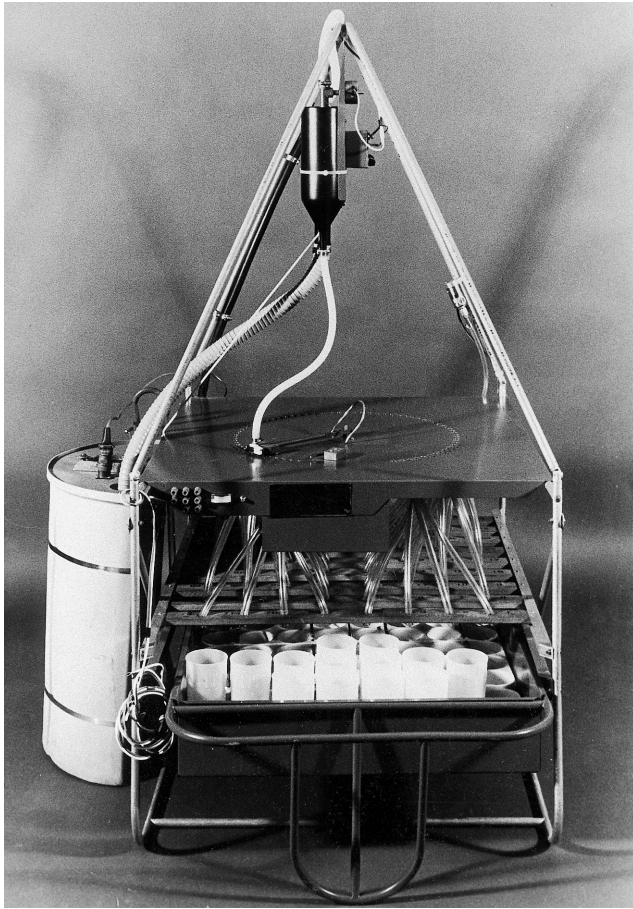

Figure 23. US PS-69 pumping sampler.

The PS-69 was evaluated by W.F. Curtis and C.A. Onions (written commun., 1982) by comparing the sampler's attributes to the 17 criteria previously listed. Results of this comparison are included in table 2.

The US CS-77, or Chickasha, sediment sampler (fig. 24) was designed and developed by the Agricultural Research Service, Durant, Oklahoma. This sampler was fashioned after an earlier design (US XPS-62, developed by F.I.S.P.) but has not been widely used by USGS personnel.

Like the PS-69, this sampler is time- or stage-activated to facilitate sampling on a predetermined schedule as well as during runoff events. Sampling times are recorded during the sampling procedure as part of the standard sampler's design of operation, in lieu of add-on modules and recording devices common to other samplers discussed here.

Table 2. Automatic pumping-type sampler evaluation

[A, US PS-69; B, US CS-77; C, US PS-82; D, Manning S-4050; E, ISCO 1680; mg/L, milligrams per liter; mL, milliliter; mm, millimeter; ≥, greater than or equal to; <, less than; >, greater than]

Evaluation criteria	Samplers meeting criteria
1. Sample collection isokinetic	None
2. Sediment concentration constant stream to sample container	A ¹ , B ² , C ² , D
3. Cross-contamination prevented	A, B, C, D
4. Collects concentrations to 50,000 mg/L and particles to 0.25 mm	A ¹ , B ^{2,1} , C ¹ , D ¹ , E ²
5. Sample volume >350 mL	A ³ , B ³ , C ³ , D ³ , E ³
6. Intake diameter 3/4 inch	A
7. Mean velocity at intake and in internal plumbing great enough to ensure turbulent flow with a Reynolds number of 4,000	A ³ , B ² , C ¹ , D ³ , E ³
8. Vertical pumping lift >35 feet	A ² , B ² , C ²
9. Capable of collecting an adequate number of samples to accomplish the purpose of sampling	A ³ , B ³ , C ³ , D, E
10. Sampler protected against freezing, evaporation, and dust	A ² , B ² , C, D ² , E ²
11. Sample-container tray removable single unit	A, D, E
12. Sampling cycle activated by timer or stage change	A, B, C, D, E
13. Capable of recording sample date and time	A ² , B, C ² , D ² , E ²
14. AC or DC power capability	A ² , B ² , C ² , D ² , E ²
15. Sampler or principle components <100 pounds	A ² , B ² , C ³ , D ³ , E ³
16. Sampler dimensions <35 inches wide by 79 inches high	A ² , B ² , C ³ , D ³ , E ³
17. Required floor space <9 square feet (3 feet by 3 feet)	C ³ , D ³ , E ³

¹Sampler shows a reduction in capacity with particle sizes >0.250 mm.

²Sampler requires modification to meet criteria.

³Sampler exceeds criteria.

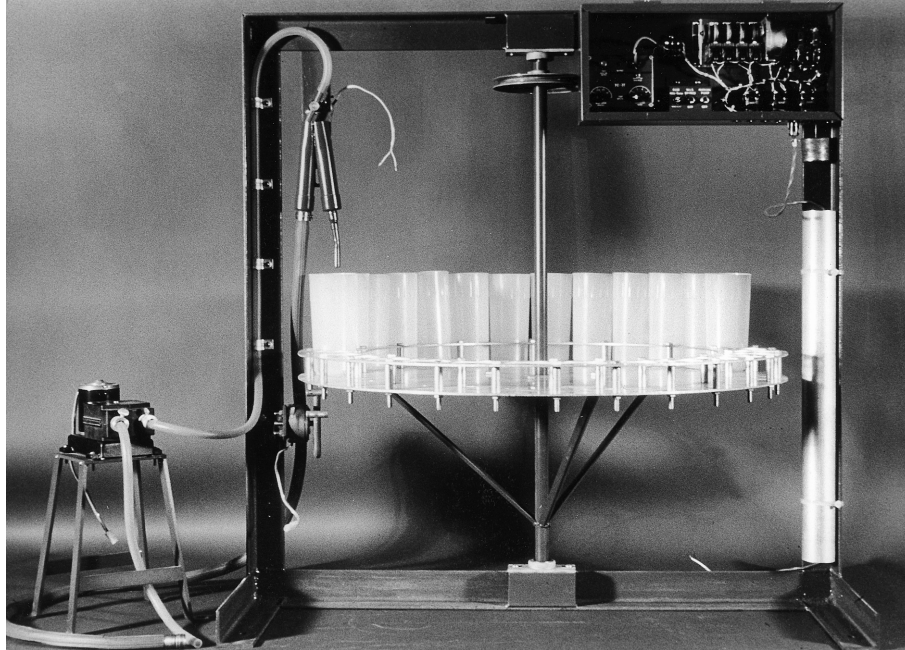

Figure 24. US CS-77 (Chickasha) pumping sampler.

Pumping lift attained by the standard CS-77 sampler configuration is 16 vertical feet; however, relocation of the pump unit to a lower elevation will establish a pull-push sequence, enabling greater sample lifts.

Further modification is necessary to improve the sampling efficiency for high concentration flows carrying greater than 10 percent sand-sized material. Additional information regarding this sampler may be obtained from the evaluation in table 2 and by contacting personnel at the F.I.S.P.

The US PS-82 automatic pumping-type sampler (fig. 25) was made available in March 1984 from F.I.S.P., but it is not widely used under field conditions. The Federal Inter-Agency Sedimentation Project (1983) describes the PS-82 as a lightweight portable pumping sampler, driven by 12-volt battery power, which is used to sample streamflows transporting particles ranging to fine sand size. These samplers weigh 35 pounds and can be housed under a 55-gallon oil drum. An evaluation of this sampler is included in table 2. For more specific information concerning the technical aspects of this sampler and its availability, the interested reader should contact the F.I.S.P.

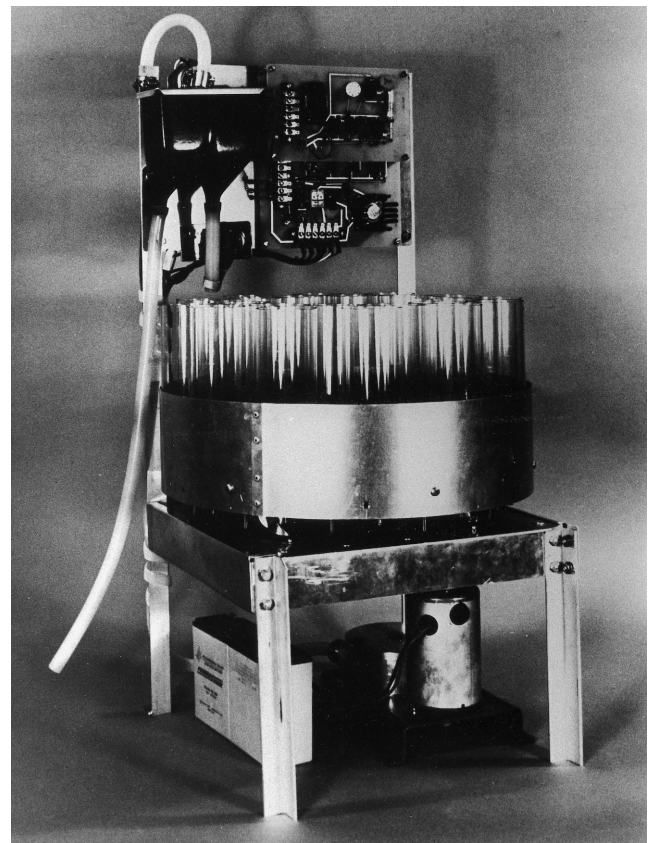

Figure 25. US PS-82 pumping sampler.

The aforementioned samplers were developed by Federal agencies concerned with the collection of suspended-sediment data in a timely, cost-effective manner and are available to the interested investigator from the F.I.S.P. at Waterways Experiment Station, 3909 Halls Ferry Road, Vicksburg, MS 39180-6199.

The following discussion is a description of the Manning S-4050 and ISCO 1680 automatic pumping-type samplers, which are not available through F.I.S.P., but may be obtained from the individual manufacturers. These samplers are described because they represent the types of samplers that are commonly available from commercial sources and used by the USGS.

The Manning S-4050 portable sampler was originally designed as a lightweight unit for sampling sewage. Modifications to this sampler have rendered it useful as a suspended-sediment sampler.

The sampler features a time- or stage-activated electric compressor, which purges the sample intake using the pressure side and draws a sample through the intake using the suction side to create a vacuum in the line, allowing atmospheric pressure to push the sample up to a maximum of 22 feet during the sampling mode. Particle suspension within the sampler is maintained by swirling action of the sample as it passes through the measuring chamber to the sample container.

Evaluation of this sampler in the same manner used for the previously discussed samplers indicates that this instrument is well suited to conditions where extreme pumping lifts are not necessary. Results of this evaluation are included in table 2.

The ISCO 1680, with a super-speed pump sampler, was originally developed as a sewage or wastewater sampler, like the Manning sampler. Normally, wastewater does not carry significant amounts of sediment. Therefore, representation of particle distribution was not a considered criteria during its design and testing stages. The sampler features an electrically driven peristaltic pump, which is activated on a predetermined schedule by an internal timer or in response to stage change. The intake tube is purged before and after each pumping period by automatic reversal of the pump.

The ISCO sampler demonstrates two major shortcomings regarding sediment collection: (1) continuity of sediment concentration from stream to sample container is not maintained efficiently, and (2) a possibility of cross contamination exists from sample to sample as a result of residue remaining in

the system after the purge cycle. These problems can be minimized by the installation of a high output pump, available as an option with recent models. A sampler evaluation included in table 2 shows less than acceptable results for representative sediment-data collection.

Support Equipment

Sediment-sampling equipment has been designed by F.I.S.P. to facilitate the use of existing support equipment normally used in stream-gaging procedures. Other than wading rods and hand lines, support equipment is generally necessary for the proper operation of the heavier versions of sediment samplers. In general, support equipment consists of steel cable, hanger bars, reels, and cranes. However, specific conditions at a site may dictate modifications to these pieces of equipment to improve ease of handling in response to the local conditions. Modifications of support equipment necessary to facilitate the handling of samplers and improve safety are encouraged. Investigators are cautioned against alterations that might adversely affect sample collection, either by disturbing the streamflow in the cross section or by changing the sediment-trapping characteristics of the sampler. To ensure sample integrity, specialists should be consulted before any modifications of this type are made.

Commonly used support items include C-type hanger bars; type-A, type-B, and type-E reels; and portable cranes with 2-, 3-, and 4-wheel bases. The C-type hanger bars can be shortened to eliminate awkward and hazardous handling. Type-A reels can be used to suspend lightweight to medium-weight samplers and have been widely used at permanent single-vertical observer sites. Type-B and type-E reels are typically used with medium and heavy samplers. The type-B reel can be used manually or with an available power unit, allowing the sampler to be lowered by releasing the brake mechanism and letting it slip until the sampler reaches the water surface, then manually integrating the sampled vertical and raising the sampler, either manually or by activating the DC-powered motor to drive the reel. The type-E reel is a DC-powered reel that lends itself more readily to permanent installations where heavy sampling equipment is required. Cranes are used to provide a

mechanical advantage over hand-line or bridge-board suspended equipment, for more effective maneuvering of a sampler. The 2-, 3-, and 4-wheel base cranes are useful when sampling from a bridge deck; however, safety precautions should be taken to warn approaching traffic and to avoid blocking the roadway. Boom assemblies also are used in some instances, such as with truck- and boat-mounted installations. Reels, cranes, and powered hoists can be purchased from HIF. HIF can provide information on the availability, installation requirements, and operation of this equipment. Some additional information also may be obtained from the report "Discharge Measurements at Gaging Stations" (Buchanan and Somers, 1969).

SEDIMENT-SAMPLING TECHNIQUES

The sediment-sampling method and frequency of collection are dictated by the hydrologic and sediment characteristics of the stream, the required accuracy of the data, the funds available, and the proposed use of those data collected. When sampling sediment moving through a stream cross section, emphasis should be placed on the collection of a statistically representative population of the sediment particles in transit. To acquire a representative sample, one must first obtain a sample that adequately defines the concentration of particles over the full depth of the sampled vertical. Secondly, a sufficient number of verticals must be sampled to adequately define the horizontal variation in the cross section. The type of sampler used to collect the sample, the method of depth integration, the site at which the samples are collected, and the number of verticals needed to define the stream's concentration depend on the flow conditions at the time of sample collection, characteristics of the sediment being transported, the accuracy required of the data, and the objectives of the program for which the samples are being collected. The purpose of this section is to discuss site selection; equipment selection and maintenance; depth integration; sediment-discharge measurements; point integration; surface and dip sampling; transit rates; sample frequency, quantity, integrity, and identification; sediment-related data; cold-weather sampling; bed-material sampling; bedload sampling; total sediment discharge; and

reservoir sedimentation. This section then deals with the decisions to be made and the instructions necessary to obtain the quantity and quality of samples required for computation and compilation of the desired sediment records.

Site Selection

The selection procedure for establishing a sampling location should emphasize the quest for a stream-data site. A stream-data site is best defined as a cross section displaying relatively stable hydrologic characteristics and uniform depths over a wide range of stream discharges, from which representative water-quality and sediment data can be obtained and related to a stage-discharge rating for the site. This is a rather idealized concept because the perfect site is rare at best. Therefore, it is necessary to note the limitations of the most suitable site available and build a program to minimize the disadvantages and maximize the advantages. Most often, sampling sites are located at or near existing gage sites, which may not always be well suited to water-quality and sediment-data collection. For this reason, future sites selected for stream gaging should be carefully assessed for suitability as a water-quality and sediment-sampling site.

As indicated, the site should be at or near a gaging station because of the obvious relation of sediment movement to the flow of the stream. If the sediment-measuring site is more than a few hundred feet from the water-stage recorder or at a site other than where the water-discharge measurement is made, it may be desirable to install a simple nonrecording stage indicator at the site so that a correlation of the flow conditions between the sediment and the distant water-measuring sites can be developed. The obvious difficulties with inflow between the sites from small tributaries also should be avoided where possible. Sites that may be affected by backwater conditions should be avoided whenever possible. Backwater affects both the stage-discharge and velocity-discharge relation at the site. Therefore, a given discharge may have varying stage and mean stream velocity and thus have varying sediment transport rates. If a site is affected by backwater, samples will have to be collected more frequently, and the cost in both man-hours and money will be significantly higher than for more "normal" sites.

A sediment-measuring site downstream from the confluence of two streams also may require extra sediment measurements. The downstream site may be adequate for water-discharge measurement, but could present problems if used as a sediment-measuring site due to incomplete mixing of the flows from the tributaries. Therefore, it might be desirable to move far enough downstream to ensure adequate mixing of the tributary flows. As indicated in Book 3, Chapter C1, "Fluvial Sediment Concepts" (Guy, 1970, p. 24), the distance downstream from a confluence that is required for complete mixing depends on the stream velocity, depth, and mixing width. If the flow at a sediment-measuring site is not mixed, extra samples will be required on a continuing basis because the relative flow quantity and sediment concentration from the two tributaries will change with time.

Aside from the confluence or tributary problem, the type of cross section for flow both in the channel and on the flood plain may affect the ease with which data can be obtained and the quality of the samples. The ratio of suspended load to total load and its variation with time can be greatly affected by the width-depth ratio, especially for sand-bed streams. For sites where the data are expected to be correlated with channel properties and the landforms of the region, a normal or average section should be used. When a fixed-routine sampling installation is used, a measuring section at a bend may provide a more stable thalweg and, hence, a more uniform adjustment coefficient with respect to time than one at a crossover. Sites in areas of active bank erosion should be avoided.

As a result of economic necessity, most sediment-measuring sites are located at highway bridges. These bridges are often constructed so that they restrict the flow width, or they may be located at a section where the channel is naturally restricted in width. Figure 26 (Culbertson and others, 1967) illustrates the conditions at several kinds of natural and artificially induced flow constrictions. As expected, the sand-bed type of stream causes the most serious flow problems with respect to scour in the vicinity of such constrictions. Even if the bridge abutments do not interfere with the natural width of the stream, the bridge may be supported by several midstream piers that can interfere with the streamflow lines and, thereby, reduce the effective cross-sectional area. As indicated in figure 26F, midstream piers can catch debris and, thereby, interfere with effective sediment sampling.

Because sediment samples must be obtained more frequently during floods, it is imperative that a site be selected where obtaining data during times of flooding is feasible. That is, particular attention should be given to the ease of access to the water-stage recorder and to a usable bridge or cable during a flood. Because of the need to collect samples frequently during floods, many of which occur at night, sites accessible only by poorly maintained backroads or trails should be avoided. Sometimes the choice of a sediment-measuring site also must be determined by the availability of a suitable observer to collect the routine samples.

In choosing a sediment-measurement site, it should be emphasized that samples need to be collected at the same cross-section location throughout the period of record. Different sampling cross sections can be used, if absolutely necessary, during the low-water wading stage and the higher stages requiring the use of a bridge or cableway. Although the total sediment transported through the different cross sections is probably equal at a given flow stage, the percentage of that total load represented by suspended-sediment load may be drastically different from one cross section to the other, due to differences in hydraulic and sediment-transport characteristics. When data computations are performed, these differences must be considered because the data may not be compatible, and the usefulness of the data in answering the objectives of the sampling program could be threatened. Sites where highway or channel realignment or other construction is anticipated during the period of record should be avoided. Good photographs of proposed or selected sediment-measuring sites are necessary to help document such features as channel alignment, water-surface conditions at various stages, composition of bed and bank material (at low flow), and natural or man-made features, which could affect the water-discharge and (or) sediment-discharge relations. Such pictures and extensive field notes are particularly useful when deciding on alternatives among sites and in later consideration of environmental changes at the site(s).

Equipment Selection and Maintenance

Before departing on a field trip where sediment data are to be collected, a field person should assemble and check all equipment needed to collect the best samples and related measurements. For example, if data are

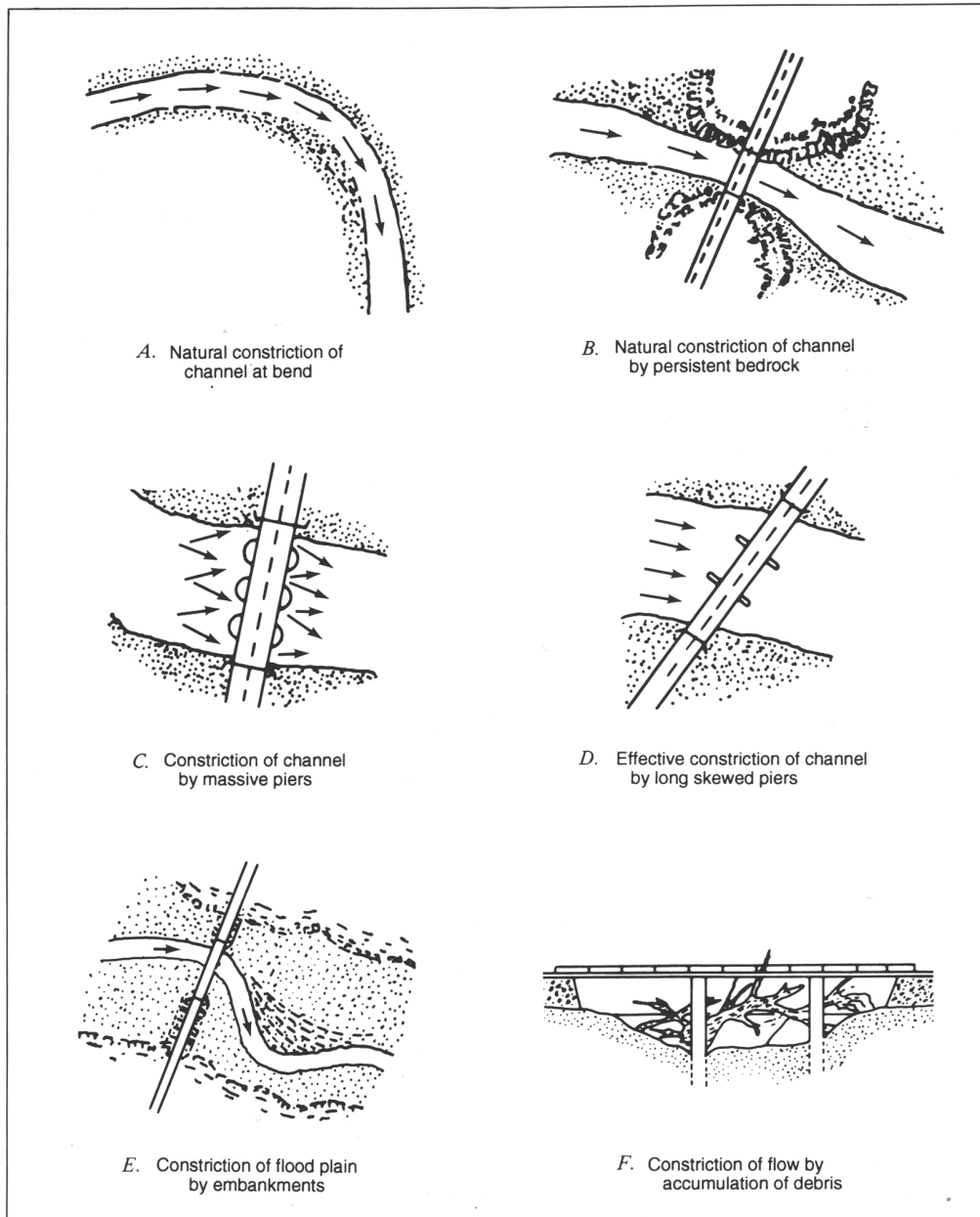

Figure 26. Examples of natural and artificially induced streamflow constrictions encountered at sediment-measurement sites. Modified from Culbertson and others (1967).

needed for total-load computation, equipment is needed for water-discharge measurement, suspended-sediment sampling, bedload sampling, and (or) bed-material sampling. If suspended-sediment concentration and particle-size profiles are required, point samplers and water-discharge-measuring equipment will be needed. Some of the special equipment used only at one location may be stored in the station gage house, with the observer, or in special storage shelters

or boxes. However, a sampler or some support equipment could be damaged or stolen without the observer noticing or reporting the loss. Hence, it is necessary for field personnel to carry repair equipment, spare parts (including nozzles and gaskets), and perhaps even an extra sampler.

The streamflow conditions and sampling structures (bridge, cableway, or other) determine more specifically which sampler or samplers should be used at a

station. Stream depth determines whether hand samplers, such as the DH-48 or the BMH-53, or cable-suspended samplers, such as the D-74 or the P-61, should be used. Depths over 15 feet will require the use of point samplers as depth-integrating samplers to avoid overfilling or using too fast a transit rate. Stream velocity as well as depth are factors in determining whether or not a stream can be waded. A general rule is that when the product of depth in feet and velocity in feet per second equals 10 or greater, a stream's wadability is questionable. Application of this rule will vary considerably among field persons according to an individual's stature and the condition of the streambed. That is, if footing is good on the streambed, a heavier field person with a stocky build will generally wade more easily than will a lighter, thinner person when a stream depth-velocity product approaching 10 exists.

The depth-velocity product also affects the action of each sampler. The larger this product, the heavier and more stable the sampler must be to collect a good sample. At a new station or for inexperienced persons, considerable trial and error may be necessary to determine which sampler is best for a given stream condition.

All sampler nozzles, gaskets, and air exhausts, as well as the other necessary equipment, should be checked regularly and replaced or serviced if necessary. Sampler nozzles in particular should be checked to ensure that they are placed in the appropriate instrument or series. See the guidelines presented in table 1 to determine whether the nozzle is correct. The correct size of nozzle to use for a given situation must often be determined by trial. As mentioned in the previous section, it is best to use the largest nozzle possible that will permit depth integration without overfilling the sample bottle or exceeding the maximum transit rate (about 0.4 of the mean velocity in the sampled vertical for most samplers with pint containers).

If a sample bottle does not fill in the expected time, the nozzle or air-exhaust passages may be partly blocked. The flow system can be checked, as described in the section titled "Gaskets," by sliding a length of clean rubber or plastic tubing over the nozzle and blowing through the nozzle with a bottle in the sampler. This procedure should be performed carefully, avoiding direct contact with the nozzle, thus eliminating the possibility of ingesting any pollutant that might exist on the sampler. When air pressure is

applied in this manner, circulation will occur freely through the nozzle, sample container, and out the air exhaust. Obstructions can be cleared by removing and cleaning the nozzle and (or) air exhaust, using a flexible piece of multistrand wire. This procedure should be adequate for most airway obstruction problems. However, if blockage results from accumulation of ice or from damage to the sampler, a heat source must be used to melt the ice or the sampler must be sent to the F.I.S.P. or HIF repair facility. Point samplers can be checked using the same technique, if the valve mechanism is placed in the sampling position while air is forced into the nozzle and through the air exhaust.

All support equipment required for sampling, such as cranes, waders, taglines, power sources, and current meters, should be examined periodically, and as used, to ensure an effective and safe working condition. For example, be certain that the supporting cable to the sampler or current meter is fastened securely in the connector; if worn or frayed places are noted, the cable should be replaced. Power equipment used with the heavier samplers and point samplers need a periodic operational check and battery charge. Point samplers should be checked immediately before use to determine, among other things, if the valve is opening and closing properly. By exercising such precautions, the field person will avoid unnecessary exposure to traffic on the bridge and will avoid lost sampling time should repairs and adjustments be required.

Maintenance of samplers and support equipment will be facilitated if a file of instructions for assembly, operation, and maintenance of equipment can be accumulated in the field office. Such a file could include F.I.S.P. reports as well as other pertinent information available from HIF.

Suspended-Sediment Sampling Methods

Sediment-Discharge Measurements

The usual purpose of sediment sampling is to determine the instantaneous mean discharge-weighted suspended-sediment concentration at a cross section. Such concentrations are combined with water discharge to compute the measured suspended-sediment discharge. A mean discharge-weighted suspended-sediment concentration for the entire cross

section is desired for this purpose and for the development of coefficients to adjust observer and automatic pumping-type sampler data.

Ideally, the best procedure for sampling any stream to determine the sediment discharge would be to collect the entire flow of the stream over a given time period, remove the water, and weigh the sediment. Obviously, this method is a physical impossibility in the majority of instances. Instead, the sediment concentration of the flow is determined by (1) collecting depth-integrated suspended-sediment samples that define the mean discharge-weighted concentration in the sample vertical and (2) collecting sufficient verticals to define the mean discharge-weighted concentration in the cross section.

Single Vertical

The objective of collecting a single-vertical sample is to obtain a sample that represents the mean discharge-weighted suspended-sediment concentration in the vertical being sampled at the time the sample was collected. The method used to do this depends on the flow conditions and particle size of the suspended sediment being transported. These conditions can be generalized to four types of situations: (1) low velocity ($v < 2.0$ ft/s) when little or no sand is being transported in suspension; (2) high velocity ($2.0 < v < 12.0$ ft/s) when depths are less than 15 feet; (3) high velocity ($2.0 < v < 12.0$ ft/s) when depths are greater than 15 feet; and (4) very high velocities ($v > 12.0$ ft/s).

First case.—In the first case, the velocity is low enough that no sand is being transported as suspended sediment. The distribution of sediment (silt and clay) is relatively uniform from the stream surface to bed (Guy, 1970, p. 15). The sampling error for this case, when only sediment particles less than 0.062 mm are in suspension, is small, even with intake velocities somewhat higher or lower than the ambient mean stream velocities. Therefore, it is not as important to collect the sample isokinetically with fines in suspension as it is when particles greater than 0.062 mm are in suspension. In shallow streams, a sample may be collected by submerging an open-mouthed bottle into the stream by hand. The mouth should be pointed upstream and the bottle held at approximately a 45-degree angle from the streambed. The bottle should be filled by moving it from the surface to the streambed and back. Care should be taken to avoid

touching the mouth of the bottle to the streambed. An unsampled zone of about 3 inches should be maintained in order to obtain samples that are compatible with depth-integrated samples collected at higher velocities.

If the stream is not wadable, a weighted-bottle type sampler may be used. Remember that these samples are not discharge-weighted samples and that, if possible, their analytical results should be verified by or compared to data obtained using a standard sampler and sampling technique.

Second case.—In the second case, when $2.0 < v < 12.0$ ft/s and the depth is less than 15 feet, the standard depth-integrating samplers, such as DH-48, DH-75, DH-59, D-49, and D-74 may be used. The method of sample collection is basically the same for all these samplers, whether used while wading or from a bridge or cableway. Insert a clean sample bottle into the sampler and check to see that there are no obstructions in the nozzle or air-exhaust tube. Then lower the sampler to the water surface so that the nozzle is above the water, and the lower tail vane or back of the sampler is in the water for proper upstream-downstream orientation. After orientation of the sampler, depth integration is accomplished by traversing the full depth and returning to the surface with the sampler at a constant transit rate.

When the bottom of the sampler touches the streambed, immediately reverse the sampler direction and raise the sampler to clear the surface of the flow at a constant transit rate. The transit rate used in raising the sampler need not be the same as the one used in lowering, but both rates must be constant in order to obtain a velocity- or discharge-weighted sample. The rates should be such that the bottle fills to near its optimum level (approximately 3 inches below the top or 350 to 420 milliliters, for the pint milk bottle, or 2 inches below the top or 650 to 800 milliliters for the quart bottle).

For streams that transport heavy loads of sand, and perhaps for some other streams, at least two complete depth integrations of the sample vertical should be made as close together in time as possible, one bottle for each integration. Each bottle then constitutes a sample and can be analyzed separately or, for the purposes of computing the sediment record, concentrations from two or more bottles can be averaged, whereby they are called a set. This set then is a sample in time with respect to the record. Sample analyses from two or more individual bottles for a given

observation are useful for checking sediment variations among bottles—an obvious advantage in the event the sediment concentration in one bottle is quite different from the concentration in the other bottles for the same observation. Immediately after collection, every bottle or sample should be inspected visually by swirling the water in the bottle and observing the quantity of sand particles collected at the bottom. If there is an unusually large quantity or a difference in the quantity of sands between bottles, another sample from the same vertical should be taken immediately. The sample suspected of having too much sand should be discarded. If it is saved, an explanation such as “too much sand” should be clearly written on the bottle. If by chance, a bottle is overfilled or if a spurt of water is seen coming out of the nozzle

when the sampler is raised past the water surface, the sample should be discarded. A clean bottle must be used to resample the vertical.

To help avoid the problem of striking the nozzle into a dune or settling the sampler too deeply into a soft bed, it is recommended that a slow downward integration be used, followed by a more rapid upward integration. Because most of the sand is transported near the bed, it is essential that the transit direction of the sampler be immediately reversed as the sampler touches the bed.

Pertinent information as shown in figure 27 must be available with each bottle for use in the laboratory and in compiling the record. Most districts provide bottles with an etched area on which a medium-soft lead (blue or black) or wax pencil can be used. Other districts use

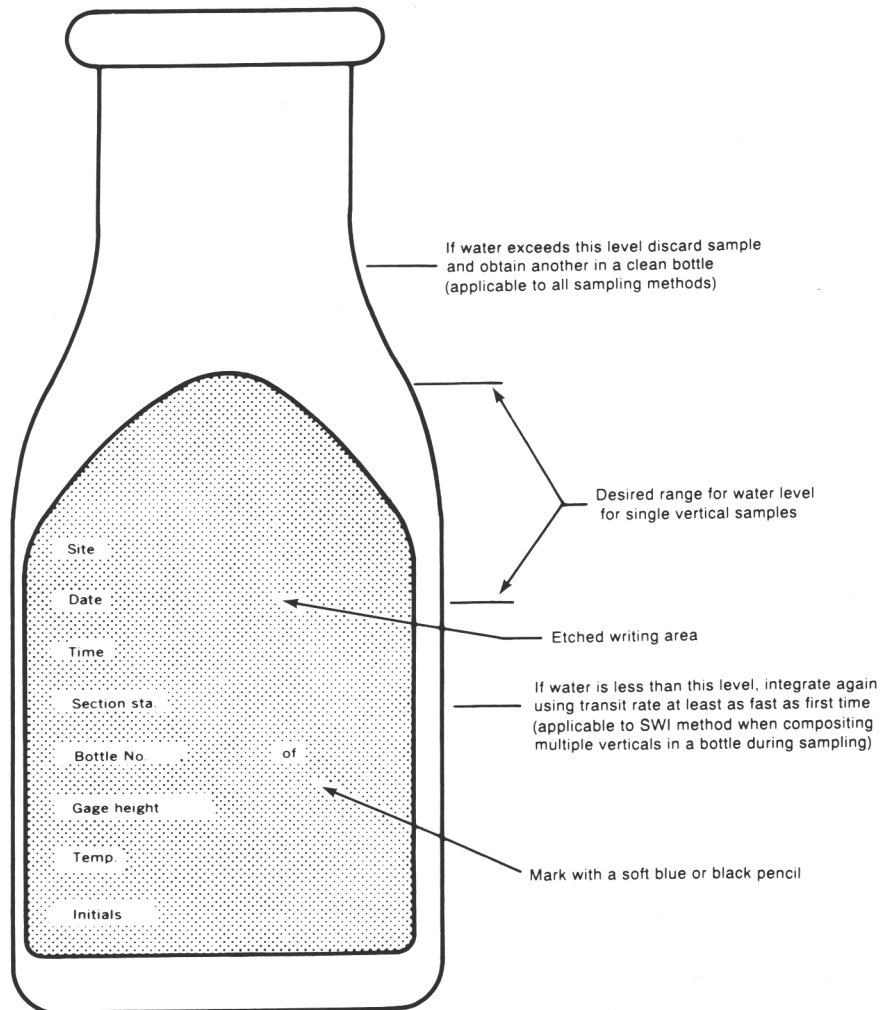

Figure 27. Sample bottle showing desired water levels for sampling methods indicated and essential record information applicable to all sampling methods.

plain bottles and attach tags for recording the required information. The required information may be recorded on the bottle cap if there are no other alternatives, but this should be avoided because of the small writing space and because of the possibility of putting the cap on the wrong bottle. Paper caps should not be used because they do not form as good a seal as do the plastic caps and may allow evaporation of the sample.

Third case.—In the third case, the depth-integrating samplers cannot be used because the depth exceeds the maximum allowable depth for these samplers. In this case, one of the point-integrating or bag-type samplers must be used. Because the bag sampler is still new and sufficient field data have not been collected to verify its sampling efficiency, USGS personnel who wish to use it must contact the Chief, Office of Surface Water, Reston, Virginia, and must set up a comparability sampling system to verify the sampler's efficiency under their specific conditions. The technique for collection of a sample using the bag-type sampler is similar to that used with the depth-integrating samplers.

The point samplers may be used to collect depth-integrated samples in verticals where the depth is greater than 15 feet. For streams with depths between 15 and 30 feet, the procedure is as follows:

1. Insert a clean bottle in the sampler and close the sampler head.
2. Lower the sampler to the streambed, keeping the solenoid closed and note the depth to the bed.
3. Start raising the sampler to the surface, using a constant transit rate. Open the solenoid at the same time the sampler begins the upward transit.
4. Keep the solenoid open until after the sampler has cleared the water surface. Close the solenoid.
5. Remove the bottle containing the sample, check the volume of the sample, and mark the appropriate information on the bottle. (If the sample volume exceeds allowable limits, discard the sample and repeat depth integration at a slightly higher transit rate.)
6. Insert another clean bottle into the sampler and close the sampler head.
7. Lower the sampler until the lower tail vane is touching the water, allowing the sampler to align itself with the flow.
8. Open the solenoid and lower the sampler at a constant transit rate until the sampler touches the bed.

9. Close the solenoid the instant the sampler touches the bed. (By noting the depth to the streambed in step 2 above, the operator will know when the sampler is approaching the bed.)

The transit rate used when collecting the sample in the upward direction need not be the same as that used in the downward direction. If the stream depth is greater than 30 feet, the process is similar, except that the upward and downward integrations are broken into segments no greater than 30 feet. Figure 28 illustrates the procedure for sampling a stream with a depth of 60 feet. Note the transit rate used in the upward direction (RT_3 and RT_4) is not equal to the transit rate in the downward direction (RT_1 and RT_2), but $RT_1 = RT_2$ and $RT_3 = RT_4$. Samples collected by this technique are composited for each vertical, and a single mean concentration is computed for the vertical. In addition to the usual information (fig. 27), the label on each bottle should indicate the segment or range of depth sampled and whether it was taken on a descending or ascending trip.

Samples **must** be obtained at a given vertical for both the downward and upward directions. Tests in the Colorado River (Federal Inter-Agency Sedimentation Project, 1951, p. 34) have shown an increase in the intake ratio of about 4 percent when descending versus a decrease in the intake ratio of about 4 percent on ascent.

Surface and Dip Sampling

Fourth case.—In the fourth case, circumstances are often such that surface or dip sampling is necessary. When the velocities are too high to use the depth- or point-integrating samplers or when debris makes normal sample collection dangerous or impossible, surface or dip samples may be collected.

A surface sample is one taken on or near the surface of the water, with or without a standard sampler. At some locations, stream velocities are so great that even the heaviest samplers will not reach the streambed while attempting to integrate the sampled vertical. Under such conditions, it can be expected that all, except the largest, particles of sediment will be thoroughly mixed within the flow; and, therefore, a sample near the surface is representative of the entire vertical. Extreme care should be used, however, because often such high velocities occur during floods when large debris is moving, especially on the rising part of the hydrograph. This debris may strike or

FIELD METHODS FOR MEASUREMENT OF FLUVIAL SEDIMENT

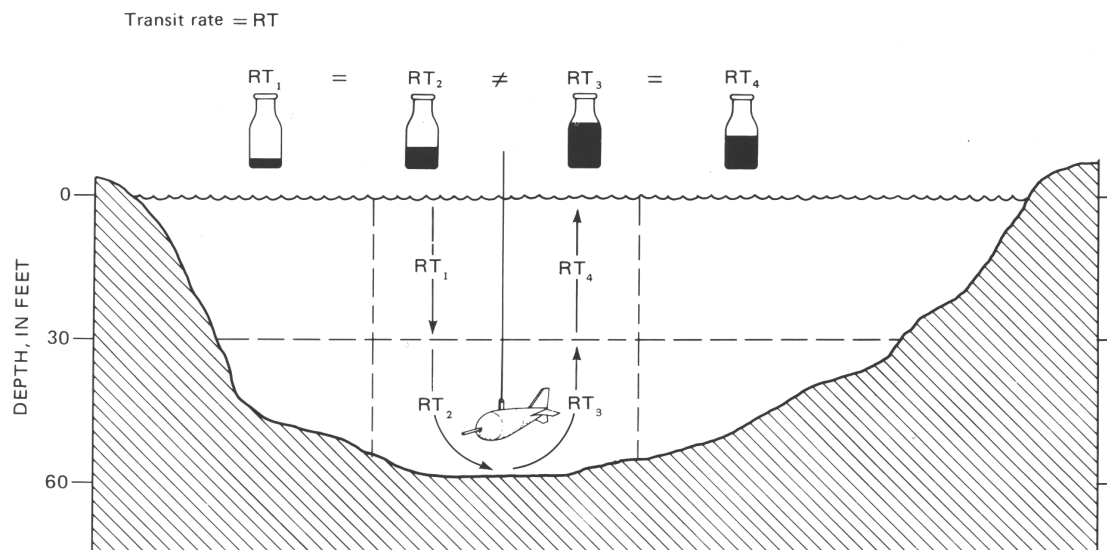

Figure 28. Uses of point-integrating sampler for depth integration of deep streams. RT, transit rate.

become entangled with the sampler and, thereby, damage the sampler, break the sampler cable, or injure the field person. Of course, a full explanation of sampling conditions should be noted on the bottle and in the field notes in order that special handling may be given the samples in the laboratory and in computing the records. The amount of debris in the flow may decrease considerably after the flood crest; even the velocity might decrease somewhat.

Because of the many problems associated with surface and dip sampling, these samples should be correlated to regular depth-integrated samples collected under more normal flow conditions, as soon as possible after the high flow recedes. Along with the depth-integrated sample, a sample should be collected in a manner duplicating the sampling procedure used to collect the surface or dip sample. These samples will be used to adjust the analytical results of the surface or dip sample collected during the higher flow, if necessary, to facilitate the use of these data in sediment-discharge computations and data analyses.

Multivertical

A depth-integrated sample collected using the procedures outlined in the previous section will accurately represent the discharge-weighted suspended-sediment concentration along the vertical at the time of the sample collection. As mentioned before, the purpose of collecting sediment samples is to determine the instantaneous sediment concentration

at a cross section. The question now becomes, how do we locate the verticals in the cross section so that the end result will be a sample that is representative of the mean discharge-weighted sediment concentration?

The USGS uses two basic methods to define the location or spacing of the verticals. One is based on equal increments of water discharge; the second is based on equal increments of stream or channel width.

The Equal-Discharge-Increment Method

With the equal-discharge-increment method (EDI), samples are obtained from the centroids of equal-discharge increments (fig. 29). This method requires some knowledge of the distribution of streamflow in the cross section, based on a long period of discharge record or on a discharge measurement made immediately prior to selecting sampling verticals. If such knowledge can be obtained, the EDI method can save time and labor (compared to the equal-width-increment method, discussed in the next section), especially on the larger streams, because fewer verticals are required (Hubbell and others, 1956).

To use the EDI method without the benefit of previous knowledge of the flow distribution in the sampling cross section, first measure the discharge of the stream and determine the flow distribution across the channel at the sampling cross section prior to sampling. From the discharge measurement preceding the sampling (fig. 30) or from historic discharge-measurement records, equal-discharge increments can

SEDIMENT-SAMPLING TECHNIQUES

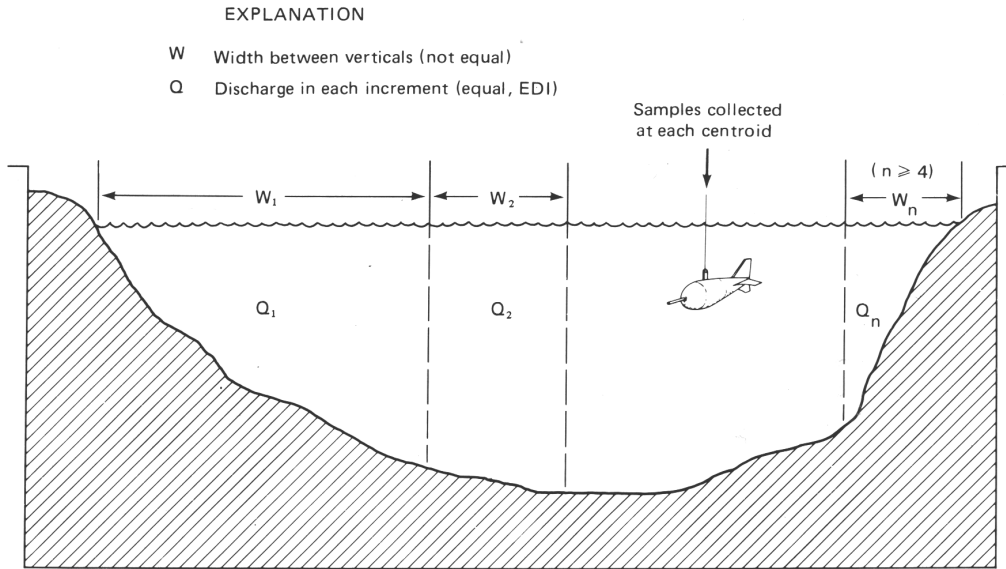

Figure 29. Example of equal-discharge-increment (EDI) sampling technique. Samples are collected at the centroids of flow of each increment.

be determined and centroids at which samples are to be collected can be located. In this example, the total discharge is equal to $166 \text{ ft}^3/\text{s}$ (cubic feet per second). For illustration purposes, it was determined, by methods to be discussed later, that five verticals would be sampled. The equal increments of discharge (EDI's) then are computed by dividing the total discharge by the number of verticals (166 divided by $5 = 33.2 \text{ ft}^3/\text{s}$). The first vertical (A) is located at the centroid of the initial EDI or at a point where the cumulative discharge from the left edge of water (LEW) is one-half of the EDI, in this case 33.2 divided by $2 = 16.6 \text{ ft}^3/\text{s}$.

Subsequent centroids (B, C, and so on) are located by adding the increment discharge to the discharge at the previously sampled centroid; in this example, $A = 16.6 \text{ ft}^3/\text{s}$, $B = A + 33.2 \text{ ft}^3/\text{s}$, $C = B + 33.2 \text{ ft}^3/\text{s}$, and so on. Samples are, therefore, collected at points where the cumulative discharge relative to the LEW is 16.6 , 49.8 , 83.0 , 116.2 , and $149.4 \text{ ft}^3/\text{s}$.

A minimum of four and a maximum of nine verticals should be used when using the EDI method. This method assumes that the sample collected at the centroid represents the mean concentration for the subsection.

To determine the stationing of the centroids, the field person must include a cumulative discharge

column (ΣQ) on the discharge-measurement notes by adding the discharges shown in the "discharge" column and keeping a running total as shown in figure 31. The next step is to estimate the stationing of the above centroids. Each centroid is located at the station in the cross section corresponding to the occurrence of its computed cumulative discharge. As shown in figure 31, the cumulative discharge at station 26 equals $8.32 \text{ ft}^3/\text{s}$, while station 34 corresponds to $18.5 \text{ ft}^3/\text{s}$. Actually, the cumulative discharge is computed to the point midway between stations (far midpoint, fig. 31). Therefore, the point where the cumulative discharge equals $8.32 \text{ ft}^3/\text{s}$ is located halfway between stations 26 and 34, at station 30. In like manner, the cumulative discharge of $18.5 \text{ ft}^3/\text{s}$ occurs at the far mid-point between stations 34 and 42, at station 38. The first centroid then would be located between stations 30 and 38. Interpolating between these stations, the centroid discharge of $16.6 \text{ ft}^3/\text{s}$ would be located at a station closer to station 38, where $18.5 \text{ ft}^3/\text{s}$ occurs, in this case near station 37. Using the same procedure, estimates of centroid stationing yield stations 60, 83, 109, and 144 for the four remaining centroids.

If the cross section at the measurement site is stable and the control governing the stage at the measurement cross section also is stable, previous measure-

River at _____												
Angle coefficient	Dist. from initial point	Width	Depth	Observation depth	Revolutions	Time in seconds	VELOCITY		Adjusted for hor. angle or.	Area	Discharge	
							At point	Mean in vertical			Q	ΣQ
Far	Mid-Point											
14	10	4	0			LEW				0	0	0
22	18	8	.6		15	47		.72		4.8	3.46	3.46
30	26	8	.8		15	44		.76		6.4	4.86	8.32
38	34	8	1.0		25	44		1.27		8.0	10.16	16.60
46	42	8	1.0		30	45		1.48		8.0	11.84	30.32
54	50	8	1.3		25	48		1.16		10.4	12.06	42.38
62	58	8	1.25		20	44		1.01		10.0	10.10	52.48
70	66	8	1.25		20	40		1.11		10.0	11.10	63.58
78	74	8	1.3		20	39		1.14		10.4	11.86	75.44
86	82	8	1.3		25	45		1.24		10.4	12.90	88.34
94	90	8	1.2		20	45		1.24		9.6	11.90	100.24
102	98	8	1.0		20	43		1.04		8.0	8.32	108.56
110	106	8	.9		25	47		1.19		7.2	8.57	117.13
118	114	8	1.0		20	42		1.06		8.0	8.48	125.61
126	122	8	1.0		20	40		1.11		8.0	8.88	134.49
134	130	8	.9		15	43		.78		7.2	5.62	140.11
142	138	8	.8		20	40		1.11		6.4	7.10	147.21
150	146	8	.7		25	44		1.27		5.6	7.11	154.32
158	154	8	.9		25	44		1.27		7.2	9.14	163.46
166	162	8	.8		10	54		.42		6.4	2.69	166.15
170	170	4	0			REW				0	0	166.15
	160	160								152.0	166.15	166
EDI cumulative discharge												
EDI far mid-point centroid stationing												

Figure 31. Discharge-measurement notes used to estimate the equal-discharge-increment centroid locations based on cumulative discharge and far-midpoint stationing.

ments may be used to determine centroids of equal increments of discharge.

By plotting the cumulative discharge versus stations for our example (fig. 32), the stations of the centroids may be read directly from the curve. Their values are 36, 59, 82, 110, and 146 ft³/s, which correspond nicely with our previously estimated values.

A number of these measurements may be plotted on the same sheet (fig. 33) and carried into the field. For discharges that fall between those plotted, the field person can estimate the locations of the centroids by interpolating between the curves.

An alternate method of estimation is to plot cumulative percent of total discharge on the y-axis, instead of cumulative discharge (fig. 34). This method entails one additional step, in that the cumulative percent must be calculated; however, it does have the advantage of showing the variation in stations for the same percentage of flow for different discharges. For example, figure 34 shows that for discharges 86 to 200 ft³/s, the 10-percent centroid (the centroid of the

first 20 percent of flow) can range from station 20 to station 50.

The transit rate used in traversing the distance from water surface to streambed and back to water surface need not be the same in both directions and can vary among centroids. This technique should facilitate collection of approximately equal sample volumes from each centroid (fig. 35).

Individual bottles collected as part of an EDI sample set can be analyzed for concentration separately and their concentrations averaged to give the mean discharge-weighted concentration for the set. The advantage of this method is that data describing the cross-sectional variation in concentration are produced. Additionally, a bottle containing an abnormally high concentration compared to others in the set (due to recirculation or to digging the nozzle into the bed) could be excluded from the concentration calculation where it might seriously affect the results. If approximately equal volumes of sample are collected at each vertical, the samples may be composited prior to analysis.

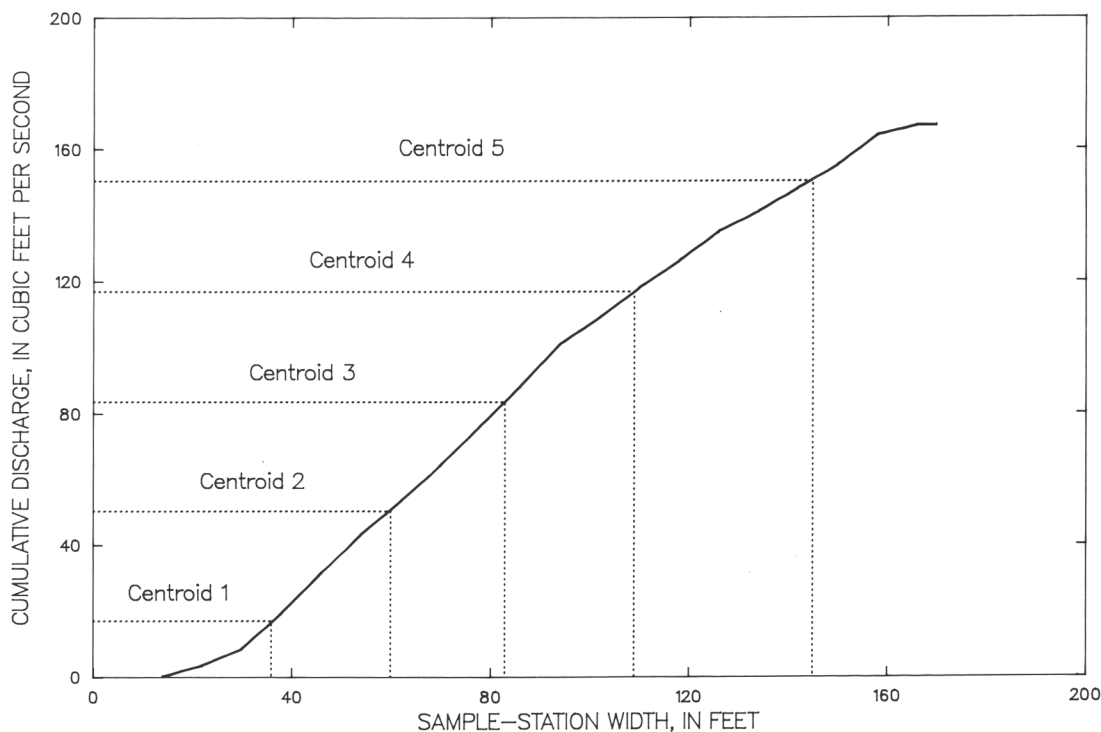

Figure 32. Cumulative discharge versus sample-station widths for determining equal-discharge-increment centroid locations.

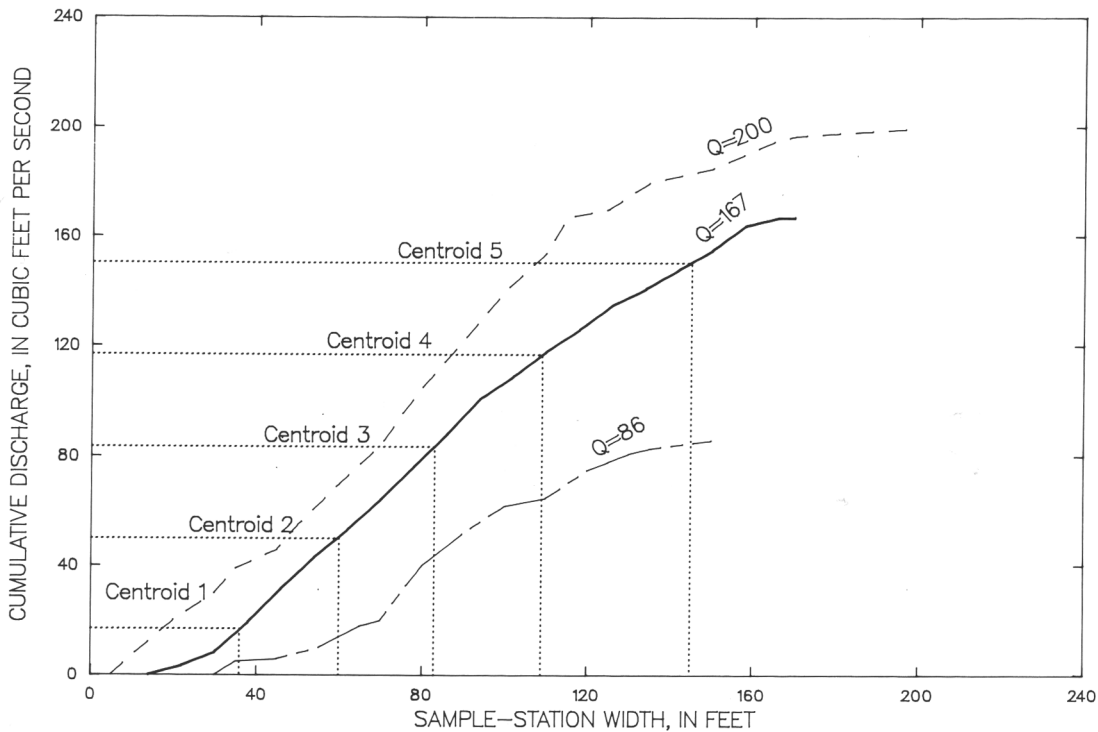

Figure 33. Cumulative discharge versus sample-station widths for determining equal-discharge-increment centroid locations. Multiple discharge-measurement plots allow users to estimate centroid locations by interpolating between curves.

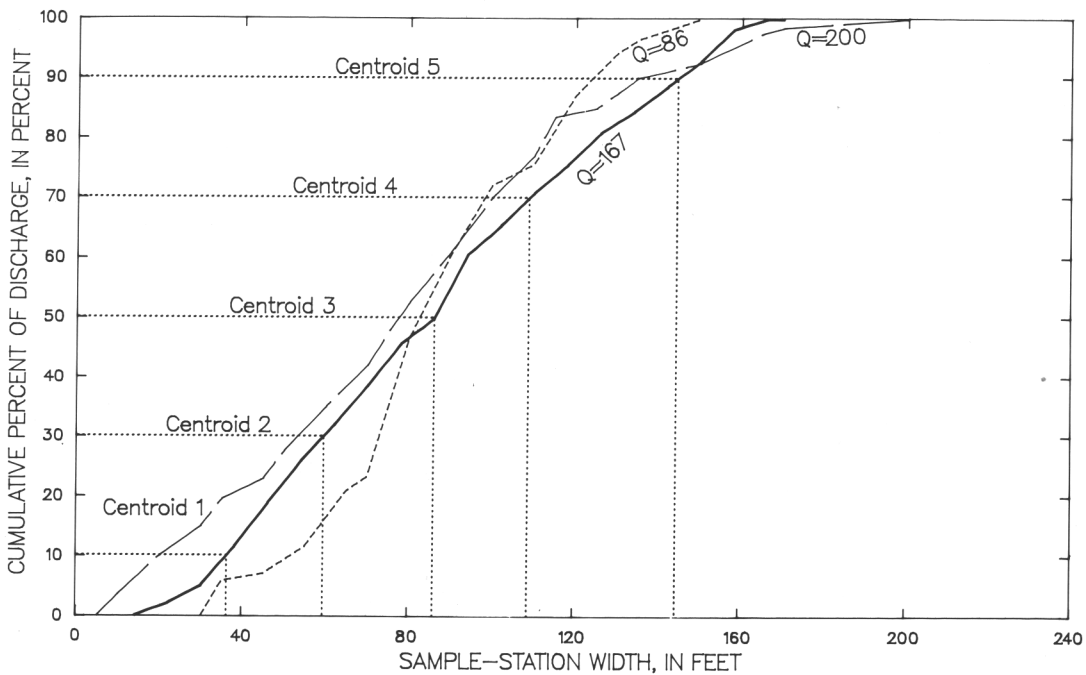

Figure 34. Cumulative percent of discharge versus sample-station widths for determining equal-discharge-increment centroid locations.

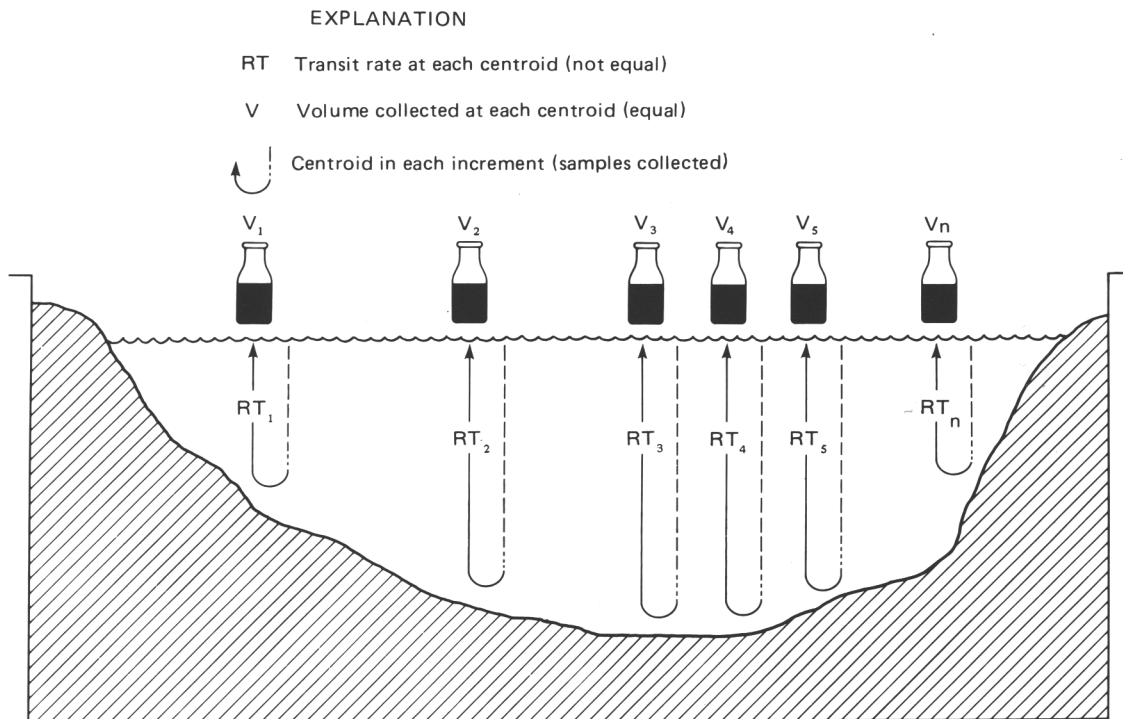

Figure 35. Vertical transit rate relative to sample volume collected at each equal-discharge-increment centroid.

The streambed of a sand-bed stream characteristically shifts radically, at single points and across segments of the width, over a period of weeks or in a matter of hours. This not only makes it impossible to establish cumulative discharge or cumulative percentage of discharge versus station curves applicable from one visit to the next, but also makes it impossible to be certain the discharge distribution does not change between the water-discharge measurement and the sediment sampling (see Guy, 1970, fig. 15).

The Equal-Width-Increment Method

A cross-sectional suspended-sediment sample obtained by the equal-width-increment (EWI) method requires a sample volume proportional to the amount of flow at each of several equally spaced verticals in the cross section. This equal spacing between the verticals (EWI) across the stream and sampling at an equal transit rate at all verticals yields a gross sample volume proportional to the total streamflow. It is important, obviously, to keep the same size nozzle in the sampler for a given measurement. This method was first used by B.C. Colby in 1946 (Federal Inter-

Agency Sedimentation Project, 1963b, p. 41) and is used most often in shallow, wadable streams and (or) sand-bed streams where the distribution of water discharge in the cross section is not stable. It also is useful in streams where tributary flow has not completely mixed with the main-stem flow.

The number of verticals required for an EWI sediment-discharge measurement depends on the distribution of concentration and flow in the cross section at the time of sampling, as well as on the desired accuracy of the result. On many streams, both statistical approaches and experience are needed to determine the desirable number of verticals. Until such experience is gained, the number of verticals used should be greater than necessary. In all cases, a minimum of 10 verticals should be used for streams over 5 feet wide. For streams less than 5 feet wide, as many verticals as possible should be used, as long as they are spaced a minimum of 3 inches apart, to allow for discrete sampling of each vertical and to avoid overlaps. Through general experience with similar streams, field personnel can estimate the required minimum number of verticals to yield a desired level

of accuracy. For all but the very wide and shallow streams, a maximum of 20 verticals is usually ample.

The width of the increments to be sampled, or the distance between verticals, is determined by dividing the stream width by the number of verticals necessary to collect a discharge-weighted suspended-sediment sample representative of the sediment concentration of the flow in the cross section (fig 36). For example, if the stream width determined from the tagline, cableway, or bridge-rail markings at the sample cross section is 160 feet, and the number of verticals necessary is 10, then the width (W) of each sampled increment would be 16 feet. The sample station within each width increment is located at the center of the increment ($W/2$), beginning at a location of 8 feet from the bank nearest the initial point for width measurement. The verticals then are spaced 16 feet apart, resulting in sample stationing at 8, 24, 40, 56, 72, 88, 104, 120, 136, and 152 feet of width. However, in the event the width increment results in a fractional measurement, the width can be rounded to the nearest integer that will yield a whole numbered station for the initial sample vertical. That is, if the increment computation yields a width of 15.5 feet, the nearest integer width would be 16 feet, and the initial vertical would be located at 8 feet from the bank; the stationing would be similar to the previous example. Results of samples obtained using this nonideal stationing will not be measurably affected because alterations in width occur in the increments nearest the streambank, where flow velocity is low compared to midstream increments.

The EWI sampling method requires that all verticals be traversed using the transit rate (fig. 37) established at the deepest and fastest vertical in the cross section. The descending and ascending transit rates must be equal during the sampling traverse of each vertical, and they must be the same at all verticals. By using this equal-transit-rate technique with a standard depth- or point-integrating sampler at each vertical, a volume of water proportional to the flow in the vertical will be collected (fig. 37).

It is often difficult to maintain an equal transit rate when collecting samples while wading. The authors have found the following procedure to be effective in alleviating this difficulty. The field person should hold the sampler at a reference point on the body (for example, the hip), at which level the downward and upward integration is started and finished (even though part of the traverse is in air). The same

reference point should be used at each vertical, allowing the same amount of time to elapse during the round trip traverse of the sampler (regardless of the stream depth encountered). In this manner, the transit rate will remain constant for the entire cross section. It should be remembered that the reference point at which the sampler traverse is started and stopped must be located above the water surface at the deepest vertical sampled and must be the same for each vertical.

Because the maximum transit rate must not exceed $0.4 v_m$ (v_m equals the mean ambient velocity in the sampled vertical) and because the minimum rate must be sufficiently fast to keep from overfilling any of the sample bottles, it is evident that the transit rate to be used for all verticals is limited by conditions at the vertical containing the largest discharge per foot of width (largest product of depth times velocity). A discharge measurement can be made to determine where this vertical is located, but generally, it is estimated by sounding for depth and acquiring a feel for the relative velocity with an empty sampler or wading rod. The transit rate required at the maximum discharge vertical then must be used at all other verticals in the cross section and is usually set to fill a bottle to the maximum sample volume in a round trip. It is possible to sample at two or more verticals using the same bottle if the bottle is not overfilled. If a bottle is overfilled, it must be discarded, and all verticals previously sampled using that bottle must be resampled, using a sufficient number of bottles to avoid overfilling. Note: a sample bottle is overfilled when the water surface in the bottle is above the nozzle or air exhaust with the sampler held level.

Advantages and Disadvantages of Equal-Discharge-Increment and Equal-Width-Increment Methods

Some advantages and disadvantages of both the EDI and EWI methods have been mentioned in the previous discussion. It must be remembered, however, that both methods, if properly used, yield the same results. The advantages of the EDI method are—

1. Fewer verticals are necessary, resulting in a shortened collection time.
2. Sampling during rapidly changing stages is facilitated by the shorter sampling time.
3. Bottles comprising a sample set may be composited for laboratory analysis when equal volumes of sample are collected from each vertical.

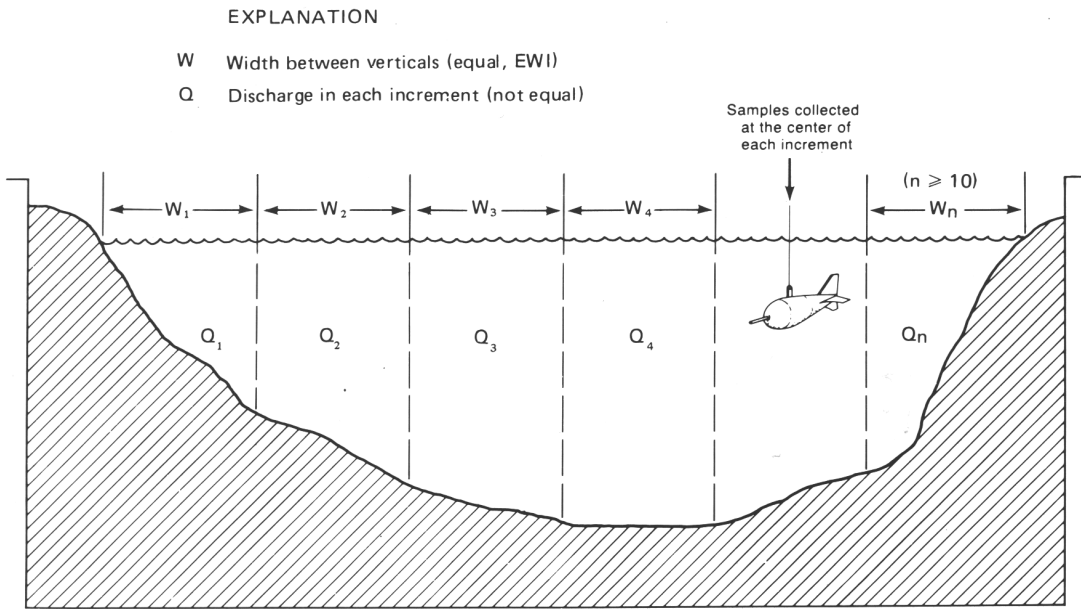

Figure 36. Equal-width-increment sampling technique.

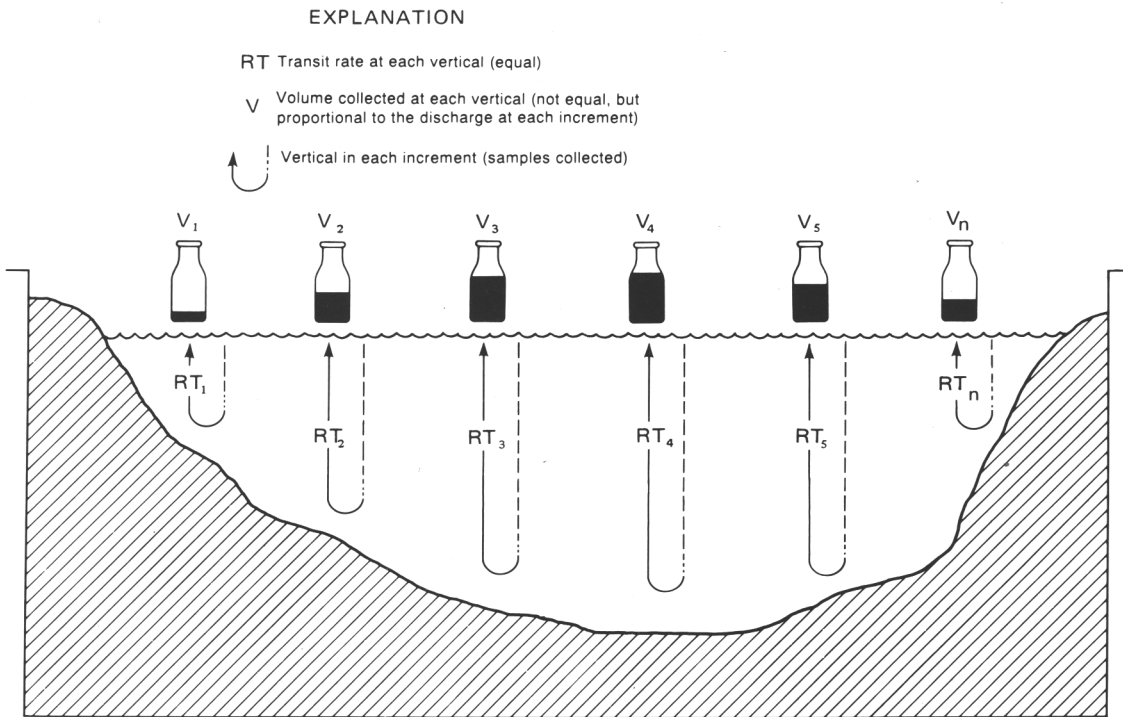

Figure 37. Equal-width-increment vertical transit rate relative to sample volume, which is proportional to water discharge at each vertical.

4. The cross-sectional variation in concentration can be determined if sample bottles are analyzed individually.
5. Duplicate cross-section samples can be collected simultaneously.
6. A variable transit rate can be used among verticals. The advantages of the EDI method are—
 1. Previous knowledge of flow distribution in the cross section is not required.
 2. Variations in the distribution of concentration in the cross section may be better defined, due to the greater number of verticals sampled.
 3. Analytical time is reduced as sample bottles are composited for laboratory analysis.
 4. This method is easily taught to and used by observers because the spacing of sample verticals is based on the easily obtained stream width, instead of on discharge.
 5. Generally less total time is required on site, if no discharge measurement is deemed necessary and the cross section is stable.

From the previous discussion it is obvious that, while both methods have definite advantages, the advantages of one method are, in many cases, the disadvantages of the other. One major disadvantage of the EDI method that should be noted is the inability to adequately distinguish obviously bad samples in the sample set, as illustrated by the following:

Example:

Vertical/bottle	1	2	3	4	5	6
Weight of sediment (g)	0.053	0.036	0.699	0.053	0.047	0.036
Weight of water sediment mixture (g)	350	300	325	330	360	355
Concentration (mg/L)	151	120	2,150	161	131	101
Mean concentration						
EWI and EDI methods (composited) = 457 mg/L						
EDI method (individual bottles analyzed, concentration averaged) = 469 mg/L						
EDI method (individual bottles analyzed excluding bottle 3, concentration averaged) = 133 mg/L						

As this example shows, if the sample were an EDI sample and composited for analysis, the computed

mean concentration is 457 mg/L, which also is the mean concentration if the sample were considered as an EDI sample similarly composited for analysis. If, in the case of the EDI sample, the individual bottles were analyzed, normal computation would result in a mean concentration of 469 mg/L. From the data, bottle 3 appears to have been enriched and is not consistent with the other data points for this cross section. By exercising the flexibility of the EDI method and eliminating the number 3 bottle, the mean concentration of the remaining five bottles is computed to be 133 mg/L, which is probably more consistent with the actual mean concentration in the cross section.

Point Samples

A point sample is a sample of the water-sediment mixture collected from a single point in the cross section. It may be collected using a point-integrating sampler.

Point-integrated samples may be collected using one of the point-integrating samplers previously discussed. Data obtained in this manner may be used to define the distribution of sediment in a single vertical, such as the observer's fixed station, the vertical and horizontal distribution of sediment in a cross section, and the mean spatial sediment concentration.

The purpose for which point samples are to be collected determines the collection method to be used. If samples are collected for the purpose of defining the horizontal and vertical distribution of concentration and (or) particle size, samples collected at numerous points in the cross section, with any of the "P" type samplers, will be sufficient. Normally, 5 to 10 verticals are sufficient for horizontal definition. Vertical distribution can be adequately defined by obtaining samples from a number of points in each sample vertical. Specifically, samples should be taken at the surface, from 1 foot above the bed point, with the sampler touching the bed, and from 6 to 10 additional points in the vertical above the 1-foot-above-bed point. Each individual point sample should be analyzed separately. The results then can be plotted on a cross section relative to their instream location.

If point samples are collected to define the mean concentration in a vertical, 5 to 10 samples should be collected from the vertical. The sampling time for each sample (the time the nozzle is open) must be equal.

This will ensure that samples collected are proportional to the flow at the point of collection. These samples then are composited for laboratory analysis. If the EDI method is used to define the stationing of the verticals, the sampling time may be varied among verticals. If the EWI method is used to determine the location of verticals, a constant sampling time for samples from all verticals must be used.

Number of Verticals

The number of suspended-sediment sampling verticals at a measuring site may depend on the kind of information needed in relation to the physical aspects of the river. For example, to determine the distribution of sediment concentration or particle size across the stream, it is necessary to sample at several verticals. The number of verticals necessary to define such a cross-sectional distribution depends on the accuracy being sought and on the systematic variation of sediment concentration at different verticals across the stream.

As noted previously, suspended-sediment samplers are designed to accumulate a sample that is directly proportional to the stream discharge or velocity. The accumulated sample may be from a point in the stream cross section, a vertical line between the surface and streambed, or several such vertical lines across the entire stream cross section. Such a sample then can be considered to be representative of some element of cross-sectional flow, whether it be a few square feet adjacent to the point sample, a few square feet adjacent to both sides of a vertical line, or the area of the entire flow summed by several vertical lines. The number of verticals sampled must be adequate to represent the cross section in the sample. The number of sample bottles to be collected will depend on the kind of analysis to be made in the laboratory, and the location of the sampling verticals will depend on the concentration and size distribution of sediment moving through the stream cross section.

Both EDI and EWI methods of sediment-discharge measurement obtain a water-discharge weighted sample at each vertical. The volumetric sum from all verticals yields a sample volume proportional to the water discharge for the stream. Remember that all or nearly all of the concentration variations at different verticals across the stream may be the result of non-uniform distribution of sand-sized material and that finer sediments are generally more uniformly

dispersed throughout the section. If the section is close to a tributary, mixing of main stream and tributary flows may not be complete. Therefore, locating sampling sections downstream from tributary inflows should be avoided.

Colby (1964) showed that the discharge of sand is approximately proportional to the third power of the mean velocity, with constant temperature and a given particle-size distribution for a range of velocity from about 2 to 5 ft/s and within some reasonable range of depths. Thus, $Q_s = k_1 v^3$, in which Q_s is the discharge of sand per unit width; k_1 is a constant for a given depth, particle size, and temperature; and v is the mean velocity. The sand discharge can be written as $Q_s = k_2 c v d$, in which k_2 is another constant, c is the mean discharge-weighted concentration in the sampled vertical, and d is the total sampled depth. Solving for c gives

$$c = \frac{k_1}{k_2} \frac{v^2}{d}$$

Thus, the variability of concentration at different sampling verticals should be closely related to the variability of v^2/d . In order to have a v^2/d index useful for comparison among all streams, the compound ratio

$$\frac{v^2 d_{(\max)}}{v^2 d}$$

is suggested,

where $[v^2 d_{(\max)}]$ is the ratio from the vertical having the maximum v^2/d , and v^2/d is the ratio of the mean velocity squared to the mean depth of the whole stream cross section. The mean velocity and mean depth are computed and available from water-discharge measurements.

Based on the v^2/d index concepts of variability, P.R. Jordan used data from Hubbell and others (1956) to prepare a nomograph (fig. 38) that indicates the number of sampling verticals required for a desired maximum acceptable relative standard error (sampling error) based on the percentage of sand and the v^2/d index. In the example illustrated by figure 38, the acceptable relative standard error is 15 percent, the sample is 100-percent sand, the v^2/d index is 2.0, and the required number of verticals is seven. Notice that if the sediment were 50-percent sand, the same results

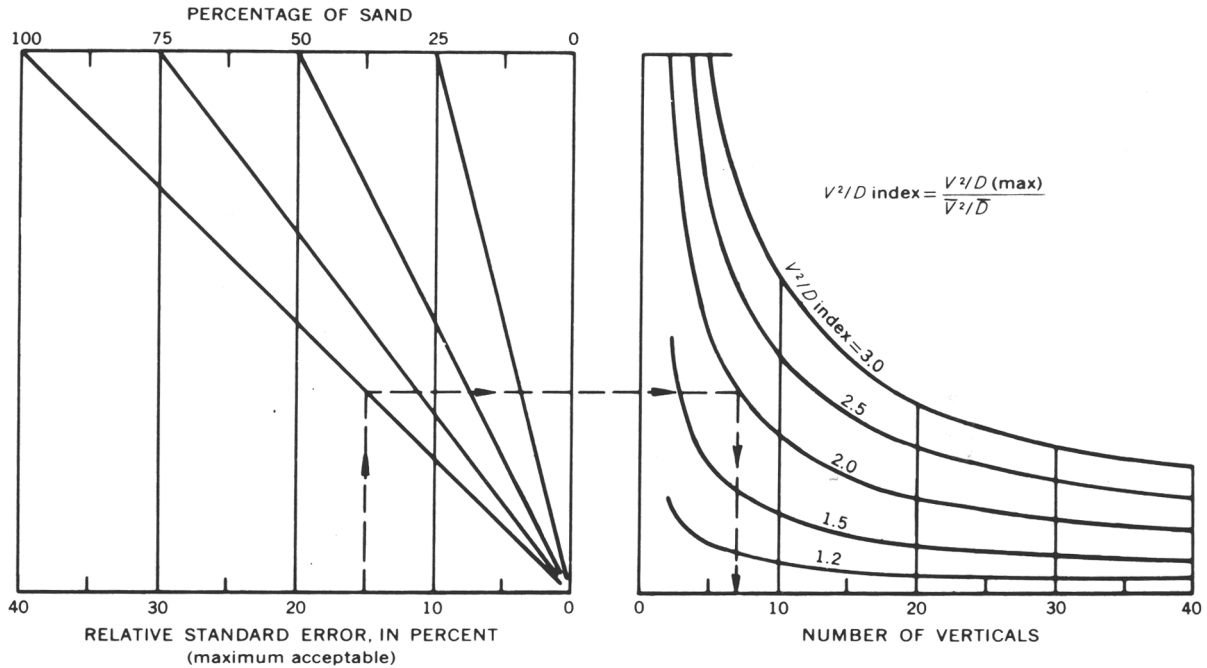

Figure 38. Nomograph to determine number of sampling verticals required to obtain results within an acceptable relative standard error.

could be obtained with three verticals; or, if seven verticals were used with 50-percent sand, the relative standard error would be about 8 percent. When the discharge of sand-sized particles is of primary interest, the 100-percent line should be used regardless of the amount of fines in the sample.

Transit Rates for Suspended-Sediment Sampling

The sample obtained by passing the sampler throughout the full depth of a stream is quantitatively weighted according to the velocity through which it passes. Therefore, if the sampling vertical represents a specific width of flow, the sample is considered to be discharge weighted because, with a uniform transit rate, suspended sediment carried by the discharge throughout the sampled vertical is given equal time to enter the sampler. In previous writings, the point was made to keep the transit rate of the samplers constant throughout at least a single direction of travel.

The maximum transit rate used with any depth-integrating sampler must be regulated to ensure the collection of representative samples. If the transit rate is too fast, the rate of air-volume reduction in the sample container is less than the rate of increase in hydrostatic pressure surrounding the sampler, and water may be forced into the intake or air exhaust.

Additionally, an excessive transit rate can result in intake velocities less than the stream velocity at the intake, due to a large entrance angle between the nozzle and streamflow lines caused by the vertical movement of the sampler in the flow (Federal Inter-Agency Sedimentation Project, 1952). To alleviate these problems, transit rates should never exceed 0.4 of the mean velocity ($0.4 v_m$) in a vertical. Figures 39, 40, and 41 can be used to determine the appropriate transit rate to be used with a given nozzle-size/sample-container-size combination. These figures show that maximum transit rates vary from about $0.1 v_m$ to the approach angle limit of $0.4 v_m$, previously noted. This variation is a function of both nozzle size and sample-container size. The smaller nozzle (1/8 inch) is greatly affected by approach angle intake velocity reductions; figures 39 and 40 show that the transit rate decreases directly with nozzle size. Also, by comparison of figures 39 and 40, it is obvious that transit rates are inversely affected by sample-container size because an increase in sampler container size produces a decrease in allowable transit rate due to the effects of hydrostatic pressure compressing the air within the container during the downward transit. Figures 39, 40, and 41 were constructed using procedures from F.I.S.P. (1952), Report 6, Section 8, as contained in the

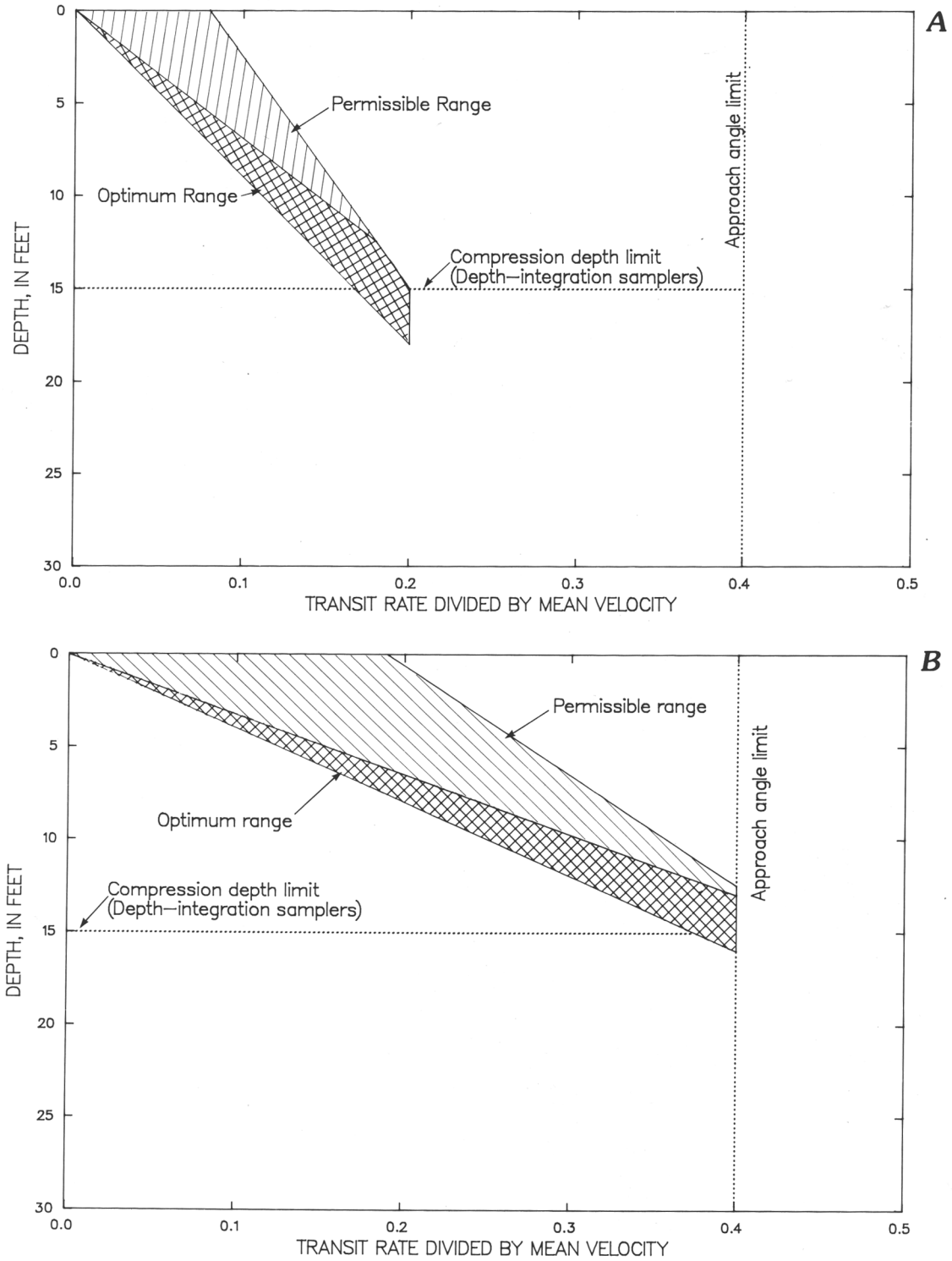

Figure 39. Variation of range of transit rate to mean velocity ratio versus depth relative to nozzle size for pint-size sample container. A, 1/8-inch nozzle. B, 3/16-inch nozzle. C, 1/4-inch nozzle.

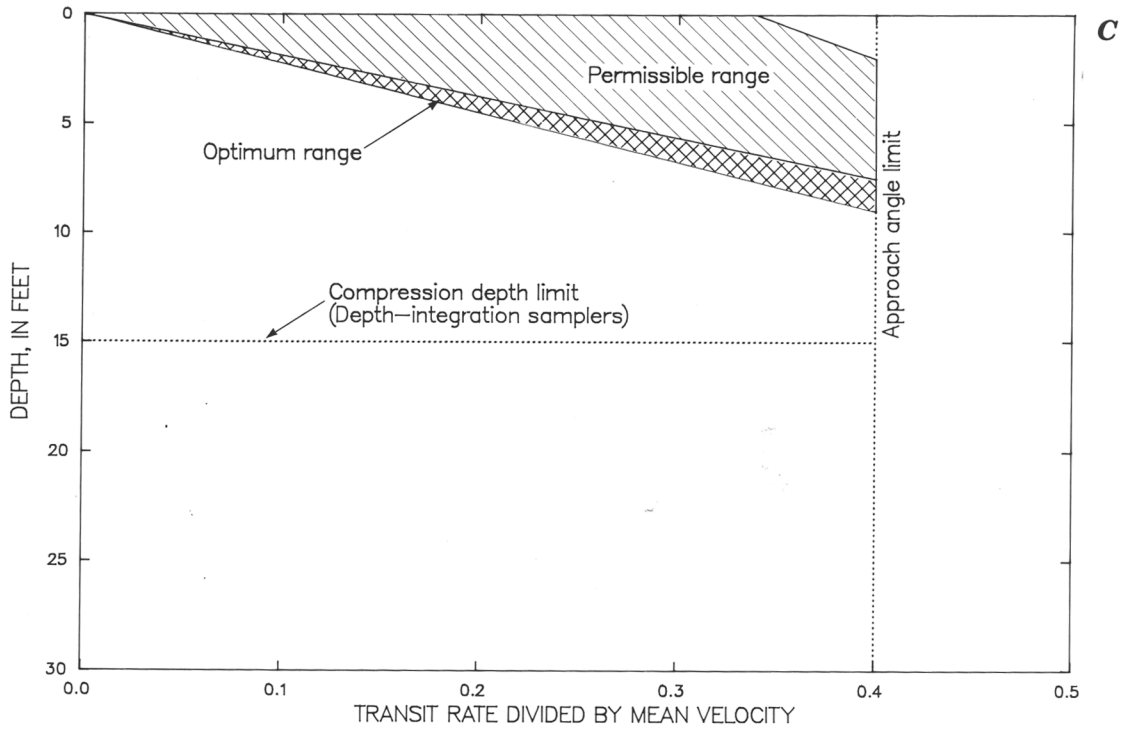

Figure 39. Variation of range of transit rate to mean velocity ratio versus depth relative to nozzle size for pint-size sample container. A, 1/8-inch nozzle. B, 3/16-inch nozzle. C, 1/4-inch nozzle—Continued.

sampling instructions for the D-74 depth-integrating sampler.

Figure 42 is a graphic presentation of the procedure to be followed when constructing transit-rate graphs similar to those presented in figures 39, 40, and 41, using the following nomenclature and equations:

A_n = Area of intake nozzle at entrance; square feet
 1/8 inch = 8.52×10^{-5} , 3/16 inch = 19.2×10^{-5} , 1/4 inch = 34.1×10^{-5} , and 5/16 inch = 53.3×10^{-5}

d_c = Stream depth where bottom compression limit equals surface compression; feet

h_1 = Atmospheric pressure at water surface = 34 feet at sea level

Q_{max} = Maximum sample volume; cubic feet (pint bottle, 420 mL = 0.015 ft^3 ; quart bottle, 800 mL = 0.028 ft^3 ; 3-liter bottle, 2,700 mL = 0.095 ft^3)

Q_{min} = Minimum sample volume; cubic feet (pint bottle, 300 mL = 0.011 ft^3 ; quart bottle, 650 mL = 0.023 ft^3 ; 3-liter bottle, 2,000 mL = 0.071 ft^3)

r_b = Relative velocity near stream bottom; feet per second

RT = Transit rate of sampler; feet per second (rising rate equals lowering rate for EWI method)

r_s = Relative velocity at stream surface; feet per second

V_1 = Volume of container; cubic feet
 1 pint = 0.01671 ft^3 , 1 quart = 0.03342 ft^3 , and 3-liter bottle = 0.105 ft^3

V_m = Mean stream velocity in vertical; feet per second

$$\text{Point 1 } \frac{RT}{V_m} = \frac{A_n r_b h_1}{V_1}$$

$$\text{Point 2 } \frac{RT}{V_m} = \frac{A_n h_s h_1}{V_1}$$

$$\text{Point 3 } d_c = \frac{h_1 (r_s - r_b)}{r_{b+1}} =$$

15 feet, for assumed velocity profile in figure 42.

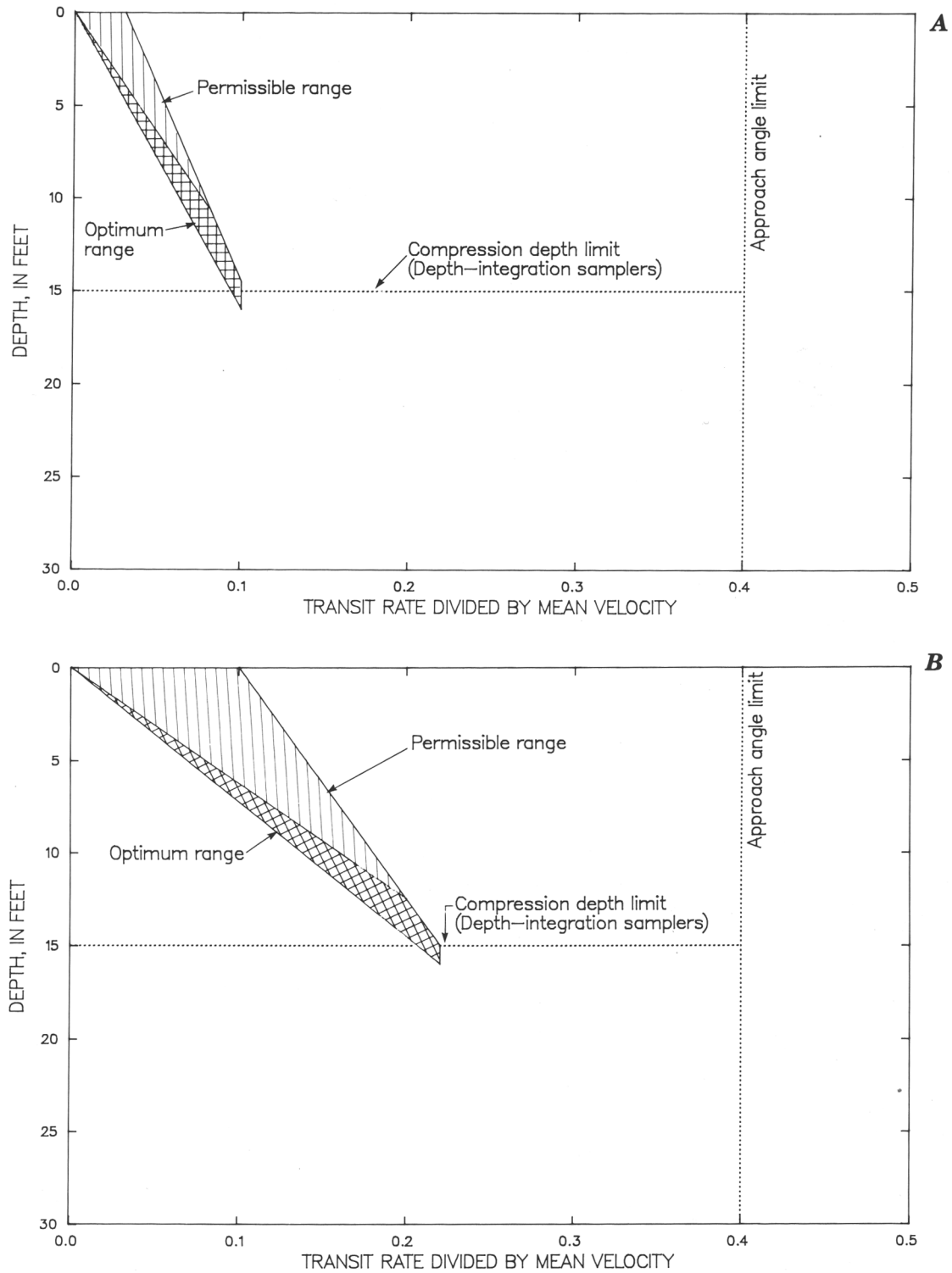

Figure 40. Variation of range of transit rate to mean velocity ratio versus depth relative to nozzle size for quart-size sample container. *A*, 1/8-inch nozzle. *B*, 3/16-inch nozzle. *C*, 1/4-inch nozzle.

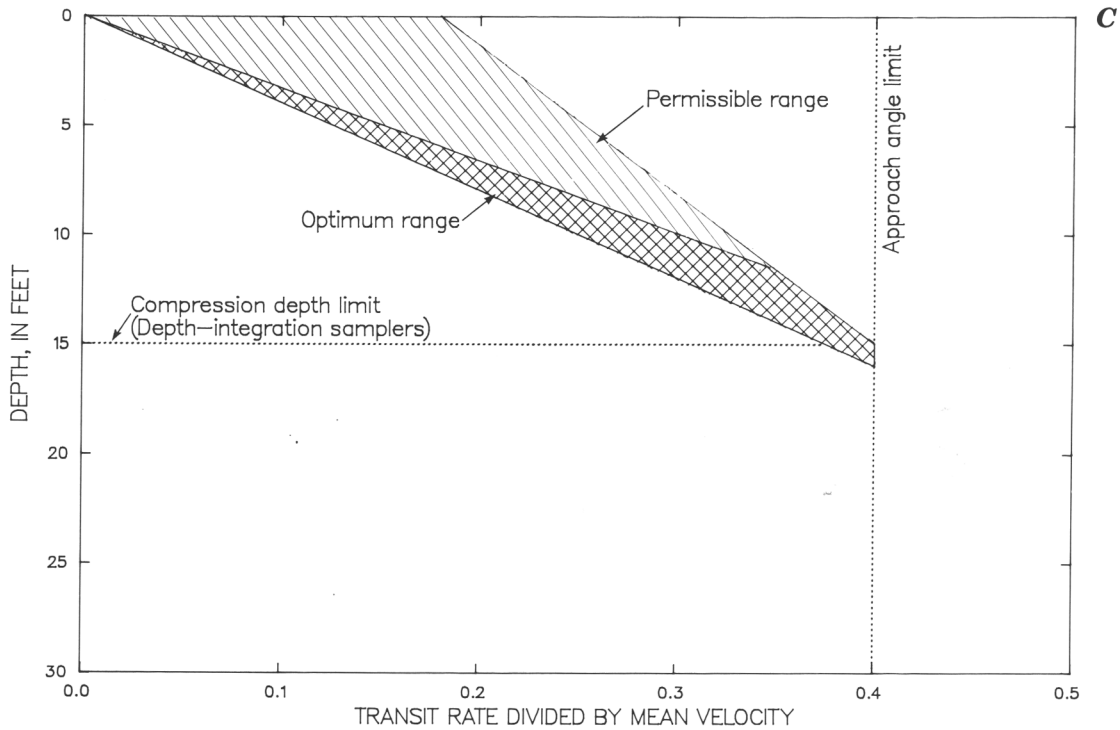

Figure 40. Variation of range of transit rate to mean velocity ratio versus depth relative to nozzle size for quart-size sample container. A, 1/8-inch nozzle B, 3/16-inch nozzle. C, 1/4-inch nozzle—Continued.

$$\text{Point 4 } \frac{RT}{V_m} = \frac{20 A_n}{Q_{max}}$$

$$\text{Point 5 } \frac{RT}{V_m} = \frac{20 A_n}{Q_{min}}$$

For points 4 and 5, the depth is arbitrarily taken at 10 feet to facilitate plotting. Also, the following sample vertical velocity profile is assumed:

Relative depth	Velocity/ mean velocity in vertical
surface	1.16
.1	1.17
.2	1.16
.3	1.15
.4	1.10
.5	1.05
.6	1.0
.7	.94
.8	.84
.9	.67
1.0 bottom	.5

The technique for use of figures 39, 40, and 41 to determine the transit rate to be used in a given situation depends upon (1) the depth of the sample vertical, (2) the mean velocity of the vertical, (3) the nozzle size being used, and (4) the sample-bottle size used in the sampler. An example of transit-rate determination is presented in figure 43. The nozzle size and sample-bottle size must be known so the proper figure can be selected. In this case, a 3/16-inch nozzle and 1-pint bottle will be used. The depth and mean velocity of the sample vertical also must be known. For this example, a depth of 10 feet and mean velocity of 2 ft/s are assumed. To determine transit rate for this example (1) select the depth of the sample vertical (10 feet); (2) draw a line perpendicular to the depth on the vertical scale that terminates at the center of the optimum range; (3) read the value of RT/V_m from the horizontal scale corresponding to this point (0.28); and (4) multiply the RT/V_m value by the mean velocity ($V_m = 2$ ft/s) to determine the transit rate ($RT = 0.56$ ft/s). Note that, if the same nozzle, depth, and mean velocity were used with a quart sample container in lieu of the pint container (fig. 40B), an RT value of 0.30 ft/s would be used, reducing the transit rate by almost one-half.

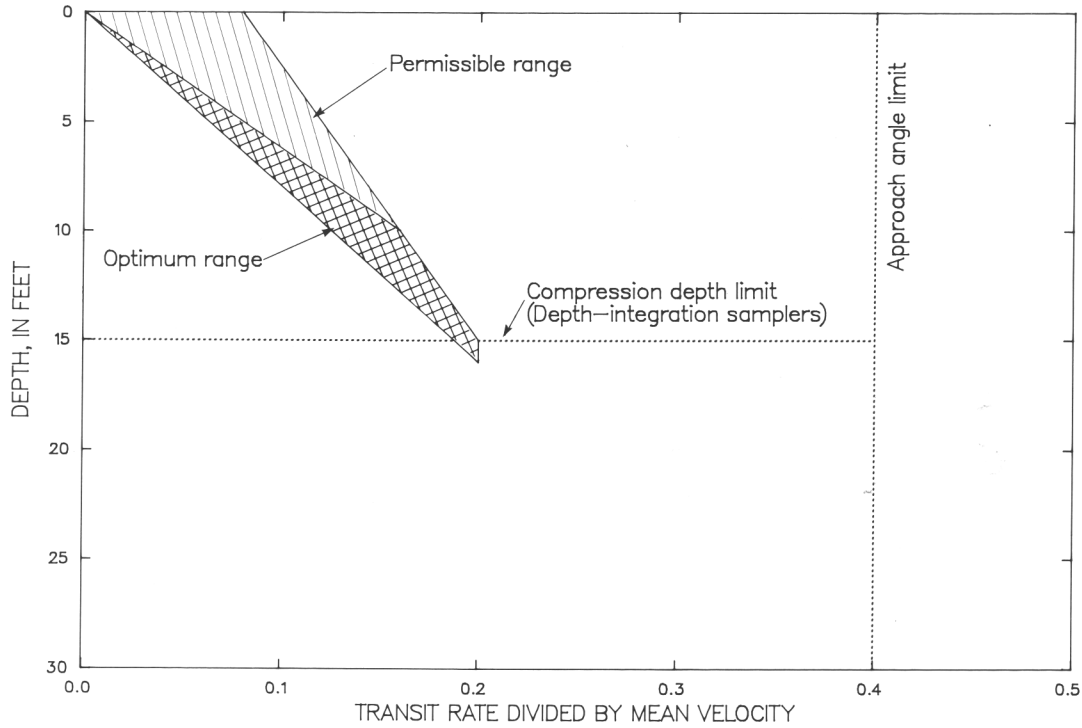

Figure 41. Range of transit rate to mean velocity ratio versus depth for 5/16-inch nozzle on a 3-liter sample bottle.

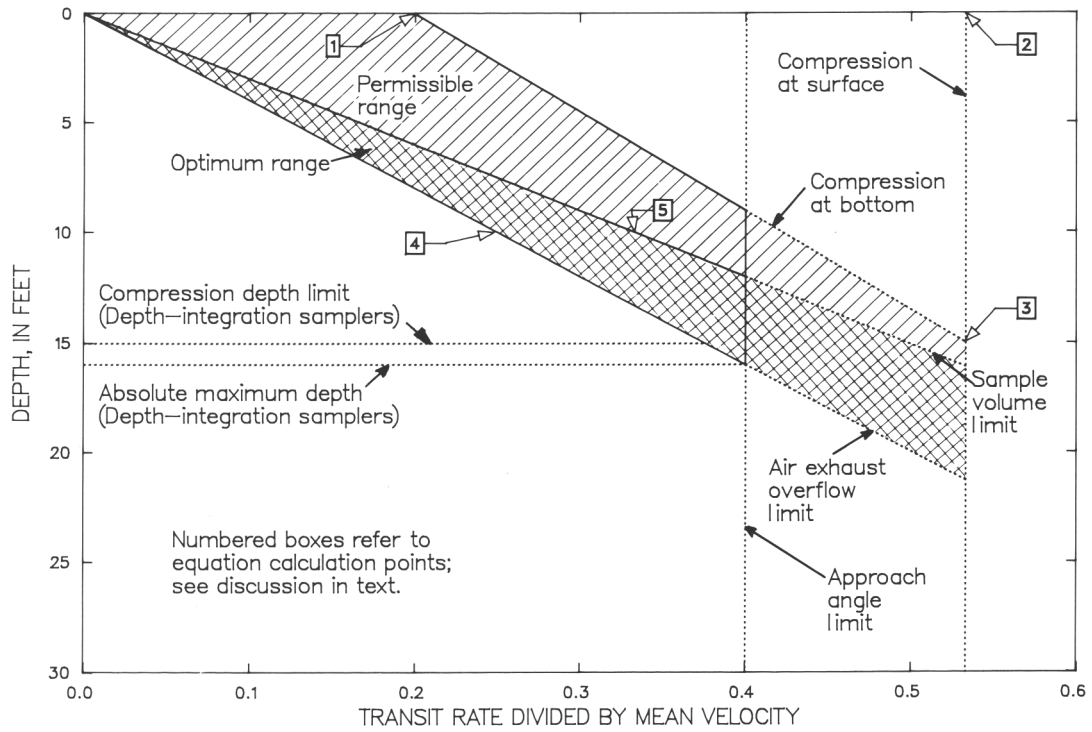

Figure 42. Construction of a transit-rate determination graph (see text for explanation of numbered points).

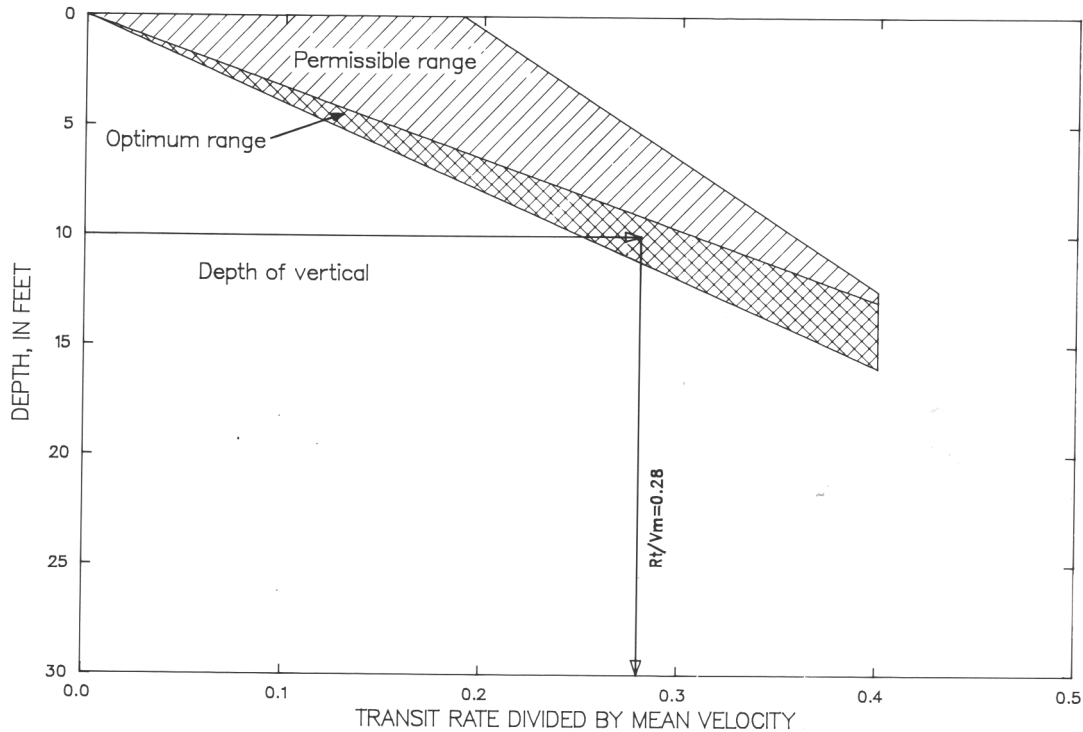

Figure 43. Example of transit rate determination using graph developed for 3/16-inch nozzle and a 1-pint sample container (see text for discussion).

Use of transit rates determined from the optimum range of figures 39, 40, or 41 will yield a representative sample of adequate volume to provide for laboratory analysis and avoid overfilling. In some instances, however, sampler operation within the optimum range is not possible. Under these conditions, operation using a transit rate determined from the permissible range is acceptable. In these cases, it should be realized that a representative sample can still be obtained, but the sample volume may be less than adequate for laboratory purposes and, therefore, more integrations may be required at each vertical to obtain the necessary volume of sample.

Additional explanation and qualifications with respect to the transit rate for depth-integrated suspended-sediment sampling include the following:

1. For cable-suspended samplers, the instantaneous actual transit rate, RT_a , may differ considerably from the computed rate, RT , if V_m exceeds about 6 ft/s and if the sampler is suspended from more than 20 feet above the water surface. Under such conditions, the sampler is dragged downstream, and the indicated depth is greater than the true depth. Corrections for indicated depth are given by Buchanan and Somers (1969, p. 50–56) for various angles and lengths of

sounding line used for suspension of a weight in deep, swift water. The correct depth then would be used to enter in figures 39, 40, and 41 to determine the appropriate transit rate.

2. In theory, the allowable RT may be greater than $0.4 V_m$, and sampling depth thereby increased if the sampler is cable suspended and capable of being tilted somewhat in the direction of vertical movement (that is, nozzle is slightly down when sampler is lowered and slightly up when sampler is raised, due to the effect of vertical forces on the horizontal tail-fin stabilizer). On the other hand, if the sampler cannot be tilted, the velocity at the bottom of the vertical is much less than V_m , and there is a heavy concentration of suspended sand near the bed, the use of an RT value near the $0.4 V_m$ limitation may cause RT to approach or even exceed the actual velocity near the bed and thus cause an excessive error in the collection of sand particles. The approach-angle theoretical depth limits will, of course, be less if either the downward or the upward transit rates, RT_d or RT_u , are different from RT . However, determining the attitude of the sampler during actual use is difficult at best and impossible under turbid flow conditions. For this reason, varying either RT or sampling beyond recommended limits is

not advisable and probably not necessary because small errors during descent will probably be cancelled during ascent.

3. The air-compression lower limit is based on the assumption that a uniform velocity distribution exists throughout the vertical. Actually, the velocity varies with the depth throughout the vertical. Therefore, where the velocity is considerably greater than the mean in the upper part of the vertical, the lower limit could be increased somewhat. In theory, the air-compression lower limit could be effectively increased by using a downward transit rate, RT_d , where RT_d is less than RT , and compensating for the extra filling of the bottle on the downward trip by using an upward transit rate, RT_u , where $RT_u = RT + (RT - RT_d)$. Note: this brief discussion is presented here as an interesting concept and should not be practiced in actual field conditions, where channel configuration and velocity profiles may not represent the ideal flow conditions found in a controlled flume environment.

4. Because of possible greater deviation from the ideal relation of intake velocity to stream velocity of 1.0, the 1/8-inch nozzle should not be used if there are significant quantities of sand larger than 0.25 mm in suspension. The 1/8-inch nozzle also is less reliable than the larger nozzles where small roots and other organic fibers are suspended in the flow.

5. In the event the sampler accommodates other than a pint-sized sample container, the RT should be carefully determined because RT for a quart container may be nearly one-half of that acceptable for a pint container with a given nozzle size. The use of a sample container larger than 1 pint does not, however, increase the sample depth range, due to the air-compression depth limit. Therefore, samples should not be taken from greater than about 15 feet with a depth-integrating sampler.

Observer Samples

At many sites, collection of suspended-sediment data is required on a frequent basis. To define the sediment-discharge trends, these data could be required once daily or more often (in the case of high-flow events). Frequent suspended-sediment data collection can put extreme pressure on a project's fiscal resources as well as on the personnel involved. In order to save money, travel time and, most importantly, to ensure timely collection of data on a

regular basis and during extreme events, local residents are often contracted to work as observers.

Observers usually lack technical background, but can be trained to collect cross-section samples using either the EDI or EWI method. However, due to the complexities involved in computing centroids and a lack of expertise in obtaining the stream discharge for the EDI method, this technique is not recommended for observer-operated sites. Observers most often collect samples from an established single vertical in the cross section, as previously mentioned. The best location in the cross section for a single-vertical sediment sample is determined by data collection. Generally, each new sediment-record site is carefully investigated by means of several detailed sediment-discharge measurements to determine the concentration of sediment across the stream at different discharges. These sediment data can be collected using either the EDI or EWI method.

If the single vertical is used to obtain observer-collected samples, these data must be treated much the same as point-sample data collected with a pumping sampler. That is, cross-section samples must be taken occasionally for comparison with the observer samples in order to establish adjustment coefficients. Samples should be collected at the observer's single-vertical using the observer's equipment, both before and after each cross-section sample is taken. These samples then form the basis for a coefficient that can be used to adjust the concentration of the single-vertical samples. This adjustment coefficient, or comparison of the routine single vertical with the cross section, is determined by computing the ratio of the average concentration of cross-section samples to the average concentration of single-vertical samples. This ratio then can be applied to the daily samples taken between sediment-discharge measurements. If the coefficient is consistently above or below unity, it may be desirable to change the position of the fixed routine sampling installation to a location where the coefficient would be at or near unity. Generally, if the coefficients are within 5 percent of unity, a coefficient of 1.0 is applied, unless they are consistently high or low for long periods of time. Guy (1968) illustrated methods for determining the quality of the coefficient and the number of samples needed in a sample set. Porterfield (1972) gave further details on how coefficients are used in the computation of sediment records.

During high flows, when the depth of the single vertical exceeds the theoretical 15-foot compression

depth limit of the depth-integrating sampler, the observer should try to obtain a sample by altering the technique to collect the most representative sample possible. The best collection technique under these conditions would be to depth integrate 0.2 of the vertical depth ($0.2d$), or a 10-foot portion of the vertical. These samples then can be checked and verified by collecting a set of reference samples with a point-integrating sampler. By reducing the sampled depth during periods of high flow, the transit rate can be maintained at $0.4 V_m$ or less in the vertical, and a partial sample can be collected without overfilling the sample container, even under conditions of higher velocities that usually accompany increases in discharge.

Sampling Frequency, Sediment Quantity, Sample Integrity, and Identification

Sampling Frequency

When should suspended-sediment samples be taken? How close can samples be spaced in time and still be meaningful? How many extra samples are required during a flood period? These are some questions that must be answered because timing of sample observations is as important to record computations (see Porterfield, 1972) as is the technique for taking them. Answering such questions is relatively easy for those who compute and assemble the records because they have the historical record before them and can easily see what is needed. However, the field person frequently does not have this record and certainly cannot know what the conditions will be in the future.

Observers should be shown typical hydrographs or recorder charts of their stations or of nearby stations to help them understand the importance of timing their samples so that each sample yields maximum information. The desirable time distribution for samples depends on many factors, such as the season of the year, the runoff characteristics of the basin, the adequacy of coverage of previous events, and the accuracy of information desired or dictated by the purpose for which the data are collected.

For many streams, the largest concentrations and 70 to 90 percent of the annual sediment load occur during spring runoff; on other streams, the most important part of the sediment record may occur during the period of the summer thunderstorms or during winter storms. The frequency of suspended-sediment

sampling should be much greater during these periods than during the low-flow periods. During some parts of these critical periods, hourly or more frequent sampling may be required to accurately define the trend of sediment concentration. During the remainder of the year, the sampling frequency can be stretched out to daily or even weekly sampling for adequate definition of concentration. Hurricane or thunderstorm events during the summer or fall require frequent samples during short periods of time. Streams having long periods of low or intermittent flow should be sampled frequently during each storm event because most of the annual sediment transport occurs during these few events.

During long periods of rather constant or gradually varying flow, most streams have concentrations and quantities of sediment that vary slowly and may, therefore, be adequately sampled every 2 or 3 days; in some streams, one sampling a week may be adequate. Several samplings a day may occasionally be needed to define the diurnal fluctuation in sediment concentration. Fluctuations in power generation and evapotranspiration can cause diurnal fluctuations. Sometimes diurnal temperature fluctuations result in a snow and ice freeze/thaw cycle causing an accompanying fall and rise in stage. Diurnal fluctuations also have been noted in sand-bed streams when water-temperature changes cause a change in flow regime and a drastic change in bed roughness (Simons and Richardson, 1965).

The temporal shape of the hydrograph is an indicator of how a stream should be sampled. Sampling twice a day may be sufficient on the rising stage if it takes a day or more for a stream to reach a peak rate of discharge. During the peak, samples every few hours may be needed. During the recession, sampling can be reduced gradually until normal sampling intervals are sufficient.

The sediment-concentration peak may occur at any time relative to the water discharge; it may coincide with the water-discharge peak or occur several days prior to or after it. Hydrographs for large rivers, especially in the Midwest, typically show water-discharge peaks occurring several days after a storm event. If the sediment concentration has its source locally, the sediment peak can occur a day or more prior to the water-discharge peak. In this case, the receding limb of the sediment-concentration curve will nearly coincide with the lagging water-discharge peak. In this event, intensive sampling logically

should be done prior to the water-discharge peak. Detailed sampling of hydrograph peaks during the initial stages of a monitoring program will help determine when the sediment-sampling frequency should be increased and decreased in order to optimize the sediment-sampling effort relative to peak-flow conditions.

Intermittent and ephemeral streams usually have hydrograph traces in which the stage goes from a base flow or zero flow to the maximum stage in a matter of a few minutes or hours, and the person responsible for obtaining the samples frequently does not know when such an event is to occur. A sampling scheme should be designed to define the sediment discharge by taking samples during the rising stage, then the peak stage and the recession. Generally, adequate coverage of the peak is obtained if samples on the rising limb are four times as frequent as samples collected during the recession. For example, if the recession is best sampled on a bi-hourly basis, the rising limb should be sampled every one-half hour.

Elaborate and intensive sampling schedules are not required for each and all events on small streams that drain basins of rather uniform geologic and soil conditions because similar runoff conditions will yield similar concentrations of sediment for the different runoff events. Once a concentration pattern is established, samples collected once or twice daily may suffice, even during a storm period (Porterfield, 1972).

Streams draining basins with a wide variety of soils and geologic conditions and receiving uneven distributions of precipitation cannot be adequately sampled by a rigid, predetermined schedule. Sediment concentration in the stream depends not only on the time of year, but also on the source of the runoff in the basin. Thus, each storm or changing flow event should be covered as thoroughly as possible, in a manner similar to that described for intermittent and ephemeral streams.

The accuracy needed in the sediment information also dictates how often a stream should be sampled. The greater the required accuracy and the more complicated the flow system, the more frequently it will be necessary to obtain samples. This increase in sampling frequency—with the added costs of laboratory analysis—greatly increases the cost of obtaining the desired sediment information. Often, however, the record may actually cost less when adequate samples are collected than when correlation and other synthetic

means must be used to compute segments of a record because of inadequate sampling.

Stream-sediment stations may be operated or sampled on a daily, weekly, monthly, or on an intermittent or miscellaneous schedule. Usually, those operated on a daily basis are considered adequate to yield the continuous record. One should be mindful that each sample at a specific station costs about the same amount of money, but the amount of additional information obtained often decreases with each succeeding sample after the first few samples are taken. Sometimes samples obtained on a monthly basis yield more information for the money than those from a daily station, although there is a danger that too little information may be of no value or may even be misleading. For a given kind of record, the optimum number of samples should be a balance between the cost of collecting additional samples and the cost of a less precise record.

The frequency of collection of bed-material samples depends upon the stability of the streambed at the sample site. In many cases, seasonal samples may be adequate to characterize the distribution among particles comprising the bed. However, samples should be obtained whenever possible during high-flow events in order to describe the composition of bed material as compared to its composition during periods of normal or low flow. Particularly important is the collection of bed-material samples following high flows that have inundated the flood plain and greatly altered the streambed configuration.

Sediment Quantity

Previous sections discussed the number of sampling verticals required at a station to obtain a reliable sediment-discharge measurement or a sample of the cross-sectional concentration. The number of cross-sectional samples required to define the mean concentration within specific limits also has been discussed. The requirements in terms of quantity of sediment for use in the laboratory to determine particle-size gradation may at times exceed the other requirements for concentration. The size range and quantity of sediment needed for the several kinds of sediment analyses in the laboratory are given in table 3. The desirable minimum quantity of sediment for exchange capacity and mineralogical analyses is based on the requirements for radioactive cesium techniques described by Beetem and others (1962).

Table 3. The desired quantity of suspended sediment required for various sediment analyses

[mm, millimeter; g, gram]

Analysis	Size range (mm)	Desirable minimum quantity of sediment (g)
Size:		
Sieves:		
Fine.....	0.062–0.5	0.07
Medium.....	0.25–2	.5
Coarse.....	1.0–16	20
Visual accumulation tube:		
Smallest.....	0.062–0.5	.05
Largest.....	0.062–2	5
Pipette.....	0.002–0.062	1.8
Bottom withdrawal tube.....	0.002–0.062	1.5
Exchange capacity:		
Fine.....	0.002	1
Medium.....	0.002–0.062	2
Coarse.....	0.062–2	10
Mineralogical:		
Fine.....	0.002	1
Medium.....	0.002–0.062	2
Coarse.....	0.062–2	5

¹Double the quantities shown if both native and dispersed media are required.

To estimate visually the quantity of sediment entrained in a sample or series of sample bottles requires considerable experience. It also is difficult to determine what portion of the total sample is sands (greater than 0.062 mm) because the proportion can be different from stream to stream and from time to time in the same stream. To aid in estimating such sediment quantities, it is helpful to have, in the office or laboratory, reference bottles with various known quantities and concentrations for visual inspection. The number of bottles of sample, the amount of sand, and sample concentration needed for a given kind of analysis are shown in figure 44 (G. Porterfield, written commun., 1968).

Although it is possible to conduct the laboratory operation for particle-size analysis in a manner that also will give the sediment concentration, it is best to obtain separate samples for size analysis and concentration analysis. Such “special” samples should be plainly labeled. Generally, it is desirable to instruct the

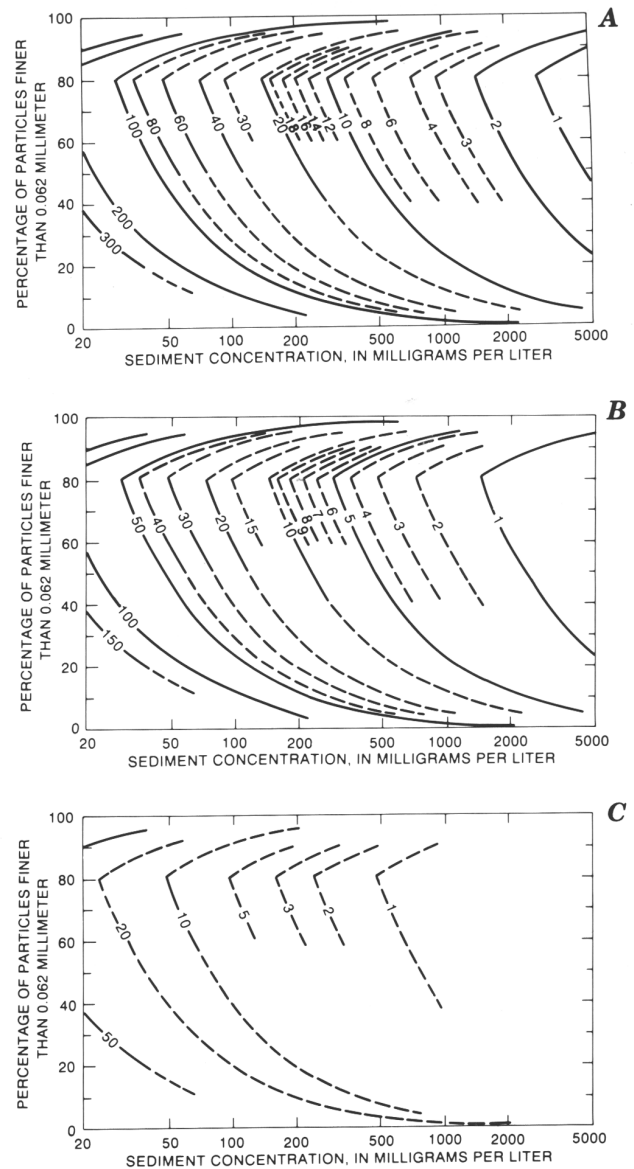

Figure 44. Minimum number of bottles containing optimum sample volume needed to yield sufficient sediment for size analysis (from Porterfield, 1972). A, Pint bottles each containing 400 milliliters with 1.0 gram of sediment. B, Quart bottles each containing 800 milliliters with 2.0 grams of sediment. C, Three-liter bottles each containing 2,400 milliliters with 3.0 grams of sediment.

observer to collect additional samples for particle-size analysis.

Sample Integrity

Every sample taken by a field person should be, as previously indicated, the best sample possible considering the stream conditions, the available equipment,

and the time available for sampling. Because sampling errors on sand-bed streams frequently occur in the dune regime where the nozzle of the sampler can accidentally pick up sand from the downstream side of a dune, each sample bottle must be inspected in the field immediately after removing it from the sampler. The cost of the field and laboratory work, to say nothing of the embarrassment of a bad record, is sufficient incentive to make this simple check and, if necessary, to collect another sample.

After the first bottle is taken, it can be checked by swirling the contents of the bottle, then holding the bottle where the sand on the bottom can be seen moving. A mental note is made of the quantity of sand contained in the bottle. The second and remaining bottles then can be examined and compared with the previous bottles. Any vertical or verticals where a bottle or bottles contain a significantly different quantity of medium and coarse sand should be carefully resampled. If the check sample also contains a noticeably different amount of sand in comparison to others in the set, retain both bottles and note that the high or low concentration of sand is consistent at the vertical or verticals in question. If the check sample contains a smaller or more representative amount of sand, or if the quantity of sand is different from the first but still not normal, it may be desirable to wait several minutes to take a third bottle on the assumption that the dune face would move beyond the sample vertical. This procedure is qualitative, however, and it must be noted that the extremely high errors are more likely to be detected by this method than are small errors.

A more subtle error in sample concentration may occur when a bottle is overfilled. This error also results in too high a concentration, possibly caused by overfilling the sample bottle. Such a sample should be discarded and another sample obtained using an increased transit rate. If the transit rate or the nozzle must be changed to avoid overfilling during an EWI measurement, then it is best to discard any previous samples and resample in clean bottles. The computations required to make use of an EWI measurement having two transit rates are more costly and error prone than the minor expense of discarding samples.

Sample Identification

Although most of the information needed on sample bottles is indicated by figure 27, other informa-

tion may be helpful in the laboratory and in records processing. The field person will need to keep the requirements for such processing in mind so that other explanatory notes can be recorded on the sample or inspection sheets (fig. 45). Such notes, some of which have been mentioned previously, may include:

1. Time—Sometimes operations cross zone boundaries or the use of daylight time may cause confusion.
2. Method or location—Routine vertical, EDI, or EWI cross-section sample.
3. Stationing—Is it one location or sampling vertical, or is the sample an accumulation of several verticals at different locations?
4. Unusual sample conditions—Consistent sampling of sand at this location: surface sample or dip sample.
5. Variation of desired technique—Such as change of transit rate, change of sampling vertical location, depth somewhat beyond capacity of instrument, or transit rate may have exceeded $0.4 V_m$.
6. Condition of stream—Such as boils noted on water surface, soft dune bed, swift smooth water, braided stream, sandbar in cross section, or slush ice present.
7. Location in the vertical—If a point sampler is used for one-way integration, mention which direction the sampler was moving, the depth dividing the integrated portions, and the total depth.
8. Gage height—Note if the inside or outside gage was used. Note any unusual conditions that may affect the reading.
9. Collector's name.

Sediment-Related Data

Water Temperature

Water-temperature data may seem unimportant in comparison with the sediment data. However, it has a growing list of uses besides the need to help evaluate the sediment-transport characteristics of the stream. The temperature or viscosity of the flow affects sediment suspension and deposition and may affect the roughness of a sand-bed stream.

The best or preferred method to obtain the correct water temperature is to submerge the thermometer while wading some distance out in the stream. The thermometer is held beneath the water for sufficient time (about one-half minute) to allow the temperature

UNITED STATES
DEPARTMENT OF THE INTERIOR
GEOLOGICAL SURVEY
WATER RESOURCES DIVISION
INSPECTION SHEET

Sta. No. 11-4810 Date JAN. 14, 1969
 Station MAD RIVER NEAR ARCATA, CALIF.
 Party GAMBLE Disch. 29,000
 Width 191 Area 3000 Vel. 9.70 Time 1000 G.H. 24.65 inside
 G.H. _____ outside

SUSPENDED SEDIMENT SAMPLES: Wading, (cable) ice, boat, upstr., downstr.,
 side bridge _____ feet, mile above, below gage and _____
 Sampler: D-43, (D-49), DH-48, DH-59, P-46, P-61, other _____

Method	Time	G.H.	No. of Vert.	No. of Bottles	Stations
<u>CENT.</u>	<u>1030</u>	<u>24.67</u>	<u>4</u>	<u>8</u>	<u>50, 100, 150, 200</u>

Nozzle size 3/16 in.
 Air: 45° °F at 1045
 Water: 44 °F at 1045
 Weather COOL RAINY
 Flow TURBULENT
 Turbidity _____

BED MATERIAL SAMPLES: Time 1210 G.H. 24.74 No. samples 4
 Sampler: DRAG Wading, cable, ice, boat, upstr., downstr., side
(bridge) 300 (feet) mile above, (below gage) and _____
 Stations 50, 100, 150, 200

Stage: (Rising) falling, steady, peak Peak G.H. 24.77
 Observer: Contacted-yes no _____ Cases-in 3 out 3 res. 6

INSTRUCTIONS: _____

REMARKS: _____

Figure 45. Example of inspection sheet for use by field person to record the kinds of measurements made and the stream conditions observed during a visit to a sediment-measurement site.

of the thermometer to equalize with the water temperature. The stem or the scale of the thermometer is raised out of the water and held so that the etched scale on the stem is at right angles to the line of sight; the temperature then should be read to the nearest one-half degree. The bulb of the thermometer should always remain in the water until after the reading is obtained. The reading of a wet thermometer when exposed to the air may decrease several degrees in a matter of seconds because of evaporation, if the air is dry, or the wind is blowing. Be certain that the location in the stream where the temperature is taken is not affected by the inflow from a spring or tributary.

When it is not possible to wade out into a stream, the water temperature may be taken from a sample bottle. The thermometer should be inserted first into a bottle from near midstream to let the thermometer adjust to the approximate temperature. Then, immediately after removing the next bottle from the sampler, transfer the thermometer from the previous bottle and allow about 15 seconds for the temperature to stabilize. The thermometer should be read while the bulb of the thermometer is submerged. When removing the thermometer from a bottle, lift the thermometer about 2 inches from the bottom and shake slightly to remove sediment from the case of the thermometer. Most freshwaters freeze at 0°C; therefore, if a negative reading is obtained, an error is indicated. Brackish and brine waters freeze at temperatures somewhat less than 0°C, depending on the kind and concentration of ions present.

Stream Stage

As with temperature, stream-stage data may seem insignificant but in reality can be very important. The data may be used to construct missing gage-height records for periods of recorder failure or to verify time of sampling. Gage heights also may serve to indicate whether the observer actually obtained a sample at the time and in the manner indicated by available notes.

Remember that the gage height is defined as the water-surface elevation referred to some arbitrary gage datum. For the gage height to be considered correct, the observer or field person should always note which gage is read. The streamflow and sediment records are computed on the basis of the inside or recording gage. The observer is usually instructed to read only the outside or reference gage. Because of differences in location and the effect of velocity head, it is not

expected that both gages will read the same at a given time, although some relation may exist between them as the stage changes (Buchanan and Somers, 1968; Carter and Davidian, 1968). The field person should record all stream-stage information on the inspection sheet (fig. 45).

The outside reference gage may be one of two types. The most common of those exposed continuously to the flowing stream are the staff gage and the slope gage. Under turbulent flow conditions, these exposed gages should be read by noting the average of several high and low readings made within a period of 10 or 15 seconds. It is necessary to make certain that the observers understand that the scale is divided into hundredths of a foot and not feet, inches, and fractions of an inch, and that they understand the divisions of the metric system if that is used. The other type of outside gage is the wire-weight gage or chain gage that is usually attached to a bridge railing. The weight from this type of gage is lowered so that its bottom breaks the water surface about one-half the time when there are water waves or ripples. For the wire-weight gage, the gage height is read on the scale of the drum at the pointer. For the chain gage, the reading is obtained by reference to the scale provided.

The inside gage height is usually referenced by tape from a float in a stilling well to a pointer. The stilling well is connected hydraulically to the flow of the stream. The inside reference gage should correspond to the gage height being recorded, but, as mentioned previously, it may vary somewhat from the outside gage. If the variance between inside and outside gages is unusually large and the inside gage is lagging the actual gage height of the stream, the intake should be flushed to remove any obstruction caused by sediment accumulation.

The field person should record the inside gage reading at least once each visit to ensure that the gage is working properly. Also, if the observer uses the outside gage, the field person should record the readings from both the outside and the inside gages.

Cold-Weather Sampling

Subfreezing temperatures can cause surface ice, frazil ice, and anchor ice to form on or in a stream and create many difficulties with regard to suspended-sediment sampling. The surface ice usually forms at the edges of the stream first and covers the midstream part last. If it is necessary to use surface ice for support

to make holes for sampling, extreme caution should be exercised because the strength of such ice can be deceiving, especially if weakened during alternating freezing and warm periods. If these auger holes are to be reused later, a cover of wood or some other low-cost insulating material can be used to protect them from refreezing. However, it should be realized that covers of this type may be lost if the weather warms sufficiently for the ice to break up. In some cases (to avoid walking out on the ice or if a warming trend is expected), it may be possible to prevent loss by attaching the cover to a line or to the sampler cable to allow its easy removal. If the sampler cable is used for this purpose, however, the sampler should be secured to or removed from the sampler shelter to avoid its loss by falling through the open bottom of the shelter. Suspended-sediment samplers should never be used to break through seemingly thin ice by dropping the sampler more than 3 or 4 inches because the sampler and nozzle can be damaged by the force of the drop. If the ice will not break by the sheer weight or very gentle drop of the sampler, a hole must be opened by some other means.

If the ice is too thin to safely support a person's weight, it is best not to obtain a sample for 1 or more days because winter samples are generally low in sediment concentration and are, therefore, most certainly not worth the chance of an accident. When the spring breakup occurs, the large slabs of floating ice can easily cause damage to the sampler or the support equipment or injure the operator. Under these conditions, a surface sample may be all that can be obtained between cakes of floating ice. Every effort should be made to obtain such a surface sample because the sediment concentration can, and usually does, change considerably under such conditions.

Frazil ice is composed of the small ice crystals formed at the surface in the turbulent part of the stream. The crystals are formed in a variety of shapes, from slender needles to flat flakes. They do not freeze together because of the swift current, but may bunch together to form a soft mass. This kind of ice may partly or completely clog the intake nozzle of the sampler. Sampling may be best accomplished by moving the sampler swiftly through the layer of frazil ice and then using a normal transit rate to sample the relatively ice-free region below. Often when such ice obstructs the nozzle, it will remove itself when the sampler is brought out of the water, and the only indication that the sample is in error would be that the

quantity of water in the bottle is significantly less than would be expected under normal circumstances.

Anchor ice is formed on the bottom of shallow streams by radiation of heat during the colder nighttime hours. Incoming radiation and the warmer temperatures during the day allow this ice to break loose from the bottom and float to the top to mix with the frazil ice. Sometimes, when the nozzle contains frazil or small pieces of anchor ice as the sampler is brought out of the water, a subfreezing air temperature will cause the ice to freeze tight in the nozzle. If the ice freezes tight to the nozzle or if the sample bottle freezes to the sampler casing, it will be necessary to heat the sampler, by using the heater in the field vehicle, soaking the sampler in a container of warm water, or heating the nozzle and sampler head with a small propane torch. Care must be taken when employing the torch method because the gaskets in the sampler head and plastic nozzles can be damaged by the open flame. Some of these problems can be avoided by the use of two samplers; while one is thawing, the other can be used to sample.

If the sampler or samplers are kept beneath the heater in the field vehicle while the observer drives to the station or from one station to another, the first one or two verticals can be more easily sampled. The observer should be advised and encouraged to remove the nozzle from the sampler and leave the sampler head in the open position after completing the sampling. This will allow the gasket, nozzle, and air vent to dry more completely and may avoid a frozen sampler nozzle or sampler head frozen shut on the next visit.

Aside from the problems with plugged sampler nozzles, a very cold sampler may cause freezing of water between the sample bottle and the inside of the sampler. This problem can be minimized by removing the bottle as quickly as possible from the sampler after the integration is complete; otherwise, it may be necessary to heat the sampler as described above. It also should be obvious that samples in glass bottles must be protected from freezing after the measurement and during transport to the laboratory. Freezing itself does not harm a sample for sediment analysis, but a broken bottle will obviously result in loss of the sample.

If an extensive sampling program is to be carried out during the winter months in areas of extreme cold, it is advisable for the investigator to obtain DH-75 and D-77 samplers. These samplers are designed to be used in freezing conditions, as previously discussed.

Several sample bottles and nozzle and cap assemblies can be taken to the site, where they can be easily changed if nozzle or air-exhaust freezeups occur during sampling.

Bed-Material Sampling

Data on the size of material making up the streambed (across the entire channel, including flood plains) are essential for the study of the long-range changes in channel conditions and for computations of unmeasured or total load.

Materials Finer Than Medium Gravel

Selection of a suitable bed-material sampler is dependent on the size of bed material to be sampled, and on stream depth and velocity. When a stream can be waded, the most practical of the standard samplers is the BMH-53 or BMH-80 (figs. 15 and 17). When sampling from a boat, these samplers can be used to depths of about 4 feet.

In use, the BMH-53 is placed in a vertical position on the streambed with the piston extended to the open end of the cylinder. The cylinder then is pushed a full 8 inches into the bed while the piston is held at the bed surface. Complete filling of the cylinder will help ensure a minimum of disturbance of the top 1 or 2 inches when the sampler is raised through the flow. When coarse sand or gravel material is being sampled, it is often necessary to pull on the piston rod while pushing on the cylinder. By pulling on the piston, a partial vacuum is created above the sample, which helps draw the sample into the cylinder. The sampler then is withdrawn from the bed and held in an inclined position above the water with the cylinder end highest. For most purposes, only the upper inch of material nearest the surface of the streambed is desired or needed in an analysis. This is obtained by pushing on the piston while the sampler is still inclined until only 1 inch of material remains in the tube. Any excess material is removed by smoothing off the end of the cylinder with a spatula or a straight pencil. The material left in the sampler is ejected into a container (usually a paper or plastic carton). An experienced field person can composite samples from the entire cross section into just a few cartons. The inexperienced field person would do well to use a separate container for each vertical. Before storing the sampler, it should be rinsed by stroking the piston a few times

in the stream to remove sediment particles from the cylinder and piston seal.

The BMH-80 is used in a manner similar to that of the BMH-53. The sampler is extended to the streambed with the bucket in the open position. After the sampler contacts the bed material, the field person should keep a firm downward pressure on the sampler while closing the sample bucket, thus trapping a shallow sample of the streambed. This sampling procedure should be repeated until the streambed has been representatively sampled.

If the stream is too deep or swift for the BMH-53 or BMH-80, the BMH-60 or the BM-54 can be used. The 30-pound BMH-60 is easiest to use when stream velocities are under 2 or 3 ft/s and depths are less than about 10 feet. To use the BMH-60, suspend the entire weight of the sampler by the hanger rod and cock the bucket in the open position with the allen wrench provided. The energy thus imparted to the spring and the sharp edge of the bucket make it obvious that one must keep hands away from the bucket opening at all times. If necessary, the safety yoke may be fastened around the hanger bar while opening and cocking the bucket. After the safety yoke is removed and fastened to the tail, the sampler then can be lowered by hand or by cable and reel to the surface of the streambed. Any jerking motions made while lowering the sampler that would cause the cable to slack may release the catch and allow the bucket to close prematurely. This can happen if the water surface is struck too hard. After the cocked sampler touches the streambed and tension is released on the line, the sampler should be lifted slowly from the bed so the bucket will scoop a sample.

To remove the sample from the bucket, a carton or container is positioned under the sampler, and the bucket is opened with the allen wrench. The sampler need not be held by the hanger bar during sample removal unless considerable material is clinging to the flat plate within the bucket cavity. If removal of such material is required, the bucket should be cocked in the open position and the sample brushed into the container with a stick or small brush. When moving the sampler between verticals and when storing it in the vehicle, the bucket should be in the closed position to avoid an accidental closing and to reduce the tension on the spring. If the bucket is closed for transport as suggested, a stick, a piece of tire, or similar material should be used to cushion the force of the bucket when it is closed because the closing force is sometimes great enough to break welded joints in

the mechanism (J.V. Skinner, Federal Inter-Agency Sedimentation Project, written commun., 1985).

The 100-pound BM-54 is used when velocities are greater than 2 or 3 ft/s and depths are greater than 10 feet. The BM-54 sampling action, described previously, is similar to the BMH-60, except that the bucket opens front to back. It is used only with a cable-and-reel suspension and is rather awkward to handle when removing the sample. The techniques for taking a sample with the BM-54 are essentially the same as for the BMH-60. One important difference in operation is the use of a safety bar on the BM-54 to hold the bucket in an open position instead of the safety yoke as on the BMH-60. As noted earlier, the sampler should be stored with the bucket in a closed position and, if extended storage is anticipated, the tension on the spring should be further reduced.

A BM-54 can be used in extremely high velocities if a C-type weight is attached to the hanger bar above the sampler. If additional weights are required with the BM-54, extreme care should be taken to avoid bending and possibly breaking the hanger bar between the sampler and the C-type weight.

Personnel of F.I.S.P. have developed a heavy bed-material sampler (the BM-84, which weighs about 160 pounds). The P-61 point-integration sampler body is used to provide a large mass. The streamlined body configuration is fitted with a spring-driven sample scoop that is activated by a solenoid system similar to that used on point samplers. Otherwise, the sampler is similar to, and performs the same function as, the BM-54. The design is an attempt to cope with bed-material sampling problems encountered in the vicinity of Mount St. Helens volcano (J.V. Skinner, Federal Inter-Agency Sedimentation Project, oral commun., 1984). The weight of this configuration is increased by filling void space within the sampler body to increase the cross-sectional density of the sampler, thus increasing its stability in deep, high velocity conditions.

As previously discussed, other sampling equipment is available commercially—for example, the ponar sampler and core samplers, such as the vibra-core unit and gravity corer. These samplers can be very useful; however, careful planning of the proposed sampling project and analytical methods is essential to obtaining a representative sample and reliable data.

Materials Coarser Than Medium Gravel

Gravels in the 2- to 16-mm range can be analyzed by mechanical dry sieving; in order to obtain a representative particle-size distribution, the size of the sample to be collected must be increased with particle size. Large sediment sizes (>16 mm) are difficult both to collect and to analyze. The method now used for size determination of these very large particles involves a pebble count, in which at least 100 pebbles from a wadable streambed are manually collected and measured. A fixed grid pattern locating the sampling points can be paced, outlined by surveys, or designated by small floats. At the intersections of the fixed grid pattern, the pebble underlying the field person's toe is retrieved, and a measurement is made of the long, intermediate, or short diameters, or all three. The measurements are tabulated as to size interval, and the percentage of the total of each interval then is determined (Wolman, 1954).

Because the pebble-count method entails the measurement of the dimensions of randomly selected particles in the field, it is laborious and usually limits the number of particles counted. Too often this results in an inadequate sample of the population,

Another method for analyzing coarse particles involves the use of an instrument known as the Zeiss Particle Size Analyzer (Ritter and Helley, 1968). For the Zeiss technique, a photograph of the streambed is made during low flow with a 35-mm camera supported by a tripod about 2 meters above the streambed—the height depends on the size of the bed material. A reference scale, such as a steel tape or surveyor's rod, must appear near the center of the photograph to provide a size reference.

In the laboratory, particle diameters are registered cumulatively or individually on exponential or linear scales of size ranges (Guy, 1969). After the data are tabulated, the sizes registered on the counter of the particle-size analyzer must be multiplied by the reduction factor of the photograph, which is calculated from the reference scale in the photograph.

In nonwadable streams, a pipe dredge is useful in sampling these large particles. However, this method entails the use of equipment capable of handling extremely heavy loads and requires special attention to safety during operation.

Location and Number of Sampling Verticals

Bed-material samples are often collected in conjunction with a discharge measurement and (or) a set of suspended-sediment samples. If the discharge measurement and (or) the suspended samples are taken first, the bed-material samples should be collected at the same stations, but not necessarily from the same number of stations. By taking them at the same stationing points, any change in bed material or radical change in discharge across the stream that would affect the sediment-discharge computations can be accounted for by subdividing the stream cross section at one or between two of the common verticals.

To avoid collection of bed-material samples from an excessively disturbed streambed, it is best to obtain the bed-material samples prior to making other measurements, especially in wadable streams. Also, by taking the bed material first, radical changes across the section in bed-material size and water discharge can be used as a basis for choosing desirable verticals for other measurements.

Most results from bed-material samples will not be noticeably affected, but it should be remembered that the sample taken with the BMH-53 or other core sampler is different from that taken with the BMH-60, BMH-80, and the BM-54. The cross section of the BMH-53 or other core sampler is constant with depth so that each increment of sample with depth is equally represented by volume. The curved buckets of the BMH-80, BMH-60, and BM-54 do not sample equal volumes of material with depth; instead, the bottom one-half inch of the 2-inch-deep bucket contains only 15 percent of the total sample, whereas the upper one-half inch contains 33 percent of the sample.

The number and location of bed-material samples required at a cross section must be adequate to provide a representative statistical population. This population should include samples collected from the entire cross section. To obtain this population, the logical procedure is to use the results from a rather detailed set of 10 to 20 uniformly spaced bed-material samples taken from the cross section. Some studies may require that flood-plain deposits be represented in the bed-material sampling scheme to get a representative population.

Sample Inspection and Labeling

As samples are obtained across the stream, the field person should visually check and compare each sample with the previous samples to see if the material varies considerably in size from one location to the next. Samples of different sizes and (or) weight should not be composited. If a given sample does contain considerable coarser or finer material, another sample should be obtained about a foot from the original location. If, after two or three tries in the vicinity of the first sample, no appreciable difference is noted, the first sample should be retained. Small deposits of material that are coarser or finer than most of the bed material are not considered representative of the bed-material size for the stream cross section.

Proper labeling of bed-material samples is not only necessary for future identification but also provides important information useful in the laboratory analysis and the preparation of records. Information desired on each bed-material sample carton should include:

- Station Name
- Date
- Time
- Gage height
- Water temperature
- Stationing number
- Bed form and flow conditions
- Carton number of the set
- Kind of sampler used
- Purpose of sample or special instructions for analysis and computations
- Initials of field person

Bedload Sampling Technique

The sediment moving in the unsampled zone (see fig. 1) comprises suspended sediment and bedload. Bedload is the sediment that moves by sliding, rolling, or bouncing along on or within a few grain diameters of the streambed.

Although many investigations have provided extensive knowledge in the areas of how bedload moves in a channel and how pressure-differential bedload samplers operate, a great deal more work in these areas is needed. The following paragraph, taken from Hubbell (1964, p. 2), is still appropriate:

In the past, attempts have been made to determine the bedload discharge in three general ways: by direct measurement with some type of apparatus, by definition of physical relations from which the bedload could be

estimated, and by quantitative measurements of the results of some sedimentation process such as erosion or deposition. Unfortunately, direct-measuring apparatus have been useful for only a very limited range of sediment and hydraulic conditions; the definition of physical relations has not been complete enough to estimate precisely the bedload discharge; and the quantitative measurements have supplied information only on the characteristics of the reach that was studied. As a result, no single apparatus or procedure, whether theoretical or empirical, has been universally accepted as completely adequate for the determination of bedload discharge over the wide range of sediment and hydraulic conditions in nature.

Despite these difficulties, the hydrologist often is called upon to provide estimates of bedload transport from measurements. The purpose of this section is not only to outline instructions governing the collection of

bedload samples, but also to present a discussion of variations in bedload-discharge rate, the problems involved in collecting samples, and considerations in the design and development of a sampling program to define bedload movement.

Bedload discharge can be extremely variable. Variations can occur both spatially and temporally during steady-flow conditions, as well as with changes in stream discharge. In order to collect a sample that represents the mean bedload-discharge rate, all variations must be taken into account.

Even for constant flow conditions, the temporal variation of bedload transport rates at a given point in a cross section is quite large. When dunes are present, bedload discharges are zero, or near zero, in the

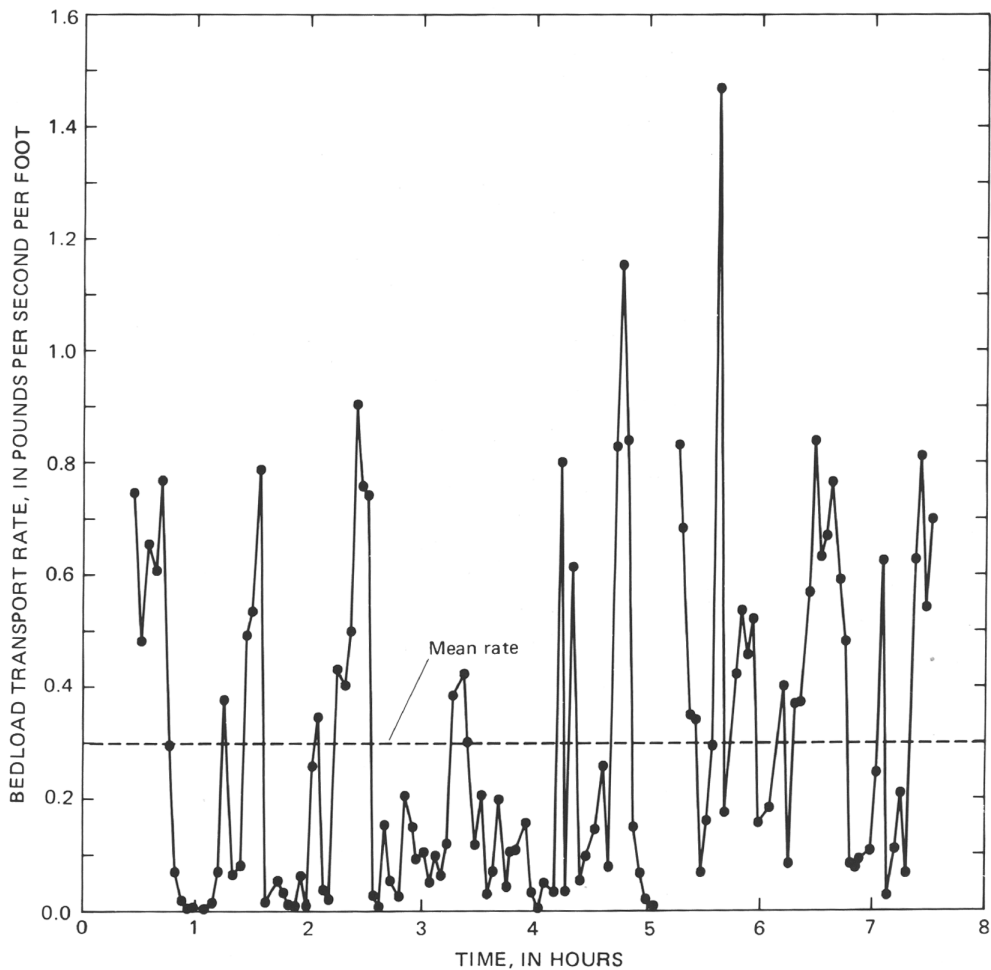

Figure 46. Temporal variation of bedload transport rates for 120 consecutive bedload samples from a stream with constant water discharge (Carey, 1985).

troughs, increase progressively along the upstream side of the dune, and are maximum at the crest. Even in streams with gravel beds, the bedload appears to move in cycles or slugs (Emmett, 1981). These variations have been measured in the laboratory flume by Hubbell and others (1981) and in the field by Emmett (1975) and Carey (1985) (fig. 46).

Temporal variation in sampled bedload rates collected at steady-flow conditions at a single vertical are primarily dependent on the ratio of sampling time to the time it takes one dune, cycle, or slug to pass by the sampling point. Obviously, if the sampling time were equal to the cycle period or several times greater than the cycle period, the temporal variation at a single sampling point would be small. However, as the sample time becomes less with respect to the cycle time, the temporal variation can become quite large.

Einstein (1937) and Hamamori (1962) both developed theoretical distributions to describe the temporal distribution of bedload transport rates at a vertical. Einstein based his distribution on the assumption that bedload particles move in a random series of steps and rests, with the particles generally resting a much longer period of time than they are moving. Hamamori's distribution was derived to define the

temporal variation when dunes are present on the bed. Figure 47 shows a comparison of Einstein's and Hamamori's distributions. Einstein's T is defined as the nondimensional sampling time measured in terms of the average rest period. Einstein's $T = 2$ distribution (sample time equals the length of two average rest periods) and Hamamori's distribution are nearly identical. As T increases (sampling-time increases), the two theoretical distributions depart from one another, and Einstein's distribution indicates reduced variability.

The temporal variations in bedload transport rates measured by Carey (1985) at a single vertical in a sand-bed stream in Tennessee are shown in figure 46. The cumulative probability distribution of bedload discharges measured by Carey fit the theoretical distribution developed by Hamamori. As indicated in the figure, even for a constant flow condition, the rate determined from a sample taken from a single vertical at a point in time may differ considerably from the mean bedload discharge at that vertical. This extreme temporal variability in bedload transport rates has been known since at least 1931 (Hubbell, 1964).

The spatial or cross-channel variation in bedload discharge is usually significant. Typically, bedload

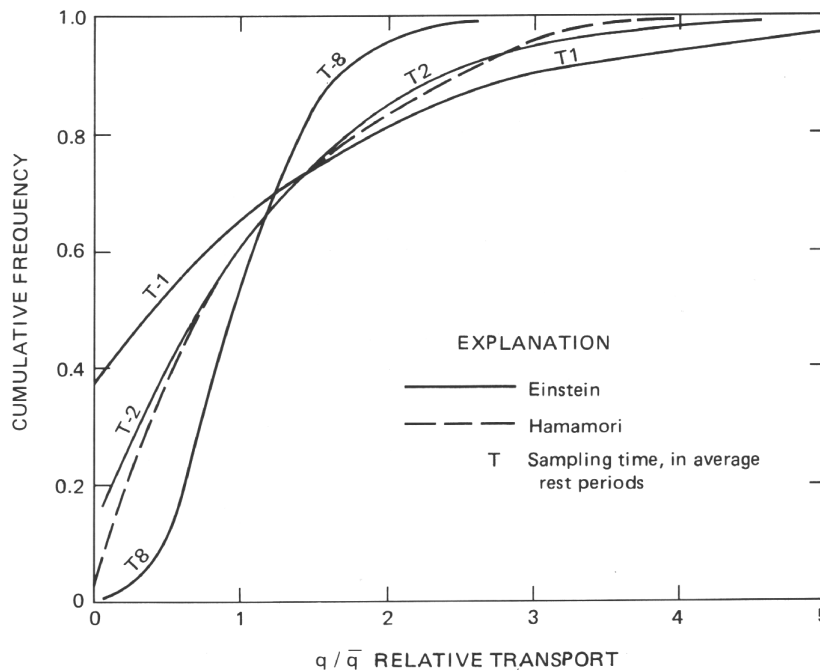

Figure 47. Comparison of cumulative probability distributions of bedload transport rates predicted by Einstein (1937) and Hamamori (1962) (D.G. McLean, University of British Columbia, written commun., 1986).

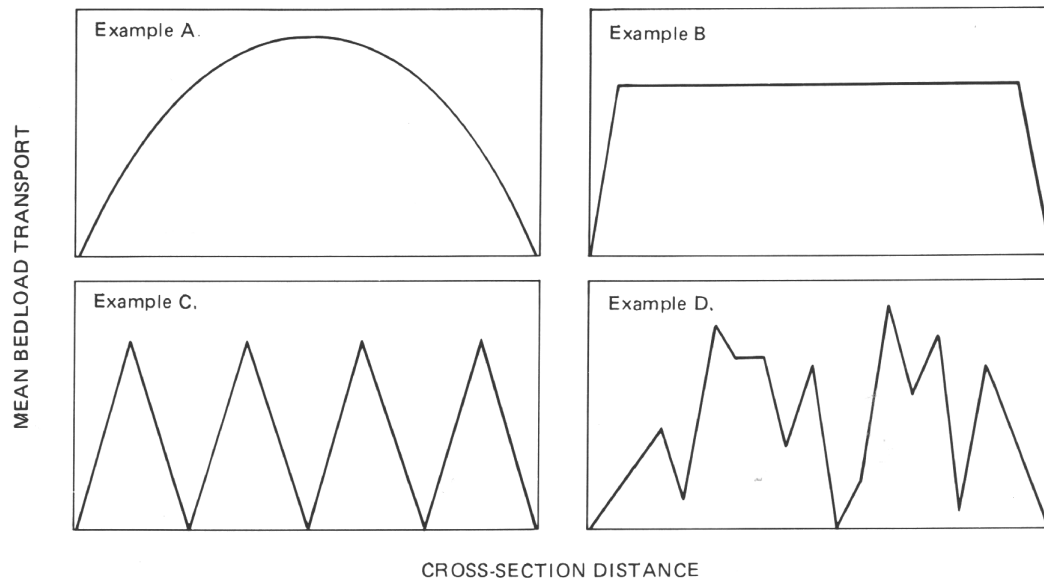

Figure 48. Examples of possible distribution of mean bedload transport rates in a cross section. *A*, Discharge varies uniformly. *B*, Discharge is uniformly consistent. *C*, Discharge is erratic with varying tendencies. *D*, Discharge is an unpredictable combination of varying tendencies.

transport rates vary from zero or small near banks through larger values toward midstream. The mean cross-channel distribution of bedload discharge may vary uniformly (fig. 48A), may be uniformly consistent (fig. 48B), may be erratic with varying tendencies (fig. 48C), or may be an unpredictable combination of varying tendencies (fig. 48D). Each river is likely to have a unique combination; adjacent reaches of the same river may have different configurations, and these configurations are likely to change with changing flow conditions (stages). There is little proven basis for predicting spatial variability.

The temporal and spatial variations in transport rates of bedload discharge that occur under steady-flow conditions are amplified when the stage changes rapidly. Because of these temporal and spatial variations, many samples have to be collected at many verticals in the cross section to ensure an accurate estimate of the mean bedload discharge. The samples also would have to be collected over a short enough period of time to avoid any change in transport rates due to changing stage. In most field sampling programs, the number of samples collected must represent and compromise between accuracy and economic or physical feasibility.

Another major problem encountered in bedload sampling is that of collecting a representative sample. To collect a representative sample, the sampler must

(1) trap, during the sampling period, all bedload particles that would normally have passed through the width occupied by the sampler; and (2) reject all particles that normally would not have passed through the width during the same period. The degree to which this is accomplished is termed the "sampling efficiency," which is defined as the ratio of the mass of bedload collected to mass of bedload that would have passed through the sampler width in the same time period had the sampler not been there (Hubbell, 1964). For perfect representative sampling, the sampling efficiency should be 1.0 (or 100 percent) for all sizes of bedload particles in transport at the sampling point during the sampling period.

Currently, the most commonly used bedload sampler is the Helley-Smith sampler (see page 25 for discussion of recommended samplers). Over 3,000 of these samplers have been placed in use since the model was introduced in the early 1970's. It should be understood that the Helley-Smith is not a true bedload sampler because it collects some particles moving in suspension. As previously noted, bedload moves on or very near the streambed. Depending on the size of the unsampled zone, the Helley-Smith has the potential to collect a sample from the entire unsampled zone. Even if the Helley-Smith sampler has a sampling efficiency of 1.0, the total sediment discharge cannot necessarily be calculated by simply summing the measured suspended-sediment discharge and the measured

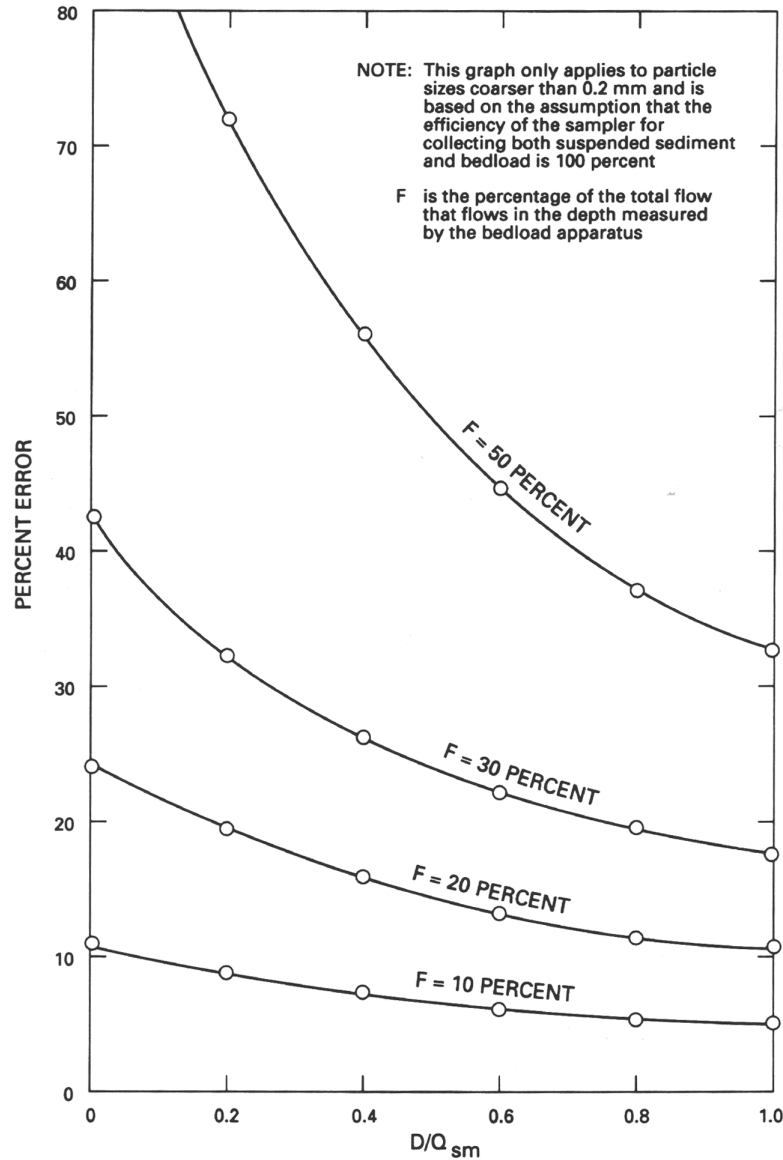

Figure 49. Percent error due to computing total sediment discharge of a size range by summing measured suspended-sediment discharge (Q_{sm}) and bedload discharge measured with a Helley-Smith sampler (D).

bedload discharge. Figure 49 shows the percent error involved in computing total sediment discharge for a particular size range by summing the measured suspended-sediment discharge (Q_{sm}) and the bedload discharge measured with a Helley-Smith sampler (D) for that particular size range.

In order to make bedload sampling practical, methods must be used that minimize the number of samples required to obtain a reasonable estimate of the mean cross-sectional bedload discharge. Field experience has shown that the collection of about 40 individual bedload transport rate measurements per

cross-section sample is, in most cases, practical and economically feasible (Emmett, 1980a). The following general methods can be used to collect the samples.

(1) Starting at one bank and proceeding to the other, collect one sample per vertical at 20 evenly spaced verticals in the cross section, return to the bank, and repeat the process. We will refer to this method as the single equal-width-increment (SEWI) method (fig. 50). The time the sampler is left on the bottom should be equal for all verticals in a given cross section. The time the sampler is left on the bottom need

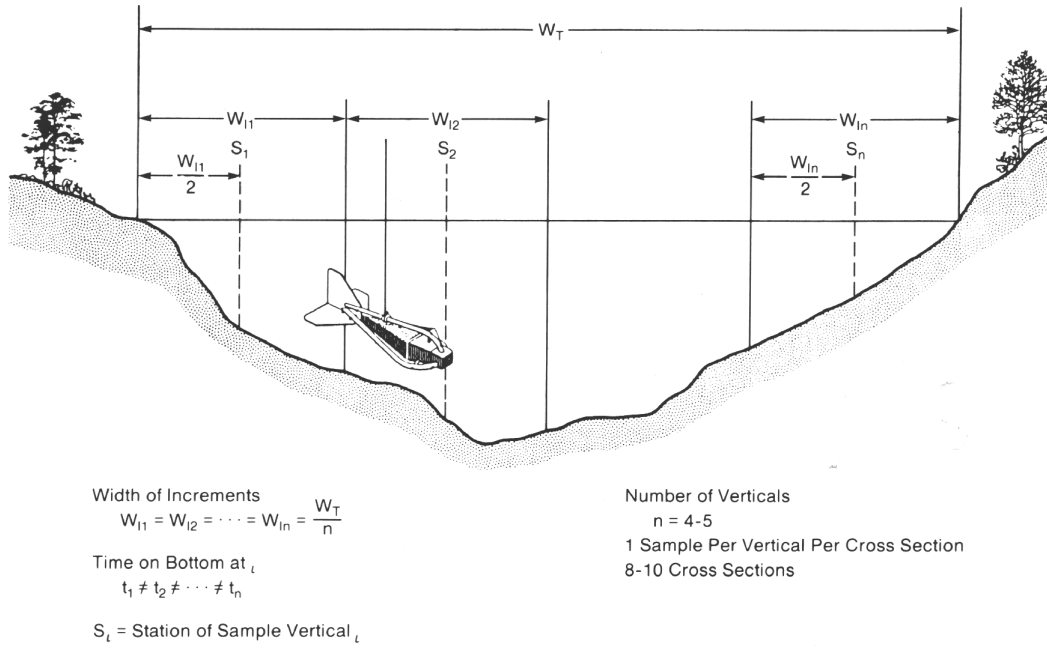

Figure 51. Multiple equal-width-increment bedload-sampling method.

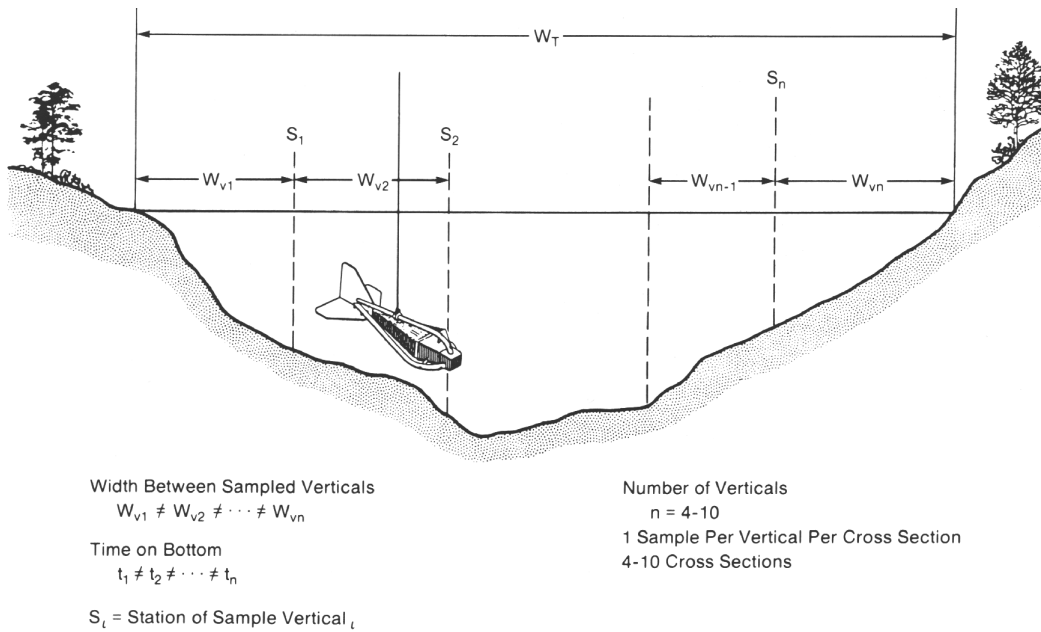

Figure 52. Unequal-width-increment bedload-sampling method.

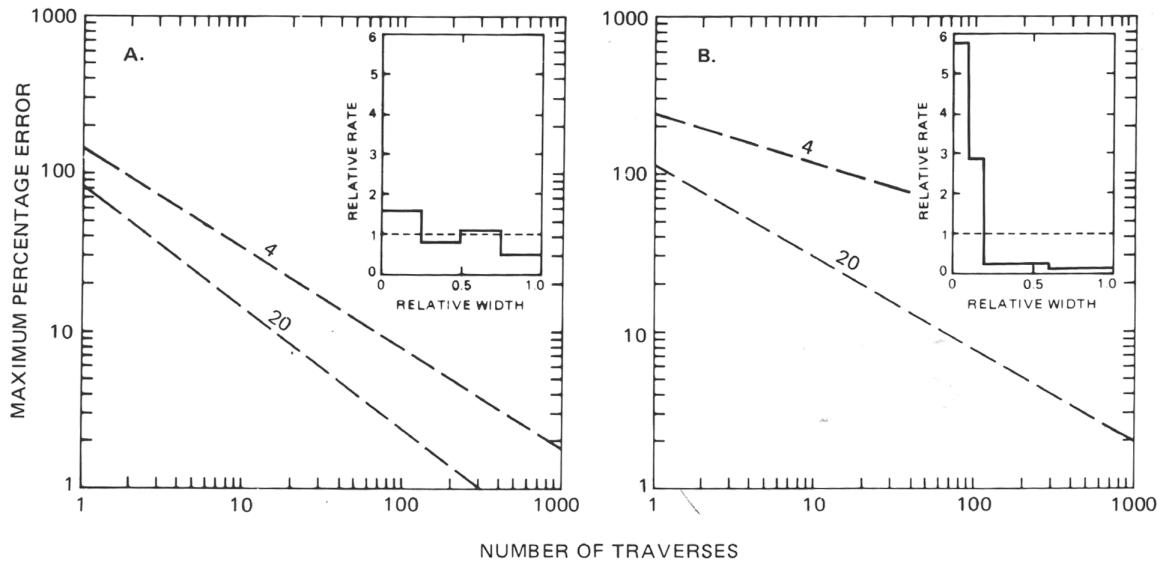

Figure 53. Variation in maximum probable errors with number of sampling traverses at 4 and 20 equally spaced verticals at cross sections with different bedload transport rates (modified from Hubbell and Stevens, 1986). *A*, Fairly uniform transport rates. *B*, Skewed transport rates.

assumed that the sampler used had a 100-percent sampling efficiency. The results of test runs using two different spatial variations are shown in figure 53. In the first case, the lateral distribution of mean bedload transport rates is fairly uniform across the cross section and, in the second case, it is skewed. If these results were used to estimate maximum possible error for using the SEWI and MEWI methods, in the first case, the MEWI method would give a lower maximum possible error (35 percent) than would the SEWI method (50 percent). In the second case, however, using the SEWI method would result in a maximum error of 80 percent and using the MEWI method would result in a maximum error of 120 percent. The maximum probable error with the UWI method cannot be evaluated from figure 53.

From the previous discussion, it is obvious that no one method works best in all situations and that no one standard sampling protocol can be used at all stations. This should come as no surprise. There are two acceptable methods for collecting suspended-sediment samples (EWI and EDI). Both work equally as well as the other but are better suited to different stream conditions and cross-sectional sediment distributions. Likewise, a unique sampling protocol must be derived for each site at which bedload-discharge data are to be

collected. Probably the best way to start sampling at a site is to do multiple sets of complete SEWI and MEWI or UWI measurements each time the site is visited and over as many flow ranges as possible. Unfortunately, human resources and budget restrictions, as well as hydrologic conditions, may prevent multiple or even single SEWI, MEWI, or UWI type cross-sectional measurements. If it is not possible or feasible to collect full SEWI, MEWI, and (or) UWI type samples, the approach listed below can be used as a minimum protocol to follow when first starting to collect bedload data at a site. Caution should be used, however, because the modified SEWI, MEWI, or UWI methods will not supply as much information as would the complete method. Therefore, more sets of samples may be needed to acquire sufficient knowledge of the cross section to design an efficient sampling protocol. (Note: The SEWI method helps define cross-sectional variations in bedload transport rates, whereas the MEWI and UWI methods are more effective in defining temporal variations at individual verticals.)

(1) Using the SEWI method, collect samples at approximately 20 equally spaced verticals in the cross section. The spacing and location of the verticals should be determined by the sampling procedure used in the EWI method. For very wide sections, where

large variations in bedload rates are suspected, sampling stations should not be spaced more than 50 feet apart. For narrow cross sections, sampling stations need not be closer than 1 foot apart.

(2) Lower the sampler to the streambed and use a stopwatch to measure the time interval during which the sampler is on the streambed. The sampling-time interval should be the same for each vertical sampled in the cross section. The time required to collect a proper sample can vary from 5 seconds or less to several hours or more. Generally, a sampling time that does not exceed 60 seconds is preferred. Because of the temporal variations in bedload transport rates, there is no easy way to determine the appropriate sampling time. Several test samples (as many as 10 or more collected sequentially at a vertical with a suspected high transport rate) may be needed in order to estimate the proper sampling-time interval to be used. The sample time should be short enough to allow for the collection of a sample from the section with the highest transport rate, without filling the sample bag more than about 40 percent full. The sample bag may be filled to 40 percent full with sediment coarser than the mesh size of the bag without reducing the hydraulic efficiency of the sampler (Druffel and others, 1976). Sediment that is approximately equal to the mesh size may clog the bag and cause a change in the sampling efficiency of the sampler.

(3) One sample should be collected at each vertical, starting at one bank and proceeding to the other. It is recommended that, during this initial data gathering stage, a minimum of one transect using the SEWI method be used. The samples should be placed in separate bags for individual analysis and labeled with the vertical's station number. They may be composited into one or several sample bags for a composite analysis, but if composited, no information on cross-sectional variability can be obtained from the data.

(4) A second sample should be collected using the UWI or MEWI methods. Four or five verticals should be sampled four or five times each, obtaining a total of 20 samples. Samples should be collected using the same procedure as described in number 2 above, except that the sample time for each sample need not be the same. All samples should be bagged and tagged for separate analysis.

(5) The following data must be recorded on a field note sheet for each cross-section sample:

Station name/number
Date

Cross-section sample starting and ending times

Gage height at the start and end of sample collection

Total width of the cross section, including stations on both banks

Width between verticals (SEWI method)

Number of verticals sampled (SEWI method)

Station of verticals sampled (UWI or MEWI method)

Time sampler was on the bottom at each vertical

Type sampler used

Name of person collecting sample

In addition, the following information should be recorded on each sample container:

Station name

Date

Designation of cross-section sample to which the container belongs (that is, if two cross-section samples were collected, one would be "A" and the other "B")

Number of containers for that cross section (for example, "1 of 2" or "2 of 2")

Stations(s) of the vertical(s) the sample was collected from

Time sampler was on the bottom and at the vertical station

Clock time the sample was collected (start and finish if composite)

Collector's initials

Analysis of the first transect (SEWI method) will give some indication of the cross-sectional variability if individual verticals are analyzed separately. Analysis of the second set of transects (UWI or MEWI method) will give some indication of temporal variability. As stated before, the procedure described above should be considered the minimum to be followed when first collecting bedload data at a site. Additional samples and transects will help define the temporal and spatial variation at the site for all flow ranges. After a cross section has been sampled several times at different flow ranges using the above procedure, it should be possible to develop a sampling protocol that fits the site better.

Computation of Bedload-Discharge Measurements

The bedload transport rate at a sample vertical may be computed by the equation

$$R_i = \frac{KM_i}{t_i} \quad (1)$$

$$K = (86,400 \text{ seconds/day}) \frac{1 \text{ ton}}{(907,200 \text{ grams})} \frac{1 \text{ foot}}{(N_w)} \quad (2)$$

where

- R_i = bedload transport rate, as measured by bedload sampler, at vertical i , in tons per day per foot;
- M_i = mass of the sample collected at vertical i , in grams;
- t_i = time the sampler was on the bottom at vertical i , in seconds; and
- K = a conversion factor used to convert grams per second per foot into tons per day per foot. It is computed as

where

N_w is the width of sampler nozzle in feet. (For a 3-inch nozzle, $K = 0.381$; for a 6-inch nozzle, $K = 0.190$.)

The cross-sectional bedload discharge measured by the Helley-Smith sampler may be computed using the total cross-section, midsection, or mean-section method. The simplest method of calculating bedload discharge from a sample collected with a Helley-Smith type bedload sampler is the total cross-section method (fig. 54). This method should only be used if the following three conditions are met:

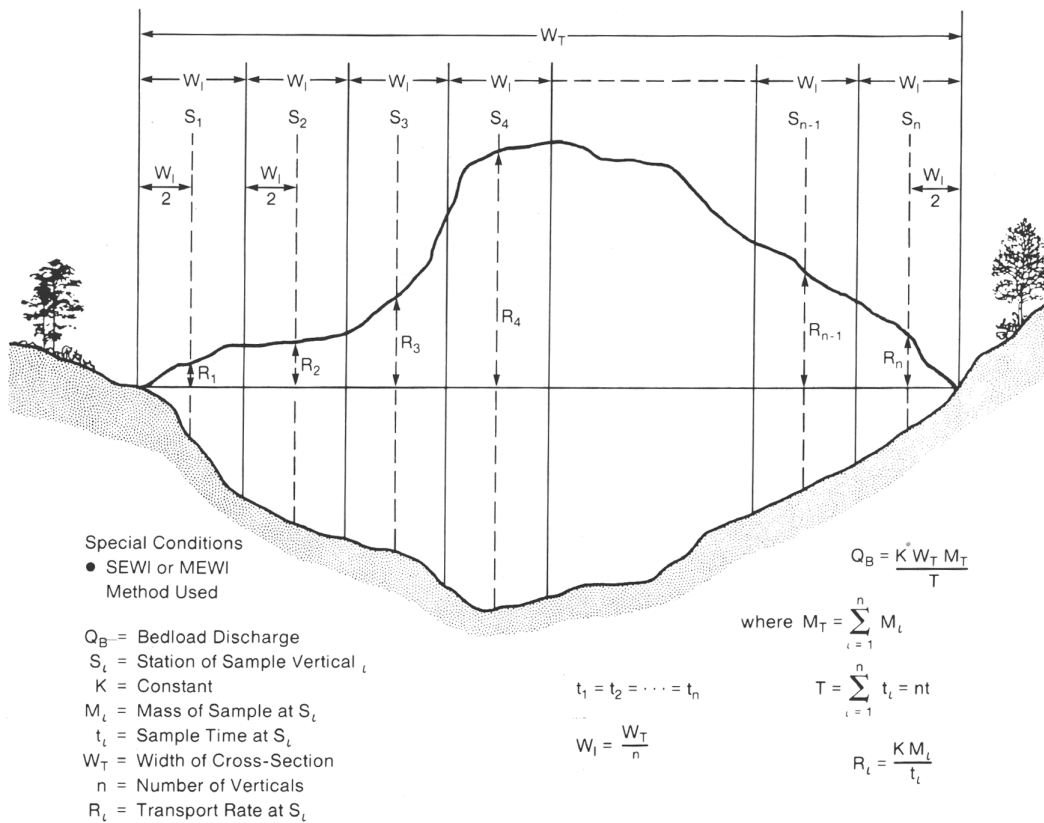

Figure 54. Total cross-section method for computing bedload discharge from samples collected with a Helley-Smith bedload sampler.

1. The sample times (t_i) at each vertical are equal.
 2. The verticals were evenly spaced across the cross section (that is, SEWI or MEWI method used).
 3. The first sample was collected at one-half the sample width from the starting bank.
- If these conditions are met, then

$$Q_B = K \frac{W_T}{t_T} M_T \quad (3)$$

where

- Q_B = bedload discharge, as measured by bedload sampler, in tons per day;
- W_T = total width of stream from which samples were collected, in feet, and is equal to the increment width (W_i) times n (n = total number of vertical samples);

- t_T = total time the sampler was on the bed, in seconds, computed by multiplying the individual sample time by n ;
- M_T = total mass of sample collected from all verticals sampled in the cross section, in grams; and
- K = conversion factor as described in equation 2 above.

If any of the three conditions stated above are not met, then either the midsection or mean-section method should be used. Mathematically, the two methods, if used with no modifications, will produce identical answers. However, as indicated under the discussion of the UWI method, the placement of the sampling verticals with respect to breaks in the lateral cross-sectional distribution curve of mean bedload transport rate will somewhat dictate which method should be used. The midsection method (fig. 55) is computed using the following equation:

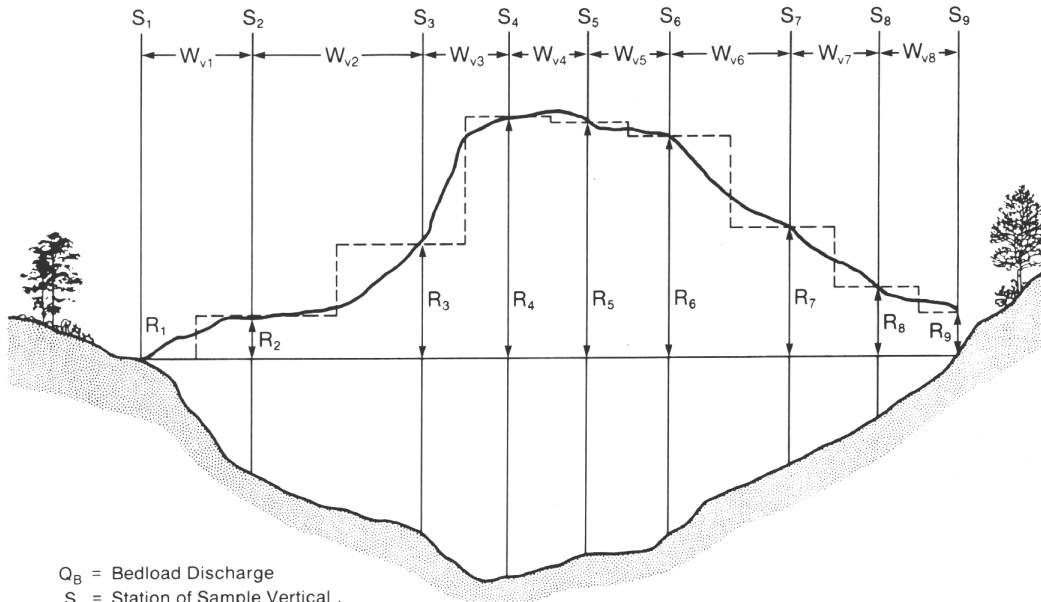

- Q_B = Bedload Discharge
- S_i = Station of Sample Vertical i
- R_i = Transport Rate at S_i
- K = Constant
- M_i = Mass of Sample Collected at S_i
- t_i = Sample Time at S_i
- n = Number of Verticals
- W_{v_i} = Width Between Verticals i and $i + 1$

$$Q_B = \frac{R_1 W_{v1}}{2} + \sum_{i=2}^{n-1} R_i \left[\frac{(S_i - S_{i-1})}{2} + \frac{(S_{i+1} - S_i)}{2} \right] + \frac{R_n W_{vn-1}}{2}$$

$$= \frac{K}{2} \left[\frac{M_1}{t_1} W_{v1} + \frac{M_n}{t_n} W_{vn-1} + \sum_{i=2}^{n-1} \frac{M_i}{t_i} (S_{i+1} - S_{i-1}) \right]$$

Figure 55. Midsection method for computing bedload discharge from samples collected with a Helley-Smith bedload sampler.

$$Q_B = \frac{R_1 W_1}{2} + \sum_{i=2}^{n-1} R_i \left[\frac{(S_i - S_{i-1})}{2} + \frac{(S_{i+1} - S_i)}{2} \right] + \frac{R_n W_{n-1}}{2} \quad (4)$$

$$Q_B = \frac{K}{2} \left[\frac{M_1 W_1}{t_1} + \frac{M_n W_{n-1}}{t_n} + \sum_{i=2}^{n-1} \frac{M_i}{t_i} (S_{i+1} - S_{i-1}) \right] \quad (5)$$

where

- W_i = width between sampling verticals i and $i+1$, in feet;
- S_i = stations of the vertical (i) in the cross section measured from some arbitrary starting point, in feet; and

Q_B , n , R , and K have previously been defined,

You will note that equation 3 is very similar to the equation used to compute a surface-water discharge measurement. This method corresponds to the midpoint method currently used to compute surface-water discharge measurements (Buchanan and Somers, 1969). By combining equations 1 and 4 and rearranging terms:

One advantage to using the midsection method is that the distance W_1 need not necessarily be equal to the distance between sampling verticals. At times, it may become apparent, due to local conditions, that a particular R_1 should not be applied over a width equal to halfway back to the last station and halfway forward to the next, but applied to some other width. This width, sometimes referred to as the effective width, is decided on by the user. Bridge piers, large boulders, abrupt changes in velocity or lateral bed topography, or other conditions that may obstruct or cause sudden changes to bedload transport rate will affect the selection of the effective width.

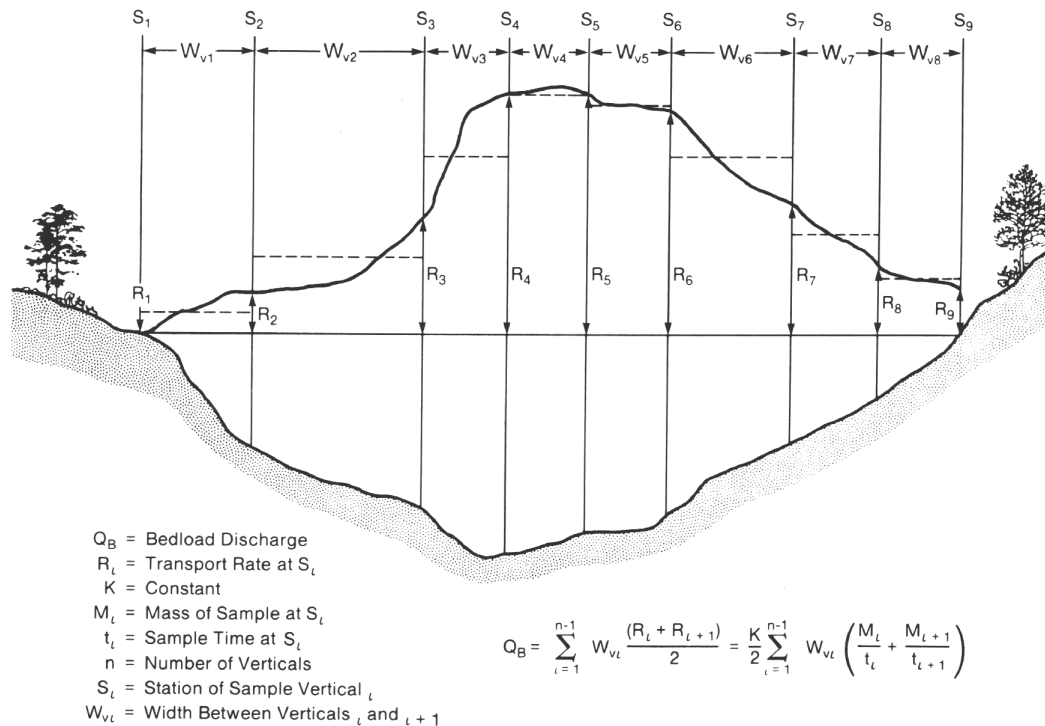

Figure 56. Mean-section method for computing bedload discharge from samples collected with a Helley-Smith bedload sampler.

The third method, the mean-section method (fig. 56), is computed using the following equation:

$$Q_B = \sum_{i=1}^{n-1} W_i \frac{(R_i + R_{i+1})}{2}, \quad (6)$$

which is equivalent to:

$$Q_B = \frac{K}{2} \sum_{i=1}^{n-1} W_i \left(\frac{M_i}{t_i} + \frac{M_{i+1}}{t_{i+1}} \right) \quad (7)$$

All the above terms are the same as used in the midsection method. This method averages the two adjoining rates and applies the average rate over the distance between them. For this reason, it is important to try to place the sampling verticals at points where the trends in lateral mean bedload transport rate change. Under most field conditions, this might be difficult.

For situations where the total cross-section method cannot be used, it is recommended that the midsection method be used. This recommendation is made because of its similarity to the surface-water discharge-measurement method, which most field personnel are familiar with, and because of the flexibility in using the effective width concept.

Collecting bedload samples will generate 40 or more samples, creating a potential problem regarding transportation and analyses of so many samples. Carey (1984) adapted a procedure for measuring the submerged weight of bedload samples in the field and converting that measurement to dry weight from a laboratory procedure used by Hubbell and others (1981). The method uses the basic equation

$$W_{ds} = \frac{SG_s}{SG_s - 1} W_{ss} \quad (8)$$

where

W_{ds} = dry weight of the sediment;

SG_s = specific gravity of the sediment; and

W_{ss} = submerged weight of the sediment.

Measurements for Total Sediment Discharge

Total sediment discharge is the mass of all sediment moving past a given cross section in a unit of time. It can be defined as the sum of the (1) measured and unmeasured sediment discharges, (2) suspended-sediment discharge and bedload discharge, or (3) fine-material discharge (sometimes referred to as the washload) and coarse-material or bed-material discharge.

There are some sand-bed streams with sections so turbulent that nearly all sediment particles moving through the reach are in suspension. Sampling the suspended sediment in such sections with a standard suspended-sediment sampler represents very nearly the total load. Several streams with turbulent reaches are described in Benedict and Matejka (1953). Further discussion concerning total-load measurement also can be found in Inter-Agency Report 14 (Federal Inter-Agency Sedimentation Project, 1963b, p. 105–115). Turbulence flumes or special weirs can be used to bring the total load into suspension. Total load can usually be sampled with suspended-sediment samplers to a high degree of accuracy where the streambed consists of an erosion resisting material such as bedrock or a very cohesive clay. In such situations, most, if not all, the sediment being discharged is in suspension (or the bed would contain a deposit of sand).

Benedict and Matejka (1953) and Gonzales and others (1969) have described some structures used for artificial suspension of sediment to enable total-load sampling. However, most total-load sampling is usually accomplished at the crest of a small weir, dam, culvert outlet, or other place where the sampler nozzle integrates throughout the full depth of flow from the surface to the top of the weir.

Where such conditions or structures are not present, the unmeasured load must be computed by various formulas. The unmeasured load can be approximated by use of a bedload formula such as that of Meyer-Peter and Muller (1948), Einstein (1950), Colby and Hembree (1955), or Chang and others (1965). However, these computational procedures can give widely varying answers. The Colby and Hembree (1955) method [modified from Einstein (1950)] determines the total load in terms of the amount transported for different particle-size ranges. Colby

and Hubbell (1961) later simplified the modified Einstein method to include the use of four nomographs in lieu of a major computational step. The essential data required for the Colby and Hubbell technique at a particular time and location are listed here:

1. Stream width, average depth, and mean velocity.
2. Average concentration of suspended sediment from depth-integrated samples.

3. Size analyses of the suspended sediment included in the average concentration.

4. Average depth of the verticals where the suspended-sediment samples were collected.

5. Size analyses of the bed material.

6. Water temperature.

Stevens (1985) has developed two computer programs for the computation of total sediment discharge by the modified Einstein procedure. One

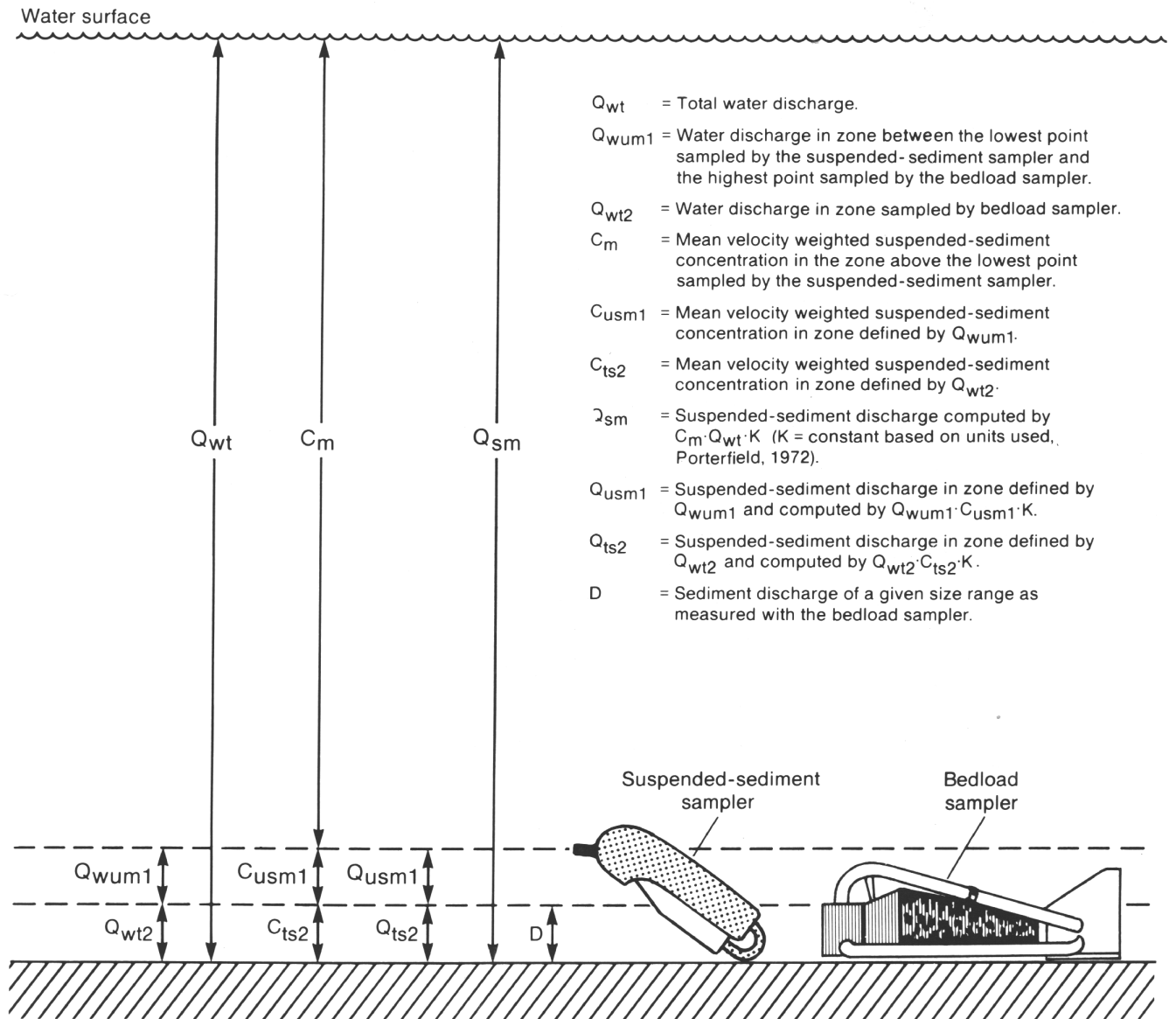

- Q_{wt} = Total water discharge.
- Q_{wum1} = Water discharge in zone between the lowest point sampled by the suspended-sediment sampler and the highest point sampled by the bedload sampler.
- Q_{wt2} = Water discharge in zone sampled by bedload sampler.
- C_m = Mean velocity weighted suspended-sediment concentration in the zone above the lowest point sampled by the suspended-sediment sampler.
- C_{usm1} = Mean velocity weighted suspended-sediment concentration in zone defined by Q_{wum1} .
- C_{ts2} = Mean velocity weighted suspended-sediment concentration in zone defined by Q_{wt2} .
- Q_{sm} = Suspended-sediment discharge computed by $C_m \cdot Q_{wt} \cdot K$ (K = constant based on units used, Porterfield, 1972).
- Q_{usm1} = Suspended-sediment discharge in zone defined by Q_{wum1} and computed by $Q_{wum1} \cdot C_{usm1} \cdot K$.
- Q_{ts2} = Suspended-sediment discharge in zone defined by Q_{wt2} and computed by $Q_{wt2} \cdot C_{ts2} \cdot K$.
- D = Sediment discharge of a given size range as measured with the bedload sampler.

Figure 57. Zones sampled by suspended-sediment and bedload samplers and the unmeasured zone.

program is written in FORTRAN 77 for use on the PRIME computer; the other is in BASIC and can be used on most microcomputers.

Hubbell (1964) gives the following formula for determining the total sediment discharge of a given size range from the measured suspended-sediment discharge and the discharge measured with any type of bedload apparatus (see fig. 57).

$$Q_T = \frac{Q_D}{eff} + Q_{sm} + Q_{usm1} - FQ_{sm} + (1 - E/e)Q_{ts2} \quad (9)$$

where

Q_T = total sediment discharge of the size range,

Q_D = discharge of the size range as measured with the bedload apparatus. If the apparatus measures more than the bedload discharge, as does the Helley-Smith, Q_D includes some of the suspended-sediment discharge,

e = efficiency of the bedload apparatus in measuring bedload discharge of the size range,

Q_{sm} = measured suspended-sediment discharge of the size range,

Q_{usm1} = unmeasured suspended-sediment discharge of the size range in the depth between the lowest point measured by the suspended-sediment sampler and the highest point measured by the bedload apparatus,

F = the fraction of the total depth represented by the flow in the depth measured by the bedload apparatus,

E = the efficiency of the bedload apparatus in measuring the suspended-sediment discharge of the size range transported through the vertical sampled by the apparatus, and

Q_{ts2} = total suspended-sediment discharge of the size range through the depth measured by the bedload apparatus.

A more detailed explanation of how to compute the total sediment discharge from measured suspended-sediment discharge and bedload discharge measured with a bedload measuring apparatus is given by Hubbell (1964, p. 7-9). If the efficiency of the bedload sampler is 100 percent for both bedload and suspended-sediment load and if the bedload sampler samples the entire unsampled zone, then the above equation is much simpler.

Reservoir-Trap Efficiency

The efficiency with which a reservoir traps sediment depends mostly on its size with respect to the rate of inflow. Other factors may include the reservoir shape, its operation, the water quality, and the size and kind of inflowing sediment. Except for small detentions with bottom outlets, all of the sand-sized and much of the silt-sized particles would be expected to be trapped. An evaluation of reservoir-trap efficiency must involve measurements of the quantity and size characteristics of the sediment entering and leaving the reservoir (Mundorff, 1964, 1966). Sometimes measurements of sediment accumulation in the reservoir plus the sediment output are used as a practical method of evaluating the sediment yield of the drainage basin.

Inflow Measurements

On many reservoirs, trap efficiency cannot be evaluated in sufficient detail from measurements of accumulation and sediment outflow. For such reservoirs, it is necessary to measure the sediment discharge and particle size entering the reservoirs. This measurement requires that stations be operated daily or continuously on streams feeding into the reservoir. Trap efficiency on a storm-event basis can be determined if several samples adequately define the concentration of the inflow and outflow hydrographs. For small detention reservoirs, it may be difficult or impractical to measure the inflow on a daily basis. If a continuous record is not possible, the objective should be to obtain observations sufficient to define the conditions for several inflow hydrographs so that a storm-event sediment rating curve can be constructed for use in estimating the sediment moved by the unsampled storms (Guy, 1965).

If it is impractical to obtain sufficient data to define the sediment content of several storm events, the least data for practical analysis should include 10 or 15 observations per year so that an instantaneous sediment rating curve can be constructed (Miller, 1951). It is expected that the instantaneous curve will yield less accurate results than the storm-event curve, which in turn will be less accurate than the continuous record. Each of the rating-curve methods may require data for a range of conditions so that adjustments can be determined for the effect of time of year, antecedent

conditions, storm intensity, and possibly for the storm location in the basin (Colby, 1956; Jones, 1966).

As for most new sediment stations, particle-size analysis should be made on several of the inflow observations during the first year. These particle-size analyses will form a data base, which may make it possible to reduce the number of analyses required in future years.

Outflow Measurements

The outflow from a reservoir is drastically different from the inflow because of the attenuating effect of the flow through the reservoir or because of possible willful control in the release of water (Carter and Godfrey, 1960; Mitchell, 1962). Logically, the smaller reservoirs, which are likely to have fixed outlets and the poorest trap efficiencies, require the most thorough outflow measurement schedules. If an inflow-outflow relation for sediment discharge can be constructed, such a relation may change considerably in the direction of greater sediment output (lower trap efficiency) as the reservoir fills with sediment.

Normally, the particle size of sediment outflow is expected to be finer than for the inflow; and, therefore, the concentration of outflowing sediment should not fluctuate as rapidly as that of the inflow. The normal slowly changing outflow concentration may not occur if the outflow is from the vicinity of the interface involving a density current.

A desirable sampling schedule for outflow may vary from once a week for the large reservoir to several observations during a storm event for a small reservoir. The need for outflow particle-size data also will depend on the scale of the stream and reservoir system, the trap efficiency, and how well the inflow is defined. With respect to quality control, if the trap efficiency of a reservoir is expected to be more than 95 percent and if the sediment inflow can only be measured to the nearest 10 or 15 percent of its expected true value, it is not necessary to measure the sediment outflow in great detail unless there is a need to accurately define the amount of sediment in the flow downstream from the reservoir.

Sediment Accumulation

The small reservoir or detention basin can be used—if trap efficiency can be estimated or measured—to provide a measure of the average annual sediment yield of a drainage basin. This method is useful in very small basins where the inflow

is difficult to measure and where the amount of water-inflow and sediment-concentration data is not important.

For small catchment basins or reservoirs on ephemeral streams (those that are dry most of the time), the determination of sediment accumulation involves a detailed survey of the reservoir from which stage-capacity curves can be developed—usually 1-foot contours for the lower parts of the reservoirs and 2- to 5-foot contours for the upper parts, depending on the terrain and size of the reservoir (Peterson, 1962). The accretion of sediment then can be measured either by monumented range lines in the reservoir or by resurvey for a new stage-capacity curve.

For reservoirs not dry part of the time, the sediment accumulation is usually measured by sounding on several monumented range lines spaced to provide a representative indication of the sediment accumulation between measurements. Methods for reservoir surveys are described by Heinemann (1961), Porterfield and Dunnam (1964), and Vanoni (1975). A summary of reservoir sediment deposition surveys made in the United States through 1975 was compiled by Dendy and Champion (1978). The period from 1976 to 1980 has been covered by the Inter-Agency Advisory Committee on Water Data's Subcommittee on Sediment (1983).

In order to convert the measurements of sediment volume found in reservoirs to the usual expression of mass of sediment yield, it is necessary that the sedimentation surveys of reservoirs include information on the volume-mass of sediment. Heinemann (1964) reports that this was accomplished in Sebetha Lake, Kansas, using a gamma probe and a piston sampler. From his data, obtained at 41 locations, he found that the best equation for predicting volume-mass is

$$V_M = 1.688d - 0.888c + 98.8 \quad (10)$$

where

V_M = the dry unit volume-mass, in pounds per cubic foot;

d = the depth of sample from the top of the deposit; and

c = the percentage of clay smaller than 0.002 mm.

On the basis of 1,316 reservoir deposit samples, Lara and Pemberton (1965) found the unit volume-mass to vary according to changes in reservoir operation and to the fraction of clay, silt, and sand. The Office of Water Data Coordination (1978) reported that refinements based on reservoir operation, sediment size, and compaction could be made to the estimates made by Lara and Pemberton (1965) and Lane and Koelzer (1943). The following formula, along with factors listed in table 4, may be used to estimate dry unit volume-mass:

$$V_M = V_{tc}P_c + V_{tm}P_m + V_{ts}P_s \quad (11)$$

where

- V_M = dry unit volume-mass, in pounds per cubic foot;
- V_t = dry unit volume-mass as computed in equation 12, in pounds per cubic foot;
- c = clay-size material;

Table 4. Initial dry unit volume-mass (V_i) and K factors for computing dry unit volume-mass of sediment deposits in pounds per cubic foot (Office of Water Data Coordination, 1978)

Type of reservoir operation	V_i			K		
	Clay	Silt	Sand	Clay	Silt	Sand
1. Sediment submerged	26	70	97	16	5.7	0
2. Moderate to considerable annual drawdown	35	71	97	8.4	1.8	0
3. Normally empty	40	72	97	0	0	0
4. River sediment	60	73	97	0	0	0

- m = silt-size material;
- s = sand-size material;
- P = percent of total sample, by weight, in size class (clay, silt, sand); and

$$V_t = V_i + 0.43K \left[\frac{T}{T-1} (\log T) - 1 \right] \quad (12)$$

where

- V_i = initial unit volume-mass, in pounds per cubic foot from table 4;

- K = Lane and Koelzer (1943) factors from table 4, in pounds per cubic foot; and
- T = time after deposition, in years.

OTHER SEDIMENT DATA-COLLECTION CONSIDERATIONS

In retrospect, it must be emphasized that field methods for fluvial-sediment measurements must be coordinated with methods for other hydrologic and environmental measurements. With the ever-increasing requirements of a thorough data-acquisition system, together with advances in technology, it must be expected that methods will continue to change in the future. For example, because there is a foreseeable need for increasing water-pollution surveillance studies with respect to stream-quality standards, it is apparent that a continuous recording of some indicator of sediment conditions is badly needed at a large number of sites. Consequently, the F.I.S.P. has undertaken the development of sensors and automatic pumping-type samplers with a view toward continuously recording the concentration of sediment that moves in streams. The development of such automatic equipment is likely to enhance rather than detract from the need for conventional manual observations.

The authors sincerely hope that the material regarding the equipment and techniques for sampling presented herein will stimulate the ongoing development of better equipment and techniques for the future and, at the same time, help to standardize and make more efficient the day-to-day operations.

The opportunity certainly exists at the field level for many innovations for improving the end product or the sediment record. Some field people, for example, may like to carry a copy of the station stage-discharge rating curve, on which all particle-size analyses are recorded, showing date and kind of sample for each measuring site. As communications and river forecasting become more sophisticated, it may be possible to have better dialogue between the office and the field people or local observers, who are trying to obtain the maximum information at many sampling sites. Such communication is especially critical during

periods of flooding, when timely data are most important.

In addition to increasing coordination of sediment-data activities with other related measurements, it is important to stress that adequate notes be obtained (including pictures) so that those involved in the laboratory analysis of the samples, those responsible for preparing the record, and especially those responsible for interpreting the data can properly read what happened at the sample site. The amount of new information to be obtained from data interpretation is seriously affected by the quality of the information with respect to timing and representativeness of the sediment measurements.

The authors further emphasize the need for a concerted and continuing effort with respect to safety in the measurement program. Aside from the hazards of highway driving, the work usually involves the use of heavy equipment during floods or other unusual natural events, often in darkness and under unpleasant weather conditions. Even though the hazards of working from highway bridges and cableways are mostly self-evident, there are many opportunities for the unusual to happen and, therefore, a great deal of effort must be expended to ensure safety. Such effort, of course, must be increased when it is necessary to accomplish the work in a limited amount of time and with a reduced work force.

SELECTED REFERENCES

- American Society for Testing and Materials, 1987, Annual book of American Society for Testing and Materials Standards: Water and Environmental Technology, section 11, v. 11.02, 1,083 p.
- Beetem, W.A., Janzer, V.J., and Wahlberg, J.S., 1962, Use of cesium-137 in the determination of cation exchange capacity: U.S. Geological Survey Bulletin 1140-B, 8 p.
- Benedict, P.C., and Matejka, D.Q., 1953, The measurement of total sediment load in alluvial streams: Iowa City, Iowa, Iowa University, Proceedings of the Fifth Iowa Hydraulics Conference, Engineering Bulletin 34, p. 263-286.
- Buchanan, T.J., and Somers, W.P., 1968, Stage measurements at gaging stations: U.S. Geological Survey Techniques of Water-Resources Investigations, chap. A7, book 3, 28 p.
- 1969, Discharge measurements at gaging stations: U.S. Geological Survey Techniques of Water-Resources Investigations, chap. A8, book 3, 65 p.
- Carey, W.P., 1984, A field technique for weighing bedload samples: Water Resources Bulletin, American Water Resources Association, v. 20, no. 2, p. 261-265.
- 1985, Variability in measured bedload-transport rates: Water Resources Bulletin, American Water Resources Association, v. 21, no. 1, p. 39-48.
- Carter, R.W., and Davidian, Jacob, 1968, General procedure for gaging streams: U.S. Geological Survey Techniques Water-Resources Investigations, chap. A6, book 3, 13 p.
- Carter, R.W., and Godfrey, R.G., 1960, Storage and flood routing: U.S. Geological Survey Water-Supply Paper 1543-B, p. 102-104.
- Chang, F.M., Simons, D.B., and Richardson, E.V., 1965, Total bed-material discharge in alluvial channels: U.S. Geological Survey Water-Supply Paper 1498-I, 23 p.
- Colby, B.R., 1956, Relationship of sediment discharge to streamflow: U.S. Geological Survey Open-File Report, 170 p.
- 1963, Fluvial sediments—A summary of source, transportation, deposition, and measurement of sediment discharge: U.S. Geological Survey Bulletin 1181-A, 47 p.
- 1964, Discharge of sands and mean-velocity relationships in sand-bed streams: U.S. Geological Survey Professional Paper 462-A, 47 p.
- Colby, B.R., and Hembree, C.H., 1955, Computations of total sediment discharge, Niobrara River near Cody, Nebraska: U.S. Geological Survey Water-Supply Paper 1357, 187 p.
- Colby, B.R., and Hubbell, D.W., 1961, Simplified methods for computing total sediment discharge with the modified Einstein procedure: U.S. Geological Survey Water-Supply Paper 1593, 17 p.
- Culbertson, D.M., Young, L.E., and Brice, J.C., 1967, Scour and fill in alluvial channels, with particular reference to bridge sites: U.S. Geological Survey Open-File Report, 58 p.
- Dendy, F.E., and Champion, W.A., 1978, Sediment deposition in United States reservoirs, summary of data reported through 1975: U.S. Department of Agriculture, Agricultural Research Service, Miscellaneous Publication 1362, 84 p.
- Druffel, Leroy, Emmett, W.W., Schneider, V.R., and Skinner, J.V., 1976, Laboratory hydraulic calibration of the Helley-Smith bedload sediment sampler: U.S. Geological Survey Open-File Report 76-752, 63 p.
- Einstein, H.A., 1937, Die Eichung des im Rhein verwenderten Geschiebefängers [Calibrating the bedload trap as used in the Rhine]: Schweizer, Bauzeitung, v. 110, no. 12, p. 29-32.
- 1950, The bedload function for sediment transportation in open channel flows: U.S. Department of Agriculture Technical Bulletin 1026, 70 p.
- Emmett, W.W., 1975, The channels and waters of the upper Salmon River area, Idaho: U.S. Geological Survey Professional Paper 870-A, 116 p.
- 1980a, A field calibration of the sediment-trapping characteristics of the Helley-Smith bed-load sampler: U.S. Geological Survey Professional Paper 1139, 44 p.
- 1980b, Bedload sampling in rivers: International Symposium on River Sedimentation, Beijing, China, 1980, Proceedings, p. 991-1017.
- 1981, Measurement of bed load in rivers, *in* Erosion and sediment transport measurement: Florence, International Association of Hydrological Sciences Association Proceedings 133, p. 3-5.
- Emmett, W.W., Leopold, L.B., and Myrick, R.M., 1983, Some characteristics of fluvial processes in rivers: Second International Symposium on River Sedimentation, Nanjing, China, 1983, Proceedings, 29 p.
- Emmett, W.W., and Seitz, H.R., 1974, Suspended and bedload sediment transport in the Snake and Clearwater Rivers in the vicinity of Lewiston, Idaho—July 1973 through July 1974: U.S. Geological Survey Basic-Data Report, 76 p.
- Federal Inter-Agency Sedimentation Project, 1941, Laboratory investigation of suspended-sediment samplers: Iowa City, Iowa University Hydraulics Laboratory, Inter-Agency Report 5, 99 p.
- 1951, Field tests on suspended-sediment samplers, Colorado River at Bright Angel Creek near Grand Canyon, Arizona: Iowa City, Iowa, University Hydraulics Laboratory, Inter-Agency Report F, 119 p.

- 1952, The design of improved types of suspended-sediment samplers: Minneapolis, Minnesota, St. Anthony Falls Hydraulics Laboratory, Inter-Agency Report 6, 103 p.
- 1958, Operating instructions for US DH-48 suspended-sediment hand sampler: Minneapolis, Minnesota, St. Anthony Falls Hydraulics Laboratory, Inter-Agency Report J, 5 p.
- 1959, Sedimentation instruments and reports: Minneapolis, Minnesota, St. Anthony Falls Hydraulics Laboratory, Inter-Agency Report AA, 38 p.
- 1961, The single-stage sampler for suspended-sediment: Minneapolis, Minnesota, St. Anthony Falls Hydraulics Laboratory, Inter-Agency Report 13, 105 p.
- 1963a, A summary of the work of the Federal Inter-Agency Sedimentation Project: Minneapolis, Minnesota, St. Anthony Falls Hydraulics Laboratory, Inter-Agency Report S, 29 p.
- 1963b, Determination of fluvial sediment discharge: Minneapolis, Minnesota, St. Anthony Falls Hydraulics Laboratory, Inter-Agency Report 14, 151 p.
- 1964, Operation and maintenance of US BM-54 bed-material sampler: Minneapolis, Minnesota, St. Anthony Falls Hydraulics Laboratory, Inter-Agency Report M, 16 p.
- 1965, Instructions for sampling with depth-integrating suspended-sediment samplers, US D-49 and DH-59: Minneapolis, Minnesota, St. Anthony Falls Hydraulics Laboratory, Inter-Agency Report O, 7 p.
- 1966, Laboratory investigation of pumping-sampler intakes: Minneapolis, Minnesota, St. Anthony Falls Hydraulics Laboratory, Inter-Agency Report T, 59 p.
- 1974, An investigation of a device for measuring the bulk density of water-sediment mixtures: Minneapolis, Minnesota, St. Anthony Falls Hydraulics Laboratory, Inter-Agency Report U, 35 p.
- 1976, Instructions for sampling with depth-integrating, suspended-sediment samplers, D-74, D-74 AL, D-74 TM, and D-74 AL-TM: Minneapolis, Minnesota, St. Anthony Falls Hydraulics Laboratory, Inter-Agency Report, 13 p.
- 1981a, Instruments and reports for fluvial sediments investigations: Minneapolis, Minnesota, St. Anthony Falls Hydraulics Laboratory, Inter-Agency Report Catalog, 134 p.
- 1981b, Test and design of automatic fluvial suspended-sediment samplers: Minneapolis, Minnesota, St. Anthony Falls Hydraulics Laboratory, Inter-Agency Report W, 53 p.
- 1982a, A fluid-density gage for measuring suspended-sediment concentration: Minneapolis, Minnesota, St. Anthony Falls Hydraulics Laboratory, Inter-Agency Report X, 125 p.
- 1982b, Development of a bag-type suspended-sediment sampler: Minneapolis, Minnesota, St. Anthony Falls Hydraulics Laboratory, Inter-Agency Report Y, 32 p.
- 1982c, Theory and operation manual for the autopipet semi-automatic pipet withdrawal apparatus: Minneapolis, Minnesota, St. Anthony Falls Hydraulics Laboratory, Inter-Agency Report Z, 71 p.
- 1983, Operator's manual, PS-82 automatic pumping sampler: Minneapolis, Minnesota, St. Anthony Falls Hydraulics Laboratory, Inter-Agency Draft Report, 34 p.
- Gonzales, D.D., Scott, C.H., and Culbertson, J.K., 1969, Stage-discharge characteristics of a weir in a sand-channel stream: U.S. Geological Survey Water-Supply Paper 1898-A, 29 p.
- Guy, H.P., 1965, Residential construction and sedimentation at Kensington, Maryland—Proceedings of the Federal Inter-Agency Sedimentation Conference, Jackson, Mississippi, 1963: U.S. Department of Agriculture, Agriculture Research Service, Miscellaneous Publication 970, p. 30-37.
- 1968, Quality control of adjustment coefficients, *in* Geological Survey Research 1968: U.S. Geological Survey Professional Paper 600-B, p. B165-B168.
- 1969, Laboratory theory and methods for sediment analysis: U.S. Geological Survey Techniques of Water-Resources Investigations, chap. C1, book 5, 58 p.
- 1970, Fluvial sediment concepts: U.S. Geological Survey Techniques of Water-Resources Investigations, chap. C1, book 3, 55 p.
- Guy, H.P., and Simons, D.B., 1964, Dissimilarity between spatial and velocity-weighted sediment concentrations, *in* Short papers in geology and hydrology: U.S. Geological Survey Professional Paper 475-D, p. D134-D137.
- Guy, H.P., Simons, D.B., and Richardson, E.V., 1966, Summary of alluvial channel data from flume experiments, 1956-61: U.S. Geological Survey Professional Paper 462-I, 96 p.
- Hamamori, A., 1962, A theoretical investigation on the fluctuations of bedload transport: Delft Hydraulics Laboratory Report R4, 21 p.
- Heinemann, H.G., 1961, Sediment distribution in small floodwater-retarding reservoirs in the Missouri Basin Loess Hills: U.S. Department of Agriculture Report, ARS 41-44, 37 p.
- 1964, Volume-weight of reservoir sediment: American Society of Civil Engineers Transactions, v. 129, p. 64-66.
- Helley, E.J., and Smith, Winchell, 1971, Development and calibration of a pressure-difference bedload sampler: U.S. Geological Survey Open-File Report 73-108, 38 p.
- Hubbell, D.W., 1960, Progress report no. 2, Investigations of some sedimentation characteristics of sand-bed streams: U.S. Geological Survey Open-File Report, 54 p.
- 1964, Apparatus and techniques for measuring bedload: U.S. Geological Survey Water-Supply Paper 1748, 74 p.
- Hubbell, D.W., and others, 1956, Progress report no. 1, Investigations of some sedimentation characteristics of a sand-bed stream: U.S. Geological Survey Open-File Report, 78 p.
- Hubbell, D.W., and Stevens, H.H., 1986, Factors affecting accuracy of bedload sampling: Proceedings of the Fourth Federal Interagency Sedimentation Conference, v. 1, p. 4-20-29.
- Hubbell, D.W., Stevens, H.H., Skinner, J.V., and Beverage, J.P., 1981, Recent refinements in calibrating bedload samplers: Proceeding of the Specialty Conference, Water Forum 1981, American Society of Civil Engineers, San Francisco, California, v. 1, 13 p.
- 1985, New approach to calibrating bedload samplers: American Society of Civil Engineers, Journal of Hydraulic Engineering, v. III, no. 4, p. 677-694.
- Inter-Agency Advisory Committee on Water Data, Subcommittee on Sediment, 1983, Sediment deposition in U.S. reservoirs—Summary of data reported through 1976-80: U.S. Geological Survey, Office of Water Data Coordination, 32 p.
- Jones, B.L., 1966, Effects of agricultural conservation practices on the hydrology of Corey Creek Basin, Pennsylvania, 1954-60: U.S. Geological Survey Water-Supply Paper 1532-C, 55 p.
- Kellerhals, Rolf, 1967, Stable channels with gravel paved beds: Waterways and Harbors Division Journal, American Society of Civil Engineers, Proceedings, v. 93, no. WW1, p. 63.
- Lane, E.W., and Carlson, E.J., 1953, Some factors affecting the stability of canals constructed in coarse granular materials: Minneapolis, Minnesota, International Association for Hydrologic Research, p. 76-81.
- Lane, E.W., and Koelzer, V.A., 1943, Density of sediments deposited in reservoirs: Iowa City, Iowa University Hydraulics Laboratory, Federal Inter-Agency Sedimentation Project Report 9, 60 p.
- Lara, J.M., and Pemberton, E.L., 1965, Initial unit weight of deposited sediments—Proceedings of the Federal Inter-Agency Sedimentation Conference, Jackson, Mississippi, 1963: U.S. Department of Agriculture, Agriculture Research Service, Miscellaneous Publication 970, p. 818-845.

- Leopold, L.B., and Emmett, W.W., 1977, 1976 bedload measurement, East Fork River, Wyoming: Proceedings of the National Academy of Sciences, v. 74, no. 7, p. 2644–2648.
- Leopold, L.B., Wolman, M.G., and Miller, J.P., 1964, Fluvial processes in geomorphology: San Francisco, California, W.H. Freeman and Company, 522 p.
- Meyer-Peter, E., and Muller, R., 1948, Formulas for bedload transport: International Association of Hydraulic Structures Research, 2d meeting, Stockholm, Sweden, 1948, Proceedings, p. 39–64.
- Miller, C.R., 1951, Analysis of flow-duration, sediment rating curve method of computing sediment yield: Bureau of Reclamation Report, 15 p.
- Mitchell, W.D., 1962, Effect of reservoir storage on peak flow: U.S. Geological Survey Water-Supply Paper 1580–C, 25 p.
- Mundorff, J.C., 1957, A handline suspended-sediment sampler: U.S. Geological Survey Open-File Report, 2 p.
- 1964, Fluvial sediment in Kiowa Creek Basin, Colorado: U.S. Geological Survey Water-Supply Paper 1798–A, 70 p.
- 1966, Sedimentation in Brownell Creek sub-watershed no. 1, Nebraska: U.S. Geological Survey Water-Supply Paper 1798–C, 49 p.
- Office of Water Data Coordination, 1978, National handbook of recommended methods for water-data acquisition: U.S. Geological Survey, chap. 3—Sediment, 100 p.
- Peterson, H.V., 1962, Hydrology of small watersheds in Western States: U.S. Geological Survey Water-Supply Paper 1475–I, p. 223–227.
- Porterfield, George, 1972, Computation of fluvial sediment discharge: U.S. Geological Survey Techniques of Water-Resources Investigations, chap. C3, book 3, 66 p.
- Porterfield, George, and Dunnam, C.A., 1964, Sedimentation of Lake Pillsbury, Lake County, California: U.S. Geological Survey Water-Supply Paper 1619–EE, 46 p.
- Prych, E.A., and Hubbell, D.W., 1966, A sampler for coring sediments in rivers and estuaries: Geological Society of America Bulletin, v. 77, p. 549–556.
- Randle, T.J., and Blanton, J.O., III, 1986, Underwater mapping river channels and reservoirs: Proceedings of the Fourth Federal Interagency Sedimentation Conference, v. 1, p. 1–79 to 1–88.
- Ritter, J.R., and Helley, E.T., 1968, An optical method for determining particle sizes of coarse sediment: U.S. Geological Survey Open-File Report, 43 p.
- Simons, D.B., and Richardson, E.V., 1965, A study of variables affecting flow characteristics and sediment transport in alluvial channels—Proceedings of the Federal Inter-Agency Sedimentation Conference, Jackson, Mississippi, 1963: U.S. Department of Agriculture, Agriculture Research Service, Miscellaneous Publication 970, p. 193–207.
- 1966, Resistance to flow in alluvial channels: U.S. Geological Survey Professional Paper 422–J, 61 p.
- Skinner, J.V., 1982, Proposed practice for sampling fluvial sediment in motion: American Society for Testing and Materials Standards, Annual Book, pt. 31, 24 p. [Published for information only].
- Stevens, H.H., Jr., 1985, Computer program for the computation of total sediment discharge by the modified Einstein procedure: U.S. Geological Survey Water-Resources Investigations Report 85–4047, 76 p.
- Thornbury, W.D., 1969, Principles of geomorphology (2d ed.): New York, Wiley, 594 p.
- Vanoni, V.A., ed., 1975, Sedimentation engineering: American Society of Civil Engineers, Manuals and Reports on Engineering Practice, no. 54, 745 p.
- Winterstein, T.A., and Stefan, H.E., 1983, Suspended-sediment sampling in flowing water—Laboratory study of the effects of nozzle orientation, withdrawal rate and particle size: Minneapolis, University of Minnesota, St. Anthony Falls Hydraulic Laboratory External Memorandum M–168, 97 p.
- Wolman, M.G., 1954, A method of sampling coarse river bed material: American Geophysical Union Transcript, v. 35, no. 6, p. 951.