



U.S. Department
of Transportation

**Federal Highway
Administration**

Publication No. FHWA-SA-95-003

February 1995

BACKGROUND of SUPERPAVE ASPHALT MIXTURE DESIGN AND ANALYSIS

NATIONAL ASPHALT TRAINING CENTER
DEMONSTRATION PROJECT 101



Innovation Through Partnerships

NOTICE

This document is disseminated under the sponsorship of the Department of Transportation in the interest of information exchange. This publication does not constitute a standard, specification, or regulation.

The United States Government does not endorse products or manufacturers. Trademarks or manufacturers' names appear herein only because they are considered essential to the object of this document.

1. Report No. FHWA-SA-95-003		2. Government Accession No.		3. Recipient's Catalog No.	
4. Title and Subtitle Background of SUPERPAVE Asphalt Mixture Design & Analysis				5. Report Date November 1994	
				6. Performing Organization Code	
7. Author(s) R.B. McGennis, R.M. Anderson, T.W. Kennedy, M. Solaimanian				8. Performing Organization Report No.	
9. Performing Organization Name and Address Asphalt Institute P.O. Box 14052 Lexington, KY 40512-4052				10. Work Unit No. (TRIS)	
				11. Contract or Grant No. DTFH61-92-C-0098	
12. Sponsoring Agency Name and Address Federal Highway Administration Office of Technology Applications 400 Seventh St., SW Washington, DC 20590				13. Type of Report and Period Covered Final Report December 1992-November 1994	
				14. Sponsoring Agency Code HTA-21	
15. Supplementary Notes FHWA Technical Representative - J.R. Bukowski					
16. Abstract This manual represents the first formal training document that embodies the complete series of SUPERPAVE asphalt mixture design and analysis test equipment and procedures. These tests and procedures represent the results of the SHRP 5-year research effort to investigate and improve asphalt cement technology. This manual was developed under the FHWA's National Asphalt Training Center. Students attending the center utilize this manual to obtain a better understanding of the underlying theory behind asphalt mixture design and analysis, as well as how to perform each of the new procedures.					
17. Key Words Asphalt mix, asphalt cement, gyratory compactor, indirect tensile tester, level 1 design, mixture design, shear tester, SHRP, SUPERPAVE			18. Distribution Statement No restrictions. This document is available to the public from the National Technical Information Service, Springfield, Virginia 22161		
19. Security Classif. (of this report) Unclassified		20. Security Classif. (of this page) Unclassified		21. No. of Pages 160	22. Price

FOREWORD

From October 1987 through March 1993, the Strategic Highway Research Program (SHRP) conducted a \$50 million research effort to develop new ways to specify, test, and design asphalt materials. Near the end of SHRP, the Federal Highway Administration assumed a leadership role in the implementation of SHRP research. An essential part of FHWA's implementation strategy was development of a nationally accessible training center aimed at educating agency and industry personnel in the proper use and application of the final SHRP asphalt products, collectively referred to as Superpave™. This project was administered by the FHWA's Office of Technology Applications and designated Demonstration Project 101, the National Asphalt Training Center (NATC).

The NATC resides at the Asphalt Institute's Research Center in Lexington, Kentucky. While the day-to-day affairs of the NATC are directed by Institute personnel, course development and technical direction were duties shared by a team of engineers from the Asphalt Institute, the Pennsylvania State University, the University of Texas at Austin, National Center for Asphalt Technology, Marathon Oil Company, and FHWA.

The objective of the educational program is to train students in the practical applications of SHRP asphalt products. It is composed of two parts: Superpave asphalt binder technology and Superpave asphalt mixture design and analysis.

This manual represents the textbook students use as a reference throughout the 40 hours of training in Superpave mixture design and analysis. Best efforts were made to present the information in an easy to understand style. It was written for laboratory technicians and engineers with no previous training in Superpave, but with some knowledge in asphalt materials and mixture design. Other instructional aids consist of provisional AASHTO test methods (when available) and a separate illustrated overview document pertaining to Superpave gyratory compaction.

The training program consists of 40 hours of instruction. Of this 40 hours, students receive 12 hours of classroom instruction, 16 hours of laboratory instruction, and 12 hours of group discussion of actual test results. By the end of the course, students will be familiar with Superpave asphalt mixture test procedures and equipment. This course emphasizes (but is not limited to) Superpave Level 1 design and analysis.

The training program and this manual do not present any information in English units. Superpave test procedures were largely developed in SI or metric units. The NATC team believed it would be counter productive and make learning more difficult if material properties were shown in U.S. customary, as well as the original SI and metric units. For example, it is easy for a student to understand and remember that the gyratory compaction pressure is 600 kPa. To show an English conversion such as, "600 kPa (86 psi)," serves no purpose since students have no previous knowledge of typical U.S. customary units for this test parameter. The only exception to this is that some

performance based testing software was developed (and remains) in U.S. customary units. The NATC team has no control over these products but encourages the software developers to assist the industry and this training effort by standardizing the units, in SI, on test output.

Users of this manual will note that no references are cited throughout the text. That is because as this manual was being prepared in late 1993, very few, if any, SHRP research reports had been published. The authors were able to glean important information from draft reports and verbally from researchers involved in the numerous areas of the SHRP asphalt research program. The authors are indebted to the many individuals who graciously shared their knowledge during the early phases of the NATC. Users are strongly encouraged to obtain and study the reports cited in the bibliography for the most complete information pertaining to Superpave.

As this edition was being prepared, Superpave was still in an emerging phase. Many of the AASHTO test procedures were (and still are) under development. In addition, Superpave testing equipment is only now becoming available. Consequently, some of the information herein contained may be subject to change. Users of this manual are resolutely encouraged to stay abreast of Superpave technology through the many venues that have become available as a result of SHRP. The National Asphalt Training Center and asphalt user-producer groups are two examples of forums that specifically address Superpave technology.

Mr. John R. Bukowski of FHWA's Office of Technology Applications is the Contracting Officer's Technical Representative for NATC. This manual was co-authored by:

*Mr. Robert B. McGennis
Director of Research & Engineering Services
Asphalt Institute*

*Mr. R. Michael Anderson
Asphalt Systems Engineer
Asphalt Institute*

*Dr. Thomas W. Kennedy
Engineering Foundations Professor of Civil Engineering
The University of Texas at Austin*

*Dr. Mansour Solaimanian
Research Engineer
The University of Texas at Austin*

November 1994
Lexington, KY

Superpave™ is a registered trademark of the Strategic Highway Research Program

TABLE OF CONTENTS

I. HOW ASPHALT MIXTURES BEHAVE	1
ASPHALT BINDER BEHAVIOR	1
MINERAL AGGREGATE BEHAVIOR.....	3
ASPHALT MIXTURE BEHAVIOR.....	7
Permanent Deformation.....	7
Fatigue Cracking.....	10
Low Temperature Cracking	13
CURRENT WAYS TO SPECIFY ASPHALT CEMENTS.....	14
CURRENT ASPHALT MIXTURE DESIGN PROCEDURES.....	16
II. SUPERPAVE TO THE RESCUE.....	21
INTRODUCTION	21
ASPHALT BINDERS	21
MINERAL AGGREGATES	26
ASPHALT MIXTURES	28
PUTTING IT ALL TOGETHER.....	30
III. MATERIALS SELECTION	33
INTRODUCTION	33
ASPHALT BINDERS	33
SUPERPAVE Weather Database	34
Reliability	34
Start with Air Temperature.....	35
Convert to Pavement Temperature	36
Select Binder Grade.....	37
Effect of Loading Rate on Binder Selection	38
Effect of Traffic Level on Binder Selection	39
MINERAL AGGREGATE.....	39
Consensus Properties	40
Coarse Aggregate Angularity	40
Fine Aggregate Angularity	41
Flat, Elongated Particles.....	42
Clay Content.....	44
Source Properties.....	45
Toughness	45
Soundness.....	46
Deleterious Materials	46
Gradation	46
ASPHALT MIXTURES	50
Mixture Volumetric Requirements	50
Dust Proportion	51
Moisture Susceptibility.....	52
IV. ASPHALT MIXTURE VOLUMETRICS	53
INTRODUCTION	53
COMPONENT DIAGRAM APPROACH.....	53
SPECIFIC GRAVITY	55
EXAMPLE CALCULATIONS	59
V. SUPERPAVE GYRATORY COMPACTION.....	65
INTRODUCTION	65
TEST EQUIPMENT.....	65

Table of Contents

SPECIMEN PREPARATION	68
OVERVIEW OF PROCEDURE.....	69
DATA ANALYSIS AND PRESENTATION.....	70
CALIBRATION AND STANDARDIZATION.....	74
VI. VOLUMETRIC MIX DESIGN	75
INTRODUCTION	75
MATERIAL SELECTION	76
Binder Selection.....	76
Aggregate Selection	78
Coarse Aggregate Angularity	80
Fine Aggregate Angularity	80
Flat and Elongated Particles	81
Clay Content (Sand Equivalent)	82
SELECT DESIGN AGGREGATE STRUCTURE	82
SELECT DESIGN ASPHALT BINDER CONTENT	103
EVALUATE MOISTURE SENSITIVITY	112
VII. PERFORMANCE TESTING (LEVELS 2 AND 3)	115
INTRODUCTION	115
PERFORMANCE MODELS	116
TEST PARAMETERS.....	117
Test Temperatures	117
Asphalt Binder Contents	118
SUPERPAVE SHEAR TESTER	119
Testing Apparatus.....	119
Test Control Unit.....	120
Environmental Control Unit.....	120
Hydraulic System.....	120
Specimen Preparation and Instrumentation.....	121
Test Procedures.....	123
Volumetric Test.....	123
Uniaxial Strain Test.....	124
Repeated Shear Test at Constant Stress Ratio	125
Repeated Shear Test at Constant Height.....	127
Simple Shear Test at Constant Height	128
Frequency Sweep Test at Constant Height	129
INDIRECT TENSILE TESTER	130
Testing Apparatus.....	131
Control Unit and Data Acquisition System.....	131
Load Measuring Device.....	132
Environmental Control Chamber	132
Specimen Preparation and Instrumentation.....	132
Test Procedures.....	133
IDT Creep Compliance and Strength (Low Temperature Cracking Analysis).....	133
IDT Strength (Fatigue Cracking Analysis)	134
DATA ANALYSIS AND INTERPRETATION.....	135
APPENDIX A: SUPERPAVE ASPHALT BINDER SPECIFICATION.....	139
APPENDIX B: SUPERPAVE ASPHALT MIXTURE GRADATION REQUIREMENTS.....	141
37.5 MM NOMINAL SIZE	141
25 MM NOMINAL SIZE	142
19 MM NOMINAL SIZE	143

12.5 MM NOMINAL SIZE	144
9.5 MM NOMINAL SIZE	145
APPENDIX C: SUPERPAVE CONSENSUS AGGREGATE REQUIREMENTS.....	147
COARSE AGGREGATE ANGULARITY	147
FINE AGGREGATE ANGULARITY	147
FLAT AND ELONGATED PARTICLES.....	148
CLAY CONTENT	148
APPENDIX D: VOLUMETRIC ANALYSIS OF COMPACTED HOT MIX ASPHALT (HMA)	149
DESCRIPTION OF TERMS	149
STANDARD CONVENTIONS	150
CALCULATIONS	151
APPENDIX E: OUTLINE OF STEPS IN SUPERPAVE LEVEL 1 MIX DESIGN.....	153
I. SELECTION OF MATERIALS.....	153
II. SELECTION OF DESIGN AGGREGATE STRUCTURE.....	153
III. SELECTION OF DESIGN ASPHALT BINDER CONTENT.....	154
IV. EVALUATION OF MOISTURE SENSITIVITY OF DESIGN ASPHALT MIXTURE USING AASHTO T283	154
APPENDIX F: TESTING REQUIREMENTS FOR SUPERPAVE.....	155
SUPERPAVE LEVEL 1.....	155
SUPERPAVE LEVEL 2.....	156
SUPERPAVE LEVEL 3.....	157
BIBLIOGRAPHY	159

I.

HOW ASPHALT MIXTURES BEHAVE

Asphalt concrete (sometimes referred to as “hot mix asphalt” or simply “HMA”) is a paving material that consists of asphalt binder and mineral aggregate. The asphalt binder, which can be asphalt cement or modified asphalt cement, acts as a binding agent to glue aggregate particles into a cohesive mass. Because it is impervious to water, the asphalt binder also functions to waterproof the mixture. When bound by the asphalt binder, mineral aggregate acts as a stone framework to impart strength and toughness to the system. Because HMA contains both asphalt binder and mineral aggregate, the behavior of the mixture is affected by the properties of the individual components and how they react with each other in the system.

ASPHALT BINDER BEHAVIOR

Asphalt binder alone is a very interesting and challenging construction material with which to work. Its most important characteristic, which is both a strength and sometimes a weakness, is its temperature susceptibility. That is, its measured properties are very dependent on its temperature. That is why almost every asphalt cement and mixture characterization test must be accompanied by a specified test temperature. Without specifying a test temperature, the test result cannot be effectively interpreted. Asphalt cement behavior is also dependent on time of loading. The same load applied for a different duration will cause an asphalt to exhibit different properties. As with temperature, asphalt cement tests must specify a loading rate. Because asphalt cement behavior is dependent on temperature and duration of load, these two factors can be used interchangeably (Figure I-1). That is, a slow loading rate can be simulated by high temperatures and fast loading rate can be simulated by low temperatures.

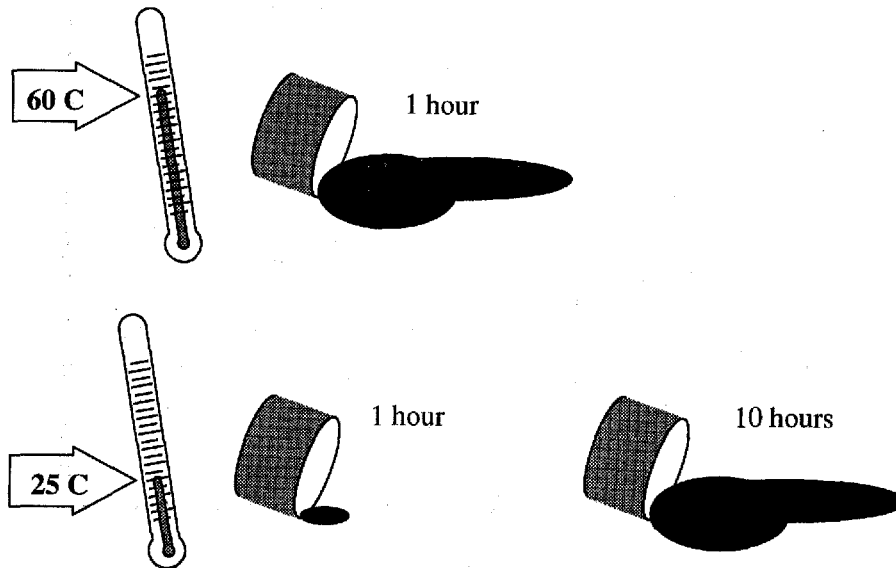

Figure I-1. Asphalt Cement Time Temperature Dependency

Asphalt cement is sometimes referred to as a *visco-elastic* material because it simultaneously displays both viscous and elastic characteristics (Figure I-2). At high temperatures, asphalt cement acts almost entirely as a viscous fluid. In other words, when heated to a high enough temperature (e.g., $> 100^{\circ}\text{C}$), it displays the consistency of a lubricating fluid such as motor oil. At very low temperatures (e.g., $< 0^{\circ}\text{C}$), asphalt cement behaves mostly like an elastic solid. That is, it acts like a rubber band. When loaded it stretches or compresses to a different shape. When unloaded, it easily returns to its original shape. At intermediate temperatures, which also happen to be those in which pavements are expected to function, asphalt cement has characteristics of both a viscous fluid and an elastic solid.

There remains another important characteristic about asphalt cement. Because it is composed of organic molecules, it reacts with oxygen from the environment. This reaction is called “oxidation” and it changes the structure and composition of the asphalt molecules. When an asphalt reacts with oxygen, a harder and more brittle structure always results and that is the origin of the terms “oxidative hardening” or “age hardening.” Oxidation occurs more rapidly at high temperatures. That is why a significant amount of hardening occurs during HMA production, when the asphalt cement is necessarily heated to facilitate mixing and compaction. That is also why oxidation is more of a concern when the asphalt cement is used in a pavement in a hot, desert climate.

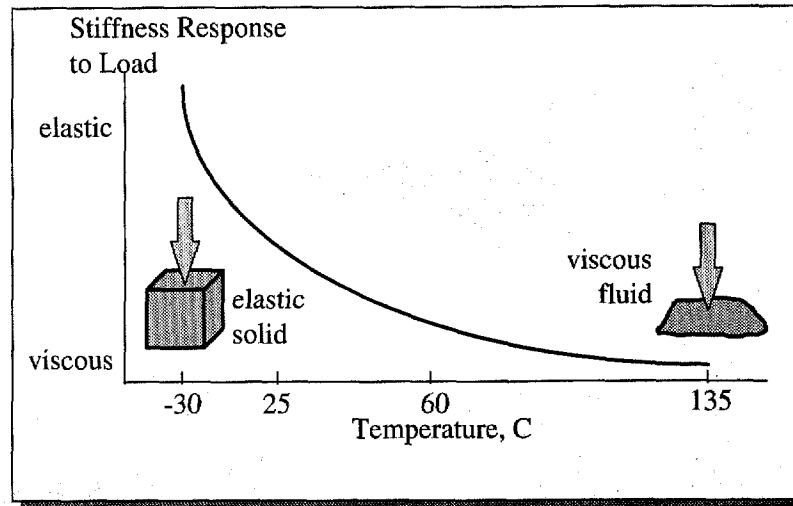

Figure I-2. Visco-Elastic Behavior of Asphalt

Modified asphalt binders are produced to alter and improve the properties of the asphalt to enhance the long term performance of pavements. While the modifier may affect many properties, the majority of modifiers attempt to reduce temperature dependency and oxidative hardening of asphalt cement and the moisture susceptibility of asphalt mixtures.

MINERAL AGGREGATE BEHAVIOR

A wide variety of mineral aggregate has been used to produce HMA. Some materials are referred to as *natural* aggregate because they are simply mined from river or glacial deposits and are used without further processing to manufacture HMA. These are often called “bank-run” or “pit-run” materials. *Processed* aggregate can include natural aggregate that has been separated into distinct size fractions, washed, crushed, or otherwise treated to enhance certain performance characteristics of the finished HMA. However, in most cases processed aggregate is quarried and the main processing consists of crushing and sizing.

Synthetic aggregate consists of any material that is not mined or quarried and in many cases represents an industrial by-product. Blast furnace slag is one example. Occasionally, a synthetic aggregate will be produced to impart a desired performance characteristic to the HMA. For example, light-weight expanded clay or shale is sometimes used as a component to improve the skid resistance properties of HMA.

An existing pavement can be removed and reprocessed to produce new HMA. Reclaimed asphalt pavement or "RAP" is a growing and important source of aggregate for asphalt pavements.

Increasingly, waste products are used as aggregate or otherwise disposed of in asphalt pavements. Scrap tires and glass are the two most well known waste products that have been successfully "landfilled" in asphalt pavements. In some cases, waste products can actually be used to enhance certain performance characteristics of HMA. In other cases, it is considered sufficient that a solid waste disposal problem has been solved and no performance enhancing benefit from the waste material is expected. However, it is hoped that performance will not be sacrificed simply to eliminate a solid waste material.

Regardless of source, processing method, or mineralogy, aggregate is expected to provide a strong, stone skeleton to resist repeated load applications. Cubical, rough-textured aggregates provide more strength than rounded, smooth-textured aggregates (Figure I-3). Even though a cubical piece and rounded piece of aggregate may possess the same inherent strength, cubical aggregate particles tend to lock together resulting in a stronger mass of material. Instead of locking together, rounded aggregate particles tend to slide by each other.

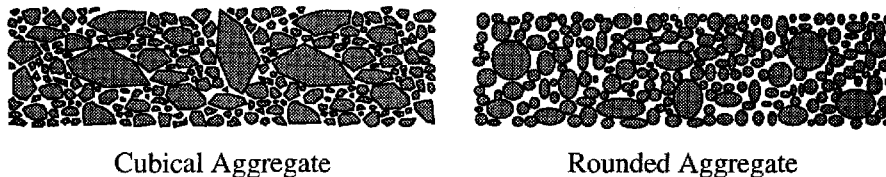

Figure I-3. Aggregate Stone Skeletons

When a mass of aggregate is loaded, there may occur within the mass a plane where aggregate particles begin to slide by or "shear" with respect to each other (Figure I-4), which results in permanent deformation of the mass. It is at this plane where the "shear stress" exceeds the "shear strength" of the aggregate mass. Aggregate shear strength is of critical importance in HMA.

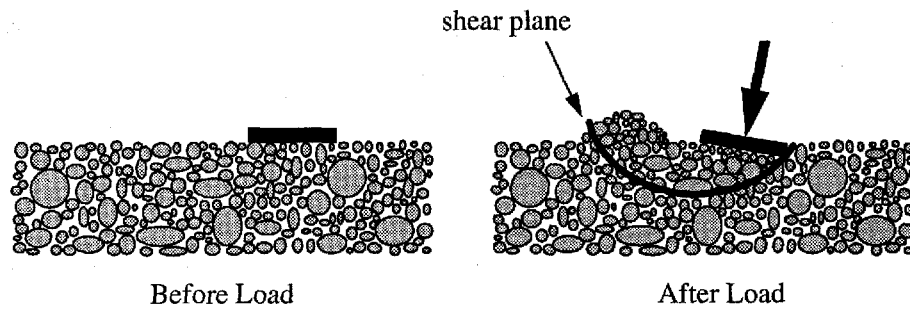

Figure I-4. Shear Loading Behavior of Aggregate

Contrasting aggregate shear strength behavior can easily be observed in aggregate stockpiles whereby crushed (i.e., mostly cubical) aggregates form steeper, more stable piles than rounded aggregates. Engineers refer to the slope on stockpiles as the angle of repose. The angle of repose of a crushed aggregate stockpile is greater than that of an uncrushed aggregate stockpile (Figure I-5).

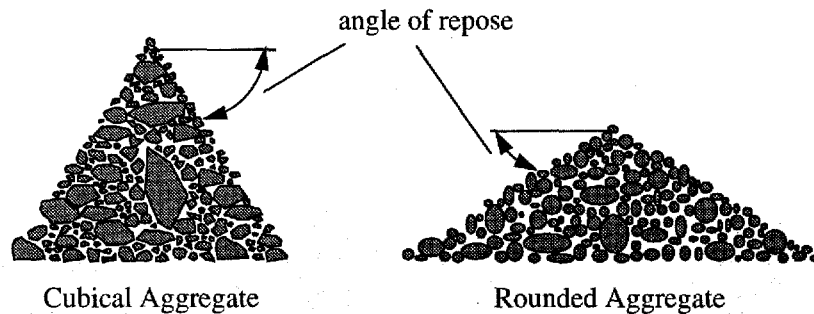

Figure I-5. Stockpile Behavior of Cubical and Rounded Aggregate

Engineers explain the shearing behavior of aggregate (and many other) materials using Mohr-Coulomb theory, named after the individuals who originated the concept. This theory declares that the shear strength of an aggregate mixture is dependent on how well the aggregate particles hold together in a mass (often called cohesion), the stress the aggregates may be under, and the internal friction of the aggregate. The Mohr-Coulomb equation used to express the shear strength of a material is:

$$\tau = c + \sigma \times \tan \phi$$

I. How Asphalt Mixtures Behave

where, τ = shear strength of aggregate mixture,
 c = cohesion of aggregate,
 σ = normal stress to which the aggregate is subjected, and
 ϕ = angle of internal friction.

The Mohr-Coulomb shearing behavior of materials is shown in Figure I-6.

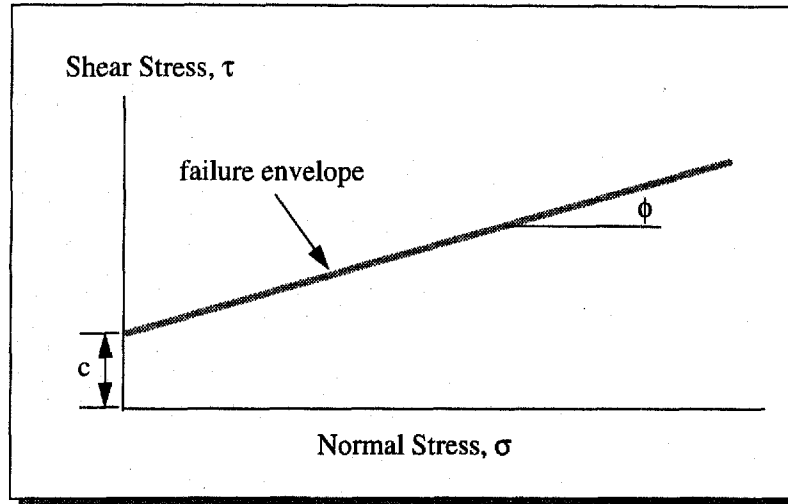

Figure I-6. Mohr-Coulomb Theory

A mass of aggregate has relatively little cohesion. Thus, the shear strength is primarily dependent on the resistance to movement provided by the aggregates. In addition, when loaded, the mass of aggregate tends to be stronger because the resulting stress tends to hold the aggregate more tightly together. In other words, shear strength is increased. The angle of internal friction indicates the ability of aggregate to interlock, and thus, create a mass of aggregate that is almost as strong as the individual pieces.

A last consideration in understanding the shearing properties of aggregate is the concept of *dilatancy*. When subjecting a mass of aggregate to shearing stresses, aggregate particles must fracture or crawl up and over each other if movement is to occur. This phenomenon is called *dilation* because it results in an enlargement or increased volume of the mass of aggregate (Figure I-7). Strong materials that are more densely packed and have high internal friction tend to dilate more than weaker materials.

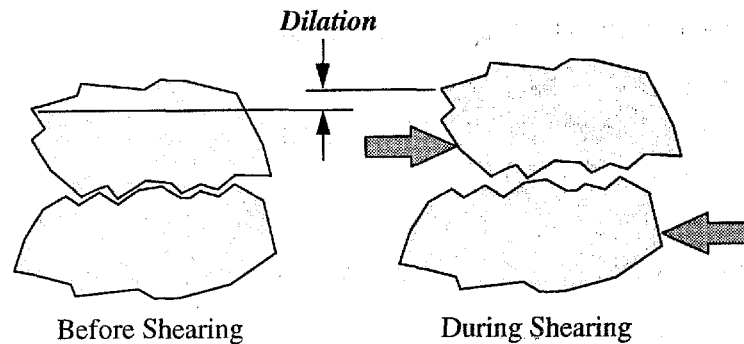

Figure I-7. Dilation of Two Aggregate Particles When Sheared

To ensure a strong aggregate blend for HMA, engineers typically have specified aggregate properties that enhance the internal friction portion of the overall shear strength. Normally, this is accomplished by specifying a certain percentage of crushed faces for the coarse portion of an aggregate blend. Because natural sands tend to be rounded, with poor internal friction, the amount of natural sand in a blend is often limited.

ASPHALT MIXTURE BEHAVIOR

While the individual properties of HMA components are important, asphalt mixture behavior is best explained by considering asphalt cement and mineral aggregate acting as a system. One way to understand asphalt mixture behavior is to consider the primary asphalt pavement distress types that engineers try to avoid: permanent deformation, fatigue cracking, and low temperature cracking.

Permanent Deformation

Permanent deformation is the distress that is characterized by a surface cross section that is no longer in its proper position. It is called “permanent” deformation because it represents an accumulation of small amounts of deformation that occur each time a load is applied. This deformation cannot be recovered. Wheel path rutting is the most common form of permanent deformation. While wheel path rutting can have many causes (e.g., underlying HMA weakened by moisture damage, abrasion, traffic densification), it has two principal causes.

In one case, the rutting is caused by too much repeated stress being applied to the native soil (i.e., subgrade), subbase, or base below the asphalt layer (Figure I-8). Although stiffer paving materials will partially reduce this type of rutting, it is normally considered more of a structural problem rather than a materials problem. It is often the result of too thin a pavement section because there is simply not enough depth of cover on the subgrade to reduce the stress from applied loads to a tolerable level. It may also be the result of a subgrade that has been unexpectedly weakened by the intrusion of moisture. The accumulated deformation occurs in the subgrade rather than in the overlying asphalt layers.

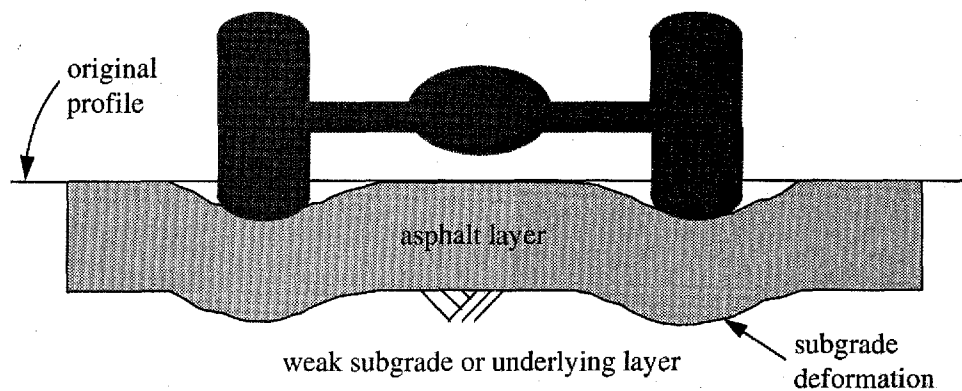

Figure I-8. Rutting from Weak Subgrade

The other principal type of rutting (and that which is of most concern here) results from accumulated deformation in the asphalt layers. This type of rutting is caused by an asphalt mixture that is too low in shear strength to resist the repeated heavy loads to which it is subjected (Figure I-9). Sometimes the rutting occurs in a weak asphalt surface course. In other cases, the surface course may not itself be prone to rutting, but may simply conform to an underlying asphalt course that is too weak.

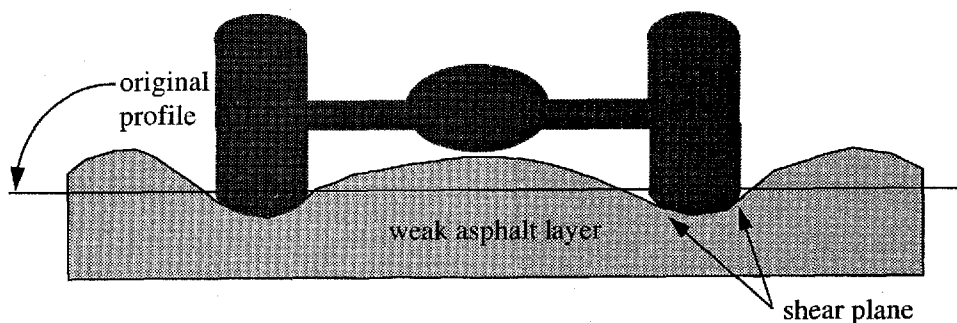

Figure I-9. Rutting from Weak Mixture

When an asphalt mixture ruts, it is evidence that the mixture has poor shear strength. Each time a heavy truck applies a load, a small, but permanent, shear deformation occurs. Shear deformation is characterized by a downward and lateral movement of the mixture. With enough load applications a rut will appear. Rutted asphalt pavements pose a safety hazard because the ruts will trap enough water to cause hydroplaning and ice accumulation.

Asphalt pavement rutting from weak asphalt mixtures is a high temperature phenomenon. That is, it most often occurs during the summer when high pavement temperatures are evident. While this might suggest that rutting is solely an asphalt cement problem, it is more correct to address rutting by considering the mineral aggregate and asphalt cement. In fact, the previously described Mohr-Coulomb equation ($\tau = c + \sigma \times \tan \phi$) can again be used to illustrate how both materials can affect rutting.

In this case, τ is considered the shear strength of the asphalt mixture. The cohesion term (c) can be considered the portion of the overall mixture shear strength provided by the asphalt cement. Because rutting is an accumulation of very small permanent deformations, one way to ensure that asphalt cement provides its "fair share" of shear strength is to use an asphalt cement that is not only stiffer but also behaves more like an elastic solid at high pavement temperatures (Figure I-10). That way, when a load is applied to the asphalt cement in the mixture, it tends to act more like a rubber band and spring back to its original position rather than stay deformed.

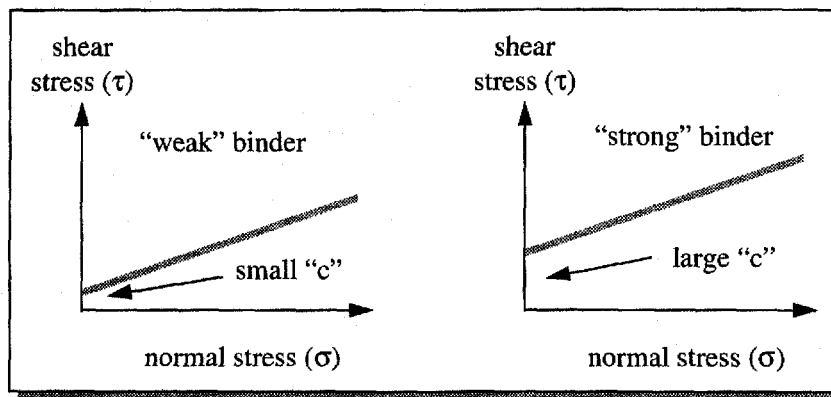

Figure I-10. Contrasting Asphalt Binder Contribution to Mixture Shear Strength

Another way to increase the shear strength of an asphalt mixture is by selecting an aggregate that has a high degree of internal friction (ϕ). This is accomplished by selecting an aggregate that is cubical, has a rough surface texture, and graded in a manner to develop particle-to-particle contact. Figure I-11 shows the contrasting aggregate contribution to mixture shear strength. When a load is applied to the aggregate in the mixture, the aggregate particles lock tightly together and function not merely as a mass of individual particles, but more as a *large, single, elastic stone*. As with the asphalt cement, the aggregate will act like a rubber band and spring back to its original shape when unloaded. That way, no deformations (i.e., permanent) are accumulated.

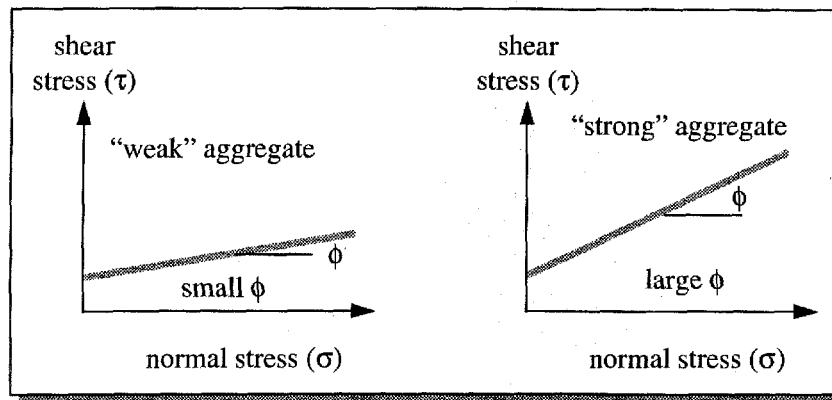

Figure I-11. Contrasting Aggregate Contribution to Mixture Shear Strength

While it is obvious that the largest portion of the resistance to permanent deformation of the mixture is provided by the aggregate, the portion provided by the asphalt binder is very important. Binders which have low shear characteristics due to composition or temperature minimize cohesion and to a certain extent, the confining "normal" stress. Thus the mixture begins to behave more like an unbound aggregate mass.

Fatigue Cracking

Like rutting, fatigue cracking is a distress type that most often occurs in wheel paths where repeated heavy loads are applied. An early sign of fatigue cracking consists of intermittent longitudinal wheel path cracks (i.e., in the direction of traffic). Fatigue cracking is a progressive type of distress because at some point, the initial cracks will

join, which in turn, causes even more cracks to form. An intermediate stage of fatigue cracking is sometimes called “alligator cracking” because the crack pattern resembles an alligator’s skin (Figure I-12). In some extreme cases, the final stage of fatigue cracking is disintegration when potholes form. A pothole forms when several of the pieces become dislodged and removed under the action of traffic.

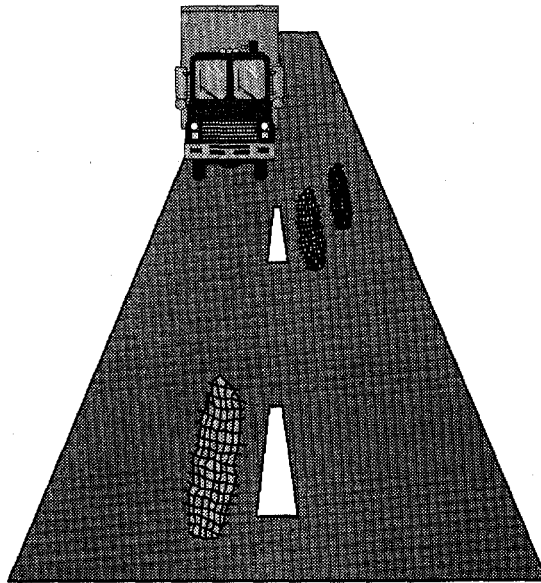

Figure I-12. Alligator (Fatigue) Cracking

Engineers have long recognized that very stiff asphalt mixtures tend to have poor fatigue properties when the pavement structure allows the asphalt mixture layer to deflect. Stiffer materials, high deflection, and high stress levels translate to lower fatigue life.

While the mechanism of fatigue cracking is easy to understand, its cause often is not. It cannot be addressed as just a materials problem. Fatigue cracking is usually caused by a number of pavement factors that have to occur simultaneously. Obviously, repeated heavy loads must be present. Some engineers believe that poor subgrade drainage, resulting in a soft, high deflection pavement, is the principal cause of fatigue cracking. Poorly designed and/or poorly constructed pavement layers that are also prone to high deflections when loaded probably contribute to fatigue cracking. Thus, thin, very stiff pavement layers, subjected to high deflections from repeated heavy loads are most susceptible to fatigue cracking.

In many cases, fatigue cracking is merely a sign that a pavement has received the number of load applications for which it was designed. Consequently, it is simply “worn out” and in need of a planned rehabilitation. Assuming that the occurrence of fatigue cracking coincides approximately with the design period, it may even not be considered a failure, but rather the natural progression of a pavement design strategy. If the observed cracking occurs much sooner than the design period, it may be a sign that the pavement received more heavy loads, earlier than expected.

Consequently, the best ways to overcome fatigue cracking are:

- adequately account for the anticipated number of heavy loads during design,
- keep the subgrade dry using whatever means available,
- use thicker pavements,
- use paving materials that are not excessively weakened in the presence of moisture, and
- use paving materials that are resilient enough to withstand normal deflections.

In general, asphalt mixtures are unaffected and largely impervious to moisture. In some extreme cases however, moisture vapor has been shown to strip asphalt cement from mineral aggregate. While stripping of an underlying asphalt layer can manifest itself as fatigue cracking in an upper asphalt layer, it is not normally considered a fatigue failure. A more common instance of fatigue cracking being caused by a moisture weakened layer is with an unbound base that has too many fine particles to allow for rapid drainage of moisture. Unbound bases should be selected so that they do not trap moisture.

Only the last item, selection of resilient materials, can be addressed strictly from a materials selection perspective. As a load is applied, horizontal tensile stresses occur near the bottom of an asphalt layer (Figure I-13). Clearly, the material in this vicinity must be very strong with sufficient tensile strength to withstand the applied tensile stress. However, to overcome fatigue cracking, material in this vicinity also must be resilient. In this context, resilient means that the material can withstand many load applications at stress levels far less than the tensile strength, without cracking.

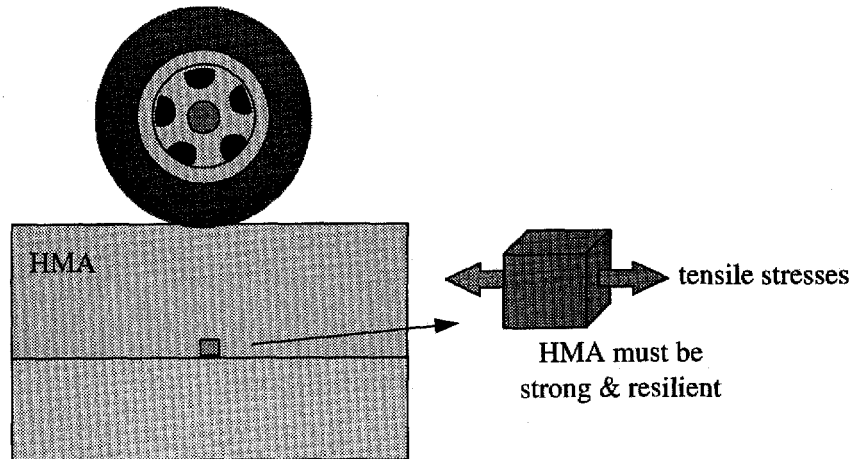

Figure I-13. Tensile Stresses at Bottom of HMA Layer

Thus, to overcome fatigue cracking from a materials perspective, HMA must be selected so that it behaves like a soft elastic material. Since the tensile behavior of HMA is strongly influenced by asphalt cement, this is accomplished by selecting an asphalt cement that has upper limits placed on the elastic part of its overall stiffness. In effect, soft asphalts have better fatigue properties than hard asphalts.

Low Temperature Cracking

As its name indicates, low temperature cracking is a distress type that is caused by adverse environmental conditions rather than by applied traffic loads. It is characterized by intermittent transverse cracks (i.e., perpendicular to the direction of traffic) that occur at a surprisingly consistent spacing (Figure I-14).

Low temperature cracks form when an asphalt pavement layer shrinks in cold weather. As the pavement shrinks, tensile stresses build within the layer. At some point along the pavement, the tensile stress exceeds the tensile strength and the asphalt layer cracks. Thus, low temperature cracks occur primarily from a single cycle of low temperature. Some engineers, however, also believe it is a fatigue phenomenon due to the cumulative effect of many cycles of cold weather.

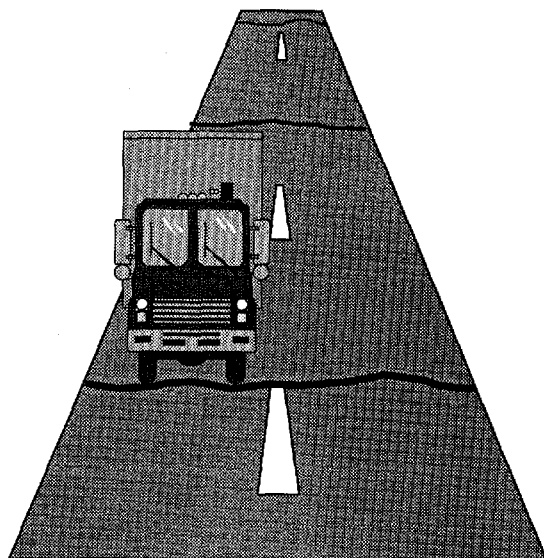

Figure I-14. Low Temperature Cracking

Both groups agree that asphalt binder plays the central role in low temperature cracking. In general, hard asphalt binders are more prone to low temperature cracking than soft asphalt binders. Asphalt binders that are excessively oxidized, either because they are unduly prone to oxidation or contained in a mixture left with too many air voids after construction, or both, are more prone to low temperature cracking. Thus, to overcome low temperature cracking engineers must use a soft binder, a binder that is not overly prone to aging, and control in-place air void content so that the binder is not excessively oxidized.

CURRENT WAYS TO SPECIFY ASPHALT CEMENTS

The current method to characterize asphalt cement consistency is by either penetration or viscosity tests as shown in Figure I-15. Both of these tests have been used to measure the effect of temperature on asphalt behavior. This is done by measuring viscosity or penetration at two temperatures and plotting the results as shown in Figure I-16.

In this example, all three asphalts are the same viscosity grade because they are within specified limits at 60° C. While Asphalts A and B display the same temperature dependency, they have much different consistencies at all temperatures. Asphalts A and C have the same consistency at low temperatures but remarkably different high temperature consistency. Asphalt B has the same consistency at 60° C, but shares no

other similarities with Asphalt C. Because these asphalts share the same grade, they might erroneously be expected to display the same characteristics during construction and during hot and cold weather performance conditions.

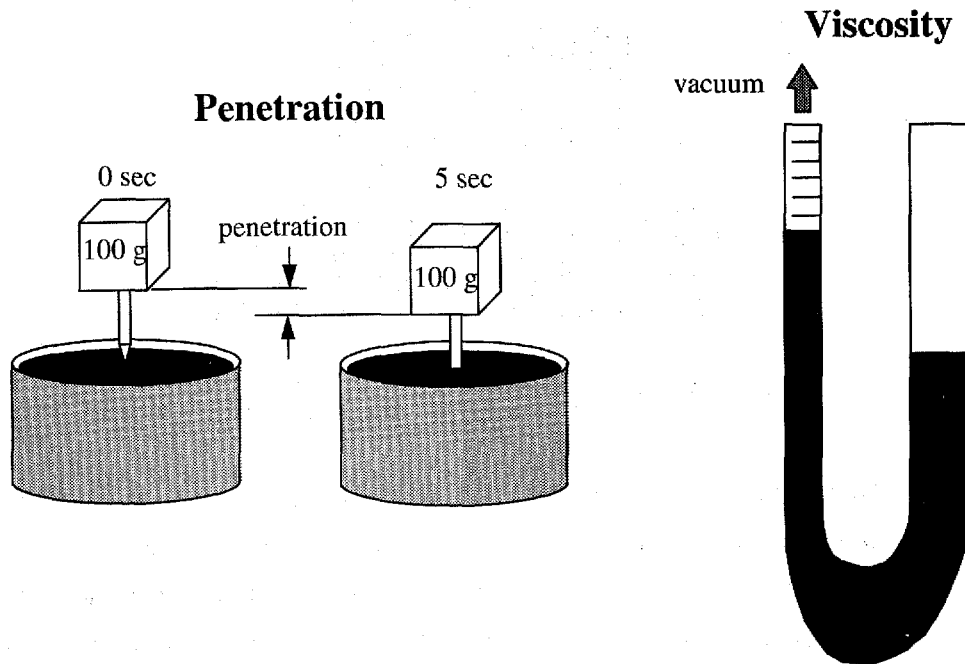

Figure I-15. Penetration and Viscosity Tests

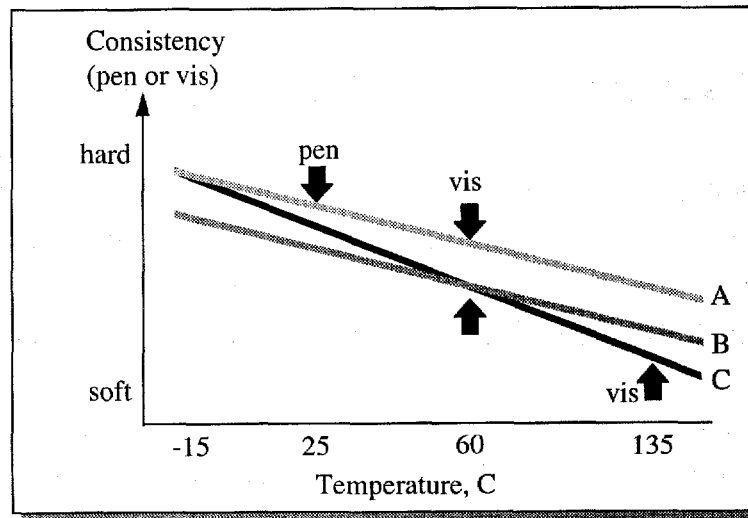

Figure I-16. Temperature Susceptibility of Three Viscosity or Penetration Graded Asphalts

Although viscosity is a fundamental measure of flow, it only provides information about higher temperature viscous behavior, not about the low or intermediate temperature elastic behavior needed to completely predict performance. Penetration describes only the consistency at an intermediate temperature, 25° C. No low temperature properties are directly measured in the current grading system. Often, viscosity and penetration tests do not completely show the advantages or possible disadvantages of some modified asphalts.

Because of these deficiencies, many state highway agencies have amended standard test procedures and specifications to better suit local conditions. In some locations, this proliferation of tests and specifications has caused serious problems for asphalt suppliers wishing to sell the same asphalt grades in several states. Often, states with very similar performance conditions and materials will specify remarkably different asphalts. In the current systems for specifying asphalt, tests are performed on unaged or "tank" asphalt and on asphalt that has been laboratory aged to simulate construction aging. However, no tests are performed on asphalts that have been aged to simulate in-service aging.

CURRENT ASPHALT MIXTURE DESIGN PROCEDURES

Most agencies currently use the Marshall mix design method. It is by far the most common procedure used in the world to design HMA. This technique was developed by Bruce Marshall, a former employee of the Mississippi State Highway Department. The U.S. Army Corps of Engineers refined and added certain features to Marshall's approach to the extent that it was formalized as ASTM D 1559, *Resistance to Plastic Flow of Bituminous Mixtures Using the Marshall Apparatus*. The Marshall method entails a laboratory experiment aimed at developing a suitable asphalt mixture by means of stability/flow and density/voids analyses.

One of the strengths of the Marshall method is its attention to density/voids properties of asphalt materials. This analysis ensures that the important volumetric proportions of mix constituents are at their proper levels to achieve a durable HMA. Another advantage of the Marshall method is that the required equipment is relatively inexpensive and very portable, and thus, lends itself to remote quality control operations. Unfortunately, many engineers believe that the impact method of laboratory compaction used with the Marshall method does not simulate mixture densification that occurs under traffic in a real pavement. Furthermore, the strength parameter used in this approach, Marshall

stability (Figure I-17), does not adequately estimate the shear strength of HMA. These two situations may result in asphalt mixtures prone to rutting. Consequently, there has been a growing feeling among asphalt technologists that the Marshall method has outlived its usefulness for modern asphalt mixture design.

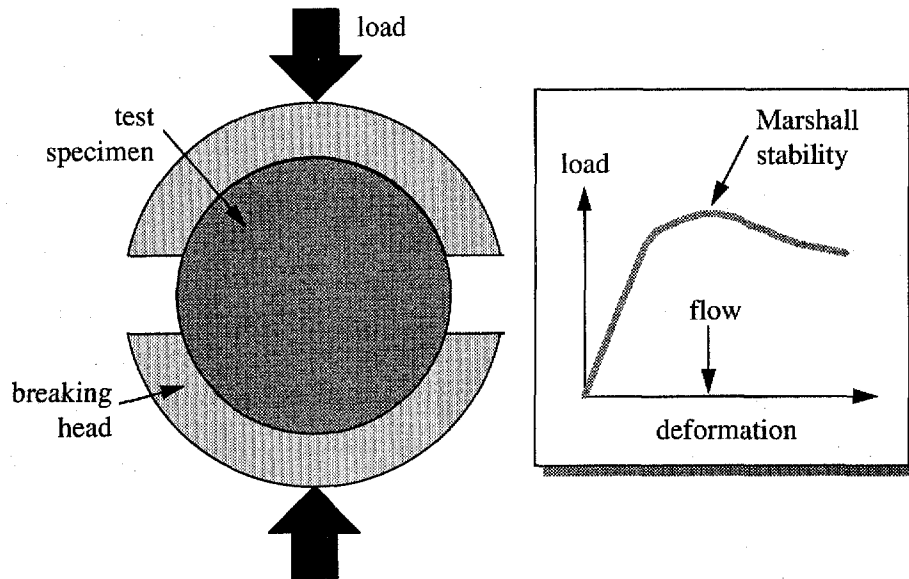

Figure I-17. Marshall Stability

The Hveem mix design procedure was developed by Francis Hveem, once the Materials and Research Engineer for the California Department of Transportation. Hveem and others developed and refined the procedure over a long period. The procedure is outlined in ASTM D 1560, *Resistance to Deformation and Cohesion of Bituminous Mixtures by Means of Hveem Apparatus*, and ASTM D 1561, *Preparation of Bituminous Mixture Test Specimens by Means of California Kneading Compactor*. It is not commonly used outside western states of the U.S.

The Hveem method also entails a density/voids and stability analysis. Mixture resistance to swell in the presence of water is also determined. The Hveem method has two real advantages. First, the kneading method of laboratory compaction is thought by most engineers to better simulate the densification characteristics of HMA in a real pavement. Second, the strength parameter, Hveem stability (Figure I-18), is a direct measurement of the internal friction component of shear strength. It measures the ability of a test specimen to resist lateral displacement from application of a vertical load.

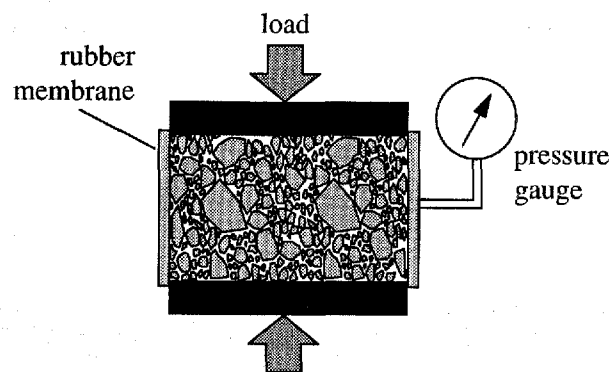

Figure I-18. Hveem Stability

The disadvantage of the Hveem procedure is that the testing equipment, particularly the kneading compactor and Hveem stabilometer, are somewhat more expensive than Marshall equipment and not very portable. Furthermore, some important mixture volumetric properties that are related to mix durability are not routinely determined as part of the Hveem procedure. Some engineers believe that the method of selecting asphalt content in the Hveem method is too subjective and may result in non durable HMA with too little asphalt.

There are other mix design procedures in common use besides the Marshall and Hveem procedures. For example, the Texas gyratory method is currently used by the state DOTs in Texas, Oklahoma, and Colorado. This procedure retains volumetric design elements of the Marshall method and the stability determination from the Hveem method. It is differentiated from the others by its method of laboratory compaction, the Texas gyratory compactor, which is thought by some engineers to be a suitable means of simulating traffic densification. While the Texas gyratory design method eliminates some of the disadvantages of the Marshall and Hveem methods, some believe that the operational characteristics of the compactor need refining to be suitable for a wider variety of design applications.

Increasingly, agencies are augmenting their customary mix design procedures with empirical strength testing. These tests are called empirical because their test outputs simply result in a go or no go decision based on the experience of the agency with the test calibrated to real pavements. One example of this type of testing is the Georgia Loaded Wheel Tester (GALWT). The GALWT subjects HMA beam specimens to repeated pneumatic stresses applied through a loaded wheel riding on a pressurized hose (Figure I-

19). After the required number of load applications, beam rutting is measured and the mixture is either accepted or rejected.

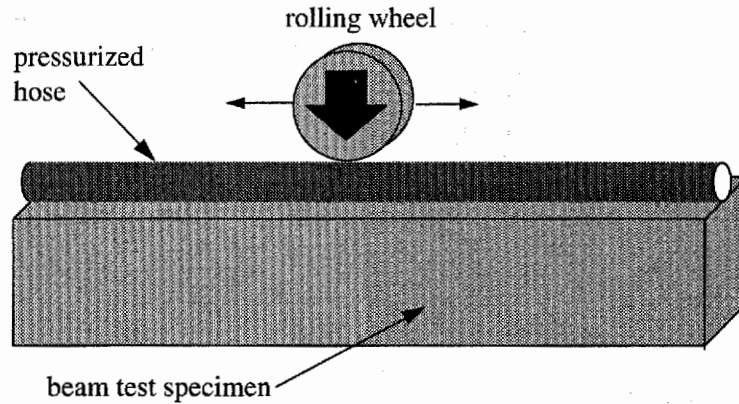

Figure I-19. Principle of the Georgia Loaded Wheel Tester

The advantage of empirical strength testing is that agencies can develop very clear accept/reject criteria, backed up by performance data from real pavements. This is also a disadvantage however, because agencies have to expend considerable resources in experimentation to achieve this experience. Even then the experience is only applicable to the materials and environmental conditions tested. New products and materials require additional experimentation. Furthermore, because empirical strength tests result in a simple accept/reject test result and no degree of performance is measured, they are difficult to use for economic comparisons of alternate materials.



II.

SUPERPAVE TO THE RESCUE

INTRODUCTION

In 1987, the Strategic Highway Research Program (SHRP) began developing a new system for specifying asphalt materials. The final product of the SHRP asphalt research program is a new system referred to as Superpave which stands for Superior Performing Asphalt Pavements. Superpave software is a computer program that assists engineers in materials selection and mix design. However, the term "Superpave" refers to more than just the computer program. Most important, it represents an improved system for specifying component materials, asphalt mixture design and analysis, and pavement performance prediction. The system includes test equipment, test methods, and criteria.

ASPHALT BINDERS

One portion of Superpave is a new asphalt binder specification with a new set of tests to match. The document is called a *binder* specification because it is intended to function equally well for modified as well as unmodified asphalts. A portion of the asphalt binder specification is shown in Appendix A.

The new system for specifying asphalt binders is unique in that it is a performance based specification. It specifies binders on the basis of the climate and attendant pavement temperatures in which the binder is expected to serve. Physical property requirements remain the same, but the temperature at which the binder must attain the properties changes. For example, the high temperature, unaged binder stiffness ($G^*/\sin \delta$) is required to be at least 1.00 kPa. But this requirement must be achieved at higher temperatures if the binder is expected to serve in a hot climate.

Performance graded (PG) binders are graded such as PG 64-22. The first number, 64, is often called the "high temperature grade." This means that the binder would possess

II. Superpave to the Rescue

adequate physical properties at least up to 64° C. This would be the high pavement temperature corresponding to the climate in which the binder is actually expected to serve. Likewise, the second number (-22) is often called the “low temperature grade” and means that the binder would possess adequate physical properties in pavements at least down to -22° C. Additional consideration is given to the time of loading (open highway, city streets, intersections, etc.) and magnitude of loads (heavy trucks).

Another key feature to binder evaluation in the Superpave system is that physical properties are measured on binders that have been laboratory aged to simulate their aged condition in a real pavement. Some binder physical property measurements are performed on unaged binder. Physical properties are also measured on binders that have been aged in the rolling thin film oven (RTFO) to simulate oxidative hardening that occurs during hot mixing and placing. A pressure aging vessel (PAV) is used to laboratory age binder to simulate the severe aging that occurs after the binder has served many years in a pavement (Figure II-1).

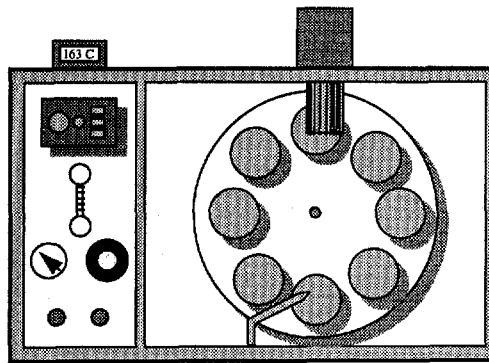

Rolling Thin Film Oven (RTFO)

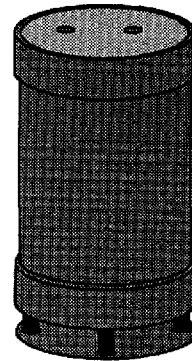

Pressure Aging Vessel (PAV)

Figure II-1. SHRP Binder Aging Techniques

Binder physical properties are measured using four devices:

- dynamic shear rheometer,
- rotational viscometer,
- bending beam rheometer, and
- direct tension tester.

The dynamic shear rheometer (DSR) is used to characterize the visco-elastic properties of the binder. It measures the complex shear modulus (G^*) and phase angle (δ) by subjecting a small sample of binder to oscillatory shear stresses while sandwiched between two parallel plates (Figure II-2).

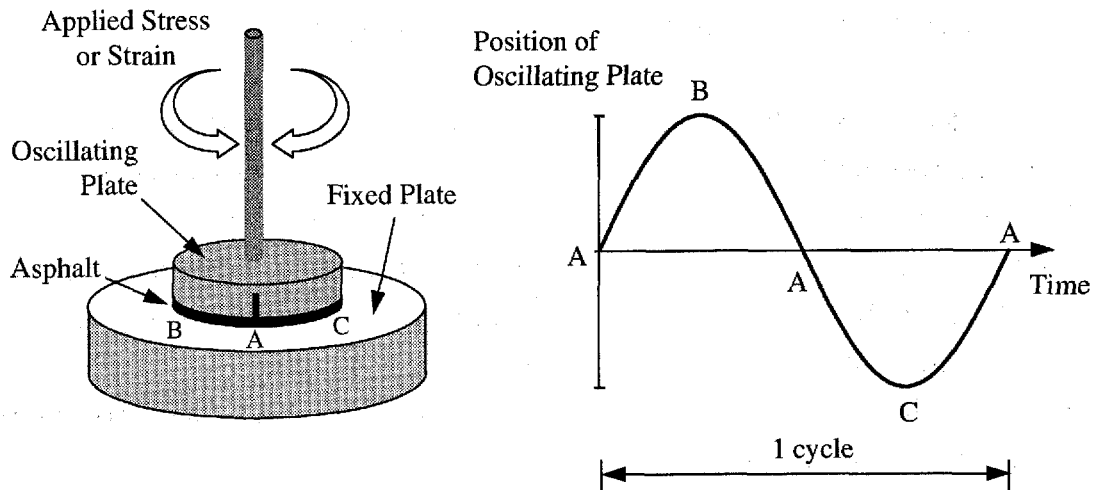

Figure II-2. Dynamic Shear Rheometer

The DSR measures G^* and δ by measuring the shear strain response of the specimen to a fixed torque as shown in Figure II-3. In this figure, the shear strain response of a binder specimen is “out of phase” with the applied stress by a certain time interval Δt . This time interval represents the time lag in strain response. Phase lag is normally reported in angular measurement by simply multiplying the time lag (Δt) by the angular frequency (ω) to arrive at a phase angle (δ). For totally elastic materials there is no lag between applied shear stress and shear strain response and δ equals zero degrees. For totally viscous materials, strain response is completely out of phase with applied stress and δ is 90 degrees. Viscoelastic materials like asphalt binders possess phase angles between zero and 90 degrees, depending on test temperature. At high temperatures, δ approaches 90 degrees while at low temperatures δ is nearly zero degrees. The binder specification uses either $G^*/\sin \delta$ at high temperatures ($> 46^\circ \text{C}$) or $G^*\sin \delta$ at intermediate temperatures (between 7° and 34°C) as a means of controlling asphalt stiffness.

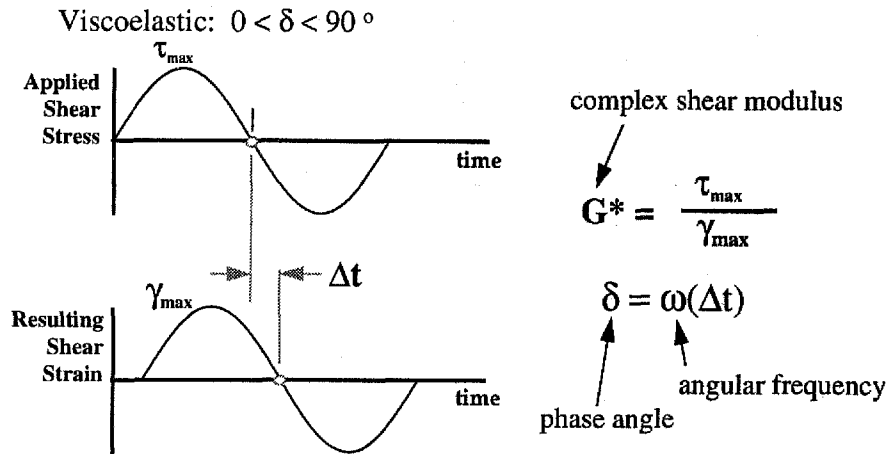

Figure II-3. Computation of G^* and δ

By controlling stiffness at high temperatures, the binder specification ensures that asphalt provides its fair share of the overall shear strength of the mixture in terms of high temperature elasticity. Likewise, the specification ensures that the binder does not contribute to fatigue cracking by limiting its stiffness at intermediate temperatures.

The rotational viscometer (RTV) characterizes the stiffness of the asphalt at 135°C , where it acts almost entirely as a viscous fluid. It is a rotational coaxial cylinder viscometer that measures viscosity by the torque required to rotate a spindle submerged in a sample of hot asphalt (Figure II-4) at a constant speed. The binder specification requires that binders have a viscosity of less than $3\text{ Pa}\cdot\text{s}$. This ensures that the binder can be pumped and otherwise handled during HMA manufacturing.

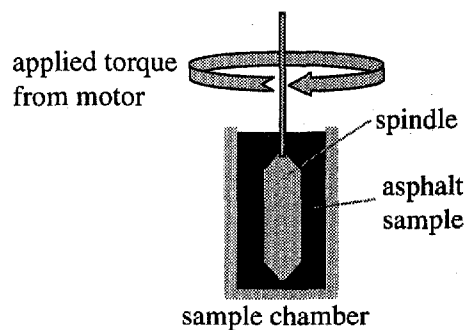

Figure II-4. Rotational Viscometer

The bending beam rheometer (BBR) is used to characterize the low temperature stiffness properties of binders. It measures the creep stiffness (S) and logarithmic creep rate (m).

These properties are determined by measuring the response of a small binder beam specimen to a creep load at low temperatures (Figure II-5). By knowing the load applied to the beam and the deflection at any time during the test, the creep stiffness can be calculated using engineering beam mechanics. The binder specification places limits on creep stiffness and m-value depending on the climate in which the binder will serve. Binders that have a low creep stiffness will not crack in cold weather. Likewise, binders with high m-values are more effective in shedding stresses that build in asphalt pavements as temperatures drop, again, ensuring that low temperature cracking will be minimized.

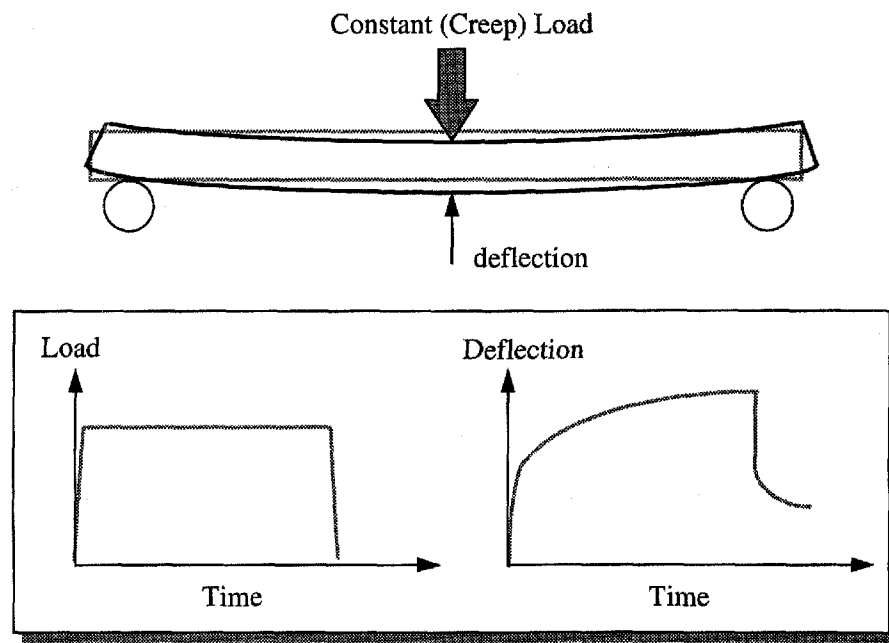

Figure II-5. Bending Beam Rheometer

Some binders, particularly some polymer-modified asphalts, may exhibit a higher than desired creep stiffness at low temperatures. However, they may not crack because they retain their ability to stretch without fracture at low temperatures. Consequently, the binder specification allows a higher creep stiffness if it can be shown through the direct tension test (DTT) that binders are sufficiently ductile at low temperatures. The output of the DTT is tensile failure strain, which is measured on a small dog bone shaped specimen that is stretched at low temperatures until it breaks (Figure II-6). As with the BBR, the DTT ensures that the binder's resistance to low temperature cracking is maximized.

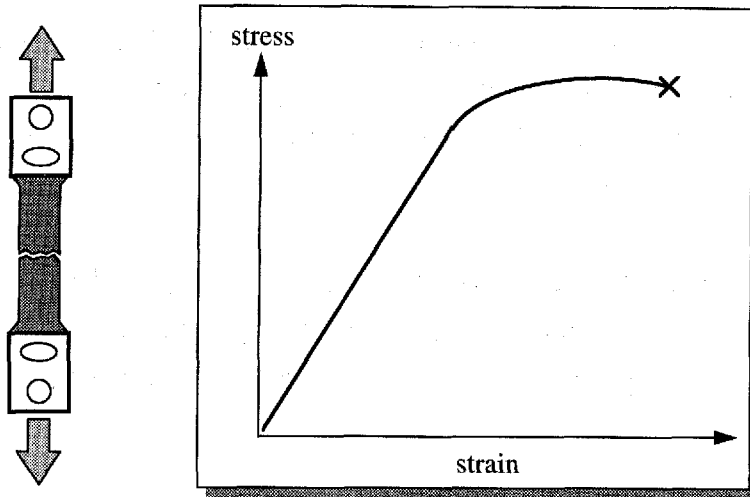

Figure II-6. Direct Tension Tester

MINERAL AGGREGATES

SHRP researchers also believed that mineral aggregates played a key role in HMA performance. While they did not develop any new aggregate test procedures, they refined existing procedures to fit within the Superpave system. Two types of aggregate properties are specified in the Superpave system: consensus properties and source properties.

Consensus properties are those which the SHRP researchers believed were critical in achieving high performance HMA. These properties must be met at various levels depending on traffic level and position within the pavement. High traffic levels and surface mixtures (i.e., shallow pavement position) require more strict values for consensus properties. Many agencies already use these properties as quality requirements for aggregates used in HMA. These properties are:

- coarse aggregate angularity,
- fine aggregate angularity,
- flat, elongated particles, and
- clay content.

By specifying coarse and fine angularity, SHRP researchers were seeking to achieve HMA with a high degree of internal friction and thus, high shear strength for rutting

resistance. Limiting elongated pieces ensures that the HMA will not be as susceptible to aggregate breakage during handling and construction and under traffic. By limiting the amount of clay in aggregate, the adhesive bond between asphalt binder and aggregate is strengthened and otherwise enhanced.

Source properties are those which agencies often use to qualify local sources of aggregate. The SHRP researchers believed that achieving these properties was important, but did not specify critical values since they are so source specific. The source properties are:

- toughness,
- soundness, and
- deleterious materials.

Toughness is measured by the LA abrasion test. Soundness is measured by the sodium or magnesium sulfate soundness test. Deleterious materials are measured by the clay lumps and friable particles test. These tests are already in common use by most agencies.

To specify aggregate gradation (Appendix B), SHRP researchers refined an approach already in wide use by many agencies. It uses the 0.45 power gradation chart with control limits and a restricted zone (Figure II-7) to develop a *design aggregate structure*.

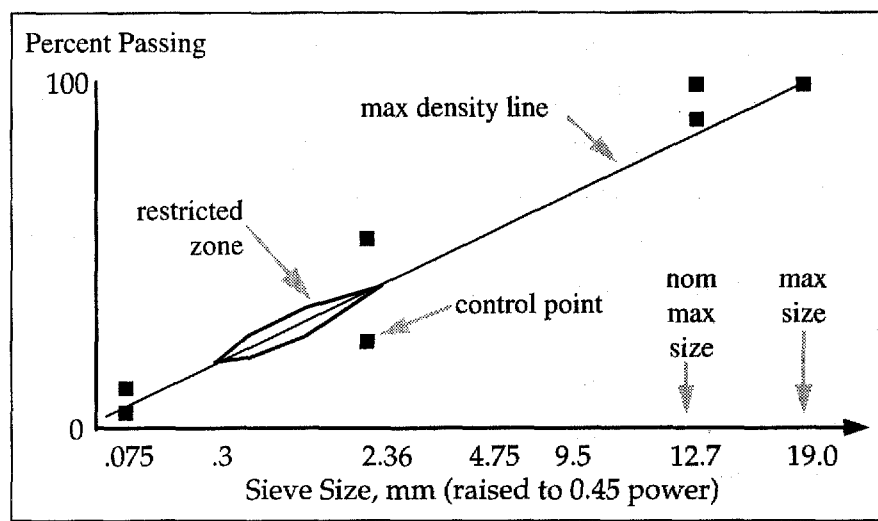

Figure II-7. Superpave Gradation Limits, 12.5 mm Mixture

A Superpave design aggregate structure must pass between the control points while avoiding the restricted zone. The maximum density gradation is drawn from the 100

percent passing the maximum aggregate size through the origin. Maximum aggregate size is defined as one size larger than the nominal maximum aggregate size. Nominal maximum size is defined as one size larger than the first sieve size to retain more than 10 percent. The restricted zone is used by SHRP Superpave to avoid mixtures that have a high proportion of fine sand relative to total sand and gradations that follow the 0.45 power line, which do not normally have adequate voids in the mineral aggregate (VMA). In many instances, the restricted zone will discourage the use of fine natural sand in an aggregate blend. It will encourage the use of clean manufactured sand. The design aggregate structure approach ensures that the aggregate will develop a strong, stone skeleton to enhance resistance to permanent deformation while achieving sufficient void space for mixture durability.

ASPHALT MIXTURES

Two key features in the Superpave system are laboratory compaction and performance testing. Laboratory compaction is accomplished by means of a Superpave Gyrotory Compactor (SGC). While this device shares some common traits with the Texas gyrotory compactor, it is a completely new device with new operational characteristics. Its main utility is to fabricate test specimens. However, by capturing data during SGC compaction, a mix design engineer can also gain insight into the compactibility of HMA. The SGC can be used to design mixtures that do not exhibit tender mix behavior and do not densify to dangerously low air void contents under the action of traffic.

The performance of HMA immediately after construction is influenced by mixture properties resulting from hot mixing and compaction. Consequently, a short term aging protocol was incorporated into the Superpave system. This was accomplished by requiring that loose mixture specimens, prior to compaction by the SGC, be oven aged for four hours at 135° C.

Perhaps the most important development to arise from the SHRP asphalt research program was performance based tests and performance prediction models for HMA. Output from these tests can be used to make detailed predictions of actual pavement performance (Figure II-8). In other words, test procedures and performance prediction models were developed that will allow an engineer to estimate the performance life of a prospective HMA in terms of equivalent axle loads (ESALs) or time to achieve a certain level of rutting, fatigue cracking, and low temperature cracking.

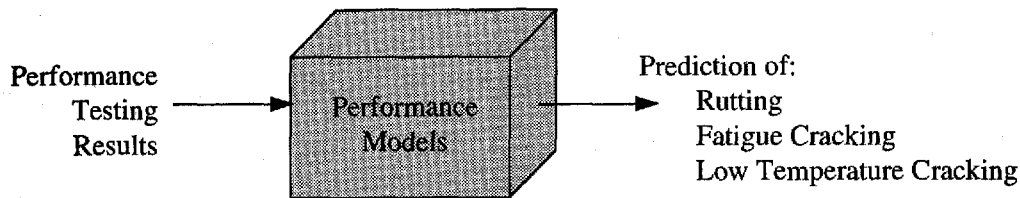

Figure II-8. Superpave Pavement Performance Prediction

Two new performance based testing procedures were developed, the Superpave Shear Tester (SST) and Indirect Tensile Tester (IDT). The output from these tests is input to performance prediction models in Superpave to estimate actual pavement performance (e.g., millimeters of rutting).

The SST is a testing device that performs the following six tests on HMA specimens:

- volumetric test,
- uniaxial strain test,
- simple shear test at constant height,
- repeated shear test at constant stress ratio,
- frequency sweep test at constant height, and
- repeated shear test at constant height (option).

The first two tests involve testing the specimen using confining pressure. To accomplish this, the SST has a testing chamber capable of applying confining pressure by means of compressed air. Test temperature is also carefully controlled by the testing chamber. The SST has axial and horizontal hydraulic actuators with accompanying linear variable differential transducers (LVDTs) to measure the response of test specimens to load. Tests proceed by closed-loop feedback control. This means that the response of a specimen to loading from one actuator is measured by an LVDT. The other actuator uses the signal from this LVDT to respond as required. For example, in the simple shear test at constant height, a shear stress is applied to the HMA specimen by the horizontal actuator. As the specimen is sheared, it tends to dilate. The vertical LVDT senses this dilation as a change in specimen height and a signal is sent to the vertical actuator to apply sufficient vertical load to keep the specimen's height from changing. Thus, dilation is prevented.

II. Superpave to the Rescue

Tests using the SST are performed at a variety of temperatures to simulate actual pavement temperatures. While a portion of the tests are aimed at fatigue cracking, the SST's main utility is a means of designing against permanent deformation.

The IDT is used to measure creep compliance and tensile strength of HMA. This test uses a single vertical actuator to load a test specimen across its diametral plane. It is used to characterize HMA as a means of designing against fatigue and low temperature cracking.

In the Superpave system, the results of SST and IDT testing are input into pavement performance prediction models. Using these models, mix design engineers can estimate the combined effect of asphalt binders, aggregates, and mixture proportions. The models take into account the structure, condition, and properties of the existing pavement (if applicable) and the amount of traffic to which the proposed mixture will be subjected over its performance life. The output of the models is millimeters of rutting, percent area of fatigue cracking, and spacing (in meters) of low temperature cracks. By using this approach, the Superpave system accomplishes what no previous design procedure has; namely, it joins material properties with pavement structural properties to predict actual pavement performance. Thus, the benefit (or detriment) of new materials, different mix designs, asphalt modifiers, and other products can finally be quantified in terms of cost versus predicted performance.

PUTTING IT ALL TOGETHER

Because Superpave mixture design and analysis is more complex than those in current use, the extent of its use depends on the traffic level or functional classification of the pavement for which it is being used. Consequently, three levels of Superpave mixture design were developed. Their extent of use and testing requirements are shown in Table II-1.

Table II-1. Superpave Mix Design Levels

Traffic, ESALs	Design Level	Testing Requirements ¹
$ESALs \leq 10^6$	1	volumetric design
$10^6 < ESALs \leq 10^7$	2	volumetric design + performance prediction tests
$ESALs > 10^7$	3	volumetric design + enhanced performance prediction tests

¹ In all cases, moisture susceptibility must be evaluated using AASHTO T283.

While much of the resources in SHRP were devoted to developing the SST, IDT, their protocols, and performance prediction models, volumetric mix design occupies a key role in Superpave mix design. Volumetric design, which is all that is required by a Level 1 mixture design, entails fabrication of test specimens using the SGC and selecting asphalt content on the basis of air voids, voids in the mineral aggregate (VMA), voids filled with asphalt (VFA), and the ratio of dust to effective asphalt content. Consensus and source aggregate properties must be achieved.

A Level 2 mixture design uses a volumetric mix design as a starting point. A battery of SST and IDT tests are performed to arrive at a series of go/no go performance predictions.

A Level 3 mixture design encompasses most of the facets of Levels 1 and 2. Additional SST and IDT tests are performed at a wider variety of temperatures. Level 3 design is the only protocol that utilizes SST confined specimen testing. Because of the more comprehensive range of tests and results, Level 3 design offers an enhanced and more reliable level of performance prediction.

III.

MATERIALS SELECTION

INTRODUCTION

Superpave utilizes a completely new system for testing, specifying, and selecting asphalt binders. While no new aggregate tests were developed, current methods of selecting and specifying aggregates were refined and incorporated into the Superpave mix design system. Superpave asphalt mixture requirements were established from currently used criteria.

ASPHALT BINDERS

The new SHRP binder specification (a portion of which is shown in Appendix A) is unique in that it is performance based and that binders are selected on the basis of the climate in which they are intended to serve. The physical property (e.g., creep stiffness, $G^*/\sin \delta$, etc.) requirements are constant among all grades of binders.

What differentiates the various binder grades is the temperature at which the requirements must be met. For example, a binder classified as a PG 64-22 means that the binder must meet high temperature physical property requirements at least up to a temperature of 64° C and low temperature physical property requirements at least down to -22° C.

Table III-1 shows the current binder grades in the SHRP binder specification. In this table, the PG 76 and 82 grades are used only to accommodate slow transient or standing loads, or excessive truck traffic.

Table III-1. Superpave Binder Grades

High Temperature Grade	Low Temperature Grade
PG 46-	34, 40, 46
PG 52-	10, 16, 22, 28, 34, 40, 46
PG 58-	16, 22, 28, 34, 40
PG 64-	10, 16, 22, 28, 34, 40
PG 70-	10, 16, 22, 28, 34, 40
PG 76-	10, 16, 22, 28, 34
PG 82-	10, 16, 22, 28, 34

A module in the Superpave software assists users in selecting binder grades. Superpave contains three methods by which the user can select an asphalt binder grade:

- By Geographic Area: An Agency would develop a map showing binder grade to be used by the designer based on weather and/or policy decisions.
- By Pavement Temperature: The designer would need to know design pavement temperature.
- By Air Temperature: The designer determines design air temperatures, which are converted to design pavement temperatures.

Superpave Weather Database

Superpave software contains a database of weather information for 6500 reporting stations in the US and Canada, which allows users to select binder grades for the climate specific to project location. For each year a weather station has been in operation the hottest seven-day period is determined and the average maximum air temperature for those seven consecutive days is calculated. For all the years of record (stations with less than 20 years of records were not used) a mean and standard deviation are calculated. Likewise the coldest day of each year is identified and the mean and standard deviation are calculated.

Reliability

As used in Superpave, reliability is the percent probability in a single year that the actual temperature will not exceed the design temperature. SHRP binder selection is very

flexible in that a different level of reliability can be assigned to high and low temperature grades. Consider summer air temperatures in Topeka, Kansas, which has a mean seven-day maximum of 36°C and a standard deviation of 2°C . Figure III-1 shows the frequency distribution for this data. In an average year there is a 50 percent chance the seven-day maximum air temperature will exceed 36°C . However, only a two percent chance exists that the temperature will exceed 40°C ; hence, a design air temperature of 40°C will provide 98 percent reliability.

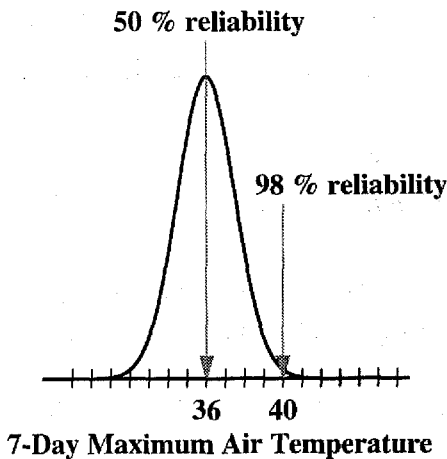

Figure III-1. Distribution of Annual Seven-Day Maximum Air Temperature for Topeka, KS

Start with Air Temperature

To see how the binder selection works assume that an asphalt mixture is designed for Topeka. Figure III-2 shows frequency distributions for high and low design air temperatures. In a normal summer, the average seven-day maximum air temperature is 36°C with a standard deviation of 2°C . In a normal winter, the average coldest temperature is -23°C . For a very cold winter the temperature is -31°C , with a standard deviation of 4°C .

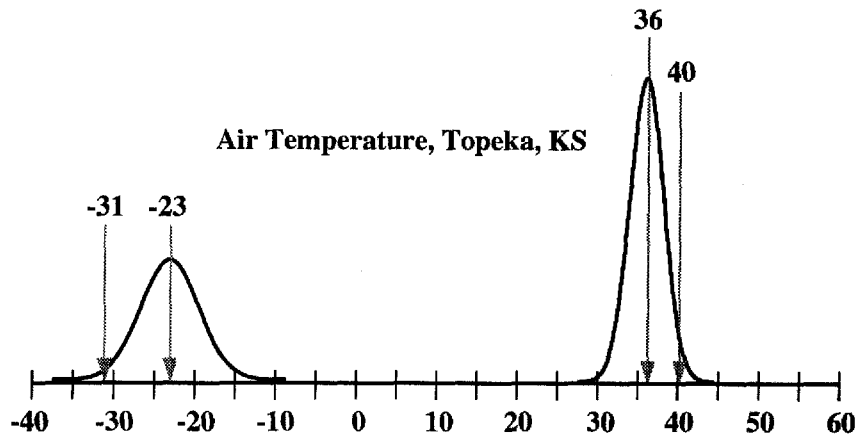

Figure III-2. Distribution of High and Low Design Air Temperatures for Topeka, KS

Convert to Pavement Temperature

Superpave software calculates high pavement temperature 20 mm below the pavement surface and low temperature at the pavement surface. For a wearing course at the top of a pavement section, the pavement temperatures in Topeka are 56° and -23° C for 50 percent reliability and 60° (56° + 2 standard deviations) and -31° C for 98 percent reliability (Figure III-3).

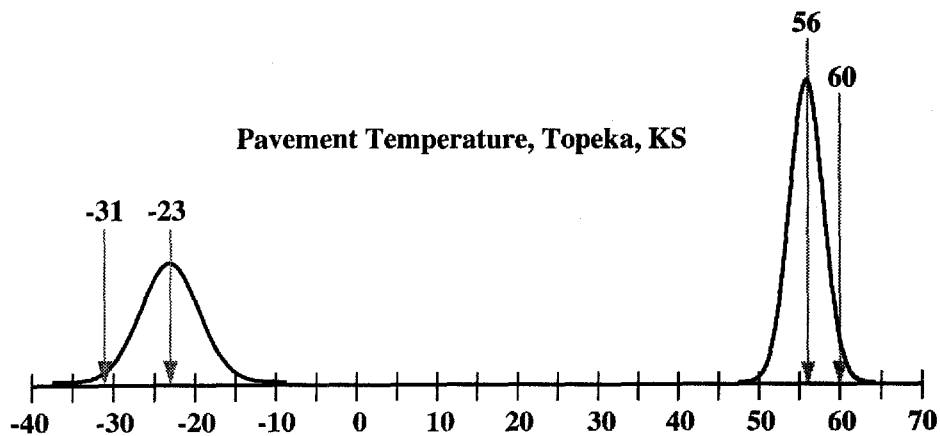

Figure III-3. Distribution of High and Low Design Pavement Temperatures for Topeka, KS

In Superpave, the high pavement design temperature at a depth of 20 mm is computed by the following formula:

$$T_{20\text{mm}} = (T_{\text{air}} - 0.00618\text{lat}^2 + 0.2289\text{lat} + 42.2)(0.9545) - 17.78$$

where, $T_{20\text{mm}}$ = pavement temperature at a depth of 20 mm in °C,

T_{air} = maximum average high air temperature during the hottest seven-day period in °C, and

lat = project latitude in degrees.

There are two possible ways to determine the low pavement design temperature in Superpave. First, the low pavement design temperature simply can be assumed to be the same as the low air temperature. This method was originally recommended by SHRP researchers. This is a very conservative assumption because pavement temperature is almost always warmer than air temperature in cold weather. The Topeka, Kansas example above used this approach. The second method utilizes the following formula, which was developed by Canadian SHRP researchers:

$$T_{\text{min}} = 0.859T_{\text{air}} + 1.7^\circ$$

where, T_{min} = minimum pavement design temperature in °C,

T_{air} = minimum air temperature in average year in °C.

Using this approach for the Topeka example, the minimum pavement design temperature would be $0.859 \times -23^\circ + 1.7^\circ$ or 18° C. This method of computing minimum pavement design temperature is gaining favor among asphalt technologists in North America. However, the first method is still used by Superpave.

Select Binder Grade

For a reliability of at least 50 percent, the high temperature grade must be PG 58 for Topeka. Selecting a PG 58 would actually result in a higher level of reliability, about 85 percent, because of the “rounding up” to the next standard grade. The next lower grade only protects to 52° C, less than 50 percent reliability. The low temperature grade must be a PG XX-28. As with high temperature grade, rounding to this standard low temperature grade results in almost 90 percent reliability. For 98 percent reliability, the needed high temperature grade is PG 64; the low temperature grade is PG XX-34.

Both of these low temperature grades utilize the Superpave approach that assumes low air and low pavement temperatures are the same. Had the alternative approach been used, the binder grades selected would have been PG 58-22 for minimum 50 percent reliability and PG 58-28 for minimum 98 percent reliability. The method of converting low air to low pavement temperature has a profound effect on the binder selection process.

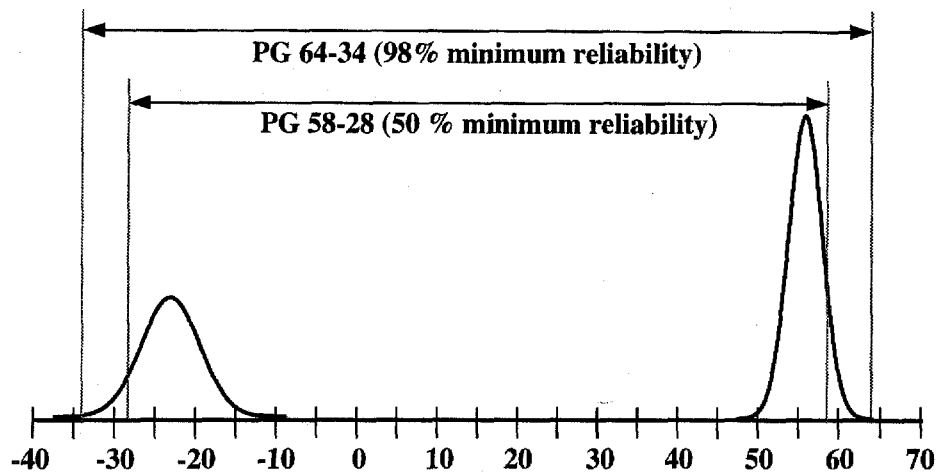

Figure III-4. Various Binder Grades for Topeka, KS

Manipulating temperature frequency distributions is not a task that the designer need worry about. Superpave software handles the calculations. For any site, the user can enter a minimum reliability and Superpave will calculate the required asphalt binder grade. Alternately the user can specify a desired asphalt binder grade and Superpave will calculate the reliability obtained.

Effect of Loading Rate on Binder Selection

SHRP binder selection by climate only assumes that a binder will be used in a mixture subjected to fast moving loads. The loading rate used by the dynamic shear rheometer is 10 radians per second, which corresponds to a traffic speed of approximately 90 kilometers per hour. Much slower loading rates are experienced by pavements near intersections, toll booths, etc. In some cases, loads are not moving but rather are stationary. In these cases, a binder would have to exhibit a higher stiffness to overcome the slower loading rate.

To accommodate these situations, Superpave requires that the high temperature grade be increased by at least one or as many as two grades. For example, if a temperature based selection resulted in a desired binder grade of PG 64-22, to account for slow transient loads, the designer would select one grade higher binder, a PG 70-22. If standing loads were anticipated, the designer would select a PG 76-22. Loading rate has no effect on the selected low temperature grade. Pavement design temperatures of 76° or 82° C do not correspond to any climate zone in North America. Specifying this grade is simply a means of ensuring that the binder will have higher stiffness at 64° C, the actual high pavement design temperature. Because the highest possible pavement temperature in North America is about 70° C, two additional high temperature grades, PG 76 and PG 82, were necessary to accommodate slow loading rates.

Effect of Traffic Level on Binder Selection

Superpave recommends that traffic level be considered when selecting binders. When the design traffic level exceeds 10 million equivalent single axle loads (ESALs), the designer is encouraged to “consider” increasing the high temperature grade by one grade. When the design traffic level exceeds 30 million ESALs, the designer is required to increase the high temperature grade by one grade. As with loading rate, there is no effect of traffic level on low temperature grade. For the Topeka example where the temperature based selection required a PG 58-28, a project with a very high number of ESALs would require a PG 64-28.

MINERAL AGGREGATE

During SHRP, pavement experts were surveyed to ascertain which aggregate properties were most important. There was general agreement that aggregate properties played a central role in overcoming permanent deformation. Fatigue cracking and low temperature cracking were less affected by aggregate characteristics. SHRP researchers relied on the experience of these experts and their own to identify two categories of aggregate properties that needed to be used in the Superpave system: consensus properties and source properties. In addition, a new way of specifying aggregate gradation was developed. It is called the design aggregate structure.

Consensus Properties

It was the consensus of the pavement experts that certain aggregate characteristics were critical and needed to be achieved in all cases to arrive at well performing HMA. These characteristics were called “consensus properties” because there was wide agreement in their use and specified values. Those properties are:

- coarse aggregate angularity,
- fine aggregate angularity,
- flat, elongated particles, and
- clay content.

There are required standards for these aggregate properties. The consensus standards are not uniform. They are based on traffic level and position within the pavement structure. Materials near the pavement surface subjected to high traffic levels require more stringent consensus standards. They are intended to be applied to a proposed aggregate blend rather than individual components. However, many agencies currently apply such requirements to individual aggregates so that undesirable components can be identified.

Coarse Aggregate Angularity

This property ensures a high degree of aggregate internal friction and rutting resistance. It is defined as the percent by weight of aggregates larger than 4.75 mm with one or more fractured faces.

Many state DOTs have protocols to measure coarse aggregate angularity. These usually involve manually counting particles to determine fractured faces. A fractured face is defined as any fractured surface that occupies more than 25 percent of the area of the outline of the aggregate particle visible in that orientation. One test method example is the Pennsylvania DOT's Test Method No. 621, “Determining the Percentage of Crushed Fragments in Gravel.”

Table III-2 outlines the required minimum values for coarse aggregate angularity as a function of traffic level and position within the pavement.

Table III-2. Superpave Coarse Aggregate Angularity Requirements

Traffic, million ESALs	Depth from Surface	
	< 100 mm	> 100 mm
< 0.3	55/-	-/-
< 1	65/-	-/-
< 3	75/-	50/-
< 10	85/80	60/-
< 30	95/90	80/75
< 100	100/100	95/90
≥ 100	100/100	100/100

Note: "85/80" means that 85 % of the coarse aggregate has one fractured face and 80 % has two fractured faces.

Fine Aggregate Angularity

This property ensures a high degree of fine aggregate internal friction and rutting resistance. It is defined as the percent air voids present in loosely compacted aggregates smaller than 2.36 mm. Higher void contents mean more fractured faces.

A test procedure currently promulgated by the National Aggregates Association is used to measure this property. In the test, a sample of fine aggregate is poured into a small calibrated cylinder by flowing through a standard funnel (Figure III-5).

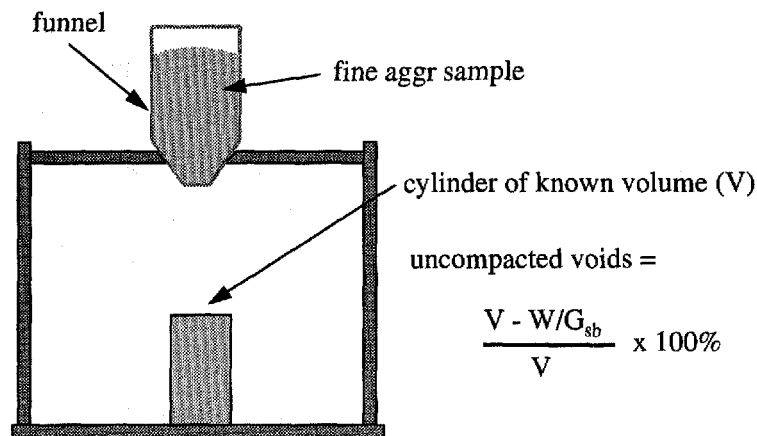

Figure III-5. Fine Aggregate Angularity Apparatus

By determining the weight of fine aggregate (W) in the filled cylinder of known volume (V), void content can be calculated as the difference between the cylinder volume and fine aggregate volume collected in the cylinder. The fine aggregate bulk specific gravity (G_{sb}) is used to compute fine aggregate volume.

Table III-3 outlines the required minimum values for fine aggregate angularity as a function of traffic level and position within pavement.

Table III-3. Superpave Fine Aggregate Angularity Requirements

Traffic, million ESALs	Depth from Surface	
	< 100 mm	> 100 mm
< 0.3	-	-
< 1	40	-
< 3	40	40
< 10	45	40
< 30	45	40
< 100	45	45
≥ 100	45	45

Note: Criteria are presented as percent air voids in loosely compacted fine aggregate.

Flat, Elongated Particles

This characteristic is the percentage by weight of coarse aggregates that have a maximum to minimum dimension of greater than five. Elongated particles are undesirable because they have a tendency to break during construction and under traffic. The test procedure used is ASTM D 4791, "Flat or Elongated Particles in Coarse Aggregate" and it is performed on coarse aggregate larger than 4.75 mm.

The procedure uses a proportional caliper device (Figure III-6) to measure the dimensional ratio of a representative sample of aggregate particles. In Figure III-6, the aggregate particle is first placed with its largest dimension between the swinging arm and fixed post at position A. The swinging arm then remains stationary while the aggregate is placed between the swinging arm and fixed post at position B. If the aggregate passes through this gap, then it is counted as a flat or elongated particle.

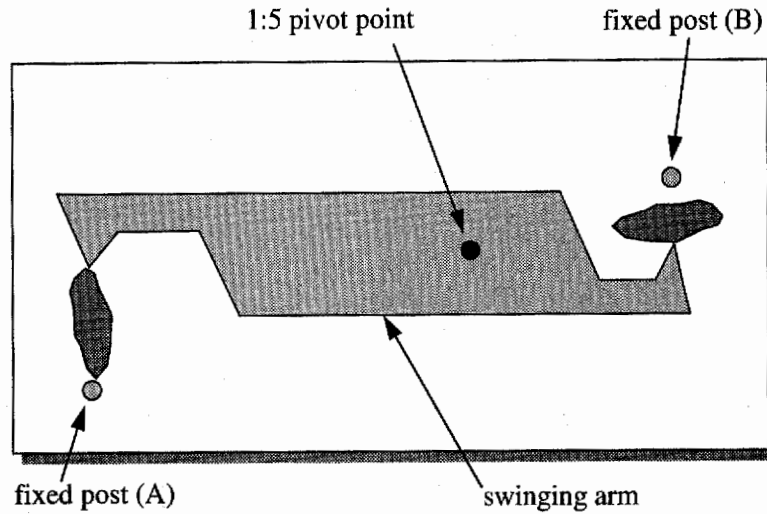

Figure III-6. Proportional Caliper Device to Measure Flat and Elongated Particles

Two values are measured: percentage of flat particles and percentage of elongated particles. Table III-4 outlines the required maximum values for flat, elongated particles in coarse aggregate.

Table III-4. Superpave Flat, Elongated Particle Requirements

Traffic, million ESALs	Percent
< 0.3	-
< 1	-
< 3	10
< 10	10
< 30	10
< 100	10
≥ 100	10

Note: Criteria are presented as maximum percent by weight of flat and elongated particles.

Clay Content

Clay content is the percentage of clay material contained in the aggregate fraction that is finer than a 4.75 mm sieve. It is measured by AASHTO T 176, "Plastic Fines in Graded Aggregates and Soils by Use of the Sand Equivalent Test."

In this test, a sample of fine aggregate is placed in a graduated cylinder with a flocculating solution and agitated to loosen clayey fines present in and coating the aggregate. The flocculating solution forces the clayey material into suspension above the granular aggregate. After a period that allows sedimentation, the cylinder height of suspended clay and sedimented sand is measured (Figure III-7). The sand equivalent value is computed as a ratio of the sand to clay height readings expressed as a percentage.

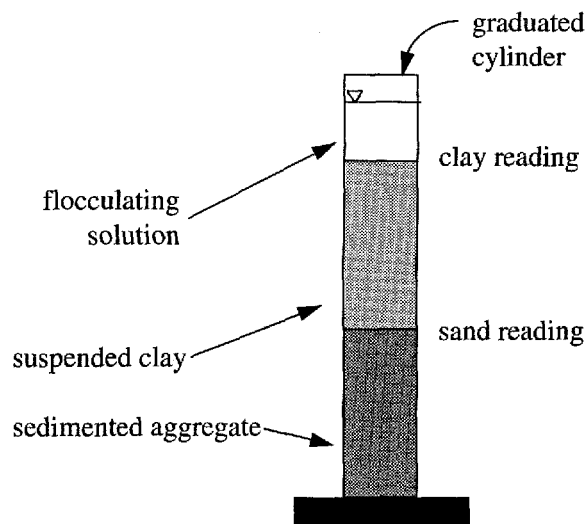

Figure III-7. Sand Equivalent Test

Table III-5 outlines the required clay content values for fine aggregate.

Table III-5. Superpave Clay Content Requirements

Traffic, million ESALs	Sand Equivalent, minimum
< 0.3	40
< 1	40
< 3	40
< 10	45
< 30	45
< 100	50
≥ 100	50

Source Properties

In addition to the consensus aggregate properties, pavement experts believed that certain other aggregate characteristics were critical. However, critical values of these properties could not be reached by consensus because needed values were source specific.

Consequently, a set of "source properties" were recommended. Specified values are established by local agencies. While these properties are relevant during the mix design process, they may also be used as source acceptance control. Those properties are:

- toughness,
- soundness, and
- deleterious materials.

Toughness

Toughness is the percent loss of materials from an aggregate blend during the Los Angeles Abrasion test. The procedure is stated in AASHTO T 96, "Resistance to Abrasion of Small Size Coarse Aggregate by Use of the Los Angeles Machine." This test estimates the resistance of coarse aggregate to abrasion and mechanical degradation during handling, construction, and in-service. It is performed by subjecting the coarse aggregate, usually larger than 2.36 mm, to impact and grinding by steel spheres. The test

III. Materials Selection

result is percent loss, which is the weight percentage of coarse material lost during the test as a result of the mechanical degradation. Maximum loss values typically range from approximately 35 to 45 percent.

Soundness

Soundness is the percent loss of materials from an aggregate blend during the sodium or magnesium sulfate soundness test. The procedure is stated in AASHTO T 104, "Soundness of Aggregate by Use of Sodium Sulfate or Magnesium Sulfate." This test estimates the resistance of aggregate to weathering while in-service. It can be performed on both coarse and fine aggregate. The test is performed by alternately exposing an aggregate sample to repeated immersions in saturated solutions of sodium or magnesium sulfate each followed by oven drying. One immersion and drying is considered one soundness cycle. During the drying phase, salts precipitate in the permeable void space of the aggregate. Upon re-immersion the salt re-hydrates and exerts internal expansive forces that simulate the expansive forces of freezing water. The test result is total percent loss over various sieve intervals for a required number of cycles. Maximum loss values range from approximately 10 to 20 percent for five cycles.

Deleterious Materials

Deleterious materials are defined as the weight percentage of contaminants such as shale, wood, mica, and coal in the blended aggregate. This property is measured by AASHTO T 112, "Clay Lumps and Friable Particles in Aggregates." It can be performed on both coarse and fine aggregate. The test is performed by wet sieving aggregate size fractions over prescribed sieves. The weight percentage of material lost as a result of wet sieving is reported as the percent of clay lumps and friable particles. A wide range of maximum permissible percentage of clay lumps and friable particles is evident. Values range from as little as 0.2 percent to as high as 10 percent, depending on the exact composition of the contaminant.

Gradation

To specify gradation, Superpave uses a modification of an approach already used by some agencies. It uses the 0.45 power gradation chart to define a permissible gradation. This chart uses a unique graphing technique to judge the cumulative particle size distribution

of a blend of aggregate. The ordinate of the chart is percent passing. The abscissa is an arithmetic scale of sieve size in millimeters, raised to the 0.45 power. Figure III-8 illustrates how the abscissa is scaled. In this example, the 4.75 mm sieve is plotted at 2.02 units to the right of the origin. This number, 2.02, is the sieve size, 4.75 mm, raised to 0.45 power. Normal 0.45 power charts do not show arithmetic abscissa labels such as those in Figure III-8. Instead, the scale is annotated with the actual sieve size as shown in Figure III-9.

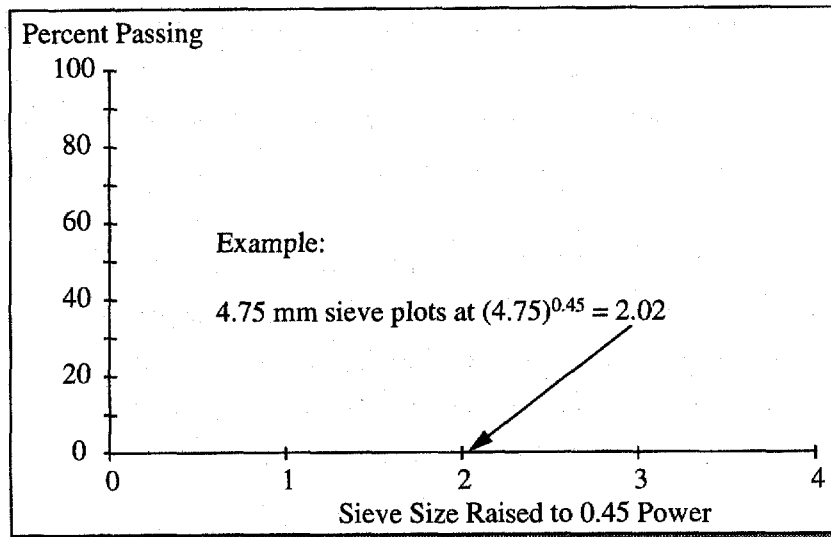

Figure III-8. Graphical Basis for 0.45 Power Chart

An important feature of this chart is the maximum density gradation. This gradation plots as a straight line from the maximum aggregate size through the origin. Superpave uses a standard set of ASTM sieves and the following definitions with respect to aggregate size (Appendix B shows sieve sizes used by Superpave):

- **Maximum Size:** One sieve size larger than the nominal maximum size.
- **Nominal Maximum Size:** One sieve size larger than the first sieve to retain more than 10 percent.

The maximum density gradation (Figure III-9) represents a gradation in which the aggregate particles fit together in their densest possible arrangement. Clearly this is a gradation to avoid because there would be very little aggregate space within which to develop sufficiently thick asphalt films for a durable mixture. Figure III-9 shows a 0.45

power gradation chart with a maximum density gradation for a 19 mm maximum aggregate size and 12.5 mm nominal maximum size.

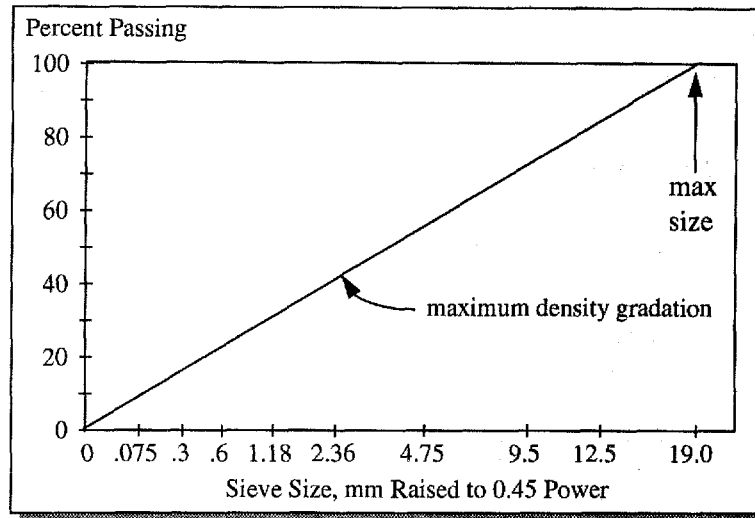

Figure III-9. Maximum Density Gradation for 19 mm Maximum Size

To specify aggregate gradation, two additional features are added to the 0.45 power chart: control points and a restricted zone. Control points function as master ranges through which gradations must pass. They are placed on the nominal maximum size, an intermediate size (2.36 mm), and the dust size (0.075 mm).

The restricted zone resides along the maximum density gradation between the intermediate size (either 4.75 or 2.36 mm) and the 0.3 mm size. It forms a band through which gradations are not permitted to pass. Gradations that pass through the restricted zone have often been called "humped gradations" because of the characteristic hump in the grading curve that passes through the restricted zone. In most cases, a humped gradation indicates a mixture that possesses too much fine sand in relation to total sand. This gradation practically always results in tender mix behavior, which is manifested by a mixture that is difficult to compact during construction and offers reduced resistance to permanent deformation during its performance life. Gradations that violate the restricted zone possess weak aggregate skeletons that depend too much on asphalt binder stiffness to achieve mixture shear strength. These mixtures are also very sensitive to asphalt content and can easily become plastic.

The term used to describe the cumulative frequency distribution of aggregate particle sizes is the *design aggregate structure*. A design aggregate structure that lies between the control points and avoids the restricted zone meets the requirements of Superpave with respect to gradation. Superpave defines six mixture types (Table III-6) as defined by their nominal maximum aggregate size:

Table III-6. Superpave Mixture Designations

Superpave Designation	Nominal Maximum Size, mm	Maximum Size, mm
37.5 mm	37.5	50
25 mm	25	37.5
19 mm	19	25
12.5 mm	12.5	19
9.5 mm	9.5	12.5

Figure III-10 illustrates the control points and restricted zone for a 12.5 mm Superpave mixture. Appendix B shows numerical gradation limits and gradation charts for the six Superpave mixtures.

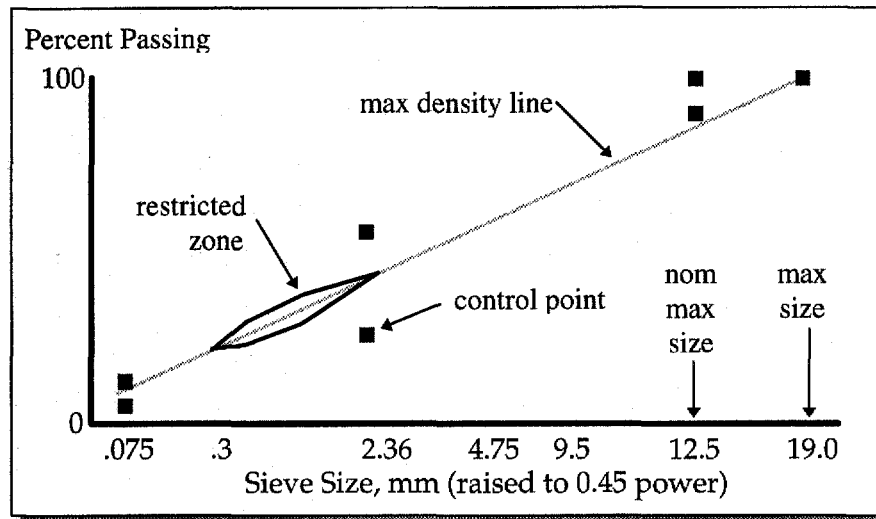

Figure III-10. Superpave Gradation Limits, 12.5 mm Mixture

Superpave recommends, but does not require, mixtures to be graded below the restricted zone. It also recommends that as project traffic level increases, gradations move closer to the coarse control points. Furthermore, the Superpave gradation control requirements were not intended to be applied to special purpose mix types such as stone matrix asphalt or open graded mixtures.

ASPHALT MIXTURES

Asphalt mixture design requirements in Superpave consist of:

- mixture volumetric requirements,
- dust proportion, and
- moisture susceptibility.

Specified values for these parameters are applied during the Level 1 mixture design phase.

Mixture Volumetric Requirements

Mixture volumetric requirements consist of air voids, voids in the mineral aggregate and voids filled with asphalt. Air void content is an important property because it is used as the basis for asphalt binder content selection. In Superpave, the design air void content is four percent.

Superpave defines voids in the mineral aggregate (VMA) as the sum of the volume of air voids and effective (i.e., unabsorbed) binder in a compacted sample. It represents the void space between aggregate particles. Specified minimum values for VMA at the design air void content of four percent are a function of nominal maximum aggregate size. Table III-7 shows Superpave VMA requirements.

Table III-7. Superpave VMA Requirements

Nominal Maximum Aggregate Size	Minimum VMA, %
9.5 mm	15.0
12.5 mm	14.0
19 mm	13.0
25 mm	12.0
37.5 mm	11.0

Voids filled with asphalt (VFA or P_{fa}) is defined as the percentage of the VMA containing asphalt binder. Consequently, VFA is the volume of effective asphalt binder expressed as a percentage of the VMA. The acceptable range of design VFA at four percent air voids is a function of traffic level as shown in Table III-8.

Table III-8. Superpave VFA Requirements

Traffic, ESALs	Design VFA, %
$< 3 \times 10^5$	70 - 80
$< 1 \times 10^6$	65 - 78
$< 3 \times 10^6$	65 - 78
$< 1 \times 10^7$	65 - 75
$< 3 \times 10^7$	65 - 75
$< 1 \times 10^8$	65 - 75
$> 3 \times 10^8$	65 - 75

Dust Proportion

Another mixture requirement is the dust proportion. This is computed as the ratio of the percentage by weight of aggregate finer than the 0.075 mm sieve to the effective asphalt content expressed as a percent by weight of total mix. Effective asphalt content is the total asphalt used in the mixture less the percentage of absorbed asphalt. Dust proportion is used during the mixture design phase as a design criterion. An acceptable dust proportion is in the range from 0.6 to 1.2, inclusive for all mixtures.

Moisture Susceptibility

The moisture susceptibility test used to evaluate HMA for stripping is AASHTO T 283, "Resistance of Compacted Bituminous Mixtures to Moisture Induced Damage." This test is not a performance based test but serves two purposes. First, it identifies whether a combination of asphalt binder and aggregate is moisture susceptible. Second, it measures the effectiveness of anti-stripping additives.

In the test, two subsets of test specimens are produced. Specimens are compacted to achieve an air void content in the range from six to eight percent with a target value of seven percent. Test specimens should be sorted so that each subset has the same air void content. One subset is moisture conditioned by vacuum saturation to a constant degree of saturation in the range from 55 to 80 percent. This is followed by an optional freeze cycle. The final conditioning step is a hot water soak. After conditioning both subsets are tested for indirect tensile strength. The test result reported is the ratio of tensile strength of the conditioned subset to that of the unconditioned subset. This ratio is called the "tensile strength ratio" or TSR. Superpave requires a minimum TSR of 80 percent. Table III-9 outlines the current test parameters in AASHTO T 283.

Table III-9. Test Parameters for AASHTO T283

Test Parameter	Test Requirement
Short-Term Aging	Loose mix ¹ : 16 hrs at 60° C Compacted mix: 72-96 hrs at 25° C
Air Voids Compacted Specimens	6 to 8 %
Sample Grouping	Average air voids of two subsets should be equal
Saturation	55 to 80 %
Swell Determination	None
Freeze	Minimum 16 hrs at -18° C (optional)
Hot Water Soak	24 hrs at 60° C
Strength Property	Indirect tensile strength
Loading Rate	51 mm/min at 25° C
Precision Statement	None
¹ Short-term aging protocol of AASHTO T 283 does not match short-term aging protocol of Superpave. Suggest using T283 procedure of 16 hours at 60° C.	

IV.

ASPHALT MIXTURE VOLUMETRICS

INTRODUCTION

A factor that must be taken into account when considering asphalt mixture behavior is the *volumetric proportions* of asphalt binder and aggregate components, or more simply, *asphalt mixture volumetrics*. The developers of Superpave felt that the volumetric properties of asphalt mixtures were so important that a volumetric mixture design protocol was developed. The following section describes volumetric analysis of HMA, which plays a significant role in most mixture design procedures, including the Superpave system.

COMPONENT DIAGRAM APPROACH

The model used to describe HMA mass and volume properties is the component diagram. It considers a compacted sample of HMA with its constituent air voids, asphalt cement, and mineral aggregate shown as discrete components (Fig IV-1). The compacted sample is assumed to consist of a unit volume (e.g., one cubic meter, one cubic centimeter, etc.) with known mass (e.g., kilograms or grams). The component diagram is particularly suited to metric units because in this system, density and specific gravity are numerically the same since the density of water is very nearly 1.000 gram per cubic centimeter and its specific gravity is 1.000 at 25° C. It is a tool commonly used for many civil engineering applications because it represents a convenient model to track distinct masses and volumes in non-homogeneous construction materials.

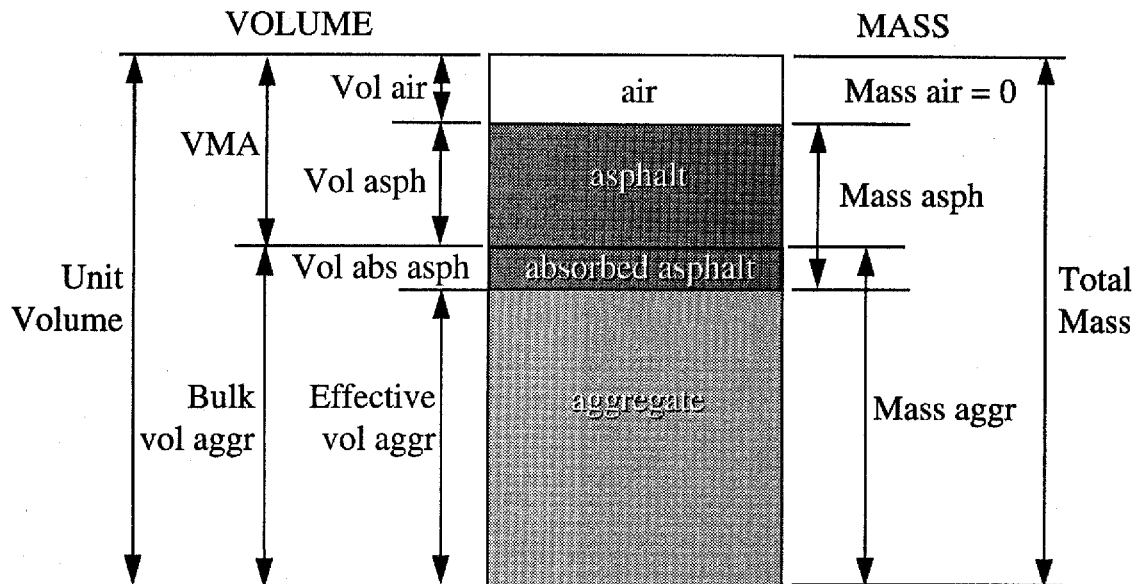

Figure IV-1. Component Diagram of Compacted Sample of HMA

The component diagram provides a clear definition of *density*, that is, the mass of a unit volume of compacted material. Since the model consists of several distinct materials, the density of the entire sample is often called its bulk density. It is determined by dividing the total mass of the sample by its total volume.

For a given asphalt content, the *maximum theoretical density* is the mass of aggregate and asphalt divided by the volume of only these two components. In other words, the volume of air voids is not included. Maximum theoretical density (or specific gravity) is an extremely useful property because it can be used as a reference to calculate several other important properties such as air void content.

Asphalt content is the mass concentration of asphalt binder. It is expressed as percent by total mass of mixture or percent by total mass of aggregate. Most agencies use percent by mass of mixture. *Effective asphalt content* is the mass concentration of asphalt binder that is not lost to absorption. *Absorbed asphalt content* is the mass concentration of asphalt binder absorbed by the aggregate. It is normally reported as a percentage of the mass of aggregate.

The volume concentration of air within the compacted sample is the *air void content*. Air voids are always expressed as a percentage of total volume of mixture.

The intergranular space occupied by asphalt and air in a compacted mixture is called the *voids in the mineral aggregate* or *VMA*. In the component diagram, the sum of the volume of air and volume of effective asphalt, expressed as a percent of total volume, is the VMA. The volume of absorbed asphalt is usually not considered to be part of the VMA.

Not shown on the diagram is the percentage of *voids filled with asphalt* or *VFA*. This property is the percentage of the VMA that contains asphalt. While it could be computed by dividing the volume of asphalt by the volume of the VMA, it is normally computed by the following formula.

$$\text{VFA} = [(\text{VMA} - \text{Volume of Air})/\text{VMA}] \times 100 \%$$

Although contrary to physical laws, the model shows mass and volume on the same diagram, with the same scale. Another deceptive feature of the component diagram is that it is not well suited for considering secondary weights and volumes such as absorbed asphalt. Furthermore, narrow reliance on the physical model sometimes inhibits a more fundamental understanding of volumetric properties such as VMA. Even with these flaws, the component diagram is still the best way to define and illustrate determination of the properties of compacted HMA.

Note that when calculating HMA properties during mix design, engineers seldom work from a sketch of a component diagram. They normally use well established formulas, originally derived from a component diagram, to arrive at the various properties of interest. Appendix D contains a list of all the formulas used to compute compacted mix properties.

SPECIFIC GRAVITY

In order to use the component diagram, it is necessary to be able to convert between mass and volume. Specific gravity is the tool employed for this purpose. Specific gravity is the ratio of the mass of a given volume of a substance to the mass of an equal volume of water, both at the same temperature. It is a unique material property that allows for two important determinations.

First, specific gravity is used to determine density by:

$$D = G \times 1.000$$

where, D = density of material in grams per cubic centimeter (g/cm^3),

G = specific gravity of material, and

1.000 = density of water in grams per cubic centimeter.

The terms “density” and “specific gravity” are often interchanged, which suggests they have the same meaning. In fact, in metric units, they have the same numerical value. While this usage is technically incorrect, context most often conveys the intended meaning. This equation offers the most precise meaning of each.

Second, knowing the mass and specific gravity of a material, the volume of the material can be determined by:

$$V = \frac{M}{(G)1.000}$$

where, V = volume of material,

M = mass of material, and

G = specific gravity of material, and

1.000 = density of water ($1.000 \text{ g}/\text{cm}^3$).

Use of this equation is best understood by the following example.

Consider an object placed on a scale and found to weigh 75 kilograms. This object is known to have a specific gravity very nearly that of water, or 1.000. Using these values in the above equation indicates the object has a volume of about 75,000 cubic centimeters (i.e., $[75 \text{ kg} \times 1,000\text{g}/\text{kg}]/[1.000 \times 1.000 \text{ g}/\text{cm}^3] = 75,000 \text{ cm}^3$).

This example is also useful to illustrate the fact that different specific gravities must often be considered. The conditions of the example were somewhat obscure with respect to the precise meaning of the specific gravity used.

While the object may be a homogeneous material, it is more likely a composite of several materials. Consequently, the conditions of the example needed to be more precise and should have specified bulk specific gravity. Bulk specific gravity is least determinate since it considers the object in whole or “bulk” form and is blind to the contributions of the object's individual components. A volume determined from a bulk specific gravity must be assumed to include the total volume and not unique component volumes.

In the case of mineral aggregate, bulk, effective, and apparent specific gravities are usually determined. Bulk specific gravity (AASHTO T84 and T85) is determined by measuring the dry weight and bulk volume of an aggregate sample (Figure IV-2). The bulk volume includes the solid aggregate volume plus the volume of surface pores holding water. The bulk volume is measured on the aggregate in a saturated surface dry (SSD) condition.

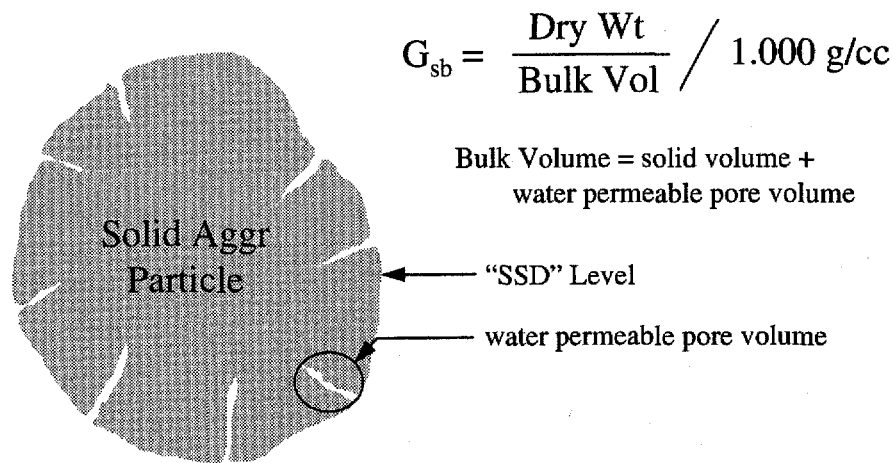

Figure IV-2. Bulk Specific Gravity of Aggregate

Apparent specific gravity (also measured using AASHTO T84 and T85) is determined by measuring the dry weight and apparent volume of an aggregate sample (Figure IV-3). The apparent volume only includes the volume of the solid aggregate and does not include the volume of any surface pores.

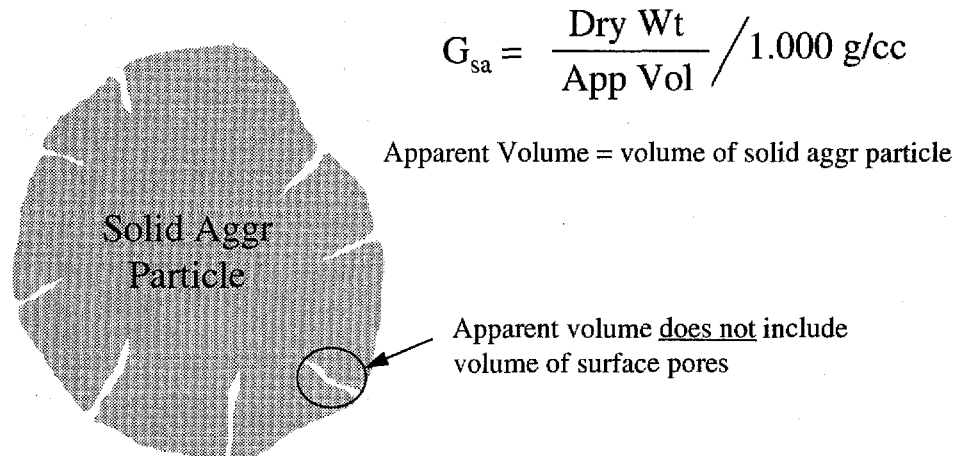

Figure IV-3. Apparent Specific Gravity of Aggregate

Effective specific gravity is measured on asphalt mixtures (AASHTO T209) of known asphalt content. In the context of bulk and apparent specific gravity, it is computed using the dry weight of aggregate and the effective volume of the aggregate. The aggregate effective volume includes the volume of the solid aggregate and the volume of surface pores filled with water but not asphalt (Figure IV-4). Aggregate effective specific gravity is not directly measured in the same manner as bulk and apparent specific gravity. Instead, it is calculated by knowing the maximum theoretical specific gravity of a mixture and the asphalt content.

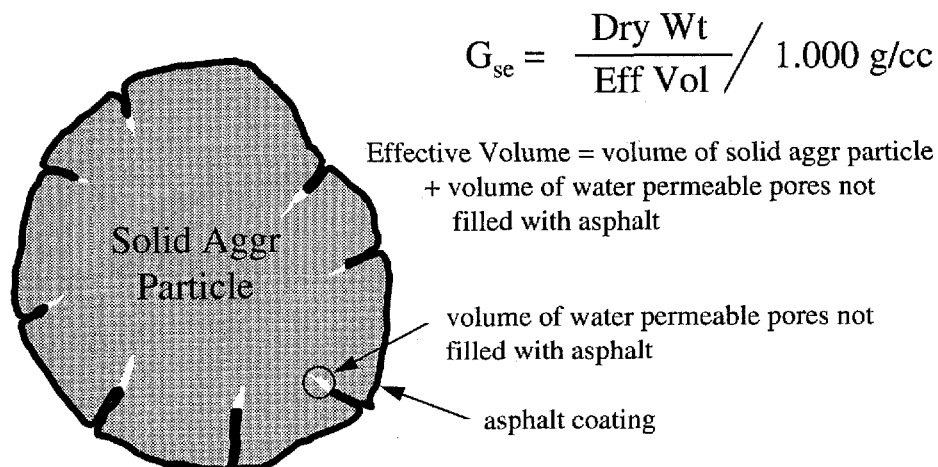

Figure IV-4. Effective Specific Gravity of Aggregate

Only bulk and effective specific gravities are used during mix design volumetric calculations. Volumes calculated with each of these would have different meanings and thus, numeric values. The wide array of asphalt, aggregate, and mixture specific gravities are often confusing to those new to asphalt technology. Careful attention to the meaning of each, and the desired HMA property will clarify the analysis.

EXAMPLE CALCULATIONS

A sample of compacted HMA is known to have the following properties at 25° C:

- Mix Bulk Specific Gravity = 2.329
- Aggregate Bulk Specific Gravity = 2.705
- Aggregate Effective Specific Gravity = 2.731
- Asphalt Binder Specific Gravity = 1.015
- Asphalt Content = 5.0 percent by mass of total mix

The air void content, VMA, VFA, maximum theoretical specific gravity, absorbed asphalt content, and effective asphalt content should be determined. Figure IV-5 shows these known items on a component diagram. The required calculations are with the following steps.

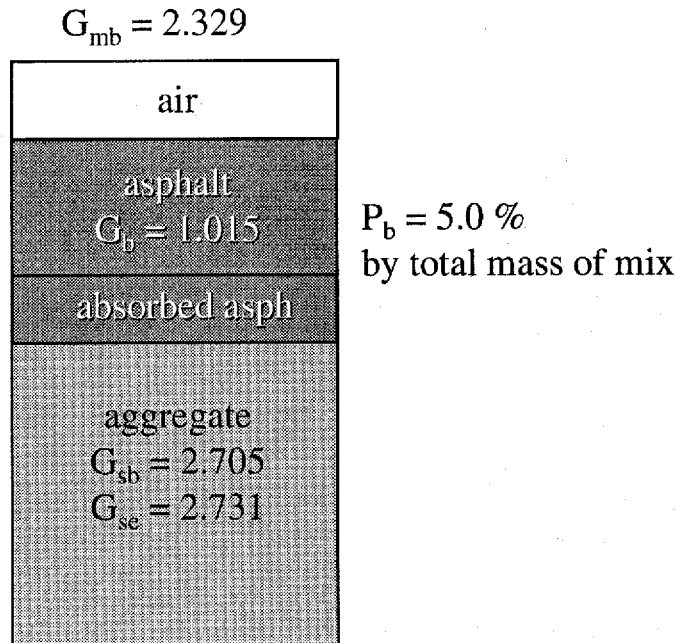

Figure IV-5. Known Items for Example

IV. Asphalt Mixture Volumetrics

Step 1: Determine Density

$$D = G_{\text{bulk-mix}} \times 1.000 \text{ g/cm}^3 = 2.329 \times 1.000 \text{ g/cc} = 2.329 \text{ g/cm}^3.$$

Thus, the sample in the component diagram is assumed to have a mass of 2.329 grams and occupy one cubic centimeter. Note that an alternate approach could use 2,329 kilograms and one cubic meter.

Step 2: Determine Mass

$$M_{\text{air}} = 0$$

$$M_{\text{asphalt}} = (5/100) \times 2.329 \text{ g} = 0.116 \text{ g}$$

$$M_{\text{aggregate}} = (95/100) \times 2.329 \text{ g} = 2.213 \text{ g}$$

Thus, in the component diagram, the asphalt binder has a mass of 0.116 g and the aggregate 2.213 g. The air was assumed to be without mass.

Step 3: Determine Volumes

$$V_{\text{total-asph}} = M_{\text{asph}}/G_{\text{asph}} \times 1.000 \text{ g/cm}^3 = 0.116 \text{ g}/(1.015 \times 1.000 \text{ g/cm}^3) = 0.114 \text{ cm}^3$$

$$V_{\text{bulk-aggr}} = M_{\text{aggr}}/G_{\text{bulk-aggr}} \times 1.000 \text{ g/cm}^3 = 2.213 \text{ g}/(2.705 \times 1.000 \text{ g/cm}^3) = 0.818 \text{ cm}^3$$

$$V_{\text{eff-aggr}} = M_{\text{aggr}}/G_{\text{eff-aggr}} \times 1.000 \text{ g/cm}^3 = 2.213 \text{ g}/(2.731 \times 1.000 \text{ g/cm}^3) = 0.810 \text{ cm}^3$$

$$V_{\text{abs-asph}} = V_{\text{bulk-aggr}} - V_{\text{eff-aggr}} = 0.818 \text{ cm}^3 - 0.810 \text{ cm}^3 = 0.008 \text{ cm}^3$$

$$V_{\text{eff-asph}} = V_{\text{total-asph}} - V_{\text{abs-asph}} = 0.114 \text{ cm}^3 - 0.008 \text{ cm}^3 = 0.106 \text{ cm}^3$$

$$V_{\text{air}} = V_{\text{total}} - (V_{\text{eff-asph}} + V_{\text{bulk-aggr}}) = 1.000 \text{ cm}^3 - (0.106 \text{ cm}^3 + 0.818 \text{ cm}^3) = 0.076 \text{ cm}^3$$

$$\text{VMA} = V_{\text{air}} + V_{\text{eff-asph}} = 0.076 \text{ cm}^3 + 0.106 \text{ cm}^3 = 0.182 \text{ cm}^3$$

Percent volume concentration by total mix of each component is calculated by:

$$\text{Percent volume air voids} = (0.076 \text{ cm}^3 / 1.000 \text{ cm}^3) \times 100 \% = 7.6 \%$$

$$\text{Percent volume of total asphalt} = (0.114 \text{ cm}^3 / 1.000 \text{ cm}^3) \times 100 \% = 11.4 \%$$

$$\text{Percent volume of effective asphalt} = (0.106 \text{ cm}^3 / 1.000 \text{ cm}^3) \times 100 \% = 10.6 \%$$

$$\text{Percent volume of bulk aggregate} = (0.818 \text{ cm}^3 / 1.000 \text{ cm}^3) \times 100 \% = 81.8 \%$$

$$\text{Percent VMA} = (0.182 \text{ cm}^3 / 1.000 \text{ cm}^3) \times 100 \% = 18.2 \%$$

An alternative procedure to compute VMA is:

$$\text{Percent VMA} = 100 \% - \% \text{ volume of bulk aggregate} = 100 \% - 81.8 \% = 18.2 \%$$

Step 4: Calculate Effective Asphalt Content and Absorbed Asphalt Content

$$\text{Mass of effective asphalt} = V_{\text{eff-asph}} \times G_{\text{asph}} \times 1.000 \text{ g/cm}^3 = 0.106 \text{ cm}^3 \times 1.015 \times 1.000 \text{ g/cm}^3 = 0.108 \text{ g}$$

$$\text{Mass of absorbed asphalt} = V_{\text{abs-asph}} \times G_{\text{asph}} \times 1.000 \text{ g/cm}^3 = 0.008 \text{ cm}^3 \times 1.015 \times 1.000 \text{ g/cm}^3 = 0.008 \text{ g}$$

$$\text{Effective Asphalt Content} = (M_{\text{eff-asph}} / M_{\text{total}}) \times 100 \% = (0.108 \text{ g} / 2.329) \times 100 \% = 4.6 \%$$

$$\text{Absorbed Asphalt Content} = (M_{\text{abs-asph}} / M_{\text{aggr}}) \times 100 \% = (0.008 \text{ g} / 2.213 \text{ g}) \times 100 \% = 0.4 \%$$

Step 5: Calculate VFA

$$\text{Percent VFA} = V_{\text{eff-asph}} / \text{Volume of VMA} \times 100 \% = (0.106 \text{ cm}^3 / 0.182 \text{ cm}^3) \times 100 \% = 58.2 \%$$

Step 6: Calculate Maximum Theoretical Specific Gravity

$$\begin{aligned} G_{\text{max-theo}} &= [(M_{\text{asph}} + M_{\text{aggr}}) / (V_{\text{eff-asph}} + V_{\text{bulk-aggr}})] / 1.000 \text{ g/cm}^3 \\ &= [(0.116 \text{ g} + 2.213 \text{ g}) / (0.106 \text{ cm}^3 + 0.818 \text{ cm}^3)] / 1.000 \text{ g/cm}^3 = 2.521 \end{aligned}$$

IV. Asphalt Mixture Volumetrics

Answer: Air Void Content = 7.6 %
 VMA = 18.2 %
 VFA = 58.2 %
 Absorbed Asphalt Content = 0.4 %
 Effective Asphalt Content = 4.6 %
 Max. theo. sp. grav. = 2.521

All of the computed masses and volumes are shown on a component diagram in Figure IV-6.

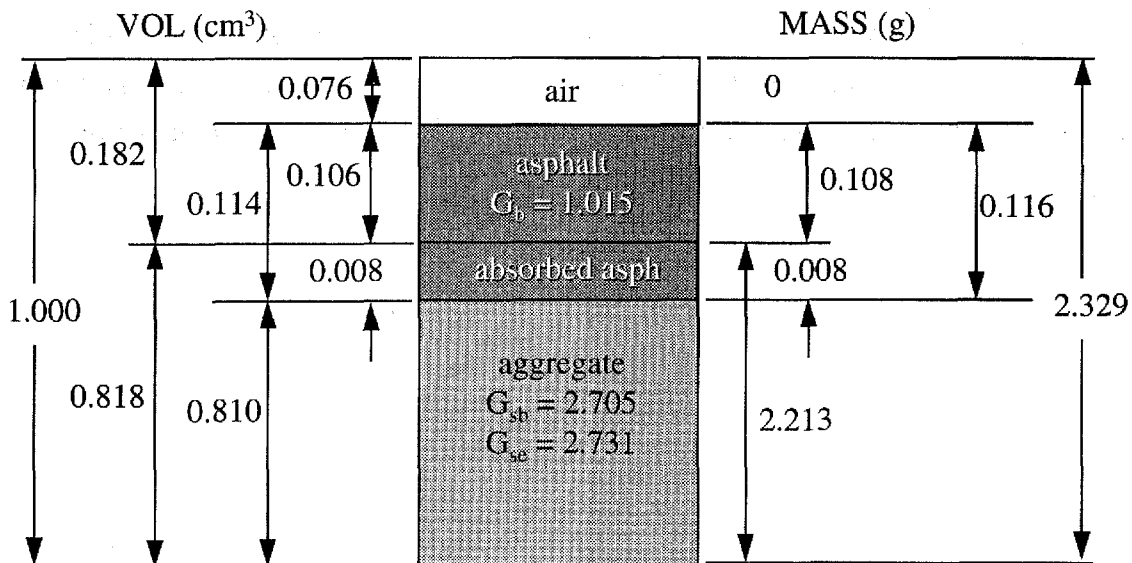

Figure IV-6. Computed Masses and Volumes for Example

The conditions of this example stated that the asphalt content was five percent by mass of total mix.” Although this is the most common method of expressing asphalt content, some agencies express asphalt content as percent by mass of aggregate. Had asphalt content been expressed in this way, the weight of asphalt and aggregate would have been calculated by:

$$5/100 = M_{\text{asph}} / M_{\text{aggr}} \quad \text{and} \quad 2.329 = M_{\text{asph}} + M_{\text{aggr}}$$

Solving these equations simultaneously yields:

$$M_{\text{asph}} = 0.111 \text{ g}$$

$$M_{\text{aggr}} = 2.218 \text{ g}$$

The analysis would continue from this point as before. This illustrates the importance of clearly stating the basis for asphalt content.

The example used the volume of effective asphalt and air voids to compute VMA. In effect, the aggregate bulk specific gravity was used to compute VMA. This is the approach currently used by most agencies. Superpave also uses this convention. In the Superpave mix design procedure, VMA criteria are based on aggregate bulk specific gravity. Use of other aggregate specific gravities to compute VMA means that the VMA criteria no longer apply and the mixture does not meet the requirements of Superpave.

V.

SUPERPAVE GYRATORY COMPACTION

INTRODUCTION

In selecting a method of laboratory compaction, SHRP researchers had several goals. Most important, they desired a device that would realistically compact trial mix specimens to densities achieved under actual pavement climate and loading conditions. The device needed to be capable of accommodating large aggregates. Furthermore, it was desired that the device afford a measure of compactibility so that potential tender mixture behavior and similar compaction problems could be identified. A high priority for SHRP researchers was a device that was well suited to mixing facility quality control and quality assurance operations. No compactor in current use achieved all these goals. Consequently, a new compactor was developed, the Superpave Gyratory Compactor (SGC).

The basis for the SGC was a large Texas gyratory compactor modified to use the compaction principles of a French gyratory compactor. The Texas device accomplished the goals of achieving realistic specimen densification and it was reasonably portable. Its 6-inch sample diameter (ultimately 150 mm on an SGC) could accommodate mixtures containing aggregate up to 50 mm maximum (37.5 nominal) size. SHRP researchers modified the Texas device by lowering its angle and speed of gyration and adding real time specimen height recordation. In fact, a considerable amount of this phase of SHRP mixture research was conducted on a modified Texas gyratory compactor loaned to SHRP by the Texas DOT.

TEST EQUIPMENT

The SGC is an mechanical device comprised of the following system of components:

- reaction frame, rotating base, and motor,

V. Superpave Gyratory Compaction

- loading system, loading ram, and pressure gauge,
- height measuring and recordation system, and
- mold and base plate.

Figure V-1 shows a generic SGC.

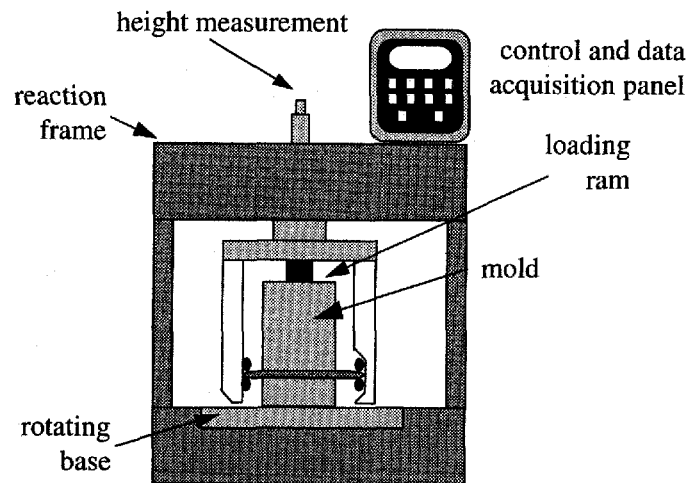

Figure V-1. Superpave Gyratory Compactor

The reaction frame provides a non-compliant structure against which the loading ram can push when compacting specimens. The base of the SGC rotates and is affixed to the loading frame. It supports the mold while compaction occurs. Reaction bearings are used to position the mold at an angle of 1.25 degrees, which is the compaction angle of the SGC. The electric motor drives the rotating base at a constant speed of 30 revolutions per minute.

A hydraulic or mechanical system applies a load to the loading ram, which imparts 600 kPa compaction pressure to the specimen. The loading ram diameter nominally matches the inside diameter of the mold, which is 150 mm. A pressure gauge with digital signal conditioning measures the ram pressure during compaction. As the specimen densifies during compaction, the pressure gauge signals the loading system to adjust the position of the loading ram so that a constant compaction pressure is maintained throughout the compaction process.

Specimen height measurement is an important function of the SGC. By knowing the mass of material placed in the mold, the diameter of the mold, and the specimen height,

an estimate of specimen density can be made at any time throughout the compaction process. Specimen density is computed by dividing the mass by the volume of the specimen. The specimen volume is calculated as the volume of a smooth-sided cylinder with a diameter of 150 mm and the measured height. Height recordation is variously accomplished by measuring the position of the ram before and during the test. The vertical change in ram position identically equals the change in specimen height. The specimen height signal is processed through a serial port connection which is connected to a personal computer, printer, or other device to record height (i.e., density) measurements throughout the compaction process. By this method, a compaction characteristic is developed as the specimen is compacted (Figure V-2).

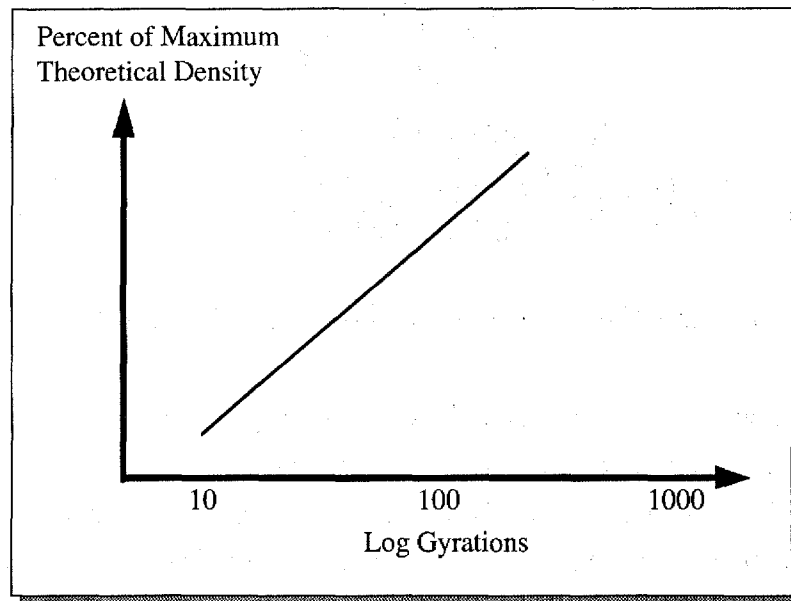

Figure V-2. Compaction Characteristic of SGC

The SGC uses a mold (Figure V-3) with an inside diameter of 150 mm and a nominal height of 250 mm. A base plate fits in the bottom of the mold to afford specimen confinement during compaction.

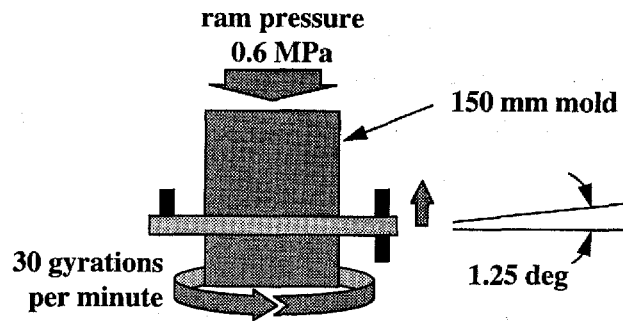

Figure V-3. SGC Mold Configuration and Compaction Parameters

SPECIMEN PREPARATION

Compaction specimens are required to be mixed and compacted under equiviscous temperature conditions corresponding to 0.170 Pa·s and 0.280 Pa·s, respectively. Figure V-4 shows a typical temperature-viscosity chart for an asphalt binder. Mixing is accomplished by a mechanical mixer. After mixing, loose test specimens are subjected to four hours of short term aging in a forced draft oven maintained at a constant 135° C. During short term aging, loose mix specimens are required to be spread into a thickness resulting in 21 to 22 kg per cubic meter and stirred every hour to ensure uniform aging. The compaction molds and base plates should also be placed in an oven at 135° C for at least 30 to 45 minutes prior to use.

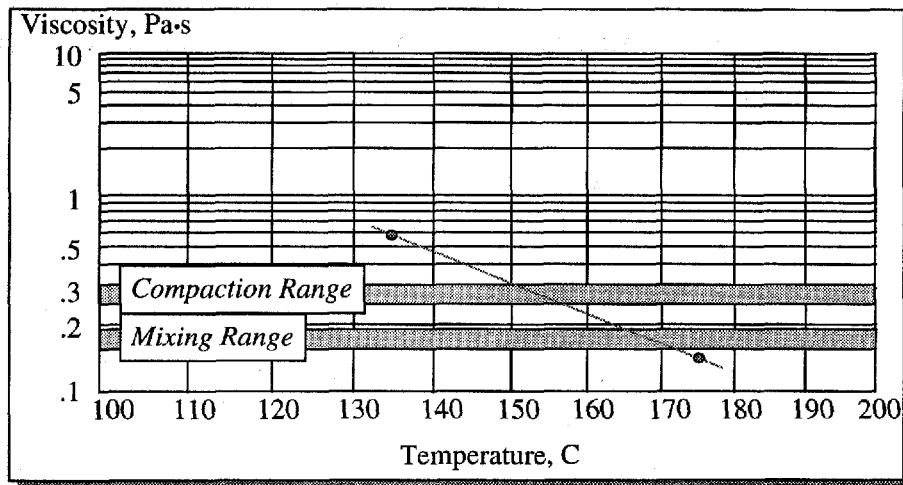

Figure V-4. Temperature-Viscosity Relationship

Three specimen sizes are used. If specimens are to be used for volumetric determinations only, use sufficient mix to arrive at a specimen 150 mm in diameter by approximately 115 mm height. This requires approximately 4500 grams of aggregate. In this case, the test specimen produced is tested without trimming. Alternatively, to produce specimens for performance testing, approximately 5500 grams of aggregate is used to fabricate a specimen that is 150 mm in diameter by approximately 135 mm height. In this case, specimens will have to be trimmed to 50 mm before testing in the SST or IDT. At least one loose sample should remain uncompacted to obtain a maximum theoretical specific gravity using AASHTO T 209. For performing AASHTO T283, test specimens are fabricated to a height of 95 mm, which requires approximately 3500 grams of aggregate.

OVERVIEW OF PROCEDURE

After short term aging the loose test specimens are ready for compacting. The compactor is initiated by turning on its main power. The vertical pressure should be set at 600 kPa (± 18 kPa). The gyration counter should be zeroed and set to stop when the desired number of gyrations is achieved. Three gyration levels are of interest:

- design number of gyrations (N_{design}),
- initial number of gyrations (N_{initial}), and
- maximum number of gyrations (N_{maximum}).

Test specimens are compacted using N_{maximum} gyrations. The relationship between N_{design} , N_{maximum} , and N_{initial} are:

$$\text{Log}_{10} N_{\text{maximum}} = 1.10 \times \text{Log}_{10} N_{\text{design}}$$

$$\text{Log}_{10} N_{\text{initial}} = 0.45 \times \text{Log}_{10} N_{\text{design}}$$

The design number of gyrations (N_{design}) ranges from 68 to 172 and is a function of the climate in which the mix will be placed and the traffic level. The average design high air temperature is provided by Superpave software and represents the average seven-day maximum air temperature for project conditions. The range of values for N_{design} , N_{maximum} , and N_{initial} is shown in Table V-1.

Table V-1. Superpave Gyrotory Compaction Effort

Design ESALs (millions)	Average Design High Air Temperature											
	<39°C			39 - 40°C			41 - 42°C			43 - 44°C		
	N _{ini}	N _{des}	N _{max}	N _{ini}	N _{des}	N _{max}	N _{ini}	N _{des}	N _{max}	N _{ini}	N _{des}	N _{max}
< 0.3	7	68	104	7	74	114	7	78	121	7	82	127
0.3 - 1	7	76	117	7	83	129	7	88	138	8	93	146
1 - 3	7	86	134	8	95	150	8	100	158	8	105	167
3 - 10	8	96	152	8	106	169	8	113	181	9	119	192
10 - 30	8	109	174	9	121	195	9	128	208	9	135	220
30 - 100	9	126	204	9	139	228	9	146	240	10	153	253
> 100	9	142	233	10	158	262	10	165	275	10	172	288

After the base plate is in place, a paper disk is placed on top of the plate and the mold is charged in a single lift. The top of the uncompacted specimen should be slightly rounded. A paper disk is placed on top of the mixture.

The mold is placed in the compactor and centered under the ram. The ram is then lowered until it contacts the mixture and the resisting pressure is 600 kPa (± 18 kPa). The angle of gyration ($1.25^\circ \pm 0.02^\circ$) is then applied and the compaction process begins.

When N_{maximum} has been reached, the compactor should automatically cease. After the angle and pressure are released, the mold containing the compacted specimen is then removed. After a suitable cooling period, the specimen is extruded from the mold.

The bulk specific gravity of test specimens should be measured using AASHTO T 166. Maximum theoretical specific gravity should be measured using AASHTO T 209.

DATA ANALYSIS AND PRESENTATION

Superpave gyrotory compaction data should be analyzed by computing the estimated bulk specific gravity, corrected bulk specific gravity, and percentage of maximum theoretical specific gravity for each desired gyration. The example specimen compaction information in Table V-2 illustrates this analysis.

Table V-2. Example Specimen Compaction Information

Specimen No. 1: Total Mass = 4869 g				
G _{mm} (measured) = 2.563				
No. of Gyration	Height, mm	G _{mb} (estimated)	G _{mb} (corrected)	% G _{mm}
8 (N _{ini})	127.0	2.170	2.218	86.5
50	118.0	2.334	2.385	93.1
100	115.2	2.391	2.444	95.4
109 (N _{des})	114.9	2.398	2.451	95.6
150	113.6	2.425	2.478	96.7
174 (N _{max})	113.1	2.436	2.489	97.1
G _{mb} (measured)	-	2.489	-	-

Project conditions for this mixture are such that N_{max} = 174, N_{des} = 109, and N_{ini} = 8 gyrations. During compaction, the height was measured after each gyration and recorded for the number of gyrations shown in the first column. The G_{mb} (estimated) values were determined by:

$$V_{mx} = \frac{\pi d^2 h_x}{4} \times 0.001 \text{ cm}^3 / \text{mm}^3$$

where, V_{mx} = volume of specimen in mold during compaction (cm³),
 d = diameter of mold (150 mm), and
 h_x = height of specimen in mold during compaction (mm).

$$G_{mb}(\text{estimated}) = \frac{W_m / V_{mx}}{1.000 \text{ g} / \text{cm}^3}$$

where, G_{mb}(estimated) = estimated bulk sp grav of specimen during compaction,
 W_m = mass of specimen (g).

To illustrate this determination, consider the specimen conditions at 50 gyrations. The specimen height is measured as 118.0 mm. The estimated volume of the specimen at 50 gyrations is:

$$V_{mx} = \frac{\pi d^2 h_x}{4} \times 0.001 \text{ cm}^3 / \text{ mm}^3 = \frac{\pi (150 \text{ mm})^2 118.0 \text{ mm}}{4} \times 0.010 \text{ cm}^3 / \text{ mm}^3 = 2085.2 \text{ cm}^3$$

Thus, the $G_{mb}(\text{estimated})$ at 50 gyrations is:

$$G_{mb}(\text{estimated}) = \frac{4867.8 \text{ g} / 2085.2 \text{ cm}^3}{1.000 \text{ g} / \text{ cm}^3} = 2.334$$

This calculation assumes that the specimen is a smooth-sided cylinder, which of course, it is not. The volume of the specimen is slightly less than the volume of a smooth-sided cylinder because of surface irregularities. That is why the final estimated G_{mb} at 174 gyrations, 2.436, is different than the measured G_{mb} after 174 gyrations, 2.489. To correct for this difference, the estimated G_{mb} at any given number of gyrations is corrected by a ratio of the measured to estimated bulk specific gravity at N_{maximum} using the following formula.

$$C = \frac{G_{mb}(\text{measured})}{G_{mb}(\text{estimated})}$$

where, C = correction factor,

$G_{mb}(\text{measured})$ = measured bulk specific gravity after N_{maximum} , and

$G_{mb}(\text{estimated})$ = estimated bulk specific gravity at N_{maximum} .

The estimated G_{mb} at all other number of gyrations can then be corrected by using the correction factor in the following formula.

$$G_{mb}(\text{corrected}) = C \times G_{mb}(\text{estimated})$$

where, $G_{mb}(\text{corrected})$ = corrected bulk sp grav of specimen at any gyration, N,

C = correction factor, and

$G_{mb}(\text{estimated})$ = estimated bulk sp grav at any gyration, N.

In this example, this ratio is 2.489/2.436 or 1.022. Percent G_{mm} is computed as the ratio $G_{mb}(\text{corrected})$ to $G_{mm}(\text{measured})$.

If this example had been for the purpose of mix design, a companion specimen would have been compacted and average percent G_{mm} values resulting from the two specimens would have been used for further analysis. A densification plot for this example showing two specimens and an average is shown in Figure V-5.

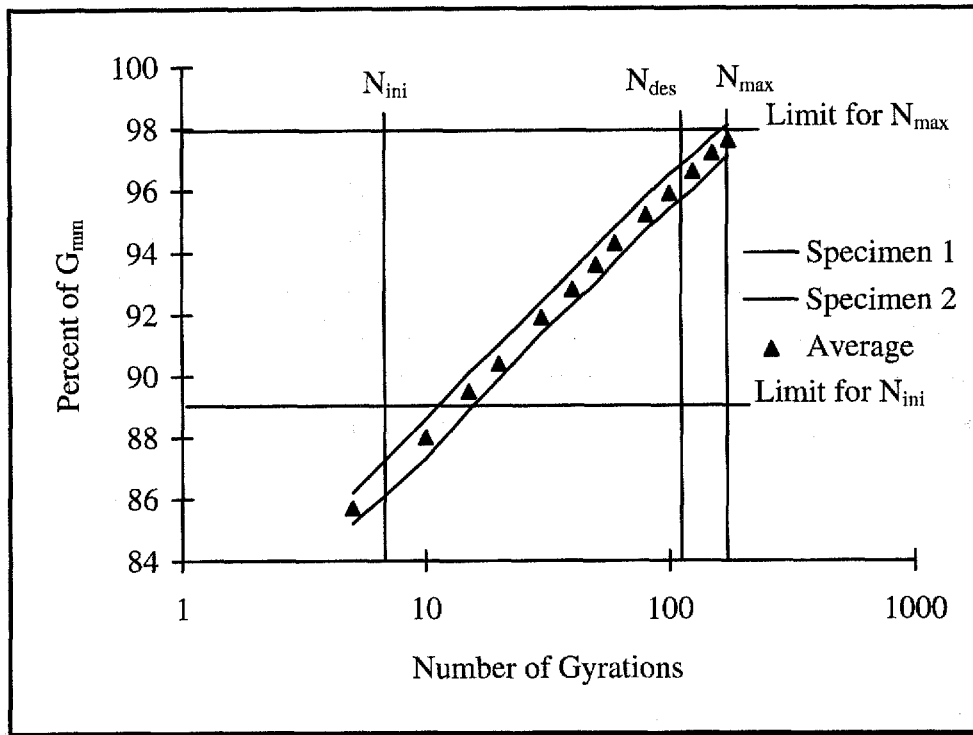

Figure V-5. Densification Plot for Example Specimens

Design parameters are established on the basis of air void content at N_{design} , $N_{initial}$, and $N_{maximum}$. The following table shows the criteria and observed average values considering the average of the two specimens in the example.

Table V-3. Densification Values and Criteria

No. of gyrations	Criterion for % G_{mm}	Observed % G_{mm}
N_{ini} (8)	< 89.0	87.1
N_{des} (109)	96.0	96.2
N_{max} (174)	< 98.0	97.6

CALIBRATION AND STANDARDIZATION

A critical calibration item is the height measurement system. This is normally accomplished by means of a dummy specimen of known dimensions. The loading ram can be calibrated by means of a proving ring or load cell of suitable accuracy. The speed of gyration can be checked by accurately timing the rotation over a known number of rotating base revolutions.

Calibration of the angle of gyration is another critical calibration item. This is accomplished by various means that are compactor dependent. One method of calibrating the angle involves the use of a digital protractor that directly reports angular deviation from a fixed datum. Another method uses precise dial gauge measurements collected with the mold at various orientations. The measurements are used to calculate the angle of gyration. In any case, the angle should be checked while the mold contains a specimen under loaded conditions.

VI.

VOLUMETRIC MIX DESIGN

INTRODUCTION

Volumetric mix design plays a central role in Superpave mixture design. The best way of illustrating its steps is by means of an example. This section provides the Superpave Level 1 mixture design test results for a project that was constructed in 1992 by the Wisconsin Department of Transportation on IH-43 in Milwaukee. The information presented follows the logical progression of testing and data analysis involved in a Level 1 mixture design and encompasses the concepts outlined in previous sections. There are four major steps (see Appendix E for an outline of the major steps in Level 1 mix design) in the testing and analysis process:

1. selection of materials (aggregates, binders, modifiers, etc.),
2. selection of a design aggregate structure,
3. selection of a design asphalt binder content,
4. evaluation of moisture sensitivity of the design mixture.

Selection of materials consists of determining the traffic and environmental factors for the paving project. From that, the performance grade of asphalt binder required for the project is selected. Aggregate requirements are determined based on traffic level and layer depth. Materials are selected based on their ability to meet or exceed the established criteria.

Selection of the design aggregate structure is a trial-and-error process. This step consists of blending available aggregate stockpiles at different percentages to arrive at aggregate gradations that meet Superpave requirements. Three trial blends are normally employed for this purpose. A trial blend is considered acceptable if it possesses suitable volumetric properties (based on traffic and environmental conditions) at a predicted design binder content. Once selected, the trial blend becomes the design aggregate structure.

Selection of a design asphalt binder content consists of varying the amount of asphalt binder with the design aggregate structure to obtain acceptable volumetric and compaction properties when compared to the mixture criteria, which are based on traffic and environmental conditions. This step is a verification of the results obtained from the previous step. This step also allows the designer to observe the sensitivity of volumetric and compaction properties of the design aggregate structure to asphalt content. The design aggregate structure at the design asphalt binder content becomes the job-mix formula.

Evaluation of moisture sensitivity consists of testing the designed mixture by AASHTO T283 to determine if the mix will be susceptible to moisture damage.

MATERIAL SELECTION

For the IH-43 project, design ESALs are determined to be 18 million in the design lane. This places the design in the traffic category from 10 to 30 million ESALs. Traffic level is used to determine design requirements such as number of design gyrations for compaction, aggregate physical property requirements, and mixture volumetric requirements. The traffic level also determines the level of mixture design required. For 18 million ESALs and higher, a Superpave Level 3 design is required. Consequently, the design process requires a Level 1 design to determine mixture volumetric properties, followed by performance testing and analysis required by Level 3.

The mixture in this example is an intermediate course mixture. It will have a nominal maximum particle size of 19.0 mm. It will be placed at a depth less than 100 mm from the surface of the pavement.

Binder Selection

Environmental conditions are determined from weather station data stored in the Superpave weather database. The project is near Milwaukee, which has 2 weather stations:

Table VI-1. Project Environmental Conditions and Binder Grades

Weather Station	Min. Pvmt. Temp. (°C)	Max. Pvmt. Temp. (°C)	Binder Grade	Design Air Temp. (°C)
Low Reliability (50%)				
Milwaukee Mt. Mary	-26	51	PG 52-28	32
Milwaukee WSO AP	-25	51	PG 52-28	31
Paving Location (Assumed)	-26	51	PG 52-28	32
High Reliability (98%)				
Milwaukee Mt. Mary	-32	55	PG 58-34	36
Milwaukee WSO AP	-33	54	PG 58-34	34
Paving Location (Assumed)	-33	55	PG 58-34	35

Low and high reliability level binders are shown. Reliability is the percent probability that the actual temperature will not exceed the design pavement temperatures listed in the binder grade. In this example, the designer chooses high reliability for all conditions. Thus, a PG 58-34 binder is needed. The average Design High Air Temperature is 35°C.

Having determined the need for a PG 58-34 binder, the binder is selected and tested for specification compliance. Test results are indicated in Table VI-2.

Table VI-2. Binder Specification Test Results

Test	Property	Test Result	Criteria
Original Binder			
Flash Point	n/a	304°C	230°C minimum
Rotational Viscosity	135°C	0.575 Pa·s	3 Pa·s maximum
Rotational Viscosity	175°C	0.142 Pa·s	n/a
Dynamic Shear Rheometer	$G^*/\sin \delta @ 58^\circ\text{C}$	1.42 kPa	1.00 kPa minimum
RTFO-aged Binder			
Mass Loss	n/a	0.14%	1.00% maximum
Dynamic Shear Rheometer	$G^*/\sin \delta @ 58^\circ\text{C}$	2.41 kPa	2.20 kPa minimum
PAV-aged Binder			
Dynamic Shear Rheometer	$G^*\sin \delta @ 16^\circ\text{C}$	1543 kPa	5000 kPa maximum
Bending Beam Rheometer	Stiffness @ -24°C	172.0 MPa	300.0 MPa maximum
Bending Beam Rheometer	m-value @ -24°C	0.321	0.300 minimum

Comparing the test results to specifications, the designer verifies that the asphalt binder meets the requirements of a PG 58-34 grade. Specification testing requires only that rotational viscosity be performed at 135°C. Additional testing was performed at 175°C to establish laboratory mixing and compaction temperatures. Figure VI-1 illustrates the temperature-viscosity relationship for this binder. Based on these test results, the mixing temperature range is selected between 165°C and 172°C. The compaction temperature range is selected between 151°C and 157°C.

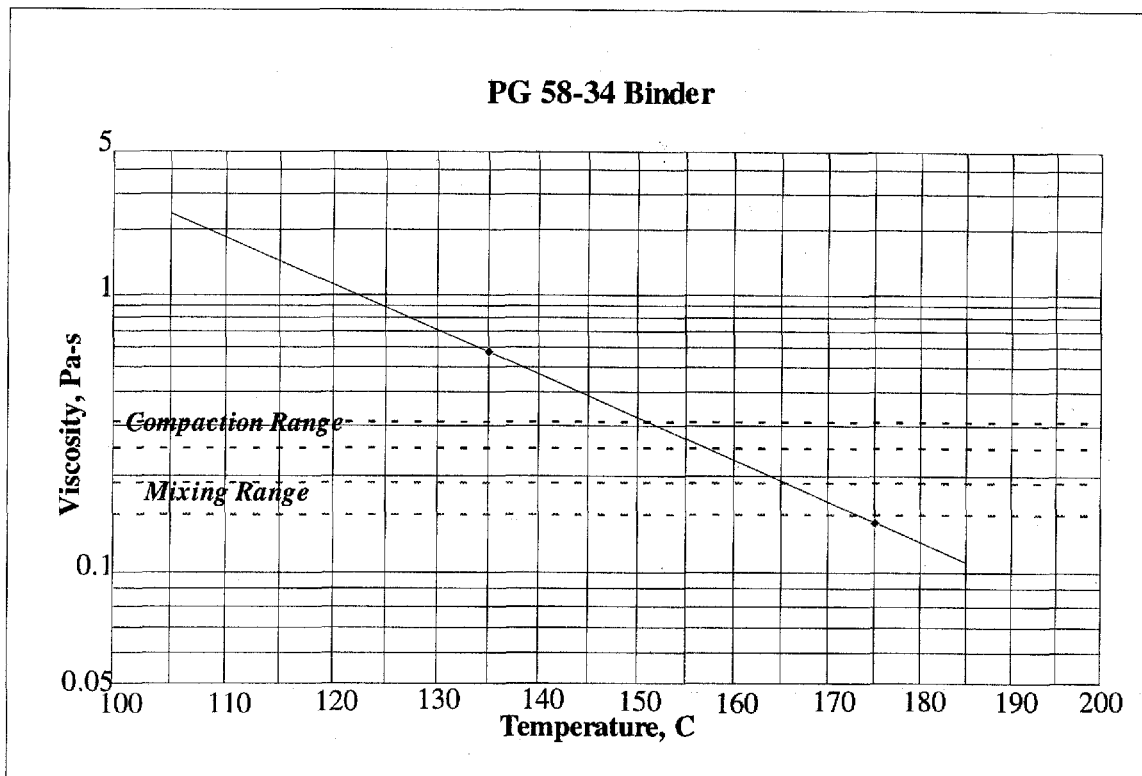

Figure VI-1. Temperature-Viscosity Relationship for Project Binder

Aggregate Selection

Next, the designer selects the aggregates to use in the mixture. For this example, there are 5 stockpiles of materials consisting of three coarse materials and two fine materials. It is assumed that the mixing facility will have at least 5 cold feed bins. If fewer cold feed bins are available, fewer stockpiles will be used. The materials are split into

representative samples, and a washed sieve analysis is performed for each aggregate. These test results are shown in the section on selecting design aggregate structure.

The bulk and apparent specific gravities are determined for each aggregate. These specific gravities are used in trial binder content and VMA calculations. Test results are indicated in Table VI-3.

Table VI-3. Aggregate Specific Gravities

Aggregate	Bulk Sp. Gravity	Apparent Sp. Gravity
#1 Stone	2.703	2.785
1/2" Chip	2.689	2.776
3/8" Chip	2.723	2.797
Manuf. Sand	2.694	2.744
Screen Sand	2.679	2.731

In addition to sieve analysis and specific gravity determination, Superpave requires that consensus aggregate tests be performed to assure that the aggregates selected for the mix design are acceptable. The four tests required are: coarse aggregate angularity, fine aggregate angularity, thin and elongated particles, and clay content. In addition, the specifying agency can select any other aggregate tests deemed important. These tests can include items such as soundness, toughness, and deleterious materials among others.

Superpave consensus aggregate criteria are intended to be applied to combined aggregate gradations rather than individual aggregate components. However, some designers find it useful to perform the aggregate tests on the individual aggregate components. This step allows the designer to use the test results in narrowing the acceptable range of blend percentages for the aggregates. It also allows for greater flexibility if multiple trial blends are attempted. The test results from the components can be used to estimate the results for a given combination of materials. The drawback to this procedure is that it takes more time to perform this additional testing. For this example, the aggregate properties are measured for each stockpile as well as for the aggregate trial blends.

Coarse Aggregate Angularity

This test is performed on the coarse aggregate particles of the aggregate stockpiles. The coarse aggregate particles are defined as particles larger than 4.75 mm. Test results are indicated in Table VI-4.

Table VI-4. Coarse Aggregate Angularity

Aggregate	1+ Fractured Faces	Criterion	2+ Fractured Faces	Criterion
#1 Stone	92%	95% min	88%	90% min
1/2" Chip	97%		94%	
3/8" Chip	99%		95%	

Note that this test is not performed on the two fine aggregates, even though they have some small percentage retained on the 4.75 mm sieve. The manufactured sand has 4.5% retained and the Screen Sand has 10.5% retained on the 4.75 mm sieve.

Table VI-4 also indicates criteria for fractured faces based on traffic (18 million ESALs) and depth from the surface (< 100 mm). The criteria change as the traffic level and layer position (relative to the surface) change. The criteria are also based on the test results from the aggregate *blend* rather than individual materials. Thus, even though the #1 Stone appears to be below the minimum criteria, it can be used as long as the selected *blend* of aggregates meets the criteria in Table VI-4.

Fine Aggregate Angularity

This test is performed on the fine aggregate particles of the aggregate stockpiles. The fine aggregate particles are defined as particles smaller than 2.36 mm. Test results are indicated in Table VI-5.

Table VI-5. Fine Aggregate Angularity

Aggregate	% Air Voids (Loose)	Criterion
Manufactured Sand	62%	45% min
Screen Sand	36%	

Note that this test is not performed on the three coarse aggregates, even though they have a small percentage passing the 2.36 millimeter sieve. The #1 Stone has 1.9% passing, the 1/2" Chip has 2.6% passing, and the 3/8" Chip has 3.0% passing the 2.36 mm sieve. Table VI-5 also indicates criterion for fine aggregate angularity based on traffic and depth from the surface. Even though the Screen Sand appears to be below the minimum criterion, it can be used as long as the selected *blend* of aggregates meets the criterion in Table VI-5.

Flat and Elongated Particles

This test is performed on the coarse aggregate particles of the aggregate stockpiles. The coarse aggregate particles are defined as particles larger than 4.75 mm. Test results are indicated in Table VI-6.

Table VI-6. Flat and Elongated Particles

Aggregate	% Thin/Elongated	Criterion
#1 Stone	0%	10% max
1/2" Chip	0%	
3/8" Chip	0%	

Note that this test is not performed on the two fine aggregates, even though they have some small percentage retained on the 4.75 mm sieve. The manufactured sand has 4.5% retained and the Screen Sand has 10.5% retained on the 4.75 mm sieve. Table VI-6 also indicates the criterion for percentage of flat and elongated particles, which is based on

traffic only. The criterion changes as the traffic level changes. In this case, the aggregates are cubical and not in danger of failing the criterion.

Clay Content (Sand Equivalent)

This test is performed on the fine aggregate particles of the aggregate stockpiles. The fine aggregate particles are defined as particles smaller than 4.75 mm. Test results are indicated in Table VI-7.

Table VI-7. Clay Content (Sand Equivalent)

Aggregate	Sand Equivalent	Criterion
Manufactured Sand	47	45 min
Screen Sand	70	

Note that this test is not performed on the three coarse aggregates, even though they have some small percentage passing the 4.75 mm sieve. The #1 Stone has 2.1% passing, the 1/2" Chip has 3.1% passing, and the 3/8" Chip has 4.8% passing the 4.75 mm sieve. Table VI-7 also indicates the criterion for clay content (sand equivalent) based on traffic only. The criterion changes as the traffic level changes. The criterion is also based on the test results from the aggregate *blend* rather than individual materials. Both fine aggregates are above the minimum requirement, so there is reasonable expectation that the blend will also meet the clay content requirement. Once all of the aggregate testing is complete, the material selection process is complete. The next step is to select the design aggregate structure.

SELECT DESIGN AGGREGATE STRUCTURE

To select the design aggregate structure, the designer establishes trial blends by mathematically combining the gradations of the individual materials into a single gradation. The blend gradation is then compared to the specification requirements for the

appropriate sieves. Gradation control is based on four control sieves: the maximum sieve, the nominal maximum sieve, the 2.36 mm sieve, and the 75 micron sieve.

The nominal maximum sieve is one sieve size larger than the first sieve to retain more than ten percent of combined aggregate. The maximum sieve size is one sieve size greater than the nominal maximum sieve.

The restricted zone is an area on either side of the maximum density line. For a 19.0 mm nominal mixture, it starts at the 2.36 mm sieve and extends to the 300 micron sieve.

The minimum and maximum values required for the control sieves change (as does the restricted zone) as the nominal size of the mixture changes. Table VI-8 indicates the gradation requirements for this example.

Table VI-8. Gradation Criteria for 19.0 mm Nominal Mixture

Gradation Control Item	Sieve Size, mm	Minimum, %	Maximum, %
Control Points	25.0	100.0	100.0
	19.0	90.0	100.0
	2.36	23.0	49.0
	0.075	2.0	8.0
Restricted Zone	2.36	34.6	34.6
	1.18	22.3	28.3
	0.600	16.7	20.7
	0.300	13.7	13.7

Any proposed trial blend gradation has to pass between the control points established on the four sieves. In addition, it has to be outside of the area bounded by the limits set for the restricted zone.

Figure VI-2 indicates the gradation requirements for a 19.0 mm nominal mixture.

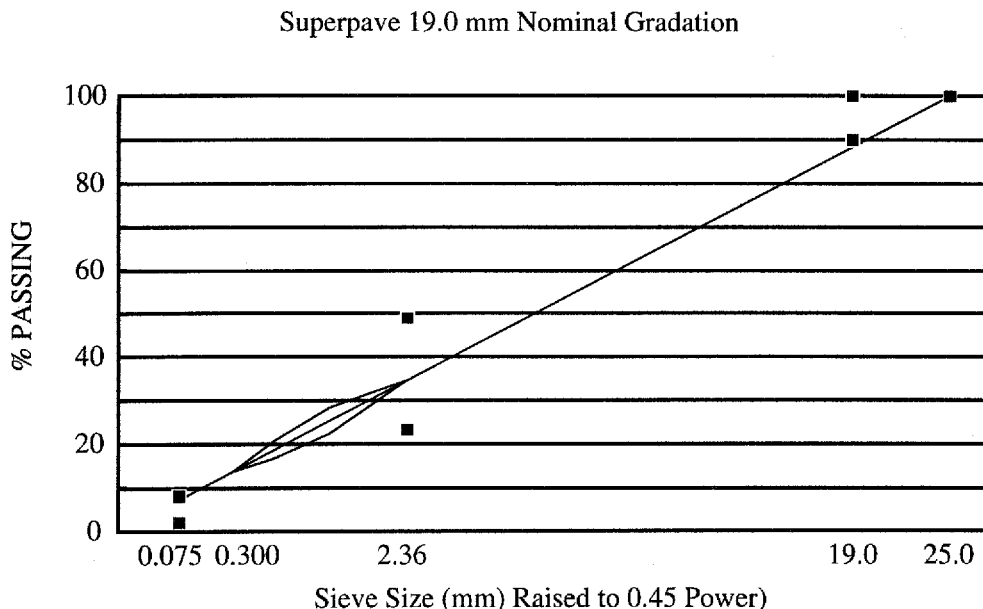

Figure VI-2. Gradation Requirements for 19.0 mm Nominal Mixture

Any number of trial blends can be attempted, but three is the standard number of blends. Trial blending consists of varying stockpile percentages of each aggregate to obtain blend gradations meeting the gradation requirements for that particular mixture. For this example, three trial blends are used: an intermediate blend, a coarse blend, and a fine blend. The intermediate blend is combined to produce a gradation that is not close to either the gradation limits for the control sieves, or the restricted zone. The stockpile percentages and combined gradation for Trial Blend 1 are indicated in Table VI-9 and Figure VI-3. The coarse blend is combined to produce a gradation that is close to the minimum criteria for the nominal maximum sieve, the 2.36 mm sieve, and the 75 micron sieve. The stockpile percentages and combined gradation for Trial Blend 2 are indicated in Table VI-10 and Figure VI-4. The fine blend is combined to produce a gradation that is close to the maximum criteria for the nominal maximum sieve, and the restricted zone. The stockpile percentages and combined gradation for Trial Blend 3 are indicated in Table VI-11 and Figure VI-5.

Table VI-9. Trial Gradation for Intermediate Blend

	<i>#1 Stone</i>	<i>1/2" chip</i>	<i>3/8" chip</i>	<i>Mfg sand</i>	<i>Scr. sand</i>			
Blend 1	25.0%	15.0%	22.0%	18.0%	20.0%			
Blend 2	30.0%	25.0%	13.0%	17.0%	15.0%			
Blend 3	10.0%	15.0%	30.0%	31.0%	14.0%			
						Blend 1 Gradation	Blend 2 Gradation	Blend 3 Gradation
Sieve								
25.4 mm	100.0	100.0	100.0	100.0	100.0	100.0	100.0	100.0
19.0 mm	76.1	100.0	100.0	100.0	100.0	94.0	92.8	97.6
12.5 mm	14.3	87.1	100.0	100.0	100.0	76.6	71.1	89.5
9.5 mm	3.8	26.0	94.9	100.0	99.8	63.7	51.9	77.7
4.75 mm	2.1	3.1	4.8	95.5	89.5	37.1	31.7	44.3
2.36 mm	1.9	2.6	3.0	63.5	76.7	28.3	23.9	31.9
1.18 mm	1.9	2.4	2.8	38.6	63.5	21.1	17.6	22.2
600 μm	1.8	2.3	2.6	21.9	45.6	14.4	12.0	14.5
300 μm	1.8	2.2	2.5	11.0	23.1	7.9	6.8	7.9
150 μm	1.7	2.1	2.4	5.7	8.4	4.0	3.6	4.1
75 μm	1.6	1.9	2.2	5.7	4.7	3.1	2.9	3.5

IH-43 Trial Blend 1- Intermediate Blend
19.0 mm Nominal Mixture

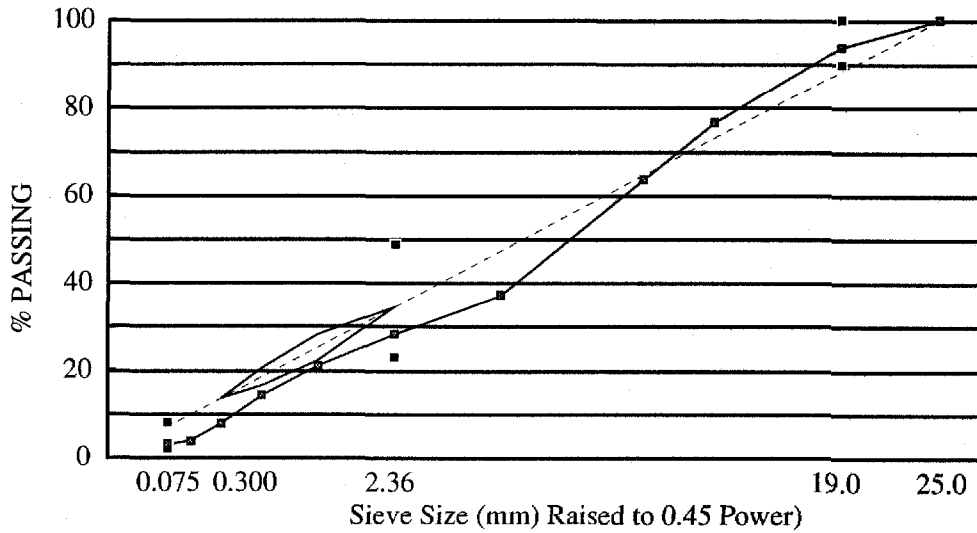

Figure VI-3. Trial Blend 1 - Intermediate Blend

Table VI-10. Trial Gradation for Coarse Blend

	#1	1/2"	3/8"	Mfg	Scr.
	Stone	chip	chip	sand	sand
Blend 1	25.0%	15.0%	22.0%	18.0%	20.0%
Blend 2	30.0%	25.0%	13.0%	17.0%	15.0%
Blend 3	10.0%	15.0%	30.0%	31.0%	14.0%

<u>Sieve</u>	Blend 1	Blend 2	Blend 3
	Gradation	Gradation	Gradation
25.4 mm	100.0	100.0	100.0
19.0 mm	76.1	92.8	97.6
12.5 mm	14.3	71.1	89.5
9.5 mm	3.8	51.9	77.7
4.75 mm	2.1	31.7	44.3
2.36 mm	1.9	23.9	31.9
1.18 mm	1.9	17.6	22.2
600 μm	1.8	12.0	14.5
300 μm	1.8	6.8	7.9
150 μm	1.7	3.6	4.1
75 μm	1.6	2.9	3.5

IH-43 Trial Blend 2 - Coarse Blend
19.0 mm Nominal Mixture

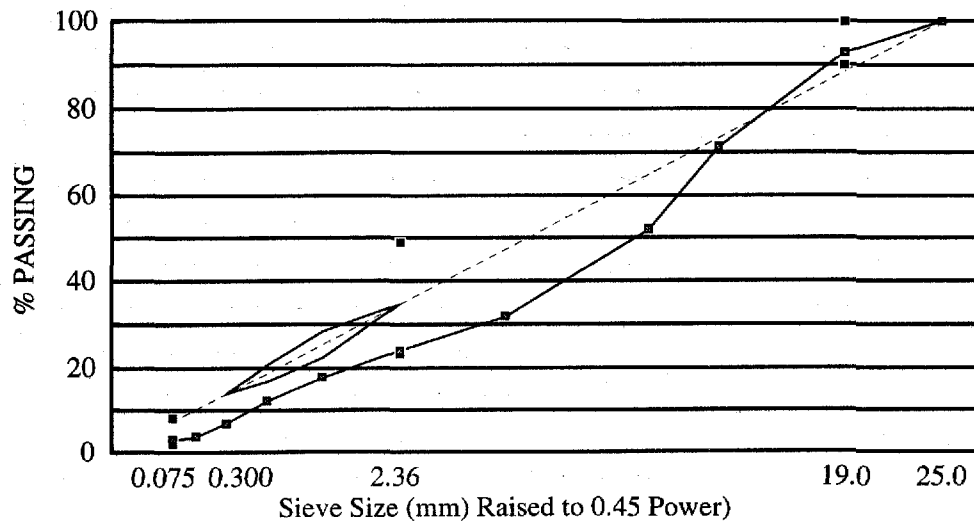

Figure VI-4. Trial Blend 2 - Coarse Blend

Table VI-11. Trial Gradation for Fine Blend

	<i>#1</i>	<i>1/2"</i>	<i>3/8"</i>	<i>Mfg</i>	<i>Scr.</i>			
	<i>Stone</i>	<i>chip</i>	<i>chip</i>	<i>sand</i>	<i>sand</i>			
Blend 1	25.0%	15.0%	22.0%	18.0%	20.0%			
Blend 2	30.0%	25.0%	13.0%	17.0%	15.0%			
Blend 3	10.0%	15.0%	30.0%	31.0%	14.0%			
<i>Sieve</i>						Blend 1	Blend 2	Blend 3
						Gradation	Gradation	Gradation
25.4 mm	100.0	100.0	100.0	100.0	100.0	100.0	100.0	100.0
19.0 mm	76.1	100.0	100.0	100.0	100.0	94.0	92.8	97.6
12.5 mm	14.3	87.1	100.0	100.0	100.0	76.6	71.1	89.5
9.5 mm	3.8	26.0	94.9	100.0	99.8	63.7	51.9	77.7
4.75 mm	2.1	3.1	4.8	95.5	89.5	37.1	31.7	44.3
2.36 mm	1.9	2.6	3.0	63.5	76.7	28.3	23.9	31.9
1.18 mm	1.9	2.4	2.8	38.6	63.5	21.1	17.6	22.2
600 μm	1.8	2.3	2.6	21.9	45.6	14.4	12.0	14.5
300 μm	1.8	2.2	2.5	11.0	23.1	7.9	6.8	7.9
150 μm	1.7	2.1	2.4	5.7	8.4	4.0	3.6	4.1
75 μm	1.6	1.9	2.2	5.7	4.7	3.1	2.9	3.5

IH-43 Trial Blend 3 - Fine Blend
19.0 mm Nominal Mixture

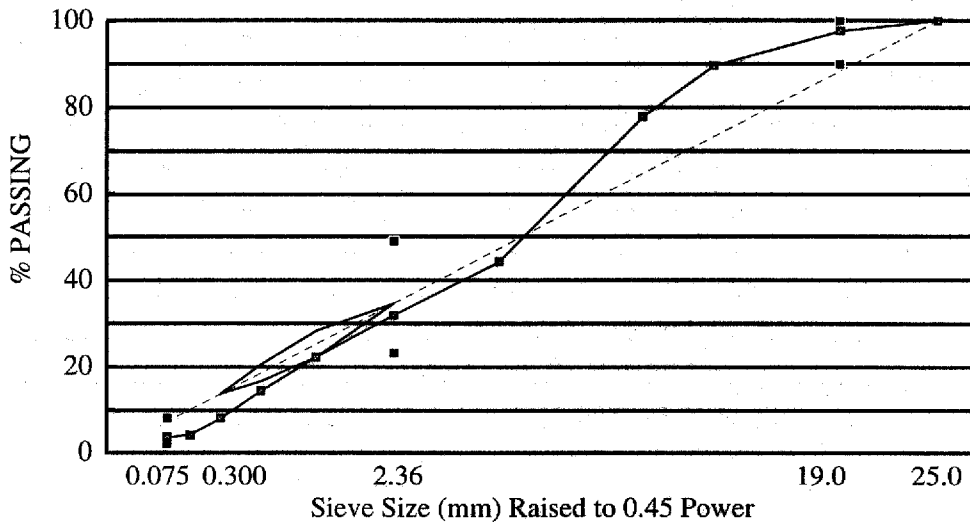

Figure VI-5. Trial Blend 3 - Fine Blend

VI. Volumetric Mix Design

All three of the trial blends are shown graphically in Figure VI-6. Note that all three trial blends pass below the restricted zone. This is not a requirement. Superpave allows but does not recommend blends that plot above the restricted zone.

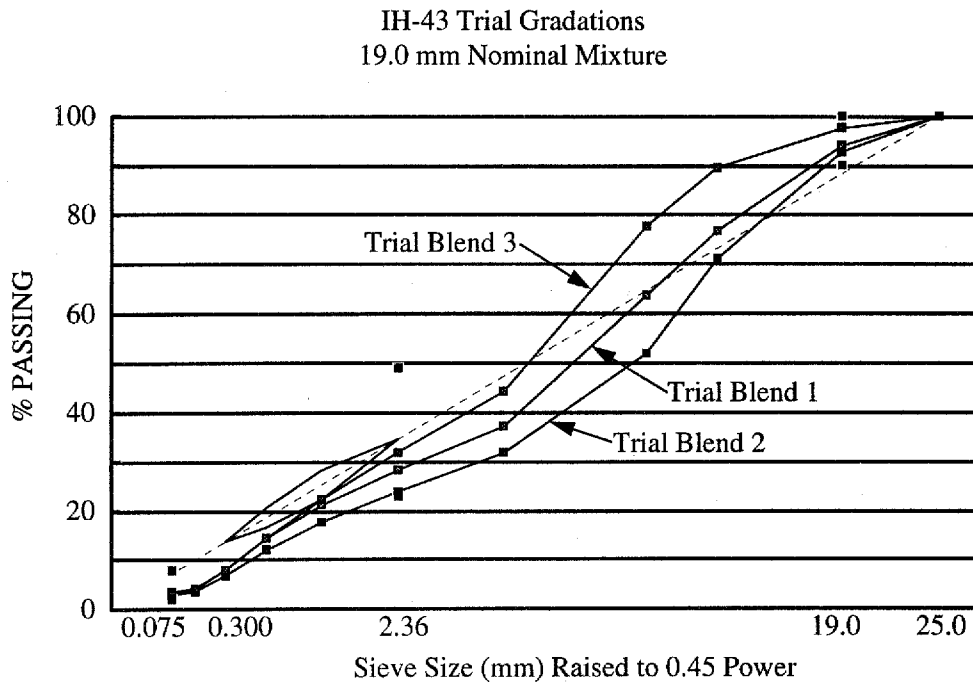

Figure VI-6. IH-43 Trial Blends

Once the trial blends are selected, a preliminary determination of the blended aggregate properties is necessary. This can be estimated mathematically from the aggregate properties (Tables VI-3 to VI-7). Estimated values are indicated in Table VI-12.

Table VI-12. Estimated Aggregate Blend Properties

Property	Criteria	Trial Blend 1	Trial Blend 2	Trial Blend 3
Coarse Ang.	95%/90% min.	96%/92%	95%/92%	97%/93%
Fine Ang.	45% min.	48%	50%	54%
Thin/Elongated	10% max.	0%	0%	0%
Sand Equivalent	45 min.	59	58	54
Combined G_{sb}	n/a	2.699	2.697	2.701
Combined G_{sa}	n/a	2.768	2.769	2.767

Values for coarse aggregate angularity are shown as percentage of one or more fractured faces followed by percentage of two or more fractured faces. Based on the estimates, all three trial blends are acceptable. When the design aggregate structure is selected, the blend aggregate properties will need to be verified by testing.

The next step is to evaluate the trial blends by compacting specimens and determining the volumetric properties of each trial blend. For each blend, a minimum of two specimens will be compacted using the SGC. The trial asphalt binder content is determined for each trial blend by estimating the effective specific gravity of the blend and using the calculations shown below. The effective specific gravity (G_{se}) of the blend is estimated by:

$$G_{se} = G_{sb} + 0.8 \times (G_{sa} - G_{sb})$$

The factor, 0.8, can be adjusted at the discretion of the designer. Absorptive aggregates may require values closer to 0.6 or 0.5. The blend calculations are shown below:

$$\text{Blend 1: } G_{se} = 2.699 + 0.8 \times (2.768 - 2.699) = 2.754$$

$$\text{Blend 2: } G_{se} = 2.697 + 0.8 \times (2.769 - 2.697) = 2.755$$

$$\text{Blend 3: } G_{se} = 2.701 + 0.8 \times (2.767 - 2.701) = 2.754$$

The volume of asphalt binder (V_{ba}) absorbed into the aggregate is estimated using the following equation:

$$V_{ba} = \frac{P_s \times (1 - V_a)}{\left(\frac{P_b}{G_b} + \frac{P_s}{G_{se}}\right)} \times \left(\frac{1}{G_{sb}} - \frac{1}{G_{se}}\right)$$

where V_{ba} = volume of absorbed binder, cm^3/cm^3 of mix

P_b = percent of binder (assumed 0.05),

VI. Volumetric Mix Design

P_s = percent of aggregate (assumed 0.95),

G_b = specific gravity of binder (assumed 1.02),

V_a = volume of air voids (assumed 0.04 cm³/cm³ of mix)

$$\text{Blend 1: } V_{ba} = \frac{0.95 \times (1 - 0.04)}{\left(\frac{0.05}{1.02} + \frac{0.95}{2.754}\right)} \times \left(\frac{1}{2.699} - \frac{1}{2.754}\right) = 0.0171 \text{ cm}^3/\text{cm}^3 \text{ of mix}$$

$$\text{Blend 2: } V_{ba} = \frac{0.95 \times (1 - 0.04)}{\left(\frac{0.05}{1.02} + \frac{0.95}{2.755}\right)} \times \left(\frac{1}{2.697} - \frac{1}{2.755}\right) = 0.0181 \text{ cm}^3/\text{cm}^3 \text{ of mix}$$

$$\text{Blend 3: } V_{ba} = \frac{0.95 \times (1 - 0.04)}{\left(\frac{0.05}{1.02} + \frac{0.95}{2.754}\right)} \times \left(\frac{1}{2.701} - \frac{1}{2.754}\right) = 0.0165 \text{ cm}^3/\text{cm}^3 \text{ of mix}$$

The volume of the effective binder (V_{be}) can be determined from the equation below:

$$V_{be} = 0.081 - 0.02931 \times [\ln(S_n)]$$

where S_n = the nominal maximum sieve size of the aggregate blend (in inches)

$$\text{Blend 1-3: } V_{be} = 0.081 - 0.02931 \times [\ln(0.75)] = 0.089 \text{ cm}^3/\text{cm}^3 \text{ of mix}$$

Finally, the initial trial asphalt binder (P_{bi}) content is calculated from the following equation:

$$P_{bi} = \frac{G_b \times (V_{be} + V_{ba})}{(G_b \times (V_{be} + V_{ba})) + W_s} \times 100$$

where P_{bi} = percent (by weight of mix) of binder

W_s = weight of aggregate, grams

$$W_s = \frac{P_s \times (1 - V_a)}{\left(\frac{P_b}{G_b} + \frac{P_s}{G_{se}}\right)}$$

Blend 1:
$$W_s = \frac{0.95 \times (1 - 0.04)}{\left(\frac{0.05}{1.02} + \frac{0.95}{2.754}\right)} = 2.315$$

$$P_{bi} = \frac{1.02 \times (0.089 + 0.0171)}{(1.02 \times (0.089 + 0.0171)) + 2.315} \times 100 = 4.46\% \quad (\text{by mass of mix})$$

Blend 2:
$$W_s = \frac{0.95 \times (1 - 0.04)}{\left(\frac{0.05}{1.02} + \frac{0.95}{2.755}\right)} = 2.316$$

$$P_{bi} = \frac{1.02 \times (0.089 + 0.0181)}{(1.02 \times (0.089 + 0.0171)) + 2.316} \times 100 = 4.46\% \quad (\text{by mass of mix})$$

Blend 3:
$$W_s = \frac{0.95 \times (1 - 0.04)}{\left(\frac{0.05}{1.02} + \frac{0.95}{2.754}\right)} = 2.315$$

$$P_{bi} = \frac{1.02 \times (0.089 + 0.0165)}{(1.02 \times (0.089 + 0.0171)) + 2.315} \times 100 = 4.46\% \quad (\text{by mass of mix})$$

Next, a minimum of two specimens for each trial blend are compacted using the SGC. Two specimens are also prepared for determination of the mixture's maximum theoretical specific gravity (G_{mm}). An aggregate weight of 4500 grams is usually sufficient for the compacted specimens. An aggregate weight of 2000 grams is usually sufficient for the specimens used to determine maximum theoretical specific gravity (G_{mm}). AASHTO T 209 should be consulted to determine the minimum sample size required for various mixtures.

Specimens are mixed at the appropriate mixing temperature, which is 165°C to 172°C for the selected PG 58-34 binder. The specimens are then short-term aged by placing the loose mix in a flat pan, in a forced draft oven at 135°C, for 4 hours. Next, the specimens are brought to compaction temperature range (151°C to 157°C) by placing them in another oven for a short time (generally less than 30 minutes). Finally, the specimens are then removed and either compacted or allowed to cool loose (for G_{mm} determination).

The number of gyrations used for compaction is determined based on the design high air temperature of the paving location (35°C) and the traffic level. Table VI-13 indicates the number of gyrations required.

Table VI-13. Gyrotory Compactive Effort

Design ESALs (millions)	Average Design High Air Temperature											
	<39°C			39° - 40°C			41° - 42°C			43° - 44°C		
	N_{ini}	N_{des}	N_{max}	N_{ini}	N_{des}	N_{max}	N_{ini}	N_{des}	N_{max}	N_{ini}	N_{des}	N_{max}
< 0.3	7	68	104	7	74	114	7	78	121	7	82	127
0.3 - 1	7	76	117	7	83	129	7	88	138	8	93	146
1 - 3	7	86	134	8	95	150	8	100	158	8	105	167
3 - 10	8	96	152	8	106	169	8	113	181	9	119	192
10 - 30	8	109	174	9	121	195	9	128	208	9	135	220
30 - 100	9	126	204	9	139	228	9	146	240	10	153	253
> 100	9	142	233	10	158	262	10	165	275	10	172	288

From Table VI-13, the number of gyrations for initial compaction, design compaction, and maximum compaction are determined:

$$N_{initial} = 8 \text{ gyrations}$$

$$N_{design} = 109 \text{ gyrations}$$

$$N_{maximum} = 174 \text{ gyrations}$$

The equations used to develop the information in Table VI-13, which describes the relationship among N_{design} , $N_{initial}$, and $N_{maximum}$ are shown below:

$$\text{Log}_{10}(N_{\text{initial}}) = 0.45 \times \text{Log}_{10}(N_{\text{design}})$$

$$\text{Log}_{10}(N_{\text{maximum}}) = 1.10 \times \text{Log}_{10}(N_{\text{design}})$$

Each specimen will be compacted to the maximum number of gyrations, with specimen height data collected during the compaction process. This is illustrated for Trial Blend 1 in Table VI-14. SGC compaction data reduction is accomplished as follows.

During compaction, the height of the specimen is continuously monitored. Knowing the mass of the mix, the fixed diameter of the mold (150 mm), and the measured height at any gyration, the specimen specific gravity can be estimated [$G_{\text{mb}}(\text{est})$ in Table VI-14] at any gyration throughout the compaction process. This is accomplished by dividing the mass of the specimen by volume of the specimen, which is represented by the volume of a smooth-sided cylinder of known diameter and (measured) height.

After compaction is complete, the specimen is extruded from the mold and allowed to cool. Next, the measured bulk specific gravity [$G_{\text{mb}}(\text{meas})$ in Table IV-14] of the specimen is determined by AASHTO T166. The G_{mm} of each blend is also determined by AASHTO T209 [$G_{\text{mm}}(\text{meas})$ in Table VI-14].

A comparison of the specimen's estimated bulk specific gravity [$G_{\text{mb}}(\text{est})$] and measured bulk specific gravity [$G_{\text{mb}}(\text{meas})$] at N_{max} shows a difference between these two parameters. In Table VI-14, these two values are 2.436 and 2.489, respectively. The assumption that was used to estimate the bulk specific gravity was that during compaction, the volume of the specimen could be represented by a smooth-sided cylinder, which of course, it is not. The actual volume of the specimen is slightly smaller due to the presence of surface voids surrounding the perimeter of the specimen. Thus, the estimated bulk specific gravity of the specimen at any given gyration must be corrected by a factor that is the ratio of the measured to estimated bulk specific gravity of the specimen at N_{max} . In Table VI-14, this ratio is 2.489/2.436 or 1.022. This corrective step is indicated in Table VI-14 in the column labeled $G_{\text{mb}}(\text{corr})$. In this step, each value in

the column labeled $G_{mb}(\text{est})$ is multiplied by the correction factor, 1.022, to arrive at the values in the column labeled $G_{mb}(\text{corr})$.

Coarser aggregate mixtures, or mixtures lean in asphalt binder, tend to have larger differences between estimated and measured bulk specific gravity at N_{maximum} . Finer aggregate mixtures, or mixtures rich in asphalt binder, tend to have smaller differences between these two parameters. That is because fine, high asphalt content mixtures more closely approximate the “smooth-sided cylinder” assumption.

The final step is to report $\%G_{mm}$ for each specimen. This is computed by dividing the corrected bulk specific gravity of the specimen by the measured value for G_{mm} . The average $\%G_{mm}$ for the duplicate specimens is also reported. The average $\%G_{mm}$ is used as the basis for comparison among the trial mixtures.

The SGC data reduction for the three trial blends is shown in Tables VI-14, VI-15, and VI-16. The most important points of comparison are $\%G_{mm}$ at N_{initial} , N_{design} , and N_{maximum} which are highlighted in these tables. Figures VI-7 to VI-9 illustrate the compaction plots for data generated in these tables. The figures show $\%G_{mm}$ versus the logarithm of the number of gyrations.

Table VI-14. Densification Data for Trial Blend 1

$G_{mm} (meas) = 2.563$									
	Specimen 1				Specimen 2				AVG
Gyrations	Ht, mm	$G_{mb}(est)$	$G_{mb}(corr)$	$\%G_{mm}$	Ht, mm	$G_{mb}(est)$	$G_{mb}(corr)$	$\%G_{mm}$	$\%G_{mm}$
5	129.0	2.136	2.182	85.2	130.3	2.154	2.209	86.2	85.7
8	127.0	2.170	2.217	86.5	128.1	2.191	2.247	87.6	87.1
10	125.7	2.192	2.240	87.3	126.7	2.215	2.272	88.6	88.0
15	123.5	2.230	2.279	88.9	124.7	2.250	2.308	90.1	89.5
20	122.2	2.254	2.303	89.9	123.4	2.275	2.333	91.0	90.4
30	120.1	2.294	2.344	91.4	121.5	2.309	2.368	92.4	91.9
40	119.0	2.315	2.365	92.3	120.2	2.334	2.394	93.4	92.8
50	118.0	2.334	2.385	93.0	119.3	2.353	2.413	94.2	93.6
60	117.2	2.351	2.402	93.7	118.5	2.369	2.430	94.8	94.3
80	116.0	2.376	2.428	94.7	117.3	2.393	2.455	95.8	95.2
100	115.2	2.392	2.444	95.4	116.4	2.411	2.473	96.5	95.9
109	114.9	2.398	2.450	95.6	116.1	2.417	2.479	96.7	96.2
125	114.4	2.409	2.461	96.0	115.6	2.427	2.489	97.1	96.6
150	113.7	2.424	2.477	96.6	115.0	2.440	2.503	97.7	97.2
174	113.1	2.436	2.489	97.1	114.5	2.451	2.514	98.1	97.6
$G_{mb}(meas)$	-	2.489	-	-	-	2.514	-	-	-

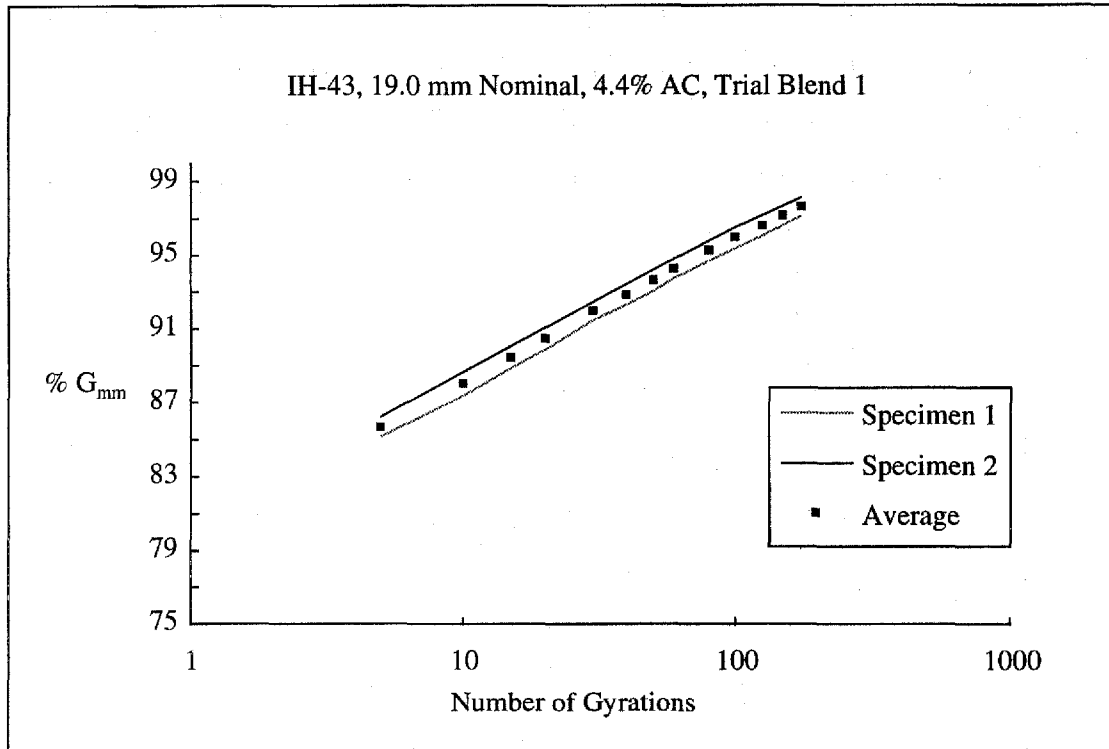

Figure VI-7. Densification Curves for Trial Blend 1

Table VI-15. Densification Data for Trial Blend 2

G _{mm} (meas) = 2.565									
	Specimen 1				Specimen 2				AVG
Gyrations	Ht, mm	G _{mb} (est)	G _{mb} (corr)	%G _{mm}	Ht, mm	G _{mb} (est)	G _{mb} (corr)	%G _{mm}	%G _{mm}
5	131.7	2.090	2.158	84.2	132.3	2.098	2.159	84.2	84.2
8	129.5	2.127	2.196	85.6	130.1	2.134	2.196	85.6	85.6
10	128.0	2.151	2.221	86.6	128.7	2.158	2.221	86.6	86.6
15	125.8	2.188	2.260	88.1	126.5	2.195	2.259	88.1	88.1
20	124.3	2.215	2.287	89.2	124.9	2.223	2.288	89.2	89.2
30	122.2	2.253	2.327	90.7	122.7	2.262	2.328	90.8	90.7
40	120.7	2.281	2.356	91.8	121.2	2.290	2.357	91.9	91.9
50	119.6	2.302	2.377	92.7	120.1	2.311	2.379	92.8	92.7
60	118.7	2.320	2.396	93.4	119.2	2.329	2.397	93.5	93.4
80	117.3	2.347	2.424	94.5	117.8	2.357	2.426	94.6	94.5
100	116.3	2.368	2.445	95.3	116.8	2.377	2.447	95.4	95.4
109	115.9	2.375	2.453	95.6	116.4	2.385	2.455	95.7	95.7
125	115.3	2.388	2.466	96.1	115.8	2.398	2.468	96.2	96.2
150	114.6	2.403	2.482	96.7	115.1	2.412	2.483	96.8	96.8
174	113.9	2.417	2.496	97.3	114.4	2.427	2.498	97.4	97.4
G _{mb} (meas)	-	2.496	-	-	-	2.498	-	-	-

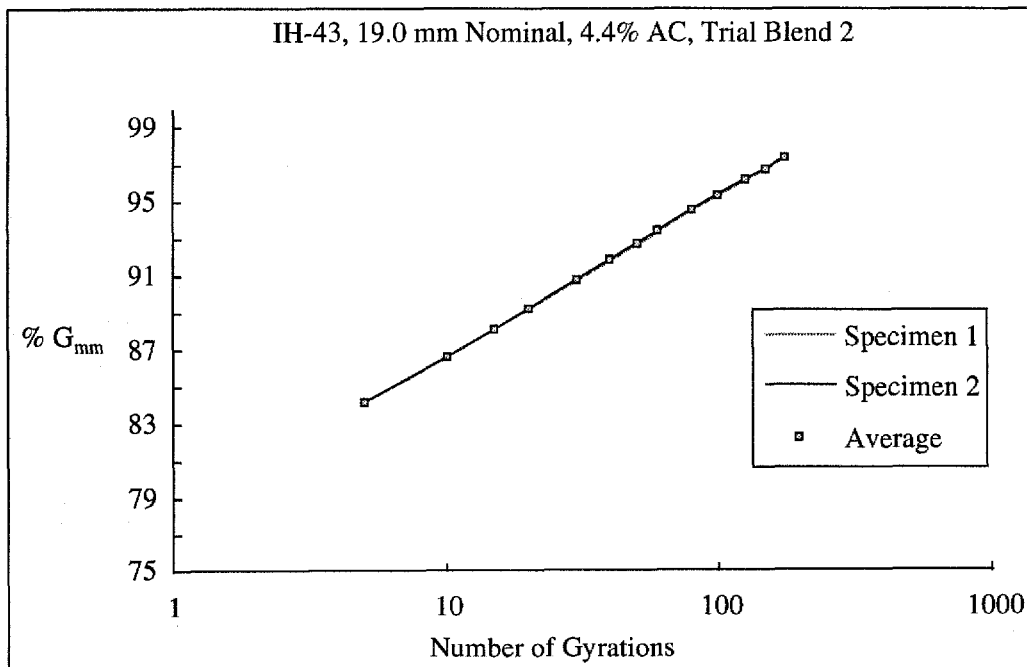

Figure VI-8. Densification Curves for Trial Blend 2

Table VI-16. Densification Data for Trial Blend 3

$G_{mm} (meas) = 2.568$									
	Specimen 1				Specimen 2				AVG
Gyrations	Ht, mm	$G_{mb}(est)$	$G_{mb}(corr)$	$\%G_{mm}$	Ht, mm	$G_{mb}(est)$	$G_{mb}(corr)$	$\%G_{mm}$	$\%G_{mm}$
5	130.9	2.116	2.169	84.4	129.5	2.136	2.188	85.2	84.8
8	127.2	2.153	2.207	85.9	127.3	2.172	2.225	86.6	86.3
10	127.2	2.178	2.232	86.9	125.9	2.196	2.249	87.6	87.3
15	125.1	2.214	2.269	88.3	124.1	2.229	2.283	89.0	88.7
20	123.7	2.239	2.295	89.3	122.8	2.253	2.308	89.9	89.6
30	121.8	2.274	2.331	90.7	121.0	2.286	2.342	91.2	91.0
40	120.5	2.298	2.355	91.7	119.7	2.310	2.366	92.2	91.9
50	119.6	2.317	2.375	92.5	118.7	2.330	2.387	93.0	92.7
60	118.8	2.332	2.390	93.1	118.1	2.342	2.399	93.5	93.3
80	117.6	2.355	2.414	94.0	116.9	2.365	2.423	94.4	94.2
100	116.7	2.373	2.432	94.7	116.1	2.383	2.441	95.1	94.9
109	116.4	2.379	2.438	95.0	115.8	2.389	2.447	95.3	95.2
125	115.9	2.390	2.449	95.4	115.2	2.400	2.458	95.7	95.6
150	115.3	2.402	2.462	95.8	114.6	2.413	2.472	96.3	96.1
174	114.8	2.413	2.473	96.3	114.1	2.424	2.483	96.7	96.5
$G_{mb}(meas)$	-	2.473	-	-	-	2.483	-	-	-

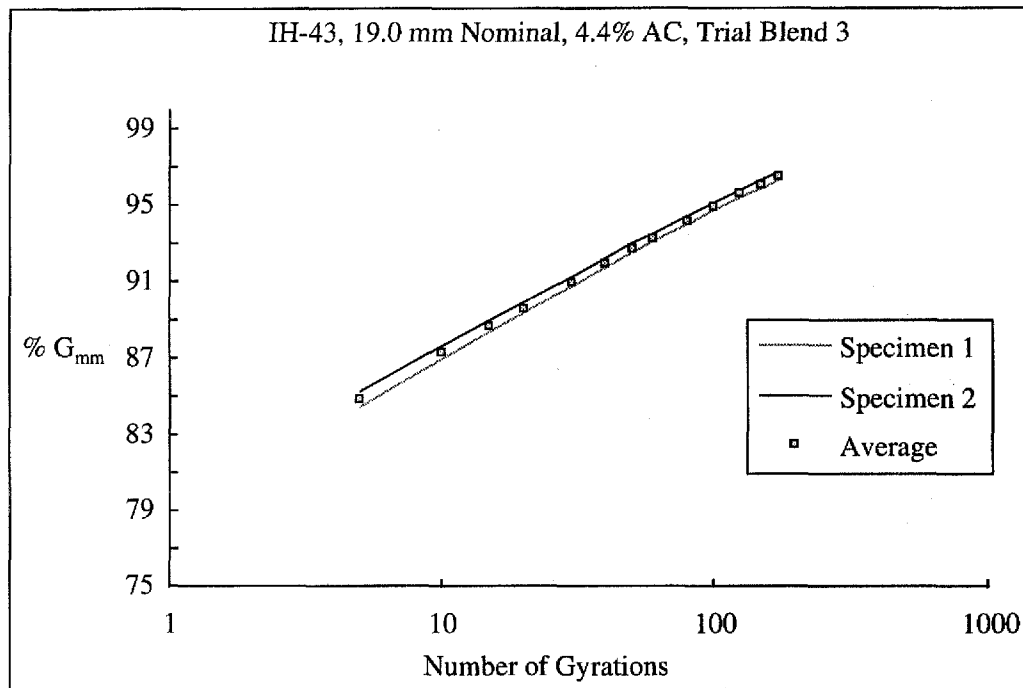

Figure VI-9. Densification Curves for Trial Blend 3

VI. Volumetric Mix Design

The average %G_{mm} is determined for N_{initial} (8 gyrations), N_{design} (109 gyrations), and N_{maximum} (174 gyrations) for each trial blend. This data is extracted directly from Tables VI-14 to VI-16. Table VI-17 indicates these values for Trial Blends 1, 2, and 3.

Table VI-17. Determination of %G_{mm} at N_{ini}, N_{des}, and N_{max} for Trial Blends

Trial Blend	% G _{mm} @ N _{ini}	% G _{mm} @ N _{des}	% G _{mm} @ N _{max}
1	87.1	96.2	97.6
2	85.6	95.7	97.4
3	86.3	95.2	96.5

The percent of air voids and voids in the mineral aggregate (VMA) are determined at N_{design}. The percent air voids is calculated as follows:

$$\% \text{Air Voids} = 100 - \%G_{\text{mm}} @ N_{\text{design}}$$

Blend 1: %Air Voids = 100 - 96.2 = 3.8%

Blend 2: %Air Voids = 100 - 95.7 = 4.3%

Blend 3: %Air Voids = 100 - 95.2 = 4.8%

The percent voids in the mineral aggregate is calculated as follows:

$$\% \text{VMA} = 100 - \left(\frac{\%G_{\text{mm}} @ N_{\text{des}} \times G_{\text{mm}} \times P_s}{G_{\text{sb}}} \right)$$

Blend 1: %VMA = 100 - $\left(\frac{96.2\% \times 2.563 \times 0.956}{2.699} \right)$ = 12.7%

Blend 2: %VMA = 100 - $\left(\frac{95.7\% \times 2.565 \times 0.956}{2.697} \right)$ = 13.0%

Blend 3: %VMA = 100 - $\left(\frac{95.2\% \times 2.568 \times 0.956}{2.701} \right)$ = 13.5%

Table VI-18. Compaction Summary of Trial Blends

Blend	%AC	%G _{mm} @ N=8	%G _{mm} @ N=174	%G _{mm} @ N=109	%Air Voids	%VMA
1	4.4%	87.1%	97.6%	96.2%	3.8%	12.7%
2	4.4%	85.6%	97.4%	95.7%	4.3%	13.0%
3	4.4%	86.3%	96.5%	95.2%	4.8%	13.5%

Table VI-18 indicates the compaction summary of the trial blends. The central premise in Superpave Level 1 mix design is that the correct amount of asphalt binder is used in each trial blend so that each blend achieves exactly 96% of G_{mm} or 4% air void content at N_{design}. Clearly, this did not happen for any of the three IH-43 trial blends. Because the trial blends exhibit different air void contents at N_{design}, their other volumetric and compaction properties cannot be properly compared. For example, Trial Blend 1 contained slightly too much asphalt to achieve 4% air voids at N_{design}. Instead, it had only 3.8% air voids. The VMA of Trial Blend 1 is also too low. The designer must ask the question, "If I had used less asphalt in Trial Blend 1 to achieve 4% air voids at N_{design}, would the VMA and other required properties improve to acceptable levels?"

Providing an answer to this question is an important step in Level 1 mix design. To answer this question, an estimated asphalt binder content to achieve 4% air voids (96% G_{mm} at N_{design}) is determined for each trial blend using the following empirical formula.

$$P_{b,estimated} = P_{bi} - (0.4 \times (4 - V_a))$$

where $P_{b,estimated}$ = estimated percent binder

P_{bi} = initial (trial) percent binder

V_a = percent air voids at N_{design}

Blend 1: $P_{b,estimated} = 4.4 - (0.4 \times (4 - 3.8)) = 4.3\%$

Blend 2: $P_{b,estimated} = 4.4 - (0.4 \times (4 - 4.3)) = 4.5\%$

VI. Volumetric Mix Design

$$\text{Blend 3: } P_{b,\text{estimated}} = 4.4 - (0.4 \times (4 - 4.8)) = 4.7\%$$

The volumetric (VMA and VFA) and mixture compaction properties are then estimated at this asphalt binder content using the equations that follow. These steps are solely aimed at answering the question, "What would have been the trial blend properties if I had used the right amount of asphalt to achieve 4% air voids at N_{design} ?" It is by these steps that a proper comparison among trial blends can be accomplished.

For VMA:

$$\%VMA_{\text{estimated}} = \%VMA_{\text{initial}} + C \times (4 - V_a)$$

where: $\%VMA_{\text{initial}}$ = %VMA from trial asphalt binder content

C = constant (either 0.1 or 0.2)

Note: C = 0.1 if V_a is less than 4.0%

C = 0.2 if V_a is greater than 4.0%

$$\text{Blend 1: } \%VMA_{\text{estimated}} = 12.7 + (0.1 \times (4.0 - 3.8)) = 12.7\%$$

$$\text{Blend 2: } \%VMA_{\text{estimated}} = 13.0 + (0.2 \times (4.0 - 4.3)) = 13.0\%$$

$$\text{Blend 3: } \%VMA_{\text{estimated}} = 13.5 + (0.2 \times (4.0 - 4.8)) = 13.3\%$$

For VFA:

$$\%VFA_{\text{estimated}} = 100\% \times \frac{(\%VMA_{\text{estimated}} - 4.0)}{\%VMA_{\text{estimated}}}$$

$$\text{Blend 1: } \%VFA_{\text{estimated}} = 100\% \times \frac{(12.7 - 4.0)}{12.7} = 68.5\%$$

$$\text{Blend 2: } \%VFA_{\text{estimated}} = 100\% \times \frac{(13.0 - 4.0)}{13.0} = 69.2\%$$

$$\text{Blend 3: } \%VFA_{\text{estimated}} = 100\% \times \frac{(13.4 - 4.0)}{13.4} = 70.1\%$$

For %G_{mm} at N_{initial}:

$$\%G_{mm \text{ estimated}} @ N_{ini} = \%G_{mm \text{ trial}} @ N_{ini} - (4.0 - V_a)$$

Blend 1: %G_{mm estimated} @ N_{ini} = 87.1 - (4.0 - 3.8) = 86.9%

Blend 2: %G_{mm estimated} @ N_{ini} = 85.6 - (4.0 - 4.3) = 85.9%

Blend 3: %G_{mm estimated} @ N_{ini} = 86.3 - (4.0 - 4.8) = 87.1%

For %G_{mm} at N_{maximum}:

$$\%G_{mm \text{ estimated}} @ N_{max} = \%G_{mm \text{ trial}} @ N_{max} - (4.0 - V_a)$$

Blend 1: %G_{mm estimated} @ N_{max} = 97.6 - (4.0 - 3.8) = 97.4%

Blend 2: %G_{mm estimated} @ N_{max} = 97.4 - (4.0 - 4.3) = 97.7%

Blend 3: %G_{mm estimated} @ N_{max} = 96.5 - (4.0 - 4.8) = 97.3%

Tables VI-19 and VI-20 indicate the estimated volumetric and mixture compaction properties for the trial blends at the asphalt binder content that should result in 4.0% air voids at N_{design}.

Table VI-19. Estimated Mixture Volumetric Properties @ N_{design}

Blend	Trial %AC	Est. %AC	%Air Voids	%VMA	%VFA
1	4.4%	4.3%	4.0%	12.7%	68.5%
2	4.4%	4.5%	4.0%	13.0%	69.2%
3	4.4%	4.7%	4.0%	13.3%	70.1%

Estimated properties are compared against the mixture criteria. For the design traffic and nominal maximum particle size, the volumetric and densification criteria are as follows:

VI. Volumetric Mix Design

% Air Voids	4.0%
% VMA	13.0% (19.0 mm nominal mixture)
% VFA	65% - 75% (10-30 × 10 ⁷ ESALs)
% G _{mm} @ N _{initial}	less than 89%
%G _{mm} @ N _{maximum}	less than 98%

Table VI-20. Estimated Mixture Compaction Properties

Blend	Trial %AC	Est. %AC	%G _{mm} @ N=8	%G _{mm} @ N=174
1	4.4%	4.3%	86.9%	97.4%
2	4.4%	4.5%	85.9%	97.7%
3	4.4%	4.7%	87.1%	97.3%

Finally, there is a required range on the dust proportion. This criteria is constant for all levels of traffic. It is calculated as the percent by mass of the material passing the 0.075 mm sieve (by wet sieve analysis) divided by the effective asphalt binder content (expressed as percent by mass of mix). The effective asphalt binder content is calculated as follows:

$$P_{be, estimated} = -(P_s \times G_b) \times \left(\frac{G_{se} - G_{sb}}{G_{se} \times G_{sb}} \right) + P_{b, estimated}$$

$$\text{Blend 1: } P_{be, estimated} = -(95.7 \times 1.02) \times \left(\frac{2.754 - 2.699}{2.754 \times 2.699} \right) + 4.3 = 3.6\%$$

$$\text{Blend 2: } P_{be, estimated} = -(95.5 \times 1.02) \times \left(\frac{2.755 - 2.697}{2.755 \times 2.697} \right) + 4.5 = 3.7\%$$

$$\text{Blend 3: } P_{be, estimated} = -(95.3 \times 1.02) \times \left(\frac{2.754 - 2.701}{2.754 \times 2.701} \right) + 4.7 = 4.0\%$$

Dust Proportion is calculated as follows:

$$DP = \frac{P_{.075}}{P_{be, estimated}}$$

$$\text{Blend 1: } DP = \frac{3.1}{3.6} = 0.86$$

$$\text{Blend 2: } DP = \frac{2.9}{3.7} = 0.78$$

$$\text{Blend 3: } DP = \frac{3.5}{4.0} = 0.88$$

The dust proportion must be between 0.6 and 1.2. Table VI-21 indicates the results.

Table VI-21. Dust Proportion of Trial Blends

Blend	Dust Proportion	Criterion
Trial Blend 1	0.86	0.6 - 1.2
Trial Blend 2	0.78	
Trial Blend 3	0.88	

After establishing all the estimated mixture properties, the designer can observe the values for the trial blends and decide if one or more are acceptable, or if further trial blends need to be evaluated.

Blend 1 is unacceptable based on a failure to meet the minimum VMA criteria. Blend 2 is acceptable, but the VMA is at the minimum. Blend 3 has acceptable VMA as well as meeting the criteria for VFA, dust proportion, and the densification criteria. From this data, Trial Blend 3 is selected as the design aggregate structure.

SELECT DESIGN ASPHALT BINDER CONTENT

Once the design aggregate structure is selected, Trial Blend 3 in this case, specimens are compacted at varying asphalt binder contents. The mixture properties are then evaluated to determine a design asphalt binder content.

A minimum of two specimens are compacted at each of the following asphalt contents:

VI. Volumetric Mix Design

- estimated binder content
- estimated binder content $\pm 0.5\%$, and
- estimated binder content $+ 1.0\%$.

For Trial Blend 3, the binder contents for the mix design are 4.2%, 4.7%, 5.2%, and 5.7%. Four asphalt binder contents are a minimum in Superpave Level 1 analyses.

A minimum of two specimens are also prepared for determination of maximum theoretical specific gravity at the estimated binder content. Specimens are prepared and tested in the same manner as the specimens from the "Select Design Aggregate Structure" section.

Tables VI-22 to VI-25 indicate the test results in tabular form for each trial asphalt binder content. Figures VI-10 to VI-13 illustrate the densification curves for each trial asphalt binder content. Figure VI-14 illustrates the average densification curves for each trial asphalt binder content.

Table VI-22. Densification Data for Blend 3, 4.2% Asphalt Binder

G _{mm} (meas) = 2.582									
	Specimen 1				Specimen 2				AVG
Gyrations	Ht, mm	G _{mb} (est)	G _{mb} (corr)	%G _{mm}	Ht, mm	G _{mb} (est)	G _{mb} (corr)	%G _{mm}	%G _{mm}
5	131.3	2.116	2.167	83.9	131.0	2.136	2.186	84.7	84.3
8	129.0	2.153	2.205	85.4	128.8	2.172	2.223	86.1	85.7
10	127.5	2.178	2.230	86.4	127.4	2.196	2.248	87.1	86.7
15	125.4	2.214	2.267	87.8	125.5	2.229	2.281	88.4	88.1
20	124.0	2.239	2.293	88.8	124.2	2.253	2.306	89.3	89.1
30	122.1	2.274	2.329	90.2	122.4	2.286	2.340	90.6	90.4
40	120.9	2.298	2.353	91.1	121.1	2.310	2.364	91.6	91.4
50	119.9	2.317	2.373	91.9	120.1	2.330	2.385	92.4	92.1
60	119.1	2.332	2.388	92.5	119.4	2.342	2.397	92.9	92.7
80	117.9	2.355	2.412	93.4	118.3	2.365	2.421	93.8	93.6
100	117.0	2.373	2.430	94.1	117.4	2.383	2.439	94.5	94.3
109	116.7	2.379	2.436	94.4	117.1	2.389	2.445	94.7	94.6
125	116.2	2.390	2.447	94.8	116.6	2.400	2.456	95.1	95.0
150	115.6	2.402	2.460	95.2	115.9	2.413	2.470	95.7	95.5
174	115.1	2.413	2.471	95.7	115.4	2.424	2.481	96.1	95.9
G _{mb} (meas)	-	2.471	-	-	-	2.481	-	-	-

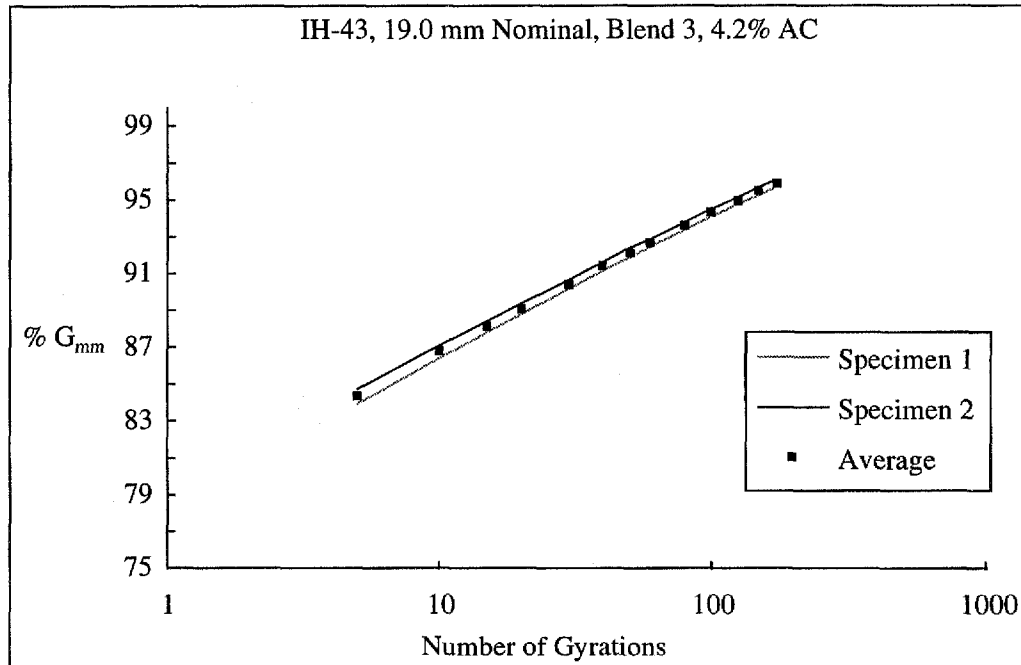

Figure VI-10. Densification Curves for Blend 3, 4.2% Asphalt Binder

Table VI-23. Densification Data for Blend 3, 4.7% Asphalt Binder

G _{mm} (meas) = 2.562									
Gyrations	Specimen 1				Specimen 2				AVG
	Ht, mm	G _{mb} (est)	G _{mb} (corr)	%G _{mm}	Ht, mm	G _{mb} (est)	G _{mb} (corr)	%G _{mm}	%G _{mm}
5	130.4	2.152	2.199	85.8	130.8	2.142	2.189	85.5	85.7
8	128.2	2.188	2.236	87.2	128.8	2.176	2.224	86.9	87.1
10	126.8	2.212	2.260	88.2	127.4	2.199	2.248	87.8	88.0
15	124.8	2.247	2.296	89.6	125.5	2.233	2.283	89.1	89.4
20	123.5	2.271	2.320	90.6	124.1	2.258	2.308	90.1	90.3
30	121.5	2.308	2.358	92.1	122.1	2.294	2.345	91.5	91.8
40	120.3	2.332	2.382	93.0	120.8	2.319	2.370	92.6	92.8
50	119.3	2.351	2.402	93.7	119.9	2.337	2.389	93.3	93.5
60	118.5	2.368	2.419	94.4	119.0	2.355	2.407	94.0	94.2
80	117.2	2.393	2.445	95.4	117.9	2.377	2.430	94.9	95.1
100	116.4	2.409	2.461	96.1	117.0	2.395	2.448	95.6	95.8
109	116.1	2.415	2.467	96.4	116.7	2.400	2.453	95.8	96.1
125	115.6	2.426	2.478	96.8	116.2	2.410	2.463	96.2	96.5
150	115.0	2.440	2.493	97.3	115.5	2.425	2.479	96.8	97.0
174	114.5	2.450	2.503	97.7	115.0	2.436	2.490	97.2	97.5
G _{mb} (meas)	-	2.503	-	-	-	2.490	-	-	-

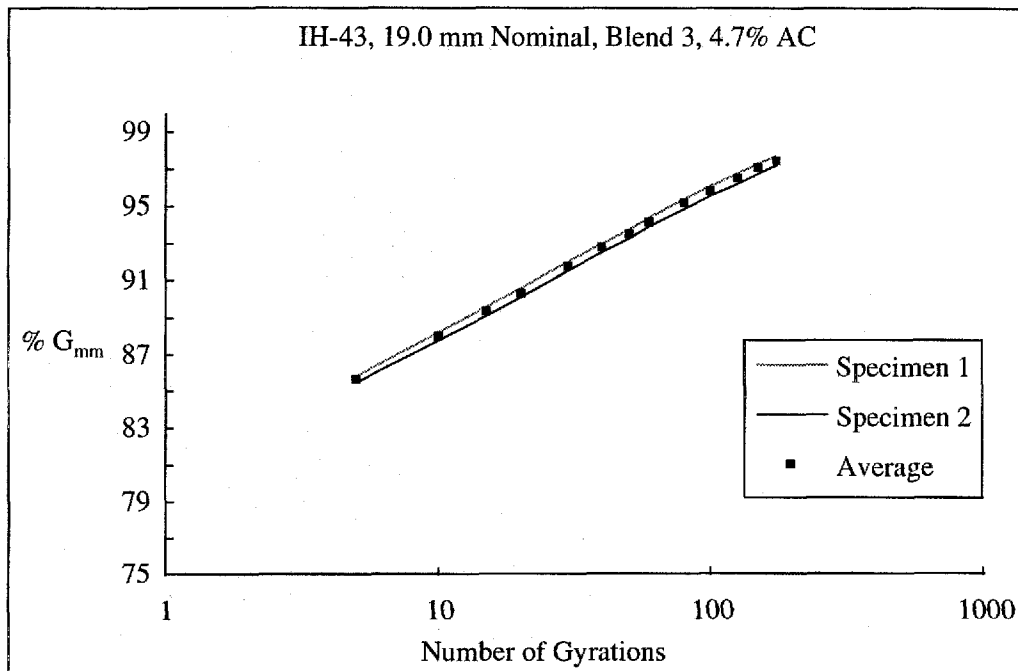

Figure VI-11. Densification Curves for Blend 3, 4.7% Asphalt Binder

Table VI-24. Densification Data for Blend 3, 5.2% Asphalt Binder

G _{mm} (meas) = 2.542									
	Specimen 1				Specimen 2				AVG
Gyrations	Ht, mm	G _{mb} (est)	G _{mb} (corr)	%G _{mm}	Ht, mm	G _{mb} (est)	G _{mb} (corr)	%G _{mm}	%G _{mm}
5	132.0	2.148	2.187	86.0	132.6	2.142	2.183	85.8	85.9
8	129.8	2.185	2.224	87.5	130.4	2.179	2.221	87.4	87.4
10	128.3	2.209	2.249	88.5	128.9	2.204	2.246	88.4	88.4
15	126.2	2.246	2.287	90.0	126.7	2.241	2.284	89.8	89.9
20	124.8	2.272	2.314	91.0	125.2	2.268	2.311	90.9	91.0
30	122.8	2.309	2.351	92.5	123.2	2.305	2.349	92.4	92.4
40	121.4	2.335	2.378	93.5	121.7	2.333	2.378	93.5	93.5
50	120.3	2.356	2.399	94.4	120.7	2.353	2.398	94.3	94.3
60	119.5	2.373	2.416	95.1	119.9	2.369	2.414	95.0	95.0
80	118.2	2.398	2.442	96.1	118.6	2.395	2.441	96.0	96.0
100	117.3	2.417	2.461	96.8	117.7	2.414	2.460	96.7	96.8
109	117.0	2.424	2.468	97.1	117.4	2.420	2.466	97.0	97.1
125	116.4	2.436	2.481	97.6	116.8	2.431	2.478	97.4	97.5
150	115.8	2.449	2.494	98.1	116.1	2.447	2.494	98.1	98.1
174	115.3	2.459	2.504	98.5	115.6	2.457	2.504	98.5	98.5
G _{mb} (meas)	-	2.504	-	-	-	2.504	-	-	-

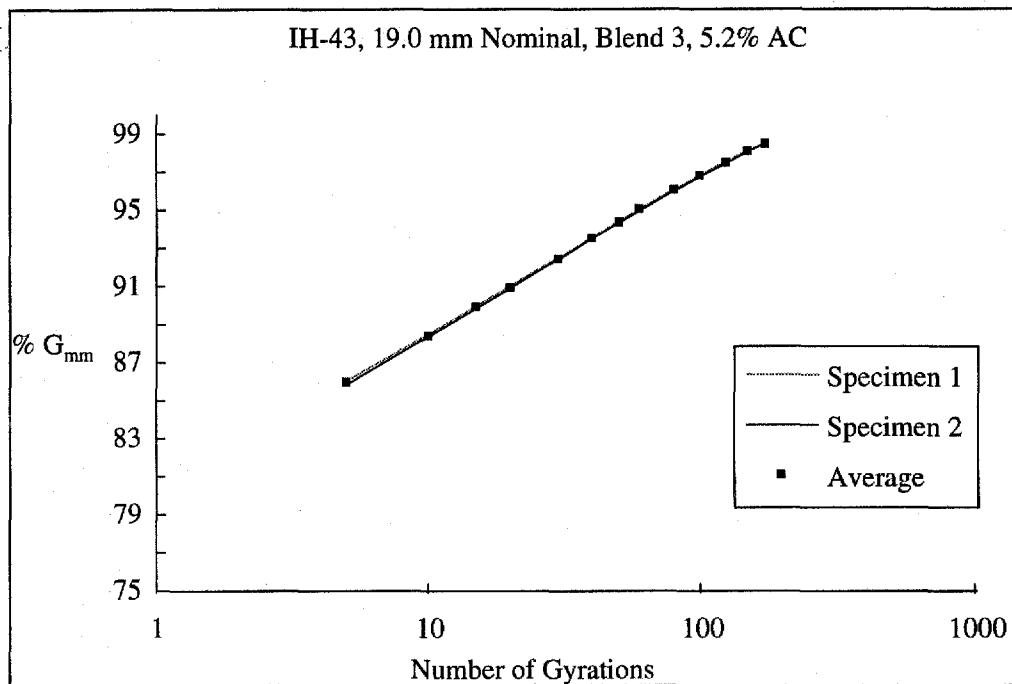

Figure VI-12. Densification Curves for Blend 3, 5.2% Asphalt Binder

Table VI-25. Densification Data for Blend 3, 5.7% Asphalt Binder

$G_{mm}(\text{meas}) = 2.523$									
	Specimen 1				Specimen 2				AVG
Gyrations	Ht, mm	$G_{mb}(\text{est})$	$G_{mb}(\text{corr})$	$\%G_{mm}$	Ht, mm	$G_{mb}(\text{est})$	$G_{mb}(\text{corr})$	$\%G_{mm}$	$\%G_{mm}$
5	130.4	2.170	2.204	87.4	131.5	2.172	2.201	87.2	87.3
8	128.6	2.201	2.236	88.7	129.4	2.207	2.236	88.6	88.6
10	127.4	2.222	2.257	89.5	128.0	2.230	2.260	89.6	89.5
15	125.4	2.256	2.292	90.8	126.2	2.262	2.292	90.8	90.8
20	124.0	2.282	2.318	91.9	124.9	2.286	2.316	91.8	91.8
30	122.4	2.313	2.349	93.1	123.1	2.319	2.350	93.1	93.1
40	120.5	2.349	2.386	94.6	121.3	2.353	2.384	94.5	94.5
50	119.4	2.371	2.408	95.5	120.2	2.375	2.407	95.4	95.4
60	118.9	2.381	2.419	95.9	119.5	2.390	2.422	96.0	95.9
80	117.6	2.406	2.444	96.9	118.2	2.415	2.447	97.0	96.9
100	116.7	2.426	2.464	97.7	117.2	2.437	2.469	97.8	97.8
109	116.2	2.453	2.474	98.1	116.7	2.446	2.479	98.2	98.2
125	115.4	2.452	2.491	98.7	115.9	2.463	2.496	98.9	98.8
150	114.9	2.463	2.502	99.2	115.5	2.472	2.505	99.3	99.2
174	114.3	2.476	2.515	99.7	114.9	2.485	2.518	99.8	99.8
$G_{mb}(\text{meas})$	-	2.515	-	-	-	2.518	-	-	-

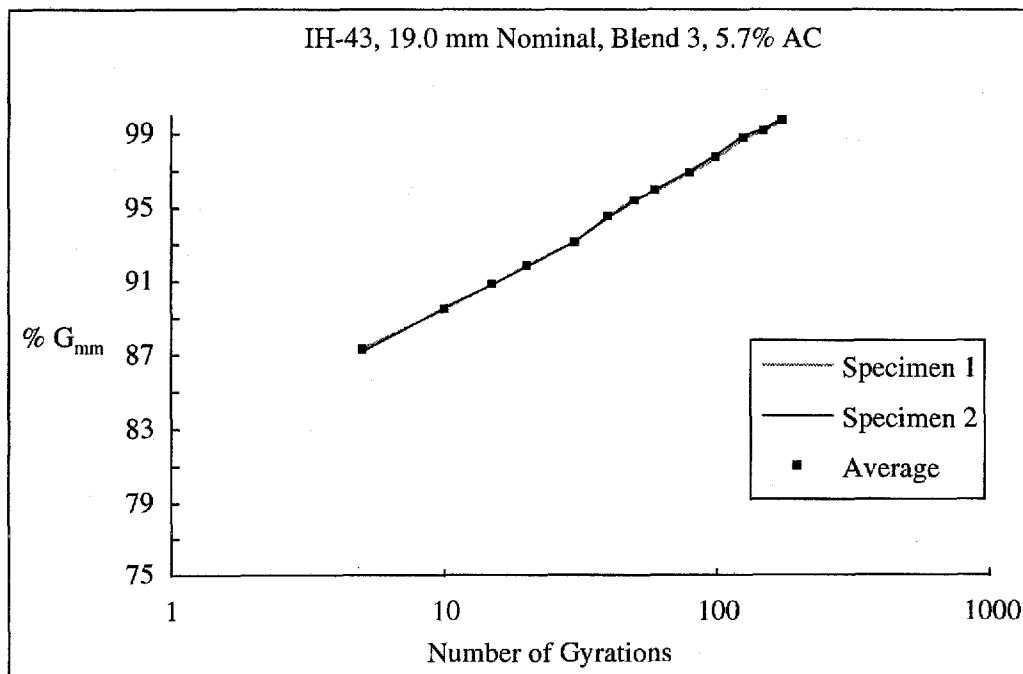

Figure VI-13. Densification Curves for Blend 3, 5.7% Asphalt Binder

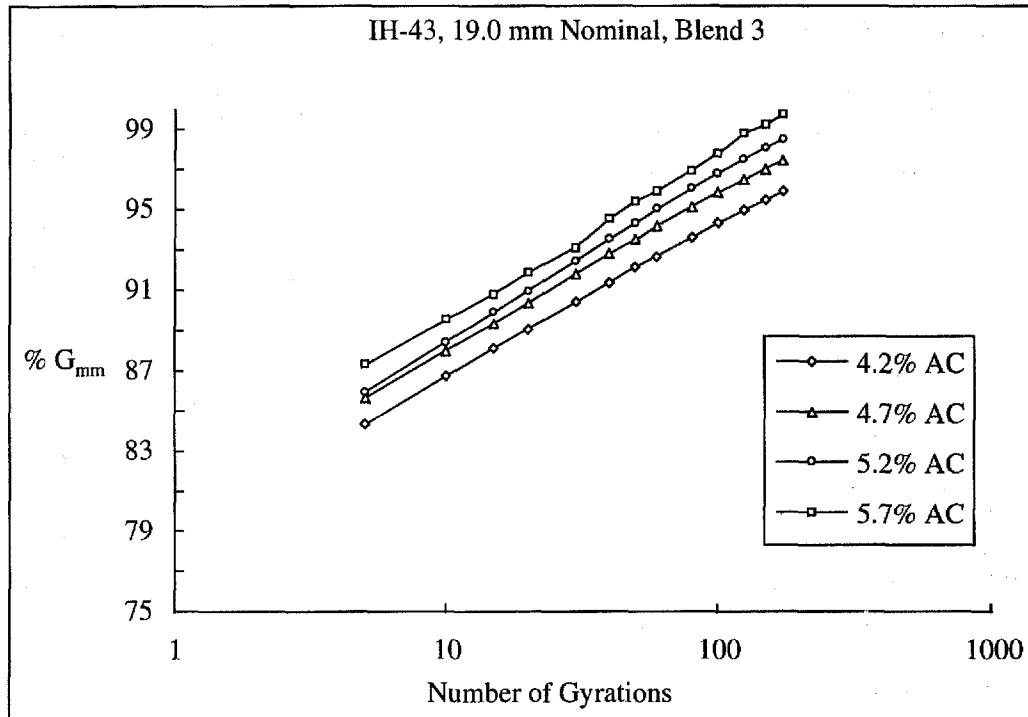

Figure VI-14. Average Densification Curves for Blend 3, Varying Asphalt Binder Content

Mixture properties are evaluated for the selected blend at the different asphalt binder contents, by using the densification data at $N_{initial}$ (8 gyrations), N_{design} (109 gyrations), and $N_{maximum}$ (174 gyrations). Tables VI-26 and VI-27 indicate the response of the mixture's compaction and volumetric properties with varying asphalt binder contents.

Table VI-26. Summary of Blend 3 - Mix Compaction Properties

%AC	%G _{mm} @ N=8	%G _{mm} @ N=174	%G _{mm} @ N=109
4.2%	85.8%	95.9%	94.5%
4.7%	87.1%	97.5%	96.1%
5.2%	87.4%	98.5%	97.0%
5.7%	88.6%	99.8%	98.1%

Table VI-27. Summary of Blend 3 - Mix Volumetric Properties at N_{design}

%AC	%Air Voids	%VMA	%VFA	Density (kg/m ³)
4.2%	5.5%	13.4%	59.3%	2441
4.7%	3.9%	13.2%	70.1%	2461
5.2%	3.0%	13.4%	77.9%	2467
5.7%	1.9%	13.6%	86.2%	2476

The volumetric properties are calculated at the design number of gyrations (N_{design}) for each trial asphalt binder content. From these data points, the designer can generate graphs of air voids, VMA, and VFA versus asphalt binder content.

The design asphalt binder content is established at 4.0% air voids. In this example, the design asphalt binder content is 4.7% - the value that corresponds to 4.0% air voids at $N_{\text{design}} = 109$ gyrations. All other mixture properties are checked at the design asphalt binder content to verify that they meet criteria. The design values for the 19.0 mm nominal mixture (Trial Blend 3) are indicated in Table VI-28.

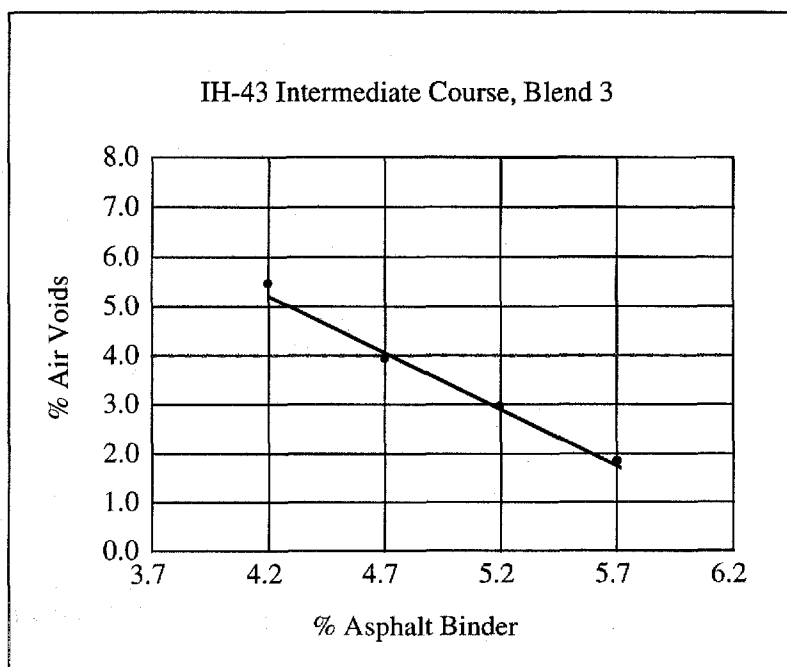

Figure VI-15. Air Voids versus Asphalt Binder Content

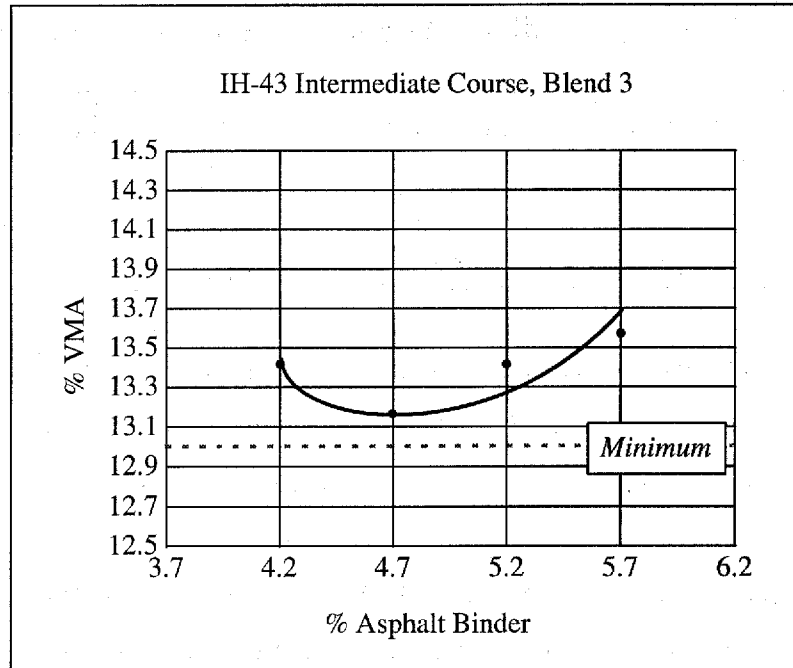

Figure VI-16. VMA versus Asphalt Binder Content

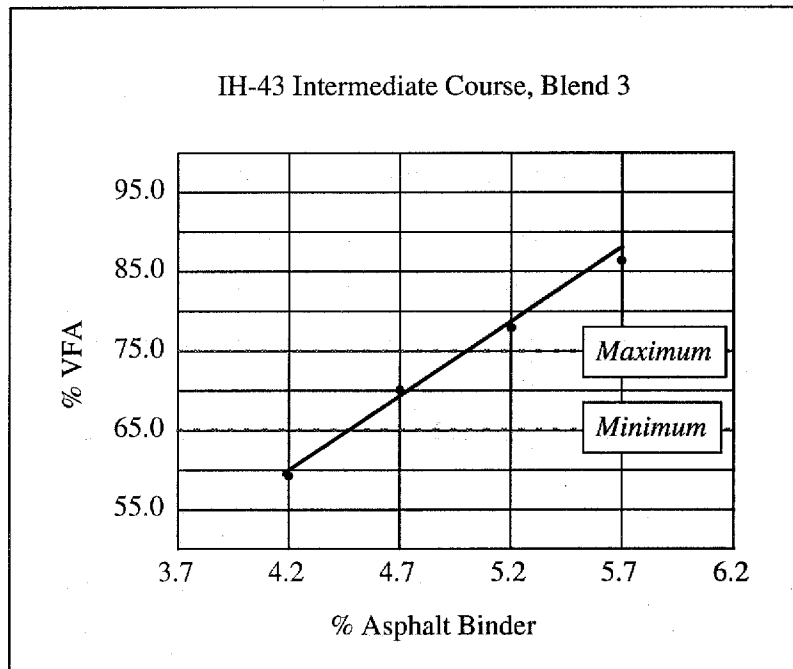

Figure VI-17. VFA versus Asphalt Binder Content

Table VI-28. Design Mixture Properties at 4.7% Binder Content

Mix Property	Result	Criteria
% Air Voids	4.0%	4.0%
%VMA	13.2%	13.0% min.
%VFA	70.0%	65% - 75%
Dust Proportion	0.88	0.6 - 1.2
%G _{mm} @ N _{initial} = 8	87.1%	less than 89%
%G _{mm} @ N _{maximum} = 174	97.5%	less than 98%

EVALUATE MOISTURE SENSITIVITY

The final step in the Level 1 mix design process is to evaluate the moisture sensitivity of the design mixture. This step is accomplished by performing AASHTO T 283 testing on the design aggregate blend at the design asphalt binder content. Specimens are compacted to approximately 7% air voids. One subset of three specimens are considered control specimens. The other subset of three specimens is the conditioned subset. The conditioned subset is subjected to vacuum saturation followed by an optional freeze cycle, followed by a 24 hour thaw cycle at 60° C. All specimens are tested to determine their indirect tensile strengths. The moisture sensitivity is determined as a ratio of the tensile strengths of the conditioned subset divided by the tensile strengths of the control subset. Table VI-29 indicates the moisture sensitivity data for the mixture at the design asphalt binder content.

Table VI-29. Moisture Sensitivity Data for Blend 3 at 4.7% Design Asphalt Binder Content

SAMPLE		1	2	3	4	5	6
Diameter, mm	D	150.0	150.0	150.0	150.0	150.0	150.0
Thickness, mm	t	99.2	99.4	99.4	99.3	99.2	99.3
Dry mass, g	A	3986.2	3981.3	3984.6	3990.6	3987.8	3984.4
SSD mass, g	B	4009.4	4000.6	4008.3	4017.7	4013.9	4008.6
Mass in Water, g	C	2329.3	2321.2	2329.0	2336.0	2331.5	2329.0
Volume, cc (B-C)	E	1680.1	1679.4	1679.3	1681.7	1682.4	1679.6
Bulk Sp Gravity (A/E)	F	2.373	2.371	2.373	2.373	2.370	2.372
Max Sp Gravity	G	2.558	2.558	2.558	2.558	2.558	2.558
% Air Voids(100(G-F)/G)	H	7.2	7.3	7.2	7.2	7.3	7.3
Vol Air Voids (HE/100)	I	121.8	123.0	121.6	121.7	123.4	122.0
Load, N	P				20803	20065	20354
Saturated							
SSD mass, g	B'	4060.9	4058.7	4059.1			
Mass in water, g	C'	2369.4	2373.9	2372.8			
Volume, cc (B'-C')	E'	1691.5	1684.8	1686.3			
Vol Abs Water, cc (B'-A)	J'	74.7	77.4	74.5			
% Saturation (100J'/I)		61.3	62.9	61.3			
% Swell (100(E'-E)/E)		0.7	0.3	0.4			
Conditioned							
Thickness, mm	t''	99.5	99.4	99.4			
SSD mass, g	B''	4070.8	4074.9	4074.8			
Mass in water, g	C''	2373.7	2380.3	2379.0			
Volume, cc (B''-C'')	E''	1697.1	1694.6	1695.8			
Vol Abs Water, cc (B''-A)	J''	84.6	93.6	90.2			
% Saturation (100J''/I)		69.5	76.1	74.2			
% Swell (100(E''-E)/E)		1.0	0.9	1.0			
Load, N	P''	16720	16484	17441			
Dry Str. (2000P/(tD π))	S _{td}				889	858	870
Wet Str. (2000P''/(t''D π))	S _{tm}	713	704	745			
Average Dry Strength (kPa)			872				
Average Wet Strength (kPa)			721				
%TSR			82.6%				

The minimum criteria for tensile strength ratio 80%. The design blend (82.6%) exceeded the minimum requirement. The Superpave Level 1 Mix Design is now complete for the intermediate mixture for IH-43. Additional performance prediction testing is required as described under the Level 3 testing process.

1. The first part of the document discusses the importance of maintaining accurate records of all transactions and activities. It emphasizes that this is crucial for ensuring transparency and accountability in the organization's operations.

2. The second part outlines the various methods and tools used to collect and analyze data. This includes both traditional manual methods and modern digital technologies, highlighting the benefits of automation and data integration.

3. The third part focuses on the challenges faced in data management, such as data quality, security, and privacy. It provides strategies to address these challenges and ensure that the data remains reliable and secure.

4. The fourth part discusses the role of data in decision-making and strategic planning. It explains how data-driven insights can help organizations identify trends, opportunities, and risks, leading to more informed and effective decisions.

5. The fifth part covers the importance of data governance and compliance with relevant regulations. It outlines the key principles of data governance and provides guidance on how to implement them within the organization.

6. The sixth part addresses the future of data management, including emerging trends like artificial intelligence, big data, and cloud computing. It discusses how these technologies will impact the way data is collected, stored, and analyzed.

7. The seventh part provides a summary of the key points discussed in the document and offers recommendations for further action. It encourages organizations to embrace a data-driven culture and invest in the necessary infrastructure and talent to succeed in the digital age.

VII.

PERFORMANCE TESTING (LEVELS 2 AND 3)

INTRODUCTION

In the Superpave mixture design and analysis system, performance tests are used only in situations involving moderate to high traffic. This means that they are required only for Levels 2 and 3 mixture designs. Performance testing utilizes new equipment and procedures to ensure that Superpave mixtures exhibit acceptable amounts of the distress types that were considered by SHRP researchers: permanent deformation, fatigue cracking, and low temperature cracking. Two performance test devices were developed: the Superpave Shear Tester (SST) and the Indirect Tensile Tester (IDT). The extent of use of performance testing for Levels 2 and 3 mix design are shown in Table VII-1 for a new two layer HMA system, which is the most new layers considered by Superpave.

Table VII-1. Performance Tests, Levels 2 and 3 (New Construction)

Design Level	Performance Distress Mode		
	Permanent Deformation ¹	Fatigue Cracking	Low Temperature Cracking
2	Simple shear test at constant height at $T_{eff}(PD)$. Frequency sweep test at constant height at $T_{eff}(PD)$.	Simple shear test at constant height at $T_{eff}(FC)$. Frequency sweep test at constant height at $T_{eff}(FC)$. Indirect tensile strength at $T_{eff}(FC)$.	Indirect tensile creep compl at 0°, -10°, -20° C. Indirect tensile strength at -10° C. Binder creep stiffness (S) and creep rate (m).
3	Frequency sweep test at constant height at 4°, 20°, 40°C. Uniaxial strain test at 4°, 20°, 40° C. Volumetric test at 4°, 20°, 40° C. Simple shear test at constant height at 4°, 20°, 40° C.	Indirect tensile strength at -10°, 4°, and 20° C.	Indirect tensile creep compliance and strength at 0°, -10°, -20° C.

¹ To check for tertiary flow, Level 2 and 3 require repeated shear test at constant stress ratio at T_e .

If an overlay is being designed, Superpave does not attempt to predict fatigue cracking or low temperature cracking. Only permanent deformation is considered. Consequently, the extent of use of performance testing for asphalt mixtures used for overlays is shown in Table VII-2.

Table VII-2. Performance Tests, Levels 2 and 3 (Overlay Construction)

Design Level	Permanent Deformation ¹
2	Simple shear test at constant height at $T_{eff}(PD)$ Frequency sweep test at constant height at $T_{eff}(PD)$
3	Frequency sweep test at constant height at 4°, 20°, and 40°C Uniaxial strain test at 4°, 20°, and 40° C Volumetric test at 4°, 20°, and 40° C Simple shear test at constant height at 4°, 20°, and 40° C
¹ To check for tertiary flow, Level 2 and 3 require repeated shear test at constant stress ratio at T_c	

PERFORMANCE MODELS

While much attention was focused in SHRP on the new test equipment and testing protocols, a key component of performance testing are performance models. These are prediction algorithms that accept performance test results and output predicted pavement performance. The models account not only for the new asphalt mixture being designed, but also the characteristics of the in-place pavement. The use of performance testing and performance prediction models represents an important new tool for engineers in designing and managing pavements.

Performance prediction is accomplished by the Superpave software using four components:

- material property model,
- environmental effects model,
- pavement response model, and
- pavement distress model.

Performance test results (i.e., SST and IDT) are used as input to the material property model to determine non-linear elastic, viscoelastic, plastic, and fracture properties. The environmental effects model calculates pavement temperature as a function of depth and material thermal characteristics. The pavement response model uses a two-dimensional, axisymmetric finite element approach to predict stresses and strains within the layered system. It uses output from the material property and environmental effects models to predict these responses of the pavement system to traffic and environmental loads. Output from the pavement response and material property models are used by the distress models to estimate rutting and fatigue and low temperature cracking. Figure IV-1 shows the performance prediction approach of Superpave.

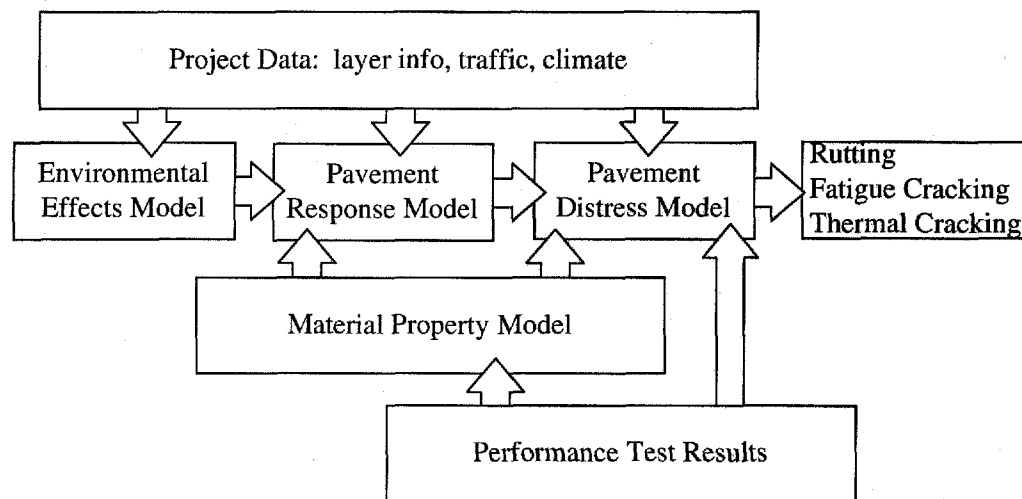

Figure VII-1. Superpave Performance Prediction System

TEST PARAMETERS

Test Temperatures

Level 3 testing provides a more reliable prediction of pavement performance because it involves performance testing over a wider range of temperatures (i.e., 4°, 20°, and 40° C). This allows use of the environmental effects model to more accurately predict pavement performance.

Level 2 testing involves performing tests at an effective temperature (T_{eff}). While a less accurate performance prediction results in Level 2 testing, the testing is greatly

simplified. Because permanent deformation and fatigue cracking occur at different temperatures, two effective temperatures are used: $T_{\text{eff}}(\text{PD})$ and $T_{\text{eff}}(\text{FC})$. $T_{\text{eff}}(\text{PD})$ is the single temperature at which the predicted permanent deformation would be identical to that predicted by a multiple temperature analysis. $T_{\text{eff}}(\text{FC})$ is the single temperature at which an equal amount of fatigue damage would occur to that measured by considering each season separately throughout the year. Both temperatures are computed by Superpave software and are a function of project mean annual air temperature, layer depth, and user selected reliability.

While tertiary flow is a permanent deformation type of distress, it is treated separately by Superpave. Tertiary flow occurs when an asphalt mixture densifies to a very low air void content, normally less than about two to three percent air voids. In this condition, the mixture exhibits extreme plastic flow with very few load applications. Figure VII-2 illustrates the concept of tertiary flow.

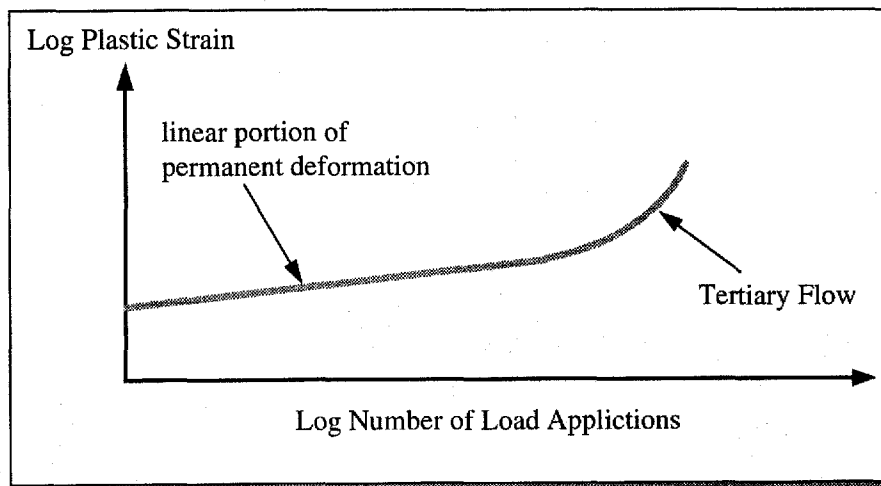

Figure VII-2. Tertiary Rutting

The tertiary flow analysis using the repeated shear test at constant stress ratio is conducted at a control temperature (T_c). The control temperature is computed by Superpave software and depends on project weather and traffic conditions.

Asphalt Binder Contents

Superpave performance testing requires that specimens be tested at multiple asphalt binder contents. For tests concerned with permanent deformation, fatigue cracking, and

low temperature cracking, these consist of binder contents that result in three, four, and six percent air voids at N_{design} . However, performance test specimens are fabricated using less gyrations than N_{design} in order to achieve test specimens containing approximately seven percent air voids.

For the tertiary flow analysis, only the binder content resulting in three percent air voids is used. Two test specimens are required for a given test condition (i.e., test temperature and binder content). They are fabricated to achieve three percent air voids. Appendix F shows a visual representation of specimen requirements for Levels 1, 2, and 3 testing.

SUPERPAVE SHEAR TESTER

The SST (Figure VII-3) is a closed-loop feedback, servo hydraulic system that consists of four major components: the testing apparatus, the test control unit and data acquisition system, the environmental control chamber, and the hydraulic system.

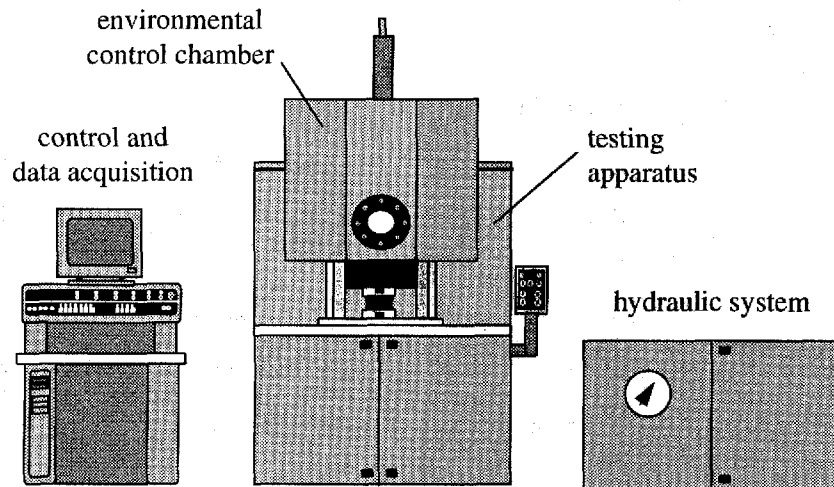

Figure VII-3. Superpave Shear Tester Components

Testing Apparatus

The testing apparatus includes a reaction frame and shear table. It also serves to house the various components that are driven by other system components such as temperature/pressure control, hydraulic actuators, and input and output transducers. The reaction frame is extremely rigid so that precise specimen displacement measurements

can be achieved without worrying about displacements from frame compliance. The shear table holds specimens during testing and can be actuated to impart shear loads.

Test Control Unit

The test control unit consists of the system hardware and software. The hardware interfaces with the testing apparatus through input and output transducers, and it consists of controllers, signal conditioners, and a computer and its peripherals. The software consists of the algorithms required to control the testing apparatus and to acquire data during a test.

Linear variable differential transducers (LVDTs) are affixed to specimens and measure the response of specimens to applied testing loads. The LVDTs make it possible for the system to operate in a closed loop feedback mode, which means that LVDT signals are used to control applied testing loads.

Environmental Control Unit

The environmental control unit is required to control the temperature and air pressure inside the testing chamber at a constant level. The unit is capable of providing temperatures within a wide range from 1° to 80° C. Air pressure and the rate of pressure change within the chamber is precisely controlled. Air pressure is normally applied at a rate of 70 kPa per second up to a maximum value of 840 kPa. This is achieved by storing compressed air in separate storage tanks that can be emptied into the testing chamber at the required rate. Air pressure provides specimen confinement for two of the six tests.

Hydraulic System

The hydraulic system provides the required force to load specimens for different testing conditions. A hydraulic motor powers two actuators, each with a capacity of approximately 32 kN. The vertical actuator applies an axial force to test specimens. The horizontal actuator drives the shear table, which imparts shear loads to the specimen.

Specimen Preparation and Instrumentation

The first step in specimen preparation is to trim test specimens to a thickness of 50 mm. For the three tests that require no confining pressure, the specimen is glued between two platens.

A gluing device (Figure VII-4) is used to squeeze the specimen between the platens while the glue cures. An epoxy-type glue such as Devcon Plastic Steel is employed for this purpose. The gluing device rigidly holds the platens and specimen to ensure that the platen faces are parallel.

After the glue has cured, four screws are affixed to the side of the specimen using a gap filling variety of cyanoacrylate glue. These screws are used to affix the bracket that holds the horizontal LVDT (Figures VII-5 and VII-6). Axial LVDTs are affixed to the platens.

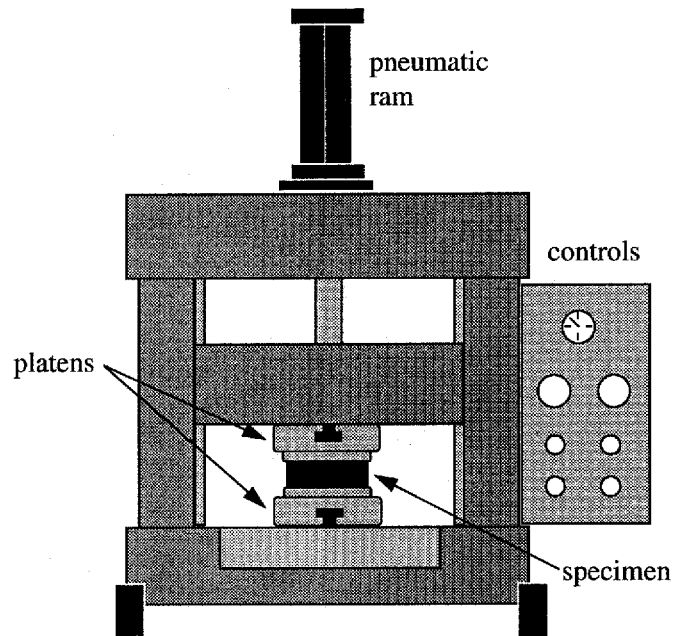

Figure VII-4. SST Gluing Device

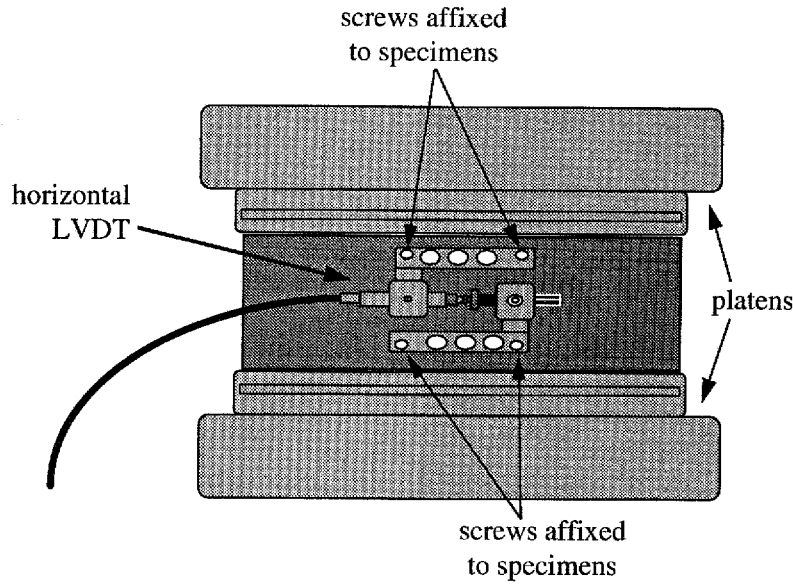

Figure VII-5. Specimen Instrumentation for Unconfined SST Tests (Side View)

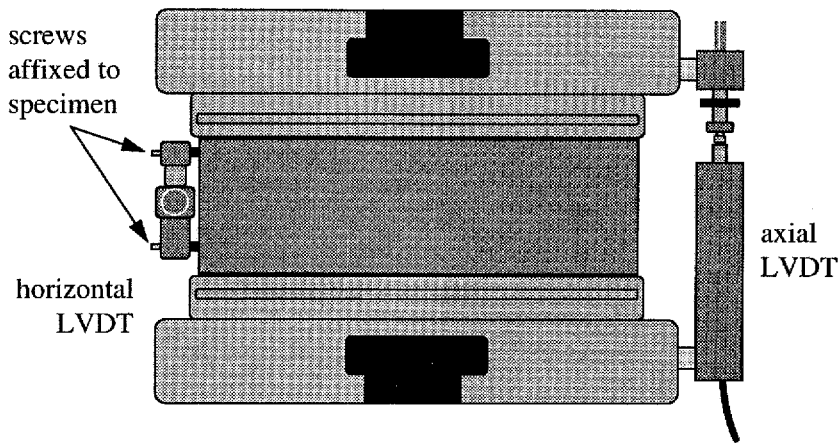
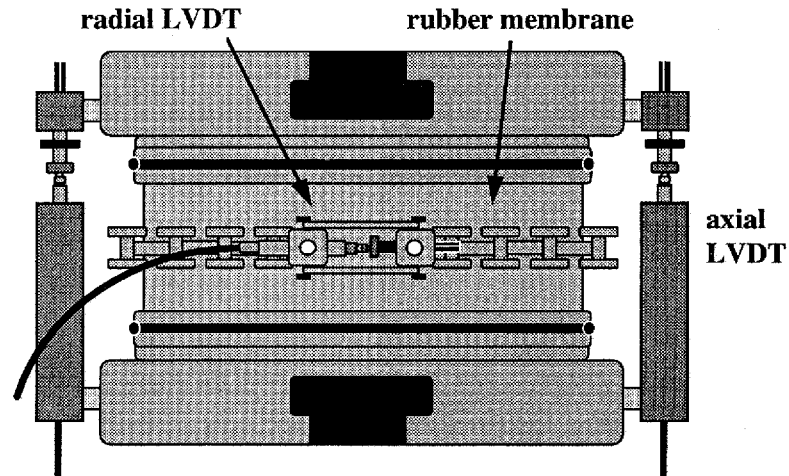

Figure VII-6. Specimen Instrumentation for Unconfined SST Tests (Front View)

A different specimen configuration is used for confined tests. Test specimens are still placed between platens, however, no glue is used. A rubber membrane surrounds the specimen. A radial LVDT is affixed by a collar that surrounds the perimeter of the specimen (Figure VII-7). Axial LVDTs are affixed to the platens.



**Figure VII-7. Specimen Instrumentation for Confined SST Tests
(Front View)**

Test Procedures

Six tests are performed using the SST:

- volumetric test,
- uniaxial strain test,
- repeated shear test at constant stress ratio,
- repeated shear test at constant height (not required by Superpave),
- simple shear test at constant height, and
- frequency sweep test at constant height.

The volumetric and uniaxial strain tests use confining pressure in their protocol. These two tests are performed only for a Level 3 mixture design. Levels 2 and 3 design use repeated shear at constant stress ratio, simple shear at constant height, and frequency sweep at constant height tests. The repeated shear test at constant height is a stand-alone test that can be used for rut depth estimation and it is not a part of the Superpave mixture design and analysis system. A brief description of each test follows.

Volumetric Test

The volumetric test is one of two tests that uses confining pressure. It is performed at three temperatures and pressures as indicated below.

Table VII-3. Volumetric Test Parameters

Temperature, °C	Pressure, kPa
4	830
20	690
40	550

The test is performed by increasing the confining stress at a rate of 70 kPa per second up to the values shown and measuring the circumferential strain by means of the radial LVDT. Figure VII-8 shows the change in confining pressure versus time during the volumetric test at 20° C.

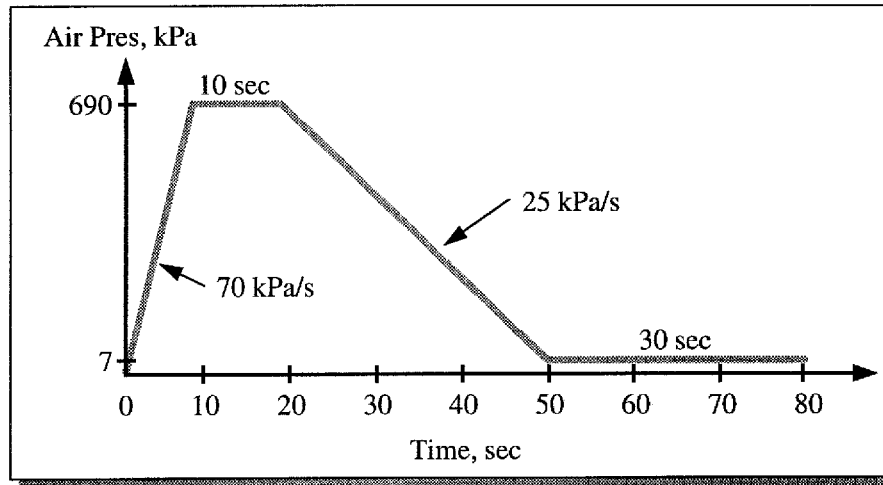

Figure VII-8. Confining Pressure in Volumetric Test at 20° C

Uniaxial Strain Test

The uniaxial strain test also uses confining pressure. In this test, axial stress is applied to the test specimen and the specimen tries to increase its circumference. The radial LVDT senses this change in circumference and air pressure is applied so that the circumference remains constant. This approach uses the signal from the radial LVDT as feedback for the purpose of applying confining pressure to prevent radial deformation. Three axial stress levels are used depending on the test temperature as shown in Table VII-4.

Table VII-4. Uniaxial Strain Test Parameters

Temperature, °C	Axial Stress, kPa
4	655
20	550
40	345

Confining pressure is measured throughout the test. Axial deformation is measured on both sides of the specimen by the vertical LVDTs. Axial load is also measured. Radial deformation is also measured although it should be relatively small. Figure VII-9 shows the application of axial stress during the test.

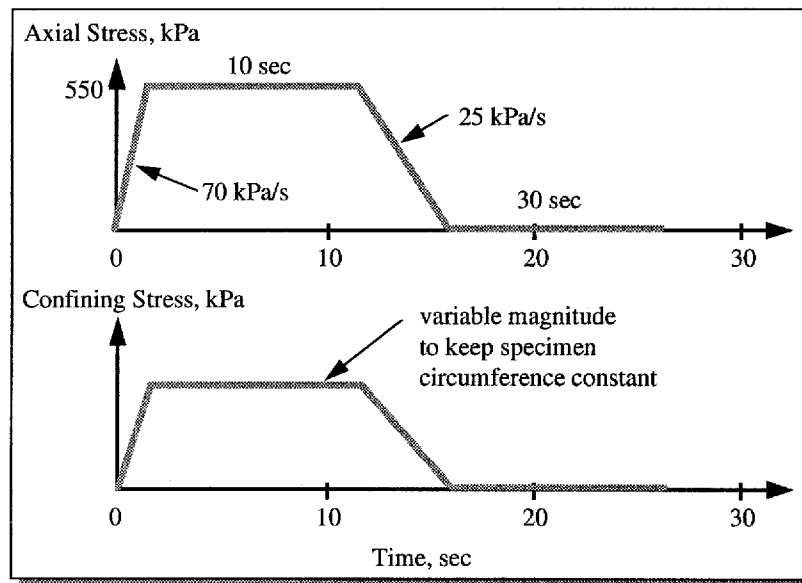
**Figure VII-9. Stress Applications in Uniaxial Strain Test at 20° C**

Repeated Shear Test at Constant Stress Ratio

The repeated shear test at constant stress ratio is performed for either Level 2 or 3 mix design. It is a screening test to delineate an asphalt mixture that is subject to tertiary rutting. This form of rutting occurs at low air void contents and is the result of bulk mixture instability.

In this test, repeated synchronized haversine shear and axial load pulses are applied to the specimen. A load cycle consists of 0.7-second, which is comprised of 0.1-second load application followed by 0.6-second rest period. Test specimens are subjected to a varying number of load cycles in the range from 5000 to 120,000, depending on the traffic level and climate conditions or until accumulated permanent strain reaches five percent. The ratio of axial to shear stress is maintained constant in the range from 1.2 to 1.5. The magnitude of stresses are selected to simulate actual in-place stresses that will be encountered by the mixture. Suggested stress values are shown in Table VII-5.

Table VII-5. Suggested Stress Values for Repeated Shear Test at Constant Stress Ratio

Base Condition	Asphalt Content					
	High		Medium		Low	
	Shear Stress, kPa	Axial Stress, Pa	Shear Stress, kPa	Axial Stress, kPa	Shear Stress, kPa	Axial Stress, kPa
Weak	84	119	63	98	49	56
Strong	98	175	84	105	56	91

In Table VII-5, a weak base is considered any unstabilized granular material while a strong base is considered an existing pavement or stabilized layer. The test temperature used is called the control temperature (T_c) for permanent deformation. It is computed by Superpave as a function of the project traffic conditions and climate. The test is typically performed at high asphalt contents corresponding to three percent air voids, which is the extreme condition for tertiary rutting.

During the test axial and shear loads and deformations are measured and recorded. Figure VII-10 shows typical stress pulses in the test.

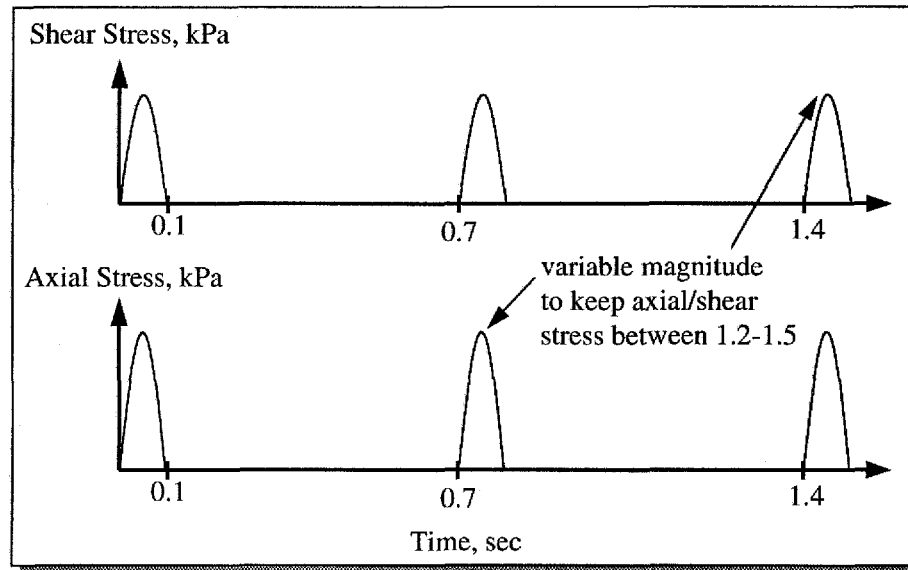

Figure VII-10. Stress Pulses in Repeated Shear Test at Constant Stress Ratio

Repeated Shear Test at Constant Height

This test is performed as an option to Levels 2 or 3 design to estimate rut depth and is not required by Superpave. A haversine shear load is applied to achieve a controlled shear stress level of 68 kPa. When the repeated shear load is applied, the test specimen seeks to dilate. The signal from the axial LVDT is used as feedback by the vertical actuator to apply sufficient axial load to keep the specimen from dilating.

A load cycle consists of 0.7-second, which is comprised of 0.1-second shear load application followed by 0.6-second rest period. Test specimens are subjected to 5000 load cycles or until the permanent shear strain reaches five percent.

The test temperature used is T_{\max} , which is the seven-day maximum pavement temperature at 50 mm depth. During the test, axial and shear loads and deformations are measured and recorded. Figure VII-11 shows typical stress pulses in the test.

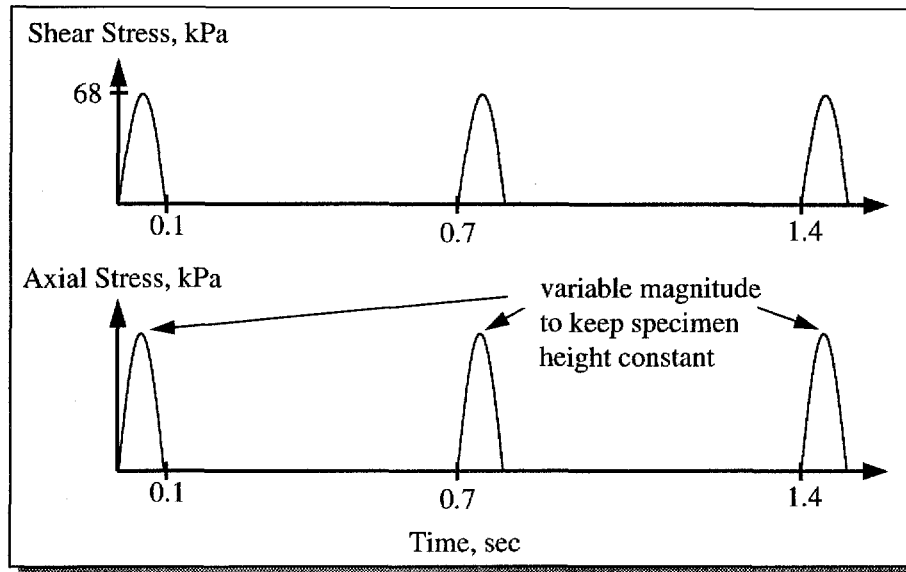

Figure VII-11. Stress Pulses in Repeated Shear Test at Constant Height

Simple Shear Test at Constant Height

This test is performed in Levels 2 or 3 design. A controlled shearing stress is applied to a test specimen. As the test specimen is sheared, it seeks to dilate, which increases its height. The vertical actuator uses the signal from the axial LVDT to apply sufficient axial stress to keep the specimen height constant. The test is performed at different stress levels and temperatures depending on whether a Level 2 or 3 design is being performed. The following tables outline test parameters.

Table VII-6. Simple Shear Test Parameters

Mix Design Level	Temperature, °C	Shear Stress, kPa
2	$T_{eff}(PD)$	35
	$T_{eff}(FC)$	105
3	4	345
	20	105
	40	35

In this table, $T_{eff}(FC)$ is the effective pavement temperature for fatigue cracking. It is computed by Superpave as a function of climate, depth of mixture in pavement, and designer selected reliability level in the same manner as $T_{eff}(PD)$. Figure VII-12 shows

the application of stresses during the test. During the test axial and shear loads and deformations are measured and recorded.

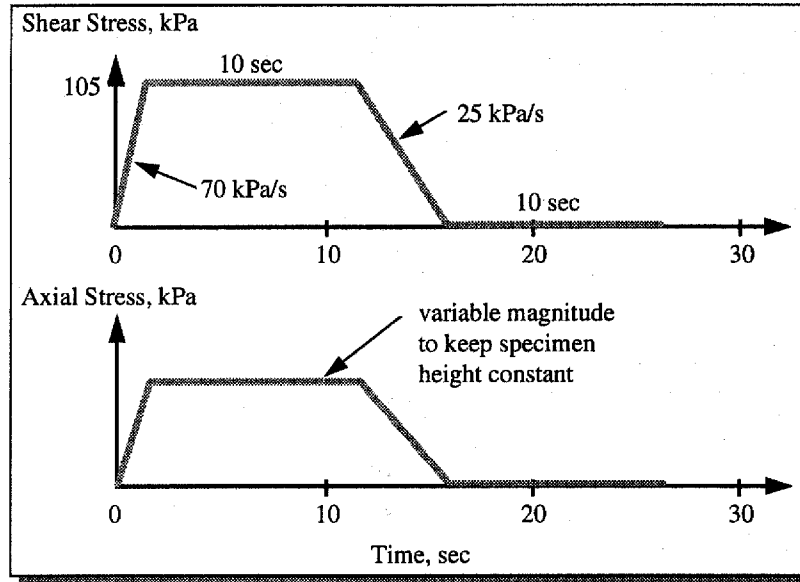

Figure VII-12. Stress Applications in Simple Shear Test at 20° C

Frequency Sweep Test at Constant Height

This test is performed in Levels 2 or 3 design. A repeated sinusoidal shearing load is applied to the specimen to achieve a controlled shearing strain of 0.005 percent. One hundred cycles are used for the test at each of the following loading frequencies: 10, 5, 2, 1, 0.5, 0.2, 0.1, 0.05, 0.02, and 0.01 Hz.

As the test specimen is sheared, it seeks to dilate, which increases its height. The vertical actuator uses the signal from the axial LVDT to apply sufficient axial stress to keep the specimen height constant. The test is performed at different temperatures depending on whether a Level 2 or 3 design is being performed. The following table outlines test parameters.

Table VII-6. Frequency Sweep Test Parameters

Mix Design Level	Temperature, °C
2	$T_{eff}(PD)$
	$T_{eff}(FC)$
3	4
	20
	40

During the test axial and shear loads and deformations are measured and recorded. Figure VII-13 illustrates the application of shearing strains and axial stresses during the test.

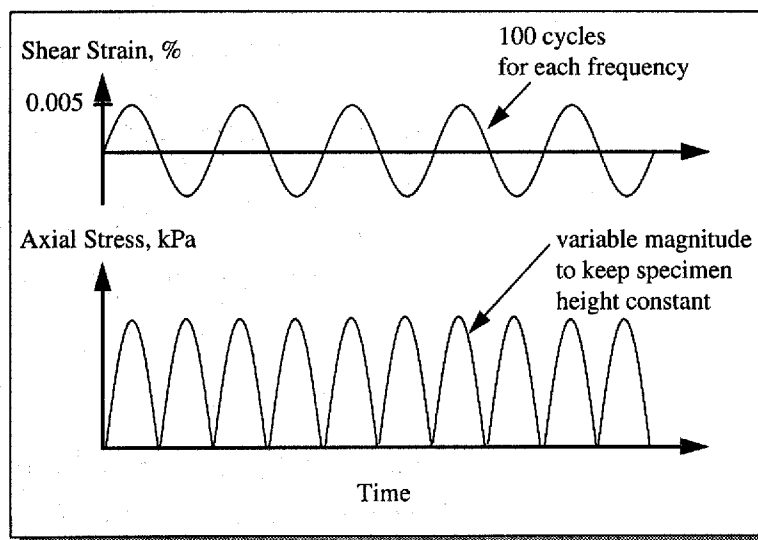

Figure VII-13. Shear Strain and Axial Stress Applications in Frequency Sweep Test at Constant Height

INDIRECT TENSILE TESTER

The IDT is a device that measures the creep compliance and strength of asphalt mixtures using indirect tensile loading techniques at intermediate to low temperatures ($< 20^{\circ} C$). Indirect tensile testing involves applying a compressive load across the diametrical axis of

a cylindrical specimen (Figure VII-14). The mechanics of the test are such that a nearly uniform state of tensile stress is achieved across the diametrical plane.

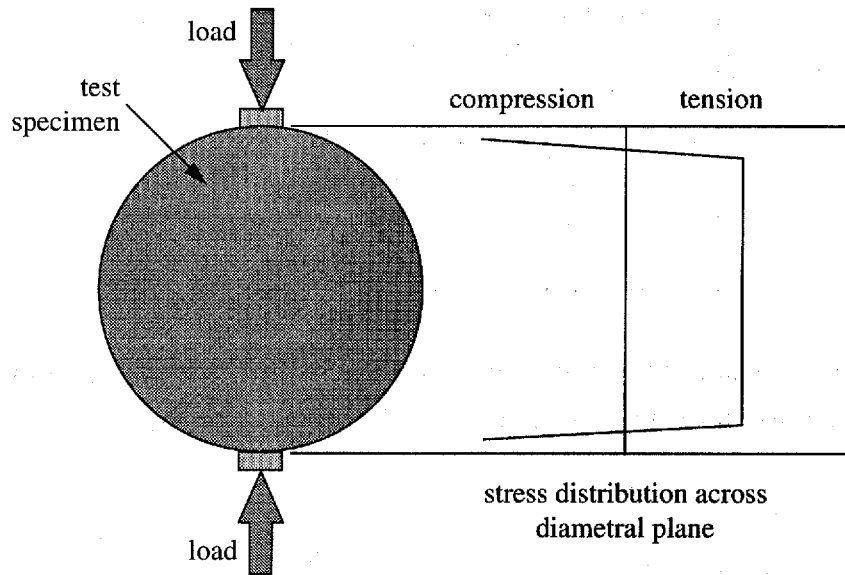

Figure VII-14. Indirect Tensile Test

The IDT device has four components: the testing apparatus, the test control unit and data acquisition system, load measuring device, and the environmental control chamber.

Testing Apparatus

The testing apparatus consists of a closed-loop electrohydraulic, servohydraulic, or mechanical screw system capable of resolving static loads as low as 5 N. A rigid loading frame is also necessary so that precise displacement measurements can be made without frame compliance contributing to displacement measurements.

Control Unit and Data Acquisition System

The reaction of specimens to load can be captured by means of a multi-channel strip chart recorder or an analog to digital data acquisition device.

Load Measuring Device

Applied loads are measured and controlled by means of an electronic load cell. The load cell resides between the loading piston and loading platen. It accurately measures the load applied to the test specimen.

Environmental Control Chamber

The environmental chamber controls test specimen temperature during the test. It must be able to accurately control temperature in the range from -20° to 20° C and have sufficient room to accommodate at least three test specimens and the loading frame.

Specimen Preparation and Instrumentation

The first step in specimen preparation is to trim test specimens to a thickness such that their thickness to diameter ratio is greater than 0.33. For a 150 mm diameter specimen, the minimum specimen thickness is 50 mm. Specimens must also be trimmed so that they possess smooth, parallel surfaces onto which measurement gauges can be mounted.

The response of test specimens to load is measured by LVDTs mounted to the face of the specimen (Figure VII-15). Two LVDTs are mounted at right angles on each side of the specimen for a total of four mounted LVDTs. The LVDTs are mounted very close to the surface of the specimen, in no case greater than 6 mm.

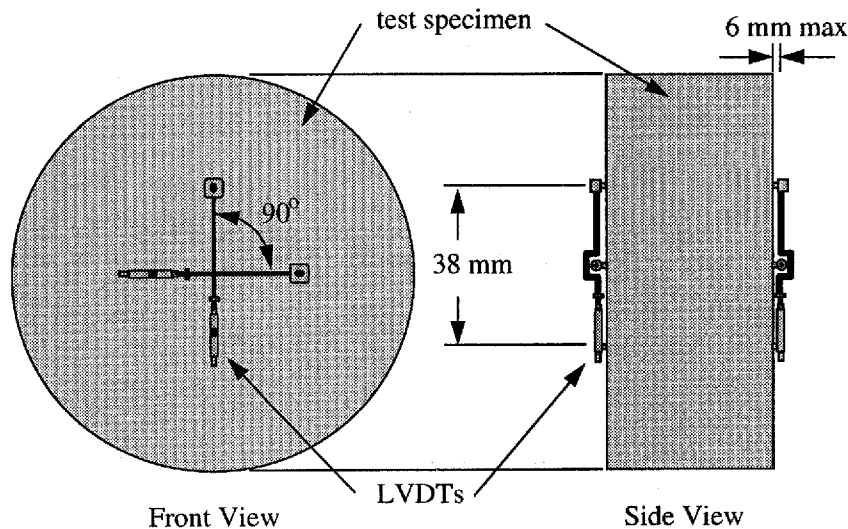

Figure VII-15. Specimen Instrumentation for IDT

Test Procedures

Two tests are performed using the IDT:

- IDT Creep Compliance and Strength at Low Temperatures and
- IDT Strength at Intermediate Temperatures.

A brief description of each test follows.

IDT Creep Compliance and Strength (Low Temperature Cracking Analysis)

This test is used to analyze mixtures for low temperature cracking. It is performed at three temperatures for both levels of mixture design. These temperatures are 0° , -10° , and -20° C.

In the first phase of the test, a static creep load of fixed magnitude is placed on the specimen (Figure VII-16). The magnitude of the load should be that which produces between 50 and 750 horizontal microstrain in the test specimen during the 100 seconds, which is the duration of the creep phase of the test. Vertical and horizontal deformations are measured on both sides of the specimen throughout the test.

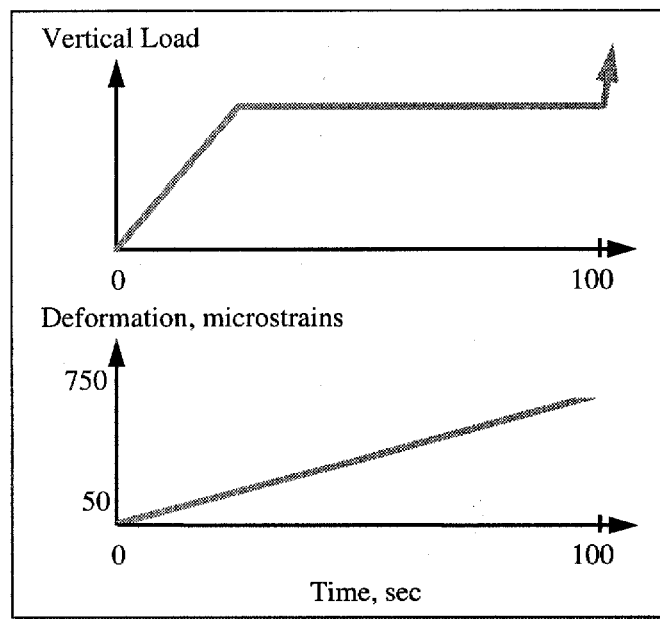

Figure VII-16. Load Controlled Creep Portion of IDT Test

At the conclusion of the creep loading period, the specimen is loaded until failure (peak load) by applying additional load at a rate of 12.5 mm per minute. Vertical and horizontal movements and load are measured. Measurements are taken until the load has decreased to a value of at least 10 percent less than peak load. Figure VII-17 shows the controlled deformation portion of the test.

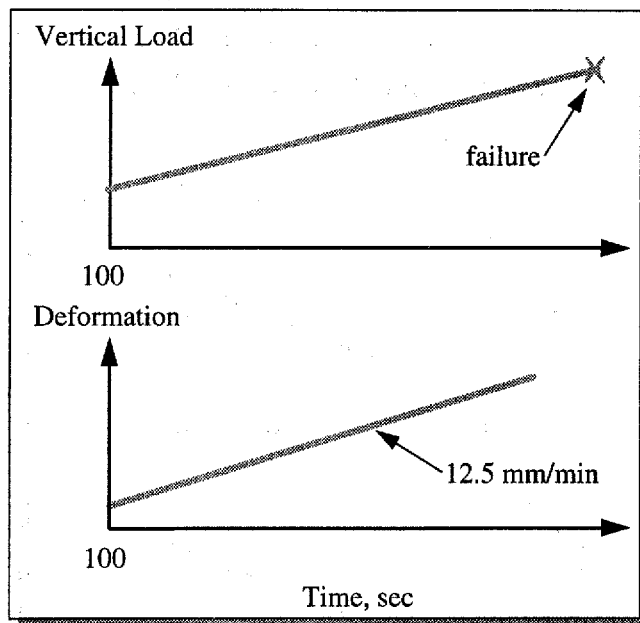

Figure VII-17. Deformation Controlled Failure Portion of IDT Test

In Level 2 mixture design, test specimens are tested for creep compliance at 0°, -10°, and -20° C with tensile strength measured only at -10° C. Level 3 mixture design requires that creep compliance and tensile strength be measured at all three temperatures.

IDT Strength (Fatigue Cracking Analysis)

This test is used to analyze mixtures for fatigue cracking resistance. It is performed at various temperatures ranging from -10° to 20° C. Levels 2 and 3 use different temperatures at which to acquire data as shown in Table VII-7.

Table VII-7. Indirect Tensile Strength Test Parameters

Mix Design Level	Temperature, °C
2	$T_{eff}(FC)$
3	-10, 4, 20

In this test, the specimen is loaded at a constant deformation rate of 50 mm per minute of vertical ram movement. The specimen is loaded until failure, which is the peak load. Load and deformation are measured throughout the test. Figure VII-18 shows the load and deformation characteristics of this test.

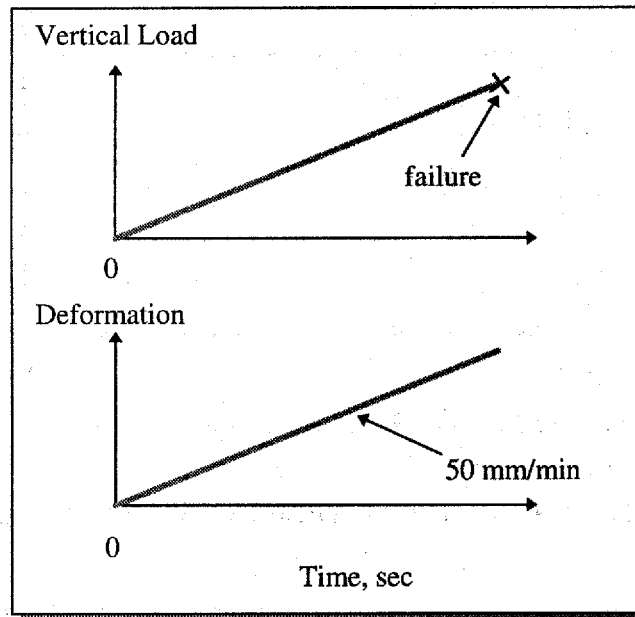

Figure VII-18. Load and Deformation Characteristics of IDT Fatigue Cracking Test

DATA ANALYSIS AND INTERPRETATION

The data collected from performance testing is used by the performance prediction models in Superpave to predict pavement performance for various combinations of asphalt binder and mineral aggregate. Performance plots such as those shown in Figures VII-19, 20, and 21 are used to select a mixture that offers the desired level of performance. In these figures, Materials A, B, and C might be three entirely different materials. If so, the performance prediction would be considered part of an *analysis*

VII. Performance Testing

procedure. This methodology is suited to evaluating the performance effects of aggregate types and proportions, asphalt and mixture modifiers, or any other potentially innovative HMA ingredient.

For the materials represented in Figures VII-19, 20, and 21, no material meets all the distress criteria at the design number of ESALs. However, if distress such as fatigue and low temperature cracking were of most concern, Material C would be a clear choice since it meets the specified performance values. Unfortunately, Material C would exhibit significant rutting after relatively few load applications. Both Materials A and B meet the rutting criterion but they fail the cracking criteria. Because fatigue life is greatly affected by pavement thickness, it may be possible to slightly increase the layer thickness and so that Material B would meet the fatigue cracking criterion.

Alternatively, Materials A, B, and C might be the same aggregate blend with varying asphalt content. Material A has the lowest asphalt content while Material C has the highest asphalt content. Material B has a median value of asphalt content. In that case, the performance prediction would be considered a *design* procedure and three additional design plots would be useful (Figures VII-22). These design plots would define the range of asphalt contents meeting performance standards. In this example, an asphalt content approximately two-thirds between B and C would optimize pavement performance. This type of information would also be useful in establishing job control tolerances.

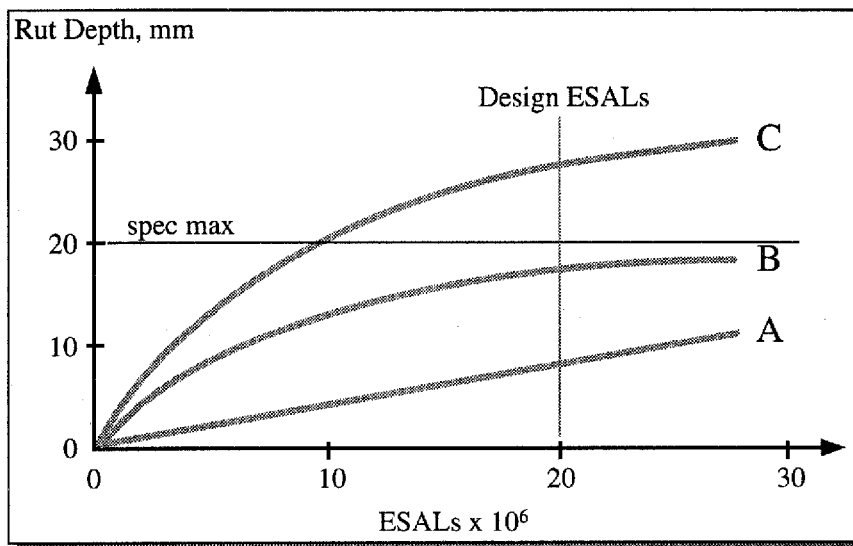

Figure VII-19. Predicted Performance - Permanent Deformation

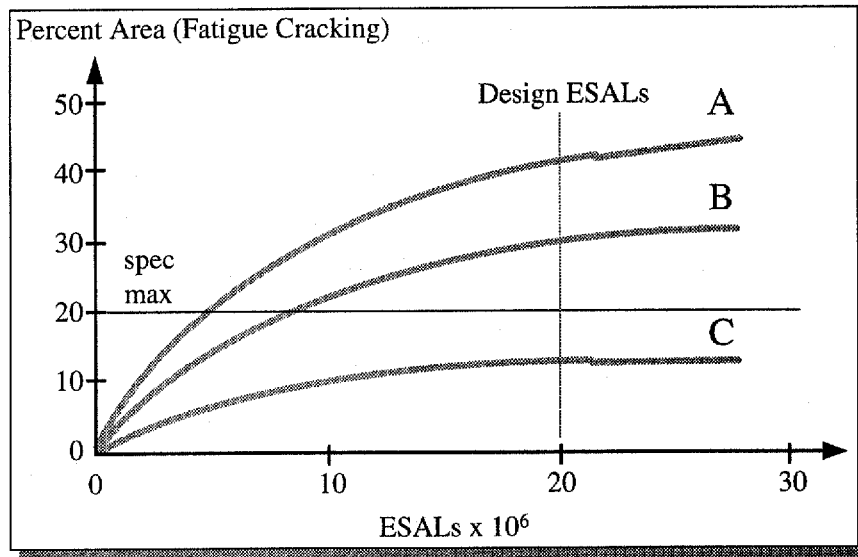

Figure VII-20. Predicted Performance - Fatigue Cracking

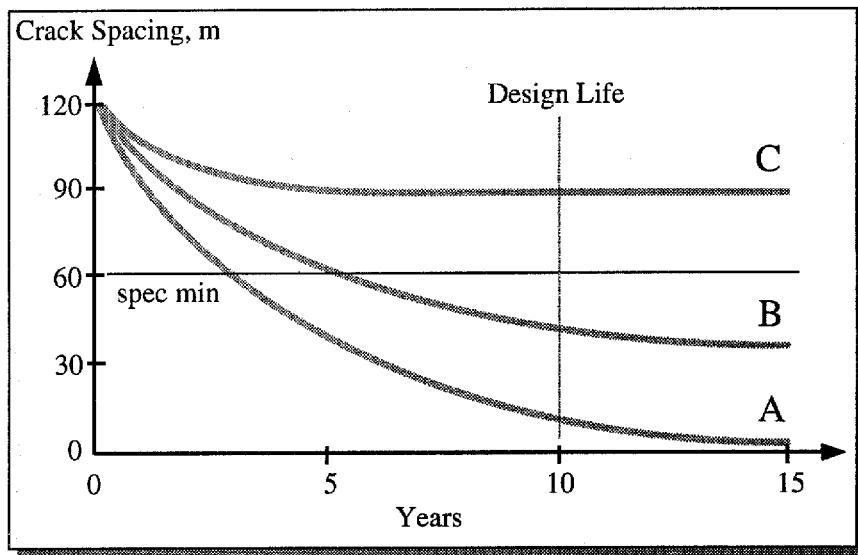

Figure VII-21. Predicted Performance - Low Temperature Cracking

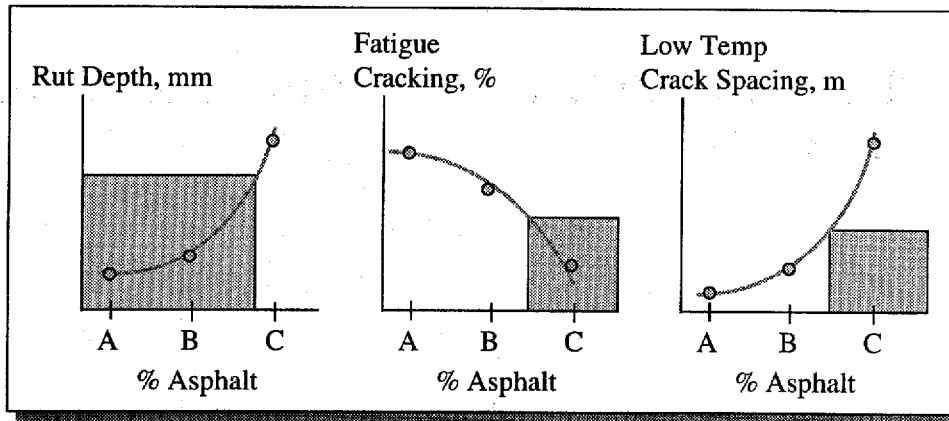

Figure VII-22. Design Chart

APPENDIX A: SUPERPAVE ASPHALT BINDER SPECIFICATION

Performance Graded Binder Specification

Performance Grade	PG 52						PG 58					PG 64					PG 70				
	-10	-16	-22	-28	-34	-40	-46	-16	-22	-28	-34	-40	-16	-22	-28	-34	-40	-10	-16	-22	-28
Average 7-day Maximum Pavement Design Temperature, °C ^a	<52						<58					<64					<70				
Minimum Pavement Design Temperature, °C ^a	>-10	>-16	>-22	>-28	>-34	>-40	>-46	>-16	>-22	>-28	>-34	>-40	>-16	>-22	>-28	>-34	>-40	>-10	>-16	>-22	>-28
Original Binder																					
Flash Point Temp, T48: Minimum °C	230																				
Viscosity, ASTM D 4402: ^b Maximum, 3 Pa·s (3000 cP), Test Temp, °C	135																				
Dynamic Shear, TP5: ^c G*/sin δ, Minimum, 1.00 kPa Test Temperature @ 10 rad/s, °C	52						58					64					70				
Rolling Thin Film Oven (T240) or Thin Film Oven (T179) Residue																					
Mass Loss, Maximum, %	1.00																				
Dynamic Shear, TP5: G*/sin δ, Minimum, 2.20 kPa Test Temp @ 10 rad/sec, °C	52						58					64					70				
Pressure Aging Vessel Residue (PP1)																					
PAV Aging Temperature, °C ^d	90						100					100					100(110)				
Dynamic Shear, TP5: G*/sin δ, Maximum, 5000 kPa Test Temp @ 10 rad/sec, °C	25	22	19	16	13	10	7	25	22	19	16	13	28	25	22	19	16	34	31	28	25
Physical Hardening ^e	Report																				
Creep Stiffness, TP1: ^f S, Maximum, 300 MPa m-value, Minimum, 0.300 Test Temp, @ 60 sec, °C	0	-6	-12	-18	-24	-30	-36	-6	-12	-18	-24	-30	-6	-12	-18	-24	-30	0	-6	-12	-18
Direct Tension, TP3: ^f Failure Strain, Minimum, 1.0% Test Temp @ 1.0 mm/min, °C	0	-6	-12	-18	-24	-30	-36	-6	-12	-18	-24	-30	-6	-12	-18	-24	-30	0	-6	-12	-18

Notes:

- a. Pavement temperatures can be estimated from air temperatures using an algorithm contained in the SUPERPAVE software program or may be provided by the specifying agency, or by following the procedures as outlined in PPX.
- b. This requirement may be waived at the discretion of the specifying agency if the supplier warrants that the asphalt binder can be adequately pumped and mixed at temperatures that meet all applicable safety standards.
- c. For quality control of unmodified asphalt cement production, measurement of the viscosity of the original asphalt cement may be substituted for dynamic shear measurements of G*/sin δ at test temperatures where the asphalt is a Newtonian fluid. Any suitable standard means of viscosity measurement may be used, including capillary or rotational viscometry (AASHTO T 201 or T 202).
- d. The PAV aging temperature is based on simulated climatic conditions and is one of three temperatures 90° C, 100° C or 110° C. The PAV aging temperature is 100° C for PG 58- and above, except in desert climates, where it is 110° C.
- e. Physical Hardening - TP 1 is performed on a set of asphalt beams according to Section 13.1, except the conditioning time is extended to 24 hrs ± 10 minutes at 10° C above the minimum performance temperature. The 24-hour stiffness and m-value are reported for information purposes only.
- f. If the creep stiffness is below 300 MPa, the direct tension test is not required. If the creep stiffness between 300 and 600 MPa the direct tension failure strain requirement can be used in lieu of the creep stiffness requirement. The m-value requirement must be satisfied in both cases.

APPENDIX B: SUPERPAVE ASPHALT MIXTURE GRADATION REQUIREMENTS

37.5 MM NOMINAL SIZE

Sieve, mm	Control Points		Restricted Zone Boundary	
			Minimum	Maximum
50		100.0		
37.5	90.0	100.0		
25				
19				
12.5				
9.5				
4.75			34.7	34.7
2.36	15.0	41.0	23.3	27.3
1.18			15.5	21.5
0.600			11.7	15.7
0.300			10	10
0.150				
0.075	0.0	6.0		

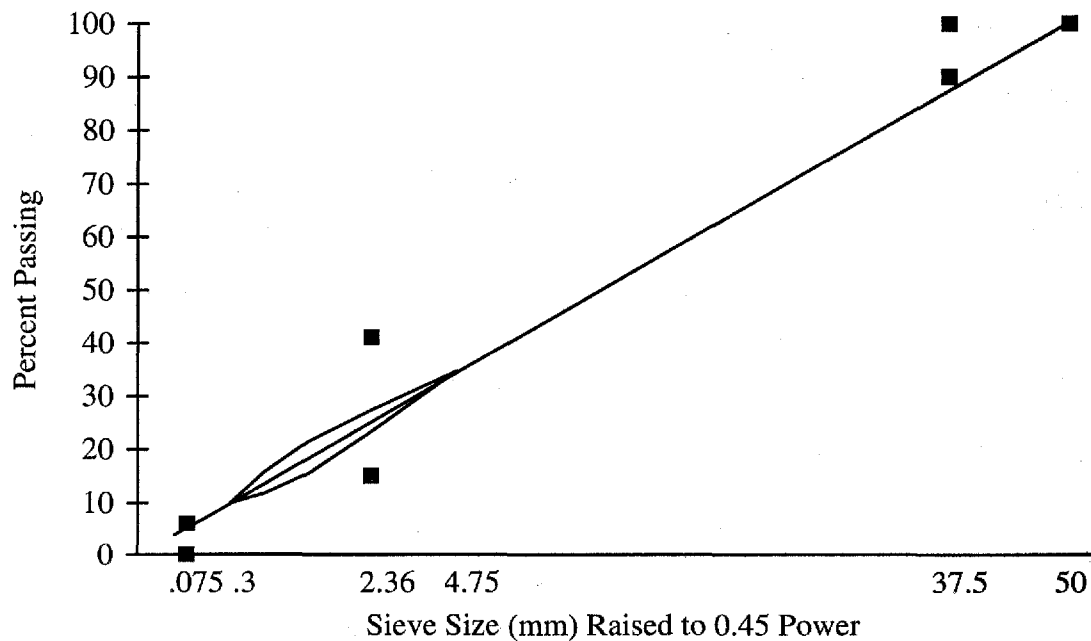

25 MM NOMINAL SIZE

Sieve, mm	Control Points		Restricted Zone Boundary	
			Minimum	Maximum
37.5		100.0		
25	90.0	100.0		
19				
12.5				
9.5				
4.75			39.5	39.5
2.36	19.0	45.0	26.8	30.8
1.18			18.1	24.1
0.600			13.6	17.6
0.300			11.4	11.4
0.150				
0.075	1.0	7.0		

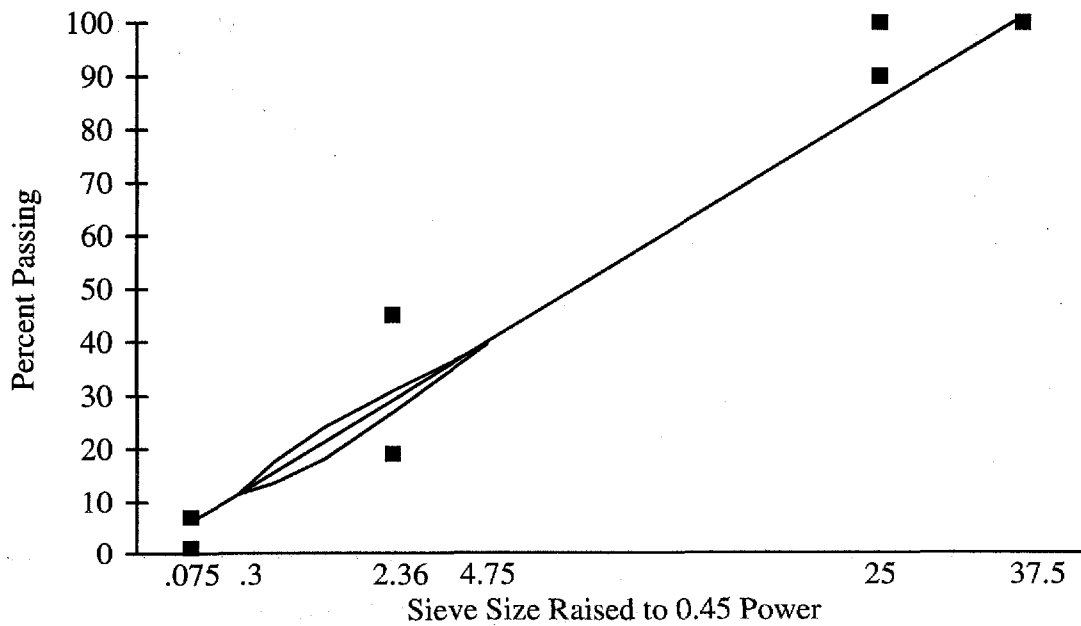

19 MM NOMINAL SIZE

Sieve, mm	Control Points		Restricted Zone Boundary	
			Minimum	Maximum
25		100.0		
19	90.0	100.0		
12.5				
9.5				
4.75				
2.36	23.0	49.0	34.6	34.6
1.18			22.3	28.3
0.600			16.7	20.7
0.300			13.7	13.7
0.150				
0.075	2.0	8.0		

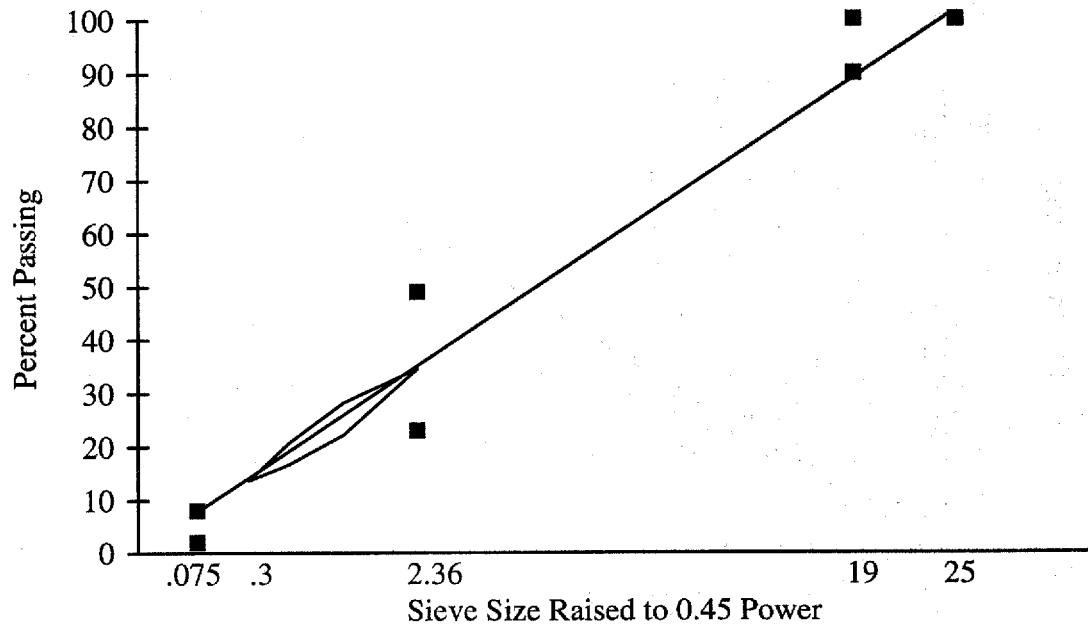

12.5 MM NOMINAL SIZE

Sieve, mm	Control Points		Restricted Zone Boundary	
			Minimum	Maximum
19		100.0		
12.5	90.0	100.0		
9.5				
4.75				
2.36	28.0	58.0	39.1	39.1
1.18			25.6	31.6
0.600			19.1	23.1
0.300			15.5	15.5
0.150				
0.075	2.0	10.0		

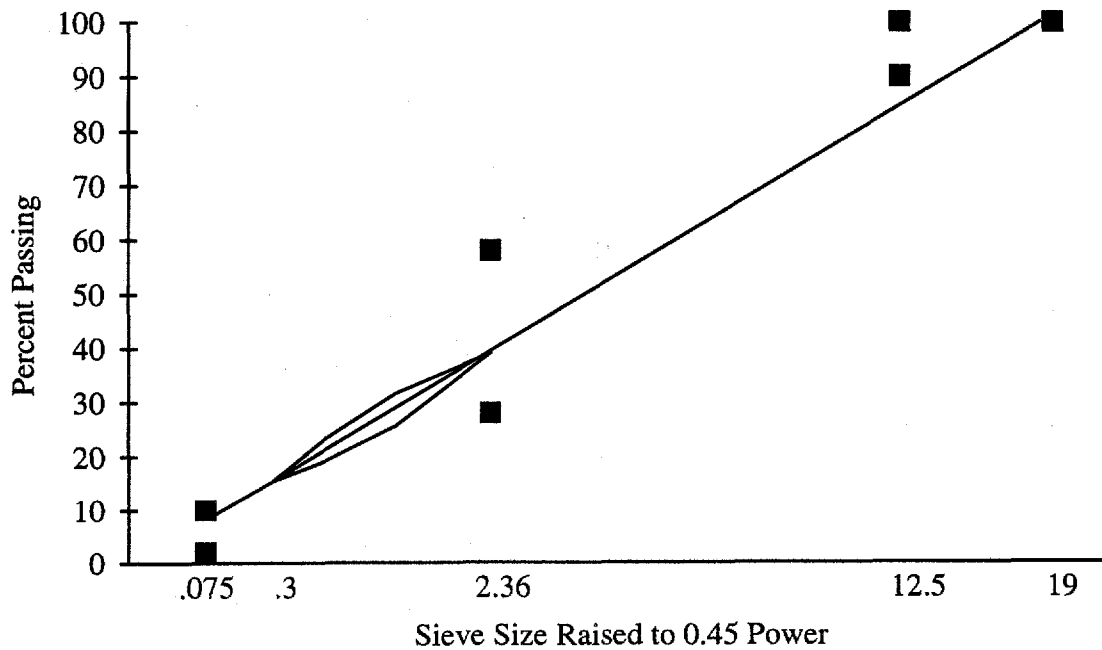

9.5 MM NOMINAL SIZE

Sieve, mm	Control Points		Restricted Zone Boundary	
			Minimum	Maximum
12.5		100.0		
9.5	90.0	100.0		
4.75				
2.36	32.0	67.0	47.2	47.2
1.18			31.6	37.6
0.600			23.5	27.5
0.300			18.7	18.7
0.150				
0.075	2.0	10.0		

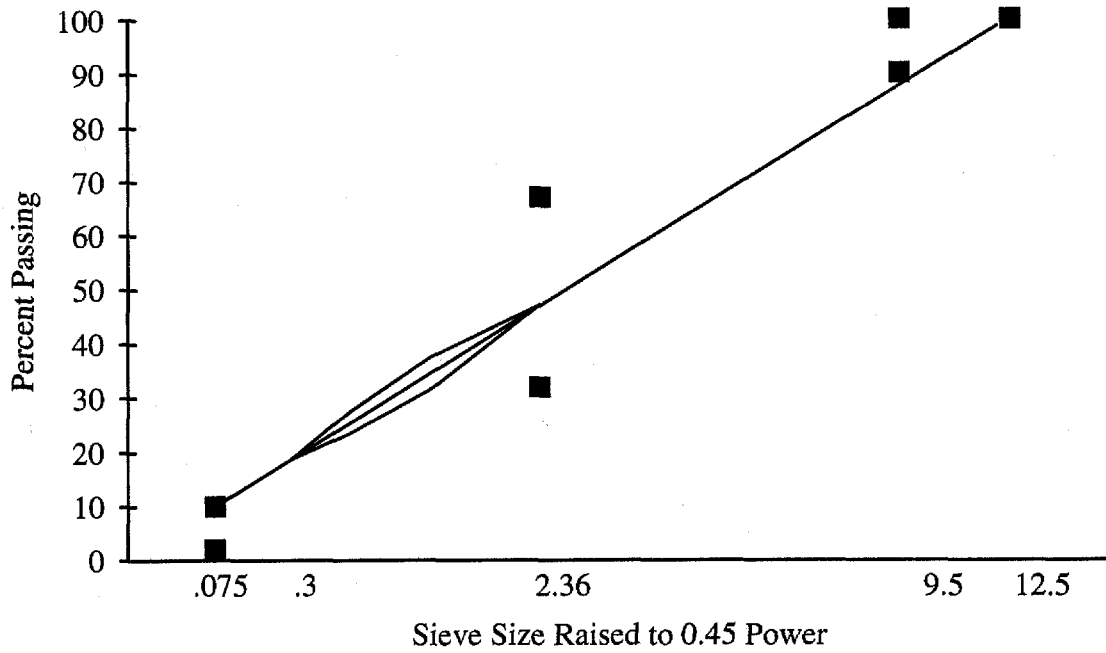



APPENDIX C: SUPERPAVE CONSENSUS AGGREGATE REQUIREMENTS

COARSE AGGREGATE ANGULARITY

Coarse Aggregate Angularity:		
Traffic, million ESALs	Depth from Surface	
	< 100 mm	> 100 mm
< 0.3	55/-	-/-
< 1	65/-	-/-
< 3	75/-	50/-
< 10	85/80	60/-
< 30	95/90	80/75
< 100	100/100	95/90
≥ 100	100/100	100/100

Note: "85/80" denotes that 85 % of the coarse aggregate has one fractured face and 80 % has two fractured faces.

FINE AGGREGATE ANGULARITY

Fine Aggregate Angularity:		
Traffic million, ESALs	Depth from Surface	
	< 100 mm	> 100 mm
< 0.3	-	-
< 1	40	-
< 3	40	40
< 10	45	40
< 30	45	40
< 100	45	45
≥ 100	45	45

Note: Criteria are presented as percent air voids in loosely compacted fine aggregate.

FLAT AND ELONGATED PARTICLES

Flat, Elongated Particles	
Traffic, million ESALs	Percent
< 0.3	-
< 1	-
< 3	10
< 10	10
< 30	10
< 100	10
≥ 100	10

Note: Criteria are presented as maximum percent by weight of flat and elongated particles.

CLAY CONTENT

Clay Content	
Traffic, million ESALs	Sand Equivalent, minimum
< 0.3	40
< 1	40
< 3	40
< 10	45
< 30	45
< 100	50
≥ 100	50

APPENDIX D: VOLUMETRIC ANALYSIS OF COMPACTED HOT MIX ASPHALT (HMA)

DESCRIPTION OF TERMS

Term	Identifier	Description
Air Voids	P_a or V_a	total volume of the small air pockets between coated aggregate particles; expressed as a percentage of the bulk volume of the compacted paving mixture
Voids in the Mineral Aggregate	VMA	the volume of inter granular void space between the aggregate particles of a compacted paving mixture that includes the air voids and effective asphalt content; expressed as a percentage of the total volume of the compacted paving mixture
Effective Asphalt Content	P_{bc}	the total asphalt content of the paving mixture less the portion of asphalt binder that is absorbed by the aggregate particles; expressed as a percentage of the total weight of the compacted paving mixture
Voids Filled with Asphalt	P_{fa} or VFA	the portion of the VMA that contains asphalt binder; expressed as a percentage of the total volume of mix or VMA
Aggregate Bulk Specific Gravity	G_{sb}	the ratio of the mass in air of a unit volume of aggregate, including permeable and impermeable voids, to the mass of an equal volume of water, both at the same temperature
Aggregate Effective Specific Gravity	G_{se}	the ratio of the mass in air of a unit volume of aggregate, excluding voids permeable to asphalt, to the mass of an equal volume of water, both at the same temperature
Asphalt Binder Specific Gravity	G_b	the ratio of the mass in air of a given volume of asphalt binder to the mass of an equal volume of water, both at the same temperature

Mixture Bulk Specific Gravity	G_{mb}	the ratio of the mass in air of a given volume of compacted HMA to the mass of an equal volume of water, both at the same temperature
Theoretical Maximum Specific Gravity of the Mix	G_{mm}	the ratio of the mass of a given volume of HMA with no air voids to the mass of an equal volume of water, both at the same temperature
Volume of Absorbed Asphalt	V_{ba}	the volume of asphalt binder that has been absorbed into the pores of the aggregate

STANDARD CONVENTIONS

The following conventions are used to abbreviate binder, aggregate, and mixture characteristics.

Specific Gravity (G): G_{xy}

x - b = binder
 s = aggregate (i.e., stone)
 m = mixture

y - b = bulk
 e = effective
 a = apparent
 m = maximum theoretical

Mass (P) or Volume (V) Concentration: P_{xy} or V_{xy}

x - b = binder
 s = aggregate (i.e., stone)
 a = air

y - e = effective
 a = absorbed

(note: standard conventions do not apply to V_{ba} and P_{fa})

CALCULATIONS

The following equations are necessary to compute the volumetric properties of compacted HMA:

Bulk Specific Gravity of the combined aggregate (G_{sb}):

$$G_{sb} = \frac{(P_1 + P_2 + P_3)}{\left[\frac{P_1}{G_1} + \frac{P_2}{G_2} + \frac{P_3}{G_3} \right]}$$

where, P_i = percent by mass of each component aggregate in blend

(note: $P_1 + P_2 + P_3 = 100$)

$G_i = G_{sb}$ of each component aggregate in blend

Effective Specific Gravity (G_{se}):

$$G_{se} = \frac{(100 - P_b)}{\left(\frac{100}{G_{mm}} - \frac{P_b}{G_b} \right)}$$

where, P_b = percent by mass total mix of asphalt binder in mix,

G_b = specific gravity of asphalt binder, and

G_{mm} = maximum theoretical specific gravity of mixture at P_b .

Maximum Theoretical Specific Gravity (G_{mm}):

$$G_{mm} = \frac{100}{\left(\frac{P_s}{G_{se}} + \frac{P_b}{G_b} \right)}$$

Percent Absorbed Asphalt (P_{ba}):

$$P_{ba} = \frac{(100G_b)(G_{se} - G_{sb})}{(G_{sb}G_{se})}$$

where P_{ba} = percent absorbed asphalt by total mass of aggregate

Percent Effective Asphalt Content (P_{be}):

$$P_{be} = P_b - \left[\frac{(P_{ba} P_s)}{100} \right]$$

where, P_{be} = percent effective asphalt by total mass of mix,
 P_b = percent asphalt content in mix by mass of total mix, and
 P_s = percent aggregate content in mix by mass of total mix.

Voids in the Mineral Aggregate (VMA):

$$VMA = 100 - \left[\frac{(G_{mb} P_s)}{G_{sb}} \right]$$

where, G_{mb} = bulk specific gravity of compacted mix.

Percent Air Voids (P_a):

$$P_a = 100 \left[\frac{(G_{mm} - G_{mb})}{G_{mm}} \right]$$

(Note: P_a is sometimes abbreviated V_a)

Percent Voids Filled with Asphalt (P_{fa}):

$$P_{fa} = 100 \left[\frac{VMA - P_a}{VMA} \right]$$

(Note: P_{fa} is often called VFA)

Dust Proportion:

$$DP = \left[\frac{P_{.075}}{P_{be}} \right]$$

where, $P_{.075}$ = percent by mass of total aggregate passing 0.075 mm sieve, and
 P_{be} = percent effective asphalt content by mass total mix.

(Note: The 0.075 mm sieve is often called the 75 micron sieve).

APPENDIX E: OUTLINE OF STEPS IN SUPERPAVE LEVEL 1 MIX DESIGN

I. SELECTION OF MATERIALS

A. Selection of Asphalt Binder

1. Determine project weather conditions using weather database
2. Select reliability
3. Determine design temperatures
4. Verify asphalt binder grade
5. Temperature-viscosity relationship for lab mixing and compaction

B. Selection of Aggregates

1. Consensus properties
 - a. Combined gradation
 - b. Coarse aggregate angularity
 - c. Fine aggregate angularity
 - d. Flat and elongated particles
 - e. Clay content
2. Agency and Other properties
 - a. Specific gravity
 - b. Toughness
 - c. Soundness
 - d. Deleterious materials
 - e. Other

C. Selection of Modifiers

II. SELECTION OF DESIGN AGGREGATE STRUCTURE

A. Establish Trial Blends

1. Develop three blends
2. Evaluate combined aggregate properties

B. Compact Trial Blend Specimens

1. Establish trial asphalt binder content
 - a. Superpave method
 - b. Engineering judgment method
2. Establish trial blend specimen size
3. Determine N_{initial} & N_{design} & N_{maximum}
4. Batch trial blend specimens
5. Compact specimens and generate densification tables
6. Determine mixture properties (G_{mm} & G_{mb})

C. Evaluate Trial Blends

1. Determine %G_{mm} @ N_{initial} & N_{design} & N_{maximum}
2. Determine %Air Voids and %VMA
3. Estimate asphalt binder content to achieve 4% air voids
4. Estimate mix properties @ estimated asphalt binder content
5. Determine dust-asphalt ratio
6. Compare mixture properties to criteria

D. Select Most Promising Design Aggregate Structure for Further Analysis

III. SELECTION OF DESIGN ASPHALT BINDER CONTENT

A. Compact Design Aggr Structure Specimens Multiple Binder Contents

1. Batch design aggregate structure specimens
2. Compact specimens and generate densification tables

B. Determine Mixture Properties versus Asphalt Binder Content

1. Determine %G_{mm} @ N_{initial} & N_{design} & N_{maximum}
2. Determine volumetric properties
3. Determine dust-asphalt ratio
4. Graph mixture properties versus asphalt binder content

C. Select Design Asphalt Binder Content

1. Determine asphalt binder content at 4% air voids
2. Determine mixture properties at selected asphalt binder content
3. Compare mixture properties to criteria

IV. EVALUATION OF MOISTURE SENSITIVITY OF DESIGN ASPHALT MIXTURE USING AASHTO T283

APPENDIX F: TESTING REQUIREMENTS FOR SUPERPAVE

SUPERPAVE LEVEL 1

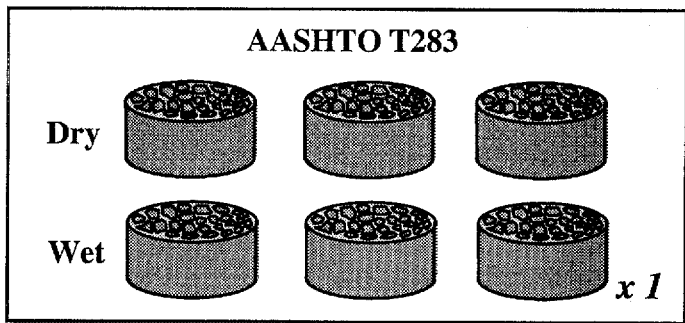
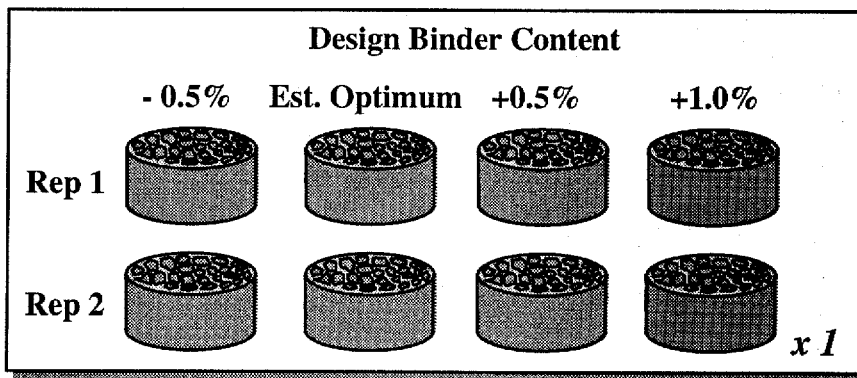
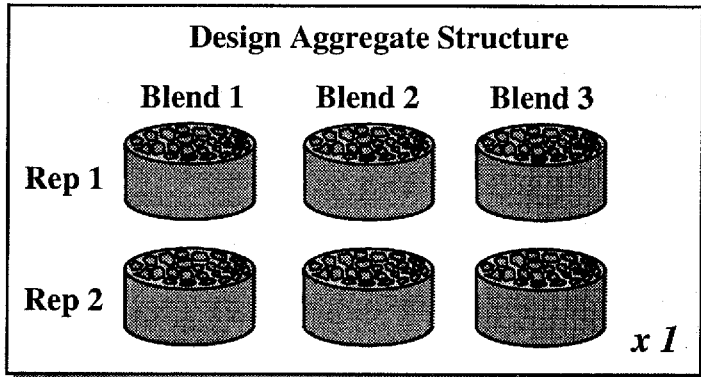

Total Specimens = 20

SUPERPAVE LEVEL 2

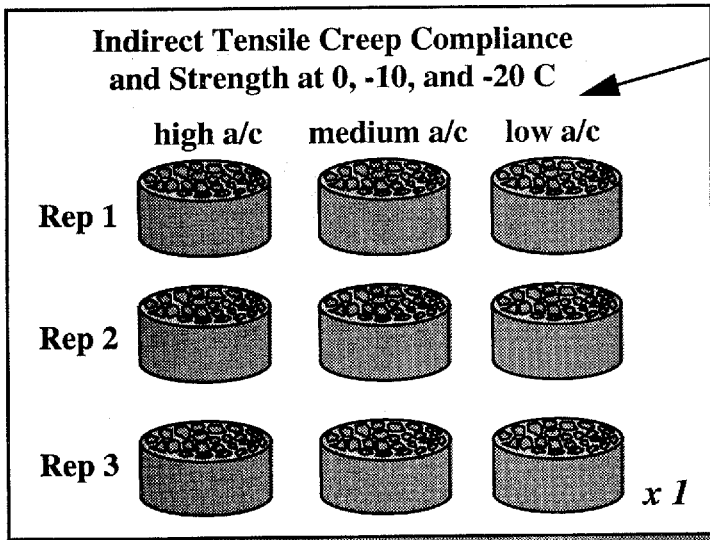
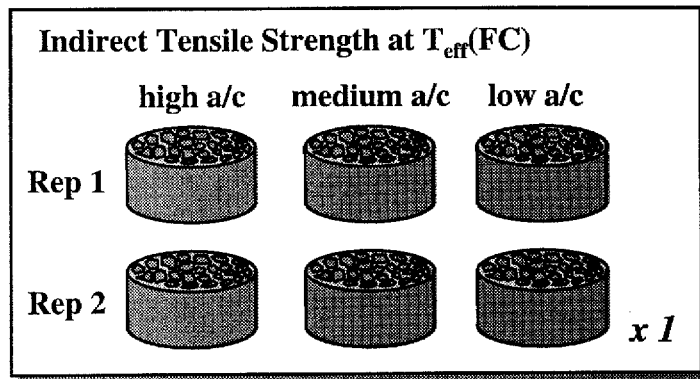
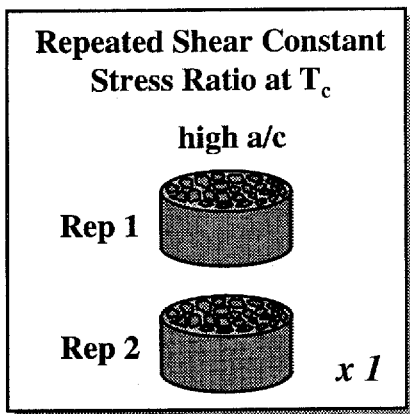
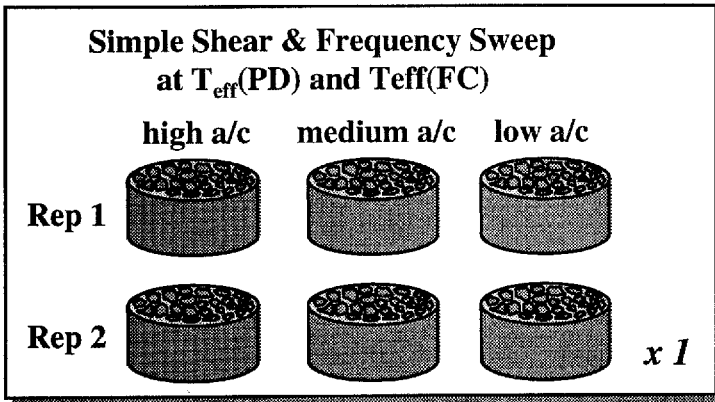

test strength at -10 C only

Total Specimens = 23

SUPERPAVE LEVEL 3

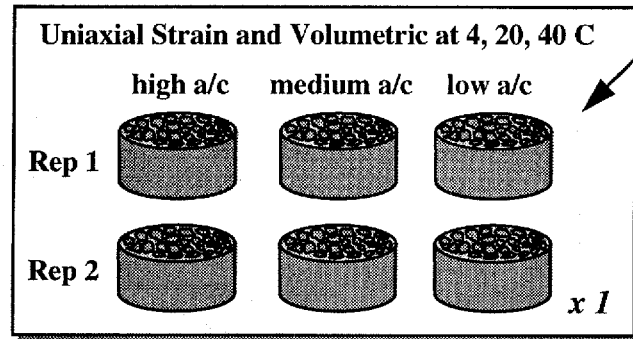
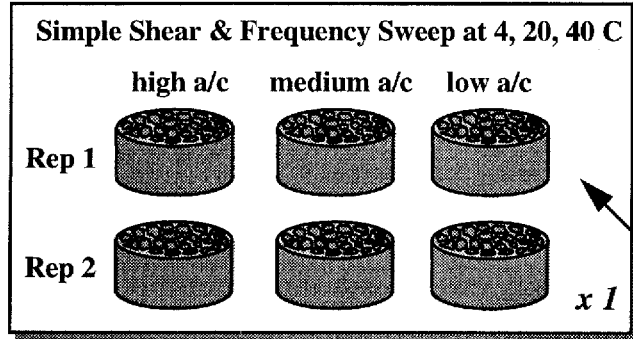

use same specimen at each of three temps

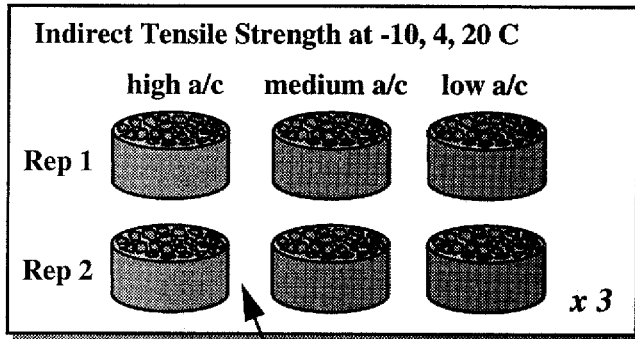
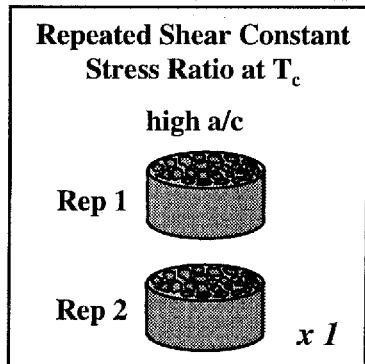

use different specimens at each of three temps

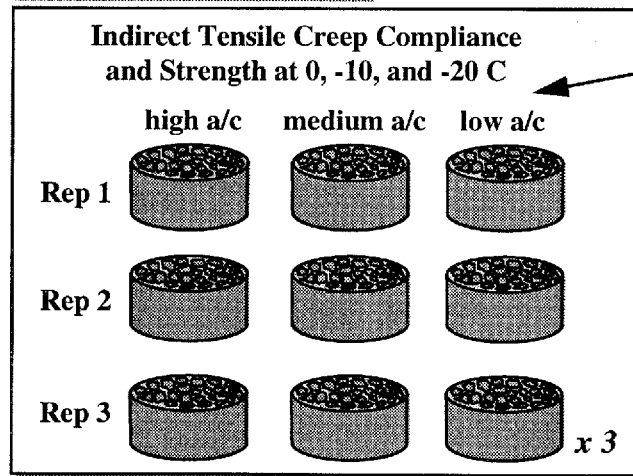

Total Specimens = 59



BIBLIOGRAPHY

1. R. J. Cominsky, G. A. Huber, T. W. Kennedy, and R. M. Anderson, "The Superpave Mix Design Manual for New Construction and Overlays," Strategic Highway Research Program, SHRP-A-407, 1994. *This is an important manual that describes the details of Superpave mix design and analysis. It is essential for those who are interested in or will be intimately involved in mix designs of the future.*
2. T. W. Kennedy, G. A. Huber, E. T. Harrigan, R. J. Cominsky, C. S. Hughes, H. L. Von Quintus, and J. S. Moulthrop, "Superior Performing Asphalt Pavements (Superpave): The Product of the SHRP Asphalt Research Program," Strategic Highway Research Program, SHRP-A-410, 1994. *This report provides a broad overview of the Superpave system including binder and mixture analysis. It explains special approaches necessary in Superpave for handling modified binder and mixture systems.*
3. G. A. Huber, "Weather Database for the Superpave Mix Design System," Strategic Highway Research Program, SHRP-A-648A, 1994. *This report describes how weather station data is used for the purpose of Superpave binder selection. It lists binder selection weather database parameters for 5313 United States and 1515 Canadian weather stations. This is an important information source for those interested in understanding weather based Superpave binder selection.*
4. R. J. Cominsky, R. B. Leahy, and E. T. Harrigan, "Level One Mix Design: Materials Selection, Compaction, and Conditioning," Strategic Highway Research Program, SHRP-A-408, 1994. *This report describes the background of many features found in Superpave Level 1 mix design. It relates important information pertaining to aggregate selection, gyratory compaction, aging, and moisture sensitivity.*
5. J. D'Angelo, J. R. Bukowski, and T. Harman, "Superpave Level 1 Mixture Design Workshop, Illinois #9402B," Federal Highway Administration, Office of Technology Applications, Demonstration Project No. 90, July 1994. *This report, developed by FHWA/OTA, provides very useful, practical Level 1 mix design information. It also provides a good list of standard AASHTO and ASTM test procedures for performing Superpave mix design. It is available through FHWA/OTA.*
6. D. A. Anderson, D. W. Christensen, H. U. Bahia, R. Dongre, M. G. Sharma, C. E. Antle, and J. Button, "Binder Characterization and Evaluation, Volume 3: Physical Characterization," Strategic Highway Research Program, SHRP-A-369, 1994. *This report explains the science and engineering behind the Superpave method of binder characterization. It is a very important resource for those who are interested in understanding more about asphalt binder rheology, particularly as generalized by the Superpave system.*

7. R. L. Lytton, J. Uzan, E. G. Fernando, R. Roque, D. Hiltunen, and S. M. Stoffels, "Development and Validation of Performance Prediction Models and Specifications for Asphalt Binders and Paving Mixes," Strategic Highway Research Program, SHRP-A-357, 1993. *This report explains the methodology and theory of the pavement performance prediction algorithms in Superpave Levels 2 and 3 mix design. It is a must for those who intend to use this important new tool for asphalt mix design and analysis.*
8. R. B. Leahy and H. L. Von Quintus, "Validation of Relationships Between Specification Properties and Performance," Strategic Highway Research Program, SHRP-A-409, 1994. *This report outlines the two-stage process and results used to validate Superpave binder and mixture tests and specifications.*
9. E. T. Harrigan, R. B. Leahy, and J. S. Youcheff, "The Superpave Mix Design System Manual of Specifications, Test Methods, and Practices," Strategic Highway Research Program, SHRP-A-379, 1994. *This report lists the Superpave binder and mixture tests as produced by SHRP researchers. It is a valuable tool for practitioners who desire to know the exact protocols recommended by SHRP researchers. However, users are cautioned that many changes have occurred to these test procedures as they have been adopted by AASHTO.*
10. The Asphalt Institute, "Mix Design Methods for Asphalt Concrete and Other Hot-Mix Types," Manual Series No. 2 (MS-2), Sixth Edition, 1993. *While this manual is mostly devoted to Marshall and Hveem methods of mix design, its chapter on volumetric properties of compacted paving mixes remains one of the best available sources on this important subject.*

SHRP publications are available through the Transportation Research Board.

RBM/hc



Printed By
Federal Highway Administration
Office of Technology Applications
U.S. Department of Transportation
400 Seventh Street, SW
Washington, D.C. 20590

HTA-21/5-95(4M)QE