

---

# Prediction of Chloride Penetration in Concrete

---

PUBLICATION NO. FHWA-RD-00-142

OCTOBER 2001



U.S. Department of Transportation  
**Federal Highway Administration**

Research, Development, and Technology  
Turner-Fairbank Highway Research Center  
6300 Georgetown Pike  
McLean, VA 22101-2296

## FOREWORD

This report presents the results of a study conducted for the Federal Highway Administration to identify or develop a test method to predict the chloride penetration resistance of concrete in a short time frame (less than 35 days). The test was to be applicable for evaluating new mixes, for accepting or rejecting new concrete, and for evaluating in-place concrete. This report will be of interest to materials engineers and others who are involved in design, construction, and evaluation of concrete susceptible to corrosion.

In the first phase of the project, a literature review was performed and a number of tests identified in the literature were subjected to a preliminary screening process. Those methods identified as promising were subjected to a more rigorous evaluation over a wide range of concrete mixtures, and the test identified as the most promising was then further examined and refined. As a result of this work, the Rapid Migration Test (RMT) was identified as most successful. It correlated as well or better than AASHTO T277 with long-term ponding tests and was able to evaluate correctly a wider variety of concretes, including those containing corrosion inhibitors. An interlaboratory evaluation of the method was also included in the study.



T. Paul Teng, P.E.  
Director, Office of Infrastructure  
Research and Development

## NOTICE

This document is disseminated under the sponsorship of the Department of Transportation in the interest of information exchange. The United States Government assumes no liability for its contents or use thereof. This report does not constitute a standard, specification, or regulation.

The United States Government does not endorse products or manufacturers. Trade and manufacturers' names appear in this report only because they are considered essential to the object of the document.

**Technical Report Documentation Page**

1. Report No. FHWA-RD-00-142		2. Government Accession No.		3. Recipient's Catalog No.	
4. Title and Subtitle PREDICTION OF CHLORIDE PENETRATION IN CONCRETE				5. Report Date October 2001	
				6. Performing Organization Code 480017	
7. Author(s) R.D. Hooton, M.D.A Thomas, K. Stanish				8. Performing Organization Report No.	
9. Performing Organization Name and Address University of Toronto, Department of Civil Engineering 35 St. George St. Toronto, ON M5S 1A4 Canada				10. Work Unit No. (TRAIS)	
				11. Contract or Grant No. DTFH61-97-R-00022	
12. Sponsoring Agency Name and Address Federal Highway Administration Office of Infrastructure R&D 6300 Georgetown Pike McLean, VA 22101				13. Type of Report and Period Covered Final Report Sept. 1997 - Sept. 2000	
				14. Sponsoring Agency Code	
15. Supplementary Notes Contracting Officer's Technical Representatives (COTRs): Susan Lane (HRDI-06) and Marcia Simon (HRDI-12)					
16. Abstract <p>The objective of this study was to identify or develop a test for predicting chloride penetration in concrete, to be used for evaluating new mixes, for accepting or rejecting new concrete according to specifications, and for evaluating in-place concrete. The test was intended to supplement or replace the use of AASHTO T27-93 "Electrical Indication of Concrete's Ability to Resist Chloride." In this study, different test procedures were evaluated for use in predicting the chloride penetration resistance of concrete in a short time frame (less than 35 days). The test results were correlated to those of long-term salt ponding and diffusion tests.</p> <p>In the first phase, a number of tests identified in the literature were subjected to a preliminary screening process. In the second phase, test identified as promising were subjected to a more rigorous evaluation. In the third phase, the best test procedure was further examined. As a result of this work, the Rapid Migration Test (RMT) was identified as the most successful. The RMT involves using an electrical potential to drive chloride ions into a concrete sample for a specific test duration and then evaluating the depth of chloride penetration with a colorimetric indicator. The RMT correlates as well or better than AASHTO T277 with the long term ponding tests and was able to evaluate correctly a wider variety of concretes, including those with corrosion inhibitors. The quantitative parameter obtained in the RMT was related to those from AASHTO T277 in the high performance concrete (HPC) grades identified by Goodspeed, Vanikar, and Cook (1996).</p> <p>As part of the work described above, an interlaboratory evaluation was performed to assess the RMT and to refine the procedure.</p>					
17. Key Words Concrete, high-performance concrete, chloride penetration, testing, quality control, corrosion			18. Distribution Statement No restrictions. This document is available to the public through the National Technical Information Service, Springfield, Virginia, 22161		
19. Security Classif. (of this report) Unclassified		20. Security Classif. (of this page) Unclassified		21. No. of Pages 412	22. Price

# SI\* (MODERN METRIC) CONVERSION FACTORS

APPROXIMATE CONVERSIONS TO SI UNITS					APPROXIMATE CONVERSIONS FROM SI UNITS				
Symbol	When You Know	Multiply By	To Find	Symbol	Symbol	When You Know	Multiply By	To Find	Symbol
<b>LENGTH</b>					<b>LENGTH</b>				
in	inches	25.4	millimeters	mm	mm	millimeters	0.039	inches	in
ft	feet	0.305	meters	m	m	meters	3.28	feet	ft
yd	yards	0.914	meters	m	m	meters	1.09	yards	yd
mi	miles	1.61	kilometers	km	km	kilometers	0.621	miles	mi
<b>AREA</b>					<b>AREA</b>				
in <sup>2</sup>	square inches	645.2	square millimeters	mm <sup>2</sup>	mm <sup>2</sup>	square millimeters	0.0016	square inches	in <sup>2</sup>
ft <sup>2</sup>	square feet	0.093	square meters	m <sup>2</sup>	m <sup>2</sup>	square meters	10.764	square feet	ft <sup>2</sup>
yd <sup>2</sup>	square yards	0.836	square meters	m <sup>2</sup>	m <sup>2</sup>	square meters	1.195	square yards	yd <sup>2</sup>
ac	acres	0.405	hectares	ha	ha	hectares	2.47	acres	ac
mi <sup>2</sup>	square miles	2.59	square kilometers	km <sup>2</sup>	km <sup>2</sup>	square kilometers	0.386	square miles	mi <sup>2</sup>
<b>VOLUME</b>					<b>VOLUME</b>				
fl oz	fluid ounces	29.57	milliliters	mL	mL	milliliters	0.034	fluid ounces	fl oz
gal	gallons	3.785	liters	L	L	liters	0.264	gallons	gal
ft <sup>3</sup>	cubic feet	0.028	cubic meters	m <sup>3</sup>	m <sup>3</sup>	cubic meters	35.71	cubic feet	ft <sup>3</sup>
yd <sup>3</sup>	cubic yards	0.765	cubic meters	m <sup>3</sup>	m <sup>3</sup>	cubic meters	1.307	cubic yards	yd <sup>3</sup>
<b>MASS</b>					<b>MASS</b>				
oz	ounces	28.35	grams	g	g	grams	0.035	ounces	oz
lb	pounds	0.454	kilograms	kg	kg	kilograms	2.202	pounds	lb
T	short tons (2000 lb)	0.907	megagrams (or "metric ton")	Mg (or "t")	Mg (or "t")	megagrams (or "metric ton")	1.103	short tons (2000 lb)	T
<b>TEMPERATURE (exact)</b>					<b>TEMPERATURE (exact)</b>				
°F	Fahrenheit temperature	5(F-32)/9 or (F-32)/1.8	Celsius temperature	°C	°C	Celsius temperature	1.8C + 32	Fahrenheit temperature	°F
<b>ILLUMINATION</b>					<b>ILLUMINATION</b>				
fc	foot-candles	10.76	lux	lx	lx	lux	0.0929	foot-candles	fc
fl	foot-Lamberts	3.426	candela/m <sup>2</sup>	cd/m <sup>2</sup>	cd/m <sup>2</sup>	candela/m <sup>2</sup>	0.2919	foot-Lamberts	fl
<b>FORCE and PRESSURE or STRESS</b>					<b>FORCE and PRESSURE or STRESS</b>				
lbf	poundforce	4.45	newtons	N	N	newtons	0.225	poundforce	lbf
lbf/in <sup>2</sup>	poundforce per square inch	6.89	kilopascals	kPa	kPa	kilopascals	0.145	poundforce per square inch	lbf/in <sup>2</sup>

\* SI is the symbol for the International System of Units. Appropriate rounding should be made to comply with Section 4 of ASTM E380.

# Table of Contents

<u>Section</u>	<u>Page</u>
<b>1</b>	<b>1</b>
<b>1.1</b>	<b>1</b>
<b>1.2</b>	<b>2</b>
<b>2</b>	<b>5</b>
<b>2.1</b>	<b>5</b>
<b>2.2</b>	<b>5</b>
2.2.1	5
2.2.2	5
<b>2.3</b>	<b>8</b>
2.3.1	8
2.3.2	10
2.3.3	15
2.3.4	15
2.3.5	24
2.3.6	26
2.3.7	32
2.3.8	35
2.3.9	39
2.3.10	43
2.3.11	33
<b>2.4</b>	<b>44</b>
<b>3</b>	<b>47</b>
<b>3.1</b>	<b>47</b>
<b>3.2</b>	<b>47</b>
<b>3.3</b>	<b>48</b>
<b>4</b>	<b>49</b>
<b>4.1</b>	<b>49</b>
<b>4.2</b>	<b>49</b>
<b>4.3</b>	<b>49</b>
4.3.1	49
4.3.2	51
4.3.3	57
4.3.4	64
4.3.5	73
<b>4.4</b>	<b>79</b>
<b>5</b>	<b>81</b>
<b>5.1</b>	<b>81</b>

## Table of Contents (Continued)

<u>Section</u>		<u>Page</u>
<b>5.2</b>	<b>Testing Program</b>	81
5.2.1	Rapid Migration Test	81
5.2.2	Pressure Penetration Testing	82
<b>5.3</b>	<b>Results</b>	83
5.3.1	RMT Evaluation	83
5.3.2	Pressure Penetration Evaluation	89
<b>5.3</b>	<b>Conclusions</b>	90
<b>6</b>	<b>INTERLABORATORY EVALUATION</b>	91
<b>6.1</b>	<b>Introduction</b>	91
<b>6.2</b>	<b>Preparation of Test Specimens</b>	91
<b>6.3</b>	<b>Laboratory Visits</b>	91
<b>6.4</b>	<b>Interlaboratory Tests</b>	93
<b>6.5</b>	<b>Conclusions</b>	96
<b>7</b>	<b>RAPID MIGRATION TEST PROCEDURE</b>	99
<b>7.1</b>	<b>Concerns of Interlaboratory Evaluators</b>	99
<b>7.2</b>	<b>New Test Procedure</b>	99
7.2.1	Re-evaluation of Phase 3 Data	99
7.2.2	Re-evaluation of Interlaboratory Evaluation Data	102
7.2.3	Modified Test Protocol	102
<b>7.3</b>	<b>Comparison With NTBuild 492</b>	104
<b>7.4</b>	<b>Rating Criteria</b>	104
<b>8</b>	<b>CONCLUSIONS</b>	107
<b>8.1</b>	<b>Long-Term Test Procedures</b>	107
<b>8.2</b>	<b>AASHTO T277 – Rapid Chloride Permeability Tests</b>	108
<b>8.3</b>	<b>Monfore Conductivity Test</b>	108
<b>8.4</b>	<b>Pressure Penetration Test</b>	108
<b>8.5</b>	<b>The CTH/RMT Test</b>	109
<b>9</b>	<b>REFERENCES</b>	111
	<b>APPENDICES</b>	
1	Testing The Chloride Penetration Resistance of Concrete: A Literature Review	113
2	Test Procedures	149
3	Phase 1 Test Data	169
4	Phase 1A Test Data	175
5	Phase 2 Test Data	179

## Table of Contents (Continued)

<u>Section</u>		<u>Page</u>
6	Phase 3 Test Data	187
7	Interlaboratory Evaluation Results	203
8	Re-Evaluated RMT Data	217
9	Rapid Migration Test Procedure and Construction Drawings	221
10	Chloride Profiles	237

## List of Figures

<u>Figure</u>		<u>Page</u>
1	Phase I Concrete Strengths.	9
2	Typical AASHTO T259 Profile.	10
3	Salt Ponding Integrated Chloride vs. 40-Day Bulk Diffusion.	12
4	Salt Ponding Integrated Chloride vs. 90-Day Bulk Diffusion.	12
5	Salt Ponding 'D' vs. 40-Day Bulk Diffusion.	13
6	Salt Ponding 'D' vs. 90-Day Bulk Diffusion.	13
7	Salt Ponding Depth of 0.1 Percent Chloride vs. 40-Day Bulk Diffusion.	14
8	Salt Ponding Depth of 0.1 Percent Chloride vs. 90-Day Bulk Diffusion.	14
9	AASHTO T277 Change With Age.	16
10	Modified AASHTO T277 Change With Age.	16
11	Modified AASHTO T277 vs. Standard AASHTO T277.	17
12	AASHTO T277 vs. 40-Day Bulk Diffusion.	18
13	AASHTO T277 vs. 90-Day Bulk Diffusion.	18
14	AASHTO T277 vs. 365-Day Bulk Diffusion.	19
15	AASHTO T277 vs. 90-Day Salt Ponding Pseudo-D.	19
16	AASHTO T277 vs. 90-Day Salt Ponding Chloride Depth.	20
17	AASHTO T277 vs. 365-Day Salt Ponding Pseudo-D.	20
18	Modified AASHTO T277 vs. 40-Day Bulk Diffusion.	21
19	Modified AASHTO T277 vs. 90-Day Bulk Diffusion.	21
20	Modified AASHTO T277 vs. 365-Day Bulk Diffusion.	22
21	Modified AASHTO T277 vs. 90-Day Salt Ponding Pseudo-D.	22
22	Modified AASHTO T277 vs. 90-Day Salt Ponding Chloride Depth.	23
23	Modified AASHTO T277 vs. 365-Day Salt Ponding Pseudo-D.	23
24	Typical Migration Cell Results.	24
25	CTH Penetration Depth With Test Duration.	26
26	Typical CTH Profile, Showing Actual and Theoretical.	28
27	CTH Depth vs. 40-Day Bulk Diffusion.	28
28	CTH Depth vs. 90-Day Bulk Diffusion.	29
29	CTH Depth vs. 365-Day Bulk Diffusion.	29
30	CTH Depth vs. 90-Day Salt Ponding Pseudo- D.	30
31	CTH Depth vs. 90-Day Salt Ponding Depth of Penetration.	30
32	CTH Depth vs. 365-Day Salt Ponding Pseudo-D.	31
33	Conductivity (Monfore) vs. 40-Day Bulk Diffusion.	32
34	Conductivity (Monfore) vs. 90-Day Bulk Diffusion.	33
35	Conductivity (Monfore) vs. 365-Day Bulk Diffusion.	33
36	Conductivity (Monfore) 90-Day Salt Ponding Pseudo-D.	34
37	Conductivity (Monfore) vs. 90-Day Salt Ponding Depth of Penetration.	34
38	Conductivity (Monfore) vs. 365-Day Salt Ponding Pseudo-D.	35
39	Chloride Conductivity Sample Profiles (Streicher & Alexander).	36
40	Chloride Conductivity (Streicher & Alexander) vs. 40-Day Bulk Diffusion.	36



## List of Figures (Continued)

<u>Figure</u>		<u>Page</u>
41	Chloride Conductivity (Streicher & Alexander) vs. 90-Day Bulk Diffusion.	37
42	Chloride Conductivity (Streicher & Alexander) vs. 365-Day Bulk Diffusion.	37
43	Chloride Conductivity (Streicher & Alexander) vs. 90-Day Salt Ponding Pseudo-D.	38
44	Chloride Conductivity (Streicher and Alexander) vs. 90-Day Salt Ponding Depth of Penetration.	38
45	Chloride Conductivity (Streicher & Alexander) vs. 365-Day Salt Ponding Pseudo-D.	39
46	Wenner Probe Conductivity vs. 40-Day Bulk Diffusion.	40
47	Wenner Probe Conductivity vs. 90-Day Bulk Diffusion.	40
48	Wenner Probe Conductivity vs. 365-Day Bulk Diffusion.	41
49	Wenner Probe Conductivity vs. 90-Day Salt Ponding Pseudo-D.	41
50	Wenner Probe Conductivity vs. 90-Day Salt Ponding Depth of Penetration.	42
51	Wenner Probe Conductivity vs. 365-Day Salt Ponding Pseudo-D.	42
52	Phase 1A Penetration vs. Voltage x Time.	48
53	AASHTO T277 – 28 Days vs. 90-Day Bulk Diffusion Highlighting DCI Subset.	52
54	AASHTO T277 – 28 Days vs. 90-Day Bulk Diffusion Highlighting Metakaolin Subset.	52
55	AASHTO T277 – 118 Days vs. 90-Day Bulk Diffusion Highlighting DCI Subset.	53
56	AASHTO T277 – 393 Days vs. 90-Day Bulk Diffusion Highlighting Steel Subset.	53
57	AAASHTO T277 – 28 Days vs. 365-Day Bulk Diffusion Highlighting SCM Subset.	54
58	AASHTO T277 – 118 Days vs. 365-Day Bulk Diffusion Highlighting SCM Subset.	54
59	AASHTO T277 – 393 Days vs. 365-Day Bulk Diffusion Highlighting SCM Subset.	55
60	AASHTO T277 – 28 Days vs. Salt Ponding Evaluation Highlighting SCM Subset.	55
61	AASHTO T277 – 28 Days vs. Salt Ponding Evaluation Highlighting Silica Fume Subset.	56
62	AASHTO T277 – 118 Days vs. Salt Ponding Evaluation Highlighting SCM Subset.	56
63	AASHTO T277 – 393 Days vs. Salt Ponding Evaluation Highlighting SCM Subset.	57
64	Modified AASHTO T277 – 28 Days vs. 90-Day Bulk Diffusion Highlighting Metakaolin Subset.	58

## List of Figures (Continued)

<u>Figure</u>		<u>Page</u>
65	Modified AASHTO T277 – 28 Days vs. 90-Day Bulk Diffusion Highlighting 7°C Subset.	58
66	Modified AASHTO T277 – 118 Days vs. 90-Day Bulk Diffusion Highlighting DCI Subset.	59
67	Modified AASHTO T277 – 118 Days vs. 90-Day Bulk Diffusion Highlighting Metakaolin Subset.	59
68	Modified AASHTO T277 – 393 Days vs. 90-Day Bulk Diffusion Highlighting DCI Subset.	60
69	Modified AASHTO T277 – 28 Days vs. 365-Day Bulk Diffusion Highlighting SCM Subset.	60
70	Modified AASHTO T277 – 118 Days vs. 365-Day Bulk Diffusion Highlighting SCM Subset.	61
71	Modified AASHTO T277 – 28 Days vs. Salt Ponding Evaluation Highlighting SCM Subset.	61
72	Modified AASHTO T277 – 28 Days vs. Salt Ponding Evaluation Highlighting Silica Fume Subset.	62
73	Modified AASHTO T277 – 118 Days vs. Salt Ponding Evaluation Highlighting SCM Subset.	62
74	Modified AASHTO T277 – 118 Days vs. Salt Ponding Evaluation Highlighting Silica Fume Subset.	63
75	Modified AASHTO T277 – 393 Days vs. Salt Ponding Evaluation.	63
76	Monfore Conductivity – 28 Days vs. 90-Day Bulk Diffusion Highlighting Metakaolin Subset.	65
77	Monfore Conductivity – 118 Days vs. 90-Day Bulk Diffusion Highlighting DCI Subset.	65
78	Monfore Conductivity – 118 Days vs. 90-Day Bulk Diffusion Highlighting Metakaolin Subset.	66
79	Monfore Conductivity – 118 Days vs. 90-Day Bulk Diffusion Highlighting Steel Subset.	66
80	Monfore Conductivity – 393 Days vs. 90-Day Bulk Diffusion Highlighting DCI Subset.	67
81	Monfore Conductivity – 393 Days vs. 90-Day Bulk Diffusion Highlighting Metakaolin Subset.	67
82	Monfore Conductivity – 393 Days vs. 90-Day Bulk Diffusion Highlighting Steel Subset.	68
83	Monfore Conductivity – 118 Days vs. 365-Day Bulk Diffusion Highlighting SCM Subset.	68
84	Monfore Conductivity – 118 Days vs. 365-Day Bulk Diffusion Highlighting Metakaolin Subset.	69
85	Monfore Conductivity – 393 Days vs. 365-Day Bulk Diffusion Highlighting SCM Subset.	69

## List of Figures (Continued)

<u>Figure</u>		<u>Page</u>
86	Monfore Conductivity – 393 Days vs. 365-Day Bulk Diffusion Highlighting Metakaolin Subset.	70
87	Monfore Conductivity – 28 Days vs. Salt Ponding Evaluation Highlighting Silica Fume Subset.	70
88	Monfore Conductivity – 118 Days vs. Salt Ponding Evaluation Highlighting SCM Subset.	71
89	Monfore Conductivity – 393 Days vs. Salt Ponding Evaluation Highlighting SCM Subset.	71
90	Monfore Conductivity – 28 Days vs. 365-Day Bulk Diffusion.	72
91	CTH – 28 Days vs. Salt Ponding Evaluation Highlighting Elevated Temperature Subset.	74
92	CTH – 118 Days vs. Salt Ponding Evaluation Highlighting 7°C Subset.	74
93	CTH – 28 Days vs. 90-Day Bulk Diffusion Coefficients.	75
94	CTH – 118 Days vs. 90-Day Bulk Diffusion Coefficients.	76
95	CTH – 393 Days vs. 90-Day Bulk Diffusion.	76
96	CTH – 28 Days vs. 365-Day Bulk Diffusion.	77
97	CTH – 118 Days vs. 365-Day Bulk Diffusion.	77
98	CTH – 393 Days vs. 365-Day Bulk Diffusion.	78
99	CTH – 393 Days vs. Salt Ponding Evaluation.	78
100	RMT Evaluation, 28 Days vs. 90-Day Bulk Diffusion.	84
101	RMT Evaluation, 28 Days vs. Salt Ponding Evaluation.	85
102	AASHTO T277, 28 Days vs. 90-Day Bulk Diffusion.	85
103	AASHTO T277, 28 Days vs. Salt Ponding Evaluation.	86
104	Modified AASHTO T277, 28 Days vs. 90-Day Bulk Diffusion.	86
105	Modified AASHTO T277, 28 Days vs. Salt Ponding Evaluation.	87
106	Monfore Conductivity, 28 Days vs. 90-Day Bulk Diffusion.	87
107	Monfore Conductivity, 28 Days vs. Salt Ponding Evaluation.	88
108	Results of First Set of Cylinders – Mix # 1.	95
109	Results of Second Set of Cylinders – Mix # 2.	95
110	Phase 3 – Different Evaluation Procedures.	100
111	Phase 3 – Single-Point RMT Rate of Penetration vs. 90-Day Bulk Diffusion.	100
112	Phase 3 – Single-Point RMT Rate of Penetration vs. Salt Ponding Evaluation.	101
113	Phase 3 – Three-Point RMT Rate of Penetration vs. 90-Day Bulk Diffusion.	101
114	Phase 3 – Three-Point RMT Rate of Penetration vs. Salt Ponding Evaluation.	102
115	RMT Rate of Penetration vs. AASHTO T277 – Phase 2 & 3.	101.

## List of Tables

<u>Table</u>	<u>Page</u>
1 Phase 1 Mix Designs and Fresh Concrete Properties.	6
2 Material Sources – All Phases.	6
3 Phase 1 Test Procedures.	7
4 Phase 1 Long-Term Test Correlation Coefficients ( $r^2$ ).	11
5 Phase 1 – Correlation Coefficients – Short-Term Tests to Reference Tests.	25
6 Time to Breakthrough for Migration Cells (in Days).	25
7 Phase 1 Pressure Penetration Data.	44
8 Phase 1A CTH Testing Schedule.	47
9 Phase 1A 0.45, Plain CTH Results.	48
10 Phase 1A 0.35, 8 Percent SF CTH Results.	48
11 Phase 2 – General Level of Agreement ( $r^2$ values).	50
12 Phase 2 – Number of Samples in Each Subset.	50
13 Phase 2 – 90-Day Bulk Diffusion Rejected Subsets, 95 Percent Confidence Level.	64
14 Phase 2 – 365-Day Bulk Diffusion Rejected Subsets, 95 Percent Confidence Level.	72
15 Phase 2 – 90-Day AASHTO T259 Rejected Subsets, 95 Percent Confidence Level.	73
16 Phase 3 Concretes.	82
17 RMT Procedure – Test Conditions (Voltage, Time).	82
18 Phase 3 Correlation Coefficients.	84
19 With and Without DCI Comparison.	88
20 Phase 3 Pressure Penetration Measurements (Single Test Result Based on Average of Seven Depth Measurements).	90
21 Mix Designs and Fresh Concrete Properties.	92
22 Cylinders Assigned to Each Lab.	92
23 Interlaboratory Test Results Summary.	94
24 Interlaboratory Evaluation Results.	103
25 Rapid Migration Test Conditions.	103
26 Comparison of Different Rapid Migration Test Conditions.	105
27 FHWA HPC Performance Grade Chloride Penetration Criteria.	106

# 1 Introduction

Reinforced concrete structures are exposed to harsh environments yet are often expected to last for long periods of time (often 100 years or more). For reinforced concrete bridges, one of the major forms of environmental attack is chloride ingress, which leads to corrosion of the reinforcing steel and a subsequent reduction in the strength, serviceability, and aesthetics of the structure. This may necessitate early repair or premature replacement of the structure. A common method of preventing such deterioration is to prevent chlorides from penetrating the structure to the level of the reinforcing steel bar by using relatively impenetrable concrete. Therefore, the ability of chloride ions to penetrate the concrete must be known for design as well as quality control purposes. The penetration of the concrete by chloride ions, however, is a slow process, and it cannot be determined directly in a time frame that would be useful as a quality control measure. Consequently, to assess chloride penetration a test method that accelerates the process is needed, to allow the determination of diffusion values in a reasonable time.

## 1.1 Mechanisms of Chloride Ingress

Capillary absorption, hydrostatic pressure, and diffusion are the means by which chloride ions can penetrate concrete. The most familiar method is diffusion, the movement of chloride ions under a concentration gradient. For diffusion to occur, the concrete must have a continuous liquid phase and there must be a chloride ion concentration gradient.

A second mechanism for chloride ingress is permeation, driven by pressure gradients. If there is an applied hydraulic head on one face of the concrete and chlorides are present, they may permeate into the concrete. A situation where a hydraulic head is maintained on a highway structure is rare, however.

A more common transport method is absorption. As a concrete surface is exposed to the environment, it will undergo wetting and drying cycles. When water (possibly containing chlorides) encounters a dry surface, it will be drawn into the pore structure through capillary suction. Absorption is driven by moisture gradients. Typically, the depth of drying is small, however, and this transport mechanism will not, by itself, bring chlorides to the level of the reinforcing steel unless the concrete is of extremely poor quality and the reinforcing steel is shallow. It does serve to quickly bring chlorides to some depth in the concrete and reduce the distance that they must diffuse to reach the rebar [Thomas et al., 1995].

Of the three transport mechanisms described above that can bring chlorides into the concrete to the level of the rebar, the principal method is that of diffusion. It is rare for a significant hydraulic head to be exerted on the structure, and the effect of absorption is typically limited to a shallow cover region. In the bulk of the concrete, the pores remain saturated and chloride ion movement is controlled by concentration gradients. A fuller review of diffusion theory and a discussion on the testing of the chloride penetration resistance of concrete was previously produced as a literature review for

distribution on the Federal Highway Administration (FHWA) website. The literature review, along with a glossary of common terms, is included as Appendix 1 of this report.

## **1.2 Research Project Objectives**

The broad objective of this research program is to develop a new method or methods for predicting chloride ion penetration into portland cement concrete typical of that used for bridges and pavements. This method must be capable of evaluating new mixtures, accepting or rejecting concrete according to specifications, and evaluating already placed concrete; with emphasis on the first two uses. This new test is required because of limited applicability of existing test procedures and the time required to perform these tests.

For a test to perform these functions satisfactorily, the following list of criteria was developed:

1. The test shall be able to be used to evaluate new mixtures, to accept or reject newly constructed concrete members based on specific requirements, and to evaluate existing concrete.
2. The quantitative parameter(s) measured by the new test(s) shall be such that they can be incorporated into the four performance grades of the FHWA high performance concrete definition, as defined by Goodspeed et al. [1996].
3. The test shall be valid for use in reinforced concrete and prestressed concrete; as such, the presence of reinforcing and/or prestressing steel shall not invalidate the test procedure.
4. The test shall have the data as quickly as possible, but no later than 35 days after the casting of the concrete.
5. It is desirable, but not essential, that the equipment be able to be housed in a mobile trailer and cost less than US\$25,000.
6. The test(s) shall be immune to the effects of chemical and mineral admixtures and sealers on the validity of the test results. These chemical and mineral admixtures include, but are not limited to:
  - a) corrosion inhibitors
  - b) water reducers
  - c) superplasticizers
  - d) accelerators
  - e) retarders
  - f) hydration inhibitors
  - g) air entraining agents
  - h) slag
  - i) silica fume
  - j) fly ash
  - k) metakaolin
  - l) latex
  - m) sealers

7. The test(s) shall produce valid results for concretes with water-to-cementitious materials ratios (w/cm) from 0.25 to 0.50.
8. The test(s) shall be immune to effects of variable curing histories of the concretes for concretes cured at temperatures ranging from 40°F to 190°F (4.5°C to 88°C).
9. The test is intended for concrete that does not contain fiber reinforcement.
10. The baseline test against which performance of the rapid test is to be judged against is AASHTO T259-80 "Resistance of Concrete to Chloride Ion Penetration," the 90-day salt ponding test, and longer-term salt ponding tests.

In Phase 1, a preliminary evaluation of eight short-term tests, identified in the literature review as promising, was undertaken to identify the tests with the best potential. In Phase 2, two of the more promising of these test methods were subjected to a more rigorous study, meeting all the above requirements. In Phase 3, a further evaluation of the final tests was completed in order to finalize the details of the testing procedure. An interlaboratory evaluation in conjunction with several highway agencies was also performed. These comments were then incorporated into the testing procedure.





## **2 Phase 1**

### **2.1 Objectives**

Phase 1 was planned as a preliminary investigation of a variety of potentially promising tests drawn from the literature, as identified in the literature review, provided in Appendix 1. Eight different concrete mixtures were cast and subjected to 10 different tests for evaluating chloride penetration. The individual tests were evaluated based on the project criteria, the complexity of the test procedure, and the numerical results. Two were selected as suitable for further evaluation.

### **2.2 Testing Program**

#### **2.2.1 Concrete Mixtures and Fresh Concrete Properties**

To evaluate the different tests, eight concrete mixtures were designed such that they represent a variety of different concrete qualities and compositions. The concretes ranged from a water-to-cementitious materials ratio (w/cm) of 0.50 to 0.25, and some mixtures either contained silica fume, fly ash, or slag. The mix designs are included in Table 1, with the material sources in Table 2. For each mixture, 11 350-mm x 250-mm x 75-mm slabs and 18 100-mm  $\varnothing$  x 200-mm cylinders were cast. The mixtures were cast over a 1-month period in January 1998. The slump, air content, and plastic density of each mixture were determined during casting. This information is included in Table 1. The concretes were moist cured for 14 days, and then stored in laboratory air until the time they were tested.

#### **2.2.2 Test Schedule**

In Phase 1, eight short-term and two long-term permeability tests were performed in addition to strength. The strength tests were performed at 7, 28, 56, and 91 days of age on the cylinders. Two were tested at each age.

To measure the chloride penetration resistance of the concrete, two reference, long-term tests were performed: the AASHTO T259 – Resistance of Concrete to Chloride Ion Penetration (the salt ponding test), and the Scandinavian NTBuild 443 – Accelerated Chloride Penetration into Hardened Concrete (bulk diffusion test). The salt ponding test was done for 90 days and 365 days of exposure to chloride solution, while the bulk diffusion test was done for 40, 90, and 365 days of exposure. The current, commonly accepted short-term test, AASHTO T277 – rapid chloride penetration resistance (RCPT), was also done. This was performed at 7, 28, 91, and 365 days of age. In addition, seven tests identified from the literature as possible candidates for this project were evaluated. Because of scheduling concerns and equipment limitations, different tests were done at different ages. Each test was done at the same age for all concretes. An outline of the various tests, including a brief description, a reference for the test procedure, and when they were tested is included in Table 3. Except for the Wenner Probe, the tests were performed on two 100-mm diameter cores taken from the slabs. The Wenner Probe was performed on a single complete slab. With the exception of tests

**Table 1.** Phase 1 Mix Designs and Fresh Concrete Properties.

Mixture	1	2	3	4	5	6	7	8
W/cm	0.50	0.45	0.45	0.45	0.45	0.35	0.35	0.25
Bags of Cement	6.0	6.5	6.5	6.5	6.5	7.5	7.5	10.0
Cement (pcy)	564	611	562.1	488.8	397.1	705	648	865
Cement (kg/m <sup>3</sup> )	335	362.5	333.5	290	235.6	418	384.6	513.4
Silica Fume (kg/m <sup>3</sup> )	0	0	29.0 (8%)	0	0	0	33.4 (8%)	44.6 (8%)
Fly Ash (kg/m <sup>3</sup> )	0	0	0	72.5 (20%)	0	0	0	0
Slag (kg/m <sup>3</sup> )	0	0	0	0	126.9 (35%)	0	0	0
Water (kg/m <sup>3</sup> )	167	163	163	163	163	146	146	139.4
20 mm Coarse Aggregate (kg/m <sup>3</sup> )	1025	1025	1025	1025	1025	1025	1025	1025
Fine Aggregate (kg/m <sup>3</sup> )	710	698	688	682	690	695	684	580
Air Entrainer (mL/100 kg)	30	30	30	30	30	30	30	30
Water Reducer (mL/100 kg)	0	49	250	250	250	300	300	350
Superplasticizer (mL/100 kg)	0	0	196	0	0	498	250	770
Slump (mm)	160	100	70	165	170	175	30	55
Air Content (%)	7.5	8	9	8	8.5	5.5	8	3
Plastic Density (kg/m <sup>3</sup> )	2362	2348	2275	2268	2254	2394	2377	2522

**Table 2.** Material Sources--All Phases.

Portland Cement	Silica Fume	Fly Ash	Slag	Coarse Aggregate
Lafarge Type 10 (I)	SKW Beçancoeur	Columbia Unit 1 (Class C)	Lafarge Stoney Creek	Dufferin Crushed Limestone
Sand	Air Entraining Agent	Water Reducing Agent	SuperPlasticizer	
Dufferin Glacial	ConChem ProAir	ConChem 25 XL	ConChem SPN	

**Table 3. Phase 1 Test Procedures.**

Test	Age Performed	Description	Reference
Salt Ponding	28 days – duration: 90 days, 365 days	<b>Long Term:</b> Unsaturated specimen, exposed to 3% NaCl solution on one face with the opposite face exposed to drying environment	AASHTO T259
Bulk Diffusion	28 days – duration: 40 days, 90 days, 365 days	<b>Long Term:</b> Saturated specimen sealed on all sides but one, immersed in a 165 g/L NaCl solution, then profiled for chloride content	NTBuild 443
Rapid Chloride Penetration Test	7 days, 28 days, 91 days, 365 days	<b>Short Term:</b> 60 V applied across a saturated specimen for 6 hours with 3% NaCl solution on one side and 0.3 M NaOH solution on the other	AASHTO T277, ASTM C1202
Sorptivity	28 days, 5 months	<b>Short Term:</b> Unsaturated specimen placed one face in water and monitored for mass gain over 25 minutes	Hall, 1989
CTH Test	28 days	<b>Short Term:</b> Saturated specimen, with 30 V applied for 8 hours with chloride solution on one side and non-chloride solution on other. Specimen then broken open, sprayed with 0.1 M AgNO <sub>3</sub> , and rated based on depth of chloride penetration	Tang and Nilsson, 1991
Migration Cells	56 days	<b>Short Term:</b> Saturated specimen subjected to voltage (12 or 20 V), separating a chloride-containing solution and a chloride-free solution, and the chloride-free solution is monitored for chloride concentration	McGrath, 1996
Monfore Resistivity	56 days	<b>Short Term:</b> Water-saturated specimen, DC resistance determined at two different voltages (3 V and 5 V) to account for polarization	Monfore, 1968
Chloride-Saturated Resistivity	56 days	<b>Short Term:</b> As Monfore resistivity, but saturated with 5.0 M chloride solution, allows calculation of D values	Streicher and Alexander, 1995
Wenner Probe Resistivity	56 days, 1 year	<b>Short Term:</b> <i>In situ</i> resistivity determined using four embedded probes	Morris et al., 1996
Pressure Penetration	Various > 56 days; due to limited equipment	<b>Short Term:</b> A 3% NaCl solution under 6900 kPa exposed to a 25-mm-thick saturated specimen to accelerate chloride ingress	Lee et al., 1996

standardized by the American Association of State Highway and Transportation Officials (AASHTO) or the American Society for Testing and Materials (ASTM), complete descriptions of all test procedures are included in Appendix 2. A further discussion of the theoretical background is available in the literature review produced for this contract that is contained in Appendix 1. The chloride content of the concrete was determined, when necessary, according to AASHTO T260 – Sampling and Testing for Chloride Ions in Concrete and Concrete Raw Materials.

The final pieces of information determined for these concretes were the background chloride levels and the porosities. The background chloride level was determined by reserving a piece of concrete that was never exposed to chlorides and then grinding off four 0.5-millimeter layers. The chloride content of these powders was determined according to AASHTO T260, and the average value was reported as the background chloride level. The porosity was determined by taking an additional small sample (approximately 5 mm x 15 mm x 30 mm), determining its mass after drying for 7 days at 50°C, and then both its water-saturated mass in air and in water. This was done on two samples for each concrete type.

### **2.3 Results**

A summary of the numerical results from Phase 1 is included in Appendix 3. Each of the short-term test results was plotted against the data from the long-term test procedures evaluation in a log-log graph: the diffusion coefficients ( $D$ ) from the 40-day, 90-day, and 365-day bulk diffusion tests, the pseudo- $D$  (explained in Section 2.3.2), the depth of 0.1 percent chloride concentration by concrete mass above background and the total integrated chloride by percent concrete mass above background from the 90-day salt ponding test; and the pseudo- $D$  from the 365-day salt ponding test. The determination of these values is explained in Section 2.3.2. These log-log plots were used to determine correlation coefficients ( $r^2$ ) and lines of best fit using standard least-squares fitting. The evaluation was done considering the logarithms of the values due to the wide range of numerical values considered – varying over orders of magnitude. If the correlation were done on the actual values, the relation would be dominated by the higher numerical values. The  $r^2$  values are included in Table 5.

The different test procedures were evaluated first by considering the degree to which they satisfied the project objectives. This primarily meant that the test duration was satisfactory. In addition, the test procedure was evaluated for practicality and simplicity. A test too complicated to perform would be of little use. The theoretical basis of the test was evaluated. Finally, the ability of the test to predict the reference procedures, as represented by the  $r^2$  values, was considered.

#### **2.3.1 Strength**

The compressive strength of each mixture was evaluated at 7, 28, 56, and 91 days. Figure 1 is a plot of the change in compressive strength with time for each of the concrete mixtures. One plot is included for each mixture. In general, the strength increased between 7 and 28 days, and leveled off thereafter. The strength generally increased with

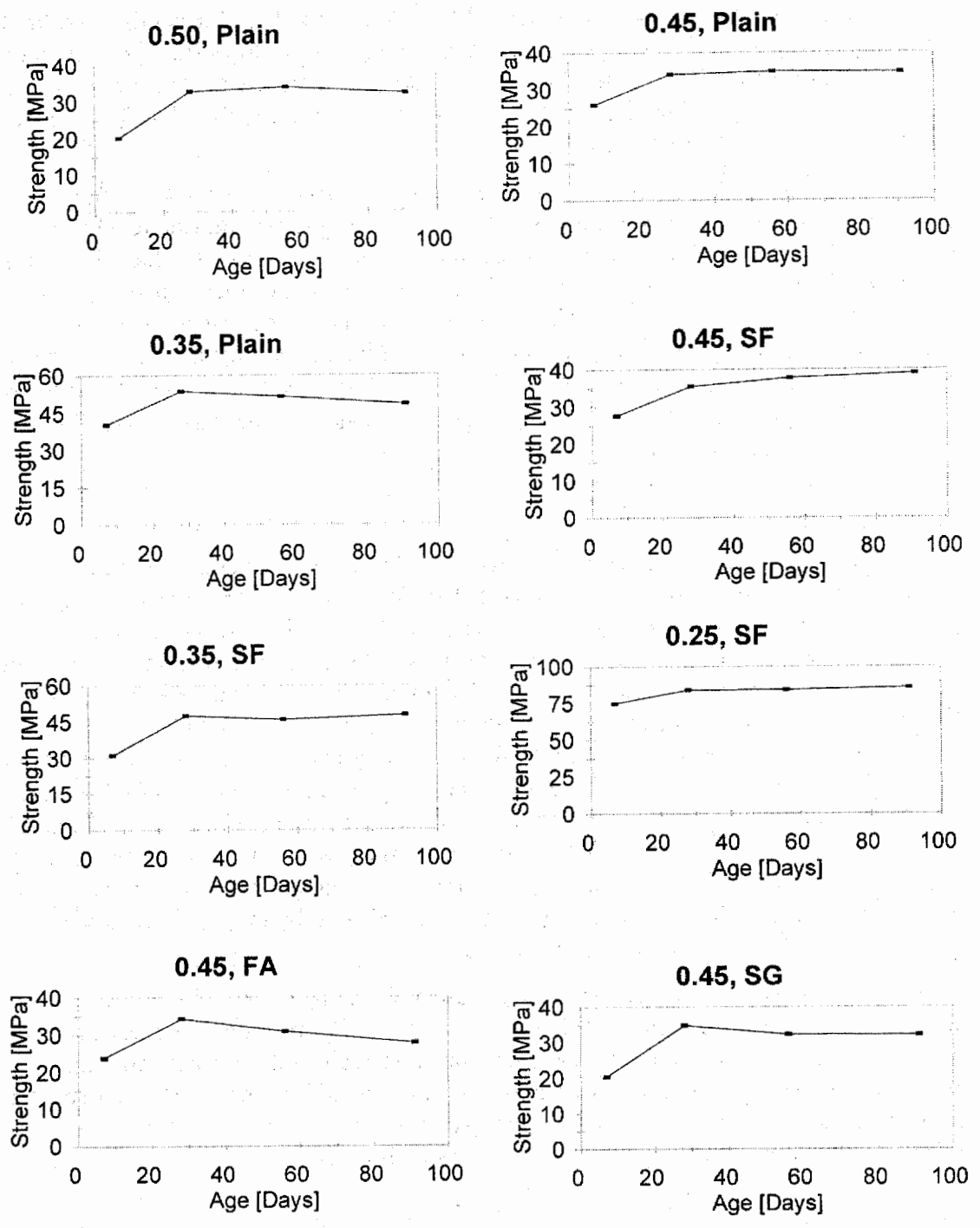
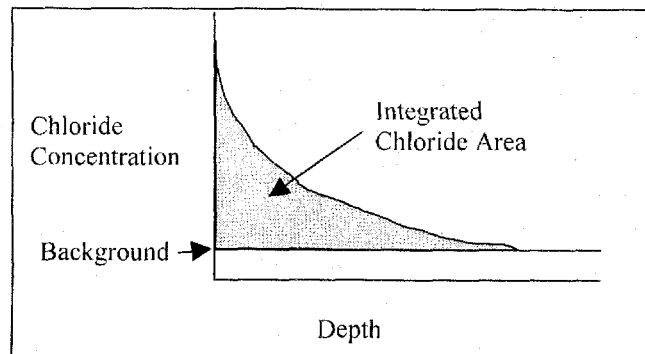


Figure 1. Phase 1 Concrete Strengths.

decreasing water-cement ratio and the inclusion of silica fume. The inclusion of either fly ash or slag had little or no effect on the strengths.

### 2.3.2 Reference, Long-Term Chloride Penetration Procedures

Two different long-term reference procedures were used for various exposure durations. At 28 days of age, the Nordtest bulk diffusion test (NTBuild 443) was started for 40, 90, and 365 days of chloride exposure. The AASHTO T259 test was done for 90 and 365 days of exposure. After these exposure periods, the samples were then frozen if necessary to stop the movement of chloride ions until they were profiled as described in Section 2.3.3.



**Figure 2.** Typical AASHTO T259 Profile.

After the AASHTO T259 ponding tests were completed, these samples were profiled. A typical chloride profile is shown in Figure 2. For the 90-day exposure duration, the data were evaluated by three methods. The first was to determine the total integrated chloride content that had penetrated the concrete. This was done by integrating the area under the curve of the chloride profile and subtracting the background chloride levels, to obtain a value in the units of percentage of concrete mass-mm. Whiting (1991) and Sherman et al. (1996) have used this approach. In addition, Crank's error function solution for Fick's Second Law was fitted to the chloride profiles and a pseudo-diffusion coefficient (pseudo-D) determined. This technique is not completely sound in theory, though it has been used by others [McGrath and Hooton, 1999]. The equation only accounts for movement of chlorides resulting from diffusion, and in this salt ponding test more types of chloride transport are occurring. For example, because the sample does not start out initially saturated, there is an initial sorption effect. Second, as the other face is exposed to air at 50 percent relative humidity during ponding, there is also a concrete wicking effect. As diffusion is not the only transport mechanism, Crank's solution is not the correct mathematical solution. It does, however, have the right shape, and if it is remembered that the pseudo-D value obtained is not a true diffusion coefficient, then fitting this curve to the data may be a useful evaluation technique. Finally, the data were evaluated by determining the depth of penetration of 0.1 percent chloride by mass of concrete above the background chloride level [McGrath and Hooton, 1999]. This value was chosen as it is sufficiently high that it will be on the steep portion of the penetration curve so that it is relatively insensitive to errors associated with the determination of chloride levels or variations in the background

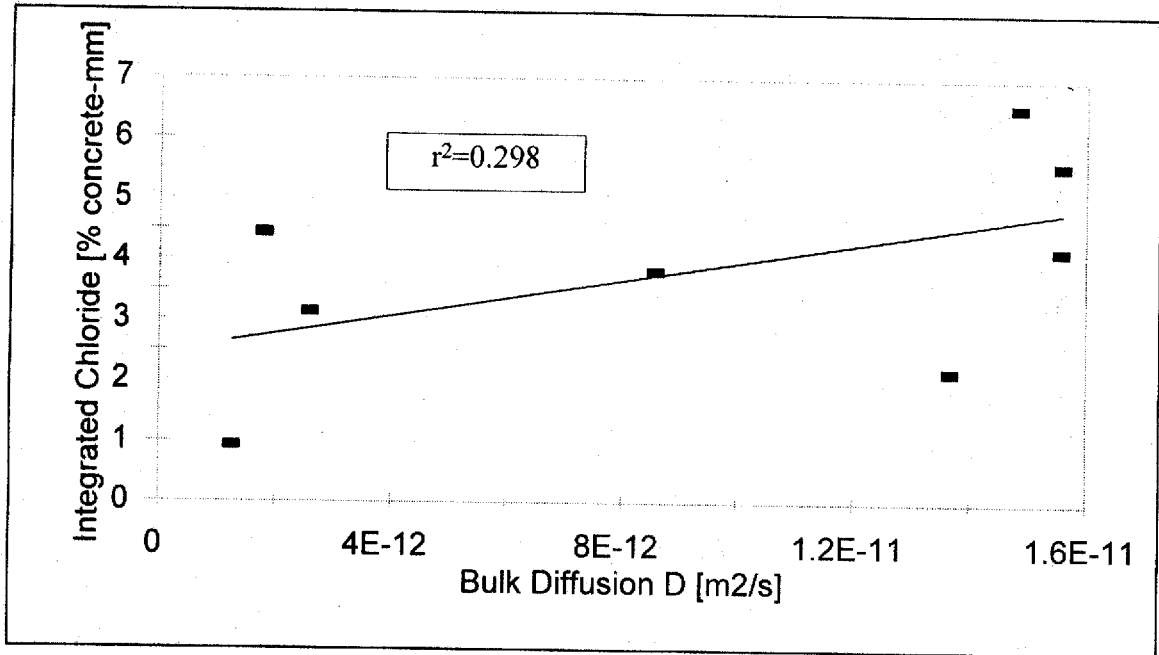
concentration. For the 365-day exposure period, the data were evaluated only by fitting Crank's solution to the data and determining a pseudo-D value.

The Nordtest bulk diffusion samples were profile ground and the resulting profile was fit to Crank's solution to Fick's Second Law. Because the testing conditions are different from those that exist for the salt ponding test, diffusion is the only transport mechanism that is occurring, and thus the D value obtained is the true apparent diffusion coefficient.

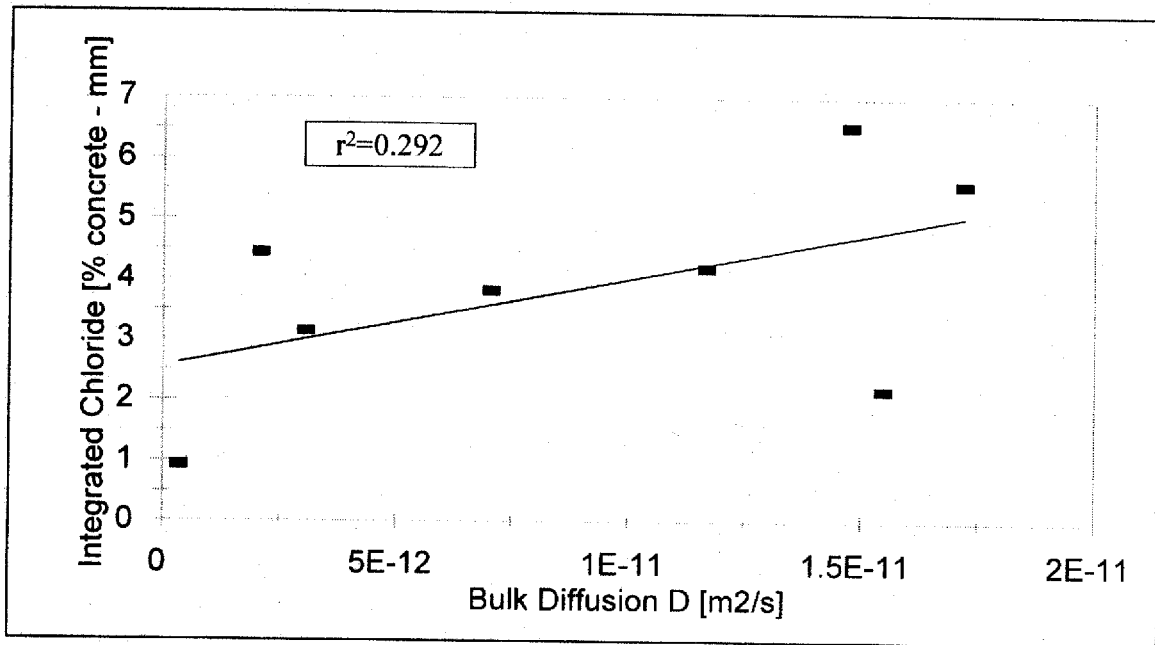
The values obtained in the 90-day salt ponding test were compared with the diffusion coefficients obtained from the 40- and 90-day bulk diffusion tests. The authors consider that the bulk diffusion values obtained have been shown to give a good prediction of the long-term performance of concrete in service. The AASHTO salt ponding test is thought to be less relevant to what is occurring in service. For further discussion of this, please refer to the literature review produced for this contract included in Appendix 1. The correlation coefficients obtained are included in Table 4, corresponding to those shown in Figures 3 to 8. It can be observed that the values obtained for the AASHTO T259 total integrated chlorides do not compare well with the diffusion coefficients obtained by the bulk diffusion tests; the  $r^2$  values are both around 0.29. It is not that these tests are attempting to measure unrelated quantities, but that the total integrated chloride measurement used by others [Sherman et al., 1996; Whiting, 1981] is a poor method of evaluating the chloride penetrability of concrete. Measuring the integrated chloride content does not account for the shape of the curve. It does not differentiate between the situation where there is a high concentration of chlorides at the surface, but little at depth, and the situation where the surface chloride level is lower but it has penetrated a great deal [McGrath and Hooton, 1999]. The diffusion coefficient obtained from the bulk diffusion tests is analogous to the slope of the curve. The pseudo-D value of the curve fit to the 90-day salt ponding data seems to be a better measure of the bulk diffusion coefficient. It compares fairly well with both the 40- and 90-day bulk diffusion coefficients, though the AASHTO T259 salt ponding test has more mechanisms occurring than the bulk diffusion test. These mechanisms will have a different influence from concrete to concrete. It correlates better with the 90-day bulk diffusion test because both tests have the same duration and thus experience the same change with respect to continuing hydration. However, the depth to 0.1 percent chloride concentration above background level appears to give an equally satisfactory measure of the chloride penetration resistance. In addition, it has the advantage of not assuming a false relationship, (i.e., that the pseudo-D values calculated from the AASHTO T259 test are diffusion values) that could easily be used incorrectly. It does have the disadvantage of not providing much information about the total chloride profile. In

**Table 4.** Phase 1 Long-Term Test Correlation Coefficients ( $r^2$ ).

90-day Salt Ponding Evaluation Method	Integrated Chloride Content	Pseudo-D of fitted error function curve	0.1% Chloride Concentration Depth
Bulk Diffusion - 40 Days	0.298	0.678	0.706
Bulk Diffusion - 90 Days	0.292	0.742	0.709



**Figure 3.** Salt Ponding Integrated Chloride vs. 40-Day Bulk Diffusion.



**Figure 4.** Salt Ponding Integrated Chloride vs. 90-Day Bulk Diffusion.



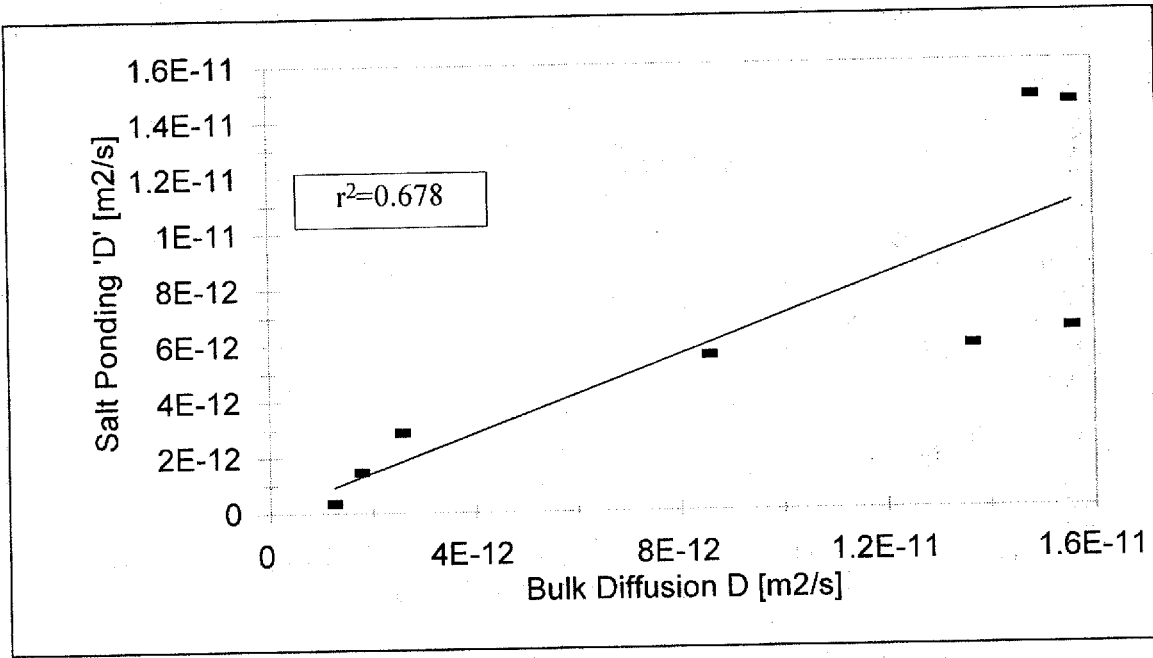


Figure 5. Salt Ponging Pseudo-D vs. 40-Day Bulk Diffusion.

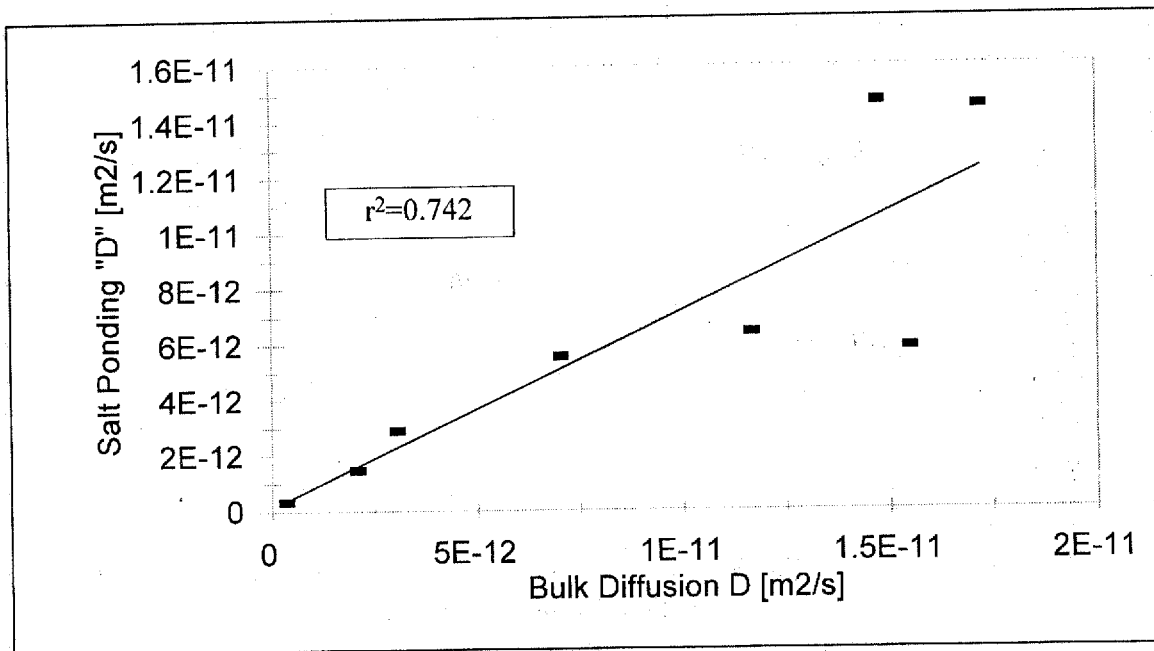
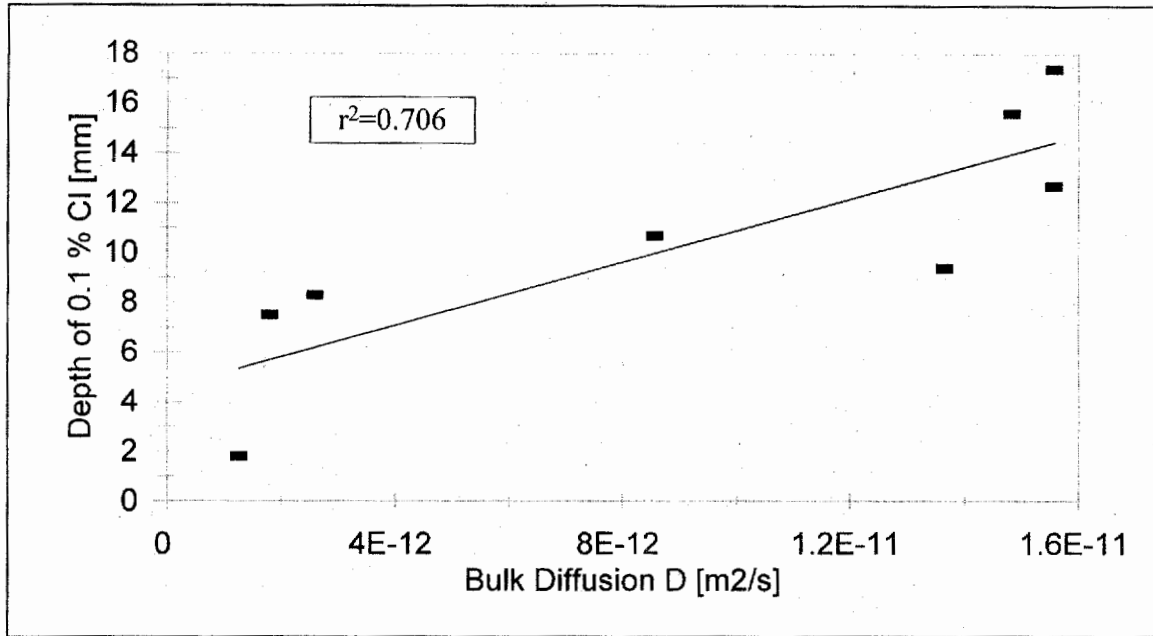
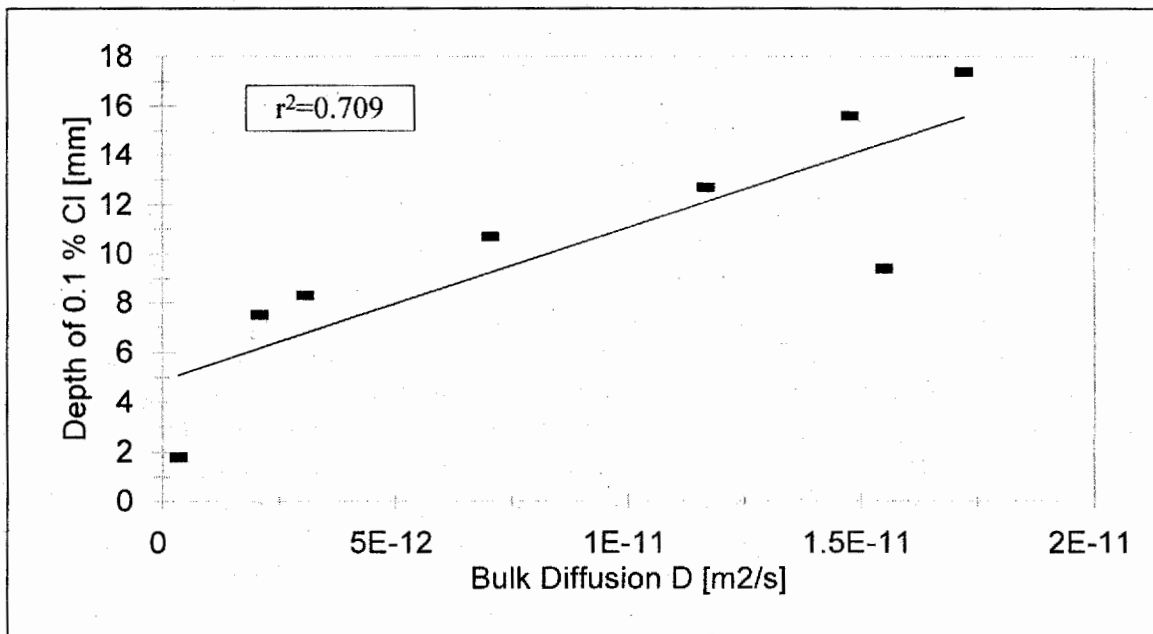


Figure 6. Salt Ponging Pseudo-D vs. 90-Day Bulk Diffusion.



**Figure 7.** Salt Ponding Depth of 0.1 Percent Chloride vs. 40-Day Bulk Diffusion.



**Figure 8.** Salt Ponding Depth of 0.1 Percent Chloride vs. 90-Day Bulk Diffusion.

addition, if the exposure period has been a long one, to determine the depth of 0.1 percent chloride concentration above background requires significantly more work than to determine a pseudo-D value. Thus this method of evaluation was considered impractical for the evaluation of the 365-day duration tests.

### 2.3.3 Profile Grinding

A reference has been made previously to profile grinding of the long-term test specimens. This procedure is described as follows.

The sample is mounted in a vise on the bed of a milling machine fitted with a 50-mm diameter diamond-tipped bit. (Other equipment such as lathes or drill presses have also been used elsewhere.) The sample is leveled so that the axis of advance of the bit is perpendicular to the surface of the sample. A pass is made at each depth to grind the concrete sample into dust, which is then collected. This is repeated at greater and greater depths, at depth increments on the order of 0.5 mm. The chloride content of the powder is then determined according to AASHTO T260. This chloride content is expressed in terms of %-concrete mass.

For the bulk diffusion tests and salt ponding test, the error function solution of Fick's Second Law is then fit to the curve using a least squares fit. This allows the determination of a diffusion value and surface chloride concentration. For other test procedures, the error function solution is not appropriate, so no curve was fit.

The profiles obtained throughout this contract are presented in Appendix 10.

### 2.3.4 AASHTO T277

The rapid chloride test method was performed on each concrete at 7, 28, 91, and 365 days of age. A plot of the total charge passed in 6 hours versus age is shown in Figure 9. In addition, the rapid chloride test method was evaluated differently than the standard procedure. It was evaluated by taking the charge passed at 30 minutes and extrapolating the value to 6 hours by multiplying by 12 [Hooton et al., 1997]. It was thought that this would minimize any potential effects of heating of the concrete sample by reducing the time to which it is exposed to an applied voltage. The change in value obtained by this method with age is included in Figure 10. Figure 11 contains a plot of this modified AASHTO T277 evaluation procedure versus the standard value. It can be seen that for high-quality concretes (AASHTO T277 values of less than 2000 coulombs), the two procedures give very similar numbers. For lower-quality concretes (high AASHTO T277 values), the modified procedure is generally lower than the standard procedure. This indicates the effect of temperature rise on the pore solution conductivity during the later portion of the 6-hour testing time frame. For a comparison reference value, the 28-day charge passed was used for both evaluation techniques, as recommended in the standard. The change in the AASHTO T277 value with time was surprising. In general, it decreased between 7 and 28 days and then increased or, for 0.35, 8 percent silica fume and 0.25, 8 percent silica fume, remained constant. Since the curing period was ended at 14 days, it would be expected that the AASHTO T277 values would not change after this time as the hydration of the concrete has likely stopped. It is

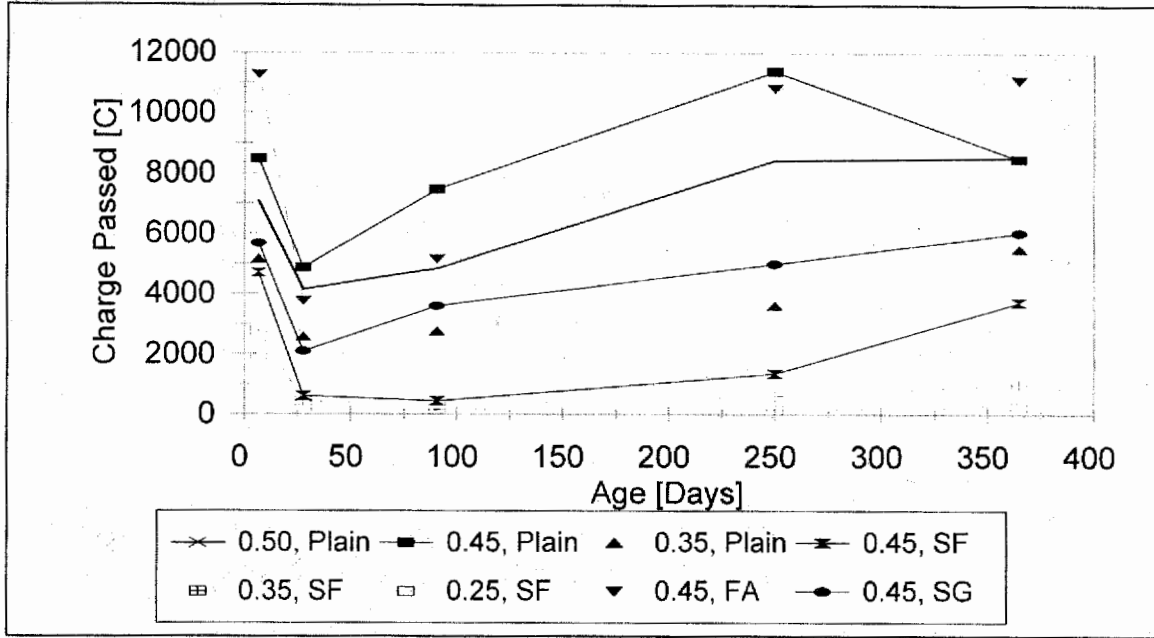


Figure 9. AASHTO T277 Change With Age.

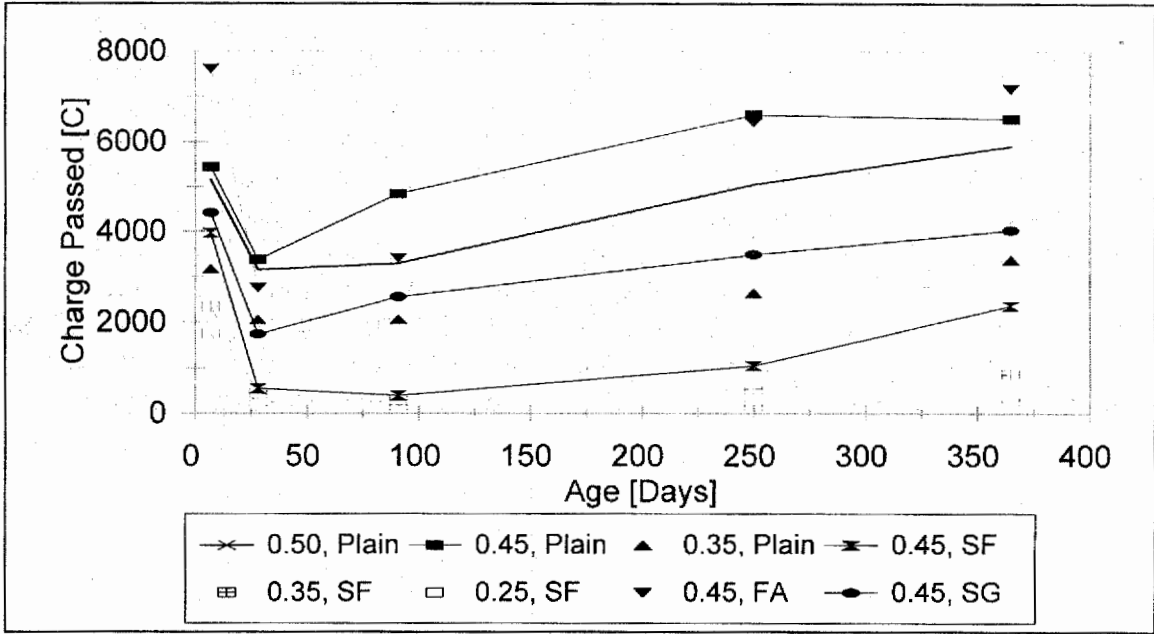


Figure 10. Modified AASHTO T277 Change With Age.

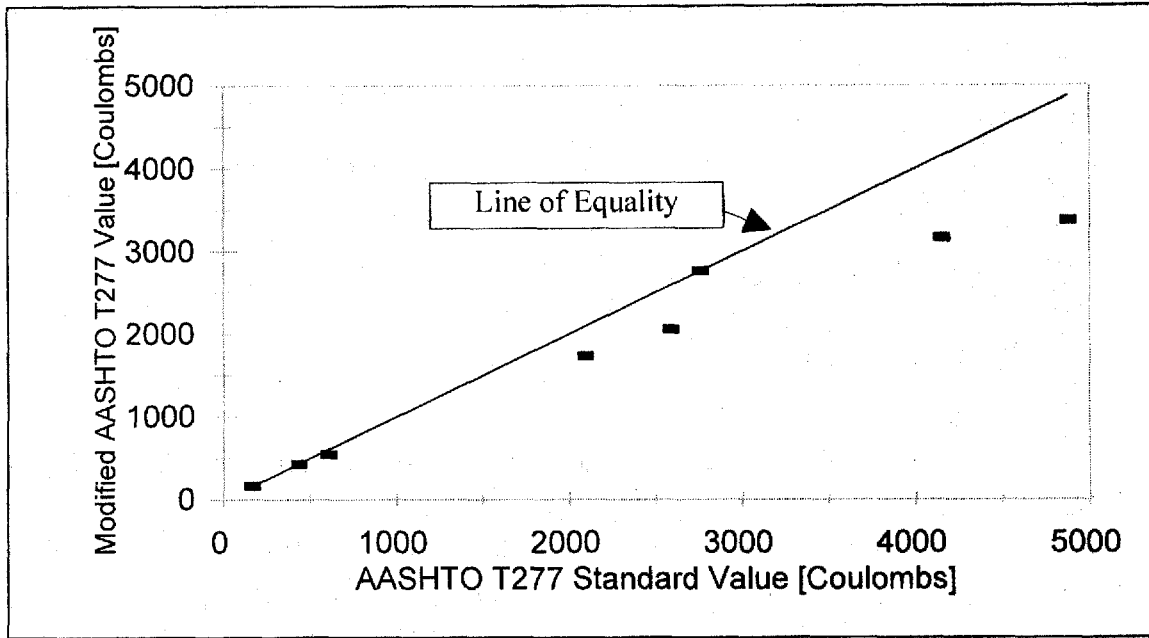


Figure 11. Modified AASHTO T277 vs. Standard AASHTO T277.

possible that some of the increase in permeability is due to shrinkage-induced cracking of the concrete, creating additional porosity.

Both these methods of evaluating the AASHTO T277 procedure were then correlated in log-log plots versus the bulk diffusion values (40, 90 and 365 days), the pseudo-D value, and the depth of penetration of 0.1 percent chloride by concrete mass above the background level obtained from the 90-day AASHTO T259 test and the pseudo-D value from the 365-day AASHTO T259 test. The relevant graphs, with their least-squares line-of-best fit are included as Figures 12 to 23. In addition, a summary of all the correlation coefficients is included in Table 5. It can be seen that for both the standard and modified AASHTO T277 procedures, the correlation coefficient is high, ranging from 0.991 (12 x 30-minute value versus 90-day bulk diffusion coefficient) to 0.821 (T277 6-hour value versus depth of 0.1 percent chloride concentration). It tends to be slightly higher for the modified T277 procedure, and a better correlation is achieved when comparisons are made to the bulk diffusion values as opposed to the AASHTO T259 values.

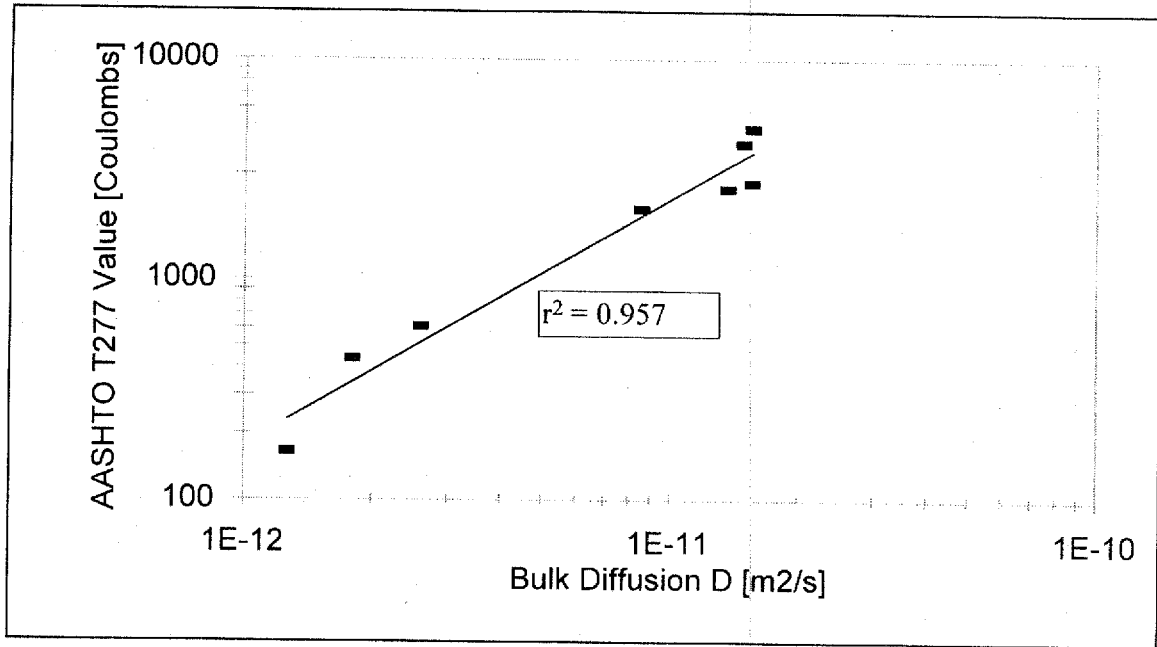


Figure 12. AASHTO T277 vs. 40-Day Bulk Diffusion.

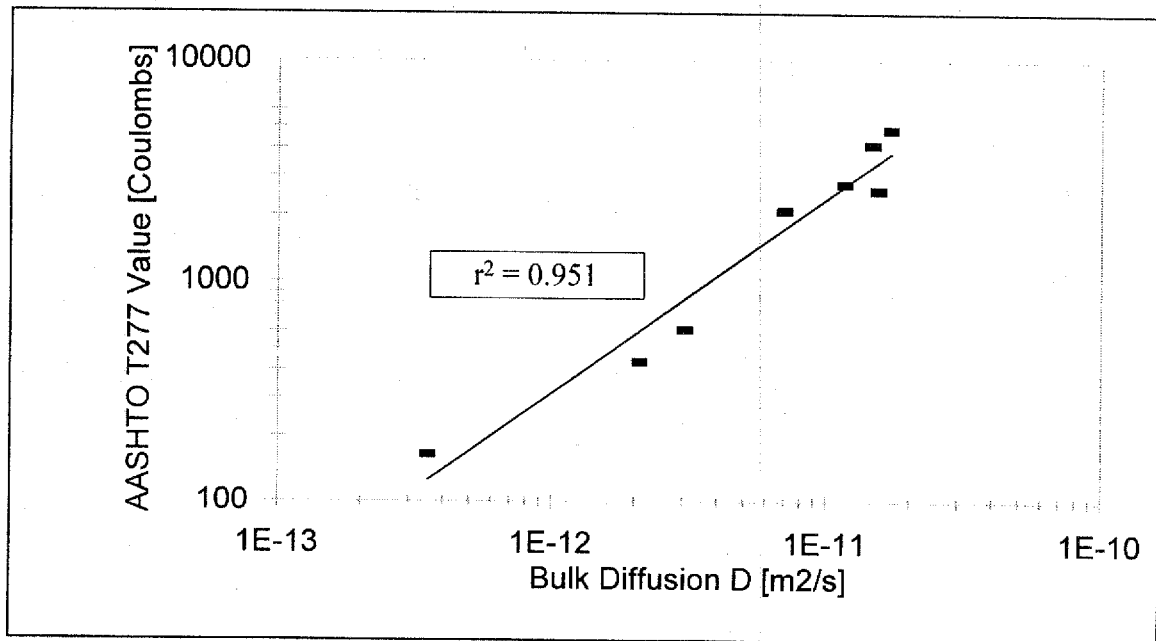
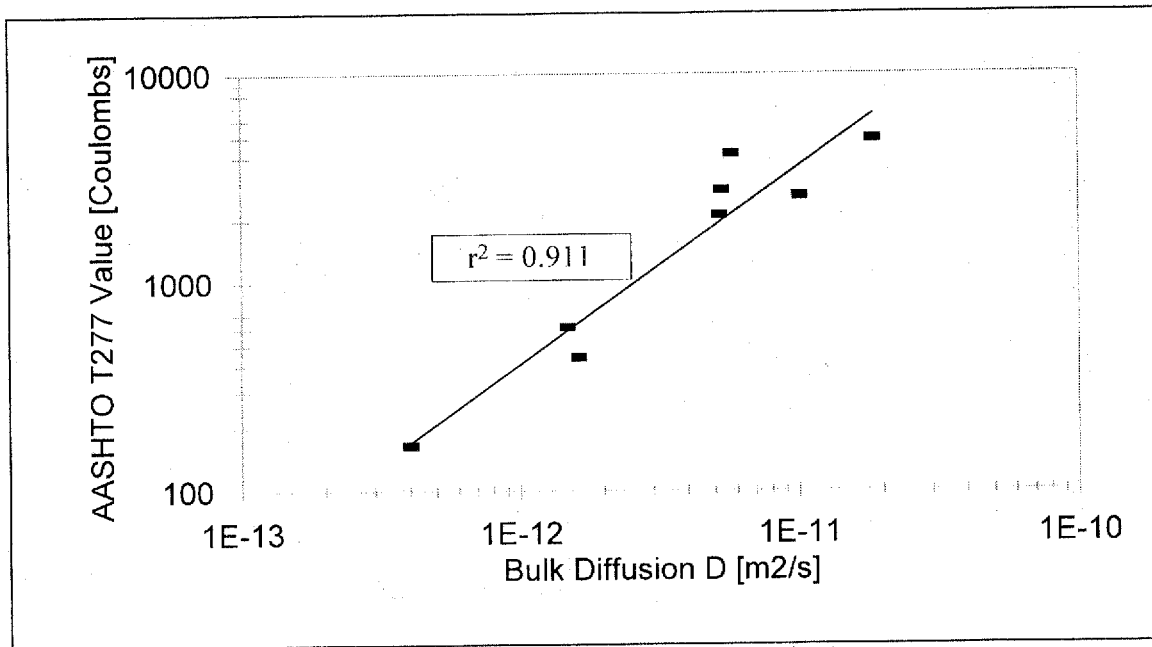
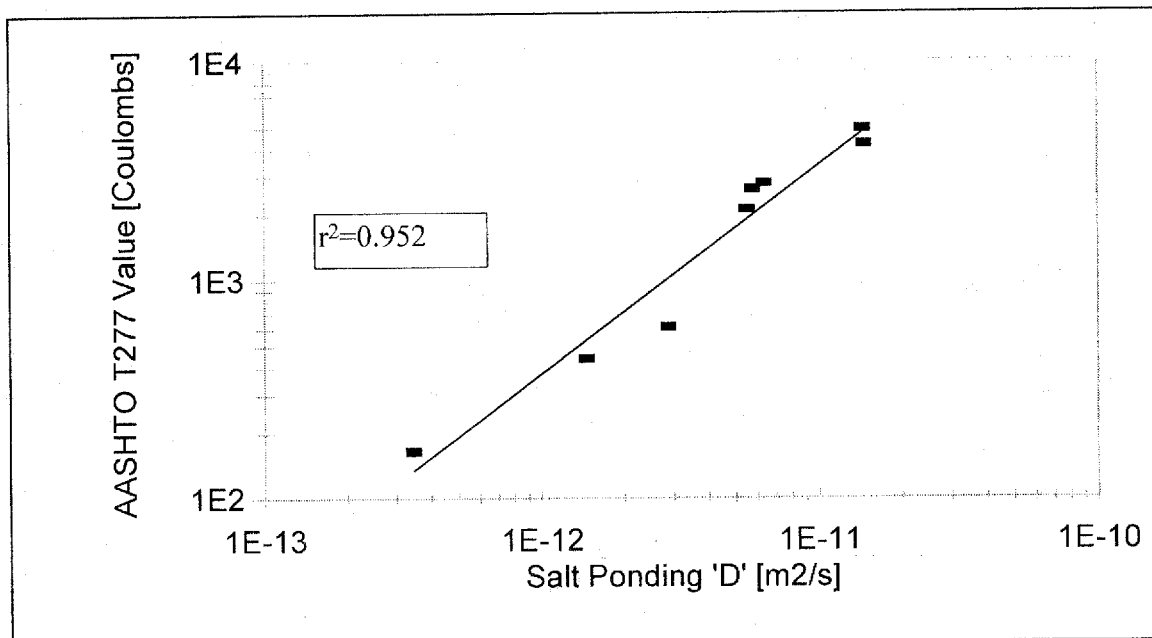


Figure 13. AASHTO T277 vs. 90-Day Bulk Diffusion.



**Figure 14.** AASHTO T277 vs. 365-Day Bulk Diffusion.



**Figure 15.** AASHTO T277 vs. 90-Day Salt Ponding Pseudo-D.

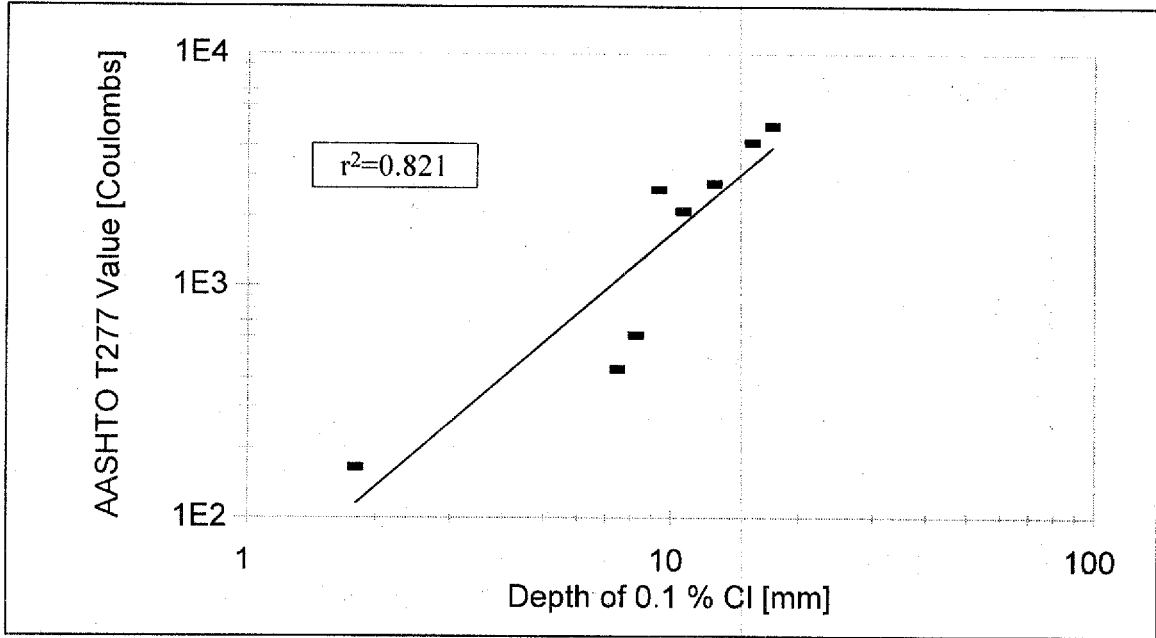


Figure 16. AASHTO T277 vs. 90-Day Salt Ponding Chloride Depth.

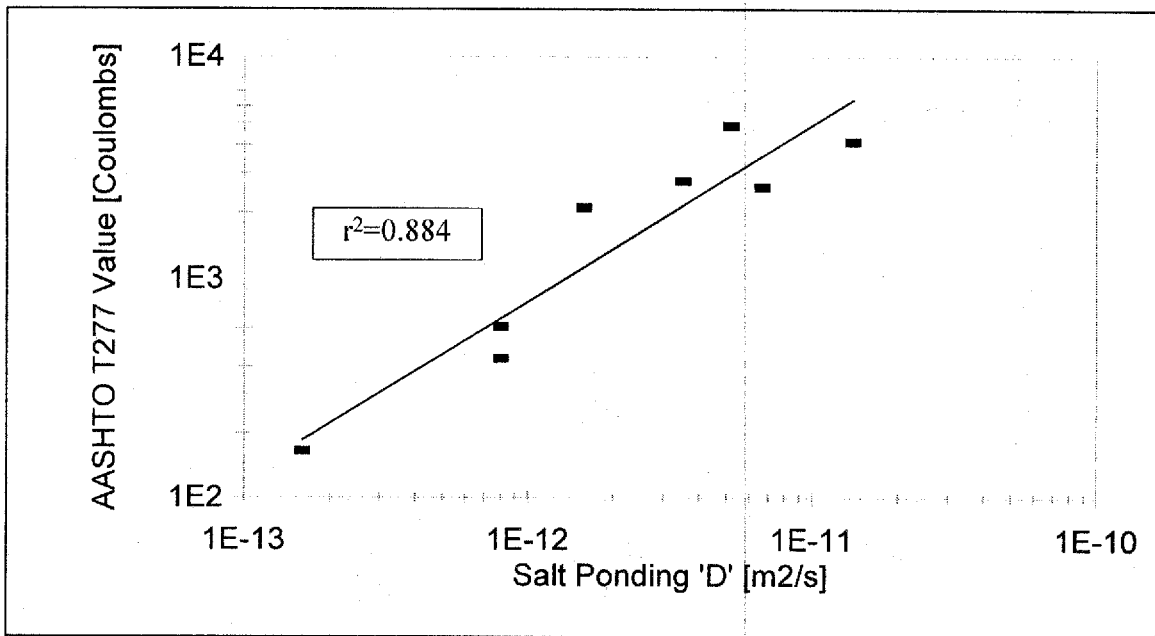
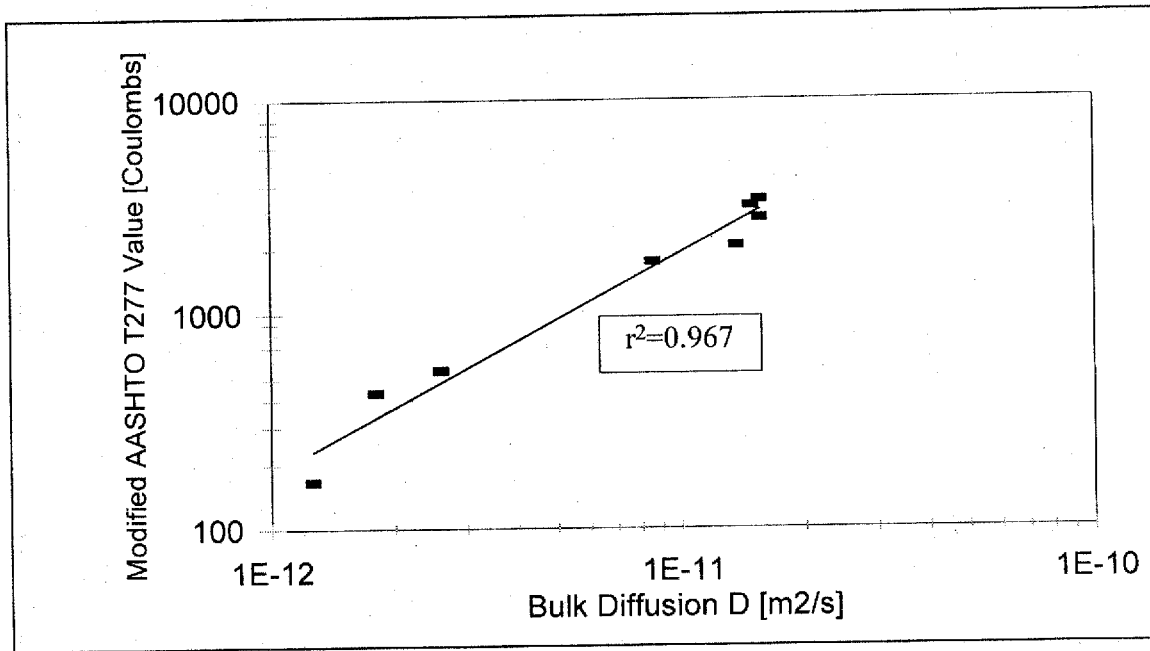
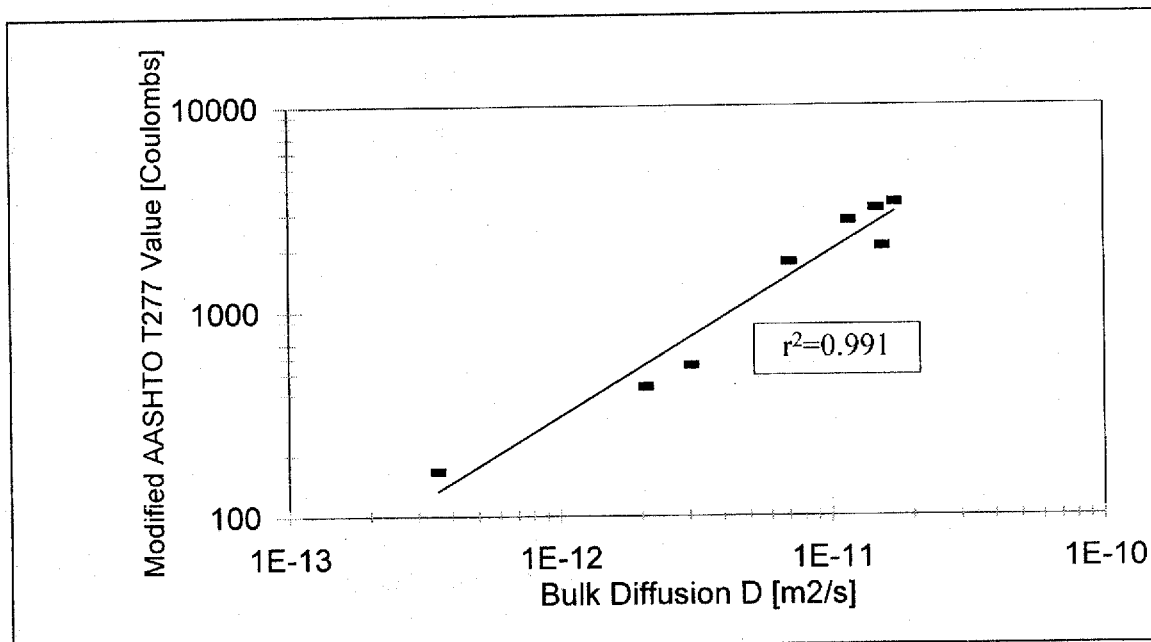


Figure 17. AASHTO T277 vs. 365-Day Salt Ponding Pseudo-D.

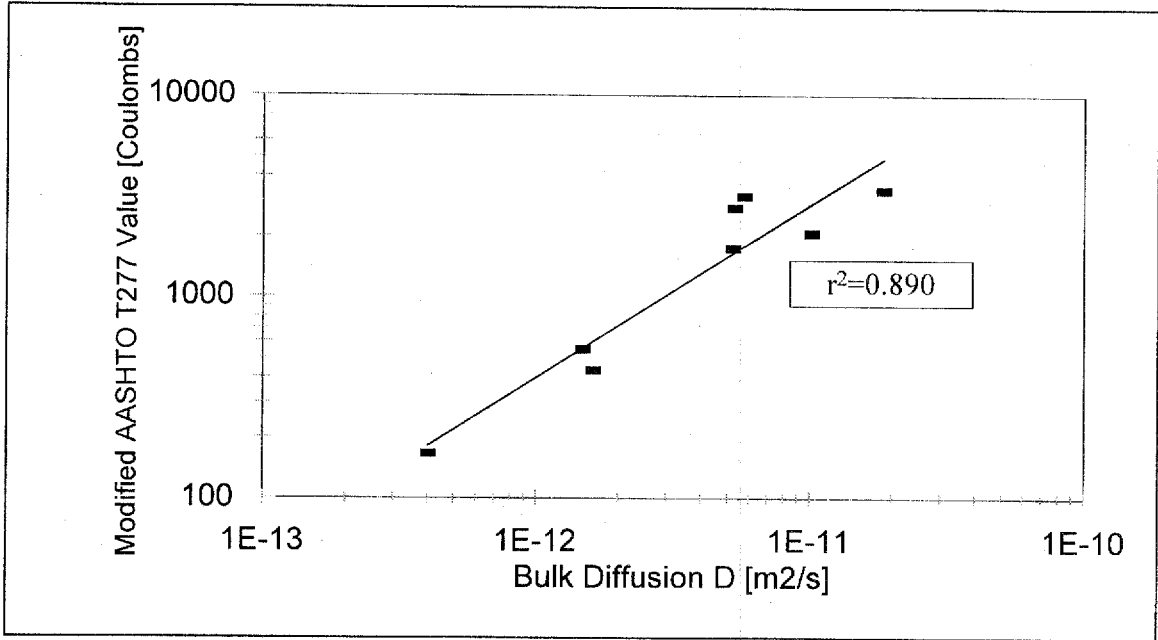




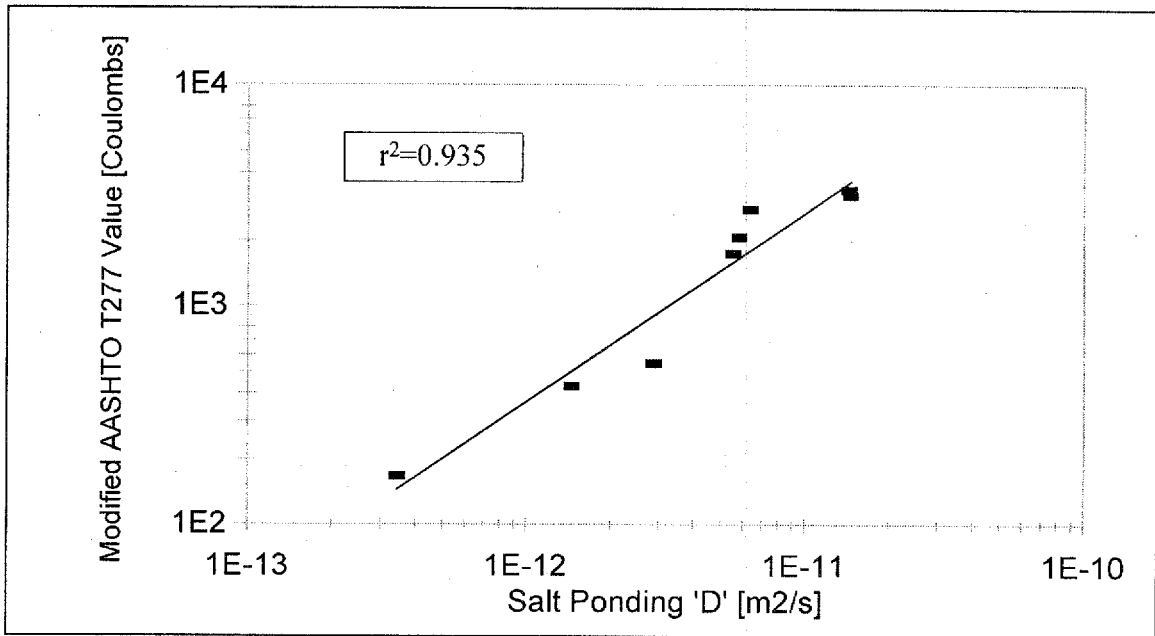
**Figure 18.** Modified AASHTO T277 vs. 40-Day Bulk Diffusion.



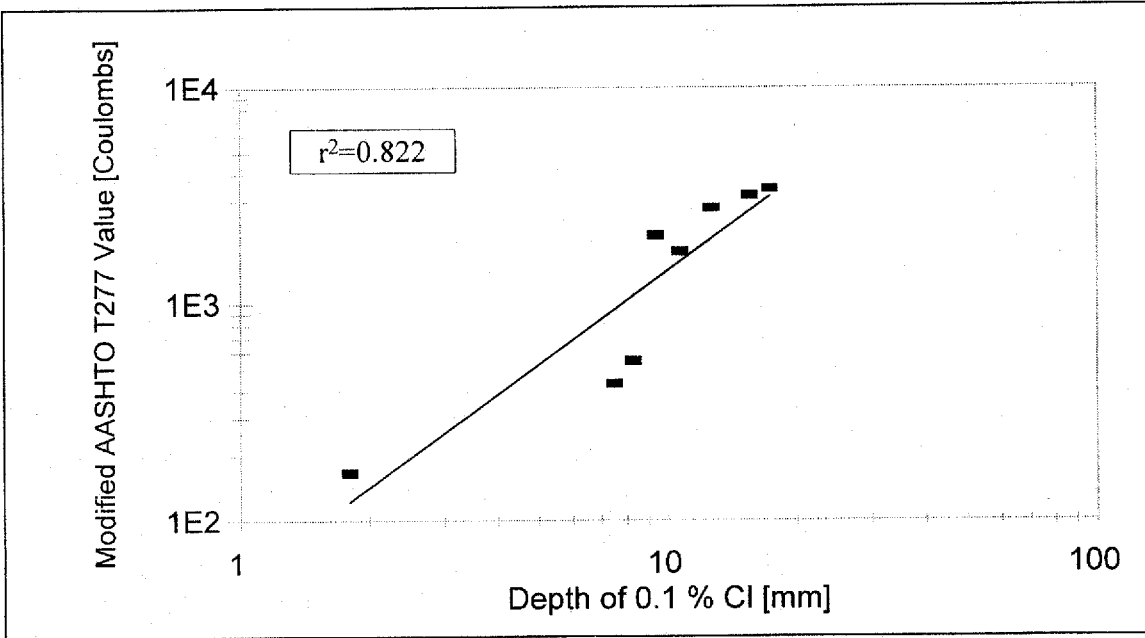
**Figure 19.** Modified AASHTO T277 vs. 90-Day Bulk Diffusion.



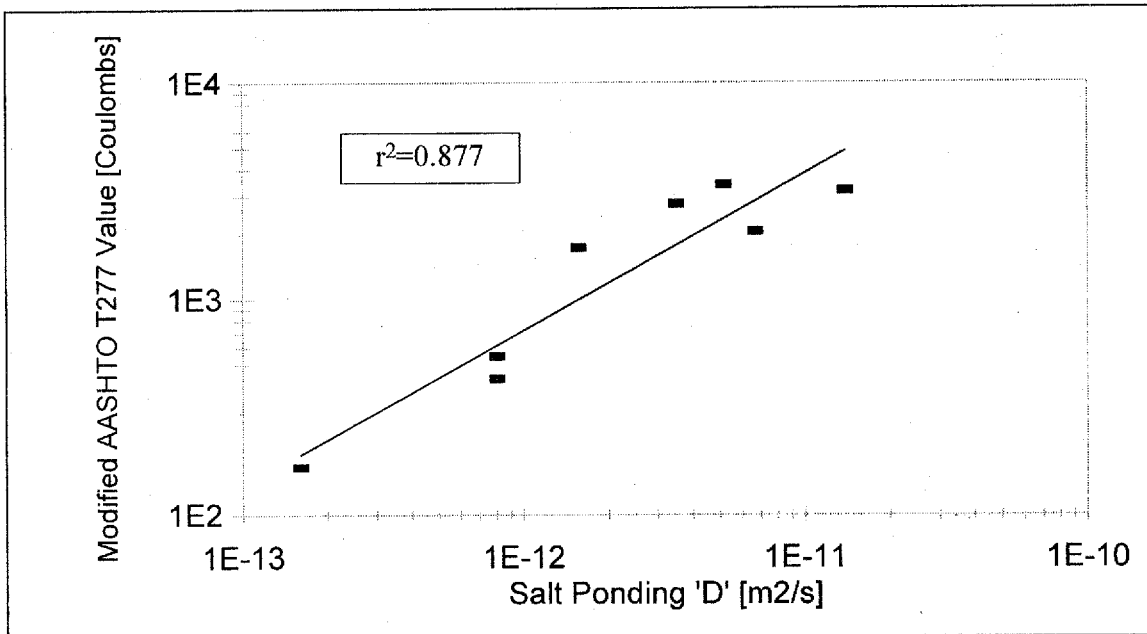
**Figure 20.** Modified AASHTO T277 vs. 365-Day Bulk Diffusion.



**Figure 21.** Modified AASHTO T277 vs. 90-Day Salt Ponding Pseudo-D.



**Figure 22.** Modified AASHTO T277 vs. 90-Day Salt Ponding Chloride Depth.

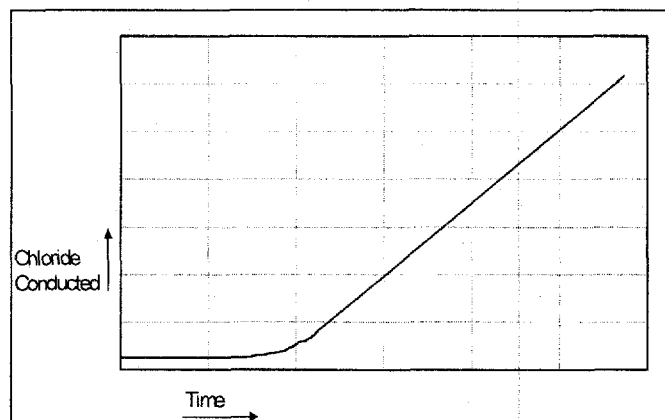


**Figure 23.** Modified AASHTO T277 vs. 365-Day Salt Ponding Pseudo-D.

### 2.3.5 Migration Test

This test involves placing a concrete sample between two solutions, one containing chloride and one without. A voltage is then applied across the sample and the downstream, initially chloride-free solution is monitored for chloride concentration. Diffusion coefficients can be determined from both the time it takes for chloride ions to reach the downstream cell and from the steady-state chloride flux [McGrath and Hooton, 1996]. Typical results for this form of test are presented in Figure 24. The time to breakthrough is when the chloride concentration begins to increase in the downstream cell, and the steady-state chloride flux can be determined from the slope of the increasing portion of the curve.

For the purposes of this project, the problem with this test was its duration. To meet the maximum 35 days of the project requirements, only 7 days were available for testing after an initial minimum 28-day curing period. Thus, the maximum reasonable voltage that would not cause significant heating (30 V) and the minimum representative sample thickness (40 mm) were used. Even under these conditions, it was expected that only breakthrough could possibly be achieved in 7 days, though, for the purposes of this trial, the cells were to be monitored until steady state conditions can be determined. The times to breakthrough are reported in Table 6. When the test was performed even using these most extreme conditions, it was not possible to achieve breakthrough in 7 days in the concretes containing silica fume. In addition, for the concrete with a higher penetrability, the situation in the downstream cell changed too rapidly to enable sufficient samples to be taken to allow the accurate determination of breakthrough time as well as to have sufficient points on the steady-state portion of the curve to achieve a reasonable estimate of the diffusion coefficient. This test, while significantly decreasing the testing time relative to a standard diffusion cell without an applied voltage, is still too slow for the purposes of this project. Also, ideally one would know the quality of the concrete with some accuracy before the start of testing, which will not always be the case.



**Figure 24.** Typical Migration Cell Results.

**Table 5.** Phase 1 – Correlation Coefficients – Short-Term Tests to Reference Tests.

Test Procedure	40-Day Bulk Diffusion	90-Day Bulk Diffusion	365-Day Bulk Diffusion	90-Day Salt Ponding 'D'	90-Day Salt Ponding 0.1 % Depth	365-Day Salt Ponding Pseudo-D
AASHTO T277	0.957	0.951	0.911	0.952	0.821	0.884
Modified AASHTO T277	0.967	0.991	0.890	0.935	0.822	0.877
8-hour CTH	0.840	0.840	0.586	0.725	0.571	0.438
1-day CTH	0.914	0.839	0.813	0.864	0.724	0.701
3-day CTH	0.900	0.647	0.552	0.650	0.364	0.567
Monfore Conductivity	0.966	0.848	0.820	0.821	0.656	0.741
Streicher & Alexander	0.366	0.451	0.223	0.427	0.522	0.503
Wenner Probe – Initial	0.597	0.604	0.668	0.708	0.519	0.688
Wenner Probe – Second	0.329	0.529	0.327	0.458	0.517	0.589
Sorptivity – Original	0.511	0.361	0.370	0.468	0.349	0.241
Sorptivity – Harsh	0.767	0.688	0.546	0.751	0.683	0.610
Sorptivity – Soft	0.907	0.950	0.952	0.943	0.861	0.849

**Table 6.** Time to Breakthrough for Migration Cells (in Days).

	0.50, Plain	0.45, Plain	0.45, 8 % SF	0.45, 20 % FA	0.45, 35 % Slag	0.35, Plain	0.35, 8 % SF	0.25, 8 % SF
30 V	1.9	0.9	12.8	0.9	3.0	2.8	95.1	79.7
12 V	5.3	2.1	43.7	1.7	8.3	6.7	101.9	288.1

### 2.3.6 CTH Migration Test

The CTH test was initially proposed by Tang Luping and Lars-Olof Nilsson at Chalmers Technical University, Sweden (1991). CTH stands for Chalmers Tekniska Högskola (Chalmers University of Technology). Conceptually, the test consists of subjecting the saturated test specimen to an electrical field with a chloride-bearing solution on one side, a chloride-free solution on the other, such that the chlorides are driven into the concrete. This situation is maintained for a specified period, and the concrete is then split open and sprayed with an indicator for chlorides,  $\text{AgNO}_3$ . The concrete can then be rated depending upon the depth of chloride penetration. This value can also be theoretically related to the chloride diffusion coefficient. In this work, 30 V for 24 hours was used. The detailed test method is included in Appendix 2. The CTH migration cell showed promise from early on in the laboratory testing program. There exists the possibility that this test could be performed in the cells currently used for the AASHTO T277 test, although this avenue was not investigated.

For the initial test regimen, it was decided to perform this test for three different durations: 8 hours, 1 day, and 3 days. These were performed, and a plot of the depth of chloride penetration as determined by silver nitrate spray versus test duration is included as Figure 25. It can be seen that the increase in chloride depth appears to be linear with time. These lines do not project back through the origin at time 0, as would be expected if they were linear. This is thought to be because, while the specimens were vacuum saturated, they were then left to dry for some short time while the silicone sealant attaching the sleeve to the concrete was allowed to dry. This would cause an initial sorption effect that would lead to higher penetration than would otherwise be the case. That is likely why the curves will not pass through the origin. This effect can be easily remedied by using a sleeve that attaches mechanically so that the initial drying period can

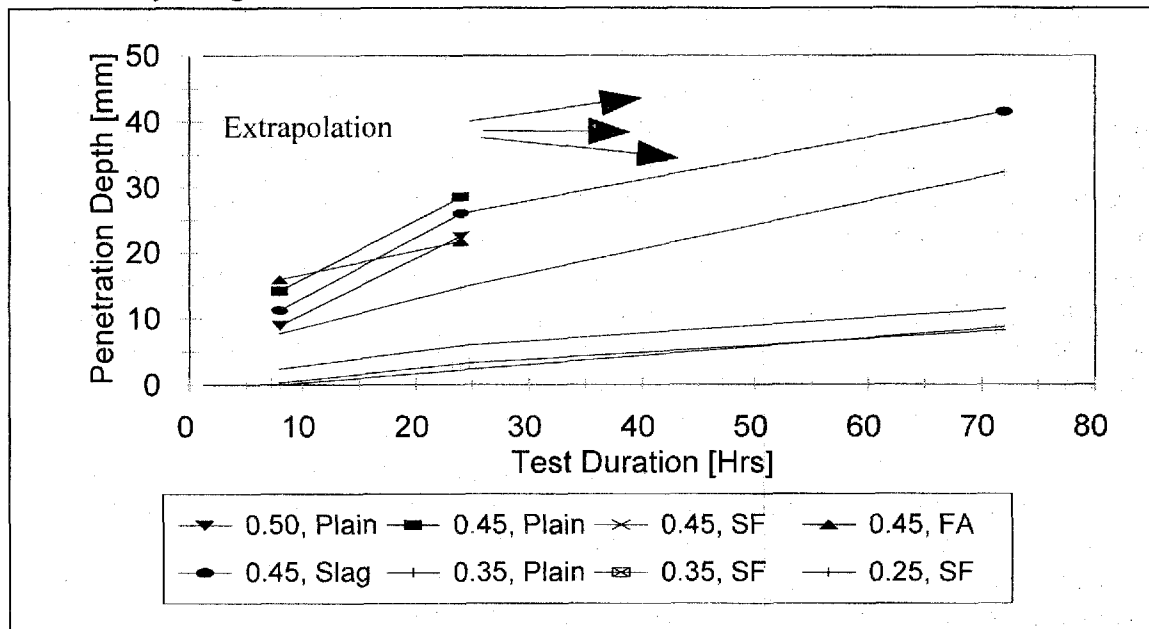


Figure 25. CTH Penetration Depth With Test Duration.

be avoided. The use of the mechanically attached sleeve in later work did reduce the amount of initial penetration, as represented by the value of the intercept. See Section 5 – Phase 3 for further discussion of this influence.

In the method proposed by Tang and Nilsson (1991), the depth of penetration is used in a theoretical equation to determine a diffusion coefficient. This has not been done in this work for two reasons. First, the primary purpose of this work is to develop a method for evaluating the quality of concrete, and not necessarily the chloride diffusion coefficient. Second, the theory developed by Tang assumes an S-shaped curve and a sharp chloride front, where the chloride concentration changes rapidly within a small distance. This has not been observed in the profiles obtained in this contract (see Figure 26 for a typical profile), and thus the equation developed is treated with skepticism, and its use is avoided.

The correlations in log-log space with the bulk diffusion values (40, 90, and 365 days), the two different 90-day AASHTO T259 evaluation techniques, and the 365-day AASHTO T259 pseudo-D values are included in Table 5 and presented graphically as Figures 27 to 32. It can be seen that the correlation values are generally fair, with the shorter test durations resulting in the better correlation. One exception is the comparison of the CTH values with the depth of 0.1 percent chloride by concrete mass of the 90-day AASHTO T259 test. This is worse than the others. This is thought to highlight more the poor quality of the AASHTO T259 salt ponding test procedure with regards to the multiple transport mechanisms that are occurring, as discussed in Section 2.3.2, more than the possibility that the CTH test does not present a good measurement of the chloride penetrability of the concrete. Compared with the 365-day bulk diffusion test the CTH test is also a little worse, probably because the CTH test was performed at an early age compared with the 365-day chloride exposure time of the bulk diffusion test.

Although this test does look promising, there are some difficulties in performing the test that must be discussed. The first is that the original method, as proposed by Tang and Nilsson, called for the concrete to be exposed to a voltage gradient for 8 hours, after which the specimen is split and sprayed with  $\text{AgNO}_3$  to determine the depth of chloride ions. This is a difficult procedure to fit in the normal working day, though this can be remedied by altering the duration of the test. To partially remedy this and to get a substantial penetration of chlorides for all concretes, Tang and Nilsson have revised their suggested test method so different voltages and durations are selected depending upon the initial current exhibited by the concrete [Tang, 1998]. Separate from this contract, the procedure devised by Tang was tried at the University of Toronto as part of a graduate student project, but it met with limited success, due to erratic chloride penetration fronts [Boddy, 1998]. This was investigated further in later parts of the contract.

Also, some difficulties do exist with performing the measurements for chloride penetration in this test. The chloride front will intersect aggregates as it penetrates the concrete, and these may cause uncharacteristic depth measurements if the point of measurement intersects an aggregate. The obvious solution to this difficulty is to discard these measurements but then it may become difficult to take sufficient measurements across the face of the concrete specimen. This is especially true if the aggregate used was large relative to the test specimen diameter. In addition, it was noted with the 0.25 w/cm ratio concrete containing 8 percent silica fume, that the dark color of the concrete made it

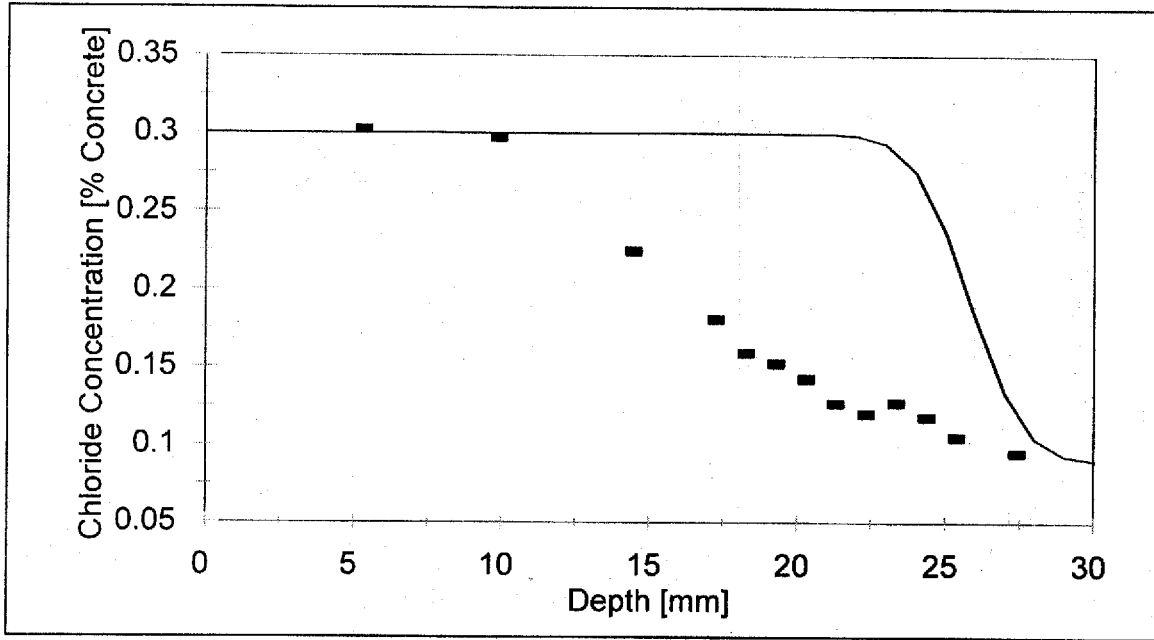


Figure 26. Typical CTH Profile, Showing Actual and Theoretical.

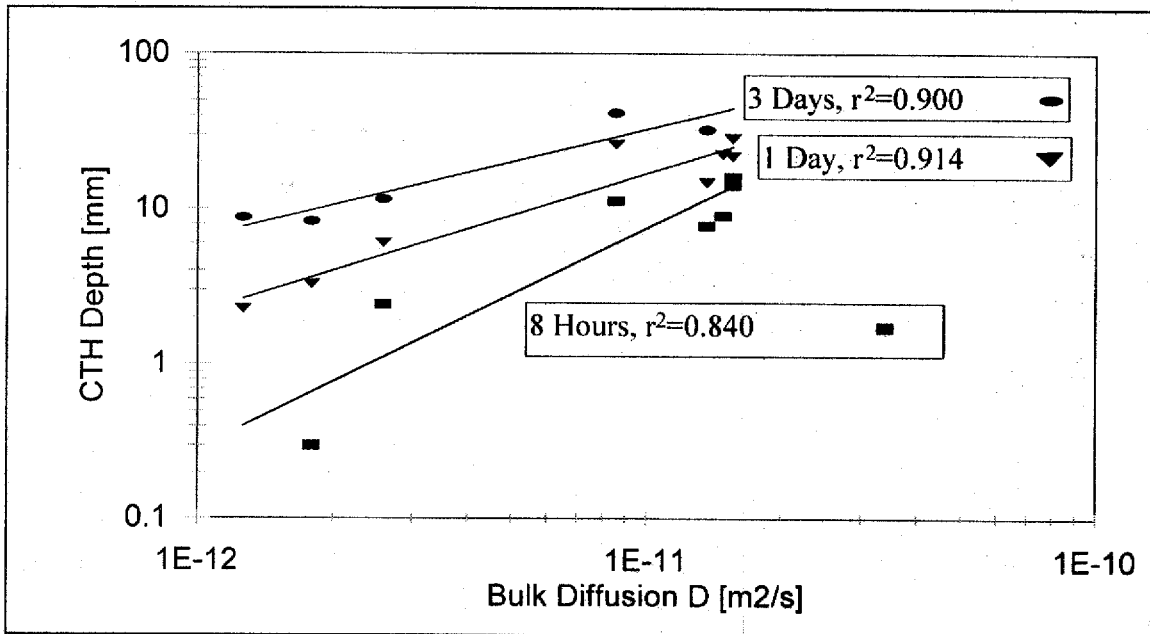
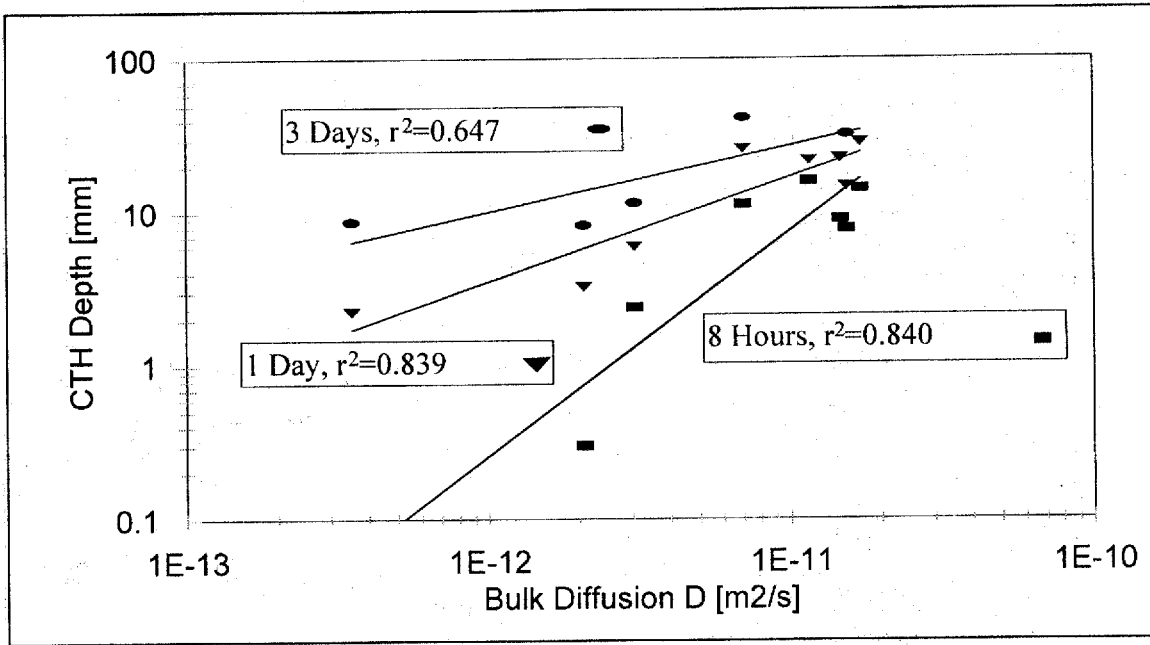
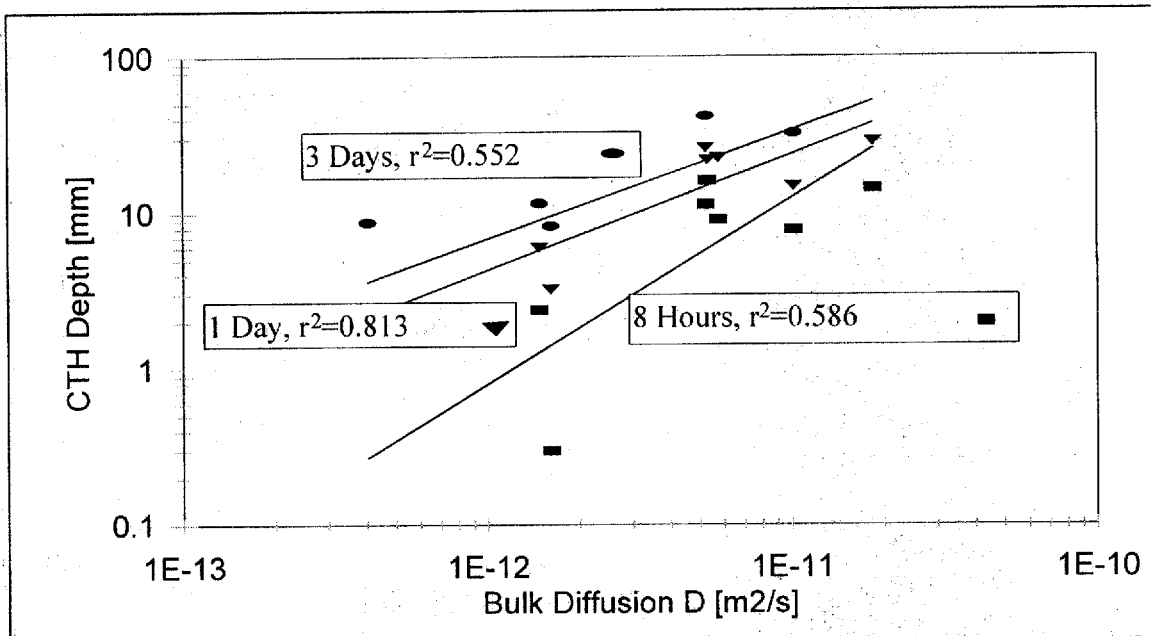


Figure 27. CTH Depth vs. 40-Day Bulk Diffusion.





**Figure 28.** CTH Depth vs. 90-Day Bulk Diffusion.



**Figure 29.** CTH Depth vs. 365-Day Bulk Diffusion.

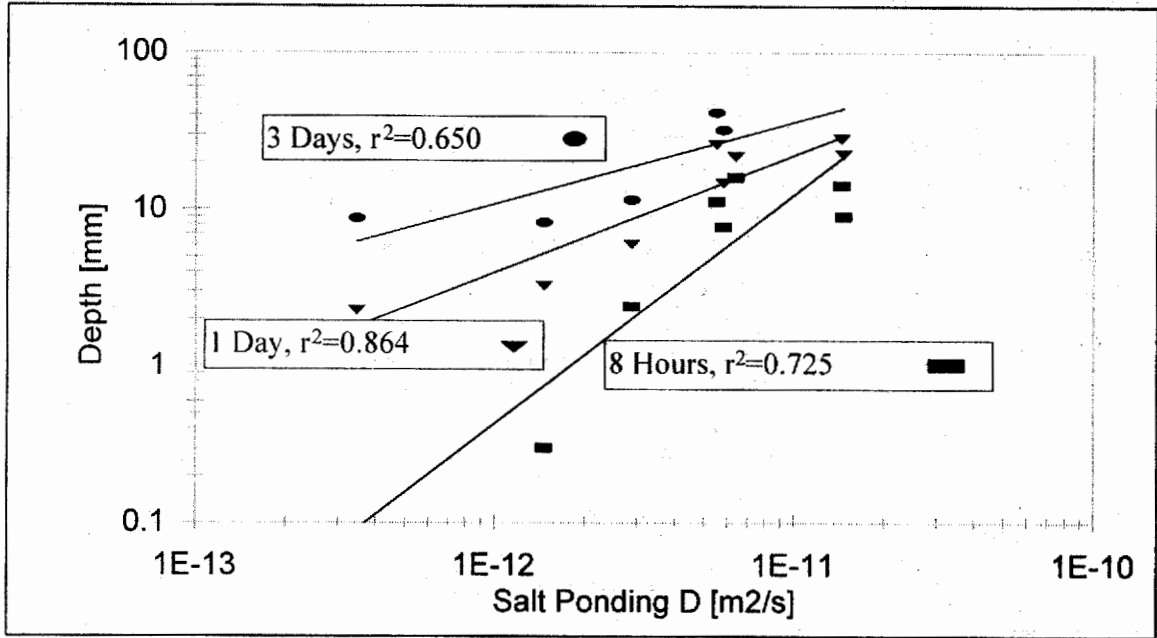


Figure 30. CTH Depth vs. 90-Day Salt Ponding Pseudo-D.

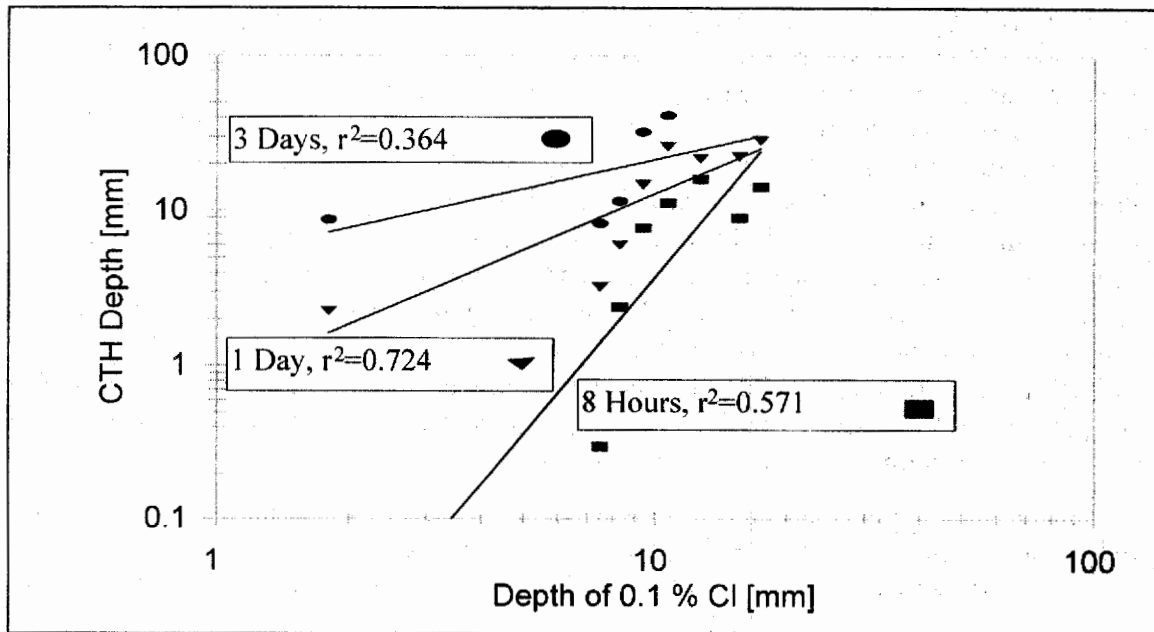
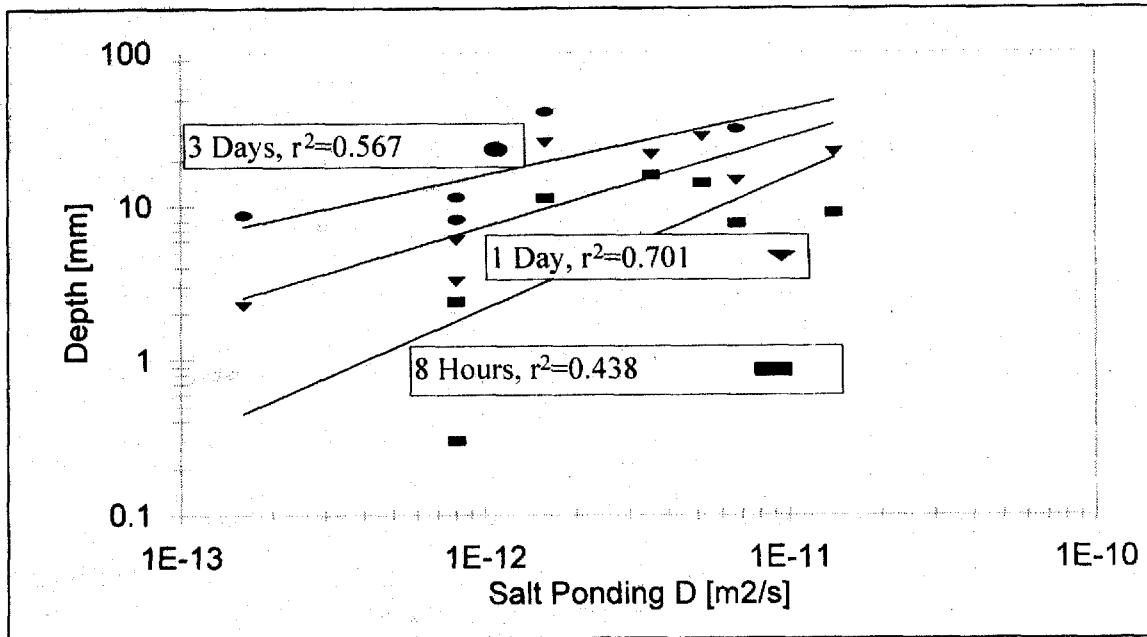


Figure 31. CTH Depth vs. 90-Day Salt Ponding Depth of Penetration.



**Figure 32.** CTH Depth vs. 365-Day Salt Ponding Pseudo-D.

more difficult to distinguish the color change boundary. Extra care had to be taken. The test apparatus proposed by Tang and Nilsson has slight differences from the test procedure first used here, and a full testing setup was acquired by the University of Toronto from them after the original Phase 1 testing program. It was thus decided to repeat this testing at a later stage to determine if their setup provided any significant advantages over the modified apparatus used here. All Phase 1 mixes were retested, using a test duration of 24 hours, at 30 V and a chloride solution concentration of 10 percent. The results are shown in Appendix 3, under the title Retest. There did appear to be some improvements, namely in the reduction of hydrogen gas buildup below the specimens and the use of mechanical fasteners to avoid an initial drying of the concrete. The concrete was tested at approximately 6 months of age. There was greater chloride ingress in these concrete samples than the ones tested at an earlier age, which is counterintuitive. It is believed that this is due to the increased chloride concentration in the upstream cell, as well as possibly more efficient voltage application from lower hydrogen gas buildup at the sample surface.

As this test appeared from early on to be a promising one, a brief reproducibility study was conducted [Boddy, 1998]. It showed that the variation between different samples of the same concrete mixture was relatively low, indicating good reproducibility.

Thus, it was concluded that this test method showed promise and was continued into the next phase.

### 2.3.7 Monfore Conductivity

The conductivity test used in this program was based on procedures first outlined by Monfore (1968). This test was designed to be used in the laboratory, which is thought to be superior to an *in situ* test as it is easier to control the moisture condition of the test sample, though there have been *in situ* tests developed for determining resistivity. The DC resistivity is calculated by alternate application of two DC voltages and determining the current experienced at each of these voltages. Alternating between the two applied voltages accounts for the effects of polarization. A more complete description of the technique used has been provided in Appendix 2. The conductivity (inverse of resistivity) values were compared with the diffusion values as they are thought to be analogous properties.

The conductivity values determined were then compared with the reference values (the three bulk diffusion coefficients and the various salt ponding test evaluation procedures). The results are shown in Table 5 and in Figures 33 to 38. This test did seem to perform well when compared with all baselines except the depth of 0.1 percent chloride concentration measured in AASHTO T259, which is thought to be a reflection of the poor quality of the salt ponding test instead of the conductivity, as previously discussed regarding transport mechanisms (Section 2.3.2).

This test has the advantage of simplicity. No solutions need to be made and the actual test takes approximately 15 to 20 minutes. Thus, one testing apparatus can be used to test multiple samples within a short period of time. The actual test can be almost fully automated; all that would be required is that the technician place the sample between two plates and start the machine. This test appeared promising, and was studied further in Phase 2.

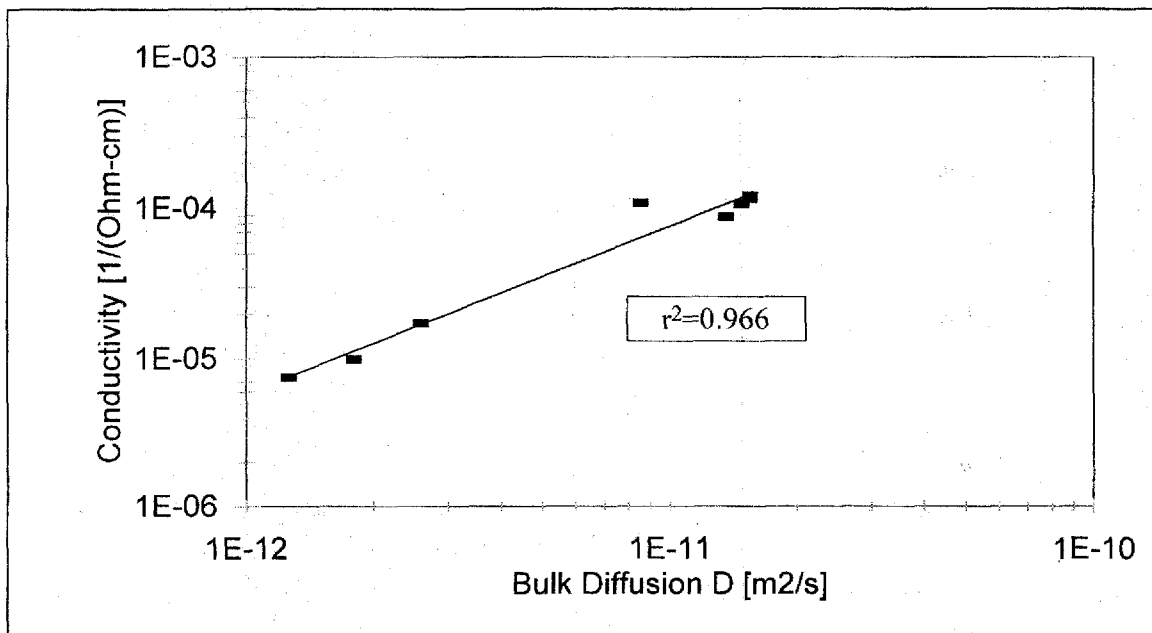
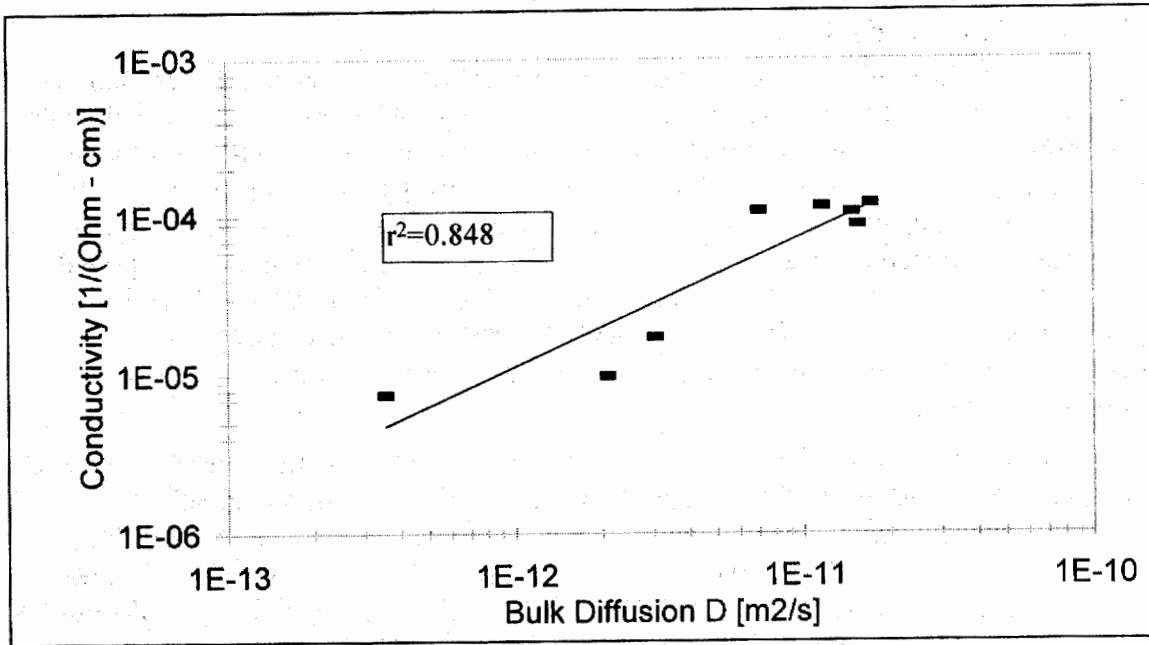
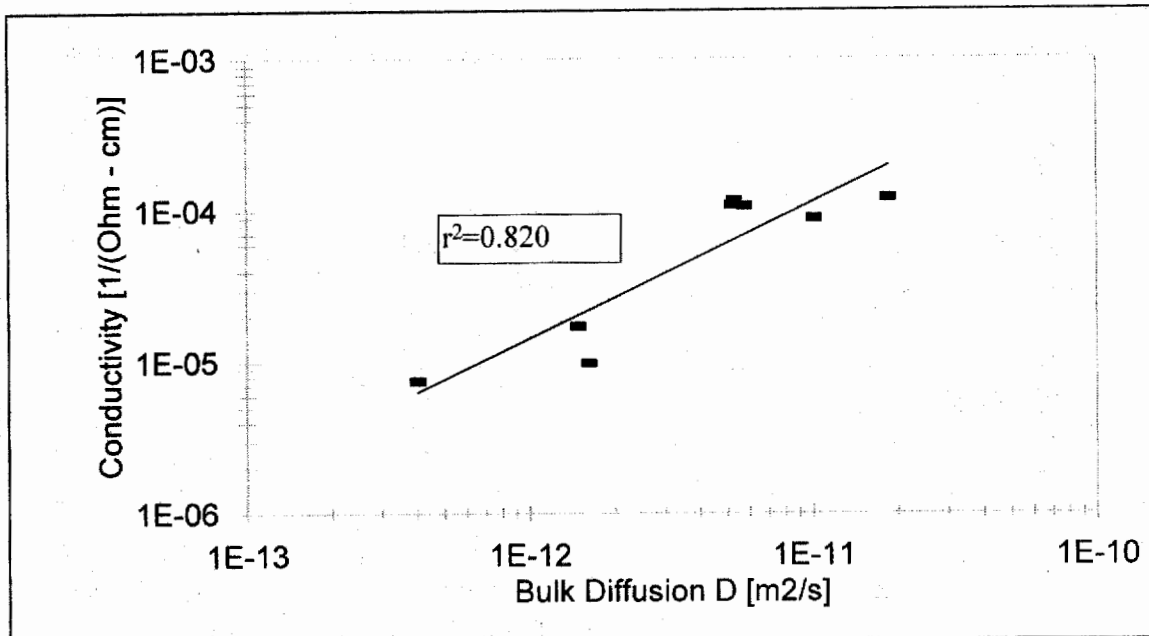


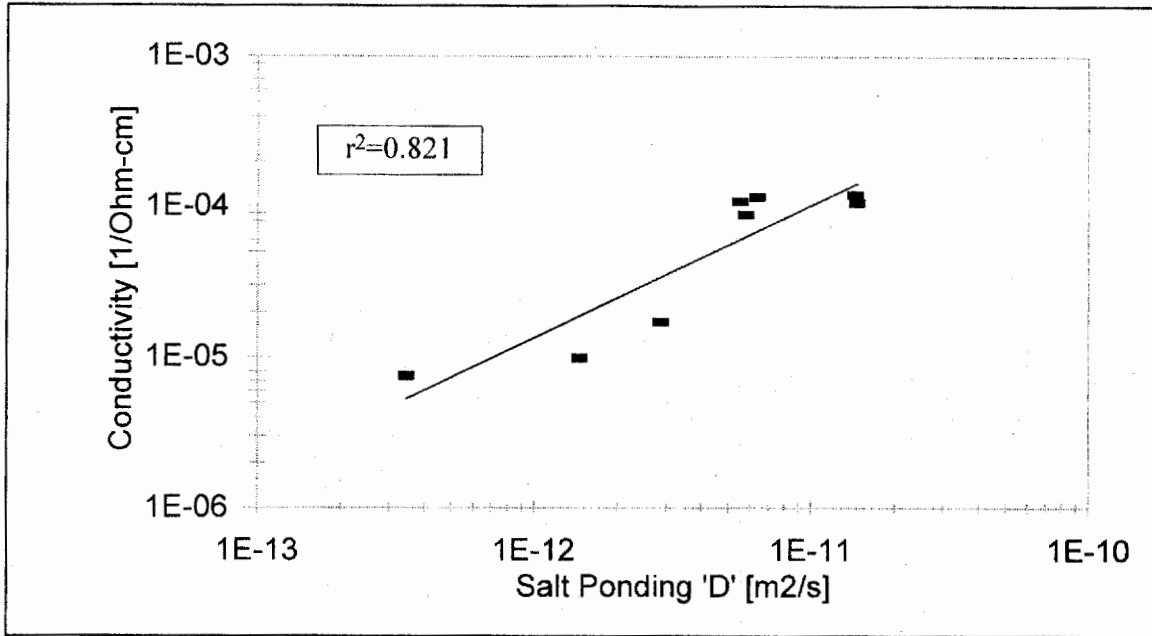
Figure 33. Conductivity (Monfore) vs. 40-Day Bulk Diffusion.



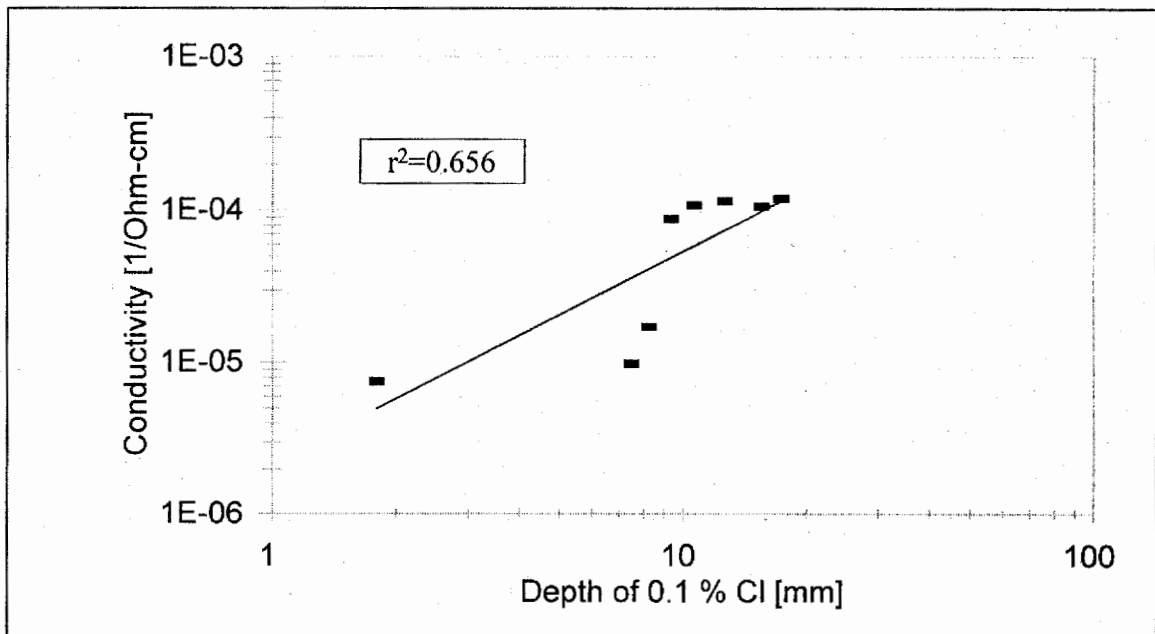
**Figure 34.** Conductivity (Monfore) vs. 90-Day Bulk Diffusion.



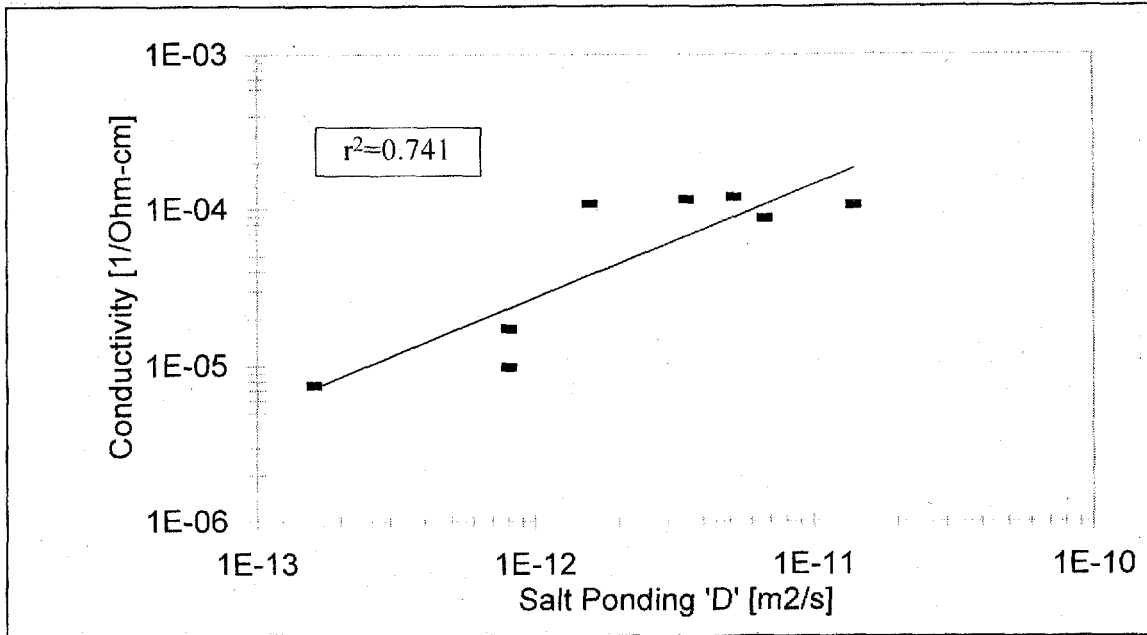
**Figure 35.** Conductivity (Monfore) vs. 365-Day Bulk Diffusion.



**Figure 36.** Conductivity (Monfore) vs. 90-Day Salt Ponding Pseudo-D.



**Figure 37.** Conductivity (Monfore) vs. 90-Day Salt Ponding Depth of Penetration.



**Figure 38.** Conductivity (Monfore) vs. 365-Day Salt Ponding Pseudo-D.

### 2.3.8 Chloride-Saturated Resistivity Test

This test method, as proposed by Streicher and Alexander (1995), involves saturating a concrete sample with a highly concentrated chloride solution and then determining its resistivity. The concept is to obtain a measure of the pore system connectivity that is not influenced by the composition of the pore solution. They theoretically related this value to the diffusion coefficient. One important assumption in this is that the sample is uniformly saturated with the salt solution. This assumption was tested by saturating several samples and then profile grinding them. The vacuum saturation procedure used here was slightly different than that used by Streicher and Alexander. The saturation procedure used was identical to that used in AASHTO T277, but a 5.0 M NaCl solution was introduced instead of normal tapwater. Streicher and Alexander dry the samples before saturation. The profile was obtained for four concretes from the exposed surface to the mid-depth (Figure 39), and it was immediately obvious that the assumption of constant chloride concentration is not valid.

In addition, the values achieved did not correlate well with the diffusion coefficients obtained from the 40-, 90-, and 365-day bulk diffusion tests or from the 90- and 365-day salt ponding test, as can be seen from Table 5 and Figures 40 to 45.

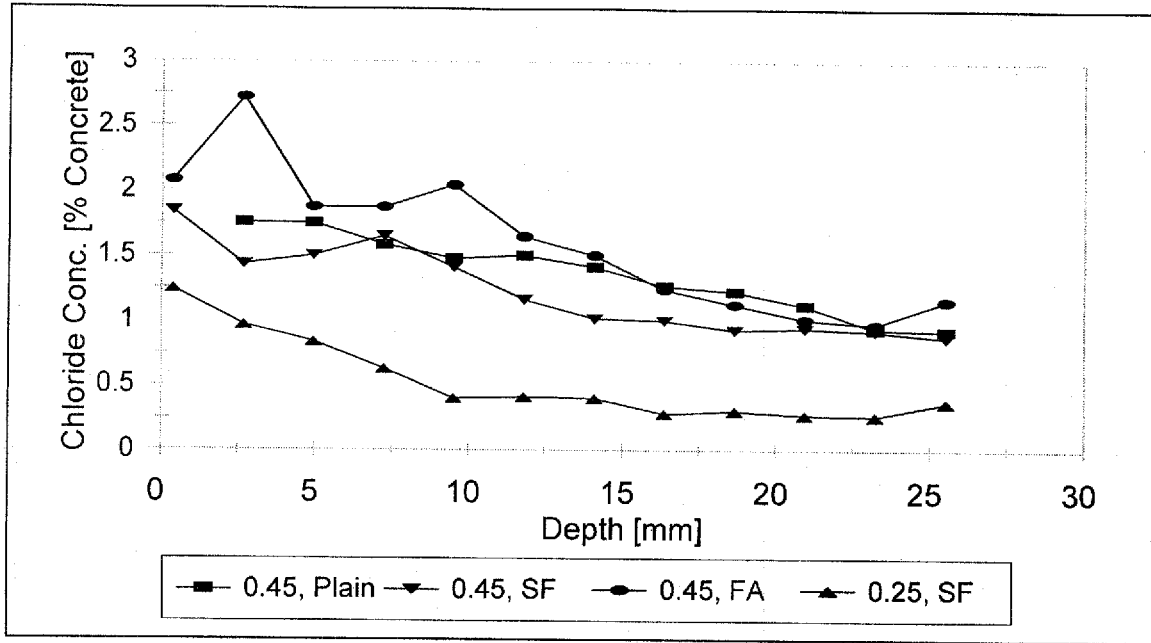


Figure 39. Chloride Conductivity Sample Profiles (Streicher & Alexander).

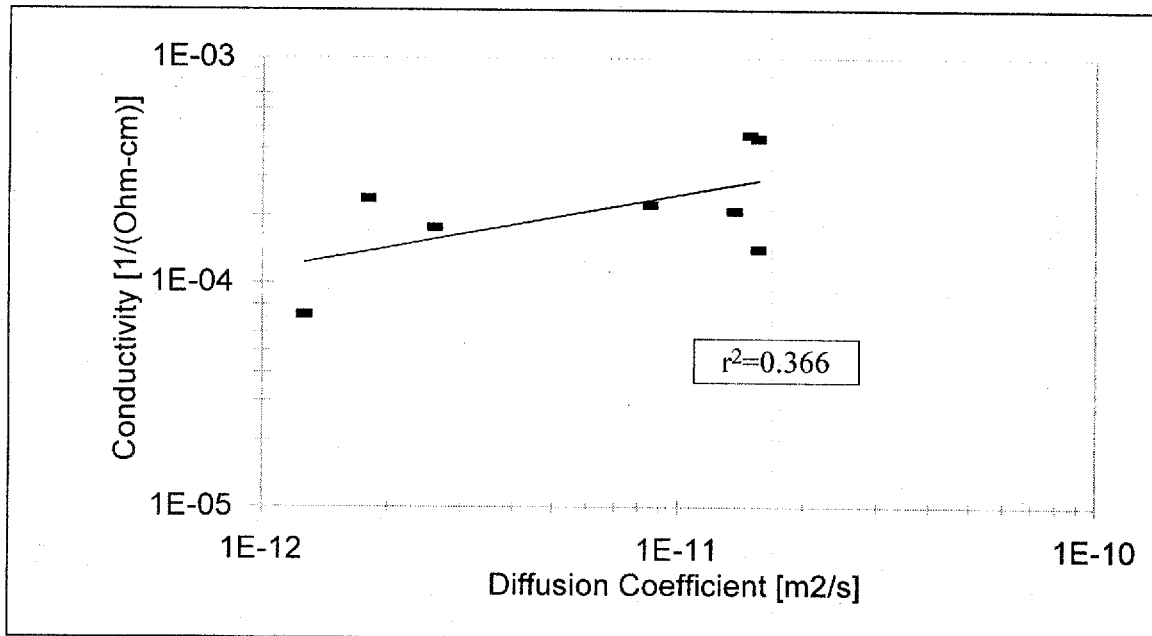
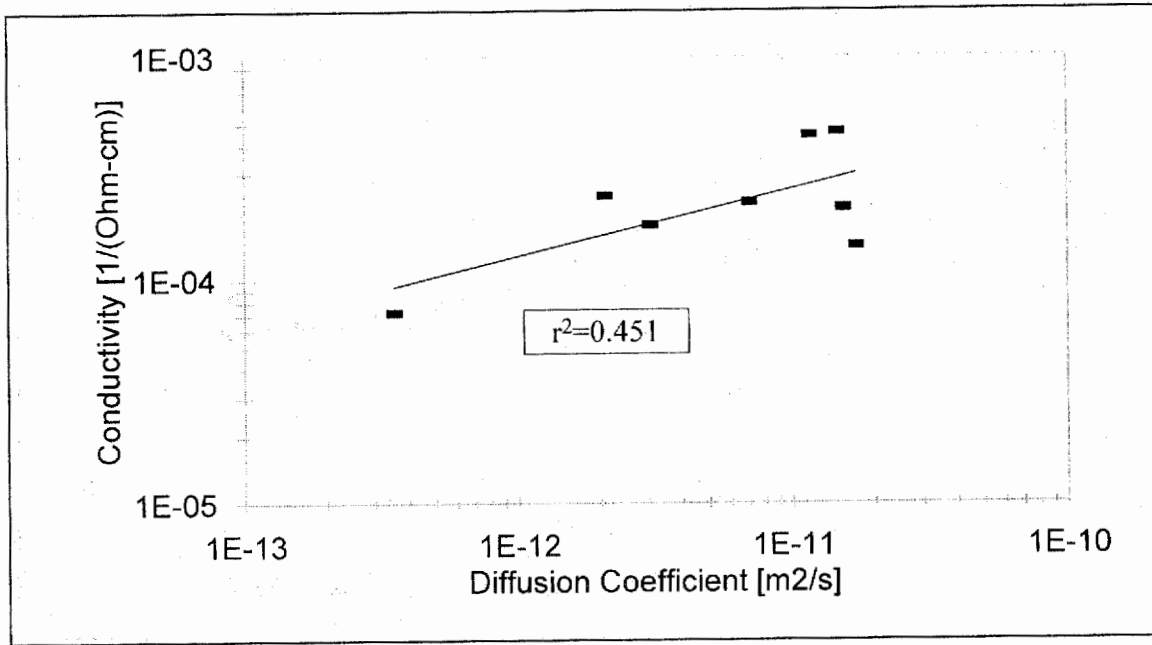
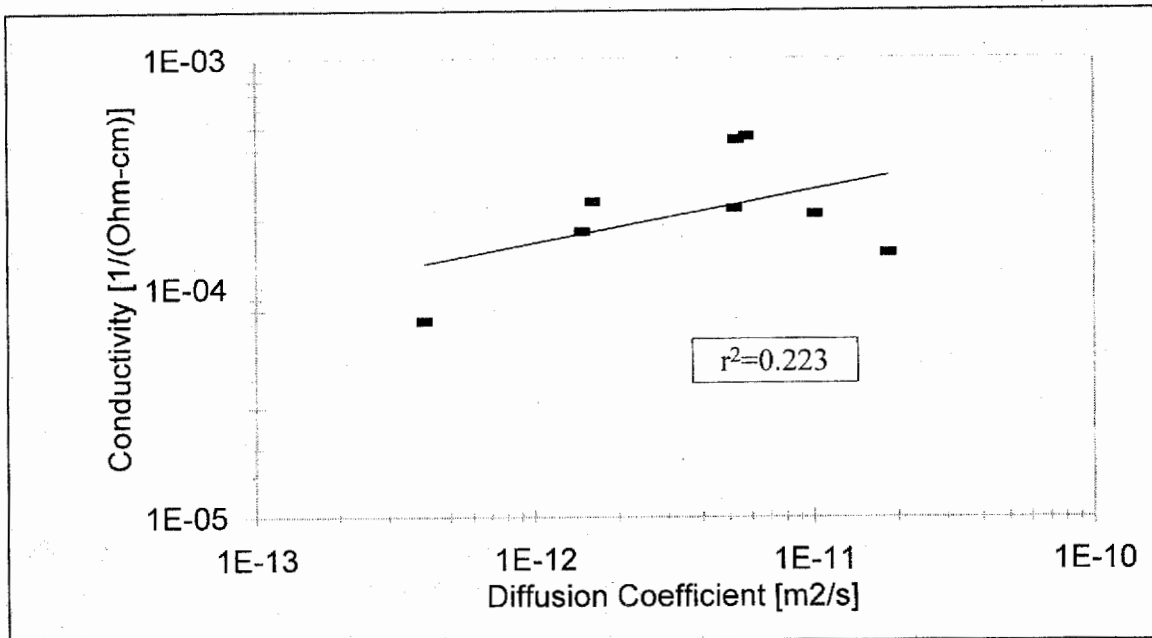


Figure 40. Chloride Conductivity (Streicher & Alexander) vs. 40-Day Bulk Diffusion.

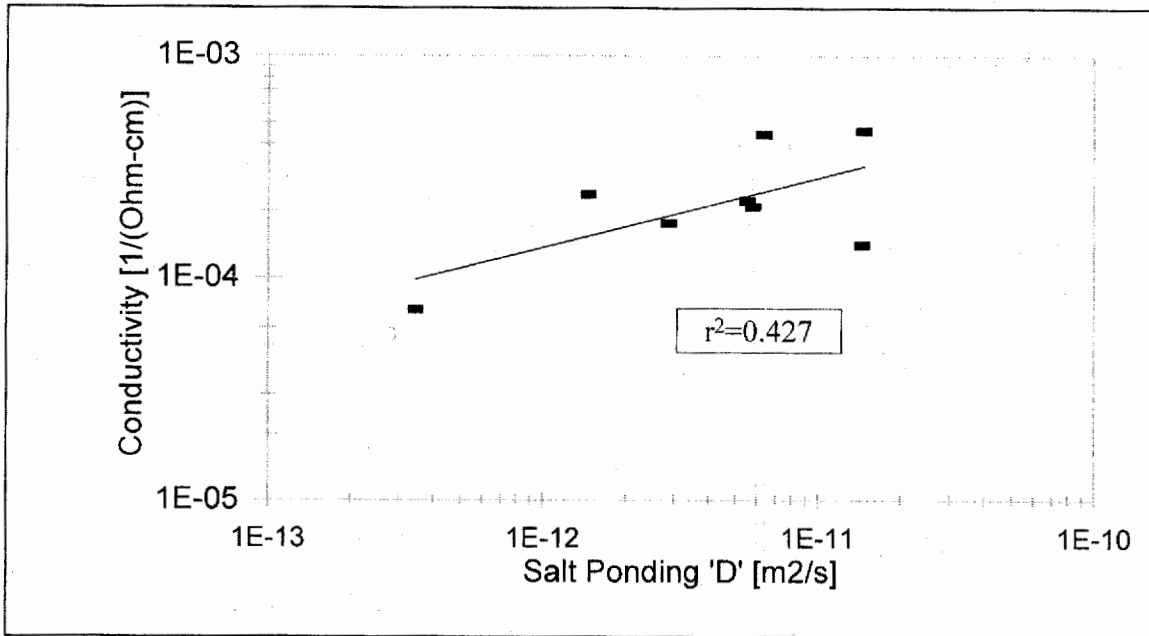




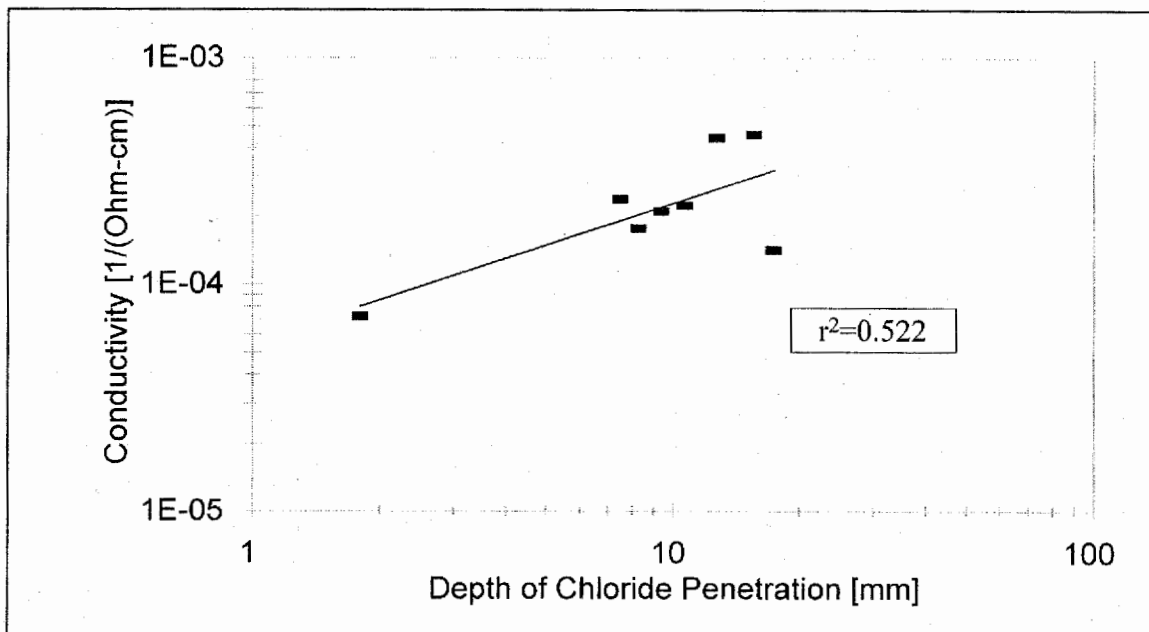
**Figure 41.** Chloride Conductivity (Streicher & Alexander) vs. 90-Day Bulk Diffusion.



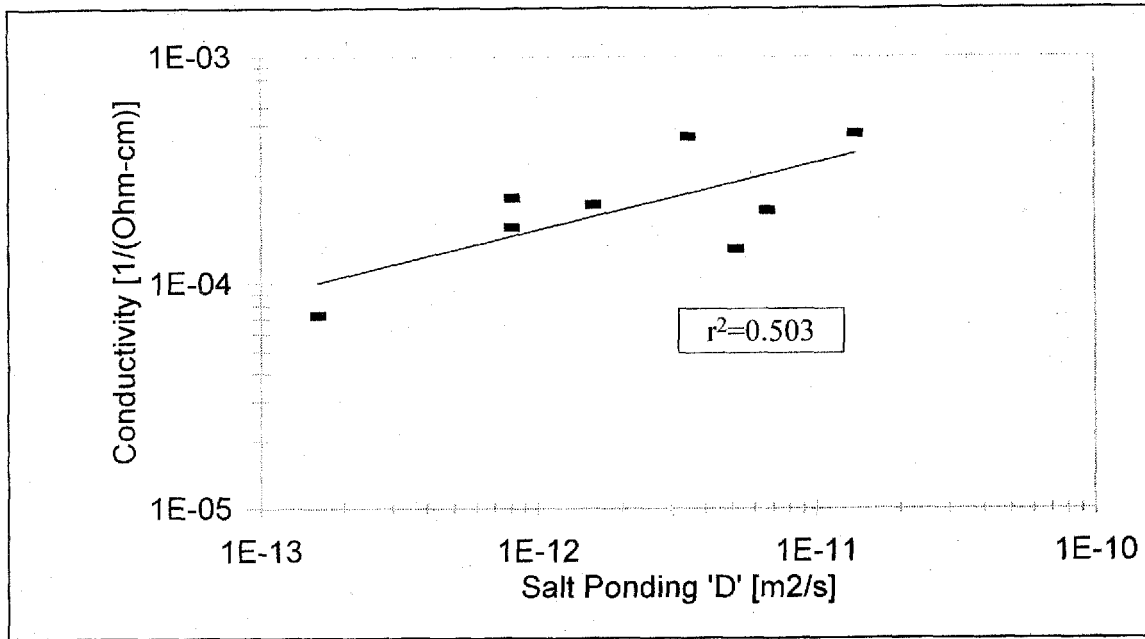
**Figure 42.** Chloride Conductivity (Streicher & Alexander) vs. 365-Day Bulk Diffusion.



**Figure 43.** Chloride Conductivity (Streicher & Alexander) vs. 90-Day Salt Ponding Pseudo-D.



**Figure 44.** Chloride Conductivity (Streicher & Alexander) vs. 90-Day Salt Ponding Depth of Penetration.



**Figure 45.** Chloride Conductivity (Streicher & Alexander) vs. 365-Day Salt Ponding Pseudo-D.

### 2.3.9 Wenner Probe

Using a four-point Wenner Probe device [Morris et al., 1996] to determine the resistivity of the concrete was not very successful. It was difficult to obtain a reading because of the low sensitivity of the apparatus used and the high resistance of the concrete. It was also difficult to saturate the concrete to any meaningful degree and this is the probable reason that some of the resistance values are so high. It was felt that this technique was more complicated than determining the resistance of a core and gave few practical advantages over that method other than field use. This is especially true for quality control testing, which can test additional, specially cast samples and not necessarily the concrete *in situ*.

A second attempt at evaluating the concrete's resistivity using the Wenner Probe technique was performed when the concrete was 1 year of age. Instead of placing the specimens face down in a shallow pool of water overnight, as was done previously to simulate pooling standing water on the top surface of the specimen, the entire specimen was submerged in water overnight. This second procedure was more successful in saturating the concrete to a uniform degree, and thus more reasonable, lower values were obtained. However, there is still significant scatter in the results, which was attributed to the different degrees of saturation of different concretes. This can be seen by examining Figures 46 to 51. No practical method can be seen for saturating concrete *in situ* simply for use in a technique such as this. It is believed that the preferred method of determining the resistivity of the concrete, if that is the method proposed, is a laboratory technique, testing cores taken from the structure.

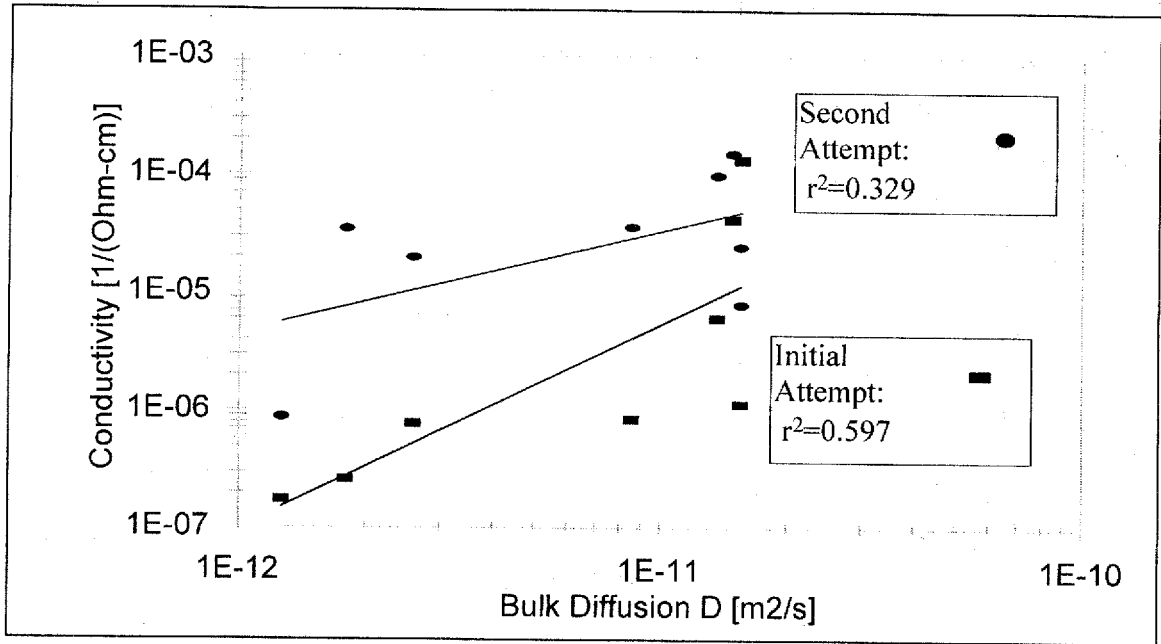


Figure 46. Wenner Probe Conductivity vs. 40-Day Bulk Diffusion.

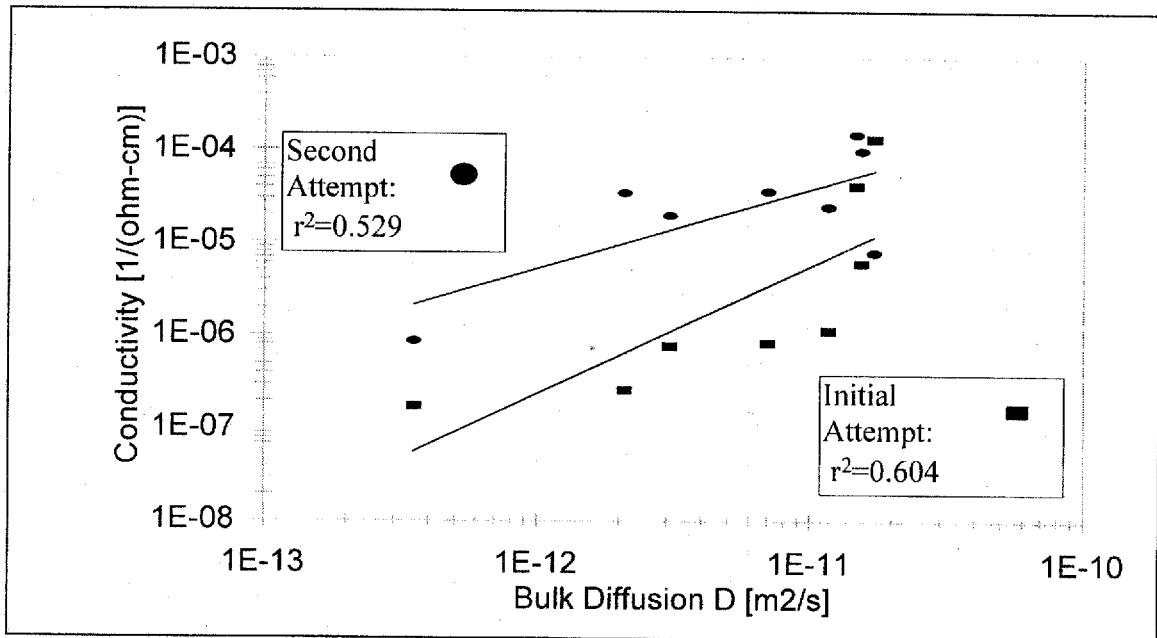


Figure 47. Wenner Probe Conductivity vs. 90-Day Bulk Diffusion.

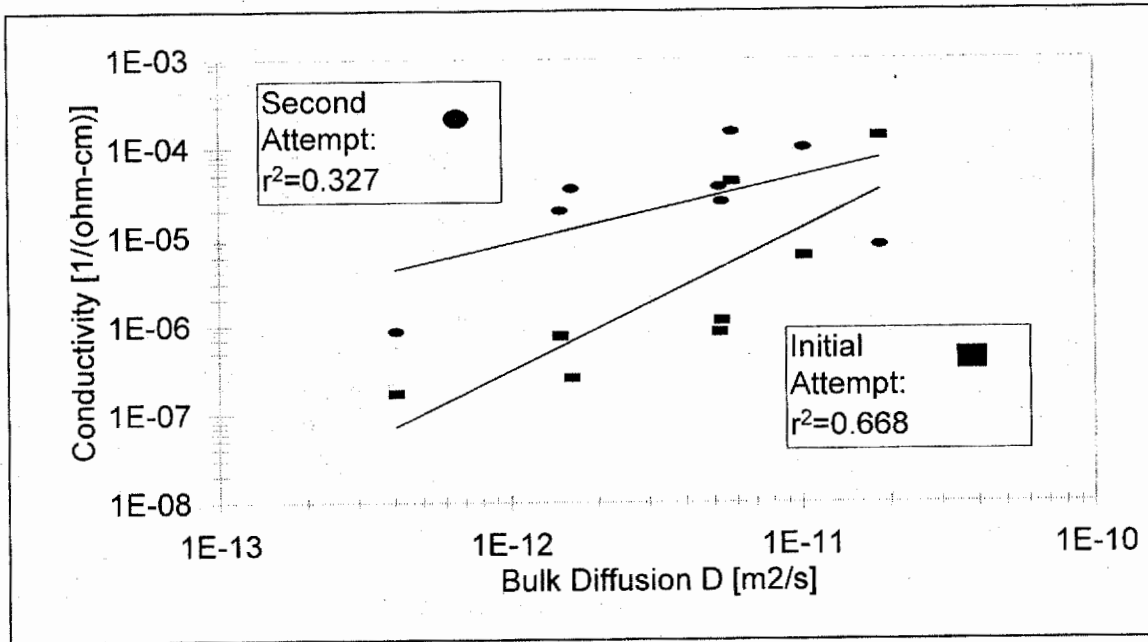


Figure 48. Wenner Probe Conductivity vs. 365-Day Bulk Diffusion.

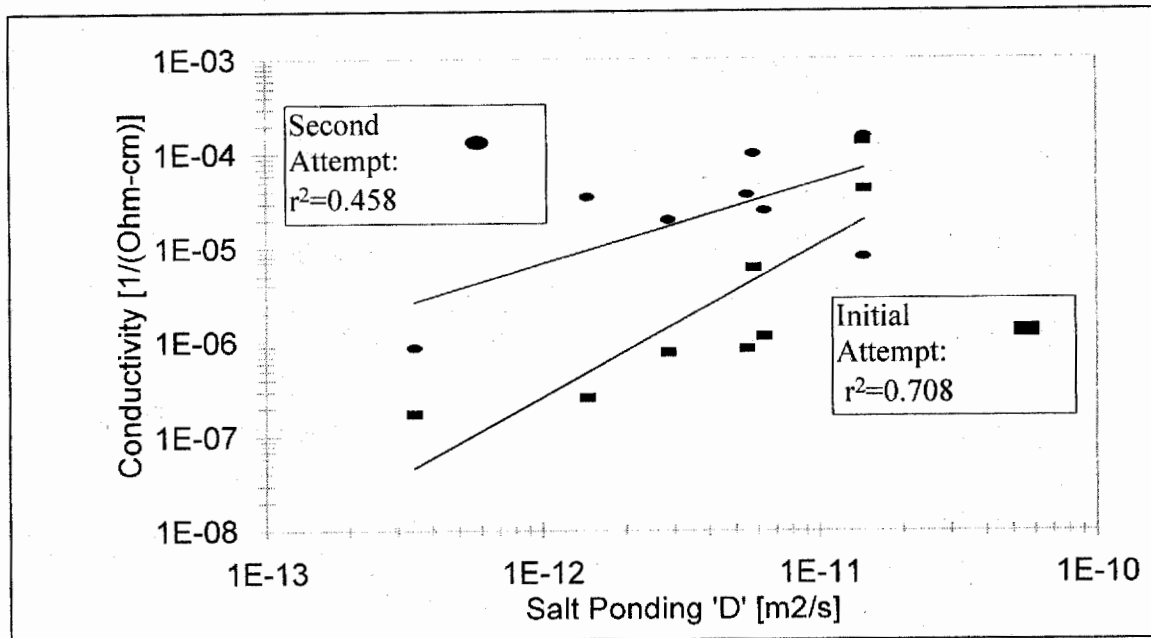


Figure 49. Wenner Probe Conductivity vs. 90-Day Salt Ponding Pseudo-D.

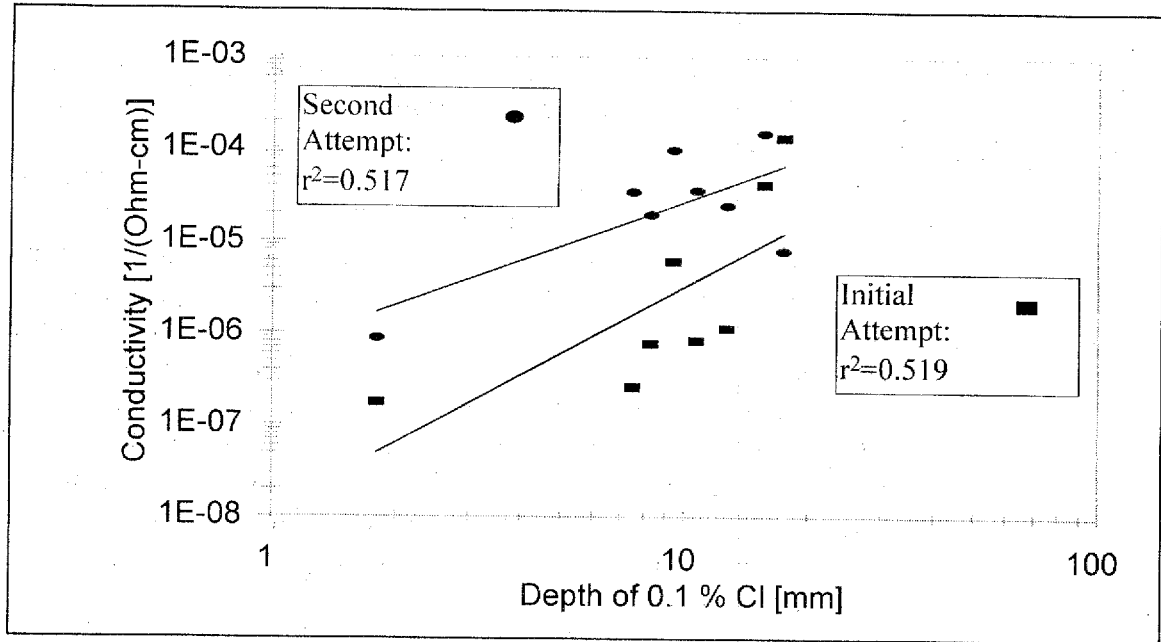


Figure 50. Wenner Probe Conductivity vs. 90-Day Salt Ponding Depth of Penetration.

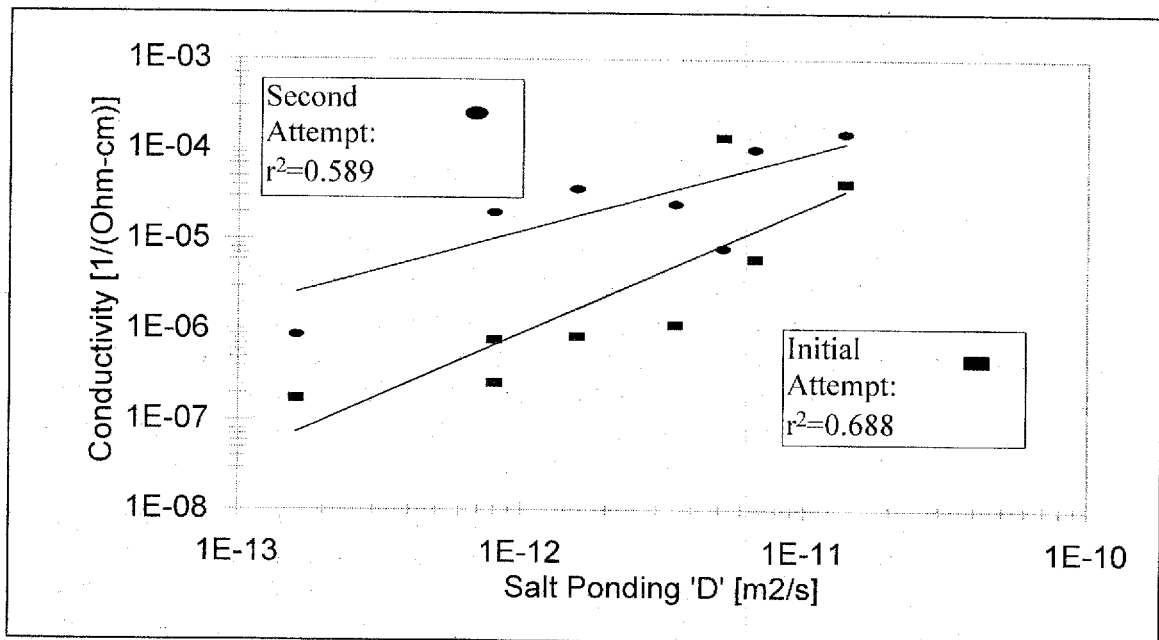


Figure 51. Wenner Probe Conductivity vs. 365-Day Salt Ponding Pseudo-D.

### 2.3.10 Sorptivity

The sorptivity test was initially carried out at 28 days of age on all mixtures. The results did not correlate well with the resistance to chloride penetration. This initial test was carried out with a drying regimen that was developed to produce a moisture condition that would emulate the moisture conditions in the field [Parrott, 1990; DeSouza et al., 1997]. This drying regimen was 3 days in an oven at 50°C, then in a sealed container at 50°C for 4 days. It is known that the sorptivity value determined is strongly dependent on the initial moisture condition of the concrete. It was thus suggested that a different drying regimen might produce a better correlation. To determine if this was the case, the sorptivity test was repeated later when the concrete was about 5 months old. At this time two different drying regimes were employed. One was the same drying regimen initially used, where the concrete was dried for 3 days in an oven at 50°C and then placed in a sealed container and left in the 50°C oven for 4 additional days, referred to as the soft drying regimen. The second regimen was one used earlier at the University of Toronto, where the samples are placed in a 50°C convection oven for 7 days, but not in a sealed container, referred to as the harsh drying regimen.

The hope was that this second drying regimen might improve the correlation between the sorptivity values and the long-term diffusion coefficients as determined by bulk diffusion and T259 salt ponding tests. As can be seen from the correlation coefficients reported in Table 5, the different drying regimen, while improving the correlation, was still unsatisfactory. However, the original drying regimen (3 days + 4 days) appeared to give a better correlation with the reference test results when it was repeated. As this drying regimen was unsuitable when it was performed originally, however, this does not indicate that it will be a consistently reliable test for predicting chloride penetrability.

### 2.3.11 Pressure Penetration Methods

Pressure penetration tests were carried out on all concretes. In this test, a 25-mm-thick, water-saturated concrete sample was tested in a high-pressure permeability test apparatus. It was capable of providing a confining pressure of 17.2 MPa (2500 lbf/in<sup>2</sup>) and a driving pressure of 6.9 MPa (1000 lbf/in<sup>2</sup>). A 3 percent NaCl solution was introduced on the upstream side. This condition was maintained for 6 days, and the sample was then removed and the depth of chloride penetration evaluated with the AgNO<sub>3</sub> spray. The primary advantage of this test is that it is independent of the effect of steel reinforcement. Unlike most of the other accelerated tests considered, there are no potentials applied, which the presence of steel may interfere with.

The first difficulty with this test is in achieving results in the time frame required in the project. To prevent leakage around the sides of the sample, a high confining pressure is required, which should be at least two times, but preferably two and a half or three times, the driving pressure. To do this, a substantial cell is required and a method must be devised to apply this pressure. This is done at the University of Toronto by the application of a two-phase pump driven by air pressure [El-Dieb and Hooton, 1994]. This technique does not lend itself readily to application in the field. Second, in addition to applying a confining pressure, a driving pressure needs to be applied such that it will be maintained as the solution penetrates the concrete. This is done in this lab using a

lever arm and a dead weight system, but this would be unsuitable for field use. The final difficulty in the testing parameters used herein was the sample thickness. Normally, it is recommended that a sample size at least two times the maximum aggregate diameter be used to avoid interfacial effects. It was realized that this guideline was broken here and would have to be remedied if this test was to be developed for further use, but it was necessary to evaluate if this test had any potential to fulfill the requirements of the contract with regard to time.

It quickly became apparent that, using these testing parameters, this test was unacceptable. For the lower quality concretes, the salt solution quickly penetrated the entire depth of the sample and there was a flow of the chloride solution through to the outflow side. For the higher quality concretes, there was little or no visible penetration of the chloride solution. The results are given in Table 7.

**Table 7.** Phase 1 Pressure Penetration Data.

Mixture	Pressure Penetration Test Results
#1 – 0.50, Plain	Flow – Chloride Penetrated Entire Specimen
#2 – 0.45, Plain	Flow – Chloride Penetrated Entire Specimen
#3 – 0.35, Plain	Flow – Chloride Penetrated Entire Specimen
#4 – 0.45, SF	Good Test – Penetration of Approximately 10 mm
#5 – 0.35, SF	Sprayed With AgNO <sub>3</sub> - Little Penetration (2-3 mm)
#6 – 0.25, SF	Sprayed With AgNO <sub>3</sub> - No Visible Penetration (< 1 mm)
#7 – 0.45, FA	Flow - Chloride Penetrated Entire Specimen
#8 – 0.45, Slag	Flow - Chloride Penetrated Entire Specimen

The difficulty is that while the concrete can thus be generally divided into two groups, one with extensive penetration and one with little penetration, the range of qualities in each group still contains an extremely wide variety of concrete qualities. It is possible that this range in each category may be further subdivided with the proper selection of the test parameters at the start of the test. However, unlike in some other tests, there is no initial information on which to base the selection of these test parameters. It is possible that if additional time was allowed for the test duration, some improvement could be made, but this would not fit in with the project requirements. Some additional study of this procedure was performed in Phase 3, reported in Section 5.2.2.

#### **2.4 Conclusions From Phase 1**

Two long-term tests were evaluated – the bulk diffusion test and the salt ponding test. The salt ponding test was evaluated in a variety of ways. The bulk diffusion test has a strong theoretical basis – what is occurring is straightforward and simple to describe mathematically. The salt ponding test is more difficult since a variety of transport mechanisms are occurring, and this complicates evaluation. When compared with the bulk diffusion test, evaluating the salt ponding test by fitting an pseudo-diffusion profile and by determining the depth of 0.1 percent chloride concentration by mass of concrete



were successful, while evaluating the integrated chloride content was not. For the pseudo-diffusion value, it must be remembered what this value represents – a collection of influences – and must not be applied incorrectly.

It is thought that the use of a profile grinding technique, where the concrete is removed in small (approximately 0.5-mm) layers is a superior method of evaluating the chloride penetration into a long-term test compared with the relatively thick slices proposed by AASHTO T259. The profile grinding technique provides more information about the shape of the curve. While it does require more work than the slicing of layers, it is worth it, especially considering the work that has gone into producing the sample.

Two procedures were used to evaluate the data collected from the AASHTO T277 test in an attempt to avoid one of the main drawbacks of this test – the effect of temperature rise in the later stages of the test for poor quality concrete. It was successful in that the modified procedure (12 x 30-minute charge passed value) was able to predict the reference methods with a greater success than the standard procedure.

From the data collected, and for the reasons described in the previous discussion, two tests were selected for further study in Phase 2: the CTH migration test and the resistivity test. These tests appeared to give a good prediction of the bulk diffusion test, both are relatively simple to perform, and both fit within the 35-day time frame established by the project requirements. The migration test and the pressure penetration test took too long to perform and were complicated; the chloride-saturated resistivity test was not able to achieve the required theoretical conditions and was unable to predict the reference values; and the sorptivity and Wenner Probe test did not prove to be able to predict the long-term reference tests.



### 3 Phase 1A

#### 3.1 Objective

After Phase 1, although the promising test methods had been selected, it was thought that some more information was required before Phase 2 could commence. It was decided to examine the CTH test to see if a single duration and voltage could be used for all concretes.

The difficulty in using a single voltage-time combination is the wide range of concrete qualities that may be evaluated. In general, the diffusion coefficient can vary over one and a half or two orders of magnitude, depending upon the concrete quality. The diffusion coefficient controls the amount of penetration of the chlorides in a given condition through the Nernst-Planck equation. Thus, if a low quality concrete is tested with either too high a voltage or too long a duration, then the chlorides will penetrate the entire depth of the concrete. If this complete penetration happens for too wide a range of concrete quality, then all that has been determined is that the concrete tested is worse than a concrete that has just less than full penetration. On the other end of the scale, if the concrete is subjected to a voltage that is too low or a duration that is too short, very little penetration will be observed. If this is the case for too wide a range of concrete qualities, then insufficient information will be gathered to differentiate between such concrete.

#### 3.2 Testing Program

Two concrete mixtures were repeated from Phase 1, the w/cm = 0.45, OPC (Mixture #2) and the w/cm = 0.35, 8 percent silica fume (Mixture # 7) with identical materials as Phase 1 (See Tables 1 and 2). These were selected to represent the extremes of the concrete qualities that are likely to be encountered in highway structures. For each mixture, the 28-day strength was determined, and the AASHTO T277 test was performed at 28 days. Finally, the CTH test was performed for three different durations and at three different voltages, according to Table 8. Two different upstream sodium chloride concentrations (10 percent NaCl and 3 percent NaCl by mass) were also investigated for one voltage-time combination (22.5 V and 6 hr, 0.45, plain; 30 V and 6 hr, 0.35, 8 percent silica fume). The testing commenced at 28 days of age.

**Table 8.** Phase 1A CTH Testing Schedule.

Voltage Applied	6 Hours	1 Day	2 Days	3 Days
20 V	Both Mixes	Both Mixes	0.45, Plain	0.35, 8 % S.F.
22.5 V	0.45, Plain	0.45, Plain	0.45, Plain	-
30 V	0.35, 8 % S.F.	0.35, 8 % S.F.	-	0.35, 8 % S.F.
40 V	Both Mixes	Both Mixes	0.45, Plain	0.35, 8 % S.F.

### 3.3 Results

The CTH results are included in Tables 9 and 10. All the numerical results are reported in Appendix 4. For the low-quality concrete (0.45, OPC), breakthrough was achieved after 2 days for all voltage levels. By examining the results obtained, it was thought that a test duration of 24 hr at a voltage of 30 V would result in sufficient chloride penetration depths, while minimizing the possibility of chloride breakthrough in the test. Thus, these values were used in Phase 2.

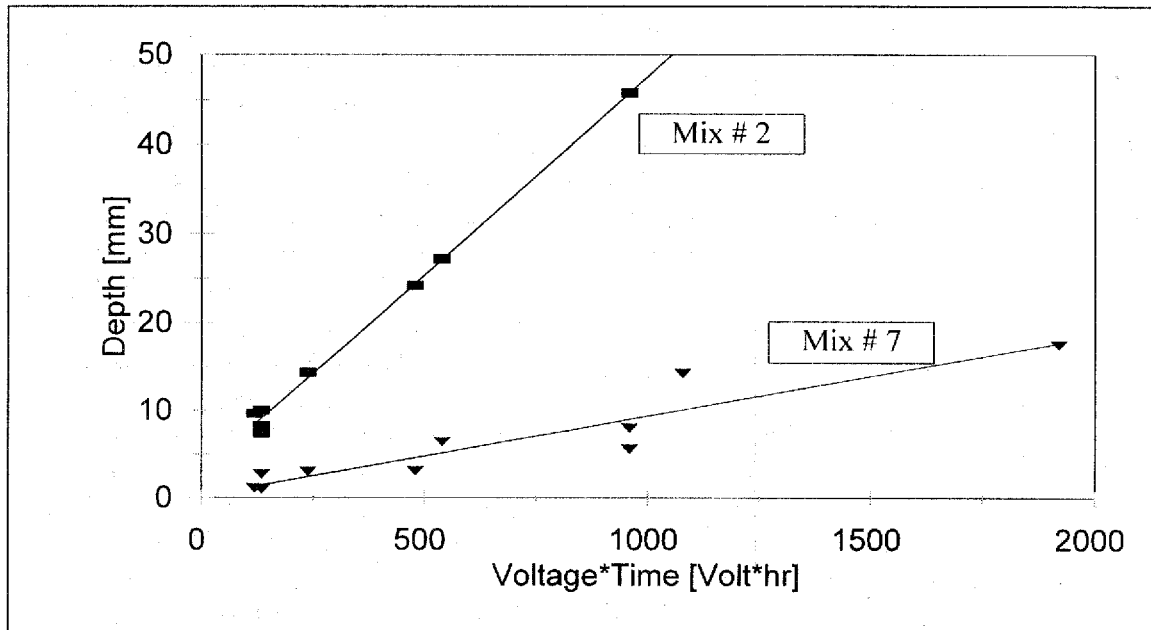
**Table 9.** Phase 1A 0.45, Plain CTH Results.

Voltage Applied	6 Hours	1 Day	2 Days	3 Days
20 V	9.6 mm	24.2 mm	Full Depth	-
22.5 V	10.0 mm	27.2 mm	Full Depth	-
40 V	14.3 mm	45.8 mm	Full Depth	-

**Table 10 -** Phase 1A 0.35, 8 % SF CTH Results

Voltage Applied	6 Hours	1 Day	2 Days	3 Days
20 V	1.1 mm	3.1 mm	-	8.0 mm
30 V	2.7 mm	6.4 mm	-	14.2 mm
40 V	3.0 mm	5.6 mm	-	17.5 mm

In addition, the depth of penetration was plotted for both concretes versus the product of the voltage and the time. These results are shown in Figure 52. These results indicate that the rate of penetration – the depth penetrated per volt-hour – is independent of the testing conditions used. This suggests that this value may be used to rate the concrete. This concept is returned to in Phase 3, Section 5.



**Figure 52.** Phase 1A Penetration vs. Voltage x Time.

## **4 Phase 2**

### **4.1 Objectives**

The purpose of Phase 2 was to investigate more fully the CTH test and the Monfore Conductivity test.

### **4.2 Testing Program**

In this phase, the CTH migration test and the Monfore Conductivity test were evaluated on a wide range of concrete mixture designs, containing all the variables specified in the contracting documents. A table of the 28 concrete mixture designs, for the 32 different test factors used in Phase 2, is included in Appendix 5. To avoid the possible problems associated with shrinkage and microcracking encountered in Phase 1 (See Section 2.3.4), the concrete was continuously moist cured until the date of test. The short-term tests were conducted at 28, 118 (90+28) and 383 (365+28) days to evaluate time-dependent effects. In addition, 90- and 365-day duration bulk diffusion (NTBuild 443) and 90-day salt ponding (AASHTO T259) reference tests were started at 28 days of age. For each test, two replicate cores were taken from 350-mm x 250-mm x 75-mm slabs, and cut to length.

The Phase 2 data are included in tabular form in Appendix 5.

### **4.3 Results**

#### **4.3.1 Data Evaluation Procedure**

The evaluation technique was two pronged. First, the data were plotted on a log-log graph, the line of best fit was established in log-log space, and the correlation coefficient was determined (Table 11). This was done comparing the 90-day and 365-day diffusion values from the bulk diffusion test and the 90-day value from the AASHTO T259 data with the test data at all three ages (28 days, 118 days, and 393 days). Once this was done to determine a general level of acceptance, smaller sets of data were identified containing all samples with a specific feature. These subsets were then examined to determine if they had been evaluated appropriately by the test. First, plots were constructed highlighting the different subsets. Second, the residuals (the difference between the test value and the value resulting from the line-of-best fit) of each subset were identified. They were then tested to determine the validity of the hypothesis that the residuals of the subset of interest was part of the main population of residuals at a 95 percent confidence level, assuming normal distribution of the residuals, with mean and standard deviation known. A total of 14 subsets were identified, and the results for all three short-term tests are included in Table 13 when compared with the 90-day bulk diffusion test, Table 14 for the 365-day bulk diffusion test and with Table 15 when compared to the 90-day AASHTO T259 salt ponding test. The parameter selected from the AASHTO T259 test was the chloride concentration at 12.5-mm depth. This parameter was selected as it was simpler to determine than the depth of 0.1 percent chloride concentration. However, for high-quality concrete, it is possible that no chloride will reach the 12.5-mm depth. Table 12 includes the number of elements in any subset,

**Table 11.** Phase 2 – General Level of Agreement ( $r^2$  values).

		Bulk Diffusion 90 days (D, m <sup>2</sup> /s)	AASHTO T259 90 days ([Cl] @12.5 mm)	Bulk Diffusion 365 days (D, m <sup>2</sup> /s)
AASHTO T277 (Charge Passed, C)	28 days	0.833	0.802	0.786
	118 days	0.858	0.823	0.803
	393 days	0.858	0.754	0.753
Modified AASHTO T277 (Charge Passed, C)	28 days	0.828	0.787	0.765
	118 days	0.854	0.769	0.811
	393 days	0.780	0.744	0.737
Monfore Conductivity ( $\Omega$ -cm)	28 days	0.840	0.916	0.753
	118 days	0.801	0.784	0.752
	393 days	0.786	0.772	0.791
CTH (Depth of Penetration, mm)	28 days	0.845	0.801	0.791
	118 days	0.862	0.748	0.765
	393 days	0.880	0.465	0.787

**Table 12.** Phase 2 – Number of Samples in Each Subset.

	AASHTO T277			Mod. AASHTO T277			Monfore Conductivity			CTH		
	28 day	118 day	393 day	28 day	118 day	393 day	28 day	118 day	393 day	28 day	118 day	393 day
w/cm = 0.45	20	20	11	20	20	11	19	20	20	12	14	14
w/cm = 0.35	10	10	10	10	10	10	10	10	10	10	10	10
Admixtures (not DCI)	8	8	3	8	8	3	7	8	8	5	6	6
DCI	3	3	2	3	3	2	3	3	3	2	2	2
Accelerator	2	2	0	2	2	0	1	2	2	1	2	2
Retarder	3	3	0	3	3	0	3	3	3	1	1	1
SCM	10	10	9	10	10	9	10	10	10	10	10	10
Silica Fume	5	5	4	5	5	4	5	5	5	5	5	5
Fly Ash	2	2	2	2	2	2	2	2	2	2	2	2
Slag	2	2	2	2	2	2	2	2	2	2	2	2
Metakaolin	3	3	3	3	3	3	3	3	3	3	3	3
Elevated Temperature	5	5	3	5	5	3	5	5	5	1	1	1
Cured at 7°C	2	2	1	2	2	1	2	2	2	0	2	2
Steel Rebar	2	2	1	2	2	1	2	2	2	1	1	1
Total	32	32	22	32	32	22	31	32	32	24	26	26

which is an important piece when evaluating the significance of these tests. In addition, for each rejected subset, a plot of the data highlighting the rejected subset is shown. The rejected subsets were then removed from the data and the line of best fit was re-evaluated, though it is not shown. In general, the removal of the unsuitable data had little influence on the shape or location of this line, though the correlation coefficient was slightly increased. Based on this information, the test procedure was then evaluated for suitability.

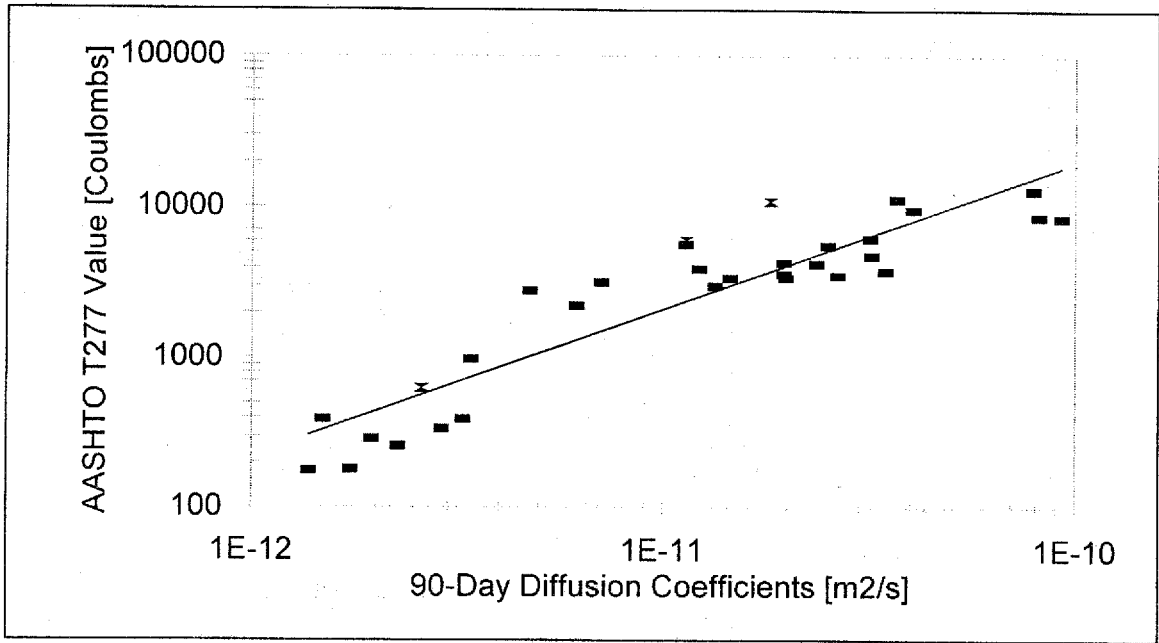
#### 4.3.2 The AASHTO T277 Test

The AASHTO T277 test was also performed on each concrete mixture in order to establish a minimum threshold for acceptance. It was thought that any new test should be able to predict diffusion coefficients at least as well as the existing methodology (i.e., AASHTO T277) and have fewer subsets (types of concrete) that are not properly evaluated.

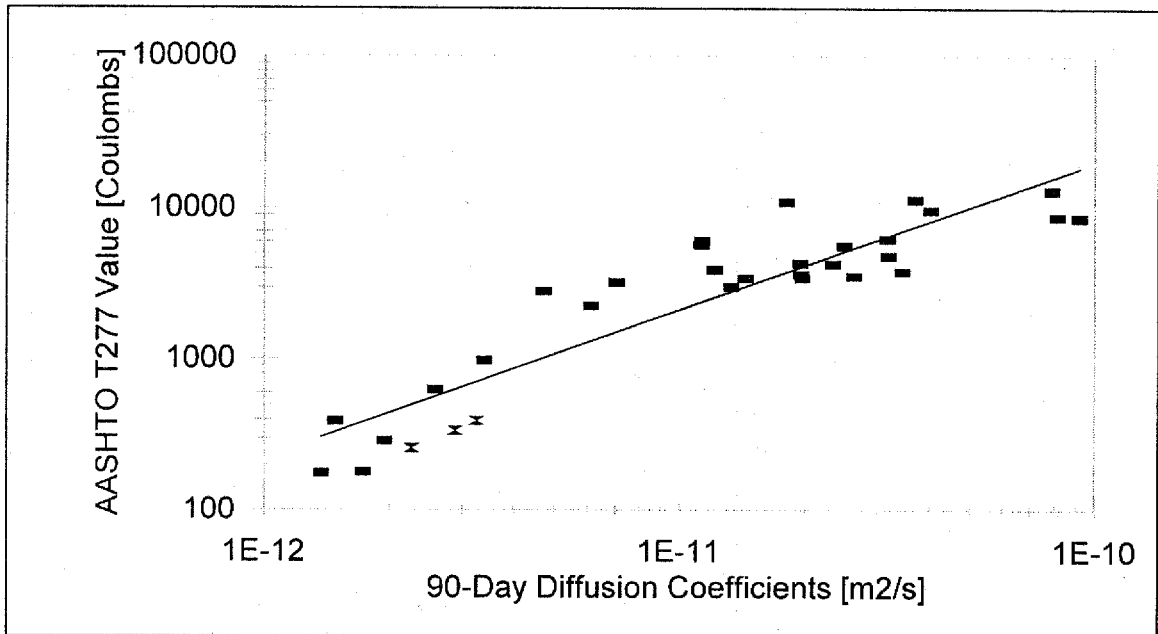
In examining the entire set of data, it appears that the AASHTO T277 test has a fairly high level of general correlation, with correlation coefficients ( $r^2$ ) ranging between 0.753 and 0.858, as shown in Table 11. It is thus desired that the other tests proposed should give a correlation for the entire set of data at least at comparable levels for acceptance.

The difficulty with the AASHTO T277 test is more apparent when the individual data subsets are examined. Referring to Tables 13 to 15, it can be seen that at a 95 percent confidence level, a number of subsets have been rejected. The rejected subsets are illustrated in Figures 52 to 63. What is meant by rejected is that there is a less than 5 percent chance that those subsets belong to the same population as represented by the entire set of data. A point should be made here that, statistically, just because a subset is not rejected by this test does not mean that it is necessarily a member of that population, and vice versa. This is especially true here as most of the subsets were very small (2 or 3 data points) and thus it is difficult to reject a subset with confidence. A table of the number of elements in each subset is included as Table 12.

The subsets rejected for the AASHTO T277 test were corrosion inhibitor (DCI) (90-day bulk diffusion vs. test at 28 and 118 days), metakaolin (90-day bulk diffusion vs. test at 28 days), steel (90-day bulk diffusion vs. test at 393 days), supplementary cementing materials (SCM) (365-day bulk diffusion and 90-day AASHTO T259 vs. test at all ages) and silica fume (90-day AASHTO T259 vs. test at 28 days). The DCI subsets tended to estimate high. This can be understood by a consideration of what corrosion inhibitor does to the concrete and what the tests are measuring. The bulk diffusion test is measuring the ease with which chloride ions travel through the pore structure. Its results are dominated by the effect of the pore structure. Corrosion inhibitor does not have a significant effect on the pore structure and how chloride ions move through it, which is represented by the bulk diffusion  $D$ . It does have an influence on the pore chemistry, however. There is an increase in the ionic concentration and mobility of the pore solution, and thus when an electrical field is applied, there is a greater current, which is measured by AASHTO T277. This reflects the change in pore solution composition, not a change in pore structure, the actual property of interest. The metakaolin subset and the silica fume subset estimated low. They have an influence in the opposite direction of

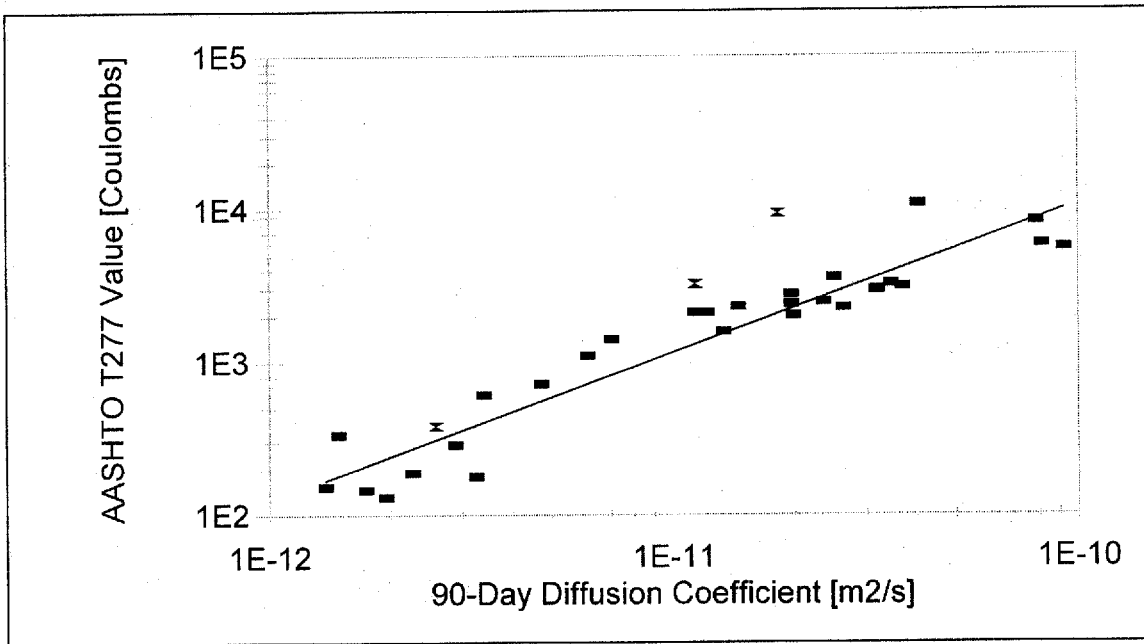


**Figure 53.** AASHTO T277 – 28 Days vs. 90-Day Bulk Diffusion Highlighting DCI Subset ( X ).

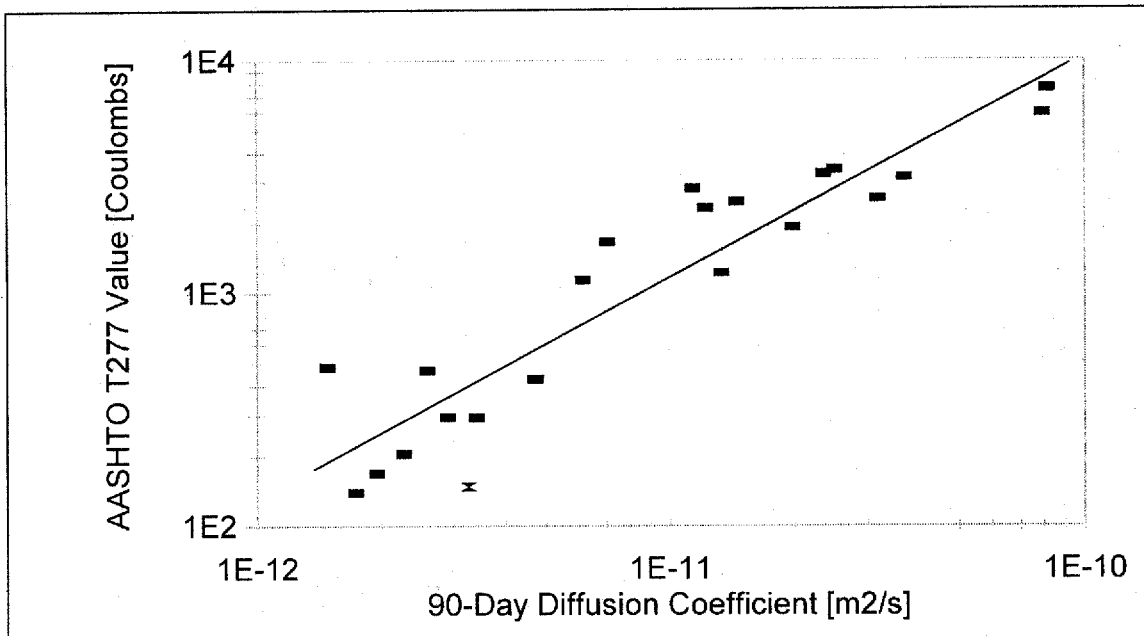


**Figure 54.** AASHTO T277 – 28 Days vs. 90-Day Bulk Diffusion Highlighting Metakaolin Subset ( X ).

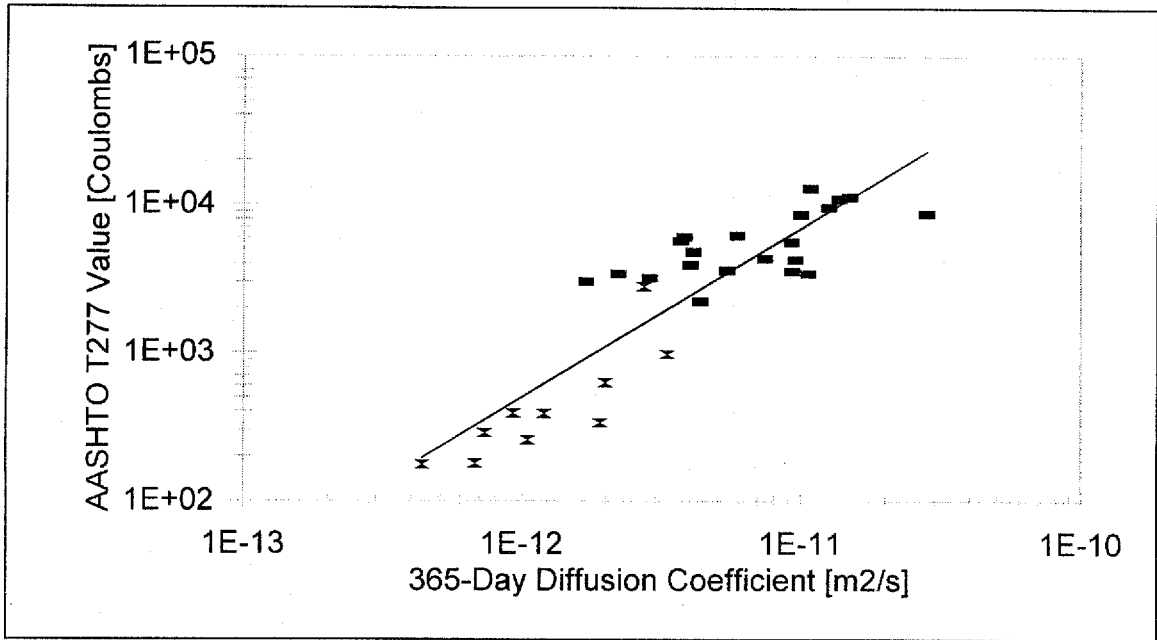




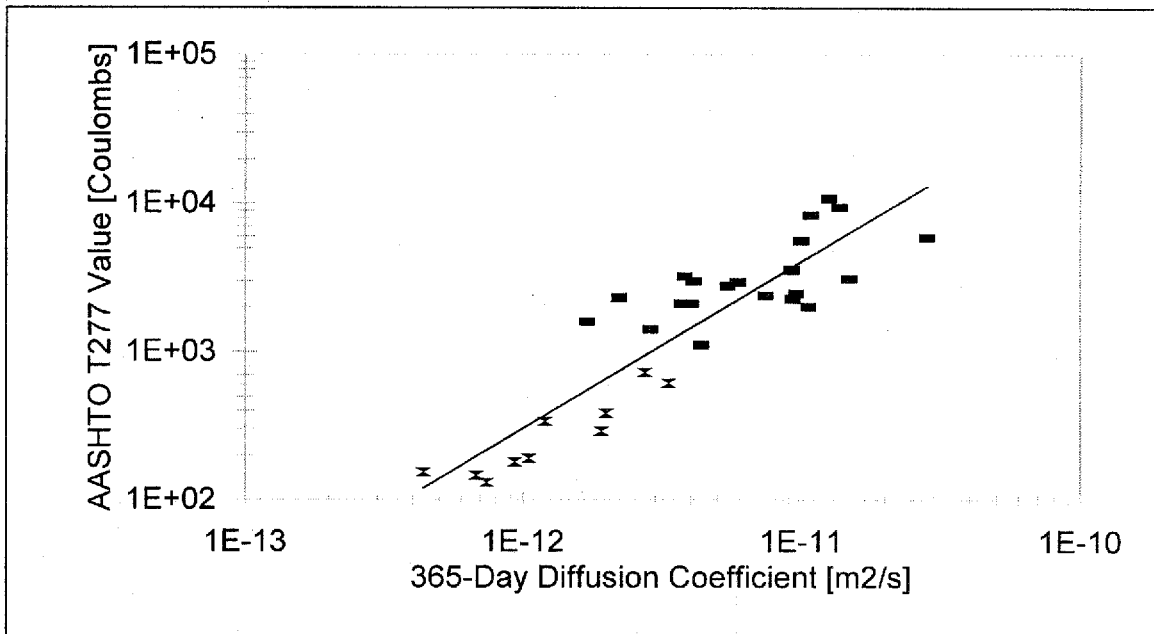
**Figure 55.** AASHTO T277 – 118 Days vs. 90-Day Bulk Diffusion Highlighting DCI Subset ( X ).



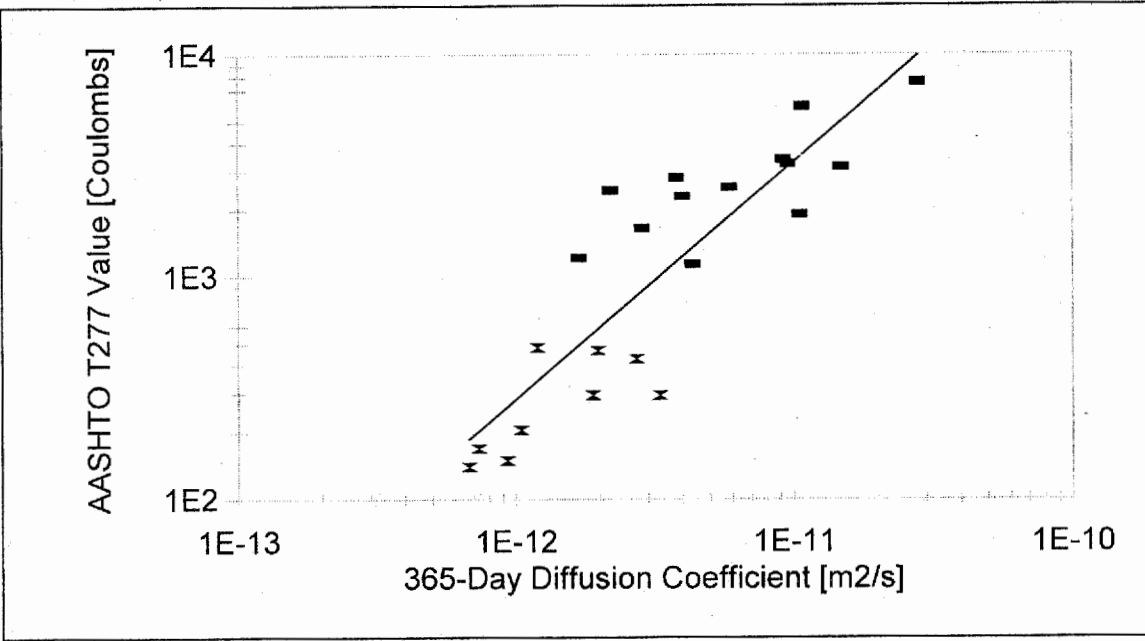
**Figure 56.** AASHTO T277 – 393 Days vs. 90-Day Bulk Diffusion Highlighting Steel Subset ( X ).



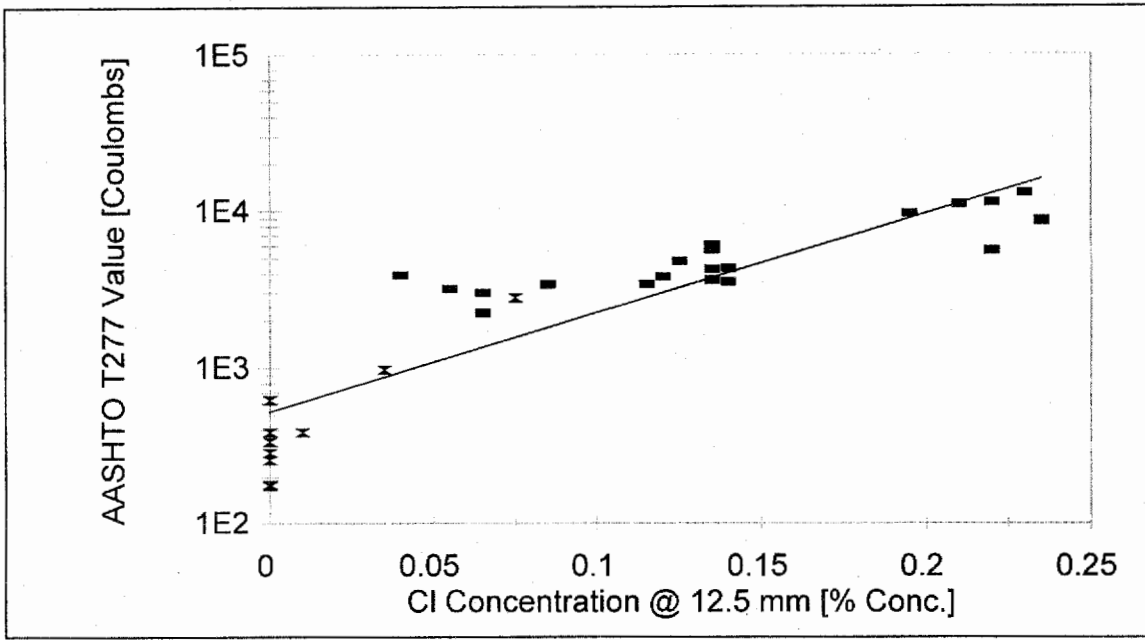
**Figure 57.** AASHTO T277 – 28 Days vs. 365-Day Bulk Diffusion Highlighting SCM Subset ( X ).



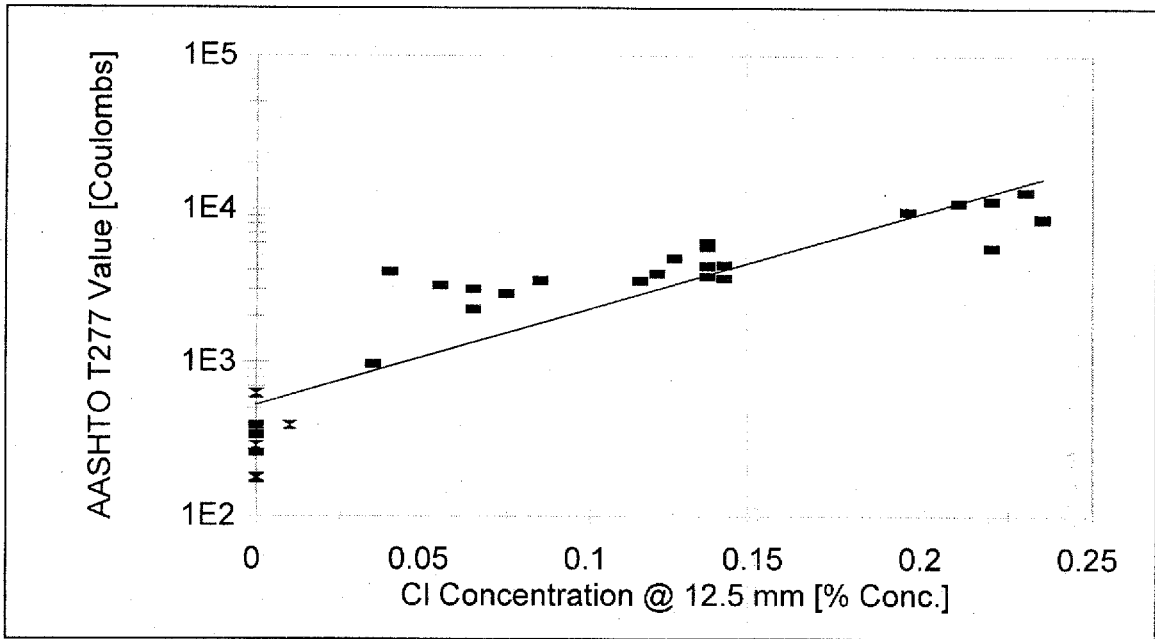
**Figure 58.** AASHTO T277 – 118 Days vs. 365-Day Bulk Diffusion Highlighting SCM Subset ( X ).



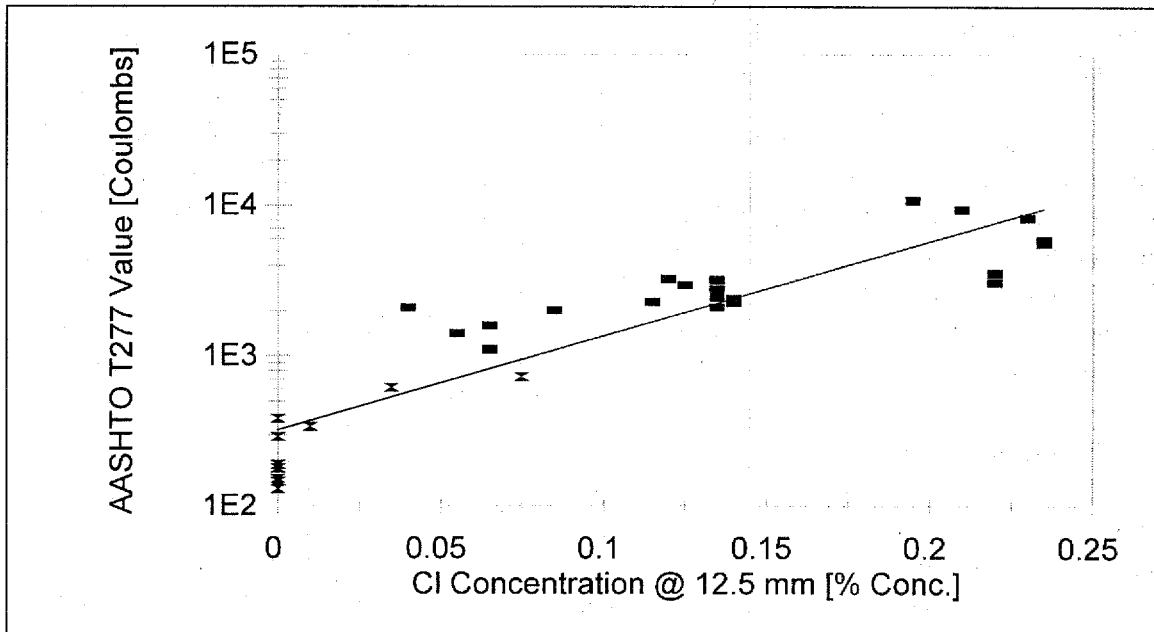
**Figure 59.** AASHTO T277 – 393 Days vs. 365-Day Bulk Diffusion  
 Highlighting SCM Subset ( X ).



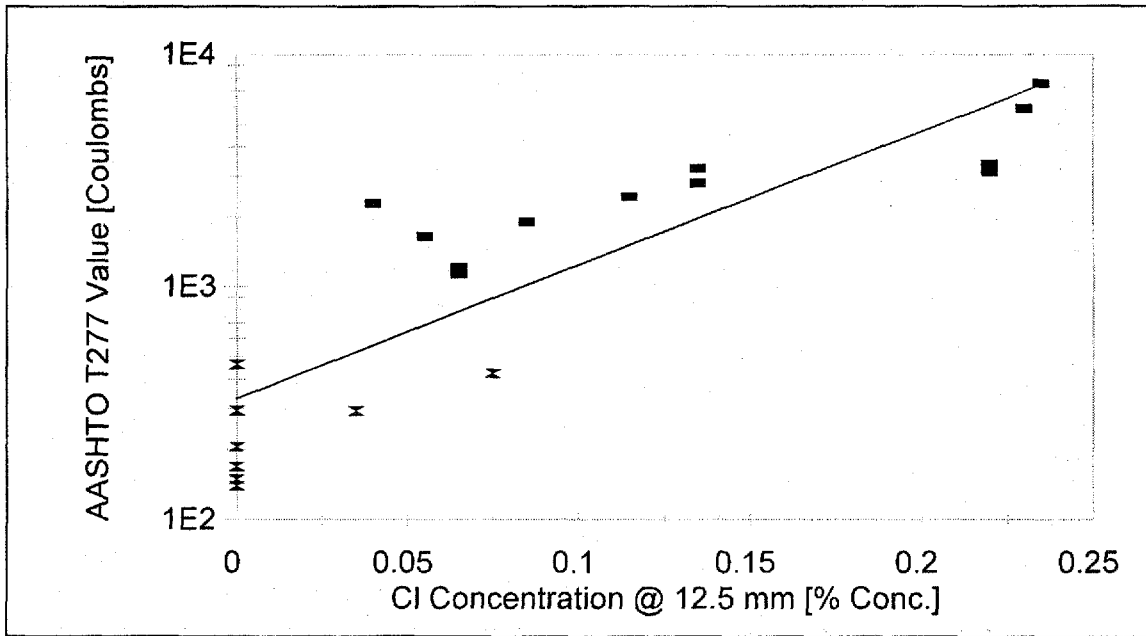
**Figure 60.** AASHTO T277 – 28 Days vs. Salt Ponding Evaluation  
 Highlighting SCM Subset ( X ).



**Figure 61.** AASHTO T277 – 28 Days vs. Salt Ponding Evaluation Highlighting Silica Fume Subset ( X ).



**Figure 62.** AASHTO T277 – 118 Days vs. Salt Ponding Evaluation Highlighting SCM Subset ( X ).

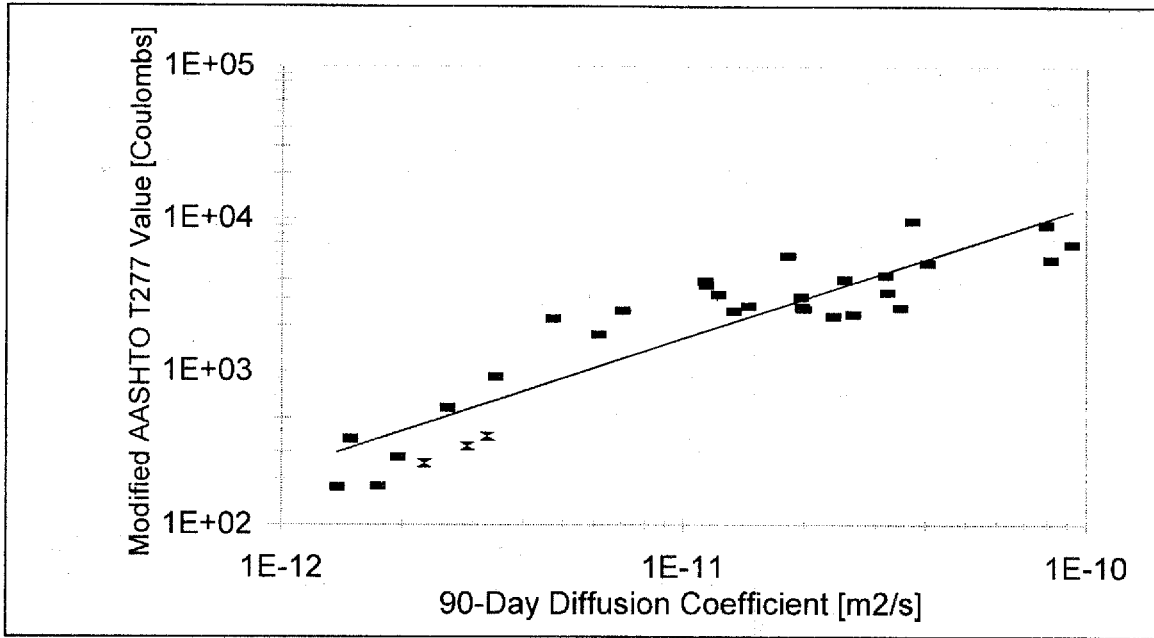


**Figure 63.** AASHTO T277 – 393 Days vs. Salt Ponding Evaluation Highlighting SCM Subset ( X ).

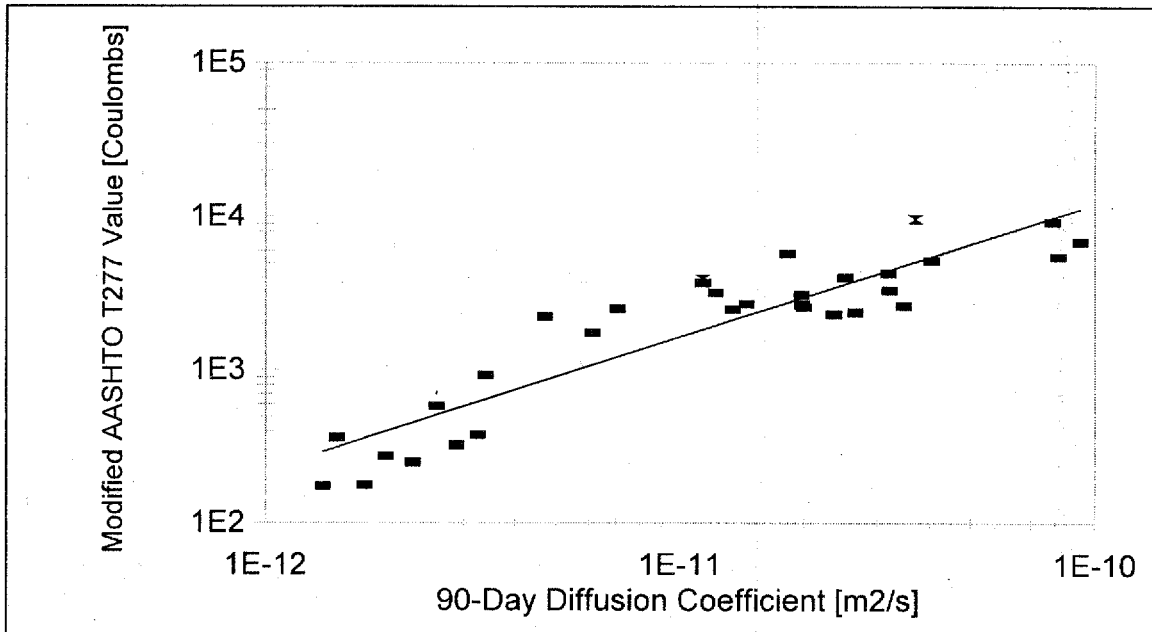
DCI. They serve to reduce the pore solution ionic concentration and mobility, without affecting the pore structure. The steel subset rejected was only 1 point, though it was low. The supplementary cementing materials subset was a large one. For the salt ponding evaluation, the samples containing SCM all had little or no chloride penetration at 12.5 mm. This would result in a range of concrete qualities having the same value according to the salt ponding test, while for the AASHTO T277 test, they are rated differently. This would cause the ejection of the SCM subset. This is not the whole reason the SCM subsets are rejected, however, or they would not have been rejected when compared with the 365-day bulk diffusion coefficients. The SCM subset represents the entire set of higher quality concrete. It is likely, then, that these concretes have a different pore chemistry than a concrete that does not contain SCM and that changes in pore structure have a different influence on the change in AASHTO T277 result for these concretes.

#### 4.3.3 Modified AASHTO T277

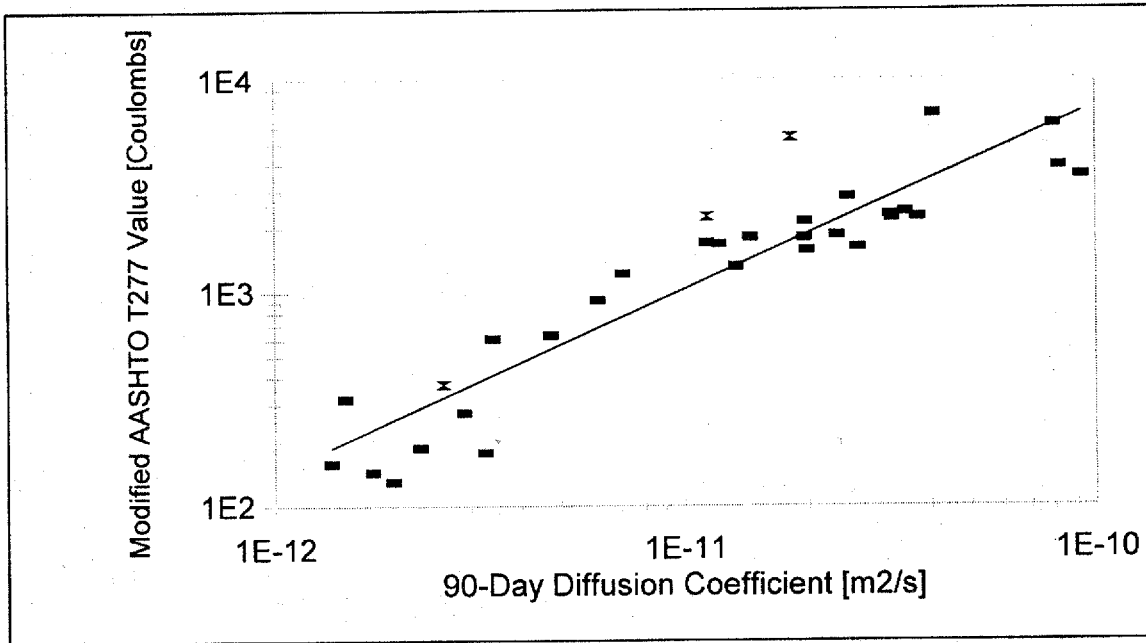
The modified AASHTO T277 test evaluation procedure was also evaluated. The modification to the procedure is to simply take the 30-minute value and multiply it by 12 and use in place of the 6-hour value. The correlation coefficients, determined as previously, are reported in Table 11. Contrary to previous experience (Phase 1) with this test modification, the correlation coefficients so determined appear to be lower than those achieved with the standard AASHTO T277 procedure. In addition, the number of rejected subsets (Tables 13 to 15, Figures 64 to 74) is equal or higher than that encountered with the standard procedure. It is not surprising that the number of rejected subsets does not decrease because the modification to the test procedure, while avoiding



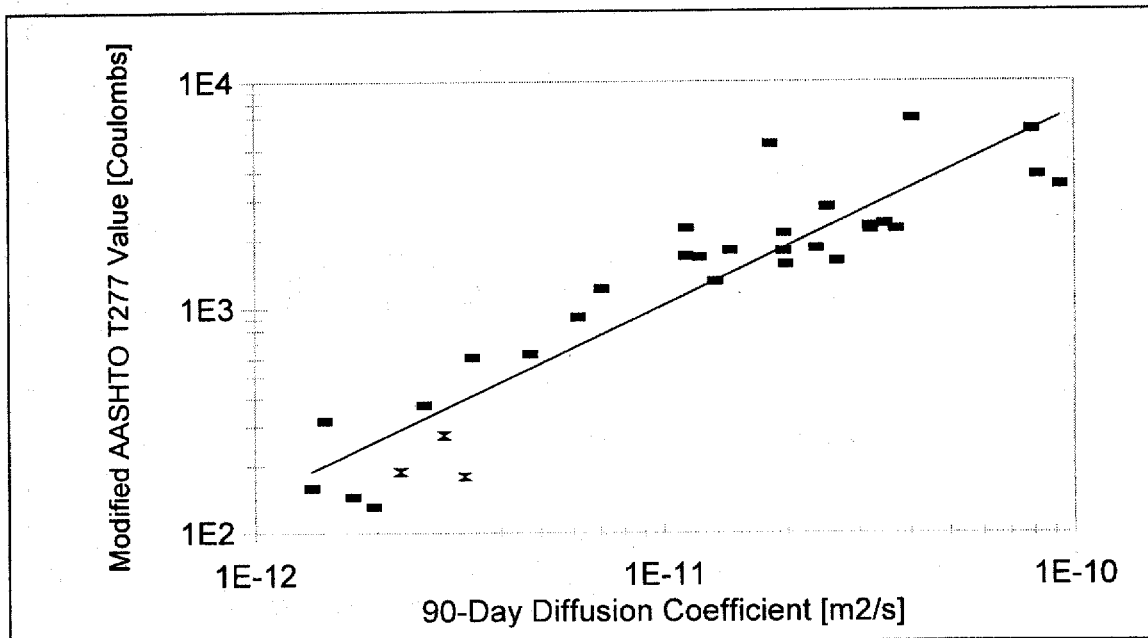
**Figure 64.** Modified AASHTO T277 – 28 Days vs. 90-Day Bulk Diffusion Highlighting Metakaolin Subset ( X ).



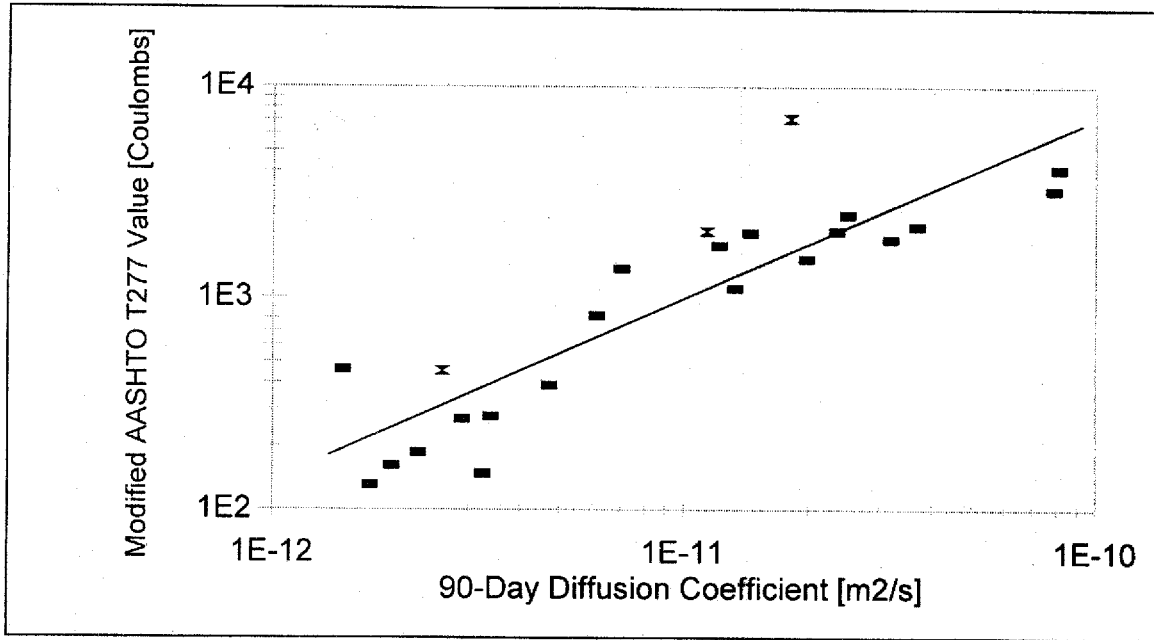
**Figure 65.** Modified AASHTO T277 – 28 Days vs. 90-Day Bulk Diffusion Highlighting 7°C Subset ( X ).



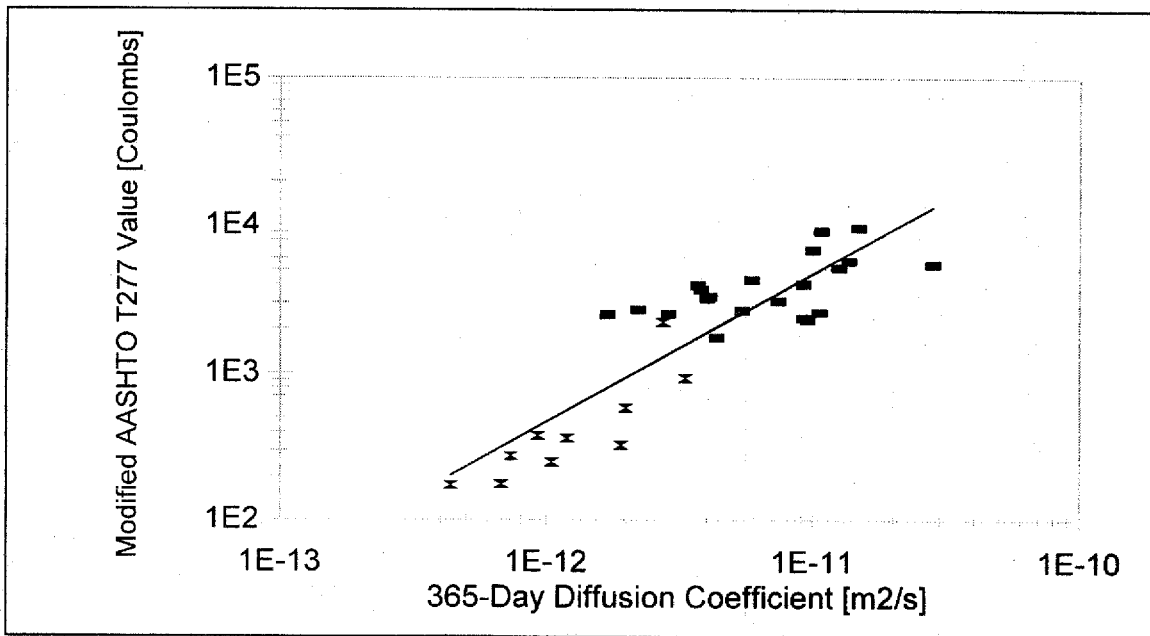
**Figure 66.** Modified AASHTO T277 – 118 Days vs. 90-Day Bulk Diffusion Highlighting DCI Subset ( X ).



**Figure 67.** Modified AASHTO T277 – 118 Days vs. 90-Day Bulk Diffusion Highlighting Metakaolin Subset ( X ).

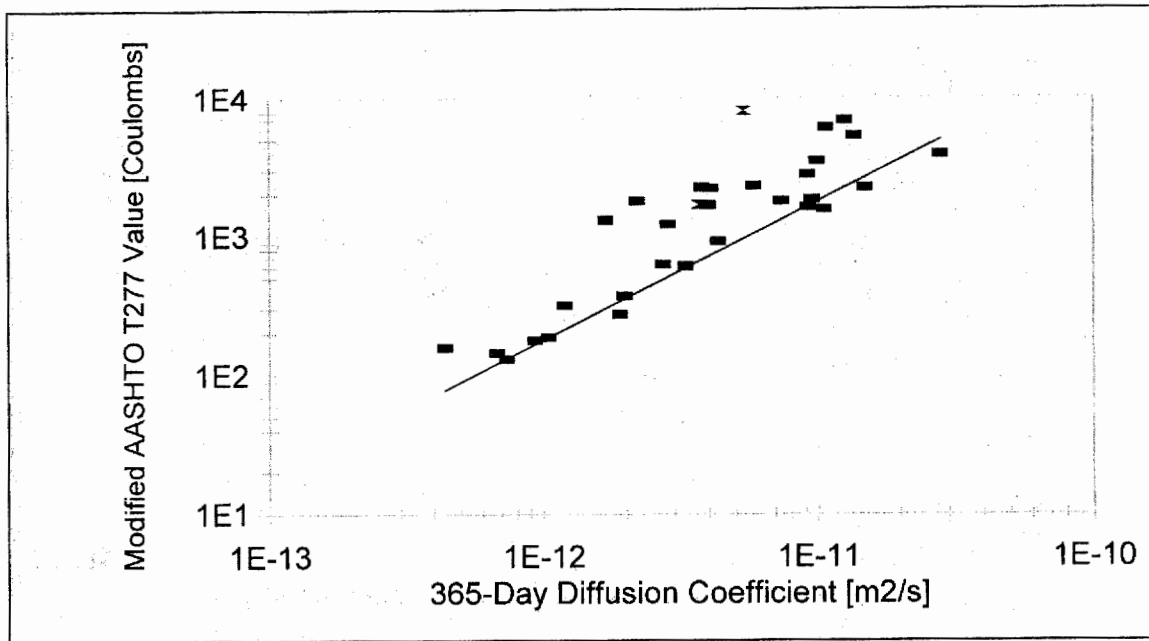


**Figure 68.** Modified AASHTO T277 – 393 Days vs. 90-Day Bulk Diffusion Highlighting DCI Subset ( X ).

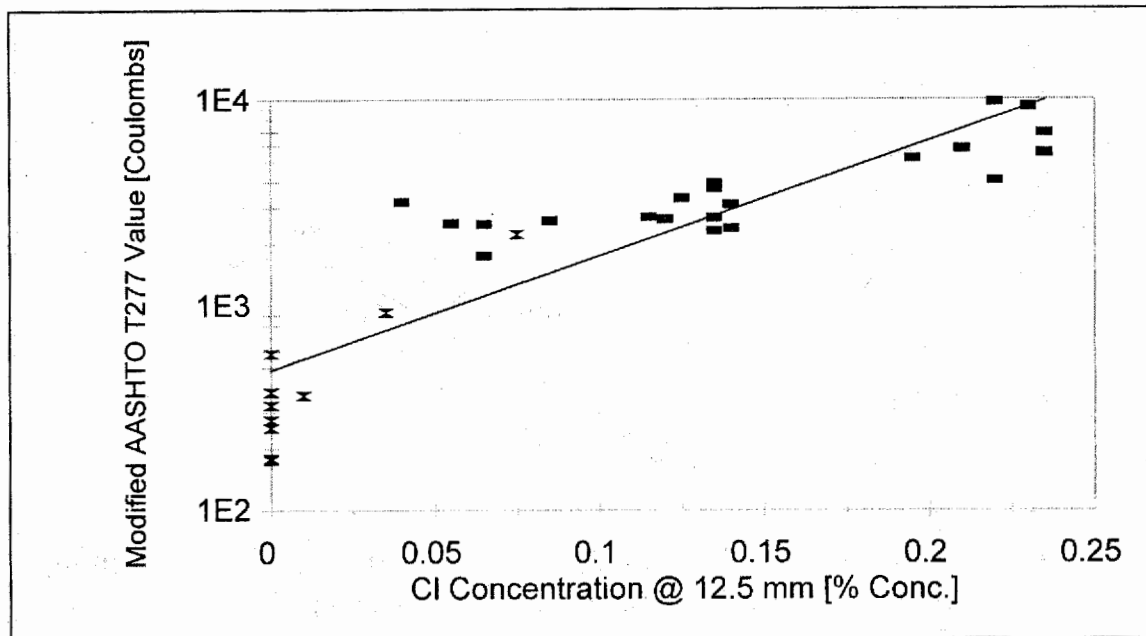


**Figure 69.** Modified AASHTO T277 – 28 Days vs. 365-Day Bulk Diffusion Highlighting SCM Subset ( X ).





**Figure 70.** Modified AASHTO T277 – 118 Days vs. 365-Day Bulk Diffusion  
 Highlighting SCM Subset ( X ).



**Figure 71.** Modified AASHTO T277 – 28 Days vs. Salt Ponding Evaluation  
 Highlighting SCM Subset ( X ).

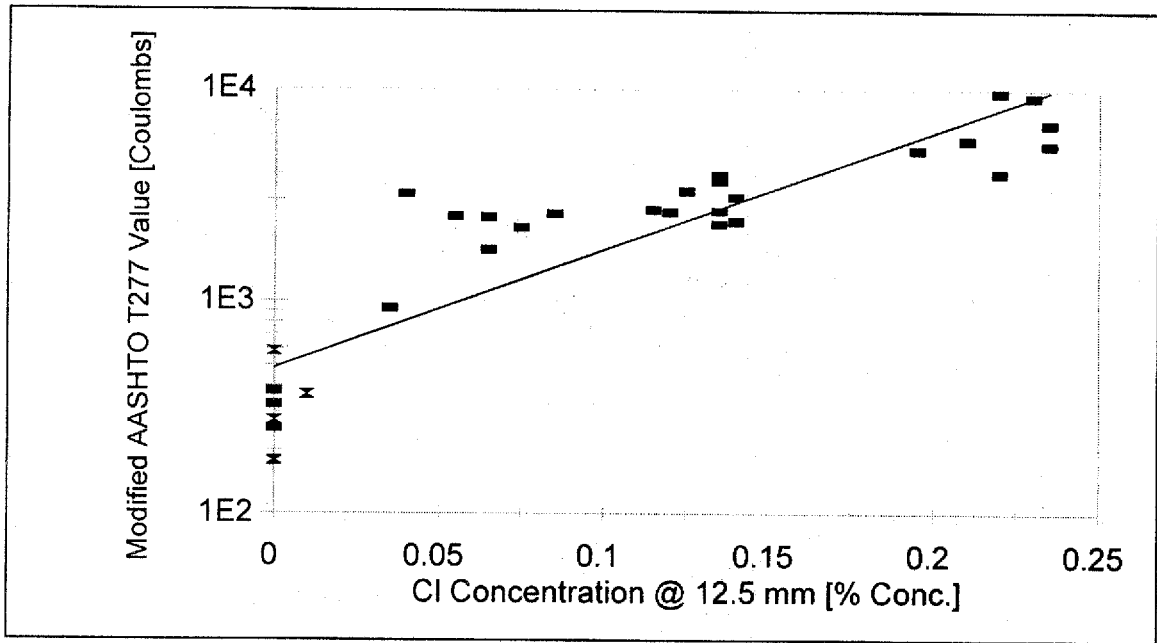


Figure 72. Modified AASHTO T277 – 28 Days vs. Salt Ponding Evaluation Highlighting Silica Fume Subset ( X ).

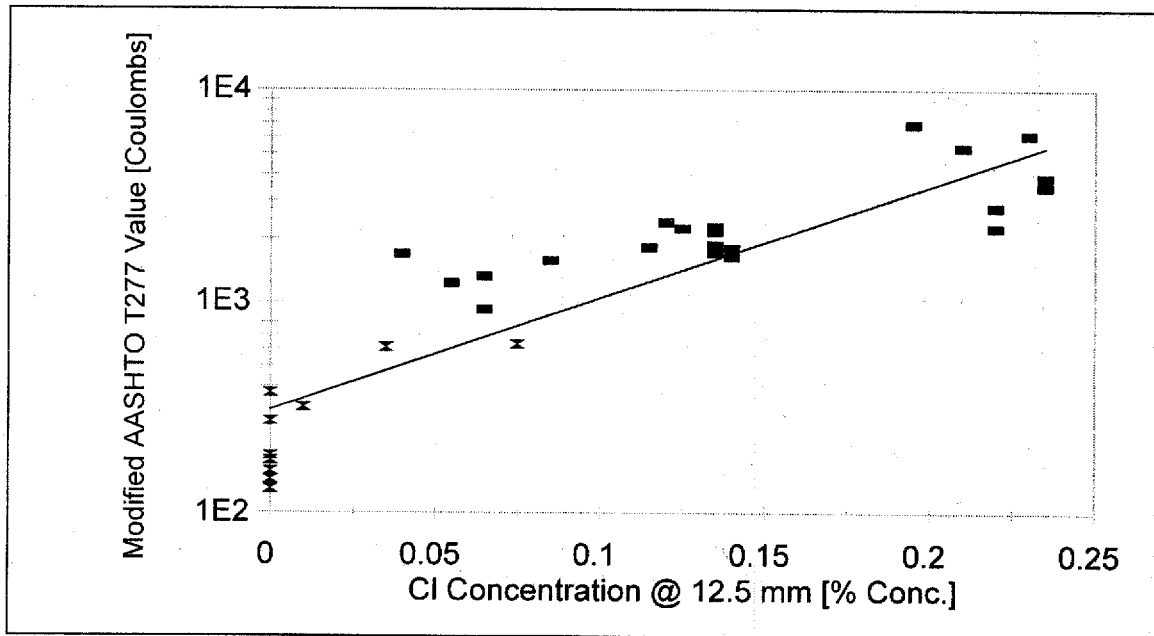


Figure 73. Modified AASHTO T277 – 118 Days vs. Salt Ponding Evaluation Highlighting SCM Subset ( X ).

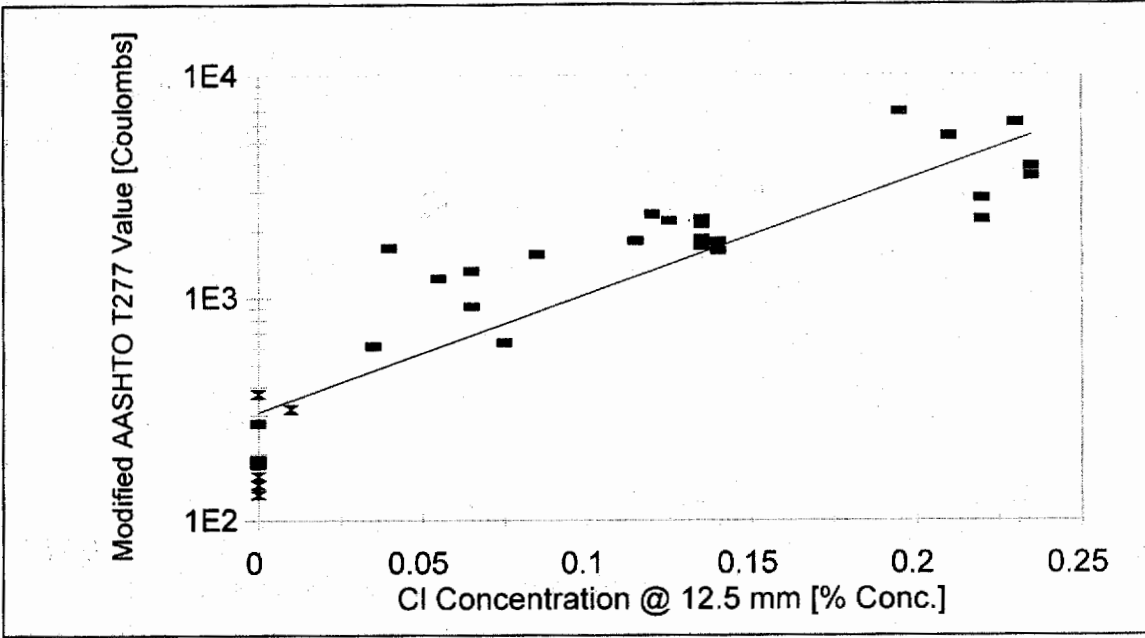


Figure 74. Modified AASHTO T277 – 118 Days vs. Salt Ponding Evaluation Highlighting Silica Fume Subset ( X ).

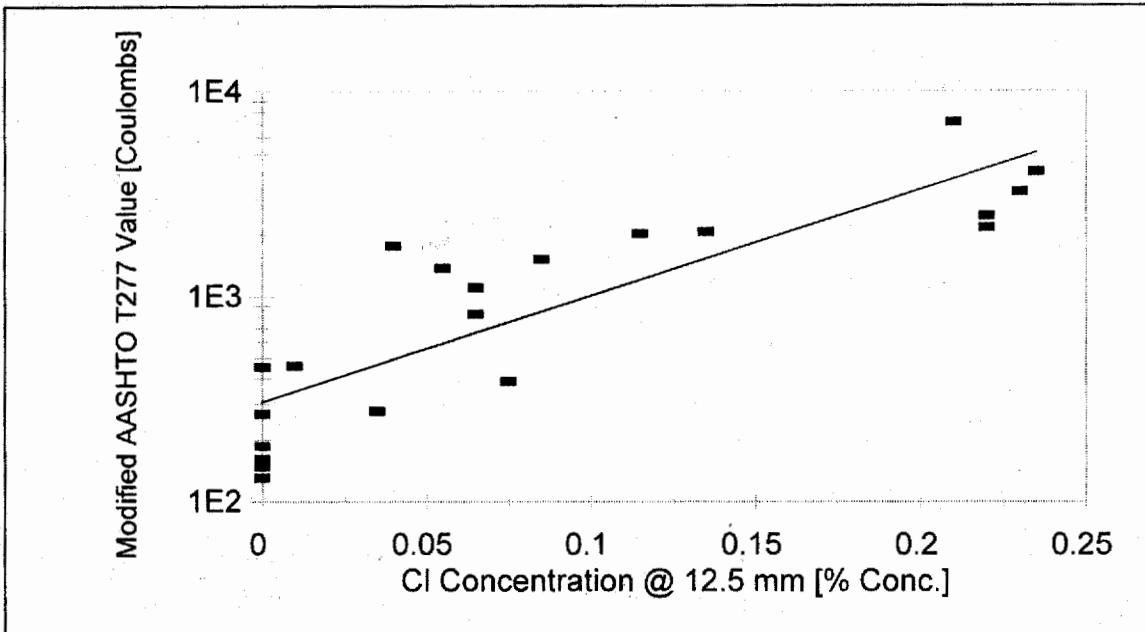


Figure 75. Modified AASHTO T277 – 393 Days vs. Salt Ponding Evaluation.

the temperature rise that may occur, does not address other drawbacks of the AASHTO T277 test, i.e., different properties of the pore solution. It is these drawbacks that tend to cause the rejection of subsets. The subsets that were rejected were rejected for a similar reason as for the standard AASHTO T277 test. No subsets were rejected comparing the modified AASHTO T277 393-day values to the salt ponding evaluation, Figure 75.

**Table 13.** Phase 2 – 90-Day Bulk Diffusion Rejected Subsets, 95 Percent Confidence Level.

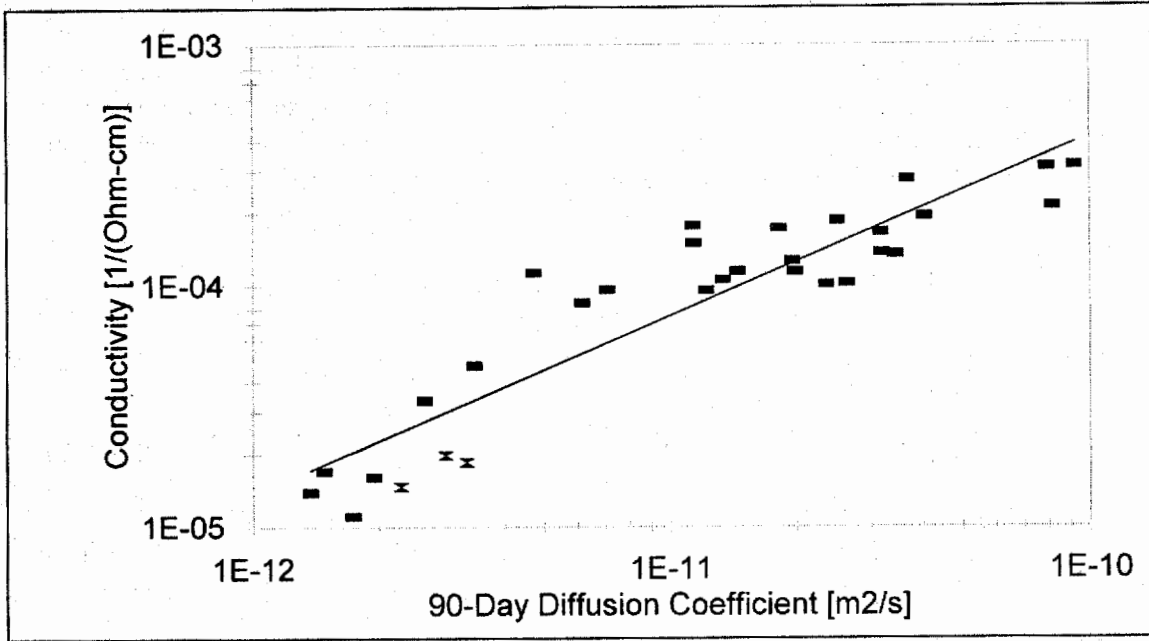
	AASHTO T277			Mod. AASHTO T277			Monfore Conductivity			CTH		
	28 day	118 day	393 day	28 day	118 day	393 day	28 day	118 day	393 day	28 day	118 day	393 day
w/cm = 0.45												
w/cm = 0.35												
Admixtures (not DCI)												
DCI	X	X			X	X		X	X			
Accelerator			∅			∅						
Retarder			∅			∅						
SCM												
Silica Fume												
Fly Ash												
Slag												
Metakaolin	X			X	X		X	X	X			
Elevated Temperature												
Cured at 7°C				X						∅		
Steel Rebar			X					X	X			

∅ represents empty subsets.

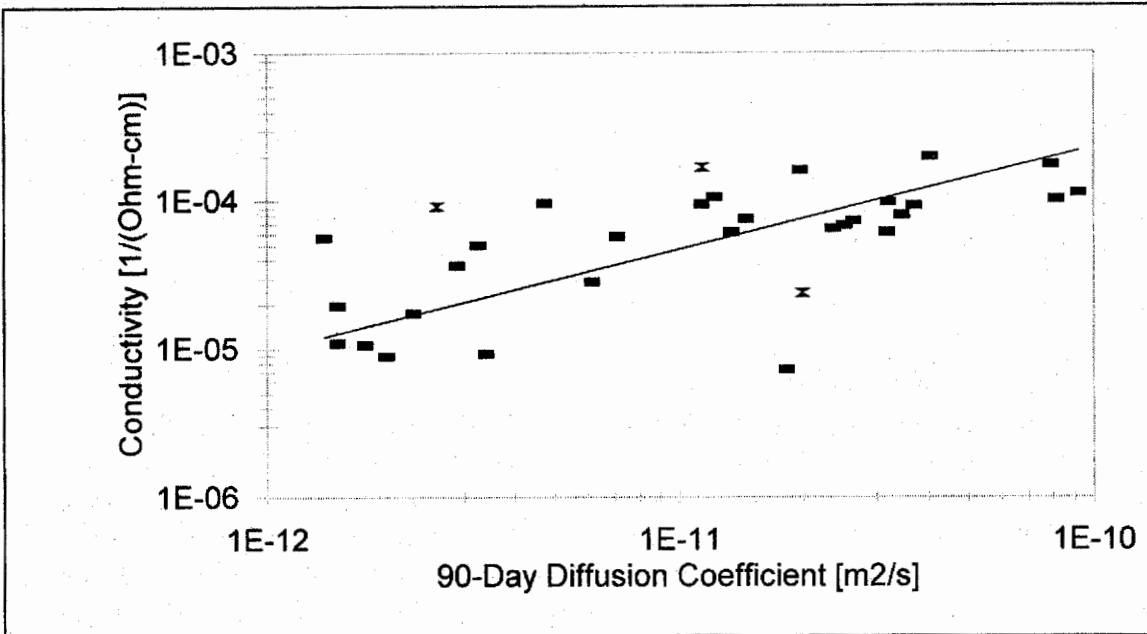
#### 4.3.4 Monfore Conductivity Test

The correlation between the Monfore Conductivity values and the different reference values were determined as shown in Table 11. As may be observed from the correlation coefficients shown, the conductivity test gave a similar level of correlation as the AASHTO T277 test. This is not surprising as it has long been recognized that the AASHTO T277 test is an extended form of a conductivity test. Thus, in a general sense, the Monfore Conductivity test performs as well as the AASHTO T277 test, with the additional advantage of being a more rapid test, taking minutes rather than hours.

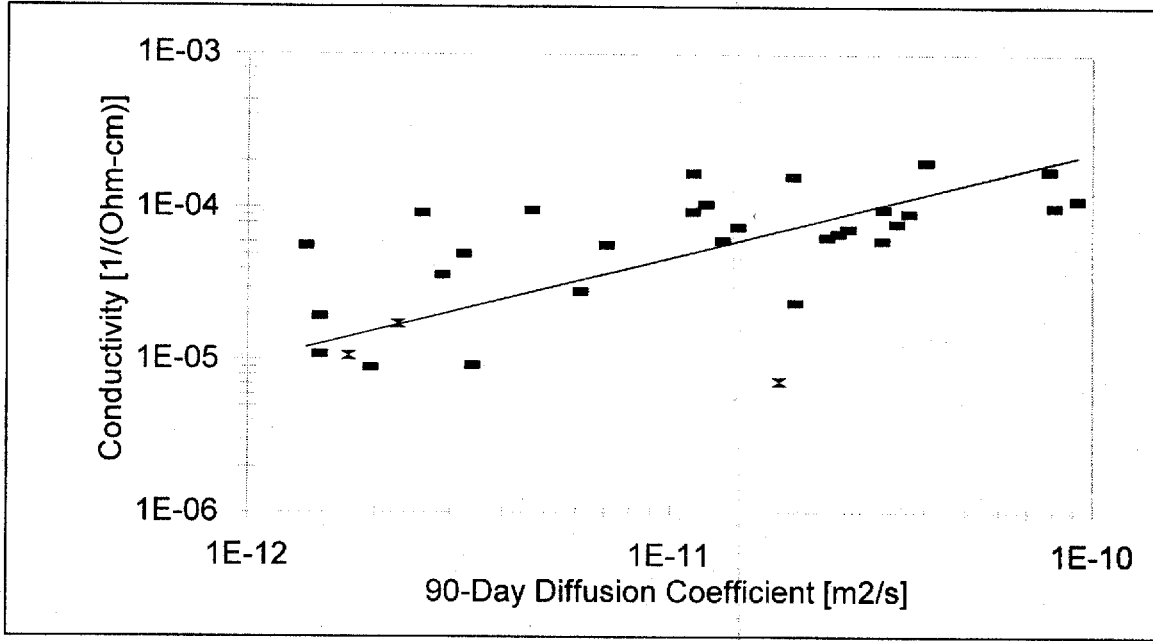
When examining the data subsets for acceptability, a number of subsets were rejected. These are noted in Tables 13 to 15 and illustrated in Figures 76 to 89. It is interesting to note that none of the subsets were rejected when the 365-day bulk diffusion values were compared with the 28-day conductivity values. This set is illustrated in



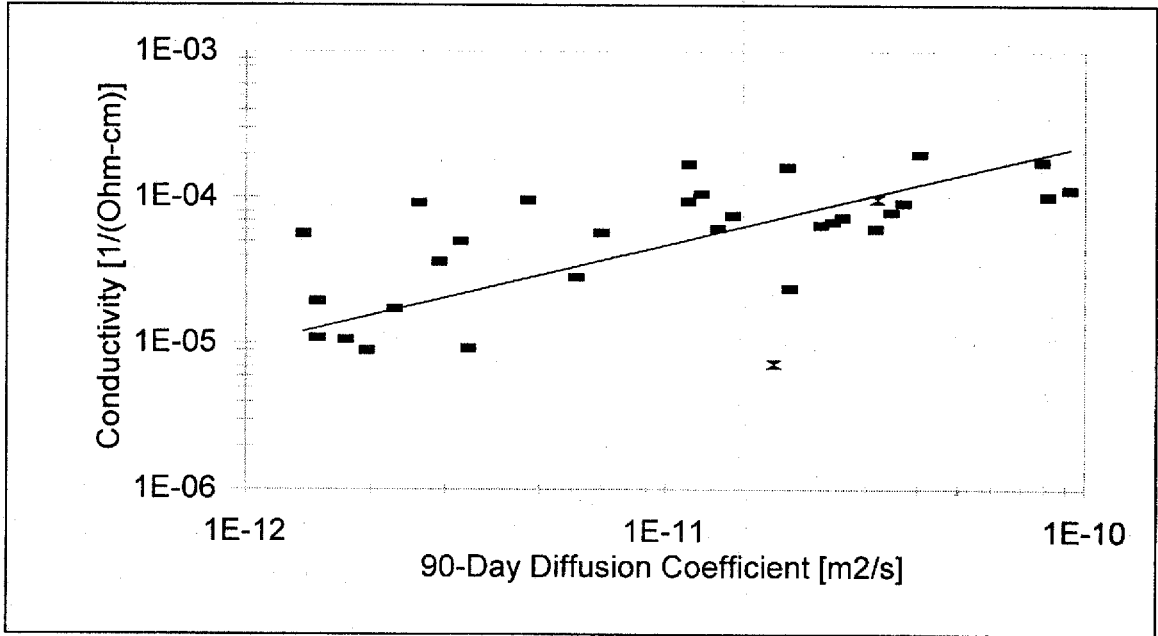
**Figure 76.** Monfore Conductivity – 28 Days vs. 90-Day Bulk Diffusion Highlighting Metakaolin Subset ( X ).



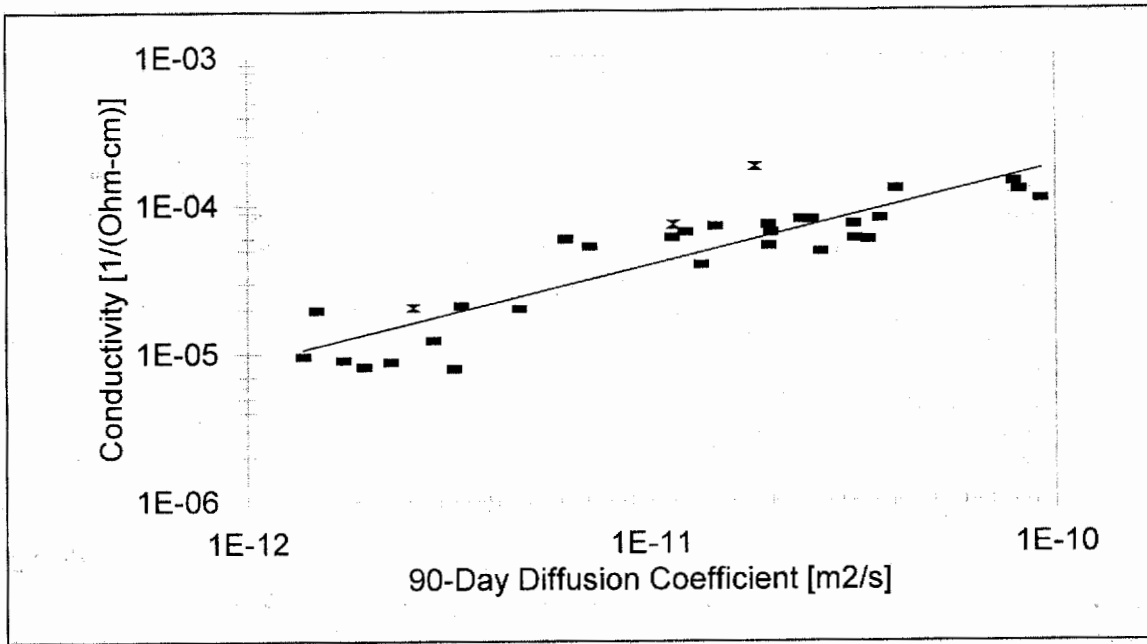
**Figure 77.** Monfore Conductivity – 118 Days vs. 90-Day Bulk Diffusion Highlighting DCI Subset ( X ).



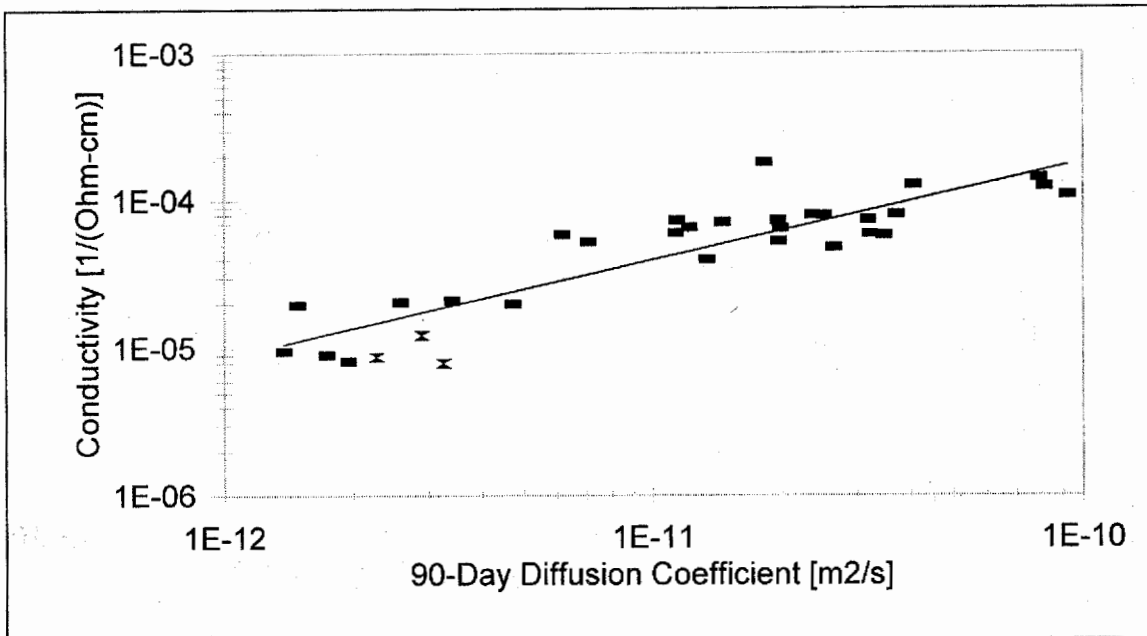
**Figure 78.** Monfore Conductivity – 118 Days vs. 90-Day Bulk Diffusion Highlighting Metakaolin Subset ( X ).



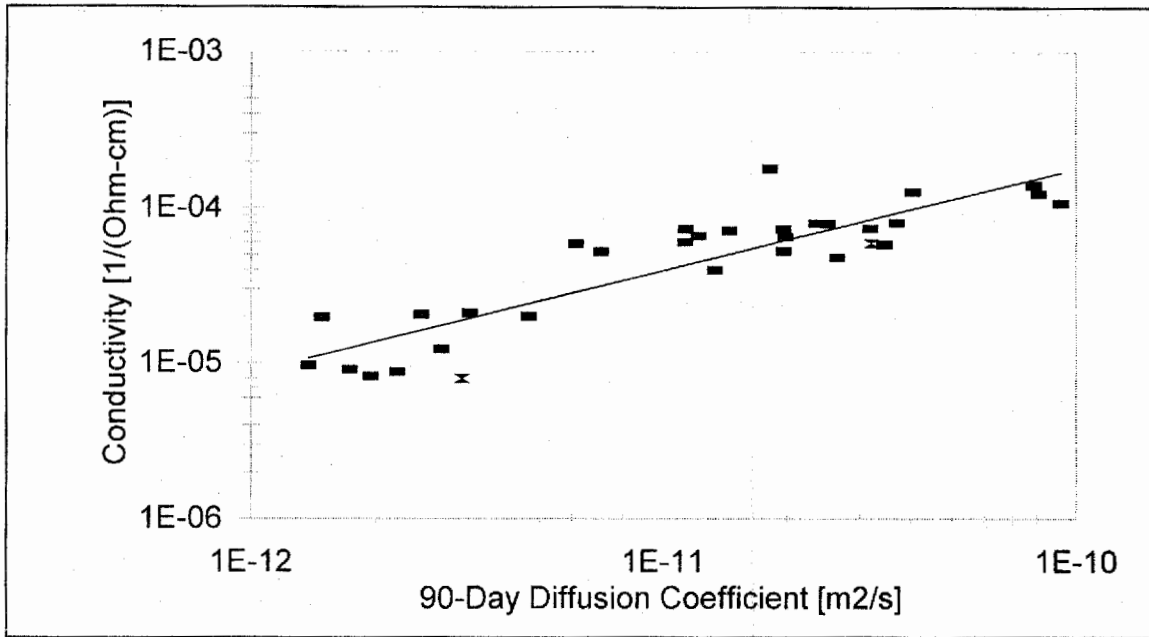
**Figure 79.** Monfore Conductivity – 118 Days vs. 90-Day Bulk Diffusion Highlighting Steel Subset ( X ).



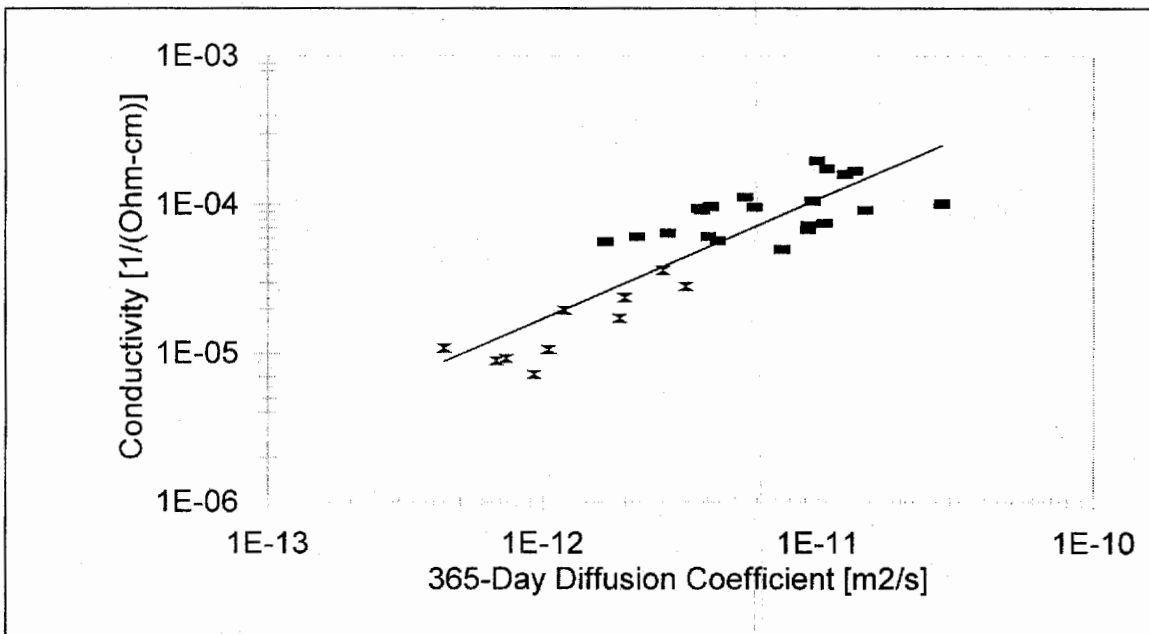
**Figure 80.** Monfore Conductivity – 393 Days vs. 90-Day Bulk Diffusion Highlighting DCI Subset ( X ).



**Figure 81.** Monfore Conductivity – 393 Days vs. 90-Day Bulk Diffusion Highlighting Metakaolin Subset ( X ).

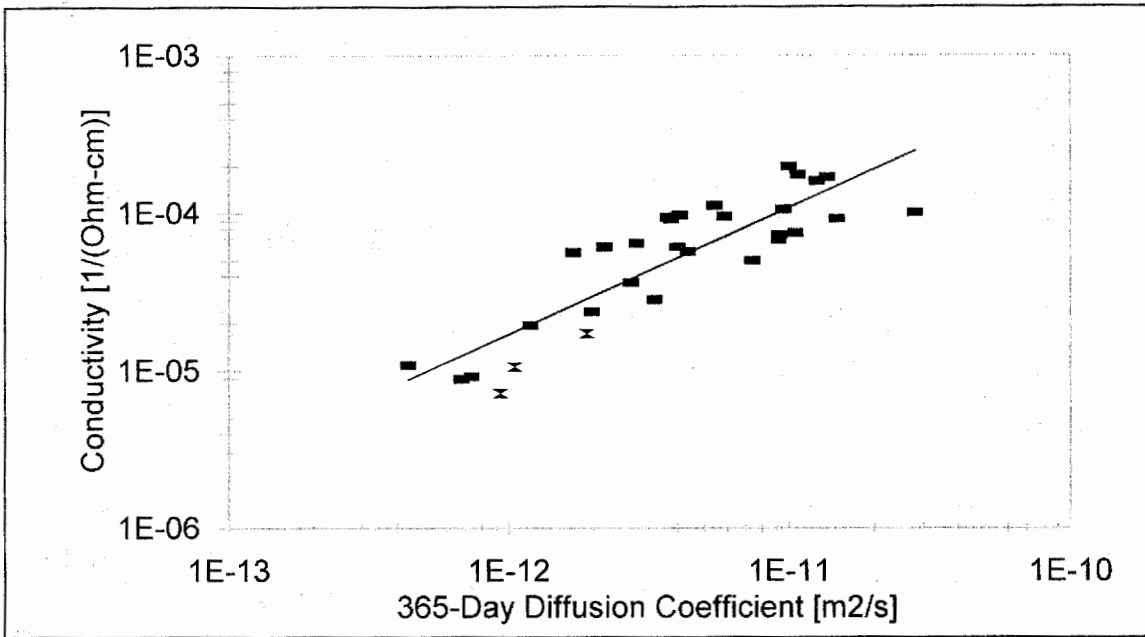


**Figure 82.** Monfore Conductivity – 393 Days vs. 90-Day Bulk Diffusion Highlighting Steel Subset ( X ).

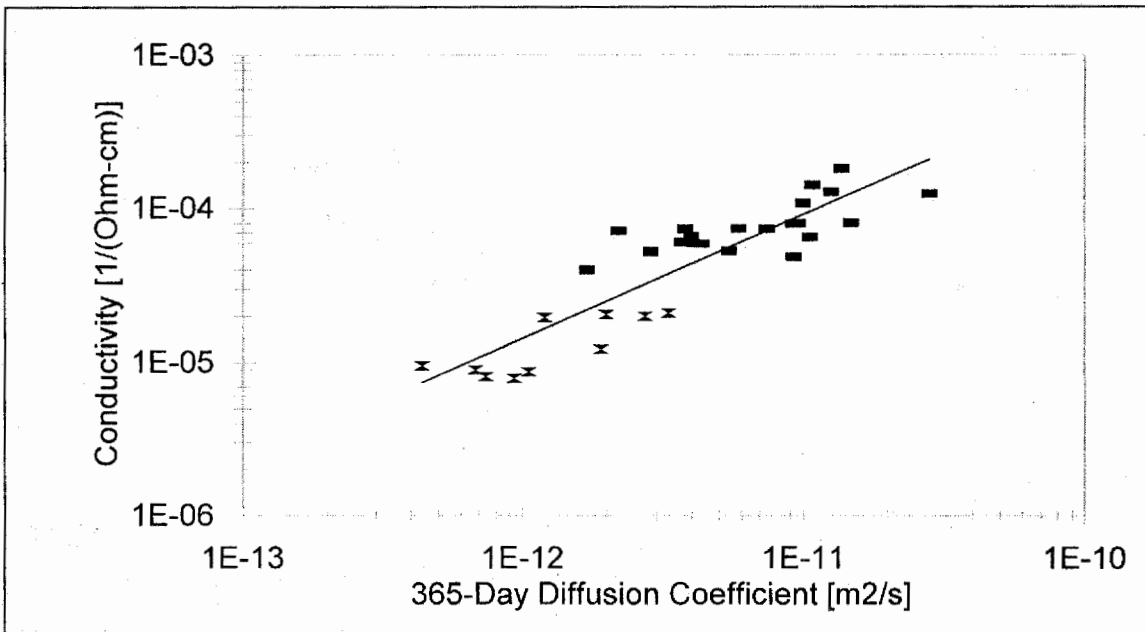


**Figure 83.** Monfore Conductivity – 118 Days vs. 365-Day Bulk Diffusion Highlighting SCM Subset ( X ).

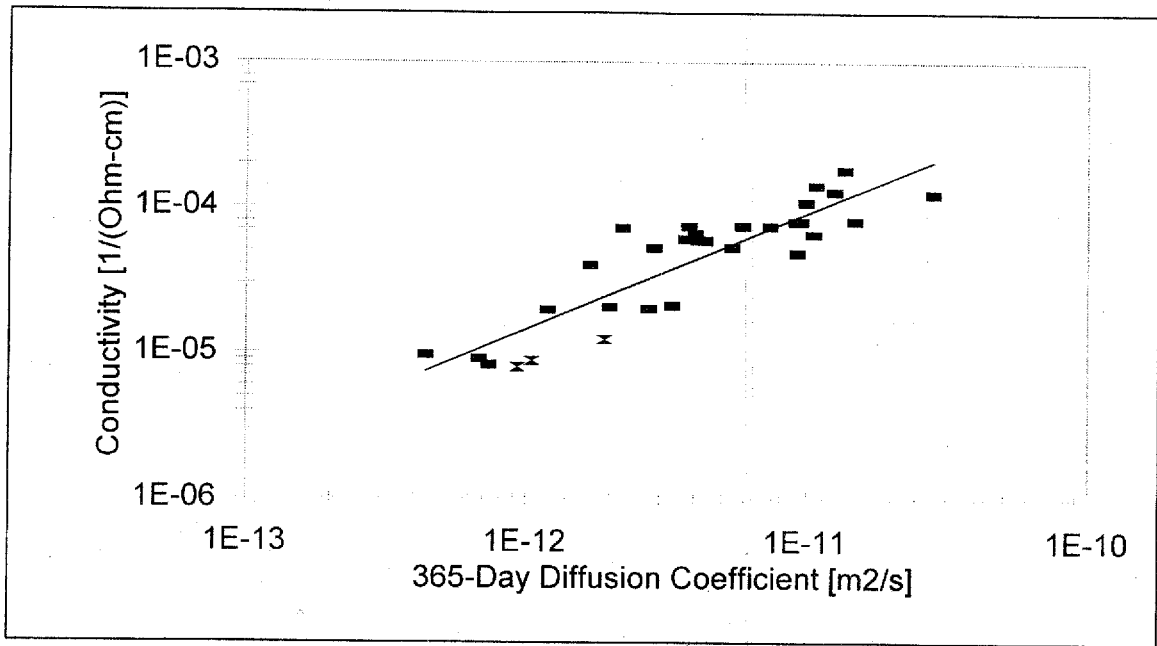




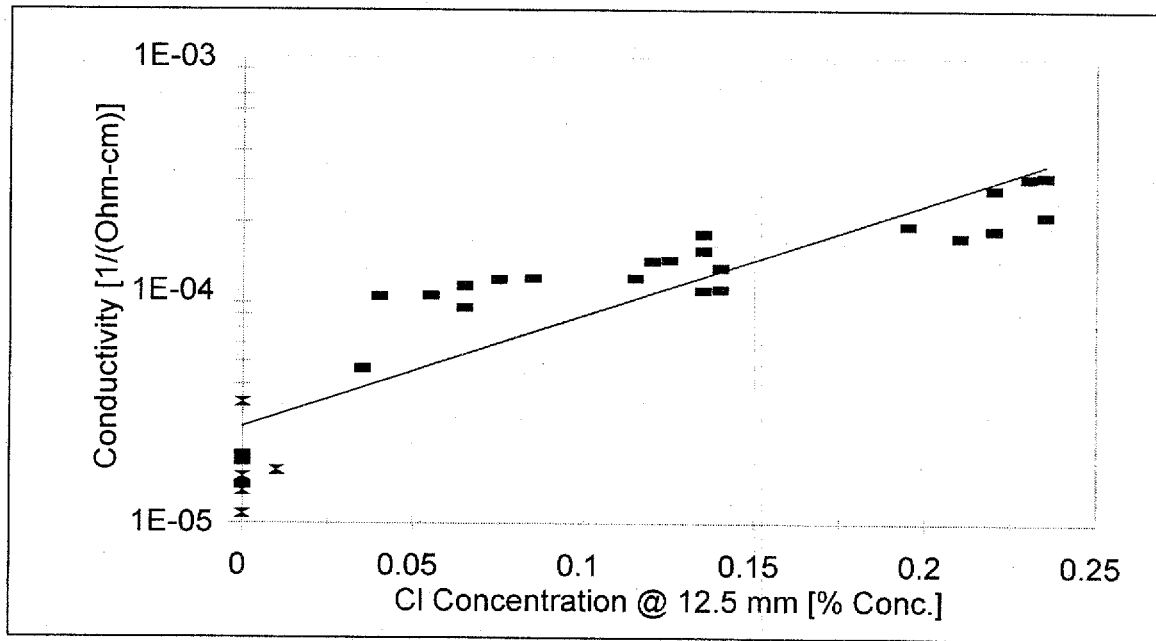
**Figure 84.** Monfore Conductivity – 118 Days vs. 365-Day Bulk Diffusion Highlighting Metakaolin Subset ( X ).



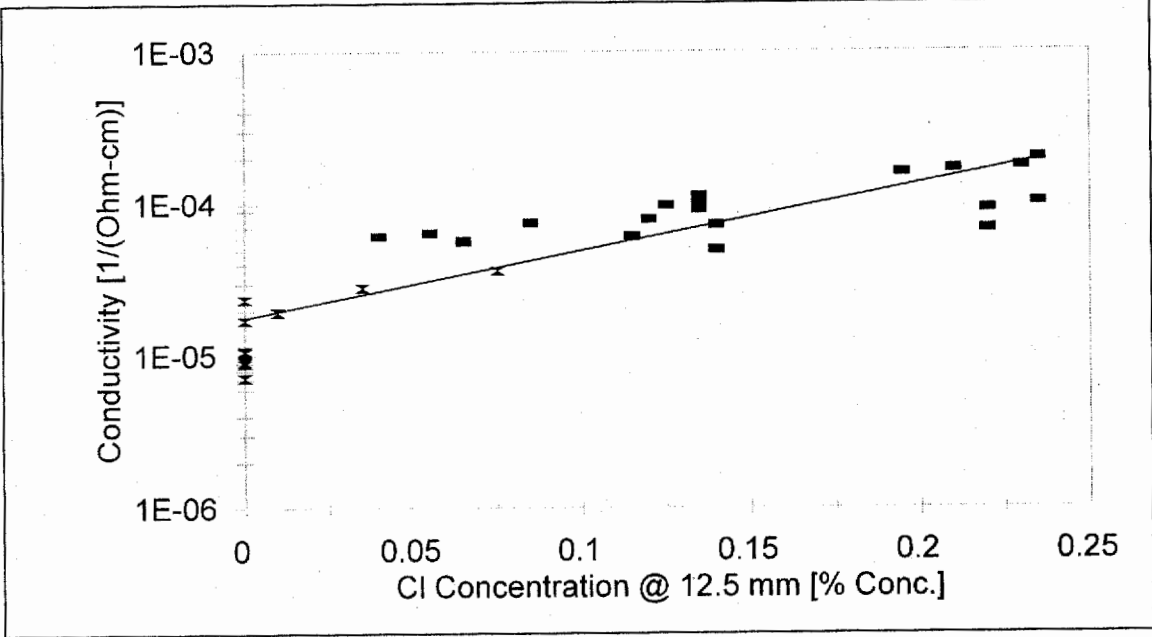
**Figure 85.** Monfore Conductivity – 393 Days vs. 365-Day Bulk Diffusion Highlighting SCM Subset ( X ).



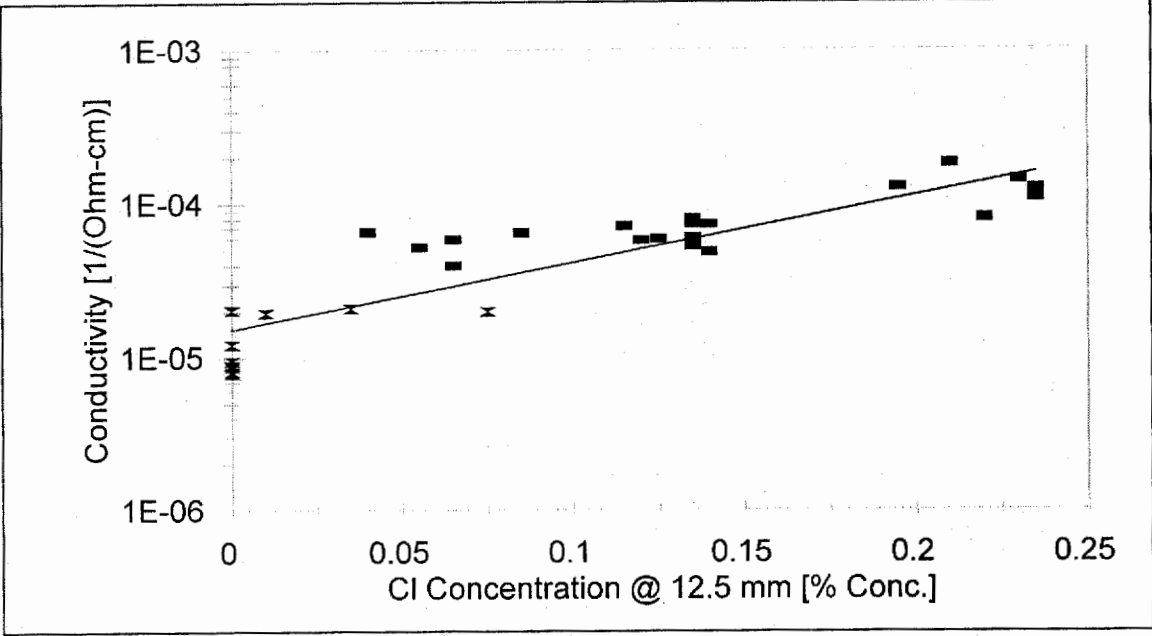
**Figure 86.** Monfore Conductivity – 393 Days vs. 365-Day Bulk Diffusion Highlighting Metakaolin Subset ( X ).



**Figure 87.** Monfore Conductivity – 28 Days vs. Salt Ponding Evaluation Highlighting Silica Fume Subset ( X ).



**Figure 88.** Monfore Conductivity – 118 Days vs. Salt Ponding Evaluation Highlighting SCM Subset ( X ).



**Figure 89.** Monfore Conductivity – 393 Days vs. Salt Ponding Evaluation Highlighting SCM Subset ( X ).

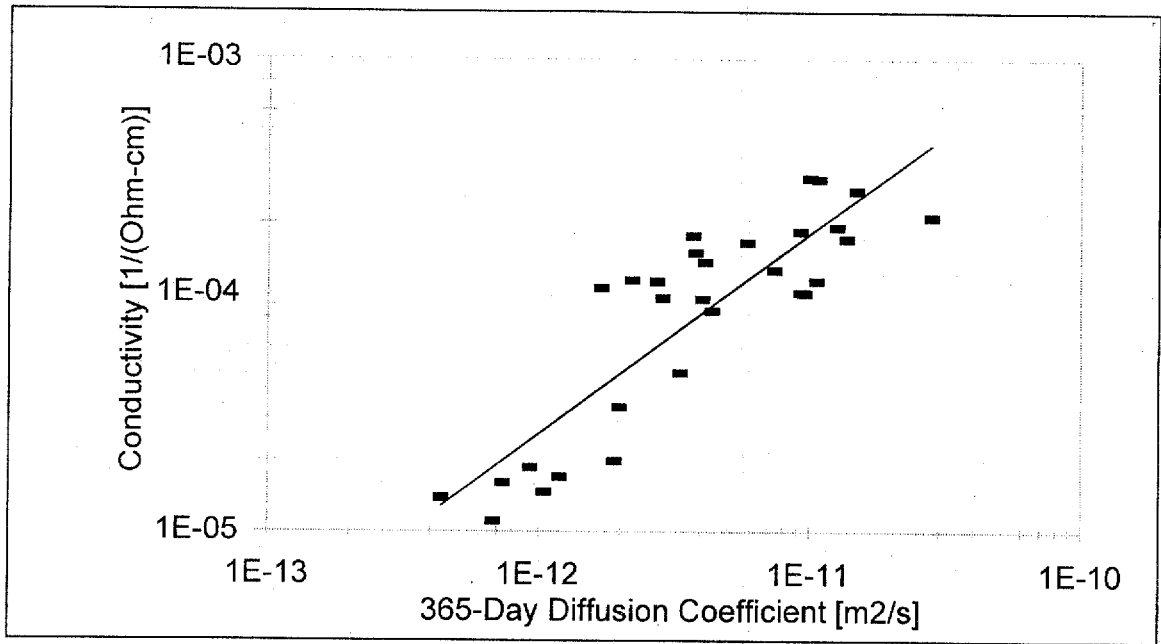


Figure 90. Monfore Conductivity – 28 Days vs. 365-Day Bulk Diffusion.

Table 14. Phase 2 – 365-Day Bulk Diffusion Rejected Subsets, 95 Percent Confidence Level.

	AASHTO T277			Mod. AASHTO T277			Monfore Conductivity			CTH		
	28 day	118 day	393 day	28 day	118 day	393 day	28 day	118 day	393 day	28 day	118 day	393 day
w/cm = 0.45												
w/cm = 0.35												
Admixtures (not DCI)												
DCI												
Accelerator			∅			∅						
Retarder			∅			∅						
SCM	X	X	X	X	X	X		X	X			
Silica Fume												
Fly Ash												
Slag												
Metakaolin								X	X			
Elevated Temperature												
Cured at 7°C											∅	
Steel Rebar												

∅ represents empty subsets.

Figure 90. The degree of rejection of subsets indicates that the conductivity test has the same range of applicability as the AASHTO T277 test. Because the conductivity is a measure of the movement of ions under an electrical field, the reason for the rejected subsets is similar to that discussed under the AASHTO T277 test (Section 4.3.2).

#### 4.3.5 The CTH Test

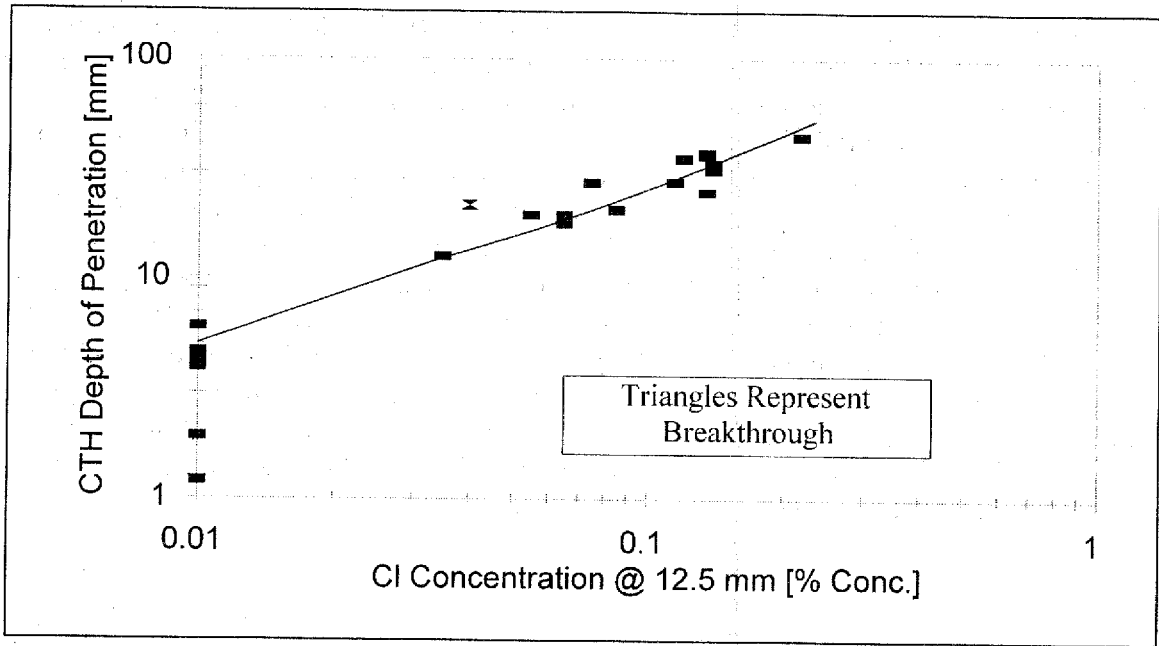
The correlation coefficients achieved in log-log plots versus the different reference test values are included in Table 11. As can be seen from the correlation coefficients, the CTH test provides a relationship to the diffusion values that is at least as good as the AASHTO T277 test. The one exception is the comparison of the 90-day salt ponding value with the 393-day CTH value. This indicates that, in general, the applicability of the CTH test to a wide range of concretes is satisfactory.

**Table 15 – Phase 2 – 90-Day AASHTO T259 Rejected Subsets, 95 Percent Confidence Level.**

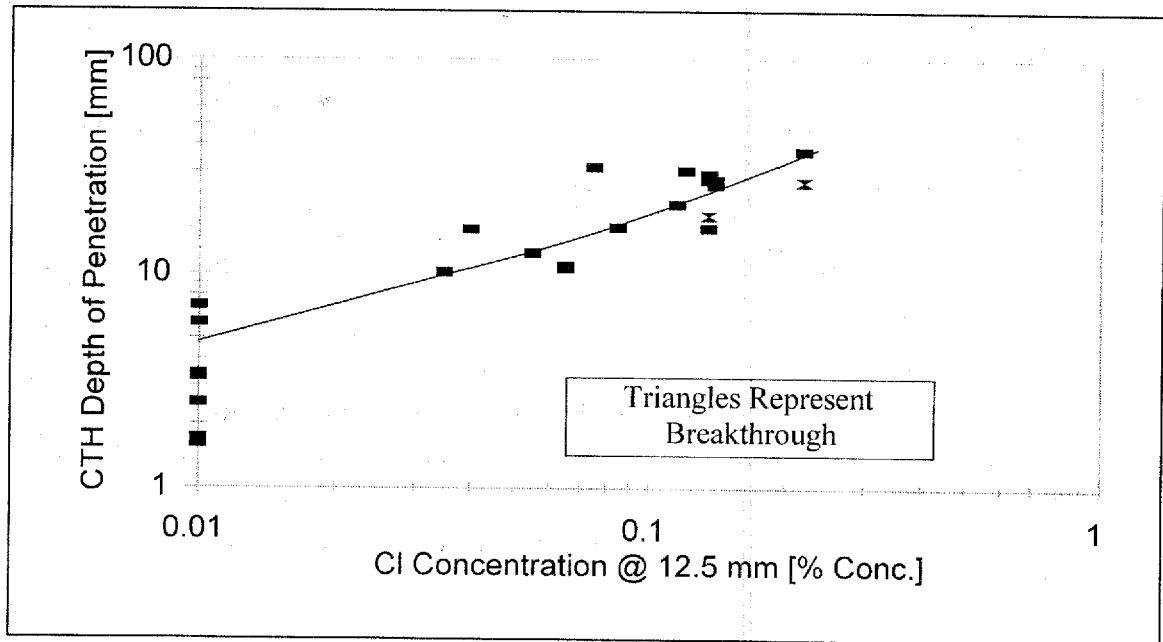
	AASHTO T277			Mod. AASHTO T277			Monfore Conductivity			CTH		
	28 day	118 day	393 day	28 day	118 day	393 day	28 day	118 day	393 day	28 day	118 day	393 day
w/cm = 0.45												NA
w/cm = 0.35												NA
Admixtures (not DCI)												NA
DCI												NA
Accelerator			∅			∅						NA
Retarder			∅			∅						NA
SCM	X	X	X	X	X			X	X			NA
Silica Fume	X			X			X					NA
Fly Ash												NA
Slag												NA
Metakaolin												NA
Elevated Temperature										X		NA
Cured at 7°C										∅	X	NA
Steel Rebar												NA

∅ represents empty subsets.

None of the data subsets examined could be rejected at the 95 percent confidence level for the CTH test when compared with the bulk diffusion data, for either test duration. When compared with the salt ponding data, two subsets were rejected – the 28-day value of the “Elevated Temperature” subset and the 118-day value of the “7°C” subset (Figures 91 and 92). Both the subsets were very small, however. The 393-day CTH values versus the salt ponding subsets were not investigated due to the low level of general correlation. For the reference test, CTH combinations that do not contain a



**Figure 91.** CTH – 28 Days vs. Salt Ponding Evaluation Highlighting Elevated Curing Temperature Subset ( X ).



**Figure 92.** CTH – 28 Days vs. Salt Ponding Evaluation Highlighting 7°C Subset ( X ).

rejected subset, the entire plot is shown (Figures 93 to 99). The lack of rejected subsets indicates that the CTH test may have a greater range of applicability for various concretes than the AASHTO T277 test, though part of the explanation may also lie in the small sample size of each of the subsets. This effect was potentially heightened, because some CTH test results where complete chloride penetration (breakthrough) occurred were unable to be included for the CTH test. For Mixture # 3a, containing steel in relatively low-quality concrete, a satisfactory depth of penetration was unable to be measured. When the chlorides penetrated to the depth of the steel, instead of penetrating further they reacted with the steel and caused rust to form. In addition, for 7 samples at 28 days and 5 samples at 118 days, complete chloride penetration was achieved with the test conditions used. All that can be said is that the penetration is at least 50 mm, which is the sample thickness. In the plot of these data, these points are shown as empty triangles at 50 mm. While these data have not been included in the analysis, they do appear to fit in well with the general trend established for the data.

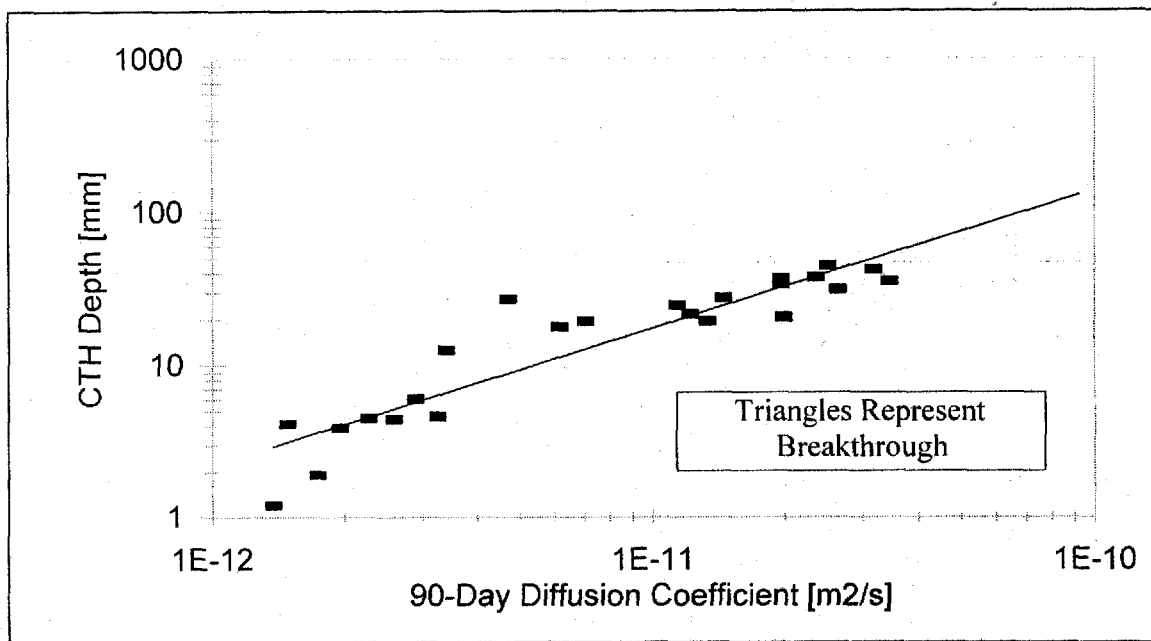
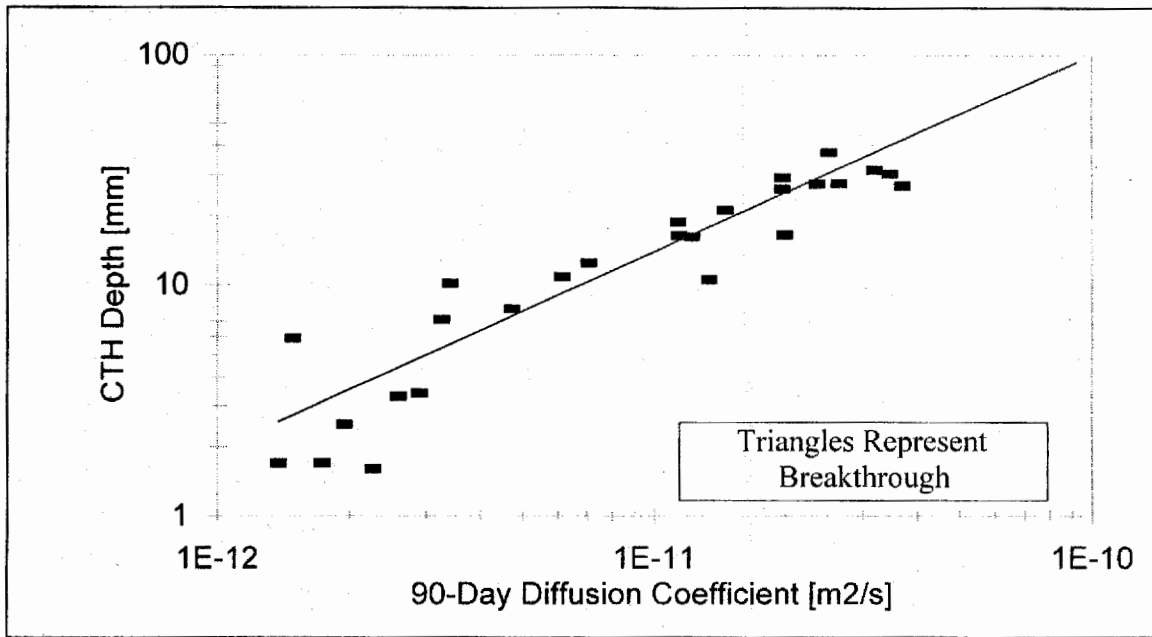
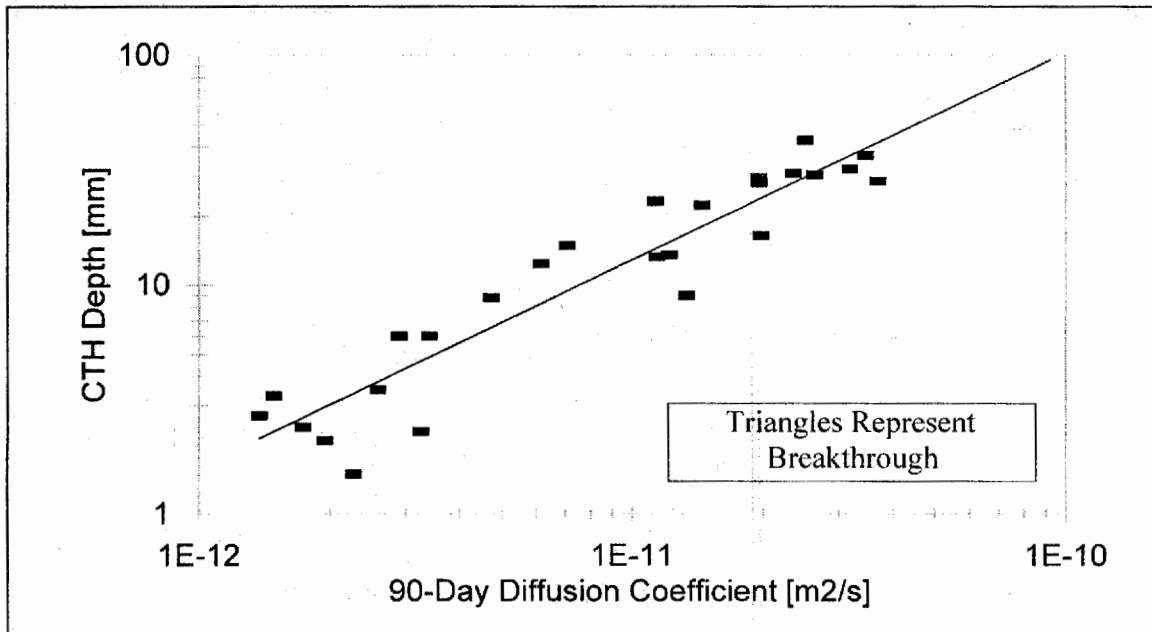


Figure 93. CTH – 28 Days vs. 90-Day Bulk Diffusion.



**Figure 94.** CTH – 118 Days vs. 90-Day Bulk Diffusion.



**Figure 95.** CTH – 393 Days vs. 90-Day Bulk Diffusion.



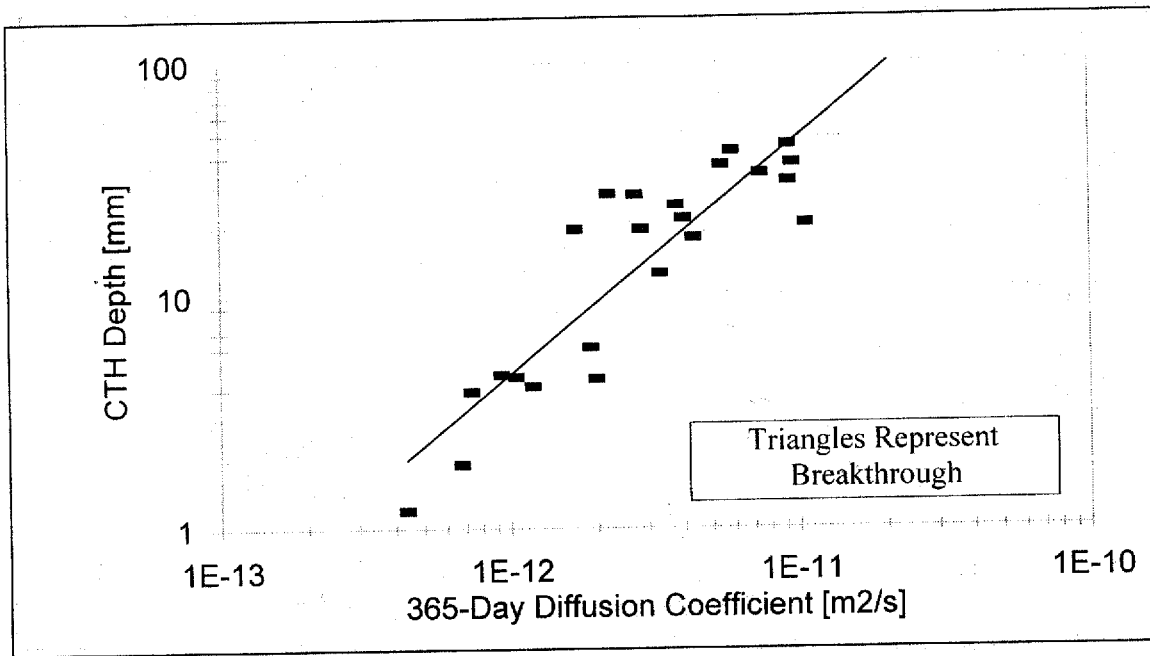


Figure 96. CTH – 28 Days vs. 365-Day Bulk Diffusion.

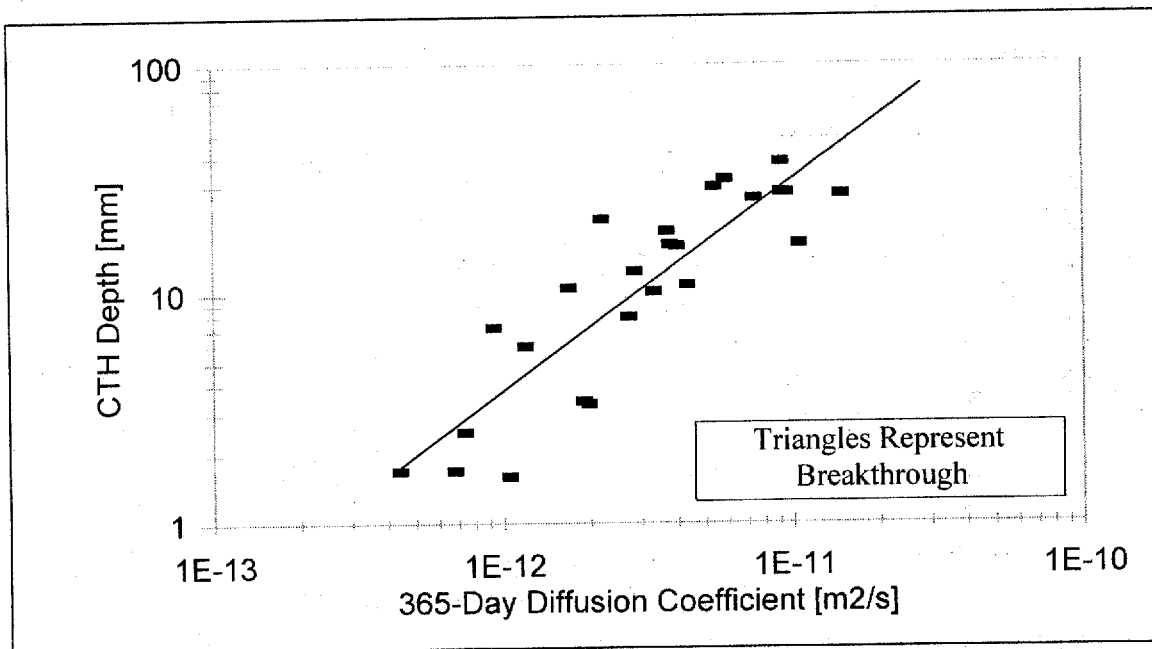
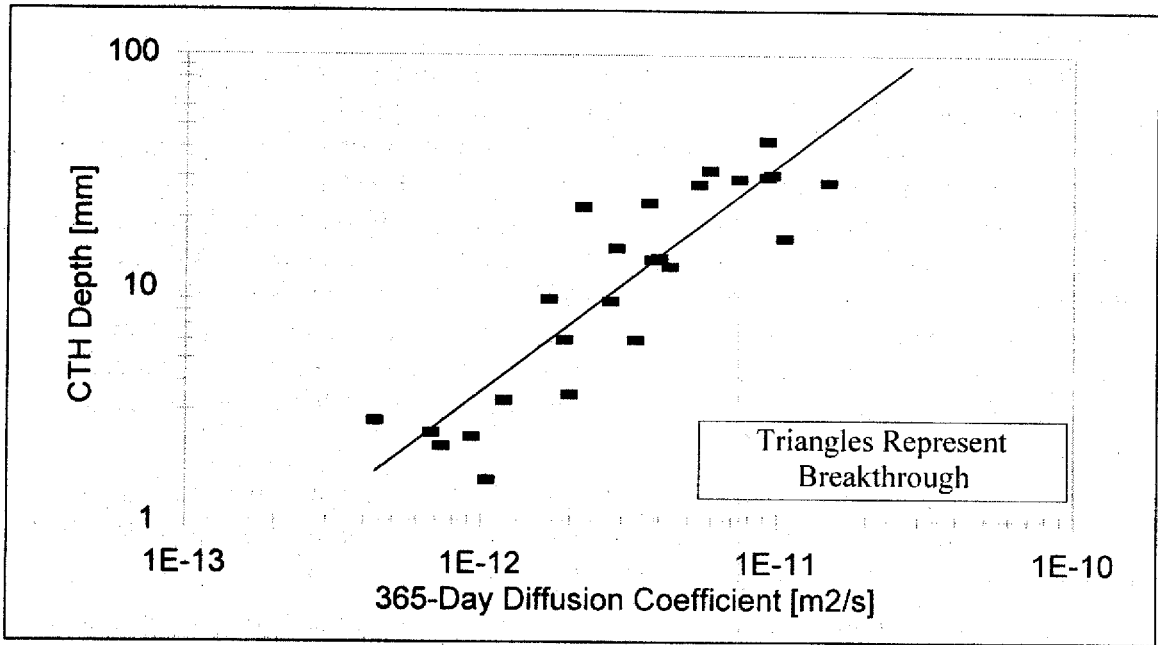
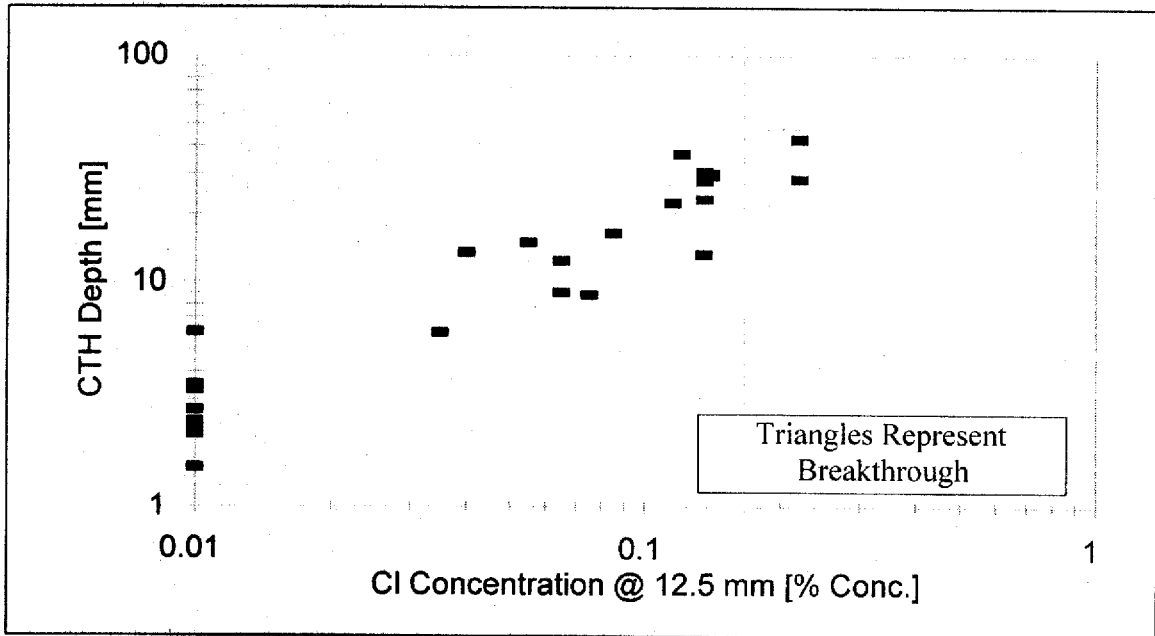


Figure 97. CTH – 118 Days vs. 365-Day Bulk Diffusion.



**Figure 98.** CTH – 393 Days vs. 365-Day Bulk Diffusion.



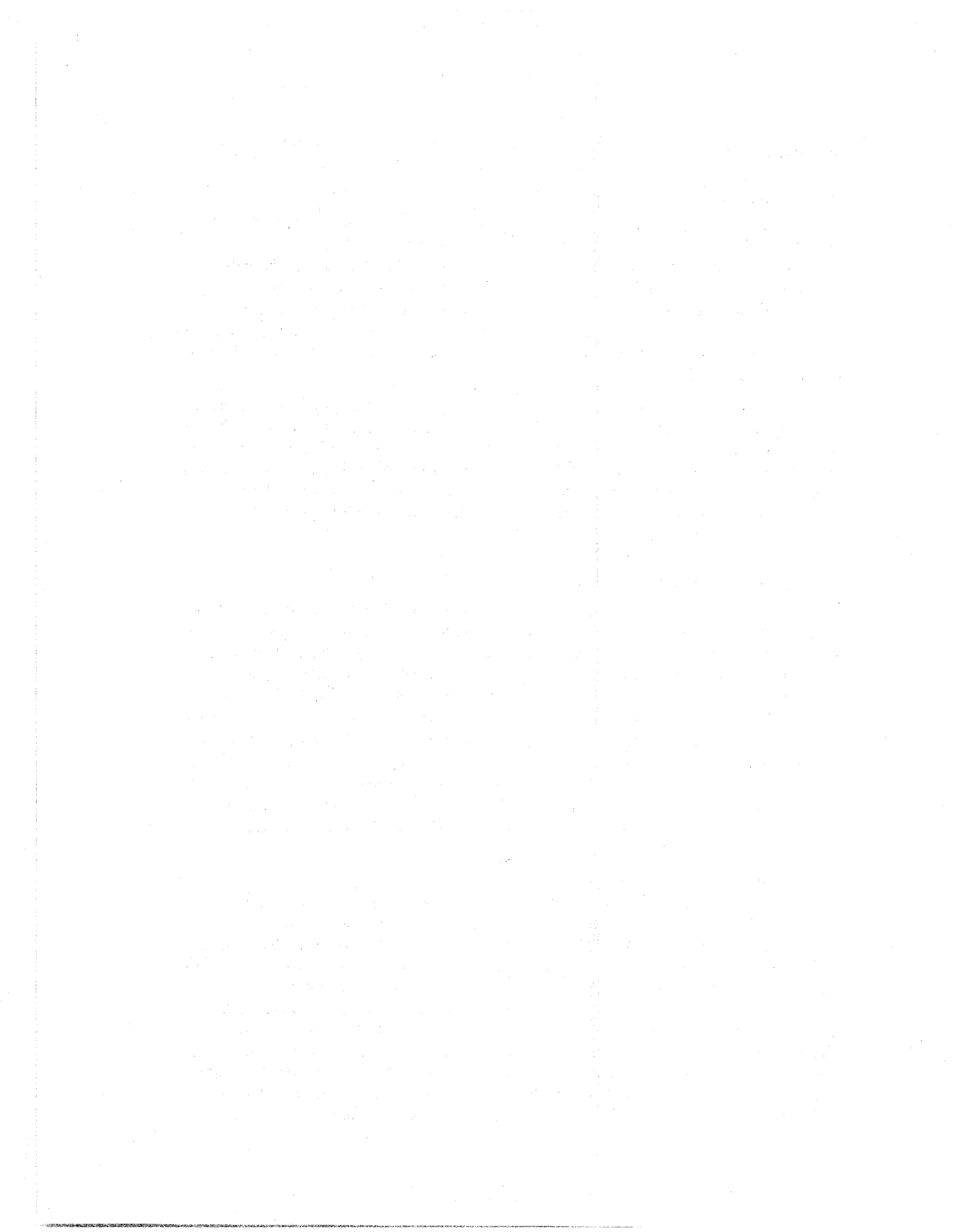
**Figure 99.** CTH – 393 Days vs. Salt Ponding Evaluation.

#### **4.4 Conclusions**

It appears that the CTH test has the most promise of the tests examined. Except for the comparison of the CTH – 393-day depth of penetration with the AASHTO T259 chloride concentration at 12.5 mm, the CTH test has a high correlation with the reference tests. The correlation of the 393-day CTH value to the AASHTO T259 depth of penetration is significantly lower than the other values. In addition, the CTH test did not reject any of the identified subsets in this study, indicating that it has a wider degree of applicability than the other tests study – the AASHTO T277 test and Monfore Conductivity. The procedure used in Phase 2 was unable to evaluate all of the concretes of interest, however. It was decided that in Phase 3 some modifications were needed to improve the ability of the CTH test to adequately evaluate the entire range of relevant concretes.

The Monfore Conductivity test and the AASHTO T277 test also provide a good level of agreement. For these tests, however, there were some rejected subsets identified. This indicates a more limited range of applicability than the CTH test.

In this phase, a different procedure was used to evaluate the salt ponding test. The concrete was evaluated based on the concentration at a specified depth. This procedure makes it easier to evaluate than the depth of some specified concentration, as the entire concentration profile does not need to be determined. It does have the disadvantage that, depending upon the depth chosen, there may be a wide range of concrete for which the chloride concentration at that depth is zero.



## **5 Phase 3**

### **5.1 Summary**

Phase 3 was conducted to further refine the CTH migration test and to further investigate the pressure penetration test. For the CTH test, instead of testing at one specific time and voltage combination, a chart was established that would allow the selection of the voltage and duration based on the initial current of the sample. In addition, three voltage-time combinations were used to get a series of values for use in evaluation. This procedure was adopted to avoid the possibility of breakthrough for low-quality concrete. To distinguish this alternate procedure from that used previously, it was retitled the Rapid Migration Test (RMT).

In addition, additional concrete mixtures were cast to further evaluate the pressure penetration technique. Since the CTH test may be affected by the presence of reinforcing steel if the chloride ions penetrate that far, it was felt that a re-evaluation of the pressure penetration test was warranted. If the pressure penetration test were successful, it would likely be applicable if steel were present. The pressure penetration test was then evaluated using a more manageable test apparatus and using possible longer test durations.

### **5.2 Testing Program**

A suite of 12 concrete mixtures was chosen, in consultation with the FHWA, to represent the range of parameters of interest (see Table 16). The mix designs and fresh concrete properties are presented in Appendix 6. These concretes were continuously moist cured until the day of test. At 28 days of age, the AASHTO T259 test, the bulk diffusion test, the AASHTO T277, the Monfore Conductivity test, and the RMT as described below were performed. For this phase, samples cut from 100-mm  $\varnothing$  x 200-mm cylinders were tested. For the AASHTO T277, and the Monfore Conductivity test, two samples were tested. For the RMT, three samples were required. The AASHTO T259 test was evaluated by determining the chloride concentration at 12.5 mm, as in Phase 2. In addition, these concretes were used to further evaluate the possibilities of the pressure penetration test, with a focus on using a lower, more manageable testing pressure.

#### **5.2.1 Rapid Migration Test**

In Phase 2, the CTH test was carried out at one voltage (30 V) and one duration (24 hr). While this resulted in an acceptable level of prediction, there were some limitations. Chloride breakthrough was achieved for some of the lower-quality concretes while for some of the higher-quality concretes, there was little penetration. To remedy this, it was decided to use the initial current to aid in the selection of the testing conditions as has been previously done [Tang, 1998]. Instead of using one test duration for a single test as was done in that work, in this study three durations were selected so that approximately 10 mm, 25 mm, and 40 mm of penetration would be achieved. The testing conditions required to achieve this were estimated based on consideration of the earlier results of this contract, and are shown in Table 17. The linearity of the depth vs. voltage-time curve noted in Phase 1A (Section 3) was used and the rate of chloride

ingress (mm/(V-hr)) was determined and used to rate the concrete. This allows comparison between different concrete samples even though they may be tested under different conditions. In the Nordtest procedure, the concrete test results were evaluated by determining a diffusion coefficient. To do this calculation, the assumption of a sharp chloride front and an S-shaped curve in the chloride profile was used by Tang. By using the rate of penetration as evaluation criteria, this assumption was avoided, since it was not supported by the work in Phase 1.

**Table 16. Phase 3 Concretes.**

w/cm	0.35	0.40	0.45	0.55
Ordinary portland cement (OPC)	X	X	X	X
8 % silica fume (SF)	X		X	
35 % Slag		X		
20 % Fly Ash (FA)		X		
DCI			X	
Steel			X	
6.4 % SF, 20 % FA	X		X	

**Table 17. RMT Procedure - Test Conditions (Voltage, Time)**

Current @ 30 V (mA)	Test Condition 1	Test Condition 2	Test Condition 3
< 5	60 V, 96 hr	70 V, 168 hr	80 V, 168 hr
5-10	60 V, 48 hr	60 V, 96 hr	60 V, 168 hr
10-15	40 V, 48 hr	40 V, 96 hr	40 V, 168 hr
15-20	30 V, 24 hr	30 V, 72 hr	30 V, 120 hr
20-30	25 V, 24 hr	25 V, 48 hr	25 V, 96 hr
30-40	20 V, 24 hr	20 V, 48 hr	20 V, 72 hr
40-60	15 V, 24 hr	15 V, 48 hr	15 V, 72 hr
60-90	10 V, 24 hr	10 V, 48 hr	10 V, 72 hr
90-120	5 V, 24 hr	5 V, 48 hr	5 V, 72 hr
120-240	5 V, 6 hr	5 V, 24 hr	5 V, 48 hr
240-600	5 V, 4 hr	5 V, 6 hr	5 V, 24 hr
> 600	5 V, 2 hr	5 V, 4 hr	5 V, 6 hr

### 5.2.2 Pressure Penetration Testing

In Phase 1, a driving pressure of approximately 6.9 MPa was placed across a 25-mm-thick specimen. This resulted in a driving pressure gradient of approximately 2800 m/m. This situation was maintained for 6 days, and the depth of chloride penetration was then determined. The results were discussed in Phase 1 (Section 2.3.11), but in summary, for the lower-quality concretes, the chloride solution penetrated the entire depth of the concrete, while for the higher-quality mixes there was very little or no visible penetration.

For only one of the eight concretes tested (0.45, 8 percent silica fume) had the chloride penetration front only partially penetrated the concrete sample.

This initial test setup was not a realistic one to use for the purposes of the contract. First, the driving pressure was fairly high, necessitating a high confining pressure. The apparatus to provide this is relatively elaborate and expensive and does not readily lend itself to widespread use. Second, a specimen thickness of 25 mm is too thin for use. The interfacial transition zones that form around the aggregate may then dominate the behavior as they could extend through the entire thickness of the specimen. Typically, it is desirable to have a specimen thickness of no less than two to two and a half times the maximum aggregate diameter [Hooton and Wakeley, 1989]. This requires a specimen thickness of no less than 50 mm. This test setup was used because some preliminary calculations based on estimated permeability coefficients indicated that there may be some difficulty for the higher-quality concretes in achieving sufficient penetration in the time frame allowed. The pressure gradient was thus maximized in this preliminary work to determine the potential for this test.

To overcome some of these limitations in the Phase 1 work, a modified procedure was used to test the Phase 3 concrete. Instead of 6.9 MPa, a lower driving pressure of around 0.69 MPa was used. This lower driving pressure meant that a lower confining pressure could be used, one that is simpler to apply. As well the apparatus would be far less costly to construct. In the University of Toronto, a procedure has been developed to confine these samples using a flexible latex ring through the Poisson effect [Hearn and Mills, 1991]. This is much more manageable than the previously used method of using water under pressure to triaxially confine the sample in a rubber sleeve in a Hessler cell [El-Dieb and Hooton, 1994]. The method used to apply the driving pressure remained the same, but the lower applied pressure meant that it was easier to accomplish. A different technique of applying this lower driving pressure is conceivable. In addition, instead of the 25-mm-thick specimen, a 50-mm specimen thickness was used for the reasons previously discussed. For both phases, an upstream concentration of 3 percent NaCl by mass was used.

For this series of tests, two different test durations were used. To comply with the original requirements of the project, one set of samples was subjected to the pressure gradient for 7 days. This would allow the test samples to be cured for 28 days and still be tested within the 35-day time limit specified as the initial project objectives. Based on the previous experience from Phase 1, it was thought that this would likely be too short a time frame to achieve any significant penetration, as the hydraulic gradient was reduced by a factor of 20 (one-tenth the pressure, twice the specimen thickness) from that used in Phase 1. As the primary purpose of the further evaluation of this test was to possibly evaluate existing structures, it was decided, in conjunction with FHWA, to disregard the time allotted for curing and to use the full 35-day period for the pressure penetration test.

## **5.3 Results**

### **5.3.1 RMT Evaluation**

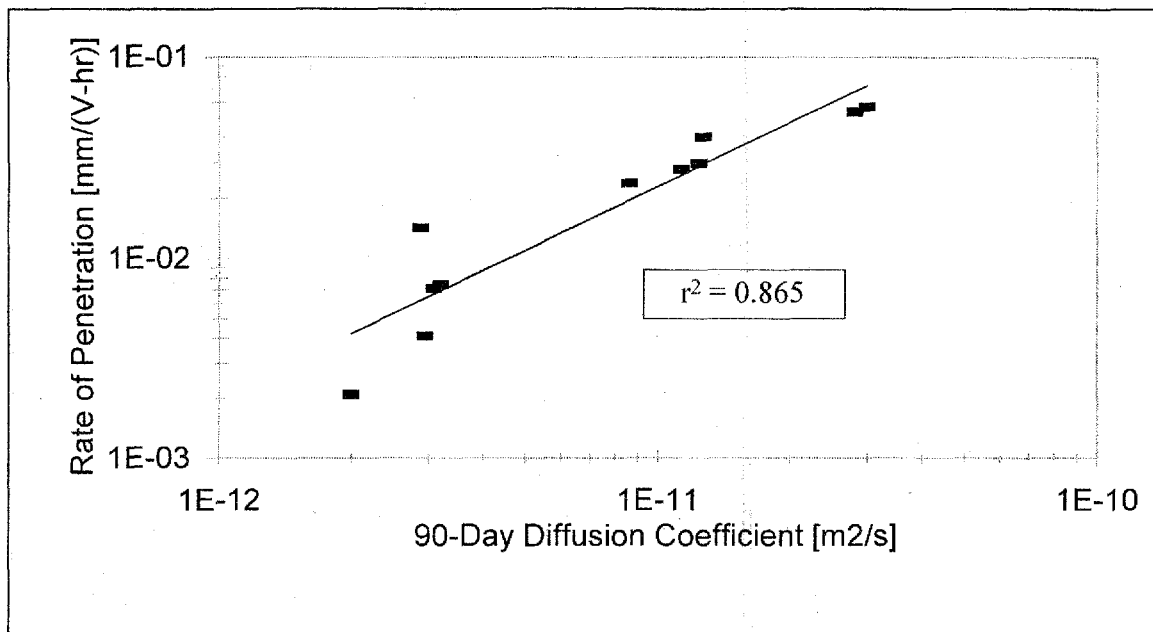
The RMT procedure was used to evaluate the suite of concretes previously described. For the concrete that contained steel [a piece of 20M reinforcing steel

(approx. a #6 bar) at mid-depth], corrosion occurred for two out of the three test conditions, preventing a successful evaluation. Thus, this concrete was not included in the test evaluation. Plots of the RMT evaluation versus the 90-day bulk diffusion coefficients and the salt ponding evaluation (chloride concentration above background at a depth of 12.5 mm) are included as Figures 100 and 101. In addition, similar plots were constructed of the 28-day AASHTO T277 data, the modified AASHTO T277 procedure described earlier, and 28-day conductivity values (Figures 102 to 107). The correlation coefficients obtained on log-log plots are presented in Table 18.

**Table 18.** Phase 3 Correlation Coefficients.

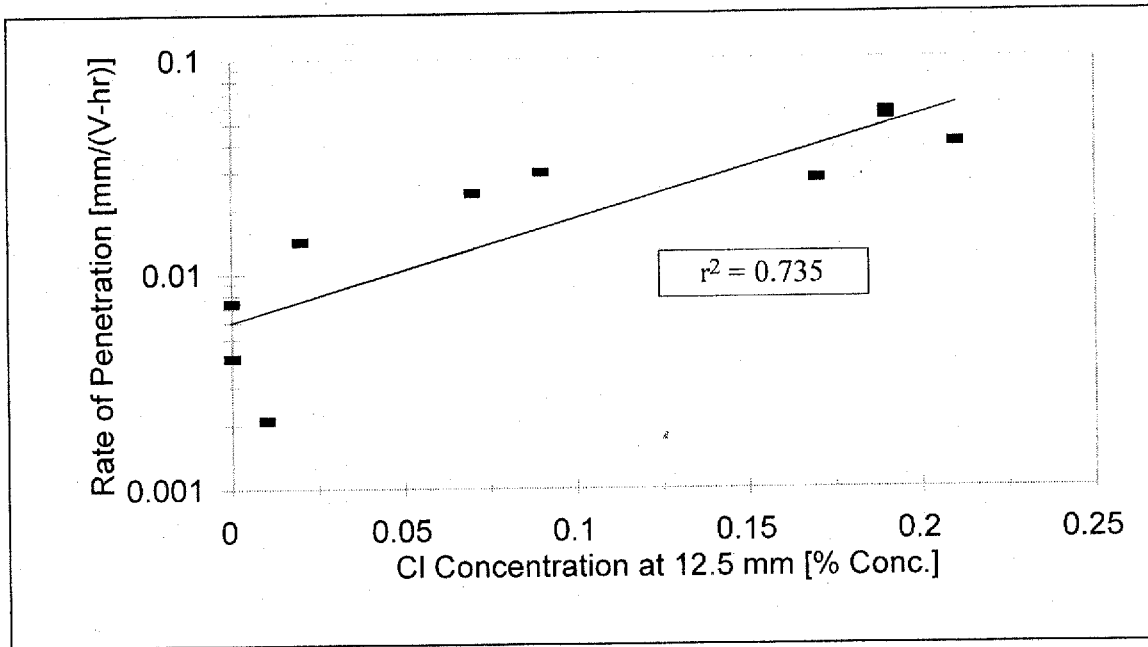
	RMT	AASHTO T277	Modified AASHTO T277	Conductivity
90-Day Bulk Diffusion	0.865	0.820	0.826	0.697
90-Day Salt Ponding	0.735	0.825	0.834	0.809

The degree of correlation exhibited by the RMT was higher than that for the other rapid test procedures when compared with the 90-day bulk diffusion test, and similar, but slightly lower, when compared with the chloride concentration above background at 12.5-mm depth of the 90-day salt ponding test (AASHTO T259). This indicates that this test procedure does a good job of predicting the long-term chloride penetration resistance of concrete.

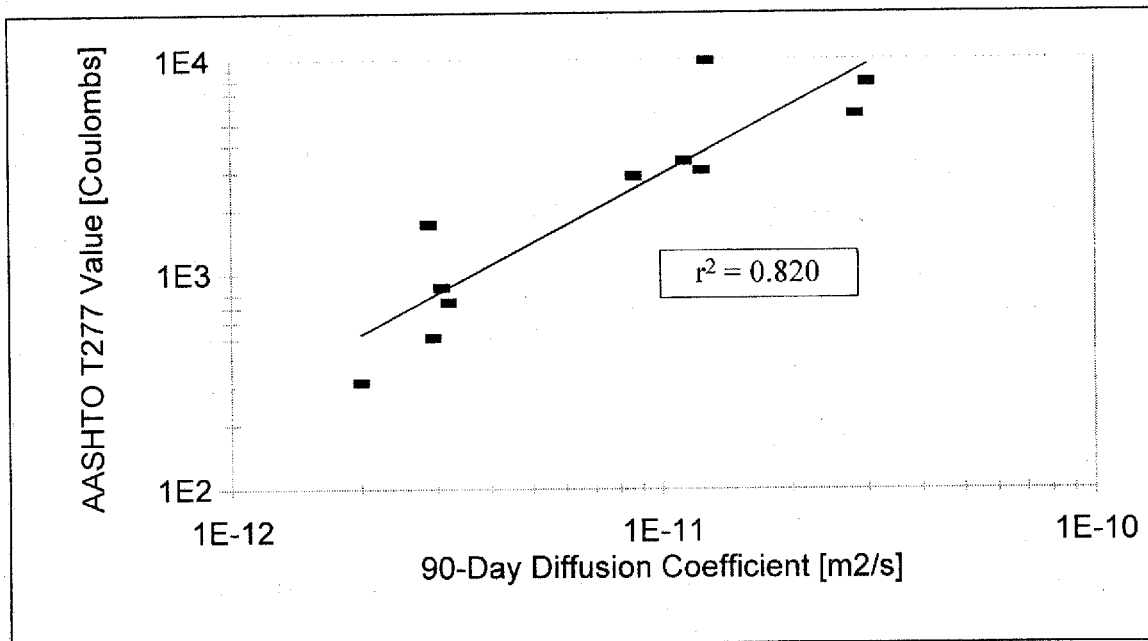


**Figure 100.** RMT Evaluation, 28 Days vs. 90-Day Bulk Diffusion.





**Figure 101.** RMT Evaluation, 28 Days vs. Salt Ponding Evaluation.



**Figure 102.** AASHTO T277, 28 Days vs. 90-Day Bulk Diffusion.

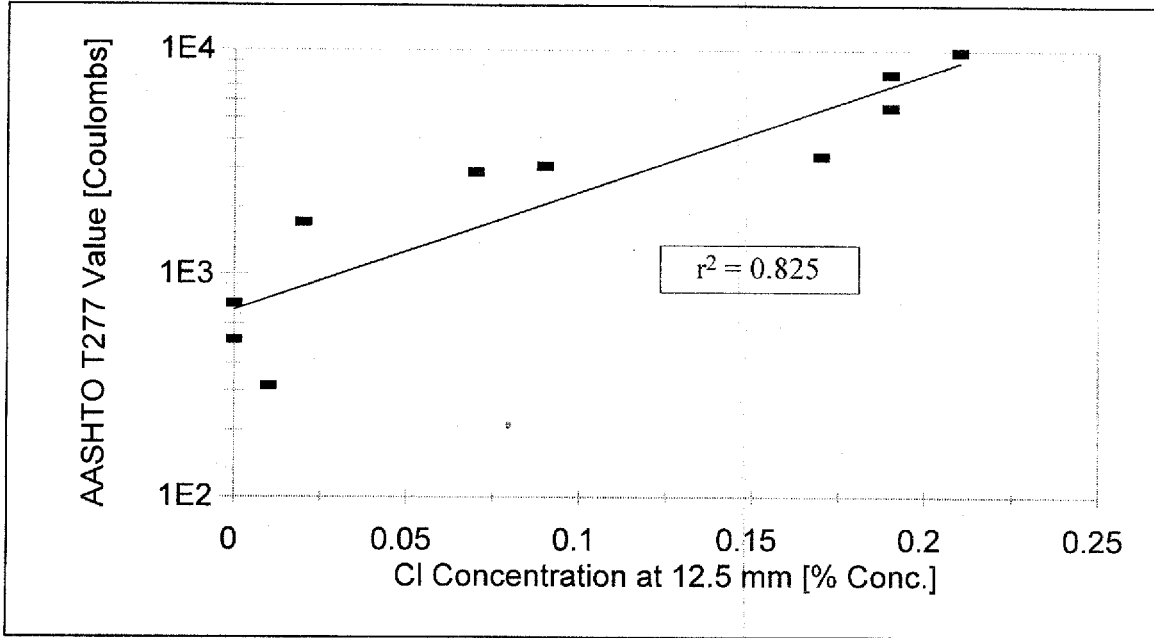


Figure 103. AASHTO T277, 28 Days vs. Salt Ponding Evaluation.

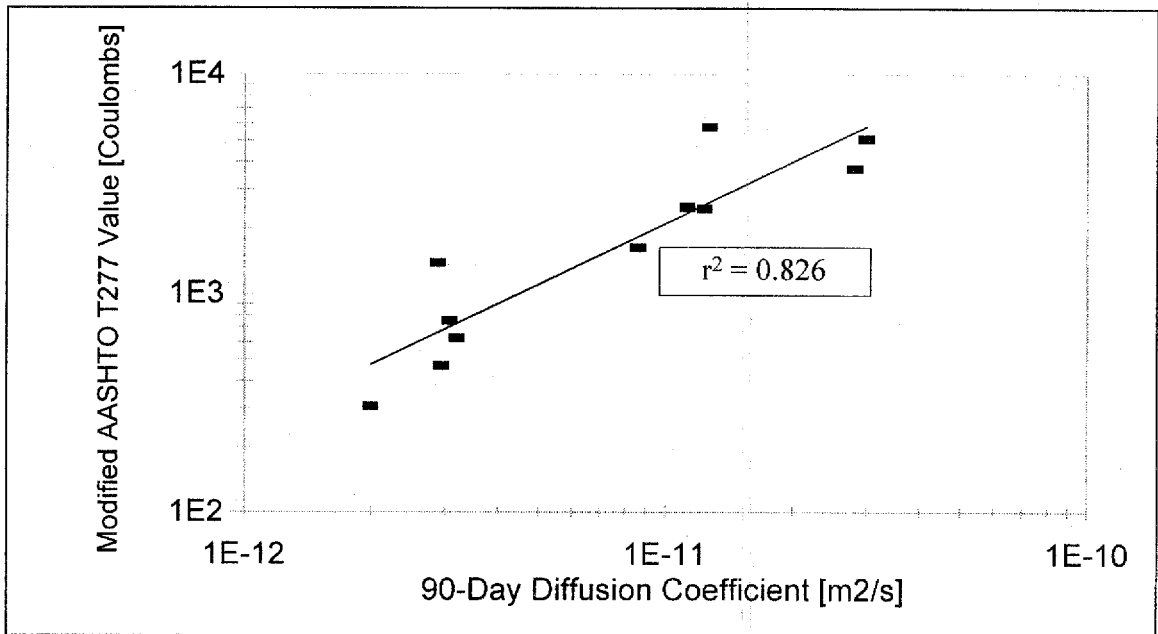
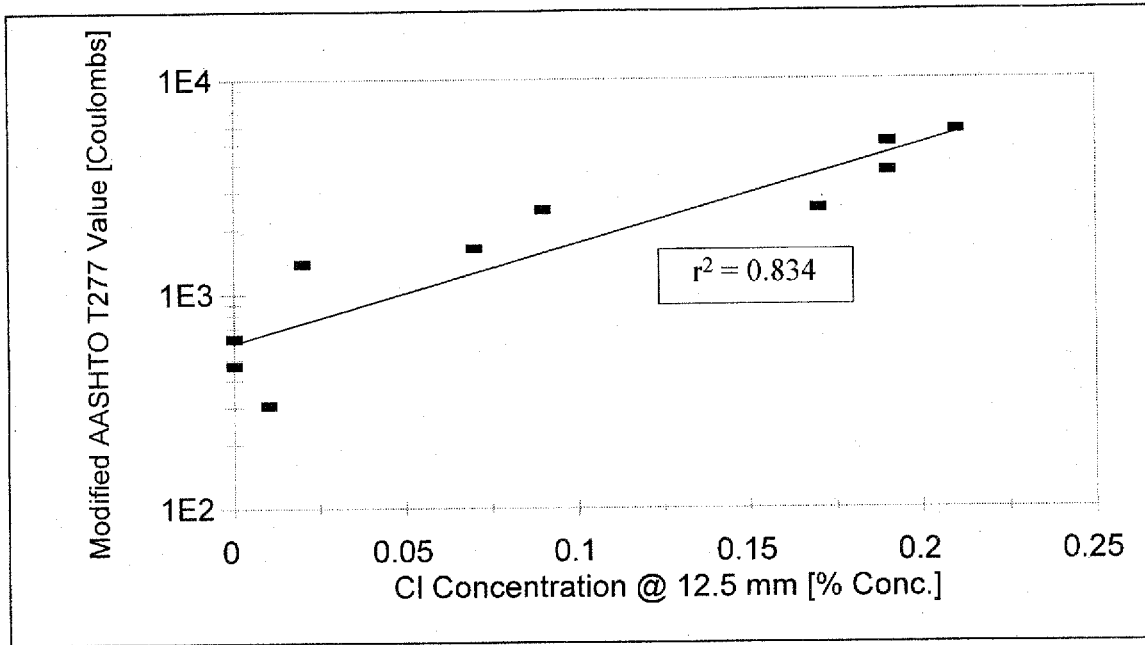
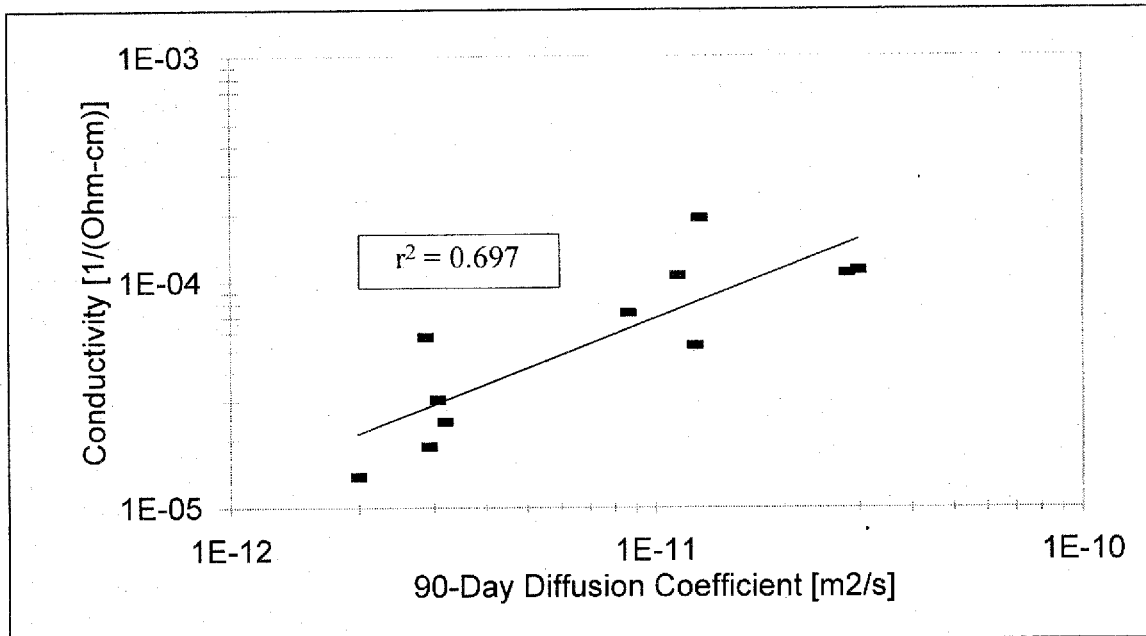


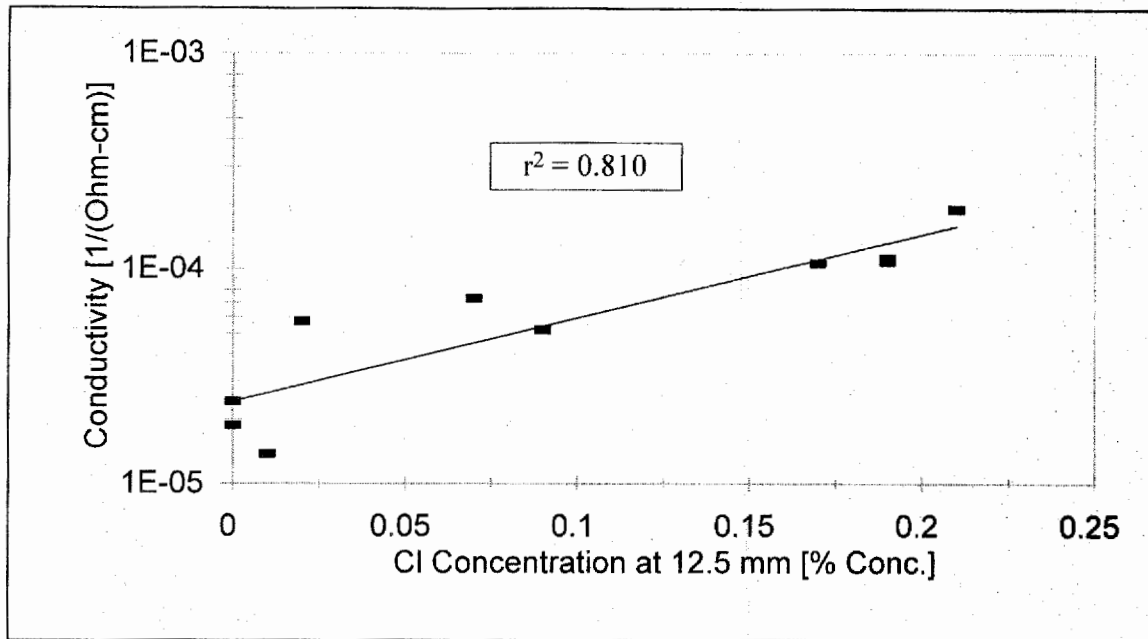
Figure 104. Modified AASHTO T277, 28 Days vs. 90-Day Bulk Diffusion.



**Figure 105.** Modified AASHTO T277, 28 Days vs. Salt Ponding Evaluation.



**Figure 106.** Monfore Conductivity, 28 Days vs. 90-Day Bulk Diffusion.



**Figure 107.** Monfore Conductivity, 28 Days vs. Salt Ponding Evaluation.

There was not a wide enough variety of concrete in this phase to evaluate rejected subsets, as was done in Phase 2. It is reasonable to assume that the RMT procedure would exhibit similar results to the CTH test procedure studied in Phase 2. To support this, an examination of the numerical results for the 0.45, DCI and the 0.45, OPC concrete is useful (Table 19). The bulk diffusion coefficient of the 0.45, DCI is slightly lower than the 0.45, OPC, and the chloride concentration at 12.5 mm is slightly higher, indicating a comparable chloride penetrability, with the 0.45, DCI concrete being possibly slightly more resistant. The AASHTO T277 values (both procedures) are significantly higher and the Monfore Conductivity value is significantly higher for the 0.45, DCI concrete. This would indicate that the 0.45, DCI mixture is a more penetrable concrete, but this is really an effect of the higher electrolyte concentration of the pore solution compositions due to the presence of calcium nitrite. The RMT

**Table 19.** With and Without DCI Comparison.

	0.45, DCI	0.45, Plain
Bulk Diffusion [m <sup>2</sup> /s]	1.27 x 10 <sup>-11</sup>	2.82 x 10 <sup>-11</sup>
Salt Ponding [% Concrete]	0.21	0.19
AASHTO T277 [C]	9874	5557
Modified AASHTO T277 [C]	5751	3721
Conductivity [1/(Ω-cm)]	0.000191	0.000101
RMT [mm/(V-hr)]	0.0403	0.0539

procedure did not exhibit this difference, with the 0.45, DCI mixture a slightly lower result.

### 5.3.2 Pressure Penetration Evaluation

The testing apparatus used in this phase was simpler to use than the apparatus used in Phase 1. However, it is still not simple to use or set up. It is a lot less robust than other techniques proposed, in that there are a significant number of valves and connections that must remain leak-free. Second, it is a relatively complicated procedure to fill the piping with either deaired water or deaired NaCl solution. This makes the test awkward. Finally, the test procedure requires a 0.69 MPa (100 lbf/in<sup>2</sup>) pressure to be applied. It was difficult to apply this pressure exactly. While for a traditional permeability test, this is not an issue as the actual pressure applied can be recorded and this value is then used in the calculations, the test procedure applied here does not have this flexibility. It requires that the depth of penetration be compared with a standard value to rate the concrete. This assumes that the pressure applied is the same as for the standard. While the applied pressure variation was kept to around 5 percent, this does remain a drawback to this test.

The results obtained are reported in Table 20. Four values were obtained for a 7-day exposure period and five results for a 35-day test duration. The concretes tested represent the extremes of quality for this testing program. For a 7-day test duration, the maximum penetration achieved, and thus the likely maximum to be expected for the range of concretes of interest for this test program using these test parameters, was 7.1 mm. To attempt to differentiate concrete qualities based upon this small range of possible values is optimistic. It can be easily imagined that slight errors in test procedure and reproducibility effects would have a more significant impact on the test result than the actual concrete quality. As an example of this, if a concrete sample was allowed to dry for 5 to 10 minutes before being placed in the testing apparatus, this would lead to an increase in penetration depth due to sorption, with the salt solution being rapidly drawn into the pore structure. This effect may only be 1 or 2 mm, but if the cut-off between pass and fail is only something like 4 mm, there would be a problem. This influence is the likely cause of the 0.45, ternary blend having a lower penetration than the 0.35, ternary-blend concrete. While the maximum penetration of the 35-day test duration was greater, it was still not large enough to discriminate different concrete qualities. The penetration achieved in the lowest quality concrete was still only 16.7 mm.

In addition, for many tests the test conditions may be determined based on an initial parameter. For example, the initial current at 30 V determines the RMT testing conditions. This is not an option for the pressure penetration test, however. There is no instantaneous value that can be used to roughly estimate the concrete quality. Thus all the testing must be undertaken at the same condition. This limits the flexibility of the pressure penetration test procedure.

**Table 20.** Phase 3 Pressure Penetration Results (Single Test Result Based on Average of Seven Depth Measurements).

Concrete	7 Days	35 Days
0.55, plain	7.1 mm	16.7 mm
0.45, plain	6.8 mm	12.1 mm
0.45, SF, FA	1.2 mm	2.6 mm
0.35, SF, FA	2.6 mm	2.7 mm
0.35, SF	-	No visible penetration

#### **5.4 Conclusions**

The RMT procedure behaved satisfactorily. It was able to predict the chloride penetration of the concrete, as measured by the long-term tests, with a good degree of success. In addition, it did not appear to be affected by the presence of calcium nitrite corrosion inhibitor in the concrete as were the other short-term tests used. However, the presence of steel in the concrete did invalidate the results, because the chloride ions caused corrosion as soon as they penetrated to the steel.

The pressure penetration test did not perform satisfactorily in this work. The range of results achieved with the simpler test apparatus used in this phase was too small to be useful as a basis for evaluation. If an alternative method of conducting the test is found that is simpler and possibly allows an increase in applied pressure, there may be a way to utilize this test method. In that case, the pressure penetration test technique would need to be re-evaluated.

## **6 Interlaboratory Evaluation**

### **6.1 Introduction**

An interlaboratory evaluation of the rapid migration test (RMT) was performed. An outline of the test procedure is included as Appendix 2. For this purpose, four additional test apparatus were constructed and sent to four laboratory facilities previously identified as willing to participate in this study. The laboratories were: FHWA Turner-Fairbank Center (FHWA); the Virginia Transport Research Council (VTRC); Texas Department of Transportation (TxDOT); and the Ministry of Transportation – Ontario (MTO). In addition, the concrete was tested at the University of Toronto (UofT). Each test apparatus was sent out on December 20, 1999, along with a single concrete cylinder. The purpose of this cylinder was to allow the participants to familiarize themselves with the testing equipment prior to the actual evaluation. Thus, any results obtained on this cylinder were not reported. Also, prior to the testing day, each of the labs was visited to ensure that the tests were being conducted correctly and to answer any questions or concerns that may have arisen. For the evaluation, two batches of concrete were cast into cylinders at the FHWA Turner-Fairbank Center, and sent to each of the participating facilities. The RMT tests were conducted on February 15, 2000, for Mixture 1 and February 29, 2000, for Mixture 2. In addition, the labs were asked to conduct an AASHTO T277 test on the same concrete at the same time. Each lab then sent its results to the University of Toronto, where they were then collated.

### **6.2 Preparation of Test Specimens**

Two sets of cylinders were cast at the FHWA Turner-Fairbank laboratories in McLean, Virginia. Each set was of a different concrete mix design and replicated one of the mixes from Phase 3 of the contract. The mixes were selected to represent a wide range of concrete qualities. The details of the mix designs are included as Table 21. Mix 1 was cast on January 18, 2000, and Mix 2 was cast February 1, 2000. For each mix, 23 cylinders were cast and moist cured until they were shipped approximately 14 days later. Each testing facility was randomly assigned four cylinders (three primary and one reserve) upon which to conduct the tests. Which cylinder was assigned to which location is indicated in Table 22. During transport, the cylinders were kept moist by wrapping the cylinders in wet towels and placing them in sealed plastic bags. After the cylinders reached the testing facility, they were to be moist cured until the time came to prepare the specimens for testing at 28 days of age. The three remaining cylinders were used to measure 28-day compressive strength at FHWA.

### **6.3 Laboratory Visits**

To ensure that the personnel at the participating laboratories completely understood the test procedures, they were each visited by K. Stanish approximately 1 month after receiving the testing apparatus and approximately 2 weeks before the first of the interlaboratory tests was to occur. MTO was visited January 27, 2000; FHWA was visited February 2, 2000; VTRC was visited February 3, 2000; and TxDOT was visited February 10, 2000. Previous to this, the labs had all conducted some trial runs with

**Table 21. Mix Designs and Fresh Concrete Properties.**

Component	Mix # 1	Mix # 2
w/cm	0.45	0.35
Type 1 Lehigh Cement	620.3 lb/yd <sup>3</sup> (348.6 kg/m <sup>3</sup> )	664.6 lb/yd <sup>3</sup> (373.5 kg/m <sup>3</sup> )
Silica Fume	0 lb/yd <sup>3</sup> (0 kg/m <sup>3</sup> )	57.7 lb/yd <sup>3</sup> (32.4 kg/m <sup>3</sup> )
Water	279.2 lb/yd <sup>3</sup> (156.9 kg/m <sup>3</sup> )	252.3 lb/yd <sup>3</sup> (141.8 kg/m <sup>3</sup> )
Coarse Aggregate #57 Crushed Limestone	1675.1 lb/yd <sup>3</sup> (941.3 kg/m <sup>3</sup> )	1692.3 lb/yd <sup>3</sup> (951.0 kg/m <sup>3</sup> )
Fine Aggregate Goose Bay Sand	1329.0 lb/yd <sup>3</sup> (746.8 kg/m <sup>3</sup> )	1321 lb/yd <sup>3</sup> (742.3 kg/m <sup>3</sup> )
MicroAir Air Entraining Agent	0.4 oz/cwt (26.0 mL/100 kg)	0.7 oz/cwt (42.3 mL/100 kg)
25 XL Low Range Water Reducer	3.3 oz/cwt (211.4 mL/100 kg)	5.5 oz/cwt (357.8 mL/100 kg)
SPN High Range Water Reducer	0 oz/cwt (0 mL/100 kg)	12 oz/cwt (780.6 mL/100 kg)
Slump	6.0 inches (150 mm)	3.0 inches (75 mm)
Air Content	5 %	4 %
Temperature	18.6 °C	17.8 °C
Unit Weight (Measured)	145.6 lb/ft <sup>3</sup> (2333 kg/m <sup>3</sup> )	148.0 lb/ft <sup>3</sup> (2371 kg/m <sup>3</sup> )
Unit Weight (Calculated)	144.6 lb/ft <sup>3</sup> (2317 kg/m <sup>3</sup> )	147.8 lb/ft <sup>3</sup> (2369 kg/m <sup>3</sup> )
28 Day Strength	4730 psi (32.6 MPa)	9220 psi (63.6 MPa)

**Table 22. Cylinders Assigned to Each Lab.**

Participating Laboratory	Assigned Cylinders (Spare in Brackets)	
	Mix # 1	Mix # 2
FHWA	24, 06, 17, (07)	39, 30, 27, (48)
VTRC	04, 05, 19, (25)	28, 46, 42, (40)
TxDOT	11, 12, 18, (10)	29, 43, 41, (36)
MTO	02, 16, 13 (15)	45, 35, 31, (37)
U of T	14, 08, 20, (01)	34, 26, 33, (32)

either the concrete cylinder provided or additional specimens they had available (or both). In all cases, the general procedure was understood, though occasionally a few clarifications had to be made. The primary clarification dealt with the three different conditions under which the samples had to be tested. It was not clear to the participants that one sample was to be tested under each condition, and the average rate of penetration determined as the test parameter. Some thought that a single condition was to be used.



Some concerns were expressed over the timing (some tests may end on the weekend, for example), but this simple concern could be rectified by the inclusion of a timer to turn off the voltage automatically in the final test apparatus.

#### **6.4 Interlaboratory Tests**

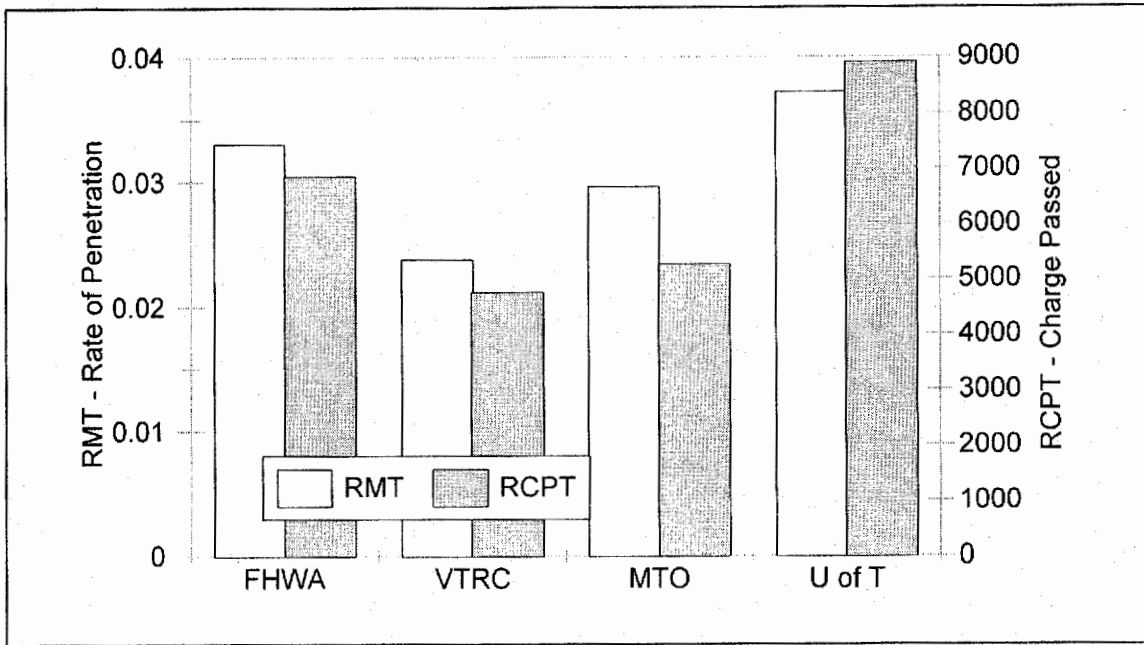
Once the tests were conducted, the data were sent to the University of Toronto for analysis. The results from each participant are included as Table 23. Included in the table are the rates of penetration, the constants and the correlation coefficients determined from the RMT, and the charge passed from the RCPT. In addition to the standard method of evaluating the RCPT, an alternative procedure was used. The charge passed at 30 minutes was multiplied by 12 and this value was then adjusted for specimen diameter as the regular 6-hour value. This avoids the effect of temperature increase, and possible premature abortion of the test. Unfortunately, MTO was unable to provide this information. The RMT is evaluated by the rate of penetration, but the constant and the correlation coefficient determined provide a measure of the quality of the test result. The raw data are included as Appendix 7. The RMT and standard RCPT data from TxDOT were then discarded for the reasons discussed below, and the average, standard deviation and coefficients of variations were then calculated. Although the number of participating laboratories was likely insufficient, from the coefficient of variation, the acceptable range of two results ( $d_{2s}\%$ ) was calculated in accordance with ASTM C670. All the results are reported in Table 23. For the RMT, three values are reported. First, the slope of the line of best fit of the average depth of penetration vs. voltage-time plot is reported. This is the criterion that is used to evaluate the concrete for chloride penetrability resistance. The other two measures are an indication of the quality of the test. They are the intercept of the line of best fit (the constant) and the correlation coefficient of that line ( $r^2$ ). In theory the constant should be zero, though in practice it is normally a small positive number. The correlation coefficient should be close to 1. The AASHTO T277 results and the RMT results from the four labs other than TxDOT are also presented in graphical form, with the results from the first set of cylinders in Figure 107, the second in Figure 108.

Before the numerical results are discussed, some elements of interest will be mentioned. First, TxDOT reported difficulty in obtaining the depth of penetration measurements from the samples. The chloride penetration front was too frequently intersected by the aggregate and they were unable to make an accurate measurement. This resulted in correlation coefficients that were significantly lower than the other results obtained and the constant was higher. In addition, the standard AASHTO T277 test for the first set of cylinders from TxDOT was stopped due to excessive temperatures. While the results obtained by the other labs would support this finding as reasonable, there was an absence of numerical data for comparison. The alternative AASHTO value (12 x 30 min) was able to be determined, however. Though a result was obtained for the RCPT for the second set of cylinders, this was not included in the evaluation for consistency.

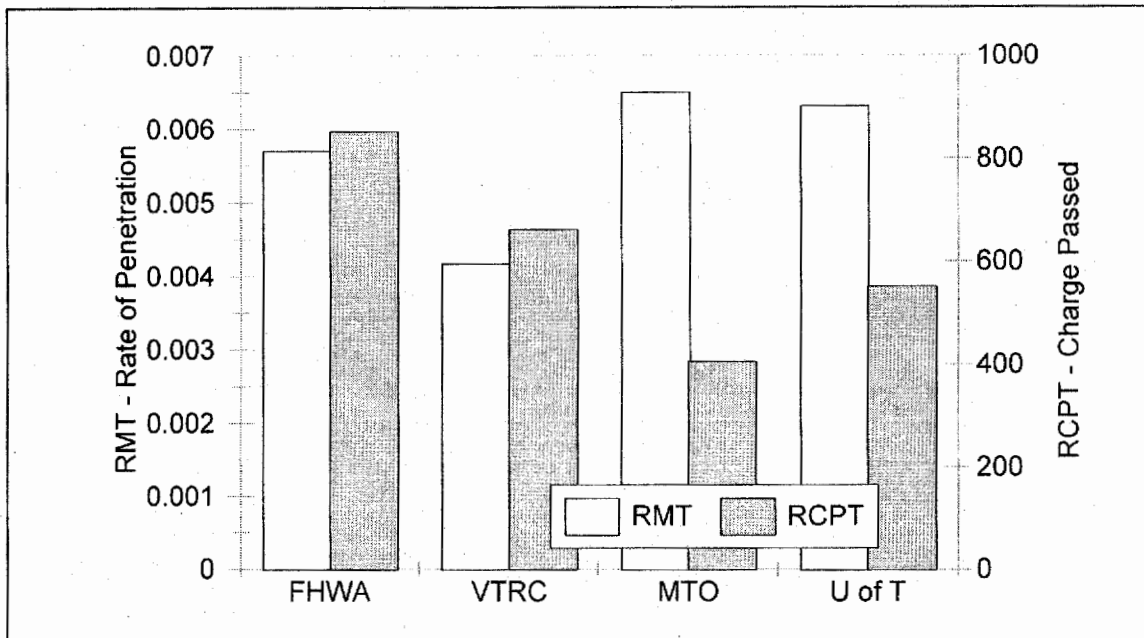
**Table 23.** Interlaboratory Test Results Summary.

	Set 1					Set 2				
	RMT: Penetration Rate (mm/V-hr)	RMT: Constant (mm)	RMT: $r^2$	RCPT: 6 Hour Charge Passed (C)	RCPT: 12 x 30 min Charge Passed (C)	RMT: Penetration Rate (mm/V-hr)	RMT: Constant (mm)	RMT: $r^2$	RCPT: 6 hour Charge Passed (C)	RCPT: 12 x 30 min Charge Passed (C)
FHWA	0.0331	1.7	0.9916	6859	4924	0.0057	1.6	0.9899	852	819
VTRC	0.0238	2.5	0.9868	4758	4782	0.00417	2.9	0.9976	662	754
MTO	0.0296	1.5	0.9871	5262	NA*	0.0065	0.25	0.9999	405	NA*
UofT	0.0372	0.6	0.9686	8904	5187	0.00631	2.2	0.9995	551	523
TxDOT	0.00248*	3.8	0.4798	Too Hot*	4610	0.01223*	-7.6	0.7674	702*	695
Average	0.0309	-	-	6540	4876	0.00567	-	-	618	798
SD	0.0049	-	-	1420	211	0.00092	-	-	163	110
COV	15.9 %	-	-	25.1 %	4.3 %	16.1 %	-	-	26.4 %	15.8 %
d2s%	45.0 %	-	-	71.0 %	12.2 %	45.6 %	-	-	74.7 %	44.7 %

\* The 30-minute data from MTO were unavailable at this time. The statistics for the RMT and standard RCPT were calculated omitting the TxDOT data. The statistics for the 12x30 minute RCPT data were calculated without the MTO data.



**Figure 108.** Results of First Set of Cylinders – Mix #1.



**Figure 109.** Results of Second Set of Cylinders – Mix #2.

Second, the use of a different source of concrete than that produced at the University of Toronto appeared to have an interesting effect. All previous work had been done at the University of Toronto with the same raw materials. This concrete was produced with different materials, those native to the Washington, D.C., area. When the initial current at 30 V was determined and used to set the test conditions, the test conditions were based upon the results from the previous work done at the University of Toronto. The conditions were set to achieve a penetration of approximately 10 mm, 25 mm, and 40 mm, and had been successful previously. The penetrations on this concrete were significantly less. This likely contributed to the difficulty that TxDOT had with making accurate measurements. The likely reason is that the materials used resulted in a different relationship between the resistivity of the concrete and its chloride penetration resistance.

Nevertheless, for four out of five of the laboratories, a result was obtained. Comparing the calculated coefficients of variation (COV), it can be seen that for both sets of concrete there was less variation in the RMT results than for the RCPT. For both sets of cylinders, the COV was about 16 percent for the RMT, while it was 23 percent or 26 percent for the RCPT. This number is similar to the precision that is reported in the ASTM C1202 standard for the RCPT. The alternative method of evaluating the RCPT had better success, though. Its COV was 4.3 percent for the first set of cylinders and 15.8 percent for the second set. In addition, it was able to provide a result for both concrete mixtures tested from all laboratories.

That the correlation coefficient is better for the RMT than the standard method of evaluating the RCPT and is equivalent for the alternative procedure is very promising. Even though every attempt was made to give the participating laboratories the most opportunity to familiarize themselves with the equipment before the test date, with the exception of the University of Toronto they had only performed two or three trial runs at most. Thus they were still relatively unfamiliar with the procedure. On the other hand, the participating labs all routinely perform the RCPT test. The level of consistency achieved in this situation indicates that the test is easy to perform and that it is likely that the level of consistency would improve with greater familiarity with the test procedure.

## **6.5 Conclusions**

The interlaboratory evaluation of the RMT highlighted some aspects of the test that need further clarification. First, the different test durations may be problematic. The way they were set up for this evaluation, the tests often were required to be ended on weekends or evenings. This difficulty could be partially overcome by the inclusion of automatic shut-off timers on the test apparatus, something that was not included in the prototypes supplied. However, the different test durations also means that the test apparatus may be in use for one test for up to a week. This would require multiple sets of testing equipment to be available if more than one set of concrete is to be tested in a week. This is not ideal, and would contribute to a lack of acceptance by the concrete testing community. This issue is further addressed in the next section.

The coefficient of variation was lower for the RMT procedure than for the AASHTO T277 standard evaluation procedure. Modifying the AASHTO T277 evaluation procedure by using an earlier charge passed also lowered the coefficient of

variation. For one concrete, it was extremely low (around 5 percent) while for the other it was similar to that achieved by the RMT. These numbers are especially encouraging considering the relative lack of familiarity the participating labs had with the RMT compared with the AASHTO T277 test.

In addition, the use of different concrete source materials seemed to alter the relationship between the initial current passing and the chloride penetrability. This was unexpected and requires further investigation.



## **7 Rapid Migration Test Procedure**

After trying the test, the participants in the interlaboratory evaluation expressed some concerns about the test procedure. This section addresses these concerns and the changes that this resulted in are outlined and discussed.

### **7.1 Concerns of Interlaboratory Evaluators**

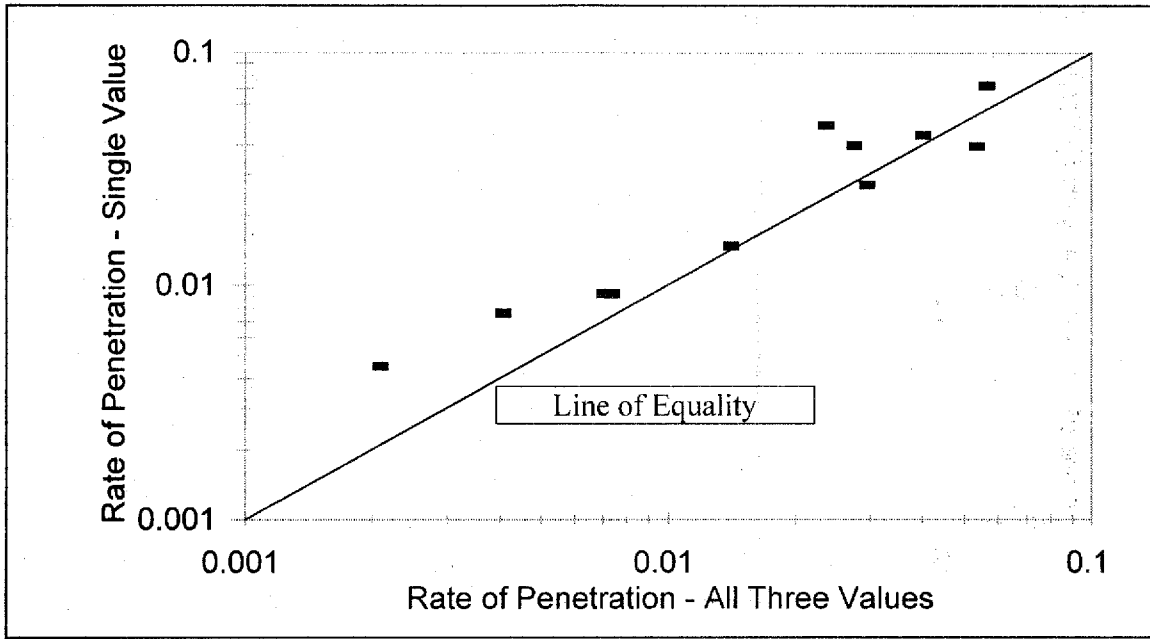
During the interlaboratory evaluations, some comments were received from the evaluators regarding practical aspects of the test procedure for use as a quality control method in a busy testing laboratory. The testing duration was considered too long. The evaluators felt that a shorter turnaround time was necessary. This would increase the volume of testing that could be performed by a single test apparatus. There was also a general feeling that the use of three different test durations was too confusing and should be simplified. In addition, with the testing procedures as written, there was a high probability that the end of the test would fall on a weekend, which is a problem for most labs. An additional complication of the test procedure was the large number of different testing conditions (voltage-time combinations) that may be needed for different concretes.

### **7.2 New Test Procedure**

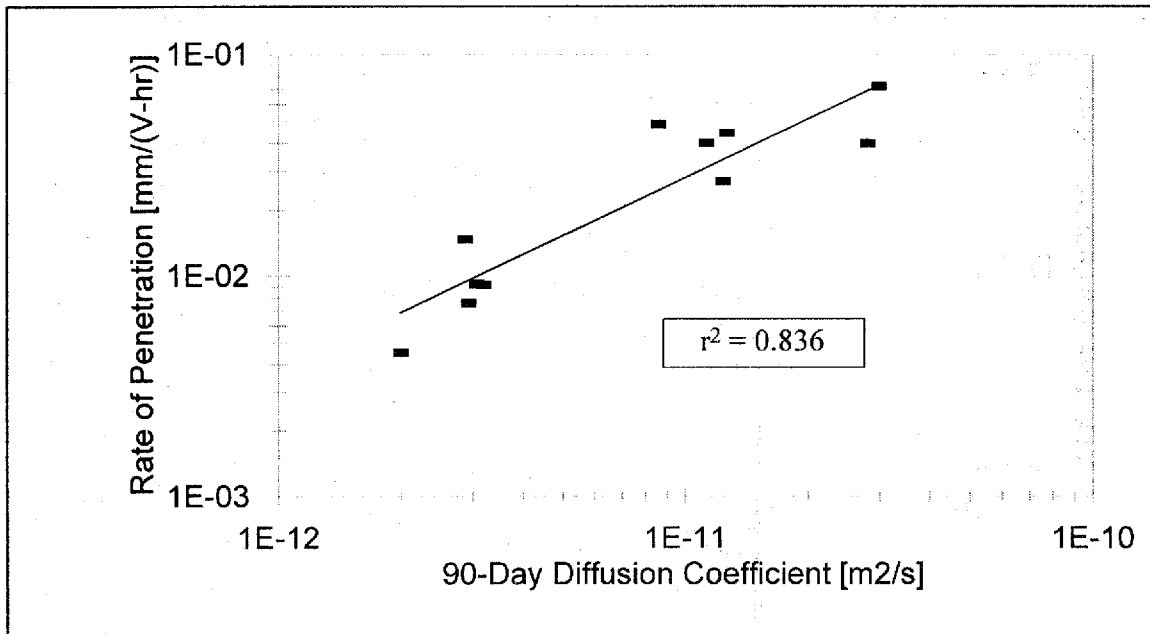
The best way to address these concerns was to re-examine the testing conditions that were used. It was decided to determine the effect of making the test simpler by returning to a single voltage-time combination to evaluate the concrete, instead of using the three test durations and fitting a line to them.

#### **7.2.1 Re-evaluation of Phase 3 Data**

The Phase 3 data were re-examined, but instead of using all three data points, only the center voltage-time combination was used. The numerical results of this re-evaluation are included in Appendix 8. It was evaluated by dividing the average penetration by the product of the voltage and time to determine a rate of penetration. Figure 110 is a plot of how the two values compare with one another. The results are fairly similar, though the determination from the center value may be slightly higher. In addition, the evaluation determined from this single-point evaluation procedure was then plotted against the 90-day bulk diffusion values and the AASHTO T259 values to determine how well this evaluation procedure relates to the reference tests. These are shown as Figures 111 and 112, with the graphs previously shown relating the original three-point evaluation procedure repeated as Figures 113 and 114. Comparing the correlation coefficients shown on these figures, there is a slight reduction in correlation when the single point is used as compared with the three-point (0.836 vs. 0.865 for bulk diffusion, 0.721 vs. 0.735 for AASHTO T259). This reduction is small, however, and the level of correlation is still at least comparable to the result achieved from the AASHTO T277 test. In addition, this was only the result of testing one sample, as compared with the average of two for the AASHTO T277 test and the average penetration rate of three samples for the original evaluation procedure. The use of multiple samples would be expected to improve the test correlation.

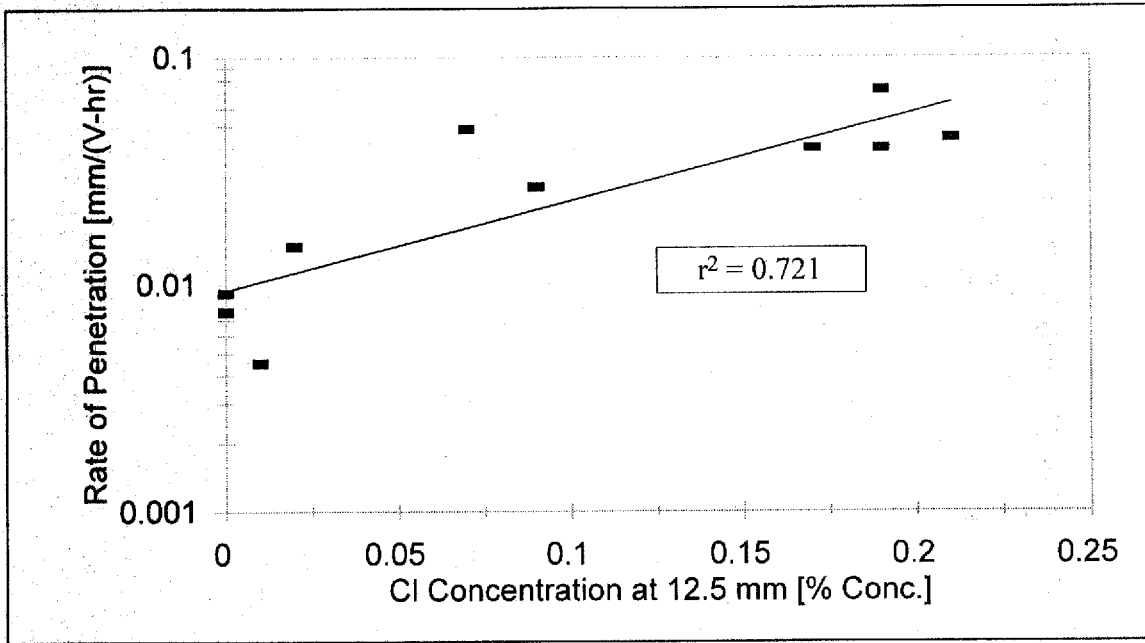


**Figure 110.** Phase 3 – Different Evaluation Procedures.

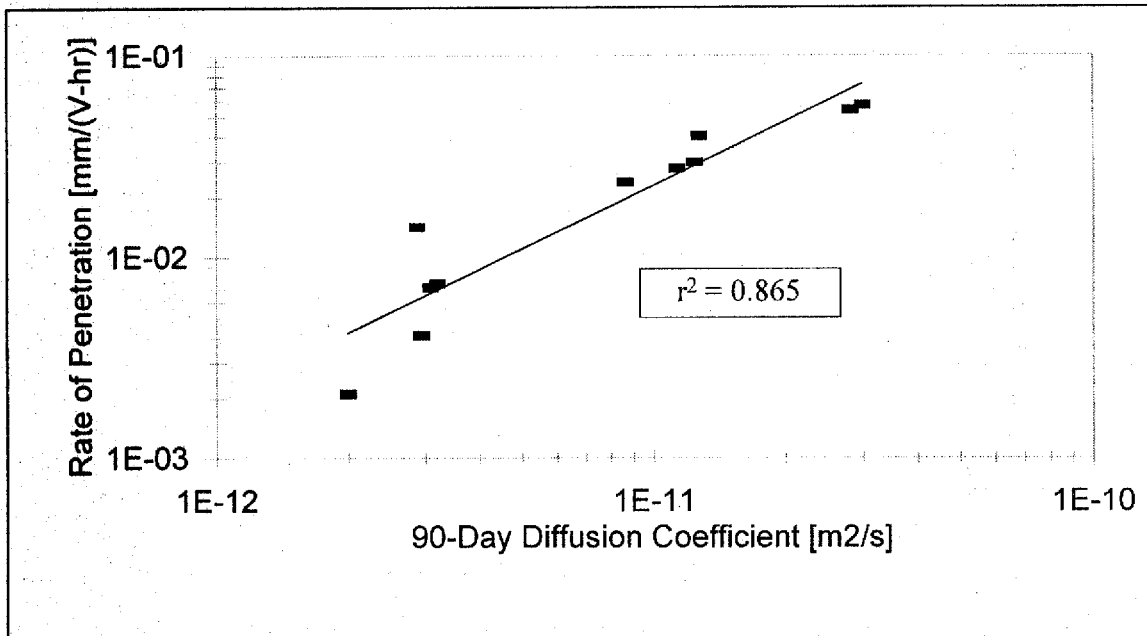


**Figure 111.** Phase 3 – Single-Point RMT Rate of Penetration vs. 90-Day Bulk Diffusion.

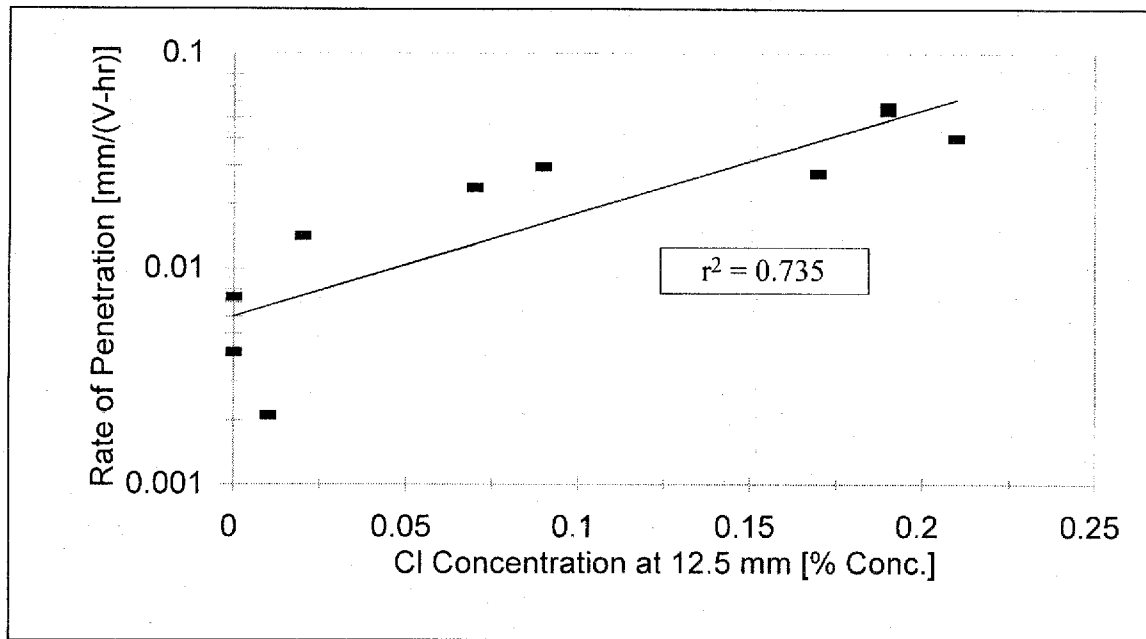




**Figure 112.** Phase 3 – Single-Point RMT Rate of Penetration vs. Salt Ponding Evaluation.



**Figure 113.** Phase 3 – Three-Point RMT Rate of Penetration vs. 90-day Bulk Diffusion.



**Figure 114.** Phase 3 – Three-Point RMT Rate of Penetration vs. Salt Ponding Evaluation.

### 7.2.2 Re-Evaluation of Interlaboratory Evaluation Data

To determine the effect of altering the test procedure on the interlaboratory variability of the test, the data for the interlaboratory evaluation were reanalyzed. As was done to reanalyze the Phase 3 data, the rate of penetration was recalculated from the middle voltage-time combination. The results from the four participating laboratories are shown in Table 24 as well as Appendix 8, together with the statistical results. This results in a reduction of the between-lab coefficient of variation from 15.9 percent to 11.1 percent for the first set of concrete and from 16.1 percent to 5.9 percent for the second set of concrete cylinders. These results also highlight the fact that evaluating the results with a single point tends to increase the rate of penetration results because there is nothing to account for the slight initial penetration due to sorption effects, i.e., the intercept is assumed to be zero for the single-point evaluation instead of the slight positive number that is typical for the three-point evaluation.

### 7.2.3 Modified Testing Protocol

To address the concerns about the test durations and the difficulty in scheduling of testing durations for different quality concretes, the test duration was standardized at 18 hours, to enable a one-day turnaround. One concrete could be started one day, finished the next day, and a different test could be started that same day. It was not possible to use a single category to evaluate all concrete, but the number of categories was kept to a minimum. The test evaluation categories are contained in Table 25. These were selected to avoid full depth of penetration of the chlorides, but at the same time minimizing the number of categories that are required, based on the initial current. It is recommended that concrete exhibiting an initial current of greater than 800 mA at a 60 V

potential not be tested under this procedure as breakthrough is likely to occur, causing corrosion of the anode. This concrete is much worse than any quality where testing would be an issue, and much lower quality than any concrete that was tested in this project, where the highest initial current under 30 V was 110 mA, or 220 mA under 60 V.

**Table 24.** Interlaboratory Evaluation Results.

	Concrete Mix #1		Concrete Mix # 2	
	Three-Point Evaluation	Single-Point Evaluation	Three-Point Evaluation	Single-Point Evaluation
FHWA	0.0331	0.0442	0.0057	0.00650
VTRC	0.0238	0.0329	0.00417	0.00675
MTO	0.0296	0.0420	0.0065	0.00675
UofT	0.0372	0.0433	0.00631	0.00758
Average	0.0309	0.0406	0.00567	0.00690
Standard Deviation	0.0049	0.0045	0.000915	0.000408
COV	15.9 %	11.1 %	16.1 %	5.9 %

One point should be made, that though there are three different test conditions, most high-performance concrete (HPC) will be tested under the first test condition, 60 V for 18 hours, as long as it does not contain corrosion inhibitor. As an example, of the 10 concretes tested in Phase 3, 7 would have been tested in the first testing condition, the exceptions being 0.55, plain, 0.45, plain and 0.40, plain. Of these three concretes, only one, 0.40, plain, would have qualified as at least Category 1 HPC according to Goodspeed et al. (1996). Thus, most high-performance concrete, not containing corrosion inhibitor, will be tested under identical conditions. The other categories will mostly be used for lower-quality concrete.

Since not all concrete is tested under the same condition, the depth of penetration alone cannot be used to evaluate the concrete. The concrete must be evaluated by taking the average depth of penetration, as before, and dividing by the voltage and test duration to determine an average rate of penetration. This value is then used to rate the concrete for its chloride penetration resistance. While this technique does lose some of the accuracy of the three-point evaluation technique (i.e., it assumes an intercept of zero), this loss of accuracy is not significant, as shown in Section 7.2.1, and is worth sacrificing for the improved practicality.

**Table 25.** Rapid Migration Test Conditions.

Initial Current at 60 V [mA]	Applied Voltage [V]	Test Duration [hours]
<120	60	18
120-240	30	18
240-800	10	18
>800	Do Not Test	Do Not Test

### **7.3 Comparison With NTBuild 492**

This general testing procedure was originally developed in Sweden by Tang and Nilsson (1991). This has been standardized under NordTest, the Nordic standardization organization, as test NTBuild 492. A comparison of these two procedures is presented.

The NTBuild procedure uses the theory to calculate diffusion coefficients from the depth of penetration, the voltage, and the test duration. This is what is used to rate the concrete. It is thought that this is not the correct way to approach this, as the theory developed does not match the profiles that were obtained. This is discussed in Phase 1. Thus, the rate of penetration is thought to be a more appropriate evaluation criterion.

The NTBuild procedure uses different voltage-time test conditions based on the initial current. These conditions are different than the ones proposed here. A direct comparison is presented as Table 26. The procedure proposed here has fewer categories (4 versus 12). This simplifies the test procedure, especially since most high quality concrete will fall into the first category. The ability to discriminate between the highest quality concretes may be reduced due to the reduction in categories but this is likely not critical for quality control purposes.

In addition, the testing condition chart proposed by NTBuild 492 makes it possible that the test may take as long as 4 days, or as little as 6 hours. While most tests will be conducted for 24 hours, the possibility that it will be longer is enough to make scheduling difficult.

Finally, the predicted depths of penetration, based on the work done here, are shown in Table 26. The NTBuild 492 procedure appears to result in situations where chloride breakthrough would occur. This is obviously undesirable.

### **7.4 Rating Criteria**

In addition, a system of rating criteria was developed in order to include this test in the quality system developed by Goodspeed et al. (1996). A plot was constructed of all the rates of penetration determined by the Rapid Migration Test in both Phase 2 and Phase 3 and the AASHTO T277 values. Then the AASHTO T277 values proposed by Goodspeed et al. (1996) were converted to RMT rates of penetration. This plot is shown in Figure 115. This conversion results in performance criteria contained in Table 27. Although Goodspeed et al. (1996) recommended that the testing be conducted at 56 days of age, we recommend that the Rapid Migration Test be conducted at 28 days to fit within the parameters of the contract. The categories were developed assuming this to be the case.

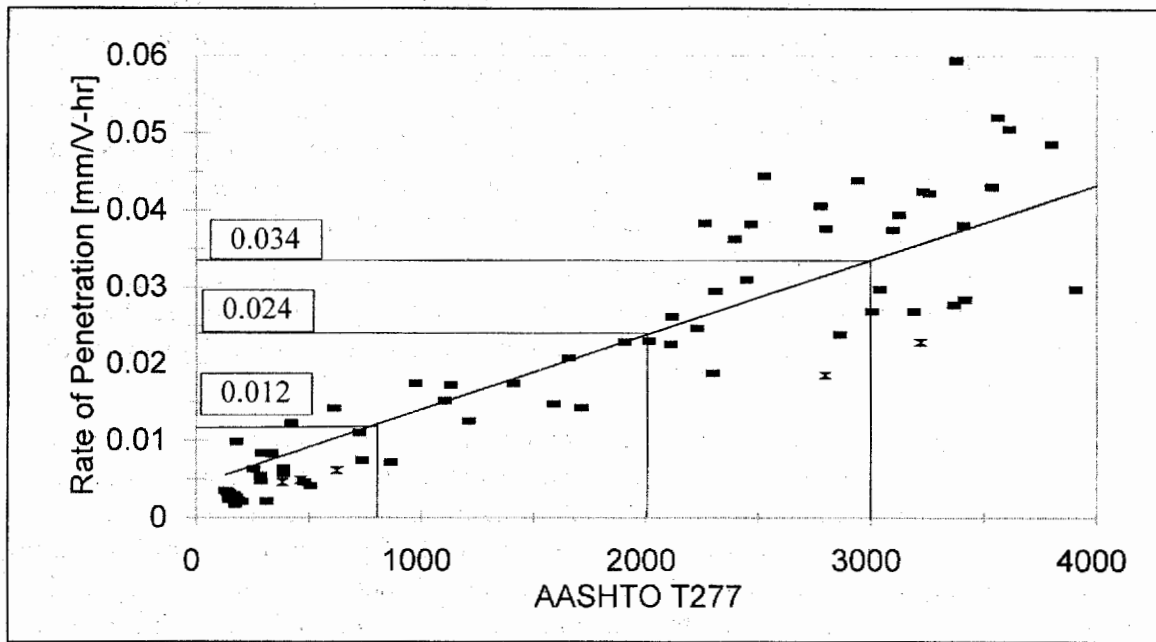
**Table 26.** Comparison of Different Rapid Migration Test Conditions.

Initial Current @ 30 V [mA]	Initial Current @ 60 V [mA]	This Work				NTBuild 492			
		Voltage [V]	Time [hr]	Expected Penetration	V*t [V-hr]	Voltage [V]	Time [hr]	Expected Penetration	V*t [V-hr]
< 5	<10	60	18	< 40 mm	1080	60	96	<23 mm	5760
5-10	10-20					60	48	12-20 mm	2880
10-15	20-30					60	24	10-15 mm	1440
15-20	30-40					50	24	12-16 mm	1200
20-30	40-60					40	24	12-18 mm	960
30-40	60-80					35	24	15-21 mm	840
40-60	80-120					30	24	18-27 mm	720
60-90	120-180	30	18	20-40 mm	540	25	24	22-33 mm	600
90-120	180-240					20	24	26-35 mm	480
120-240	240-480	10	18	13-40 mm	180	15	24	26-54 mm	360
240-400	480-800					10	24	36-77 mm	240
400-600	800-1200					No Test	No Test	No Test	No Test
>600	>1200	No Test	No Test	No Test	No Test	10	6	>19 mm	60

**Table 27.** FHWA HPC Performance Grade Chloride Penetration Criteria.

Standard Test Method	FHWA HPC Performance Grade			
	1	2	3	4
AASHTO T277* (x = coulombs)	$3000 \geq x > 2000$	$2000 \geq x > 800$	$800 \geq x$	
RMT (x = rate of penetration)	$0.034 \geq x > 0.024$	$0.024 \geq x > 0.012$	$0.012 \geq x$	

\*From Goodspeed et al., 1996



**Figure 115.** RMT Rate of Penetration vs. AASHTO T277 – Phase 2 & 3.

## 8 Conclusions

This work details the results of Contract DTFH61-97-R-00022 "Prediction of Chloride Penetration into Concrete," which was executed at the University of Toronto during the period September 1997 to June 2000. A variety of test procedures were examined, and the conclusions that can be drawn are presented here.

### 8.1 Long-Term Test Procedures

Two long-term test procedures were used throughout this project as a reference against which the other tests were evaluated. These test procedures were the AASHTO T259 – the 90-Day Salt Ponding Test and the NTBuild 443 – Bulk Diffusion Test. Both tests were conducted for different durations, principally 90 days and 365 days.

To determine the chloride profile in the concrete, approximately 0.5-mm-thick layers were evaluated, instead of the thicker layers recommended by the AASHTO T259 standard. These thinner layers are superior because they provide more information about the shape of the chloride profile and allow evaluation after a shorter time frame. It is recommended that these procedures be adopted for use in evaluating similar tests. They may be more expensive and time-consuming than the method of removing large slices, but it is thought that the additional information provided is worth the expense, especially given the amount of work that has already been put in to acquiring the sample.

The bulk diffusion test is believed to be a superior method of evaluating concrete for long-term performance in relation to chloride penetration. This is because the testing conditions as set up are simpler to describe theoretically and lend themselves to better interpretation.

A variety of different test evaluation procedures were used in conjunction with the AASHTO T259 test because the recommendations in the test procedure were deemed inadequate. The testing conditions for the salt ponding test are difficult to describe theoretically and do not necessarily match those that occur in practice. Four different test evaluation procedures were used with varying degrees of success. First, an integrated chloride value was calculated, but this did not have any relation to the bulk diffusion test. A pseudo-diffusion coefficient was then fit to the profile. This correlated fairly well with the bulk diffusion test, but has the disadvantage of assuming an improper relationship. Determining the depth of a specific concentration was also successful in predicting the diffusion coefficient, but a lot of work is required to determine the single number as the depth is unknown at the start and thus the entire specimen must be profiled. The chloride concentration at a specific depth was also used, due to its greater simplicity in determination. This has the drawback that for high-quality concrete, the chloride may not penetrate to the reference depth. This may result in a test value of zero for a wide range of concrete quality. The preferred evaluation procedure will depend upon the application of interest.

With the equipment available for use in this project, a test duration of 90 days was sufficient to achieve a measurable chloride profile for all the concrete tested. If, however, a coarser evaluation procedure is the only one available (i.e. not able to remove for analysis half-millimeter layers), a longer test duration may be required.

## **8.2 AASHTO T277 – Rapid Chloride Permeability Tests**

The current standard for rapid testing of concrete for chloride penetration resistance is AASHTO T277 or ASTM C1202, commonly called the rapid chloride permeability test. The perceived deficiencies of this test procedure were the motivation for this contract. This test was conducted on all the concretes in this contract in order to provide a basis for comparison of the efficacy of the proposed tests. In general, the rapid chloride test did provide a good measure of the chloride penetration resistance for most of the concretes tested, with fairly high correlation to the reference tests. However, it did meet with some limitations in regards to range of applicability. In Phase 2, there were certain subsets for which it provided a false measure of the chloride penetration resistance. In addition, during the interlaboratory evaluation, the standard AASHTO T277 procedure proved to have a greater coefficient of variation than the other test investigated.

In an attempt to rectify some of the drawbacks with the rapid chloride test but to maintain the existing equipment and procedure as much as possible, an alternative evaluation procedure was investigated. Some of the difficulties with the traditional rapid chloride test relate to the temperature rise that is experienced by lower quality concrete during the latter part of the 6-hour testing time. To avoid this, an earlier reading of the charged passed was used to evaluate the concrete. Thirty minutes was chosen because at least one variety of commercial device already provides such data. This procedure was slightly more successful than the traditional rapid chloride technique in predicting the chloride penetration resistance of the concrete tested, and it exhibited a much lower variability. However, it does not serve to reduce some of the other factors that cause the measurement to be in error.

## **8.3 Monfore Conductivity Test**

The conductivity test, based on the conductivity procedure first developed by Monfore (1968), was one of the tests investigated as a replacement for the rapid chloride test. It was as successful as the rapid chloride permeability test in predicting the chloride penetration resistance of concrete. However, it did not provide an improvement in the ability of the test to predict the chloride penetration resistance in those situations where the rapid chloride test was unsuccessful. Thus this test was not subjected to an interlaboratory evaluation. This test procedure does not provide any advantages over the AASHTO T277 test with regard to accuracy of results or range of applicability. It does, however, provide some advantages in speed of test and simplicity of test procedures.

## **8.4 Pressure Penetration Test**

The pressure penetration test was evaluated as an attempt to develop a test that would not be subjected to problems induced by electrically assisted measurement for certain subsets of concretes. However, it was not successful. The test proved cumbersome and difficult to perform accurately. In addition, the use of a reasonable driving pressure combined with the time constraints imposed by the objectives of the contract did not result in sufficient penetration on which to base evaluation criteria. If a different pressure application technique is considered or the time frame is changed, then this test may need to be re-evaluated.



## 8.5 The CTH/RMT Test

A few alternative testing conditions were used in this study within the basic testing framework proposed by Tang (1998). All of the testing procedures were successful in predicting the chloride penetration resistance of the concretes tested. The only sample condition of those tested that was not predicted successfully was when the sample contained embedded steel bars. If the chloride penetration front reaches steel in the concrete sample, the chlorides cease to penetrate further and instead reacts with the steel to cause corrosion. If the steel is deep enough and the concrete tested is of a high enough quality that the chlorides do not reach the steel, then the test result will be reasonable.

After evaluating a variety of different testing conditions for the Rapid Migration Test and taking into consideration the comments received from the participants in the interlaboratory evaluation, a modified testing procedure was decided upon. The duration of testing was fixed at 18 hours to maximize productivity. The test voltage is 60 V, 30 V, or 10 V, depending upon the initial current measured at 60 V. For most concrete of a quality that would be used in a situation where this test would be used, a voltage of 60 V would be applied. The rate of penetration in mm/(V-hr) is then determined and used to rate the concrete. Criteria for classifying the chloride resistivity of concrete were developed to match the grades developed by Goodspeed et al. (1996). The interlaboratory evaluation showed that the RMT resulted in a lower variation than that which was experienced using the RCPT.

Thus it is thought that the RMT is a promising rapid test for use in the prediction of the rate of chloride ion penetration into concrete. A test procedure and the necessary drawings for producing a test apparatus are included in Appendix 9.

Some questions still need to be investigated regarding the RMT. First, the apparent different relationship between the initial current and the rate of penetration between the concrete that was prepared at the University of Toronto and the concrete prepared at FHWA for the interlaboratory evaluation should be investigated. The mix designs were nominally identical but each was produced with local materials. In addition, the discrepancy between the actual profiles achieved and that which is predicted by the theory developed by Tang and Nilsson (1991) should be investigated. This may not be critical to applying the test procedure, but may aid in understanding the results.



## 9 References

- “Sampling and Testing for Chloride Ions in Concrete and Concrete Raw Materials,” 1980 (T260-80), American Association of State Highway and Transportation Officials, Washington, D.C., U.S.A.
- “Standard Method of Test for Resistance of Concrete to Chloride Ion Penetration,” 1980 (T259-80), American Association of State Highway and Transportation Officials, Washington, D.C., U.S.A.
- “Electrical Indication of Concrete’s Ability to Resist Chloride,” 1983, (T277-93), American Association of State Highway and Transportation Officials, Washington, D.C., U.S.A.
- “Standard Test Method for Electrical Indication of Chloride’s Ability to Resist Chloride,” 1994 (ASTM C1202-94), *1994 Annual Book of ASTM Standards V 04.02*, ASTM, Philadelphia, pp. 620-5.
- Boddy, A., 1998, “The Nordtest Draft CTH Method: A Review and Reproducibility Study,” University of Toronto, Term Project for CIV 1250S Course.
- DeSouza, S.J., Hooton, R.D., and Bickley, J.A., 1997, “Evaluation of Laboratory Drying Procedures Relevant to Field Conditions for Concrete Sorptivity Measurements,” *Cement, Concrete and Aggregates*, Vol. 19, No. 2, pp. 59-63.
- El-Dieb, A.S. and Hooton, R.D., 1994, “A High Pressure Triaxial Cell With Improved Measurement Sensitivity for Saturated Water Permeability of High Performance Concrete,” *Cement and Concrete Research*, Vol. 24, No. 5, pp. 854-62.
- Goodspeed, C.H., Vanikar, S., and Cook, R.A., 1996, “High Performance Concrete Defined for Highway Structures,” *ACI Concrete International*, Vol. 18, No. 2, pp. 62-67.
- Hall, C., 1989, “Water Sorptivity of Mortars and Concretes: A Review,” *Magazine of Concrete Research*, Vol. 41, No. 147, pp. 51-61.
- Hearn, N.H. and Mills, R.M., 1991, “A Simple Permeameter for Water and Gas Flow,” *Cement and Concrete Research*, Vol. 21, pp. 257-61.
- Hooton, R.D., Pun, P., Kojundic, T., and Fidjestol, P., 1997, “Influence of Silica Fume on Chloride Resistance of Concrete,” *Proceedings of the PCI/FHWA International Symposium on High Performance Concrete*, New Orleans, Louisiana, October 20-2, pp. 245-56.
- Hooton, R.D. and Wakeley, L.D., 1989, “Influence of Test Conditions on Water Permeability of Concrete in a Triaxial Cell,” *Materials Research Symposium Proceedings: Pore Structure and Permeability of Cementitious Materials*, Vol. 137, Boston, Mass.

- Lee, S.L., Wong, S.F., Swaddiwudhipong, S., Wee, T.H., and Loo, Y.H., 1996, "Accelerated Test of Ingress of Chloride Ions in Concrete Under Pressure and Concentration Gradients," *Magazine of Concrete Research*, Vol. 48, No. 174, pp. 15-25.
- McGrath, P.F. and Hooton, R.D., 1996, "Influence of Voltage on Chloride Diffusion Coefficients from Chloride Migration Tests," *Cement and Concrete Research*, Vol. 26, No. 8, pp. 1239-44.
- McGrath, P.F. and Hooton, R.D., 1999, "A Re-Evaluation of the AASHTO T259 - 90 Day Salt Ponding Test," *Cement and Concrete Research*, Vol. 29, pp. 1239-48.
- McGrath, P., 1996, *Development of Test Methods for Predicting Chloride Penetration into High Performance Concrete*, Ph.D. Thesis, Department of Civil Engineering, University of Toronto.
- Monfore, G.E., 1968, "The Electrical Resistivity of Concrete," *Journal of the PCA Research and Development Laboratories*, pp. 35-48, May.
- Morris, W., Moreno, E.I., and Sagues, A.A., 1996, "Practical Evaluation of Resistivity of Concrete in Test Cylinders using a Wenner Array Probe," *Cement and Concrete Research*, Vol. 26, No. 12, pp. 1779-87.
- NordTest Method for Accelerated Chloride Penetration Into Hardened Concrete, 1995, NTBuild 443.
- Parrott, L.J., 1990, "Influence of Environmental Parameters Upon Permeability: A Review," *Permeability of Concrete as Criterion of its Durability, Report of RILEM Technical Committee*, 116-PCD, RILEM, Paris.
- Sherman, M.R., McDonald, D.B., and Pfeifer, D.W., 1996, "Durability Aspects of Precast Prestressed Concrete Part 2: Chloride Permeability Study," *PCI Journal*, Vol. 41, No. 4, pp. 76-95.
- Streicher, P.E. and Alexander, M.G., 1995 "A Chloride Conduction Test for Concrete," *Cement and Concrete Research*, Vol. 25, No. 6, pp. 1284-94.
- Tang, L., 1998, "Chloride Migration Coefficient from Non-Steady State Migration Experiments," Nordtest Standard NTBuild 492.
- Tang, L., and Nilsson, L-O., 1991, "Rapid Determination of the Chloride Diffusivity in Concrete by Applying an Electrical Field," *ACI Materials Journal*, Vol. 89, No. 1 pp. 49-53.
- Thomas, M.D.A., Pantazopoulou, S.J., and Martin-Perez, B., "Service Life Modelling of Reinforced Concrete Structures Exposed to Chlorides-A Literature Review," Prepared for the Ministry of Transportation, Ontario, at the University of Toronto, 1995.
- Whiting, D., 1981, "Rapid Measurement of the Chloride Permeability of Concrete," *Public Roads*, Vol. 45, No. 3, pp. 101-12.

# **Appendix 1:**

## **Testing the Chloride Penetration Resistance of Concrete: A Literature Review**

By

K.D. Stanish, R.D. Hooton, and M.D.A. Thomas

Department of Civil Engineering

University of Toronto

Toronto, Ontario, Canada



## Table of Contents

<b>1.0 INTRODUCTION</b>	115
<b>2.0 OBJECTIVE AND SCOPE</b>	115
<b>3.0 THEORETICAL BACKGROUND</b>	115
3.1 Mechanisms of Chloride Ion Transport	115
3.2 Chloride Diffusion: A Brief Review of the Underlying Theory	116
3.3 Properties of the Concrete That Affect the Chloride Penetration Rate	117
<b>4.0 EXISTING TEST METHODS</b>	118
4.1 AASHTO T259: Standard Method of Test for Resistance of Concrete to Chloride Ion Penetration (Salt Ponding Test)	118
4.2 Bulk Diffusion Test (NordTest NTBuild 443)	119
4.3 AASHTO T277: Electrical Indication of Concrete's Ability to Resist Chloride Ion Penetration (Rapid Chloride Permeability Test)	120
4.4 Electrical Migration Techniques	122
4.5 The Rapid Migration Test (The CTH Test)	125
4.6 Resistivity Techniques	127
4.7 Pressure Penetration Techniques	130
4.8 Indirect Measurement Techniques	131
4.9 Sorptivity	132
4.10 Other Test Methods	135
4.11 Summary	135
<b>5.0 CONCLUSIONS</b>	137
<b>6.0 REFERENCES</b>	137
<b>APPENDIX: GLOSSARY OF TERMS RELATED TO CHLORIDE PENETRATION AND TESTING IN CONCRETE</b>	143





## **1.0 INTRODUCTION**

Reinforced concrete structures are exposed to harsh environments yet are often expected to last for long periods of time (often 100 years or more). Therefore, a durable structure needs to be produced. For reinforced concrete bridges, one of the major forms of environmental attack is chloride ingress, which leads to corrosion of the reinforcing steel and a subsequent reduction in the strength, serviceability, and aesthetics of the structure. This may necessitate early repair or premature replacement of the structure. A common method of preventing such deterioration is to prevent chlorides from penetrating the structure to the level of the reinforcing steel bar by using relatively impenetrable concrete. The ability of chloride ions to penetrate the concrete must then be known for design as well as quality control purposes. The penetration of the concrete by chloride ions, however, is a slow process. It cannot be determined directly in a time frame that would be useful as a quality control measure. To assess chloride penetration, a test method that accelerates the process is needed, to allow the determination of diffusion values in a reasonable time.

## **2.0 OBJECTIVES AND SCOPE**

This document presents a review of the current common methods for determining chloride penetrability of concrete. First, some theoretical background of what influences the penetration of chlorides into concrete is presented in Section 3. The different mechanisms of chloride penetration are discussed, followed by a further elaboration of the chloride diffusion theory. The influence of basic properties of concrete on its chloride penetrability is also presented. In Section 4, individual test procedures are presented. First, the existing long-term procedures are discussed, namely the salt ponding test (AASHTO T259) and the NordTest bulk diffusion test (NTBuild 443). The existing short-term tests are then presented. For each test, the procedure, the theoretical basis, and any advantages and disadvantages are presented.

Also included in this document, as an appendix, is a glossary of some of the common terms related to chloride ingress testing and measurement.

## **3.0 THEORETICAL BACKGROUND**

### **3.1 Mechanisms of Chloride Ion Transport**

Capillary absorption, hydrostatic pressure, and diffusion are the means by which chloride ions can penetrate concrete. The most familiar method is diffusion, the movement of chloride ions under a concentration gradient. For this to occur, the concrete must have a continuous liquid phase and there must be a chloride ion concentration gradient.

A second mechanism for chloride ingress is permeation, driven by pressure gradients. If there is an applied hydraulic head on one face of the concrete and chlorides

are present, they may permeate into the concrete. A situation where a hydraulic head is maintained on a highway structure is rare, however.

A more common transport method is absorption. As a concrete surface is exposed to the environment, it will undergo wetting and drying cycles. When water (possibly containing chlorides) encounters a dry surface, it will be drawn into the pore structure through capillary suction. Absorption is driven by moisture gradients. Typically, the depth of drying is small, however, and this transport mechanism will not, by itself, bring chlorides to the level of the reinforcing steel unless the concrete is of extremely poor quality and the reinforcing steel is shallow. It does serve to quickly bring chlorides to some depth in the concrete and reduce the distance they must diffuse to reach the rebar [Thomas et al., 1995].

Of the three transport mechanisms described above that can bring chlorides into the concrete to the level of the rebar, the principal method is that of diffusion. It is rare for a significant hydraulic head to be exerted on the structure, and the effect of absorption is typically limited to a shallow cover region. In the bulk of the concrete, the pores remain saturated and chloride ion movement is controlled by concentration gradients. A fuller review of the theory of diffusion is presented in the following paragraphs.

### 3.2 Chloride Diffusion: A Brief Review of the Underlying Theory

Chloride diffusion into concrete, like any diffusion process, is controlled by Fick's First Law, which, in the one-dimensional situation normally considered, states:

$$J = -D_{\text{eff}} \frac{dC}{dx} \quad (1)$$

where  $J$  is the flux of chloride ions,  $D_{\text{eff}}$  is the effective diffusion coefficient (see below),  $C$  is the concentration of chloride ions, and  $x$  is a position variable. In practical terms, this equation is only useful after steady-state conditions have been reached, i.e., there is no change in concentration with time. It can be used, however, to derive the relevant equation for non-steady conditions (when concentrations are changing), often referred to as Fick's Second Law:

$$\frac{\partial C}{\partial t} = D_{\text{eff}} \frac{\partial^2 C}{\partial x^2} \quad (2)$$

which includes the effect of changing concentration with time ( $t$ ). This has been solved using the boundary condition  $C_{(x=0, t>0)} = C_0$  (the surface concentration is constant at  $C_0$ ), the initial condition  $C_{(x>0, t=0)} = 0$  (the initial concentration in the concrete is 0), and the infinite point condition  $C_{(x=\infty, t>0)} = 0$  (far enough away from the surface, the concentration will always be 0). The solution is:

$$\frac{C(x,t)}{C_0} = 1 - \text{erf}\left(\frac{x}{\sqrt{4D_{\text{eff}}t}}\right) \quad (3)$$

where  $\text{erf}(y)$  is the error function, a mathematical construct found in math tables or as a function in common computer spreadsheets.

For concrete, there are some factors that interfere with simple interpretation of diffusion data. First of all, the chloride ions are not diffusing through a homogeneous solution. Concrete is a porous matrix that has both solid and liquid components. The diffusion through the solid portion of the matrix is negligible when compared with the rate of diffusion through the pore structure. The rate of diffusion is thus controlled not only by the diffusion coefficient through the pore solution but by the physical characteristics of the capillary pore structure. This effect is normally considered implicitly, however, and the effective diffusion coefficient of the chlorides into the concrete as a whole is considered, called here  $D_{\text{eff}}$ . Other influences are discussed below.

### **3.3 Properties of the Concrete That Affect the Chloride Penetration Rate**

The rate of ingress of chlorides into concrete depends on the pore structure of the concrete, which is affected by factors including materials, construction practices, and age.

The penetrability of concrete is obviously related to the pore structure of the cement paste matrix. This will be influenced by the water-cement ratio of the concrete, the inclusion of supplementary cementing materials that serve to subdivide the pore structure [McGrath, 1996], and the degree of hydration of the concrete. The older the concrete, the greater amount of hydration that has occurred and thus the more highly developed will be the pore structure. This is especially true for concrete containing slower reacting supplementary cementing materials such as fly ash that require a longer time to hydrate [Tang and Nilsson, 1992; Bamforth, 1995].

Another influence on the pore structure is the temperature that is experienced at the time of casting. High-temperature curing accelerates the curing process so that, at young concrete ages, a high-temperature cured concrete will be more mature and thus have a better resistance to chloride ion penetration than a normally cured, otherwise identical, concrete at the same age. However, at later ages, when the normally cured concrete has a chance to hydrate more fully, it will have a lower chloride ion diffusion coefficient than the high-temperature-cured concrete [Detwiler et al., 1991; Cao and Detwiler, 1995]. This has been attributed to the coarse initial structure that is developed in the high-temperature-cured concrete due to its initial rapid rate of hydration as well as the possible development of internal microcracking.

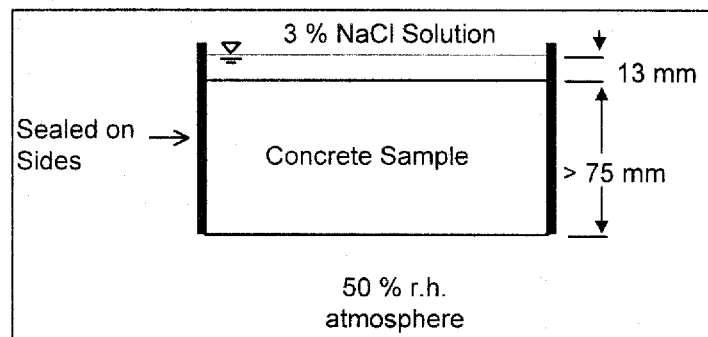
The rate of chloride penetration into concrete is affected by the chloride binding capacity of the concrete. Concrete is not inert relative to the chlorides in the pore solution. A portion of the chloride ions reacts with the concrete matrix, becoming either chemically or physically bound, and this binding reduces the rate of diffusion. However, if the diffusion coefficient is measured after steady-state conditions have been reached then all the binding can be presumed to have taken place and this effect will not then be observed. If a steady-state condition has not been reached, then not all the binding will have occurred and this will affect the results. This capacity is controlled by the cementing materials used in the concrete. The inclusion of supplementary cementing materials

affects binding, though the exact influence is unclear [Byfors, 1986; Rasheeduzafar et al., 1992; Sandberg and Larsson, 1993; Thomas et al., 1995]. Also, the  $C_3A$  content of the cement influences its binding capacity, with increased  $C_3A$  content leading to increased binding [Holden et al., 1983; Midgley and Illston, 1984; Hansson and Sorenson, 1990].

#### 4.0 EXISTING TEST METHODS

##### 4.1 AASHTO T259: Standard Method of Test for Resistance of Concrete to Chloride Ion Penetration (Salt Ponding Test)

The AASHTO T259 test (commonly referred to as the salt ponding test) is a long-term test for measuring the penetration of chloride into concrete. The test requires three slabs at least 75-mm thick and having a surface area of 300 mm square. These slabs are moist cured for 14 days, then stored in a drying room at 50 percent relative humidity (r.h.) for 28 days. The sides of the slabs are sealed but the bottom and top face are not. After the conditioning period, a 3 percent NaCl solution is ponded on the top surface for 90 days, while the bottom face is left exposed to the drying environment (see Figure 1). At the end of this time the slabs are removed from the drying environment and the chloride concentration of half-inch thick slices is then determined [AASHTO T259]. Typically, two or three slices are taken at progressive depths. There is difficulty, however, in determining what the results mean. Part of this is because of the complicated testing conditions, discussed in the following paragraph, but part is also because of the crudeness of the evaluation. Little information is being gathered about the chloride profile. Only the average chloride concentration in each half-inch slice is determined, not the actual variation of the chloride concentration over that half inch. A situation could be envisioned where there are two concretes with the same average chloride concentration in their outer half-inch slice. One, however, has an approximately uniform chloride concentration, while the other has a higher concentration near the surface and a lower concentration further in. Obviously, the first situation will result in a critical chloride concentration reached at some depth sooner than the second situation, yet this distinction would not be detected.



**Figure 1.** Salt Ponding Setup (AASHTO T259).

This test does provide a crude, one-dimensional chloride ingress profile but this profile is not just a function of chloride diffusion. Since the specimens have been left to dry for 28 days, there is an initial sorption effect when the slabs are first exposed to the solution. Salt solution is drawn quickly into the pores of the concrete. Also, the exposure of the bottom face to a 50 percent r.h. environment during the test causes chlorides to be drawn into the concrete through a mechanism other than pure diffusion. There is vapor transmission from the wet front in the concrete to the drier atmosphere at the external face. This causes more water to be drawn into the concrete, bringing the chlorides with it. This effect is called wicking.

While all these transport mechanisms may be present in a structure, the relative importance of each is not necessarily reflected by this test procedure. This test overemphasizes the importance of sorption and, to a lesser extent, wicking. The relative amount of chloride pulled into the concrete by capillary absorption to the amount entering by diffusion will be greater when the test is only 90 days than when compared with the relative quantities entering during the lifetime of a structure. Also, if wicking is occurring in the concrete element of interest, the relative humidity gradient will likely be less, at least for part of the time, than that which is set up during the test.

For some higher-quality concretes, there has also been difficulty in developing a sufficient chloride profile. Insufficient chloride may penetrate in the 90-day duration for a meaningful profile to develop. This has resulted in a need to extend this duration to allow the evaluation of higher quality concretes.

#### 4.2 Bulk Diffusion Test (NordTest NTBuild 443)

A bulk diffusion test has been developed to overcome some of the deficiencies of the salt ponding test to measure diffusion. Though not the first similar test developed, this NordTest standard is the first formally standardized version of the bulk diffusion test. The first difference in test procedure from the salt ponding test is the sample's initial moisture condition. Instead of being dried for 28 days as with the salt ponding test, the test specimen is saturated with limewater. This prevents any initial sorption effects when the chloride solution is introduced. Also, instead of coating just the sides of the sample and leaving one face exposed to air, the only face left uncovered is the one exposed to a 2.8 M NaCl solution (Figure 2). It is left this way for a minimum of 35 days before evaluation [NordTest, NTBuild 443-94].

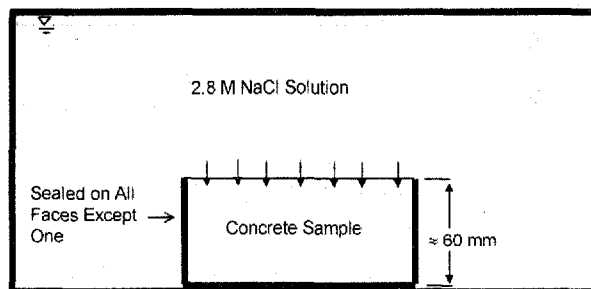


Figure 2. NordTest Setup.

To evaluate the sample, the chloride profile of the concrete is determined by mounting the sample in either a mill or lathe with a diamond-tipped bit. The sample is leveled so that the axis of advance of the bit is perpendicular to the surface of the sample. A pass is made at each depth to grind the concrete sample into dust, which is then collected. This is repeated at greater and greater depths, at depth increments on the order of 0.5 mm. The chloride content of the powder is then determined according to AASHTO T260. The error function solution of Fick's Second Law is then fit to the curve, and a diffusion value and surface chloride concentration is determined.

While this NordTest is capable of modeling chloride diffusion into concrete, it is still a long-term test. For low-quality concretes, the minimum exposure period is 35 days. For higher-quality concretes, however, this period must be extended to 90 days or longer, just as for the salt ponding test.

#### 4.3 AASHTO T277: Electrical Indication of Concrete's Ability to Resist Chloride Ion Penetration (Rapid Chloride Permeability Test)

In the AASHTO T277 (ASTM C1202) test, a water-saturated, 50-mm-thick, 100-mm-diameter concrete specimen is subjected to a 60 V applied DC voltage for 6 hours using the apparatus shown in Figure 3. In one reservoir is a 3.0 percent NaCl solution and in the other reservoir is a 0.3 M NaOH solution. The total charge passed is determined, and this is used to rate the concrete according to the criteria included as Table 1. This test was originally developed by Whiting (1981) and is commonly (though inaccurately) referred to as the Rapid Chloride Permeability Test (RCPT). This name is inaccurate as it is not the permeability that is being measured but ionic movement. In addition, the movement of all ions, not just chloride ions, affects the test results (the total charge passed).

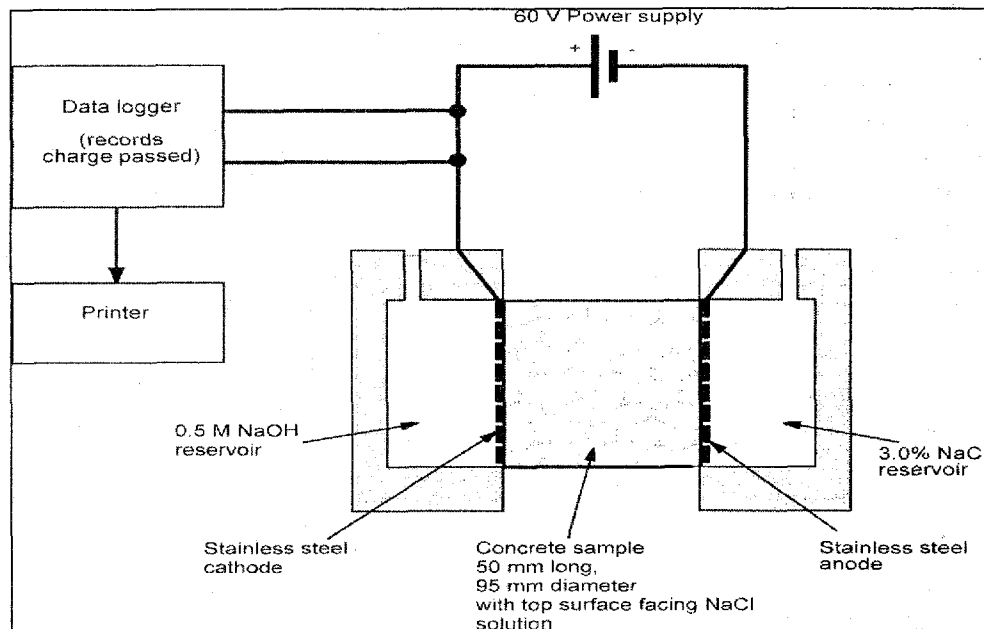


Figure 3. Rapid Chloride Permeability Test Setup.

**Table 1.** RCPT Ratings (per ASTM C1202).

Charge Passed (Coulombs)	Chloride Ion Penetrability
> 4,000	High
2,000-4,000	Moderate
1,000-2,000	Low
100-1,000	Very Low
< 100	Negligible

There have been a number of criticisms of this technique, though this test has been adopted as a standard test, is widely used in the literature [Saito and Ishimori, 1995; Goodspeed et al., 1995; Thomas and Jones, 1996; Samaha and Hover, 1992], and has been used to limit permeability in at least one standard [CSA/S413-94]. The main criticisms are: (i) the current passed is related to all ions in the pore solution, not just chloride ions; (ii) the measurements are made before steady-state migration is achieved; and (iii) the high voltage applied leads to an increase in temperature, especially for low-quality concretes, which further increases the charge passed [Andrade, 1993; Zhang and Gjorv, 1991; Malek and Roy, 1996; Roy, 1989; Geiker et al., 1990]. Lower-quality concretes heat more because the temperature rise is related to the product of the current and the voltage. The lower the quality of concrete, the greater the current at a given voltage and thus the greater heat energy produced. This leads to a further increase in the charge passed, over what would be experienced if the temperature remained constant. Thus, poor-quality concrete looks even worse than it would otherwise. These objections all lead to a loss of confidence in this technique for measuring chloride ion penetrability. In addition, they also lead to a loss of precision. The ASTM C1202 statement on precision, based on work by Mobasher and Mitchell (1988), states that the single operator coefficient of variation of a single test has been found to be 12.3 percent, and thus two properly conducted tests should vary by no more than 35 percent if done by one person. The between-laboratory measurement is naturally less precise and a single test result will have a coefficient of variation of 18.0 percent. To minimize this, three samples are generally tested and the average value reported. However, a precision statement is also given for this type of test and it is stated that the average of three samples should not differ by more than 29 percent between two separate laboratories [ASTM C1202].

Another difficulty with the RCPT test is that it depends on the conductivity of the concrete being in some way related to the chloride ion penetrability. Thus, any conducting material present in the sample will bias the results, causing them to be too high. This would be the case if any reinforcing steel is present, if conductive fibers are used (e.g., carbon or steel), or if a highly ionic conductive pore solution is present [ASTM C1202]. This pore solution effect may be noticed if calcium nitrite is included as a corrosion inhibiting admixture, and other admixtures may also have this effect [ASTM C1202]. These conductors all influence the results so that a higher coulomb value than would otherwise be recorded is determined. Thus, the method could still serve as a quality control test. It can qualify a mix, but not necessarily disqualify it [Ozyildirim,

1994]. If an acceptably low rating is achieved, it is known that the concrete is not worse than that, at least within the precision of the test method.

Despite these drawbacks and limitations, attempts have been made to correlate RCPT values with diffusion coefficients from other tests [Thomas and Jones, 1996; Berke and Hicks, 1992].

#### 4.4 Electrical Migration Techniques

Often, the movement of chlorides is accelerated through the use of an electrical field that is of a lower intensity than that used in the RCPT. The data can also be collected differently to better evaluate the actual movement of chloride ions (as opposed to simply measuring the charge passed).

The movement of ions in a solution under an electrical field is governed by the Nernst-Planck equation [Andrade, 1993]:

$$-J_i = D_i \frac{\partial C_i(x)}{\partial x} + \frac{z_i F}{RT} DC_i \frac{\partial E(x)}{\partial x} + C_i v_i(x) \quad (4)$$

where  $J_i$  is the flux of the ionic species  $i$ ,  $D_i$  is the diffusion coefficient of the ionic species  $i$ ,  $C_i(x)$  is the concentration of ionic species  $i$  as a function of location  $x$ ,  $z_i$  is the valence of ionic species  $i$ ,  $F$  is Faraday's constant,  $R$  is the universal gas constant,  $T$  is the temperature,  $E(x)$  is the applied electrical potential as a function of  $x$ , and  $v_i(x)$  is the convection velocity of  $i$ . Conceptually, this can be broken down to [Andrade, 1993]:

$$\text{Flux} = \text{pure diffusion} + \text{electrical migration} + \text{convection} \quad (5)$$

Now, considering the situation where there is no convection (i.e., no pressure or moisture gradients) and assuming that the pure diffusion portion is negligible compared with the effect of electrical migration, which is reasonable for a sufficiently strong applied voltage (at least 10 to 15 V) [Andrade, 1993], Equation 4 becomes:

$$J = \frac{z_i F D C_i}{RT} \frac{\partial E(x)}{\partial x} \quad (6)$$

This allows the solution for  $D$  once the chloride ion flux is determined if it is also assumed that the voltage drop across the cell is linear. Also, it must be assumed that the chloride concentration is constant in the upstream cell, that steady-state conditions have been reached, and that heating of the solution and concrete is negligible [Andrade, 1993].

Another method of determining  $D$  is to apply the Nernst-Einstein equation [Lu, 1997]. The Nernst-Einstein equation states:

$$D_i = \frac{RT \sigma_i}{z_i^2 F^2 C_i} \quad (7)$$



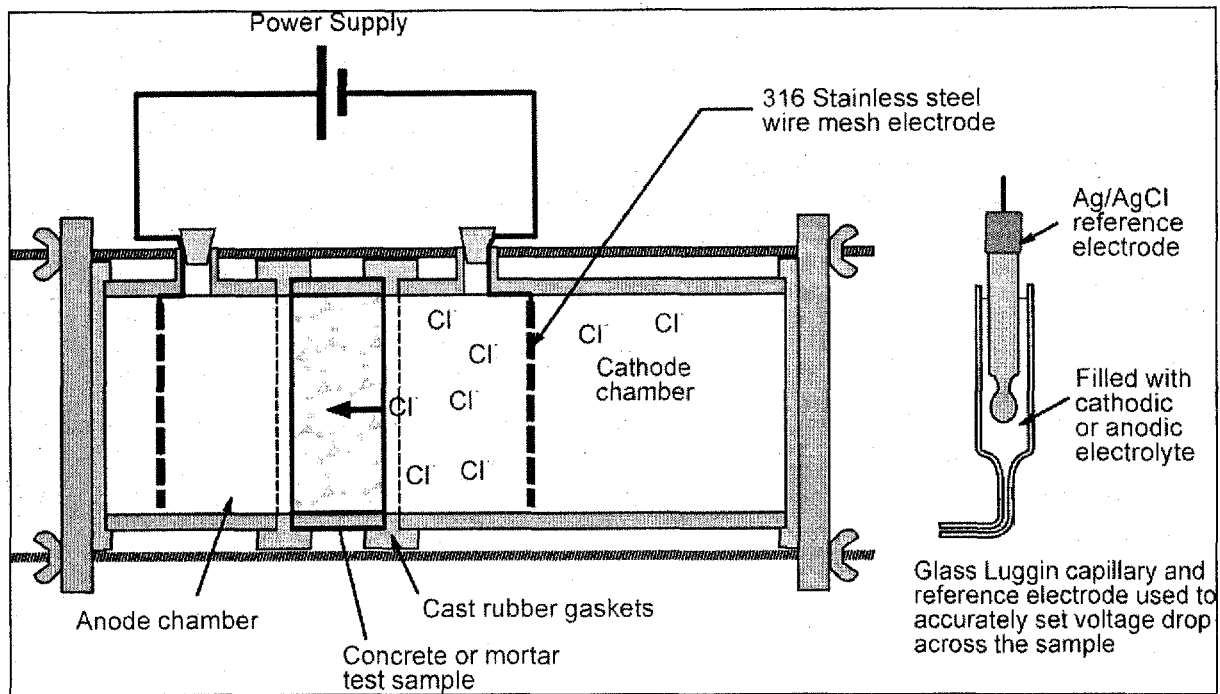
where  $\sigma_i$  is the specific conductivity, and everything else is as before. Once the specific conductivity is known, then the diffusion coefficient can be determined. To determine  $\sigma_i$ , know that:

$$\sigma_i = t_i \sigma \quad (8)$$

where  $\sigma$  is the total conductivity and:

$$t_i = \frac{Q_i}{Q} = \frac{I_i}{I} \quad (9)$$

where  $t_i$  is called the transfer number and relates the electric quantity ( $Q$ ) or current ( $I$ ) carried by species  $i$  to the total electric quantity or current. It has been suggested to take the value of  $t$  as 1 as a simple and proper approach, though it is admitted that this is not correct [Lu, 1997].



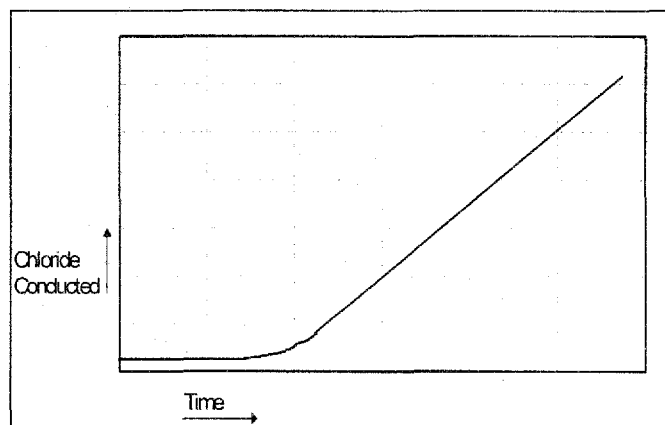
**Figure 4.** Typical Chloride Migration Cell.

Electrical migration tests are performed in a two-chamber cell with the concrete sample as the division between the two chambers (see Figure 4). The concrete sample can be of any size, but is usually a disk of 100 mm diameter and length about 15 to 50 mm. The thickness of the disk will affect the duration of the test, but a sufficient size is required to avoid aggregate interface influences. If the size of the aggregate is comparable to the thickness of the specimen, then there may exist a weak transition zone around the aggregate that extends most of the way through the sample. This will provide

a faster path for the movement of chloride ions than would exist in the bulk concrete. To avoid this, the thickness of the sample must be larger than the maximum aggregate size [Hooton and Wakeley, 1989]. Initially, the cathode chamber contains chlorides, but the anode chamber is chloride-free. The host solution varies, but is typically either distilled water or limewater. A voltage is then applied to drive the chlorides through the concrete while the chloride concentration of the downstream (anode chamber) solution is monitored, typically by periodically removing small aliquots and determining the chloride concentration of these samples. The change of chloride concentration with time allows the calculation of diffusion coefficients.

The most obvious and important difference that may arise between different testing methods is the voltage that is applied. This directly affects the time required to perform the test. A voltage low enough to avoid heating of the sample while high enough to ensure a sufficiently short test duration is required. While a wide variety of voltages are reported in the literature, they commonly are in the 10 to 12 V range [Streicher and Alexander, 1995; Zhang and Gjorv, 1991; Andrade and Sanjuan, 1994; Delagrave et al., 1996; Detwiler et al., 1991; Jacobsen et al., 1996; McGrath and Hooton, 1996]. While this voltage range avoids the problem of heating the sample, it generally results in long test durations, unless an unacceptably thin sample is used, on the order of 5 mm.

It may not be necessary to use such a low voltage to avoid the problem of heating, however. A study was conducted by El-Belbol and Buenfeld (1989) where the temperature rise was monitored for a variety of voltages in an apparatus similar to that currently used for the RCPT. They found that, for a 0.5 w/cm mortar, while there was a temperature rise of 18°C for a voltage of 60 V, there was what they called a negligible rise if the applied voltage was 40 V. Their test lasted approximately 4 days at this voltage for their concrete. Other problems that may be encountered with high voltage (excessive gas production, rapid degradation of the electrodes) were not discussed.



**Figure 5.** Typical Migration Plot.

The other drawbacks of the AASHTO T277 test previously discussed can be dealt with in an electrical migration cell, not by modifying the testing apparatus or conditions relative to the RCPT, but by altering how the test is evaluated. The chloride ion concentration of the downstream solution must be periodically monitored to ensure that only the movement of chloride ions will be used to evaluate the diffusion coefficient,  $D$ . The downstream chloride ion concentrations are then plotted as a function of time, yielding a plot such as the one shown in Figure 5. As illustrated in Figure 5, there is usually some small initial concentration of chlorides, attributable to background chlorides present in the concrete. This concentration will not change, however, until a certain time has passed, called the breakthrough time. At breakthrough, chlorides from the upstream solution have reached the downstream solution, and steady-state conditions have been achieved. The chloride concentration information can be used in a variety of ways to evaluate diffusion coefficients. First, as steady-state conditions have been achieved, the change in concentration of the chlorides in the downstream cell is equivalent to the chloride flux,  $J$ , and is constant. It is then simple to apply the Nernst-Planck equation (equation 4). This is the most common technique to determine diffusion coefficients in migration experiments [Detwiler et al. 1991; McGrath and Hooton, 1996; Dhir et al., 1990; Andrade, 1993; Zhang and Gjørsv, 1994].

Another technique is to consider non-steady-state diffusion. This is not used as often because it involves solely the time to breakthrough, which can be difficult to determine. Sometimes it is considered when the chloride conducted into the downstream cell reaches a certain level, say 25 mg, and sometimes it is the point of intersection of the initial constant portion of the curve and the linear portion of the constant flux or steady-state portion of the curve. These values can differ, which can influence the diffusion coefficients calculated [McGrath, 1996]. There is also greater numerical complexity in calculating diffusion coefficients in this manner. It has been used successfully by some researchers, however [Tang and Nilsson, 1991; Hooton and McGrath, 1995; Halamickova et al., 1995].

While capable of addressing the criticisms of the RCPT about temperature rise and ability to consider what is occurring in the migration of chlorides, there is still a significant drawback to the use of an electrical migration type test. Inclusion of conductive materials, e.g., metal or carbon, will short-circuit the cell, with the current being carried by the conductor rather than the ions in pore solution. In the case of an electrolyte, i.e., calcium nitrite, instead of the current being carried by the chloride ions, the current will be carried by the more highly ionically mobile nitrite ions. Thus, the chloride ions would effectively experience a lower potential gradient, reducing the distance they would travel in a given time. This effect may be minor in the concentrations of nitrite ions found in practice.

#### **4.5 The Rapid Migration Test (CTH Test)**

Tang and Nilsson [1991] proposed a variation on the conventional migration cell unique enough to be mentioned separately. A migration cell is set up with a specimen 50-mm thick and 100 mm in diameter, and an applied voltage of 30 V, as shown in Figure 6. The experiment proceeds as usual for an electrical migration test, but the chloride concentration of the downstream solution is not monitored. Instead, after a specified

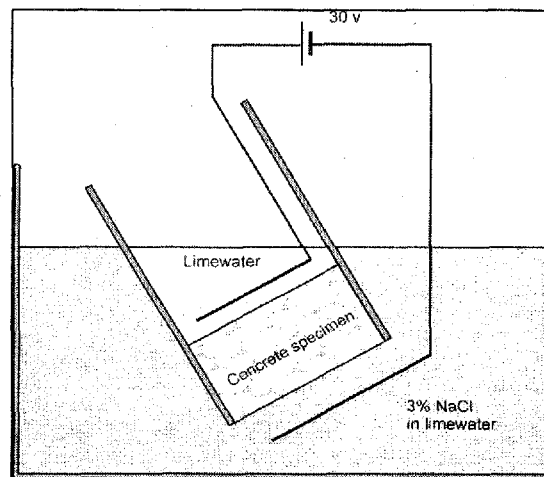
duration (Tang and Nilsson used 8 hr) the samples are removed and split, and the depth of chloride penetration is determined in one half of the specimen using a colorimetric technique in which a silver nitrate solution is used as a colorimetric indicator. When a silver nitrate solution is sprayed on a concrete containing chloride ions, a chemical reaction occurs. The chlorides bind with the silver to produce silver chloride, a whitish substance. In the absence of chlorides, the silver instead bonds with the hydroxides present in the concrete, creating a brownish color. This method was first investigated by Collepardi et al. (1970). Work done by Otsuki et al. (1992) to determine the optimum concentration of silver nitrate solution to be used indicates that a 0.1 N solution is suitable and that the color change border corresponds to the location of a soluble chloride concentration of 0.15 percent by weight of cement.

The work done by Otsuki et al. [1992] examined the total chloride content as well as the soluble chloride percentage and found that this varied depending on whether the chlorides came from an external source or were present at initial mixing, the w/c ratio of the concrete, and whether a concrete, mortar, or paste were used. The soluble chloride percentages were found to remain constant.

This depth of penetration can be used to determine a chloride ion diffusion coefficient. The equation used, developed from the Nernst-Einstein equation, is [Tang and Nilsson, 1991]:

$$D = \frac{RT}{zFE} * \frac{x_f}{t} \quad (10)$$

where  $x_f$  is the inflection point of the chloride ion profiles that needs to be related to the depth given by the colorimetric technique. The depth of penetration itself may also be a useful parameter.



**Figure 6.** Tang and Nilsson Migration Cell.

Similar to the more usual migration cell, the CTH test is capable of addressing the criticisms of the RCPT related to examination of actual chloride ion movement and temperature rise. However, as in the case of a typical migration cell, inclusion of conductive materials, e.g., metal or carbon, could short-circuit the cell with the current being carried by the conductor rather than the ions in pore solution. If the conductor does not short-circuit the cell (i.e., a piece of steel is placed crossways), there is the possibility of it reacting with the chloride ions and affecting ion movement in that manner. However, if the chloride ions do not penetrate to the depth of the steel, this would not be a problem. Also, if a conductive ionic species, i.e., calcium nitrite, is present, instead of the current being carried by the chloride ions, the current will be carried by the more highly ionically mobile nitrite ions. The chloride ions would effectively experience a lower potential gradient, reducing the distance they would travel. This effect may be minor in the concentrations of nitrite ions found in practice.

#### 4.6 Resistivity Techniques

Resistivity techniques are another method of assessing the ability of chlorides to penetrate concrete. Resistivity is the electrical resistance of a substance, normalized to a unit cross-section and length, and conductivity is the inverse of resistivity. The conductivity of a saturated porous medium is primarily determined by the conductivity of the pore solution [Kyi and Batchelor, 1994; Streicher and Alexander, 1995]. A number called the Formation Factor (FF) can then be constructed, which is:

$$FF = \sigma / \sigma_0 \quad (11)$$

where  $\sigma$  is the conductivity of the porous material and  $\sigma_0$  is the conductivity of the pore solution. Now, both the conductivity and the diffusivity in a porous medium are related to the same factors: the tortuosity, constrictivity, pore size, and connectivity. Thus, it can also be stated that:

$$FF = D / D_0 \quad (12)$$

where  $D$  is the diffusivity of the porous medium (the factor of interest) and  $D_0$  is the diffusivity of chloride in the pore solution. This final value can be determined from physical and chemical tables of constants [Streicher and Alexander, 1995].

There are two main types of tests that can be done to determine a resistivity value, involving either direct current (DC) or alternating current (AC) [Monfore, 1968]. Alternating current resistivity is measured by placing a test specimen between two electrodes and applying an alternating voltage between them and monitoring the current to determine a resistance value. Direct current resistivity can be measured by applying a voltage between two electrodes with the concrete sandwiched between them, as shown in Figure 7. However, because concrete conducts electricity as an electrolyte, polarization develops. This causes the actual voltage-causing current to be reduced by an unknown amount. Assuming that this polarization effect is constant at different applied voltages, this effect can be accounted for by taking current measurements at two voltages. The determination of DC resistance is thus from the equation [Monfore, 1968]:

$$R = \frac{E_{a1}I_2 - E_{a2}I_1}{I_1 - I_2} \quad (13)$$

where  $R$  is the resistance,  $E_{a1}$  and  $E_{a2}$  are the two applied voltages, and  $I_1$  and  $I_2$  are the relevant currents. This can be then converted to a resistivity using the equation:

$$\rho = R \frac{A}{L} \quad (14)$$

where  $\rho$  is the resistivity,  $A$  is the cross-sectional area, and  $L$  is the length of the specimen.

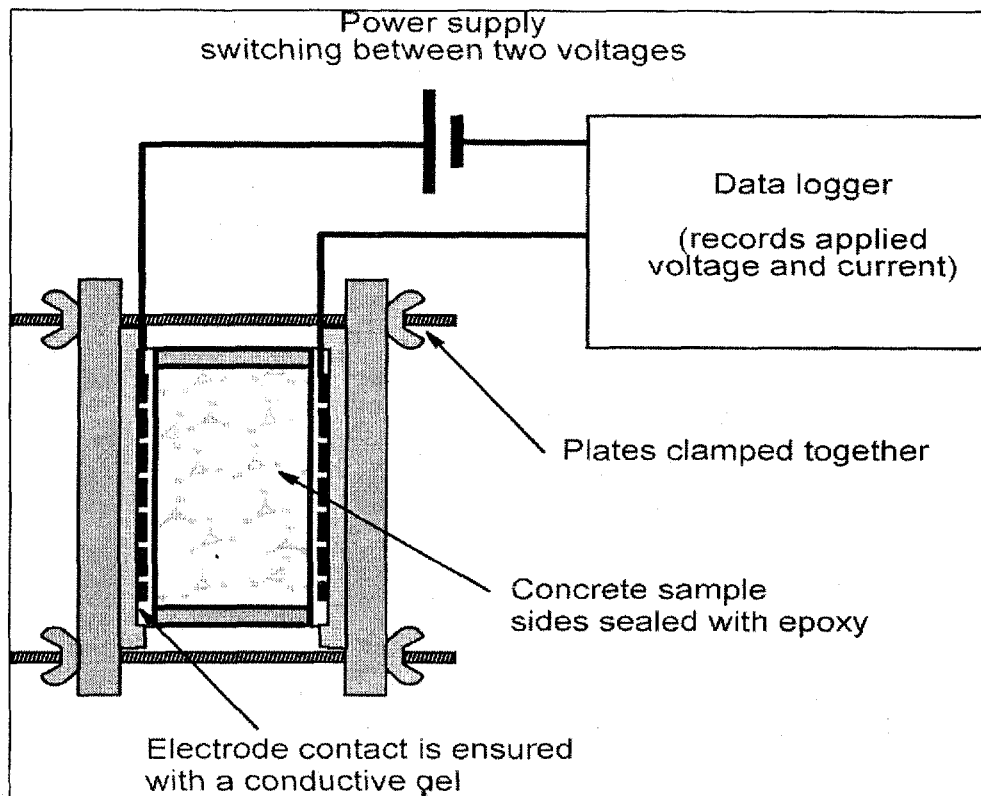
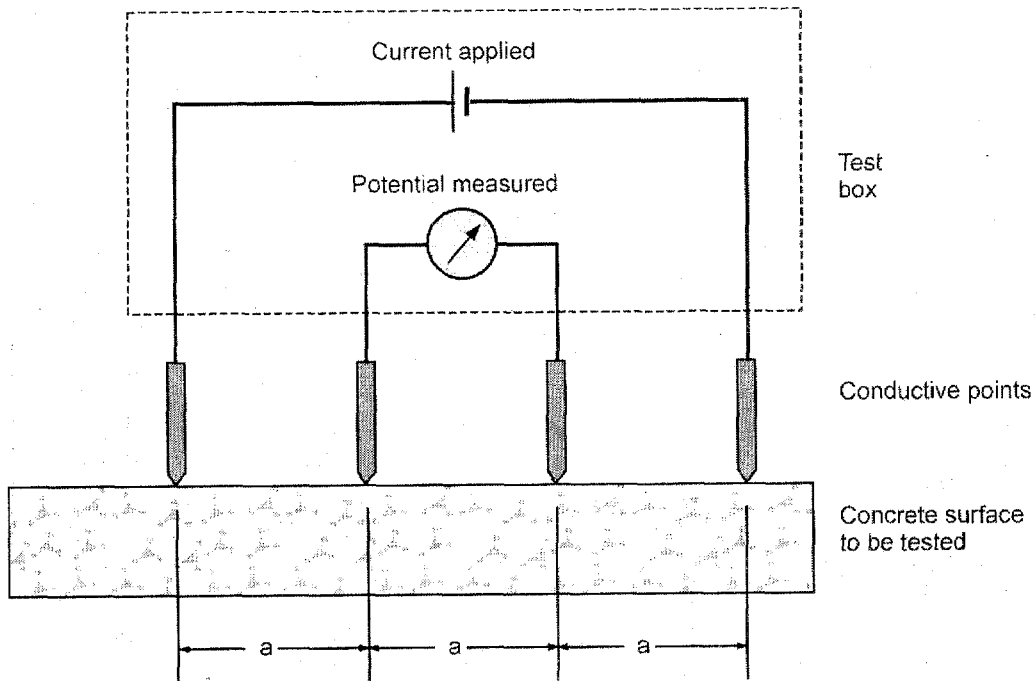


Figure 7. DC Resistivity Measuring Device.

The Wenner Array Probe is a technique for determining resistivity on concrete in situ, without removing cores from a structure. It consists of a set of four points, each a constant distance apart,  $a$ . The two outer points are where the current is applied, while the inner two points measure the potential (see Figure 8). This has the advantage of eliminating the influence of polarization because the actual potential is measured across an inner region. For a semi-infinite region (where the thickness is much greater than the distance between the points) the resistivity can be calculated as [Morris et al., 1996]:

$$\rho = 2\pi a \frac{P}{I} \quad (15)$$

where  $\rho$  is the resistivity,  $a$  is the distance between points,  $P$  is the measured potential, and  $I$  is the applied current. If the thickness is not much greater than the distance between two points, then correction factors must be applied, and have been developed by Morris et al. [1996].



**Figure 8.** Wenner Array Probe.

Resistivity techniques have the advantage of speed and deal with a test method already familiar to many concrete researchers. These tests also provide a value that may be useful when determining corrosion rates in concrete, namely the resistivity of the concrete. It avoids heating of the concrete because the voltage can be low, usually in the range of 10 V or lower [Streicher and Alexander, 1995], and is only applied for short times. Some major difficulties may arise when it comes to determining the conductivity of the pore solution, however. Either pore solution must be removed from the concrete to allow the determination of its resistivity or the concrete must be pre-saturated with a solution of known conductivity. Each of these techniques has drawbacks.

Pre-saturation of the concrete with a solution of known conductivity first requires that the sample be dried. This will prevent dilution of the saturating solution [Streicher and Alexander, 1995]. Depending on the concrete and drying technique, drying can lead to damage of the pore structure from microcracking and thus cause an increase in diffusivity [Neville, 1981]. It also may be difficult to get the solution into the concrete uniformly. Vacuum saturation techniques are normally used but this may not completely saturate the concrete for high-quality, thick concrete samples (more investigation of this

is needed). This technique assumes that the solution is identical before and after it has entered the concrete. This may not be the case. The pore solution of concrete normally contains a wide range of ions (mainly alkali hydroxides), some of which will precipitate when the concrete is dried. When a solution has entered the concrete, these ions will then return to solution and thus affect its conductivity. The magnitude of this effect is currently unknown, however, and thus may be insignificant if the solution introduced into the pore structure is of sufficiently high conductivity. Thus, normally a highly conductive solution is used, for example 5 M NaCl [Streicher and Alexander, 1995]. This technique does have the advantage of ensuring that steady-state conditions are achieved from the start of the testing procedure.

Determining the conductivity of the pore solution after the fact has its own drawbacks. First of all, steady-state conditions are unlikely to be achieved, requiring a more complicated analysis described by Andrade et al. [1993]. Also, for high-quality concretes it may be difficult to extract pore solution from a sample. A theoretical method has been presented for estimating the conductivity of the pore solution [Andrade et al., 1993], but given the inhomogeneous nature of concrete, it cannot be recommended.

Finally, resistivity techniques are still based on electrical measurements and, as such, the inclusion of conductive materials will remain a problem just as for the electrical migration cells and the RCPT.

#### 4.7 Pressure Penetration Techniques

Another method to accelerate the flow of chloride ions into concrete is by exposing one face of the concrete to a solution containing chloride that is under pressure. This will serve to drive the chlorides into the concrete under both convection and diffusion. This will be governed by the equation [Freeze and Cherry, 1979]:

$$\frac{\partial C}{\partial t} = D \frac{\partial^2 C}{\partial x^2} - \bar{v} \frac{\partial C}{\partial x} \quad (16)$$

where  $\bar{v}$  is the average linear rate of flow, which is [Freeze and Cherry, 1979]:

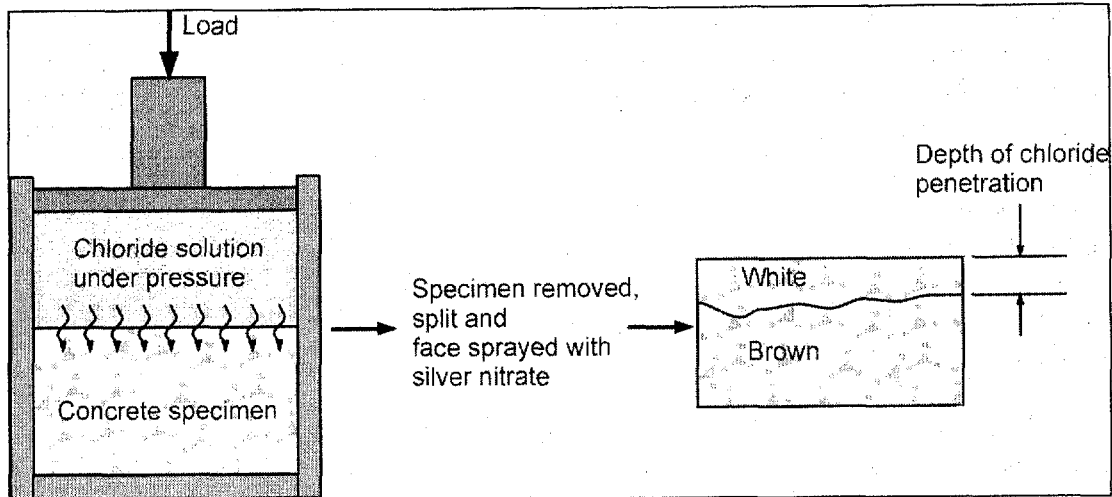
$$\bar{v} = -\frac{k}{n} \frac{\partial h}{\partial x} \quad (17)$$

and  $k$  is the hydraulic permeability,  $n$  is the porosity, and  $h$  is the applied pressure head. The solution to this differential equation is [Freeze and Cherry, 1979]:

$$\frac{C_{x,t}}{C_s} = 0.5 \left[ \operatorname{erfc} \left( \frac{x - \bar{v}t}{2\sqrt{Dt}} \right) + \exp \left( \frac{\bar{v}x}{D} \right) \operatorname{erfc} \left( \frac{x + \bar{v}t}{2\sqrt{Dt}} \right) \right] \quad (18)$$

This allows the determination of chloride diffusion coefficients, if a chloride profile is known at a specific time.





**Figure 9.** Pressure Penetration Test Procedure.

The testing of concrete for chloride penetrability using a pressure penetration method is similar to determining water permeability using a pressure cell (Figure 9). The concrete sample is pre-saturated with water and placed in a permeability cell. Care is taken to ensure an adequate seal around the sides of the cell to avoid leakage. A chloride-containing solution is introduced to one face of the concrete and a pressure is applied. This pressure is maintained for a given period of time after which the concrete sample is removed from the cell and tested for chloride, as described below.

This method can be used in two ways. First, the solution to the differential equation can be fitted to a chloride profile. This concept has the disadvantage of requiring chloride profile grinding and great numerical complexity. An alternative is to determine the depth of penetration of a known concentration of chloride at a specific time. This depth can be used to rate different concretes tested under identical conditions. The depth of a known concentration can be conveniently determined using a colorimetric technique such as that developed using silver nitrate spray, described previously in Section 4.5. This value can also be used to determine water permeability using the Valenta equation [Valenta, 1969]:

$$k = \frac{nlx_d}{th} \quad (19)$$

where  $k$  is the hydraulic conductivity,  $n$  is the porosity,  $l$  is the length of the specimen,  $x_d$  is the depth of chloride penetration,  $t$  is the time over which pressure was applied, and  $h$  is the applied head.

#### 4.8 Indirect Measurement Techniques

The permeability of concrete has been a property of interest for a long time. Many methods have been used to evaluate both water and gas permeability. Most of these are based on Darcy flow considerations.

Liquid permeability (normally water) is generally measured in one of two ways: the depth of penetration in a given time, or the rate of inflow or outflow. The variation of the rate of inflow or outflow with time can also be measured. This information allows the calculation of coefficients of permeability, using either the Darcy equation (using inflow or outflow) or the Valenta equation (depth of penetration). The calculated permeability depends on the viscosity of the fluid that is used to measure it, though formulations are available that consider the effect of viscosity [Bamforth, 1994].

Measuring the permeability of concrete to gases uses a similar technique, though the actual formula to calculate it, though analogous, also includes the effect of pressure. The permeability of a gas is strongly dependent on the pressure at which it is measured [Bamforth, 1994].

Though many techniques have been developed that are capable of measuring the permeability of concrete to gas or liquids, these techniques are not suitable for evaluating the ability of concrete to resist chloride ingress. Armaghani and Bloomquist (1993) at the Florida Department of Transportation have assessed the relationship between water permeability and chloride ion permeability. They examined the correlation between different grades of concrete as rated by the RCPT and the water permeability in the lab as measured by a constant pressure, steady-state flow permeameter. They have also developed a field permeability test, which is reported to take only 2 to 3 hours [Armaghani and Bloomquist, 1993]. No correlation between the results of the field permeability test and the RCPT is provided, though the field permeability test has been correlated to the laboratory permeability measurements [Meletiou et al., 1992]. For the lab technique developed in Florida, the time frame is too long to provide an acceptable rapid test, though the field permeability test would be acceptable. In addition, the output given is not directly theoretically related to the chloride ion permeability but to an empirical correlation to the RCPT. The property measured has little relationship to how chlorides penetrate a concrete structure.

#### 4.9 Sorptivity

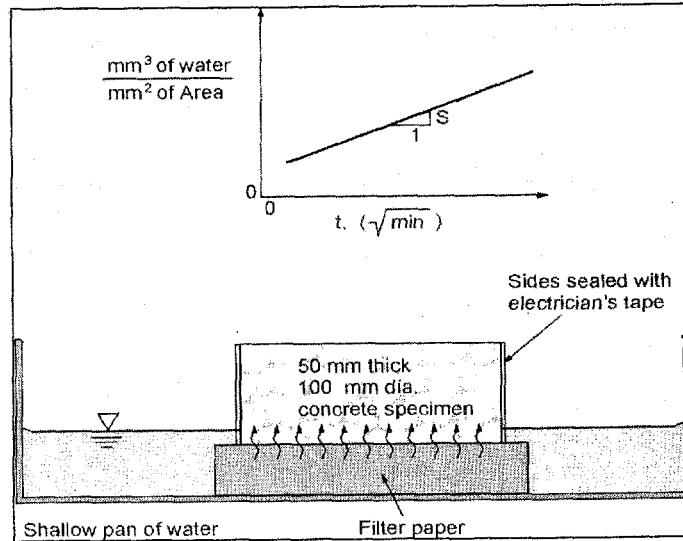
The sorptivity of concrete is a quantity that measures the unsaturated flow of fluids into the concrete [Hall, 1989]. Sorptivity is a measure of the capillary forces exerted by the pore structure, causing fluids to be drawn in to the body of the material. While theoretically possible to consider the flow in any geometry, it is too mathematically complex to be of any practical use except where there are one-dimensional flow conditions.

For one-dimensional flow, it can be stated that [Hall, 1989]:

$$i = St^{1/2} \quad (20)$$

where  $i$  is the cumulative water absorption per unit area of inflow surface,  $S$  is the sorptivity, and  $t$  is the elapsed time. In a lab situation where the concrete sample can be dried consistently and the flow conditions can be well defined, it is relatively easy to get a

good fit line using least squares regression when plotting  $i$  vs. the square root of time. A field sorptivity test has also been developed [DeSouza et al., 1995].



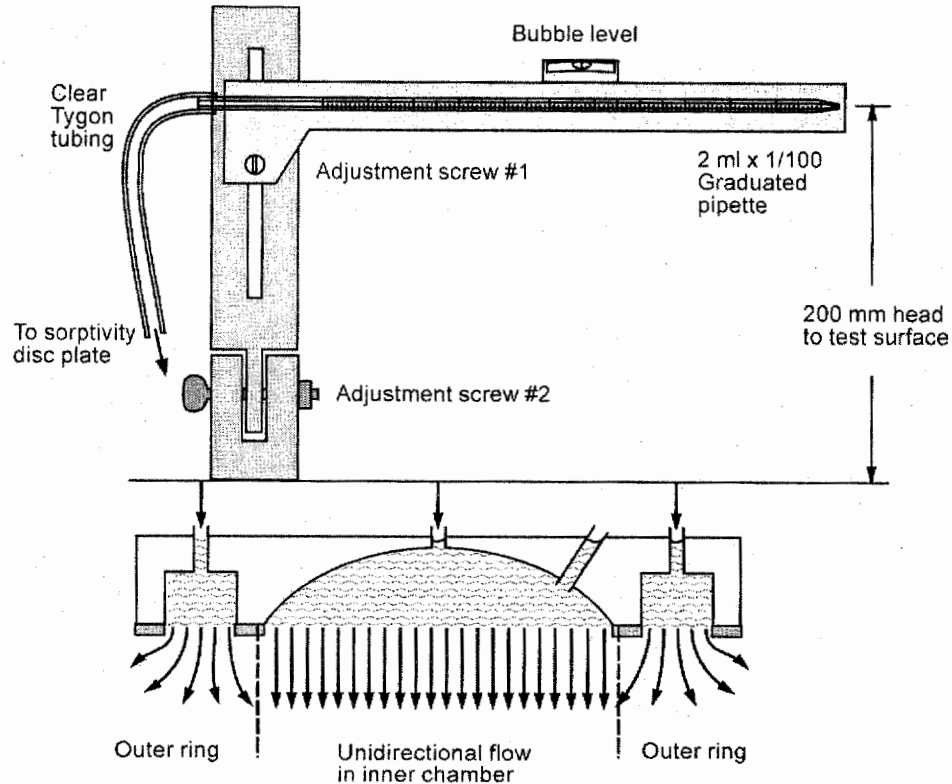
**Figure 10.** Lab Sorptivity Technique.

To determine the sorptivity of a sample in the lab is a simple, low-technology technique. According to the ASTM draft standard, all that is required is a scale, a stopwatch, and a shallow pan of water. The sample is preconditioned to a certain moisture condition, either by drying the sample for 7 days in a 50°C oven or by drying for 4 days at 50°C and then allowed to cool in a sealed container for 3 days. The sides of the concrete sample are sealed, typically with electrician's tape. The initial mass of the sample is taken, and at time 0 is immersed to a depth of 5 to 10 mm in the water. At certain times (typically 1, 2, 3, 4, 5, 9, 12, 16, 20 and 25 minutes) the sample is removed from the water, the stopwatch stopped, excess water blotted off with a damp paper towel, and the sample weighed. It is then replaced in the water and the stopwatch started again. The gain in mass per unit area over the density of water is plotted versus the square root of the elapsed time. The slope of the line of best fit of these points (ignoring the origin) is reported as the sorptivity.

A method of determining the sorptivity of concretes in the field has been developed at the University of Toronto [DeSouza, 1996]. It consists of an outer guard ring that is clamped onto the surface to be tested by a vacuum. It serves to define a test region and saturates the concrete around the test region to provide unidirectional flow. An interior plate through which water can be supplied is then attached to the concrete (bottom illustration in Figure 11). The amount of water flowing into concrete is then determined at various time intervals with a graduated pipette (top illustration in Figure 11). The moisture content of the concrete is also determined at time of testing to allow for an adjustment to a standard condition.

While this test avoids many of the difficulties of the RCPT and is able to evaluate concretes containing conductive materials, it does have its limitations. First, it is only able to evaluate the surface of the concrete. The sorptivity of concrete is affected only by

the surface conditions, at least in the time that is typically considered. Therefore, a sorptivity test will not give any information on the bulk properties of the concrete. Sorptivity tests may be useful if the steel is very shallow, but for typical depths used for high-performance, durable structures, this is not usually the case.



**Figure 11.** Field Sorptivity Apparatus.

Another difficulty is the dependence of sorptivity on the moisture content of the sample. This is not a problem in a lab situation, but for a field test the variable moisture content could drastically alter results [Hall, 1989]. Also, sorptivity is not a constant property over the long term. When a sample is initially exposed to water, it will absorb water following the above relation with some initial sorptivity, say  $S_i$ . After some time, however, there will be a change from this value and then the additional absorption will follow the same relation with another sorptivity,  $S_f$  [Martys and Ferraris, 1997]. This has been attributed to the initial dominance of the larger capillary pores resulting in a larger sorptivity value until they are filled, and then the smaller gel pores dominate with their lower sorption effects.

The final difficulty is that sorptivity is not a property that is normally dealt with by construction engineers. Permeability, i.e., movement under pressure through a saturated medium, or diffusion, ion movement, are both more common criteria.

#### 4.10 Other Test Methods

Two other test methods have been proposed in the literature for determining the diffusion of chlorides in concrete. Both of these methods use another substance to diffuse into concrete and relate the values achieved to the diffusion of chloride ions.

The first method, proposed by Feldman [1987], uses the diffusion measurement of propan-2-ol into a saturated cement paste. The weight change of an initially water saturated paste submerged in propan-2-ol is monitored. The specimens used by Feldman (paste, w/c of 0.3 to 1.0, 1.14-mm thick) were monitored for 3 to 7 days. Monitoring the weight change allows the determination of the diffusivity of propan-2-ol into the cement paste, which Feldman claims is similar to that of chloride ions. Details of this calculation are contained in the referenced paper.

Sharif et al. (1997) have proposed relating the diffusion of a gas to the chloride permeability of concrete. They propose the use of a two-chamber testing rig with a concrete specimen as the dividing wall. One chamber is filled with nitrogen gas while the other chamber is filled with helium gas at some specific pressure. The concentrations of both gases are monitored in each cell, and any presence of the other gas in a cell is due to diffusion of the gas through the concrete. The ratio of the porosity of the concrete to the tortuosity of the concrete can be calculated (see paper for details on the equations). This ratio is taken as independent of the material passing through the pore structure. Thus, the diffusion of chlorides through the concrete is a function of this ratio and the diffusion of chlorides in water. This is similar to the concept employed when considering resistivity values. The values reported by Sharif et al. (1997) in their paper comparing the diffusion coefficients from chloride ponding and that determined by gas diffusion "reveal an excellent agreement."

While some of the data presented using these techniques show that they may produce reasonable values, there are possible difficulties in performing these experiments that have not yet been mentioned. The propan-2-ol replacement technique has only been performed on very thin cement pastes. It may not be possible to perform this technique on representative concrete samples in a realistic period. For the gas diffusion technique, it can be difficult to adequately seal the sides of the concrete. Another difficulty with the gas diffusion technique is that the mathematics involved in determining useful values are complex. Also, the concept that the paste portion of concrete (often referred to as a gel to indicate its amorphous structure) presents the same porosity-tortuosity values to very different particles (e.g., helium, nitrogen, chloride) is questionable. Finally, neither of these techniques in any way considers the effects of chloride binding.

#### 4.11 Summary

Table 2 provides a summary of the test methods described in the previous sections, grouped into three main categories (long term, short term, and other). A summary of some of the advantages and disadvantages to each testing procedure is provided in the table.

An examination of Table 2 reveals that each test has its strengths and weaknesses. For example, the NTBuild 443 (bulk diffusion) test and AASHTO T259 (salt ponding) test each model the actual chloride ingress well; however, as long-term tests they are not suitable to use as a quality control test during construction. Others, like the RCPT, have a more nebulous relationship with what actually occur in the concrete, but have the advantage of a short duration. Finally, some tests fall between these two extremes.

**Table 2.** Summary of Test Methods.

Test Method		Considers Chloride Ion Movement?	At a Constant Temperature?	Unaffected by Conductors in the Concrete?	Approximate Duration of Test Procedure
Long Term	Salt Ponding (T259)	Yes	Yes	Yes	90 Day after curing and conditioning
	Bulk Diffusion (NT Build 443)	Yes	Yes	Yes	40 - 120 Days after curing and conditioning
Short Term	RCPT (T277)	No	No	No	6 hours
	Migration Cells	Yes	Yes	No	Depends on Voltage and Concrete
	Tang and Nilsson	Yes	Yes	No	8 hours
	Resistivity	No	Yes	No	30 Minutes
	Pressure Penetration	Yes	Yes	Yes	Depends on Pressure and Concrete (but potentially long)
Other	Sorptivity - Lab	No	Yes	Yes	1 week incl. Conditioning
	Sorptivity-Field	No	Yes	Yes	30 minutes
	Propan-2-ol Counter-diffusion	No	Yes	Yes	14 days with thin paste samples
	Gas Diffusion	No	Yes	Yes	2-3 hrs.

## 5.0 CONCLUSIONS

As can be seen from the work presented above, the transport of chloride ions into concrete is a complicated, multi-mechanistic phenomenon. It is important to understand some of the basic concepts underlying chloride ingress into concrete to enable the proper consideration of this eventuality when designing with reinforced concrete. A multitude of tests has been proposed and used to test the resistance of concrete to chloride ingress, and Table 2 reveals that each test procedure has its own advantages and disadvantages. What is immediately obvious, however, is that no one test is a panacea, and different situations may require different tests. A proper understanding of the limitations of each testing procedure as well as what is required for the situation at hand would allow for the correct selection of a testing procedure in each case.

## 6.0 REFERENCES

- “Standard Method of Test for Resistance of Concrete to Chloride Ion Penetration,” (T259-80), 1980, American Association of State Highway and Transportation Officials, Washington, D.C., U.S.A.
- “Standard Method for Sampling and Testing for Chloride Ion in Concrete and Concrete Raw Materials,” (T260-94), 1984, American Association of State Highway and Transportation Officials, Washington, D.C., U.S.A.
- “Electrical Indication of Concrete’s Ability to Resist Chloride,” (T277-93), 1983, American Association of State Highway and Transportation Officials, Washington, D.C., U.S.A.
- “Standard Test Method for Electrical Indication of Chloride’s Ability to Resist Chloride,” 1994, (ASTM C1202-94) *1994 Annual Book of ASTM Standards V 04.02*, ASTM, Philadelphia, pp. 620-5.
- “Draft Standard on Surface Sorptivity of Concretes,” (ASTM Draft Standard).
- Andrade, C., 1993, “Calculation of Chloride Diffusion Coefficients in Concrete From Ionic Migration Measurements,” *Cement and Concrete Research*, Vol. 23, No. 3, pp. 724-42.
- Andrade, C., Alonso, C., and Goni, S., 1993, “Possibilities for Electrical Resistivity to Universally Characterise Mass Transport Processes in Concrete,” *Concrete 2000: Economic and Durable Construction Through Excellence* (eds., R.K. Dhir and M.R. Jones), Vol. 2, E & FN Spon, Cambridge, pp. 1639-52.
- Andrade, C. and Sanjuan, M.A., 1994, “Experimental Procedure for the Calculation of Chloride Diffusion Coefficients in Concrete from Migration Tests,” *Advances in Cement Research*, Vol. 6, No. 23, pp. 127-34.
- Armaghani, J.M., and Bloomquist, D.G., 1993, “Durability Specification and Rating For Concrete,” *Concrete 2000: Economic and Durable Construction Through*

- Excellence* (eds., R.K. Dhir and M.R. Jones), Vol. 2, E & FN Spon, Cambridge, pp. 23-36.
- Bamforth, P.B., 1995, "Improving the Durability of Concrete Using Mineral Admixtures," *Concrete Durability in the Arabian Gulf*, pp. 1-26.
- Bamforth, P.B., 1994, "Specifying and Testing Impermeability," *Presentation at BCA Course: Advances in Concrete Technology and Construction Practice*, Walsall, England, 6-7 December.
- Berke, N.S., and Hicks, M.C., 1992, "Estimating the Life Cycle of Reinforced Concrete Decks and Marine Piles Using Laboratory Diffusion and Corrosion Data," *Corrosion Forms and Control for Infrastructure, ASTM STP 1137* (ed. V. Chaker), American Society for Testing and Materials, Philadelphia.
- Byfors, K., 1986, "Chloride Binding in Cement Paste," *Nordic Concrete Research*, Vol. 5, pp. 27-38.
- Canadian Standards Association, 1994, *Parking Structures-Structural Design*, CSA/S413-94, Rexdale, Ont., Cl. 7.3.1.2.
- Cao, Y. and Detwiler, R.J., 1995, "Backscatter Electron Imaging of Cement Pastes Cured at Elevated Temperatures," *Cement and Concrete Research*, Vol. 25, No. 3, pp. 627-38.
- Colleparidi, M., Marcialis, A., and Turriziani, R., 1970, "Kinetics of Penetration of Chloride Ions into the Concrete," *Il Cemento*, No. 4, pp. 157-64.
- Delagrave, A., Marchaud, J., and Samson, E., 1996, "Prediction of Diffusion Coefficients in Cement-Based Materials on The Basis of Migration Experiments," *Cement and Concrete Research*, Vol. 26, No. 12, pp. 1831-42.
- DeSouza, S.J., 1996, *Test Method for the Evaluation of Durability of Covercrete*, M.A.Sc. Thesis, Department of Civil Engineering, University of Toronto.
- DeSouza, S.J., Hooton, R.D., and Bickely, J.A., 1995, "A Field Test for Evaluating HPC Covercrete Quality." Proceedings, Annual Meeting, Canadian Society for Civil Engineering, Edmonton.
- Detwiler, R.J., Kjellsen, K.O., and Gjorv, O.E., 1991, "Resistance to Chloride Intrusion of Concrete Cured at Different Temperatures," *ACI Materials Journal*, Vol. 88, No. 1, pp. 19-24.
- Dhir, R.K., Jones, M.R., Ahmed, H.E.H., and Seneviratne, A.M.G., 1990, "Rapid Estimation of Chloride Diffusion Coefficient in Concrete," *Magazine of Concrete Research*, Vol. 42, No. 152, pp. 177-85.
- El-Belbol, S.M. and Buenfeld. N.R., 1989, "Accelerated Chloride Ion Diffusion Test," *Material Research Society Symposium Proceedings*, Vol. 137, pp. 203-8.



Feldman, R.F., 1987, "Diffusion Measurements in Cement Paste By Water Replacement Using Propan-2-ol," *Cement and Concrete Research*, Vol. 17, pp. 602-12.

Freeze, R.A. and Cherry, J.A., 1979, *Groundwater*, Prentice-Hall, Inc., New Jersey.

Geiker, M., Thaulow, N., and Andersen, P.J., 1990, "Assessment of Rapid Chloride Ion Permeability Test of Concrete With and Without Mineral Admixtures," In *Durability of Building Materials*, (eds., J.M. Baker, P.J. Nixon, A.J. Majumdar, H. Davis), E&FN Spon, London, pp. 493-502.

Goodspeed, C.H., Vanikar, S., and Cook, R.A., 1996, "High Performance Concrete Defined for Highway Structures," *ACI Concrete International*, Vol. 18, No. 2, pp. 62-7.

Halamickova, P., Detwiler, R.J., Bentz, D.P., and Garbockzi, E.J., 1995, "Water Permeability and Chloride Ion Diffusion in Portland Cement Mortars: Relationship to Sand Content and Critical Pore Diameter," *Cement and Concrete Research*, Vol. 25, No. 4, pp. 790-802.

Hall, C., 1989, "Water Sorptivity of Mortars and Concretes: A Review," *Magazine of Concrete Research*, Vol. 41, No. 147, pp. 51-61.

Hansson, C.M., and Sorenson, B., 1990, "The Threshold Concentration of Chloride in Concrete for the Initiation of Corrosion," *Corrosion Rates of Steel in Concrete*, ASTM SP 1065, 99.3-16.

Holden, W.R., Page, C.L., and Short, N.R., 1983, "The Influence of Chlorides and Sulphates on Durability," *Corrosion of Reinforcement in Concrete Construction*, (ed., A.P. Crane), Ellis, Horwood, Chichester, pp. 143-50.

Hooton, R.D. and Wakeley, L.D., 1989, "Influence of Test Conditions on Water Permeability of Concrete in a Triaxial Cell," *Proceedings of MRS Symposium on Pore Structure and Permeability of Cementitious Materials*, Boston, Mass., Nov. 28-30, 1988, pp. 157-64.

Hooton, R.D., and McGrath, P.F., 1995, "Issues Related to Recent Developments in Service Life Specifications for Concrete Structures," *Chloride Penetration into Concrete*, International RILEM Workshop, St. Remy - Les Chevreuse.

Jacobsen, S., Marchaud, J., and Boisvert, L., 1996, "Effect of Cracking and Healing on Chloride Transport in OPC Concrete," *Cement and Concrete Research*, Vol. 26, No. 6, pp. 869-81.

Kyi, A.A. and Batchelor, B., 1994, "An Electrical Conductivity Method for Measuring the Effects of Additives on Effective Diffusivities in Portland Cement Pastes," *Cement and Concrete Research*, Vol. 24, No. 4, pp. 752-64.

- Lu, X., 1997, "Application of the Nernst-Einstein Equation to Concrete," *Cement and Concrete Research*, Vol. 27, No. 2, pp. 293-302.
- McGrath, P., 1996, *Development of Test Methods for Predicting Chloride Penetration into High Performance Concrete*, Ph.D. Thesis, Department of Civil Engineering, University of Toronto.
- McGrath, P. and Hooton, R.D., 1996, "Influence of Voltage on Chloride Diffusion Coefficients From Chloride Migration Tests," *Cement and Concrete Research*, Vol. 26, No. 8, pp. 1239-44.
- Malek, R.I.A., and Roy, D.M., 1996, "The Permeability of Chloride Ions in Fly Ash-Cement Pastes, Mortars, and Concrete," *MRS Symposium*, Vol. 113, Materials Research Society, Pittsburgh, pp. 291-300.
- Martys, N.S. and Ferraris, C.F., 1997, "Capillary Transport in Mortars and Concrete," *Cement and Concrete Research*, Vol. 27, No. 5, pp. 747-60.
- Meletiou, C.A., Tia, M., and Bloomquist, D., 1992, "Development of a Field Permeability Test Apparatus and Method for Concrete," *ACI Materials Journal*, Vol. 89, No. 1, pp. 83-9.
- Midgley, H.G. and Illston, J.M., 1984, "The Penetration of Chlorides into Hardened Cement Pastes," *Cement and Concrete Research*, Vol. 14, No. 4, pp. 546-58.
- Mobasher, B. and Mitchell, T.M., 1988, "Laboratory Experience with the Rapid Chloride Permeability Test," *ACI SP-108: Permeability of Concrete*, (eds. D. Whiting, A. Walitt), American Concrete Institute.
- Monfore, G.E., 1968, "The Electrical Resistivity of Concrete," *Journal of the PCA Research and Development Laboratories*, pp. 35-48, May.
- Morris, W., Moreno, E.I., and Sagues, A.A., 1996, "Practical Evaluation of Resistivity of Concrete in Test Cylinders using a Wenner Array Probe," *Cement and Concrete Research*, Vol. 26, No. 12, pp. 1779-87.
- Nordtest Method: Accelerated Chloride Penetration into Hardened Concrete*, 1995, Nordtest, Espoo, Finland, Proj. 1154-94.
- Neville, A.M., 1981, *Properties of Concrete*- 3<sup>rd</sup> Edition, Longman Scientific and Technical, Essex, England.
- Otsuki, N., Nagataki, S., and Nakashita, K., 1992, "Evaluation of AgNO<sub>3</sub> Solution Spray Method for Measurement of Chloride Penetration into Hardened Cementitious Matrix Materials," *ACI Materials Journal*, Vol. 89, No. 6, pp. 587-92.

- Ozyildirim, C., 1994, "Rapid Chloride Permeability Testing of Silica-Fume Concrete," *Cement, Concrete and Aggregates*, Vol. 16, No. 1, pp. 53-6.
- Rasheeduzzafar, Dakhil, F.D., Bader, M.A. and Khan, M.M., 1992, "Performance of Corrosion Resisting Steels in Chloride Bearing Concrete," *ACI Materials Journal*, Vol. 89, No. 5, pp. 439-48.
- Roy, D.M., 1989, "Hydration, Microstructure and Chloride Diffusion of Chloride Ions in Hardened Cement Pastes," *ACI SP-114*, Vol. 2, American Concrete Institute, Detroit, pp. 1265-81.
- Saito, M. and Ishimori, H., 1995, "Chloride Permeability of Concrete Under Static and Repeated Compressive Loading," *Cement and Concrete Research*, Vol. 25, No. 4, pp. 803-8.
- Samaha, H.R. and Hover, K.C., 1992, "Influence of Microcracking on the Mass Transport Properties of Concrete," *ACI Materials Journal*, Vol. 89, No. 4, pp. 416-24.
- Sandberg, P. and Larsson, J., 1993, "Chloride Binding in Cement Pastes in Equilibrium with Synthetic Pore Solutions," *Chloride Penetration into Concrete Structures, Nordic Miniseminar*, Gotenberg, pp. 98-107.
- Sharif, A., Loughlin, K.F., Azad, A.K., and Navaz, C.M., 1997, "Determination of the Effective Chloride Diffusion Coefficient in Concrete via a Gas Diffusion Technique," *ACI Materials Journal*, Vol. 94, No. 3, pp. 227-33.
- Streicher, P.E. and Alexander, M.G., 1995, "A Chloride Conduction Test for Concrete," *Cement and Concrete Research*, Vol. 25, No. 6, pp. 1284-94.
- Tang, L. and Nilsson, L.-O., 1992, "Chloride Diffusivity in High Strength Concrete," *Nordic Concrete Research*, Vol. 11, pp. 162-70.
- Thomas, M.D.A. and Jones, M.R., 1996, "A Critical Review of Service Life Modelling of Concretes Exposed to Chlorides," *Concrete in the Service of Mankind: Radical Concrete Technology*, (eds., R.K. Dhir and P.C. Hewlett), E.&F.N. Spon, London, pp. 723-36.
- Thomas, M.D.A., Pantazopoulou, S.J., and Martin-Perez, B., 1995, "Service Life Modelling of Reinforced Concrete Structures Exposed to Chlorides-A Literature Review," Prepared for the Ministry of Transportation, Ontario, at the University of Toronto.
- Valenta, O., 1969, "Kinetics of Water Penetration into Concrete as an Important Factor of its Deterioration and of Reinforcement Corrosion," *RILEM International Symposium: Durability of Concrete - 1969, Part 1*, Prague, pp. A177-A189.

Whiting, D., 1987, "Rapid Measurement of the Chloride Permeability of Concrete," *Public Roads*, Vol. 45, No. 3, pp. 101-12.

Zhang, M.H. and Gjorv, O.E., 1991, "Permeability of High Strength Lightweight Concrete," *ACI Materials Journal*, Vol. 88, No. 5, pp. 463-9.

Zhang, T. and Gjorv, O.E., 1994, "An Electrochemical Method for Accelerated Testing of Chloride Diffusion," *Cement and Concrete Research*, Vol. 24, No. 8, pp. 1534-48.

## Glossary of Terms Related to Chloride Penetration and Testing in Concrete

**Absorption:** drawing in of fluids into unsaturated pores by capillary suction

**Accelerators:** admixtures to concrete that accelerate concrete setting time and increase early and ultimate strengths, governed by ASTM C494 Type C

**Admixtures:** chemicals added to concrete as it is being mixed that can affect the fresh concrete properties or the properties of concrete after it has set, governed by ASTM C494

**Anolyte:** that portion of the electrolyte in the vicinity of the anode, where electrons enter the solution

**Catholyte:** that portion of the electrolyte in the vicinity of the cathode, where electrons leave the solution

**Chloride Binding:** the combination of chloride ions with the cement matrix of the concrete either through physical or chemical means. It reduces the effective chloride concentration in the pore solution, called the free chloride concentration.

**Conductivity:** a material property describing the ease with which electrons or ions can pass through a unit length of that material of a unit cross-section, the inverse of resistivity

**Connectivity:** a concept describing the degree to which pores are connected to one another or are separated; for example, if two pores have many open paths between them, theirs is a high connectivity, while if there are few or no paths between them, theirs is a low connectivity

**Constrictivity:** a concept describing the degree to which a pore system narrows; for example a concrete with one large pore is not very constricted (has a low constrictivity) while a concrete with many narrow pores is very constricted (has a high constrictivity) even if their porosities are identical

**Convection:** the movement of a fluid, including the species it may contain, through a porous body

**Diffusion Coefficient:** the proportionality constant (D) in Fick's Laws governing diffusion

**Diffusion:** the movement of species, i.e., chloride, under a concentration gradient

**Diffusivity:** the adverb form of diffusion

**Electrolyte:** a solution in which current is carried by the movement of ions

**Fick's Laws:** the theoretical relationship governing diffusion. States either  $J = -D \frac{dC}{dx}$ ,

(Fick's First Law) or  $\frac{\partial C}{\partial t} = D \frac{\partial^2 C}{\partial x^2}$ , (Fick's Second Law).

**Flux:** quantity of material that passes a unit surface area per unit of time

**Gradient:** the change in value of a quantity per unit distance in a specified direction

**Hydration Inhibitors:** a chemical admixture which, when dispensed into concrete, prevents hydration for a period of time by forming a barrier around cement particles

**Hydraulic Head:** the water pressure which is the driving force behind permeability flow; usually expressed in m of water

**Maturity:** a concept describing the degree of hydration of a concrete. It considers both the age of the concrete and the curing conditions it experienced. For strength, it is defined as the product of the days and the temperature above a certain baseline value, commonly  $-10^{\circ}\text{C}$ . For example, if a concrete spent 3 days at  $20^{\circ}\text{C}$  and then 25 days at  $10^{\circ}\text{C}$ , its maturity would be (3 days)  $\times$  ( $20^{\circ}\text{C} - (-10^{\circ}\text{C})$ ) + (25 days)  $\times$  ( $10^{\circ}\text{C} - (-10^{\circ}\text{C})$ ) or 590 days- $^{\circ}\text{C}$ .

**Migration:** the movement of ions in a solution under an electrical potential gradient.

Related to diffusion by the Nernst-Einstein equation,  $J = D \frac{zFU}{RTL} c$ .

**Non-Steady-State Conditions:** when the situation is changing with time, i.e., a changing flux

**Penetrability:** a concept describing the ease at which chloride ions may penetrate concrete, under all transport mechanisms

**Permeability (k):** the ease of fluid ingress under a pressure gradient,  $Q = k \frac{h}{l} A$

**Permeability Cell:** a device for measuring permeability

**Polarization:** when an electrical potential is applied to an electrolyte, there is a tendency of ions to separate based on their charge; this causes a potential of the opposite direction of the applied potential; also called back emf

**Porosity:** the relative amount of pore space in concrete, expressed as the percentage of the entire volume that consists of pores

**Potential:** the voltage difference between an anode and a cathode

**Resistance:** a property of a specific item of a specific geometry and material composition that describes the difficulty with which electrons or ions have in passing through that material under an electrical field

**Resistivity ( $\rho$ ):** a material property describing the difficulty with which electrons or ions travel through a unit length of that material of a unit cross-section under an electrical field

**Retarders:** a chemical admixture that delays setting time, governed by ASTM C494 Type B

**Sorptivity:** rate of absorption of water into an unsaturated surface of concrete by capillary action

**Steady-State Conditions:** the situation is not changing with time, i.e., the flux remains constant

**Steam Curing:** a curing regimen where concrete is exposed to high temperatures for a short duration at early ages. In this work, after the initial set, the air temperature surrounding the concrete was increased from 25°C to 65°C at 20C°/hr, this temperature was maintained for 7.5 hours and then the air temperature was reduced to 25°C at 20 C°/hr. The relative humidity was maintained at nominally 100 percent.

**Superplasticizers (high range water reducing admixtures):** an admixture that reduces the quantity of mixing water required to produce concrete of a given consistency by 12 percent or greater, governed by ASTM C494 Type F

**Supplementary Cementing Materials:** minerals that are added in place of cement that exhibit cementitious and/or pozzolanic reactions in the presence of lime; can be either natural or man-made; common ones are slag, fly ash, and silica fume

**Tortuosity:** a concept describing the shape of a pore system; for example a straight pore has a low tortuosity while a convoluted, curving pore has a high tortuosity

**Transport Mechanisms:** the different methods by which ions can travel from place to place, including but not necessarily limited to diffusion, permeation, wicking, sorption, and migration

**Vapour Diffusivity:** the rate at which water vapor can travel through the unsaturated pores

**Water Reducers:** an admixture that reduces the quantity of mixing water required to produce a concrete of a given consistency

**Wicking:** evaporation of water from pores deposits salt and draws more solution to the evaporation front by absorption; requires an air-exposed surface; is dependent on humidity and the vapor diffusivity of concrete





# **Appendix 2:**

## **Test Procedures**



## **NTBuild 443: CONCRETE, HARDENED: ACCELERATED CHLORIDE PENETRATION**

Key words: Test method, hardened concrete, chloride penetration, non-steady-state diffusion

### **1 SCOPE**

This NordTest method specifies a procedure for the determination of penetration parameters for estimating the resistance against chloride penetration into hardened concrete or other cement-based materials. The resistance against chloride penetration is determined by accelerated testing.

### **2 FIELD OF APPLICATION**

The method is applicable to test specimens from existing structures and to new samples older than 28 maturity-days. The concrete test specimens must be free from construction faults such as cavities and visible cracks.

It is important to keep in mind that the values for the chloride penetration parameters are dependent on concrete maturity. Especially concretes containing pozzolans will not have reached optimum maturity after a period of 28 maturity-days, which is the specified minimum curing time before exposure.

Deviations from the requirements of the method concerning exposure temperature, exposure time, together with the composition and the chloride concentration of the exposure liquid, can be made where required by the purpose

of the test. In case of any deviations, it must be stated in the test report that the results are obtained from a modified test and the deviations must be specified.

Parameters of importance for the resistance against chloride penetration are, e.g., composition, workmanship, surfacing, curing, age.

### **3 REFERENCES**

NTBUILD 202, 2<sup>nd</sup> ed. Approved 1984-05. Concrete, hardened: Sampling and Treatment of Cores for Strength Tests.

NT BUILD 208, 2<sup>nd</sup> ed. Approved 1984-05. Concrete, hardened: Chloride Content.

### **4 DEFINITIONS**

**Chloride penetration:** The ingress of chlorides into concrete resulting from exposure to external chloride sources.

**Exposure temperature:** The temperature of the exposure liquid while the test specimen is submerged in it.

**Exposure time:** The time from immersion of the test specimen in the exposure liquid to profile grinding.

**Profile grinding:** Grinding off concrete powder in thin successive layers from a test specimen using a dry process.

Maturity-day: A concrete of 28 maturity-days has developed a maturity corresponding to curing for 28 days at 20°C.

Surface-dry condition: Is achieved by drying the water-saturated test specimen with a clean cloth or similar, leaving the test specimen damp but not wet. This is achieved by wetting the cloth with the liquid in which the test specimen has been immersed and then wringing it out sufficiently to absorb any liquid adhering to the surface of the specimen.

## 5 SAMPLING

This method requires drilled cores or cast cylinders as test specimens. They must be representative of the concrete and/or structure in question. The concrete must be hardened to minimum 28 maturity-days. At least three test specimens should be used in the test. The diameter should be at least  $\varnothing 75$  mm, but not less than three times the maximum aggregate size. The length should be a minimum of 100 mm.

## 6 METHOD OF TEST

### 6.1 Principle

A water-saturated concrete specimen is on one plane surface exposed to water containing sodium chloride. After a specified exposure time, thin layers are ground off parallel to the exposed face of the specimen and the chloride content of the layers,  $C_x$ , is measured. The original (initial) chloride content of the concrete,  $C_i$ , is measured at a suitable depth below the exposed surface. The effective chloride transport coefficient,  $D_e$ , and the

boundary condition of the chloride profile at the exposed surface,  $C_s$ , are calculated. This is done by using the related values of measured depth below the exposed surface,  $x$ , and measured chloride content,  $C_x$ .

The penetration parameter,  $K_{Cl}$ , is calculated for a selected chloride concentration,  $C_r$ . The influence of  $D_e$ ,  $C_s$ ,  $C_i$ , and  $C_r$  is combined in the calculation of  $K_{Cl}$ , which facilitates comparison of the results.

### 6.2 Reagents and Apparatus

#### 6.2.1 Reagents

- Redistilled or demineralized water
- Calcium hydroxide ( $\text{Ca}(\text{OH})_2$ ), technical quality
- Sodium chloride ( $\text{NaCl}$ ), technical quality
- 2-component (chloride-ion diffusion-proof) polyurethane or epoxy-based paint (membrane)
- Chemicals for chloride analysis according to applied test method

#### 6.2.2 Apparatus

- Water-cooled diamond saw
- Balance, accuracy better than  $\pm 0.01$  g
- Thermometer, accuracy better than  $\pm 1^\circ\text{C}$
- Temperature-controlled cupboard
- Plastic container with tight-fitting lid
- Equipment for grinding off and collecting concrete powder from thin concrete layers (less than 2 mm)
- Equipment for crushing concrete
- standard sieve, mesh width 1.0 mm
- Equipment for chloride analysis, according to applied test method

- Slide caliper, accuracy better than  $\pm 0.1$  mm

### 6.3 Preparation of Test Samples

From each of the concrete cores or concrete cylinders, the parts 6.3.1 and 6.3.2 specified below are cut off by means of a water-cooled diamond saw.

#### 6.3.1 Test Specimen for Exposure in NaCl Solution

If a drilled core is used, the test specimen is prepared by cutting off the outermost approx. 70 mm of the core. A test specimen is thus obtained, of which one end face is the original surface and the other is a sawn face. The outermost approx. 10 mm is then cut off the original concrete surface (note 1), and the resulting sawn surface is exposed in the NaCl solution.

Note 1: It is very important that the test is made on the concrete between the surface and the layer of reinforcement because it is here that the protection against chloride penetration is needed. Furthermore, the quality of the concrete in this particular area can deviate from the rest of the concrete. The outermost approx. 10 mm of concrete is removed to ensure that the measurement is made in an area with an approximately constant cement matrix content.

If a cast cylinder is used, the test specimen is prepared by dividing the cylinder into halves by a cut perpendicular to the axis of the cylinder. One half is used as a test specimen, with the sawn surface exposed in the NaCl solution.

The test specimen is immersed in a saturated  $\text{Ca(OH)}_2$  solution at about  $23^\circ\text{C}$  in a tightly closed plastic container. The container must be filled to the top to minimize carbonation of the liquid. The next day the mass in surface dry condition ( $m_{sd}$ ) is determined by weighing the test specimen.

The storage in the saturated  $\text{Ca(OH)}_2$  solution continues until  $m_{sd}$  does not change by more than 0.1 mass % per 24 hours.

All faces of the test specimen except the one to be exposed are then dried at room temperature to a stable white-dry condition and given an approx. 1 mm thick epoxy or polyurethane coating. Precautions must be taken to ensure that no coating material gets onto the surface to be exposed. It must be ensured that the method of application and hardening prescribed by the supplier of the coating material is observed.

When the coating has hardened, the test specimen is immersed in the  $\text{Ca(OH)}_2$  solution until  $m_{sd}$  stabilizes as described above.

#### 6.3.2 Slice Of at Least 20 mm Thickness

From the remainder of the drilled core or cast cylinder, a slice of at least 20 mm thickness is cut in extension of test specimen 6.3.1.

### 6.4 Procedure

#### 6.4.1 Exposure Liquid

An aqueous NaCl solution is prepared with a concentration of  $165 \text{ g} \pm 1 \text{ g NaCl per dm}^3$  solution. This exposure liquid

is used for 5 weeks and then replaced by a new pure NaCl solution. The NaCl concentration of the solution must be checked at least before and after use.

#### 6.4.2 Exposure Temperature

The temperature of the water bath must be 21 to 25 °C with a target average temperature of 23°C. The temperature must be measured at least once a day.

#### 6.4.3 Exposure

The Ca(OH)<sub>2</sub> solution in the container used for water saturation is replaced with the exposure liquid and the test specimen 6.3.1 is immersed in surface-dry condition in the saline solution. It is important that the container is completely filled with the exposure liquid and closed tightly. The ratio between the exposed area in cm<sup>2</sup> and the volume of exposure liquid in dm<sup>3</sup> shall be a minimum of 20 and maximum 80. The container is placed in the temperature-controlled cupboard during exposure. The exposure shall last for at least 35 days, and the container is shaken once every week. The date and time of exposure start and exposure stop is recorded.

#### 6.4.4 Profile Grinding

The chloride profile is measured immediately after the exposure by grinding off material in layers parallel to the exposed surface. The grinding is performed within a diameter approximately 10 mm less than the full diameter of the core. This obviates the risk of edge effects and disturbances from the coating.

At least eight layers must be ground off. The thickness of the layers must be adjusted according to the expected chloride profile, so that a minimum of 6 points covers the part of the profile between the exposed surface and the depth with a chloride content of C<sub>1</sub> + 0.03 mass percent. However, the outermost layer must always have a minimum thickness of 1.0 mm.

It must be ensured that a sample of at least 5 g of dry concrete dust is obtained from each layer. For each sample of concrete dust collected, the depth below the exposed surface is calculated as the average of five uniformly distributed measurements using a slide caliper.

#### 6.4.5 Chloride Analysis

The acid-soluble chloride content of the samples is determined to three decimals in accordance with NTBuild 208 or by a similar method with the same or better accuracy. The accuracy must be documented.

#### 6.4.6 Initial Chloride Content

From the concrete slice 6.3.2, a representative subsample of approx. 20 g is prepared, e.g., by crushing until the material passes a 1-mm standard sieve, followed by splitting. The acid-soluble chloride content of the subsample is determined to three decimals by using the method described in 6.4.5. The measured chloride content is the initial chloride content of the specimen, C<sub>i</sub>.

### 6.5 Expression of Results

#### 6.5.1 Test Results

The values of  $C_s$  and  $D_e$  are determined by fitting equation (1) to the measured chloride contents by means of a non-linear regression analysis in accordance with the method of least squares fit. The first point of the profile determined from the sawn face is omitted in the regression analysis. The other points are weighted equally.

$$C(x,t) = C_s - (C_s - C_i) \operatorname{erf}(x/\sqrt{4D_e t}) \quad (1)$$

where:

$C(x,t)$  [mass %] is the chloride concentration measured at the depth  $x$  at the exposure time  $t$

$C_s$  [mass %] is the boundary condition at the exposed surface

$C_i$  [mass %] is the initial chloride concentration measured on the concrete slice 6.3.2.

$x$  [m] is the depth below the exposed surface (to the middle of a layer)

$D_e$  [ $m^2/s$ ] is the effective chloride transport coefficient

$t$  [s] is the exposure time (with an accuracy better than 5 hours)

$\operatorname{erf}$  is the error function defined in (2)

$$\operatorname{erf}(z) = \frac{2}{\pi} \int_0^z \exp(-u^2) du \quad (2)$$

Tables with values of the error function are given in standard mathematical reference books.

The penetration parameter,  $K_{Cl}$ , is calculated using the values of  $C_i$  [mass % of concrete],  $C_s$  [mass % of concrete],  $D_e$  [ $m^2/s$ ], and  $C_r$  [mass % of concrete] (note 2) according to (3). The  $C_r$  value is set to 0.05 mass % unless another value is required.

$$K_{C_r} = 2\sqrt{D_e} \operatorname{erf}^{-1} \left( \frac{C_s - C_r}{C_s - C_i} \right) \quad (3)$$

Note 2: In (3),  $C_r$  is a selected reference chloride concentration. Note that  $K_{C_r}$  only is defined when  $C_s > C_r > C_i$ .

The test results are:

- The initial chloride concentration,  $C_i$ , stated to three decimal places in mass percent of dry concrete.
- The boundary condition at the exposed surface,  $C_s$ , stated to three decimal places in mass percent of dry concrete
- The effective chloride diffusion coefficient,  $D_e$ , stated to two significant digits in  $m^2/s$
- The penetration parameter,  $K_{Cl}$ , stated to two significant digits in  $mm/\sqrt{\text{year}}$ . The  $C_r$  value used to calculate  $K_{C_r}$  must be clearly stated in the test report.

Please note that the values of  $C_s$  and  $D_e$  should not be directly used for prediction of chloride penetration under conditions other than those used by the test. (If  $K_{C_r}$  is calculated in the units  $mm/\sqrt{s}$ , it is multiplied by  $5.6157 \times 10^6$  to translate the unit of  $mm/\sqrt{\text{year}}$ .)

### 6.5.2 Other Important Information

- The measured chloride contents at all points are plotted versus the depths below the exposed surface. The curve for the optimized mathematical model (1) is plotted on the same graph.
- The correlation between the measured chloride contents and the corresponding chloride contents

calculated according to (1) is determined by means of a linear regression analysis.

- The average exposure temperature is calculated. The variation must be illustrated, e.g., by giving the measured temperature curve.
- The average chloride content of the exposure liquid is calculated.

#### 6.6 Accuracy

The following variation coefficients (the standard deviation divided by the mean value) can be expected:

$$C_s = 20 \% ; D_c = 15 \% \text{ and } K_{Cr} = 10 \%$$

#### 6.7 Test Report

The test report shall include the following information, if relevant:

- a) Name and address of the testing laboratory, and the place at which the tests were performed if different from the laboratory address.
- b) Date and identification number of the test report.
- c) Name and address of the organization or person who ordered the test.
- d) Purpose of the test.
- e) Method of sampling and other circumstances (date and person responsible for the sampling).
- f) Name and address of the manufacturer or supplier of the tested object.

- g) Name or other identification marks of the tested object.
- h) Description of the tested object including the age of the test specimen.
- i) Date of supply of the tested object.
- j) Date of the test.
- k) Test method.
- l) Conditioning of the test specimens, environmental data during the test (temperature, chloride concentration in exposure liquid, etc.).
- m) Identification of the test equipment and instruments used.
- n) Any deviation from the test method, together with other information of importance for judging the result.
- o) Test results.
- p) Inaccuracy or uncertainty of the test results.
- q) Date and signature.



### Changes to Standard Procedure for this Work:

1. Instead of immersing the sample in saturated  $\text{Ca}(\text{OH})_2$  solution and waiting for the mass to stabilize, the sample was saturated using the vacuum saturation technique outlined in ASTM C1202 – 3 hours under vacuum dry, add deaired water, maintain vacuum for 1 additional hour, release vacuum and let soak for  $18 \pm 3$  hours.
2. The background chloride level,  $C_i$ , was determined from a single piece for each concrete type, not for each sample.
3. The value  $K_{Cr}$  was not calculated, the concrete was evaluated based on its diffusion coefficient,  $D_e$  in this outline.
4. The exposure periods were as outlined, not limited to 35 days.
5. After exposure until they were profile ground, the specimens were placed in a plastic bag and frozen at around  $-10^\circ\text{C}$  to prevent the movement of chlorides. The exposure duration was counted as the time the specimens were in the saline solution.

## **CTH/RMT Method**

Principle: An external potential is applied axially across a specimen to force external chloride ions to migrate into the specimen. After a certain test duration, the specimen is axially split, and a silver nitrate solution is sprayed on one of the faces. The depth of chloride penetration is then measured from the white chloride precipitation.

### Equipment and Reagents:

- saturated limewater
- NaCl solution (3 percent by mass in Phase 1, 10 percent by mass in Phase 2 and 3)
- 0.3 M NaOH solution
- 0.1 M AgNO<sub>3</sub> spray
- vacuum chamber capable of introducing the deaired limewater while under vacuum
- power supply capable of 30 V
- bituthane sheet & silicone (Phase 1)
- sleeves and clamps (Phase 2 & 3)
- cathode and anode in a test cell
- a press to split the sample

### Specimen Preparation:

A concrete core, nominally 100 mm in diameter and 50 mm thick, is used. The actual dimensions are taken. The specimen is vacuum saturated by placing it under vacuum for 3 hours, the deaired limewater is then introduced under vacuum and left for 1 additional hour. The vacuum is then released and the specimens are allowed to soak for  $18 \pm 3$  hours more.

### Test Procedure:

#### Phase 1:

After saturation, three samples were wrapped in a bituthane sheet, so that a reservoir is created above the sample. This is further attached with silicone, which is allowed to dry for 1 hour. The reservoir is then filled with 300 mL of 0.3 M NaOH solution, and the entire specimen is placed in a container containing the 3 percent NaCl solution and the cathode. An anode is then placed in the reservoir above the sample. This is then connected to the 30 V power supply and each sample is allowed to run for one of three durations: 8 hr, 24 hr, or 72 hr. After this time, the sample is split and sprayed with AgNO<sub>3</sub> and evaluated as below.

#### Phase 2:

After saturation, the samples are placed in a rubber sleeve, and the sleeve above the specimen is filled with 300 mL of 0.3 M NaOH solution. This is then placed in a container of 10 percent NaCl solution containing the cathode. The anode is placed on top of the concrete in the NaOH solution. The cathode is connected to the negative pole of the power supply and the anode is connected to the positive pole. The power supply is set to 30 V and this is allowed to run for

24 hr. The specimen is then disassembled and split. The silver nitrate is then sprayed on one of the split faces and left for approximately an hour.

Phase 3:

For this procedure, three samples are required. After saturation, the samples are placed in a rubber sleeve, and the sleeve above the specimen is filled with 300 mL of 0.3 M NaOH solution. This is then placed in a container of 10 percent NaCl solution containing the cathode. The anode is placed on top of the concrete in the NaOH solution. The cathode is connected to the negative pole of the power supply and the anode is connected to the positive pole. The power supply is set to 30 V and the initial current determined. The voltage is then reset based on the initial current according to Table 1. The test durations for each sample are as shown in Table 1, one sample under each test condition. After the appropriate test duration, each sample is removed from the test equipment, split, and sprayed with silver nitrate as before.

**Table 1:** Phase 3 Test Conditions

Current @ 30 V (mA)	Test Condition 1	Test Condition 2	Test Condition 3
< 5	60 V, 96 hr	60 V, 120 hr	60 V, 168 hr
5-10	60 V, 48 hr	60 V, 96 hr	60 V, 168 hr
10-15	40 V, 48 hr	40 V, 72 hr	40 V, 120 hr
15-20	30 V, 24 hr	30 V, 72 hr	30 V, 120 hr
20-30	25 V, 24 hr	25 V, 48 hr	25 V, 96 hr
30-40	20 V, 24 hr	20 V, 48 hr	20 V, 72 hr
40-60	15 V, 24 hr	15 V, 48 hr	15 V, 72 hr
60-90	10 V, 24 hr	10 V, 48 hr	10 V, 72 hr
90-120	5 V, 24 hr	5 V, 48 hr	5 V, 72 hr
120-240	5 V, 6 hr	5 V, 24 hr	5 V, 48 hr
240-600	5 V, 4 hr	5 V, 6 hr	5 V, 24 hr
> 600	5 V, 2 hr	5 V, 4 hr	5 V, 6 hr

Evaluation Procedure:

Phase 1 & 2:

The distance of the color change boundary from the exposed surface is measured at nine places along the sample, 10 mm apart. If a piece of aggregate intersects the color change boundary at a measuring location, this is noted and the measurement discarded. The high and the low values are then discarded and the remaining values averaged to obtain a depth of penetration.

Phase 3:

The depth of penetration is determined as for Phase 1 & 2 for each specimen. These values are then plotted versus the product of the voltage applied and the test duration. The line of best fit is determined and the slope of this line is reported as the rate of penetration.

Reference: CTH Rapid Test for Determination of Chloride Diffusivity in Concrete: A Nordtest NT Build Proposal.

Tang, L., and Nilsson, L-O., 1991, "Rapid Determination of the Chloride Diffusivity in Concrete by Applying an Electrical Field," *ACI Materials Journal*, Vol. 89, No. 1 pp. 49-53.

## Migration Cell Test Method

Principle: An external potential is applied across a concrete slice, driving chloride ions from a source solution to an initially chloride free solution. The chloride concentration of the downstream cell is monitored both for the initial breakthrough time and for the flux of the chlorides after breakthrough.

### Reagents and Apparatus:

- 0.3 M NaOH solution
- 0.3 M NaOH, 0.5 M NaCl solution
- tapwater
- vacuum chamber capable of introducing the deaired tapwater while under vacuum
- a migration cell consisting of an 1.5-L upstream chamber, a 600-mL downstream chamber capable of being separated by the 40-mm-thick concrete specimen and containing a stainless steel mesh electrode in each chamber
- a DC power supply
- multimeter
- 10-mL pipettes and 1-mL pipettes
- chloride analysis equipment
- epoxy and molds
- calipers

### Specimen Preparation:

A 100-mm-diameter core was taken from a slab so that it is longer than 40 mm. The diameter is measured using calipers and the core is then cast in epoxy around the sides. A 40-mm slice is cut from the center portion after the epoxy has hardened. The length is measured using the calipers. The specimen is then vacuum saturated in tapwater, by vacuuming it 3 hours dry; the deaired water is then introduced and vacuum is then applied for an additional hour. The vacuum is then released and the specimens allowed to soak for an additional  $18 \pm 3$  hours.

### Test Procedure:

After vacuum saturating, the specimen is placed in the migration cell with approximately 1.5 L of 0.3 M NaOH, 0.5 M NaCl solution in the upstream cell and 600 mL of 0.3 M NaOH solution in the downstream cell. The volume of solution in the downstream cell is measured. The electrodes are then connected to a power supply with the upstream electrode connected to the negative pole and the downstream electrode connected to the negative electrode. The actual voltage across the cell between the electrodes is taken at this point. For this study, two separate voltages were used, 12 V and 30 V. Periodically, a 10-mL sample is taken from the downstream cell and replaced with downstream solution from a stock supply. At this time the current passing through the cell is also measured. These samples are saved for titration to determine chloride content. To determine when to stop the test, a 1-mL sample is occasionally taken and titrated to determine the chloride concentration. It is usual to stop the test when a concentration of 2500 mg/L is reached in the downstream cell. When the end of the test has been reached, the

voltage applied across the actual concrete specimen is determined using the Luggin capillaries and a chloride-sensitive electrode.

The chloride concentration of the samples is then determined and plotted with time. Based on the time until chloride breakthrough or the slope of the line after breakthrough a diffusion coefficient can be determined.

Reference: McGrath, P., 1996, *Development of Test Methods for Predicting Chloride Penetration into High Performance Concrete*, Ph.D. Thesis, Department of Civil Engineering, University of Toronto.

## Monfore DC Resistivity Test Method – Water Saturated

Principle: The DC resistance of a water-saturated concrete specimen is determined by monitoring the current achieved when a voltage is applied across the specimen. To account for polarization effects, two different voltages are used.

### Equipment and Reagents:

- calipers
- two-part epoxy
- deaired tapwater
- vacuum chamber capable of introducing the deaired tapwater while under vacuum
- variable voltage power supply
- datalogger capable of recording current and voltage and controlling the variable voltage power supply
- flat plates for applying the voltage to the concrete
- conductive gel to ensure good electrical contact between the concrete and the plates

### Specimen Preparation:

A concrete core, nominally 100 mm in diameter and 50 mm thick, is used. The actual dimensions are taken and the curved sides are coated with the two-part epoxy. After this has hardened, the specimen is vacuum saturated by placing it under vacuum for 3 hours; the deaired water is then introduced under vacuum and left for 1 additional hour. The vacuum is then released and the specimens are allowed to soak for  $18 \pm 3$  hours more.

### Test Procedure:

The flat faces are coated with the conductive gel and the specimen is placed between the two conductive plates. Typically, some clamping force is exerted to ensure good contact. The datalogger is then started and the voltage is applied. This voltage is alternated between approximately 3 V and 5 V every 5 seconds. A reading of the current and voltage is taken every second. The five consecutive readings are averaged for each voltage level and used as the value at that level. The resistance is then determined for each set of two voltage levels using the equation:

$$R = \frac{E_2 - E_1}{I_2 - I_1}$$

where R is the resistance and  $E_i$  is the voltage applied at level i and  $I_i$  is the current applied at level i. This is then converted into resistivity by multiplying by the cross-sectional area and dividing by the length. These readings are taken for 10 to 15 minutes and the average resistivity value is reported. Conductivity is the inverse of resistivity.

Reference: Monfore, G.E., May 1968, "The Electrical Resistivity of Concrete," *Journal of the PCA Research and Development Laboratories*, pp. 35-48.

## **Chloride Saturated Concrete Resistivity Method**

Principle: The resistivity of the concrete is determined with a highly concentrated chloride solution saturating the concrete's pore structure. A diffusion coefficient can then be estimated by relating the conductivity of the concrete to the conductivity of the chloride in solution.

### Reagents and Equipment:

As above for Monfore DC resistivity except 5.0 M NaCl solution is used instead of tapwater.

### Specimen Preparation:

The concrete samples are saturated with 5.0 M NaCl solution by immersing the specimens in the solution and then applying a vacuum for 5 hours. The specimens are allowed to soak for  $18 \pm 3$  hours after the vacuum is released. Otherwise, the procedure is as for the Monfore DC resistivity.

### Test Procedure:

The test procedure is identical to that for the Monfore DC resistivity. The difference is in how the test is evaluated. After the resistivity is determined, the value called the Formation Factor (FF) is developed, which is:

$$FF = \frac{\sigma}{\sigma_0}$$

where  $\sigma$  is the conductivity of the concrete and  $\sigma_0$  is the conductivity of the chloride in the pore solution. Conductivity is the reciprocal of the resistivity. But the Formation Factor is also equal to the ratio of the diffusivity of the chloride in the concrete over the diffusivity of the chloride in the pore solution.

Reference: Streicher, P.E. and Alexander, M.G., 1995, "A Chloride Conduction Test for Concrete," *Cement and Concrete Research*, Vol. 25, No. 6, pp. 1284-94.



## **Sorptivity**

Principle: One face of a partially dried concrete sample is exposed to water and the rate at which water is drawn into the concrete is determined.

### Reagents and Equipment:

- tapwater
- oven set to 50°C
- shallow pan
- container for samples
- paper towel
- timer
- scale
- electrical tape
- filter paper

### Specimen Preparation:

A concrete specimen 50 mm thick and 100 mm in diameter is used. It is placed in the 50°C oven for 3 days and then transferred into the container in the oven for an additional 4 days. The specimen is then removed from the oven and allowed to cool, approximately 1 hour.

### Testing Procedure:

The dimensions of the specimen are taken and the curved sides of the core are sealed with electrical tape. The mass of the specimen is then taken. The specimen is then placed in the shallow pan of water on the filter paper such that the water is 2 to 3 mm up the sides of the concrete. At 1, 2, 3, 4, 6, 9, 12, 16, 20 and 25 minutes the specimen is removed from the water, the timer is stopped, any excess water is wiped off, and the specimen is weighed. It is then returned to the water and the timer restarted. To analyze the results, the mass gained is determined, divided by the density of water and the cross-sectional area of the specimen and plotted versus the square root of time elapsed. The slope of the line of best fit is determined and reported as the sorptivity value.

Reference: Hall, C., 1989, "Water Sorptivity of Mortars and Concretes: A Review," *Magazine of Concrete Research*, Vol. 41, No. 147, pp. 51-61.

## Wenner Probe Resistivity Measurement

Principle: The resistivity of concrete *in situ* is measured by applying a current to concrete through contact probes and measuring the voltage required.

### Reagents and Equipment:

- four metal probes
- constant power supply
- multimeter
- drill
- equipment to saturate the concrete

### Specimen Preparation:

Four holes are drilled into the concrete to be tested to a certain depth (20 mm in this study) at an equal spacing in a straight line. The spacing chosen in this study was 50 mm. The diameter of the drilled hole is slightly smaller than that of the probe. The probes are then driven into the concrete holes. The concrete around the probes is then saturated with water.

### Testing Procedure:

The power supply is attached to the outside probes and set to a certain voltage, either 5 or 10 V, depending on the concrete. The voltage across the inner two probes is then measured as well as the current passing through the outer probes. The resistivity is then calculated from:

$$\rho = 2\pi a \frac{V}{I}$$

where V is the measured voltage, I is the measured current and a is the probe spacing.

Reference: Morris, W., Moreno, E.I., and Sagues, A.A., 1996, "Practical Evaluation of Resistivity of Concrete in Test Cylinders using a Wenner Array Probe," *Cement and Concrete Research*, Vol. 26, No. 12, pp. 1779-87.

## Pressure Penetration Chloride Ingress Measurement

Principle: The ingress of chlorides is accelerated by applying pressure to the chloride containing solution.

### Reagents and Apparatus:

- deaired 3 percent NaCl solution
- deaired tapwater
- 0.1 N silver nitrate solution in spray bottle
- triaxial permeability cell
- vacuum container capable of introducing deaired water while under vacuum

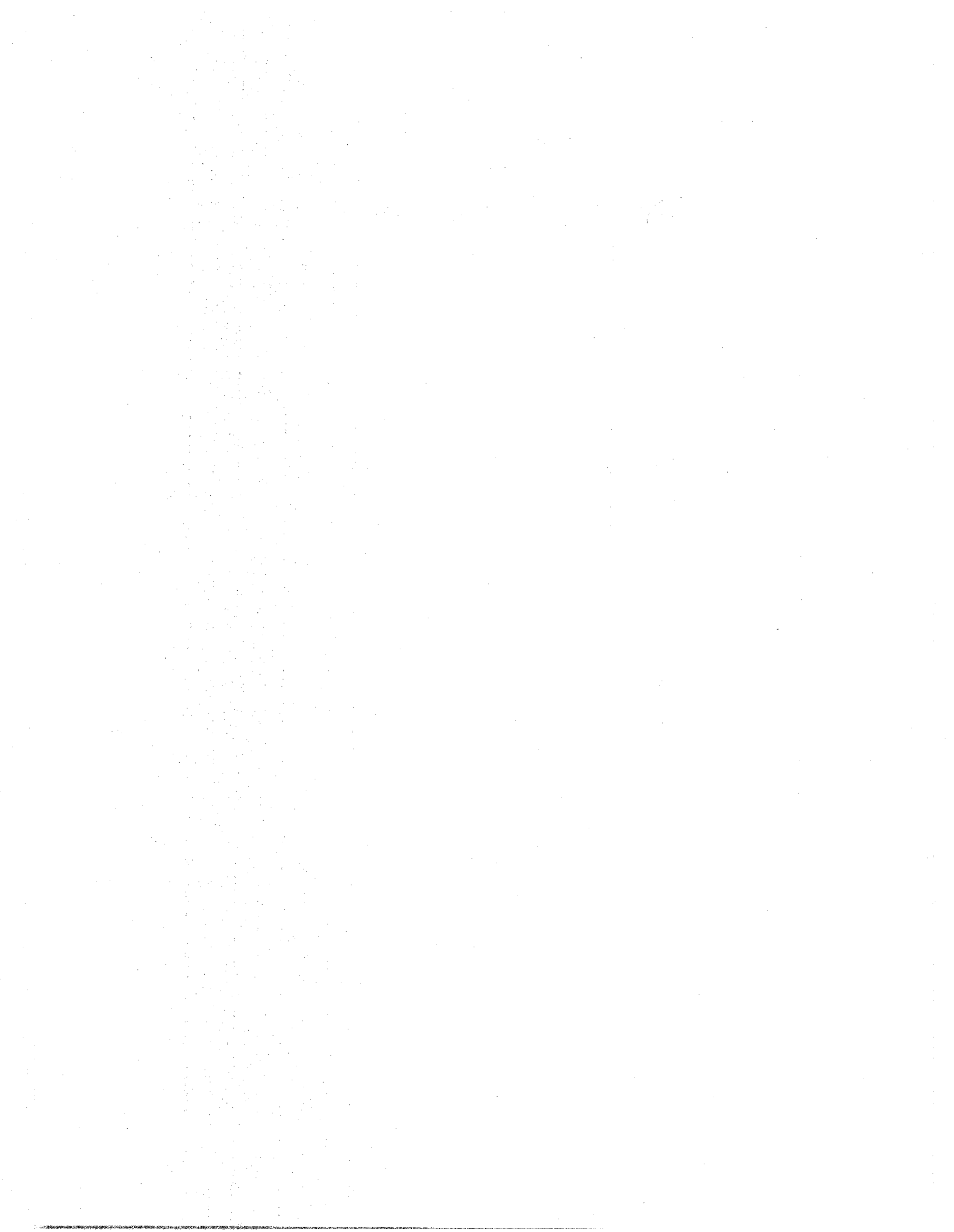
### Specimen Preparation:

A 25-mm-thick, 100-mm-diameter core is prepared for the test specimen. This sample is saturated by vacuuming 3 hours dry, then introducing the deaired water and continuing to vacuum for 1 additional hour. The vacuum is then released and the specimen is allowed to soak for an additional  $18 \pm 3$  hours.

### Testing Procedure:

The concrete specimen is placed in the triaxial cell and subjected to the confining pressure of 2 to 3 times the driving pressure. The deaired 3 percent NaCl solution is then introduced under the driving pressure. For this study, the driving pressure was 900 to 1400 psi, depending on the concrete quality. This is maintained for a period of 6 days, then the pressure is removed, the concrete is split, and one-half is sprayed with the silver nitrate solution to determine the depth of chloride penetration. The other half is saved for chloride profile grinding.

Reference: Lee, S.L., Wong, S.F., Swaddiwudhipong, S., Wee, T.H., and Loo, Y.H., 1996, "Accelerated Test of Ingress of Chloride Ions in Concrete Under Pressure and Concentration Gradients," *Magazine of Concrete Research*, Vol. 48, No. 174, pp. 15-25.



# **Appendix 3:**

## **Phase 1 Test Data**



**Phase 1: Short-Term Data**

	Units	0.50, Plain	0.45, Plain	0.35, Plain	0.45, SF	0.35, SF	0.25, SF	0.45, FA	0.45, SG
Porosity		17.1 %	19.7 %	14.9 %	21.0 %	19.8 %	14.9 %	19.3 %	20.9 %
Background Chloride	% Concrete	0.065	0.070	0.070	0.070	0.060	0.060	0.065	0.070
7 Day Strength	MPa	20.2	26.0	40.4	27.7	31.2	75.0	23.8	20.5
28 Day Strength	MPa	32.9	34.2	53.7	35.5	47.4	84.1	34.3	34.9
56 Day Strength	MPa	34.1	34.9	51.5	37.8	45.5	84.2	30.9	32.4
91 Day Strength	MPa	32.3	34.7	48.3	39.0	47.6	85.7	27.8	32.3
7 Day AASHTO T277	Coulombs	7078	8481	5169	4703	2781	1969	Hot	5685
28 Day AASHTO T277	Coulombs	4152	4875	2590	609	436	165	3773	2096
91 Day AASHTO T277	Coulombs	4845	7475	2775	443	300	164	5159	2519
1 Year AASHTO T277	Coulombs	8549	8495	5505	3736	998	241	11,102	7149
Sorptivity, Original, Soft Drying Regime	mm/min <sup>0.5</sup>	0.1101	0.1508	0.0841	0.1004	0.0623	0.0824	0.1369	0.1135
Sorptivity, Repeat, Harsh Drying Regime	mm/min <sup>0.5</sup>	0.1145	0.1106	0.0793	0.0804	0.0613	0.0548	0.1344	0.0892
Sorptivity, Repeat, Soft Drying Regime	mm/min <sup>0.5</sup>	0.1164	0.1461	0.1057	0.0673	0.0647	0.0417	0.1097	0.0946

Phase 1: Short-Term Data (continued)

	Units	0.50, Plain	0.45, Plain	0.35, Plain	0.45, SF	0.35, SF	0.25, SF	0.45, FA	0.45, SG
Migration Cell, 30 V, Breakthrough D	$10^{-12}$ m <sup>2</sup> /s	12.21	13.50	5.307	1.227	0.5406	0.201	15.53	4.912
Migration Cell, 30 V, Steady-State D	$10^{-12}$ m <sup>2</sup> /s	4.675	16.30	7.312	7.229	5.634	0.102	10.90	3.921
Migration Cell, 12 V, Breakthrough D	$10^{-12}$ m <sup>2</sup> /s	12.61	12.81	6.552	0.941	0.410	0.1208	24.56	4.732
Migration Cell, 12 V, Steady-State D	$10^{-12}$ m <sup>2</sup> /s	9.357	10.06	5.525	0.412	0.336	0.0989	8.510	2.551
CTH Cells - 30 V, 8 hr, 3 % NaCl, Depth	mm	9	14.25	7.75	2.4	0.4	0	16.0	11.25
CTH Cells - 30 V, 24 hr, 3% NaCl, Depth	mm	22.5	28.5	14.75	6.0	3.25	2.25	21.75	26.0
CTH Cells - 30 V, 72 hr, 3 % NaCl, Depth	mm	50+	50+	32.25	11.5	8.25	8.75	50+	41.5
Water, DC Resistivity	$\Omega$ -cm	9,424	8,330	11,381	58,272	101,69	133,569	8,657	9,266
Chloride, DC Resistivity	$\Omega$ -cm	2,182	7,072	4,775	5,663	4,202	13,875	2,261	4,493
Wenner Probe, 56 Days	$\Omega$ -cm	23,923	7,579	164,934	1,300,619	3,864,159	5,767,964	882,788	1,193,805
Wenner Probe, 1 year	$\Omega$ -cm	6,639	126,170	10,098	50,912	29,017	1,154,535	40,626	27,779
Pressure Penetration Depth	mm	Full Depth	Full Depth	Full Depth	8	3	1	Full Depth	Full Depth
CTH - Retest - 30V, 8hr, 10 % NaCl, Depth	mm	33.3	32.6	20.0	9.7	6.8	4.9	32.3	17.0



**Phase 1: Long-Term Values**

Concrete Mixture	Bulk Diffusion			Salt Ponding			
	D [m <sup>2</sup> /s]			"D" [m <sup>2</sup> /s]		Integrated Chloride [% concrete – mm]	Depth of 0.1 % [mm]
	40-day	90-day	365-day	90-day	365-day	90-day	90-day
0.50, Plain	1.48E-11	1.48E-11	5.79E-12	1.47E-11	1.40E-11	6.55	15.6
0.45, Plain	1.56E-11	1.72E-11	1.86E-11	1.60E-11	5.18E-12	5.59	17.4
0.35, Plain	1.37E-11	1.55E-11	1.02E-11	5.84E-12	6.72E-12	2.18	9.4
0.45, SF	2.60E-12	3.15E-12	1.49E-12	2.30E-12	8.08E-13	3.15	8.3
0.35, SF	2.51E-12	2.09E-12	1.63E-12	9.98E-13	8.08E-13	4.44	7.5
0.25, SF	2.00E-12	3.16E-13	4.05E-13	1.90E-13	1.61E-13	0.94	1.8
0.45, FA	1.56E-11	1.20E-11	5.33E-12	8.34E-12	3.52E-12	4.19	12.7
0.45, SG	8.57E-12	7.04E-12	5.25E-12	5.55E-12	1.58E-12	3.82	10.7



# **Appendix 4:**

## **Phase 1A Test Data**

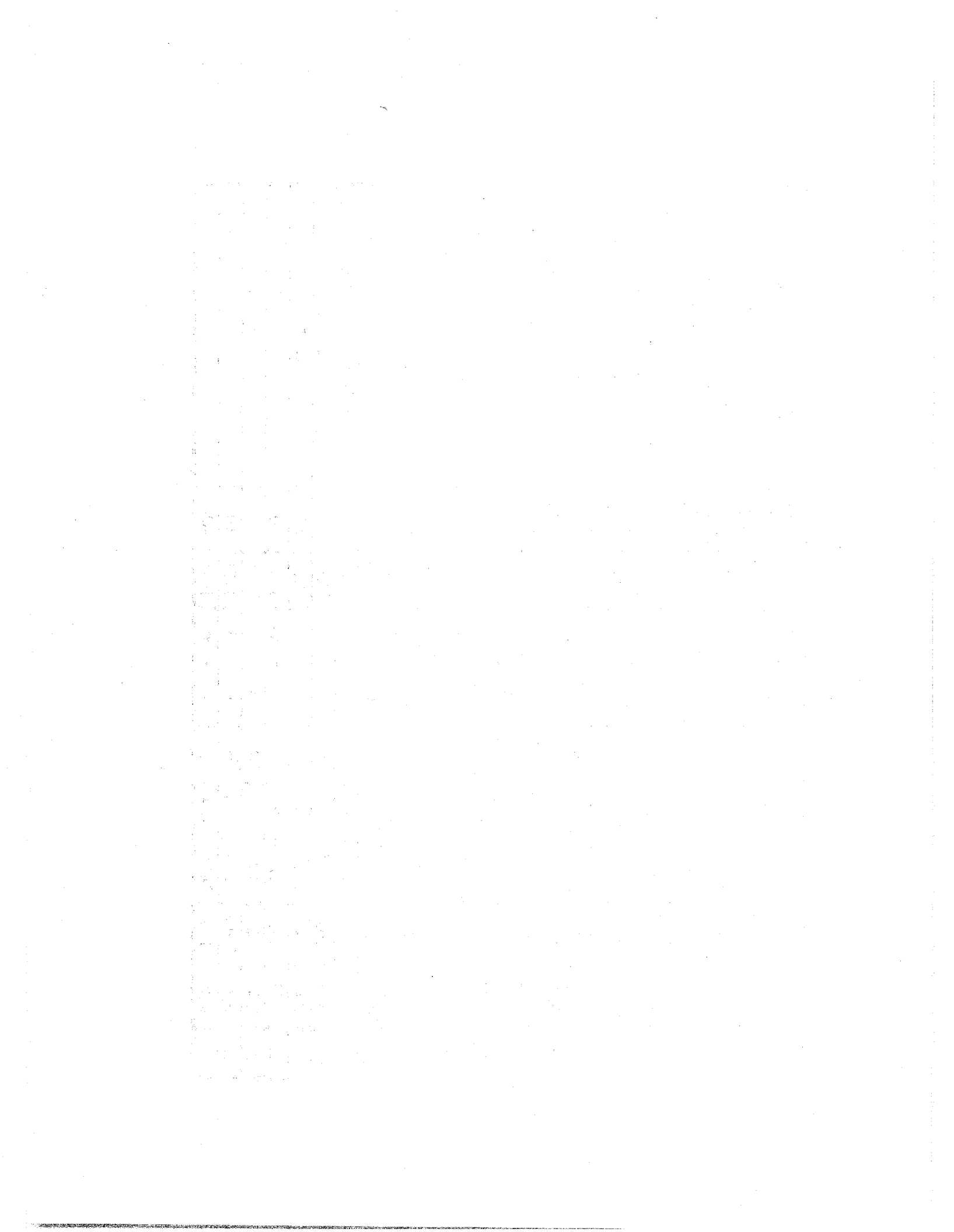


**Phase 1A: Penetration Depth for the Two Mixes Under Different CTH Testing Conditions**

Test Conditions	0.45 w/cm, Plain	0.35 w/cm, 8 % Silica Fume
10 % NaCl, 40 V, 6 hr, limewater saturated	14.3 mm	3.0 mm
10 % NaCl, 40 V, 24 hr, limewater saturated	45.8 mm, some breakthrough	5.6 mm
10 % NaCl, 40 V, 48 hr, limewater saturated	Full Depth	--
10 % NaCl, 40 V, 72 hr, limewater saturated	--	17.5 mm
10 % NaCl, 20 V, 6 hr, limewater saturated	9.6 mm	1.1 mm
10 % NaCl, 20 V, 24 hr, limewater saturated	24.2 mm	3.1 mm
10 % NaCl, 20 V, 48 hr, limewater saturated	Full Depth	--
10 % NaCl, 20 V, 72 hr, limewater saturated	--	8.0 mm
10 % NaCl, 22.5 V, 6 hr, limewater saturated	10.0 mm	--
10 % NaCl, 22.5 V, 24 hr, limewater saturated	27.2 mm	--
10 % NaCl, 22.5 V, 48 hr, limewater saturated	Full Depth	--
10 % NaCl, 22.5 V, 6 hr, water saturated	7.4 mm	--
3 % NaCl, 22.5 V, 6 hr, limewater saturated	6.7 mm	--
10 % NaCl, 22.5 V, 6 hr, limewater saturated	8.2 mm	--
10 % NaCl, 30 V, 6 hr, limewater saturated	--	2.7 mm
10 % NaCl, 30 V, 24 hr, limewater saturated	--	6.4 mm
10 % NaCl, 30 V, 72 hr, limewater saturated	--	14.2 mm
10 % NaCl, 30 V, 6 hr, water saturated	--	1.0 mm
3 % NaCl, 30 V, 6 hr, limewater saturated	--	0.7 mm
10 % NaCl, 30 V, 6 hr, limewater saturated	--	1.1 mm



# **Appendix 5: Phase 2 Test Data**





Phase 2: Mix Designs

Mix	w/cm	Water	PC	SF	FA	SG	MK	CA	Sand	Other
1	0.45	163	362.5	0	0	0	0	1025	698	
2	0.45	163	362.5	0	0	0	0	1025	698	
3	0.45	163	362.5	0	0	0	0	1025	698	
4	0.45	163	362.5	0	0	0	0	1025	698	1300 mL/100 kg Accelerator
5	0.45	163	362.5	0	0	0	0	1025	698	200 mL/100 kg Retarder
6	0.35	146	367.8	0	0	0	50.2	1025	682.5	Steel
7	0.53	199.4	374.6	0	0	0	0	1059	721.4	30 L/m <sup>3</sup> DCI
8	0.35	146	418	0	0	0	0	1025	695	30 L/m <sup>3</sup> DCI
9	0.35	146	384.6	33.4	0	0	0	1025	684	30 L/m <sup>3</sup> DCI
10	0.45	163	362.5	0	0	0	0	1025	698	20 L/m <sup>3</sup> LiNO <sub>3</sub>
11	0.45	163	362.5	0	0	0	0	1025	698	200 mL/100 kg Hydration Inhibitor
12	0.50	167	335	0	0	0	0	1025	710	
13	0.45	163	290	0	72.5	0	0	1025	682	
14	0.45	163	319	0	0	0	43.5	1025	686	
15	0.35	146	367.8	0	0	0	50.2	1025	682.5	
16	0.35	146	238.3	33.4	0	146.3	0	1025	668.5	
17	0.35	146	301	33.4	83.6	0	0	1025	660	
18	0.45	163	181.3	0	0	181.3	0	1025	680	
19	0.35	80	418	0	0	0	0	1025	540.2	124.5 kg/m <sup>3</sup> Latex
20	0.45	163	362.5	0	0	0	0	1025	698	High C <sub>3</sub> A
21	0.45	163	362.5	0	0	0	0	1025	698	Low C <sub>3</sub> A
22	0.35	146	418	0	0	0	0	1025	695	
23	0.35	146	418	0	0	0	0	1025	695	
24	0.25	139.4	513.4	44.6	0	0	0	1025	580	
25	0.35	146	384.6	33.4	0	0	0	1025	684	

**Phase 2: Data**

Mix #	Mix Components	Bulk Diffusion		Salt Ponding	
		D [m <sup>2</sup> /s]		Pseudo-D [m <sup>2</sup> /s]	Concentration at 12.7 mm [% Concrete]
		90-Day	365-Day	90-Day	90-Day
1a	0.45, 23°C	2.51E-11	9.23E-12	3.07E-11	0.22
1b	0.45, silane	3.46E-11	NA	1.56E-11	0.12
2a	0.45, 7°C	3.70E-11	1.49E-11	1.70E-11	0.22
2b	0.45, 38°C	7.92E-11	1.08E-11	5.71E-11	0.23
2c	0.45, steam	8.16E-11	2.82E-11	NA	NA
3a	0.45, steel	3.21E-11	4.11E-12	1.89E-11	0.125
3b	0.45, siloxane	2.65E-11	9.28E-12	3.28E-11	0.14
4a	0.45, accelerator, 7°C	1.14E-11	3.71E-12	1.46E-11	0.135
4b	0.45, accelerator, 23°C	1.97E-11	5.44E-12	1.92E-11	0.135
5a	0.45, retarder, 38°C	9.23E-11	9.99E-12	5.02E-11	0.235
5b	0.45, retarder, steam	4.05E-11	1.26E-11	NA	NA
5c	0.45, retarder, 23°C	1.96E-11	7.43E-12	1.57E-11	0.14
6	0.35, 12% MK, Steel	3.26E-12	9.34E-13	2.18E-12	0
7	0.45, DCI	1.82E-11	1.37E-11	4.48E-11	0.21
8	0.35, DCI	1.14E-11	3.81E-12	1.54E-11	0.14
9	0.35, 8 % SF, DCI	2.59E-12	1.99E-12	2.16E-12	0
10	0.45, LiNO <sub>3</sub>	1.99E-11	1.06E-11	9.36E-12	0.085
11	0.45, hydration inhibitor	1.45E-11	2.21E-12	1.55E-11	0.115
12	0.50, plain	3.19E-11	5.91E-12	NA	NA
13	0.45, 20 % FA	4.73E-12	2.74E-12	5.25E-12	0.075
14	0.45, 12 % MK	2.90E-12	1.91E-12	2.00E-12	0
15	0.35, 12 % MK	2.27E-12	1.05E-12	2.06E-12	0
16	0.35, 8 %SF, 35 % SG	1.74E-12	6.80E-13	9.62E-13	0
17	0.35, 8 %SF, 20 % FA	1.95E-12	7.38E-13	9.63E-13	0
18	0.45, 50 % SG	3.41E-12	3.33E-12	2.32E-12	0.035
19	0.35, Latex	6.17E-12	4.36E-12	5.63E-12	0.065
20	0.45, High C3A	7.08E-12	2.87E-12	4.95E-12	0.055
21	0.45, Low C3A	2.36E-11	9.58E-12	3.02E-11	0.135
22	0.35, steam cured	1.22E-11	4.02E-12	7.50E-12	0.04
23	0.35, plain	1.34E-11	1.70E-12	6.25E-12	0.065
24	0.25, 8 % SF	1.38E-12	4.39E-13	1.04E-12	0
25	0.35, 8 % SF	1.49E-12	1.20E-12	1.71E-12	0.01

**Phase 2: Collected Concrete Test Results - 28 Days**

Mix#	Mix Components	Strength [MPa]	AASHTO T277	AASHTO T277 (mod)	Resistivity [ $\Omega$ -cm]	CTH [mm]
1a	0.45, 23°C	22.1	5586	4022	5403	44.3
1b	0.45, silane	21.0	3801	2634	7408	35.0
2a	0.45, 7°C	15.1	11324	9698	3630	50 +
2b	0.45, 38°C	20.2	12991	9215	3248	50 +
2c	0.45, steam	25.2	8721	5474	4707	50 +
3a	0.45, steel	30.0	4789	3314	7309	*
3b	0.45, siloxane	30.0	3534	2378	9817	31.0
4a	0.45, accelerator, 7°C	24.3	5670	3927	5640	50 +
4b	0.45, accelerator, 23°C	33.0	3612	2665	**	36.4
5a	0.45, retarder, 38°C	17.3	8590	6887	3204	50 +
5b	0.45, retarder, steam	25.5	9635	5175	5193	50 +
5c	0.45, retarder, 23°C	26.6	4312	3091	7901	33.4
6	0.35, 12% MK, Steel	65.1	389	378	53732	4.6
7	0.45, DCI	29.9	10974	5756	5800	50 +
8	0.35, DCI	51	6046.5	3693	6668	24.5
9	0.35, 8 % SF, DCI	60.8	626	582	29854	4.4
10	0.45, LiNO <sub>3</sub>	29.3	3418	2587	8787	20.4
11	0.45, hydration inhibitor	31.1	3410	2699	8746	27.4
12	0.50, plain	30.5	6217	4300	6026	41.9
13	0.45, 20 % FA	32.8	2799	2221	8848	27.1
14	0.45, 12 % MK	58.6	336	326	50296	6.0
15	0.35, 12 % MK	61.1	257	252	67982	4.5
16	0.35, 8 %SF, 35 % SG	70.3	179	179	90281	1.9
17	0.35, 8 % SF, 20 % FA	51	287	276	62182	3.9
18	0.45, 50 % SG	41.1	976	925	21385	12.5
19	0.35, Latex	40.4	2229	1747	11765	17.7
20	0.45, High C3A	27.5	3189	2516	10413	19.3
21	0.45, Low C3A	20.7	4244	2308	9912	37.1
22	0.35, steam cured	45.1	3909	3197	10496	21.4
23	0.35, plain	62	3007	2492	9446	19.3
24	0.25, 8 % SF	72.4	176	176	71749	1.2
25	0.35, 8 % SF	61.7	388	364	58610	4.1

\* Invalid reading due to presence of steel.

\*\* No data

**Phase 2: Collected Concrete Test Results - 118 Days**

Mix #	Mix Components	AASHTO T277	AASHTO T277(mod)	Resistivity [ $\Omega$ -cm]	CTH [mm]
1a	0.45, 23°C	3560	2796	14766	37.5
1b	0.45, silane	3261	2372	12660	30.4
2a	0.45, 7°C	3097	2238	10892	27
2b	0.45, 38°C	8310	6123	5718	50+
2c	0.45, steam	5891	3874	9895	50+
3a	0.45, steel	2976	2221	10277	*
3b	0.45, siloxane	2264	1624	13758	27.6
4a	0.45, accelerator, 7°C	2115	1703	10623	18.8
4b	0.45, accelerator, 23°C	2776	2143	8916	29.2
5a	0.45, retarder, 38°C	5588	3498	5061	50+
5b	0.45, retarder, steam	10829	6887	6255	50+
5c	0.45, retarder, 23°C	2395	1792	20018	26.1
6	0.35, 12% MK, Steel	180	179	138826	7.1
7	0.45, DCI	9398(e)	5325	5941	50+
8	0.35, DCI	3221	2255	10909	16.4
9	0.35, 8 % SF, DCI	384	372	42259	3.3
10	0.45, LiNO <sub>3</sub>	2013	1565	13355	16.5
11	0.45, hydration inhibitor	2310	1801	16403	21.2
12	0.50, plain	2939	2309	10458	31.6
13	0.45, 20 % FA	726	629	27609	7.9
14	0.45, 12 % MK	290	274	58025	3.4
15	0.35, 12 % MK	190	188	94351	1.6
16	0.35, 8 %SF, 35 % SG	147	145	112391	1.7
17	0.35, 8 % SF, 20 % FA	131	131	108512	2.5
18	0.45, 50 % SG	614	607	35437	10.2
19	0.35, Latex	1106	916	17480	10.9
20	0.45, High C3A	1413	1221	15514	12.5
21	0.45, Low C3A	2468	1845	9485	27.5
22	0.35, steam cured	2111	1679	16356	16.2
23	0.35, plain	1590	1317	17769	10.6
24	0.25, 8 % SF	154	159	92219	1.7
25	0.35, 8 % SF	338	318	51389	5.9

\* Invalid reading due to presence of steel.  
(e) extrapolated data due to overheating.

**Phase 2: Collected Concrete Test Results - 393 Days**

Mix #	Mix Components	AASHTO T277	AASHTO T277(mod)	Resistivity [ $\Omega$ -cm]	CTH [mm]
1a	0.45, 23°C	3379	2472	12625	42.8
1b	0.45, silane	-	-	17228	36.7
2a	0.45, 7°C	3126	2176	12440	28.4
2b	0.45, 38°C	5874	3248	7083	50+
2c	0.45, steam	7524	4088	8075	50+
3a	0.45, steel	-	-	16901	??
3b	0.45, siloxane	-	-	20772	30.1
4a	0.45, accelerator, 7°C	-	-	16636	23.2
4b	0.45, accelerator, 23°C	-	-	18938	27.9
5a	0.45, retarder, 38°C	-	-	9281	50+
5b	0.45, retarder, steam	-	-	7853	50+
5c	0.45, retarder, 23°C	-	-	13631	29.3
6	0.35, 12% MK, Steel	149	148	126278	2.3
7	0.45, DCI	10560(e)	7090	5533	50+
8	0.35, DCI	2798	2071	13613	13.3
9	0.35, 8 % SF, DCI	465	452	48869	3.5
10	0.45, LiNO <sub>3</sub>	1907	1525	15396	16.4
11	0.45, hydration inhibitor	2447	2026	14025	22.3
12	0.50, plain	2528	1896	13545	32.0
13	0.45, 20 % FA	426	386	50121	8.8
14	0.45, 12 % MK	294	268	81656	6.0
15	0.35, 12 % MK	205	186	114280	1.5
16	0.35, 8 %SF, 35 % SG	140	131	110952	2.4
17	0.35, 8 % SF, 20 % FA	169	161	122629	2.1
18	0.45, 50 % SG	293	276	47767	6.0
19	0.35, Latex	1134	823	17042	12.4
20	0.45, High C3A	1656	1374	19123	14.9
21	0.45, Low C3A	3230	2063	12556	30.6
22	0.35, steam cured	2298	1770	15178	13.5
23	0.35, plain	1214	1107	25209	9.0
24	0.25, 8 % SF	-	-	104421	2.7
25	0.35, 8 % SF	481	458	51070	3.3

\* Invalid reading due to presence of steel.

(e) extrapolated data due to overheating.



# **Appendix 6:**

## **Phase 3 Test Data**





**Phase 3: Mix Designs and Fresh Concrete Properties**

	0.55, Plain	0.45, Plain	0.40, Plain	0.35, Plain	0.45, SF	0.35, SF	0.40, FA	0.40, SG	0.45, DCI	0.45, SF,FA	0.35, SF,FA	0.45, Steel
w/cm	0.55	0.45	0.40	0.35	0.45	0.35	0.40	0.40	0.45	0.45	0.35	0.45
Cement (kg/m <sup>3</sup> )	300.0	362.5	375	418.0	333.5	384.6	300	243.7	362.5	266.8	307.6	362.5
Silica Fume (kg/m <sup>3</sup> )	0	0	0	0	29.0 (8%)	33.4 (8%)	0	0	0	23.2 (6.4%)	26.8 (6.4%)	0
Fly Ash (kg/m <sup>3</sup> )	0	0	0	0	0	0	75.0 (20%)	0	0	72.5 (20%)	83.6 (20%)	0
Slag (kg/m <sup>3</sup> )	0	0	0	0	0	0	0	131.3 (35%)	0	0	0	0
Water (kg/m <sup>3</sup> )	165.0	163.0	150	146.0	163.0	146.0	150.0	150.0	163.0	163.0	146.0	163
Coarse Aggregate (kg/m <sup>3</sup> )	1025	1025	1025	1025	1025	1025	1025	1025	1025	1025	1025	1025
Fine Aggregate (kg/m <sup>3</sup> )	739	698	715	695	681	681	700	707.2	698	668.2	662.3	698
ProAir Air Entrainer (mL/ 100 kg)	30.0	35.6	44.4	37.2	45.0	45.0	50.0	45.0	45.0	50.0	50.0	50.0
25XL Water Reducer (mL/100 kg)	0	0	250	250	250	250	150	250	0	250	250	0
SPN Superplasticizer (mL/ 100 kg)	0	0	0	399	306	1329	0	0	0	184	372	0
Slump (mm)	150	145	105	100	100	210	110	95	95	125	105	195
Air Content (%)	4.5	5.5	7.5	4	5	2	7	7.5	5	6	6.5	7.5
Plastic Density (kg/m <sup>3</sup> )	2394	2352	2352	2437	2352	2493	2296	2366	2394	2352	2380	2257

\* Mix 0.45, DCI contained in addition, 30 L/m<sup>3</sup> of corrosion inhibitor. Mix 0.45, steel contained pieces of 20M steel through the midpoint of the samples.

Phase 3: Test Results

		0.55, Plain	0.45, Plain	0.40, Plain	0.35, Plain	0.45, SF	0.35, SF	0.40, FA	0.40, SG	0.45, DCI	0.45, SF,FA	0.35, SF,FA	0.45, Steel
Background	%	0.078	0.043	0.045	0.078	0.060	0.068	0.065	0.075	0.078	0.073	0.073	0.070
90-Day Bulk Diffusion D	$10^{-12}$ m <sup>2</sup> /s	30.0	28.2	11.3	12.4	3.08	2.00	8.62	2.88	12.7	3.20	2.94	48.1
90-Day Salt Ponding "D"	$10^{-12}$ m <sup>2</sup> /s	13.9	13.7	10.3	5.72	NA	1.00	4.60	2.44	18.2	1.38	0.753	NA
90-Day Salt Ponding - Concentration at 12.7 mm	%	0.19	0.19	0.17	0.09	NA	0.01	0.07	0.02	0.21	0	0	NA
AASHTO T277	C	7846	5557	3369	3039	867	315	2864	1713	9874	738	509	5781
Modified AASHTO T277	C	5086	3721	2495	2450	750	305	1629	1384	5751	625	467	3641
Resistivity	$\Omega$ -cm	8896	9182	9368	19089	33007	72699	13654	17457	5235	41461	53418	11813
RMT - Rate of Penetration	mm/V-hr	0.0569	0.0539	0.0277	0.0297	0.0071	0.0021	0.0238	0.0142	0.0403	0.0074	0.0041	NA
RMT - Constant	mm	4.2	-3.6	5.2	0.1	3.8	9.3	3.4	2.0	0.0	5.0	2.9	NA
RMT - r <sup>2</sup>		0.9639	0.9538	0.9935	0.9670	0.9963	NA	0.9992	0.9655	0.9812	NA	0.9098	NA
Pressure Penetration - 7-day Depth	mm	7.1	6.8	-	-	-	-	-	-	-	1.2	2.6	-
Pressure Penetration - 35-day Depth	mm	16.7	12.1	-	-	-	0	-	-	-	2.6	2.7	-

Sample ID: FH-3-0.55, Plain  
Date: 07-Sep-99

Operator: KS  
Age: 28 Days

Sample	Length [mm]	Diameter [mm]	Current @ 30 V [mA]	Start Temperature	End Temperature	Start Time	End Time
1	49.6	100.38	82.9	20.5	20.5	09/07/9:53	09/08/9:53
2	49.77	100.15	88.1	20.5	20	09/07/9:53	09/09/9:53
3	48.73	100.22	94.8	20.5	19	09/07/9:53	09/10/9:53

Test Conditions

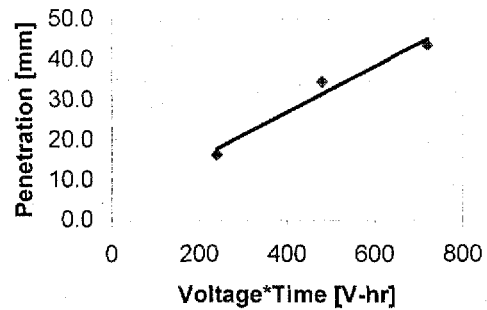
Sample	Applied Voltage [V]	Initial Current [mA]	Final Current [mA]	Test Duration [hr]
1	10	24.4	23.7	24
2	10	26.3	25.7	48
3	10	28.1	26.3	72

Penetration Measurements

Distance From Edge	Sample 1	Sample 2	Sample 3
20 mm	16	32	45
30 mm	16	35	45
40 mm	17	32	40
50 mm	15	36	44
60 mm	17	37	46
70 mm	16	35	42
80 mm	17		43
Average:	16.3	34.5	43.6

Evaluation

Sample	Voltage*Time	Penetration
1	240	16.3
2	480	34.5
3	720	43.6



**RESULTS**

Rate of Penetration: 0.05685 mm/(V-hr)  
Constant: 4.2 mm  
Correlation: 0.9639

Sample ID: FH-3-0.45, Plain  
Date: 09-Sep-99

Operator: KS  
Age: 28 Days

Sample	Length [mm]	Diameter [mm]	Current @ 30 V [mA]	Start Temperature	End Temperature	Start Time	End Time
1	49.86	102.8	72.2	20.5	20	09/09/11:29	09/10/11:29
2	49.58	100.85	73.7	20.5	19.5	09/09/11:29	09/11/11:29
3	49.59	103.06	74.9	20.5	19.5	09/09/11:29	09/12/11:29

Test Conditions

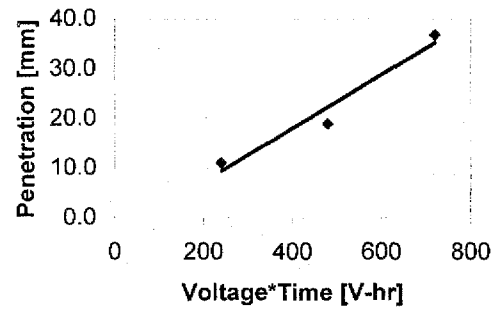
Sample	Applied Voltage [V]	Initial Current [mA]	Final Current [mA]	Test Duration [hr]
1	10	21.3	21.2	24
2	10	21.3	22.9	48
3	10	21.9	22.9	72

Penetration Measurements

Distance From Edge	Sample 1	Sample 2	Sample 3
20 mm	9	20	37
30 mm	10	17	42
40 mm	13	18	39
50 mm	11	18	36
60 mm	7	21	36
70 mm	14	20	35
80 mm	13	19	33
Average:	11.0	19.0	36.9

Evaluation

Sample	Voltage*Time	Penetration
1	240	11.0
2	480	19.0
3	720	36.9



**RESULTS**

Rate of Penetration: 0.05387 mm/(V-hr)  
Constant: -3.6 mm  
Correlation: 0.9538

Sample ID: FH-3-0.40, Plain  
 Date: 15-Sep-99

Operator: KS  
 Age: 28 Days

Sample	Length [mm]	Diameter [mm]	Current @ 30 V [mA]	Start Temperature	End Temperature	Start Time	End Time
1	49.38	102.37	73.2	19.5	20	09/15/10:53	09/16/10:53
2	51.88	101.15	63.9	19.5	19.5	09/15/10:53	09/17/10:53
3	50.49	102.15	67.2	19.5	19.5	09/15/10:53	09/18/10:53

Test Conditions

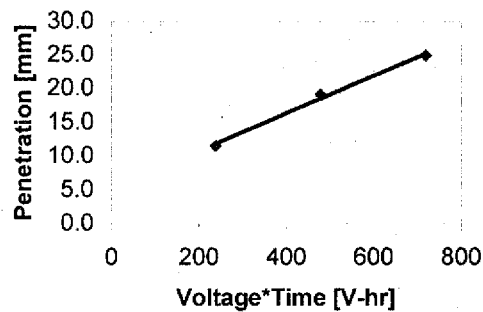
Sample	Applied Voltage [V]	Initial Current [mA]	Final Current [mA]	Test Duration [hr]
1	10	23.2	20.5	24
2	10	19.2	18	48
3	10	19.3	19.6	72

Penetration Measurements

Distance From Edge	Sample 1	Sample 2	Sample 3
20 mm	11	20	23
30 mm	11	18	25
40 mm	10	19	25
50 mm	13	18	22
60 mm	11	21	24
70 mm	14	19	27
80 mm	11	19	28
Average:	11.6	19.1	24.9

Evaluation

Sample	Voltage*Time	Penetration
1	240	11.6
2	480	19.1
3	720	24.9



**RESULTS**

Rate of Penetration: 0.02768 mm/(V-hr)  
 Constant: 5.2 mm  
 Correlation: 0.9935

Sample ID: FH-3-0.35, Plain  
 Date: 13-Sep-99

Operator: KS  
 Age: 28 Days

Sample	Length [mm]	Diameter [mm]	Current @ 30 V [mA]	Start Temperature	End Temperature	Start Time	End Time
1	50.96	102.94	58.6	20	20	09/13/10:42	09/14/10:42
2	51.61	102.78	36.9	20	20	09/13/10:42	09/15/10:42
3	51.47	102.09	63.8	20	20	09/13/10:42	09/16/10:42

Test Conditions

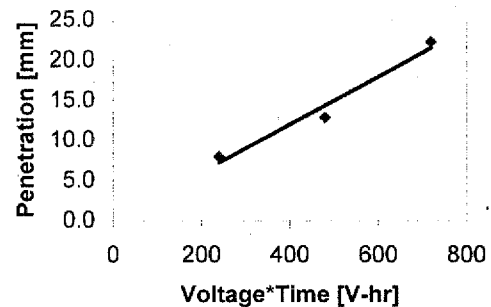
Sample	Applied Voltage [V]	Initial Current [mA]	Final Current [mA]	Test Duration [hr]
1	10	17	12	24
2	10	19.8	16	48
3	10	19.9	15.6	72

Penetration Measurements

Distance From Edge	Sample 1	Sample 2	Sample 3
20 mm	9	11	20
30 mm	14	14	21
40 mm	4	12	20
50 mm	4	13	24
60 mm	8	14	25
70 mm	6	13	25
80 mm	11	13	21
Average:	8.0	12.9	22.3

Evaluation

Sample	Voltage*Time	Penetration
1	240	8.0
2	480	12.9
3	720	22.3



**RESULTS**

Rate of Penetration: 0.02976 mm/(V-hr)  
 Constant: 0.1 mm  
 Correlation: 0.9670

Sample ID: FH-3-0.45-SF  
 Date: 28-Sep-99

Operator: KS  
 Age: 28 days

Sample	Length [mm]	Diameter [mm]	Current @ 30 V [mA]	Start Temperature	End Temperature	Start Time	End Time
1	48.54	101.72	33.5	20.5	21	09/28/9:22	09/29/9:22
2	50.16	101.01	19.8	20.5	19.5	09/28/9:22	10/01/9:22
3	49.45	100.67	19.3	20.5	20	09/28/9:22	10/03/9:22

Test Conditions

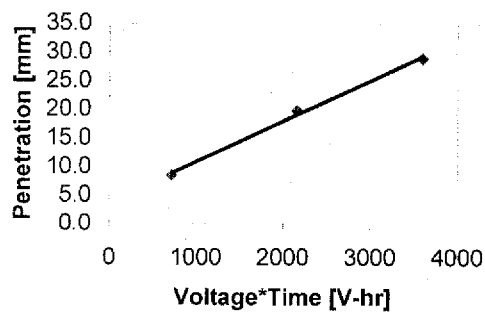
Sample	Applied Voltage [V]	Initial Current [mA]	Final Current [mA]	Test Duration [hr]
1	30	33.5	39.6	24
2	30	19.8	27.7	72
3	30	19.3	31.1	120

Penetration Measurements

Distance From Edge	Sample 1	Sample 2	Sample 3
20 mm	11	20	34
30 mm	10	22	31
40 mm	8	20	28
50 mm	9	19	25
60 mm	8	18	26
70 mm	7	19	27
80 mm	7	21	32
Average:	8.6	19.9	29.0

Evaluation

Sample	Voltage*Time	Penetration
1	720	8.6
2	2160	19.9
3	3600	29.0



**RESULTS**

Rate of Penetration: 0.00709 mm/(V-hr)  
 Constant: 3.8 mm  
 Correlation: 0.9963

Sample ID: FH-3-0.35-SF  
Date: 21-Sep-99

Operator: KS  
Age: 28 Days

Sample	Length [mm]	Diameter [mm]	Current @ 30 V [mA]	Start Temperature	End Temperature	Start Time	End Time
1	49.2	100.76	10.6	19	20	09/21/2:11	09/23/2:11
2	50.72	101.59	12.1	19	20	09/21/2:11	09/25/2:11
3	47.92	100.41	16.5	19	20	09/21/2:11	09/26/12:48

Test Conditions

Sample	Applied Voltage [V]	Initial Current [mA]	Final Current [mA]	Test Duration [hr]
1	40	14.4	14.2	48
2	40	16.3	23.2	96
3	40	22.9	48.5	118.6

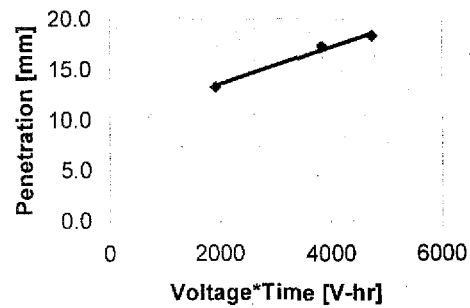
Penetration Measurements

Distance From Edge	Sample 1	Sample 2	Sample 3
20 mm	11	17	50+
30 mm	17	19	18
40 mm	13	19	19
50 mm	14	19	15
60 mm	13	16	25
70 mm	13	14	17
80 mm	12		16
Average:	13.3	17.3	18.3

Sample 3 had complete penetration on one side, but little penetration on the other. It was discarded from the analysis.

Evaluation

Sample	Voltage*Time	Penetration
1	1920	13.3
2	3840	17.3
3	4744	18.3



**RESULTS**

Rate of Penetration: 0.00210 mm/(V-hr)  
Constant: 9.3 mm  
Correlation: NA



Sample ID: FH-3-0.45-DCI  
 Date: 03-Oct-99

Operator: KS  
 Age: 28 Days

Sample	Length [mm]	Diameter [mm]	Current @ 30 V [mA]	Start Temperature	End Temperature	Start Time	End Time
1	50.18	101.37	124	20	20	10/03/10:34	10/04/10:34
2	50.45	100.85	113	20	20	10/03/10:34	10/05/10:42
3	50.96	100.88	109	20	20	10/03/10:34	10/06/4:11

Test Conditions

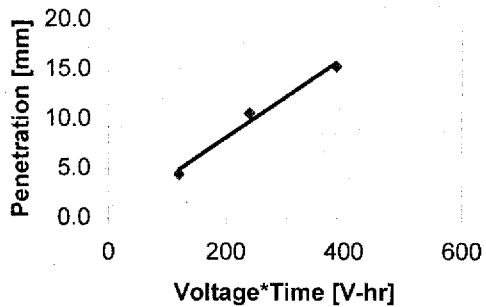
Sample	Applied Voltage [V]	Initial Current [mA]	Final Current [mA]	Test Duration [hr]
1	5	13.7	11.9	24
2	5	13.3	12	48
3	5	12.4	11.2	77.6

Penetration Measurements

Distance From Edge	Sample 1	Sample 2	Sample 3
20 mm	4	11	18
30 mm	5	9	13
40 mm	4	9	14
50 mm		14	14
60 mm	5	10	13
70 mm	4	11	17
80 mm		10	18
Average:	4.4	10.6	15.3

Evaluation

Sample	Voltage*Time	Penetration
1	120	4.4
2	240	10.6
3	388	15.3



**RESULTS**

Rate of Penetration: 0.04028 mm/(V-hr)  
 Constant: 0.0 mm  
 Correlation: 0.9812

Sample ID: FH-3-0.40, Slag  
Date: 23-Sep-99

Operator: KS  
Age: 28 Days

Sample	Length [mm]	Diameter [mm]	Current @ 30 V [mA]	Start Temperature	End Temperature	Start Time	End Time
1	50.01	100.47	36.6	20	20	09/23/1:02	09/24/1:02
2	50.1	100.1	36.8	20	20	09/23/1:02	09/25/1:02
3	48.55	100.64	46.1	20	20	09/23/1:02	09/26/1:02

Test Conditions

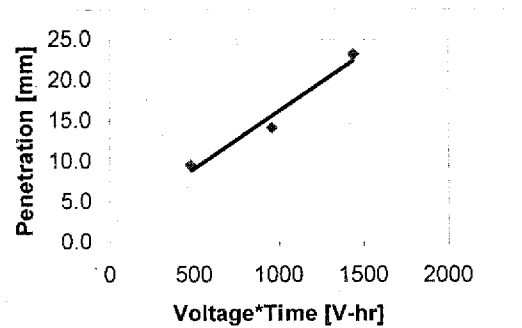
Sample	Applied Voltage [V]	Initial Current [mA]	Final Current [mA]	Test Duration [hr]
1	20	23.6	23.4	24
2	20	24.3	26.7	48
3	20	29.8	39.6	72

Penetration Measurements

Distance From Edge	Sample 1	Sample 2	Sample 3
20 mm	11	11	22
30 mm	8	10	23
40 mm	11	11	24
50 mm	10	20	24
60 mm	10	20	20
70 mm	11	16	26
80 mm	6	11	
Average:	9.6	14.1	23.2

Evaluation

Sample	Voltage*Time	Penetration
1	480	9.6
2	960	14.1
3	1440	23.2



RESULTS

Rate of Penetration: 0.01416 mm/(V-hr)  
Constant: 2.0 mm  
Correlation: 0.9655

Sample ID: FH-3-0.40-FA  
Date: 18-Oct-99

Operator: KS  
Age: 28 Days

Sample	Length [mm]	Diameter [mm]	Current @ 30 V [mA]	Start Temperature	End Temperature	Start Time	End Time
1	50.21	100.74	47.8	20	19	10/18/9:52	10/19/9:52
2	50.29	100.68	47.9	20	19.5	10/18/9:52	10/20/10:40
3	50.24	100.89	51.9	20	19.5	10/18/9:52	10/21/9:52

Test Conditions

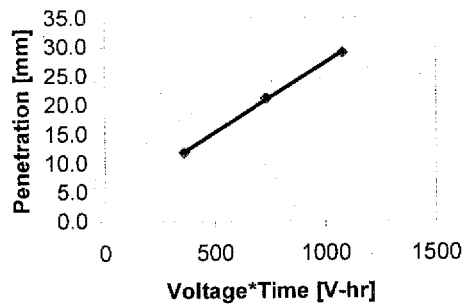
Sample	Applied Voltage [V]	Initial Current [mA]	Final Current [mA]	Test Duration [hr]
1	15	22.6	22.1	24
2	15	22.5	21.4	48.8
3	15	24.5	25.1	72

Penetration Measurements

Distance From Edge	Sample 1	Sample 2	Sample 3
20 mm	11	21	31
30 mm	12	22	27
40 mm	12	21	28
50 mm	11	22	28
60 mm	13	20	31
70 mm	12	20	30
80 mm	12	22	28
Average:	11.9	21.1	29.0

Evaluation

Sample	Voltage*Time	Penetration
1	360	11.9
2	732	21.1
3	1080	29.0



**RESULTS**

Rate of Penetration: 0.02382 mm/(V-hr)  
Constant: 3.4 mm  
Correlation: 0.9992

Sample ID: FH-3-0.45-SF,FA  
 Date: 12-Oct-99

Operator: KS  
 Age: 28 Days

Sample	Length [mm]	Diameter [mm]	Current @ 30 V [mA]	Start Temperature	End Temperature	Start Time	End Time
1	47.94	100.6	30.3	20	20	10/12/10:27	10/13/10:27
2	46.33	100.5	17.7	20	20	10/12/10:27	10/17/10:27
3	48.49	101.76	19.6	20	20	10/12/10:27	??

**Test Conditions**

Sample	Applied Voltage [V]	Initial Current [mA]	Final Current [mA]	Test Duration [hr]
1	30	30.3	41.8	24
2	30	17.7	35.4	120
3	30	19.6	???	

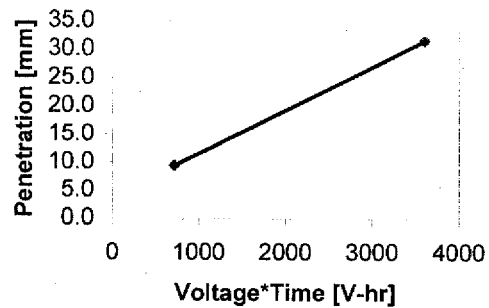
**Penetration Measurements**

Distance From Edge	Sample 1	Sample 2	Sample 3
20 mm	7	20	
30 mm	11	28	
40 mm	18	31	
50 mm	1	26	
60 mm	12	41	
70 mm	9	43	
80 mm	8	32	
Average:	9.4	31.6	

Sample 3 was prematurely disconnected.  
 No results for that sample.

**Evaluation**

Sample	Voltage*Time	Penetration
1	720	9.4
2	3600	31.6
3		



**RESULTS**

Rate of Penetration: 0.00740 mm/(V-hr)  
 Constant: 5.0 mm  
 Correlation: NA

Sample ID: FH-3-0.35-SF,FA  
 Date: 25-Oct-99

Operator: KS  
 Age: 28 Days

Sample	Length [mm]	Diameter [mm]	Current @ 30 V [mA]	Start Temperature	End Temperature	Start Time	End Time
1	48.96	102.69	13.7	21	20.5	10/25/10:58	10/26/10:58
2	49.58	100.89	24.2	21	20	10/25/10:58	10/27/10:58
3	49.76	100.95	28.1	21	21	10/25/10:58	10/29/10:58

Test Conditions

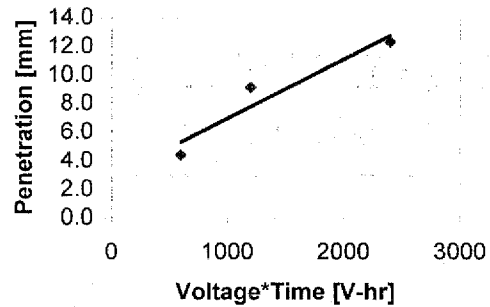
Sample	Applied Voltage [V]	Initial Current [mA]	Final Current [mA]	Test Duration [hr]
1	25	12.6	13	24
2	25	19.7	24.3	48
3	25	23.1	27.3	96

Penetration Measurements

Distance From Edge	Sample 1	Sample 2	Sample 3
20 mm	5	9	12
30 mm	4	7	17
40 mm	4	8	15
50 mm	4	6	12
60 mm	5	12	8
70 mm	4	11	8
80 mm	5	11	14
Average:	4.4	9.1	12.3

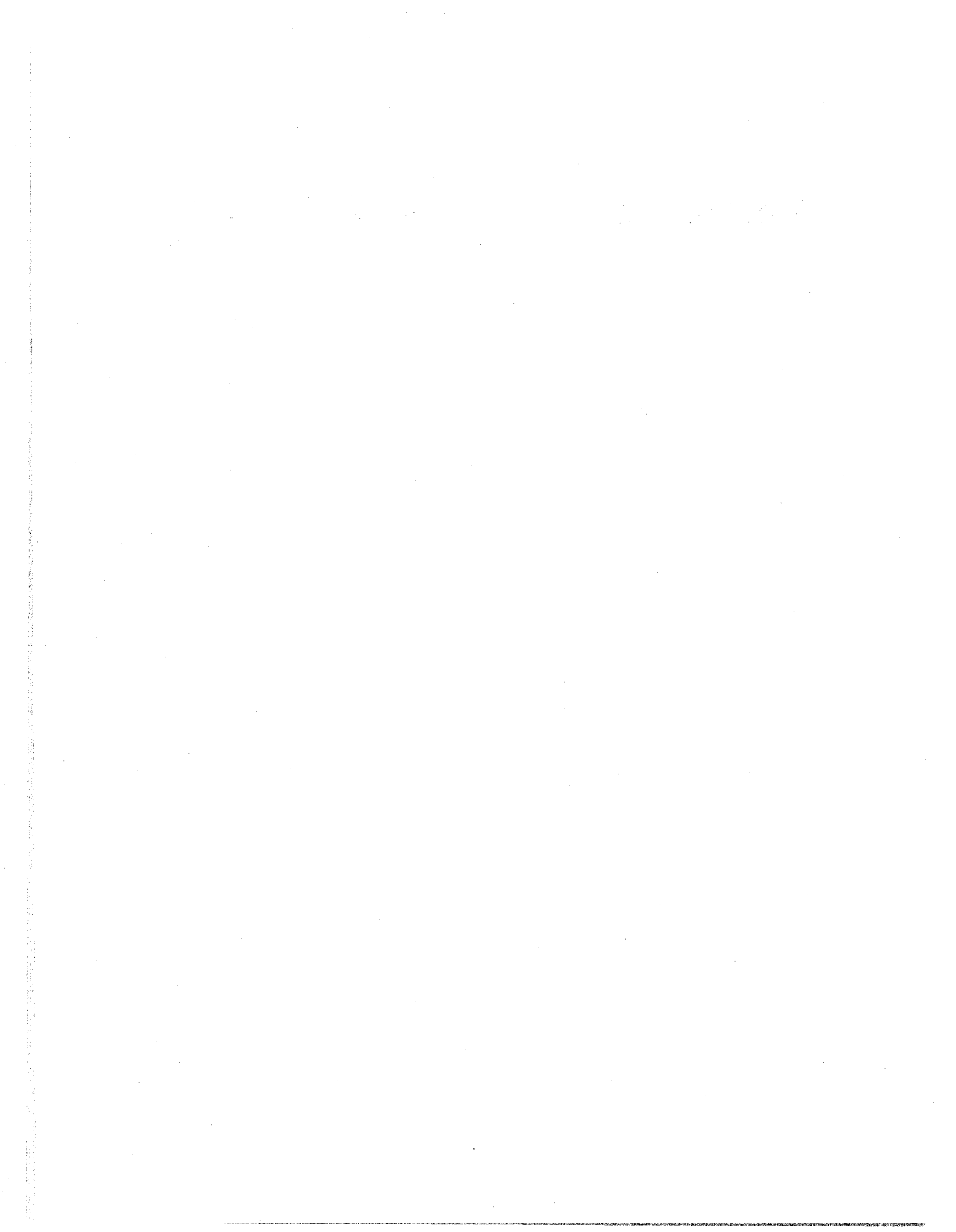
Evaluation

Sample	Voltage*Time	Penetration
1	600	4.4
2	1200	9.1
3	2400	12.3



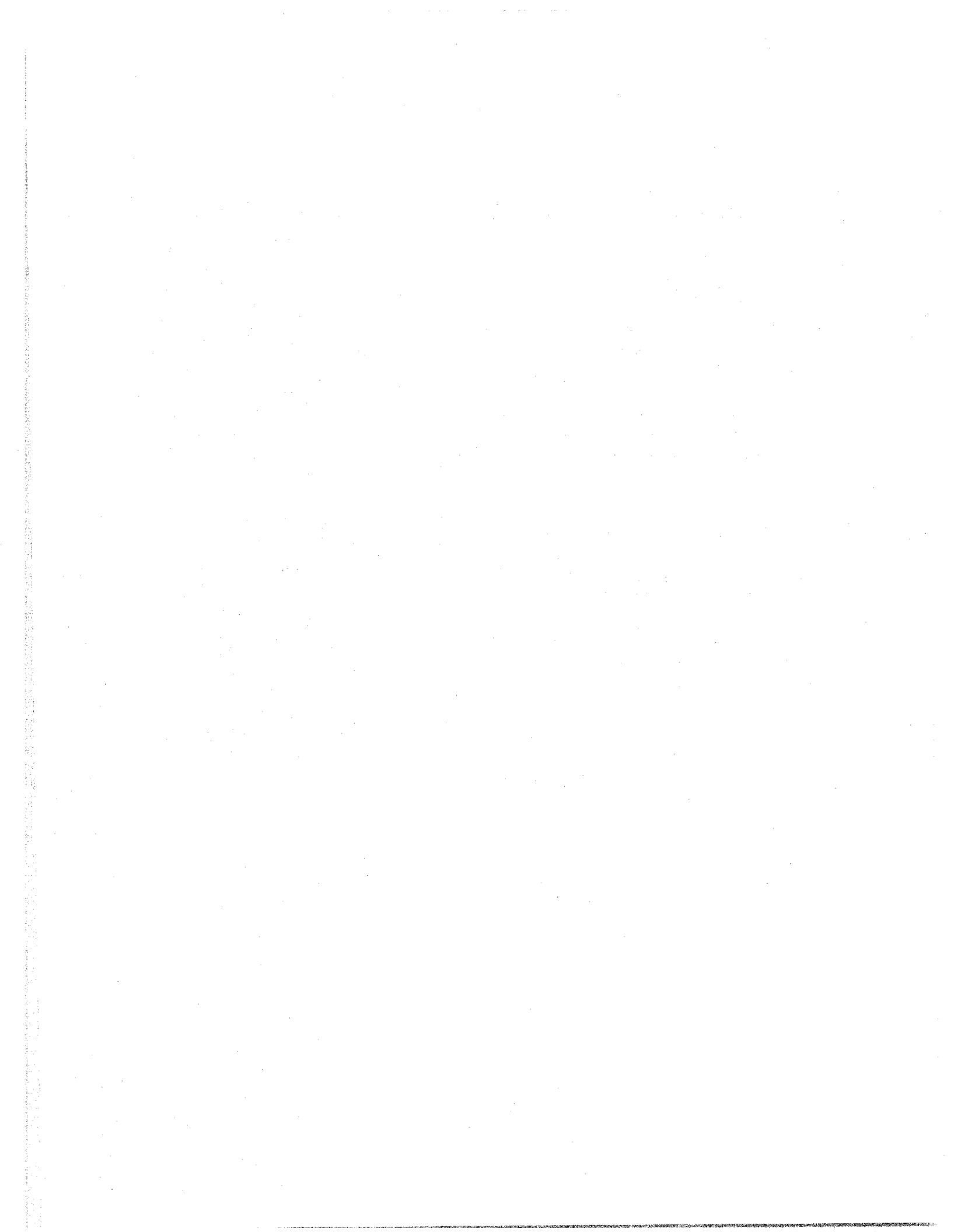
**RESULTS**

Rate of Penetration: 0.00412 mm/(V-hr)  
 Constant: 2.9 mm  
 Correlation: 0.9098



# **Appendix 7:**

## **Interlaboratory Evaluation Results**





**Interlaboratory Mix #1 – AASHTO T277 Results (After Adjustment)**

	Sample 1	Sample 2	Sample 3	Average
FHWA	5947	7581	7049	6859
VTRC	5078	4510	4686	4758
TxDOT	Too Hot	Too Hot	Too Hot	Too Hot
MTO	5966	4721	5100	5262
UofT	8770	9038	Too Hot	8904

\* The FHWA and VTRC results were adjusted at the University of Toronto in accordance with ASTM C1202 assuming a sample diameter of 100 mm. The remaining measurements were adjusted at the originating labs with the actual sample diameters.

**Interlaboratory Mix #2 – AASHTO T277 Results (After Adjustment)**

	Sample 1	Sample 2	Sample 3	Average
FHWA	841	800	914	852
VTRC	680	669	637	662
TxDOT	690	732	684	702
MTO	200	436	580	405
UofT	544	560	548	551

\* The FHWA and VTRC results were adjusted at the University of Toronto in accordance with ASTM C1202 assuming a sample diameter of 100 mm. The remaining measurements were adjusted at the originating labs with the actual sample diameters.

**Interlaboratory Mix #1 – Modified AASHTO T277 Results (After Adjustment)**

	Sample 1	Sample 2	Sample 3	Average
FHWA	5123	4484	5166	4924
VTRC	4976	4709	4662	4782
TxDOT	4490	4922	4418	4610
MTO	NA	NA	NA	NA
UofT	5269	5432	4859	5187

\* These numbers are calculated by taking the 30-minute charge passed, multiplying by 12 and applying the diameter adjustment outlined in ASTM C202. The FHWA and VTRC results were adjusted at the University of Toronto assuming a sample diameter of 100 mm. The remaining measurements were adjusted at the originating labs with the actual sample diameters.

**Interlaboratory Mix #2 – Modified AASHTO T277 Results (After Adjustment)**

	Sample 1	Sample 2	Sample 3	Average
FHWA	877	758	823	819
VTRC	826	669	768	754
TxDOT	691	709	685	695
MTO	NA	NA	NA	NA
UofT	521	532	516	523

\* These numbers are calculated by taking the 30-minute charge passed, multiplying by 12 and applying the diameter adjustment outlined in ASTM C202. The FHWA and VTRC results were adjusted at the University of Toronto assuming a sample diameter of 100 mm. The remaining measurements were adjusted at the originating labs with the actual sample diameters.

Sample ID: ILE 1  
 Date: 15-Feb-00

Operator: FHWA  
 Age: 28 Days

Sample	Length [mm]	Diameter [mm]	Current @ 30 V [mA]	Start Temperature	End Temperature	Start Time	End Time
1			0.149	20.5			
2			0.132	20.5			
3			0.13	20.5			

Test Conditions

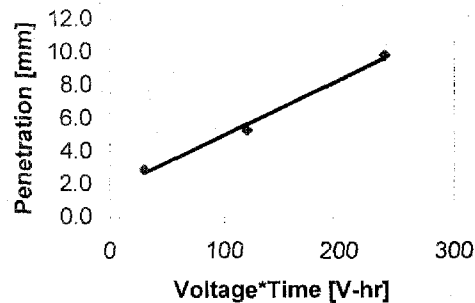
Sample	Applied Voltage [V]	Initial Current [mA]	Final Current [mA]	Test Duration [hr]
1	5	0.022	0.014	6
2	5	0.022	0.013	24
3	5	0.022	0.013	48

Penetration Measurements

Distance From Edge	Sample 1	Sample 2	Sample 3
20 mm			
30 mm			
40 mm			
50 mm			
60 mm			
70 mm			
80 mm			
Average:	2.9	5.3	9.8

Evaluation

Sample	Voltage*Time	Penetration
1	30	2.9
2	120	5.3
3	240	9.8



**RESULTS**

Rate of Penetration: 0.03311 mm/(V-hr)  
 Constant: 1.7 mm  
 Correlation: 0.9916

Sample ID: ILE-1  
Date: 15/02/00

Operator: VTRC  
Age: 28 days

Sample	Length [mm]	Diameter [mm]	Current @ 30 V [mA]	Start Temperature	End Temperature	Start Time	End Time
1	51	101	130	68.7	65.5	2-15 9.10	2-16 9.10
2	51	102	106	68.9	65.2	2-15 9.10	2-17 9.10
3	52	100	106	68.9	64.9	2-15 9.10	2-18 9.10

Test Conditions

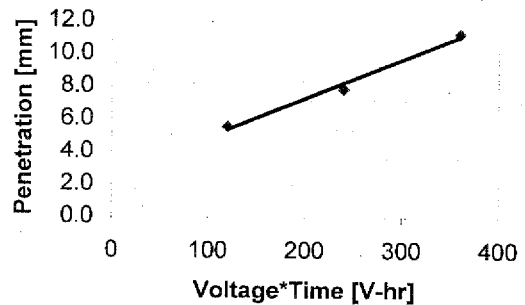
Sample	Applied Voltage [V]	Initial Current [mA]	Final Current [mA]	Test Duration [hr]
1	5	17	12.98	24
2	5	14	10.47	48
3	5	14	10.35	72

Penetration Measurements

Distance From Edge	Sample 1	Sample 2	Sample 3
20 mm	6	8	9
30 mm	6	7	10
40 mm	5	8	16
50 mm	5	8	15
60 mm	5	8	9
70 mm	6	8	10
80 mm	6	8	10
Average:	5.6	7.9	11.3

Evaluation

Sample	Voltage*Time	Penetration
1	120	5.6
2	240	7.9
3	360	11.3



**RESULTS**

Rate of Penetration: 0.02381 mm/(V-hr)  
Constant: 2.5 mm  
Correlation: 0.9868

Sample ID: ILE-1  
Date: 17/02/00

Operator: TxDOT  
Age: 28 Days

Sample	Length [mm]	Diameter [mm]	Current @ 30 V [mA]	Start Temperature	End Temperature	Start Time	End Time
1	50.32	101.13	125.8	20.1	21.9	10:41	4:45
2	45.32	101.26	111.5	20.1	21.4	10:41	10:41
3	50.43	101.35	126.6	20.2	20.8	10:41	11:30

Test Conditions

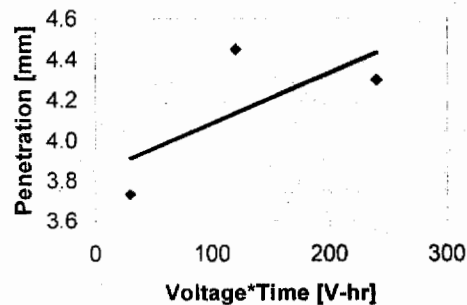
Sample	Applied Voltage [V]	Initial Current [mA]	Final Current [mA]	Test Duration [hr]
1	5	?	15.3	6
2	5	?	15.3	24
3	5	?	16.2	48

Penetration Measurements

Distance From Edge	Sample 1	Sample 2	Sample 3
20 mm		4.8	6
30 mm			3.9
40 mm	1.6		
50 mm	5.9	2.9	
60 mm	3.7	5.9	5
70 mm		4.2	2.3
80 mm			
Average:	3.7	4.5	4.3

Evaluation

Sample	Voltage*Time	Penetration
1	30	3.7
2	120	4.5
3	240	4.3



**RESULTS**

Rate of Penetration: 0.00248 mm/(V-hr)  
Constant: 3.8 mm  
Correlation: 0.4798

Sample ID: ILE1  
Date: 16-Feb-00

Operator: MTO  
Age: 28 Days

Sample	Length [mm]	Diameter [mm]	Current @ 30 V [mA]	Start Temperature	End Temperature	Start Time	End Time
1	50	100.3	165	21.8	21.8	8:20	2:20
2	50	100.8	157	21.8	21.8	8:20	2:20
3	50	100.8	150	21.8	21.9	8:20	8:20

Test Conditions

Sample	Applied Voltage [V]	Initial Current [mA]	Final Current [mA]	Test Duration [hr]
1	5	126	124	6
2	5	132	130	30
3	5	133	125	48

[Note 1]

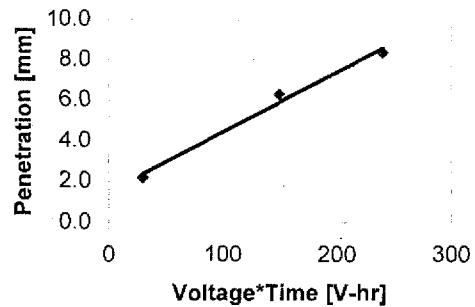
Penetration Measurements

Distance From Edge	Sample 1	Sample 2	Sample 3
20 mm	2	5	9
30 mm	2	6	8
40 mm	2	7	9
50 mm		6	
60 mm	2	6	6
70 mm	3	7	8
80 mm	2	7	10
Average:	2.2	6.3	8.3

Note 1: Test duration 30 hr instead of specified 24 hr

Evaluation

Sample	Voltage*Time	Penetration
1	30	2.2
2	150	6.3
3	240	8.3



**RESULTS**

Rate of Penetration: 0.02963 mm/(V-hr)  
Constant: 1.4 mm  
Correlation: 0.9881

Sample ID: ILE1  
 Date: 15-Feb-00

Operator: U of T  
 Age: 28 Days

Sample	Length [mm]	Diameter [mm]	Current @ 30 V [mA]	Start Temperature	End Temperature	Start Time	End Time
1	47.98	101.62	95	21	20	02/15/11:28	02/16/11:28
2	47.56	101.75	109	21	19	02/15/11:28	02/17/11:28
3	48.23	101.73	101	21	19.5	02/15/11:28	02/18/11:28

Test Conditions

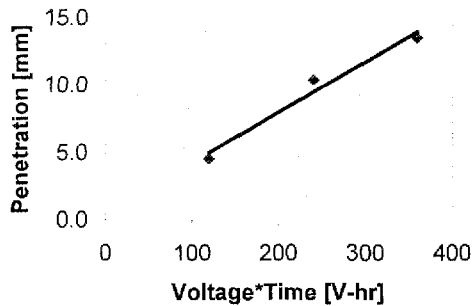
Sample	Applied Voltage [V]	Initial Current [mA]	Final Current [mA]	Test Duration [hr]
1	5	9.8	10	24
2	5	11	10.7	48
3	5	10.5	10.9	72

Penetration Measurements

Distance From Edge	Sample 1	Sample 2	Sample 3
20 mm	4	7	12
30 mm	5	8	13
40 mm	3	12	14
50 mm	5	13	
60 mm	7	11	13
70 mm	5	11	14
80 mm	3	11	15
Average:	4.6	10.4	13.5

Evaluation

Sample	Voltage*Time	Penetration
1	120	4.6
2	240	10.4
3	360	13.5



RESULTS

Rate of Penetration: 0.03720 mm/(V-hr)  
 Constant: 0.6 mm  
 Correlation: 0.9686

Sample ID: ILE 2  
 Date: Feb 29/2000

Operator: FHWA  
 Age: 28 Days

Sample	Length [mm]	Diameter [mm]	Current @ 30 V [mA]	Start Temperature	End Temperature	Start Time	End Time
1			0.03	20.5			
2			0.033	20.5			
3			0.26	20.5			

Test Conditions

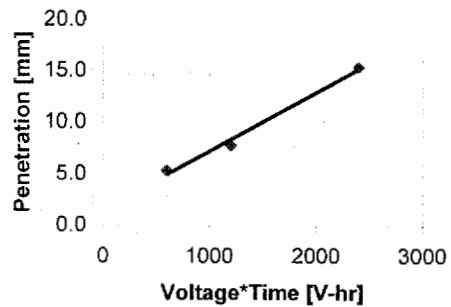
Sample	Applied Voltage [V]	Initial Current [mA]	Final Current [mA]	Test Duration [hr]
1	25	0.024	0.024	24
2	25	0.024	0.023	48
3	25	0.024	0.023	96

Penetration Measurements

Distance From Edge	Sample 1	Sample 2	Sample 3
20 mm			
30 mm			
40 mm			
50 mm			
60 mm			
70 mm			
80 mm			
Average:	5.4	7.8	15.4

Evaluation

Sample	Voltage*Time	Penetration
1	600	5.4
2	1200	7.8
3	2400	15.4



**RESULTS**

Rate of Penetration: 0.00567 mm/(V-hr)  
 Constant: 1.6 mm  
 Correlation: 0.9897



Sample ID: ILE2  
 Date: 2-29,3-4

Operator: VTRC  
 Age: 28 days

Sample	Length [mm]	Diameter [mm]	Current @ 30 V [mA]	Start Temperature	End Temperature	Start Time	End Time
1	52	100	29.33	68.7	67.5	9.30,2-29	9.30,3-1
2	52	100	29.38	68.6	67.2	9.30,2-29	9.30,3-2
3	52	100	28.51	68.7	68.3	9.30,2-29	9.30,3-4

Test Conditions

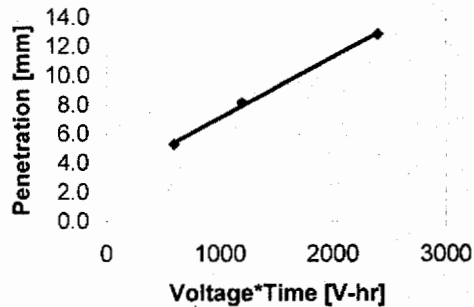
Sample	Applied Voltage [V]	Initial Current [mA]	Final Current [mA]	Test Duration [hr]
1	25	24.3	24.45	24
2	25	22.7	21.74	48
3	25	22.1	22.14	96

Penetration Measurements

Distance From Edge	Sample 1	Sample 2	Sample 3
28	28	42	46
20 mm	6	10	13
30 mm	7	10	14
40 mm	6	10	13
50 mm	4	7	12
60 mm	5	6	11
70 mm	4	7	15
80 mm	5	7	12
Average:	5.3	8.1	12.9

Evaluation

Sample	Voltage*Time	Penetration
1	600	5.3
2	1200	8.1
3	2400	12.9



RESULTS

Rate of Penetration: 0.00417 mm/(V-hr)  
 Constant: 2.9 mm  
 Correlation: 0.9976

Sample ID: ILE-2  
Date: 29/02/00

Operator: TxDOT  
Age: 28 Days

Sample	Length [mm]	Diameter [mm]	Current @ 30 V [mA]	Start Temperature	End Temperature	Start Time	End Time
1	49.2	101.45	26	20.7	20.7	9:30	9:30
2	48.73	101.61	26.5	20.8	20.8	9:30	9:28
3	47.6	101.29	28.3	20.7	20.6	9:30	9:35

Test Conditions

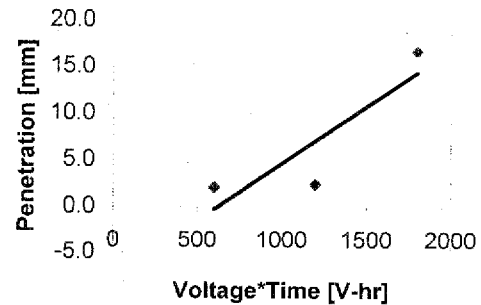
Sample	Applied Voltage [V]	Initial Current [mA]	Final Current [mA]	Test Duration [hr]
1	25	21.5	23.6	24
2	25	22.8	23.6	48
3	25	23.7	24.8	72

Penetration Measurements

Distance From Edge	Sample 1	Sample 2	Sample 3
20 mm	2.3	2.9	9.7
30 mm		2.6	22.5
40 mm	3.2		18.3
50 mm	1.7		22.9
60 mm	2.2	2.4	22.3
70 mm		1.9	13.1
80 mm	1.1	2.4	8.6
Average:	2.1	2.4	16.8

Evaluation

Sample	Voltage*Time	Penetration
1	600	2.1
2	1200	2.4
3	1800	16.8



**RESULTS**

Rate of Penetration: 0.01223 mm/(V-hr)  
Constant: -7.6 mm  
Correlation: 0.7674

Sample ID: ILE-2  
Date: Feb 29/2000

Operator: MTO  
Age: 28 Days

Sample	Length [mm]	Diameter [mm]	Current @ 30 V [mA]	Start Temperature	End Temperature	Start Time	End Time
1	50	101.7	28	23.2	23.2	7:30	7:30
2	50	101.5	32	23.2	22.2	7:30	7:30
3	50	101.5	25	23.2	22.9	7:30	7:30

Test Conditions

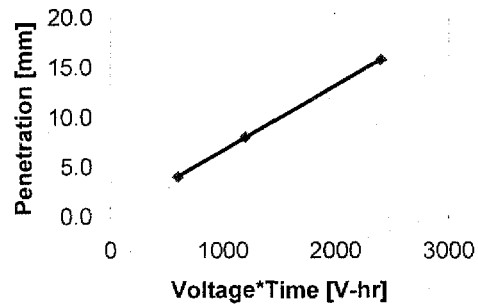
Sample	Applied Voltage [V]	Initial Current [mA]	Final Current [mA]	Test Duration [hr]
1	25	23	21.4	24
2	25	26	25.2	48
3	25	21	23	96

Penetration Measurements

Distance From Edge	Sample 1	Sample 2	Sample 3
20 mm	2	9	18
30 mm	6	7	11
40 mm	5	9	17
50 mm	4	10	15
60 mm	4	7	16
70 mm	4	8	18
80 mm	4	7	
Average:	4.1	8.1	15.8

Evaluation

Sample	Voltage*Time	Penetration
1	600	4.1
2	1200	8.1
3	2400	15.8



**RESULTS**

Rate of Penetration: 0.00648 mm/(V-hr)  
Constant: 0.3 mm  
Correlation: 0.9999

Sample ID: ILE2  
Date: 02/29/00

Operator: U of T  
Age: 28 days

Sample	Length [mm]	Diameter [mm]	Current @ 30 V [mA]	Start Temperature	End Temperature	Start Time	End Time
1	50.46	101.73	0.026	20	20	02/29:1:17pm	03/01:1:17pm
2	51.25	101.67	0.026	20	19	02/29:1:17pm	03/02:1:17pm
3	49.64	101.4	0.029	20	19	02/29:1:17pm	03/04:1:17pm

Test Conditions

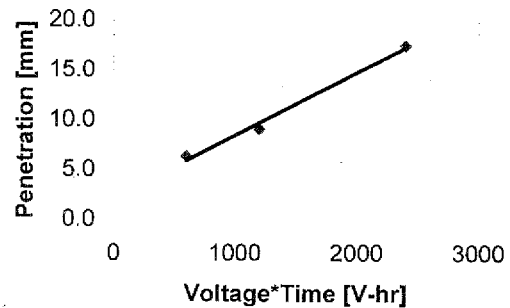
Sample	Applied Voltage [V]	Initial Current [mA]	Final Current [mA]	Test Duration [hr]
1	25	0.021	0.0186	24
2	25	0.022	0.019	48
3	25	0.023	0.0195	96

Penetration Measurements

Distance From Edge	Sample 1	Sample 2	Sample 3
20 mm	8	6	20
30 mm	6	9	14
40 mm	7	15	17
50 mm	6	10	13
60 mm	7	9	25
70 mm	7	6	19
80 mm	4	9	15
Average:	6.4	9.1	17.6

Evaluation

Sample	Voltage*Time	Penetration
1	600	6.4
2	1200	9.1
3	2400	17.6



**RESULTS**

Rate of Penetration: 0.00631 mm/(V-hr)  
Constant: 2.2 mm  
Correlation: 0.9905

# **Appendix 8: Re-Evaluated RMT Data**



**Re-Evaluated RMT Data – Phase 3**

Concrete Mix	Original RMT Rate of Penetration [mm/(V-hr)]	Single-Point RMT Rate of Penetration [mm/(V-hr)]
0.55, Plain	0.0569	0.0719
0.45, Plain	0.0539	0.0396
0.40, Plain	0.0277	0.0398
0.35, Plain	0.0297	0.0269
0.45, SF	0.0071	0.0092
0.35, SF	0.0021	0.0045
0.40, FA	0.0238	0.0485
0.40, SG	0.0142	0.0147
0.45, SF, FA	0.0074	0.0092
0.35, SF, FA	0.0041	0.0076
0.45, DCI	0.0403	0.0442

**Re-Evaluated RMT Data – Interlaboratory Evaluation**

Testing Lab – Mix #	Original RMT Rate of Penetration [mm/(V-hr)]	Single-Point RMT Rate of Penetration [mm/(V-hr)]
FHWA – Mix # 1	0.0331	0.0442
FHWA – Mix # 2	0.0057	0.0065
VTRC – Mix # 1	0.0238	0.0329
VTRC – Mix # 2	0.00417	0.00675
MTO – Mix # 1	0.0296	0.0420
MTO – Mix # 2	0.0065	0.00675
UofT – Mix # 1	0.0372	0.0433
UofT – Mix # 2	0.00631	0.00758





**Appendix 9:**  
**Rapid Migration Test Procedure**  
**And**  
**Construction Drawings**



# Rapid Migration Test Procedure

Keywords: Chlorides, concrete, diffusion, mortar, repair materials, migration, test method

## 1. SCOPE

This procedure is for the rapid evaluation of chloride penetration resistance of concrete, from non-steady-state migration experiments.

## 2. FIELD OF APPLICATION

The method is applicable to the hardened specimens cast in the laboratory or drilled from field structures.

## 3. REFERENCES

### 3.1 *ASTM Standards:*

C31 Practice for Making and Curing Concrete Test Specimens in the Field  
C92 Standard Practice for Making and Curing Concrete Test Specimens in the Laboratory

Tang, L and Sorensen, H.E., 1998, "Evaluation of the Rapid Test Methods for Chloride Diffusion Coefficient of Concrete, NORDTEST Project No. 1388-98," SP Report 1998:42, SP Swedish National Testing and Research Institute, Bords, Sweden.

## 4. DEFINITIONS

**Migration:** The movement of ions under the action of an external electrical field.

**Diffusion:** The movement of molecules or ions under a gradient of concentration, or more strictly speaking, chemical potential, from a high concentration zone to a low concentration zone.

**Chloride penetration depth:** The distance between the surface exposed to chloride solution and the chloride penetration front where the color changes from white to brown after spraying of 0.1 N silver nitrate solution.

## 5. SAMPLING

The method requires cylindrical specimens with a diameter of 100 mm and a thickness of 50 mm, sliced from cast cylinders or drilled cores with a minimum length of 100 mm. The cylinders and cores should meet the requirements described in C31 or C92. Three specimens should be used in the test.

## 6. TEST METHOD

### 6.1 Principle

An external potential is applied axially across a specimen and forces the chloride ions outside migrating into the specimen. After a certain test duration, the specimen is axially split and a silver nitrate solution is sprayed on one of the fresh split surfaces. The chloride penetration depth could then be measured

from the visible white silver chloride precipitation. From this penetration depth the rate of chloride ion penetration is determined and used to rate the concrete.

## 6.2 Reagents and Apparatus

### 6.2.1 Reagents

- Distilled or de-ionized water.
- tapwater.
- Sodium chloride: NaCl, chemical quality.
- Sodium hydroxide: NaOH, chemical quality.
- Silver nitrate: AgNO<sub>2</sub> chemical quality.

### 6.2.2 Apparatus

- Water-cooled diamond saw.
- Vacuum container; capable of containing at least three specimens.
- Vacuum pump: capable of maintaining a pressure of less than 50 mbar (5 kPa) in the container.
- Migration setup - One design (see Appendix 1) includes the following parts:
  - Silicon rubber sleeve: inner/outer diameter 100/115 mm, about 150 mm long.
  - Clamp: diameter range 105-115, 20 mm wide, stainless steel (see Fig. 2 in Appendix 1).
  - Catholyte reservoir: plastic box, 370x270x280 mm (long x wide x high).

-Plastic support: (see Fig. 3 in Appendix 1).

-Cathode: stainless steel plate (see Fig. 3 in Appendix 1), about 0.5 mm thick.

- Anode: stainless steel mesh or plate with holes (see Fig. 4 in Appendix 1), about 0.5 mm thick.

Other designs are acceptable, provided that temperatures of the specimen and solutions during the test can be maintained in the range of 20 to 25 °C (see 6.4.2).

-Power supply: capable of supplying 0-60 V DC regulated voltage with the accuracy  $\pm 0.1$  V.

-Ammeter: capable of displaying current to  $\pm 1$  mA.

-Thermometer or thermocouple with readout device capable of reading to  $\pm 1$  °C.

-Any suitable device for splitting the specimen.

- Glass or plastic spray bottle.

- Measuring equipment.

## 6.3 Preparation of Test Specimen

### 6.3.1 Test Specimen

If a drilled core is used, the outermost approximate 10~20 mm thick layer should be cut off (Note 1) and the successive 50  $\pm$  2 mm thick slice is cut as the test specimen. The end surface against the outermost layer should later be exposed in the chloride solution (catholyte).

If a cast cylinder of  $\varnothing$  100 x 100 mm is used, a  $50 \pm 2$  mm thick slice from the central portion of the cylinder is cut as the test specimen. The end surface against the trowel surface should later be exposed in the chloride solution (catholyte).

If a cast cylinder of  $\varnothing$  100 x 200 mm is used, the test specimen is prepared by first cutting the cylinder from the middle into two halves and then successively cutting a  $50 \pm 2$  mm thick slice from one half. The end surface from the first cutting (middle surface) should later be exposed in the chloride solution (catholyte).

The thickness should be measured with a slide caliper and read to 0.1 mm.

Note 1: The term "cut" here means to saw perpendicularly to the axis of a core or cylinder by means of a water-cooled diamond saw.

### 6.3.2 Preconditioning

After sawing, any burrs from the surfaces of the specimen should be brushed and washed away. The excess water on the surfaces of the specimen is wiped off. When the specimens are surface dry, they are placed in the vacuum container for vacuum treatment. Both end surfaces must be exposed. The absolute pressure in the vacuum container should be decreased to a range of 10 to 50 mbar (1 to 5 kPa) within a few minutes. The vacuum is maintained for 3 hours and then, with the vacuum pump still running, the deaired tapwater is filled into the container to immerse all the specimens. The vacuum is maintained for 1 additional hour before the air is allowed to re-enter the container. The specimens are kept in the solution for  $18 \pm 3$  hours.

## 6.4 Procedure

### 6.4.1 Catholyte and Anolyte

The catholyte solution is 10 percent NaCl by mass in tapwater (100 g NaCl in 900 g water, about 2 N) and the anolyte solution is 0.3 N NaOH in distilled or deionized water (approximately 12 g NaOH in 1 liter water). The solutions should be stored at a temperature of 20 to 25 °C.

### 6.4.2 Temperature

During the test, temperatures of the specimen and solutions should be maintained in the range of 20 to 25 °C.

### 6.4.3 Preparation of Test

- Fill the catholyte reservoir with about 12 liters of 10 percent NaCl solution.
- Assemble the rubber sleeve to the specimen in the way as shown in Fig. 2 and tighten it with two clamps. If the cured surface of the specimen is not smooth or there exist some defects on the curved surface that may result in significant leakage, a strip of silicon sealant could be applied to improve the tightness.
- Place the specimen in the catholyte reservoir and set it on the plastic support (see Fig. 1 in Appendix 1).

Note 2: If the concrete has dried substantially after removal from the saturation equipment, immerse in tapwater for a few minutes to re-saturate the specimen before placing it in the catholyte reservoir.

- Fill the sleeve above the specimen with 300 mL anolyte solution (0.3 M NaOH).
- Immerse the anode in the anolyte solution.
- Connect the cathode to the negative pole and the anode to the positive pole of the power supply.

#### 6.4.4 Migration Test

- Turn on the power, pre-set the potential to 60 V, and record the initial current through each specimen.
- Reset the potential if necessary (according to Table 1). After resetting, the records of the initial current should be renewed.
- Record the initial temperature in each anolyte solution with the thermometer or thermocouple.
- After 18 hours, record the final current and temperature before terminating the test. If the test duration was other than 18 hours, record the actual test duration.

#### 6.4.5 Measurement of Chloride Penetration Depth

- Disassemble the specimen by following the reverse procedure in 6.4.3. A wooden rod is often helpful in taking off the rubber sleeve from the specimen.
- Rinse the specimen with tap water.
- Wipe off the excess water on the surfaces of the specimen.
- Axially split the specimen into two pieces.

Choose the piece with the split surface more perpendicular to the end surfaces for the penetration depth measurement.

- Spray 0.1 M silver nitrate solution on the fresh split surface.
- When the white silver chloride precipitation on the split surface is clearly visible (about 15 minutes), measure the penetration depths from the center to both edges at an interval of 10 mm (see Fig. 5 in Appendix 1) to obtain seven depths (notes 3, 4 and 5). The depth should be read to 1 mm.

Note 3: If the penetration front to be measured is obviously blocked by the aggregate, move the measurement to the nearest front where there is no significant blocking of aggregate, or alternatively, discard this depth if there are more than five valid depths.

Note 4: If there exists a significant defect in the specimen, which results in a penetration front much larger than the average, this front is not counted as penetration depth but should specially be noted and reported.

Note 5: To obviate the edge effect due to non-homogeneous saturation degree or possible leakage, no depth measurement should be made in the range about 10 mm close to the edge (see Figure 3).

## 6.5 Expression of Results

### 6.5.1 Test Results

- For each test duration the depth of penetration is determined by discarding the

high and the low value and taking the mean of the remaining measurements.

- The rate of penetration is calculated by dividing the depth of penetration by the product of the voltage applied and the actual duration.

- The concrete is then rated according to Table 2.

## 6.6 Accuracy

### 6.6.1 Repeatability

The coefficient of variation for repeatability is 8.8 percent according to the results from the Nordic round-robin test between 6 laboratories [Tang and Sorensen, 1998].

### 6.6.2 Reproducibility

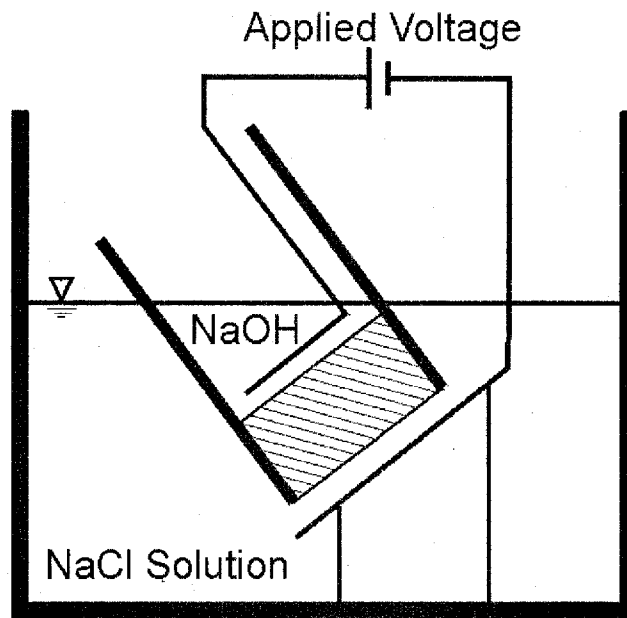
The coefficient of variation for reproducibility is 13.2 percent for portland cement concrete or the concrete blended with silica fume and 23.6 percent for the concrete blended with slag cement according to the results from the Nordic round-robin test among 6 laboratories [Tang and Sorensen, 1998]. A study between four laboratories conducted for FHWA resulted in a between-laboratory coefficient of variation of 16 percent for both concrete mixtures tested.

## 6.7 Test Report

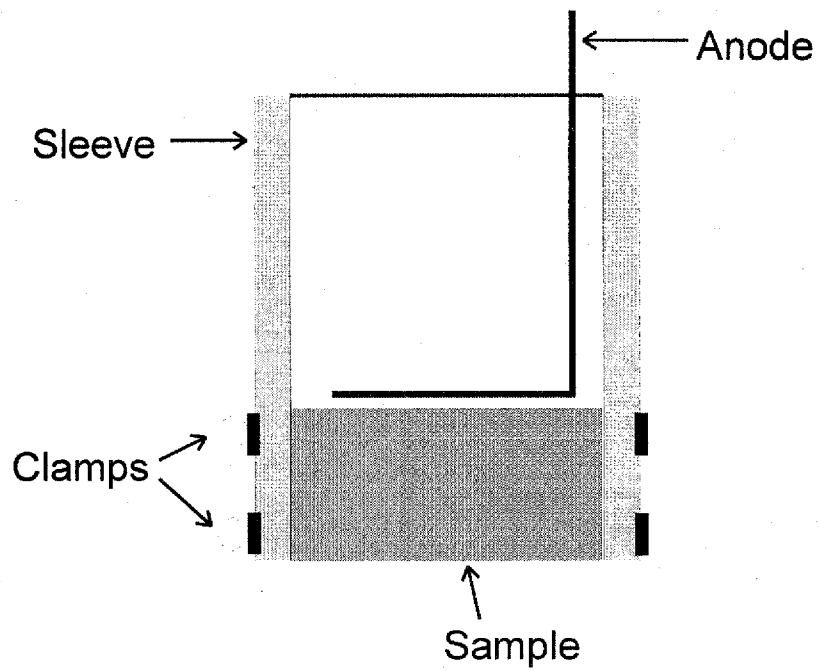
The test report should, if known, include the following information:

- a) Name and address of the testing laboratory.
- b) Date and identification number of the test report.

- c) Name and address of the organization or person who ordered the test.
- d) Name and address of the manufacturer or supplier of the tested object.
- e) Date of arrival of the tested object.
- f) Description of the tested object including sampling, composition, and curing age.
- g) Purpose of the test.
- h) Test method.
- i) Any deviation from the test method.
- j) Name and address of the person who performed the test.
- k) Date of the test.
- l) Test results including the specimen dimensions, applied potential, initial and final currents, initial and final temperatures, average as well as individual data of penetration depth, rate of penetration, and concrete rating.
- m) Any observation of large penetration front resulting from a defect in the specimen.
- o) Inaccuracy or uncertainty of the test results.
- p) Date and signature.

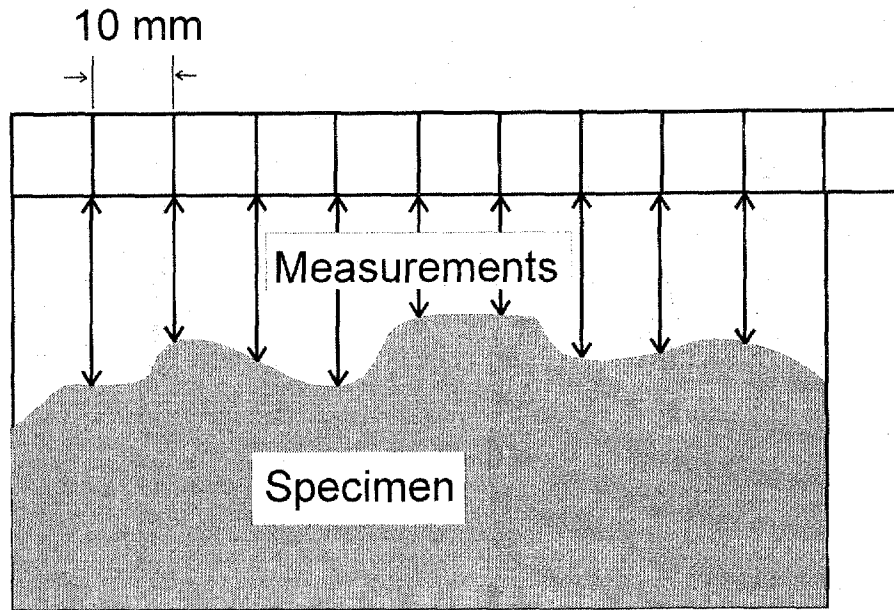


**Figure 1.** RMT Test Setup (One Design).



**Figure 2.** Assembly Diagram.





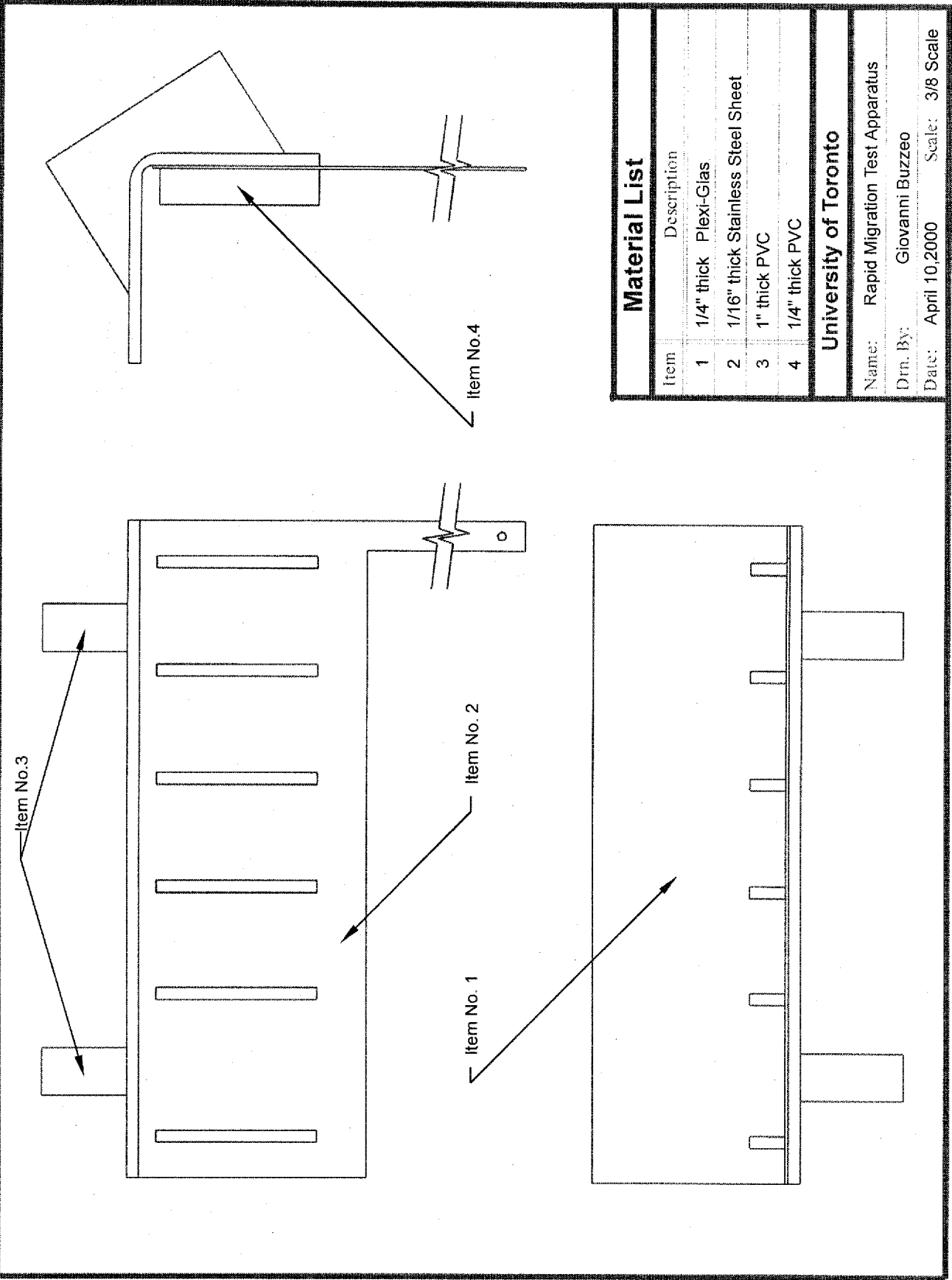
**Figure 3.** Chloride Penetration Depth Measurements.

**Table 1.** Test Conditions.

Initial Current at 60 V [mA]	Applied Voltage [V]	Test Duration [hours]
<120	60	18
120-240	30	18
240-800	10	18
>800	Do Not Test	Do Not Test

**Table 2.** FHWA HPC Performance Grade Chloride Penetration Criteria.

	FHWA HPC Performance Grade			
	1	2	3	4
Rate of penetration (mm/(V-hr))	$0.034 \geq x > 0.024$	$0.024 \geq x > 0.012$	$0.012 \geq x$	

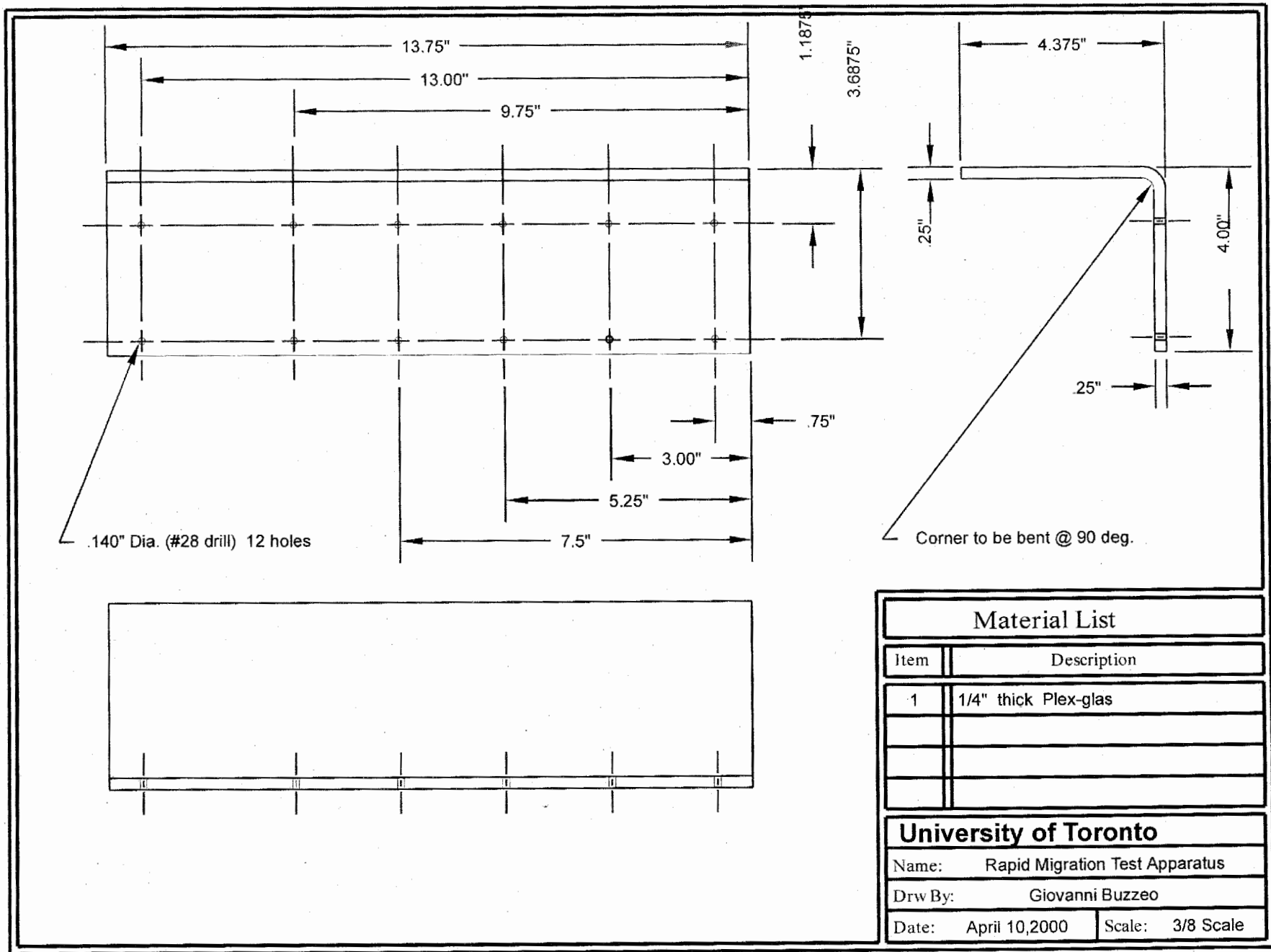


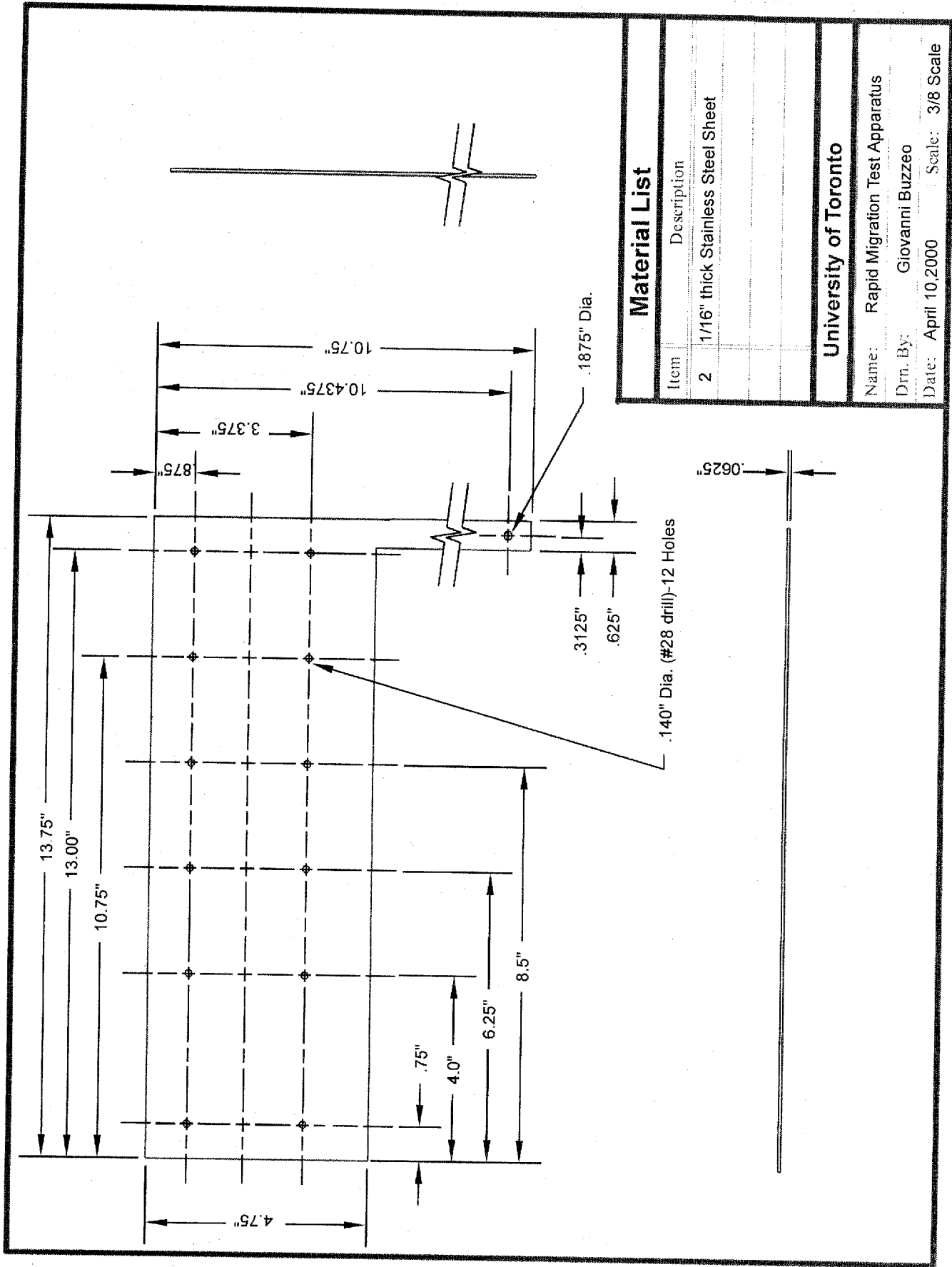
**Material List**

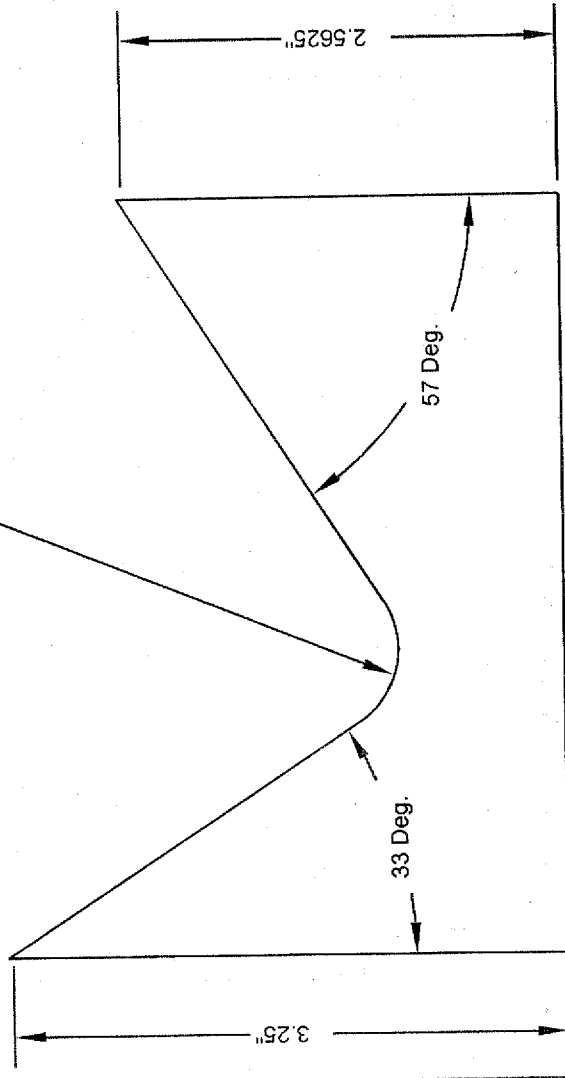
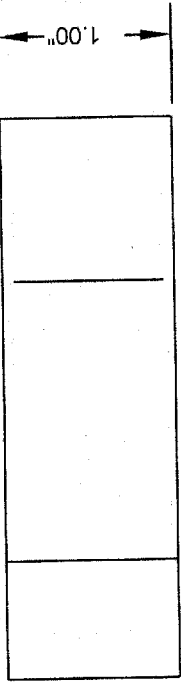
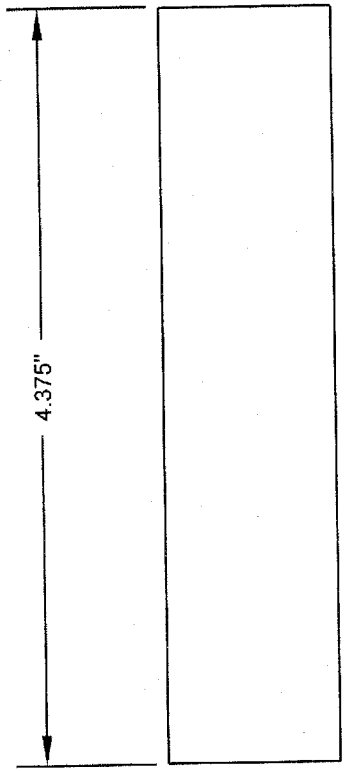
Item	Description
1	1/4" thick Plexi-Glas
2	1/16" thick Stainless Steel Sheet
3	1" thick PVC
4	1/4" thick PVC

**University of Toronto**

Name: Rapid Migration Test Apparatus  
 Dwn. By: Giovanni Buzzeo  
 Date: April 10, 2000 Scale: 3/8 Scale



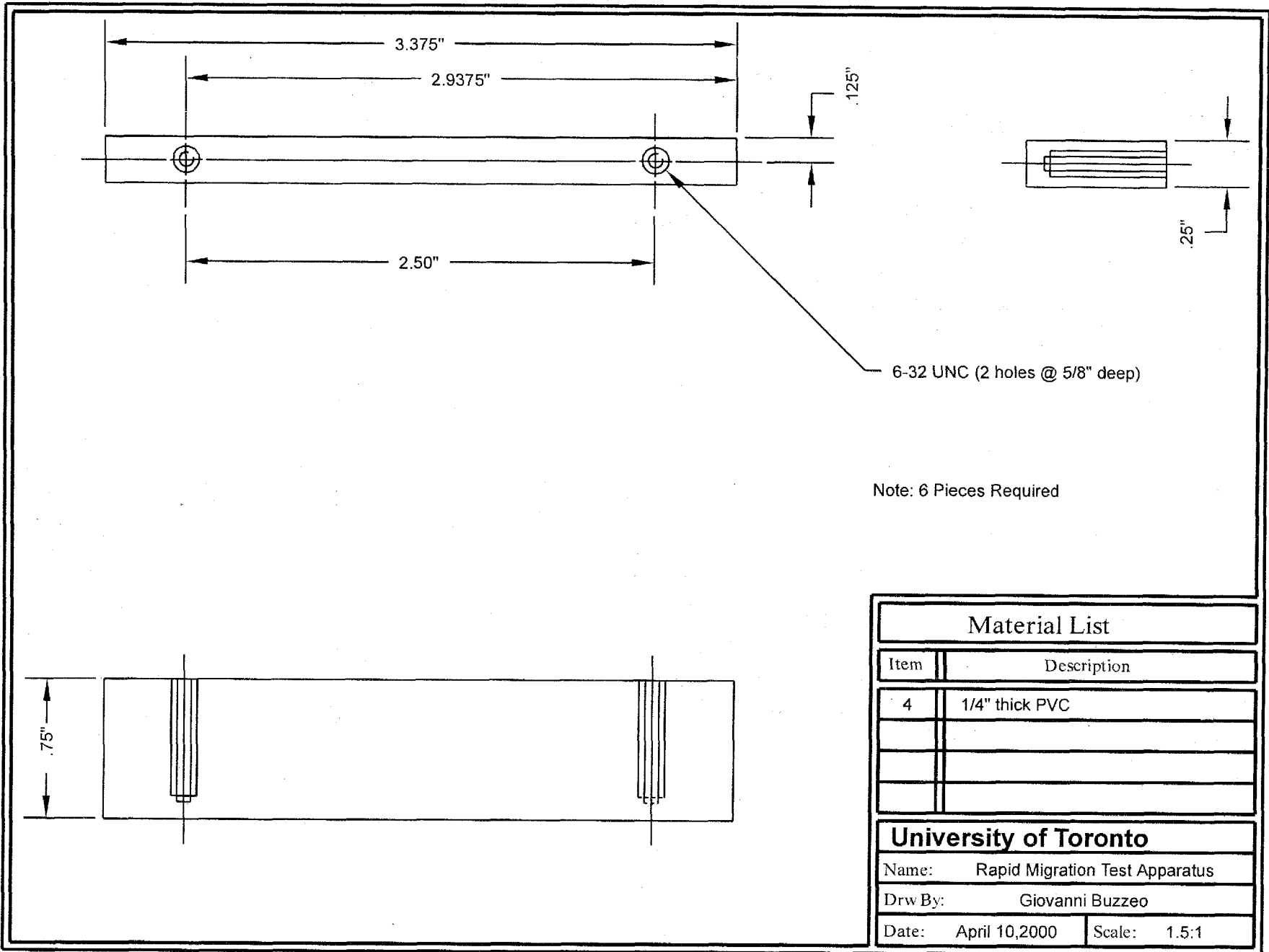




Note: 2 Pieces Required

Material List	
Item	Description
3	1" thick PVC

**University of Toronto**  
 Name: Rapid Migration Test Apparatus  
 Drawn By: Giovanni Buzzeo  
 Date: April 10, 2000 Scale: Full Scale









# **Appendix 10: Chloride Profiles**



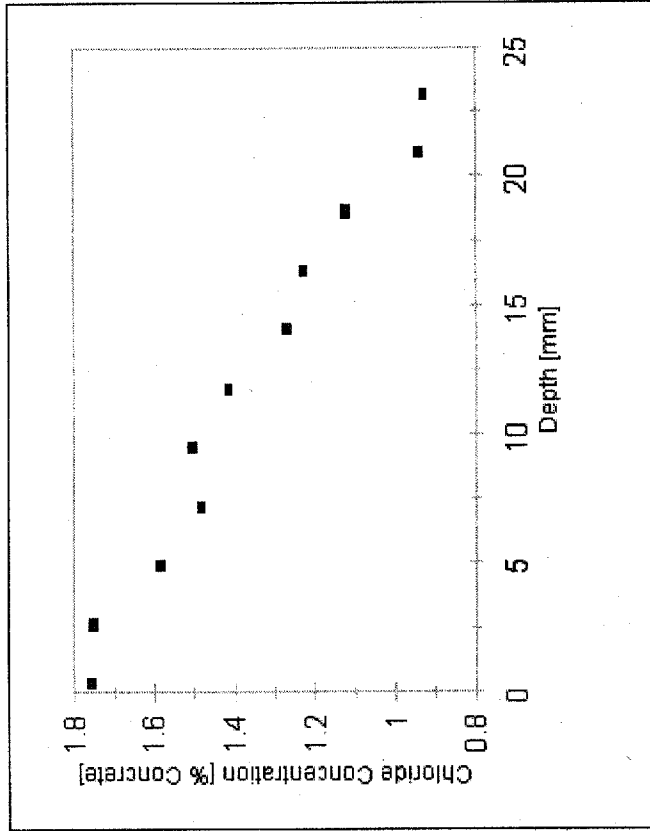
Sample: FH-1-0.45/0/0

Test: Chloride Resistivity-Before Testing

Background: 0.070 % Concrete

**Data**

Depth [mm]	Concentration [% Concrete]
0.38	1.75
2.67	1.75
4.95	1.58
7.24	1.48
9.53	1.50
11.81	1.41
14.10	1.27
16.38	1.23
18.67	1.12
20.96	0.94
23.24	0.93



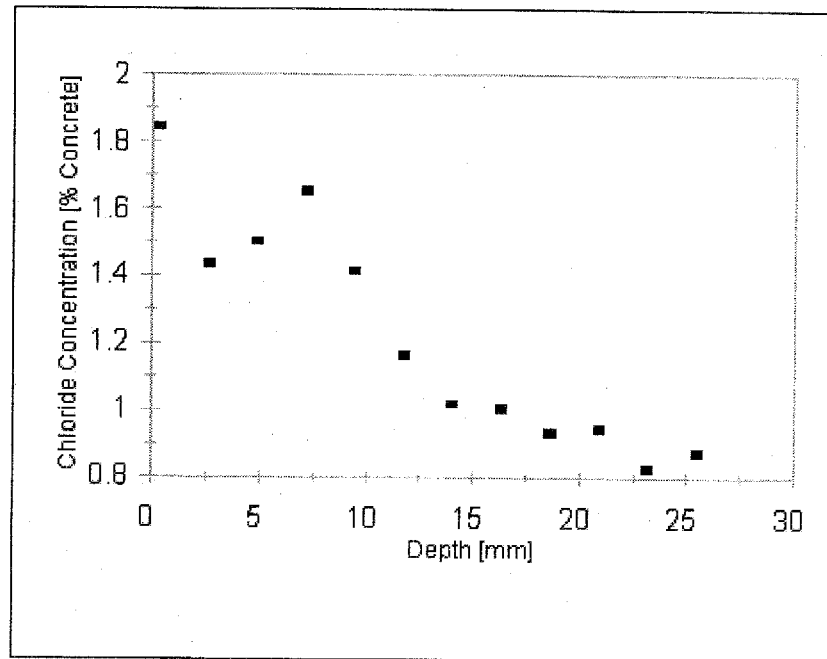
Sample: FH-1-0.45/8/0/0

Test: Chloride Resistivity-Before Testing

Background: 0.070 % Concrete

**Data**

Depth [mm]	Concentration [% Concrete]
0.38	1.84
2.67	1.43
4.95	1.50
7.24	1.65
9.53	1.41
11.81	1.16
14.10	1.02
16.38	1.00
18.67	0.93
20.96	0.94
23.24	0.82
25.53	0.87



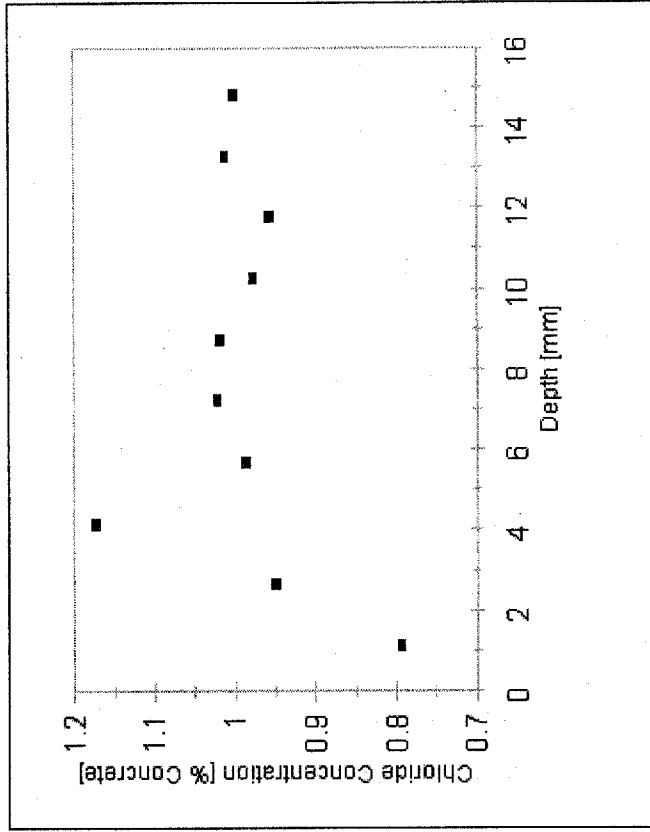
Sample: FH-1-0.35/8/0/0

Test: Chloride Resistivity-Before Testing

Background: 0.060 % Concrete

Data

Depth [mm]	Concentration [% Concrete]
1.14	0.79
2.67	0.95
4.19	1.17
5.72	0.99
7.24	1.02
8.76	1.02
10.29	0.98
11.81	0.96
13.34	1.01
14.86	1.00

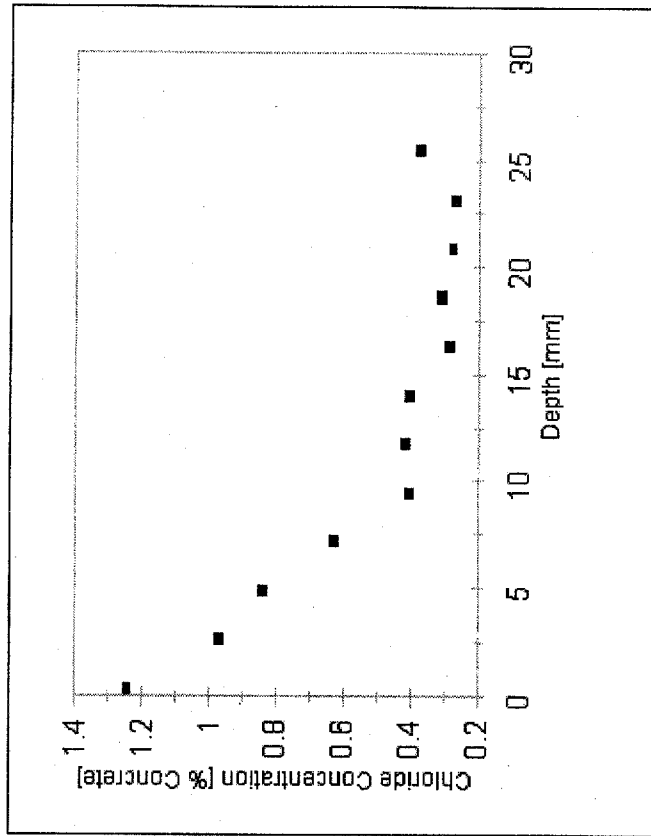


Sample: FH-1-0.25/8/0/0      Test: Chloride Resistivity-Before Testing

Background:      0.060 % Concrete

**Data**

Depth [mm]	Concentration [% Concrete]
0.38	1.24
2.67	0.97
4.95	0.84
7.24	0.63
9.53	0.40
11.81	0.41
14.10	0.40
16.38	0.28
18.67	0.31
20.96	0.28
23.24	0.27
25.53	0.37



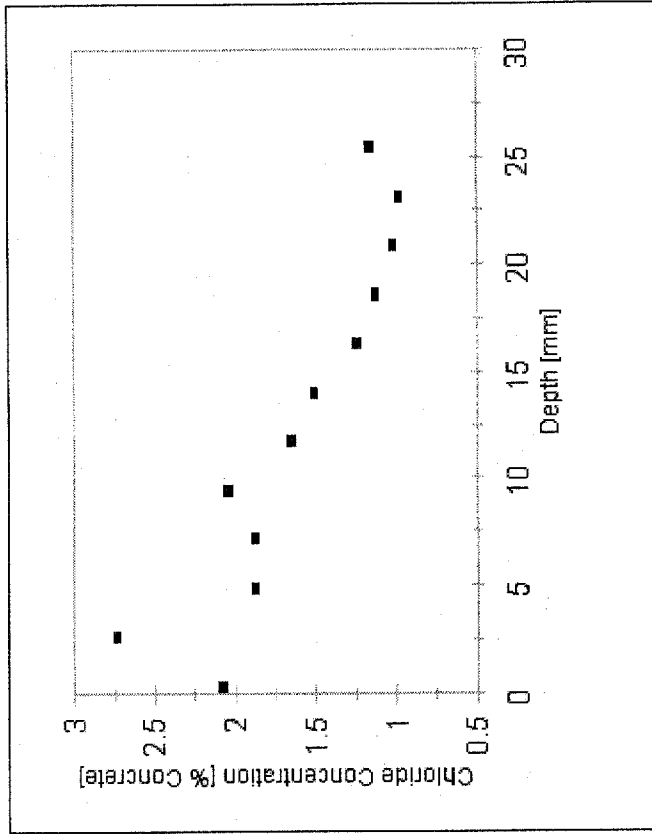
Sample: FH-1-0.45/0/20/0

Test: Chloride Resistivity-Before Testing

Background: 0.065 % Concrete

Data

Depth [mm]	Concentration [% Concrete]
0.38	2.08
2.67	2.73
4.95	1.87
7.24	1.87
9.53	2.04
11.81	1.65
14.10	1.50
16.38	1.24
18.67	1.13
20.96	1.01
23.24	0.97
25.53	1.16

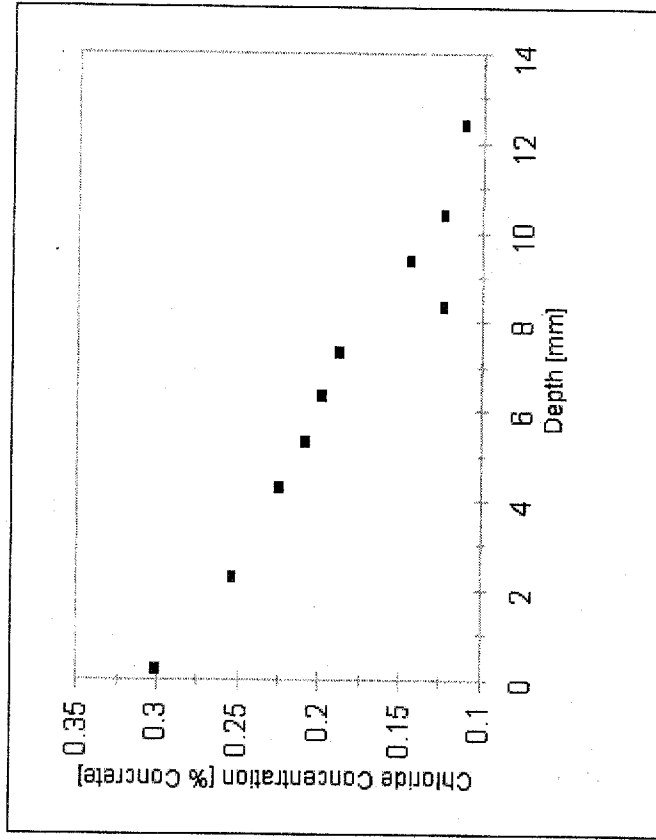


Sample: FH-1-0.50/0/0/0 Test: CTH - 8 Hours

Background: 0.065 % Concrete

Data

Depth [mm]	Concentration [% Concrete]
0.25	0.30
2.29	0.25
4.32	0.22
5.33	0.21
6.35	0.20
7.37	0.19
8.38	0.12
9.40	0.14
10.41	0.12
12.45	0.11





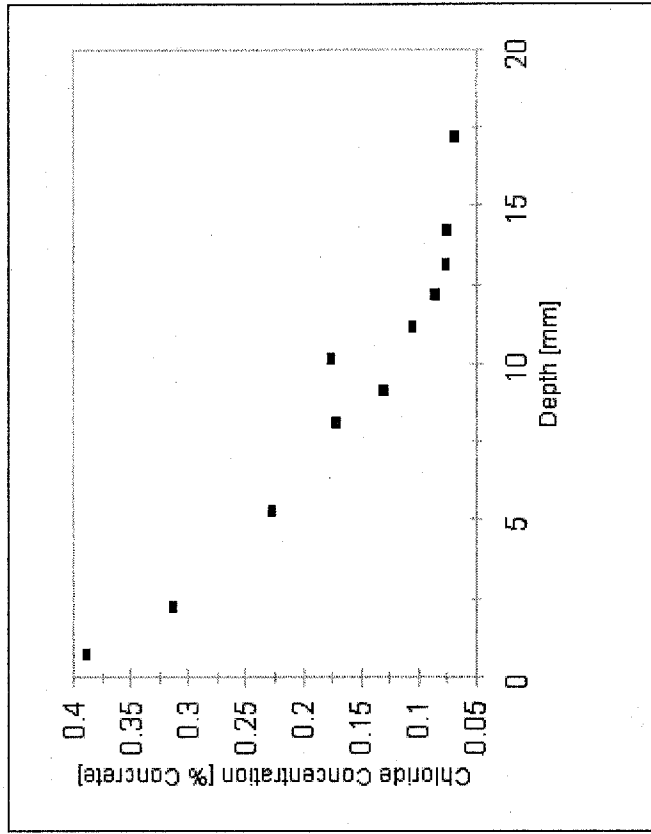
Sample: FH-1-0.45/0/0/0

Test: CTH - 8 Hours

Background: 0.070 % Concrete

Data

Depth [mm]	Concentration [% Concrete]
0.76	0.39
2.29	0.31
5.33	0.23
8.13	0.17
9.14	0.13
10.16	0.17
11.18	0.11
12.19	0.09
13.21	0.08
14.22	0.07
17.27	0.07
0.00	0.00
0.00	0.00
0.00	0.00

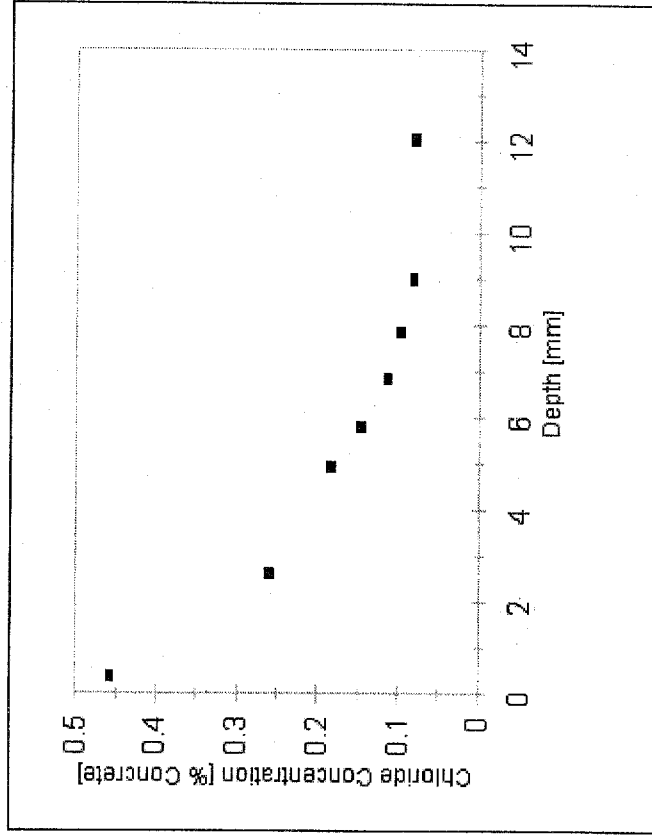


Sample: FH-1-0.35/0/0/0      Test: CTH - 8 Hours

Background: 0.070 % Concrete

**Data**

Depth [mm]	Concentration [% Concrete]
0.38	0.46
2.67	0.26
4.95	0.18
5.84	0.14
6.86	0.11
7.87	0.10
9.02	0.08
12.07	0.08



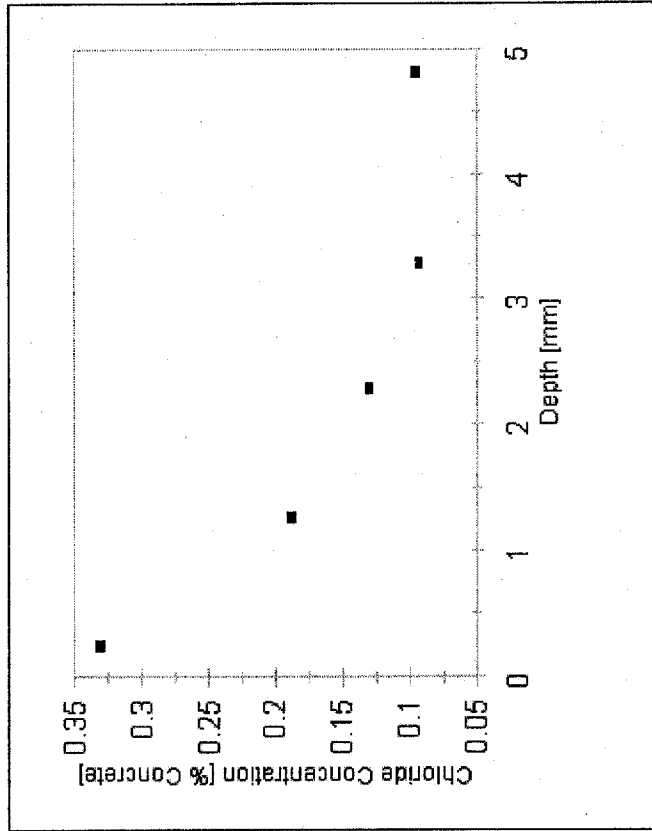
Sample: FH-1-0.45/8/0/0

Test: CTH - 8 Hour

Background: 0.070 % Concrete

Data

Depth [mm]	Concentration [% Concrete]
0.25	0.33
1.27	0.19
2.29	0.13
3.30	0.09
4.83	0.09

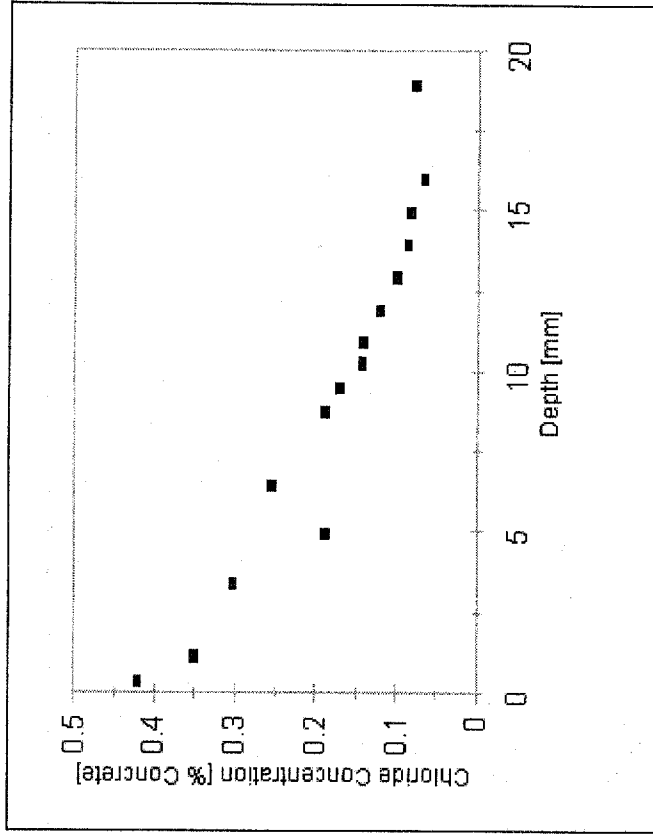


Sample: FH-1-0.45/0/20/0      Test: CTH - 8 Hours

Background: 0.065 % Concrete

**Data**

Depth [mm]	Concentration [% Concrete]
0.38	0.42
1.14	0.35
3.43	0.30
4.95	0.19
6.48	0.25
8.76	0.19
9.53	0.17
10.29	0.14
10.92	0.14
11.94	0.12
12.95	0.10
13.97	0.09
14.99	0.08
16.00	0.07
18.92	0.08



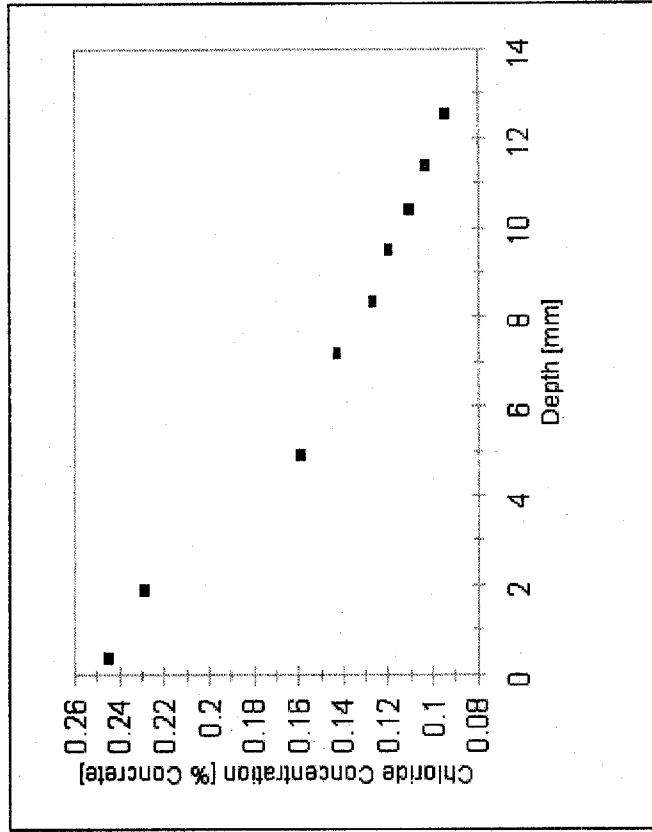
Sample: FH-1-0.45/0/0/35

Test: CTH - 8 Hours

Background: 0.070 % Concrete

Data

Depth [mm]	Concentration [% Concrete]
0.38	0.24
1.91	0.23
4.95	0.16
7.24	0.14
8.38	0.13
9.53	0.12
10.41	0.11
11.43	0.10
12.57	0.09

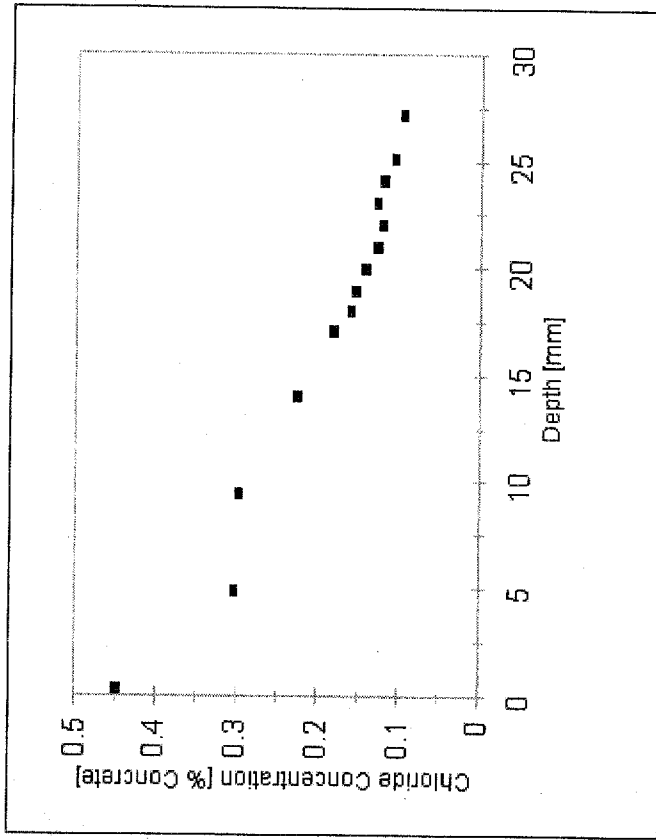


Sample: FH-1-0.50/0/0/0      Test: CTH - 1 Day

Background:      0.065 % Concrete

**Data**

Depth [mm]	Concentration [% Concrete]
0.38	0.45
4.95	0.30
9.53	0.30
14.10	0.22
17.15	0.18
18.03	0.16
19.05	0.15
20.07	0.14
21.08	0.13
22.10	0.12
23.11	0.13
24.13	0.12
25.15	0.11
27.18	0.10



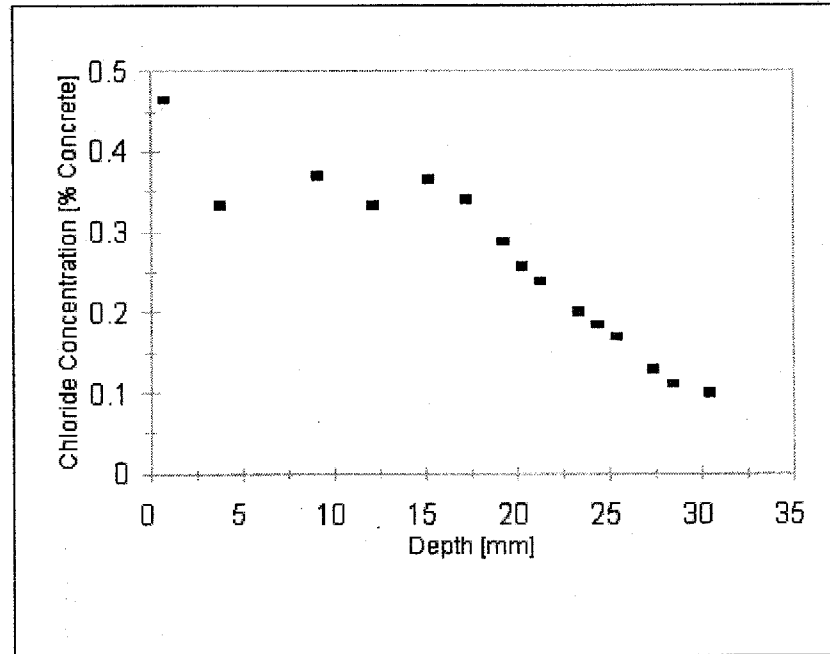
Sample: FH-1-0.45/0/0/0

Test: CTH - 1 Day

Background: 0.070 % Concrete

Data

Depth [mm]	Concentration [% Concrete]
0.76	0.46
3.81	0.33
9.14	0.37
12.19	0.33
15.24	0.36
17.27	0.34
19.30	0.29
20.32	0.26
21.34	0.24
23.37	0.20
24.38	0.18
25.40	0.17
27.43	0.13
28.45	0.11
30.48	0.10



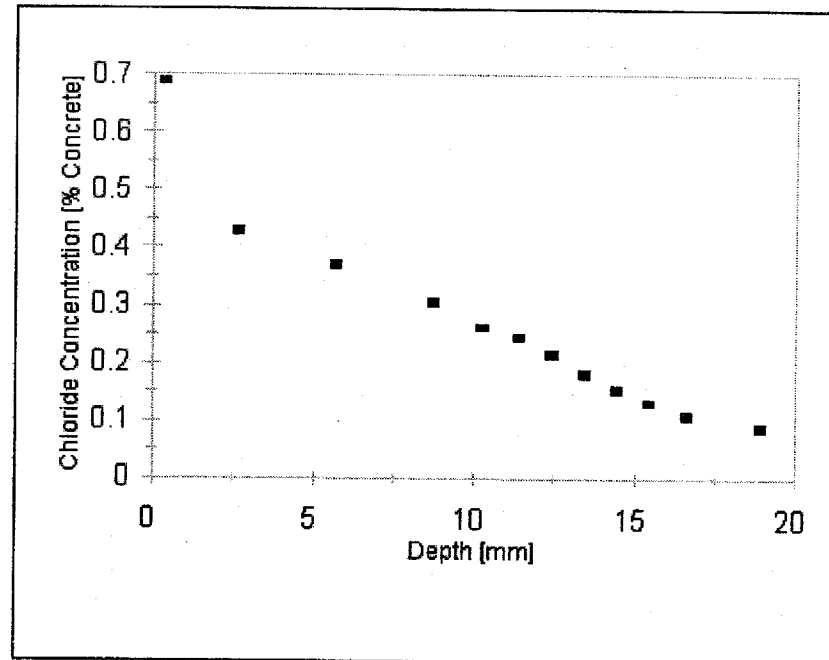
Sample: FH-1-0.35/0/0/0

Test: CTH - 1 Day

Background: 0.070 % Concrete

Data

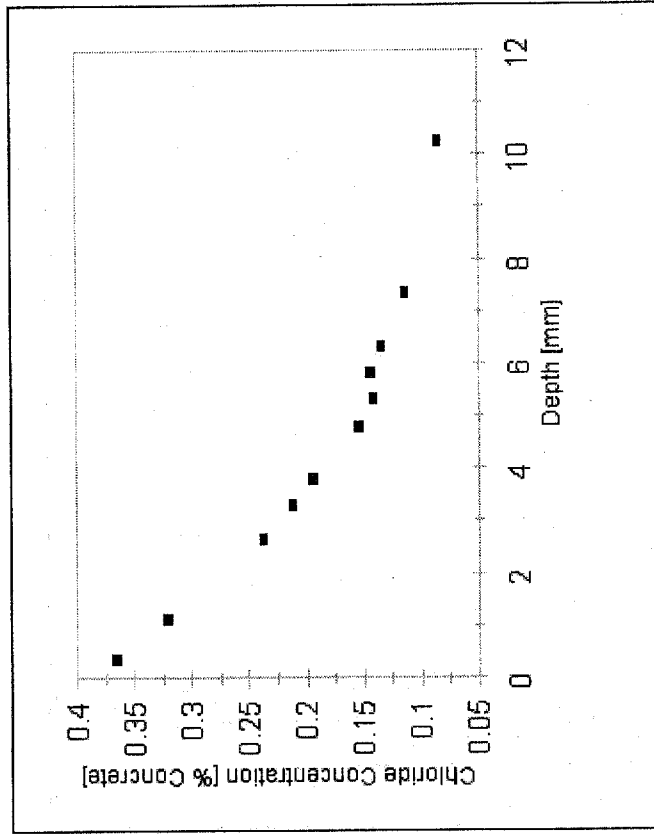
Depth [mm]	Concentration [% Concrete]
0.38	0.69
2.67	0.43
5.72	0.37
8.76	0.30
10.29	0.26
11.43	0.24
12.45	0.21
13.46	0.18
14.48	0.15
15.49	0.13
16.64	0.11
18.92	0.09





Sample: FH-1-0.45/8/0/0 Test: CTH - 1 Day

Background: 0.070 % Concrete



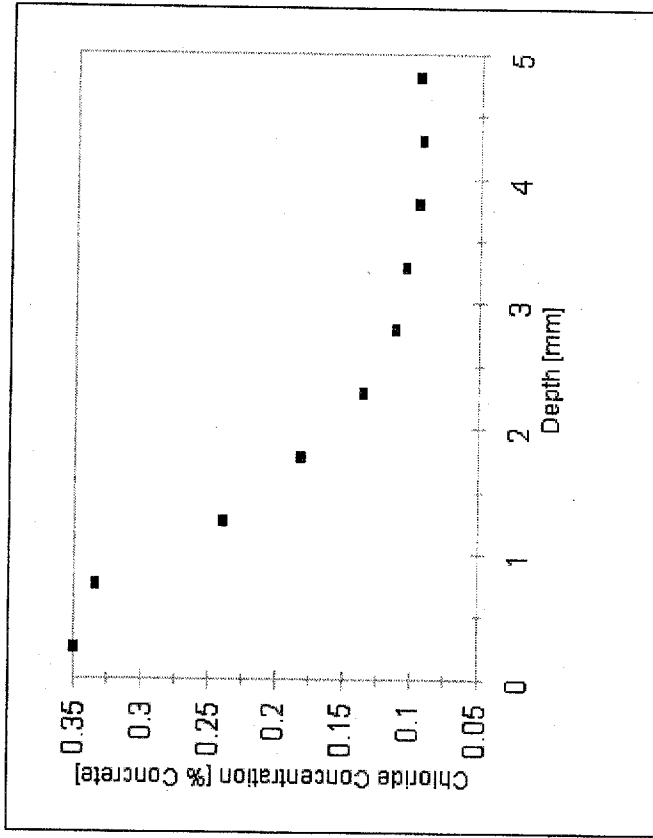
Depth [mm]	Concentration [% Concrete]
0.38	0.37
1.14	0.32
2.67	0.24
3.30	0.21
3.81	0.19
4.83	0.15
5.33	0.14
5.84	0.14
6.35	0.13
7.37	0.11
10.29	0.08

Sample: FH-1-0.35/8/0/0      Test: CTH - 1 Day

Background:      0.060 % Concrete

**Data**

<u>Depth</u> <u>[mm]</u>	<u>Concentration</u> <u>[% Concrete]</u>
0.25	0.35
0.76	0.33
1.27	0.24
1.78	0.18
2.29	0.14
2.79	0.11
3.30	0.10
3.81	0.10
4.32	0.09
4.83	0.09



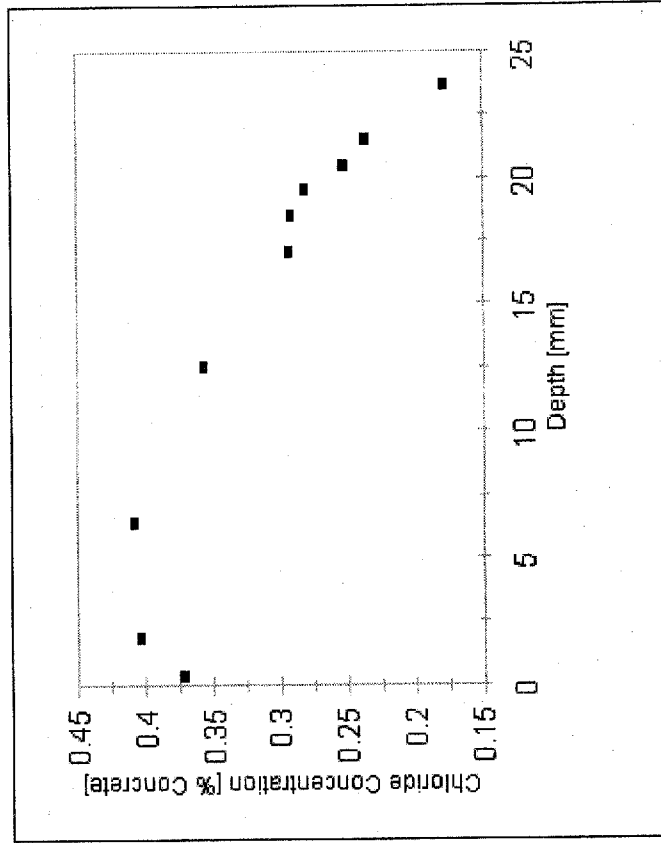
Sample: FH-1-0.45/0/20/0

Test: CTH - 1 Day

Background: 0.065 % Concrete

Data

Depth [mm]	Concentration [% Concrete]
0.38	0.37
1.91	0.40
6.48	0.41
12.57	0.36
17.15	0.29
18.54	0.29
19.56	0.28
20.57	0.25
21.59	0.24
23.75	0.18

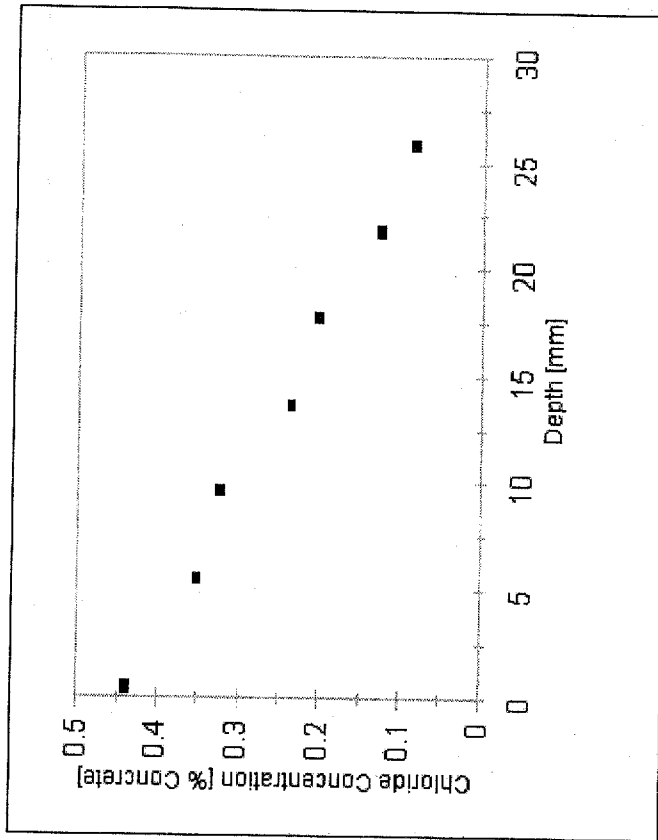


Sample: FH-1-0.45/0/20/0      Test: CTH- 1 Day

Background:      0.065 % Concrete

**Data**

Depth [mm]	Concentration [% Concrete]
0.51	0.44
5.59	0.35
9.65	0.32
13.72	0.24
17.78	0.20
21.84	0.13
25.91	0.08



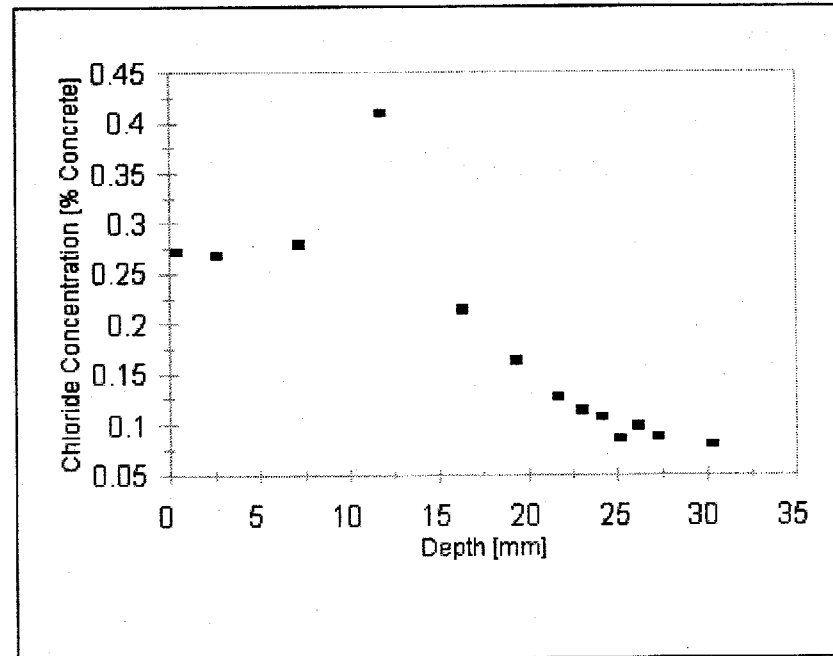
Sample: FH-1-0.45/0/0/35

Test: CTH - 1 Day

Background: 0.070 % Concrete

**Data**

<u>Depth</u> <u>[mm]</u>	<u>Concentration</u> <u>[% Concrete]</u>
0.38	0.27
2.67	0.27
7.24	0.28
11.81	0.41
16.38	0.21
19.43	0.16
21.72	0.13
23.11	0.11
24.13	0.11
25.15	0.09
26.16	0.10
27.30	0.09
30.35	0.08



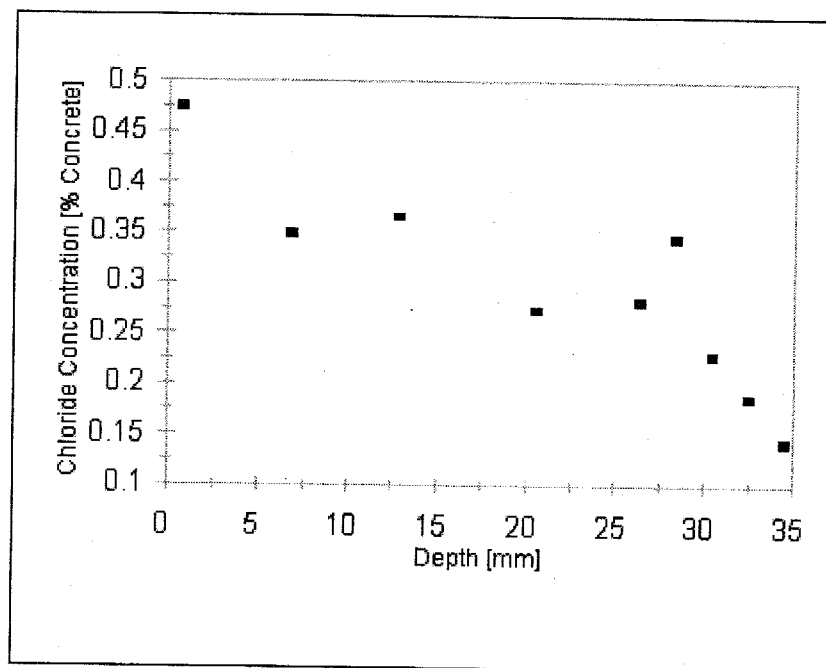
Sample: FH-1-0.35/0/0/0

Test: CTH- 3 Day

Background: 0.070 % Concrete

Data

Depth [mm]	Concentration [% Concrete]
0.76	0.47
6.86	0.35
12.95	0.37
20.57	0.27
26.42	0.28
28.45	0.34
30.48	0.23
32.51	0.19
34.54	0.14



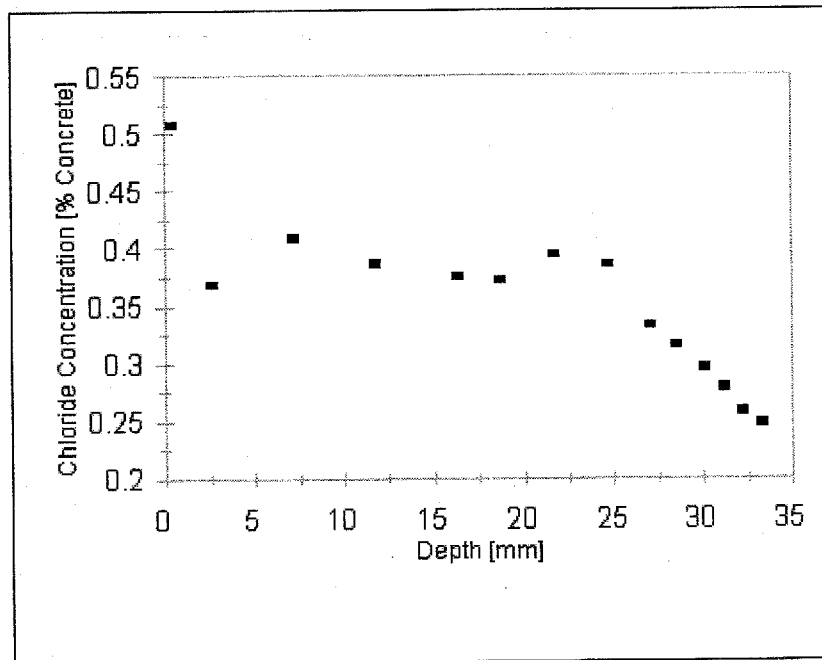
Sample: FH-1-0.35/0/0/0

Test: CTH - 3 Day

Background: 0.070 % Concrete

Data

Depth [mm]	Concentration [% Concrete]
0.38	0.51
2.67	0.37
7.24	0.41
11.81	0.39
16.38	0.38
18.67	0.37
21.72	0.39
24.77	0.39
27.05	0.33
28.58	0.32
30.10	0.30
31.24	0.28
32.26	0.26
33.27	0.25



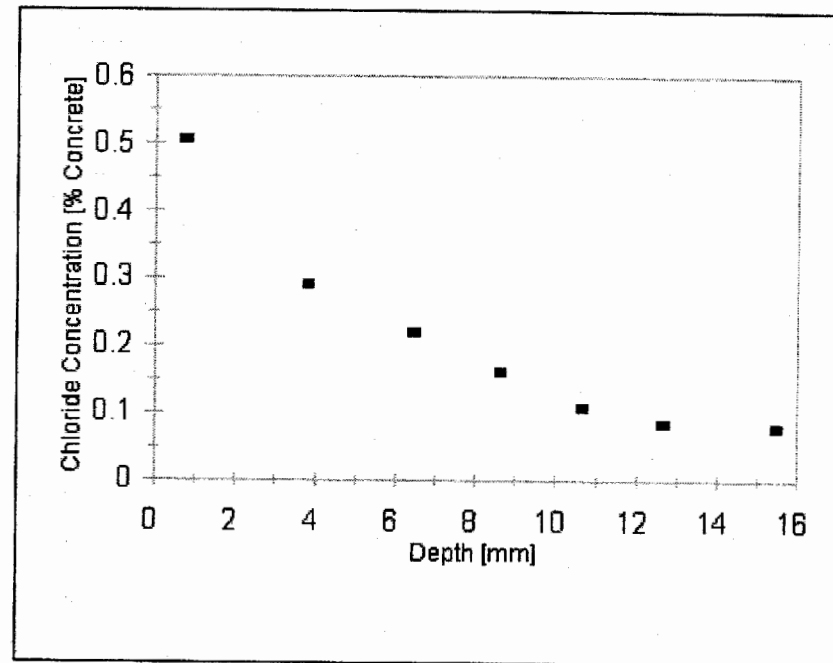
Sample: FH-1-0.45/8/0/0

Test: CTH - 3 Day

Background: 0.070 % Concrete

**Data**

<u>Depth</u> <u>[mm]</u>	<u>Concentration</u> <u>[% Concrete]</u>
0.76	0.50
3.81	0.29
6.48	0.22
8.64	0.16
10.67	0.11
12.70	0.08
15.49	0.08





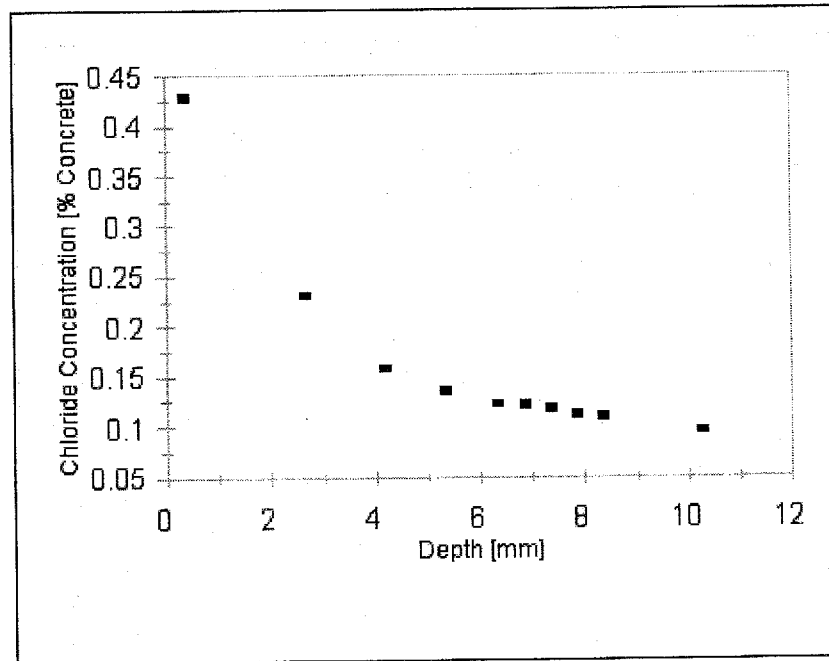
Sample: FH-1-0.35/8/0/0

Test: CTH - 3 Day

Background: 0.060 % Concrete

Data

Depth [mm]	Concentration [% Concrete]
0.38	0.43
2.67	0.23
4.19	0.16
5.33	0.14
6.35	0.12
6.86	0.12
7.37	0.12
7.87	0.11
8.38	0.11
10.29	0.09

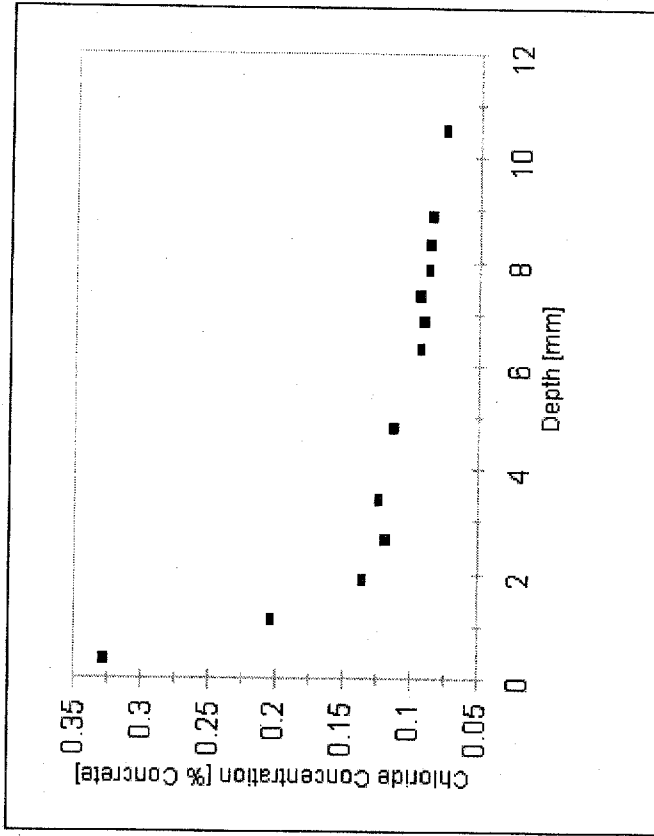


Sample: FH-1-0.25/8/0/0      Test: CTH - 3 Day

Background:      0.060 % Concrete

**Data**

Depth [mm]	Concentration [% Concrete]
0.38	0.33
1.14	0.20
1.91	0.14
2.67	0.12
3.43	0.12
4.83	0.11
6.35	0.09
6.86	0.09
7.37	0.09
7.87	0.09
8.38	0.09
8.89	0.08
10.54	0.07

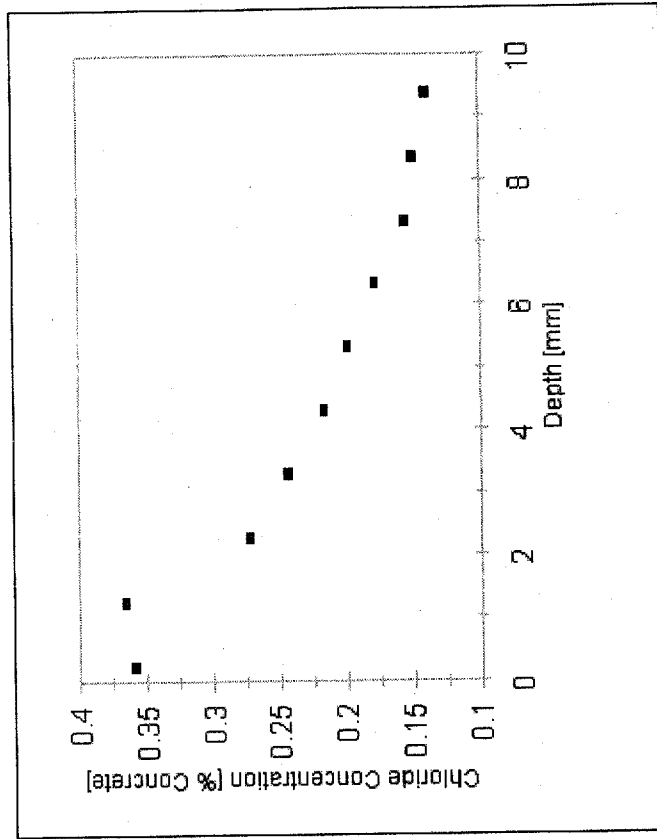


Sample: FH-1-0.45/8/0/0      Test: Pressure Penetration

Background:      0.070 % Concrete

Data

Depth [mm]	Concentration [% Concrete]
0.25	0.36
1.27	0.36
2.29	0.27
3.30	0.24
4.32	0.22
5.33	0.20
6.35	0.18
7.37	0.16
8.38	0.15
9.40	0.14

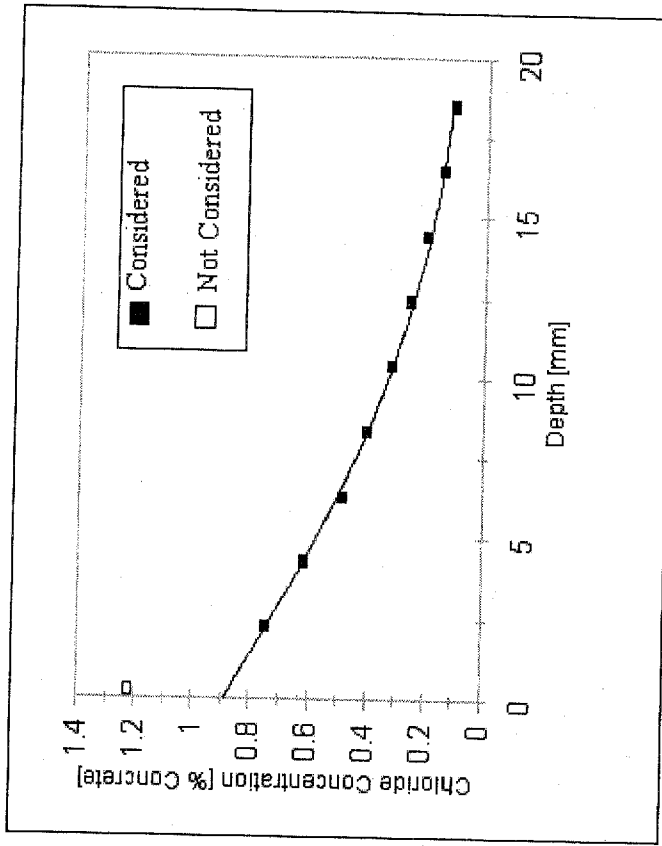


Sample: FH-1-0.50/0/0/0      Test: Bulk Diffusion      Duration: 40 Days

Diffusion Coefficient: 1.48E-11 m<sup>2</sup>/s      R<sup>2</sup>: 0.9985  
 Surface Concentration: 0.89 % Concrete  
 Background: 0.065 % Concrete

**Data**

Depth [mm]	Concentration [% Concrete]
0.25	1.22
2.29	0.75
4.32	0.61
6.35	0.48
8.38	0.40
10.41	0.32
12.45	0.26
14.48	0.20
16.51	0.15
18.54	0.11
20.57	0.10
22.61	0.08
23.62	0.07



Sample: FH-1-0.45/0/0/0

Test: Bulk Diffusion

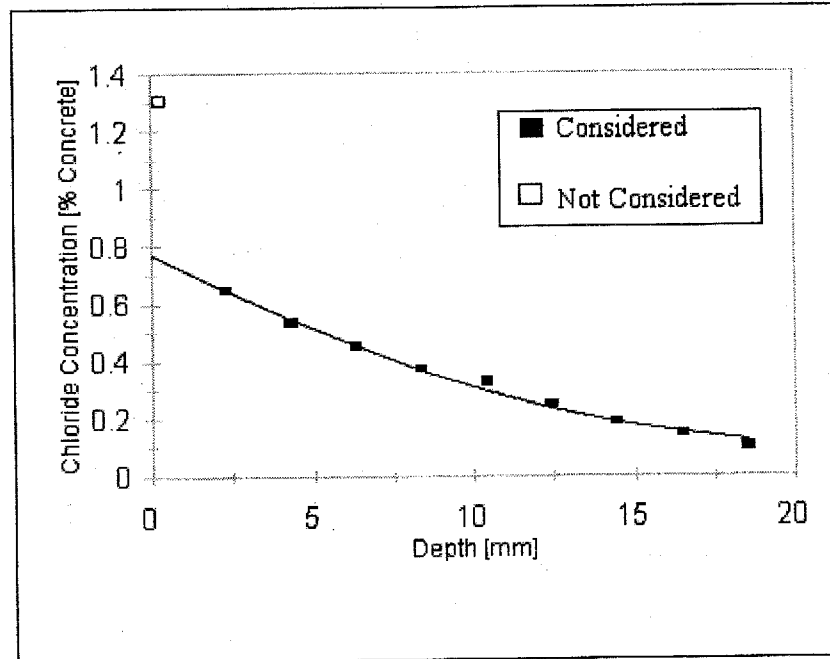
Duration: 40 Days

Diffusion Coefficient: 1.56E-11 m<sup>2</sup>/s  
Surface Concentration: 0.77 % Concrete  
Background: 0.070 % Concrete

r<sup>2</sup>: 0.9908

Data

Depth [mm]	Concentration [% Concrete]
0.25	1.31
2.29	0.65
4.32	0.53
6.35	0.45
8.38	0.37
10.41	0.32
12.45	0.25
14.48	0.18
16.51	0.14
18.54	0.10
20.57	0.07
22.61	0.07



Sample: FH-1-0.35/0/0/0

Test: Bulk Diffusion

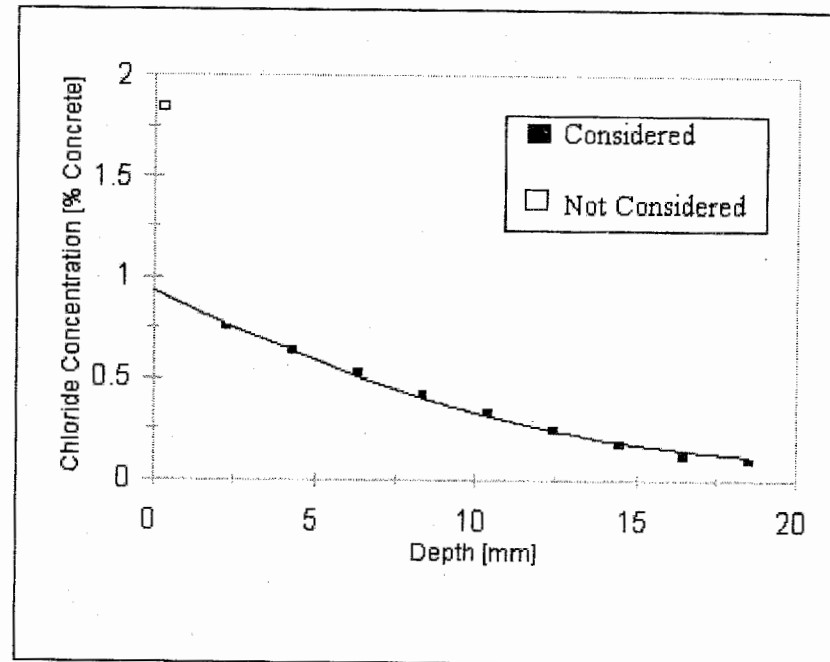
Duration: 40 Days

Diffusion Coefficient: 1.37E-11 m<sup>2</sup>/s  
Surface Concentration: 0.93 % Concrete  
Background: 0.070 % Concrete

r<sup>2</sup>: 0.9933

Data

Depth [mm]	Concentration [% Concrete]
0.25	1.84
2.29	0.75
4.32	0.64
6.35	0.53
8.38	0.42
10.41	0.33
12.45	0.24
14.48	0.17
16.51	0.12
18.54	0.09



Sample: FH-1-0.45/8/0/0

Test: Bulk Diffusion

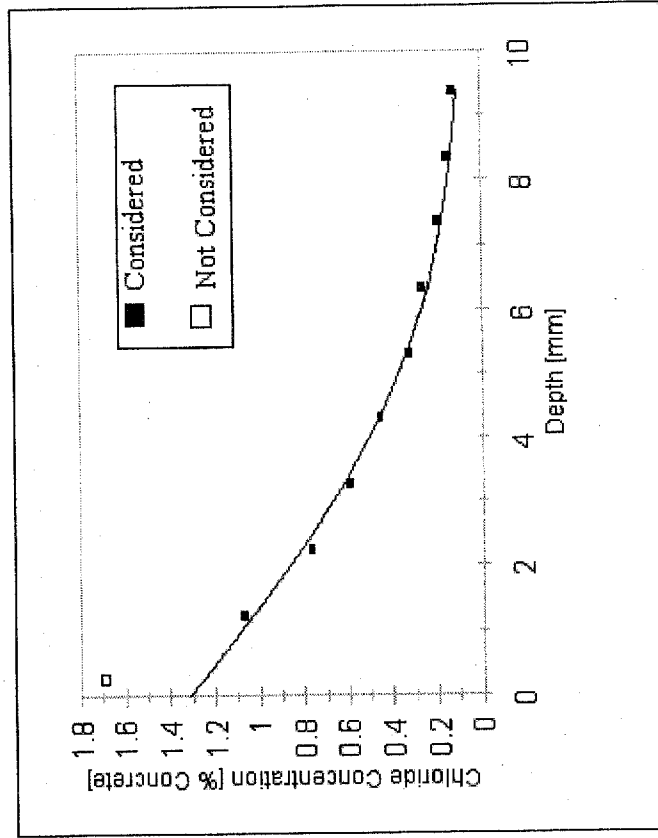
Duration: 40 Days

$r^2$ : 0.9920

Diffusion Coefficient: 2.60E-12 m<sup>2</sup>/s

Surface Concentration: 1.32 % Concrete

Background: 0.070 % Concrete



**Data**

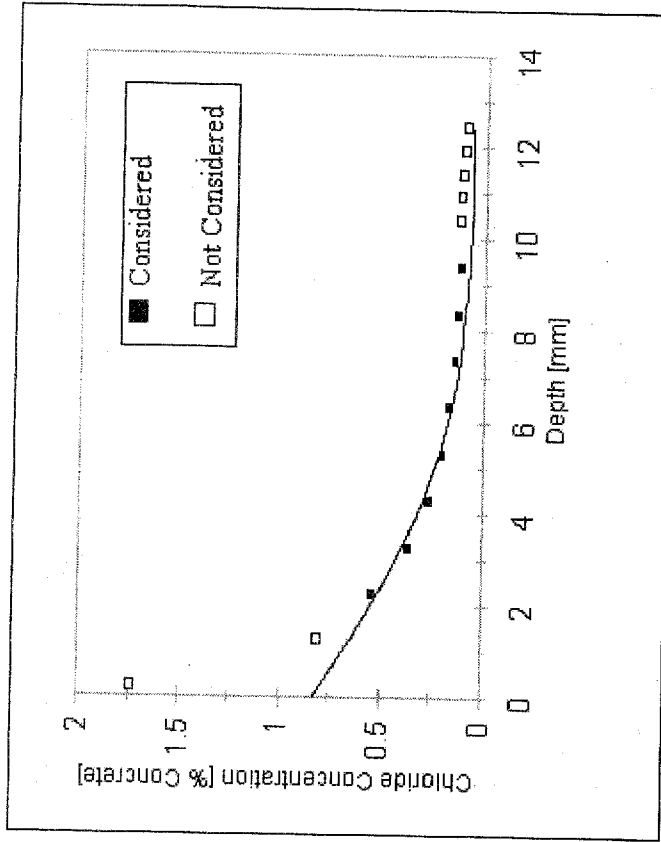
Depth [mm]	Concentration [% Concrete]
0.25	1.70
1.27	1.07
2.29	0.76
3.30	0.59
4.32	0.45
5.33	0.32
6.35	0.26
7.37	0.19
8.38	0.15
9.40	0.12

Sample: FH-1-0.35/8/0/0      Test: Bulk Diffusion      Duration: 40 Days

Diffusion Coefficient: 2.51E-12 m<sup>2</sup>/s      r<sup>2</sup>: 0.9633  
 Surface Concentration: 0.83 % Concrete  
 Background: 0.060 % Concrete

**Data**

Depth [mm]	Concentration [% Concrete]
0.25	1.73
1.27	0.81
2.29	0.54
3.30	0.36
4.32	0.26
5.33	0.20
6.35	0.16
7.37	0.14
8.38	0.13
9.40	0.12
10.41	0.13
10.92	0.12
11.43	0.12
11.94	0.11
12.45	0.10





Sample: FH-1-0.25/8/0/0

Test: Bulk Diffusion

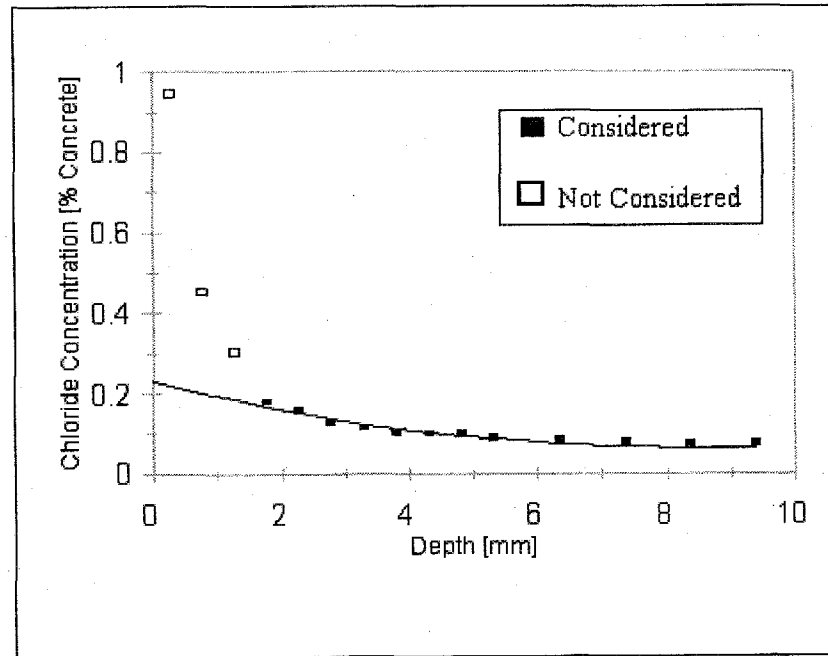
Duration: 40 Days

Diffusion Coefficient: 2.00E-12 m<sup>2</sup>/s  
Surface Concentration: 0.23 % Concrete  
Background: 0.060 % Concrete

r<sup>2</sup>: 0.9421

Data

Depth [mm]	Concentration [% Concrete]
0.25	0.95
0.76	0.45
1.27	0.30
1.78	0.18
2.29	0.15
2.79	0.13
3.30	0.11
3.81	0.10
4.32	0.10
4.83	0.09
5.33	0.09
6.35	0.08
7.37	0.08
8.38	0.07
9.40	0.07



Sample: FH-1-0.45/0/20/0

Test: Bulk Diffusion

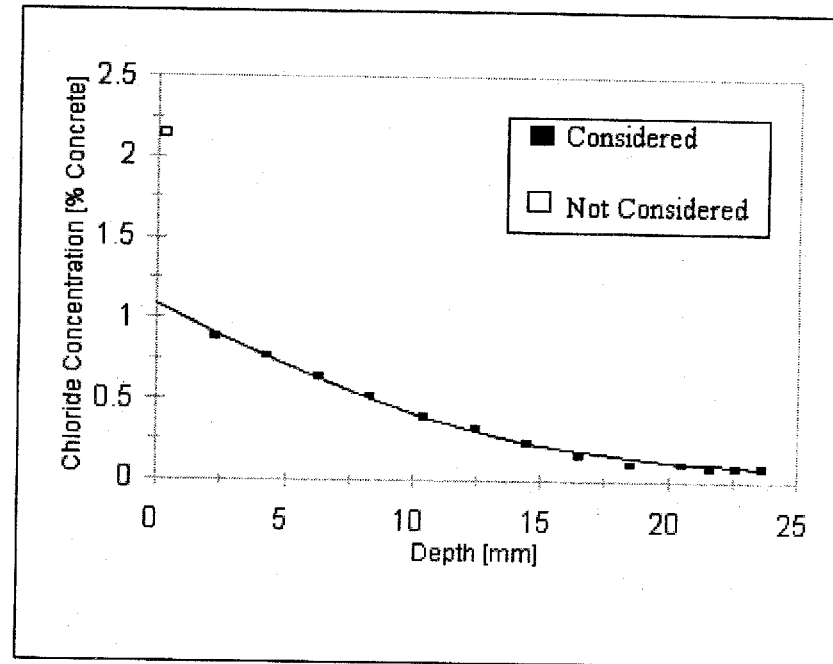
Duration: 40 Days

Diffusion Coefficient: 1.56E-11 m<sup>2</sup>/s  
Surface Concentration: 1.09 % Concrete  
Background: 0.065 % Concrete

r<sup>2</sup>: 0.9945

Data

Depth [mm]	Concentration [% Concrete]
0.25	2.14
2.29	0.88
4.32	0.77
6.35	0.64
8.38	0.52
10.41	0.39
12.45	0.32
14.48	0.23
16.51	0.16
18.54	0.10
20.57	0.10
21.59	0.09
22.61	0.08
23.62	0.08



Sample: FH-1-0.45/0/0/35

Test: Bulk Diffusion

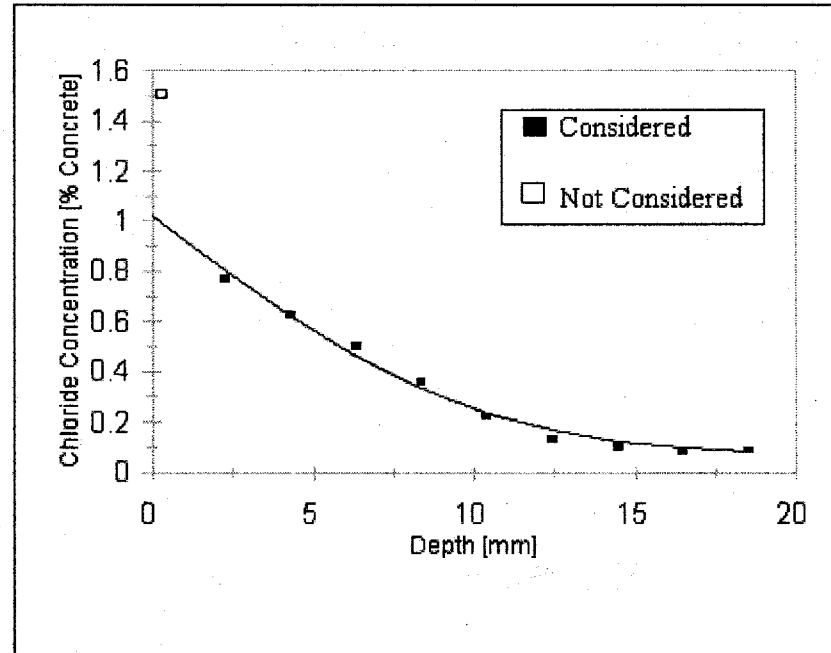
Duration: 40 Days

Diffusion Coefficient: 8.57E-12 m<sup>2</sup>/s  
Surface Concentration: 1.02 % Concrete  
Background: 0.070 % Concrete

r<sup>2</sup>: 0.9889

Data

Depth [mm]	Concentration [% Concrete]
0.25	1.51
2.29	0.77
4.32	0.63
6.35	0.50
8.38	0.36
10.41	0.22
12.45	0.13
14.48	0.10
16.51	0.09
18.54	0.09



Sample: FH-1-0.50/0/0/0

Test: Bulk Diffusion

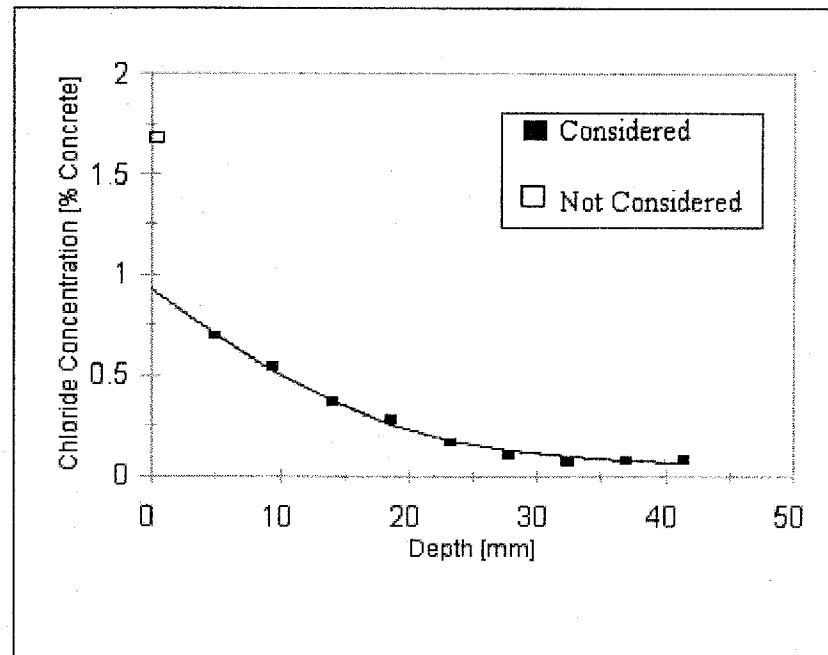
Duration: 90 Days

Diffusion Coefficient: 1.48E-11 m<sup>2</sup>/s  
Surface Concentration: 0.93 % Concrete  
Background: 0.065 % Concrete

r<sup>2</sup>: 0.9942

Data

Depth [mm]	Concentration [% Concrete]
0.38	1.69
4.95	0.69
9.53	0.54
14.10	0.37
18.67	0.28
23.24	0.16
27.81	0.10
32.39	0.07
36.96	0.08
41.53	0.08



Sample: FH-1-0.45/0/0

Test: Bulk Diffusion

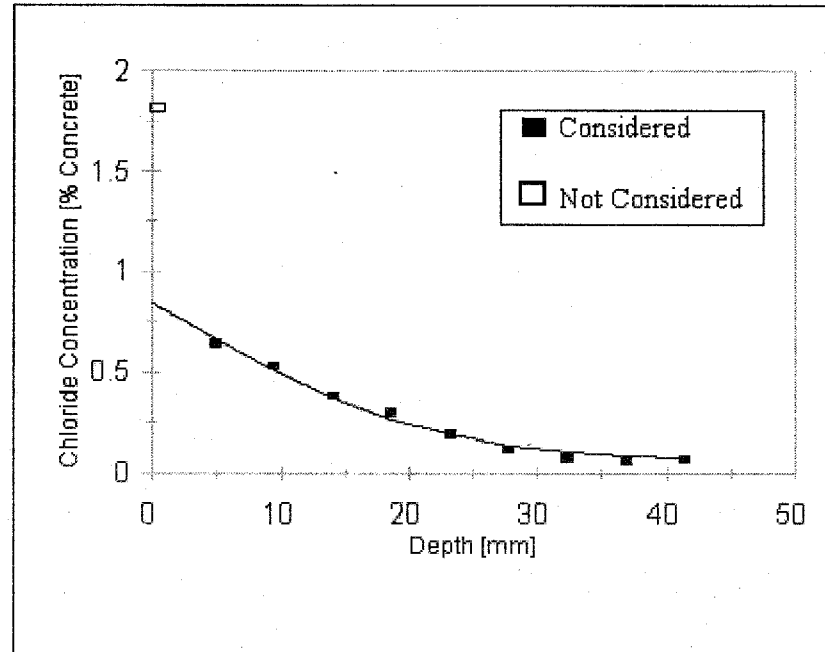
Duration: 90 Days

Diffusion Coefficient:  $1.72E-11$  m<sup>2</sup>/s  
Surface Concentration: 0.85 % Concrete  
Background: 0.070 % Concrete

$r^2$ : 0.9866

Data

Depth [mm]	Concentration [% Concrete]
0.38	1.81
4.95	0.64
9.53	0.53
14.10	0.38
18.67	0.30
23.24	0.19
27.81	0.12
32.39	0.07
36.96	0.06
41.53	0.07



Sample: FH-1-0.35/0/0/0

Test: Bulk Diffusion

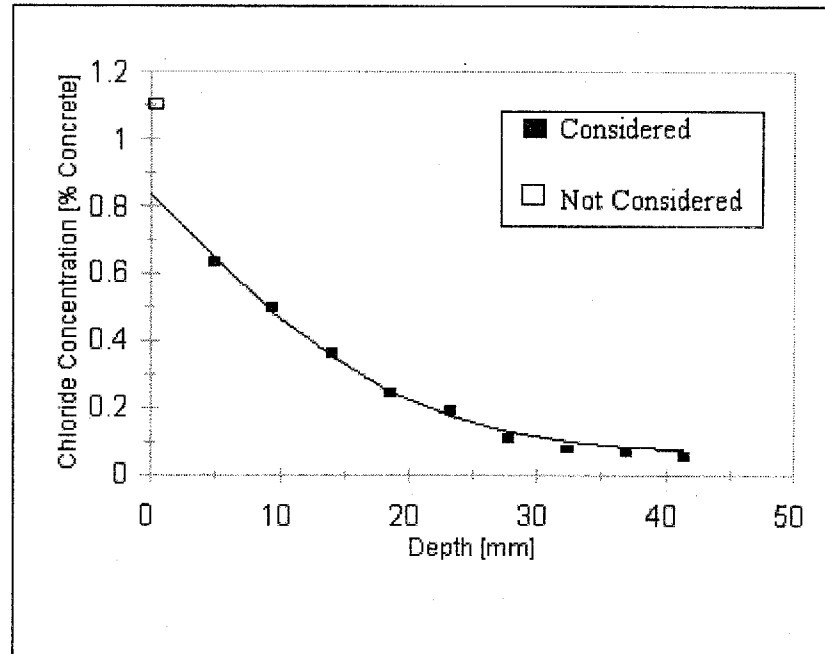
Duration: 90 Days

Diffusion Coefficient: 1.55E-11 m<sup>2</sup>/s  
Surface Concentration: 0.84 % Concrete  
Background: 0.070 % Concrete

r<sup>2</sup>: 0.9924

Data

Depth [mm]	Concentration [% Concrete]
0.38	1.10
4.95	0.63
9.53	0.50
14.10	0.36
18.67	0.24
23.24	0.19
27.81	0.11
32.39	0.08
36.96	0.06
41.53	0.06



Sample: FH-1-0.45/8/0/0

Test: Bulk Diffusion

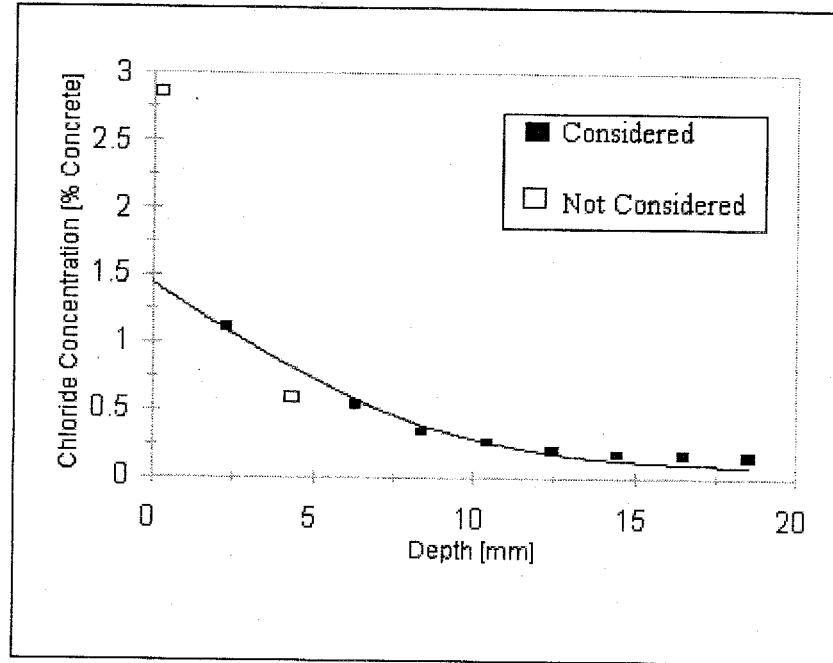
Duration: 90 Days

Diffusion Coefficient:  $3.15E-12$  m<sup>2</sup>/s  
Surface Concentration: 1.43 % Concrete  
Background: 0.070 % Concrete

r<sup>2</sup>: 0.9924

Data

Depth [mm]	Concentration [% Concrete]
0.25	2.87
2.29	1.11
4.32	0.59
6.35	0.53
8.38	0.34
10.41	0.26
12.45	0.20
14.48	0.17
16.51	0.17
18.54	0.15
20.57	0.13
22.61	0.08
23.62	0.07



Sample: FH-1-0.35/8/0/0

Test: Bulk Diffusion

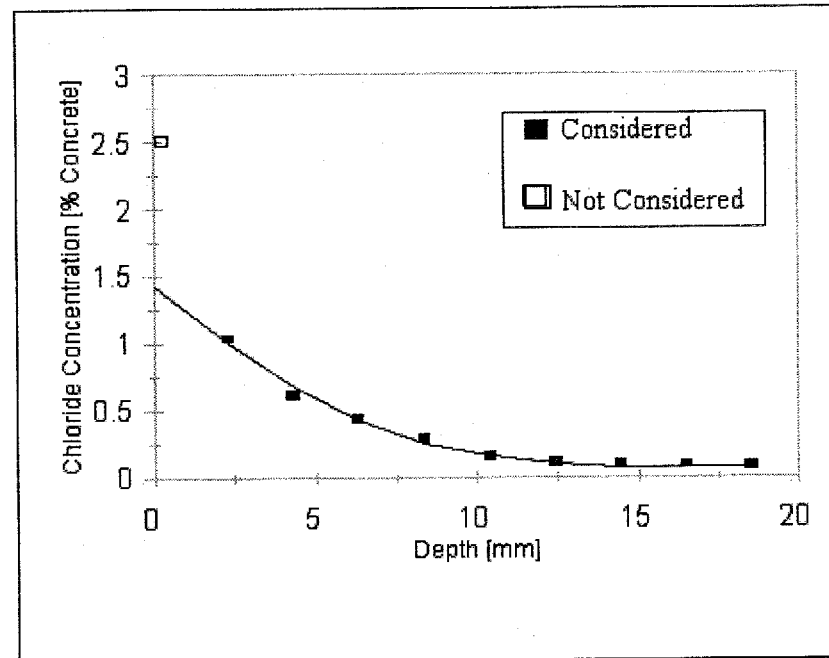
Duration: 90 Days

Diffusion Coefficient: 2.09E-12 m<sup>2</sup>/s  
Surface Concentration: 1.43 % Concrete  
Background: 0.060 % Concrete

r<sup>2</sup>: 0.9919

Data

Depth [mm]	Concentration [% Concrete]
0.25	2.51
2.29	1.03
4.32	0.61
6.35	0.43
8.38	0.28
10.41	0.15
12.45	0.11
14.48	0.09
16.51	0.09
18.54	0.08





Sample: FH-1-0.25/8/0/0

Test: Bulk Diffusion

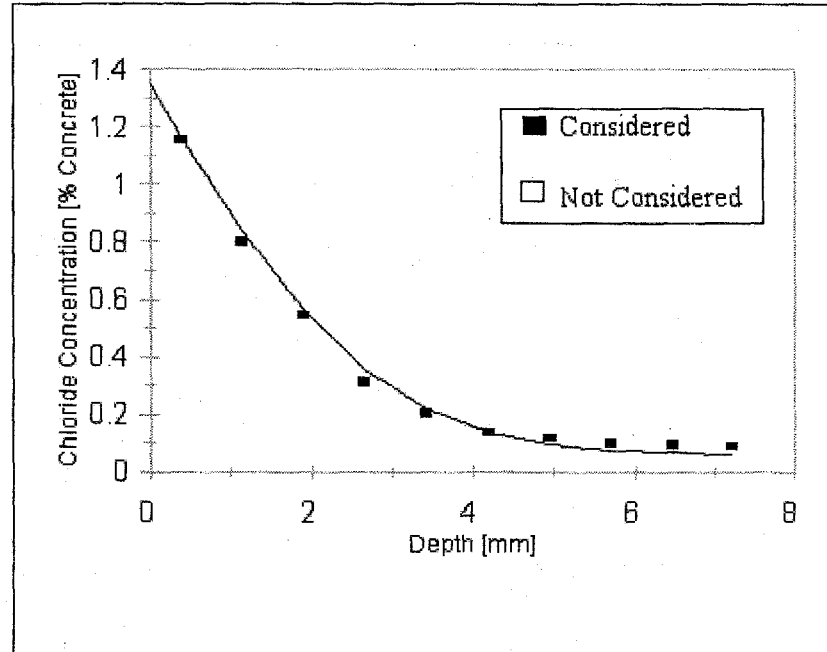
Duration: 90 Days

Diffusion Coefficient: 3.16E-13 m<sup>2</sup>/s  
Surface Concentration: 1.35 % Concrete  
Background: 0.060 % Concrete

r<sup>2</sup>: 0.9949

Data

Depth [mm]	Concentration [% Concrete]
0.38	1.15
1.14	0.80
1.91	0.54
2.67	0.31
3.43	0.20
4.19	0.14
4.95	0.12
5.72	0.10
6.48	0.09
7.24	0.09
8.00	0.07
9.53	0.07
11.05	0.07
12.57	0.06
14.10	0.06



Sample: FH-1-0.45/0/20/0

Test: Bulk Diffusion

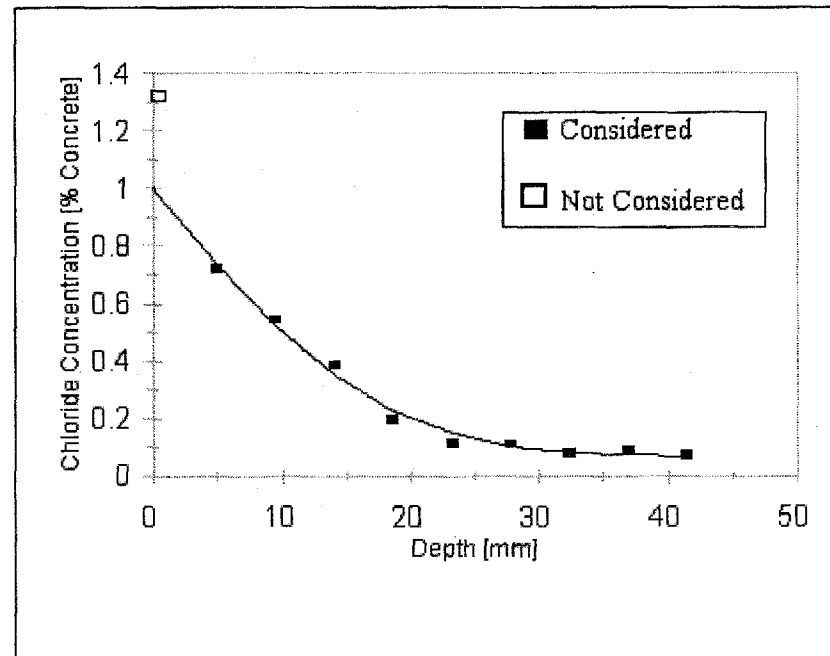
Duration: 90 Days

Diffusion Coefficient: 1.20E-11 m<sup>2</sup>/s  
Surface Concentration: 1.00 % Concrete  
Background: 0.065 % Concrete

r<sup>2</sup>: 0.9894

Data

Depth [mm]	Concentration [% Concrete]
0.38	1.32
4.95	0.72
9.53	0.54
14.10	0.38
18.67	0.20
23.24	0.11
27.81	0.11
32.39	0.08
36.96	0.09
41.53	0.07



Sample: FH-1-0.45/0/0/35

Test: Bulk Diffusion

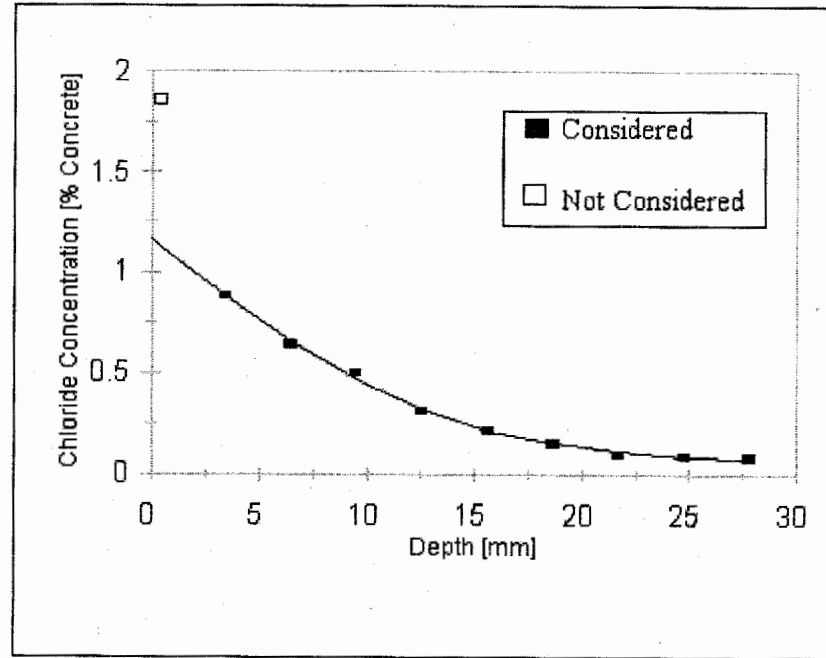
Duration: 90 Days

Diffusion Coefficient: 7.04E-12 m<sup>2</sup>/s  
Surface Concentration: 1.16 % Concrete  
Background: 0.070 % Concrete

r<sup>2</sup>: 0.9975

**Data**

Depth [mm]	Concentration [% Concrete]
0.38	1.86
3.43	0.88
6.48	0.64
9.53	0.50
12.57	0.31
15.62	0.21
18.67	0.15
21.72	0.10
24.77	0.08
27.81	0.08
30.86	0.08
33.91	0.08



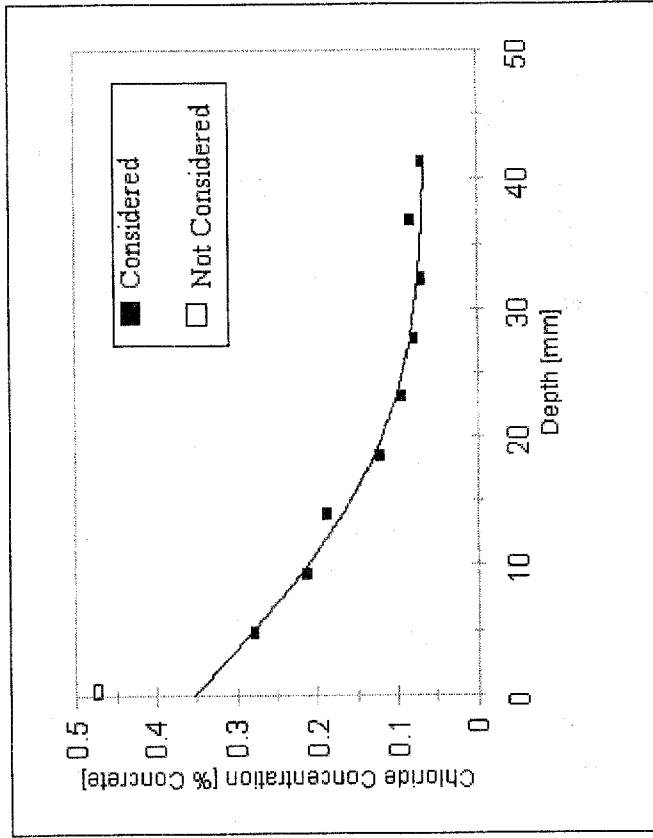
Sample: FH-1-0.50/0/0/0

Test: Salt Ponding

Duration: 90 Days

$r^2$ : 0.9821

Diffusion Coefficient: 1.47E-11 m<sup>2</sup>/s  
Surface Concentration: 0.35 % Concrete  
Background: 0.065 % Concrete



**Data**

Depth [mm]	Concentration [% Concrete]
0.38	0.47
4.95	0.28
9.53	0.21
14.10	0.19
18.67	0.12
23.24	0.09
27.81	0.08
32.39	0.07
36.96	0.08
41.53	0.07

Total Integrated Chloride Content Above Background: 6.55 % of concrete mass - mm

Depth of 0.1 % Chloride Content Above Background: 15.6 mm

Sample: FH-1-0.45/0/0/0

Test: Salt Ponding

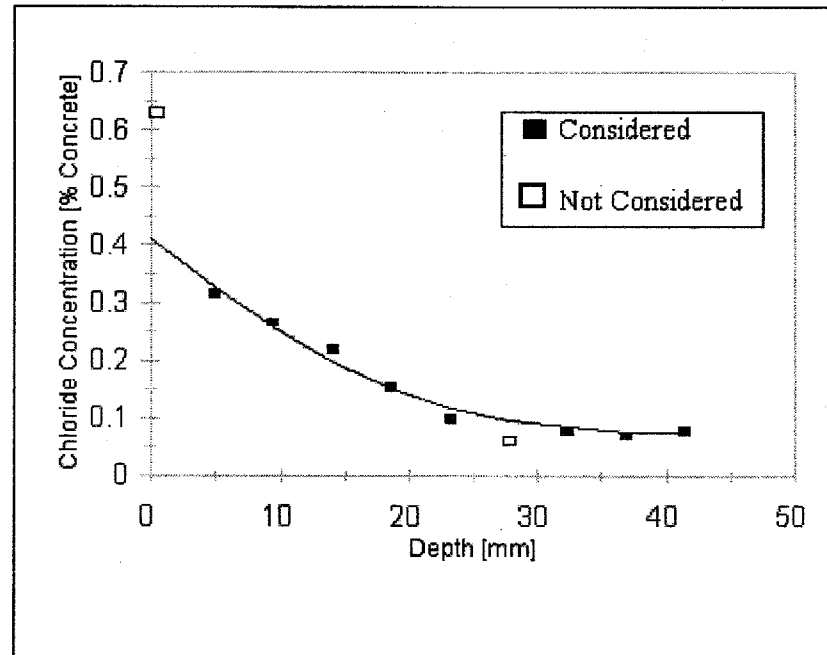
Duration: 90 Days

Diffusion Coefficient: 1.60E-11 m<sup>2</sup>/s  
Surface Concentration: 0.41 % Concrete  
Background: 0.070 % Concrete

r<sup>2</sup>: 0.9800

Data

Depth [mm]	Concentration [% Concrete]
0.38	0.63
4.95	0.31
9.53	0.26
14.10	0.22
18.67	0.15
23.24	0.10
27.81	0.06
32.39	0.08
36.96	0.07
41.53	0.08



Total Integrated Chloride Content Above Background: 5.59 % of concrete mass - mm

Depth of 0.1 % Chloride Content Above Background: 17.4 mm

Sample: FH-1-0.35/0/0/0

Test: Salt Ponding

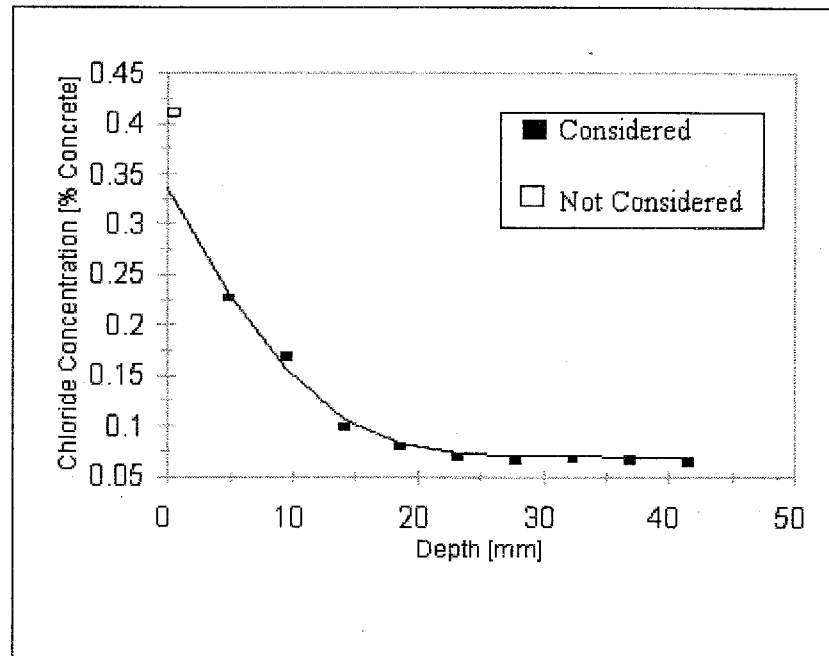
Duration: 90 Days

Diffusion Coefficient: 5.84E-12 m<sup>2</sup>/s  
Surface Concentration: 0.34 % Concrete  
Background: 0.070 % Concrete

r<sup>2</sup>: 0.9853

Data

Depth [mm]	Concentration [% Concrete]
0.38	0.41
4.95	0.23
9.53	0.17
14.10	0.10
18.67	0.08
23.24	0.07
27.81	0.07
32.39	0.07
36.96	0.07
41.53	0.06



Total Integrated Chloride Content Above Background: 2.18 % of concrete mass - mm

Depth of 0.1 % Chloride Content Above Background: 9.4 mm

Sample: FH-1-0.45/8/0/0

Test: Salt Ponding

Duration: 90 Days

$r^2$ : 0.9895

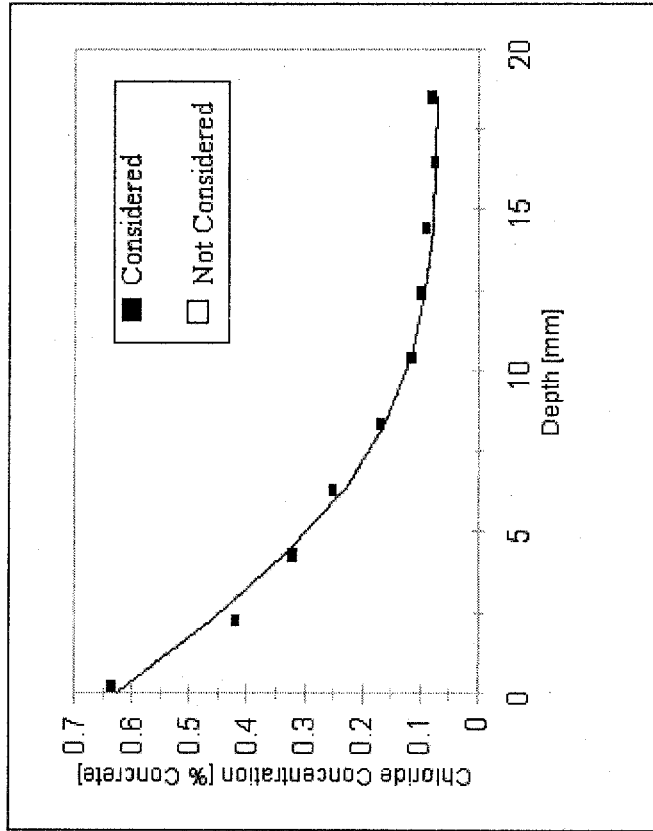
Diffusion Coefficient:  $2.30E-12 \text{ m}^2/\text{s}$

Surface Concentration: 0.63 % Concrete

Background: 0.070 % Concrete

Data

Depth [mm]	Concentration [% Concrete]
0.25	0.63
2.29	0.42
4.32	0.32
6.35	0.25
8.38	0.17
10.41	0.11
12.45	0.10
14.48	0.09
16.51	0.08
18.54	0.08



Total Integrated Chloride Content Above Background: 3.15 % of concrete mass - mm

Depth of 0.1 % Chloride Content Above Background: 8.3 mm

Sample: FH-1-0.35/8/0/0

Test: Salt Ponding

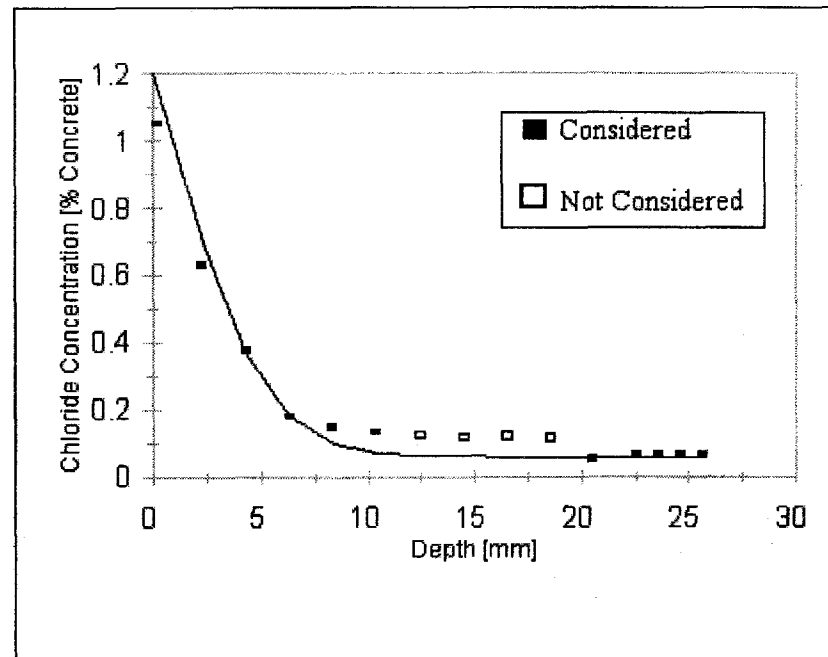
Duration: 90 Days

Diffusion Coefficient: 9.98E-13 m<sup>2</sup>/s  
Surface Concentration: 1.20 % Concrete  
Background: 0.060 % Concrete

r<sup>2</sup>: 0.9941

Data

Depth [mm]	Concentration [% Concrete]
0.25	1.05
2.29	0.63
4.32	0.38
6.35	0.18
8.38	0.15
10.41	0.13
12.45	0.13
14.48	0.12
16.51	0.12
18.54	0.12
20.57	0.05
22.61	0.06
23.62	0.06
24.64	0.06
25.65	0.06



Total Integrated Chloride Content Above Background: 4.44 % of concrete mass - mm

Depth of 0.1 % Chloride Content Above Background: 7.5 mm



Sample: FH-1-0.25/8/0/0

Test: Salt Ponding

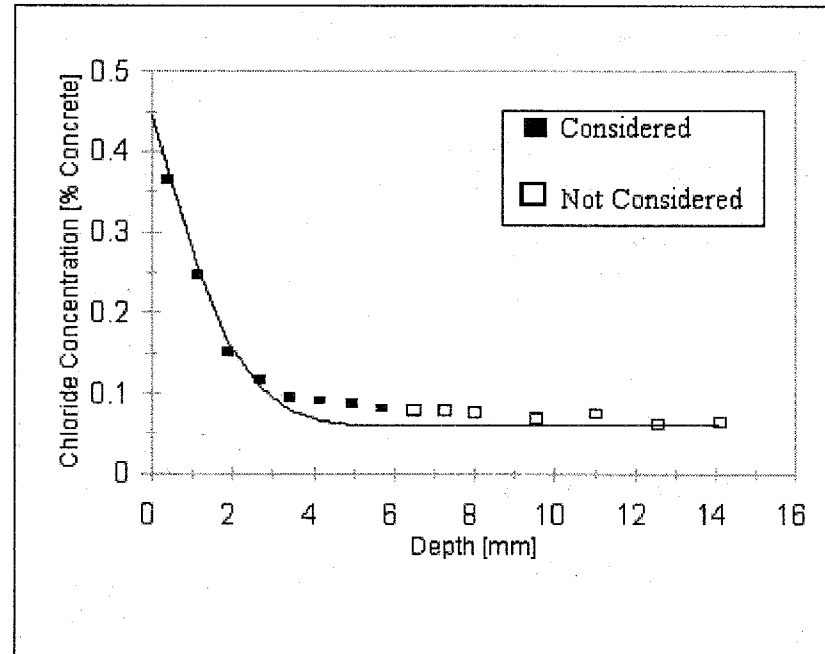
Duration: 90 Days

Diffusion Coefficient: 1.90E-13 m<sup>2</sup>/s  
Surface Concentration: 0.44 % Concrete  
Background: 0.060 % Concrete

r<sup>2</sup>: 0.9666

Data

Depth [mm]	Concentration [% Concrete]
0.38	0.36
1.14	0.25
1.91	0.15
2.67	0.12
3.43	0.09
4.19	0.09
4.95	0.09
5.72	0.08
6.48	0.08
7.24	0.08
8.00	0.08
9.53	0.07
11.05	0.08
12.57	0.06
14.10	0.06



Total Integrated Chloride Content Above Background: 0.94 % of concrete mass - mm

Depth of 0.1 % Chloride Content Above Background: 1.8 mm

Sample: FH-1-0.45/0/20/0

Test: Salt Ponding

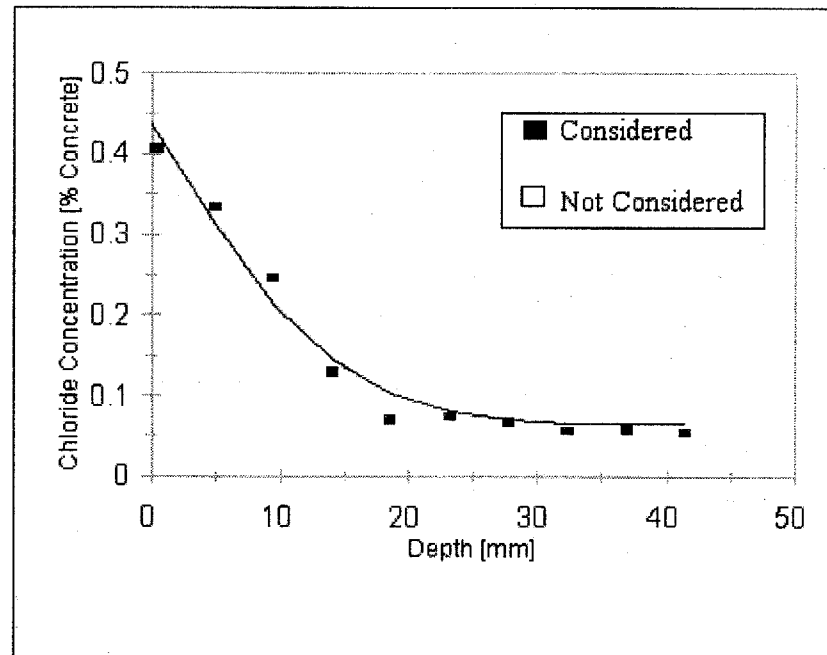
Duration: 90 Days

Diffusion Coefficient: 8.34E-12 m<sup>2</sup>/s  
Surface Concentration: 0.44 % Concrete  
Background: 0.065 % Concrete

r<sup>2</sup>: 0.9768

**Data**

Depth [mm]	Concentration [% Concrete]
0.38	0.41
4.95	0.33
9.53	0.24
14.10	0.13
18.67	0.07
23.24	0.07
27.81	0.07
32.39	0.06
36.96	0.06
41.53	0.05



Total Integrated Chloride Content Above Background: 4.19 % of concrete mass - mm

Depth of 0.1 % Chloride Content Above Background: 12.7 mm

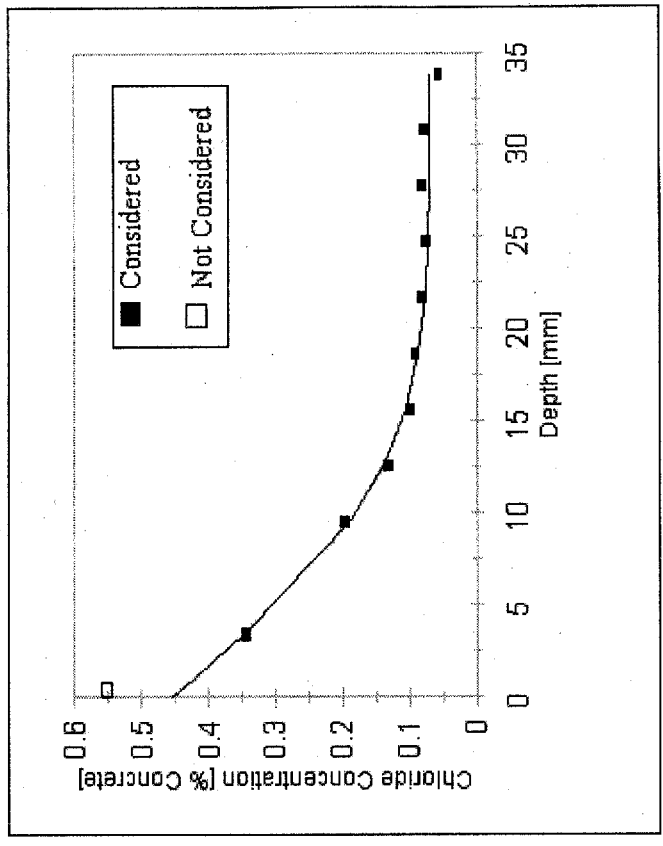
Sample: FH-1-0.45/0/0/35      Test: Salt Ponding      Duration: 90 Days

$r^2$ : 0.9910

Diffusion Coefficient: 5.55E-12 m<sup>2</sup>/s  
 Surface Concentration: 0.45 % Concrete  
 Background: 0.070 % Concrete

**Data**

Depth [mm]	Concentration [% Concrete]
0.38	0.55
3.43	0.34
9.53	0.20
12.57	0.13
15.62	0.10
18.67	0.09
21.72	0.08
24.77	0.07
27.81	0.08
30.86	0.08
33.91	0.05



Total Integrated Chloride Content Above Background: 3.82 % of concrete mass - mm

Depth of 0.1 % Chloride Content Above Background: 10.7 mm

Sample: FH-1-0.50/0/0

Test: Bulk Diffusion

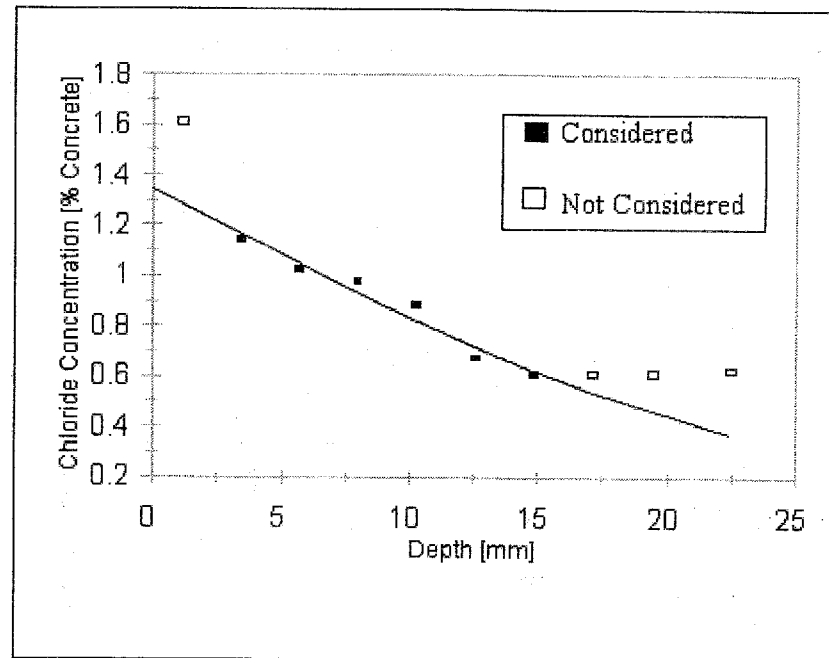
Duration: 365 Days

Diffusion Coefficient: 5.79E-12 m<sup>2</sup>/s  
Surface Concentration: 1.35 % Concrete  
Background: 0.065 % Concrete

r<sup>2</sup>: 0.9593

Data

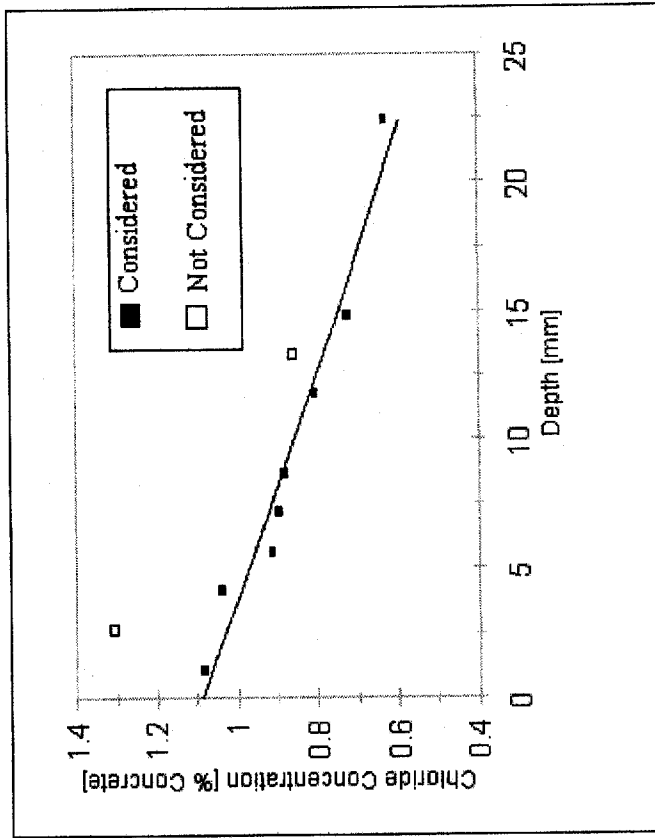
Depth [mm]	Concentration [% Concrete]
1.14	1.61
3.43	1.14
5.72	1.02
8.00	0.97
10.29	0.88
12.57	0.67
14.86	0.60
17.15	0.61
19.43	0.62
22.48	0.63



Sample: FH-1-0.45/0/0 Test: Bulk Diffusion Duration: 365 Days

$r^2: 0.9573$

Diffusion Coefficient:  $1.86E-11 \text{ m}^2/\text{s}$   
 Surface Concentration: 1.09 % Concrete  
 Background: 0.070 % Concrete



Depth [mm]	Concentration [% Concrete]
1.14	1.08
2.67	1.31
4.19	1.04
5.72	0.91
7.24	0.90
8.76	0.88
11.81	0.80
13.34	0.86
14.86	0.72
22.48	0.63

Sample: FH-1-0.35/0/0

Test: Bulk Diffusion

Duration: 365 Days

Diffusion Coefficient:  $1.02E-11 \text{ m}^2/\text{s}$

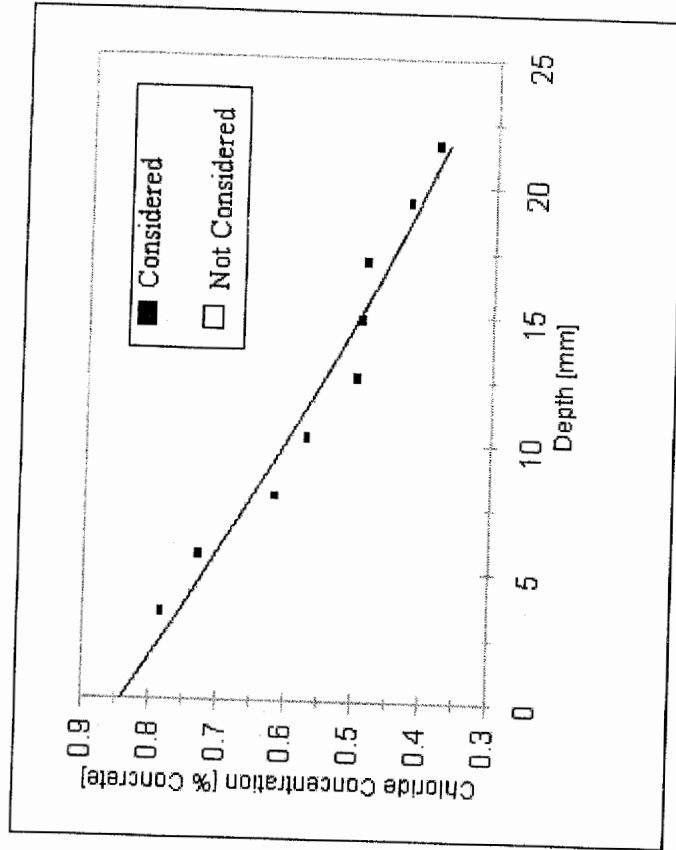
Surface Concentration: 0.84 % Concrete

Background: 0.070 % Concrete

$r^2$ : 0.9533

### Data

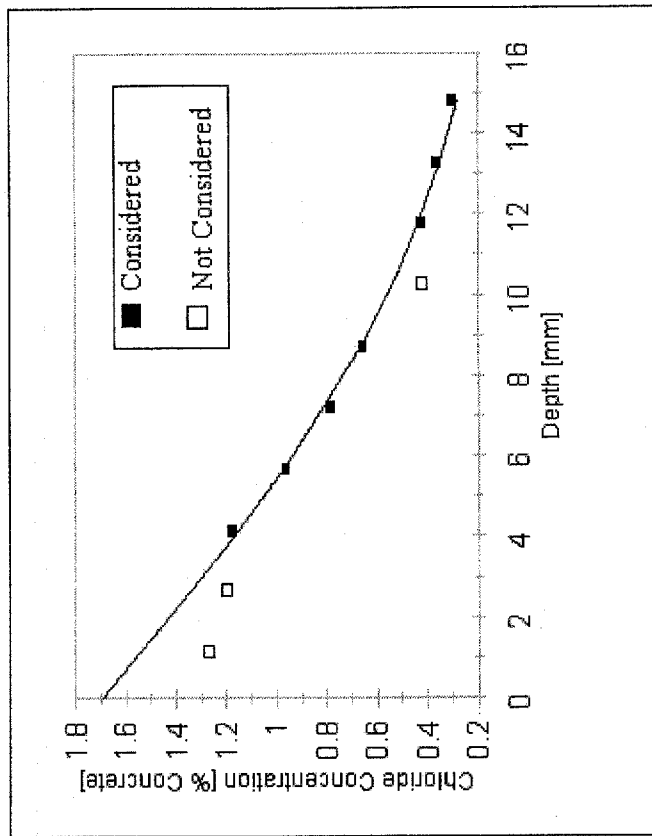
Depth [mm]	Concentration [% Concrete]
3.43	0.78
5.72	0.73
8.00	0.62
10.29	0.57
12.57	0.50
14.86	0.49
17.15	0.49
19.43	0.42
21.72	0.38



**Sample:** FH-1-0.45/8/0      **Test:** Bulk Diffusion      **Duration:** 365 Days

$r^2$ : 0.9964

**Diffusion Coefficient:** 1.49E-12 m<sup>2</sup>/s  
**Surface Concentration:** 1.69 % Concrete  
**Background:** 0.070 % Concrete



**Data**

Depth [mm]	Concentration [% Concrete]
1.14	1.27
2.67	1.20
4.19	1.17
5.72	0.96
7.24	0.78
8.76	0.65
10.29	0.42
11.81	0.42
13.34	0.36
14.86	0.30

Sample: FH-1-0.35/8/0/0

Test: Bulk Diffusion

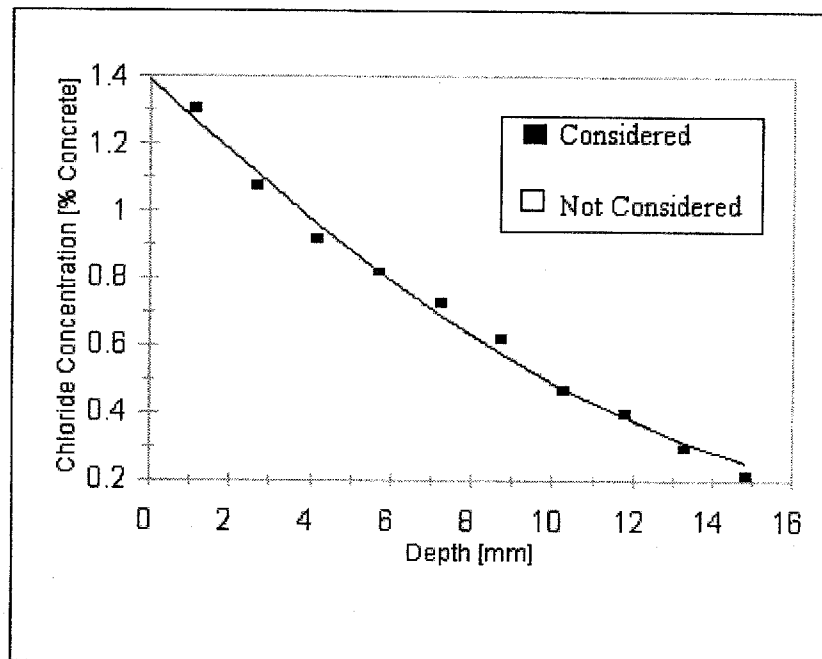
Duration: 365 Days

Diffusion Coefficient: 1.63E-12 m<sup>2</sup>/s  
Surface Concentration: 1.39 % Concrete  
Background: 0.060 % Concrete

r<sup>2</sup>: 0.9908

Data

Depth [mm]	Concentration [% Concrete]
1.14	1.30
2.67	1.07
4.19	0.92
5.72	0.82
7.24	0.73
8.76	0.62
10.29	0.47
11.81	0.40
13.34	0.29
14.86	0.21





Sample: FH-1-0.25/8/0/0

Test: Bulk Diffusion

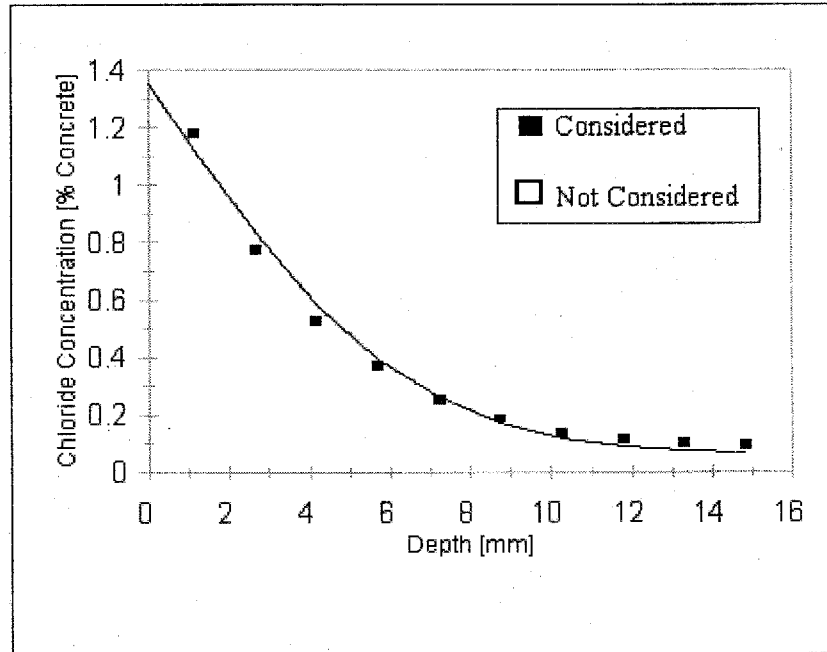
Duration: 365 Days

Diffusion Coefficient: 4.05E-13 m<sup>2</sup>/s  
Surface Concentration: 1.35 % Concrete  
Background: 0.060 % Concrete

r<sup>2</sup>: 0.9876

Data

Depth [mm]	Concentration [% Concrete]
1.14	1.18
2.67	0.77
4.19	0.52
5.72	0.36
7.24	0.25
8.76	0.18
10.29	0.13
11.81	0.11
13.34	0.10
14.86	0.09



Sample: FH-1-0.45/0/20/0

Test: Bulk Diffusion

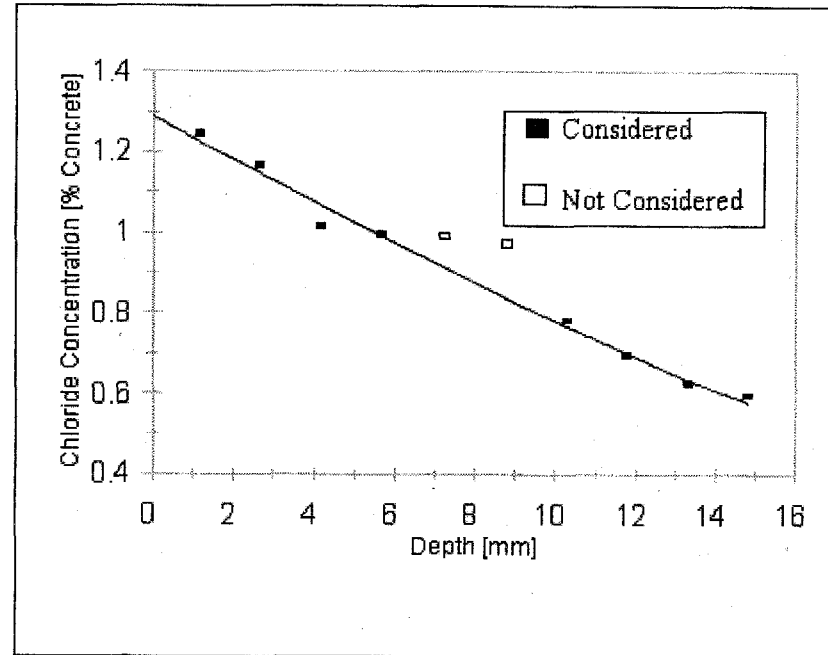
Duration: 365 Days

Diffusion Coefficient: 5.33E-12 m<sup>2</sup>/s  
Surface Concentration: 1.29 % Concrete  
Background: 0.065 % Concrete

r<sup>2</sup>: 0.9903

Data

Depth [mm]	Concentration [% Concrete]
1.14	1.24
2.67	1.17
4.19	1.01
5.72	0.99
7.24	0.99
8.76	0.97
10.29	0.78
11.81	0.70
13.34	0.62
14.86	0.59



Sample: FH-1-0.45/0/0/35

Test: Bulk Diffusion

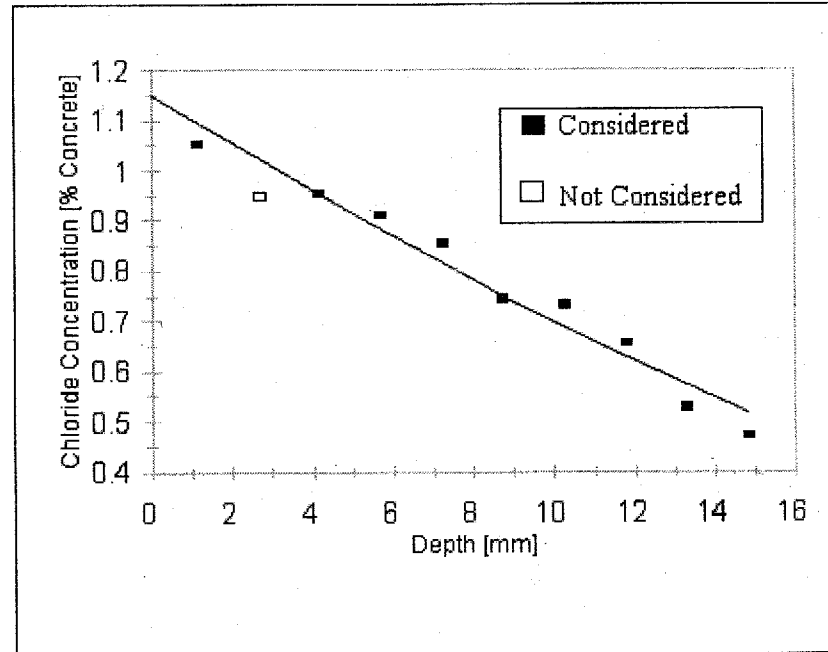
Duration: 365 Days

Diffusion Coefficient: 5.25E-12 m<sup>2</sup>/s  
Surface Concentration: 1.15 % Concrete  
Background: 0.070 % Concrete

r<sup>2</sup>: 0.9648

Data

Depth [mm]	Concentration [% Concrete]
1.14	1.05
2.67	0.95
4.19	0.95
5.72	0.91
7.24	0.85
8.76	0.74
10.29	0.73
11.81	0.65
13.34	0.53
14.86	0.47



Sample: FH-1-0.50/0/0/0

Test: Salt Ponding

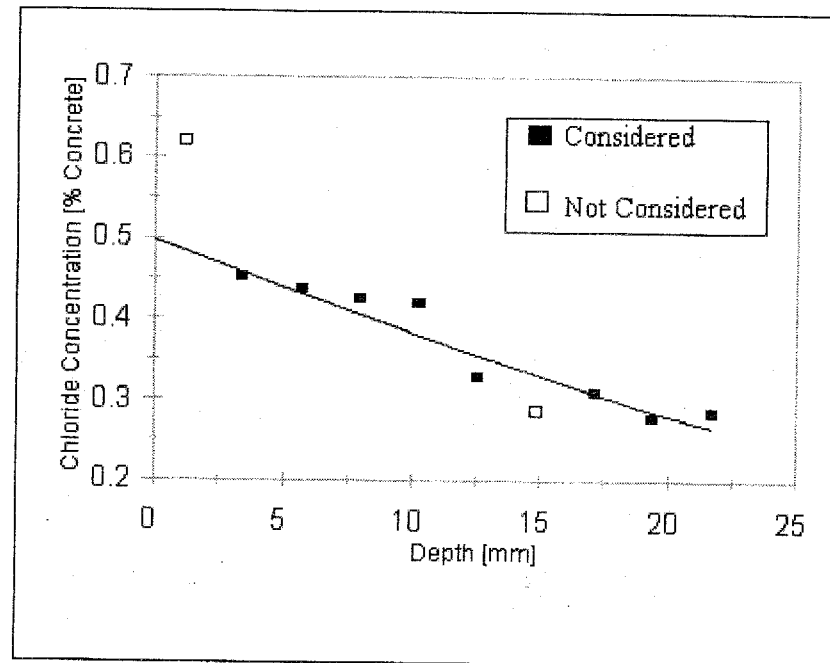
Duration: 365 Days

Diffusion Coefficient: 1.40E-11 m<sup>2</sup>/s  
Surface Concentration: 0.50 % Concrete  
Background: 0.065 % Concrete

r<sup>2</sup>: 0.9555

Data

Depth [mm]	Concentration [% Concrete]
1.14	0.62
3.43	0.45
5.72	0.44
8.00	0.42
10.29	0.42
12.57	0.33
14.86	0.29
17.15	0.31
19.43	0.28
21.72	0.28



Sample: FH-1-0.45/0/0

Test: Salt Ponding

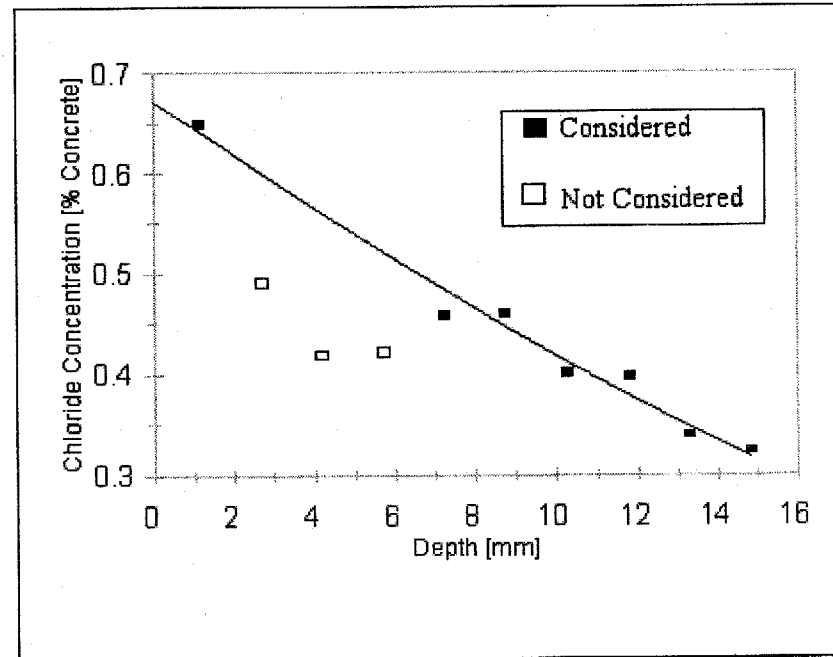
Duration: 365 Days

Diffusion Coefficient:  $5.18 \times 10^{-12}$  m<sup>2</sup>/s  
Surface Concentration: 0.67 % Concrete  
Background: 0.070 % Concrete

r<sup>2</sup>: 0.9798

Data

Depth [mm]	Concentration [% Concrete]
1.14	0.65
2.67	0.49
4.19	0.42
5.72	0.42
7.24	0.46
8.76	0.46
10.29	0.40
11.81	0.40
13.34	0.34
14.86	0.32

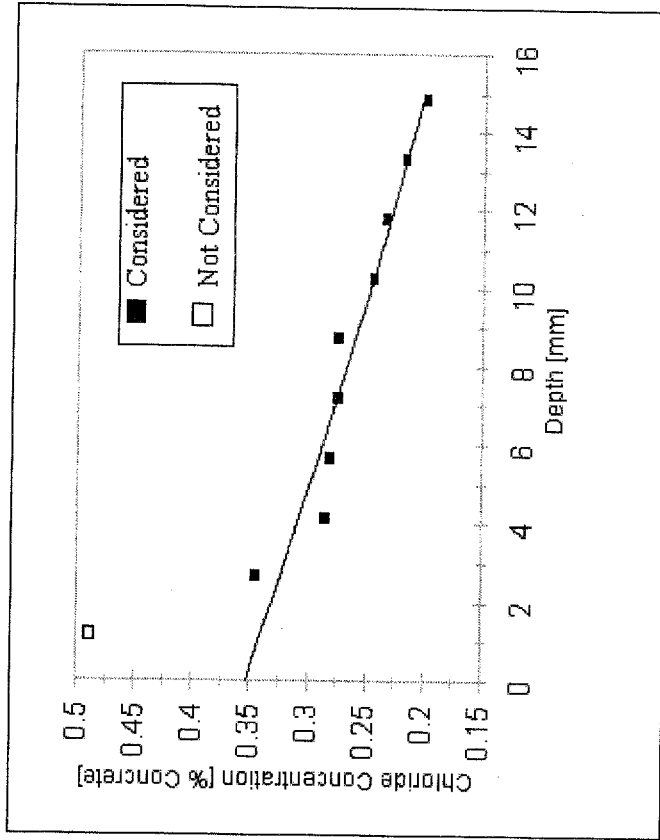


Sample: FH-1-0.35/0/0/0      Test: Salt Ponding      Duration: 365 Days

Diffusion Coefficient: 6.72E-12 m<sup>2</sup>/s      r<sup>2</sup>: 0.9144  
 Surface Concentration: 0.35 % Concrete  
 Background: 0.070 % Concrete

**Data**

Depth [mm]	Concentration [% Concrete]
1.14	0.49
2.67	0.34
4.19	0.28
5.72	0.28
7.24	0.27
8.76	0.27
10.29	0.24
11.81	0.23
13.34	0.22
14.86	0.20



Sample: FH-1-0.45/8/0/0

Test: Salt Ponding

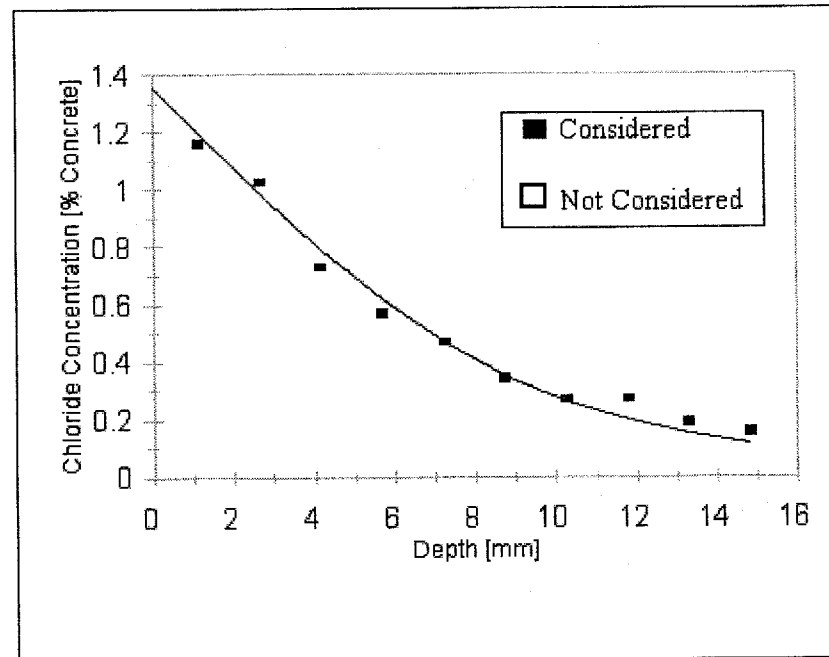
Duration: 365 Days

Diffusion Coefficient: 8.08E-13 m<sup>2</sup>/s  
Surface Concentration: 1.36 % Concrete  
Background: 0.070 % Concrete

r<sup>2</sup>: 0.9849

Data

Depth [mm]	Concentration [% Concrete]
1.14	1.16
2.67	1.02
4.19	0.73
5.72	0.56
7.24	0.47
8.76	0.34
10.29	0.27
11.81	0.27
13.34	0.19
14.86	0.15



Sample: FH-1-0.35/8/0/0

Test: Salt Ponding

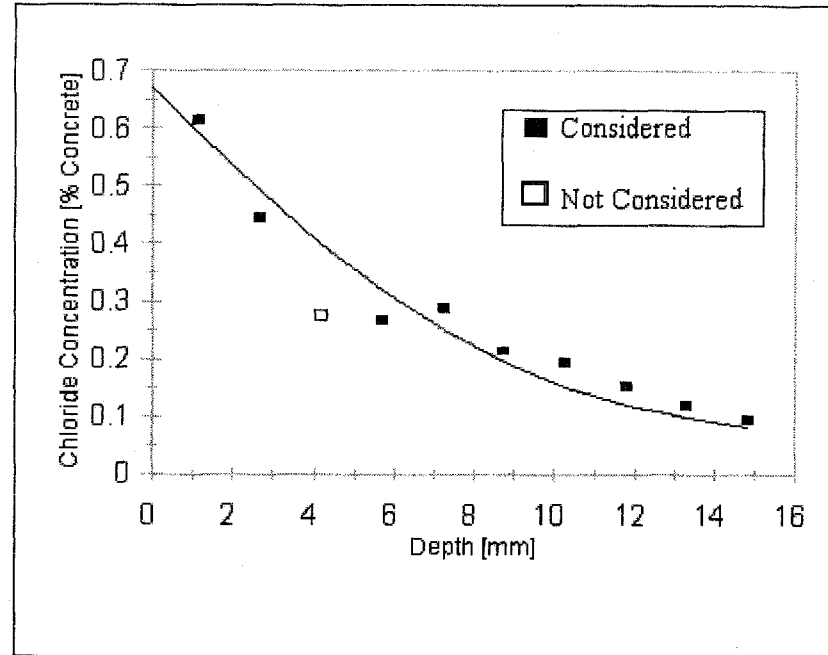
Duration: 365 Days

Diffusion Coefficient: 8.08E-13 m<sup>2</sup>/s  
Surface Concentration: 0.67 % Concrete  
Background: 0.060 % Concrete

r<sup>2</sup>: 0.9538

Data

Depth [mm]	Concentration [% Concrete]
1.14	0.61
2.67	0.44
4.19	0.28
5.72	0.27
7.24	0.29
8.76	0.21
10.29	0.19
11.81	0.15
13.34	0.12
14.86	0.09





Sample: FH-1-0.25/8/0/0

Test: Salt Ponding

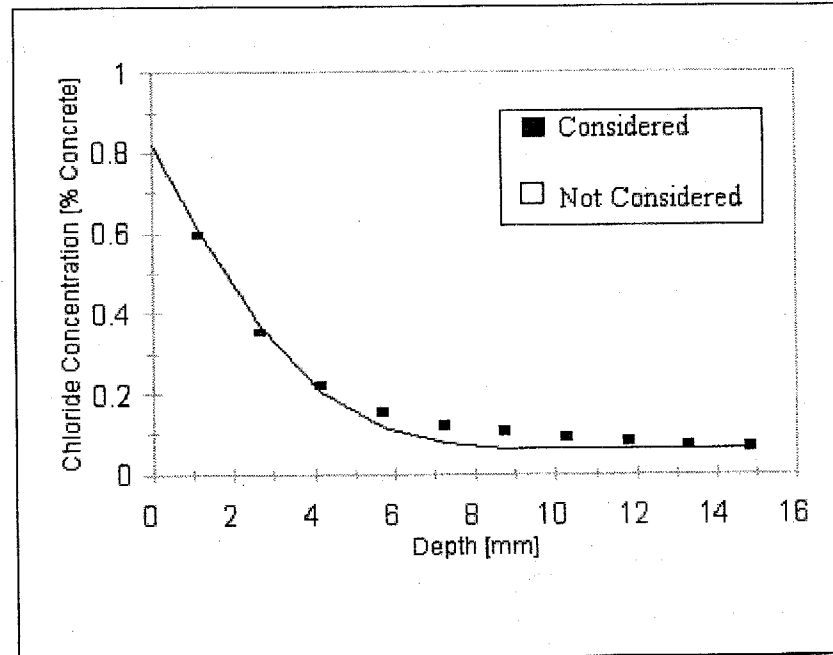
Duration: 365 Days

Diffusion Coefficient: 1.61E-13 m<sup>2</sup>/s  
Surface Concentration: 0.82 % Concrete  
Background: 0.060 % Concrete

r<sup>2</sup>: 0.9740

Data

Depth [mm]	Concentration [% Concrete]
1.14	0.59
2.67	0.35
4.19	0.22
5.72	0.15
7.24	0.12
8.76	0.10
10.29	0.09
11.81	0.08
13.34	0.07
14.86	0.06



Sample: FH-1-0.45/0/20/0

Test: Salt Ponding

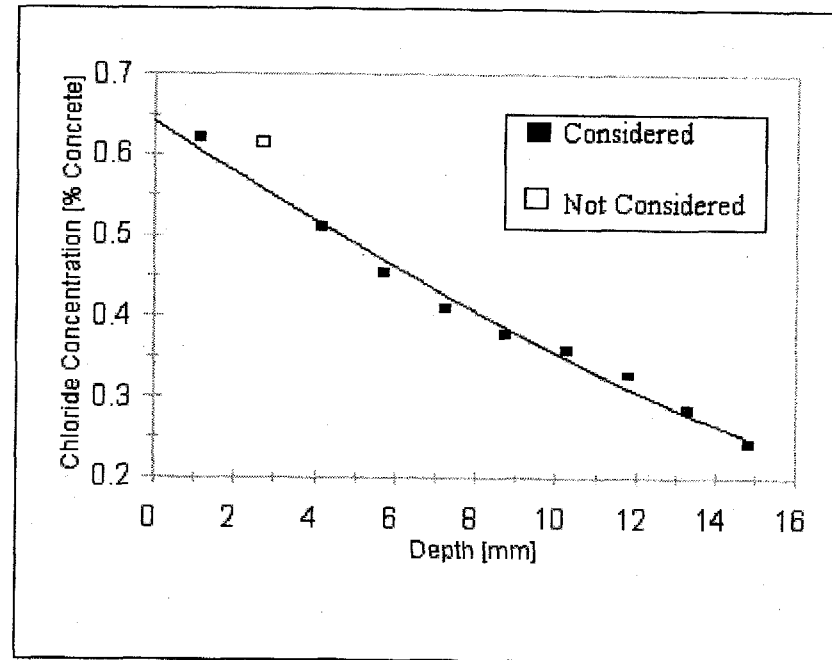
Duration: 365 Days

Diffusion Coefficient: 3.52E-12 m<sup>2</sup>/s  
Surface Concentration: 0.64 % Concrete  
Background: 0.065 % Concrete

r<sup>2</sup>: 0.9890

Data

Depth [mm]	Concentration [% Concrete]
1.14	0.62
2.67	0.62
4.19	0.51
5.72	0.45
7.24	0.41
8.76	0.38
10.29	0.36
11.81	0.33
13.34	0.28
14.86	0.24



Sample: FH-1-0.45/0/0/35

Test: Salt Ponding

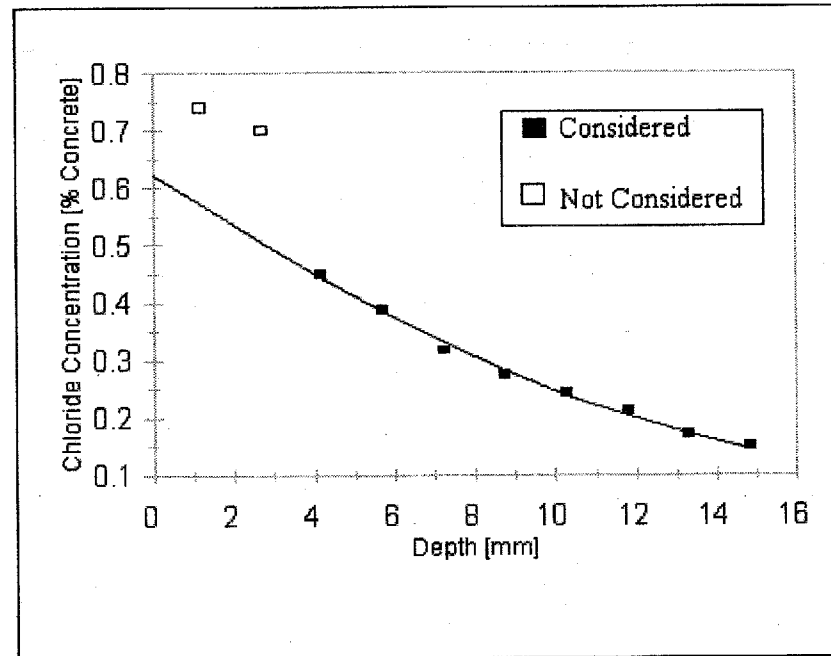
Duration: 365 Days

Diffusion Coefficient: 1.58E-12 m<sup>2</sup>/s  
Surface Concentration: 0.62 % Concrete  
Background: 0.070 % Concrete

r<sup>2</sup>: 0.9949

Data

Depth [mm]	Concentration [% Concrete]
1.14	0.74
2.67	0.70
4.19	0.45
5.72	0.39
7.24	0.32
8.76	0.27
10.29	0.24
11.81	0.21
13.34	0.17
14.86	0.15

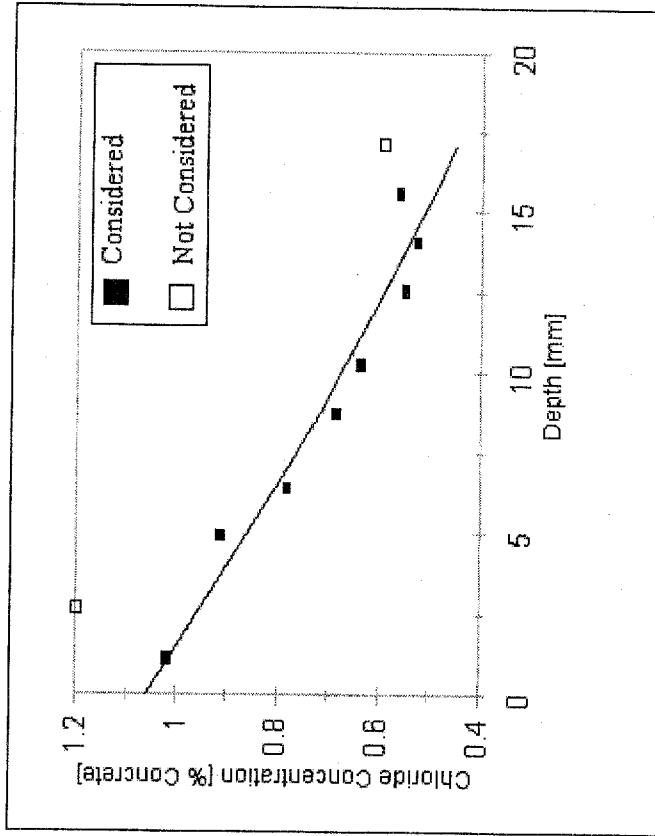


**Sample:** FH-2-0.45-23C      **Test:** Bulk Diffusion      **Duration:** 90 Days

**Diffusion Coefficient:** 2.51E-11 m<sup>2</sup>/s       $r^2$ : 0.955  
**Surface Concentration:** 1.06 % Concrete  
**Background:** 0.068 % Concrete

**Data**

Depth [mm]	Concentration [% Concrete]
1.14	1.02
2.67	1.20
4.95	0.91
6.48	0.78
8.76	0.69
10.29	0.64
12.57	0.55
14.10	0.53
15.62	0.56
17.15	0.59



Sample: FH-2-0.45-Silane

Test: Bulk Diffusion

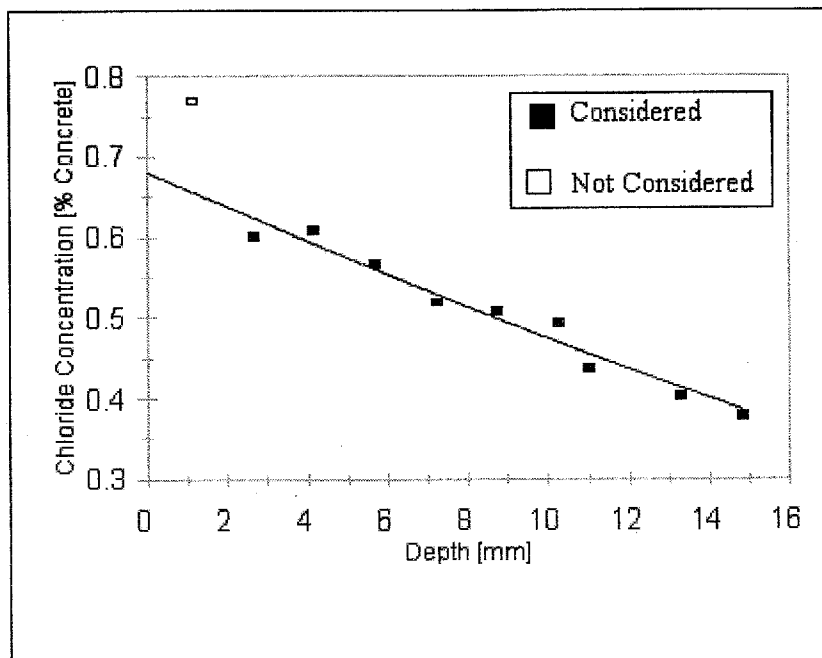
Duration: 90 Days

Diffusion Coefficient: 3.46E-11 m<sup>2</sup>/s  
Surface Concentration: 0.68 % Concrete  
Background: 0.065 % Concrete

r<sup>2</sup>: 0.9674

Data

Depth [mm]	Concentration [% Concrete]
1.14	0.77
2.67	0.60
4.19	0.61
5.72	0.57
7.24	0.52
8.76	0.51
10.29	0.49
11.05	0.44
13.34	0.40
14.86	0.38



Sample: FH-2-0.45-7C

Test: Bulk Diffusion

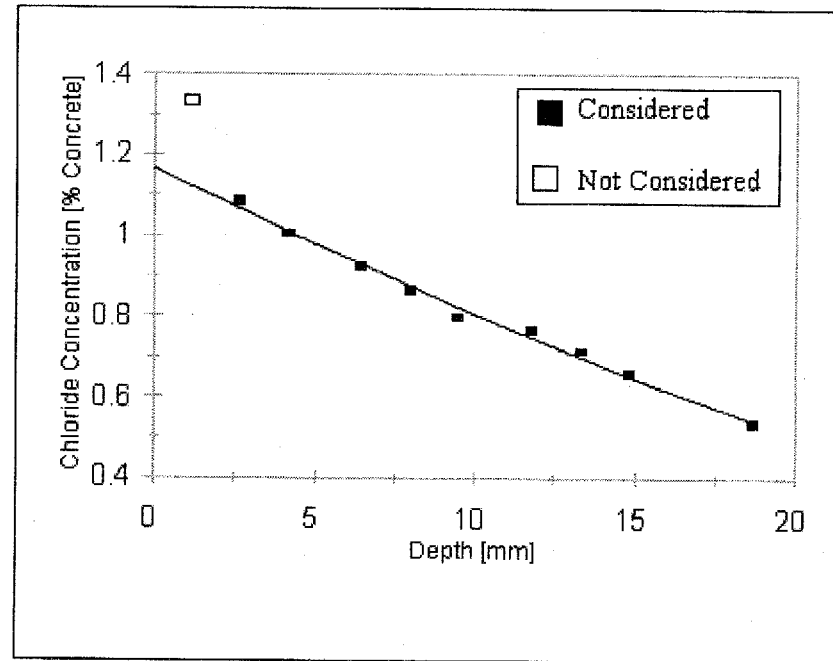
Duration: 90 Days

Diffusion Coefficient: 3.70E-11 m<sup>2</sup>/s  
Surface Concentration: 1.16 % Concrete  
Background: 0.058 % Concrete

r<sup>2</sup>: 0.9918

Data

Depth [mm]	Concentration [% Concrete]
1.14	1.33
2.67	1.09
4.19	1.00
6.48	0.92
8.00	0.86
9.53	0.80
11.81	0.76
13.34	0.71
14.86	0.66
18.67	0.53



Sample: FH-2-0.45-38C

Test: Bulk Diffusion

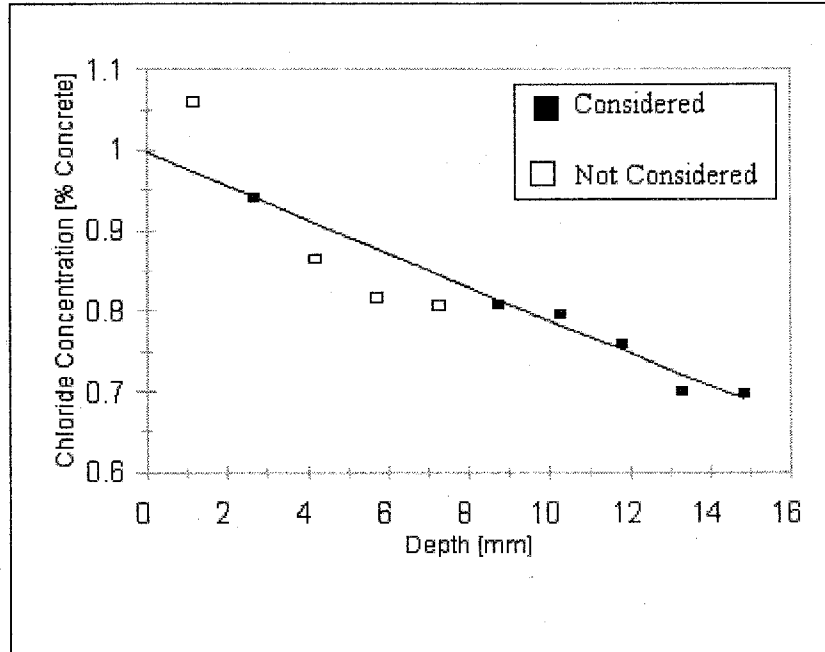
Duration: 90 Days

Diffusion Coefficient: 7.92E-11 m<sup>2</sup>/s  
Surface Concentration: 1.00 % Concrete  
Background: 0.058 % Concrete

r<sup>2</sup>: 0.9813

Data

Depth [mm]	Concentration [% Concrete]
1.14	1.06
2.67	0.94
4.19	0.86
5.72	0.82
7.24	0.81
8.76	0.81
10.29	0.79
11.81	0.76
13.34	0.70
14.86	0.70



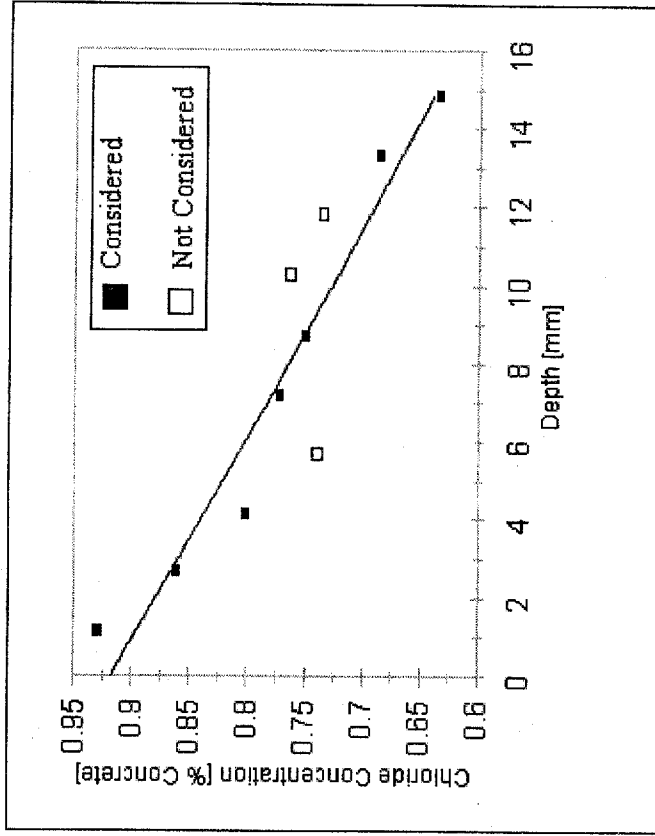
Sample: FH-2-0.45-Steam      Test: Bulk Diffusion      Duration: 90 Days

$r^2$ : 0.9527

Diffusion Coefficient:  $8.16E-11 \text{ m}^2/\text{s}$   
 Surface Concentration: 0.92 % Concrete  
 Background: 0.058 % Concrete

**Data**

Depth [mm]	Concentration [% Concrete]
1.14	0.93
2.67	0.86
4.19	0.80
5.72	0.74
7.24	0.77
8.76	0.75
10.29	0.76
11.81	0.74
13.34	0.69
14.86	0.63





Sample: FH-2-0.45-Steel

Test: Bulk Diffusion

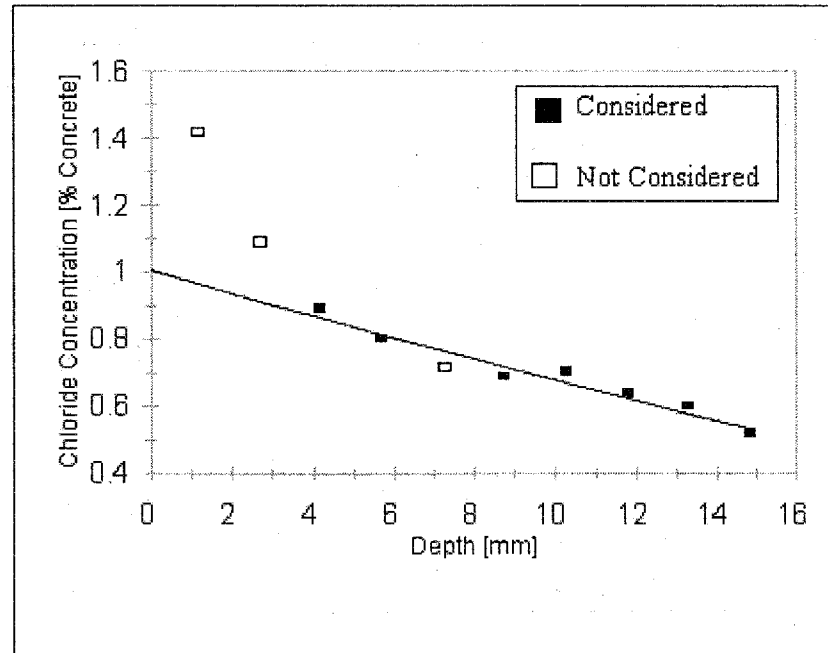
Duration: 90 Days

Diffusion Coefficient: 3.21E-11 m<sup>2</sup>/s  
Surface Concentration: 1.00 % Concrete  
Background: 0.055 % Concrete

r<sup>2</sup>: 0.9626

Data

Depth [mm]	Concentration [% Concrete]
1.14	1.42
2.67	1.09
4.19	0.89
5.72	0.80
7.24	0.72
8.76	0.69
10.29	0.70
11.81	0.64
13.34	0.60
14.86	0.52



Sample: FH-2-0.45-Siloxane

Test: Bulk Diffusion

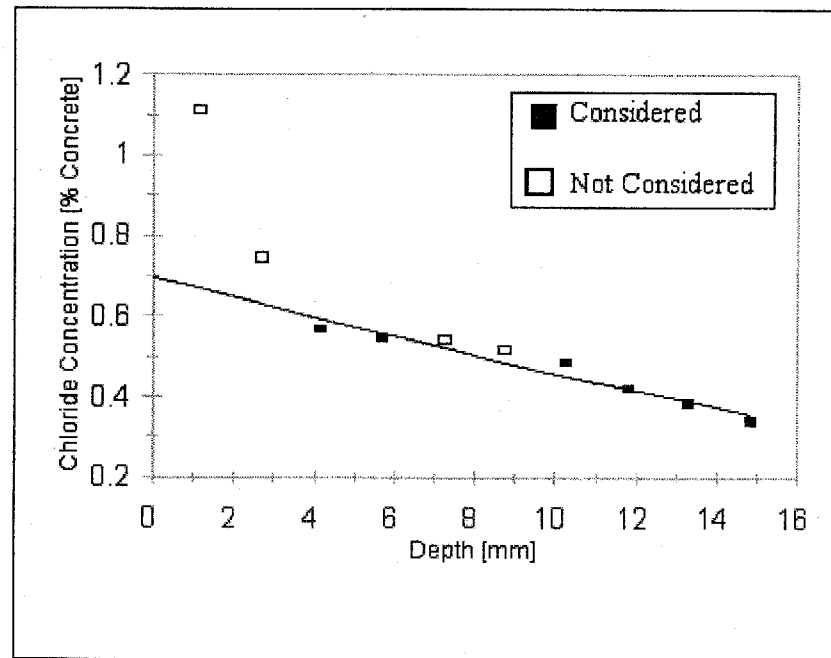
Duration: 90 Days

Diffusion Coefficient: 2.65E-11 m<sup>2</sup>/s  
Surface Concentration: 0.70 % Concrete  
Background: 0.065 % Concrete

r<sup>2</sup>: 0.9619

Data

Depth [mm]	Concentration [% Concrete]
1.14	1.11
2.67	0.75
4.19	0.57
5.72	0.54
7.24	0.54
8.76	0.52
10.29	0.48
11.81	0.42
13.34	0.38
14.86	0.34



Sample: FH-2-0.45A-7C

Test: Bulk Diffusion

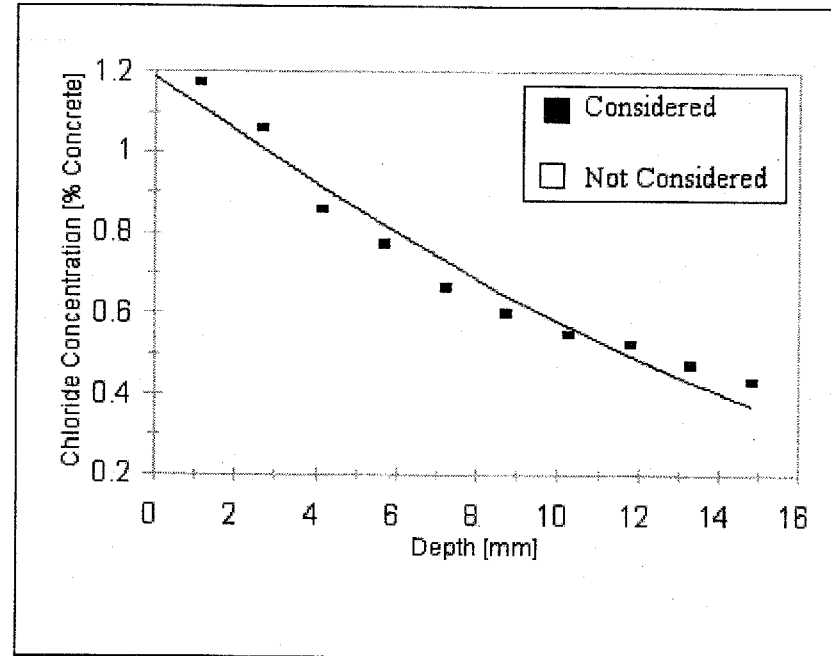
Duration: 90 Days

Diffusion Coefficient: 1.14E-11 m<sup>2</sup>/s  
Surface Concentration: 1.19 % Concrete  
Background: 0.075 % Concrete

r<sup>2</sup>: 0.9576

Data

Depth [mm]	Concentration [% Concrete]
1.14	1.17
2.67	1.06
4.19	0.86
5.72	0.77
7.24	0.66
8.76	0.60
10.29	0.55
11.81	0.52
13.34	0.47
14.86	0.43



Sample: FH-2-0.45A-23C

Test: Bulk Diffusion

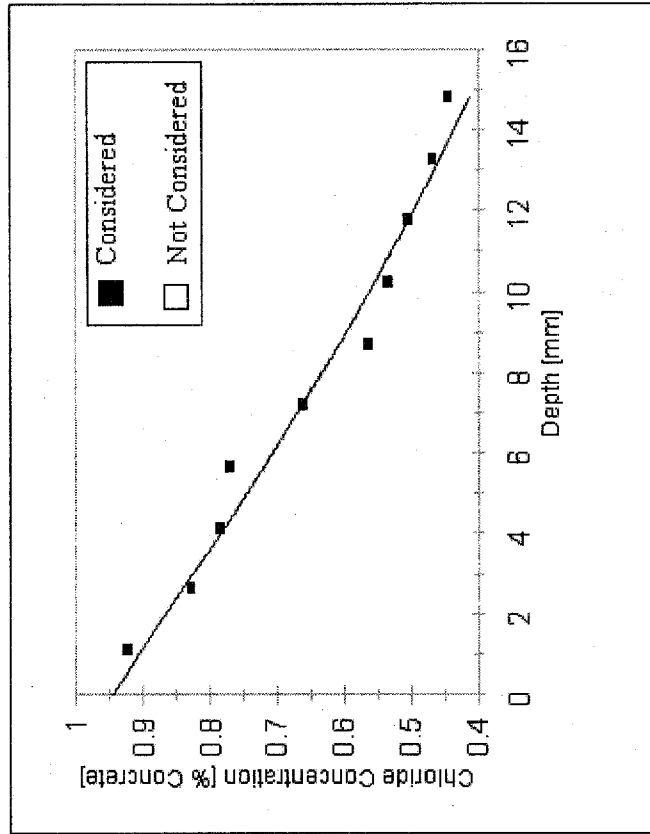
Duration: 90 Days

$r^2$ : 0.9831

Diffusion Coefficient:  $1.97E-11 \text{ m}^2/\text{s}$   
Surface Concentration: 0.95 % Concrete  
Background: 0.060 % Concrete

Data

Depth [mm]	Concentration [% Concrete]
1.14	0.92
2.67	0.83
4.19	0.78
5.72	0.77
7.24	0.66
8.76	0.56
10.29	0.53
11.81	0.50
13.34	0.47
14.86	0.44



Sample: FH-2-0.45R-38C

Test: Bulk Diffusion

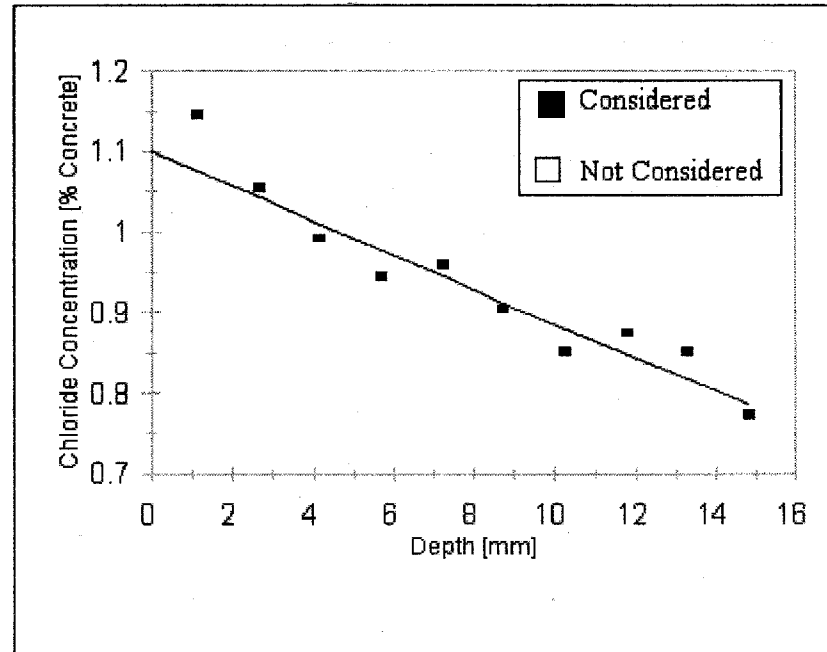
Duration: 90 Days

Diffusion Coefficient: 9.23E-11 m<sup>2</sup>/s  
Surface Concentration: 1.10 % Concrete  
Background: 0.070 % Concrete

r<sup>2</sup>: 0.9674

Data

Depth [mm]	Concentration [% Concrete]
1.14	1.14
2.67	1.05
4.19	0.99
5.72	0.94
7.24	0.96
8.76	0.90
10.29	0.85
11.81	0.87
13.34	0.85
14.86	0.77



Sample: FH-2-0.45R-Steam

Test: Bulk Diffusion

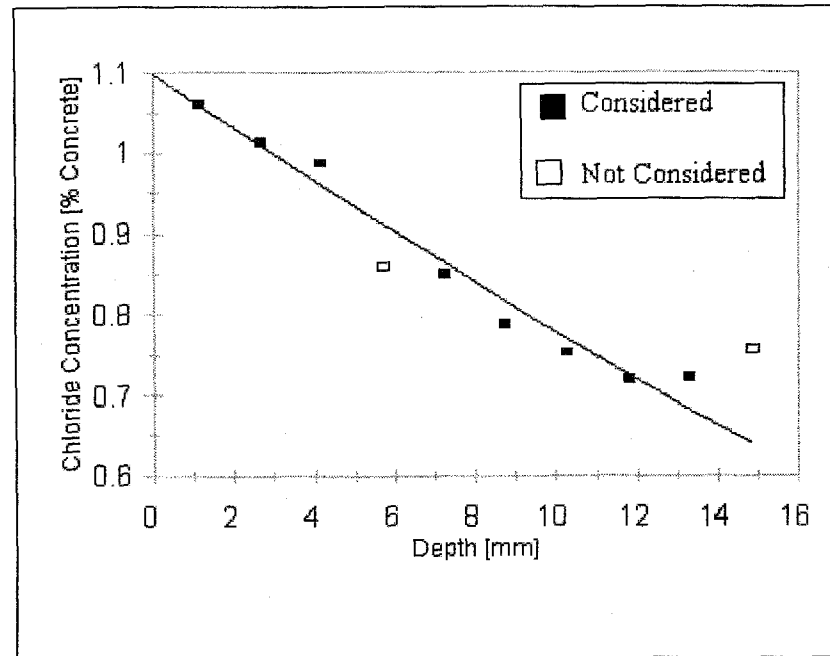
Duration: 90 Days

Diffusion Coefficient: 4.05E-11 m<sup>2</sup>/s  
Surface Concentration: 1.10 % Concrete  
Background: 0.068 % Concrete

r<sup>2</sup>: 0.9725

Data

Depth [mm]	Concentration [% Concrete]
1.14	1.06
2.67	1.01
4.19	0.99
5.72	0.86
7.24	0.85
8.76	0.79
10.29	0.75
11.81	0.72
13.34	0.72
14.86	0.76



Sample: FH-2-0.45R-23C

Test: Bulk Diffusion

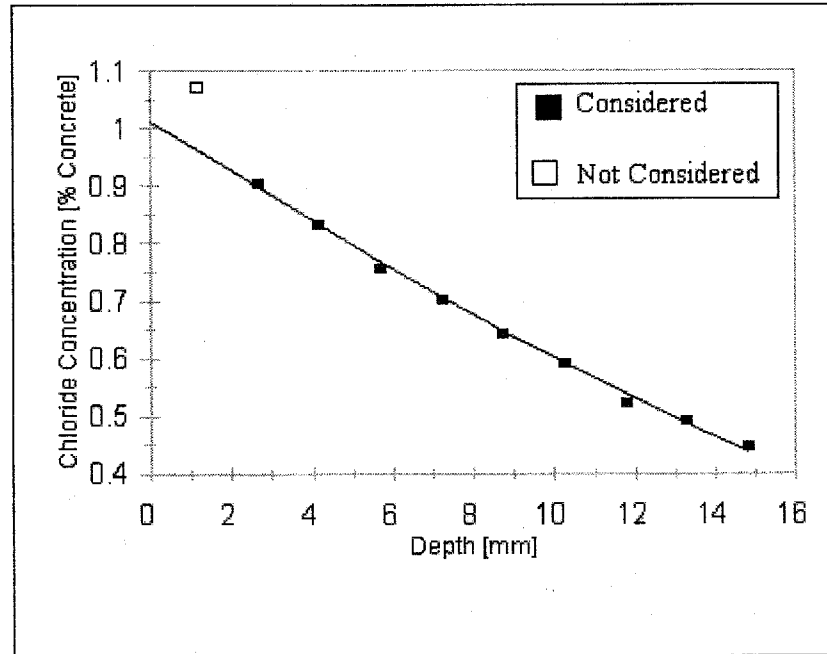
Duration: 90 Days

Diffusion Coefficient: 1.96E-11 m<sup>2</sup>/s  
Surface Concentration: 1.01 % Concrete  
Background: 0.063 % Concrete

r<sup>2</sup>: 0.9975

Data

Depth [mm]	Concentration [% Concrete]
1.14	1.07
2.67	0.90
4.19	0.83
5.72	0.76
7.24	0.70
8.76	0.64
10.29	0.59
11.81	0.52
13.34	0.49
14.86	0.45



**Sample:** FH-2-0.35-MK-Steel

**Test:** Bulk Diffusion

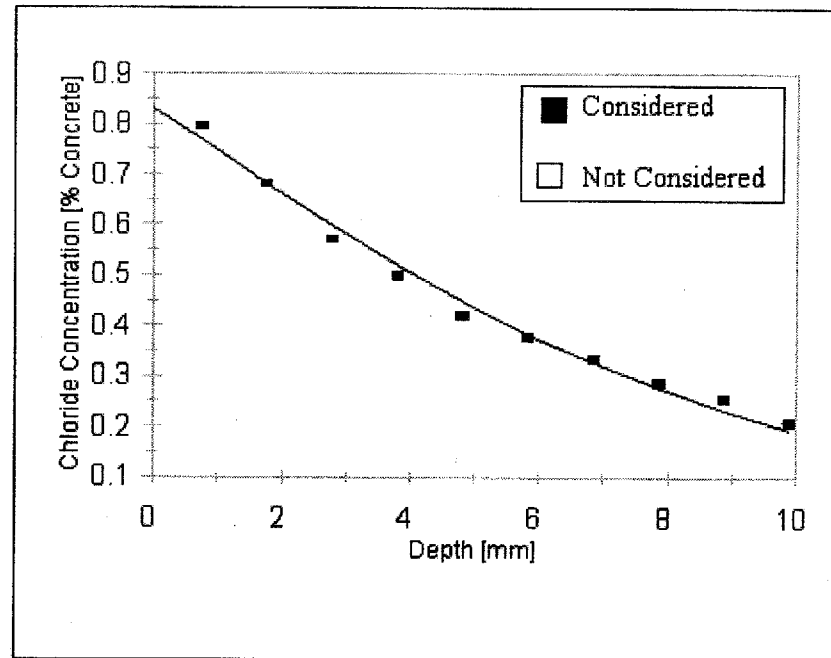
**Duration:** 90 Days

Diffusion Coefficient: 3.26E-12 m<sup>2</sup>/s  
Surface Concentration: 0.83 % Concrete  
Background: 0.070 % Concrete

r<sup>2</sup>: 0.9883

**Data**

Depth [mm]	Concentration [% Concrete]
0.76	0.80
1.78	0.68
2.79	0.57
3.81	0.50
4.83	0.42
5.84	0.38
6.86	0.33
7.87	0.29
8.89	0.25
9.91	0.21





Sample: FH-2-0.45-DCI

Test: Bulk Diffusion

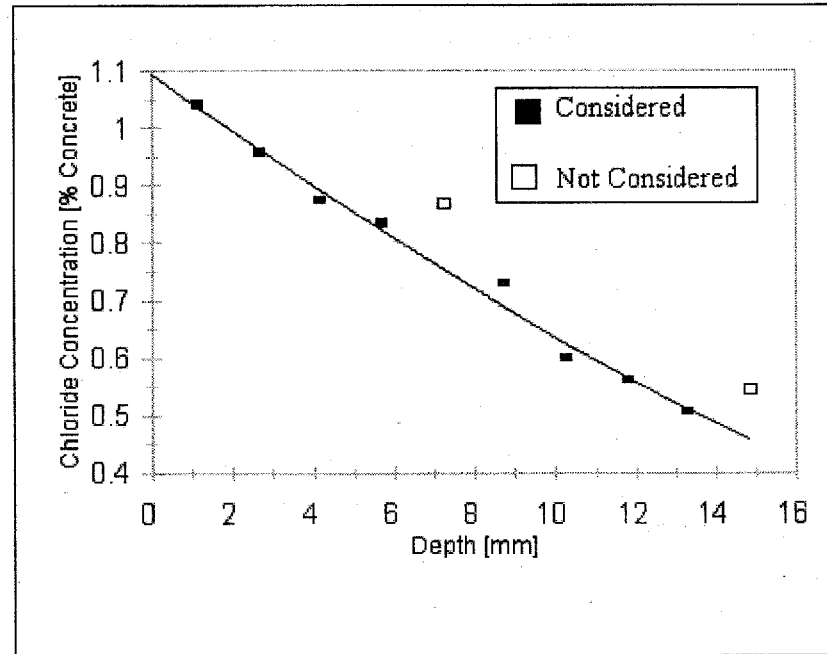
Duration: 90 Days

Diffusion Coefficient: 1.82E-11 m<sup>2</sup>/s  
Surface Concentration: 1.09 % Concrete  
Background: 0.073 % Concrete

r<sup>2</sup>: 0.9887

Data

Depth [mm]	Concentration [% Concrete]
1.14	1.04
2.67	0.96
4.19	0.87
5.72	0.84
7.24	0.87
8.76	0.73
10.29	0.60
11.81	0.56
13.34	0.51
14.86	0.54



Sample: FH-2-0.35-DCI

Test: Bulk Diffusion

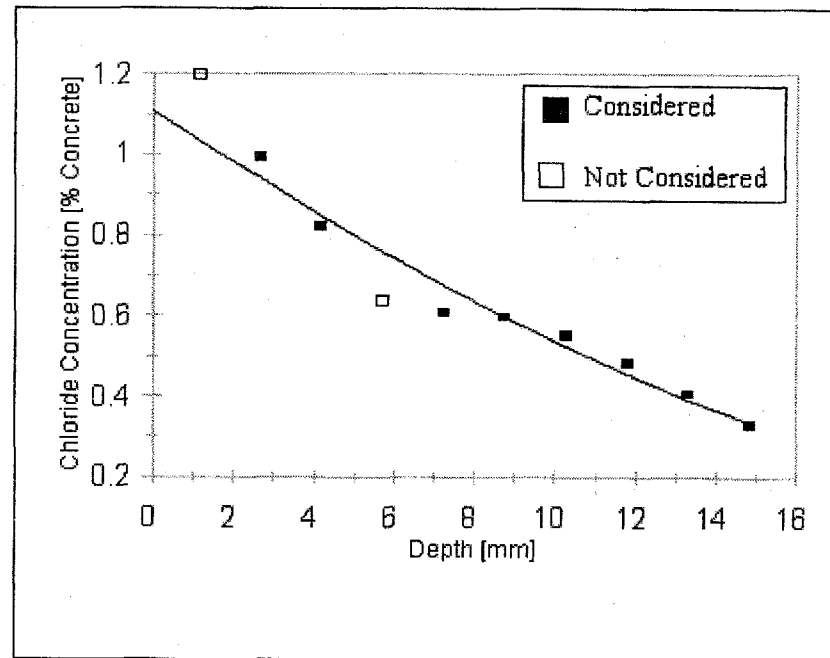
Duration: 90 Days

Diffusion Coefficient: 1.14E-11 m<sup>2</sup>/s  
Surface Concentration: 1.11 % Concrete  
Background: 0.063 % Concrete

r<sup>2</sup>: 0.9694

Data

Depth [mm]	Concentration [% Concrete]
1.14	1.20
2.67	0.99
4.19	0.82
5.72	0.64
7.24	0.61
8.76	0.60
10.29	0.55
11.81	0.48
13.34	0.40
14.86	0.33



Sample: FH-2-0.35-8SF-DCI

Test: Bulk Diffusion

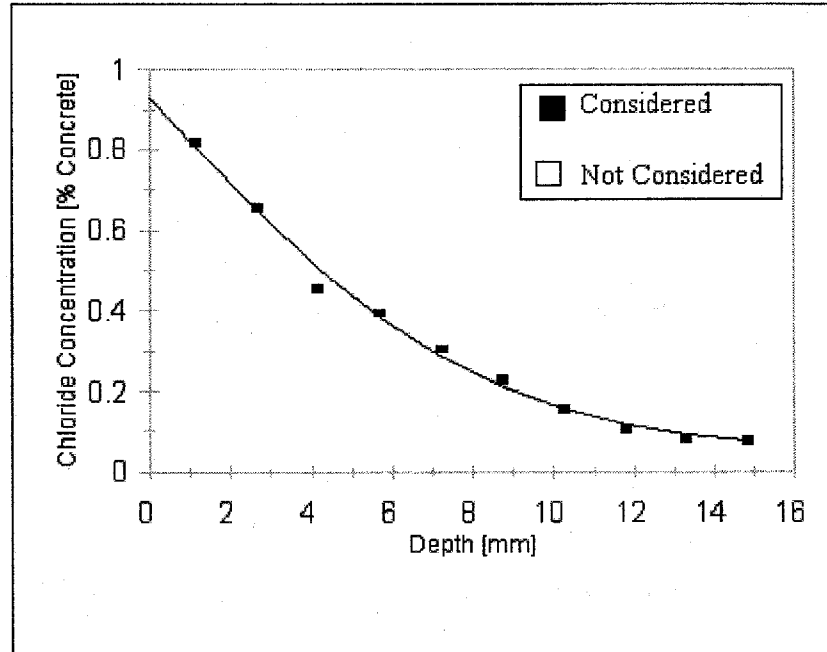
Duration: 90 Days

Diffusion Coefficient: 2.59E-12 m<sup>2</sup>/s  
Surface Concentration: 0.93 % Concrete  
Background: 0.063 % Concrete

r<sup>2</sup>: 0.9932

Data

Depth [mm]	Concentration [% Concrete]
1.14	0.82
2.67	0.66
4.19	0.45
5.72	0.39
7.24	0.30
8.76	0.23
10.29	0.15
11.81	0.10
13.34	0.08
14.86	0.07



Sample: FH-2-0.45-LINC3

Test: Bulk Diffusion

Duration: 90 Days

$r^2$ : 0.9872

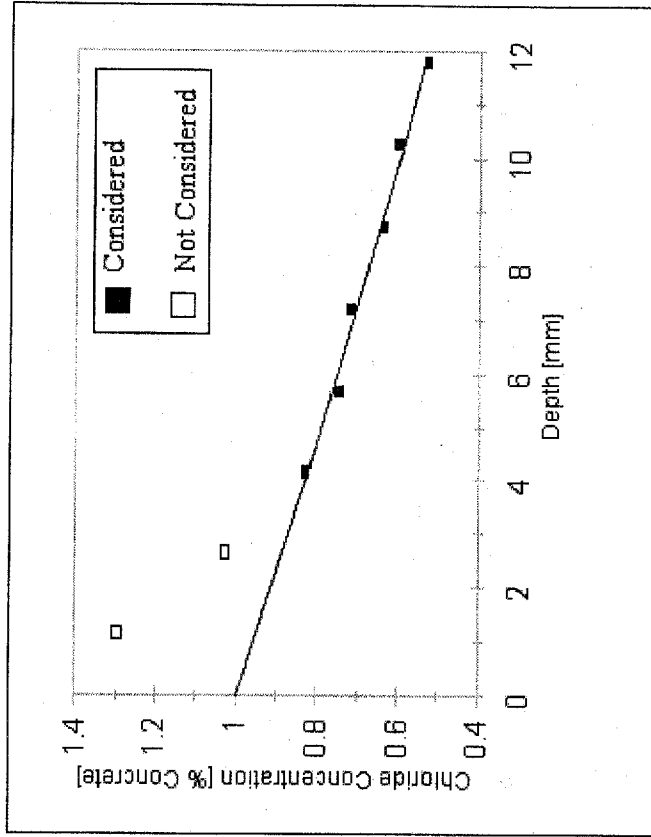
Diffusion Coefficient:  $1.99E-11 \text{ m}^2/\text{s}$

Surface Concentration: 1.00 % Concrete

Background: 0.068 % Concrete

### Data

Depth [mm]	Concentration [% Concrete]
1.14	1.29
2.67	1.03
4.19	0.83
5.72	0.75
7.24	0.72
8.76	0.63
10.29	0.60
11.81	0.53



Sample: FH-2-0.45-H.I

Test: Bulk Diffusion

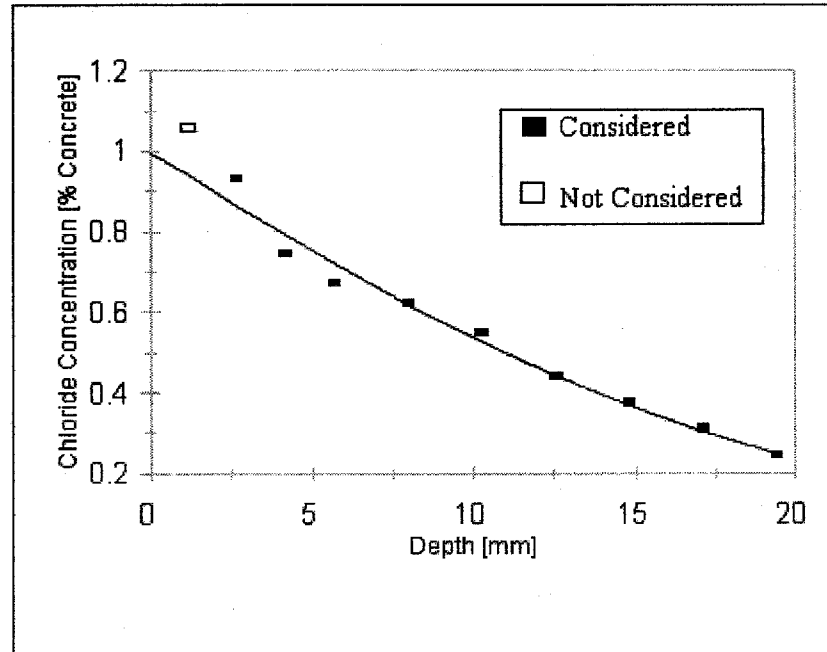
Duration: 90 Days

Diffusion Coefficient: 1.45E-11 m<sup>2</sup>/s  
Surface Concentration: 0.99 % Concrete  
Background: 0.068 % Concrete

r<sup>2</sup>: 0.9679

Data

Depth [mm]	Concentration [% Concrete]
1.14	1.06
2.67	0.93
4.19	0.74
5.72	0.67
8.00	0.62
10.29	0.55
12.57	0.44
14.86	0.37
17.15	0.31
19.43	0.24



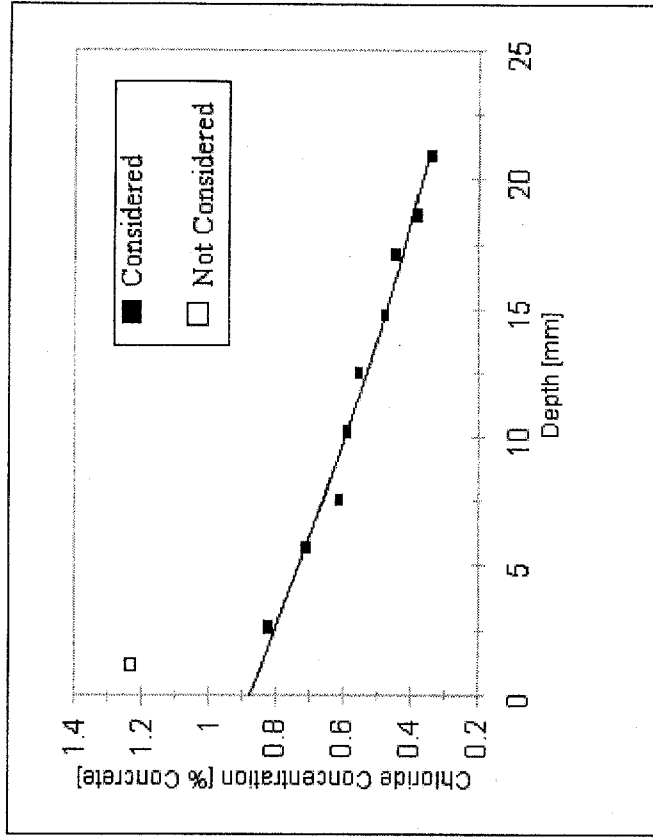
**Sample:** FH-2-0.50-Plain      **Test:** Bulk Diffusion      **Duration:** 90 Days

$r^2$ : 0.9797

**Diffusion Coefficient:** 3.19E-11 m<sup>2</sup>/s  
**Surface Concentration:** 0.88 % Concrete  
**Background:** 0.065 % Concrete

**Data**

Depth [mm]	Concentration [% Concrete]
1.14	1.24
2.67	0.82
5.72	0.71
7.62	0.61
10.29	0.59
12.57	0.55
14.86	0.48
17.15	0.44
18.67	0.38
20.96	0.34



Sample: FH-2-0.45-20FA

Test: Bulk Diffusion

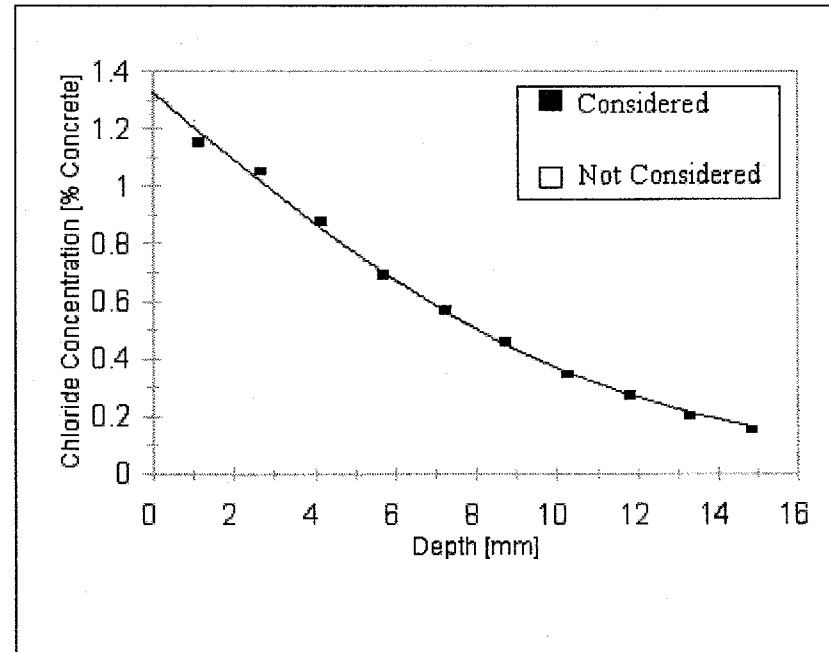
Duration: 90 Days

Diffusion Coefficient: 4.73E-12 m<sup>2</sup>/s  
Surface Concentration: 1.33 % Concrete  
Background: 0.060 % Concrete

r<sup>2</sup>: 0.9964

Data

Depth [mm]	Concentration [% Concrete]
1.14	1.15
2.67	1.05
4.19	0.88
5.72	0.69
7.24	0.57
8.76	0.45
10.29	0.34
11.81	0.27
13.34	0.20
14.86	0.15



Sample: FH-2-0.45-MK

Test: Bulk Diffusion

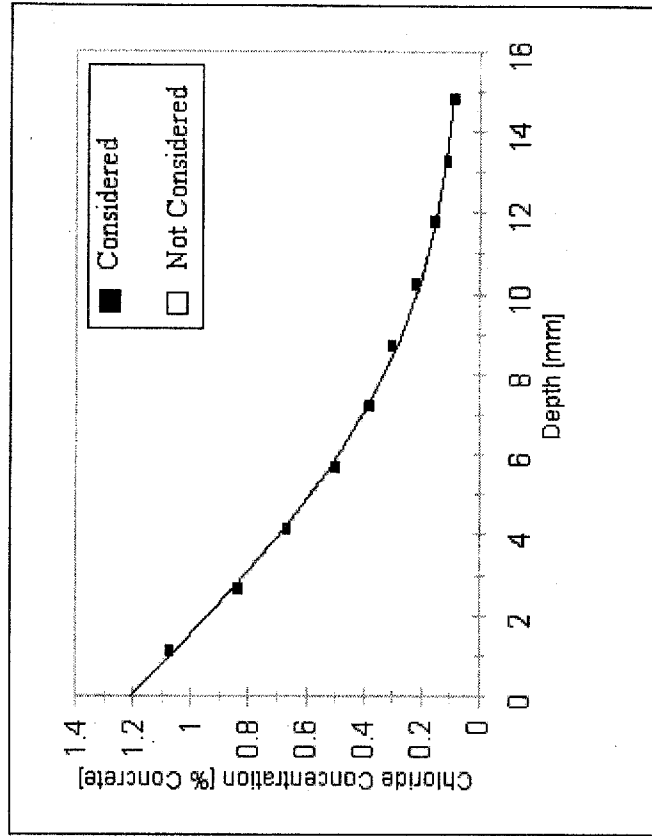
Duration: 90 Days

$r^2$ : 0.9964

Diffusion Coefficient:  $2.90E-12$  m<sup>2</sup>/s  
Surface Concentration: 1.21 % Concrete  
Background: 0.060 % Concrete

**Data**

Depth [mm]	Concentration [% Concrete]
1.14	1.07
2.67	0.83
4.19	0.67
5.72	0.50
7.24	0.38
8.76	0.30
10.29	0.22
11.81	0.15
13.34	0.11
14.86	0.09





Sample: FH-2-0.35-MK

Test: Bulk Diffusion

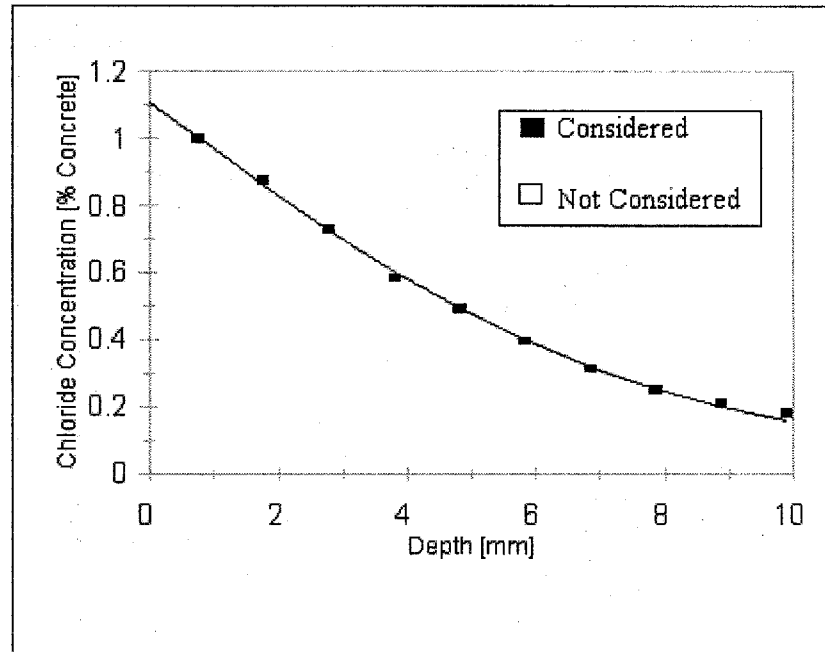
Duration: 90 Days

Diffusion Coefficient: 2.27E-12 m<sup>2</sup>/s  
Surface Concentration: 1.11 % Concrete  
Background: 0.055 % Concrete

r<sup>2</sup>: 0.9982

Data

Depth [mm]	Concentration [% Concrete]
0.76	1.00
1.78	0.87
2.79	0.73
3.81	0.58
4.83	0.49
5.84	0.39
6.86	0.31
7.87	0.25
8.89	0.21
9.91	0.18



Sample: FH-2-0.35-SF,SG

Test: Bulk Diffusion

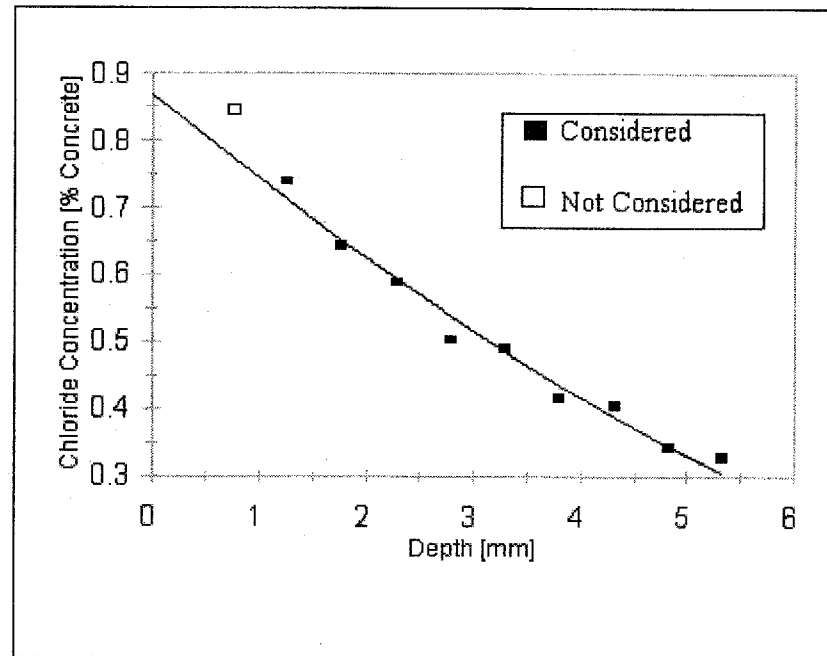
Duration: 90 Days

Diffusion Coefficient: 1.74E-12 m<sup>2</sup>/s  
Surface Concentration: 0.87 % Concrete  
Background: 0.060 % Concrete

r<sup>2</sup>: 0.9796

Data

Depth [mm]	Concentration [% Concrete]
0.76	0.85
1.27	0.74
1.78	0.64
2.29	0.59
2.79	0.50
3.30	0.49
3.81	0.42
4.32	0.40
4.83	0.34
5.33	0.33



Sample: FH-2-0.35-SF,FA

Test: Bulk Diffusion

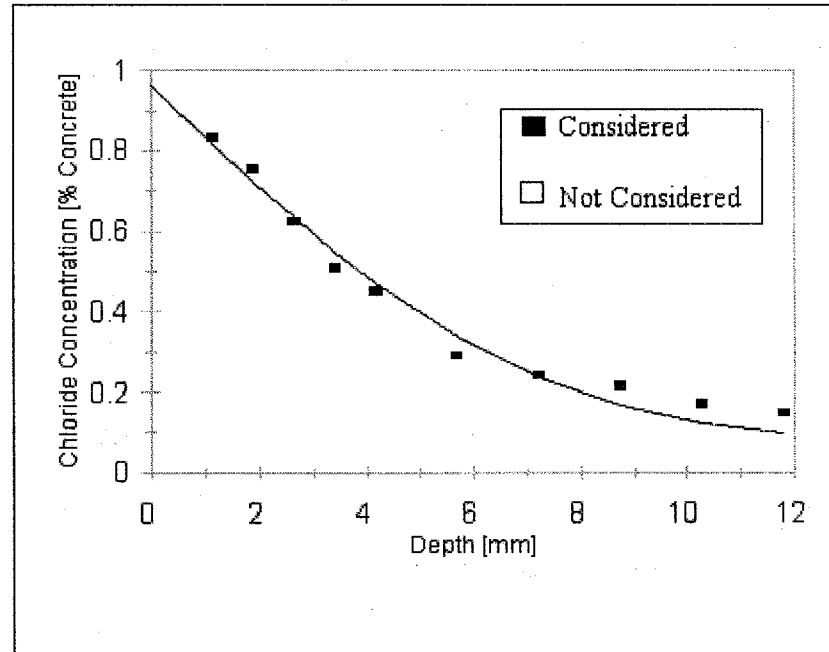
Duration: 90 Days

Diffusion Coefficient: 1.95E-12 m<sup>2</sup>/s  
Surface Concentration: 0.96 % Concrete  
Background: 0.068 % Concrete

r<sup>2</sup>: 0.9785

Data

Depth [mm]	Concentration [% Concrete]
1.14	0.83
1.91	0.75
2.67	0.62
3.43	0.51
4.19	0.45
5.72	0.29
7.24	0.24
8.76	0.21
10.29	0.17
11.81	0.15

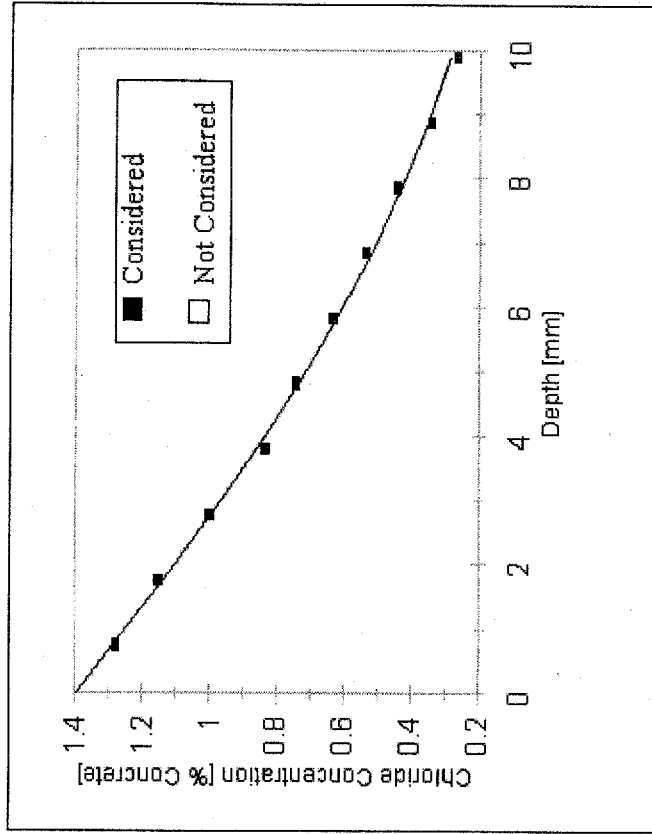


**Sample:** FH-2-0.45-50 SG      **Test:** Bulk Diffusion      **Duration:** 90 Days

**Diffusion Coefficient:** 3.41E-12 m<sup>2</sup>/s       $r^2$ : 0.9978

**Surface Concentration:** 1.40 % Concrete

**Background:** 0.053 % Concrete



**Data**

Depth [mm]	Concentration [% Concrete]
0.76	1.28
1.78	1.15
2.79	1.00
3.81	0.83
4.83	0.74
5.84	0.63
6.86	0.54
7.87	0.44
8.89	0.34
9.91	0.26

Sample: FH-2-0.35-Latex

Test: Bulk Diffusion

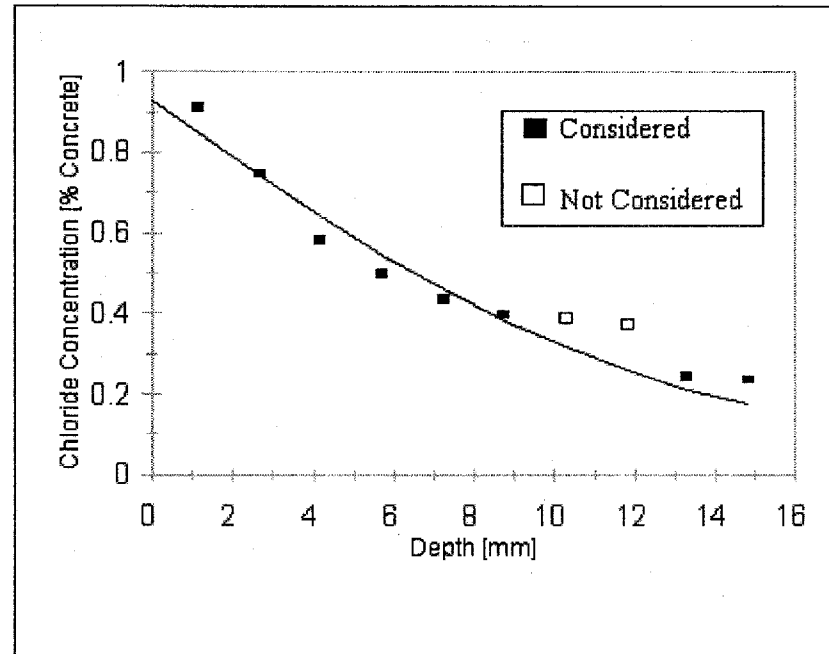
Duration: 90 Days

Diffusion Coefficient:  $6.17E-12$  m<sup>2</sup>/s  
Surface Concentration: 0.93 % Concrete  
Background: 0.063 % Concrete

r<sup>2</sup>: 0.9592

Data

Depth [mm]	Concentration [% Concrete]
1.14	0.91
2.67	0.75
4.19	0.58
5.72	0.50
7.24	0.43
8.76	0.40
10.29	0.39
11.81	0.37
13.34	0.24
14.86	0.24



Sample: FH-2-0.45-High C<sub>3</sub>A

Test: Bulk Diffusion

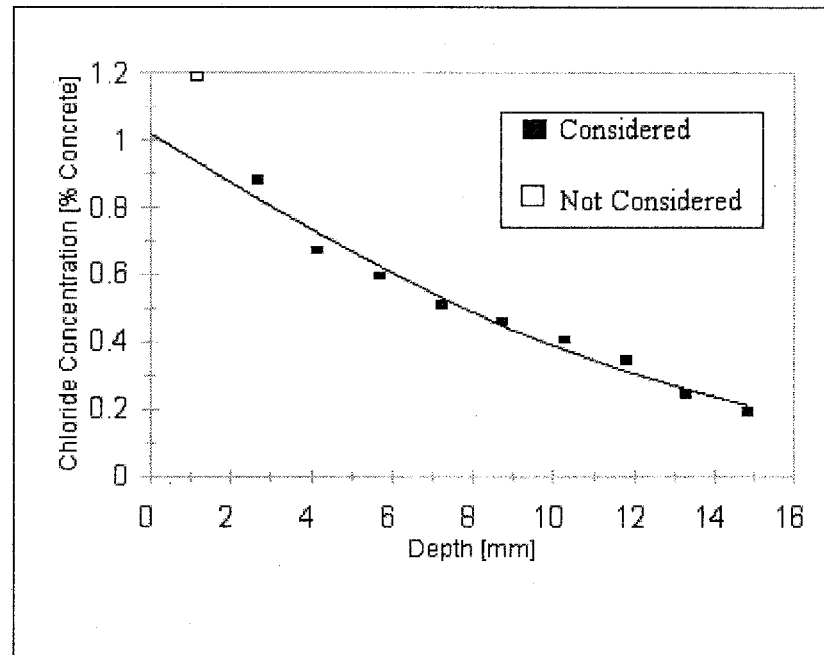
Duration: 90 Days

Diffusion Coefficient: 7.08E-12 m<sup>2</sup>/s  
Surface Concentration: 1.02 % Concrete  
Background: 0.060 % Concrete

r<sup>2</sup>: 0.9749

Data

Depth [mm]	Concentration [% Concrete]
1.14	1.19
2.67	0.88
4.19	0.67
5.72	0.59
7.24	0.51
8.76	0.46
10.29	0.41
11.81	0.34
13.34	0.24
14.86	0.19



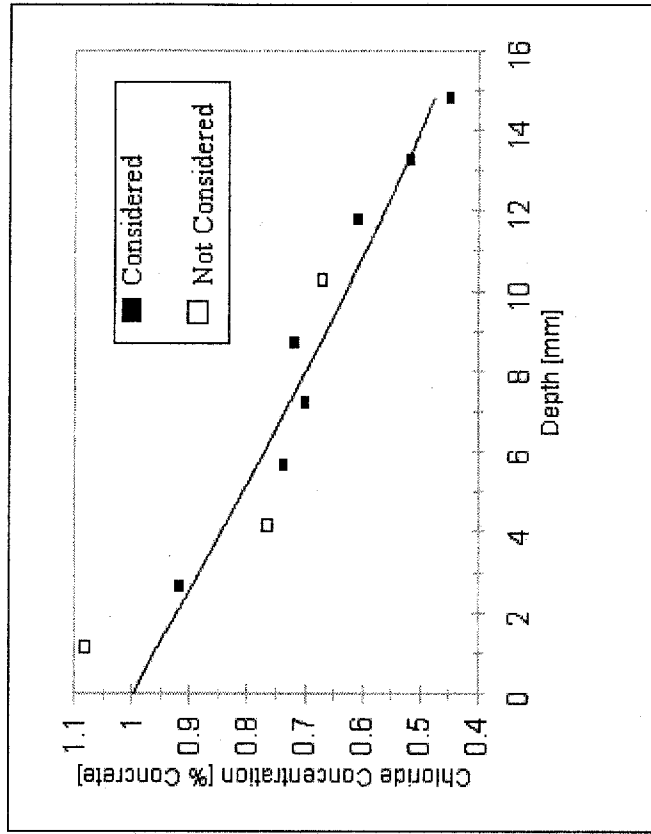
Sample: FH-2-0.45-Low C<sub>3</sub>A      Test: Bulk Diffusion      Duration: 90 Days

r<sup>2</sup>: 0.9749

Diffusion Coefficient: 2.36E-11 m<sup>2</sup>/s  
 Surface Concentration: 1.00 % Concrete  
 Background: 0.068 % Concrete

**Data**

Depth [mm]	Concentration [% Concrete]
1.14	1.08
2.67	0.92
4.19	0.77
5.72	0.74
7.24	0.70
8.76	0.72
10.29	0.67
11.81	0.61
13.34	0.52
14.86	0.45



Sample: FH-2-0.35-Steam

Test: Bulk Diffusion

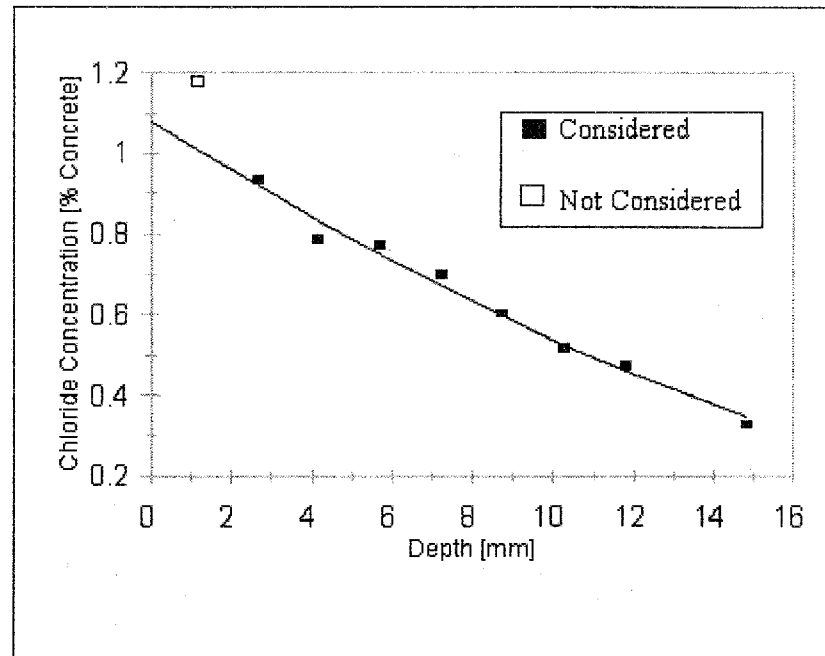
Duration: 90 Days

Diffusion Coefficient: 1.22E-11 m<sup>2</sup>/s  
Surface Concentration: 1.08 % Concrete  
Background: 0.063 % Concrete

r<sup>2</sup>: 0.9846

Data

Depth [mm]	Concentration [% Concrete]
1.14	1.18
2.67	0.93
4.19	0.79
5.72	0.77
7.24	0.70
8.76	0.60
10.29	0.52
11.81	0.47
14.86	0.33





Sample: FH-2-0.35-Plain

Test: Bulk Diffusion

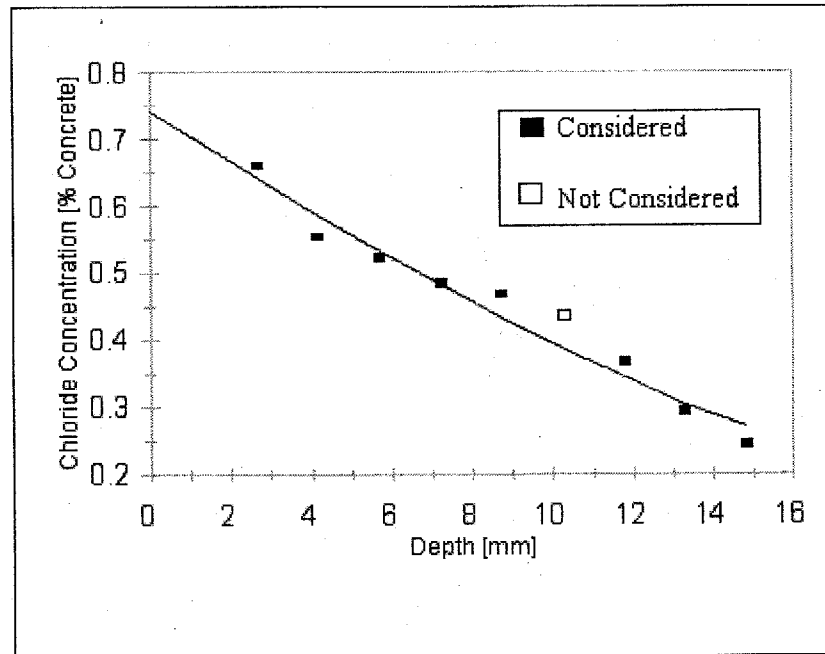
Duration: 90 Days

Diffusion Coefficient: 1.34E-11 m<sup>2</sup>/s  
Surface Concentration: 0.74 % Concrete  
Background: 0.063 % Concrete

r<sup>2</sup>: 0.9700

Data

Depth [mm]	Concentration [% Concrete]
2.67	0.66
4.19	0.55
5.72	0.52
7.24	0.48
8.76	0.47
10.29	0.44
11.81	0.37
13.34	0.29
14.86	0.24



Sample: FH-2-0.25-8% SF      Test: Bulk Diffusion      Duration: 90 Days

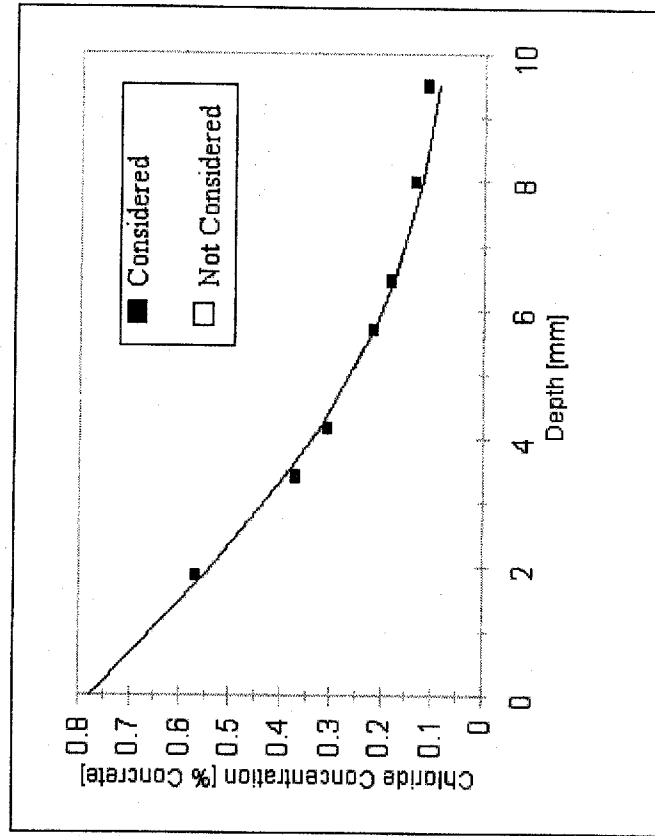
Diffusion Coefficient: 1.38E-12 m<sup>2</sup>/s      r<sup>2</sup>: 0.9890

Surface Concentration: 0.78 % Concrete

Background: 0.060 % Concrete

**Data**

Depth [mm]	Concentration [% Concrete]
1.91	0.57
3.43	0.37
4.19	0.31
5.72	0.22
6.48	0.18
8.00	0.14
9.53	0.11



Sample: FH-2-0.35-8% SF

Test: Bulk Diffusion

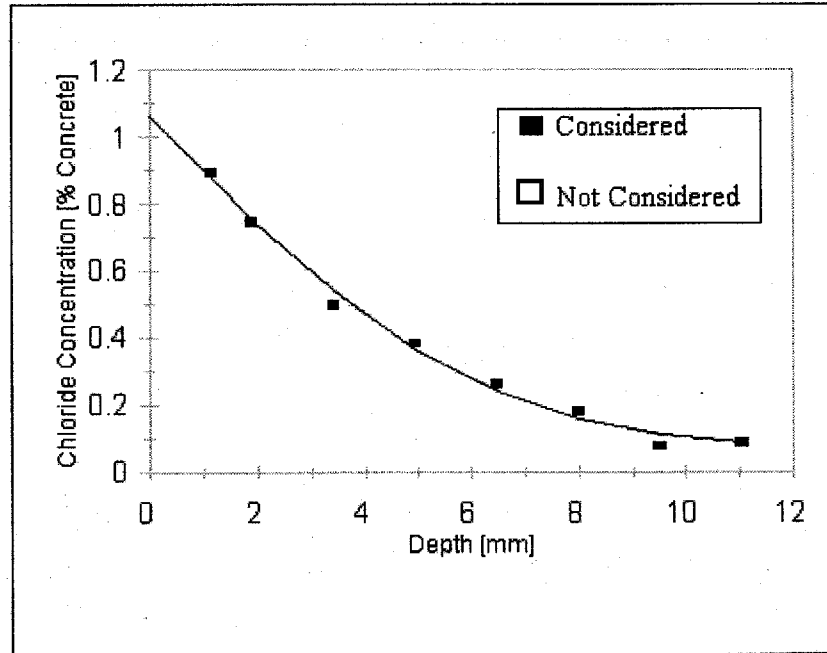
Duration: 90 Days

Diffusion Coefficient: 1.49E-12 m<sup>2</sup>/s  
Surface Concentration: 1.06 % Concrete  
Background: 0.063 % Concrete

r<sup>2</sup>: 0.9929

Data

Depth [mm]	Concentration [% Concrete]
1.14	0.89
1.91	0.75
3.43	0.50
4.95	0.38
6.48	0.26
8.00	0.18
9.53	0.08
11.05	0.08



Sample: FH-2-0.45-23 C      Test: Salt Ponding      Duration: 90 Days

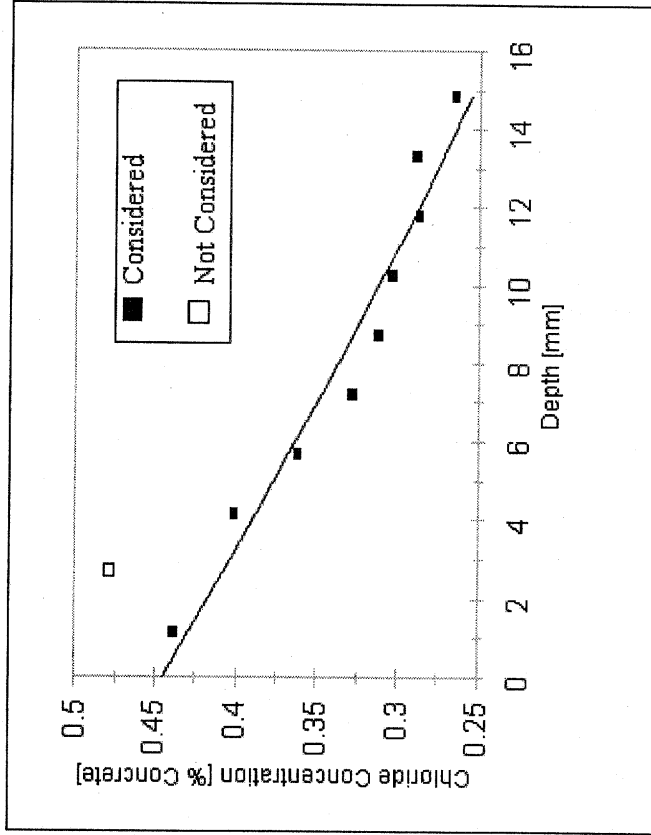
Diffusion Coefficient: 3.07E-11 m<sup>2</sup>/s      r<sup>2</sup>: 0.9506

Surface Concentration: 0.44 % Concrete

Background: 0.068 % Concrete

**Data**

Depth [mm]	Concentration [% Concrete]
1.14	0.44
2.67	0.48
4.19	0.40
5.72	0.36
7.24	0.33
8.76	0.31
10.29	0.30
11.81	0.29
13.34	0.29
14.86	0.26



Chloride concentration above background at 12.5 mm: 0.22 %

Sample: FH-2-0.45-Silane

Test: Salt Ponding

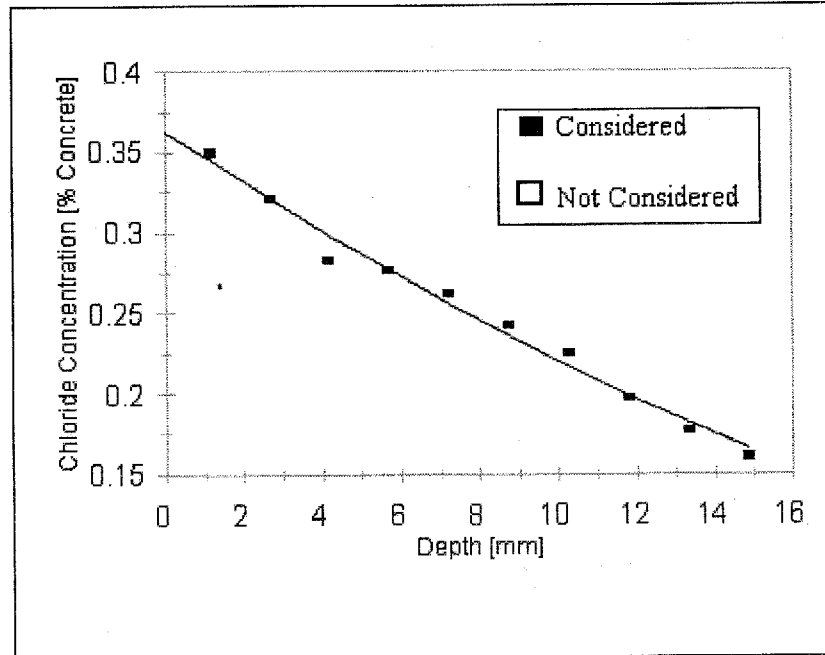
Duration: 90 Days

Diffusion Coefficient: 1.56E-11 m<sup>2</sup>/s  
Surface Concentration: 0.36 % Concrete  
Background: 0.065 % Concrete

r<sup>2</sup>: 0.9846

Data

Depth [mm]	Concentration [% Concrete]
1.14	0.35
2.67	0.32
4.19	0.28
5.72	0.28
7.24	0.26
8.76	0.24
10.29	0.22
11.81	0.20
13.34	0.18
14.86	0.16



Chloride concentration above background at 12.5 mm: 0.12 %

Sample: FH-2-0.45-7 C

Test: Salt Ponding

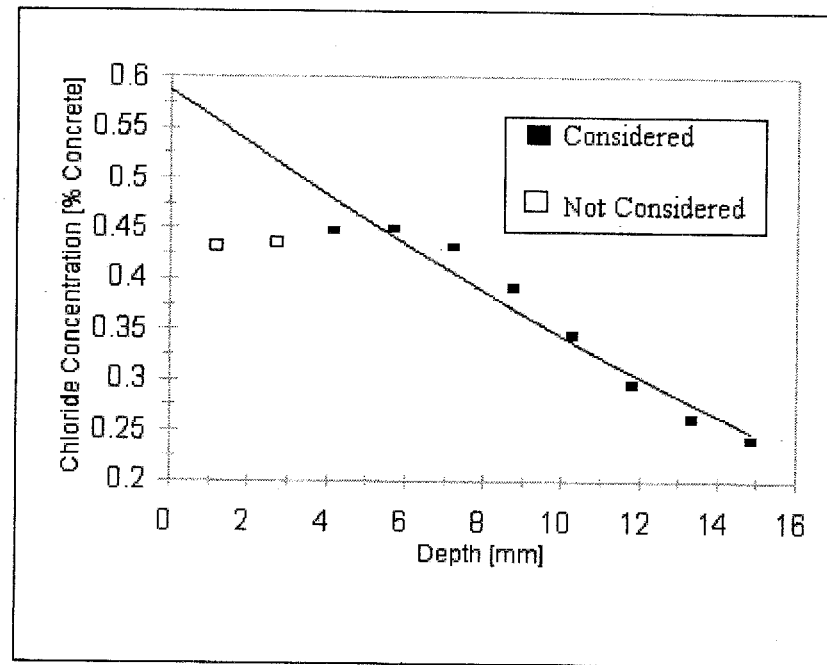
Duration: 90 Days

Diffusion Coefficient: 1.70E-11 m<sup>2</sup>/s  
Surface Concentration: 0.59 % Concrete  
Background: 0.058 % Concrete

r<sup>2</sup>: 0.9462

Data

Depth [mm]	Concentration [% Concrete]
1.14	0.43
2.67	0.44
4.19	0.45
5.72	0.45
7.24	0.43
8.76	0.39
10.29	0.34
11.81	0.29
13.34	0.26
14.86	0.24



Chloride concentration above background at 12.5 mm: 0.22 %

Sample: FH-2-0.45-38 C

Test: Salt Ponding

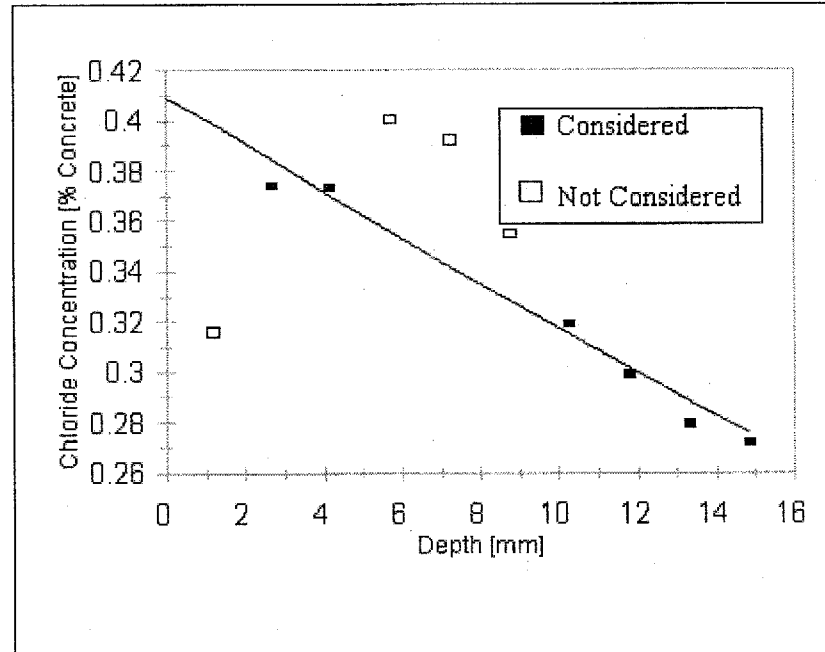
Duration: 90 Days

Diffusion Coefficient: 5.71E-11 m<sup>2</sup>/s  
Surface Concentration: 0.41 % Concrete  
Background: 0.058 % Concrete

r<sup>2</sup>: 0.9488

Data

Depth [mm]	Concentration [% Concrete]
1.14	0.32
2.67	0.37
4.19	0.37
5.72	0.40
7.24	0.39
8.76	0.35
10.29	0.32
11.81	0.30
13.34	0.28
14.86	0.27



Chloride concentration above background at 12.5 mm: 0.23 %

Sample: FH-2-0.45-Steel

Test: Salt Ponding

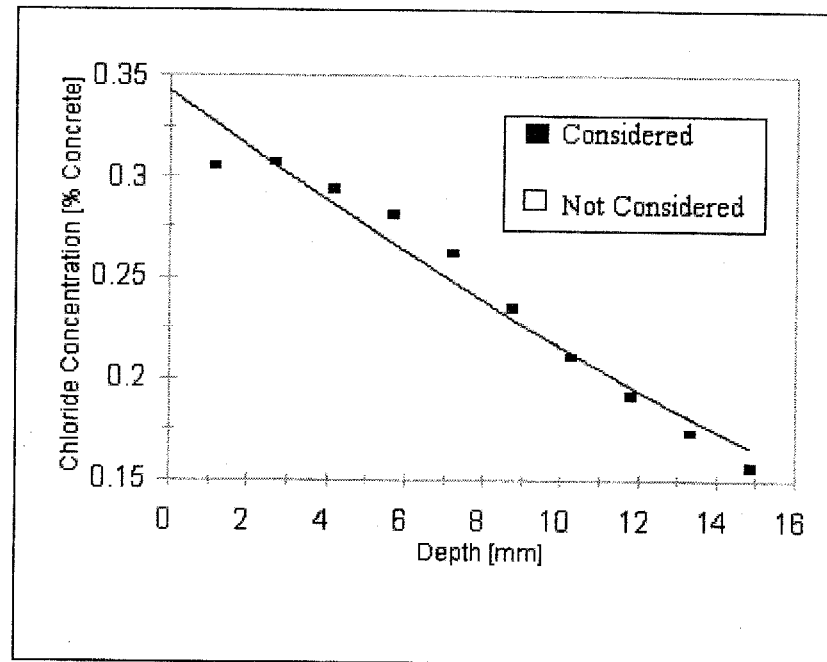
Duration: 90 Days

Diffusion Coefficient: 1.89E-11 m<sup>2</sup>/s  
Surface Concentration: 0.34 % Concrete  
Background: 0.055 % Concrete

r<sup>2</sup>: 0.9614

Data

Depth [mm]	Concentration [% Concrete]
1.14	0.31
2.67	0.31
4.19	0.29
5.72	0.28
7.24	0.26
8.76	0.24
10.29	0.21
11.81	0.19
13.34	0.17
14.86	0.16



Chloride concentration above background at 12.5 mm: 0.125 %



Sample: FH-2-0.45-Siloxane

Test: Salt Ponding

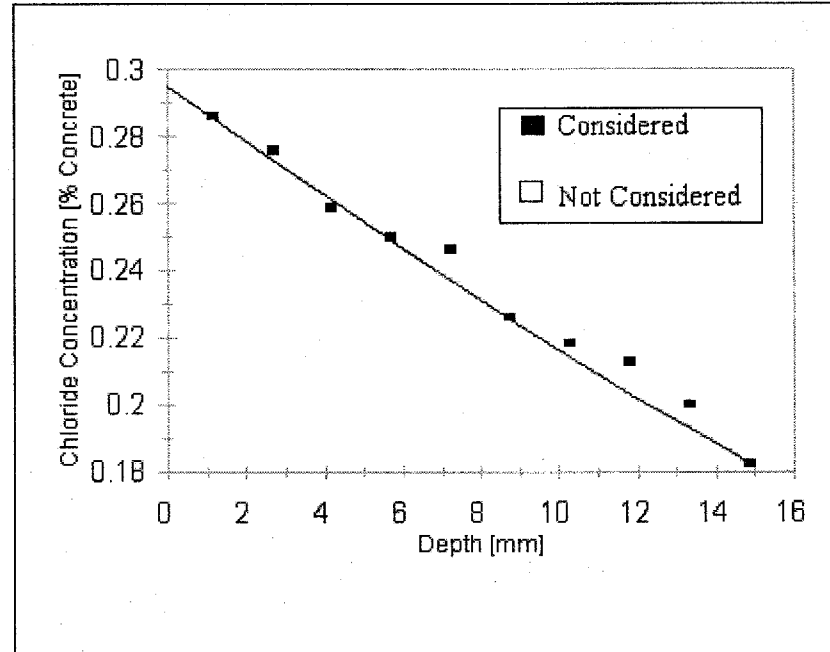
Duration: 90 Days

Diffusion Coefficient: 3.28E-11 m<sup>2</sup>/s  
Surface Concentration: 0.29 % Concrete  
Background: 0.065 % Concrete

r<sup>2</sup>: 0.9872

Data

Depth [mm]	Concentration [% Concrete]
1.14	0.29
2.67	0.28
4.19	0.26
5.72	0.25
7.24	0.25
8.76	0.23
10.29	0.22
11.81	0.21
13.34	0.20
14.86	0.18



Chloride concentration above background at 12.5 mm: 0.14 %

Sample: FH-2-0.45A-7 C

Test: Salt Ponding

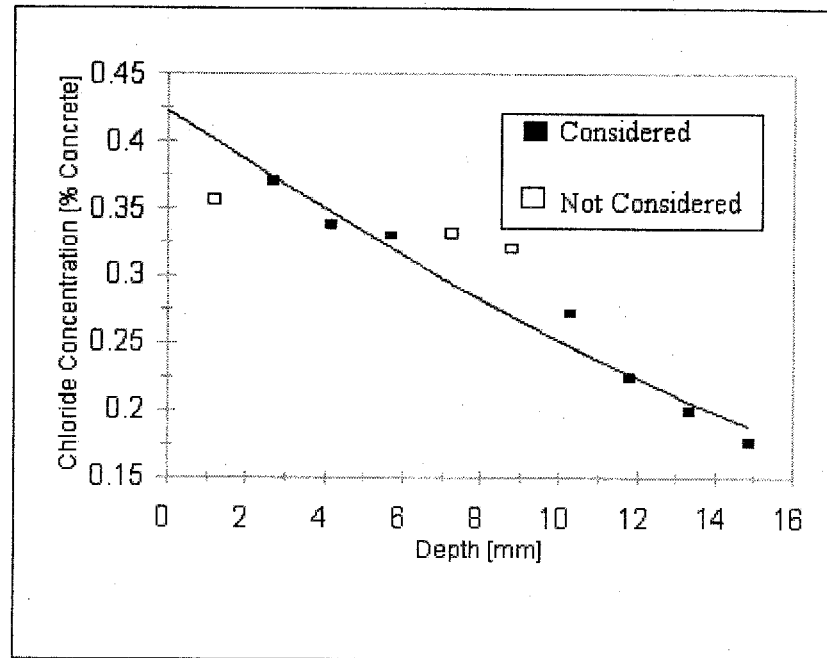
Duration: 90 Days

Diffusion Coefficient: 1.46E-11 m<sup>2</sup>/s  
Surface Concentration: 0.42 % Concrete  
Background: 0.075 % Concrete

r<sup>2</sup>: 0.9710

Data

Depth [mm]	Concentration [% Concrete]
1.14	0.36
2.67	0.37
4.19	0.34
5.72	0.33
7.24	0.33
8.76	0.32
10.29	0.27
11.81	0.22
13.34	0.20
14.86	0.18



Chloride concentration above background at 12.5 mm: 0.135 %

Sample: FH-2-0.45A-23 C

Test: Salt Ponding

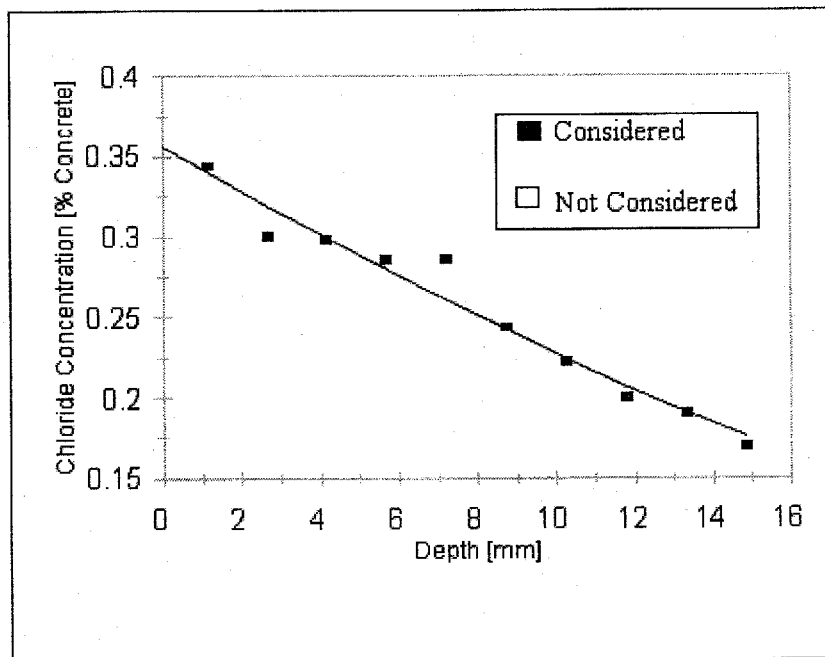
Duration: 90 Days

Diffusion Coefficient: 1.92E-11 m<sup>2</sup>/s  
Surface Concentration: 0.36 % Concrete  
Background: 0.060 % Concrete

r<sup>2</sup>: 0.9601

Data

Depth [mm]	Concentration [% Concrete]
1.14	0.34
2.67	0.30
4.19	0.30
5.72	0.29
7.24	0.29
8.76	0.24
10.29	0.22
11.81	0.20
13.34	0.19
14.86	0.17



Chloride concentration above background at 12.5 mm: 0.135 %

Sample: FH-2-0.45R-38 C

Test: Salt Ponding

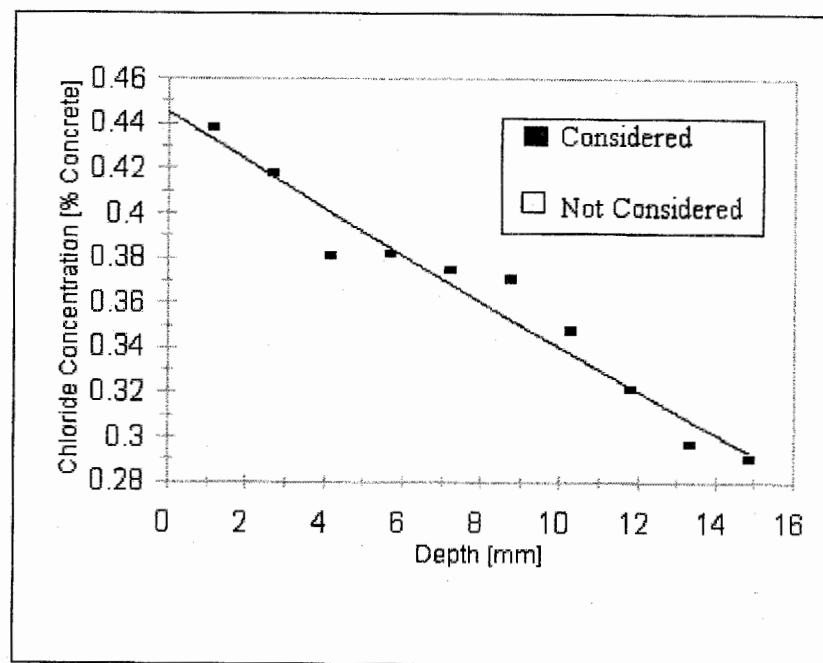
Duration: 90 Days

Diffusion Coefficient: 5.02E-11 m<sup>2</sup>/s  
Surface Concentration: 0.45 % Concrete  
Background: 0.070 % Concrete

r<sup>2</sup>: 0.9517

Data

Depth [mm]	Concentration [% Concrete]
1.14	0.44
2.67	0.42
4.19	0.38
5.72	0.38
7.24	0.37
8.76	0.37
10.29	0.35
11.81	0.32
13.34	0.30
14.86	0.29



Chloride concentration above background at 12.5 mm: 0.235 %

Sample: FH-2-0.45R-23 C

Test: Salt Ponding

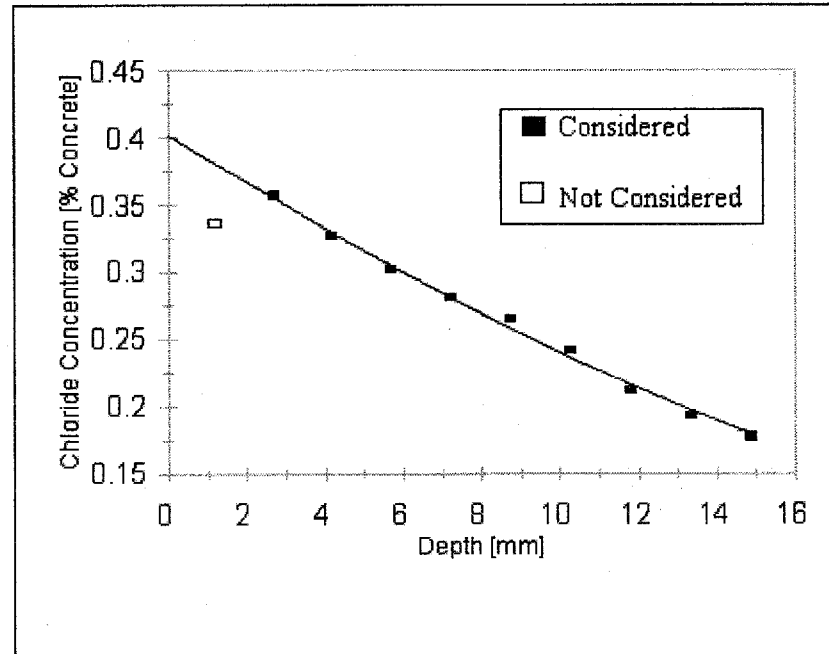
Duration: 90 Days

Diffusion Coefficient: 1.57E-11 m<sup>2</sup>/s  
Surface Concentration: 0.40 % Concrete  
Background: 0.063 % Concrete

r<sup>2</sup>: 0.9950

Data

Depth [mm]	Concentration [% Concrete]
1.14	0.34
2.67	0.36
4.19	0.33
5.72	0.30
7.24	0.28
8.76	0.26
10.29	0.24
11.81	0.21
13.34	0.19
14.86	0.18



Chloride concentration above background at 12.5 mm: 0.14 %

Sample: FH-2-0.35-MK-Steel

Test: Salt Ponding

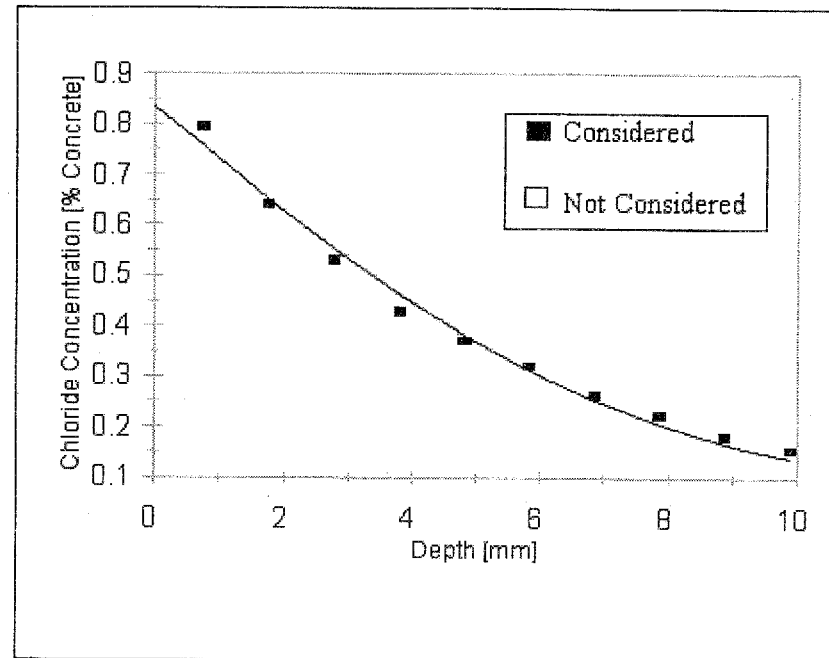
Duration: 90 Days

Diffusion Coefficient: 2.18E-12 m<sup>2</sup>/s  
Surface Concentration: 0.83 % Concrete  
Background: 0.070 % Concrete

r<sup>2</sup>: 0.9895

Data

Depth [mm]	Concentration [% Concrete]
0.76	0.79
1.78	0.64
2.79	0.53
3.81	0.43
4.83	0.37
5.84	0.32
6.86	0.26
7.87	0.22
8.89	0.18
9.91	0.15



Chloride concentration above background at 12.5 mm:

0 %

Sample: FH-2-0.45-DCI

Test: Salt Ponding

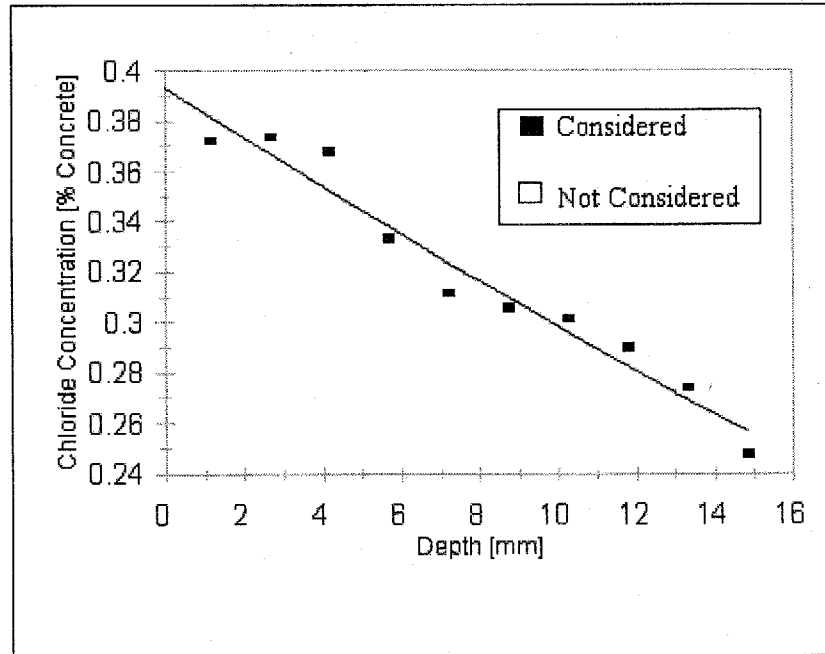
Duration: 90 Days

Diffusion Coefficient: 4.48E-11 m<sup>2</sup>/s  
Surface Concentration: 0.39 % Concrete  
Background: 0.073 % Concrete

r<sup>2</sup>: 0.9550

Data

Depth [mm]	Concentration [% Concrete]
1.14	0.37
2.67	0.37
4.19	0.37
5.72	0.33
7.24	0.31
8.76	0.31
10.29	0.30
11.81	0.29
13.34	0.27
14.86	0.25



Chloride concentration above background at 12.5 mm: 0.21 %

Sample: FH-2-0.35-DCI

Test: Salt Ponding

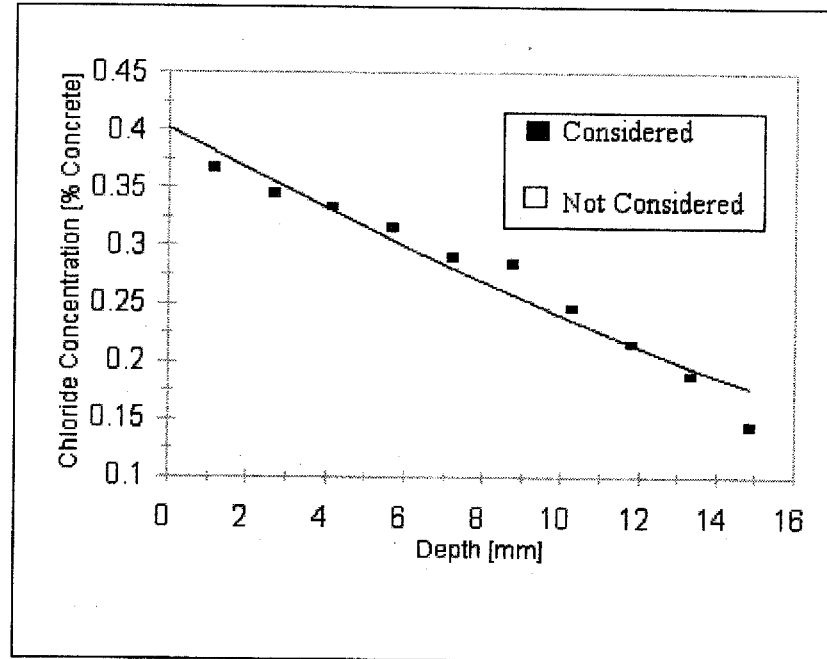
Duration: 90 Days

Diffusion Coefficient: 1.54E-11 m<sup>2</sup>/s  
Surface Concentration: 0.40 % Concrete  
Background: 0.063 % Concrete

r<sup>2</sup>: 0.9448

Data

Depth [mm]	Concentration [% Concrete]
1.14	0.37
2.67	0.34
4.19	0.33
5.72	0.32
7.24	0.29
8.76	0.28
10.29	0.25
11.81	0.21
13.34	0.19
14.86	0.14



Chloride concentration above background at 12.5 mm: 0.14 %



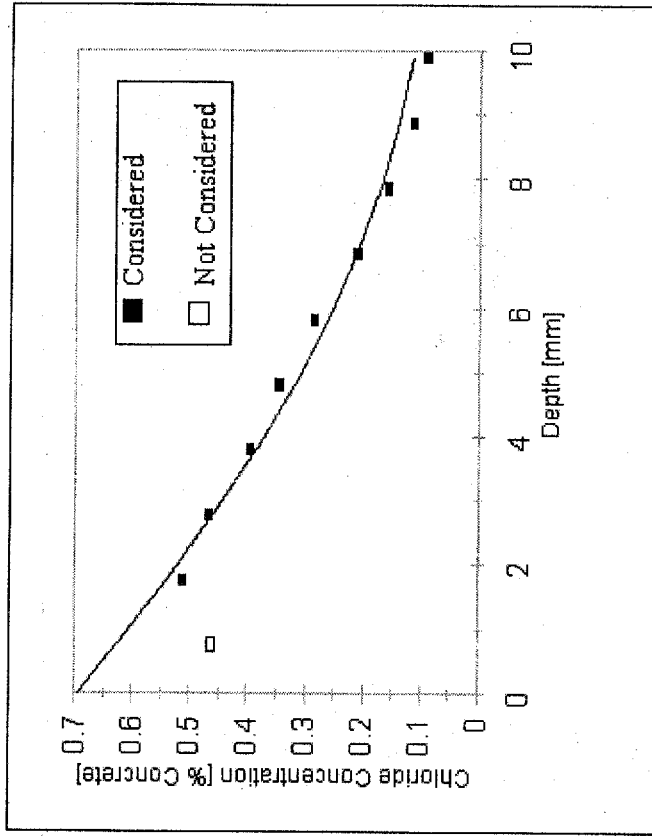
Sample: FH-2-0.35-SF, DCI      Test: Salt Ponding      Duration: 90 Days

Diffusion Coefficient: 2.16E-12 m<sup>2</sup>/s      r<sup>2</sup>: 0.9782

Surface Concentration: 0.69 % Concrete  
 Background: 0.063 % Concrete

**Data**

Depth [mm]	Concentration [% Concrete]
0.76	0.46
1.78	0.51
2.79	0.47
3.81	0.40
4.83	0.34
5.84	0.28
6.86	0.21
7.87	0.16
8.89	0.11
9.91	0.09



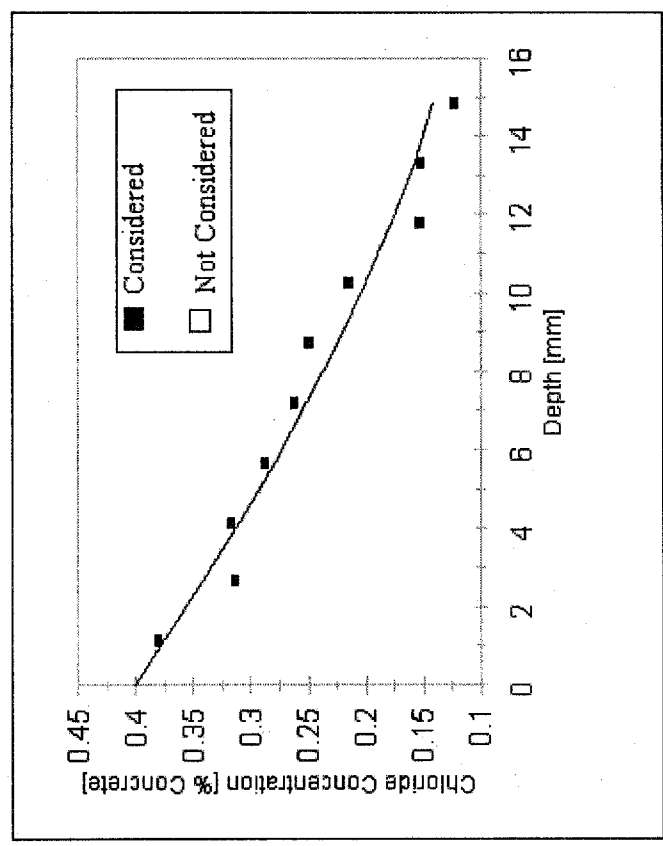
Chloride concentration above background at 12.5 mm: 0 %

**Sample:** FH-2-0.45-LiNC<sub>3</sub>      **Test:** Salt Ponding      **Duration:** 90 Days

**Diffusion Coefficient:** 9.36E-12 m<sup>2</sup>/s      **r<sup>2</sup>:** 0.9538  
**Surface Concentration:** 0.40 % Concrete  
**Background:** 0.068 % Concrete

**Data**

Depth [mm]	Concentration [% Concrete]
1.14	0.38
2.67	0.31
4.19	0.32
5.72	0.29
7.24	0.26
8.76	0.25
10.29	0.21
11.81	0.15
13.34	0.15
14.86	0.12



Chloride concentration above background at 12.5 mm: 0.085 %

Sample: FH-2-0.45-H.I

Test: Salt Ponding

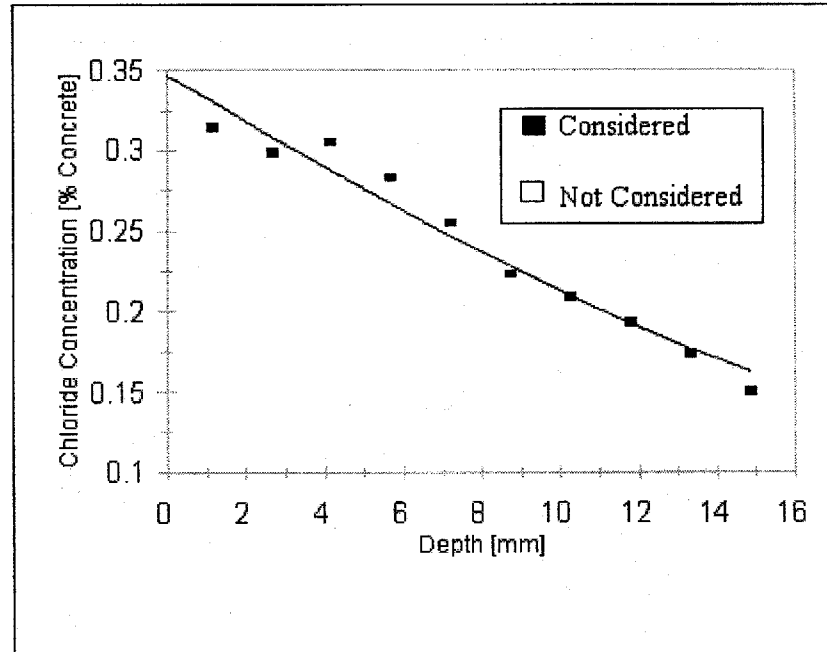
Duration: 90 Days

Diffusion Coefficient: 1.55E-11 m<sup>2</sup>/s  
Surface Concentration: 0.35 % Concrete  
Background: 0.068 % Concrete

r<sup>2</sup>: 0.9613

Data

Depth [mm]	Concentration [% Concrete]
1.14	0.31
2.67	0.30
4.19	0.30
5.72	0.28
7.24	0.25
8.76	0.22
10.29	0.21
11.81	0.19
13.34	0.17
14.86	0.15



Chloride concentration above background at 12.5 mm: 0.115 %

Sample: FH-2-0.45-20FA

Test: Salt Ponding

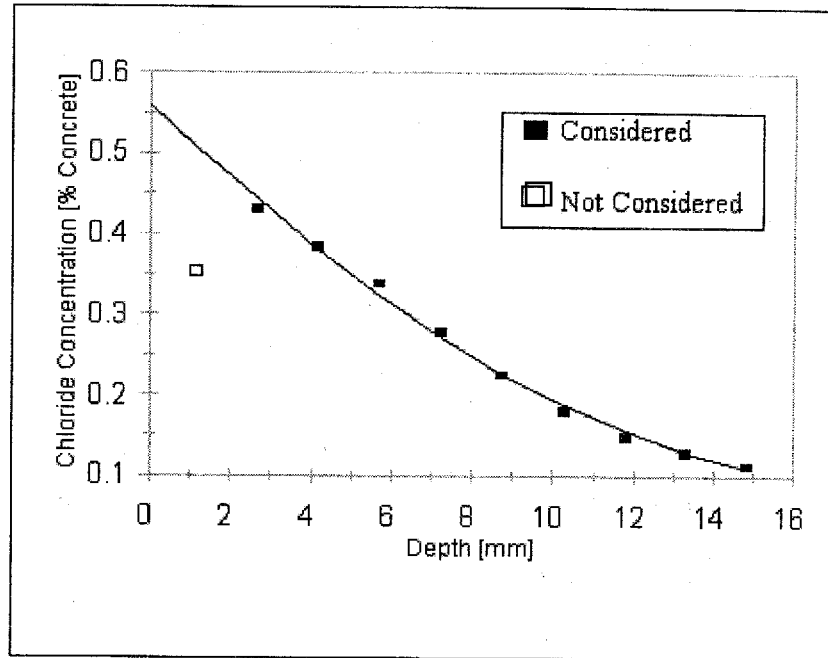
Duration: 90 Days

Diffusion Coefficient: 5.25E-12 m<sup>2</sup>/s  
Surface Concentration: 0.56 % Concrete  
Background: 0.060 % Concrete

r<sup>2</sup>: 0.9946

Data

Depth [mm]	Concentration [% Concrete]
1.14	0.35
2.67	0.43
4.19	0.38
5.72	0.34
7.24	0.28
8.76	0.22
10.29	0.18
11.81	0.15
13.34	0.13
14.86	0.11



Chloride concentration above background at 12.5 mm: 0.075 %

Sample: FH-2-0.45-MK

Test: Salt Ponding

Duration: 90 Days

Diffusion Coefficient: 2.00E-12 m<sup>2</sup>/s

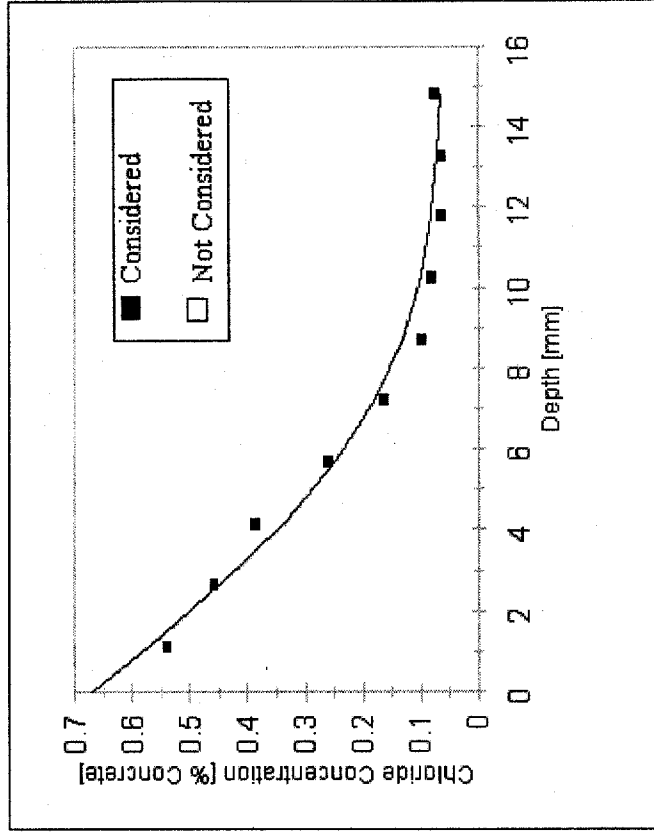
r<sup>2</sup>: 0.9794

Surface Concentration: 0.67 % Concrete

Background: 0.060 % Concrete

Data

Depth [mm]	Concentration [% Concrete]
1.14	0.54
2.67	0.46
4.19	0.39
5.72	0.26
7.24	0.16
8.76	0.10
10.29	0.08
11.81	0.06
13.34	0.06
14.86	0.07



Chloride concentration above background at 12.5 mm: 0 %

Sample: FH-2-0.35-MK

Test: Salt Ponding

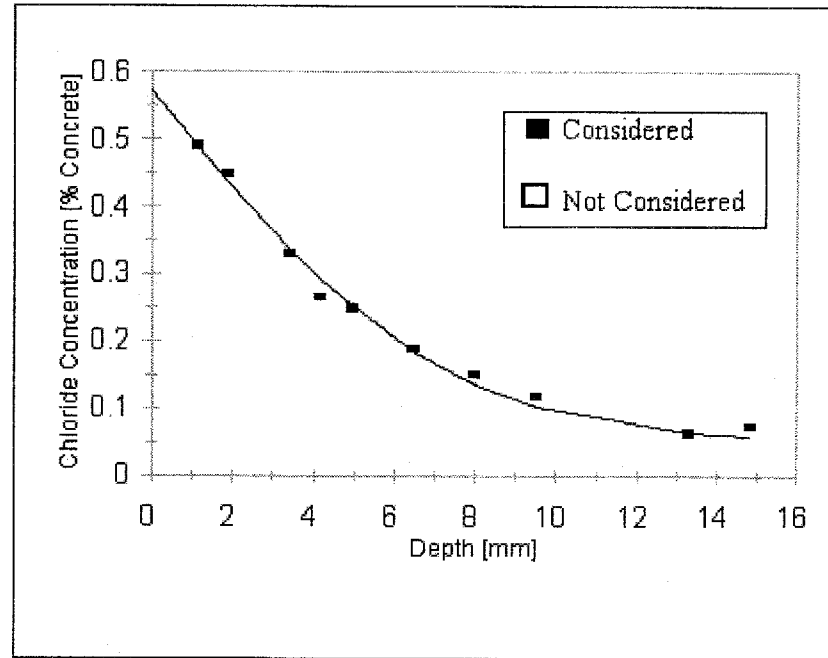
Duration: 90 Days

Diffusion Coefficient: 2.06E-12 m<sup>2</sup>/s  
Surface Concentration: 0.57 % Concrete  
Background: 0.055 % Concrete

r<sup>2</sup>: 0.9895

Data

Depth [mm]	Concentration [% Concrete]
1.14	0.49
1.91	0.45
3.43	0.33
4.19	0.26
4.95	0.25
6.48	0.19
8.00	0.15
9.53	0.12
13.34	0.06
14.86	0.07

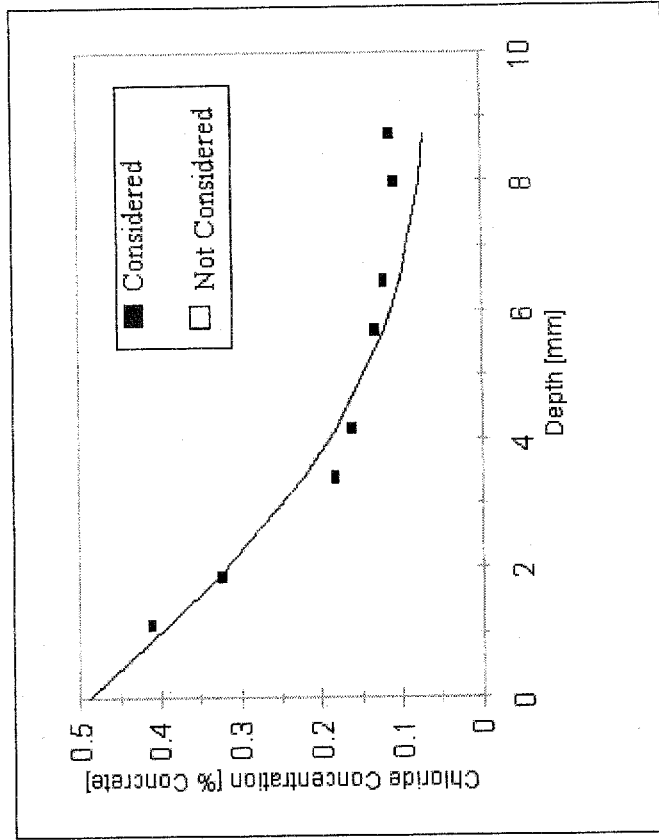


Chloride concentration above background at 12.5 mm: 0 %

Sample: FH-2-0.35-SF, SG      Test: Salt Ponding      Duration: 90 Days

$r^2$ : 0.9386

Diffusion Coefficient: 9.62E-13 m<sup>2</sup>/s  
 Surface Concentration: 0.49 % Concrete  
 Background: 0.060 % Concrete



**Data**

Depth [mm]	Concentration [% Concrete]
1.14	0.41
1.91	0.32
3.43	0.18
4.19	0.16
5.72	0.13
6.48	0.12
8.00	0.11
8.76	0.11

Chloride concentration above background at 12.5 mm: 0 %

Sample: FH-2-0.35-SF, FA

Test: Salt Ponding

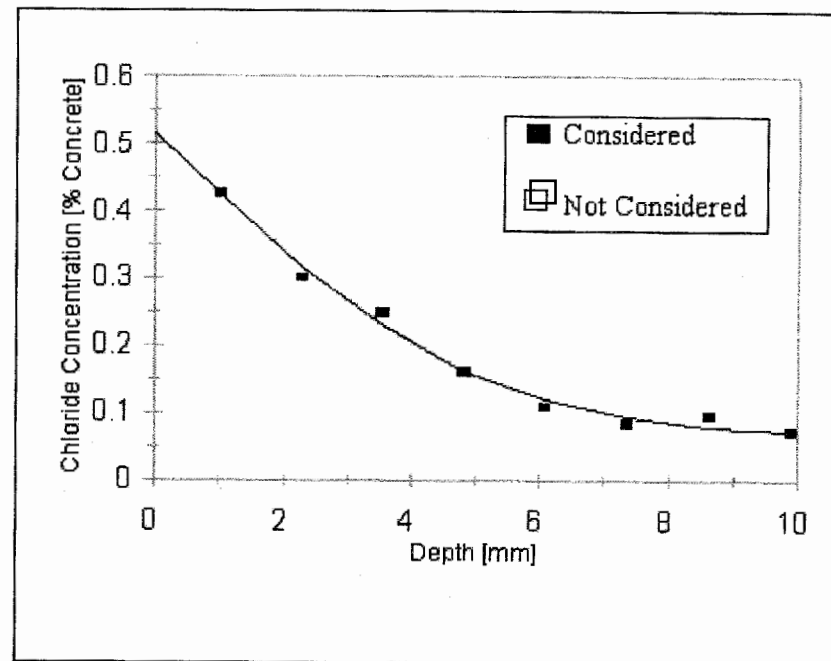
Duration: 90 Days

Diffusion Coefficient: 9.63E-13 m<sup>2</sup>/s  
Surface Concentration: 0.52 % Concrete  
Background: 0.068 % Concrete

r<sup>2</sup>: 0.9898

Data

Depth [mm]	Concentration [% Concrete]
1.02	0.43
2.29	0.30
3.56	0.25
4.83	0.16
6.10	0.11
7.37	0.08
8.64	0.09
9.91	0.07



Chloride concentration above background at 12.5 mm: 0 %



**Sample:** FH-2-0.45-50SG      **Test:** Salt Ponding      **Duration:** 90 Days

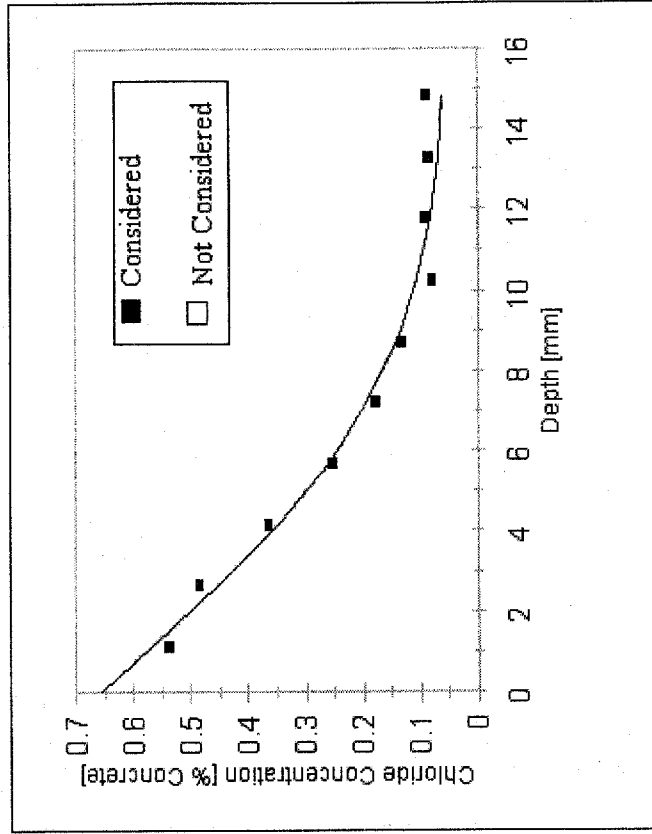
**Diffusion Coefficient:** 2.32E-12 m<sup>2</sup>/s      **r<sup>2</sup>:** 0.9841

**Surface Concentration:** 0.66 % Concrete

**Background:** 0.053 % Concrete

**Data**

Depth [mm]	Concentration [% Concrete]
1.14	0.54
2.67	0.48
4.19	0.36
5.72	0.25
7.24	0.18
8.76	0.13
10.29	0.08
11.81	0.09
13.34	0.08
14.86	0.09



Chloride concentration above background at 12.5 mm: 0.035 %

Sample: FH-2-0.35-Latex

Test: Salt Ponding

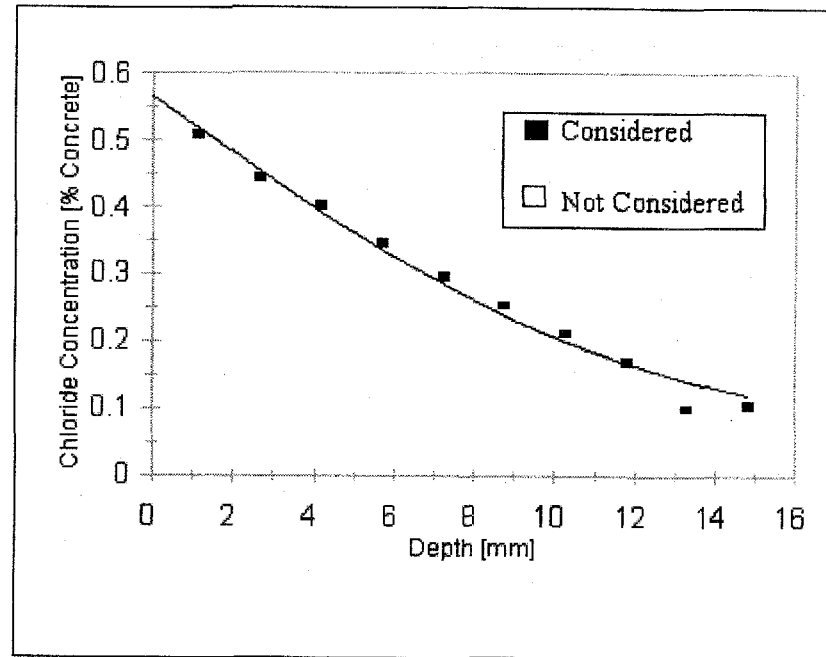
Duration: 90 Days

Diffusion Coefficient: 5.63E-12 m<sup>2</sup>/s  
Surface Concentration: 0.57 % Concrete  
Background: 0.063 % Concrete

r<sup>2</sup>: 0.9848

Data

Depth [mm]	Concentration [% Concrete]
1.14	0.51
2.67	0.44
4.19	0.40
5.72	0.34
7.24	0.30
8.76	0.25
10.29	0.21
11.81	0.17
13.34	0.10
14.86	0.10



Chloride concentration above background at 12.5 mm: 0.065 %

Sample: FH-2-0.45-High C<sub>3</sub>A

Test: Salt Ponding

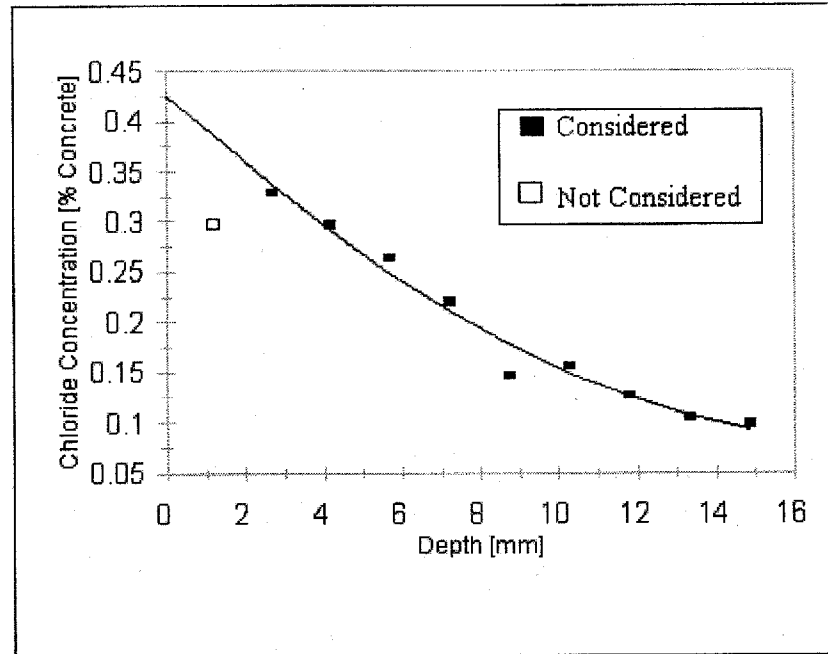
Duration: 90 Days

Diffusion Coefficient: 4.95E-12 m<sup>2</sup>/s  
Surface Concentration: 0.43 % Concrete  
Background: 0.060 % Concrete

r<sup>2</sup>: 0.9753

Data

Depth [mm]	Concentration [% Concrete]
1.14	0.30
2.67	0.33
4.19	0.30
5.72	0.26
7.24	0.22
8.76	0.15
10.29	0.16
11.81	0.13
13.34	0.10
14.86	0.10



Chloride concentration above background at 12.5 mm: 0.055 %

Sample: FH-2-0.45-Low C<sub>3</sub>A

Test: Salt Ponding

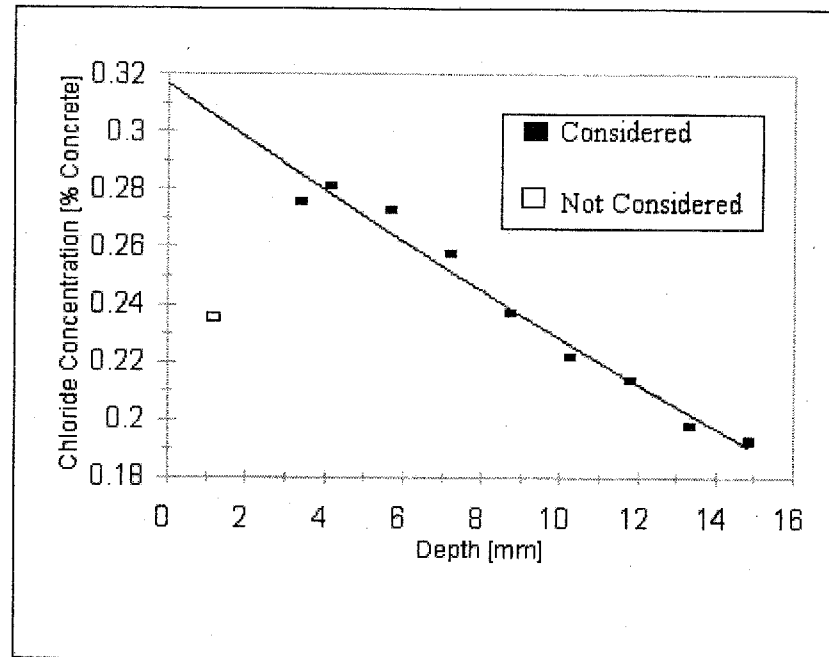
Duration: 90 Days

Diffusion Coefficient: 3.02E-11 m<sup>2</sup>/s  
Surface Concentration: 0.32 % Concrete  
Background: 0.068 % Concrete

r<sup>2</sup>: 0.9744

Data

Depth [mm]	Concentration [% Concrete]
1.14	0.24
3.43	0.28
4.19	0.28
5.72	0.27
7.24	0.26
8.76	0.24
10.29	0.22
11.81	0.21
13.34	0.20
14.86	0.19



Chloride concentration above background at 12.5 mm: 0.135 %

Sample: FH-2-0.35-Steam

Test: Salt Ponding

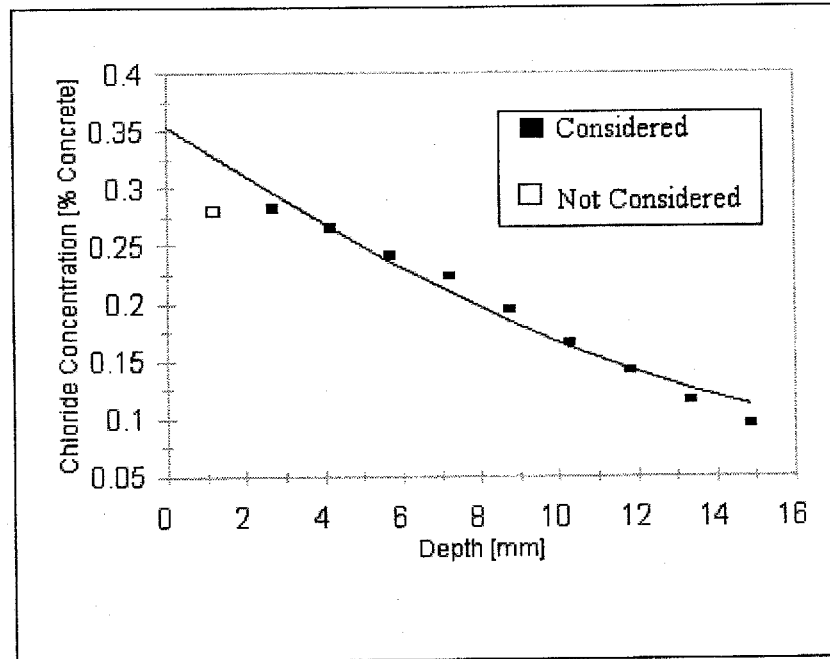
Duration: 90 Days

Diffusion Coefficient: 7.50E-12 m<sup>2</sup>/s  
Surface Concentration: 0.35 % Concrete  
Background: 0.063 % Concrete

r<sup>2</sup>: 0.9726

Data

Depth [mm]	Concentration [% Concrete]
1.14	0.28
2.67	0.28
4.19	0.27
5.72	0.24
7.24	0.22
8.76	0.19
10.29	0.17
11.81	0.14
13.34	0.12
14.86	0.09



Chloride concentration above background at 12.5 mm: 0.04 %

**Sample:** FH-2-0.35-Plain      **Test:** Salt Ponding      **Duration:** 90 Days

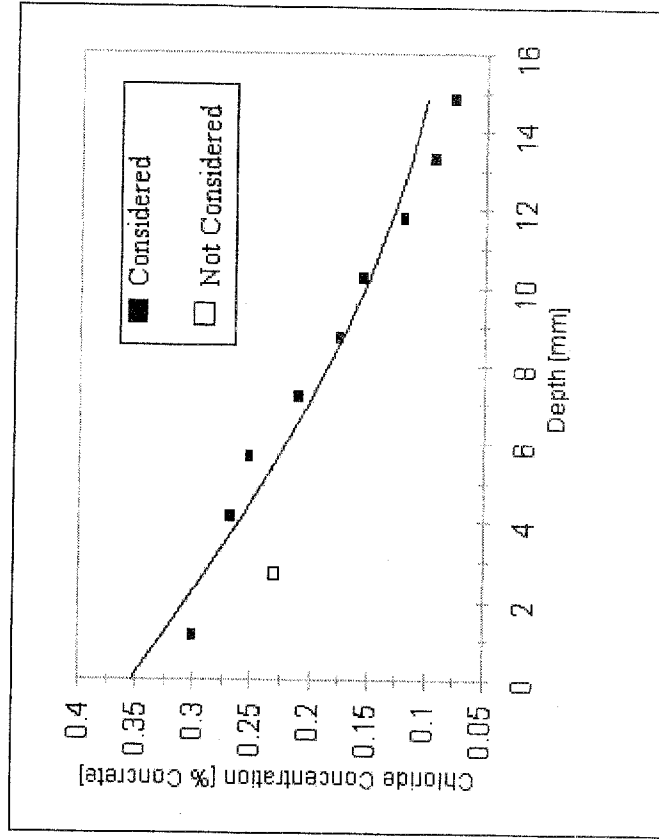
**Diffusion Coefficient:** 6.26E-12 m<sup>2</sup>/s      **r<sup>2</sup>:** 0.9444

**Surface Concentration:** 0.35 % Concrete

**Background:** 0.063 % Concrete

**Data**

Depth [mm]	Concentration [% Concrete]
1.14	0.30
2.67	0.23
4.19	0.27
5.72	0.25
7.24	0.21
8.76	0.18
10.29	0.16
11.81	0.12
13.34	0.09
14.86	0.08



Chloride concentration above background at 12.5 mm: 0.065 %

Sample: FH-2-0.25- 8 SF

Test: Salt Ponding

Duration: 90 Days

Diffusion Coefficient: 1.04E-12 m<sup>2</sup>/s

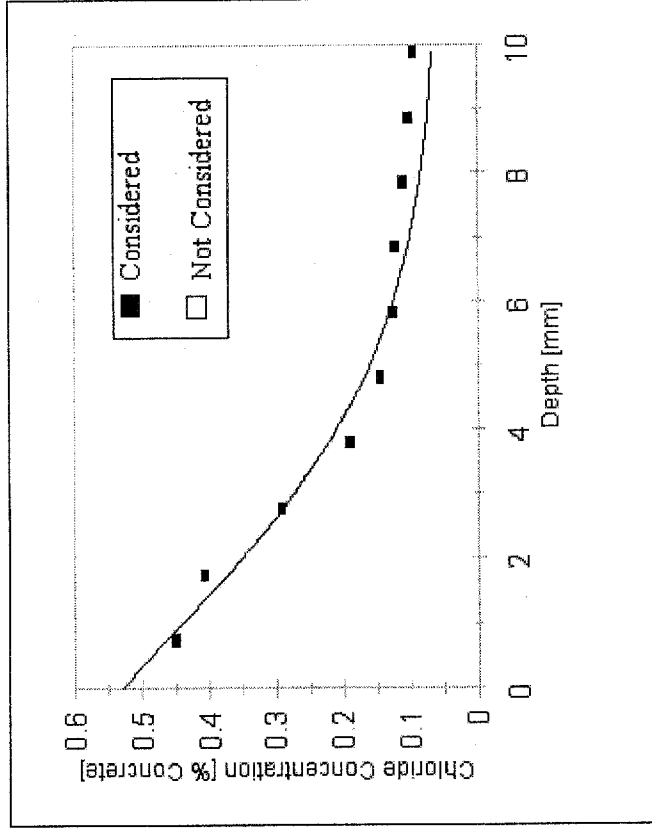
r<sup>2</sup>: 0.9642

Surface Concentration: 0.53 % Concrete

Background: 0.060 % Concrete

Data

Depth [mm]	Concentration [% Concrete]
0.76	0.45
1.78	0.41
2.79	0.29
3.81	0.19
4.83	0.14
5.84	0.12
6.86	0.12
7.87	0.11
8.89	0.10
9.91	0.09



Chloride concentration above background at 12.5 mm: 0 %

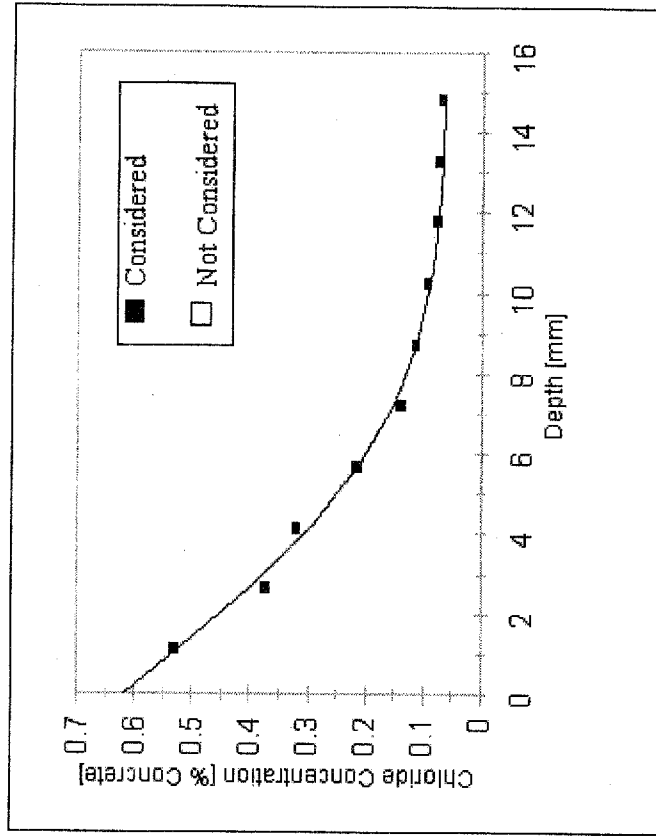
Sample: FH-2-0.35-8 SF      Test: Salt Ponding      Duration: 90 Days

$r^2$ : 0.9926

Diffusion Coefficient: 1.71E-12 m<sup>2</sup>/s  
Surface Concentration: 0.62 % Concrete  
Background: 0.063 % Concrete

**Data**

Depth [mm]	Concentration [% Concrete]
1.14	0.53
2.67	0.37
4.19	0.32
5.72	0.21
7.24	0.14
8.76	0.11
10.29	0.09
11.81	0.08
13.34	0.07
14.86	0.07



Chloride concentration above background at 12.5 mm: 0.01 %



Sample: FH-2-0.45-23 C

Test: Bulk Diffusion

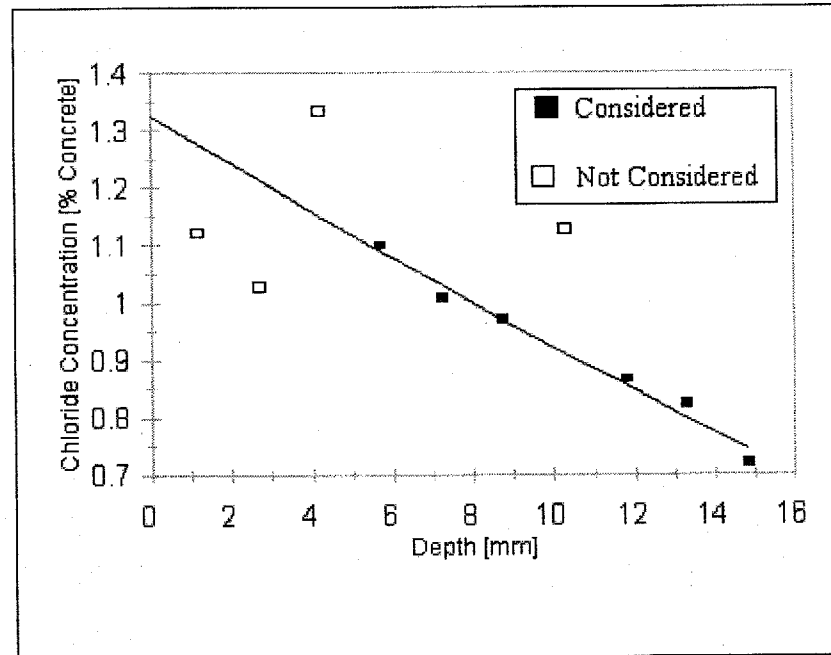
Duration: 365 Days

Diffusion Coefficient: 9.23E-12 m<sup>2</sup>/s  
Surface Concentration: 1.32 % Concrete  
Background: 0.068 % Concrete

r<sup>2</sup>: 0.9800

Data

Depth [mm]	Concentration [% Concrete]
1.14	1.12
2.67	1.03
4.19	1.33
5.72	1.10
7.24	1.01
8.76	0.97
10.29	1.13
11.81	0.86
13.34	0.82
14.86	0.72



Sample: FH-2-0.45-Silane

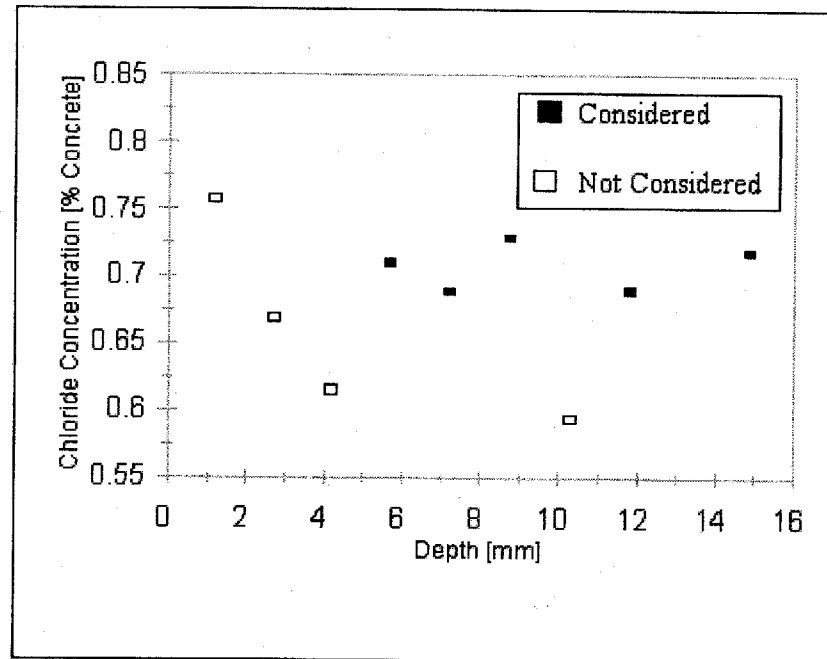
Test: Bulk Diffusion

Duration: 365 Days

Diffusion Coefficient:  $m^2/s$   
Surface Concentration: % Concrete  
Background: 0.065 % Concrete

Data

Depth [mm]	Concentration [% Concrete]
1.14	0.76
2.67	0.67
4.19	0.62
5.72	0.71
7.24	0.69
8.76	0.73
10.29	0.59
11.81	0.69
13.34	0.82
14.86	0.72



Sample: FH-2-0.45-7 C

Test: Bulk Diffusion

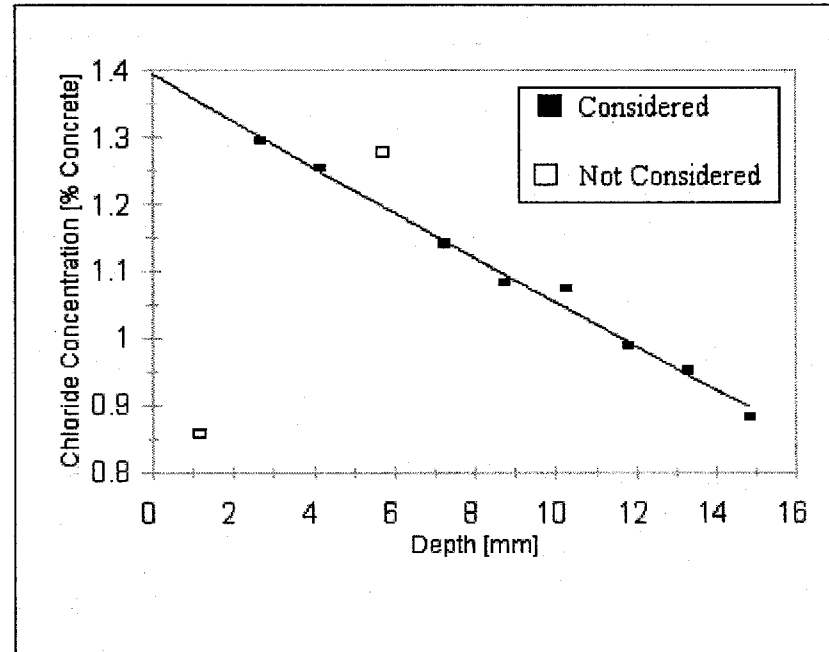
Duration: 365 Days

Diffusion Coefficient: 1.49E-11 m<sup>2</sup>/s  
Surface Concentration: 1.39 % Concrete  
Background: 0.058 % Concrete

r<sup>2</sup>: 0.9901

Data

Depth [mm]	Concentration [% Concrete]
1.14	0.86
2.67	1.29
4.19	1.25
5.72	1.28
7.24	1.14
8.76	1.08
10.29	1.07
11.81	0.99
13.34	0.95
14.86	0.88



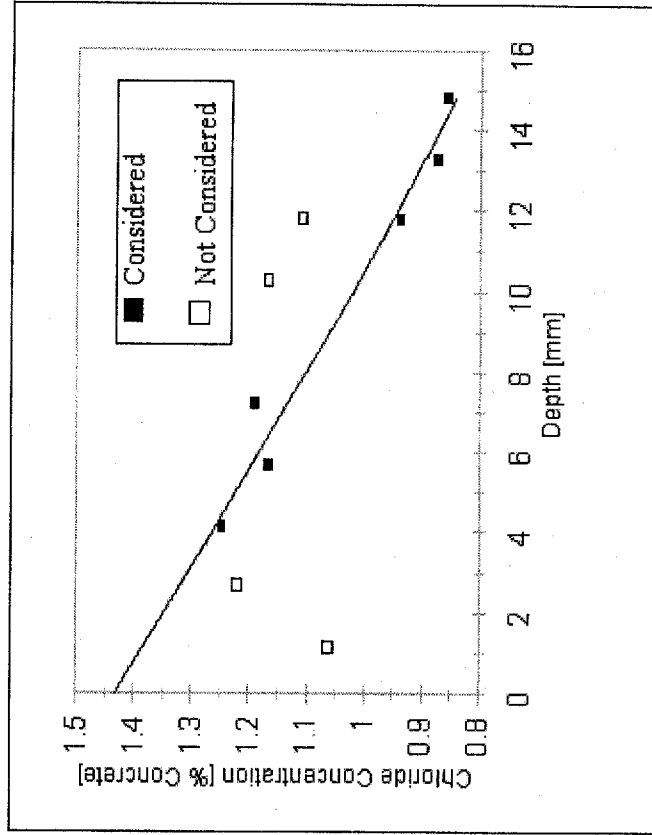
Sample: FH-2-0.45-38 C      Test: Bulk Diffusion      Duration: 365 Days

$r^2$ : 0.9655

Diffusion Coefficient: 1.08E-11 m<sup>2</sup>/s  
 Surface Concentration: 1.43 % Concrete  
 Background: 0.058 % Concrete

**Data**

Depth [mm]	Concentration [% Concrete]
1.14	1.06
2.67	1.22
4.19	1.25
5.72	1.17
7.24	1.19
8.76	1.17
10.29	1.11
11.81	0.94
13.34	0.87
14.86	0.86



Sample: FH-2-0.45-Steam

Test: Bulk Diffusion

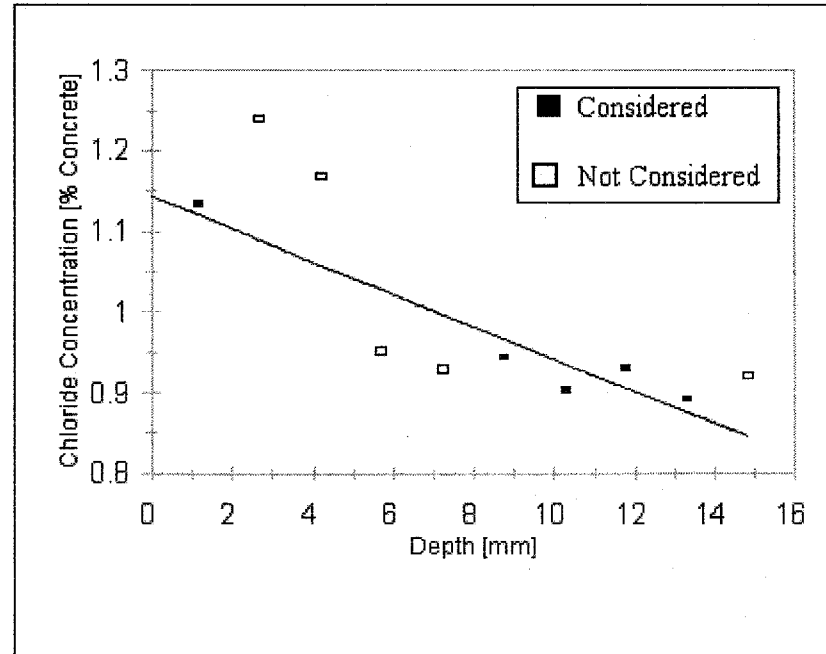
Duration: 365 Days

Diffusion Coefficient: 2.82E-11 m<sup>2</sup>/s  
Surface Concentration: 1.14 % Concrete  
Background: 0.058 % Concrete

r<sup>2</sup>: 0.9395

Data

Depth [mm]	Concentration [% Concrete]
1.14	1.13
2.67	1.24
4.19	1.17
5.72	0.95
7.24	0.93
8.76	0.94
10.29	0.90
11.81	0.93
13.34	0.89
14.86	0.92



**Sample:** FH-2-0.45-Steam

**Test:** Bulk Diffusion

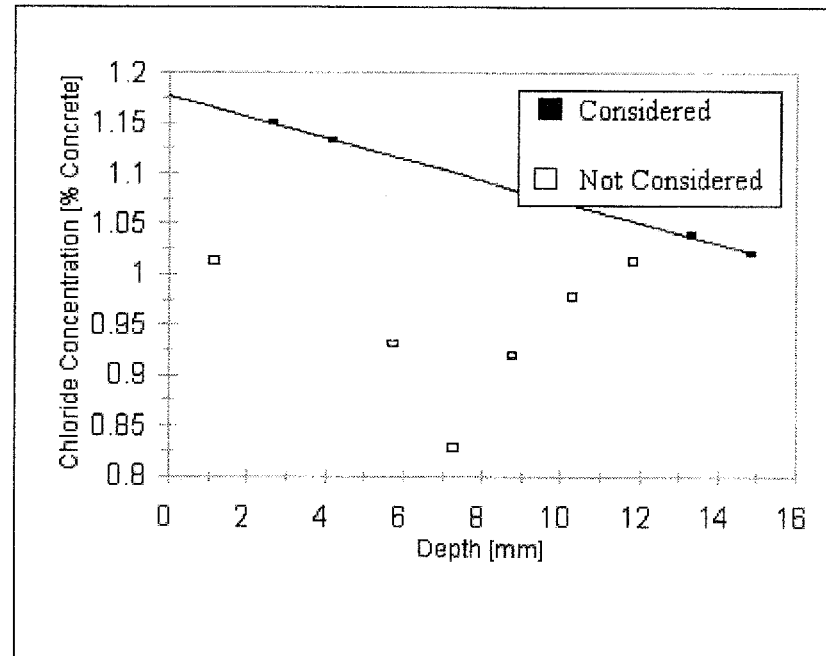
**Duration:** 365 Days

Diffusion Coefficient: 1.14E-10 m<sup>2</sup>/s  
Surface Concentration: 1.18 % Concrete  
Background: 0.058 % Concrete

r<sup>2</sup>: 0.9996

**Data**

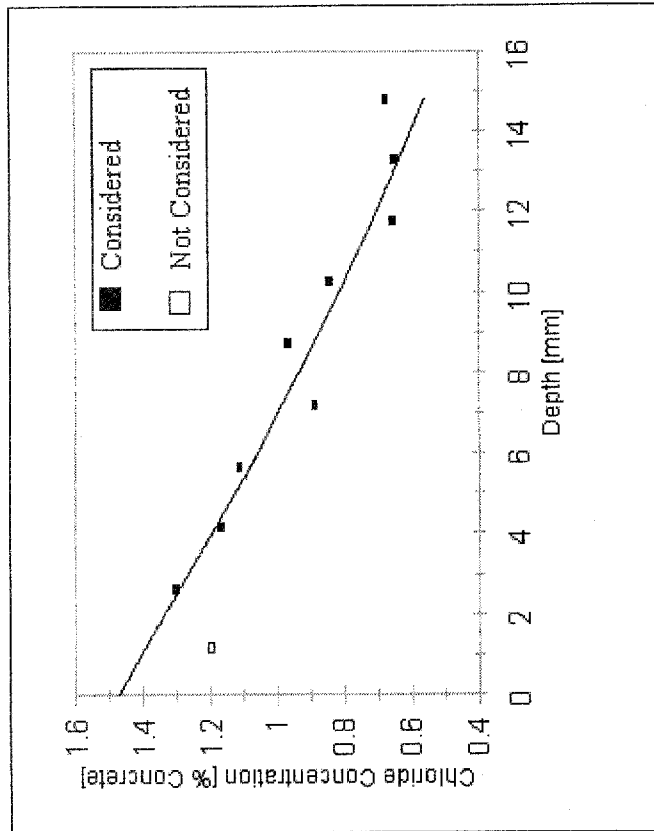
Depth [mm]	Concentration [% Concrete]
1.14	1.01
2.67	1.15
4.19	1.13
5.72	0.93
7.24	0.83
8.76	0.92
10.29	0.98
11.81	1.01
13.34	1.04
14.86	1.02



Sample: FH-2-0.45-Steel      Test: Bulk Diffusion      Duration: 365 Days

$r^2$ : 0.9422

Diffusion Coefficient: 4.11E-12 m<sup>2</sup>/s  
Surface Concentration: 1.47 % Concrete  
Background: 0.055 % Concrete



**Data**

Depth [mm]	Concentration [% Concrete]
1.14	1.20
2.67	1.30
4.19	1.16
5.72	1.11
7.24	0.88
8.76	0.97
10.29	0.84
11.81	0.65
13.34	0.65
14.86	0.67

Sample: FH-2-0.45-Siloxane

Test: Bulk Diffusion

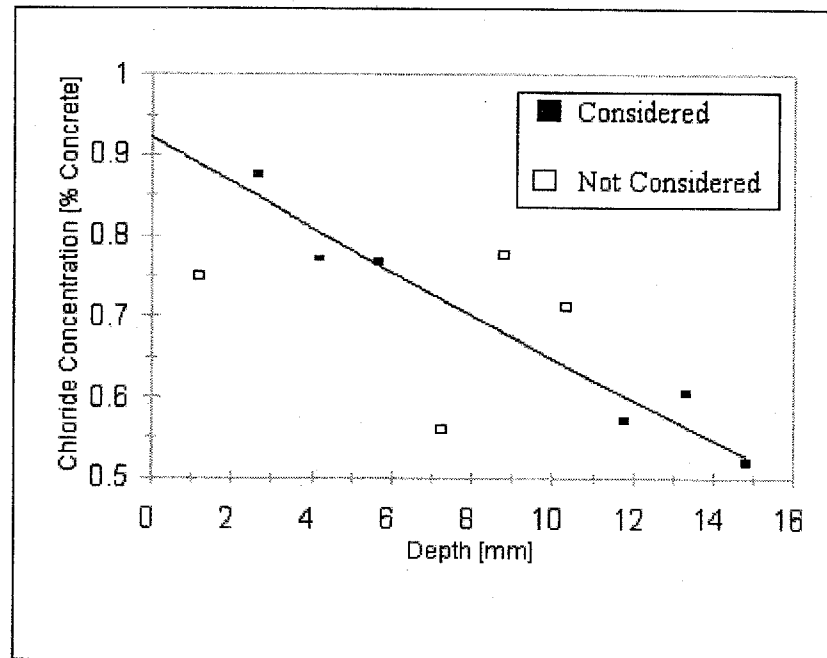
Duration: 365 Days

Diffusion Coefficient: 9.28E-12 m<sup>2</sup>/s  
Surface Concentration: 0.92 % Concrete  
Background: 0.065 % Concrete

r<sup>2</sup>: 0.9527

Data

Depth [mm]	Concentration [% Concrete]
1.14	0.75
2.67	0.88
4.19	0.77
5.72	0.77
7.24	0.56
8.76	0.78
10.29	0.71
11.81	0.57
13.34	0.60
14.86	0.52





Sample: FH-2-0.45A-7 C

Test: Bulk Diffusion

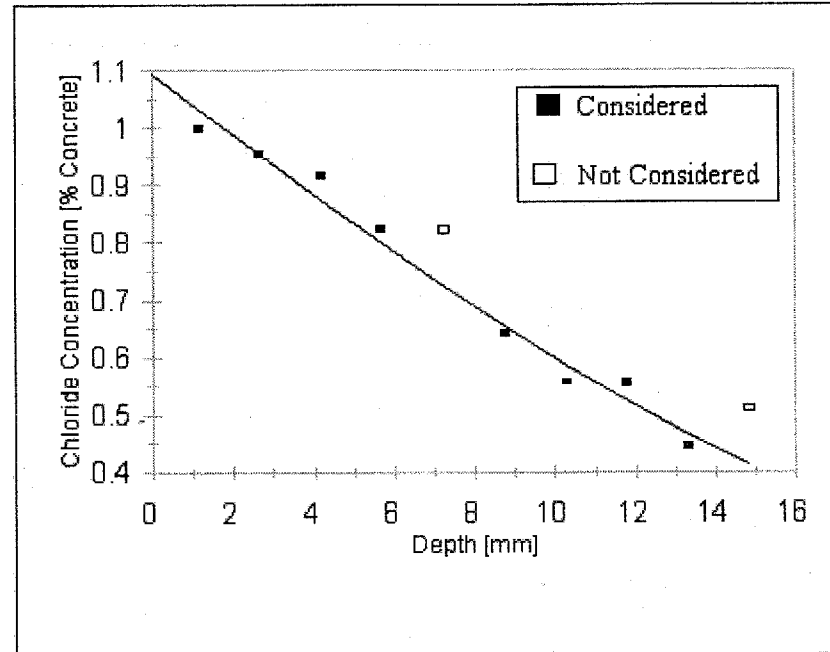
Duration: 365 Days

Diffusion Coefficient: 3.71E-12 m<sup>2</sup>/s  
Surface Concentration: 1.09 % Concrete  
Background: 0.075 % Concrete

r<sup>2</sup>: 0.9800

Data

Depth [mm]	Concentration [% Concrete]
1.14	1.00
2.67	0.95
4.19	0.92
5.72	0.82
7.24	0.82
8.76	0.64
10.29	0.56
11.81	0.56
13.34	0.44
14.86	0.51



Sample: FH-2-0.45A-23 C

Test: Bulk Diffusion

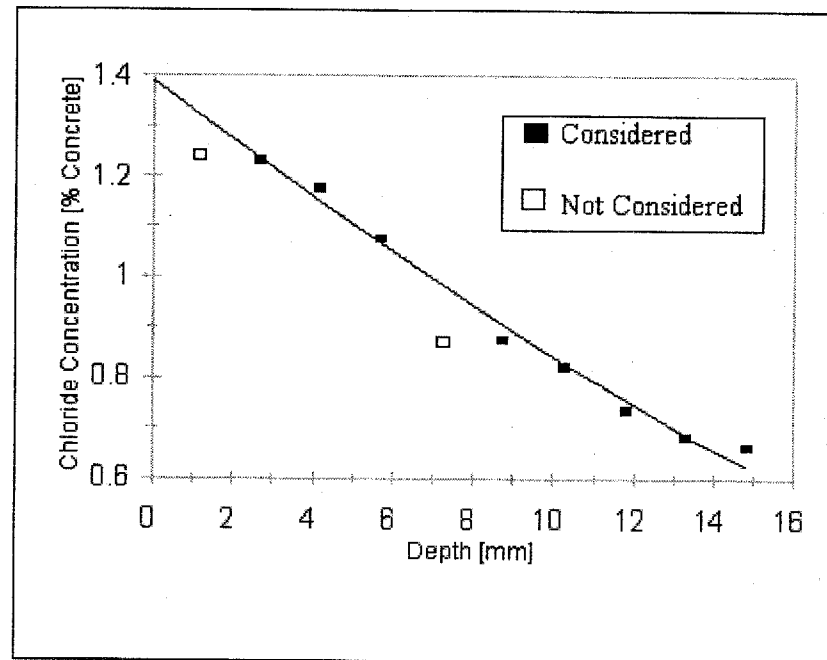
Duration: 365 Days

Diffusion Coefficient: 5.44E-12 m<sup>2</sup>/s  
Surface Concentration: 1.39 % Concrete  
Background: 0.060 % Concrete

r<sup>2</sup>: 0.9895

Data

Depth [mm]	Concentration [% Concrete]
1.14	1.24
2.67	1.23
4.19	1.17
5.72	1.07
7.24	0.87
8.76	0.88
10.29	0.82
11.81	0.74
13.34	0.68
14.86	0.66



Sample: FH-2-0.45R -38 C

Test: Bulk Diffusion

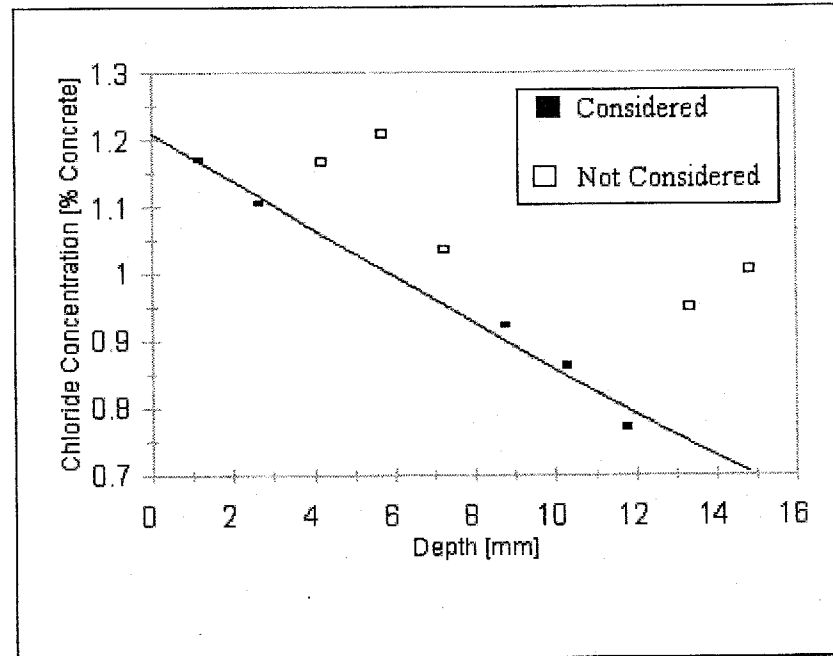
Duration: 365 Days

Diffusion Coefficient: 9.99E-12 m<sup>2</sup>/s  
Surface Concentration: 1.21 % Concrete  
Background: 0.070 % Concrete

r<sup>2</sup>: 0.9865

Data

Depth [mm]	Concentration [% Concrete]
1.14	1.17
2.67	1.10
4.19	1.17
5.72	1.21
7.24	1.04
8.76	0.92
10.29	0.86
11.81	0.77
13.34	0.95
14.86	1.01



Sample: FH-2-0.45R-Steam

Test: Bulk Diffusion

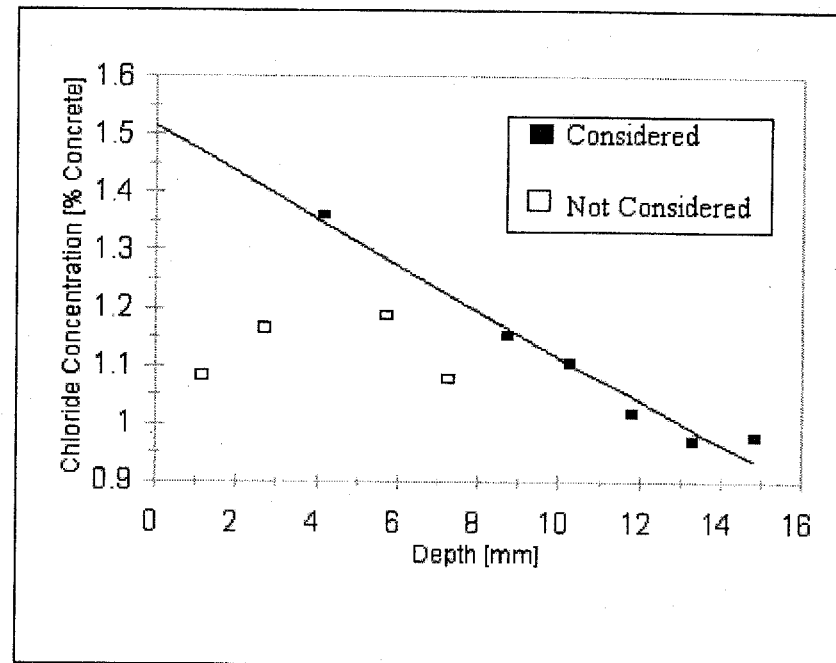
Duration: 365 Days

Diffusion Coefficient: 1.26E-11 m<sup>2</sup>/s  
Surface Concentration: 1.52 % Concrete  
Background: 0.068 % Concrete

r<sup>2</sup>: 0.9652

Data

Depth [mm]	Concentration [% Concrete]
1.14	1.08
2.67	1.16
4.19	1.36
5.72	1.19
7.24	1.08
8.76	1.15
10.29	1.10
11.81	1.02
13.34	0.97
14.86	0.98



Sample: FH-2-0.45R -23 C

Test: Bulk Diffusion

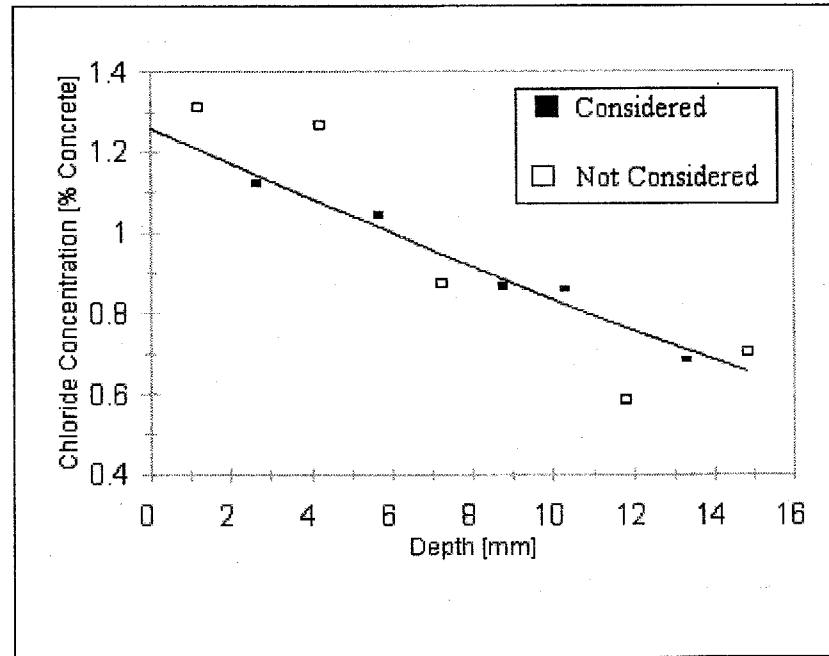
Duration: 365 Days

Diffusion Coefficient: 7.43E-12 m<sup>2</sup>/s  
Surface Concentration: 1.26 % Concrete  
Background: 0.063 % Concrete

r<sup>2</sup>: 0.9672

Data

Depth [mm]	Concentration [% Concrete]
1.14	1.31
2.67	1.12
4.19	1.27
5.72	1.04
7.24	0.87
8.76	0.87
10.29	0.86
11.81	0.59
13.34	0.68
14.86	0.70



Sample: FH-2-0.35-MK,Steel

Test: Bulk Diffusion

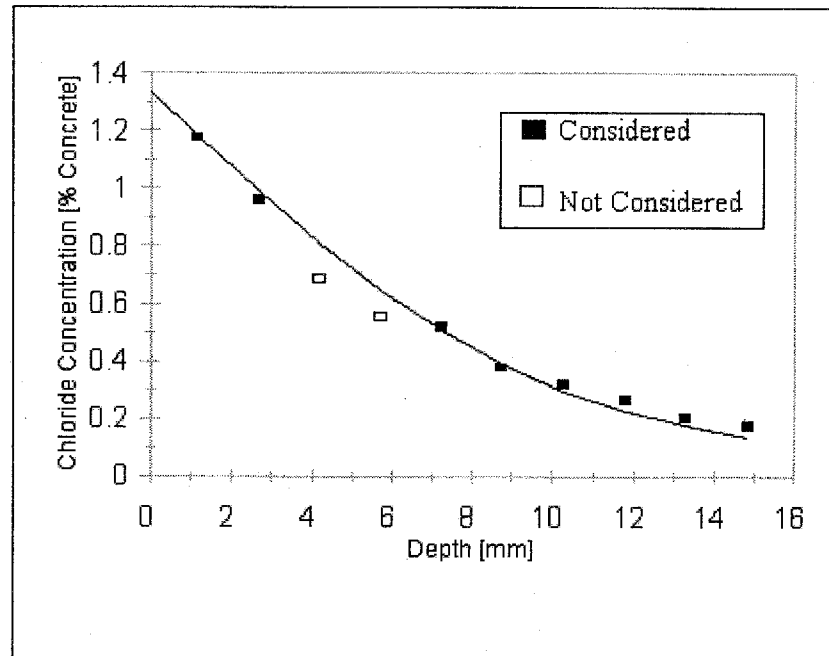
Duration: 365 Days

Diffusion Coefficient: 9.34E-13 m<sup>2</sup>/s  
Surface Concentration: 1.33 % Concrete  
Background: 0.070 % Concrete

r<sup>2</sup>: 0.9955

Data

Depth [mm]	Concentration [% Concrete]
1.14	1.18
2.67	0.96
4.19	0.69
5.72	0.55
7.24	0.52
8.76	0.38
10.29	0.32
11.81	0.26
13.34	0.20
14.86	0.17



Sample: FH-2-0.45-DCI

Test: Bulk Diffusion

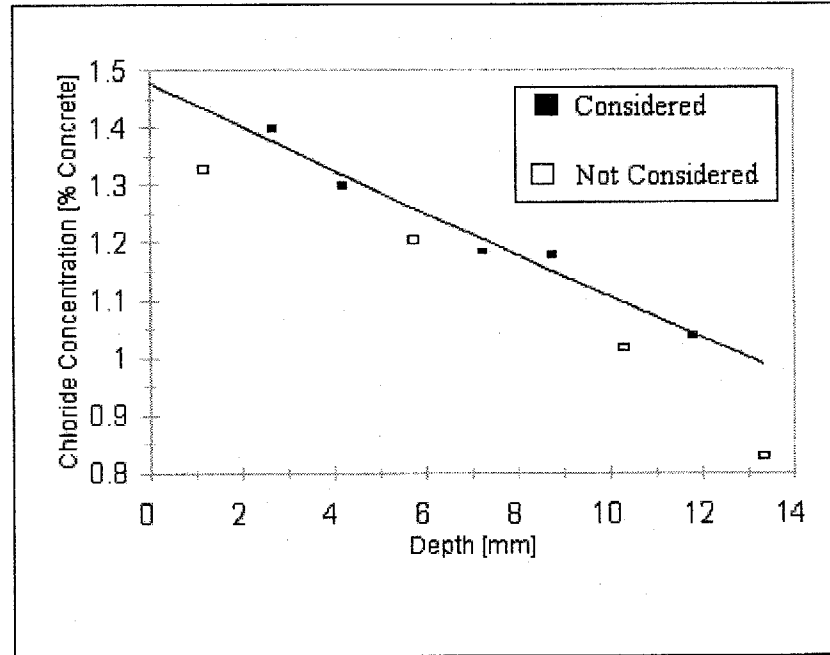
Duration: 365 Days

Diffusion Coefficient: 1.37E-11 m<sup>2</sup>/s  
Surface Concentration: 1.48 % Concrete  
Background: 0.073 % Concrete

r<sup>2</sup>: 0.9707

Data

Depth [mm]	Concentration [% Concrete]
1.14	1.33
2.67	1.40
4.19	1.30
5.72	1.21
7.24	1.18
8.76	1.18
10.29	1.02
11.81	1.04
13.34	0.83



Sample: FH-2-0.35-DCI

Test: Bulk Diffusion

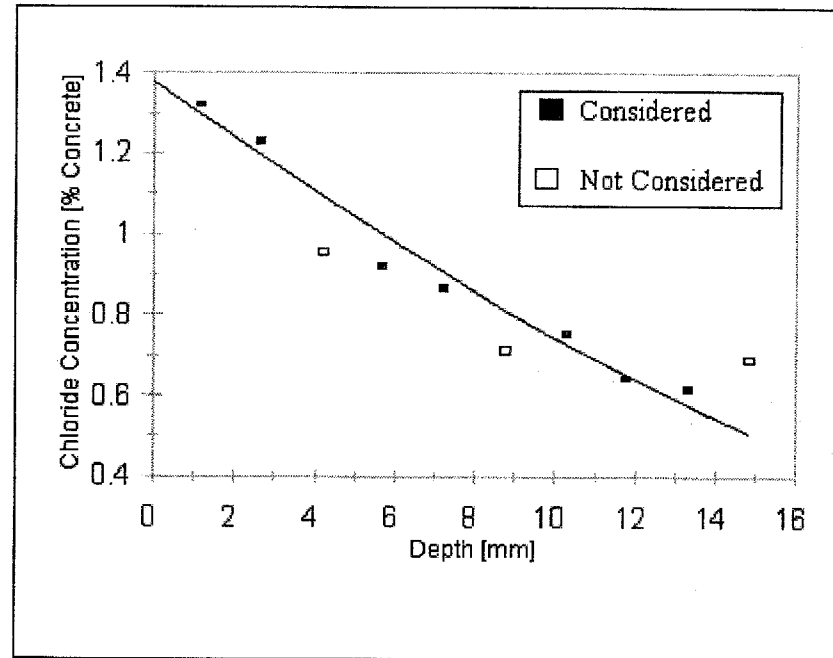
Duration: 365 Days

Diffusion Coefficient: 3.81E-12 m<sup>2</sup>/s  
Surface Concentration: 1.38 % Concrete  
Background: 0.063 % Concrete

r<sup>2</sup>: 0.9596

Data

Depth [mm]	Concentration [% Concrete]
1.14	1.32
2.67	1.23
4.19	0.96
5.72	0.92
7.24	0.87
8.76	0.71
10.29	0.75
11.81	0.64
13.34	0.61
14.86	0.69





Sample: FH-2-0.35-SF,DCI

Test: Bulk Diffusion

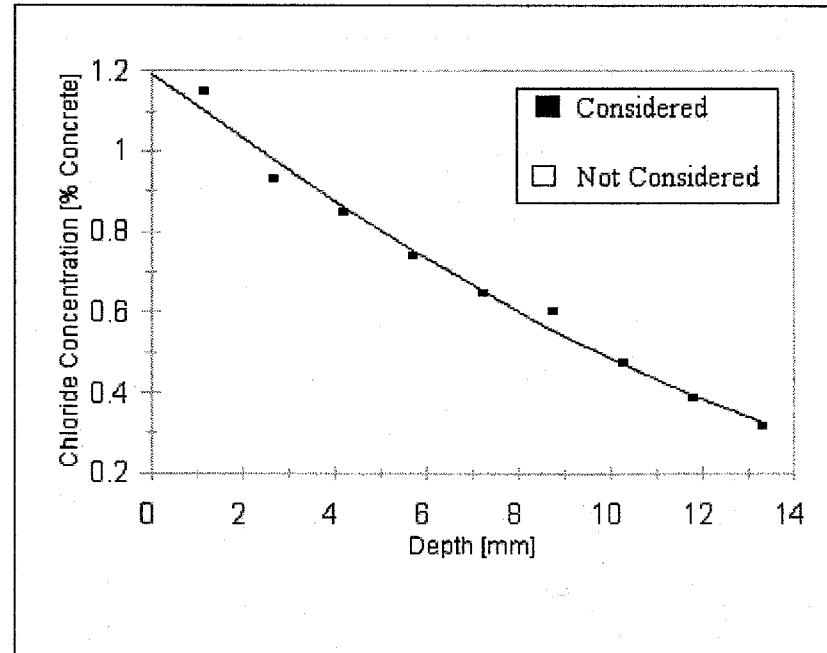
Duration: 365 Days

Diffusion Coefficient: 1.99E-12 m<sup>2</sup>/s  
Surface Concentration: 1.19 % Concrete  
Background: 0.063 % Concrete

r<sup>2</sup>: 0.9870

Data

Depth [mm]	Concentration [% Concrete]
1.14	1.15
2.67	0.93
4.19	0.85
5.72	0.74
7.24	0.65
8.76	0.60
10.29	0.47
11.81	0.38
13.34	0.32



Sample: FH-2-0.45-LiNC<sub>3</sub>

Test: Bulk Diffusion

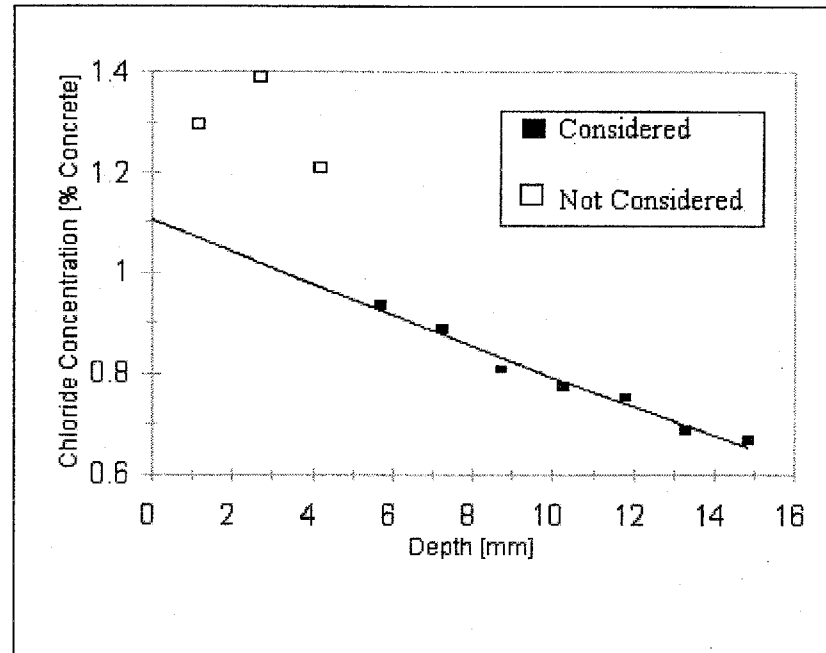
Duration: 365 Days

Diffusion Coefficient: 1.06E-11 m<sup>2</sup>/s  
Surface Concentration: 1.11 % Concrete  
Background: 0.068 % Concrete

r<sup>2</sup>: 0.9781

Data

Depth [mm]	Concentration [% Concrete]
1.14	1.30
2.67	1.39
4.19	1.21
5.72	0.94
7.24	0.89
8.76	0.81
10.29	0.77
11.81	0.75
13.34	0.69
14.86	0.67



Sample: FH-2-0.45-H.I

Test: Bulk Diffusion

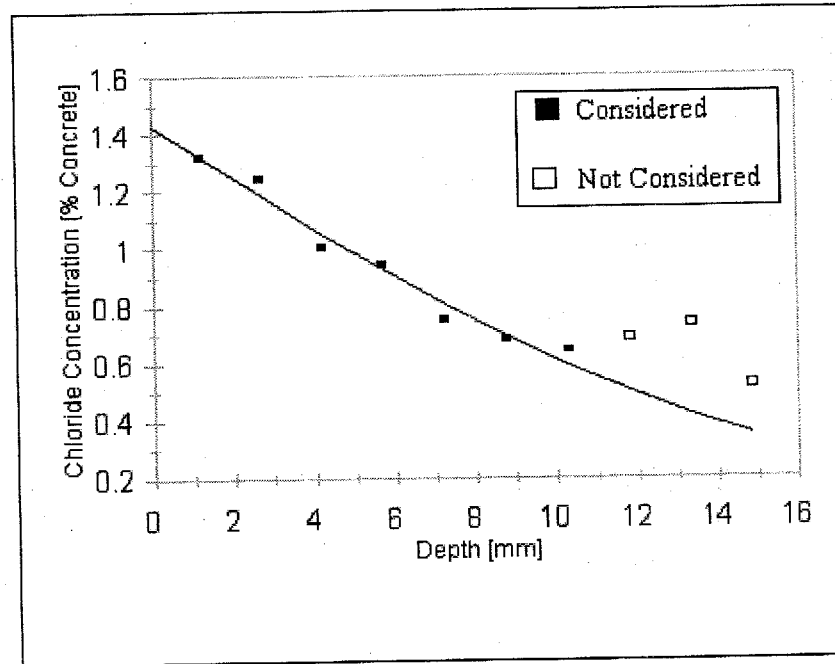
Duration: 365 Days

Diffusion Coefficient: 2.21E-12 m<sup>2</sup>/s  
Surface Concentration: 1.43 % Concrete  
Background: 0.068 % Concrete

r<sup>2</sup>: 0.9718

Data

Depth [mm]	Concentration [% Concrete]
1.14	1.32
2.67	1.24
4.19	1.00
5.72	0.94
7.24	0.75
8.76	0.68
10.29	0.64
11.81	0.69
13.34	0.74
14.86	0.52



Sample: FH-2-0.50-Plain

Test: Bulk Diffusion

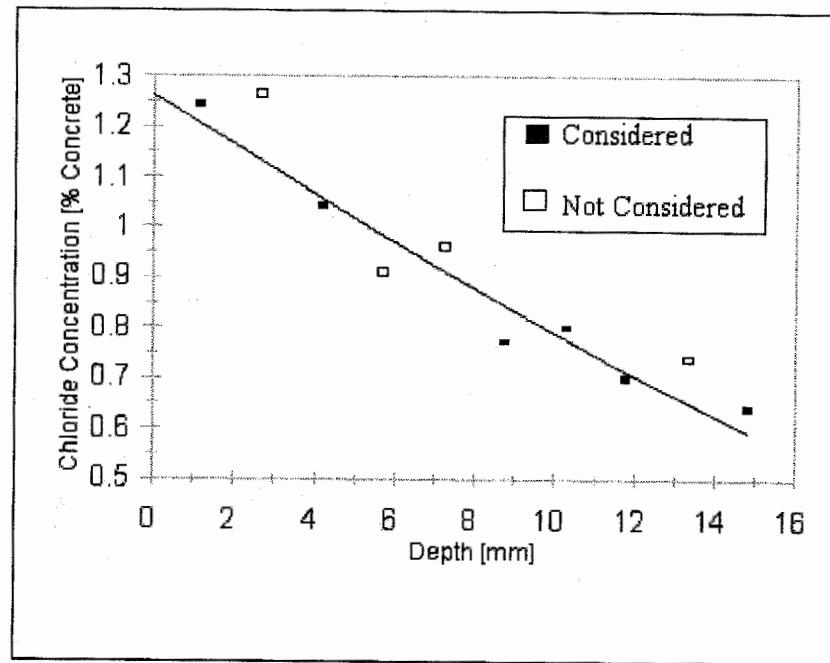
Duration: 365 Days

Diffusion Coefficient: 5.91E-12 m<sup>2</sup>/s  
Surface Concentration: 1.26 % Concrete  
Background: 0.065 % Concrete

r<sup>2</sup>: 0.9645

Data

Depth [mm]	Concentration [% Concrete]
1.14	1.24
2.67	1.27
4.19	1.04
5.72	0.91
7.24	0.96
8.76	0.77
10.29	0.80
11.81	0.70
13.34	0.74
14.86	0.64



Sample: FH-2-0.45-20 FA

Test: Bulk Diffusion

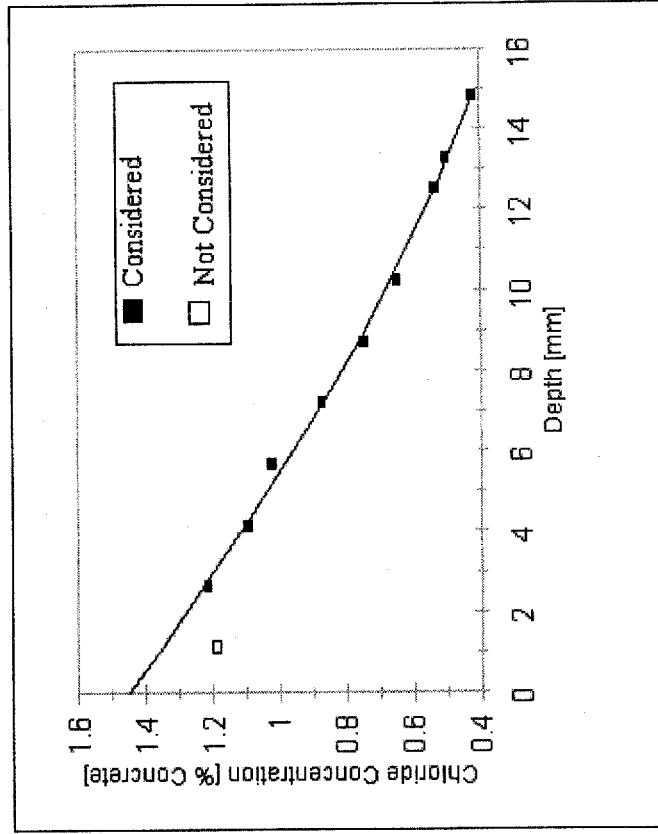
Duration: 365 Days

$r^2$ : 0.9964

Diffusion Coefficient: 2.74E-12 m<sup>2</sup>/s  
Surface Concentration: 1.45 % Concrete  
Background: 0.060 % Concrete

**Data**

Depth [mm]	Concentration [% Concrete]
1.14	1.19
2.67	1.21
4.19	1.09
5.72	1.02
7.24	0.87
8.76	0.74
10.29	0.65
12.57	0.53
13.34	0.50
14.86	0.42



Sample: FH-2-0.45-MK

Test: Bulk Diffusion

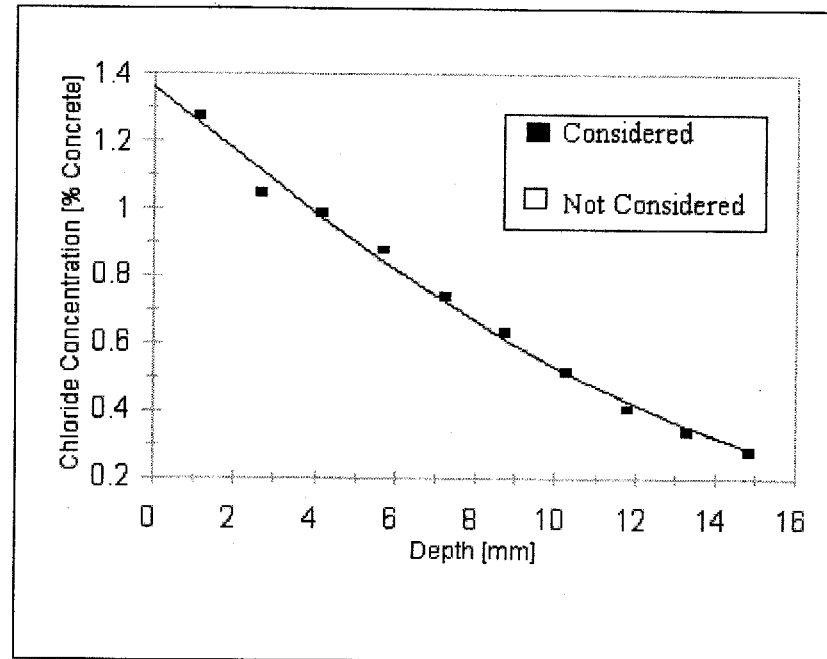
Duration: 365 Days

Diffusion Coefficient: 1.91E-12 m<sup>2</sup>/s  
Surface Concentration: 1.36 % Concrete  
Background: 0.060 % Concrete

r<sup>2</sup>: 0.9928

Data

Depth [mm]	Concentration [% Concrete]
1.14	1.27
2.67	1.05
4.19	0.99
5.72	0.88
7.24	0.74
8.76	0.63
10.29	0.52
11.81	0.41
13.34	0.34
14.86	0.28



Sample: FH-2-0.35-MK

Test: Bulk Diffusion

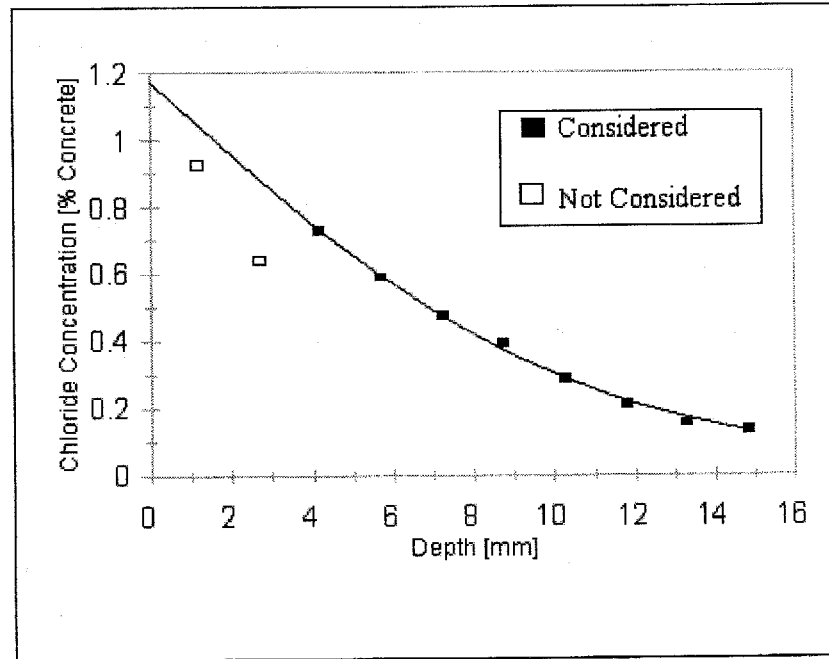
Duration: 365 Days

Diffusion Coefficient: 1.05E-12 m<sup>2</sup>/s  
Surface Concentration: 1.17 % Concrete  
Background: 0.055 % Concrete

r<sup>2</sup>: 0.9971

Data

Depth [mm]	Concentration [% Concrete]
1.14	0.93
2.67	0.64
4.19	0.73
5.72	0.59
7.24	0.47
8.76	0.39
10.29	0.29
11.81	0.21
13.34	0.15
14.86	0.13



Sample: FH-2-0.35-SF,SG

Test: Bulk Diffusion

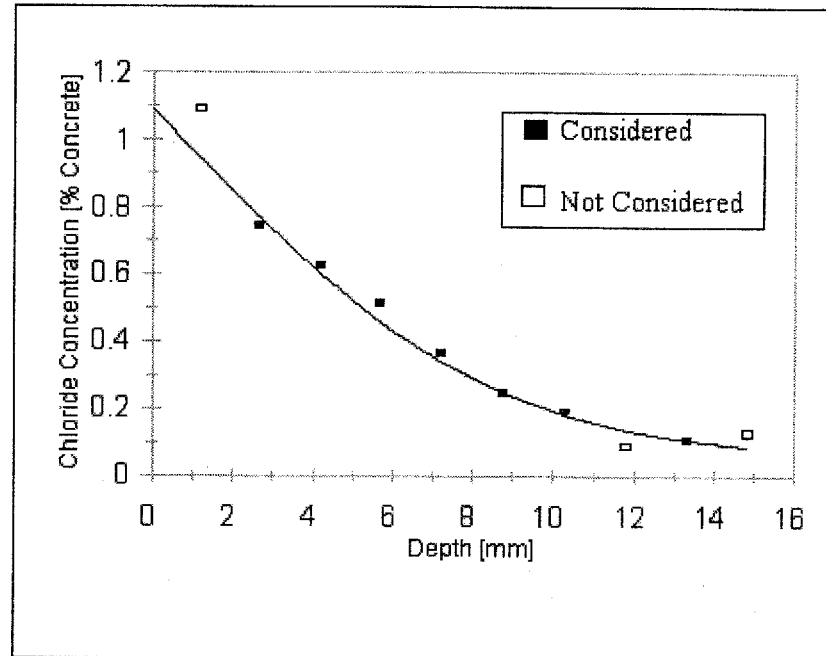
Duration: 365 Days

Diffusion Coefficient: 6.80E-13 m<sup>2</sup>/s  
Surface Concentration: 1.09 % Concrete  
Background: 0.060 % Concrete

r<sup>2</sup>: 0.9841

Data

Depth [mm]	Concentration [% Concrete]
1.14	1.09
2.67	0.74
4.19	0.62
5.72	0.51
7.24	0.36
8.76	0.25
10.29	0.19
11.81	0.09
13.34	0.10
14.86	0.13





Sample: FH-2-0.35-SF,FA

Test: Bulk Diffusion

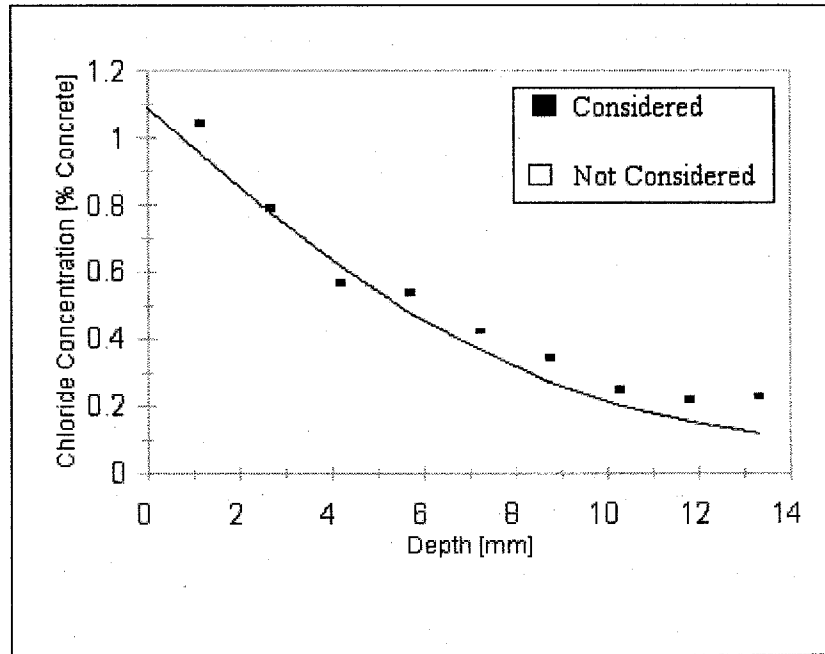
Duration: 365 Days

Diffusion Coefficient: 7.38E-13 m<sup>2</sup>/s  
Surface Concentration: 1.09 % Concrete  
Background: 0.068 % Concrete

r<sup>2</sup>: 0.9550

Data

Depth [mm]	Concentration [% Concrete]
1.14	1.04
2.67	0.79
4.19	0.56
5.72	0.54
7.24	0.42
8.76	0.34
10.29	0.24
11.81	0.22
13.34	0.22
0.00	0.00



Sample: FH-2-0.45-50SG

Test: Bulk Diffusion

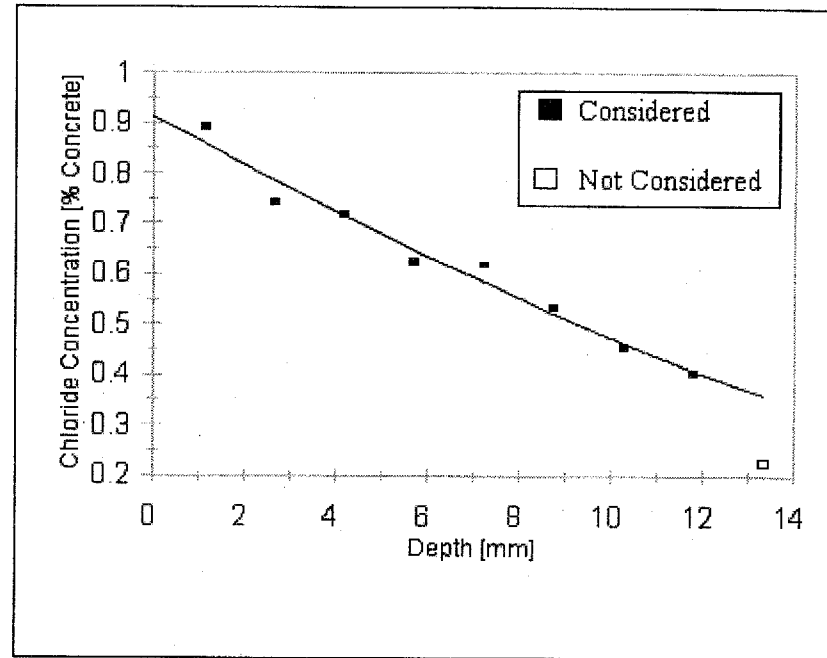
Duration: 365 Days

Diffusion Coefficient: 3.33E-12 m<sup>2</sup>/s  
Surface Concentration: 0.91 % Concrete  
Background: 0.053 % Concrete

r<sup>2</sup>: 0.9704

Data

Depth [mm]	Concentration [% Concrete]
1.14	0.89
2.67	0.74
4.19	0.72
5.72	0.62
7.24	0.62
8.76	0.53
10.29	0.45
11.81	0.40
13.34	0.23



Sample: FH-2-0.35-Latex

Test: Bulk Diffusion

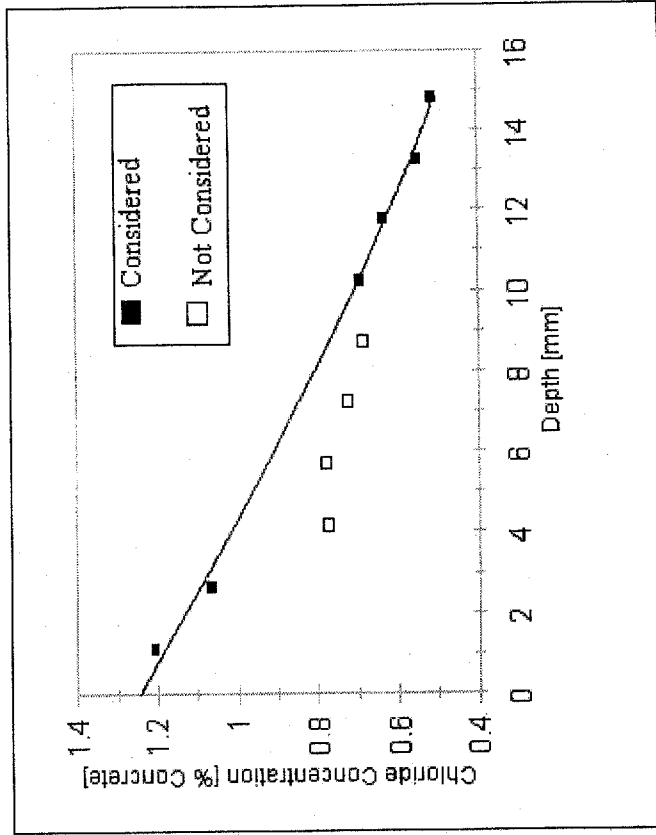
Duration: 365 Days

$r^2$ : 0.9955

Diffusion Coefficient: 4.36E-12 m<sup>2</sup>/s

Surface Concentration: 1.24 % Concrete

Background: 0.063 % Concrete



**Data**

Depth [mm]	Concentration [% Concrete]
1.14	1.20
2.67	1.06
4.19	0.77
5.72	0.78
7.24	0.73
8.76	0.69
10.29	0.69
11.81	0.63
13.34	0.55
14.86	0.51

**Sample:** FH-2-0.45-High C<sub>3</sub>A      **Test:** Bulk Diffusion      **Duration:** 365 Days

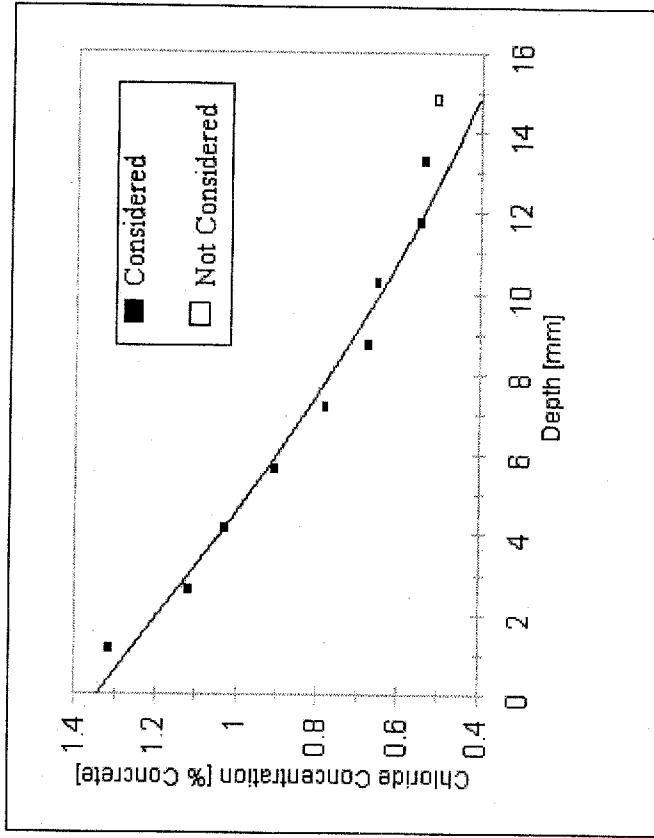
**Diffusion Coefficient:** 2.87E-12 m<sup>2</sup>/s      **r<sup>2</sup>:** 0.9794

**Surface Concentration:** 1.34 % Concrete

**Background:** 0.060 % Concrete

**Data**

Depth [mm]	Concentration [% Concrete]
1.14	1.31
2.67	1.12
4.19	1.03
5.72	0.90
7.24	0.78
8.76	0.67
10.29	0.65
11.81	0.55
13.34	0.54
14.86	0.51



Sample: FH-2-0.45-Low C<sub>3</sub>A

Test: Bulk Diffusion

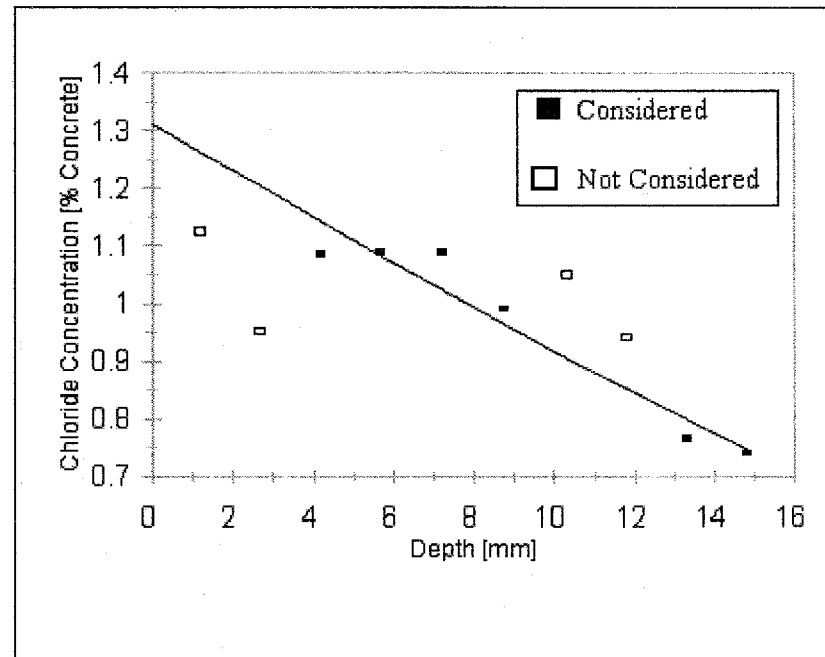
Duration: 365 Days

Diffusion Coefficient: 9.58E-12 m<sup>2</sup>/s  
Surface Concentration: 1.31 % Concrete  
Background: 0.068 % Concrete

r<sup>2</sup>: 0.9310

Data

Depth [mm]	Concentration [% Concrete]
1.14	1.13
2.67	0.95
4.19	1.08
5.72	1.09
7.24	1.09
8.76	0.99
10.29	1.05
11.81	0.94
13.34	0.77
14.86	0.74



**Sample:** FH-2-0.35-Steam

**Test:** Bulk Diffusion

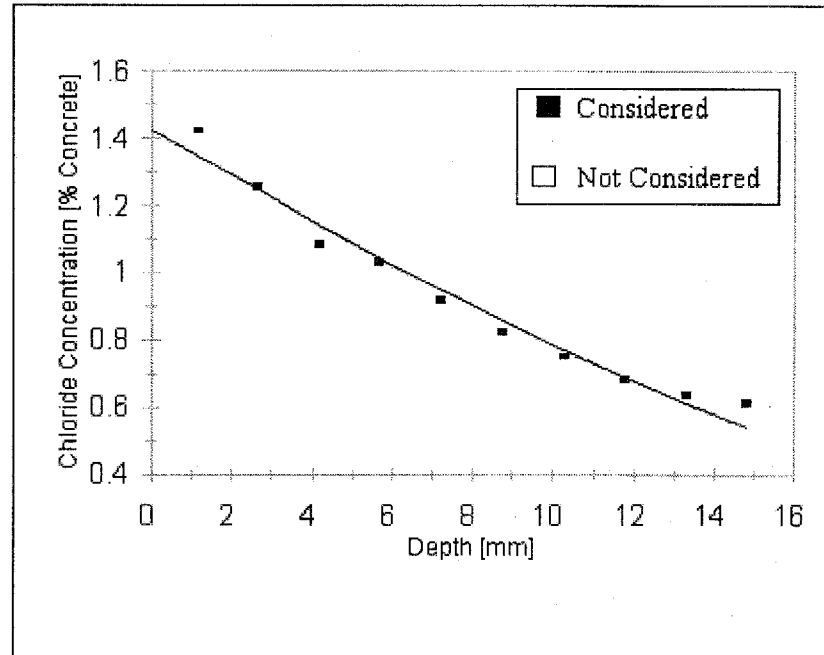
**Duration:** 365 Days

Diffusion Coefficient: 4.02E-12 m<sup>2</sup>/s  
Surface Concentration: 1.43 % Concrete  
Background: 0.063 % Concrete

r<sup>2</sup>: 0.9738

**Data**

Depth [mm]	Concentration [% Concrete]
1.14	1.42
2.67	1.25
4.19	1.08
5.72	1.03
7.24	0.92
8.76	0.82
10.29	0.75
11.81	0.68
13.34	0.64
14.86	0.61



Sample: FH-2-0.35-Plain

Test: Bulk Diffusion

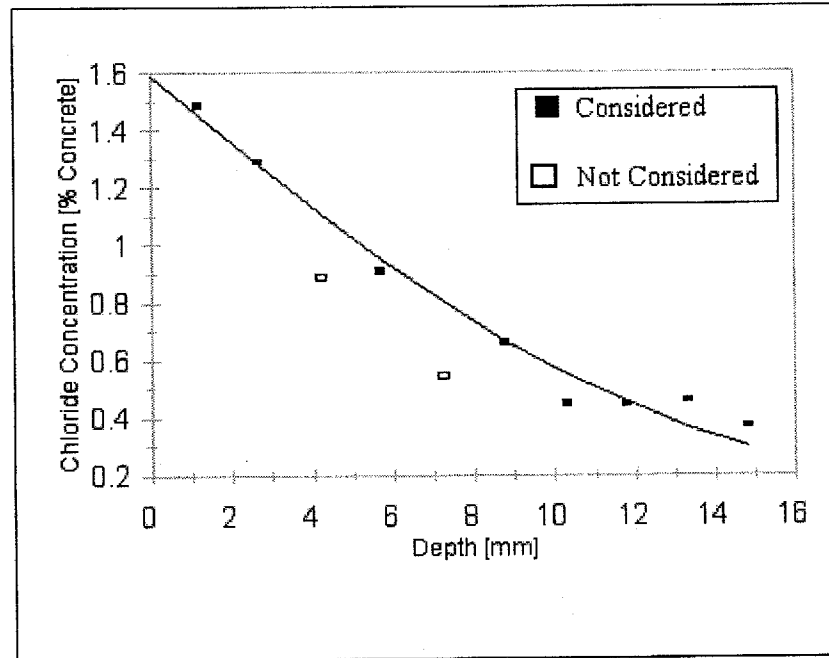
Duration: 365 Days

Diffusion Coefficient: 1.70E-12 m<sup>2</sup>/s  
Surface Concentration: 1.59 % Concrete  
Background: 0.063 % Concrete

r<sup>2</sup>: 0.9784

Data

Depth [mm]	Concentration [% Concrete]
1.14	1.49
2.67	1.29
4.19	0.89
5.72	0.91
7.24	0.55
8.76	0.66
10.29	0.45
11.81	0.44
13.34	0.46
14.86	0.37



Sample: FH-2-0.25-8SF

Test: Bulk Diffusion

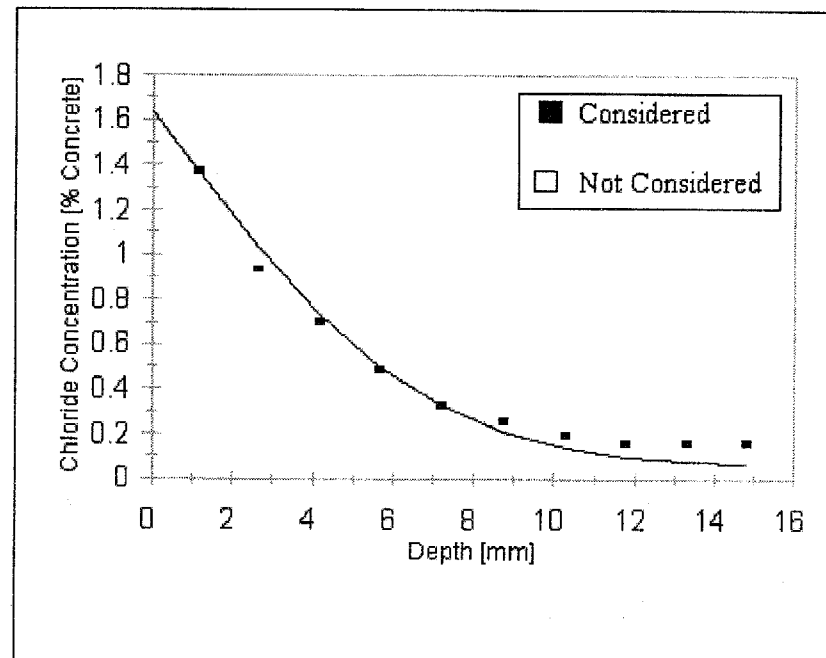
Duration: 365 Days

Diffusion Coefficient: 4.39E-13 m<sup>2</sup>/s  
Surface Concentration: 1.64 % Concrete  
Background: 0.060 % Concrete

r<sup>2</sup>: 0.9785

Data

Depth [mm]	Concentration [% Concrete]
1.14	1.37
2.67	0.93
4.19	0.70
5.72	0.48
7.24	0.33
8.76	0.25
10.29	0.19
11.81	0.16
13.34	0.16
14.86	0.16





Sample: FH-2-0.35-8SF

Test: Bulk Diffusion

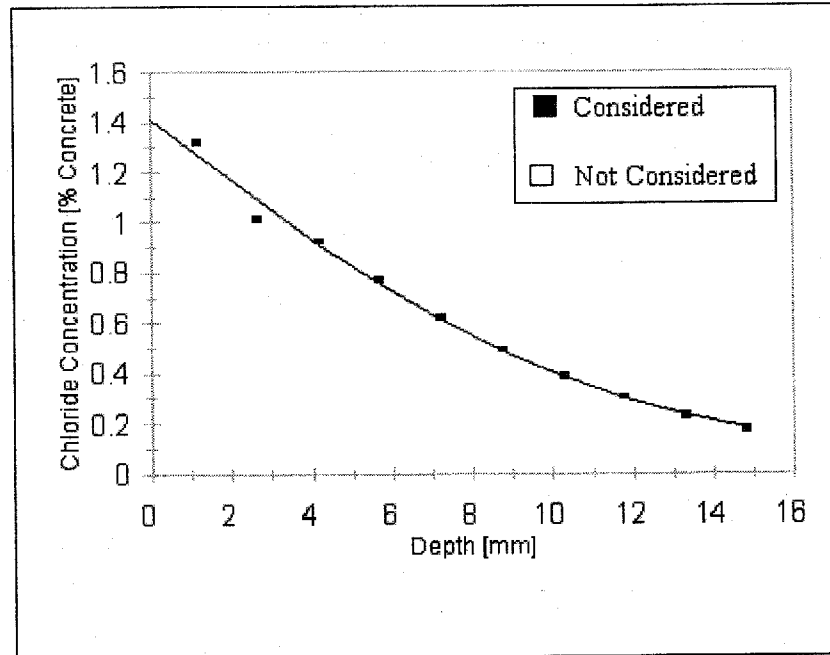
Duration: 365 Days

Diffusion Coefficient: 1.20E-12 m<sup>2</sup>/s  
Surface Concentration: 1.41 % Concrete  
Background: 0.063 % Concrete

r<sup>2</sup>: 0.9936

Data

Depth [mm]	Concentration [% Concrete]
1.14	1.32
2.67	1.01
4.19	0.92
5.72	0.77
7.24	0.62
8.76	0.49
10.29	0.39
11.81	0.30
13.34	0.23
14.86	0.17



Sample: FH-3-0.55, Plain

Test: Bulk Diffusion

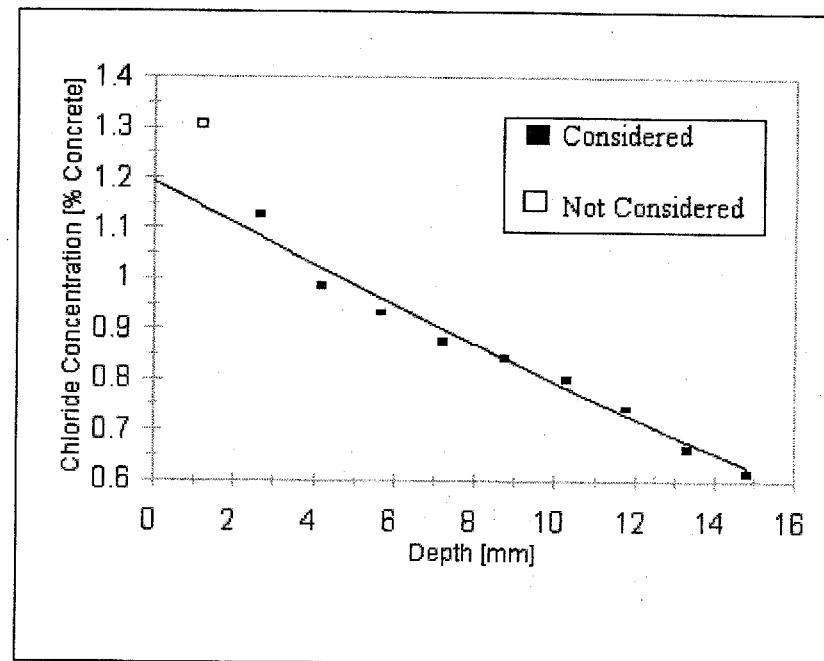
Duration: 90 Days

Diffusion Coefficient:  $3.00E-11$  m<sup>2</sup>/s  
Surface Concentration: 1.19 % Concrete  
Background: 0.078 % Concrete

$r^2$ : 0.9751

Data

Depth [mm]	Concentration [% Concrete]
1.14	1.31
2.67	1.13
4.19	0.99
5.72	0.93
7.24	0.87
8.76	0.84
10.29	0.80
11.81	0.74
13.34	0.66
14.86	0.61



Sample: FH-3-0.45-Plain

Test: Bulk Diffusion

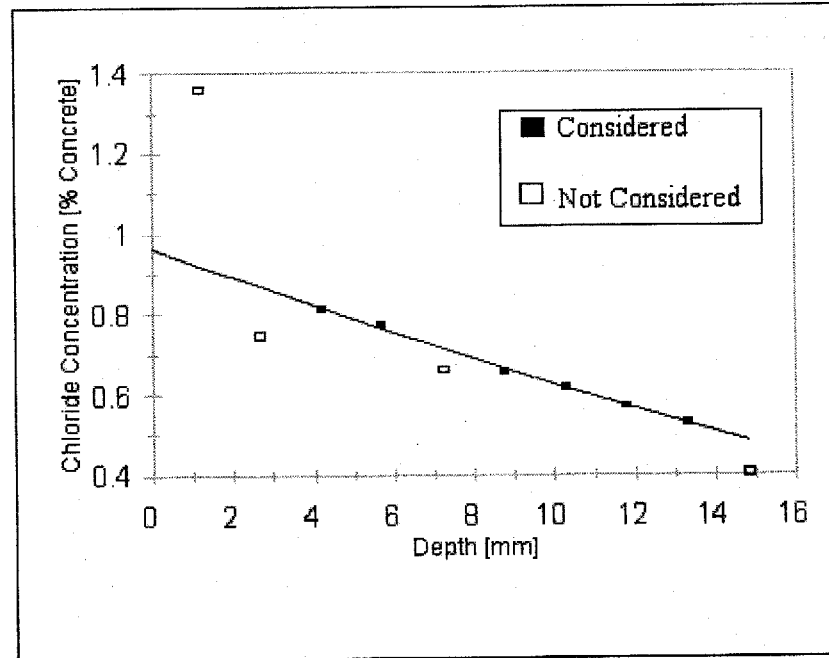
Duration: 90 Days

Diffusion Coefficient: 2.82E-11 m<sup>2</sup>/s  
Surface Concentration: 0.96 % Concrete  
Background: 0.043 % Concrete

r<sup>2</sup>: 0.9977

Data

Depth [mm]	Concentration [% Concrete]
1.14	1.36
2.67	0.75
4.19	0.81
5.72	0.77
7.24	0.66
8.76	0.66
10.29	0.62
11.81	0.57
13.34	0.53
14.86	0.41



Sample: FH-3-0.40-Plain

Test: Bulk Diffusion

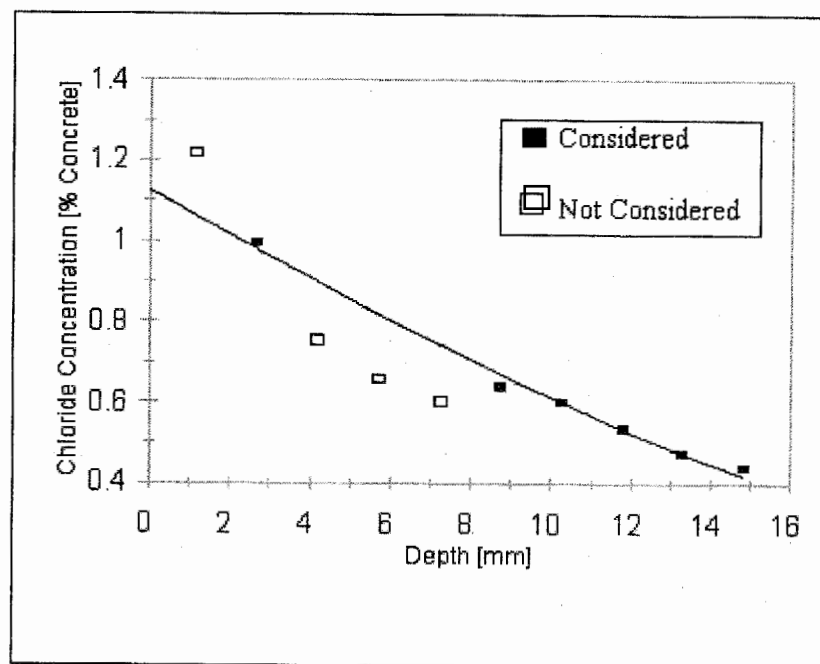
Duration: 90 Days

Diffusion Coefficient: 1.58E-11 m<sup>2</sup>/s  
Surface Concentration: 1.13 % Concrete  
Background: 0.045 % Concrete

r<sup>2</sup>: 0.9922

Data

Depth [mm]	Concentration [% Concrete]
1.14	1.22
2.67	0.99
4.19	0.76
5.72	0.66
7.24	0.60
8.76	0.64
10.29	0.60
11.81	0.53
13.34	0.47
14.86	0.44



Sample: FH-3-0.35, Plain

Test: Bulk Diffusion

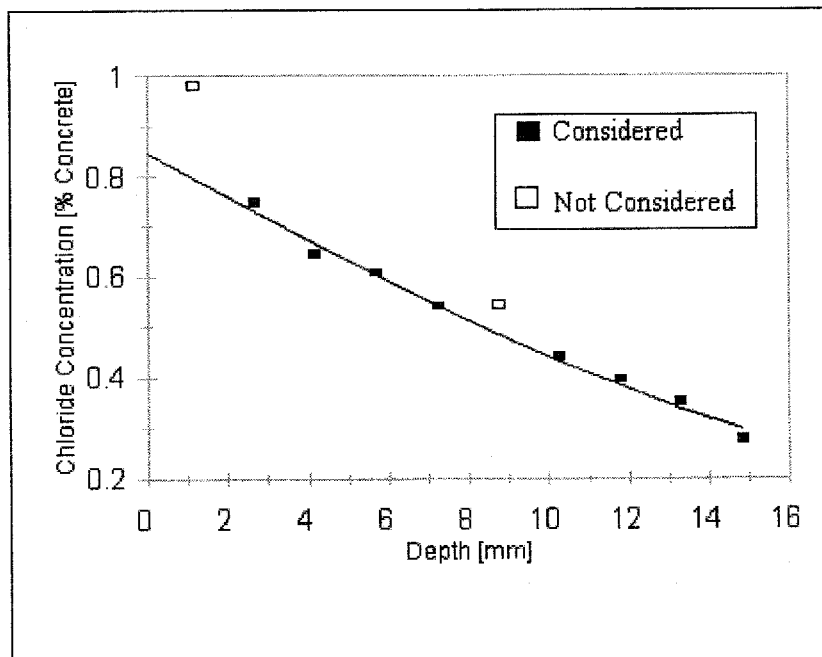
Duration: 90 Days

Diffusion Coefficient: 1.24E-11 m<sup>2</sup>/s  
Surface Concentration: 0.85 % Concrete  
Background: 0.078 % Concrete

r<sup>2</sup>: 0.9910

Data

Depth [mm]	Concentration [% Concrete]
1.14	0.98
2.67	0.75
4.19	0.65
5.72	0.61
7.24	0.54
8.76	0.54
10.29	0.44
11.81	0.40
13.34	0.35
14.86	0.27



Sample: FH-3-0.45-SF

Test: Bulk Diffusion

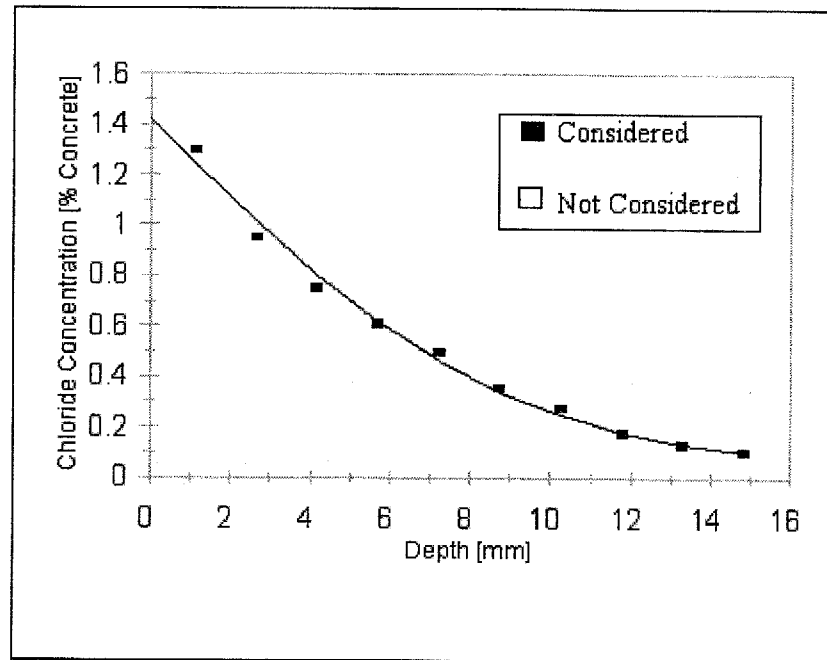
Duration: 90 Days

Diffusion Coefficient: 3.08E-12 m<sup>2</sup>/s  
Surface Concentration: 1.42 % Concrete  
Background: 0.060 % Concrete

r<sup>2</sup>: 0.9916

Data

Depth [mm]	Concentration [% Concrete]
1.14	1.30
2.67	0.95
4.19	0.75
5.72	0.61
7.24	0.49
8.76	0.35
10.29	0.27
11.81	0.17
13.34	0.13
14.86	0.10



Sample: FH-3-0.35-SF

Test: Bulk Diffusion

Duration: 90 Days

Diffusion Coefficient: 2.00E-12 m<sup>2</sup>/s

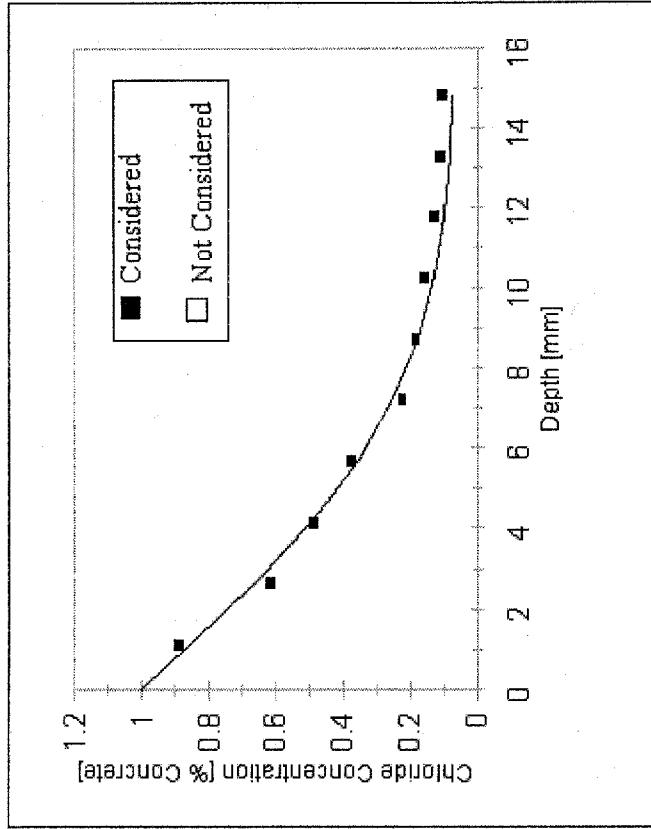
r<sup>2</sup>: 0.9889

Surface Concentration: 1.00 % Concrete

Background: 0.068 % Concrete

Data

Depth [mm]	Concentration [% Concrete]
1.14	0.89
2.67	0.61
4.19	0.48
5.72	0.37
7.24	0.22
8.76	0.18
10.29	0.15
11.81	0.12
13.34	0.11
14.86	0.10



Sample: FH-3-0.40-FA

Test: Bulk Diffusion

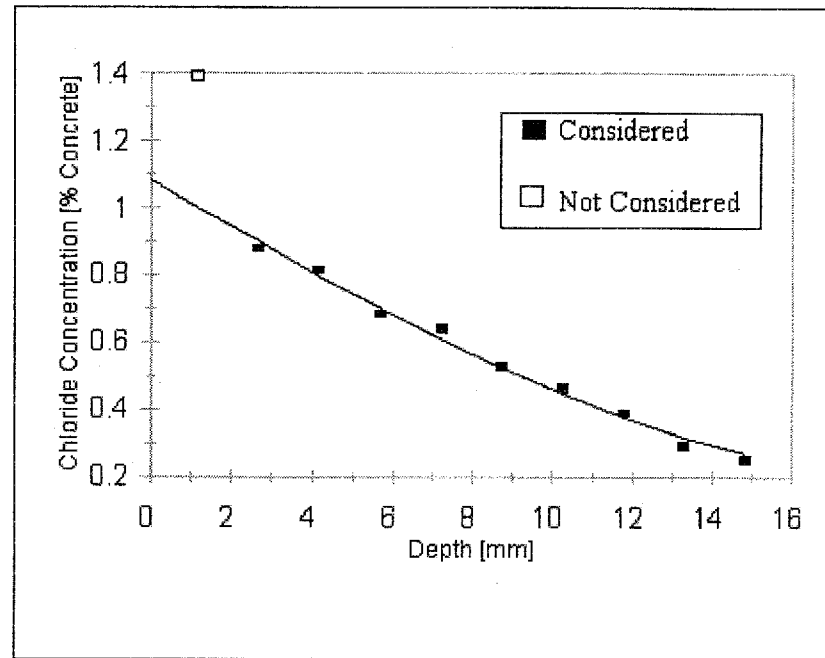
Duration: 90 Days

Diffusion Coefficient: 8.62E-12 m<sup>2</sup>/s  
Surface Concentration: 1.08 % Concrete  
Background: 0.065 % Concrete

r<sup>2</sup>: 0.9913

Data

Depth [mm]	Concentration [% Concrete]
1.14	1.39
2.67	0.88
4.19	0.81
5.72	0.68
7.24	0.64
8.76	0.53
10.29	0.46
11.81	0.39
13.34	0.29
14.86	0.25





Sample: FH-3-0.40-Slag

Test: Bulk Diffusion

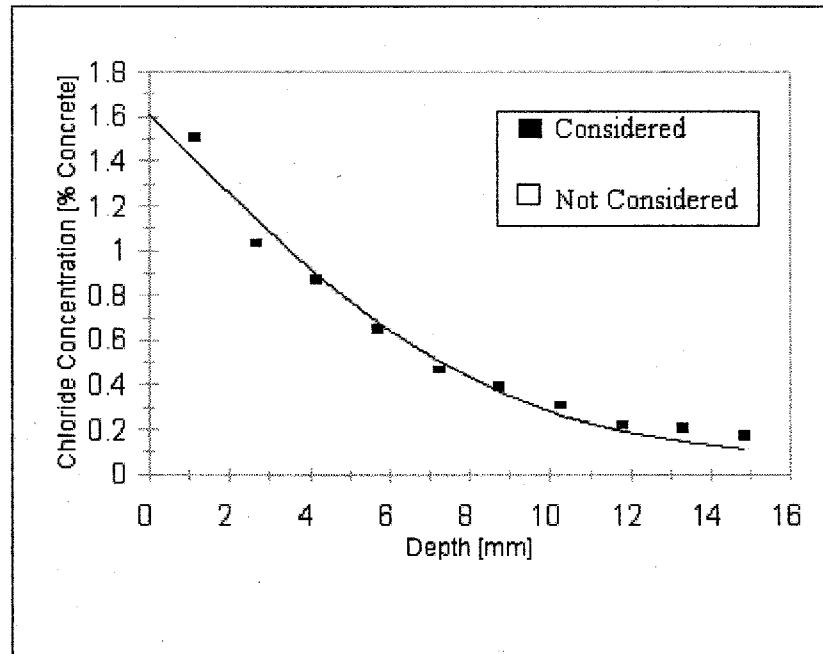
Duration: 90 Days

Diffusion Coefficient: 2.88E-12 m<sup>2</sup>/s  
Surface Concentration: 1.61 % Concrete  
Background: 0.075 % Concrete

r<sup>2</sup>: 0.9800

Data

Depth [mm]	Concentration [% Concrete]
1.14	1.50
2.67	1.03
4.19	0.87
5.72	0.65
7.24	0.47
8.76	0.39
10.29	0.31
11.81	0.22
13.34	0.21
14.86	0.17

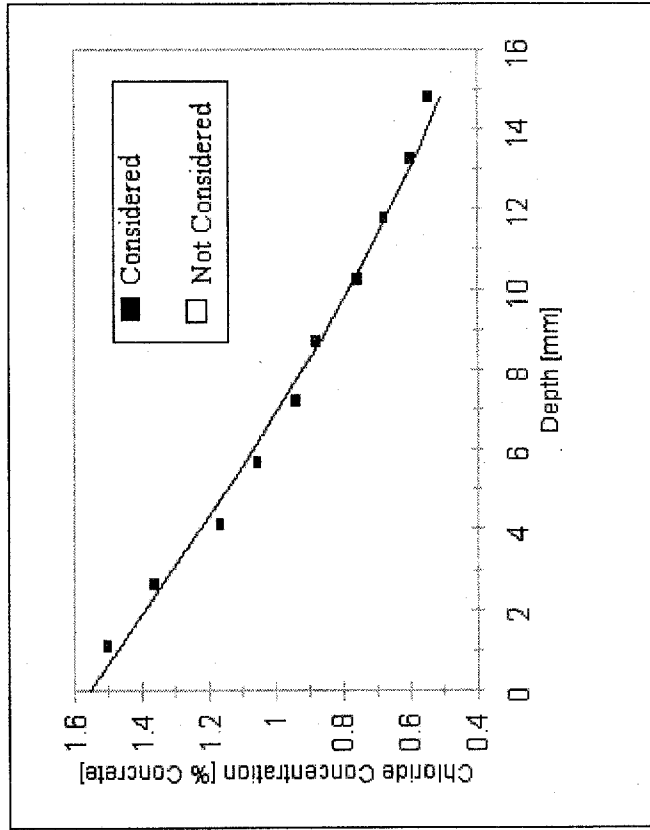


**Sample:** FH-3-0.45-DCI      **Test:** Bulk Diffusion      **Duration:** 90 Days

**Diffusion Coefficient:** 1.27E-11 m<sup>2</sup>/s      **r<sup>2</sup>:** 0.9906  
**Surface Concentration:** 1.56 % Concrete  
**Background:** 0.078 % Concrete

**Data**

Depth [mm]	Concentration [% Concrete]
1.14	1.50
2.67	1.36
4.19	1.16
5.72	1.05
7.24	0.94
8.76	0.88
10.29	0.75
11.81	0.68
13.34	0.59
14.86	0.54



Sample: FH-3-0.45-SF,FA

Test: Bulk Diffusion

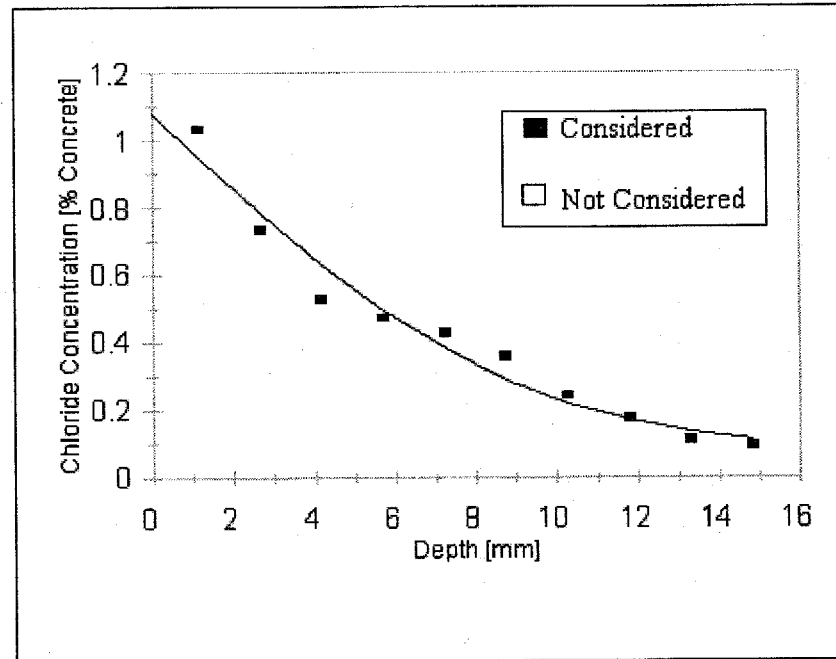
Duration: 90 Days

Diffusion Coefficient: 3.20E-12 m<sup>2</sup>/s  
Surface Concentration: 1.08 % Concrete  
Background: 0.073 % Concrete

r<sup>2</sup>: 0.9652

Data

Depth [mm]	Concentration [% Concrete]
1.14	1.03
2.67	0.73
4.19	0.53
5.72	0.47
7.24	0.43
8.76	0.35
10.29	0.24
11.81	0.17
13.34	0.11
14.86	0.09



Sample: FH-3-0.35-SF, FA

Test: Bulk Diffusion

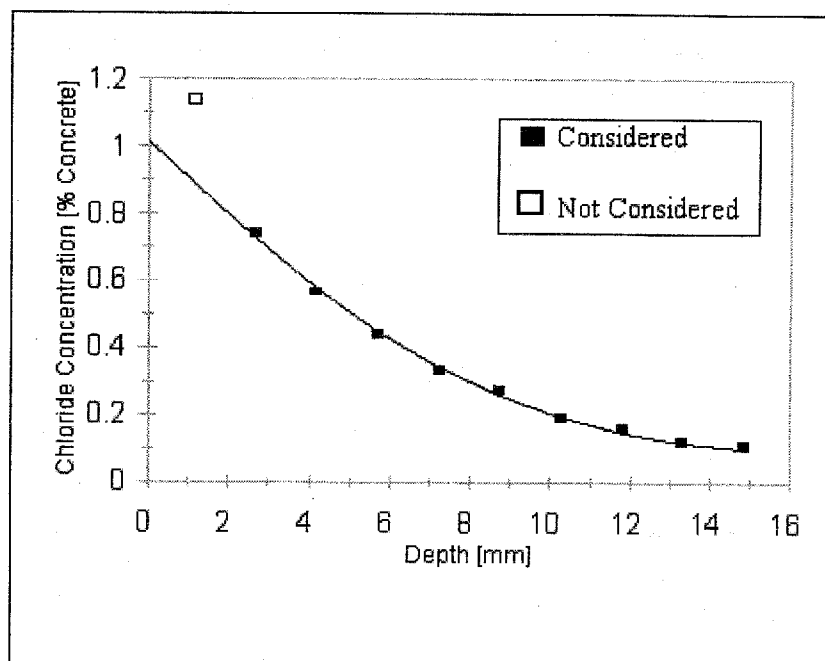
Duration: 90 Days

Diffusion Coefficient: 2.94E-12 m<sup>2</sup>/s  
Surface Concentration: 1.01 % Concrete  
Background: 0.073 % Concrete

r<sup>2</sup>: 0.9976

Data

Depth [mm]	Concentration [% Concrete]
1.14	1.14
2.67	0.74
4.19	0.56
5.72	0.44
7.24	0.33
8.76	0.27
10.29	0.19
11.81	0.16
13.34	0.12
14.86	0.11



Sample: FH-3-0.45-Steel

Test: Bulk Diffusion

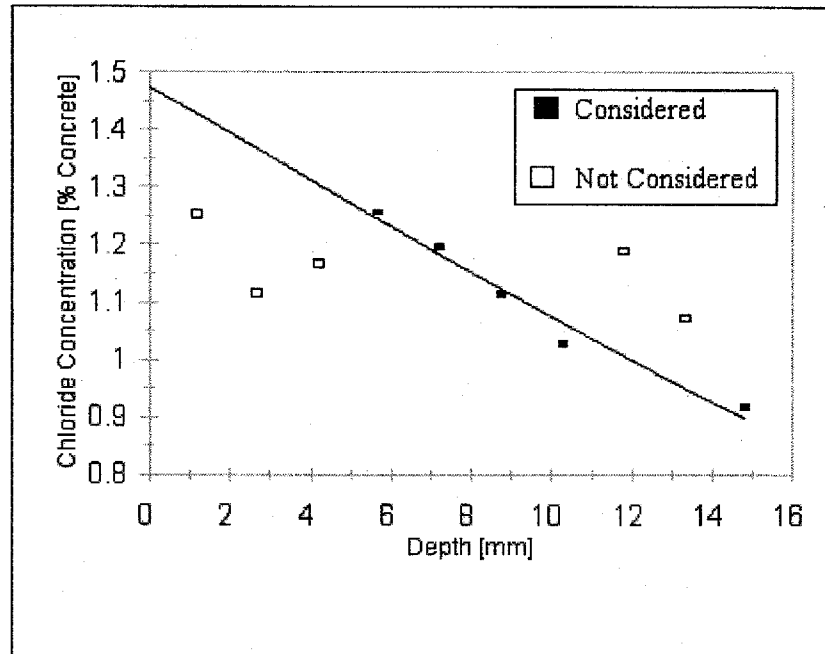
Duration: 90 Days

Diffusion Coefficient: 4.81E-11 m<sup>2</sup>/s  
Surface Concentration: 1.47 % Concrete  
Background: 0.070 % Concrete

r<sup>2</sup>: 0.9785

Data

Depth [mm]	Concentration [% Concrete]
1.14	1.25
2.67	1.12
4.19	1.17
5.72	1.25
7.24	1.20
8.76	1.11
10.29	1.03
11.81	1.19
13.34	1.07
14.86	0.92



Sample: FH-3-0.55, Plain

Test: Salt Ponding

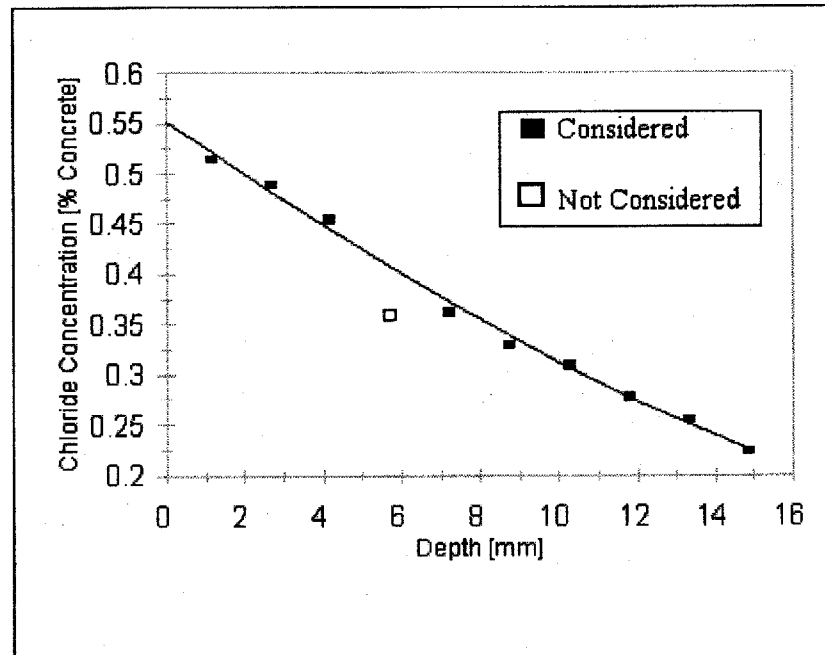
Duration: 90 Days

Diffusion Coefficient: 1.39E-11 m<sup>2</sup>/s  
Surface Concentration: 0.55 % Concrete  
Background: 0.078 % Concrete

r<sup>2</sup>: 0.9957

Data

Depth [mm]	Concentration [% Concrete]
1.14	0.51
2.67	0.49
4.19	0.45
5.72	0.36
7.24	0.36
8.76	0.33
10.29	0.31
11.81	0.28
13.34	0.25
14.86	0.22



Chloride concentration above background at 12.5 mm: 0.19 %

Sample: FH-3-0.45, Plain

Test: Salt Ponding

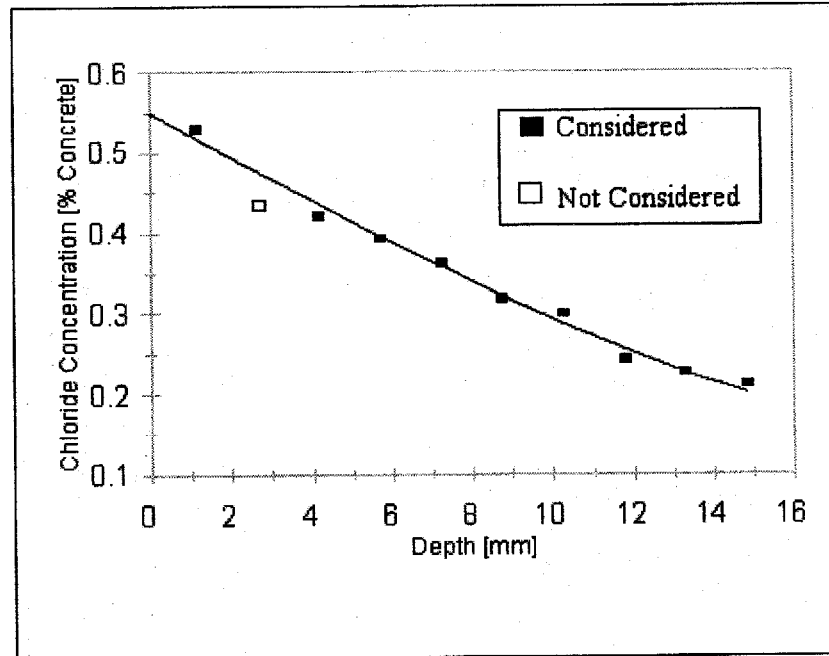
Duration: 90 Days

Diffusion Coefficient: 1.37E-11 m<sup>2</sup>/s  
Surface Concentration: 0.55 % Concrete  
Background: 0.043 % Concrete

r<sup>2</sup>: 0.9905

Data

Depth [mm]	Concentration [% Concrete]
1.14	0.53
2.67	0.43
4.19	0.42
5.72	0.39
7.24	0.36
8.76	0.32
10.29	0.30
11.81	0.24
13.34	0.23
14.86	0.21



Chloride concentration above background at 12.5 mm: 0.19 %

Sample: FH-3-0.40-Plain

Test: Salt Ponding

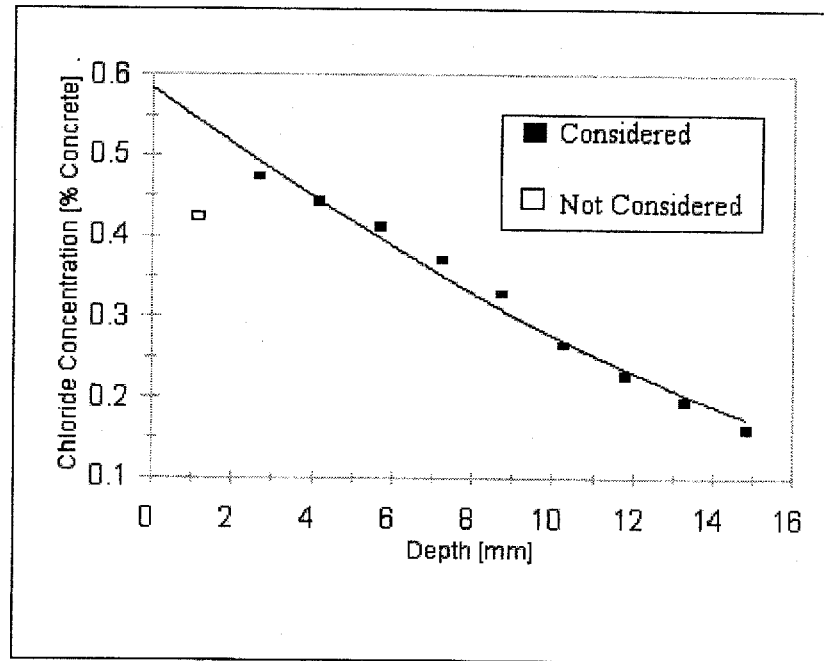
Duration: 90 Days

Diffusion Coefficient: 1.03E-11 m<sup>2</sup>/s  
Surface Concentration: 0.58 % Concrete  
Background: 0.045 % Concrete

r<sup>2</sup>: 0.9829

Data

Depth [mm]	Concentration [% Concrete]
1.14	0.42
2.67	0.47
4.19	0.44
5.72	0.41
7.24	0.37
8.76	0.33
10.29	0.26
11.81	0.23
13.34	0.19
14.86	0.16



Chloride concentration above background at 12.5 mm: 0.17 %



Sample: FH-3-0.35-Plain

Test: Salt Ponding

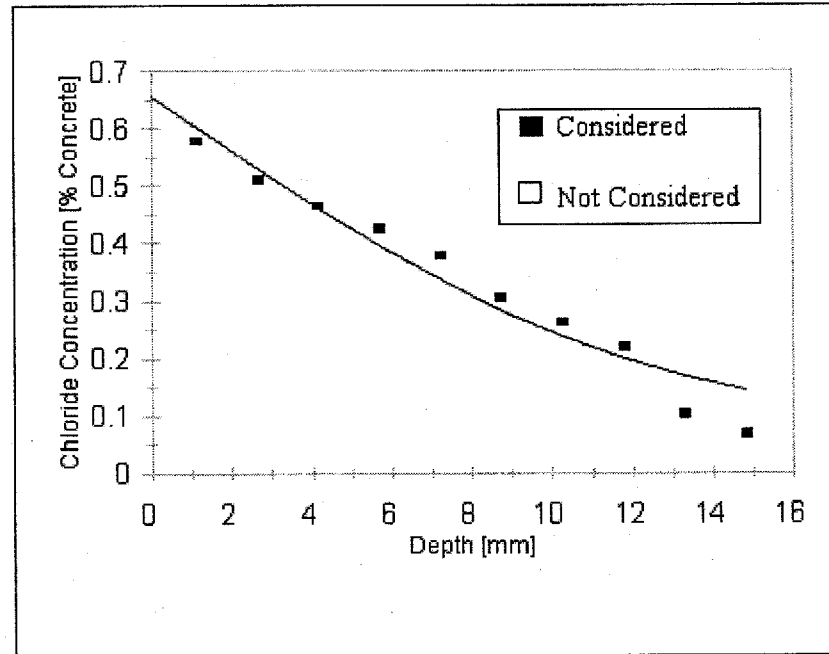
Duration: 90 Days

Diffusion Coefficient: 5.72E-12 m<sup>2</sup>/s  
Surface Concentration: 0.66 % Concrete  
Background: 0.078 % Concrete

r<sup>2</sup>: 0.9387

Data

Depth [mm]	Concentration [% Concrete]
1.14	0.58
2.67	0.51
4.19	0.46
5.72	0.42
7.24	0.38
8.76	0.30
10.29	0.26
11.81	0.22
13.34	0.10
14.86	0.06



Chloride concentration above background at 12.5 mm: 0.09 %

Sample: FH-3-0.35-8 % SF

Test: Salt Ponding

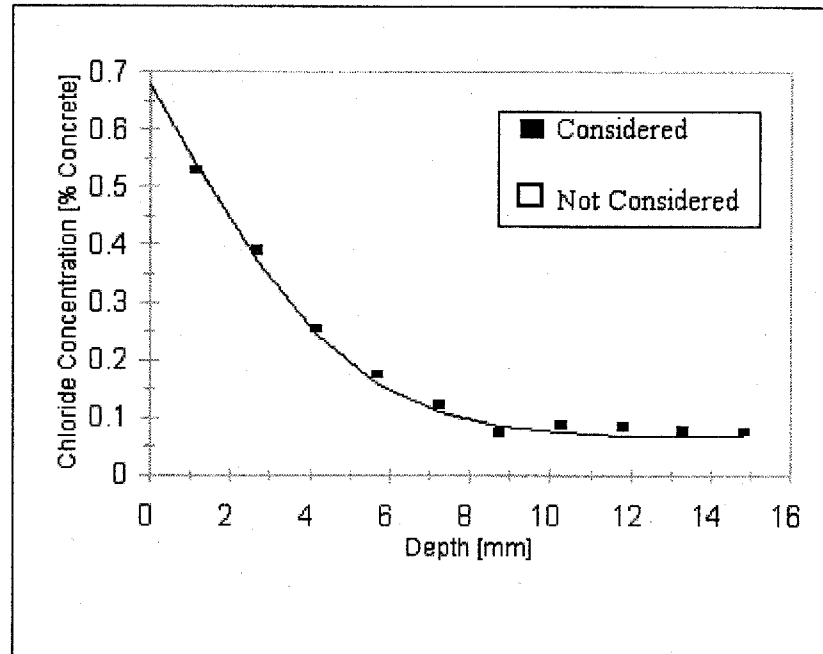
Duration: 90 Days

Diffusion Coefficient: 1.00E-12 m<sup>2</sup>/s  
Surface Concentration: 0.68 % Concrete  
Background: 0.068 % Concrete

r<sup>2</sup>: 0.9929

Data

Depth [mm]	Concentration [% Concrete]
1.14	0.53
2.67	0.39
4.19	0.25
5.72	0.17
7.24	0.12
8.76	0.07
10.29	0.09
11.81	0.08
13.34	0.08
14.86	0.07



Chloride concentration above background at 12.5 mm: 0.01 %

Sample: FH-3-0.40-Fly Ash

Test: Salt Ponding

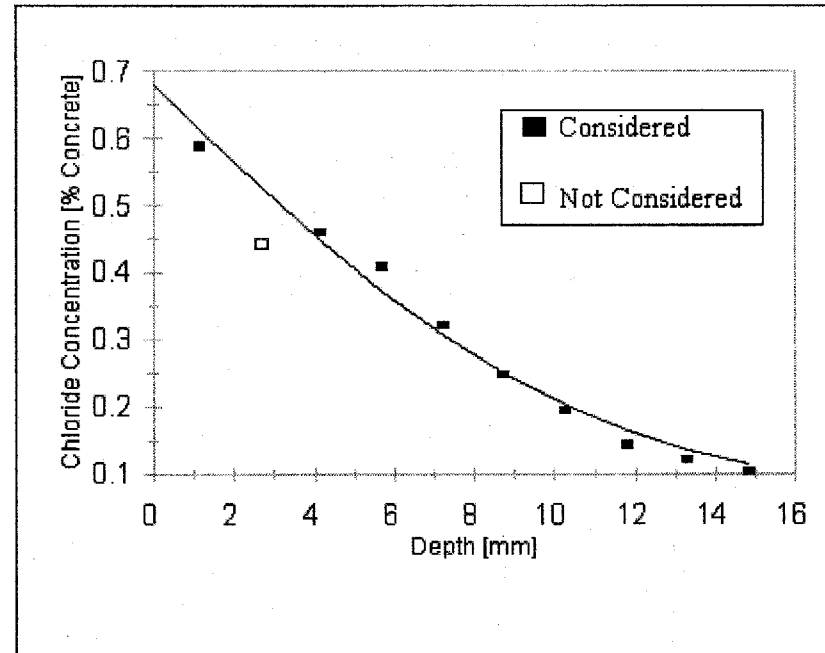
Duration: 90 Days

Diffusion Coefficient: 4.60E-12 m<sup>2</sup>/s  
Surface Concentration: 0.68 % Concrete  
Background: 0.065 % Concrete

r<sup>2</sup>: 0.9852

Data

Depth [mm]	Concentration [% Concrete]
1.14	0.59
2.67	0.44
4.19	0.46
5.72	0.41
7.24	0.32
8.76	0.25
10.29	0.19
11.81	0.14
13.34	0.12
14.86	0.10



Chloride concentration above background at 12.5 mm: 0.07 %

Sample: FH-3-0.40-Slag

Test: Salt Ponding

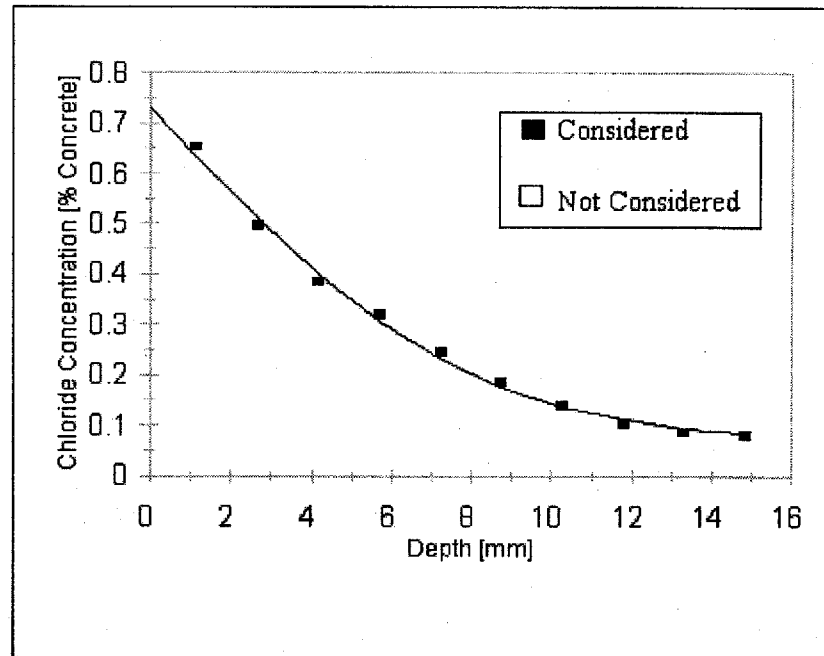
Duration: 90 Days

Diffusion Coefficient: 2.44E-12 m<sup>2</sup>/s  
Surface Concentration: 0.73 % Concrete  
Background: 0.075 % Concrete

r<sup>2</sup>: 0.9957

Data

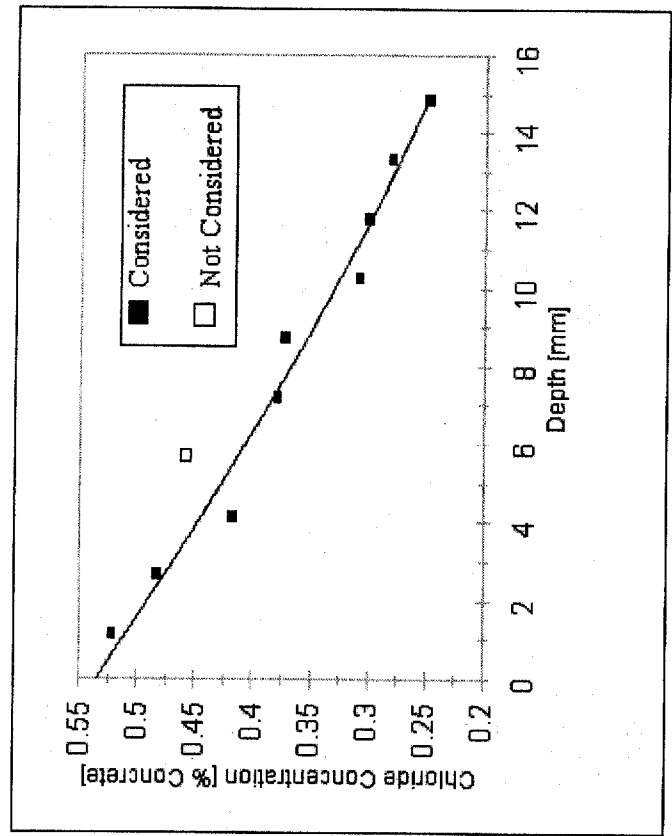
Depth [mm]	Concentration [% Concrete]
1.14	0.65
2.67	0.50
4.19	0.38
5.72	0.32
7.24	0.25
8.76	0.19
10.29	0.14
11.81	0.10
13.34	0.09
14.86	0.08



Chloride concentration above background at 12.5 mm: 0.02 %

Sample: FH-3-0.45-DCI      Test: Salt Ponding      Duration: 90 Days

Diffusion Coefficient: 1.82E-11 m<sup>2</sup>/s      r<sup>2</sup>: 0.9763  
 Surface Concentration: 0.53 % Concrete  
 Background: 0.078 % Concrete



**Data**

Depth [mm]	Concentration [% Concrete]
1.14	0.52
2.67	0.48
4.19	0.42
5.72	0.46
7.24	0.38
8.76	0.37
10.29	0.31
11.81	0.30
13.34	0.28
14.86	0.25

Chloride concentration above background at 12.5 mm: 0.21 %

Sample: FH-3-0.45-SF,FA

Test: Salt Ponding

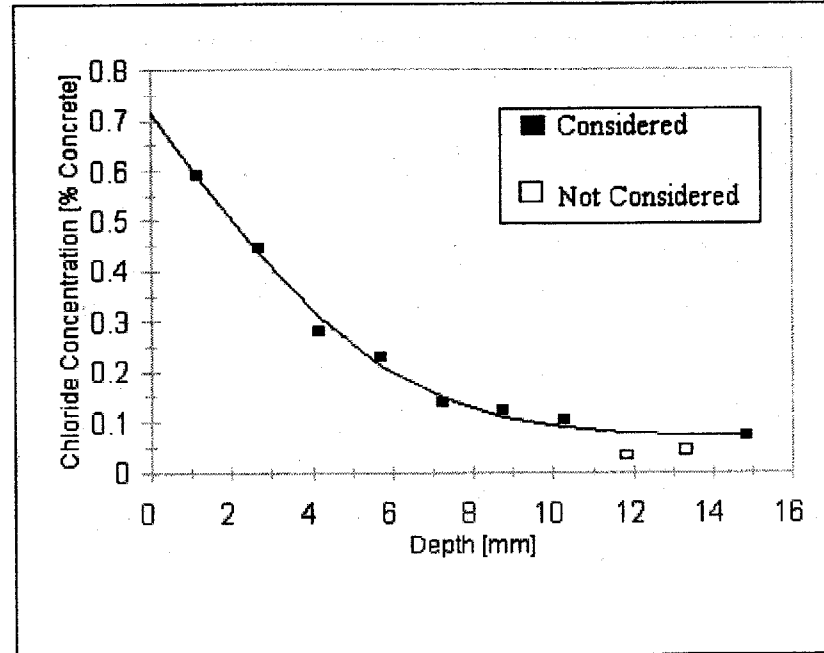
Duration: 90 Days

Diffusion Coefficient: 1.38E-12 m<sup>2</sup>/s  
Surface Concentration: 0.71 % Concrete  
Background: 0.073 % Concrete

r<sup>2</sup>: 0.9933

Data

Depth [mm]	Concentration [% Concrete]
1.14	0.59
2.67	0.44
4.19	0.28
5.72	0.23
7.24	0.14
8.76	0.12
10.29	0.10
11.81	0.04
13.34	0.04
14.86	0.07



Chloride concentration above background at 12.5 mm: 0 %

Sample: FH-3-0.35-SF,FA

Test: Salt Ponding

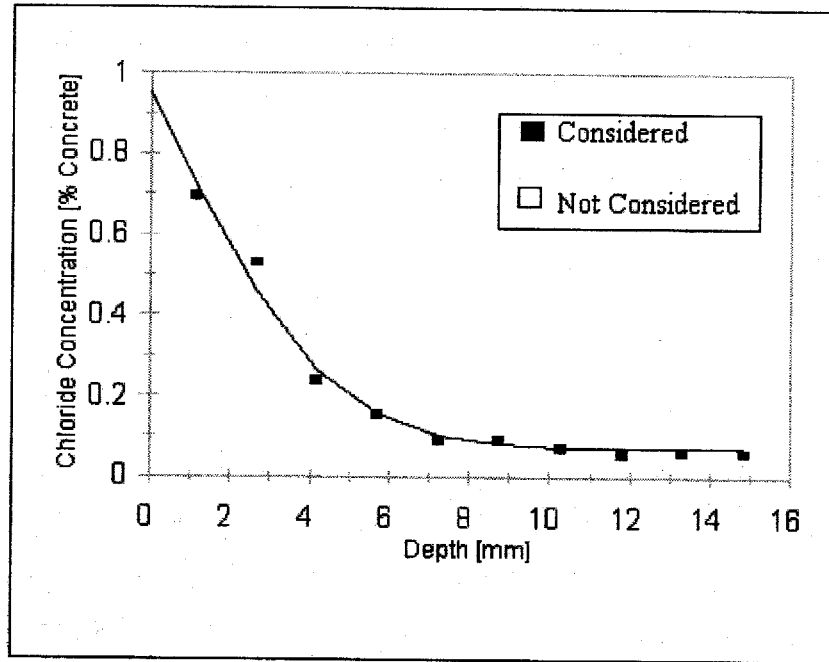
Duration: 90 Days

Diffusion Coefficient: 7.53E-13 m<sup>2</sup>/s  
Surface Concentration: 0.95 % Concrete  
Background: 0.073 % Concrete

r<sup>2</sup>: 0.9826

Data

Depth [mm]	Concentration [% Concrete]
1.14	0.69
2.67	0.53
4.19	0.24
5.72	0.15
7.24	0.09
8.76	0.09
10.29	0.07
11.81	0.06
13.34	0.06
14.86	0.06



419

Chloride concentration above background at 12.5 mm: 0 %





