



U.S. Department of Transportation
Federal Highway Administration

CONSTRUCTION OF PAVEMENT SUBSURFACE DRAINAGE SYSTEMS (INSTRUCTOR'S MANUAL)



OFFICE OF PAVEMENT TECHNOLOGY
FEDERAL HIGHWAY ADMINISTRATION
DEPARTMENT of TRANSPORTATION

January 3, 2002



Instructor's Manual

TABLE OF CONTENTS

INTRODUCTION.....	1
SESSION A	
Drainage.....	7
PCC Pavement Distress.....	10
Flexible Pavement Distress	16
Moisture Reduction Plan	18
Summary.....	19
SESSION B	
Permeable Bases.....	22
PCC Pavements.....	27
Flexible Pavements.....	29
Construction Traffic.....	31
Base Materials.....	37
SESSION C	
Unstabilized Bases.....	44
SESSION D	
Stabilized Bases.....	55
Asphalt Stabilized Bases.....	59
Cement Stabilized Bases.....	69
SESSION E	
Design Considerations.....	80
Aggregate Separator Layer.....	83
SESSION F	
Edgedrains.....	89
Geocomposites.....	101
SESSION G	
Outlet Pipe.....	107
Headwalls.....	114
Roadside Maintenance.....	121
SESSION H	
Video Inspection.....	125
Maintenance.....	135

**CONSTRUCTION of PAVEMENT
SUBSURFACE DRAINAGE
SYSTEMS WORKSHOP**



COURSE OBJECTIVES

- **Provide Design/Construction Guidance for Pavement Subsurface Drainage Systems**
- **Emphasis on Video Inspection of Edgedrains for Quality Assurance**
- **Emphasis on the Need for Maintenance**

Ever since engineers have started building roads, surface and subsurface drainage have been recognized as important factors. Unfortunately for us, the problem is compounded by the fact that pavement engineers must not only provide a pavement structural section that will drain, but the pavement section must also provide the necessary strength that will provide long-term pavement performance.

The primary objectives for this drainage workshop are listed below.

Providing Design/Construction guidance for pavement subsurface drainage is an important objective of this workshop. This workshop will provide guidance for the following three elements of the drainage system: Permeable Bases, Aggregate Separator Layer, and Edgedrains

Design /construction guidance will be provided for the following types of permeable bases: Unstabilized, Stabilized (Asphalt Stabilized and Cement Stabilized).

Design construction guidance for aggregate separator layer will be provided. The following three functions of the separator layer will be stressed: Stability, Filtration, and Permeability.

Design/construction guidance for longitudinal edgedrain systems will be provided. The following two types of edgedrains will be discussed: Conventional Pipe, and Geocomposites.

Emphasis will be placed on video inspection of newly completed edgedrains. Video inspection of the edgedrains should be a tool for the final acceptance of the edgedrain systems. This will insure an increase in the quality assurance.

The need for maintenance will be stress over and over again. Increase emphasis has been accomplished by providing two sessions on maintenance: Roadside Maintenance and Maintenance.

WORKSHOP OVERVIEW

SESSION A

- DRAINAGE
- PCC PAVEMENT DISTRESS
- FLEXIBLE PAVEMENT DISTRESS
- MOISTURE REDUCTION PLAN

Session A

Drainage module will act as an introduction to pavement subsurface drainage.

PCC pavement distress will discuss pavement distresses that are caused by moisture. The sequence of distresses that are Curling /warping, pumping, faulting and finally corner breaks will be discussed.

Flexible pavement distress will discuss distress that are caused by moisture in flexible pavements.

Moisture reduction plan will be provided This plan consists of the following two approaches. First, sealing all cracks and joints to keep out as much moisture as possible. Second, to provide drainable pavement systems to remove any moisture that may enter the pavement system.

Session B

Permeable Bases are the first element of a pavement subsurface drainage system. The stability/permeability relationship of permeable gradations is introduced. A comprehensive list of choices for the various drainage elements is provided.

PCC Pavements presents the concept of Pre- and Post Pave installation of edgedrains for PCC pavements.

In the Pre-Pave Installation of edgedrains, the edgedrains are constructed before the permeable base is placed, while in the Post-Pave Installation of edgedrains, the edgedrains are constructed after the permeable base is placed; the same as a retrofit edgedrain. The horizontal and vertical location of the edgedrain for different design condition are provided.

Flexible Pavements presents the concept of Pre- and Post Pave installation of edgedrains for flexible (AC) pavements.

In the Pre-Pave Installation of edgedrains, the edgedrains are constructed before the permeable base is placed, while in the Post-Pave Installation of edgedrains, the edgedrains are constructed after the permeable base is placed; the same as a retrofit edgedrain. The horizontal and vertical location of the edgedrain for different design condition are provided.

Construction traffic is an important consideration in the design of a pavement system that is often overlooked. Design must coordinate with construction engineers to determine if the construction sequence will interfere with the design. This is

WORKSHOP OVERVIEW (CONT.)

SESSION B

- PERMEABLE BASES
- PCC PAVEMENTS
- FLEXIBLE PAVEMENTS
- CONSTRUCTION TRAFFIC
- BASE MATERIALS

particularly true for PCC pavements. Dowel bars are an important element of PCC pavements. Method of placing dowel bars must dovetail with the construction sequence. If construction traffic is going to run on the permeable base, a dowel bar implanter must be used.

Base materials are a common element of all types of permeable base. Good aggregate materials are necessary to develop pavement sections that are durable. Strong crushed aggregates are necessary to develop aggregate interlock between the individual pieces of aggregate.

Use of the FHWA Power 0.45 gradation plot will be introduced. This plot provides pavement engineers with an insight to the stability/permeability relationship of the gradation. Terms such as effective diameter, and coefficient will be introduced. Measures of the durability of the aggregate such as L.A. Abrasion Wear and Soundness will be presented.

AASHTO No. 57 gradation is introduced as a benchmark gradation. Most likely this is the most permeable gradation that would be used. Other gradations are compared against it.

**WORKSHOP OVERVIEW
(CONT.)**

SESSION C

- UNSTABILIZED BASES

SESSION D

- STABILIZED BASES
- ASPHALT STABILIZED BASES
- CEMENT STABILIZED BASES

Session C

Unstabilized bases module provides design/construction guidance for placing the bases. Unstabilized bases require good aggregate interlock to produce their strength.

Good quality aggregates are a must for producing strong permeable bases. Sound construction procedures should be used. Emphasis is placed on placing and compacting the permeable base.

Guideline specifications for unstabilized permeable bases are provided in the Appendix.

Session D

Stabilized Bases module introduces stabilization with asphalt or cement as a means of increasing the strength of the base. Stabilization has two purposes. First to increase the strength of the base so that it will achieve the long-term performance that is expected. Second, is to provide enough strength to allow the pavement to be placed on top of it during the construction phase.

Stabilized bases are more open-graded and require the cement action of the stabilizer material to provide the necessary

strength. Contractors should have the option of providing either material as a stabilizer.

AASHTO No. 67 gradation is provided as a possible gradation for stabilized permeable bases.

Asphalt & cement stabilized bases module provides design/construction guidance for placing the bases. Good quality aggregates are a must for producing strong permeable bases. Sound construction procedures should be used. Emphasis is placed on placing and compacting the permeable base.

Guideline specifications for asphalt and cement stabilized permeable bases are provided in the Appendix.

**WORKSHOP OVERVIEW
(CONT.)**

SESSION E

- DESIGN CONSIDERATIONS
- AGGREGATE SEPARATOR LAYER

SESSION F

- EDGEDRAINS

Session E

Design Considerations that apply to all types of permeable bases will be presented. Emphasis will be placed on control strips and construction considerations.

Aggregate separator layer is the second element of a pavement subsurface drainage system. This element is the most overlooked one in drainage design. Design/construction guidance for the aggregate separator layer will be presented. Emphasis will be placed on providing good quality aggregate materials. Good quality aggregates are a must for producing an aggregate separator layer with adequate stability to serve as a construction platform.

Sound construction procedures should be used.

Guideline specifications for aggregate separator layer are provided in the Appendix.

Session F

Edgedrains are the final element in a pavement drainage system. If the water can not exit the edgedrain system, the pavement section will become saturate and loose strength. From a pavement performance viewpoint, a saturated pavement section is worst than a no-drainage system.

Design/construction guidance for constructing longitudinal edgedrain systems will be provided. Both conventional pipe and geocomposite edgedrains will be discussed. Emphasis will be placed on providing conventional pipes and geocomposites that can withstand construction loads and heavy wheel loads.

Design & construction engineers must consider maintenance needs in designing and building the edgedrain system.

It is imperative that the edgedrain system be intact and functioning at the end of the construction phase.

**WORKSHOP OVERVIEW
(CONT.)**

SESSION G

- **OUTLET PIPE**
- **HEADWALLS**
- **ROADSIDE MAINTENANCE**

SESSION H

- **VIDEO INSPECTION**
- **MAINTENANCE**

Session G

Outlet pipes should be strong enough to resist heavy wheel loads. Surface and subsurface drainage should be coordinated; adequate fall should be provided between the end of the outlet pipe and the roadside ditch.

Dual Outlets should be provided for each section of edgedrains so that there are two entrances for the video inspection and maintenance equipment.

Headwalls provide the three following functions: outlet pipe protection, erosion control, and outlet location. Outlet location is the most important. If the outlets cannot be found, there can be no video inspection or maintenance of the edgedrain systems.

Roadside maintenance will be stressed; the critical importance of providing roadside maintenance. Maintenance of outlet pipes and roadside has been historically poor. If we do not maintain these items, what are the conditions inside the edgedrain pipes. There must be a commitment to maintenance for these drainage features to work.

This will be an introduction for the need for video inspection of edgedrains.

Session H

Video inspection is the best tool for increasing quality assurance of newly completed edgedrains. Video inspection equipment and the inspection process will be discussed. Examples of crushed and clogged edgedrains will be shown. Results of FHWA's video inspection demonstration project indicated that only one-third of the edgedrains inspected were functional.

Emphasis will be placed on SHA's having a regular routine for inspecting edgedrain systems to determine if maintenance or

repairs are necessary.

Guideline specification for accepting newly constructed edgedrains based on video inspection is provided in the Appendix.

Maintenance is critical to the continued perform of both the edgedrain and the pavement structure. Inadequate maintenance will increase the rate of pavement deterioration. If a SHA is unwilling to make a maintenance commitment, then drainable pavement systems should not be provided.

BACKGROUND

- FHWA field survey of ten states
 - Determined Design Criteria and Construction Problems for Permeable Bases
- Experimental Project No. 12 “Concrete Pavement Drainage Rehabilitation”
 - Investigate the Effects of Retrofit Edgedrains on PCC Pavements

Field study of ten states conducted a study of 10 States (California, Iowa, Kentucky, Michigan, Minnesota, New Jersey, North Carolina, Pennsylvania, West Virginia, and Wisconsin) to determine design criteria and construction problems for constructing permeable bases.

This study showed that permeable bases could be constructed with the necessary stability and permeability.

Experimental Project No. 12, “Concrete Pavement Drainage Rehabilitation” investigated edgedrain systems and instrumented field sites to determine the effect of the edgedrain on the drainage of the pavement structure. One of the major finding of this project was that older dense graded aggregate bases under PCC pavements do not drain adequately.

BACKGROUND

- Demonstration Project No. 87 (Demo 87) “Drainable Pavement Systems”
 - Provided Drainage Guidance for PCC Pavements
- National Highway Institute (NHI) Course No. 130126 “Pavement Subsurface Drainage Design”
 - Extended Drainage Horizons

Demonstration Project No. 87 (Demo 87), “Drainable Pavement Systems provided drainage guidance for drainage systems for PCC pavements. Design procedures for calculating the various drainage items were provided.

NHI Course No. 130126 “Pavement Subsurface Drainage Design” extended the horizons for drainage. Drainage design for PCC pavements that was developed in Demo 87 was expanded to cover flexible pavements and retrofit edgedrains. A comprehensive pavement drainage course was developed. Cost effectiveness of drainage, need for drainage, drainage of flexible pavements and geocomposites are new subject areas covered by the training course, The role of drainage in the structural design of PCC and flexible pavements is also covered.

This course is available to SHA’s for a modest fee.

**CONSTRUCTION of PAVEMENT
SUBSURFACE DRAINAGE
SYSTEMS WORKSHOP**

SESSION A

**Drainage
PCC Pavement Distress
Flexible Pavement Distress
Moisture Reduction Plan**

The primary objective of this session is to provide participants with a working knowledge of the mechanism of drainage for the pavement section.

Drainage module will act as an introduction to pavement subsurface drainage. The role of water in pavement deterioration will be discussed along with the sources of water that may enter the pavement structure.

PCC pavement distress will discuss pavement distresses that are caused by moisture. Factors for pumping, free water, heavy wheel loads, erodible bases, and voids will be presented. The sequence of distresses that are curling /warping, pumping, faulting and finally corner breaks will be discussed.

Other elements of PCC pavements such as tied concrete shoulder, and dowels will be discussed

Flexible pavement distress will discuss distresses that are caused by moisture in flexible pavements. Flexible pavement distresses include: stripping, rutting, alligator or fatigue cracking, potholes and crack deterioration.

Moisture reduction plan will be provided This plan consists of the following two approaches. First, sealing all cracks and joints to keep out as much moisture as possible. Second, to provide drainable pavement systems to remove any moisture that may enter the pavement system.

SESSION OBJECTIVES

- Discuss Drainage of Pavements
- Explain PCC & Flexible Pavement Distress
- Discuss Moisture Reduction Plan

Upon completion of this session, participants will have a working knowledge of the mechanism of drainage for the pavement section.

Participants will be conversant with distresses caused by moisture for both PCC & Flexible pavements.

Participants will understand the plan for reducing moisture in the pavement section.

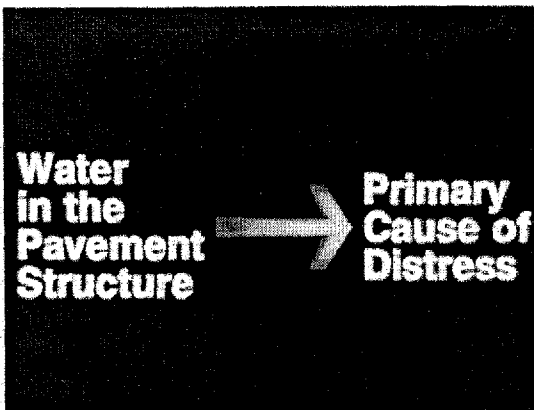

Pavement engineers recognize that water in the pavement section either causes, or aggravates, a large number of distresses in both Portland Cement Concrete pavements (PCC) or asphalt concrete pavements (flexible).

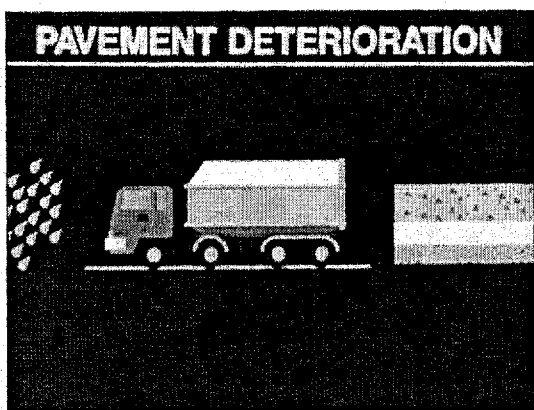

Here are the major players in the drainage of a pavement section. First on the far left, we have the rainfall that is so necessary to grow our crops and provide our cities with a water supply. In this state, we would expect about ?? inches of annual rainfall. In the center, we have our heavy wheel loads from our trucks.

As pavement engineers, we have no control over the first two factors; we only have control over the pavement section as shown on the far right. It is up to us to provide a pavement section that will drain and provide good performance over time.

Note that the pavement section is color coded with yellow representing the permeable base, while orange represents the aggregate separator layer.

SOURCES of WATER

- Surface Infiltration
- Rising Groundwater
- Seepage
- Capillary Action
- Vapor Movement

Surface Infiltration: Water entering through joints and cracks is the single largest source of water-caused pavement performance problems. Permeable bases are designed to remove this water from the pavement section.

Rising Groundwater: Seasonal fluctuations of the water table can be a significant source of water that gets into the pavement section.

Seepage: In cut sections, road sections with shallow ditches, sections of roads that have flat longitudinal grades, seepage of water from higher ground may be a significant problem.

Capillary Action: Capillary action is the sucking up of water through the interconnecting pores of water from a lower water table. This method of water transport is responsible for frost-heave damage. It is also a major source of moisture for moisture problems in flexible pavements.

Vapor Movement: Temperature gradients can cause the water vapor, present in the air voids of the subgrade and pavement

structure, to migrate and condense. Water vapor does not cause a significant volume of free water in the pavement structure.

INFILTRATION RATIO

Asphalt Concrete	0.33 – 0.50
Portland Cement	0.50 – 0.67

To put the problem into perspective, we must get an idea about how much water can enter a pavement section.

In a rational approach for determining inflows to the pavement section, the infiltration ratio for a pavement is multiplied by the rate of rainfall (inches per hour) to determine the design flow enter the pavement. The infiltration ratio is the ratio, or percent, of the rainfall that enters the pavement section though the pavement surface.

Design values for the infiltration ratio is given below:

Asphalt Concrete	0.33 – 0.50
Portland Cement Concrete	0.50 – 0.67

When a design rainstorm say a 2-year, 1-hr. storm, is applied to the pavement surface, hefty theoretical subsurface flows will occur. This is why many SHA's assume that the permeable base becomes saturated and excess rainfall becomes surface runoff. After the rainfall stops, the permeable base will drain. This is the "Time to Drain" approach

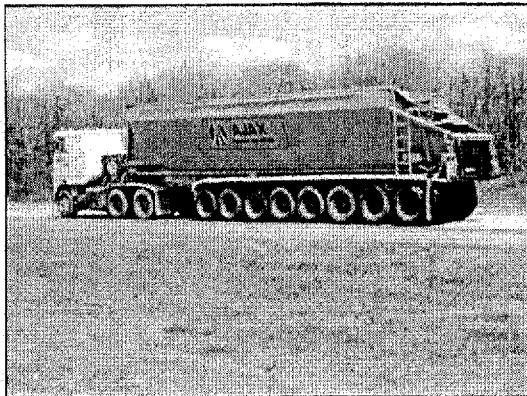

Here we see a large truck delivering a load of aggregate for the base course. The point this slide makes is that the size and weight of trucks will continue to increase.

The number of axles will better distribute the load to the pavement.



We also know that a saturated pavement section will lead to a total pavement failure producing a rough ride for the traveling public.

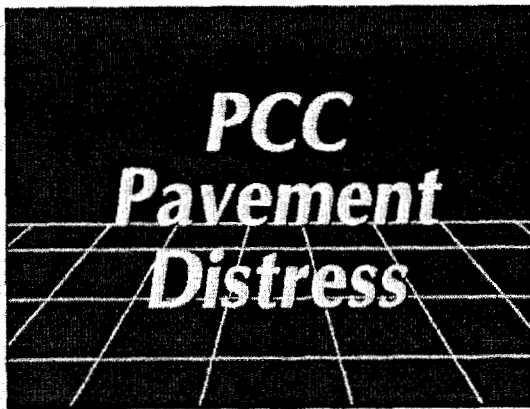

Now, let us talk about moisture related distress in Portland Cement Concrete (PCC) pavement

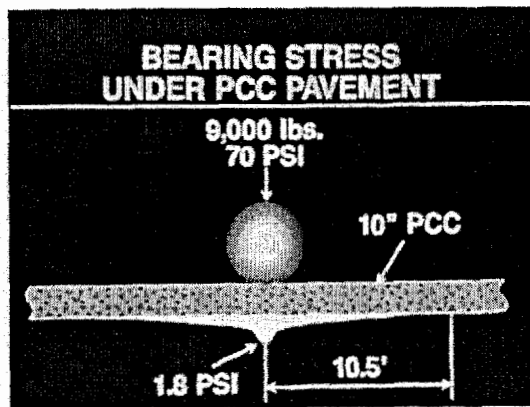

First we need to see how a PCC pavement interacts with a design wheel load. We can see in this sketch the primary benefit of a PCC pavement in that it distributes the wheel load over a relatively large area reducing the stress. The stress under the pavement is only increased by 1.8 psi; however, the PCC pavement must have uniform support.

MOISTURE DISTRESS PCC PAVEMENT

- Curling/warping
- Pumping
- Faulting
- Corner Breaks
- D-cracking
- Punchouts

We can argue over whether moisture causes a certain distress or simply aggravates it. The important point is that moisture will increase a large number of pavement distresses. Below is a list of major distresses in PCC pavements associated with excess moisture: Pumping, faulting and corner breaks are different stages of the same distress.

FACTORS FOR PUMPING

- Free Water
- Heavy Wheel Loads
- Erodible Base
- Voids

To achieve pumping, the following conditions must be present: Free water, Heavy wheel loads, Erodible Base, and Voids. For the past 50 years all of these conditions have been present in PCC pavements. We know that we cannot keep a pavement perfectly sealed. Sooner or later, cracks will develop letting moisture into the pavement section. Once the pavement section becomes saturated, pressure can build up from the passing wheel loads. We also know that our pavements will be subjected to heavier and more frequent wheel loads.

Most of the dense graded aggregate bases used in the pavement section, will have a significant amount of fines that can be eroded.

Admittedly, pavements may not have voids the day after they are constructed; however voids will result because of the PCC slab curling.

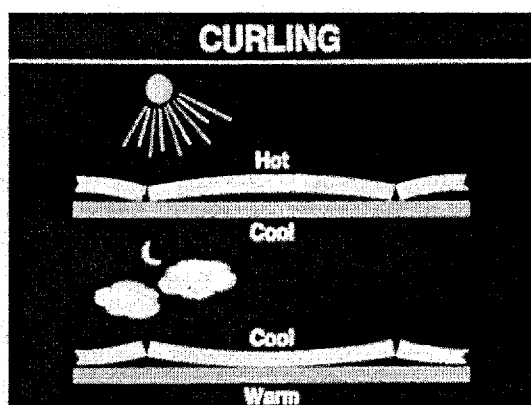

During the daylight hours, the sun will heat up the surface of the concrete slab causing it to expand more than the bottom of the slab. This will tend to bow up in the middle. During the night, the process will reverse itself. Due to the cool night air, the top of the slab will contract more than the bottom of the slab. This will tend to pull up the ends on the slab. As these cycles are repeated, small voids under the ends of the pavement slab at the joints, will be created.

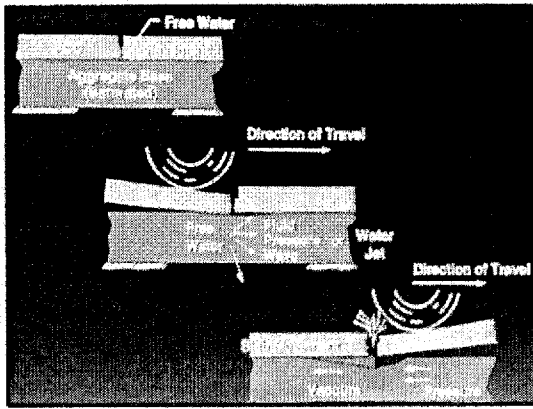

Here, we see that typical dense graded base has become saturated by water infiltrating into the pavement. As our moving wheel load approaches the pavement joint, the accompanying fluid pressure wave will move the loose fine material in the vicinity of the pavement joint. As the wheel load moves on to the leave slab, the pressure wave is reversed and material is pumped under the approach slab or out the concrete joint.

This churning action results in the erosion of material under the leave slab with some material being deposited under the approach, and the remainder of the material being pumped up through the pavement joint. Ejection of free water and material is called pumping.

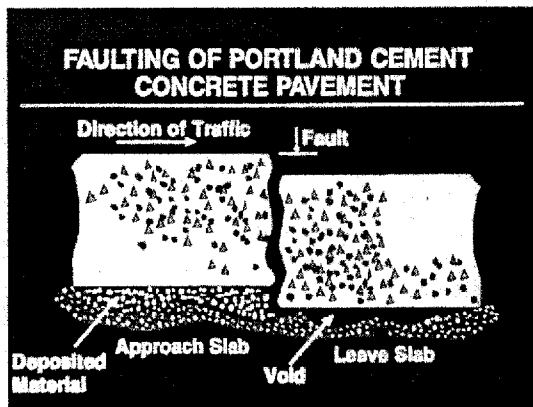

In this sketch we see that a considerable amount of materials has been loosened and deposited under the approach slab. The difference in elevation between the approach and leave slab is called faulting.

The relocated material under the approach slab is relatively loose; there is a definite loss of support under the approach slab and eventually there will be a triangular corner break. As the PCC pavement continues to lose support, additional cracks will develop until the pavement has completely failed and needs replacing.

Note that the problem is related to the direction of the traffic.

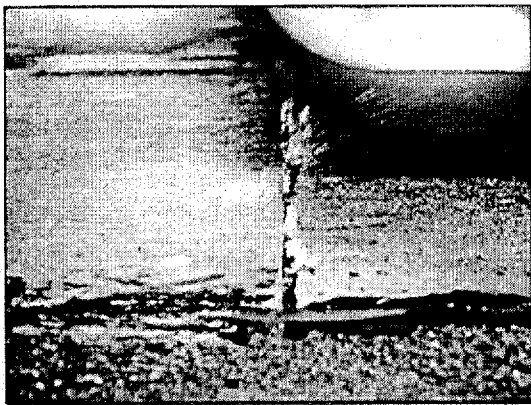

This photograph demonstrates water being ejected from a pavement joint.

With each cycle of loading, water will be ejected from the pavement. A small amount of fines will be ejected with the water each time.

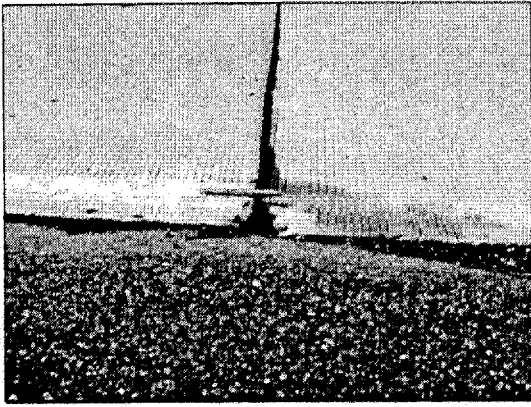

We see severe joint faulting. Cracking is most likely to occur at the corner of a pavement slab. It is a wonder that a corner break has not occurred.



...and finally we see the classic corner break.

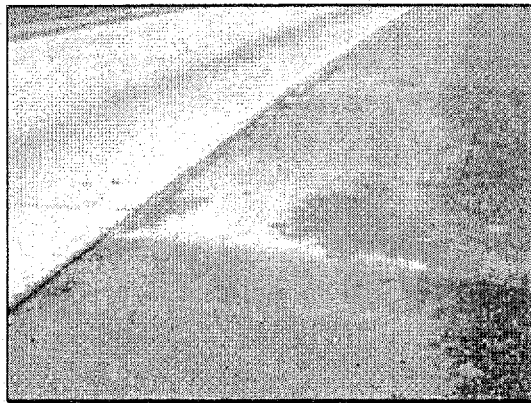

Fine material has been pumped out of the pavement and deposited on the shoulder. Our pavement is literally being washed down the road. As we lose fines, we are losing pavement support.

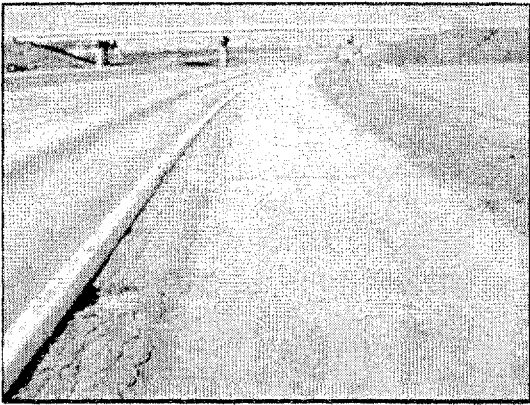

Moisture damage has contributed to the shoulder breakup at the pavement/shoulder joint. We know that the edge of the pavement is one of the highest stressed areas of the pavement. We would anticipate that loss of support has occurred under the edge of the pavement.

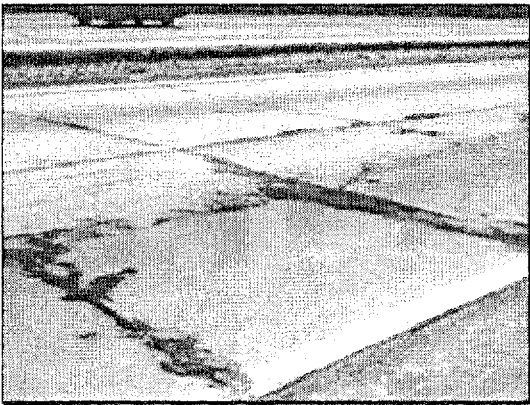

Moisture related distress is a progressive distress that will lead to total pavement failure. Total reconstruction of the pavement is the only solution for this case.

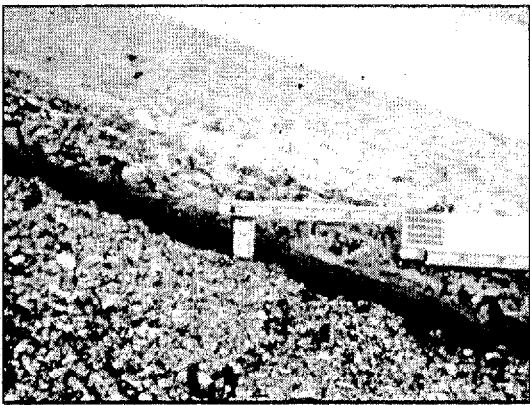

When we have a pavement shoulder joint consisting of a PCC and a flexible shoulder, the pavement shoulder joint will tend to open up more. Remember any longitudinal joint or crack has the potential to intercept 100% of the water coming to it. We do not need a joint this wide to intercept 100% of the water coming to it. It is estimated that up to 80% of the total runoff entering the pavement enters at the pavement shoulder joint.

OTHER PCC PAVEMENT ELEMENTS

While this is a drainage workshop, there other important elements of PCC design that must be addressed. It is unrealistic to consider drainage in a design vacuum.

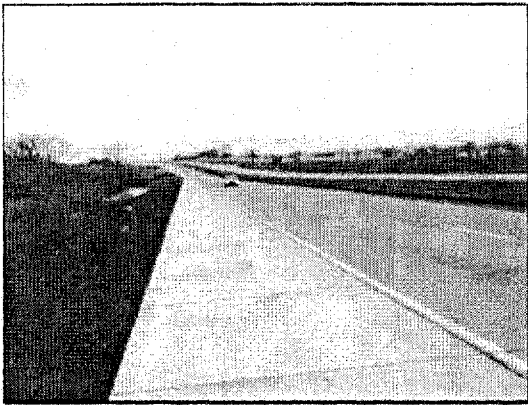

The purpose of this workshop is to discuss pavement drainage; however, there are other elements of pavement design, particularly for PCC pavements, that we should touch on.

Tied concrete shoulders provide a pavement shoulder joint of similar materials that should be better for sealing. Since the shoulder is tied to the pavement, it will provide edge support for the pavement slab. It will also minimize moisture infiltration at this critical location.

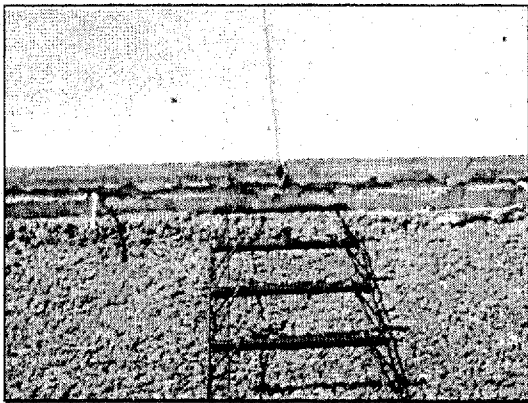

Dowel bars are the single most cost effective element that we should use in a concrete pavement. Pavement subsurface drainage would be a distant second.

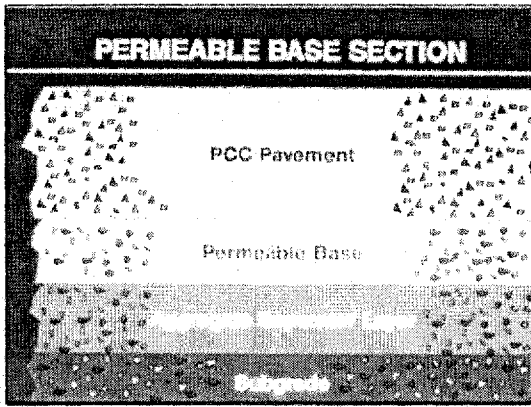

To summarize, the typical PCC pavement section is color-coded:
 Concrete pavement – light gray
 Permeable Base – yellow
 Aggregate separator layer – orange

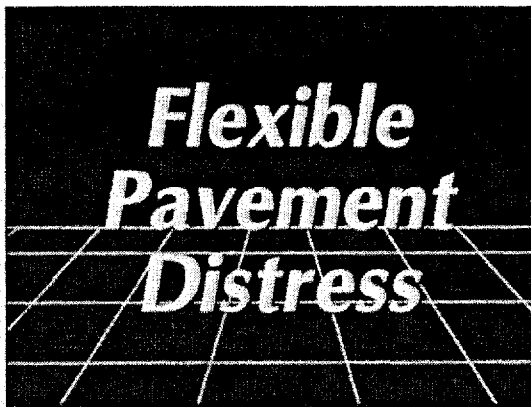

Now let us move on to moisture related distress in flexible pavement.

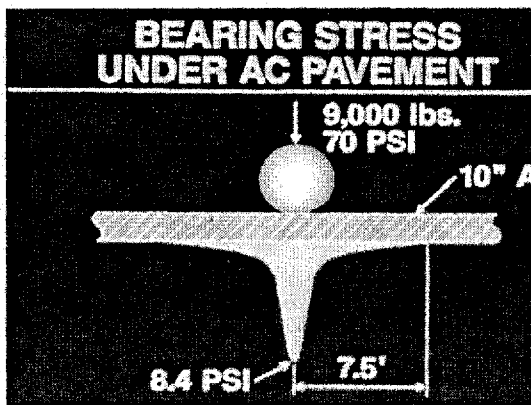

The flexible pavements acts quite differently to our design wheel load that a PCC pavement. Since the pavement is flexible, the stress under the pavement is much greater (8.4 psi.) and the load is distributed over a much smaller area. Drainage is just as important (if not more) for flexible pavements since excess moisture will weaken the subgrade.

MOISTURE DISTRESS AC PAVEMENT

- Stripping
- Rutting
- Alligator or Fatigue Cracking
- Potholes
- Crack Deterioration

Below is a list of major moisture related distresses:

Stripping is the gradual deterioration of the asphalt cement that binds the aggregate particles together.

Rutting is a continuous depression in the wheel-path of the pavement surface. This distress is caused by a combination of heavy wheel loads and excess moisture in the subgrade.

Alligator or Fatigue Cracking is caused by repeated heavy wheel loads on the pavement and is accelerated by any moisture in the pavement structure.

Potholes are the terminal distress for the flexible pavements; they represent a complete failure of the pavement structure. This distress is an extension of alligator cracking and is accelerated by any moisture in the pavement structure.

Crack Deterioration: Any excess moisture in the pavement structure will accelerate the cracking.

Stripping, rutting, alligator or fatigue cracking, and potholes are basically different stages of the same moisture related distress. While weakened subgrade is technically not a pavement distress, it certainly plays a large role in all of the distresses.

First we have a pavement section that has become saturated due to infiltrating groundwater.

Next as the moving wheel load proceeds down the pavement, the accompanying wheel creates a moving pressure wave that forces the water deeper into the subgrade; thus weakening the subgrade. Weakened subgrade is caused by excess water in the subgrade and plays a large role in flexible pavement deterioration.

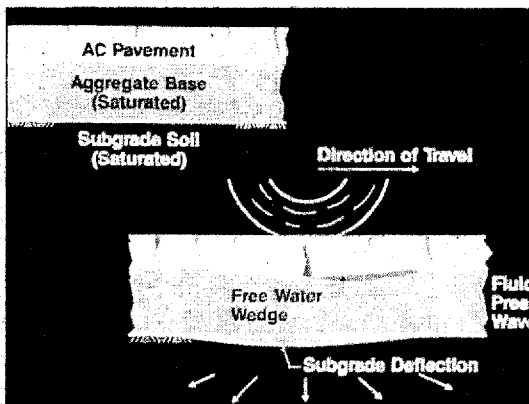

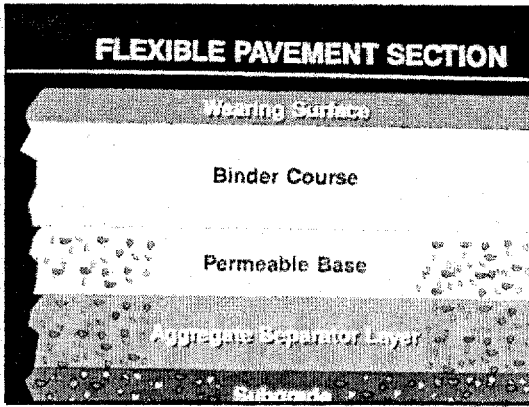

To summarize the typical pavement section is color-coded:
Flexible Pavement – light gray
Permeable Base – yellow
Aggregate Separator Layer - orange

Note that a pavement can have either an aggregate or geotextile separator layer. An aggregate separator is shown for visual purposes only.



Now lets develop a moisture reduction plan for both PCC and flexible pavements.

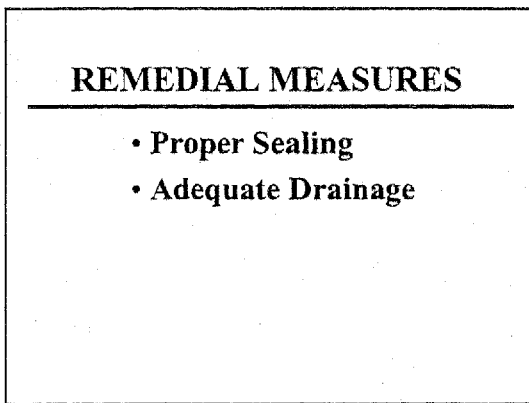

Our game plan is quite simple. Seal the Pavements to keep as much moisture out as possible. If any moisture gets into the pavement, provide a drainable pavement section to remove the water.



Seal all joints and cracks to keep out as much moisture as possible.

SUMMARY

Now let's review what we have learned....

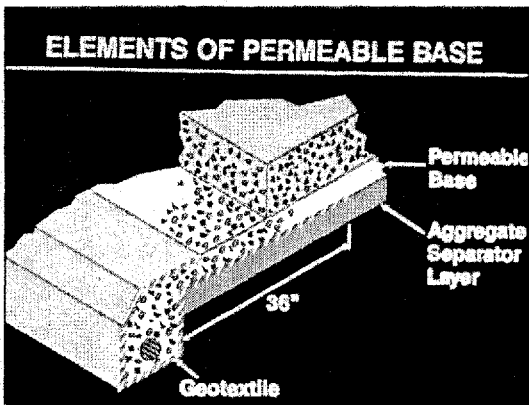

Drainage elements for a PCC pavement are: Permeable Base, Separator Layer, and Edgedrain System.

Any water that infiltrates through the PCC pavement will collect on top of the aggregate separator layer and drain over to the edgedrain system. The edgedrain system will carry the water and discharge it to the roadside ditch. The aggregate separator is necessary to keep fines in the subgrade from moving up into the permeable base.

First, the aggregate separator would be constructed; then a trench for the edgedrain would be dug. The edgedrain should be located approximately 24 inches off of the pavement shoulder joint so that the paver will not run over the edgedrain when it is placing the pavement. Since the geotextile can be placed before the pavement is placed, the geotextile would be placed so that it is under the pavement/shoulder joint where a high percentage of water would enter the system. The geotextile would then be placed in the trench and the top of the geotextile folded over to the left side.

The edgedrain and permeable base material could be placed in the trench up to the top of the aggregate separator layer. The main body of the permeable base is placed over the aggregate separator layer and the edgedrain trench in one operation..

In the next step, the paver will run on top of the permeable base while placing the concrete pavement. After the paving operation, the geotextile will be folded over the permeable base.

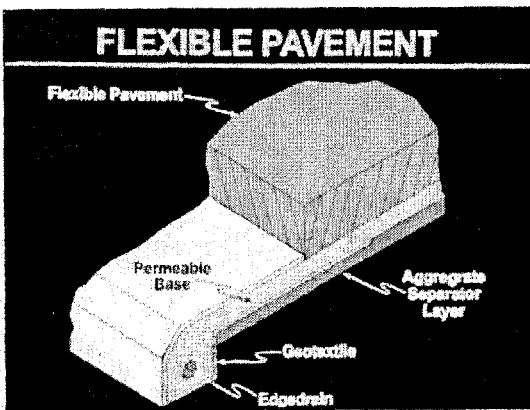

The drainage elements for a Flexible pavement are the same as a PCC pavement: Permeable Base, Separator Layer, and Edgedrain System.

This drainage system functions the same as the one for PCC pavements.

Note that flexible pavement is shown as one layer for simplicity. In real life, it would be composed of several layers.

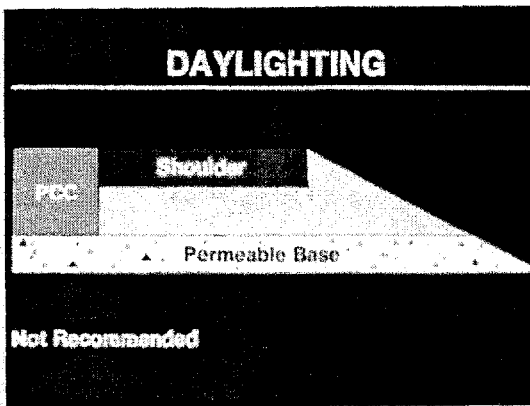

Although not recommended, daylighting is another method used.

Daylighting is extending the permeable base until the roadside ditch is reached. This system has been billed as a “zero maintenance” system.

Below is a list of problems with Daylighting:

- Length of run is increased for the permeable base.

- Invert of the ditch will fill up over time blocking the outflow.

- Landscape people will have to place 4" of topsoil and grow grass.

- Errant trucks or maintenance equipment may chew up the outflow exit.

POSITIVE DRAINAGE

- **Provide longitudinal edgedrain system with outlet pipe**

“Positive Drainage” is the term given to a longitudinal edgedrain system with outlet pipes. This system is recommended because of its hydraulic capacity and ability to be cleaned.

DRAINABLE PAVEMENT SYSTEM ELEMENTS

- **Permeable Base**
- **Separator Layer**
- **Edgedrain System**

To summarize, the drainage elements for a permeable base are:
Permeable Base
Separator Layer
Edgedrain System

SUMMARY

- **Drainage of Pavements**
- **PCC & Flexible Pavement Distress**
- **Moisture Reduction Plan**

This session provided participants will have a working knowledge of the mechanism of drainage for the pavement section.

Distresses caused by moisture for both PCC & Flexible pavements were discussed.

Participants will now understand the plan for reducing moisture in the pavement section.

CONSTRUCTION of PAVEMENT
SUBSURFACE DRAINAGE
SYSTEMS WORKSHOP

SESSION B

Permeable Bases
PCC Pavements
Flexible Pavements
Construction Traffic
Base Materials

Permeable Bases are the first element of a pavement subsurface drainage system. The stability/permeability relationship of permeable gradations is introduced. A comprehensive list of choices for the various drainage elements is provided.

PCC Pavements present the concept of Pre- and Post Pave installation of edgedrains for PCC pavements.

In the Pre-Pave Installation of edgedrains, the edgedrains are constructed before the permeable base is placed, while in the Post-Pave Installation of edgedrains, the edgedrains are constructed after the permeable base is placed; the same as a retrofit edgedrain. The horizontal and vertical locations of the edgedrain are provided for different design conditions.

Flexible Pavements present the concept of Pre- and Post Pave installation of edgedrains for flexible (AC) pavements.

In the Pre-Pave Installation of edgedrains, the edgedrains are constructed before the permeable base is placed, while in the Post-Pave Installation of edgedrains, the edgedrains are constructed after the permeable base is placed; the same as a retrofit edgedrain. The horizontal and vertical locations of the edgedrain for different design condition are provided.

Construction traffic is an important consideration in the design of a pavement system that is often overlooked. Design must coordinate with construction engineers to determine if the construction sequence will interfere with the design. This is particularly true for PCC pavements. Dowel bars are an important element of PCC pavements. Method of placing dowel bars must dovetail with the construction sequence. If construction traffic is going to run on the permeable base, a dowel bar implanter must be used.

Base materials are a common element of all types of permeable base. Good aggregate materials are necessary to develop pavement sections that are durable. Strong crushed aggregates are necessary to develop aggregate interlock between the individual pieces of aggregate.

Use of the FHWA Power 0.45 gradation plot will be introduced. This plot provides pavement engineers with an insight to the stability/permeability relationship of the gradation. Terms such as effective diameter, and coefficient will be introduced. Measures of the durability of the aggregate such as L.A. Abrasion Wear and Soundness will be presented.

AASHTO No. 57 gradation is introduced as a benchmark

Post-Pave Installation of edgedrains, the edgedrains are constructed after the permeable base is placed; the same as a retrofit edgedrain. The horizontal and vertical locations of the edgedrain for different design condition are provided.

Construction traffic is an important consideration in the design of a pavement system that is often overlooked. Design must coordinate with construction engineers to determine if the construction sequence will interfere with the design. This is particularly true for PCC pavements. Dowel bars are an important element of PCC pavements. Method of placing dowel bars must dovetail with the construction sequence. If construction traffic is going to run on the permeable base, a dowel bar implanter must be used.

Base materials are a common element of all types of permeable base. Good aggregate materials are necessary to develop pavement sections that are durable. Strong crushed aggregates are necessary to develop aggregate interlock between the individual pieces of aggregate.

Use of the FHWA Power 0.45 gradation plot will be introduced. This plot provides pavement engineers with an insight to the stability/permeability relationship of the gradation. Terms such as effective diameter, and coefficient will be introduced. Measures of the durability of the aggregate such as L.A. Abrasion Wear and Soundness will be presented.

AASHTO No. 57 gradation is introduced as a benchmark gradation. Most likely this is the most permeable gradation that would be used. Other gradations are compared against it.

SESSION OBJECTIVES

- Discuss Relationship of Edgedrains for PCC Pavements
- Discuss Relationship of Edgedrains for Flexible Pavements
- Explain Role of Construction Traffic
- Identify Importance of Good Aggregate Material

Upon completion of this session, participants will have a working knowledge of the relationship of edgedrains for PCC and Flexible pavements.

Participants will understand role of Construction Traffic in the design and construction of permeable bases.

Participants will appreciate the use of good aggregate material.

Now let's look at our first drainage element - Permeable Bases

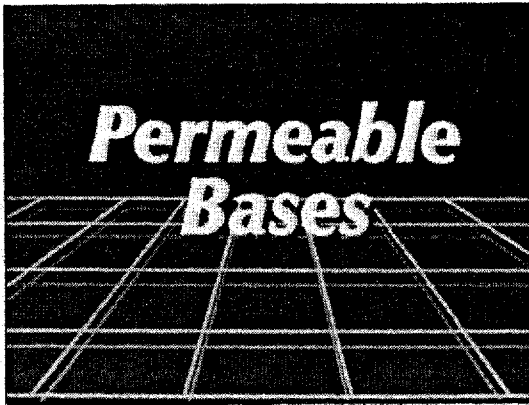

PERMEABLE BASE FUNCTIONS

- Drainage
- Adequate Strength to Achieve Pavement Performance
- Stability During Construction Phase

Permeable base serves the following three functions: Drainage, Adequate Strength to Achieve Pavement Performance, Stability During the Construction Phase.

First, a permeable base must have enough permeability to drain in accordance with the design criteria.

Second, the base must have enough long-term strength to achieve the target pavement performance. Because of the performance problems with permeable bases, more and more emphasis is being placed on long term stability.

Third, the base must have enough strength to survive the construction phase.

STABILITY / PERMEABILITY RELATIONSHIP

- Stability
- Permeability

The permeable base must meet the necessary requirements for permeability and stability. These requirements are at opposite ends of a materials spectrum. There must be a workable balance between permeability and stability. The more permeable a material is; the more unstable it will be.

STABILITY

Stability is primarily determined by:

- Quality of Aggregates
- Particle Size and Distribution
- Stabilizer Material

Permeable base stability is determined by:

Quality of Aggregates (Durability and Soundness)
Particle Size and Distribution (Gradation Analysis)
Stabilizer Material (Asphalt or Cement)

PERMEABILITY

Permeability is primarily determined by:

- Particle Size and Distribution

A permeable base's permeability is determined by:

Particle Size and Distribution (Gradation Analysis)

Note: Gradation analysis is common to both lists.

PAVEMENT SECTION

- Material Type
 - Unstabilized
 - Stabilized
- Separator Layer Type
 - Aggregate
 - Geotextile
- Edgedrain Location

The first step in the design procedure is to select the various components of the system.

Material Type – The first and most important choice is the use of stabilizer materials.

Unstabilized permeable bases do not use any stabilized materials. They are more dependent on developing good aggregate interlock for stability.

Stabilized permeable bases use asphalt or cement stabilized materials as a binder to increase the stability of the aggregate mix. It is pointed out that stabilization is not a substitute for good quality (durability, soundness) aggregates.

Separator Layer – The separator layer is the silent partner in the design of subsurface drainage system. Either an aggregate layer or geotextile can be used.

Aggregate separator layer must be designed using the filtration equation to retain the small size particles. This layer could be included in the structural design of the pavement section.

Geotextile must have a properly sized opening to retain the

smaller size particles, yet open enough to allow any build up of water to drain.

Edgedrain location is a continuing controversy among pavement engineers. FHWA recommends that the edgedrain be located near the pavement/shoulder joint for PCC pavement while the edgedrain would be located at the edge of shoulder for flexible pavements. To a somewhat lesser degree the edgedrain location is determined by the installation scheme Pre-Post Pave installation of the edgedrain.

PAVEMENT SECTION

- **Edgedrain Installation**
 - Pre-
 - Post-
- **Pavement Cross Slope**
 - Uniform
 - Crowned
- **Shoulder Type**
 - Similar
 - Dissimilar

Edgedrain Installation

Pre-Pave Installation - Edgedrain placed before pavement

Post-Pave Installation - Edgedrain placed after Pavement-Retrofit fashion

Pavement Cross Slope

Uniform – Both lanes slope to the shoulder.

Crowned – Lanes slope to median and shoulder – Cuts drainage cuts length in half.

A minimum cross of 0.02 ft/ft (2%) is recommended.

Shoulder Type – We know that if the shoulder is constructed of the same materials as main pavement, the resulting pavement/shoulder joint should be much tighter.

Similar - Concrete pavement/concrete tied shoulder, flexible pavement/flexible shoulder.

Dissimilar - Concrete pavement/flexible shoulder.

PCC Pavements

Now let's look at some typical layouts for PCC pavements.

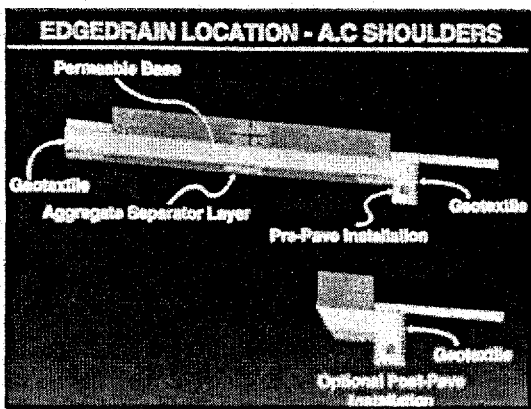

Here we see a PCC Pavement with a uniform cross slope and flexible shoulder. A geotextile is provided around the edgedrain to keep out as many of the fines as possible. A pre-pave installation is shown in the main sketch, while the post - pave installation is shown in the insert.

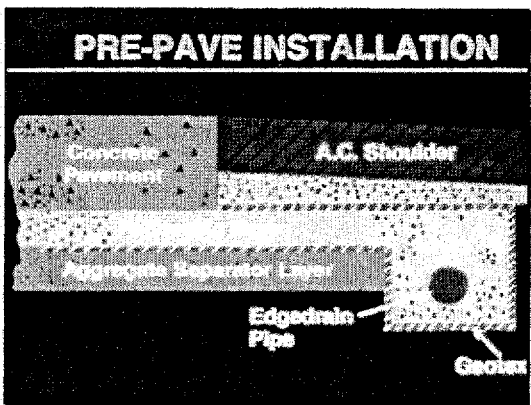

Now lets enlarge the edgedrain section and look at the design in detail:

First, in the Pre-Pave installation, the aggregate separator would be constructed; then a trench for the edgedrain would be dug. The edgedrain should be located approximately 24 inches off of the pavement/shoulder joint so that the paver will not run over the edgedrain when it is placing the pavement. Since this is a pre-pave installation (Before the pavement is placed) the geotextile would be placed so that it is under the pavement/shoulder joint where a high percentage of water would enter the system. The geotextile would then be placed in the trench and the top of the geotextile would be folded over to the right side.

The edgedrain and permeable base material could be placed in the trench up to the top of the aggregate separator layer. The main body of the permeable base could be placed over the aggregate separator layer and the edgedrain trench in one operation.

In the next step, the paver would run on top of the permeable base while placing the concrete pavement.

After the paving operation, the geotextile could be folded back over the permeable base.

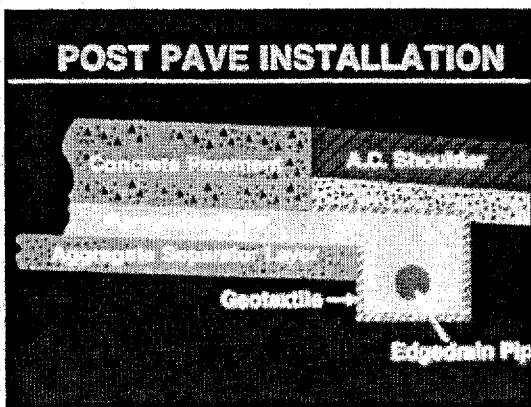

In the Post Pave installation, the permeable base is construction and the PCC pavement is placed.

Next, the edgedrain trench is dug about 12 to 18 inches from the concrete pavement so that the trench will not undermine the concrete slab. The trench is then lined with a geotextile. Note that since the pavement is already in place, the geotextile cannot be placed under the concrete pavement. The edgedrain pipe and trench backfill are then placed. This construction is the same as a retrofit edgedrain. The geotextile is folded over on top of the permeable base, and the flexible shoulder is then constructed. The shoulder provides some protection for the edgedrain against heavy wheel loads.

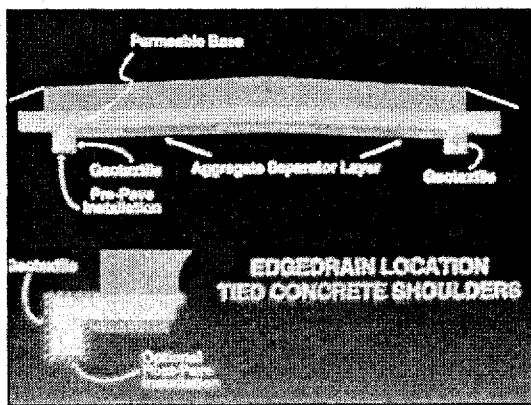

Another design scenario is shown in this slide. A crowned pavement with tied concrete shoulders has been provided. By crowning the pavement, the length of run has been cut in half, while the tied concrete shoulders should provide a tighter joint.

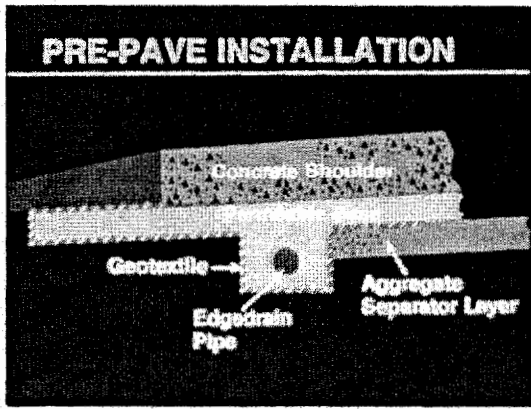

Since the pavement/shoulder joint should be tighter, the edgedrain location can be moved closer to the edge of the shoulder. It is recommended that the edgedrain be located under the concrete shoulder to provide protection from heavy wheel loads. The edgedrain trench is dug and the trench wrapped before the edgedrain pipe and trench backfill is placed. The permeable base is placed and the geotextile is folded over the completed permeable base before the concrete shoulder is constructed.

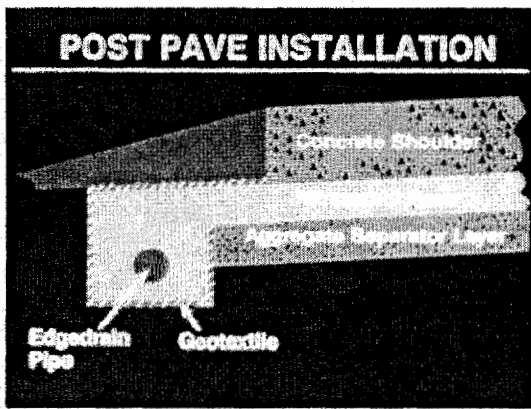

In the Post Pave installation, the permeable base is construction and the concrete shoulder is placed. Next, the edgedrain trench is dug about 12 to 18 inches from the concrete pavement so that the trench will not undermined the concrete shoulder. The trench is then lined with a geotextile. Note that since the concrete shoulder has been placed, the geotextile cannot be placed under the shoulder slab pavement. The edgedrain pipe and trench backfill are placed. This construction is the same as a retrofit edgedrain.



Now let's look at the location of the edgedrain for flexible pavements

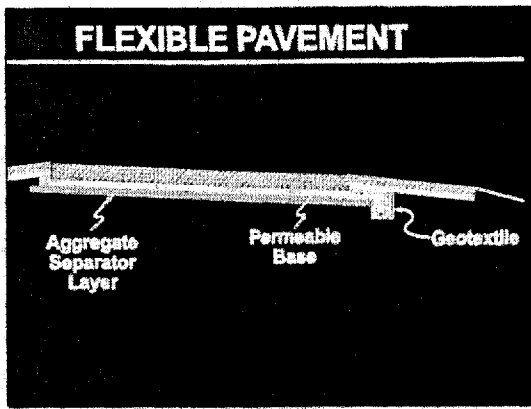

The next example is for a flexible pavement with a uniform cross slope and flexible shoulder. Geotextile is provided around the edgedrain to keep out as many of the fines as possible.

Here the arrangement and construction of the drainage elements are quite similar to PCC pavements.

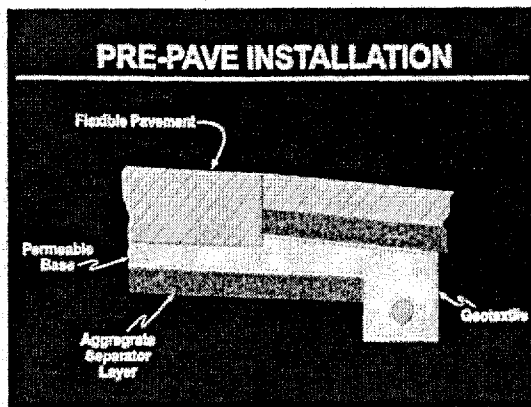

For the pre-pave installation, the arrangements and construction of the drainage element are similar to PCC pavements.

Location of the edgedrain is not as critical as in PCC pavements since the pavement and shoulder are constructed of the same material. It is recommended that the edgedrain be located relatively near the pavement/shoulder joint so that the length of run in the permeable bases is kept to a minimum. The aggregate separator layer, geotextile, edgedrain trench, and permeable base are constructed next. The main section of the flexible pavement is then constructed with the paver running directly on the permeable base. The geotextile is then folded over on top of the permeable base, and the flexible shoulder is then constructed. The shoulder provides some protection for the edgedrain pipe against heavy wheel loads.

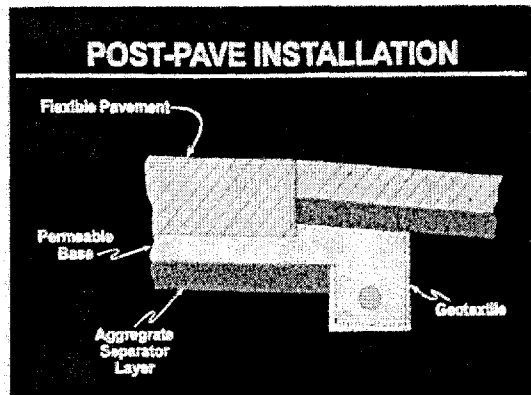

For the post-pave installation, the arrangements and construction of the drainage elements are similar to PCC pavements.

The aggregate separator layer, and permeable base are constructed first. The main pavement section of flexible pavement is then constructed with the paver running directly on the permeable base. Next the edgedrain trench is dug adjacent to the pavement and then lined with a geotextile. Note that since the pavement has been placed, the geotextile cannot be placed under the concrete pavement. The edgedrain pipe and trench backfill are then placed. This construction is the same as a retrofit edgedrain.

The geotextile is then folded over on top of the permeable base, and the flexible shoulder is then constructed.

The shoulder provides some protection for the edgedrain pipe against heavy wheel loads.

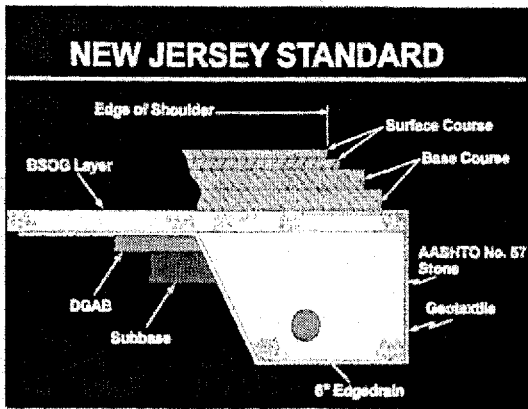

Most State highway agencies locate the edgedrain at the edge of the shoulder; just under the shoulder to protect the pipe from heavy wheel loads. A New Jersey standard is shown in this slide.



Now lets take a look at the role of construction traffic in the design and construction of pavements with permeable bases.

CONSTRUCTION TRAFFIC

Important factor in selecting type of permeable base

Construction traffic is an important factor in the design and construction of permeable bases that pavement engineers may not recognize. Since permeable bases cannot tolerate construction traffic the way DGAB can, it is more of a factor. In the preliminary design phase, the pavement engineer should meet with the construction engineer to determine the sequence of operations.



Construction traffic consists of concrete or asphalt delivery trucks bringing their product to the paver. Trucks may run directly on the permeable base or an adjacent haul road. Here we see the delivery truck running directly on the permeable base.

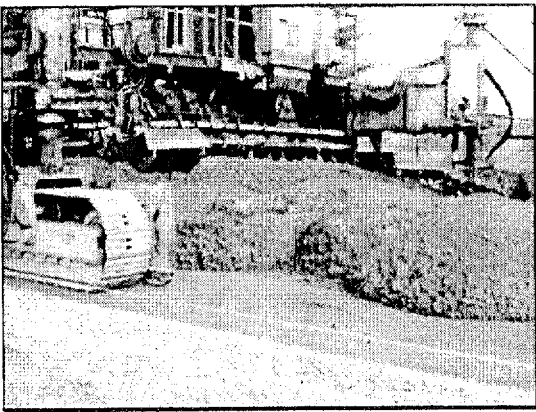

The paving operation is also considered to be part of the construction traffic. Here the paver tracks are running directly on the permeable base.

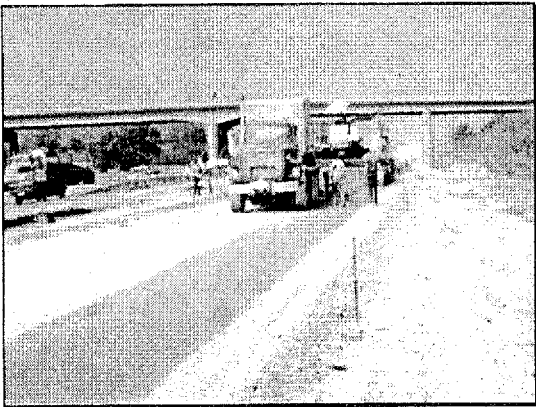

Many contractors want to deliver the paving material by directly running on the permeable base. Permeable bases can withstand a modest amount of traffic depending on the stabilizer material used.

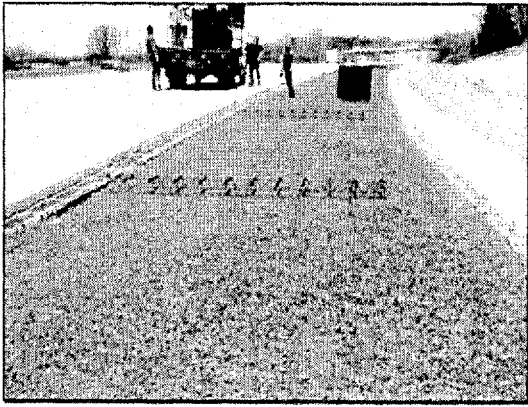

For PCC pavements, dowel bars are an important element. Some contractors may want to place the dowel bar baskets directly on the permeable base. This approach means that construction traffic must use a haul road for side delivery operation.

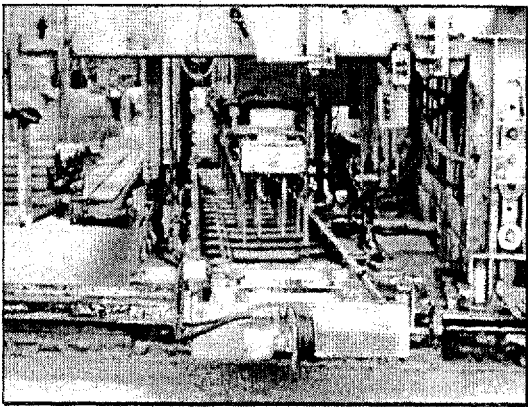

If the delivery trucks run directly on the permeable base, then the dowel bars can be placed using a dowel bar implanter. Dowel bars are distributed across the fresh concrete by a trolley. The bars are then vibrated into place by prongs. Workers mark the center of the dowel bars with spray paint to locate the joint for the sawing operation. It is important that the saw cut be centered on dowel bars.

CONSTRUCTION TRAFFIC

None	Unstabilized
Moderate	Unstabilized $C_U > 4$
Heavy	Asphalt or Cement Stabilized

As a guide, the type of permeable base is determined for three different volumes of construction traffic:

- Light - Unstabilized
- Moderate - Unstabilized $C_U > 4$
- Heavy - Stabilized - Asphalt or Cement

The volume of traffic is determined by the length of run of the trucks on the permeable base.

CONSTRUCTION TRAFFIC

- Keep Volume Down
- Keep Speed Down
- Gentle Turning
- Gentle Starting and Stopping

These guidelines produce four recommendations for construction traffic:

- Keep Volume Down
- Keep Speed Down
- Gentle Turning
- Gentle Starting and Stopping

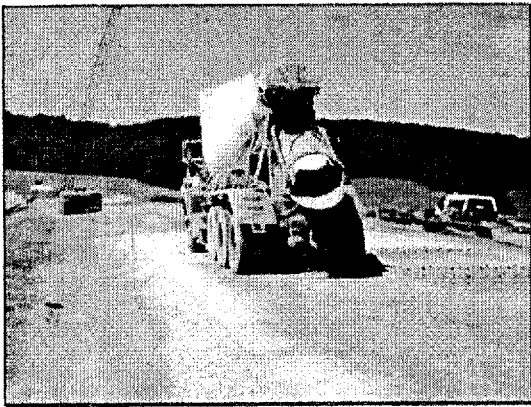

Now lets look at a case history in Wisconsin. The permeable base consists of an unstabilized AASHTO No. 67 gradation. Concrete for the PCC pavement is being delivered to the paver by delivery trucks running directly on the permeable base.

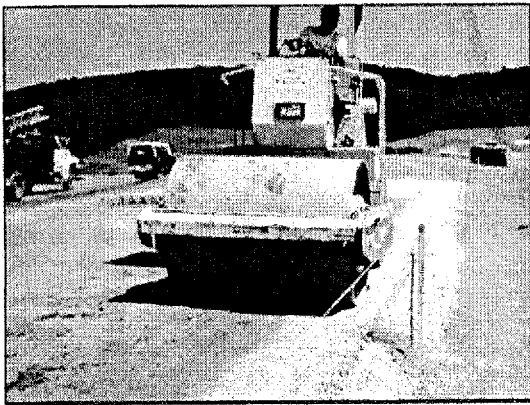

After each load of concrete has been delivered, the permeable base is rolled. Note that the surface of the permeable base is breaking down from over-rolling. Since the construction traffic is running directly on the permeable base, dowel baskets cannot be placed ahead of time.

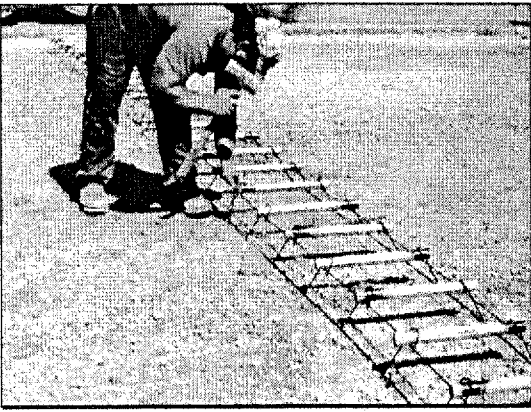

As the paver approaches a pavement joint, the dowel bars are pinned in place by hand. The baskets must be securely pinned so that they do not move in the paving operation.

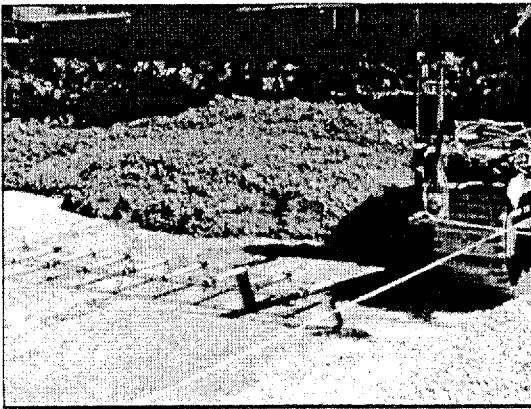

A stringline provides horizontal and vertical control for the paving operation. It is important that the dowel bars not be displaced as the paving operation moves over them.

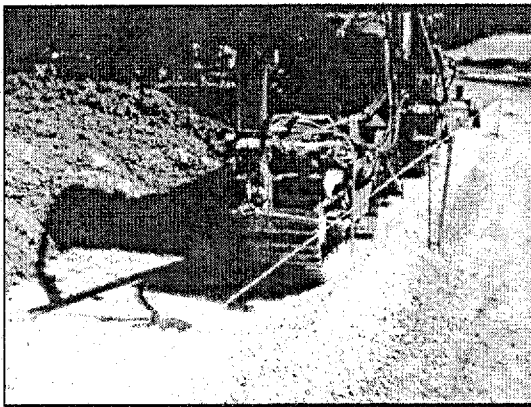

There is no noticeable displacement of permeable base material.



At a second site in Wisconsin, the permeable base consists of an unstabilized Wisconsin No. 2 gradation. This gradation was specifically developed for sites where the construction traffic would run directly on the permeable base. The gradation is close to the New Jersey unstabilized permeable gradation which is discussed in some detail in the following sessions. This gradation is somewhat finer than AASHTO No. 67.

Note the dowel bar basket adjacent to the paving operation.

Since the construction traffic is running directly on the permeable base, dowel baskets cannot be placed ahead of time.



Concrete is dumped directly onto the permeable base, and a traffic detector loop is being embedded into the pavement.



Concrete is being placed over the dowel bar baskets. It is important that the baskets do not move during the paving operation. When the contraction joint is sawed, the dowel bars must be located under the saw cut to provide load transfer.

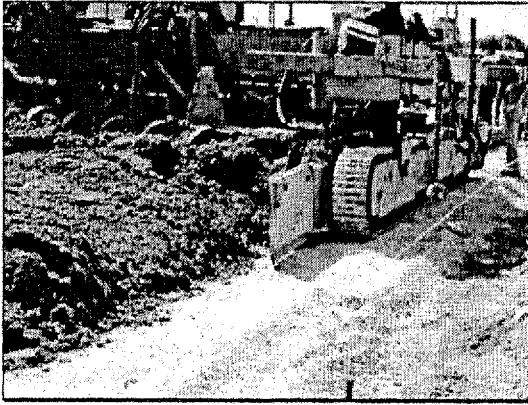

There is no noticeable displacement of permeable base material.

Again, a stringline provides horizontal and vertical control for the paving operation. As a general statement, the better the line and grade control; the better the pavement ride will be.



Aggregate is the most important element of permeable bases. Good aggregates are necessary regardless of the type of permeable base.

PERMEABLE BASE MATERIAL

- **Durable**
- **Angular**
- **Crushed – 2 Faces**
- **Aggregate Interlock**

Aggregate materials should have the qualities as shown here.

We need aggregate material that is durable, angular and crushed to produce the necessary aggregate interlock.

L.A. ABRASION WEAR

- **L.A. Abrasion Wear Not to Exceed 45 Percent**
- **Los Angeles Machine**
- **AASHTO T 96 - 94**

Los Angeles Abrasion Wear is the best measure of an aggregate's durability. L.A. abrasion wear should not exceed 45 percent. If more durable aggregates are available, the specification requirement should be lowered.

SOUNDNESS

- **Sodium Sulfate 12%**
- **Magnesium Sulfate 18%**
- **Soundness of Aggregate by Use of Sodium Sulfate or Magnesium Sulfate**
- **AASHTO T 104 - 97**

Soundness is another measure of an aggregate's durability.

Material loss should not exceed 12% for Sodium Sulfate or 18% for Magnesium Sulfate testing.

The test should be conducted in accordance with AASHTO T 104-97, "Soundness of Aggregates by Use of Sodium Sulfate or Magnesium Sulfate."

PLASTICITY

- **Plasticity is the property of a soil that allows it to be deformed beyond the point of recovery without cracking or appreciable volume change**

Plasticity is the property of a soil that allows it to be deformed beyond the point of recovery without cracking or appreciable volume change.

Plasticity is an indication of the amount of silt/clay in the aggregate material which in turn is an indication of the strength of the material

PLASTICITY

- Material Passing No. 40 Sieve (0.425 mm)
- Determining the Plastic Limit and Plasticity Index of Soils
- AASHTO T 90 - 96

The aggregate material should be tested to determine its plasticity. Only material passing the No. 40 sieve (0.425 mm) should be used in the test.

The test should be conducted in accordance with AASHTO T 90-96, "Determining the Plastic Limit and Plasticity Index of Soils".

PLASTICITY

Aggregate Material should be Non-Plastic

The aggregate material to be used should be classified as non-plastic.

The aggregate material is classified as non-plastic when:
The liquid limit or plastic limit cannot be determined.
The plastic limit is greater than or equal to the liquid limit.

PARTICLE SIZE

- Particle Size - $D_{xx} = 1.91$ mm
- "xx" - Represents the Percent Smaller
- $D_{10} = 1.91$ mm - 10 Percent of the Material Will Be Smaller than 1.91 mm

Since many of us come from different backgrounds, it is important that we understand the nomenclature used to identify particle size. Particle size is expressed as D_{xx} = Particle Size (mm) where xx represents the percent smaller.

In another words, the nomenclature means that "xx" percent of the material will be smaller than the stated particle size.

EFFECTIVE SIZE (D_{10})

Effective size (D_{10}) is the opening size in millimeters, in which 10% of the material will pass.

The effective size (D_{10}) of a material is the size in which 10% of the material is smaller. The effective size is used as a benchmark to gage a gradation's permeability. The larger the effective size, the greater the permeability will be.

COEFFICIENT OF UNIFORMITY (C_U)

$$C_U = \frac{D_{60}}{D_{10}}$$

Where:

D_{60} = Particle Size, mm
(60 percent passing)

D_{10} = Particle Size, mm
(10 percent passing)

The coefficient of uniformity (C_U) is : " $C_U = D_{60} / D_{10}$ ". If all particles were of the same size, the coefficient of uniformity would be 1.0, and the plot of this line would be vertical.

COEFFICIENT OF UNIFORMITY (C_U)

Coefficient of Uniformity (C_U) is an indicator of the spread of particle grain size

The Coefficient of Uniformity (C_U) is an indicator of the spread of the particle sizes between the 10 and 60 percent particle sizes. This in turn is an indicator of the gradation's permeability/stability:

If the coefficient of uniformity is less than 4, the gradation will tend to be usable.

Dense graded aggregate bases will be stable with a coefficient of uniformity of 40 and greater.

Permeable bases will have a coefficient of uniformity between 2 and 8.

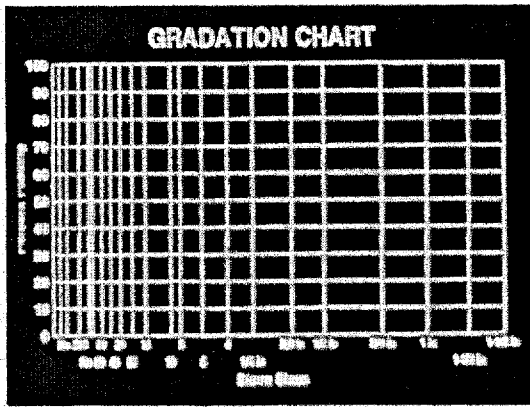

A FHWA Power 0.45 Gradation Chart is shown. This particular chart is used to identify the stability of a gradation. The vertical scale is linear ranging from 0 to 100 percent passing while the horizontal scale is a power 0.45 plot of the particle size.

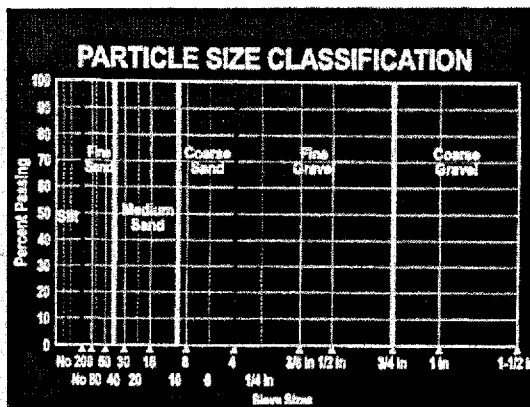

To put this gradation chart into perspective, the various soil classification sizes have been superimposed on the graph. The larger coarse gravel sizes will plot to the right, while the smaller fine sand sizes will plot to the left. Note that the No. 200 (0.075 mm) sieve size is important because it marks the division point between fine and coarse material.

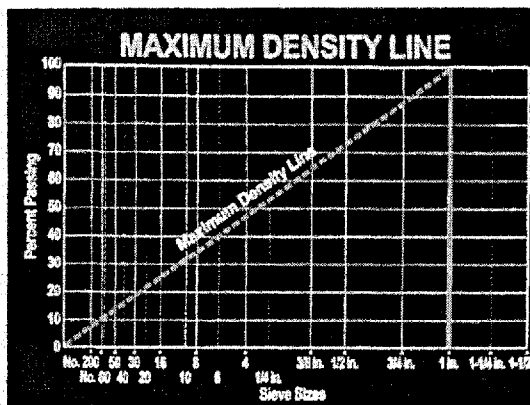

Theoretically, if we connect the origin in the lower left-hand corner with a point determine by 100 percent passing the largest sieve, we will have a maximum density line. This definition means that any gradation approaching this line would have a minimum void content or maximum density. The maximum density line is an indicator of a gradation's strength.

AASHTO No. 57

Sieve Size	Percent Passing
1-1/2"	100
1"	95 - 100
1/2"	25 - 60
No. 4	0 - 10
No. 8	0 - 5

The AASHTO No. 57 gradation with the percent passing for each sieve size.

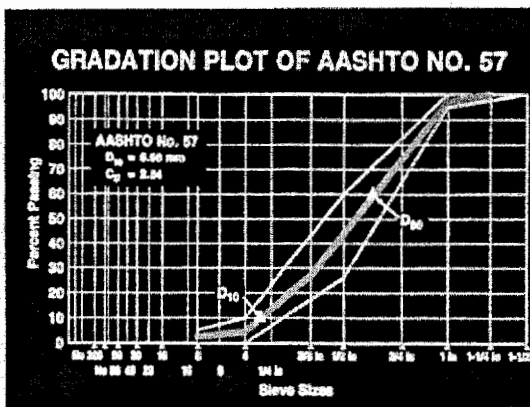

The AASHTO No. 57 gradation is plotted on the FHWA power 0.45 gradation chart. Analysis of this gradation reveals:

Effective size = 5.98 mm

Coefficient of Uniformity = 2.54

Note that the effective size is rather large. This indicates that the gradation would have a relatively large permeability.

Since the coefficient of uniformity is less than 4 ($C_u = 2.54$), we would expect that this gradation would be unstable; thus requiring some stabilizer material.

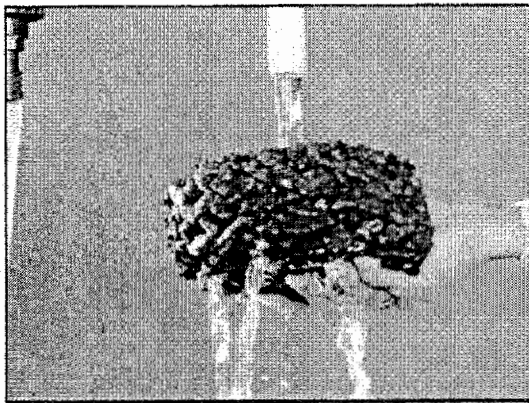

This slide reminds us that the aggregate material must also be permeable. The coefficient of permeability should be determined by a soil laboratory test of a gradation sample rather than design equations or rule of thumb guidance.

PERMEABILITY (k)

**Coefficient of Permeability (k)
should be greater than
1000 feet/day**

The permeable base material should have a minimum coefficient of permeability of 100 feet per day. This value of permeability should provide a reasonable time to drain for permeable bases.

TYPES OF PERMEABLE BASES

- **Unstabilized**
- **Stabilized**

These discussions provide the ground work for discussing the two types of permeable bases, Unstabilized and Stabilized, in the upcoming sessions.

SUMMARY

- **Relationship of Edgedrains for PCC Pavements**
- **Relationship of Edgedrains for Flexible Pavements**
- **Construction Traffic – Important Factor**
- **Use Good Aggregate Materials**

This session provided design/construction guidance for determining the horizontal and vertical location of the edgedrain.

Construction traffic is an important factor in the design of the pavement section.

Use of good aggregate materials was stressed. Good aggregate is must for developing a strong pavement section.

**CONSTRUCTION of PAVEMENT
SUBSURFACE DRAINAGE
SYSTEMS WORKSHOP**

SESSION C

Unstabilized Permeable Bases

Unstabilized bases provide design/construction guidance for placing the bases. Unstabilized bases require good aggregate interlock to produce their strength.

Good quality aggregates are a must for producing strong permeable bases. Sound construction procedures should be used. Emphasis is placed on placing and compacting the permeable base.

Guideline specifications for unstabilized permeable bases are provided in the Appendix.

SESSION OBJECTIVES

- Provide Design/Construction Guidance
- Explain the Need for Good Quality Aggregate Material
- Discuss Sound Construction Practices

At the completion of this session, participants should have a knowledge base for good design/construction guidance for unstabilized permeable bases.

Participants should be able to explain the need for good quality aggregates.

The participants should also be conversant with practical construction guidelines for unstabilized permeable bases.

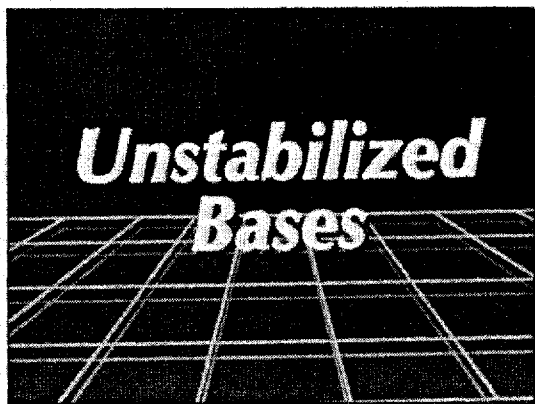

Now let us look at unstabilized permeable bases.

UNSTABILIZED BASES

- **More Finer Material**
- **Mechanical Interlock of Aggregates**

Unstabilized permeable bases consist of gradations that have finer material. Unstabilized permeable bases depend on good aggregate interlock for their stability. Because they are finer than an AASHTO No. 57, they will have less permeability.

Again FHWA recommends a minimum coefficient of permeability of 1000 feet per day.

CRUSHED STONE

FHWA recommends that only crushed stone material be used in permeable bases

Since good aggregate interlock is so important, FHWA recommends that only crushed stone be used.

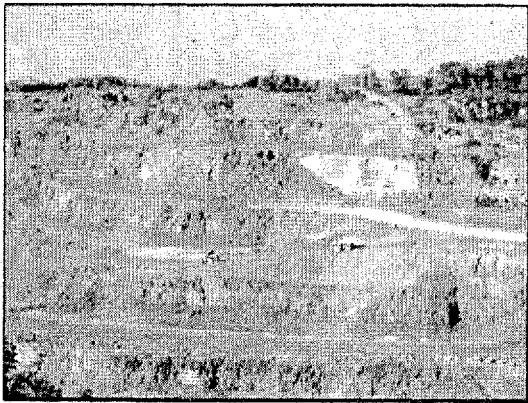

This is a slide of a stone quarry near Frederick, Md. This site has been in operation for over 200 years. The point that we want to make with this slide is that we should go to great lengths to obtain good quality aggregates.

COEFFICIENT OF UNIFORMITY (C_U)

- C_U Greater than 4

Textbooks tell us that if the coefficient of uniformity is **less than 4**, the gradation will tend to be unstable. For unstabilized permeable bases, the coefficient of uniformity should be **greater than 4**.

The Unified Soil Classification Systems defines granular, gravel-size material as “well-graded” if the coefficient of uniformity is **greater than 4**. If the amount of fines exceeds 12 percent, a C_U should not be stated since the aggregate would not be considered as a granular material.

UNTREATED PERMEABLE BASE New Jersey Gradation

Sieve Size	Percent Passing
1-1/2"	100
1"	95 - 100
1/2"	60 - 80
No.4	40 - 55
No.8	5 - 25
No. 16	0 - 8
No. 50	0 - 5

This slide shows the New Jersey gradation for unstabilized permeable bases. Considerable research went into developing an unstabilized base that would provide the proper balance of stability and permeability.

PLOT OF NEW JERSEY GRADATION

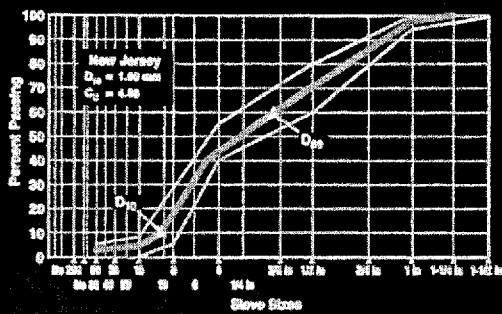

This slide shows a plot of the New Jersey gradation on FHWA power 0.45 paper. Analysis of this gradation reveals:
Effective size = 1.91 mm
Coefficient of Uniformity = 4.68

Note the differences between the New Jersey and AASHTO No. 57 gradations. The gradation plots to the left of the AASHTO No. 57 indicating smaller size materials which in turn means less permeability. The slope of the plot is flatter which indicates that the gradation will have more stability.

Based on the effective diameter the permeability of the gradation will be less than the AASHTO No. 57 that we previously saw, while stability ($C_U = 4.68$) should be adequate for light construction traffic.

Placing & Compacting Unstabilized Bases

Now let's talk about placing and compacting unstabilized permeable bases.

UNSTABILIZED BASE COMPACTION

- **1 to 3 passes of 5-10 ton steel wheel roller**
- **or**
- **Vibratory roller with care**

Compaction of unstabilized permeable bases is a difficult subject area. Since permeable bases have so much more void content, the more the compaction effort, the more the aggregate will compact reducing the base's permeability. The old guidance of providing 95 percent density to permeable bases does not apply. This approach will be discussed in more detail as we describe New Jersey DOT's approach in detail.

FHWA recommends one to three passes of a 5 - 10 ton steel wheel roller to seat the material. Vibratory rollers can be used with care.

An adequate density level should be determined by trial compaction of a control strip. Compaction should continue until no appreciable increase in density occurs without crushing the aggregate. This density level then becomes a standard benchmark level. Compaction of the permeable base roadway must then meet this standard.

AVERAGE REFERENCE DENSITY

- Control Section 400 sq. yd.
- Maximum Density
 - Nuclear Density Test
 - Aggregate Crushing

The New Jersey DOT has developed a procedure for measuring the compaction of unstabilized permeable bases called Average Reference Density. In this procedure, a 400 sq./yd. control section is constructed, and the permeable base is placed and then compacted.

To develop the maximum density for a permeable base, the base is rolled until no appreciable increase in density is obtained without crushing the aggregate. The density at this stage is determined by a nuclear density gage. This value then becomes part of the Average Reference Density.

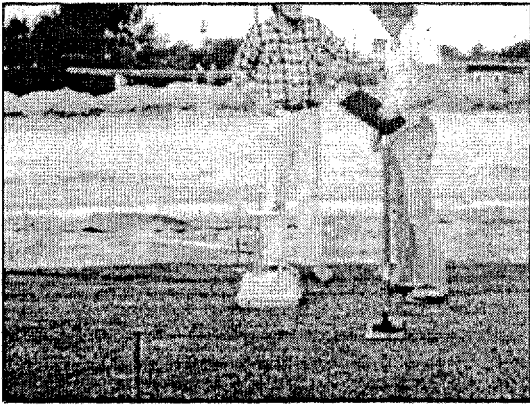

This slide shows a permeable base being tested by a nuclear density gage. The nuclear density is probably the best method for determining the density of a permeable base.

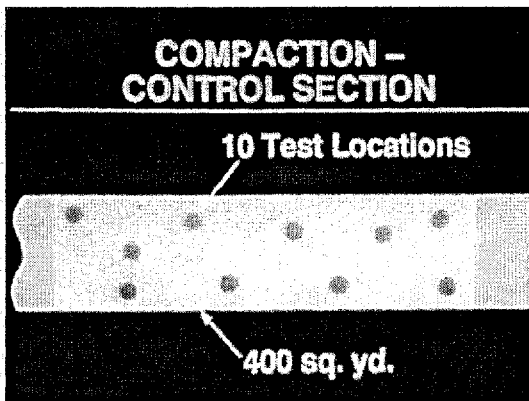

Schematically, this sketch shows the ten (10) random test locations used to develop the Average Reference Density.

AVERAGE REFERENCE DENSITY

- Average In-Place Density of Control Strip Based on 10 Tests

An average in place density of the control strip is developed by testing the control strip at ten 10 random points and averaging the density. This value becomes the Average Reference Density.

IN-PLACE DENSITY

- Determined by Nuclear Density
- Density of Soil and Soil Aggregate In-Place by Nuclear Methods
- AASHTO T 238-97

The nuclear density test should be run in accordance with the AASHTO T 238-97, "Density of Soil and Soil Aggregate In-Place by Nuclear Methods".

COMPACTION - PROJECT

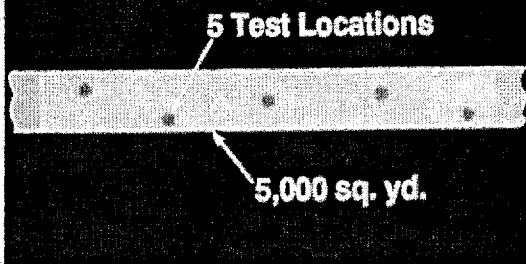

The permeable base is placed and compacted based on the procedures developed in constructing the control section. Schematically, this sketch shows the five (5) random test locations (per 5,000 sq. yd.) used to develop the Average In-Place Density of the completed permeable base. The Average In-Place Density should be at least 95% of the Average Reference Density.

AVERAGE IN-PLACE DENSITY

- Lot Size – 5,000 sq. yd.
- Random Tests – 5 Locations
- Average In-Place Density
- Not less than 95% of reference density

To summarize, the Average In-Place Density of the completed permeable base is determined by the average of five (5) test locations per 5,000 sq/yd of the project's permeable base. The Average In-Place Density should be at least 95% of the Average Reference Density.

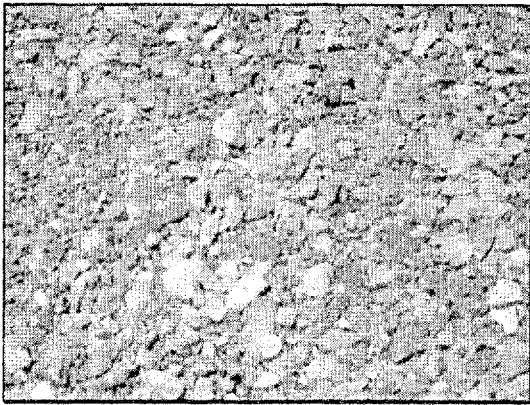

Now let's look at some field shots of the construction of a New Jersey permeable base. Here we see a close-up of a completed New Jersey unstabilized permeable base. Note the angularity of the aggregate particles. Also note the "openness" of the aggregate material. It is this "openness" that gives the base its permeability.

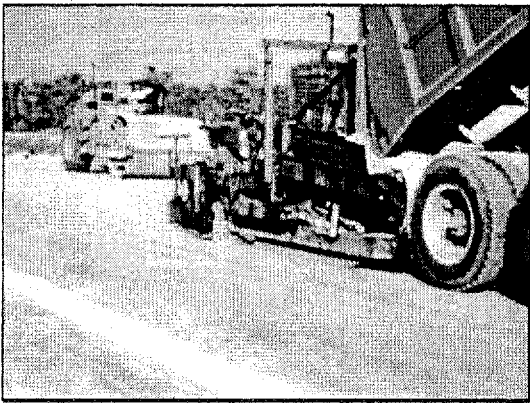

Now let's look at a case history in New Jersey that occurred several years ago. Unstabilized material is being spread by a tracked asphalt paver. A tracked asphalt paver is used to spread the material. Tracked pavers should be used to prevent rutting of the layer below the permeable base.

Note that there is no line and grade control.

Note that no stringline is being used. As a general statement, the better the line and grade control is; the smoother the pavement ride will be.

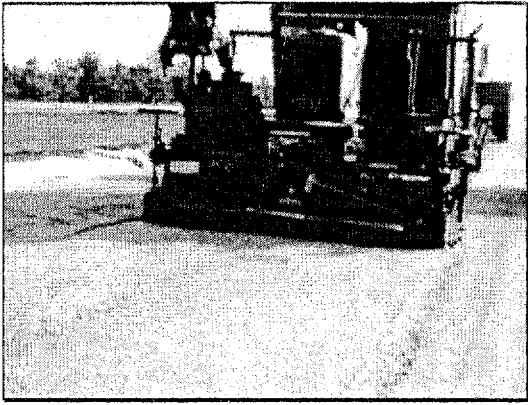

Aggregate material is spread out in a ribbon on top of the aggregate separator layer as the paver continues its pass.

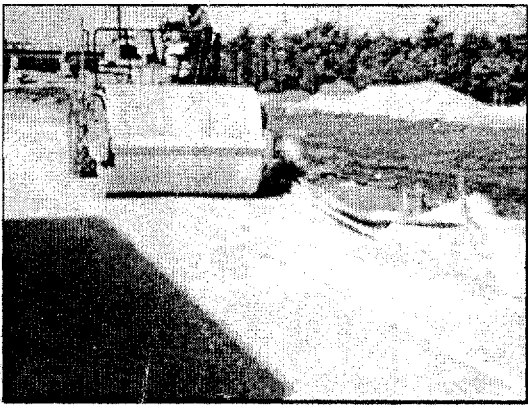

Compaction is difficult item for permeable bases, particularly those with unstabilized bases. We want good compaction to seat the material, but we know that as compaction continues the aggregates will start to crush reducing the permeability of the aggregate mix. Maximum density is not a meaningful term. Here we see the aggregate base being rolled by a vibratory roller.

An adequate density level should be determined by trial compaction of a control strip. Compaction should continue until no appreciable increase in density occurs without crushing the aggregate. This density level then becomes a standard benchmark level. Compaction of the permeable base roadway must then meet this standard.

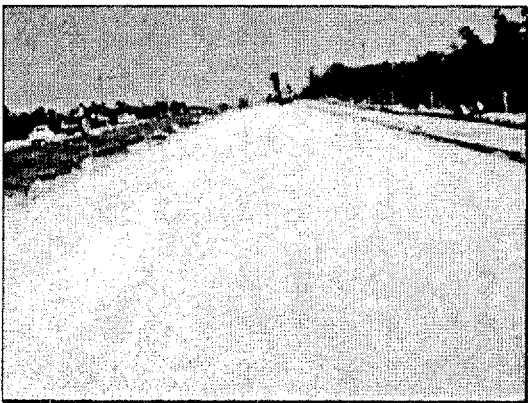

Here is a view of a completed base. Note that there are some tire tracks. This should not be a problem.



Again, we can see the “openness” of the permeable base. It is this openness that provides the permeable base with its permeability.

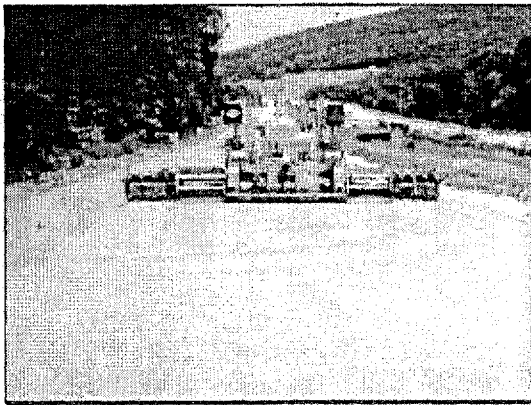

Here are some shots of a second field trip to New Jersey. The day we visited the site they were not placing any permeable base. We can see an asphalt paver, which is used to spread the unstabilized base material, at rest. Note that a string-line has been added for better horizontal and vertical control.

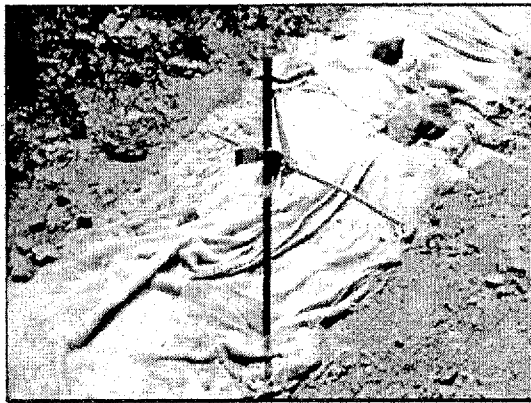

The stringline should improve the smoothness of the completed pavement.

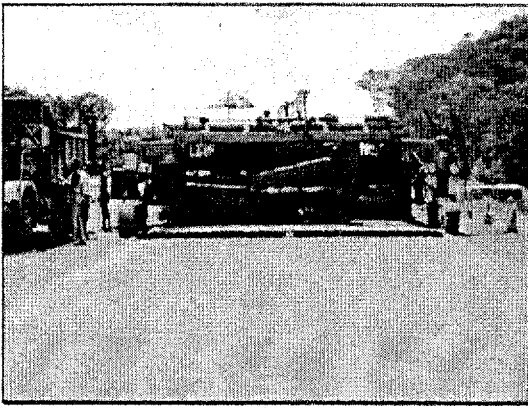

Concrete is being delivered to the paver from a haul road to the left. You can see a delivery truck backing up to the paver. This arrangement keeps all delivery truck traffic off the permeable base.

Paver is approaching an expansion joint (78 foot spacing). Paver spans the entire permeable base running directly on the aggregate separator layer.



Concrete is being delivered to the paver in a side delivery fashion. Again, there is no delivery truck traffic running on the permeable base.

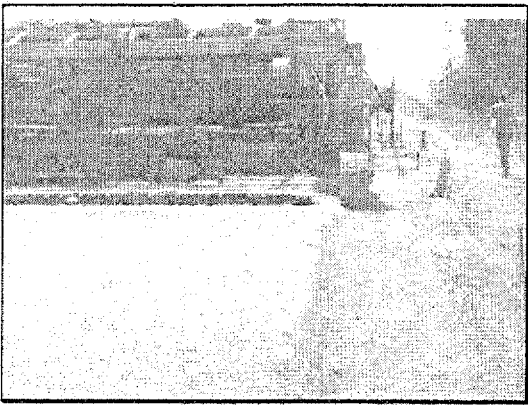

Paver spans the entire permeable base running directly on the aggregate separator layer.

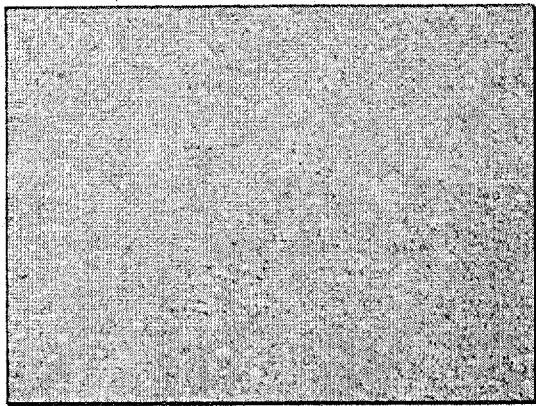

Here is a close-up of a completed New Jersey unstabilized permeable base.

SUMMARY

- Design/Construction Guidance Provided
- Use Good Quality Aggregate Material
- Use Sound Construction Practices
- Guideline Specifications for Unstabilized Permeable Bases Provided in Appendix

This session provided design/construction guidance for constructing unstabilized permeable bases. Good quality aggregates are a must for producing a permeable base with the proper balance of permeability/stability. Sound construction procedures should be used.

Guideline specifications for unstabilized permeable bases are provided in the Appendix.

**CONSTRUCTION of PAVEMENT
SUBSURFACE DRAINAGE
SYSTEMS WORKSHOP**

SESSION D

**Stabilized Bases
Asphalt Stabilized Bases
Cement Stabilized Bases**

Stabilized Bases module introduces stabilization with asphalt or cement as a means of increasing the strength of the base. Stabilization has two purposes. First to increase the strength of the base so that it will achieve the long-term performance that is expected. Second, is to provide enough strength to allow the pavement to be placed on top of it during the construction phase.

Stabilized bases are more open-graded and require the cement action of the stabilizer material to provide the necessary strength. Contractors should have the option of providing either material as a stabilizer.

AASHTO No. 67 gradation is provided as a possible gradation for stabilized permeable bases.

Asphalt & cement stabilized bases modules provides design/construction guidance for placing the bases. Good quality aggregates are a must for producing strong permeable bases. Sound construction procedures should be used. Emphasis is placed on placing and compacting the permeable base.

Guideline specifications for asphalt and cement stabilized permeable bases are provided in the Appendix.

SESSION OBJECTIVES

- Provide Design/Construction Guidance
- Explain the Need for Good Quality Aggregate Material
- Discuss Sound Construction Practices

At the completion of this session, participants should have a knowledge base for good design/construction guidance for asphalt & cement stabilized permeable bases.

Participants should be able to explain the need for good quality aggregates.

The participants should also be conversant with practical construction guidelines for asphalt & cement stabilized permeable bases.

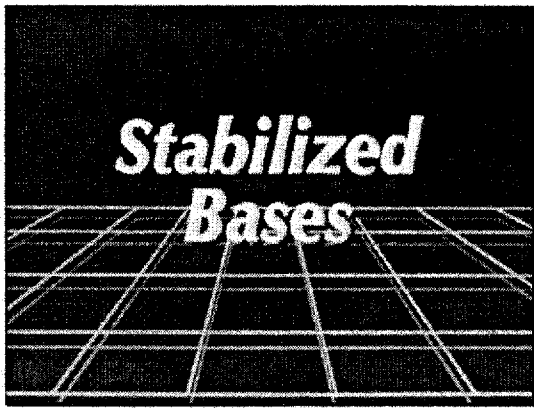

Now lets talk about stabilized permeable bases.

STABILIZED BASES

- **More open-grade material**
- **Cementing action of stabilized material at points of aggregate contact**

Stabilized bases are more “open” than unstabilized permeable bases. This can be seen by comparing the New Jersey unstabilized gradation with AASHTO No. 57 or 67. As a general statement, AASHTO No. 57 and 67 gradations will provide more permeability than required.

Stabilized bases obtain their strength by the cementing action of the stabilizer material. Aggregate materials are coated by the stabilized material. Any excess stabilized material will tend to flow to the where aggregates touch. When the stabilizer material hardens, the aggregate material will be “welded” together.

PRIMARY PURPOSE

Increase structural strength of the pavement section

The primary purpose of stabilization is to increase the strength of the pavement section so that long-term pavement performance can be achieved.

SECONDARY PURPOSE

Provide stability of the permeable base during the construction phase

The secondary purpose of providing stabilization is to provide the necessary strength to get the permeable base through the construction phase. The base must be strong enough to resist any construction traffic and the paving operation.

STABILIZER MATERIAL

Contractor may have the option of providing type of stabilizer

The Contractor should have the option of providing the stabilizer material – asphalt or cement.

AASHTO No. 67 GRADATION

<u>Sieve Size</u>	<u>Percent Passing</u>
1-1/2"	100
3/4"	90 – 100
3/8"	20 – 55
No. 4	0 – 10
No.8	0 – 5

This is the AASHTO No. 67 gradation which is also used for stabilized permeable bases. Most SHA's use an AASHTO No. 57 or 67 gradation with stabilized permeable bases.

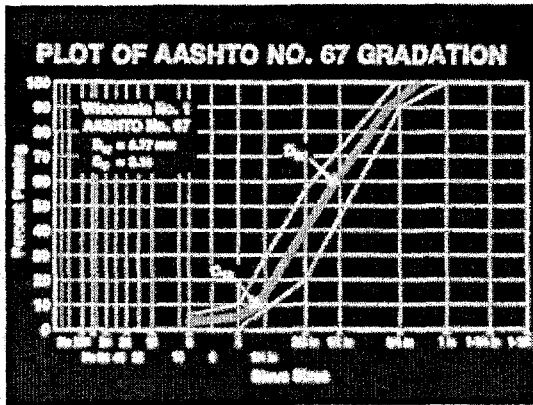

This slide shows a plot of the AASHTO No.67 gradation on FHWA power 0.45 paper. Analysis of this gradation reveals:
 Effective size = 5.77 mm
 Coefficient of Uniformity = 2.14

Now let's compare the differences between the New Jersey and AASHTO No. 67 gradations.

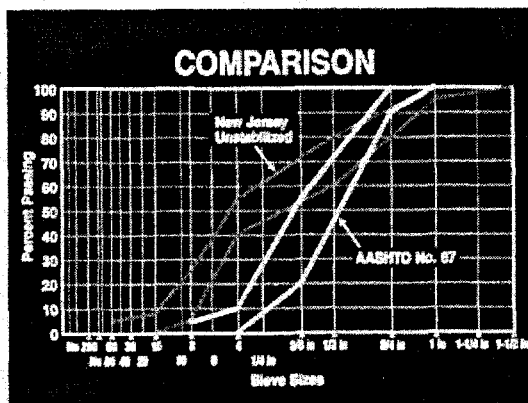

It is interesting to compare the New Jersey and AASHTO No. 67 gradations on the FHWA power 0.45 paper. The New Jersey gradation falls to the left of AASHTO No. 67 gradation. This indicates that the New Jersey unstabilized gradation has smaller material than the AASHTO No. 67 gradation with the AASHTO No. 67 having a larger effective size (D_{10}). This indicates that the AASHTO No. 67 gradation would have greater permeability. The actual permeability should be determined by a laboratory test.

The slope of the New Jersey gradation indicates that the C_u of the New Jersey would be greater than the AASHTO No. 67. This would indicate that the New Jersey Gradation would have more stability.

Visually, we have established a zone of permeability with the New Jersey unstabilized gradation having the lowest and AASHTO No. 67 having the greatest.

Stabilization is not a substitute for good quality aggregate.

STABILIZATION

Stabilization is not a substitute
 for good quality aggregates



Now let's look at an asphalt stabilized permeable base.

**MP1 98 PERFORMANCE
GRADED**

PG XX-YY

- **XX – 7 Day Average Maximum Temperature + °C**
- **YY – 7 Day Average Minimum Temperature - °C**

Structural mixture design of the pavement section is beyond the scope of this workshop, but we must have a working knowledge of the asphalt grading system.

In the MP1 98 "Performance Graded System," the first number (XX) is the 7 day average maximum pavement temperature (plus XX⁰ C) for a selected project geographical location. This number (XX⁰C) represents the hot weather temperature that the pavement must resist. This approach attempts to protect the pavement against permanent deformation (rutting).

The second number (YY) is the 7 day average minimum pavement temperature (minus YY⁰ C). This number (-YY⁰C) represents the cold weather temperature that the pavement must resist. This value protects the pavement from low temperature cracking.

These weather station temperature values are determined by Superpave Data Bind software or are available in **SHRP Report 648A, "Weather Database for the Superpave Mix Design System."**

MP1 98 EXAMPLE

PG 58 -22

- **58 - 7 Day Average Maximum Temperature + °C**
- **-22 - 7 Day Average Minimum Temperature - °C**

58⁰ C (136⁰ F) is the 7 day average maximum pavement temperature.

-22⁰ C (-7⁰ F) is the 7 day average minimum pavement temperature. Since the asphalt stabilized base will be covered by the pavement, it should not be subjected to this colder environment. Perhaps a warmer temperature could be specified.

MP1 98 PERFORMANCE GRADED

- **Asphalt Grade Should Be Determined by Pavement Engineer Using Superpave Software**
- **PG 76 - 22 or 76 - 16**

The asphalt grade should be determined by the pavement engineer using Superpave software.

An asphalt grade of PG 76 - 22 or 76 - 16 should be good for a major portion of the United States.

ASPHALT CONTENT

- **3 Percent**

FHWA recommends an application rate of 3 percent.

FHWA strongly recommends the use of an Anti-Stripping agent.

ANTI-STRIPPING AGENT

- **FHWA strongly recommends the use of a Anti-Stripping agent**

Most SHA's use an AASHTO No. 57 or 67 gradation with asphalt stabilization.

ASPHALT STABILIZED GRADATIONS

- **Most SHA's use an AASHTO No. 57 or 67 gradation with asphalt stabilization**

First, let us look at a bituminous stabilized open graded (BSOG) gradation used by New Jersey DOT

NEW JERSEY BSOG

<u>Sieve</u>	<u>Sieve</u>	<u>Percent Passing</u>
	1"	100
	3/4"	95 - 100
	1/2"	85 - 100
	3/8"	60 - 90
	No.4	15 - 25
	No.8	2 - 10
	No.16	2 - 5
	No. 200	*

* Add 2% mineral filler

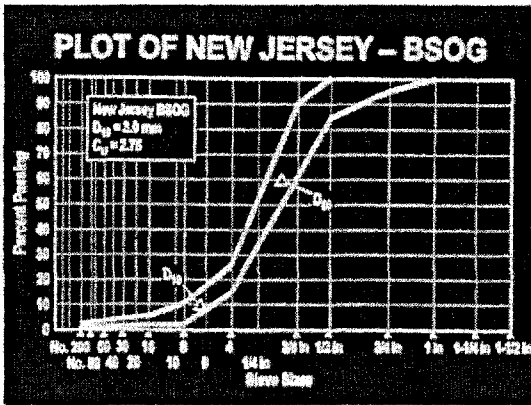

This slide shows a plot of the AASHTO No. 67 gradation on FHWA power 0.45 paper. Analysis of this gradation reveals:
 Effective size = 3.0 mm
 Coefficient of Uniformity = 2.75

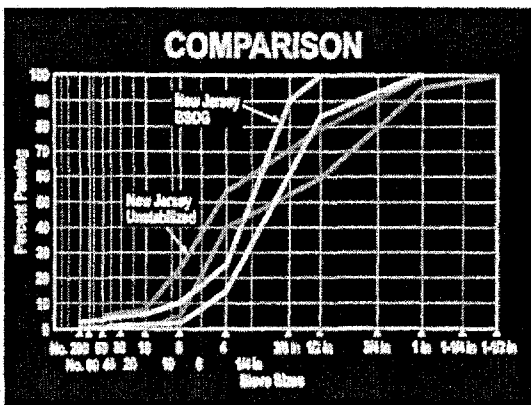

It is interesting to compare the New Jersey BSOG and Unstabilized gradations on the FHWA power 0.45 paper. The New Jersey BSOG gradation falls to the right of the unstabilized gradation. This indicates that the BSOG gradation has larger particle sizes, which in turn indicates that the BSOG gradation would have greater permeability. But the asphalt stabilizer material will fill up some of the voids.

The point we want to make here is that the coefficient of permeability should be determined in a soil laboratory.

Stability or strength is provided by the stabilizer material.

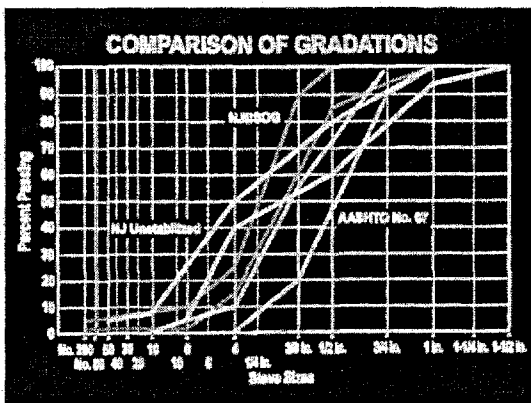

Now our comparison can be expanded by superimposing the AASHTO No. 67 gradation on the graph. Note that the NJBSOG gradation falls in the middle between the N.J. unstabilized and AASHTO No. 67 gradations. This indicates that the permeability would be an average of the other two gradations.

Again, the point we want to make here is that the coefficient of permeability should be determined in a soil laboratory.

Stability or strength is provided by the stabilizer material.

Now let's talk about placing and compacting asphalt stabilized permeable bases

Placing & Compacting Asphalt Stabilized Bases

PRE-HEAT AGGREGATES

- Aggregates should be heated to 275 – 325^o F

Temperature is extremely important in the mixing and lay-down phases of construction. If a harder grade of asphalt is used, the aggregates should be pre-heated to 275-325^oF.

HOPPER TEMPERATURE

200 – 250^o F

Temperature of the asphalt mix in the asphalt paver should be between 200-250^o F.

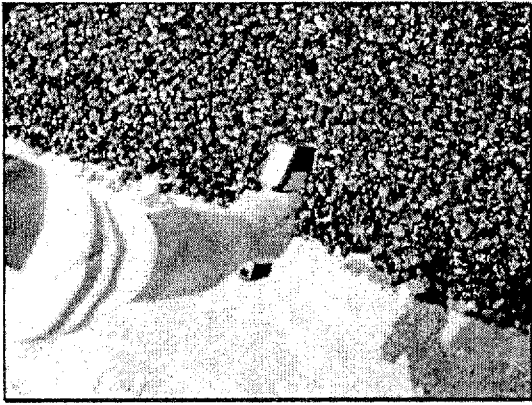

Rolling the asphalt mix before it has time to properly cool is recognized as a problem. The urge to start the compaction process should be restrained until the in-place mix has cooled to the proper temperature range.

COMPACTION TEMPERATURE

- **Cool to 150⁰ F**
- **Finish Before 100⁰ F**

The asphalt mat should cool to 150⁰ F before rolling is started. Rolling should be completed before the mat has cooled to 100⁰ F.

COMPACTION OF ASPHALT STABILIZED BASE

- **1 to 3 passes of 5-10 ton steel wheel roller**
- **No vibratory rollers**

FHWA recommends one to three passes of a 5-10 ton steel wheel roller to seat the material. Vibratory rollers can be used in the static mode.

Design Procedures used by the New Jersey DOT for quality control of the compaction effort for unstabilized permeable bases can also be used for asphalt stabilized.

IN-PLACE DENSITY

- **AASHTO T 191-93 Sand Cone Method**
- **AASHTO T 205-86 Rubber Balloon Method**
- **AASHTO T 238-97 Nuclear Methods**

The in-place density of the material can be determined by any one of these methods.

RESTRICTING TRAFFIC

Restrict traffic on ASPM bases for at least 1 day

Traffic on completed asphalt stabilized bases should be restricted for at least 1 day.

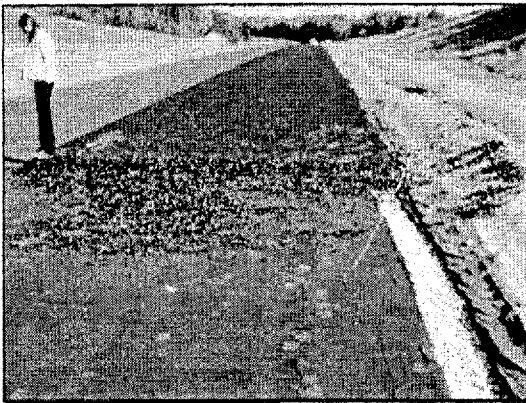

Now let's look at some field slides. Here we can see a number of elements of the pavement section:
Geotextile has been used as a separator layer.
Asphalt stabilized permeable base has been placed on top of the geotextile.
Edgedrain pipe and backfill have been constructed before the permeable base is placed.
Edge of geotextile will be folded over the completed edgedrain.

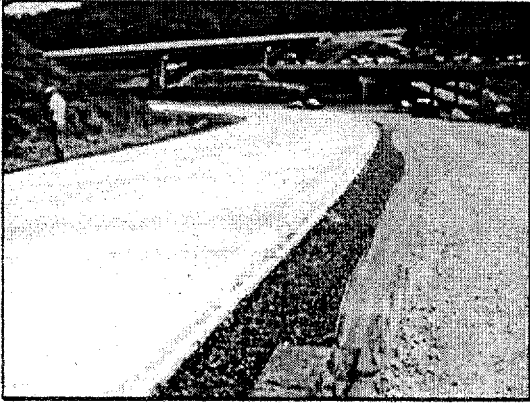

Again, we can see a number of elements of the pavement section:

Completed PCC pavement.

Asphalt stabilized material has been used as a permeable base.
Edge of geotextile will be folded over the completed edg drain.

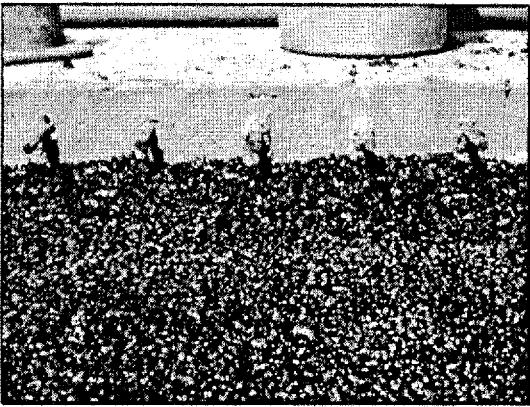

The construction joint created at end of the day's paving creates a special problem. The asphalt stabilized base should be placed and rolled past the end of the days concrete pavement paving so the area under the construction joint's dowel bars will be compacted for the next day's paving. It would be impossible to compact the areas between the dowel bars.

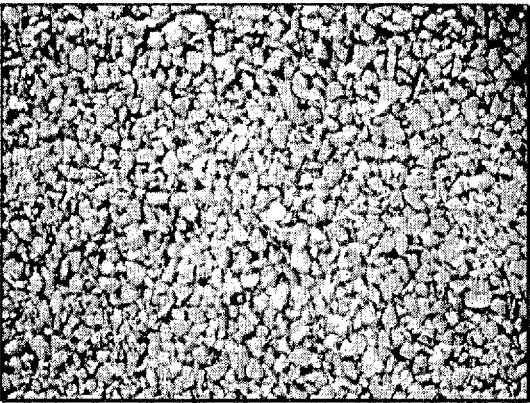

Here is a shot of a completed asphalt stabilized permeable base. Note the ever present quarter that is there for scale. Also note the "openness" of the completed base.

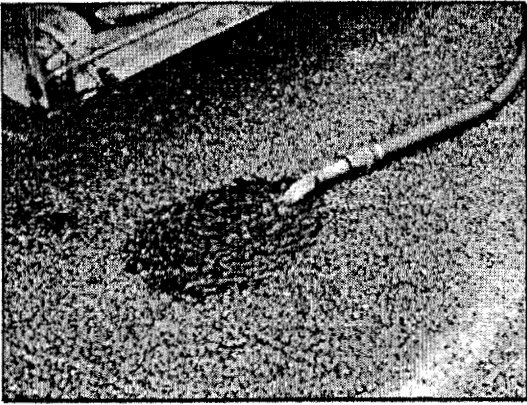

The permeability of the asphalt stabilized base is demonstrated by discharging water from a tanker truck directly on top of the permeable base. Note how small the wetted area is.



In about a minute, water is being discharged from the edgedrain pipe.

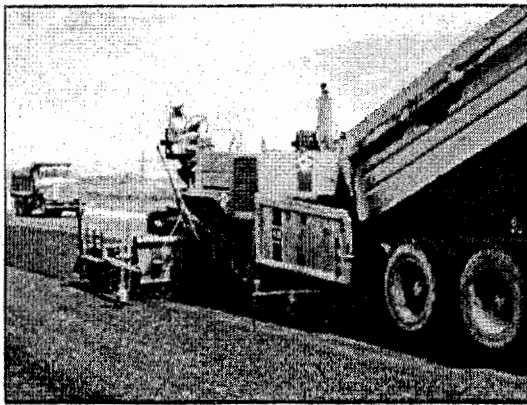

Now, let's look at a series of construction shots. Here we see the asphalt stabilized material being dumped into the hopper bin of an asphalt paver.

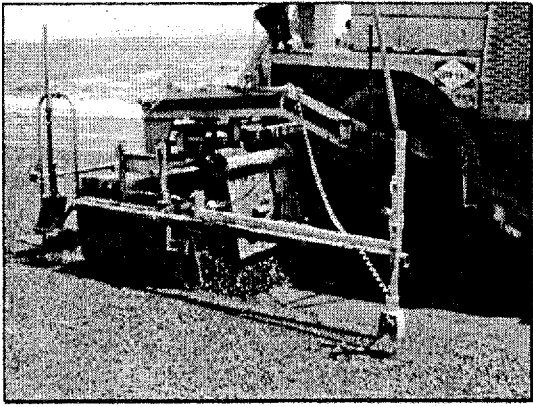

The asphalt material is then spread on top of the DGAB. The depth of the layer is controlled by a traveling shoe.

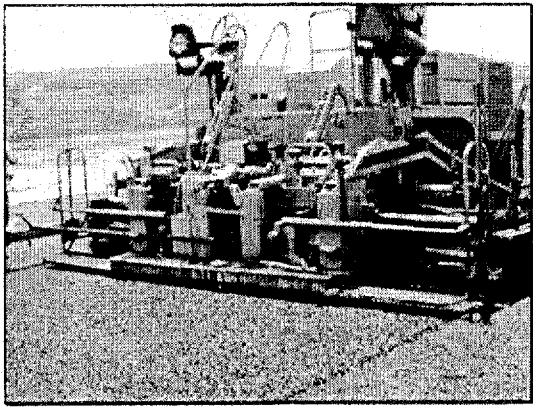

Here we see a fresh ribbon of asphalt stabilized material before it is rolled.

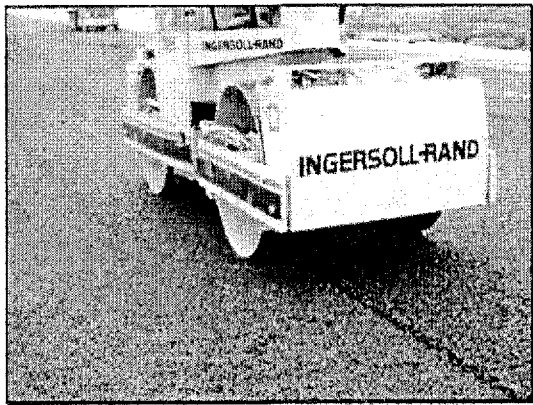

To the left, the previous pass of the paver has been rolled and compacted.

To the right, the freshly placed asphalt mat is being carefully rolled to compact it. The new pass is about $\frac{3}{4}$ " higher than the previously rolled material. This difference is called "rolldown."

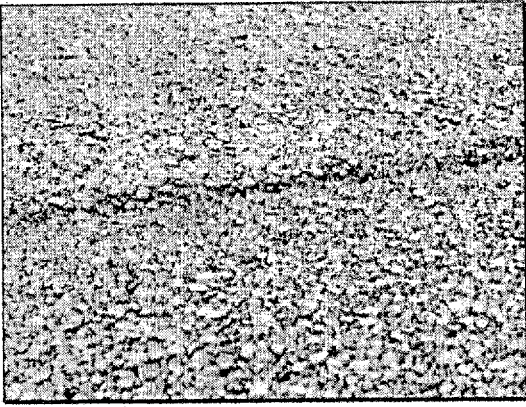

Closer view of the rolldown.

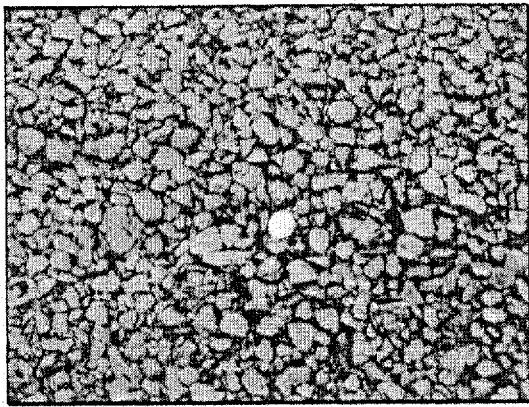

Close-up of completed asphalt stabilized permeable base.

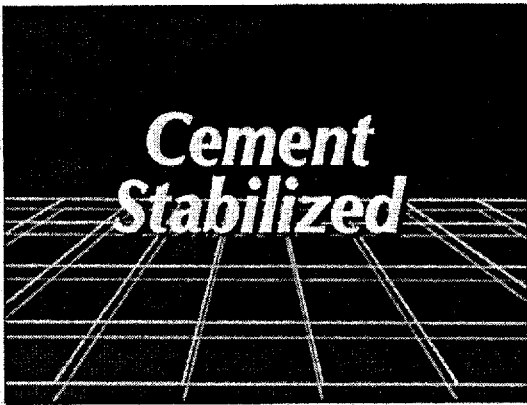

Now let's talk about cement stabilized permeable bases.

TYPE OF CEMENT

- Types I, I-P, or II
- Portland Cement
- ASTM C 150-97

Cement should be Type I, I-P, or II Portland cement in accordance with ASTM C 150-97, "Portland Cement".

CEMENT TREATED

Portland Cement 2 to 3 bags
per cu. yd.

The application rate of Portland cement is usually 2 to 3 bags of cement per cubic yard of concrete.

CEMENT STABILIZED GRADATIONS

- Most SHA's use an AASHTO No. 57 or 67 gradation with cement stabilization

Most SHA's use an AASHTO No. 57 or 67 gradation with cement stabilization.

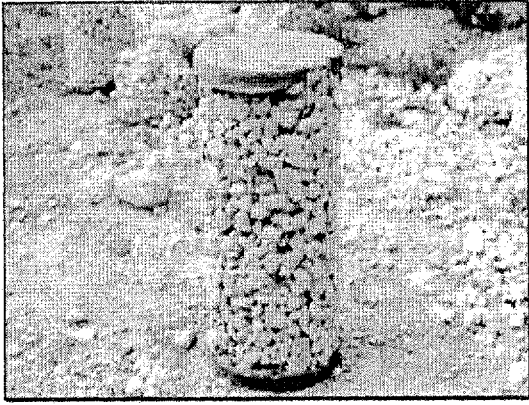

Here we see a concrete test cylinder (not a core). This slide makes two (2) points. First, the cement stabilized has considerable strength since it is free standing. Second, the interconnecting voids provide channels to drain any infiltrating water. This is what gives the mix permeability.

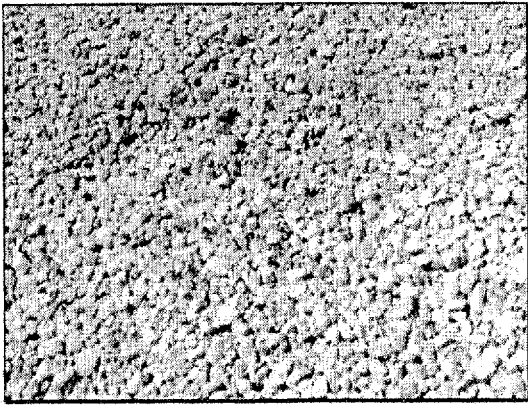

Close-up of a cement stabilized permeable base. Note how “rough” the surface appears. It is this “openness” that gives the mix its permeability.

Placing & Compacting Cement Stabilized Bases

Now let's talk about placing and compacting cement stabilized permeable bases

COMPACTION OF CEMENT STABILIZED BASE

**Vibratory screeds set base
material**

Vibratory screeds attached to the rear of the paver should seat the cement stabilized material.

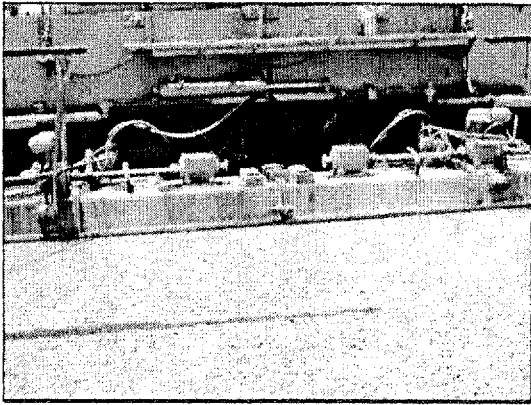

This slide shows the vibratory screeds attached to the rear of the paver. Vibration from the screeds will be enough to “seat” the mix and provide some compaction.

CURING

- **Polyethylene Sheeting**
- **Fine Mist Curing**
- **Curing Compound**

Cement stabilized permeable bases can be cured using one of the three following methods:

Polyethylene sheeting

Fine mist curing

Curing compound

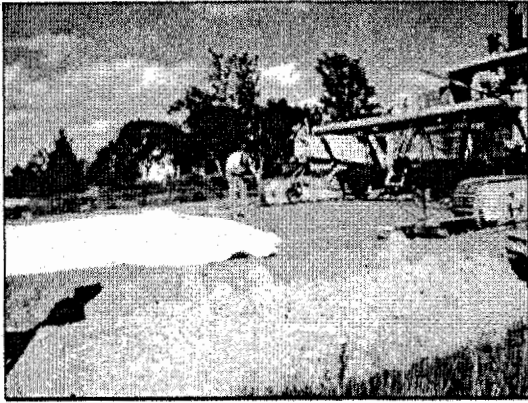

If polyethylene sheet curing is used, it should be placed as soon as practicable.



The major problem with sheeting is that it has to be secured against the wind.

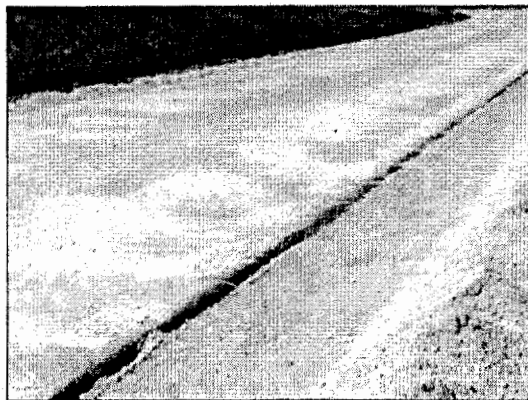

After the cement stabilized base has cured, the dirt holding the sheeting and the sheeting must be removed.

SHEETING

Minimum of 3 Days Coverage

Sheeting coverage should last a minimum of 3 days.

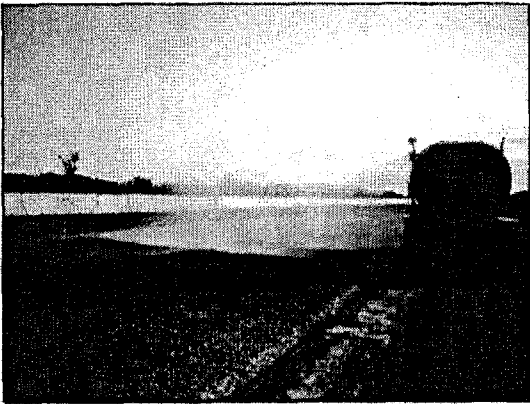

Fine mist spraying is another method for curing the cement stabilized base. Here we see the completed cement stabilized permeable being sprayed with a fine mist.

FINE MIST CURING

- **Fine Mist cure every 2 hours for 8 hours**
- **Start curing the next day**

One SHA recommends that the cement stabilized base be sprayed every two (2) hours for a period of eight (8) hours with the curing starting the next day.

CURING COMPOUND

- 1 gal. per 16.5 sq. yd.
- Liquid Membrane
- ASTM C 309-94

Curing compound is the last method of curing. Curing compound should be applied at a rate of one (1) gallon per 16.5 sq/yd. and should be in accordance with ASTM C309-94, Liquid Membrane.

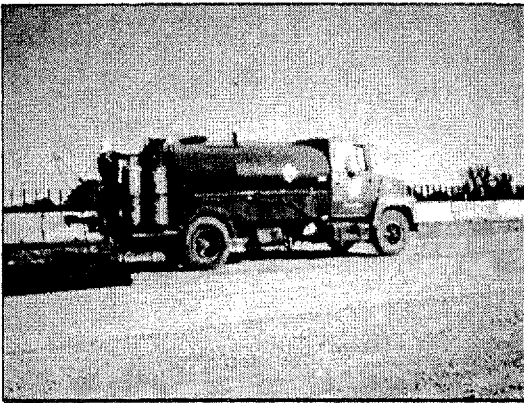

Asphalt emulsion spraying serves two functions. First, the asphalt emulsion coating will provide a line of demarcation between the cement stabilized base and the concrete pavement when the pavement is cored for payment. Second the asphalt emulsion will provide curing.

RESTRICTING TRAFFIC

- Restrict traffic on CSPM bases for 7 days

Traffic should be restricted from running on the completed permeable base for at least 7 days.

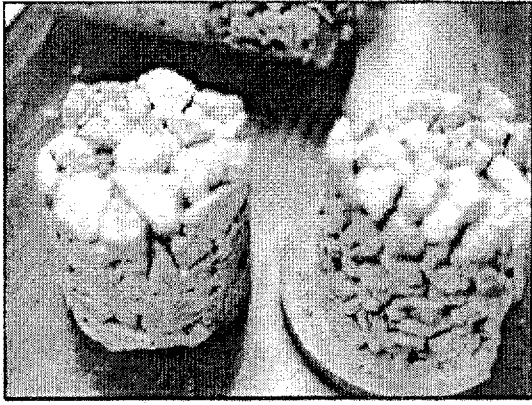

Now let's look at some field slides. Here we see some cylinder samples from a cement-stabilized permeable base. Again we can see strength because the sample has remained intact after being extracted. The interconnected openings provide the material with its permeability. The sample on the right has had its gradation adjusted by making the top sieve size equal to 1 inch.

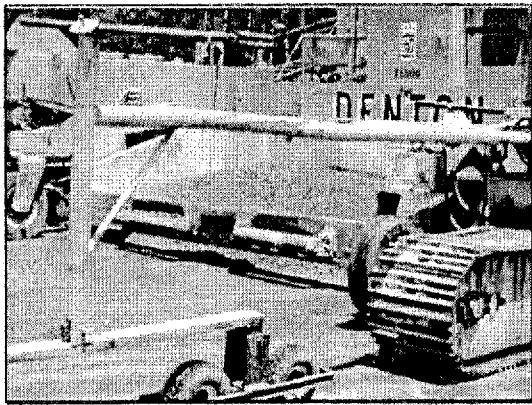

The cement-stabilized material is dumped in front of a concrete paver.

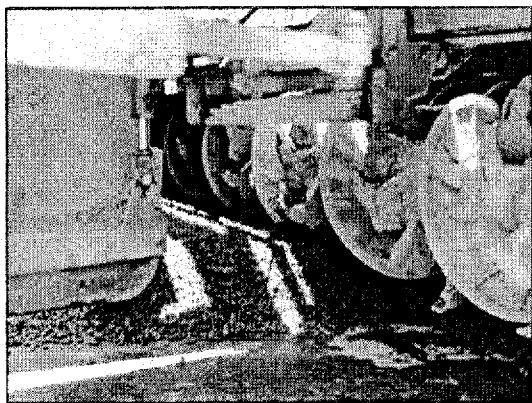

The cement-stabilized material is a rather "harsh" mix. The huge augers of the concrete paver are necessary to distribute the cement-stabilized material. For these reasons, a concrete paver is recommended to spread the cement-stabilized material.

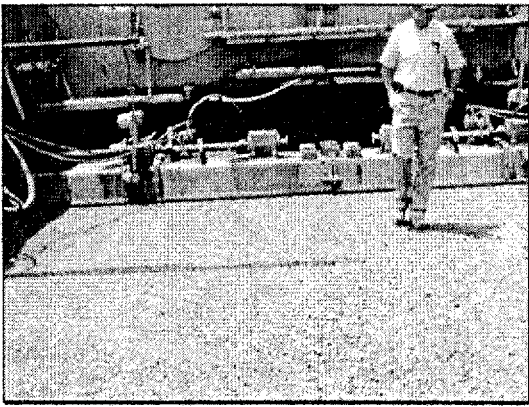

We can see the vibratory screeds that are use to seat the base. The base has considerable strength. Note that foot traffic on the base does not tear up the surface.

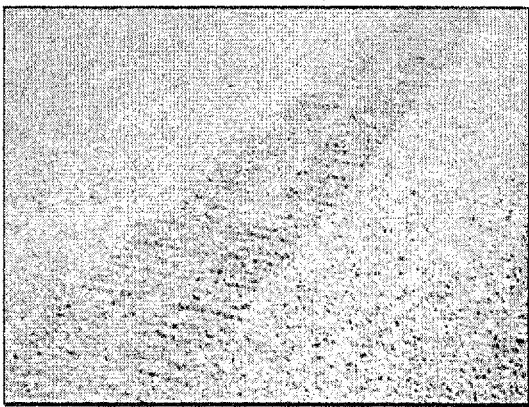

We can see paver tracks left in the permeable base. It is very difficult to adjust the surface of the cement stabilized base. These tracks should not affect the overall performance of the pavement.

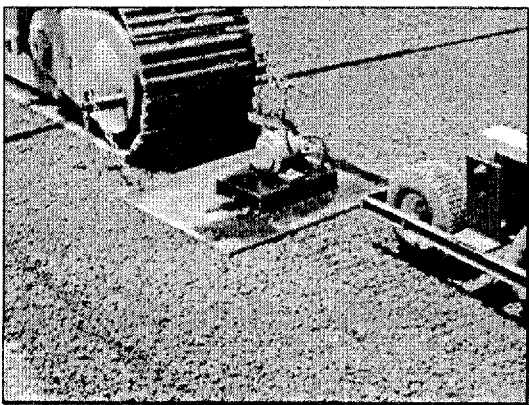

An attempt was made to smooth out the track marks by dragging a vibratory pad behind the paver track.

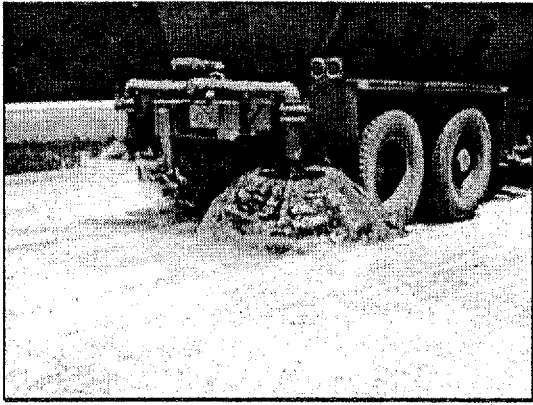

The permeability of the completed base is demonstrated by dumping water from a tanker truck directly on to the permeable base. Note that there is little spread of the discharging water. All of the water is adsorbed directly into the permeable base.

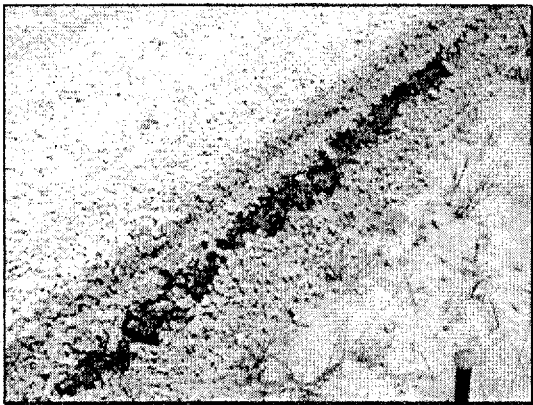

About one and a half (1-1/2) minutes later, the water began to discharge from the side of the permeable base.



In several minutes a steady flow of water occurs from the permeable base, and the engineers discover that water still runs down hill.

An important point to remember is that storm water runoff during the construction phase should be considered.

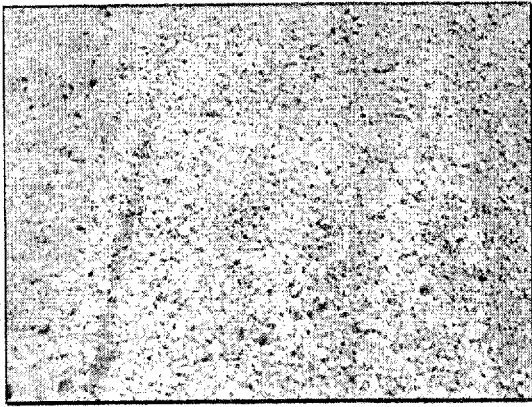

Several minutes after the test was completed the base was examined. No ponding water could be identified. The surface was only damp where the water had been discharged.

SUMMARY

- Design/Construction Guidance Provided
- Use Good Quality Aggregate Material
- Use Sound Construction Practices
- Guideline Specifications for Asphalt & Cement Stabilized Bases Are Provided in Appendix

This session provided design/construction guidance for constructing asphalt and cement stabilized permeable bases. Contractors should have the option of providing either material as a stabilizer. Good quality aggregates are a must for producing strong permeable bases. Sound construction procedures should be used.

Guideline specifications for asphalt and cement stabilized permeable bases are provided in the Appendix.

**CONSTRUCTION of PAVEMENT
SUBSURFACE DRAINAGE
SYSTEMS WORKSHOP**

SESSION E

**Design Considerations
Aggregate Separator Layer**

Design Considerations that apply to all types of permeable bases will be presented. Emphasis will be placed on control strips and construction considerations.

Aggregate separator layer is the second element of a pavement subsurface drainage system. This element is the most overlooked one in drainage design. Design/construction guidance for the aggregate separator layer will be presented. Emphasis will be placed on providing good quality aggregate materials. Good quality aggregates are a must for producing an aggregate separator layer with adequate stability to serve as a construction platform.

Sound construction procedures should be used.

Guideline specifications for aggregate separator layer are provided in the Appendix.

SESSION OBJECTIVES

- Provide Design/Construction Guidance
- Discuss Design Considerations for Permeable Bases
- Explain the Need for Good Quality Aggregate Material Discuss
- Discuss Sound Construction Practices

At the completion of this session, participants should have a knowledge base for good design/construction guidance for an aggregate separator layer bases.

Also, participants should understand other design considerations that apply to all types of permeable bases

Participants should be able to explain the need for good quality aggregates.

The participants should also be conversant with practical construction guidelines for unstabilized permeable bases.

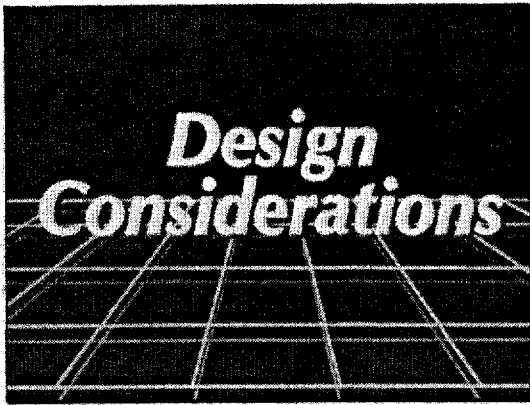

Now let's look at some design considerations that are applicable to all types of permeable bases.

CONTROL STRIP

- **FHWA recommends use of a control strip**
- **Test combination of aggregate materials and construction practices**

To repeat, FHWA strongly recommends the use of a control strip before the main paving operations begin. It is necessary to test the combination of aggregate materials and construction procedures that will be used in the main paving operation.

CONTROL STRIP

- **Minimum Length – 500 ft.**
- **Becomes part of finished roadway (if acceptable)**

Guidance concerning control strips has already been provided in the unstabilized and asphalt stabilized sections. Alternate guidance is shown here in which a 500 foot long section is constructed. If the control section is adequate, it can be incorporated into the finished roadway.

CONSTRUCTION CONSIDERATIONS

- **Quality**
 - Aggregate
 - Construction
- **Proper Application Rates**
- **Tracked Pavers**
- **Difficult to Trim Surface**

CONSTRUCTION CONSIDERATIONS

- **Compaction**
- **Construction Traffic**
- **Maintain Minimum Slope**
- **Incentive/ Disincentive Ride Requirements**

PERMEABLE BASE THICKNESS

- **Minimum Thickness – 4 inches**
- **Based on Construction Considerations**

To summarize below are some construction considerations:

Quality

Aggregates - Should be both hard and durable.

Construction - Good construction is necessary to ensure that all of the pieces come together.

Proper Application Rates - Stabilizer material should be applied at the proper application rate to ensure that the permeable base functions as intended.

Tracked Pavers should be used to prevent rutting of lower layers.

Difficult to Trim Surface - Surfaces of permeable bases are difficult to trim. Care should be taken to get the grade correct the first time.

Compaction - Compaction is the key to a successful permeable base. Compaction should be just right to balance the needs of stability and permeability.

Construction Traffic - Construction traffic is an important consideration for permeable bases. Coordination with the construction steps is vital. Construction traffic should be kept to a minimum.

Maintain Minimum Slope - A minimum slope of 2.0 percent (0.02 ft/ft) should be maintained to insure drainage of the permeable base.

Incentive/Disincentive Ride Requirements - If these recommendations are followed, the Contractor should be able to get a strong smooth permeable base and obtain any positive incentives.

Permeable bases of all types should have a minimum thickness of four (4) inches.

While there is no maximum thickness stated, the thickness of the permeable should not be increased since we are stacking up a material that is unstable.

This thickness is based on practical construction considerations rather than any hydraulic computations.

THICKNESS

Pavement drainage is not a substitute for pavement thickness or a strong subgrade

We must always remember that pavement drainage is not a substitute for pavement thickness or a strong subgrade. The point that we want to make here is that pavement subsurface system is provided to solve an excess water problem in the pavement section.

A drainage system should not be provide just to reduce the required pavement thickness determined by the structural design of the pavement section.

A strong subgrade is still required to provide a work platform for the drainage layers.

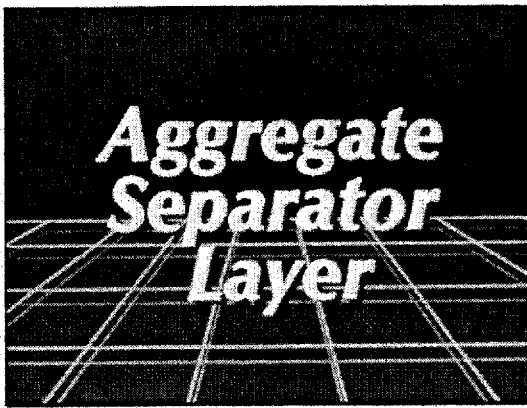

Now let's look at our second element of pavement drainage, the aggregate separator layer. The aggregate separator layer is extremely important since it keeps fines in the subgrade from migrating up into the permeable base.

AGGREGATE SEPARATOR LAYER

- Stability
- Filtration
- Permeability

The aggregate separator must provide the following functions: Stability, Filtration, and Permeability

First, the aggregate separator must provide the necessary stability (strength) to serve as a construction platform for the next layer.

Second, the aggregate separator must provide filtration. This means that the layer must retain the smaller size particles in the subgrade while providing a degree of permeability.

Third, the aggregate separator layer should have the right amount of permeability to meet its role to meet the design of the pavement section. For example, if vertical drainage is intended, the aggregate separator layer must have enough permeability to transmit the infiltration water to the subgrade.

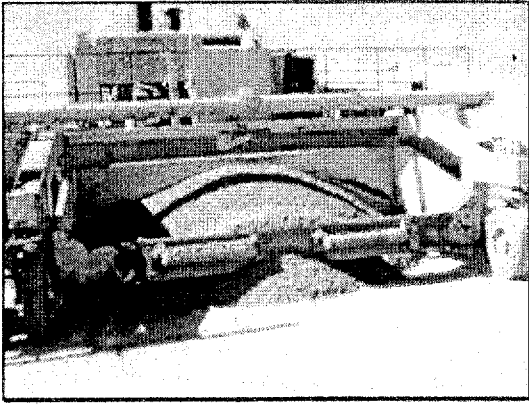

The aggregate separator must have the necessary stability (strength) to serve as a construction platform for the next layer. Here we see the permeable base being spread on the aggregate separator layer.

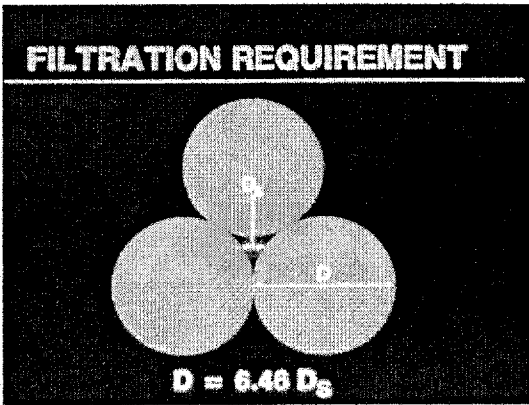

Filtration means that an aggregate separator must be able to prevent fine from moving through the permeable base and yet retain some degree of permeability. In this sketch, we see that the target sphere (D_s) will be retained until the retaining sphere (D) becomes larger than 6.46 times the target sphere.

NEW JERSEY DGAB

<u>Sieve Size</u>	<u>Percent Passing</u>
1-1/2"	100
3/4"	55 - 90
No. 4	25 - 60
No. 50	5 - 25
No. 200	3 - 12

The New Jersey Gradation DGAB should function well as an aggregate separator layer.

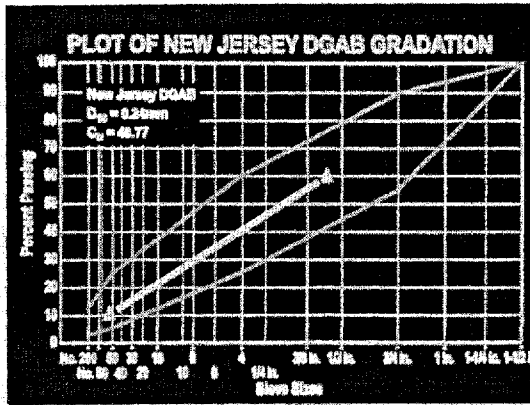

This slide shows a plot of the AASHTO No. 67 gradation on FHWA power 0.45 paper. Analysis of this gradation reveals:
 Effective size = 0.24 mm
 Coefficient of Uniformity = 46.77

- AGGREGATE SEPARATOR LAYER**
-
- Class C Aggregate
 - AASHTO M 283 – 83
 - L.A. Abrasion Wear Not to Exceed 50 Percent

Again our goal is to provide quality aggregate material. The old ASTM M 283 - 83 still provides good guidance for aggregate materials. L.A. abrasion wear should not exceed 50 percent. If more durable aggregates are available, the specification requirement should be lowered. The test should be conducted in accordance with AASHTO T 96-94, "Los Angeles Machine".

- SOUNDNESS**
-
- AASHTO T 104-97
 - Sodium Sulfate - 12%
 - Magnesium Sulfate - 18%

Soundness is another measure of an aggregate's durability. Material loss should not exceed 12% for Sodium Sulfate or 18% for Magnesium Sulfate testing.

Placing & Compacting Aggregate Separator Layer

Now let's talk about placing and compacting the aggregate separator layer.

COMPACTION

- **95 Percent Maximum Density**
- **The Moisture-Density Relations of Soils Using a 4.54-kg (10-lb) Rammer and a 457-mm (18-in) Drop**
- **AASHTO T 180 - 97**

Since strength is a requirement of any aggregate separator layer, we can return to our requirement of 95 percent density. The test for density should be performed in accordance with AASHTO T 180-97, "The Moisture- Density Relations of Soils Using a 4.54 kg (10 - lb) Rammer, and a 457 mm (18 - in) Drop".

IN-PLACE DENSITY

- **AASHTO T 191 – 93 Sand Cone Method**
- **AASHTO T 205 – 86 Rubber – Balloon Method**
- **AASHTO T 238 – 97 Nuclear Methods**

The in-place density of the material can be determined by any one of these methods:

AASHTO T 191-93 "Sand Cone Method"

AASHTO T 205-86 "Rubber Balloon Method"

ASSHTO T 238-97 "Nuclear Methods"

It is important to run the same test throughout the project to maintain consistency.

LAYER THICKNESS

**Minimum Thickness - 4 Inches
Based on Construction
Considerations**

The aggregate separator layer should have a minimum thickness of four (4) inches. This thickness is based on practical construction considerations.

CONSTRUCTION CONSIDERATIONS

- **Quality of Aggregates**
- **Compaction**

To summarize the aggregate materials used in the aggregate separator layer must be good quality (hard, durable, and angular) aggregates.

SEPARATOR LAYER SUMMARY

- **Required to keep fines from migrating into permeable base**
- **Recommend dense graded aggregate base**

To summarize, an aggregate separator layer is recommended to keep fines from the subgrade from migrating into the permeable base.

FHWA recommends a dense graded aggregate base to provide a stable construction platform for the pavement section.

SUMMARY

- **Design Considerations for Aggregate Separator Layer**
- **Design/Construction Guidance Provided**
- **Use Good Quality Aggregate Material**
- **Use Sound Construction Practices**
- **Guideline Specifications for Aggregate Separator Layer in Appendix**

This session provided design considerations that apply to all types of permeable bases.

This session provided design/construction guidance for constructing aggregate separator layer.

Good quality aggregates are a must for producing a permeable base with the proper balance of permeability/stability.

Sound construction procedures should be used.

Guideline specifications for an aggregate separator layer are provided in the Appendix.

**CONSTRUCTION of PAVEMENT
SUBSURFACE DRAINAGE
SYSTEMS WORKSHOP**

SESSION F

Edgedrains

SESSION OBJECTIVES

- **Provide Design/Construction Guidance**
- **Discuss the Need for Adequate Strength Pipe & Geocomposites, and Dual Outlets**
- **Explain the Need for the System to be Intact after Construction Phase**

Edgedrains are the third and final element in a pavement drainage system. If the water cannot exit the edgedrain system, the pavement section will become saturated and lose strength. From a pavement performance viewpoint, a saturated pavement section is worse than a no-drainage system.

Design/construction guidance for constructing longitudinal edgedrain systems will be provided. Both conventional pipe and geocomposite edgedrains will be discussed. Emphasis will be placed on providing conventional pipes and geocomposites that can withstand construction loads and heavy wheel loads.

Design & construction engineers must consider maintenance needs in designing and building the edgedrain system.

It is imperative that the edgedrain system be intact and functioning at the end of the construction phase.

At the completion of this session, participants should have a knowledge base for good design/construction guidance for conventional pipe and geocomposites.

Participants should recognize the need for adequate strength pipe and geocomposites to resist heavy wheel loads.

Participants should know that dual outlets provide two avenues of access for video inspection and cleaning equipment for the edgedrains.

Participants should recognize that the edgedrain system must be intact and functioning at the end of the construction phase.

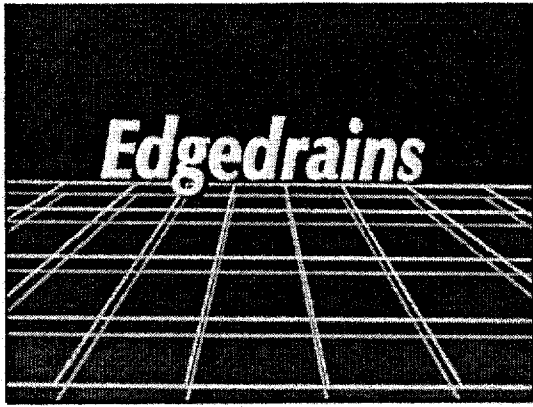

Now let's talk about the third element of a subsurface drainage system, **Edgedrains**.

TYPES OF EDGEDRAINS

- Aggregate Trench
- Conventional Pipe
- Geocomposite Fin Drains

There are three basic types of edgedrains: aggregate trench, conventional pipe, and geocomposite fin drains.

An aggregate trench edgedrain is simply a trench filled with a permeable gradation aggregate such as AASHTO No. 57 or 67. This type of drain is also known as a "**French**" drain. Since this trench will have a low flow capability and cannot be flushed or maintained it will not be discussed in this presentation.

Conventional pipe will have a high flow capacity and can be cleaned and maintained.

Geocomposite fin drains cannot be readily cleaned and maintained. They may have a role in the retrofit edgedrain applications where the flow rates would be low.

DEFINITIONS

- Edgedrains –
Pipe Systems Parallel to
Roadway
- Underdrains –
Everything else

Underdrains is a term that can vary between SHA's. Most SHA's label underdrains as drains that: remove water from cut sections, are used when unexpected groundwater is encountered, are transverse drains under the roadway.

A very simplistic definition of edgedrains and underdrains follows:

Edgedrains - Pipe systems with outlet pipes that are parallel to the roadway whose purpose is to remove infiltrated groundwater.
Underdrains - Everything else.

Underdrains are outside the scope of this drainage workshop.

Design/construction guidance used for edgedrains would also apply to underdrains.

PROBLEM SLOPES

- Sag Vertical Curves $S = 0$
- Horizontal Curve Transitions $S_x = 0$
- Level Roadway $S = 0$

Because water runs downhill we have a problem whenever the roadway slope is equal to zero. Below is a list of problem slopes:

Sag vertical curve $S = 0$
Horizontal curve transitions $S_x = 0$
Level roadway $S = 0$

Where S = roadway longitudinal slope, and S_x = roadway cross slope.

Slope is the driving force that allows drainage to occur. Without slope there is no real drainage.

At the bottom of every sag vertical curve, the longitudinal slope (S) will be equal to zero. When horizontal curves are encountered, as the roadway curve transitions from a normal section to a superelevated section at some point the cross slope S_x will be equal to zero.

For level roadways, the longitudinal slope (S) will be equal to zero.

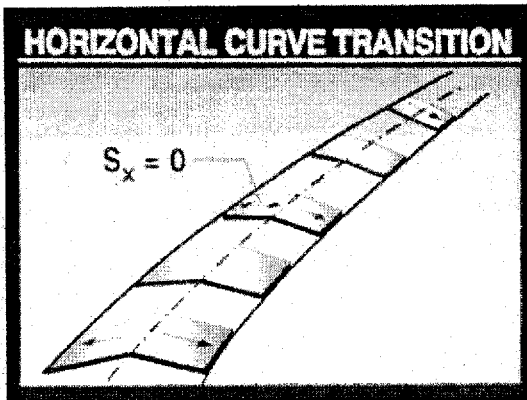

This sketch shows that when the roadway transitions from a normal crown section in the lower left to a super elevated section in the upper right at some point the cross slope S_x will be equal to zero. Whenever the cross slope is equal to zero, we have a potential drainage problem.

GEOTEXTILE PLACEMENT AROUND EDGEDRAIN

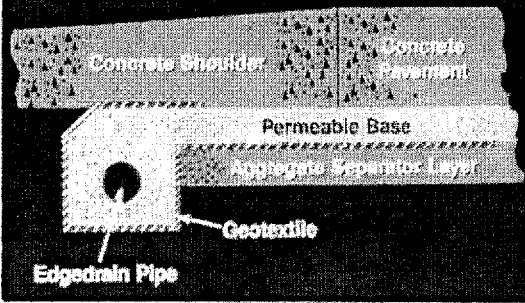

Now let's review our basic construction steps:

First, the aggregate separator layer, shown in orange, would be placed.

Next an edg drain trench would be dug and lined with a geotextile.

Then the permeable base, shown in yellow, and the pipe edg drain would be constructed.

The main pavement would then be placed with the paver tracks running directly on top of the permeable base.

After the paver passes, the geotextile would be folded back over top of the edg drain and the shoulder would be completed.

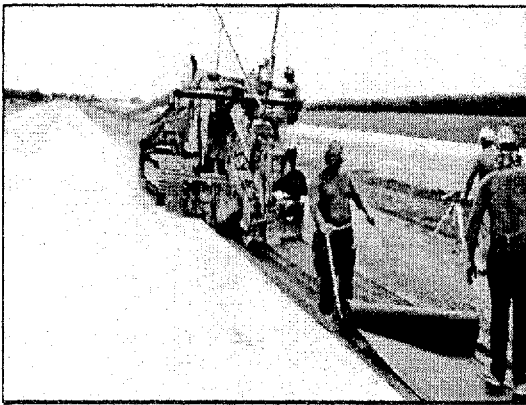

Now let's look at some actual edg drain construction. Here we see the edg drain being installed in a **post-pave** (retrofit) fashion. The pavement has been placed, and the edg drain trench is being dug by a trencher.

The geotextile fabric is being unrolled and placed in the trench.

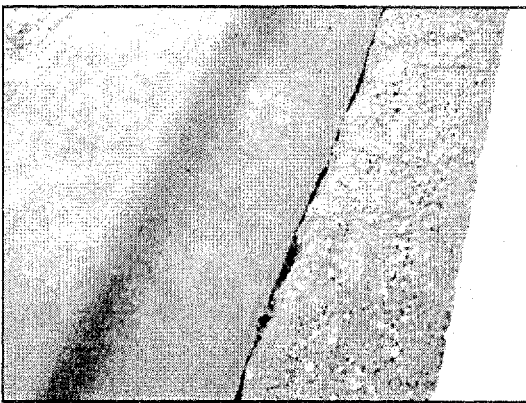

Note that the trench has been dug approximately 18 inches off of the edge of the pavement. The trench is moved off from the edge of the pavement to prevent any possible undermining of the pavement section. The geotextile fabric has been placed in the edg drain trench.

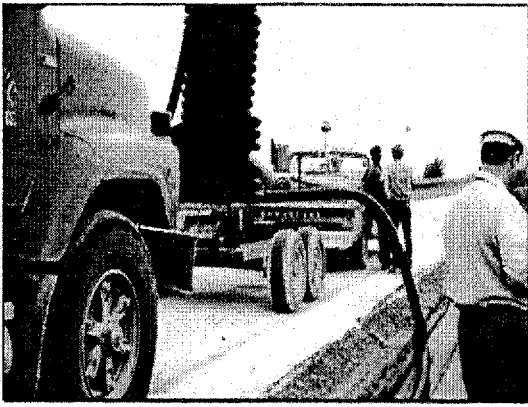

The flexible, black, corrugated, pipe is being unrolled from a spool and placed in the trench.

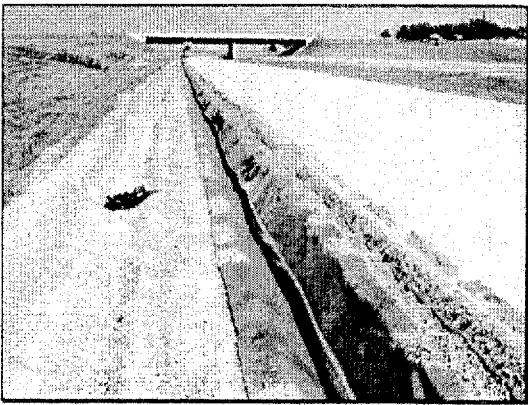

The pipe has been placed in the trench. Shovelfuls of aggregate hold the geotextile in place.

The outlet pipes will be cut in and connected to the mainline with 4"X4" tees.

We can see the trench backfill operation in the upper left side.

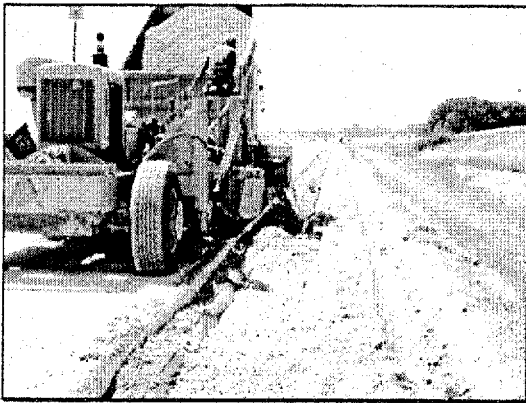

This backfilling operation is rather sloppy. It would be difficult to fold the geotextile back over the edgedrain trench.

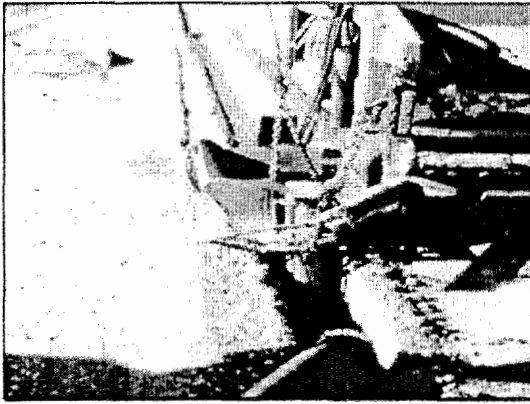

Here we see an interesting edgedrain installation in Iowa. The black, flexible, corrugated plastic pipe is threaded into a sleeve arrangement that holds the pipe in place while trench backfill aggregate is placed around the pipe. The sleeve holds the pipe in proper vertical and horizontal alignment as the laying operation proceeds down the road. Backfill aggregate is fed into the hopper and drops down around the pipe. The sleeve arrangement holds the pipe in place while the aggregate flows around the pipe.

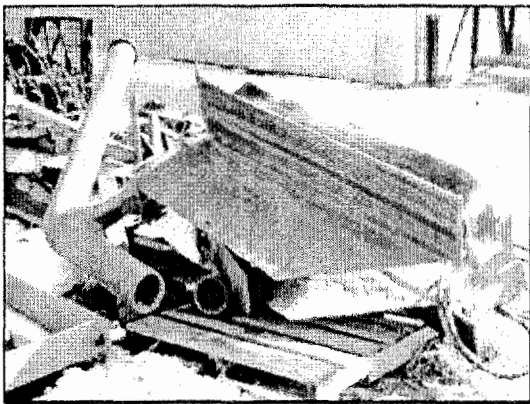

Here is a view of the sleeve in the storage yard. The flexible pipe is threaded into the top of the sleeve in the upper left of the slide. In the center of the slide a hopper arrangement will drop the aggregate backfill down on to a flap that will distribute the material.

**CORRUGATED
POLYETHYLENE PIPE
(CPE)**

- **Corrugated Polyethylene
Drainage Pipe**
- **AASHTO M 252**

Flexible, black corrugated polyethylene pipe (CPE) should conform to AASHTO M252, "Corrugated Polyethylene Drainage Pipe (CPE)."

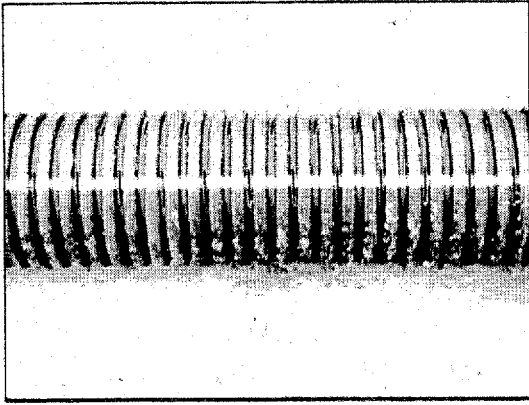

Here we see a field shot of a Corrugated Polyethylene Pipe (CPE). Note that the slot openings appear to be quite small.

New generations of CPE are “stiffer” and stronger.

SMOOTH INTERIOR CPE PIPE

- **Corrugated Polyethylene
Drainage Pipe**
- **AASHTO M 252 - Type SP**

Dual Wall or smooth interior Corrugated Polyethylene Pipe should conform to AASHTO M252, “Corrugated Polyethylene Drainage Pipe SP.”

POLYVINYL CHLORIDE PIPE (PVC)

- **Class PS 46 Polyvinyl
Chloride (PVC) Pipe**
- **AASHTO M 278**

Polyvinyl chloride pipe (PVC) should conform to AASHTO M 278, “Class PS 46 Polyvinyl Chloride (PVC) Pipe.”

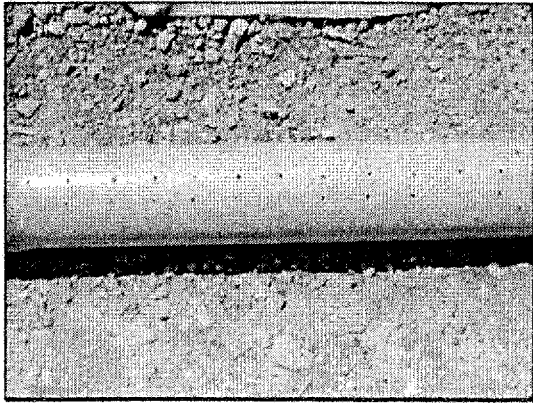

Field shot of PVC pipe. Note that the openings appear to be quite small.

CORRUGATED-SMOOTH PIPE

- **PVC Corrugated Sewer Pipe with a Smooth Interior**
- **ASTM F 949**

By combining corrugations with the interior lining of the pipe, the strength of the PVC pipe can be increased. The pipe should conform to ASTM F 949, "PVC Corrugated Sewer Pipe with a Smooth Interior."

ASTM TRENCH BACKFILL

Edgedrain pipe should be capable of resisting ASPM

If the edgedrain trench is backfilled with asphalt stabilized material, the edgedrain pipe should be capable of resisting the heat.

HEAT RESISTANT PIPE

- **PVC 90° Electric Plastic Conduit**
- **EPC-40 or EPC-80**
- **NEMA Specification TC-2**

CALTRANS suggest using PVC 90 C degrees electric plastic conduit, EPC-40 or EPC-80 in accordance with NEMA Specification TC-2 to resist the heat of asphalt stabilized material.

PIPE OPENINGS

- **Pipes should have 2 square inches of openings per linear foot of pipe**

As we saw in the previous slides the size of the openings in the pipe appeared to be quite small. FHWA recommends a minimum of 2 sq. inches of opening per linear foot of pipe.

TRENCH BACKFILL

- **Pre-pave installation - Should be the same material as the permeable base**
- **Post-pave installation - Should be as permeable as the permeable base**

For the **pre-pave** edgedrain installation, the trench backfill should be the same material as the permeable base.

For the post-pave installation (retrofit), the trench backfill material should be as permeable as the permeable base material.

TRENCH WIDTH

- **Wide enough to allow proper placement and compaction of backfill around pipe**

The trench width should be wide enough to allow for proper compaction of the backfill material around the pipe.

TRENCH DEPTH

- **Deep enough to accomplish intended drainage function**
- **Recommended depth – Top of pipe 2 inches below bottom of permeable base**

The edgedrain should be placed deep enough to serve its intended function.

FHWA recommends that the top of the pipe be at least 2 inches below the bottom of the permeable base. This will allow fall from the permeable into the edgedrain.

PIPE INSTALLATION

**Underground Installation of
Thermoplastic Pipe for
Sewers and Other Gravity
Flow Applications**

ASTM D 2321

Plastic pipe should be installed in accordance with ASTM D 2321, "Underground Installation of Thermoplastic Pipe for Sewers and Other Gravity Flow Application."

FLORIDA DRAINCRETE

- AASHTO No. 89 Gradation
- 4 Bags of Cement per Cu. Yd.
- W/C Ratio < 0.40
- Compressive Strength
800 – 1500 psi

Settlement of the edgedrain trench has been a persistent problem, particularly for the retrofit edgedrain case. One solution to the problem was developed by the Florida DOT. They developed an approach called "Florida Draincrete" in which cement stabilized aggregate backfill was used. Florida used an AASHTO No. 89 gradation aggregate with four bags of cement per cubic yard added for stabilization. Florida DOT specifications also required that the water/cement ratio be less than 0.40 with the aggregate mixture having a compressive strength between 800 to 1500 psi..

AASHTO No. 89 GRADATION

Sieve Size	Percent Passing
1/2"	100
3/8"	90 – 100
No.4	20 – 55
No. 8	5 – 30
No. 16	0 – 10
No. 50	0 – 5

First, let us look at the AASHTO No. 89 gradation. Note that the average percentage passing the No. 4 sieve is 37.5 percent. By definition (50 percent passing the No.4 sieve), the material is almost a sand. Most likely the material would be classified as a "pea gravel."

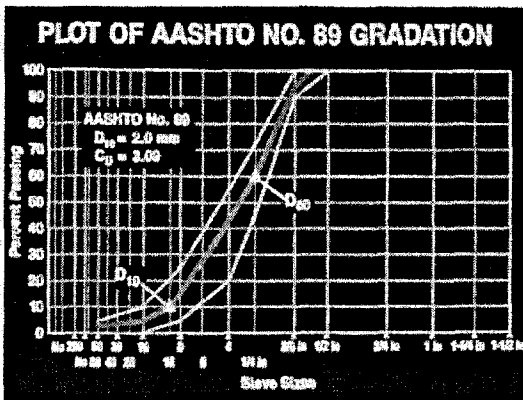

This slide shows a plot of the AASHTO No. 89 gradation on FHWA power 0.45 paper. Analysis of this gradation reveals:
 Effective size = 2.0 mm
 Coefficient of Uniformity = 3.08

A study of this gradation reveals that it is almost a sand since almost 50 percent of the material can pass the No. 4 sieve, and the plot of the gradation is relatively steep.



Here we see a retrofit edgedrain trench being backfilled with Florida "Draincrete."

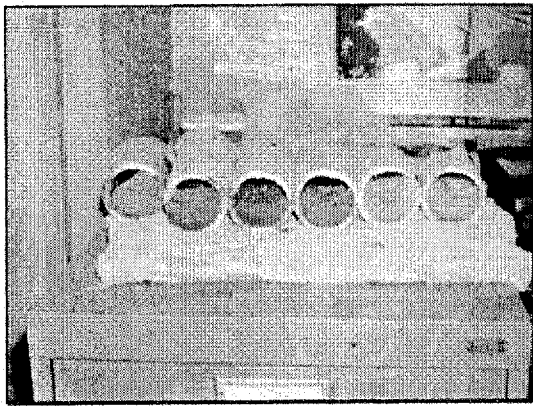

Wrapping the edgedrain trench with a geotextile is important to keep out the fines. We see that without the geotextile the pipes will quickly fill up with fines.



Another view of a plugged edgedrain.

Geocomposites

Geocomposite fin drains may have a role in the retrofit edgedrain case where the flow rates from the existing pavement section may not be that high.

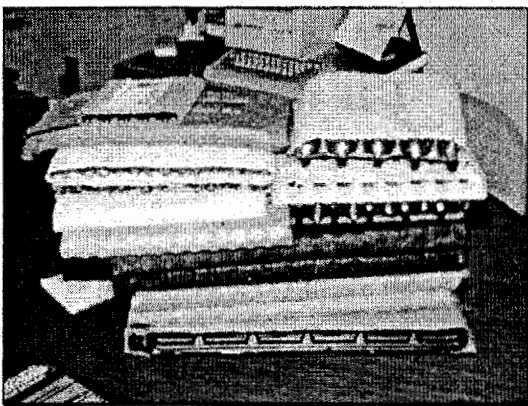

The problem with geocomposites is one of "Buyer Beware." One report identified 27 "major" manufacturers of geocomposites. In many cases you cannot identify the structural and hydraulic properties of the geocomposite.

If you do not see a geocomposite in this pile that you like,

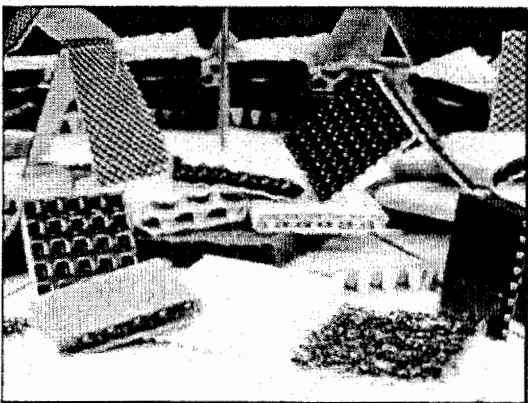

Perhaps, you can find one in this slide.

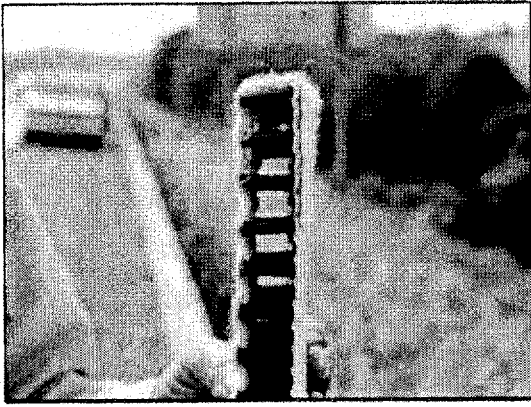

Most geocomposites fall in the general category of having a structural, plastic core covered by a geotextile.

The short, tubular, plastic “columns” provide strength for the geocomposite, while the geotextile cover filters out the larger size particles and allows water to enter the core. The water then flows horizontally between the “columns” to the outlet pipe.

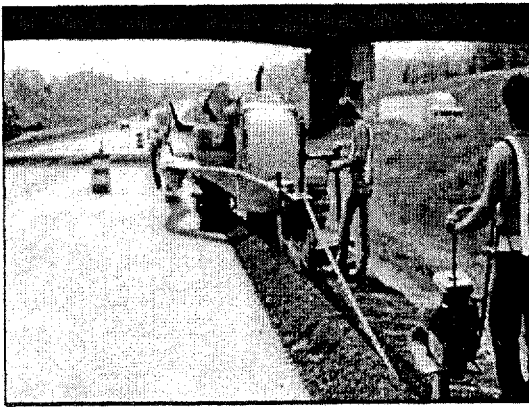

Now let's look at some construction slides. Here we see the construction train placing a geocomposite fin drain. A trencher excavates a 4" wide trench for the geocomposite, which is being threaded into the trench, while the trench compactor follows the installation operation compacting the trench backfill.

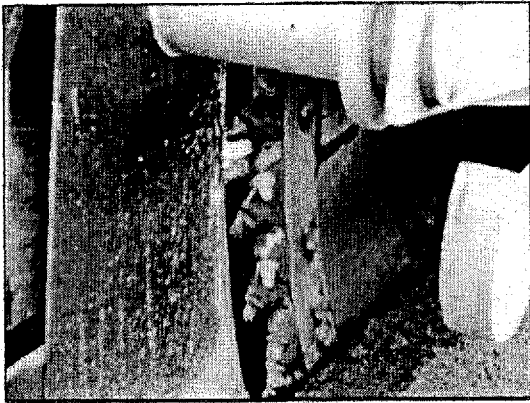

The trench is excavated by a rotating wheel cutter. Excavated material is deposited on the adjacent roadway.

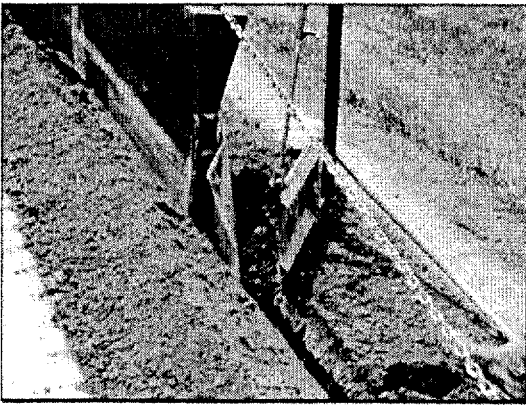

A special shoe aligns the geocomposite against the wall of the trench, and at the same time pushes the excavated material back into the trench.

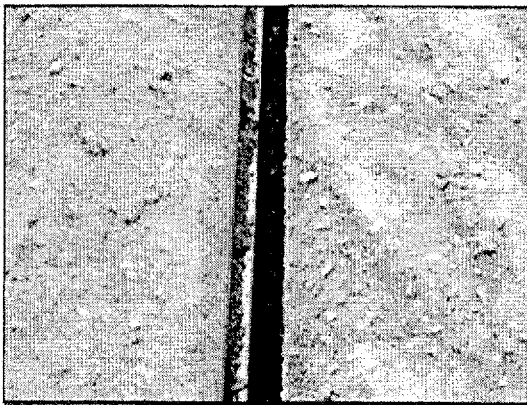

Here we see the geocomposite placed against the edge of the pavement. The geocomposite should be flush against the side of the excavated trench. Vertical buckling of the geocomposite is a frequent problem. This is called "J" buckling.

GEOCOMPOSITE ELEMENTS

- **Structural Core**
- **Geotextile**

Most geocomposites consist of the following two (2) elements:
Structural Core
Geotextile

CORE FUNCTIONS

- Structural Strength
- Water Conduit
- Skeleton for Geotextile

The core provides the following three (3) functions:
Structural Strength
Conduit for Transporting the water
Skeleton for the Geotextile

GEOTEXTILE FUNCTIONS

- Transmit Water
- Retain Soil Particles

The geotextile cover provides the following two (2) functions:
Transmits Water into the Core Section
Retains the Soil Particles

GEOCOMPOSITE EDGEDRAIN

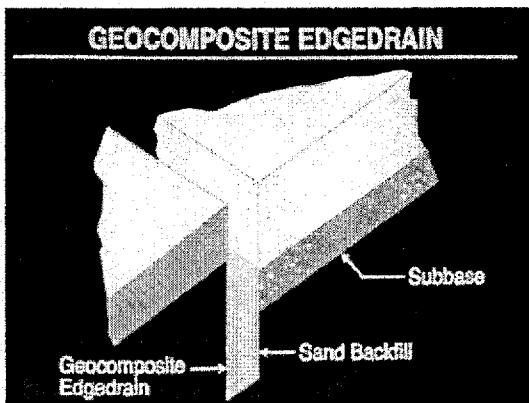

The Kentucky DOT has studied geocomposite installation in-depth. As a result of this study, Kentucky DOT now recommends that the geocomposite be placed on the **far** wall of the trench with a select sand backfill being placed between the geocomposite and the pavement section. The purpose of this is to fill any voids under the pavement section caused by the excavating operation.

Consolidation of the backfill material is provided by ponding water in the trench.

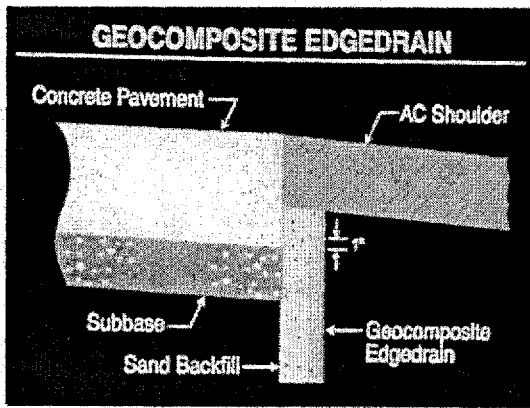

Same design approach shown in a sectional view.

GEOCOMPOSITE SAND BACKFILL

Sieve Size	Percent Passing
3/8"	100
No. 4	95 - 100
No. 8	80 - 100
No. 16	50 - 85
No. 30	10 - 30
No. 100	2 - 10
No. 200	0 - 2

Since almost 100 percent of the material can pass the No. 4 sieve, the aggregate material would be classified as a sand.

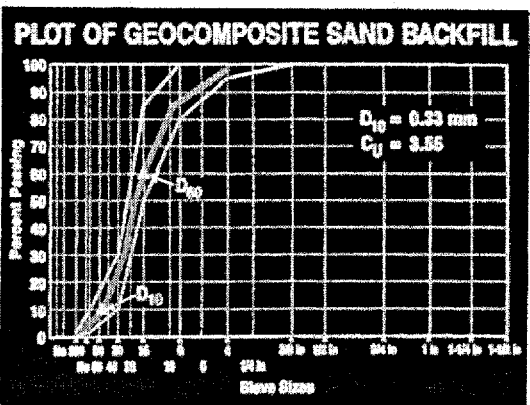

This slide shows a plot of the sand backfill gradation on FHWA power 0.45 paper. Analysis of this gradation reveals:
 Effective size = 0.33 mm
 Coefficient of Uniformity = 3.55

GEOCOMPOSITE INSTALLATION

Installation of Geocomposite Pavement Drains

ASTM D 6088

Geocomposites should be installed in accordance with ASTM D 6088, "Installation of Geocomposite Pavement Drains."

SUMMARY

- **Edgedrain Pipes Must Be Strong Enough to Resist Wheel Loads**
- **Dual Outlets Should Be Provided**
- **Design & Construction Must Consider Maintenance**
- **Edgedrain System Must Be Intact at the End of the Construction Phase**

This session provided design/construction guidance for constructing longitudinal edgedrain systems. Emphasis was placed on providing conventional pipes and geocomposites that would withstand construction loads and heavy wheel loads.

The need for providing dual outlets was stressed. Edgedrains should have two paths to allow video inspection and cleaning equipment to enter the edgedrain.

Design & Construction engineers must consider maintenance needs in designing and building the edgedrain system.

It is imperative that the edgedrain system be intact and functioning at the end of the construction phase.

**CONSTRUCTION of PAVEMENT
SUBSURFACE DRAINAGE
SYSTEMS WORKSHOP**

SESSION G

**Outlet Pipe
Headwalls
Roadside Maintenance**

Outlet pipes should be strong enough to resist heavy wheel loads. Surface and subsurface drainage should be coordinated; adequate fall should be provided between the end of the outlet pipe and the roadside ditch.

Dual Outlets should be provided for each section of edgedrains so that there are two entrances for the video inspection and maintenance equipment.

Headwalls provide the three following functions: outlet pipe protection, erosion control, and outlet location. Outlet location is the most important. If the outlets cannot be found, there can be no video inspection or maintenance of the edgedrain systems.

Roadside maintenance The critical importance of providing roadside maintenance will be stressed. Maintenance of outlet pipes and roadside has been historically poor. There must be a commitment to maintain for these drainage features for them to work.

This will be an introduction for the need for video inspection of edgedrains.

SESSION OBJECTIVES

- Explain the Need for Adequate Strength Pipe
- Explain the Importance of Providing Dual Outlets
- Discuss Importance of Coordinating Surface & Subsurface Drainage
- Describe Functions of Headwalls
- Explain the Need for Roadside Maintenance

At the completion of this session, participants will recognize that outlet pipes are subject to load stress due to the shallow cover over the pipes. Outlet pipes must be strong enough to resist construction wheel loads. It is important that the edgedrain system be intact and functioning at the end of the construction phase.

Participants will be aware that Dual Outlets are important since they provide two paths to enter a section of edgedrain with video inspection equipment.

Participants will be aware of the importance of surface and subsurface drainage be coordinated. There must be adequate fall from the end of the outlet pipe to the roadside ditch.

Participants will be aware that headwalls provide the following three functions: Outlet Protection, Erosion Control, and Outlet Location.

Participants will be aware of the critical importance of providing roadside maintenance.

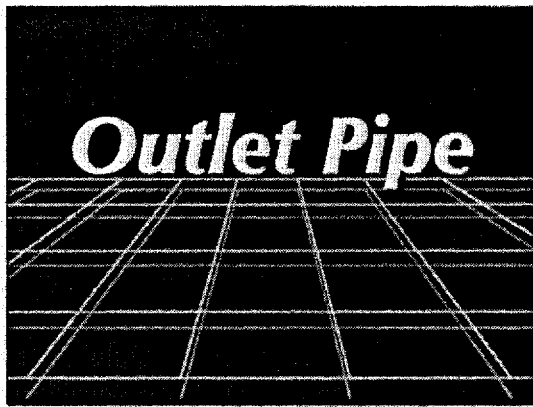

The outlet pipe is the weakest link in the drainage chain.

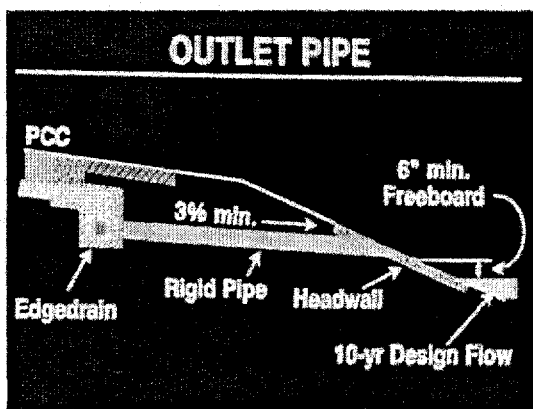

If there is one slide to remember from today's presentation, it is this one. This slide represents slope. This slide represents downhill. The longitudinal edgedrain should be located just below the bottom of the permeable base so that the base will drain into the edgedrain system. The outlet pipe should have a good slope to drain the water out of the edgedrain system. FHWA recommends a slope of 3 percent (0.03 ft/ft) for the outlet pipe.

FHWA also recommends that the outlet pipe be located 6 inches above the 10-year storm's depth of flow in the roadside ditch. As an alternate design, the pipe outlet could be located simply one (1) foot above the invert of the ditch. FHWA also recommends that the outlet pipe be a strong, rigid pipe.

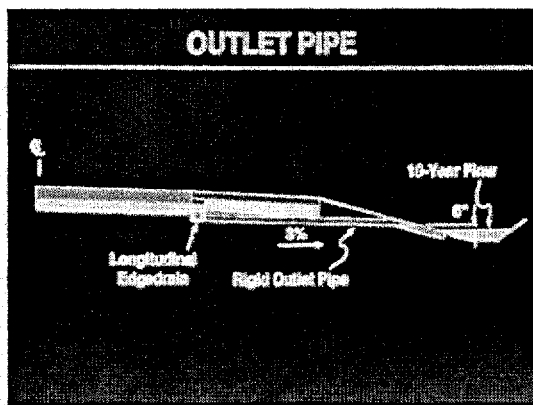

However if we draw our sketch to scale, it looks somewhat flat. This is why having the necessary fall is so important.

RIGID PIPE

- ASTM D 3034-89
- PVC Sewer Pipe
- SDR 23.5

PVC with a sidewall diameter ratio of 23.5 conforming to ASTM D 3034-89, "PVC Sewer Pipe" is one of the most rigid pipes available.



Now let's look at some field slides. What is wrong with this design? Which way do you think the pipe slopes? The real problem here is that the roadside ditch is so shallow the water cannot drain out of the edgedrain system. Most likely the outlet pipe will drain back to the pavement section.

This brings to an extremely important point. **Surface and subsurface drainage design must be coordinated.**



Again we see the same problem. By the time this hole is filled with topsoil, the outlet pipe will be clogged.

SURFACE WATER COORDINATION

Subsurface and surface water must be coordinated

Surface and subsurface drainage design must be coordinated.

STORM DRAIN CONNECTION

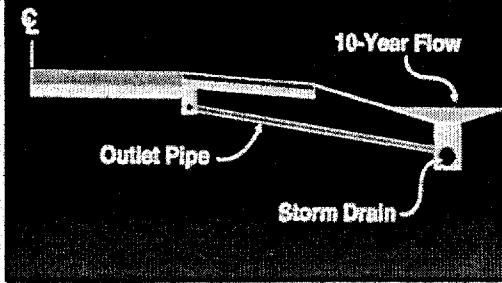

One solution is to provide a storm drain connection. The storm drain would pick up surface water with inlets approximately every 300 feet. Outlet pipes from the edgedrain system could be tied into the storm drain inlets.

MEDIAN DESIGN

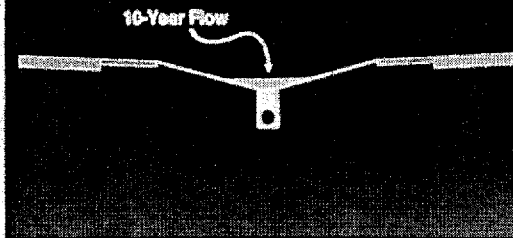

Don't forget to provide good surface and subsurface drainage for the median. As the roadway transitions through horizontal curves, some of the subsurface drainage will discharge into the median.

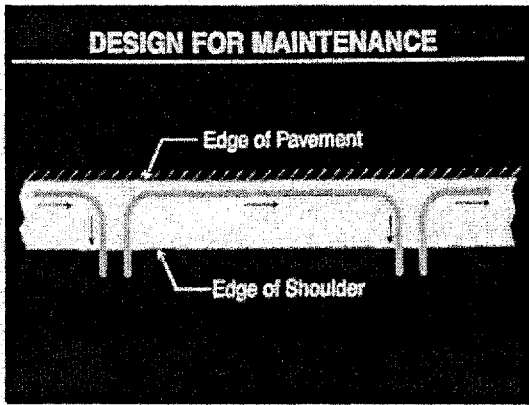

Design engineers must provide designs that give maintenance people their best shot at maintaining the system. CALTRANS developed a dual outlet or looped system with their maintenance people in mind. By providing a looped system there are two (2) outlets for each segment of edgedrain pipe.

Maintenance people have two (2) paths to get into each segment of pipe for cleaning.

Construction people have two (2) paths for entering their video equipment for quality assurance purposes.

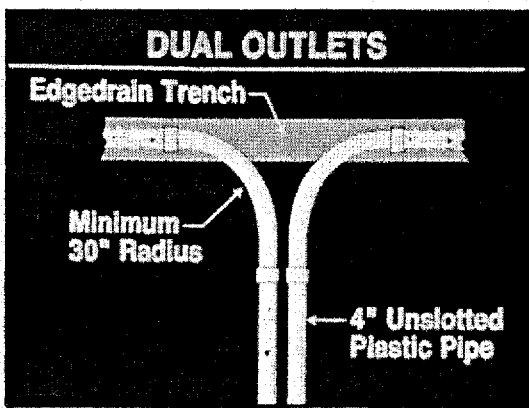

Outlet pipe bends should have a minimum radius of 30 inches so that video and cleaning equipment can make the turn.

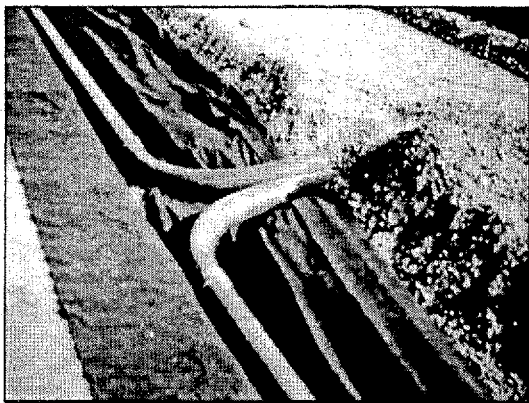

Here we see a field shot of the outlet bends.

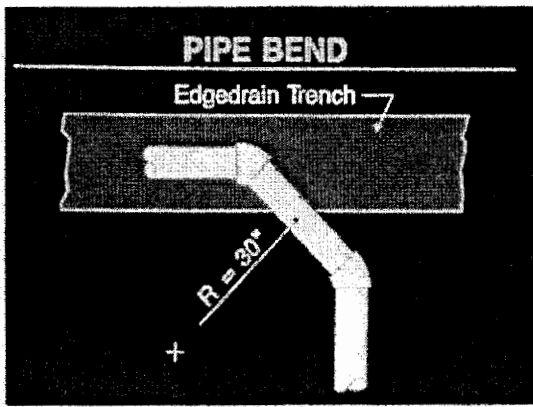

The turn can also be made using standard 45 degree bends.

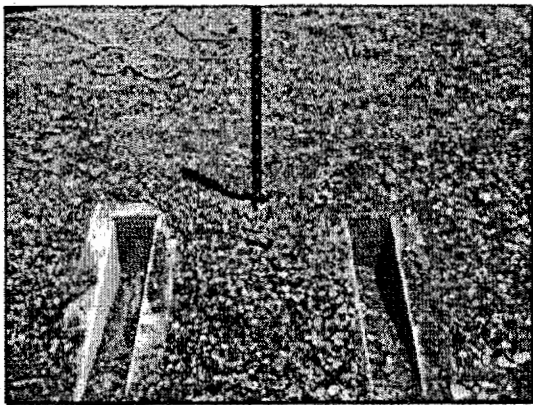

Montana DOT has adopted the dual outlets or looped system. Here we see dual headwalls.

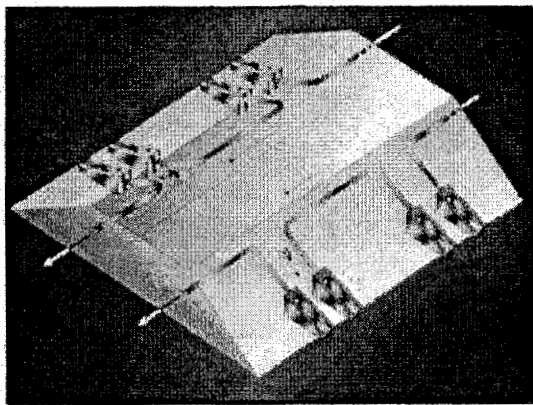

Montana developed this nice isometric sketch of a looped system for us. The edgeline water will flow from the upper right to the lower left. The upper outlet will not discharge any water, however video and cleaning equipment can be inserted into it. Water will be discharged from the lower outlet.

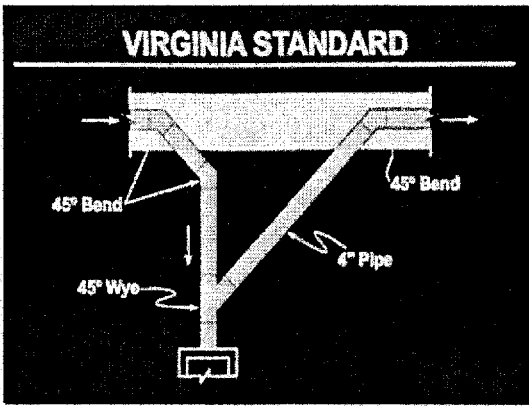

Virginia also has adopted the looped system, however, they have accomplished the same design using standard Wye's and Tee's. They believe that this arrangement is more economical.

OUTLET SPACING

- Segmented Sections
- Limited to 250 feet

FHWA recommends maximum outlet spacing of 250 feet using segmented sections.

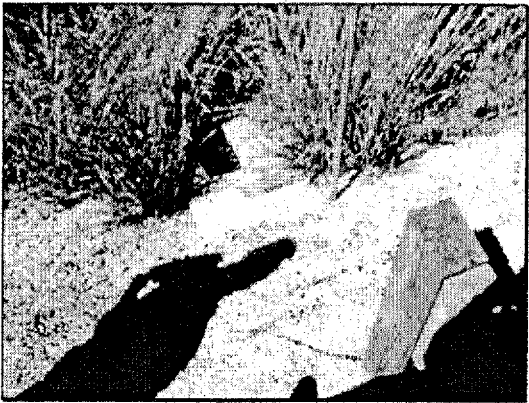

Here we see perfect alignment between the guard rail and the outlet pipe.

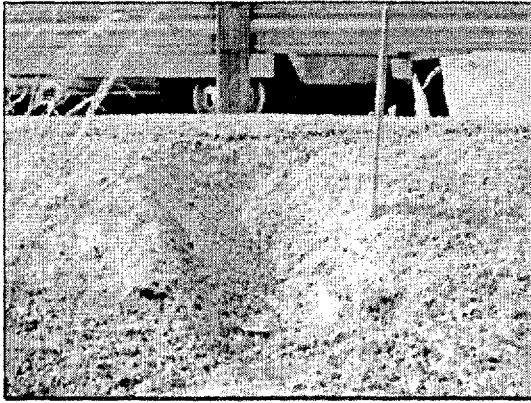

Again we see the same problem; we do not have any guidance for this.

VIDEOTAPING

**Videotape completed project
for quality assurance**

Videotaping the completed project should improve the quality assurance tremendously.

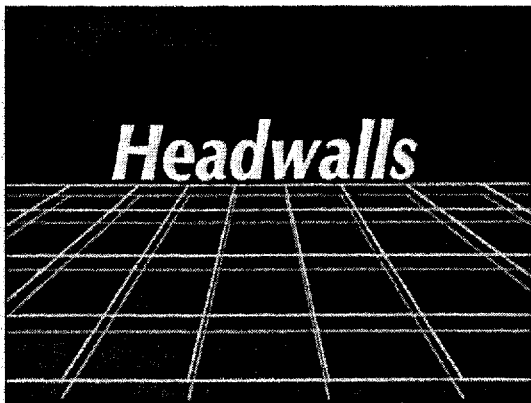

Headwalls are an important element of drainage design.

PURPOSES OF HEADWALLS

- **Pipe Protection**
- **Erosion Control**
- **Outlet Location**

Headwalls perform the following three functions: pipe protection, erosion control, and outlet location. Outlet location is particularly important since no maintenance can be performed if the maintenance crew cannot find the outlet pipe.

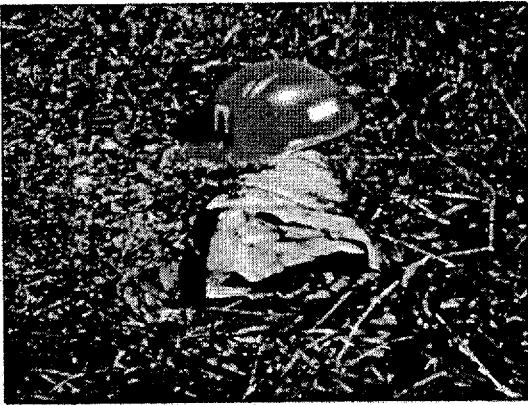

Headwalls provided protection to the end of the outlet pipe.



Headwalls help to provide protection from erosion at the outlet. We see that outlet erosion is definitely a problem even though a splash pad was provided to distribute the water.



Here is an extreme case of outlet erosion.



The view from the roadway is not any better. There is no reason to believe that surface water was concentrating at this point. Perhaps, a thunderstorm occurred before the pavement was placed with 100 percent of the rainfall going into the permeable base. This would produce high volume discharges.

REFERENCE MARKERS

**FHWA recommends the use of
reference markers**

FHWA recommends the use of Reference Markers.

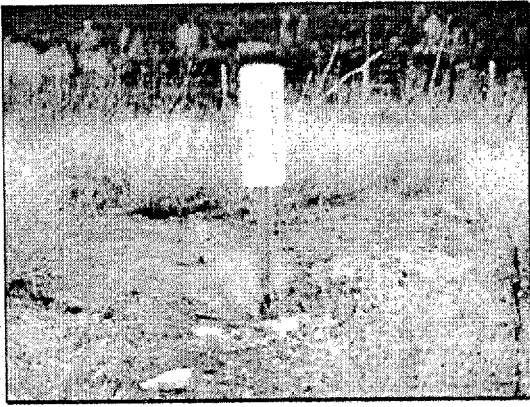

A simple metal post will do the job.

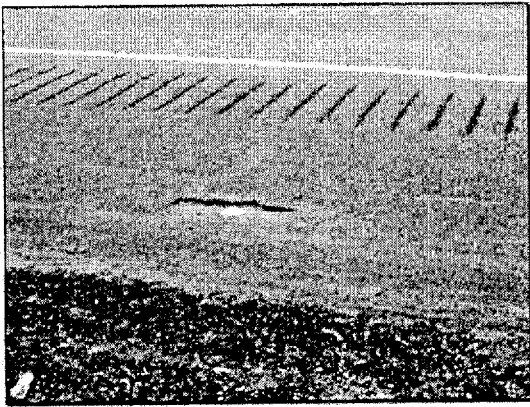

Why not use a simple delineator disk on shoulder?

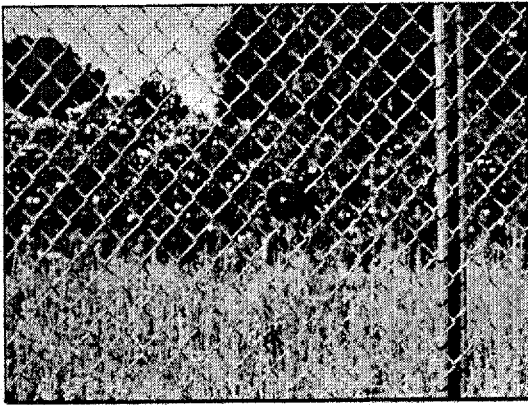

Or a blue reflector on the fence?

RODENT SCREENS

**FHWA recommends the use of
rodent screens**

FHWA recommends the use of Rodent Screens.



The rodent screen must be removable so that the edgedrain can be maintained. Here we can see a build-up of material on the inside of the screen.

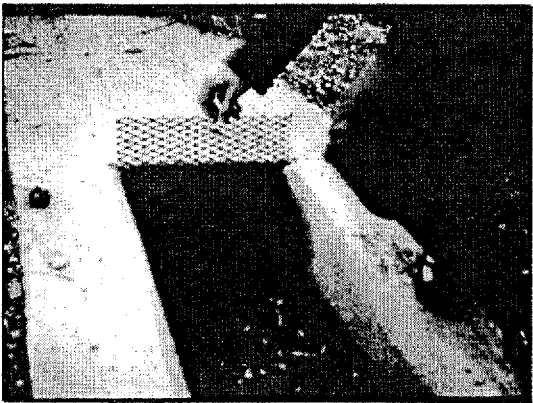

This slide demonstrates the removable feature of the screen.

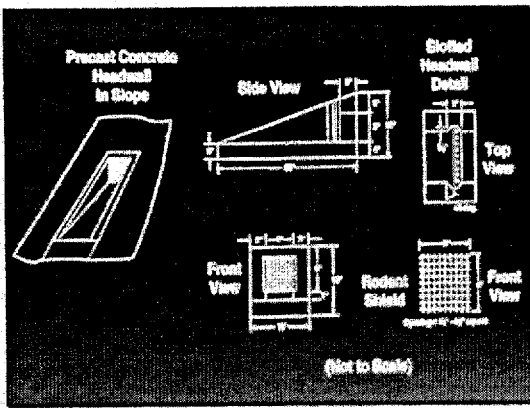

FHWA has provided guidance for the design of headwalls and rodent screens in the Demo 87, "Participant Manual" (Figure 45).

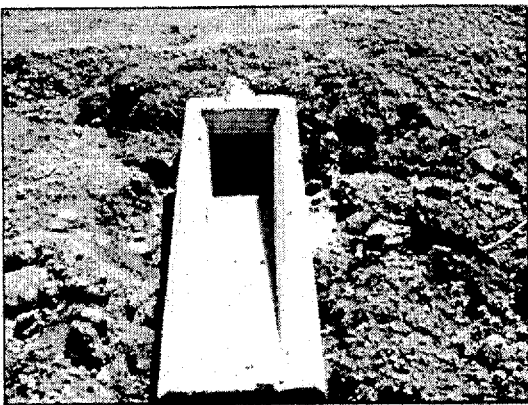

Many State DOT's use a precast concrete headwall.

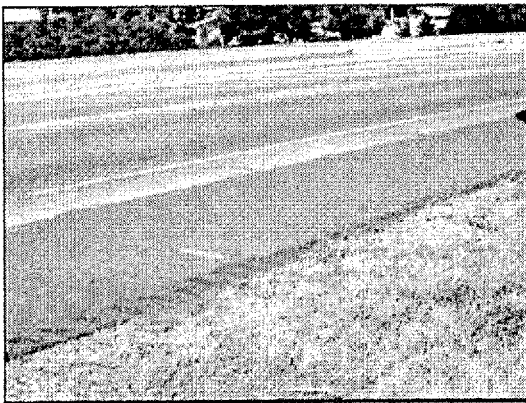

A simple painted arrow on the edge of the shoulder would be effective.

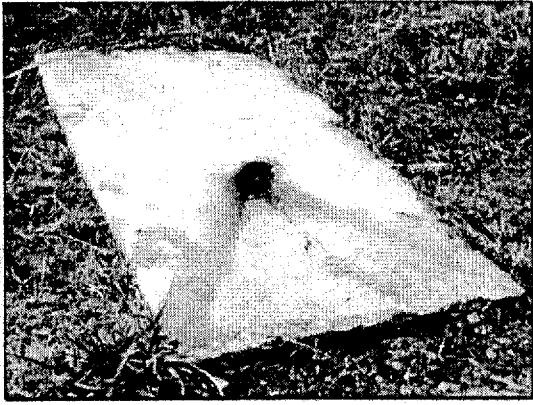

A simple poured concrete headwall is effective. Its size should keep grass roots and mowing clippings out. Since the headwall is flush with the fill slope, there should be no problem with the mowing operations. Big is better, and erosion will not be a problem.

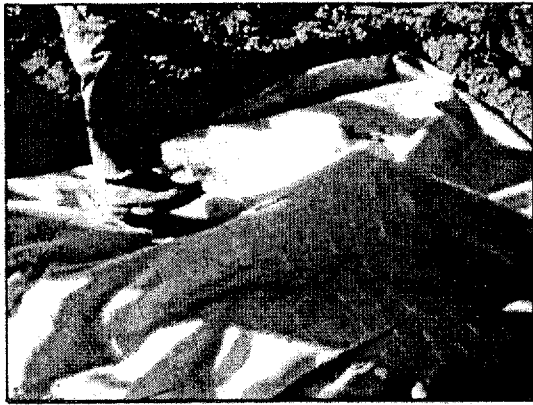

Another approach is a simple fabric bag injected with a grout consisting of cement and flyash.

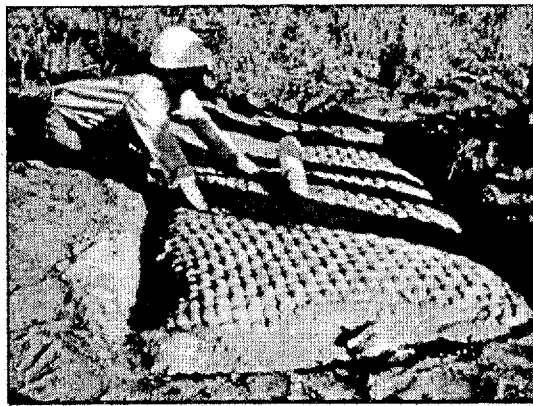

View of the headwall after the bag has been filled with grout.

Roadside Maintenance

Now let's look at the importance of maintaining the pipe outlets and the roadside ditches.

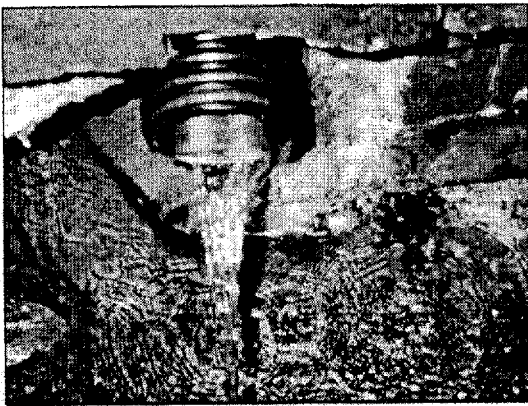

This is every pavement drainage engineer's dream, a freely discharging outlet pipe.

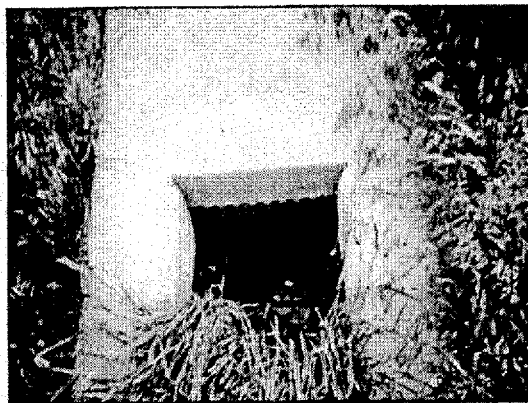

Unfortunately many times the outlet pipe looks like this.

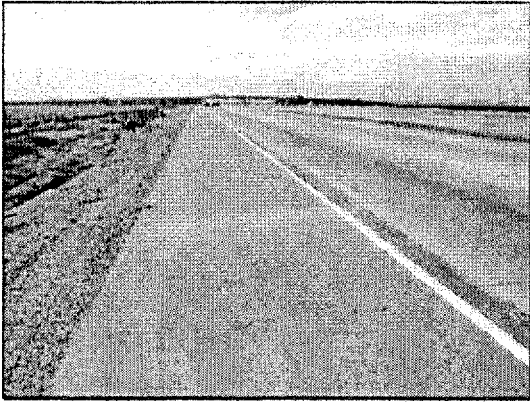

Here is a case where the shoulder was completely reconstructed and retrofit edgedrains were provided. Three (3) years later, we returned to visit the site and discover pumping stains. You can see the group searching for outlets. Since the outlets could not be found, we concluded that the edgedrain system was plugged and that no maintenance had occurred.

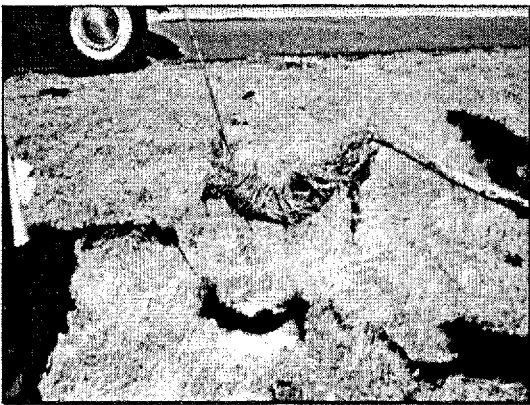

Maintenance personnel are holding up a vegetative mat that was removed from the edgedrain like a trophy.



This is a representative example of a crushed and clogged outlet.



This is a well hidden outlet.

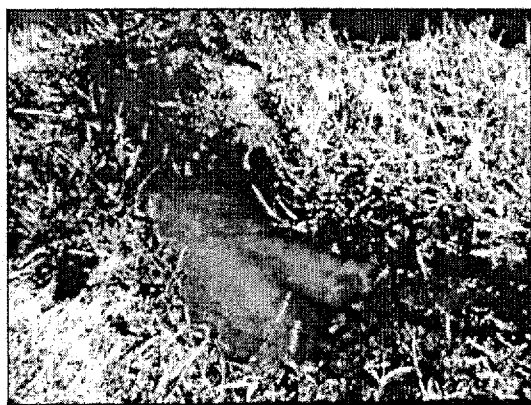

When this outlet was opened up water gushed out of it. Most likely this outlet will again quickly fill because the ditch is higher than the outlet.

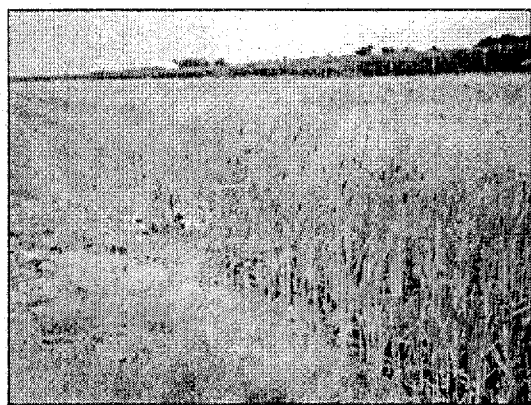

Here is an example of a roadside ditch that needs cleaning.

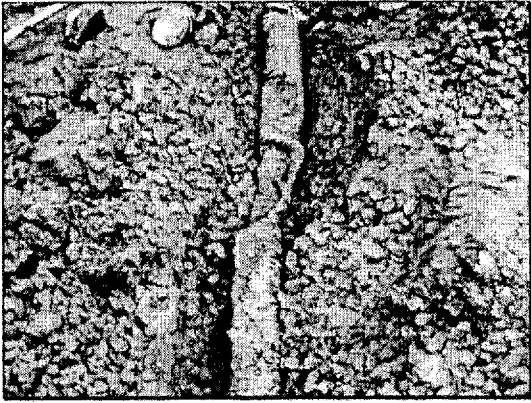

A video equipment salesman offered to demonstrate his equipment. We went out to a project that had edgedrains and looked up several outlets. Unfortunately, we could only investigate the first few feet before reaching an obstruction.

Using a small Bob Cat, we quickly opened up the pipe. As you can see it was totally crushed. Most likely this occurred in the construction phase.

These conditions prompted us to develop a video inspection demonstration program to investigate conditions inside the edgedrain.

SUMMARY

- Provide Strong Outlet Pipes
- Coordinate Surface & Subsurface Drainage
- Provide Dual Outlets
- Provide Headwalls
- Provide Roadside Maintenance

This session demonstrated that outlet pipes should be strong enough to resist heavy wheel loads.

Surface and subsurface drainage should be coordinated; adequate fall should be provided between the end of the outlet pipe and the roadside ditch.

Dual Outlets should be provided for each section of edgedrains so that there are two entrances for the video inspection and maintenance equipment.

Headwalls provide the following functions: Outlet Pipe Protection, Erosion Control, and Outlet Location.

This session stressed the critical importance of providing roadside maintenance.

**CONSTRUCTION of PAVEMENT
SUBSURFACE DRAINAGE
SYSTEMS WORKSHOP**

SESSION H

**Video Inspection
Maintenance**

Video inspection is the best tool for increasing quality assurance of newly completed edgedrains. Video inspection equipment and the inspection process will be discussed. Examples of crushed and clogged edgedrains will be shown. Results of FHWA's video inspection demonstration project indicated that only one-third of the edgedrains inspected were functional.

Emphasis will be placed on SHA's having a regular routine for inspecting edgedrain systems to determine if maintenance or repairs are necessary.

Guideline specification for accepting newly constructed edgedrains based on video inspection is provided in the Appendix.

Maintenance is critical to the continued perform of both the edgedrain and the pavement structure. Inadequate maintenance will increase the rate of pavement deterioration. If a SHA is unwilling to make a maintenance commitment, then drainable pavement systems should not be provided.

SESSION OBJECTIVES

- Identify Role of Video Inspection for Quality Assurance
- Explain Need for Routine Video Inspections
- Discuss Maintenance's Effect on Pavement Performance
- Express Need for Maintenance Commitment

At the completion of this session, participants should have a good appreciation for the need of video inspection for final acceptance of newly completed edgedrains.

Participants should be aware that a SHA should have a routine program for video inspection of existing edge drains to identify the need for maintenance.

Participants should understand that edgedrain systems that are crushed or clogged will trap water saturating the pavement structure. This will reduce the performance of the pavement. Edgedrain systems that become clogged are worst than pavements with no drainage systems.

After this session, participants will understand that if a SHA is not willing to make a Maintenance Commitment; drainage system should not be provided.

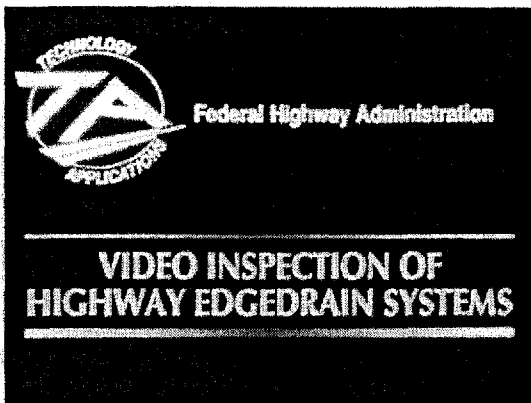

If we experienced so many sites with crushed or clogged outlets, what does the inside of the pipe look like? To answer this question FHWA developed a demonstration project to provide video inspection of existing edgedrains for any interested State.

FHWA obtained the services of a contractor who in turn purchased the necessary video equipment and provided operational personnel.

PURPOSE

- **Qualitative Picture of Edgedrain Conditions**
- **Demonstrate Video Equipment**

The purpose of the demonstration project was to:

Provide the SHA with a qualitative picture of edgedrain conditions in their State.

Demonstrate video inspection equipment.

The demonstration project accomplished both of these goals.

BENEFITS

- **Quality Control**
- **Maintenance**

The anticipated benefits of a video inspection program are: improved quality control over newly completed edgedrains, and ability to determine if maintenance is required.

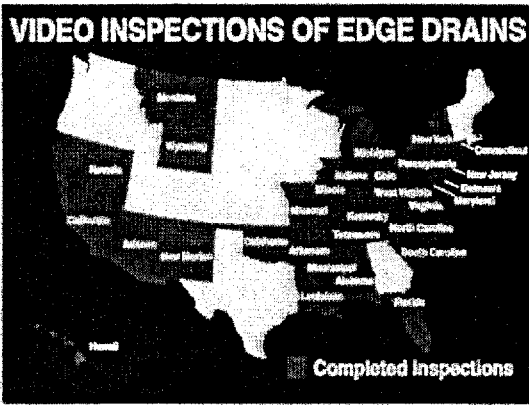

Here is a map of the participating States.



It is always nice to have a few friends over to look at your demonstration project.



Here is the business end of the project. This is the camera head; light for the video is provided by a series of headlights located around the camera lens. A closed-circuit signal is transmitted back to the TV monitor back at the control center.

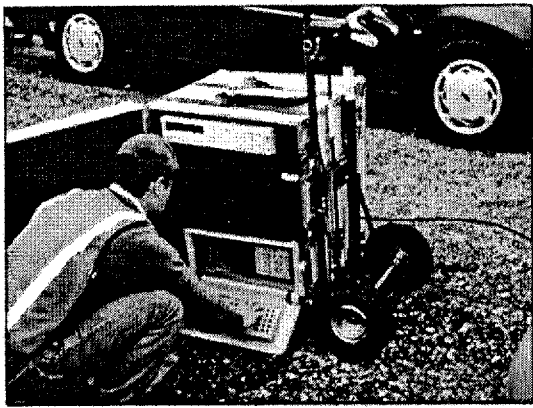

The technician is entering data about the inspection site. This data appears on the video image. The closed-circuit signal is sent back to the TV monitor located just above the technician's hands. The top unit is a standard VCR that allows the entire inspection to be video taped.

The center unit (which you can't see) allows 35 mm still shots of the TV image to be taken.

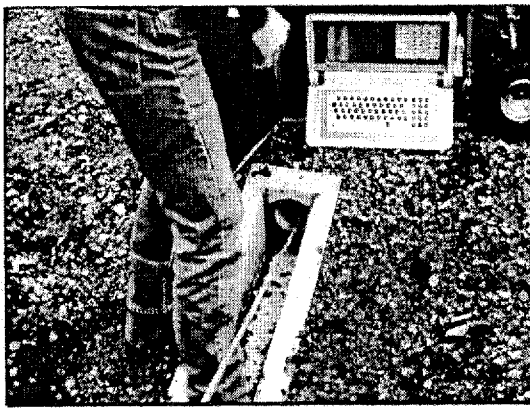

The TV camera head has been inserted into the outlet pipe and will be pushed through the edgedrain system by hand.

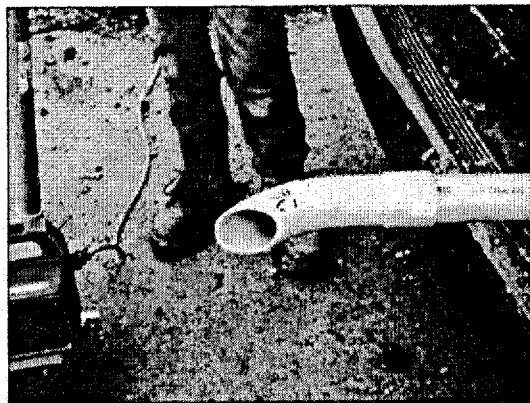

At most of the inspection sites, the outlet pipe was connected to the main longitudinal edgedrain by a 4" x 4" Tee. It was very difficult for the camera to make this turn. To solve this problem, the contractor made a sleeve out of a 2-1/2" PVC pipe. A long radius bend was sawed off and attached to the end of the sleeve. This bend had enough curvature to turn the camera in the desired direction.



The pipe sleeve is inserted into the outlet pipe, and the video inspection camera is then threaded through the sleeve.

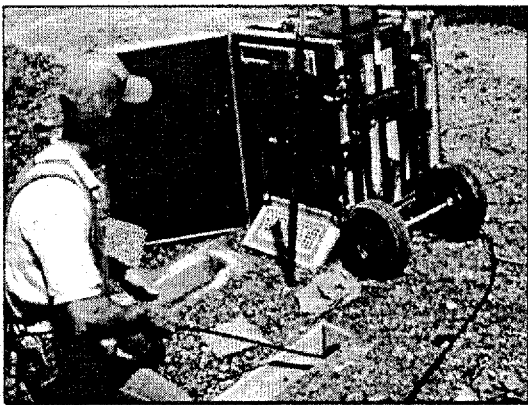

Now we are ready to begin the inspection.

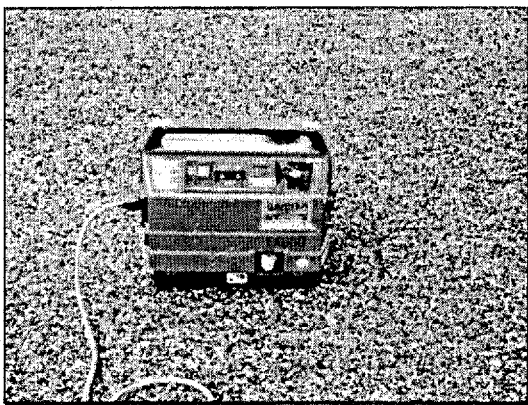

Electricity was provided by a portable generator.

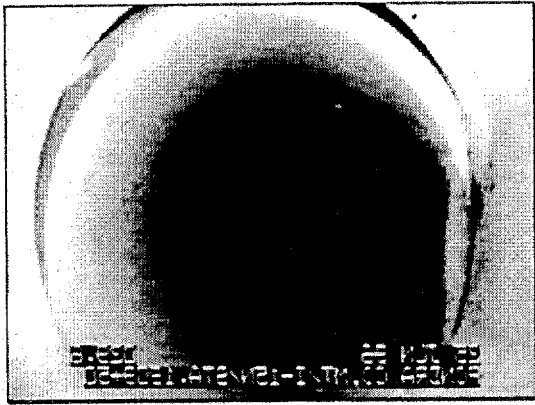

PVC pipe joints have opened up.

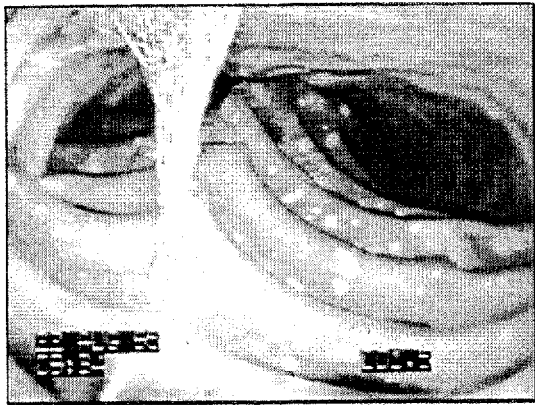

This looks like something from a high school biology class.

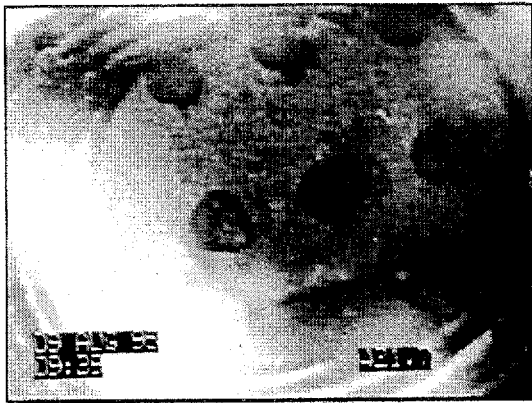

Here is a case where only the first 20 ft of the edgedrain was pipe. After this the edgedrain was an aggregate trench (French Drain). This individual wanted to keep the aggregate material out of the pipe so he used a brick as a stopper. Yet he wanted the aggregate trench to drain into the pipe so he used a brick with holes in it.

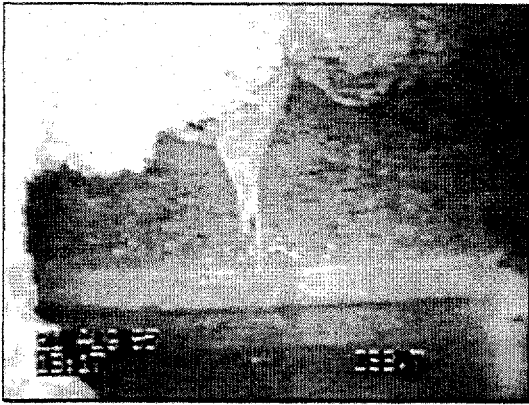

This is what a 6" x 6" 90 degree tee looks like to the TV camera. It is very difficult for the camera to make the turn.

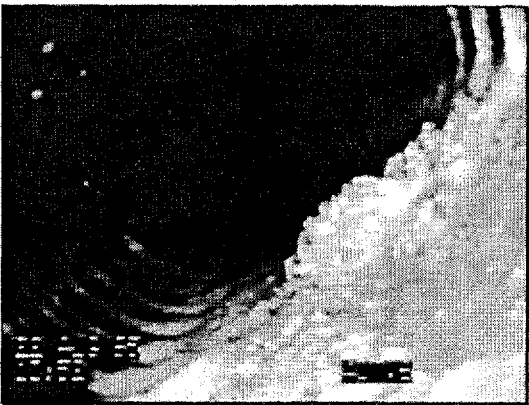

As the camera traverses the edgedrain it will rotate. The invert of the pipe can be identified by standing water or sediment build-up. This is a typical example of sediment build-up in a pipe edgedrain.

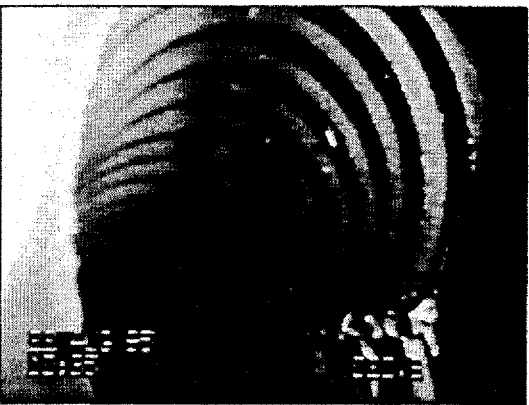

Here is another example of a crushed pipe. Note that the camera has rotated 90 degrees.

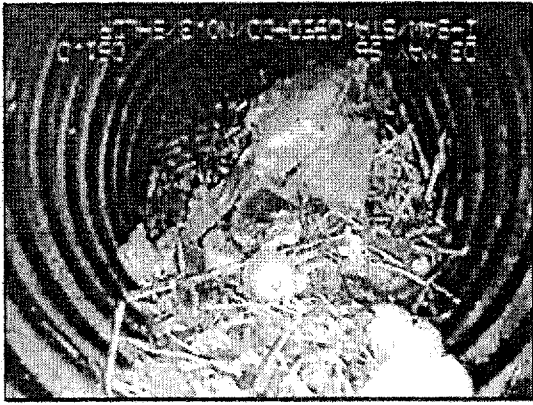

Rodent's nests are always a problem.

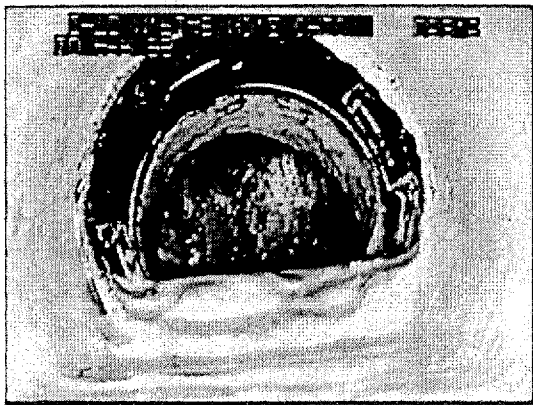

Another example of sediment build-up.

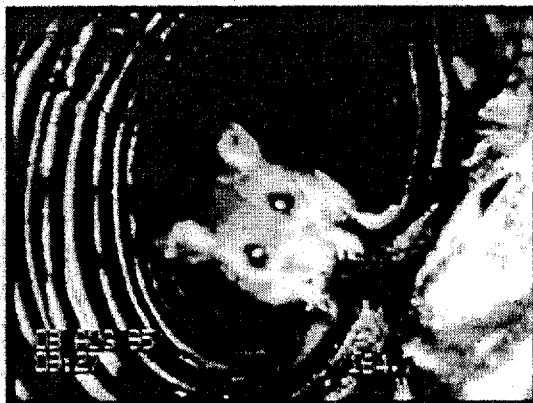

Rodents and their nests are a constant problem in edgedrains. Edgedrain pipes should be cleaned regularly to remove rodent nests.



Video inspection will accurately locate problems inside the edgedrain pipe, since there is a distance-counter that will measure the distance to any obstruction or problem.

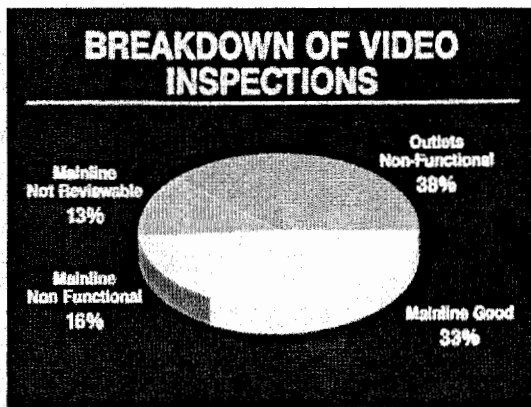

Starting with the red segment, 38 percent of the outlets inspected were classified as non-functional (crushed or clogged). In another 13 percent, the mainline was not review-able because the camera could not make the turn, or the mainline edgedrain was a geocomposite. Next in another 16 percent, the mainline was classified as non-functional (crushed or clogged).

This leaves only 33 percent of the inspections classified as functional.

IMPROVEMENT NEEDED

- 2/3 of Edgedrains Not Functioning Properly
- Must Make a Significant Improvement

or

- Abandon Drainage

This means that 2/3 of the edgedrains in this study were not working properly. We cannot live with this track record. If we cannot significantly improve edgedrain design and construction so that a high percentage of edgedrains are functional, we must abandon drainage.

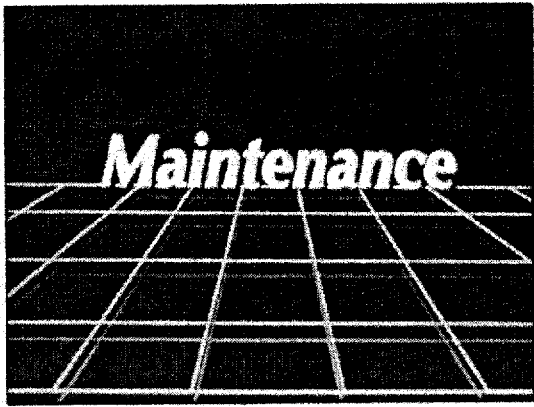

There is simply not enough that we can say about the need for maintenance.

MAINTENANCE

- **Periodical flush edgedrain system to remove sediment buildup**

Edgedrains should be periodical flushed to remove sediment build-up.

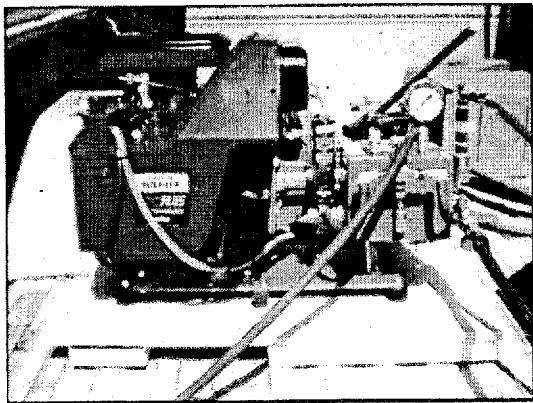

Equipment is now readily available that can be used to clean edgedrains. Water from a storage tank is pumped into the edgedrain using a jeter pump. This equipment is similar to that used to clean residential siding.



The jeter pump increases the water pressure to around 250 psi. The water is sprayed from the jeter tip into the interior of the edgeline. The water jets are slanted to help pull the jeter tip through the pipe.



Here we see a workman flushing a large amount of sediment out of a pipe.

MAINTENANCE

•Mow around outlet pipes at least twice yearly

Mow and clean roadside ditches

Maintenance forces should mow around the outlet pipe at least twice a yearly.

Maintenance forces should mow and clean roadside ditches.

MAINTENANCE

- **Inspect outlet pipes and pipe systems at least once per year**
- **Use video inspection equipment to inspect edgedrain systems**

Maintenance forces should inspect the outlet pipe and edgedrain system at least once a year.

Video Inspection equipment should be used to inspect the edgedrain system.

Maintenance is Critical to the Continued Performance

Maintenance is critical to the continued performance of subsurface drainage systems.

MAINTENANCE

- **No Maintenance Commitment**
- **No Drainable Systems**

If a SHA's is not willing to make a commitment to maintenance, pavement subsurface systems should not be provided.

SUMMARY

- **Video Inspection Acceptance**
- **SHA's Should Have Routine Program of Video Inspection**
- **Maintenance is Critical to Continued Performance of Drainage Systems**
- **No Maintenance Commitment – No Drainable Systems**

COURSE SUMMARY

- **Provided Design/Construction Guidance for Pavement Subsurface Drainage Systems**
- **Emphasized on Video Inspection of Edgedrains for Quality Assurance**
- **Emphasized on the Need for Maintenance**

This session demonstrated that video inspection is the best tool for increasing quality assurance of newly completed edgedrains.

SHA's should have a regular routine for inspecting edgedrain systems.

Guideline specification for accepting newly constructed edgedrains is provided in the Appendix.

Maintenance is critical to the continued performance of both the edgedrain and the pavement structure. Inadequate maintenance will increase the rate of pavement deterioration. If a SHA is unwilling to make a maintenance commitment, then drainable pavement systems should not be provided.

The primary objectives for this drainage workshop have been achieved.

Design/Construction guidance for pavement subsurface drainage systems was provided in this workshop. This workshop provided guidance for the following three elements of the drainage system: Permeable Bases, Aggregate Separator Layer, and Edgedrains.

Design /construction guidance was also provided for the following types of permeable bases: Unstabilized, Stabilized (Asphalt Stabilized and Cement Stabilized).

Design/construction guidance for aggregate separator layer was provided. The following three functions of the separator layer were stressed: Stability, Filtration, and Permeability.

Design/construction guidance for longitudinal edgedrain systems was provided. The following two types of edgedrains were discussed: Conventional Pipe, and Geocomposites.

Emphasis was placed on video inspection of newly completed edgedrains. Video inspection of the edgedrains should be a tool for the final acceptance of the edgedrain systems. This will insure an increase in the quality assurance.

The need for maintenance was stressed over and over again. Increase emphasis has been accomplished by providing two sessions on maintenance: Roadside Maintenance and Maintenance.

