

SECPOP2000: Sector Population, Land Fraction, and Economic Estimation Program

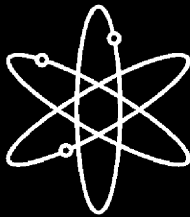

Sandia National Laboratories

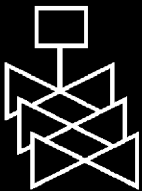

**U.S. Nuclear Regulatory Commission
Office of Nuclear Regulatory Research
Washington, DC 20555-0001**



SECPOP2000: Sector Population, Land Fraction, and Economic Estimation Program

Manuscript Completed: July 2003
Date Published: August 2003

Prepared by
N.E. Bixler, S. A. Shannon, SNL
C.W. Morrow, B.E. Meloche, SNL
J.N. Ridgely, NRC

Sandia National Laboratories
Operated by Lockheed Martin Corporation
Albuquerque, NM 87185-0748

J. N. Ridgely, NRC Project Manager

**Prepared for
Division of Risk Analysis and Applications
Office of Nuclear Regulatory Research
U.S. Nuclear Regulatory Commission
Washington, DC 20555-0001
NRC Job Code Y6594**



Abstract

The Environmental Protection Agency's computer program, SECPOP, has been used to calculate population estimates since 1973. In 1997, SECPOP90, was created to run on a PC and to use 1990 population and economic data.

When the U.S. Census Bureau released 2000 census population data and 1997 economic data, Sandia National Laboratories was tasked to develop a new version, SECPOP2000, to include the new data, be compatible with current Windows operating systems, and also be compatible with the 1990 data.

SECPOP90 supports both site and regional analyses. Site analysis evaluates population, land use, and economic data on a polar grid centered on a prescribed site. Regional analysis screens potential sites in a geographical region against a population criterion.

SECPOP2000 currently supports only site analysis. Regional analysis can be performed by using SECPOP90 as a screening tool followed by a confirmatory calculation with SECPOP2000 to evaluate potential sites with 2000 census data.

This report provides verification of the SECPOP90 and SECPOP2000 codes by comparing them with licensee-provided population data. The verification shows that SECPOP90 and SECPOP2000 provide reasonable population estimates. SECPOP2000 also agrees well with census estimates from other sources.

Table of Contents

Abstract	iii
Figures	ix
Tables	xi
1 Introduction	1
1.1 Background	1
1.2 Hardware and Software Requirements	1
2 Installation	3
2.1 Initialization	3
2.2 Starting SECPOP2000	3
3 User's Guide	5
3.1 Parts of the Main Screen	5
3.2 Menus	6
3.2.1 Main Screen	6
3.2.2 Toolbar Menu	6
3.3 Site Definition	7
3.3.1 New Site	7
Site Form Fields	8
Site Form Commands	9
3.3.2 Open Site	10
3.3.3 Save Site	10
3.3.4 Save As Site	10
3.4 Problem Definition	11
3.4.1 New Problem	11
Problem Form Fields	12
Problem Form Commands	14
3.4.2 Economic Regions	14
Economic Regions Form Fields	15
Economic Regions Form Commands	17
3.4.3 Open Problem	17
3.4.4 Save Problem	18
3.4.5 Save As Problem	18
3.5 Performing Site-Specific Calculations	18
Calculate Form Fields	19
Calculate Form Commands	19
3.6 Site-Specific Results	20

3.6.1 Population Rosette	20
3.6.2 Population Tables	21
Population	21
Cumulative	22
3.6.3 MACCS2 Input File	23
Display	23
Print	23
Save	25
3.6.4 Comma-Separated-Variable (CSV) File	25
Display	26
Print	26
Save	30
3.6.5 Load Previous Results	30
3.7 Performing Regional Calculations	30
3.8 Customizing SECPOP2000	30
3.8.1 Setup Form Fields	31
3.8.2 Setup Form Commands	31
3.9 Exiting SECPOP2000	32
4 Computational Methodology	33
4.1 Population Count and Density Algorithms	33
4.1.1 Boundaries Algorithm	33
4.1.2 First Element Location Algorithm	34
4.1.3 Specific Grid Element Determination	35
4.2 Land Fraction Algorithms	35
4.3 Economic Factors Algorithms	37
4.4 Database Structure	38
4.4.1 Block-Level Database	38
4.4.2 County-Level Database	39
5 Software Development	40
5.1 Block-Level Census Database	40
5.1.1 Construction of the 1990 Block-Level Census Database	40
5.1.2 Construction of the 2000 Block-Level Census Database	46
5.1.3 Verification of the 1990 Block-Level Census Database	47
5.1.4 Verification of the 2000 Block-Level Census Database	48
5.1.4.1 Verification Test 1	49
5.1.4.2 Verification Tests 2 and 3	49
5.1.4.3 Verification Test 4	51
5.2 County-Level Census Database	54
5.2.1 Construction of the 1990 County-Level Census Database	54
5.2.2 Changes in the County-Level Database with the 1997 Economic Census	57

5.2.3 Verification of the County-Level Census Database	61
5.3 Verification of the SECPOP90 Code	61
5.3.1 Internal Verification	61
5.3.2 External Verification for the SECPOP90 Code	61
5.4 Verification of the SECPOP2000 Code	65
5.4.1 Internal Verification	65
5.4.2 External Verification of the SECPOP2000 Code	70
6 References	75
Appendix A Site List	A - 1
Appendix B MACCS2 Site Data File Format	B - 1
B.1 Spatial Distances Data Block	B - 7
B.2 Population Data Block	B - 7
B.3 Land Fraction Data Block	B - 8
B.4 Region Index Data Block	B - 9
B.5 Watershed Index Data Block	B - 9
B.6 Crop and Season Share Data Block	B - 10
B.7 Watershed Definition Data Block	B - 10
B.8 Regional Economic Data Block	B - 11
Appendix C 1990-2000 County Inventory Changes	C - 1
Appendix D Statistical Abstracts (1990)	D - 1
Appendix E Statistical Abstracts (2000)	E - 1
Appendix F Population Tables	F - 1
Appendix G Census File Creation and Testing Source Code	G - 1
G.1 Module: "Census_File_Convert"	G - 1
G.2 Module: "Census_File_Test"	G - 5
Appendix H SECPOP2000 Source Code	H - 1
H.1 Visual Basic Code Module: CALCCODE.BAS	H - 1
H.2 Visual Basic Code Module: Cmndlg.bas	H - 16
H.3 Visual Basic Code Module: Const.bas	H - 24
H.4 Visual Basic Code Module: FormsPosition.bas	H - 29
H.5 Visual Basic Code Module: GridUtils.bas	H - 30
H.6 Visual Basic Code Module: InIt.bas	H - 36
H.7 Visual Basic Code Module: MainModule.bas	H - 44
H.8 Visual Basic Code Module: Mp_setup.bas	H - 45

H.9 Visual Basic Code Module: Outpcode1.bas	H - 46
H.10 Visual Basic Code Module: Probcode.bas	H - 64
H.11 Visual Basic Code Module: ReadFile.bas	H - 77
H.12 Visual Basic Code Module: Rptable1.bas	H - 87
H.13 Visual Basic Code Module: Run_mppr.bas	H - 90
H.14 Visual Basic Code Module: Savedata.bas	H - 91
H.15 Visual Basic Code Module: Sitecode.bas	H - 92
H.16 Visual Basic Code Module: Types.bas	H - 96
H.17 Visual Basic Code Module: Utility.bas	H - 97
H.18 Visual Basic Code Module: Utility_Rosette.bas	H - 102
H.19 Visual Basic Form Module: About.frm	H - 110
H.20 Visual Basic Form Module: Circle.frm	H - 113
H.21 Visual Basic Form Module: Cmndlgf.frm	H - 127
H.22 Visual Basic Form Module: Densform.frm	H - 137
H.23 Visual Basic Form Module: frmCalculate.frm	H - 139
H.24 Visual Basic Form Module: frmChooseDir.frm	H - 144

Figures

Figure 2-1 File and Directory Structure	4
Figure 3-1 Parts of the Screen	5
Figure 3-2 Toolbar Menu	6
Figure 3-3 Site Form	8
Figure 3-4 Outside of the Continental U.S. Notification	9
Figure 3-5 Previous Site Data	10
Figure 3-6 Problem Form	11
Figure 3-7 Rosette Definition	12
Figure 3-8 Radial Unit Conversion	13
Figure 3-9 Economic-Regions Form	15
Figure 3-10 Example Economic-Regions Form	16
Figure 3-11 Example Economic-Regions Rosette	17
Figure 3-12 Previous Problem Data	18
Figure 3-13 Calculation Error Message	18
Figure 3-14 Calculate Form	19
Figure 3-15 Stop Calculation Confirmation	19
Figure 3-16 Population Rosette	20
Figure 3-17 Population-Table Form	21
Figure 3-18 Cumulative-Population-Table Form	22
Figure 3-19 MACCS2 Site-Data File Form	23
Figure 3-20 CSV Site-Data File Form	26
Figure 3-21 Setup Form	31
Figure 3-22 Exit Confirmation Form	32
Figure 5-1 PL94-71 README File dBase to ASCII Conversion Program	45
Figure 5-2 Commercial Data Engine User Interface	46
Figure 5-3 Output for a Single Block	47
Figure 5-4 Verification Directory Structure	52
Figure 5-5 Developed Land Trends	58
Figure 5-6 Median Housing Values, 1991 through 1999	59
Figure 5-7 VFAus, United States Farm Business Assets Trend	59
Figure 5-8 Median Lot Size for American Homes	60
Figure 5-9 Millstone Rosette	63
Figure 5-10 Monticello Rosette	64
Figure 5-11 Diablo Canyon Rosette	64
Figure 5-12 San Onofre Circles Comparison	66
Figure 5-13 San Onofre Rosette Visualization Example	68
Figure 5-14 Peach Bottom Rosette Visualization Example	69
Figure 5-15 Peach Bottom Circles Comparison	69
Figure 5-16 Columbia Power Station Rosette	72
Figure 5-17 Limerick Rosette	73
Figure 5-18 River Bend Rosette	73

Figure 5-19 St. Lucie Rosette 74
Figure B-1 MACCS/MACCS2 sample Site Data file B - 3

Tables

Table 3.1 Example MACCS2 Site-Data File	24
Table 3.2 Example CSV Site-Data File	26
Table 4.1 County Level Data File Variables and Data Sources	36
Table 4.2 Excerpt From the 1990 County-Level Database	39
Table 5.1 dBase III Census Record Format	41
Table 5.2 <i>CENSUS00.DAT</i> Verification Summary	49
Table 5.3 Test 2 Results: State-by-State Comparison	50
Table 5.4 Test 3 Results: County-by-County Comparison	51
Table 5.5 Ten Mile Comparison with Census Bureau Using SECPOP90 Program and CENSUS00.DAT file	53
Table 5.6 Census of Agriculture Data Items	55
Table 5.7 Variation in COUNTY90.DAT and COUNTY97.DAT Parameters	57
Table 5.8 Total Reported and Calculated Populations	62
Table 5.9 San Onofre Circles Comparison Cumulative Population	65
Table 5.10 San Onofre Sector by Sector Comparison	67
Table 5.11 Total Reported and Calculated Populations for a 60-Mile Radius	70
Table A.1 SECPOP2000 Site File Listing	A - 1
Table D.1 1993 & 1994 Statistical Abstract of the U.S.	D - 1
Table D.2 NUREG/CR-4551 Volume 2, Revision 1, Part 7	D - 1
Table D.3 1994 County and City Data Book	D - 1
Table E.1 Fixed Reproducible Tangible Wealth	E - 1
Table E.2 Non-Federal Land Use	E - 2
Table E.3 Example Housing Value Table	E - 3
Table E.4 Farm Business Balance Sheet	E - 4
Table E.5 Lot Size Example	E - 5

1 Introduction

This report is divided into five sections. Section 1 is this introduction. Section 2 describes the installation of the SECPOP2000 software on a personal computer (PC). Section 3 is the user's guide, which explains how to use the software in a step-by-step manner. Section 4 describes the algorithms used to perform the population, land fraction, and economic estimates. Section 5 discusses the software design, development, and verification. Appendices describe input and output file formats and the conversion of U.S. Bureau of Census data (from CD-ROMs) to the block census and county economic data files that are included with SECPOP2000.

1.1 Background

In 1973 W. Athey of the U.S. Environmental Protection Agency (EPA) wrote a computer program called SECPOP that calculated population estimates. This program was intended to run on mainframe computers. It used 1970 population census data and was created to support a study on air quality. The Nuclear Regulatory Commission (NRC) adopted this program to perform siting reviews for nuclear power plant construction and to evaluate license applications.

Two things changed that suggested the need for updating the original program — more recent population censuses data became available and PC usage became widespread. The current version, SECPOP2000, can perform calculations with either 1990 or 2000 population data and runs on PCs running Windows 98™, NT™, 2000™, and XP™.

SECP90 (Reference 1) supports two types of analysis: site and regional. The site analysis provides population and economic data estimates for any location within the continental United States. Calculation results can be displayed, printed, or saved as a rosette, a table, a MACCS2 (MELCOR Accident Consequence Code System) site file, or a MACCS2-like comma-separated-variable file. Regional analysis assesses compliance of available sites against siting parameters (i.e., specific population density criteria). Regional analysis is not supported in SECPOP2000 because some of the software packages originally used for regional analysis are no longer available.

SECPOP2000 uses the latest (2000) census data, which provide greater resolution than the 1980 and 1990 census data. This greater resolution is achieved by employing over eight million census-block data points and performing the sector population estimates directly from these points. This is an increase of approximately two million data points over the 1990 census data.

1.2 Hardware and Software Requirements

SECPOP2000 was developed to run on personal computers that run the Windows 98™, NT™, 2000™, and XP™ operating systems. The SECPOP2000 software requires approximately 170 megabytes of hard-disk storage.

Minimum System Requirements:

Pentium™ or faster Intel™ processor;
Windows 98™, Windows NT™ 4.0 or later, Windows 2000™, or Windows XP™
64 MB of RAM;
170 MB of available hard-disk space;
CD-ROM drive; and
Minimum screen resolution of 800x600 (recommended)

2 Installation

SECPOP2000 can be installed on PCs running the Windows 98™, NT™, 2000™, and XP™ operating systems. If the user later decides to uninstall SECPOP2000, the uninstall process automatically leaves in place any files added or modified since the original installation.

To start the installation process, first exit or quit all other programs and insert the SECPOP2000 CD into the CD drive. If AutoRun is enabled, the installation program starts automatically. If it doesn't start automatically, open Windows Explorer, navigate to the CD drive, and double click on Setup. After answering a few basic questions, the program installs SECPOP2000. This process takes a few minutes to complete due to the large data files that must be copied to the hard drive. You may need to reboot your computer as part of the installation process.

When installation is complete, the directory contains the files and sub-directories shown in Figure 2-1. (The default main directory is C:\Program Files\SECPOP. The root of the directory is different if you chose another directory during installation.) For more information about these files see Subsections 3.7 and 4.4.

2.1 Initialization

Although the user can read or save input or output files to any directory, the program is set up during installation to initially access these files from the directories shown in Figure 2-1. The user can temporarily change the current directories from which information is accessed or stored by using the file dialogs that appear when saving or accessing files; the user can permanently change the default directories by using the Setup form (see Subsection 3.8).

All SECPOP2000 output files can be printed directly from within SECPOP2000 or from any word processor or other program capable of opening ASCII text files. The population tables and the population rosette (see Subsection 3.6) can also be printed from within SECPOP2000.

2.2 Starting SECPOP2000

SECPOP2000 can be started either by choosing SECPOP2000 from the *Start, Programs* menu or by double clicking the SECPOP2000 icon that is placed on the desktop during the installation process. (This icon can be deleted by dragging it to the Recycle Bin.)

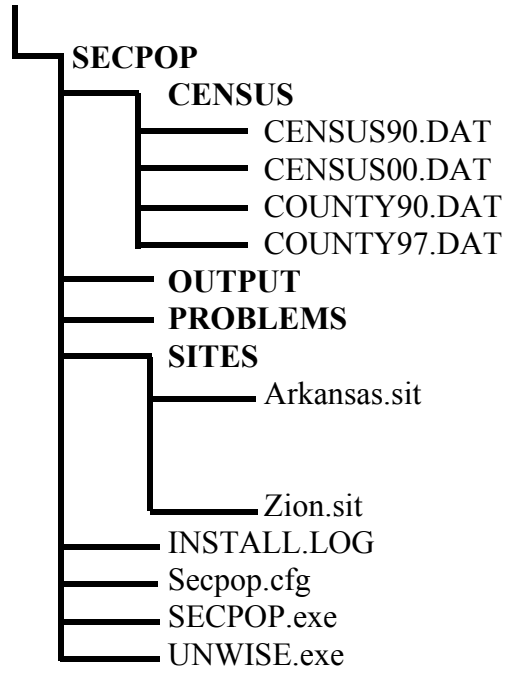

Figure 2-1 File and Directory Structure

3 User's Guide

SECPOP2000, Version 3.12, allows the user to perform population estimation calculations related to a specific site; SECPOP90 allowed the user to perform calculations related to a specific site and calculations related to a region of the continental United States. The ability to perform calculations related to a region may be added to SECPOP2000 in a future version.

The site calculation requires, among other things, a specific latitude and longitude to define the location of the site. This is typically the reactor center for a single unit site or the center point between reactors at a multi-unit site. (A small difference in location is not expected to significantly affect SECPOP2000 results or subsequent MACCS2 results.)

SECPOP2000 starts with the initial screen shown in Subsection 3.1. Site-specific calculations are described in Subsections 3.3 through 3.6. Descriptions on how to navigate through the SECPOP2000 menus and forms are provided in Subsections 3.2 and 3.3 respectively.

3.1 Parts of the Main Screen

The SECPOP2000 main screen is divided into four major sections (see Figure 3-1). Section (1), *Main Screen Title Bar*, displays the name of the SECPOP2000 program, the version number, and the Census file currently selected on the Setup form (see Subsection 3.9). Section (2), *Main Menu*, is the SECPOP2000 main menu. Section (3), *Toolbar Menu*, contains shortcuts for commonly used main menu items. Section (4), *Work Areas*, is the area where various other forms and messages appear. Most of these require the user to provide some information or make a decision. This area may be expanded to allow viewing of several forms at the same time (if the screen resolution is greater than 800X600). The *Welcome to SECPOP2000* screen shown below closes when the user clicks on the OK button, or selects a command from the main menu.

1. Main Screen Title Bar
2. Main Menu
3. Toolbar Menu

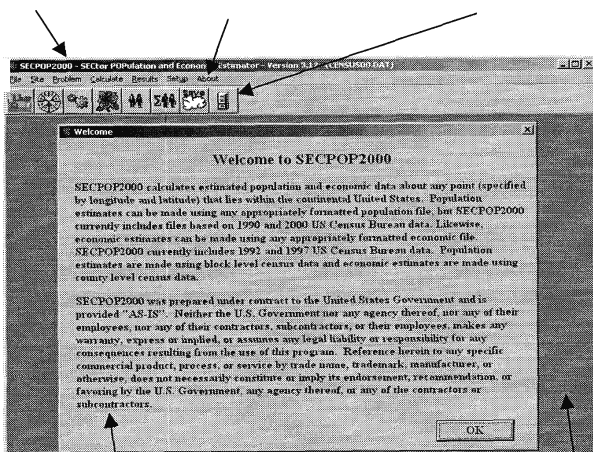

4. Welcome Screen
5. Additional Form or Message Work Area

Figure 3-1 Parts of the Screen

3.2 Menus

3.2.1 Main Screen

The main screen consists of six menus or commands:

File	exit the program;
Site	site characteristics for site-specific calculations;
Problem	additional non-site-specific parameters for site-specific calculations;
Calculate	perform site-specific or regional (inoperative in SECPOP2000) calculations;
Results	results from present or previous calculation;
Setup	customize the SECPOP2000 environment; and
About	information about SECPOP2000.

The order of the selections above outlines the order of how you might solve a site-specific problem. 1) define the site parameters such as latitude and longitude using the *Site* menu. 2) define additional problem parameters such as the radius of the exclusion area using the *Problem* menu. 3) perform the calculations using the *Calculate* menu. 4) examine the results using the *Results* menu.

Additionally, the *Setup* command allows you to modify the SECPOP2000 environment. Default pathnames for site, problem, output, and database files may be set in the *Setup* form. The About menu displays brief information about the SECPOP2000 program. The *File, Exit* menu option exits the SECPOP2000 program.

3.2.2 Toolbar Menu

The toolbar menu shown in Figure 3-2 contains the commands that are most commonly used:

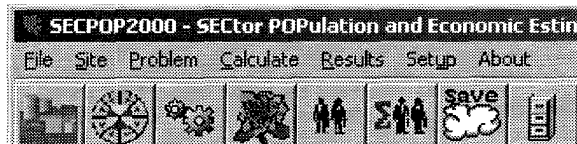









Figure 3-2 Toolbar Menu

Hovering the cursor over each icon shows a tool tip that describes function invoked when clicking on the icon.

	Open a previously saved site.
	Open a previously saved problem.
	Perform a site calculation.
	Show the population rosette.
	Show the population table.
	Show the cumulative population table.
	Save the results in a MACCS2 formatted file.
	Show the setup form.

3.3 Site Definition

Site definition consists of specifying the site name, latitude, longitude, and any desired site-specific remarks. The Site menu has four available commands. Note that some of these commands are not available at all times. For example, *Save Site* and *Save As Site* are not enabled if there is no site information to save. The four Site menu commands are:

- New Site enter the site-specific parameters for a new site;
- Open Site open a previously saved site;
- Save Site save the site information with the present filename; and
- Save As Site save the site information with a new filename.

3.3.1 New Site

Selecting New Site opens the blank form shown in Figure 3-3.

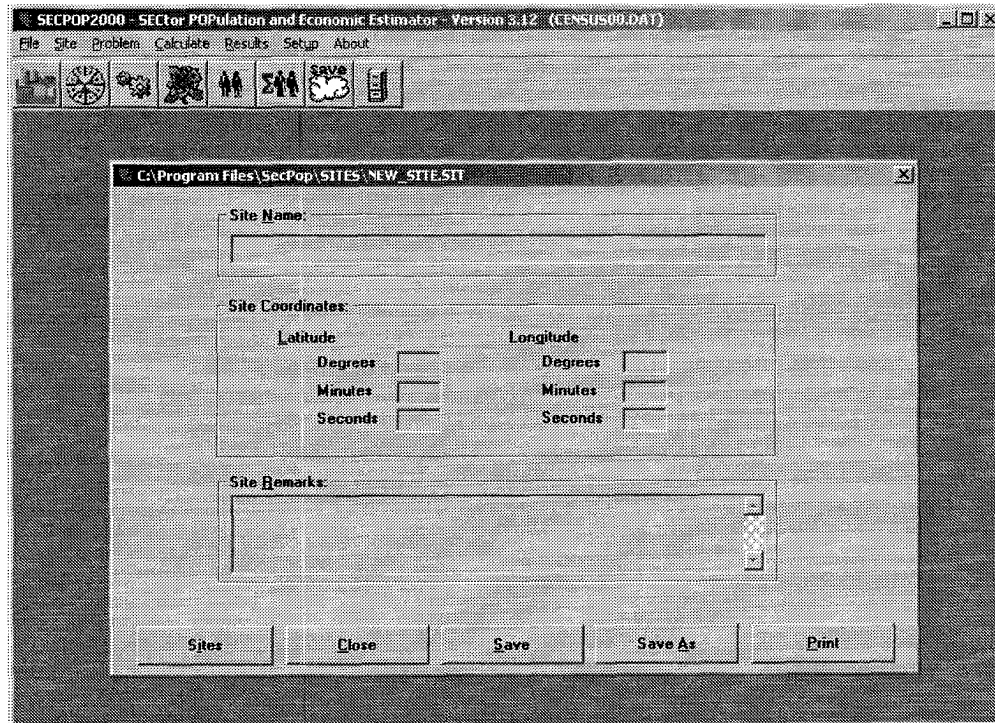

Figure 3-3 Site Form

Site Form Fields

The Site form consists of the following fields that are designed so the user may easily edit all of the site-specific information (fields are designated required or optional depending on whether they are required to perform site-specific calculations):

- | | |
|-----------|---|
| Title Bar | contains the filename of the site being edited. If this is a new problem, then the default filename “NEW_SITE.SIT” is used. If the Site form is edited, then the phrase “(Modified)” is displayed after the site filename. The filename is automatically updated when the user performs a Save or Save As command (see the next section). |
| Site Name | a descriptive name of the site. Up to eighty characters (both rows of the field in the form) may be used to describe the site. This field is displayed or printed whenever the site specific information is displayed or printed. Only the first 40 of those characters (the first row) are printed on the first line of the MACCS2 Site Data File. This field is optional. |
| Latitude | the latitude of the site in degrees, minutes, and seconds. Zeros (0s) must be entered if the minutes or seconds are equal to zero (0). This field is required. |
| Longitude | the longitude of the site in degrees, minutes, and seconds. Zeros (0s) must be entered if the minutes or seconds are equal to zero (0). This field is required. |

SECPOP2000 checks to see if the coordinates of the site lie outside of the Continental U.S. by comparing the coordinates to the minimum and maximum coordinates of the continental U.S. If the coordinates are determined to be outside of the continental U.S., then SECPOP2000 displays the error message shown in Figure 3-4.

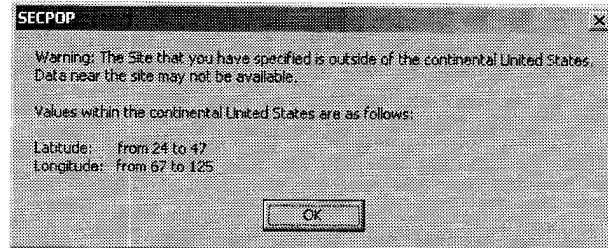

Figure 3-4 Outside of the Continental U.S. Notification

Note: this limited checking is meant to alert the user to gross typing errors. The absence of the above message does not guarantee that the site information is correct. The user should always double-check the information in the required fields with the original sources.

Site Remarks descriptive remarks about the site. Up to 80 characters (both rows of the field in the form) may be used to describe the site. This field is displayed or printed when viewing this form or printing the site-specific information (see the Print command in the next section). One use of this space could be to record plant specific information. For example:

Unit I -- GE BWR 6 with Mark III containment, licensed in 1984

This field is optional.

Site Form Commands

At the bottom of the *Site* form is a row of five command buttons. The commands support the opening, closing, saving, and printing of the *Site* form. The command buttons are as follows:

- Sites** opens a previously defined site file. This command is equivalent to the *Open Site* command of the *Site* menu. For a more detailed explanation see Subsection 3.3.2.
- Close** closes the *Site* form. All information on the form is saved in memory and can be reviewed by opening the *Site* form again. The information is lost unless the site information is stored in a file (see the *Save* and *Save As* commands below) before SECPOP2000 is exited. The user may close the *Site* form or leave it open.

Save	saves the site information using the filename displayed in the <i>Site</i> form <i>Title Bar</i> as an ASCII text file. This command is equivalent to the <i>Save Site</i> command of the <i>Site</i> menu.
Save As	saves the site information using a filename specified by the user. This command is equivalent to the <i>Save As Site</i> command of the <i>Site</i> menu. For a more detailed explanation see Subsection 3.3.4.
Print	prints the site-specific information to a user-specified printer.

3.3.2 Open Site

Selecting *Open Site* allows the user to select a site that has been previously defined and saved to a file. The user may select from the list of previously defined sites (contained in the SECPOP\SITES directory) or a personal list of sites. Once the site is chosen and the *Open* button is selected, the file is loaded into memory and the *Site* form is displayed with the saved information. The user may close the *Open Site* form or leave it open.

All predefined sites have the default filename extension *sit*. The user is not required to follow this practice. Doing so, however, makes it easier to find previously defined site files. This is especially true when a single directory has an assortment of site, problem, and results files.

If either *New Site* or *Open Site* is selected from the *Site* menu and site data have already been entered or loaded from a file, SECPOP2000 first asks the user if the previously entered or loaded data should be reviewed before overwriting them. SECPOP2000 displays the message shown in Figure 3-5.

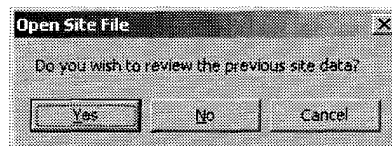

Figure 3-5 Previous Site Data

If the user selects *Yes*, then the *New Site* or *Open Site* operation is canceled and the *Site* form with the old data is displayed. If the user selects *No*, then the old data is overwritten with a blank form in the case that *New Site* was selected or with the data from the site file that was opened. Selecting *Cancel* cancels the *New Site* or *Open Site* operation.

3.3.3 Save Site

Selecting *Save Site* saves the site information using the filename displayed in the *Site* form *Title Bar*. After the file is saved, the *Title Bar* of the *Site* form is updated. This command is equivalent to the *Save* command found on the *Site* form (see Figure 3-3).

3.3.4 Save As Site

Selecting *Save As Site* allows the user to save the site information using a user-specified filename. The *Title Bar* of the *Site* form is then updated with the new filename. Selecting *Cancel* cancels the *Save As Site* operation and returns the user back to the main menu. This command is equivalent to the *Save As* command found on the *Site* form (see Figure 3-3).

3.4 Problem Definition

Problem definition consists of specifying the radii of interest, the population multiplier, the name of the site file that contains the site-specific information for the problem, mapping the problem sectors to economic regions, and any desired problem-specific remarks. The *Problem* menu has four available commands. Note that some of these commands are not available at all times. For example, *Save Problem* and *Save As Problem* are not enabled if there is no problem information to save. The four *Problem* menu commands are:

- New Problem opens the problem-specific parameter form for a new problem;
- Open Problem opens a previously saved problem;
- Save Problem saves the problem information with the present filename; and
- Save As Problem saves the problem information with a new filename.

3.4.1 New Problem

Selecting *New Problem* opens the form shown in Figure 3-6. The *Problem* form allows the user to enter or edit all problem-specific information.

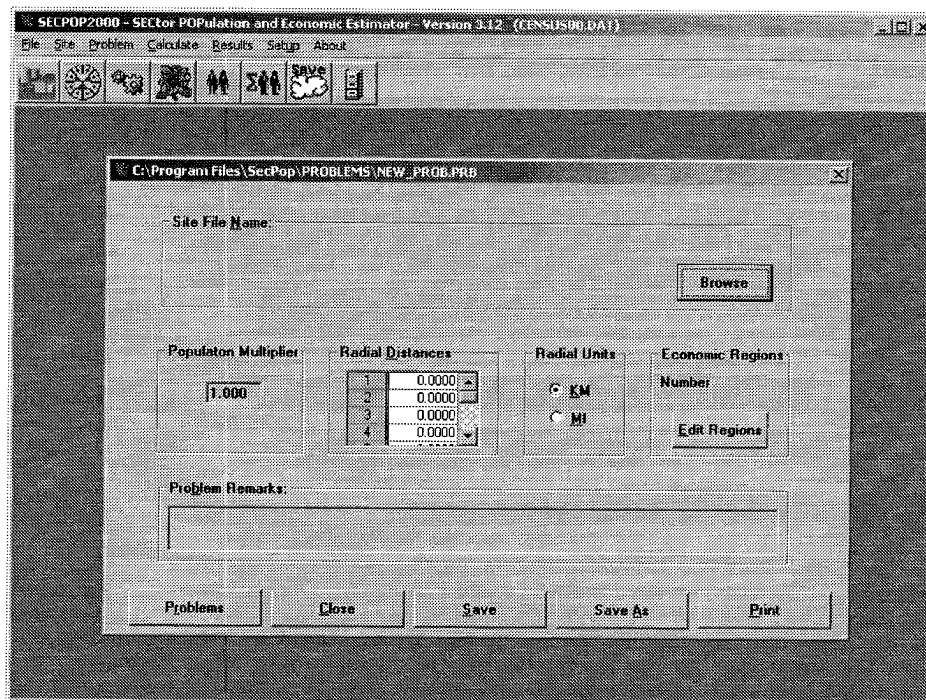

Figure 3-6 Problem Form

Problem Form Fields

The *Problem* form (see Figure 3-6) consists of the following fields that are designed so the user may easily edit all of the problem-specific information (fields are designated required or optional depending on whether they are required to perform site-specific calculations):

- Title Bar** contains the filename of the problem being edited. If this is a new problem, then the default filename “NEW_PROB.PRB” is used. If the *Problem* form is edited, then the phrase “(Modified)” is displayed after the problem filename. The *Title Bar* is automatically updated when the user performs a *Save* or *Save As* command.
- Site File Name** contains the name of the site file associated with this problem. This field is required.
- Population Multiplier** is a factor that is applied to the census population data. This field allows manipulation of the census estimates by a uniform multiplication factor. For example, if it is expected that in the year 2005 the overall population will have increased by 10%, a population scale factor of 1.1 could be used to represent this growth. The default value is 1.0. This field is required. It must have a value between 0.0 and 100.0.
- Radial Distances** are the radii of interest for the problem. The geometry of SECPOP2000 problems is based on that of MACCS2. The area around a site is divided into sixteen compass sectors that are equivalent to a standard navigational compass rosette. The rosette is then further divided into radial rings, specified according to the *Radial Distances* field. Figure 3-7 shows a rosette that has nine user-defined radial rings. The site itself is located at the very center of the rosette.

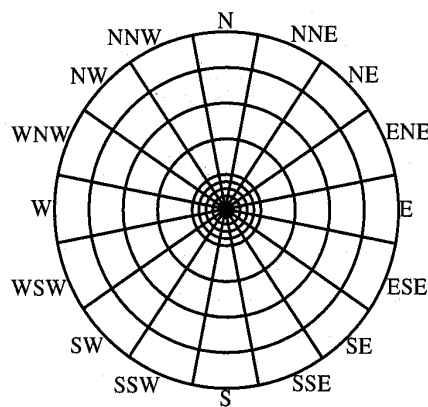

Figure 3-7 Rosette Definition

The collection of directional lines and radii naturally divide the rosette into sections that are defined by two adjacent radii and two neighboring circles. Normally the innermost circle approximates the exclusion area boundary of the site; the second radius often approximates the low population zone. These sections are mapped into economic regions by using the *Edit Regions* command described below.

Radial Units, MI

The radial distances can be expressed in miles or kilometers (see the *Radial Units* field described below). The user is limited to 35 radii to maintain compatibility with the MACCS2 Site Data File format. At least two radii must be defined. All radii must be separated from each other by at least 0.05 km (0.0311 mi.). This field is required. indicates that the radial distances are in miles. If the radial distances are in kilometers and this option is selected, then the user is given the option of performing a conversion from kilometers to miles or only changing the unit designation. This is accomplished using the form shown in Figure 3-8. Either miles or kilometers must be selected.

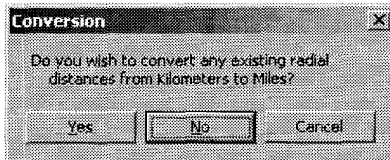

Figure 3-8 Radial Unit Conversion

Radial Units, KM

indicates that the radial distances are in kilometers. If the radial distances are in miles and this option is selected, then the user is given the option of performing a conversion from miles to kilometers or only changing the unit designation. This is accomplished using a form similar to that shown in Figure 3-8. Either kilometers or miles must be selected.

Problem Remarks

descriptive remarks about the problem. Up to eighty characters (both rows of the field in the form) may be used to describe the problem. This field is displayed or printed when viewing this form or printing the problem-specific information (see the Print command in the next section). One use of this space could be to record the source of problem-specific information. For example:

**Grand Gulf Nuclear Station (GGNS) Unit: I Emergency
Plan Section 2.2**

This field is optional.

Problem Form Commands

The *Problem* form (shown in Figure 3-6) form has six command buttons: five at the bottom of the *Problem* form similar to the *Site* form and an additional command button for editing the economic regions. The commands are executed when the buttons are selected. The commands support editing of the economic regions and the opening, closing, saving, and printing of the *Problem* form. The command buttons are as follows:

- | | |
|--------------|---|
| Edit Regions | opens the <i>Economic Regions</i> form (see Figure 3-9) and allows editing of the economic regions. This form is described in detail in Subsection 3.4.2. |
| Problems | opens a previously defined problem file. This command is equivalent to the <i>Open Problem</i> command of the <i>Problem</i> menu. For a more detailed explanation, see Subsection 3.4.3. |
| Close | closes the <i>Problem</i> form. All information on the form is saved in memory and can be reviewed by opening the <i>Problem</i> form again. The information is lost unless the problem information is stored in a file (see the <i>Save</i> and <i>Save As</i> commands below) before SECPOP2000 is exited. The user may close the <i>Problem</i> form or leave it open. |
| Save | saves the problem information using the filename displayed in the <i>Problem</i> form <i>Title Bar</i> . This command is equivalent to the <i>Save Problem</i> command of the <i>Problem</i> menu. |
| Save As | saves the problem information using a filename specified by the user in an ASCII text file. This command is equivalent to the <i>Save As Problem</i> command of the <i>Problem</i> menu. For a more detailed explanation, see Subsection 3.4.5. |
| Print | prints the problem-specific information to a user-specified printer. |

3.4.2 Economic Regions

Selecting Edit Regions from the Problem opens the form shown in Figure 3-9. The Economic Regions form allows the user to assign economic regions to the rosette sections or edit the present assignments.

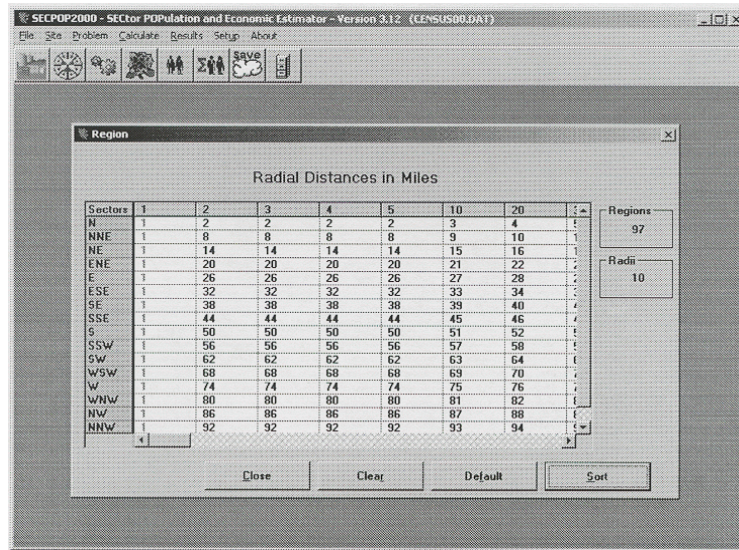

Figure 3-9 Economic-Regions Form

Economic Regions Form Fields

The *Economic Regions* form consists of the following fields that are designed so the user may assign or edit the economic regions. All of the fields on this form are required and are initially filled in by SECPOP2000. All fields except for the exclusion area (i.e., for the innermost circle) are editable by the user. These fields are designated as “User input field,” in the descriptions below.

- Radial Distances the first row of the economic-regions table contains the radial distances in the units specified on the *Problem* form (see Figure 3-7).
- Sectors the first column of the economic-regions table contains the rosette direction descriptors. These descriptors correspond to the sixteen standard directions of a navigational compass.
- Regions number of economic regions. The minimum number of allowed economic regions is 1. The maximum number of allowed regions is 99.
- Radii number of radii. The minimum number of allowed radii is 2. The maximum number of allowed radii is 35. The radii are defined on the *Problem* form.
- Rosette Sections the remaining values in the economic-regions table are the economic-region designators for the displayed rosette sections. These values correspond to the outer radius shown at the top of the column and to the inner radius shown at the top of the previous column. Economic region # 1 is automatically assigned to all of the sections that lie within the innermost ring (circle). This ring is normally thought of as the exclusion area boundary and economic region # 1 is thought of as the exclusion area.

To assign economic regions to the remaining rosette sections, enter a number for that region that is greater than or equal to 2 and less than or equal to 99. That rosette section then belongs to that economic region. If, for example, the user enters a 2 in the third column, second row of the economic regions table shown in Figure 3-10, then the rosette section defined by the first and second radii in the northern direction would be part of economic region 2. An economic region number must be assigned to each rosette section. There is no need for the same economic region to occupy adjacent cells or for all economic regions to occupy the same number of cells. This allows the user to assign a single economic region to features that might occur repeatedly over the rosette. For example, a user could assign the same economic regions to lakes or desert areas.

Figures 3-10 and 3-11 illustrate the mapping of economic regions onto a rosette for a very simple situation. In this case the economic regions occupy concentric rings, as shown in Figure 3-11. The innermost ring (circle) is always designated as economic region #1 and normally corresponds to the exclusion area, as indicated in the legend of Figure 3-11.

Sectors	5	10	15	20	25
N	1	2	3	4	5
NNE	1	2	3	4	5
NE	1	2	3	4	5
ENE	1	2	3	4	5
E	1	2	3	4	5
ESE	1	2	3	4	5
SE	1	2	3	4	5
SSE	1	2	3	4	5
S	1	2	3	4	5
SSW	1	2	3	4	5
SW	1	2	3	4	5
WSW	1	2	3	4	5
W	1	2	3	4	5
WNW	1	2	3	4	5
NW	1	2	3	4	5
NNW	1	2	3	4	5

Regions: 5
Radii: 5

Buttons: Close, Clear, Default, Sort

Figure 3-10 Example Economic-Regions Form

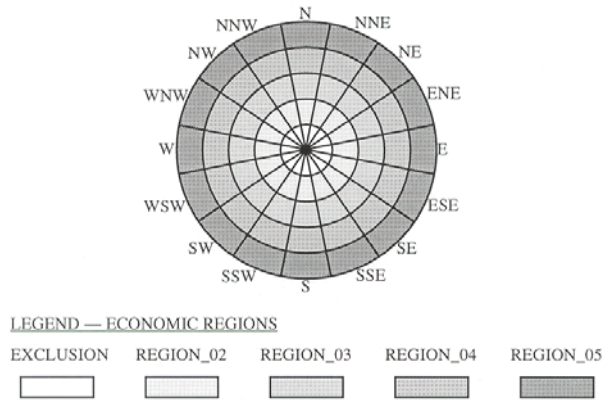

Figure 3-11 Example Economic-Regions Rosette

Economic Regions Form Commands

The *Economic Regions* form has three command buttons for performing various operations on the economic regions and a button for closing the *Economic Regions* form as follows:

- | | |
|---------|---|
| Close | sorts the economic regions and closes the Economic Regions form. To save the edited economic regions, the user must select <i>Save</i> or <i>Save As</i> from the <i>Problem</i> form (see Figure 3-6) or <i>Save Problem</i> or <i>Save As Problem</i> from the <i>Problem</i> menu. |
| Clear | clear all values from all of the rosette sections except for economic region 1, which is always the section from the center of the rosette to the first radius and is normally considered to be the exclusion area. |
| Default | restores the economic regions to the default values shown in Figure 3-10. |
| Sort | renumbers economic regions so that there are no gaps in the numbering of the regions and the regions are sorted in row-column order. Sorting the economic regions is not required but it usually makes the economic regions mapping easier to understand. |

3.4.3 Open Problem

Selecting *Open Problem* from the main menu or from the toolbar menu allows the user to select a previously defined problem file.

While users are not required to follow this practice, it is recommended that they append the filename extension .prb to all problem files. Doing so makes it easier to find previously defined problem files. This is especially true when a single directory contains an assortment of site, problem, and result files.

If either *New Problem* or *Open Problem* is selected from the *Problem* menu and problem data has already been entered or loaded from a file, SECPOP2000 first asks the user if the previously entered

or loaded data should be reviewed before overwriting it. SECPOP2000 displays the message shown in Figure 3-12.

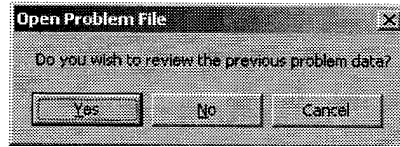

Figure 3-12 Previous Problem Data

If the user selects *Yes*, then the *New Problem* or *Open Problem* operation is canceled and the *Problem* form with the old data is displayed. If the user selects *No*, then the old data is overwritten with a blank form or the new data. Selecting *Cancel* cancels the *New Problem* or *Open Problem* operation and returns the user back to the main menu.

3.4.4 Save Problem

Selecting *Save Problem* saves the problem information using the filename displayed in the *Problem* form *Title Bar* as an ASCII text file. After the file is saved, the *Title Bar* of the *Problem* form is updated. This command is equivalent to the *Save* command found on the *Problem* form (see Figure 3-7).

3.4.5 Save As Problem

Selecting *Save As Problem* allows the user to save the problem information as a user-specified ASCII text file. The *Title Bar* of the *Problem* form is then updated with the new filename. Selecting *Cancel* cancels the *Save As Problem* operation. This command is equivalent to the *Save As* command found on the *Problem* form (see Figure 3-6).

3.5 Performing Site-Specific Calculations

Once the *Site*, *Problem*, and *Economic Regions* forms are complete, a site-specific calculation may be performed by selecting the *Calculate* menu from the main menu and then selecting *Site-Specific* from the *Calculate* menu. If there is not enough information to perform a site-specific calculation, the error message shown in Figure 3-13 is displayed, and the user must provide the necessary information before the calculation can proceed.

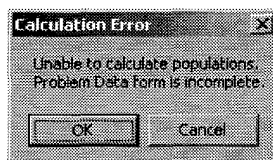

Figure 3-13 Calculation Error Message

If all of the forms have been sufficiently completed, the calculations begin and the *Calculate* form shown in Figure 3-14 is displayed.

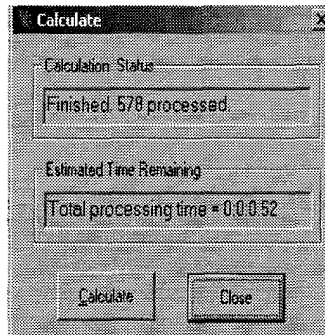

Figure 3-14 Calculate Form

Calculate Form Fields

The *Calculate* form consists of the following fields that are designed so the user may monitor the progress of the calculation. All of the fields are filled in automatically by SECPOP2000 and cannot be edited by the user.

Calculation Status	the current status of the calculation. It gives a running total of the number of records that have been processed.
Estimated Time Remaining	an estimate of how much time remains before the calculation is complete.

Calculate Form Commands

The *Calculate* form has two command buttons that are used to control the calculation and close the *Calculate* form. The commands are executed when the buttons are selected. The command buttons are as follows:

Calculate	begins the site-specific calculation; and
Close	stops the calculation if it is under way. Note: the user is asked to confirm that the calculation should be stopped, as shown in Figure 3-15. If a calculation is not under way, then this command closes the <i>Calculate</i> form.

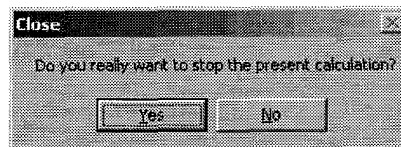

Figure 3-15 Stop Calculation Confirmation

Note: the population estimates are based on over eight million census-block records for 2000 census data (six million for 1990 census data). The economic-factor and land-fraction estimates are aggregated at the county level, which is significantly more granular than the population estimates. Subsection 5.2.1 provides notes and exceptions for the economic data.

3.6 Site-Specific Results

There are several ways to display, print, or save the site-specific calculation results. The results are accessed by selecting the *Results* menu. All of the commands and menus (except for *Regional*) apply to site-specific results and are discussed below. *Regional* calculations are not supported in SECPop2000.

Population Rosette	displays a rosette with population per section.
Population Tables	displays rosette populations in table formats.
MACCS2-Input File	displays, prints, or saves the MACCS2 Site Data File.
CSV File	displays, prints, or saves the MACCS2 Site Data File in comma-separated-variable format. This file is not directly usable by MACCS2, but may be imported into a spreadsheet or database program.
Regional	is not functional.
Load Previous Results	loads previously saved calculated results.

3.6.1 Population Rosette

Selecting *Population Rosette* from the *Results* menu or from the toolbar menu displays a rosette like the one shown in Figure 3-16. Clicking on the *Print* button sends the rosette image to a user-specified printer. Clicking on the *Save* button saves the rosette to a file in bitmap form. This file may be imported into other applications (such as a word processor).

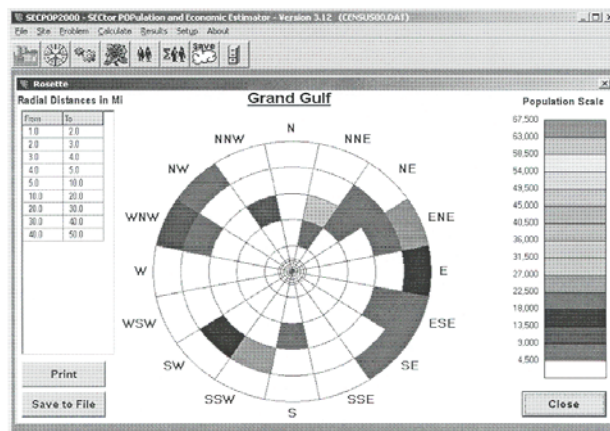

Figure 3-16 Population Rosette

3.6.2 Population Tables

Selecting *Population Tables* from the *Results* menu displays the *Population Tables* sub-menu. This sub-menu provides the user with two methods for displaying the population results: the *Population* command, which displays a tabular version of the rosette with the population values for each rosette section, and the *Cumulative* command, which displays a similar table except that the population is summed from the origin to the current radius for each sector.

Population

Selecting *Population* from the *Population Tables* sub-menu or from the toolbar menu displays a table like the one shown in Figure 3-17. The population data is shown in a manner similar to the method used to display the economic regions on the *Economic Regions* form (see Subsection 3.4.2). The table has no user input fields. There are two command buttons, *Close* and *Print*, that perform the following functions:

Close closes the *Population Table* form.

Print prints the population information to the user-specified printer.

Sectors	1	2	3	4	5	10	20	Sum
N	0	14	0	0	0	10	171	2743
NNE	0	0	0	0	29	3	5195	41832
NE	0	14	0	0	27	56	1801	14673
ENE	0	17	0	64	0	123	244	74478
E	0	0	0	113	56	102	567	20440
ESE	0	10	0	0	336	840	981	16652
SE	0	0	0	10	776	2582	1177	29536
SSE	0	14	5	37	122	571	1189	8314
S	0	0	0	0	0	34	2186	10260
SSW	0	0	4	0	22	1357	1191	34398
SW	0	0	0	0	0	74	51	21925
WSW	0	0	0	0	0	56	1671	6027
W	0	0	0	0	0	123	346	7751
WNW	0	0	0	0	0	6	2386	18260
NW	0	0	0	0	0	28	130	8573
NNW	0	0	0	0	0	0	95	14587

Figure 3-17 Population-Table Form

Cumulative

Selecting *Cumulative* from the *Population Tables* sub-menu or from the toolbar menu displays a table like the one shown in Figure 3-18. The cumulative population data is shown in a manner similar to the one used to display the economic regions on the *Economic Regions* form (see Subsection 3.4.2). The data displayed on this form is summed from the origin outward along each sector. This means that along each sector, the population includes all of the population up to that radius in the given sector.

For example, in Figure 3-18 the cumulative population inside the 5-mile radius along the eastern direction is 169. This value includes the population of 113 found between the 3- and 4-mile radii and the population of 56 between the 4- and 5-mile radii (see also Figure 3-17). The table has no user input fields. There are two command buttons, *Close* and *Print*, that perform the following functions:

- Close closes the Cumulative Population Table form.
- Print prints the cumulative-population information to the user-specified printer.

Sectors	1	2	3	4	5	10	20	Sum
N	0	14	14	14	14	24	195	2743
NNE	0	0	0	0	29	32	5227	41832
NE	0	14	14	14	41	97	1898	14673
ENE	0	17	17	81	81	204	448	74478
E	0	0	0	113	169	271	838	20440
ESE	0	10	10	10	346	1186	2167	16652
SE	0	0	0	10	786	3368	4545	29536
SSE	0	14	19	56	178	749	1938	8314
S	0	0	0	0	0	34	2220	10260
SSW	0	0	4	4	26	1383	2574	34398
SW	0	0	0	0	0	74	125	21925
WSW	0	0	0	0	0	56	1727	6027
W	0	0	0	0	0	123	469	7751
WNW	0	0	0	0	0	6	2392	18260
NW	0	0	0	0	0	28	158	8573
NNW	0	0	0	0	0	0	95	14587

Figure 3-18 Cumulative-Population-Table Form

3.6.3 MACCS2 Input File

Selecting *MACCS2 Input File* (also referred to in MACCS2 documentation as the Site Data File) from the *Result* menu displays the *MACCS2 Input File* sub-menu. This menu allows the user to display, print, or save the results in MACCS2 input-file format.

Display

Selecting *Display* from the *MACCS2 Input File* sub-menu displays the *MACCS2 Site Data File* form shown in Figure 3-19. There are no user-input fields on this form. The user can scroll through the data using the scroll button. The command *Close* closes the form. The MACCS2 Input File is displayed as ASCII text.

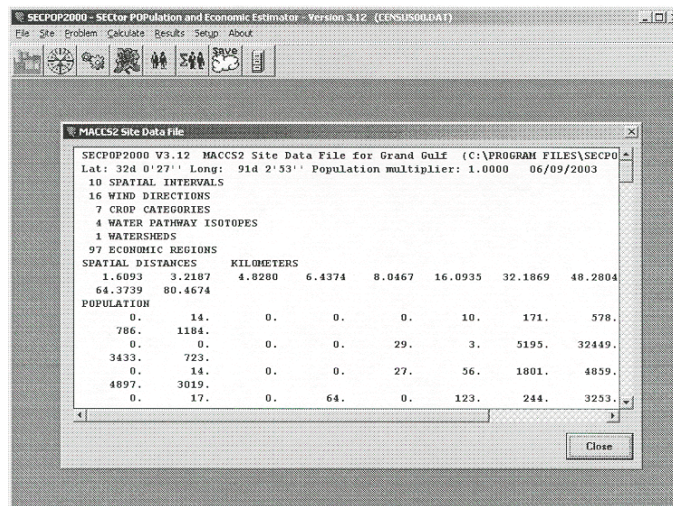

Figure 3-19 MACCS2 Site-Data File Form

Print

Selecting Print from the *MACCS2 Input File* sub-menu prints the MACCS2 Site-Data File to the user-specified printer. The MACCS2 Input File is printed as ASCH text.

Table 3.1 shows an example MACCS2 Site-Data File. SECPop2000 does not perform any calculations for estimating crop categories, water pathway isotopes, or watersheds. The values below for those categories (watershed index, crop season and share, and watershed definition) are default values generated so that the file created is completely compatible with MACCS2. For a full explanation of all of the data fields, see Appendix B.

Table 3.1 Example MACCS2 Site-Data File

```

SECPOP2000 V3.12 MACCS2 Site Data File for Grand Gulf
Lat: 32d 0'27'' Long: 91d 2'53'' Population multiplier: 1.0000 06/19/2002
10 SPATIAL INTERVALS
16 WIND DIRECTIONS
7 CROP CATEGORIES
4 WATER PATHWAY ISOTOPES
1 WATERSHEDS
97 ECONOMIC REGIONS
"SPATIAL DISTANCES KILOMETERS"
1.00 2.00 3.00 4.00 5.00 10.00 20.00 30.00
40.00 50.00
"POPULATION"
0. 0. 21. 0. 0. 0. 0. 42.
551. 175.
0. 0. 0. 0. 0. 19. 0. 2276.
16358. 19372.
0. 0. 15. 0. 0. 37. 264. 951.
3426. 2219.
0. 0. 36. 0. 0. 115. 137. 131.
721. 3265.
2. 0. 0. 0. 8. 197. 93. 418.
704. 986.
0. 0. 21. 0. 0. 556. 728. 440.
116. 348.
0. 0. 0. 0. 1. 2904. 806. 653.
287. 329.
0. 0. 4. 8. 0. 185. 1027. 373.
192. 326.
0. 0. 0. 0. 0. 0. 390. 1194.
3483. 1008.
0. 1. 0. 2. 0. 2. 1281. 307.
650. 2487.
0. 0. 0. 0. 0. 0. 1126. 108.
1151. 453.
0. 0. 0. 0. 0. 0. 273. 1516.
296. 223.
0. 0. 0. 0. 0. 40. 504. 65.
156. 244.
0. 0. 0. 0. 0. 0. 1356. 669.
255. 174.
0. 0. 0. 0. 0. 0. 71. 103.
32. 39.
0. 0. 5. 0. 0. 0. 1. 44.
237. 9750.
"LAND FRACTION"
0.97 0.00 0.97 0.00 0.00 0.97 0.95 0.95 0.96 0.96 0.00 0.00 0.00 0.00 0.00 0.97 0.95 0.95 0.95
0.95 0.00 0.00 0.97 0.00 0.00 0.97 0.96 0.95 0.95 0.97 0.00 0.97 0.97 0.00 0.00 0.97 0.97 0.97
0.99 0.99 0.97 0.00 0.00 0.00 0.97 0.97 0.97 0.97 0.99 0.99 0.97 0.97 0.97 0.00 0.97 0.97 0.97
0.97 0.99 1.00 0.00 0.00 0.00 0.97 0.97 0.97 0.97 0.98 0.99 0.97 0.00 0.97 0.97 0.00 0.97
0.97 0.99 0.99 0.99 0.00 0.97 0.00 0.00 0.00 0.97 0.98 0.99 0.99 0.99 0.00 0.97 0.00 0.97 0.97
0.97 0.97 0.99 0.99 0.96 0.00 0.00 0.00 0.00 0.00 0.97 0.97 0.97 0.98 0.94 0.00 0.00 0.00 0.97
0.00 0.94 0.95 0.94 0.94 0.94 0.00 0.00 0.97 0.00 0.94 0.94 0.94 0.94 0.94 0.97 0.00 0.00 0.00
0.00 0.00 0.96 0.94 0.94 0.94 0.96 0.00 0.00 0.00 0.97 0.00 0.95 0.94 0.94 0.94 0.96 0.00 0.00
0.97 0.00 0.00 0.95 0.94 0.95 0.96 0.96
"REGION INDEX"
1 2 2 2 2 3 4 5 6 7
1 8 8 8 8 910111213
114141414141516171819
1202020202122232425
1262626262728293031
1323232323334353637
1383838383940414243
14444444444546474849
1505050505152535455
1565656565758596061
1626262626364656667
1686868686970717273
1747474747576777879
1808080808182838485
1868686868788899091
1929292929394959697
"WATERSHED INDEX"
1, 1, 1, 1, 1, 1, 1, 1, 1, 1
1, 1, 1, 1, 1, 1, 1, 1, 1, 1
1, 1, 1, 1, 1, 1, 1, 1, 1, 1
1, 1, 1, 1, 1, 1, 1, 1, 1, 1

```

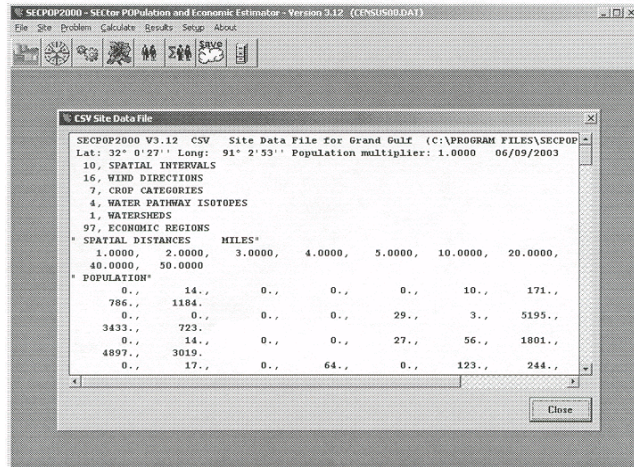



Figure 3-20 CSV Site-Data File Form

Print

Selecting *Print* from the *CSV Input File* sub-menu prints the CSV Site-Data File to the user-specified printer. The CSV Input File is printed as ASCII text.

Table 3.2 shows an example CSV Site-Data File. Note: SECPOP2000 does not perform any calculations for estimating crop categories, water pathway isotopes, or watersheds. The values below for those categories (watershed index, crop season and share, and watershed definition) are default values. For a full explanation of all of the data fields, see Appendix B.

Table 3.2 Example CSV Site-Data File

```

SECPOP2000 V3.12 CSV Site Data File for Grand Gulf (C:\PROGRAMFILES\SECPop\SITES\GRAND GULF.SIT)
Lat: 320 0'27" Long: 910 2'53" Population multiplier: 1.0000 06/09/2003
10, SPATIAL INTERVALS
16, WIND DIRECTIONS
7, CROP CATEGORIES
4, WATER PATHWAY ISOTOPES
1, WATERSHEDS
97, ECONOMIC REGIONS
"SPATIAL DISTANCES MILES"
1.0000, 2.0000, 3.0000, 4.0000, 5.0000, 10.0000, 20.0000, 30.0000
40.0000, 50.0000
"POPULATION"
0., 14., 0., 0., 10., 171., 578.
786., 1184.
0., 0., 0., 0., 29., 3., 5195., 32449.
3433., 723.
0., 14., 0., 0., 27., 56., 1801., 4859.
4897., 3019.
0., 17., 0., 64., 0., 123., 244., 3253.
4626., 66151.
0., 0., 0., 113., 56., 102., 567., 1531.
4018., 14053.
0., 10., 0., 0., 336., 840., 981., 277.
5726., 8482.
0., 0., 0., 10., 776., 2582., 1177., 637.
2720., 21634.
0.1 14., 5., 37., 122., 571., 1189., 579.
3261., 2536.

```

4, " Cs-137", 5.OOE-06, 0.0
"REGIONAL ECONOMIC DATA"
1, " EXCLUSION", 0.284, 0.015, 225.0, 1594.0, 67075.0
2, " REGION_02", 0.284, 0.015, 225.0, 1594.0, 67075.0
3, " REGION_03", 0.430, 0.006, 388.1, 1871.0, 74950.7
4, " REGION_04", 0.504, 0.000, 475.3, 2018.8, 76632.1
5, " REGION_05", 0.614, 0.000, 550.8, 1948.6, 62580.5
6, " REGION_06", 0.451, 0.000, 453.6, 2147.8, 86509.9
7, " REGION_07", 0.560, 0.000, 652.7, 2235.8, 76212.8
8, " REGION_08", 0.284, 0.015, 225.0, 1594.0, 67075.0
9, " REGION_09", 0.320, 0.002, 343.0, 2076.0, 95985.3
10, " REGION_10", 0.355, 0.000, 376.8, 2111.9, 95410.7
11, " REGION_11", 0.327, 0.000, 358.6, 2129.3, 98900.0
12, " REGION_12", 0.351, 0.000, 440.6, 2085.9, 92563.7
13, " REGION_13", 0.474, 0.002, 539.5, 2078.1, 85726.4
14, " REGION_14", 0.284, 0.015, 225.0, 1594.0, 67075.0
15, " REGION_15", 0.295, 0.006, 292.9, 1910.6, 87101.9
16, " REGION_16", 0.301, 0.003, 323.5, 2053.2, 96125.4
17, " REGION_17", 0.331, 0.003, 346.9, 2244.9, 102415.1
18, " REGION_18", 0.365, 0.006, 362.2, 2411.3, 106228.3
19, " REGION_19", 0.433, 0.009, 393.8, 2474.0, 104461.2
20, " REGION_20", 0.284, 0.015, 225.0, 1594.0, 67075.0
21, " REGION_21", 0.284, 0.015, 225.0, 1594.0, 67075.0
22, " REGION_22", 0.284, 0.015, 225.0, 1594.0, 67075.0
23, " REGION_23", 0.403, 0.011, 364.5, 2540.4, 106056.0
24, " REGION_24", 0.415, 0.010, 378.0, 2632.0, 109827.1
25, " REGION_25", 0.412, 0.011, 386.6, 2628.8, 109611.7
26, " REGION_26", 0.284, 0.015, 225.0, 1594.0, 67075.0
27, " REGION_27", 0.284, 0.015, 225.0, 1594.0, 67075.0
28, " REGION_28", 0.284, 0.016, 227.8, 1596.5, 67107.2
29, " REGION_29", 0.291, 0.068, 502.2, 2043.2, 79582.2
30, " REGION_30", 0.302, 0.063, 491.1, 2095.9, 82286.1
31, " REGION_31", 0.293, 0.057, 601.8, 2180.8, 83168.3
32, " REGION_32", 0.284, 0.015, 225.0, 1594.0, 67075.0
33, " REGION_33", 0.284, 0.015, 225.0, 1594.0, 67075.0
34, " REGION_34", 0.284, 0.015, 225.0, 1594.0, 67075.0
35, " REGION_35", 0.258, 0.078, 508.4, 1842.2, 70284.0
36, " REGION_36", 0.255, 0.088, 537.5, 1872.1, 70715.4
37, " REGION_37", 0.257, 0.177, 500.6, 1948.5, 72803.5
38, " REGION_38", 0.284, 0.015, 225.0, 1594.0, 67075.0
39, " REGION_39", 0.284, 0.015, 225.0, 1594.0, 67075.0
40, " REGION_40", 0.270, 0.013, 218.0, 1558.5, 65118.1
41, " REGION_41", 0.237, 0.051, 345.4, 1641.3, 64171.6
42, " REGION_42", 0.237, 0.358, 354.9, 2060.0, 77175.3
43, " REGION_43", 0.260, 0.461, 373.9, 2188.3, 79551.8
44, " REGION_44", 0.284, 0.015, 225.0, 1594.0, 67075.0
45, " REGION_45", 0.284, 0.015, 225.0, 1594.0, 67075.0
46, " REGION_46", 0.209, 0.002, 186.9, 1402.0, 56495.6
47, " REGION_47", 0.194, 0.017, 178.9, 1407.3, 56619.0
48, " REGION_48", 0.132, 0.230, 138.9, 1794.7, 75782.9
49, " REGION_49", 0.152, 0.303, 164.1, 1892.3, 75028.8
50, " REGION_50", 0.284, 0.015, 225.0, 1594.0, 67075.0
51, " REGION_51", 0.284, 0.015, 225.0, 1594.0, 67075.0
52, " REGION_52", 0.199, 0.000, 182.0, 1377.0, 55120.0
53, " REGION_53", 0.180, 0.064, 169.9, 1494.2, 60915.0
54, " REGION_54", 0.134, 0.231, 140.3, 1814.7, 77232.1
55, " REGION_55", 0.181, 0.316, 172.4, 1899.0, 72877.0
56, " REGION_56", 0.284, 0.015, 225.0, 1594.0, 67075.0
57, " REGION_57", 0.284, 0.015, 225.0, 1594.0, 67075.0
58, " REGION_58", 0.201, 0.000, 182.8, 1380.8, 55328.5
59, " REGION_59", 0.216, 0.000, 193.2, 1489.7, 63693.7
60, " REGION_60", 0.271, 0.000, 229.9, 1859.9, 91848.2
61, " REGION_61", 0.257, 0.048, 210.5, 1799.0, 85961.8
62, " REGION_62", 0.284, 0.015, 225.0, 1594.0, 67075.0
63, " REGION_63", 0.286, 0.015, 226.7, 1596.4, 67145.7
64, " REGION_64", 0.265, 0.002, 238.6, 1489.5, 59657.0
65, " REGION_65", 0.360, 0.001, 325.6, 1738.4, 73777.3
66, " REGION_66", 0.434, 0.000, 405.5, 1962.4, 87058.0
67, " REGION_67", 0.495, 0.000, 472.3, 2001.3, 85230.3
68, " REGION_68", 0.638, 0.004, 581.0, 2085.0, 81610.0
69, " REGION_69", 0.328, 0.014, 268.9, 1654.6, 68867.9
70, " REGION_70", 0.638, 0.004, 581.0, 2085.0, 81610.0
71, " REGION_71", 0.638, 0.004, 581.0, 2085.0, 81610.0
72, " REGION_72", 0.575, 0.001, 500.1, 2009.1, 72798.2
73, " REGION_73", 0.550, 0.000, 473.0, 1986.1, 71260.3
74, " REGION_74", 0.638, 0.004, 581.0, 2085.0, 81610.0
75, " REGION_75", 0.638, 0.004, 581.0, 2085.0, 81610.0
76, " REGION_76", 0.638, 0.004, 581.0, 2085.0, 81610.0

77,"	REGION_77"	, 0.647,	0.003,	591.9,	2075.2,	76109.2
78,"	REGION_78"	, 0.656,	0.003,	603.1,	2052.2,	66095.1
79,"	REGION_79"	, 0.649,	0.002,	594.1,	2047.5,	66256.1
80,"	REGION_80"	, 0.638,	0.004,	581.0,	2085.0,	81610.0
81,"	REGION_81"	, 0.519,	0.007,	461.8,	1920.6,	76743.8
82,"	REGION_82"	, 0.638,	0.004,	581.0,	2085.0,	81610.0
83,"	REGION_83"	, 0.637,	0.003,	579.6,	2075.4,	80023.4
84,"	REGION_84"	, 0.657,	0.002,	604.6,	2044.1,	65514.3
85,"	REGION_85"	, 0.673,	0.004,	601.3,	2190.2,	72103.9
86,"	REGION_86"	, 0.562,	0.006,	505.0,	1980.2,	78508.7
87,"	REGION_87"	, 0.628,	0.004,	571.5,	2071.9,	81221.9
88,"	REGION_88"	, 0.627,	0.003,	571.6,	2071.5,	80012.3
89,"	REGION_89"	, 0.618,	0.000,	550.9,	1951.8,	62905.7
90,"	REGION_90"	, 0.637,	0.001,	572.3,	2014.3,	64862.3
91,"	REGION_91"	, 0.680,	0.007,	584.5,	2336.8,	79063.0
92,"	REGION_92"	, 0.458,	0.010,	399.5,	1834.7,	74200.2
93,"	REGION_93"	, 0.576,	0.003,	536.9,	2095.9,	85365.6
94,"	REGION_94"	, 0.496,	0.001,	473.8,	2055.8,	82308.5
95,"	REGION_95"	, 0.617,	0.000,	550.0,	1948.0,	62374.0
96,"	REGION_96"	, 0.623,	0.000,	557.0,	1984.9,	63053.0
97,"	REGION_97"	, 0.688,	0.003,	644.8,	2430.2,	71621.7

Save

Selecting *Save* from the *CSV Input File* sub-menu saves the CSV Site-Data File to the user-specified file. It is recommended that the user save all result files in CSV format with the filename extension csv. The user is not required to follow this practice. Doing so, however, makes it easier to find previously saved results files. This is especially true when a single directory has an assortment of site, problem, and result files.

3.6.5 Load Previous Results

Selecting *Load Previous Results* from the *Results* menu allows the user to select previously calculated results that have been saved to a file. Once a file has been chosen, the results are loaded into memory and can be examined using any of the methods described above.

If results are saved in MACCS2 format, the radial distances are saved in kilometers. (If results are saved in CSV format, the radial distances are saved in the units the user specified on the Problem Form). The radial distances can be changed back to miles by opening the *Problem* form and clicking on the “Miles” option button.

3.7 Performing Regional Calculations

Regional calculations are not supported in SECPOP2000. This functionality may be included in a future version. Please see NUREG/CR-6525, SAND93-4032, “SECPop90: Sector Population, Land Fraction, and Economic Estimation Program” for more details on regional calculations.

3.8 Customizing SECPOP2000

Selecting *Setup* from the main menu displays the Setup form shown in Figure 3-21. This form allows the user to set default locations for the various SECPOP2000 files.

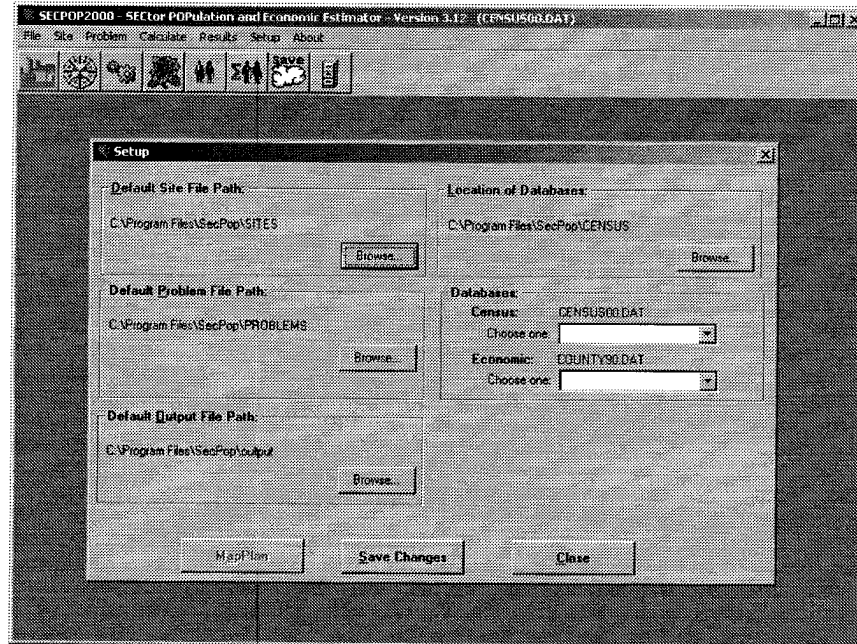

Figure 3-21 Setup Form

3.8.1 Setup Form Fields

The *Setup* form has six fields designed to allow the user to specify the default location of the input and output files. The user can override many of these values using the *File Open* and *Save As* forms discussed earlier, but these pathnames should be set to the paths that are used most often.

Default Site File Path	the default path where site files are stored.
Default Problem File Path	the default path where problem files are stored.
Default Output File Path	the default path where output files are stored.
Location of Census Databases	the default path where the block level population and county level fraction and economic census databases are stored.
Databases	Selects which census and economic files to use for the calculations. SECPOP2000 includes both the 1990 (CENSUS90.DAT) and 2000 (CENSUS00.DAT) census databases and the 1990 (COUNTY90.DAT) and 1997 (COUNTY97.DAT) economic databases are included with SECPOP2000.

3.8.2 Setup Form Commands

The *Setup* form has three command buttons: one for executing the MapPlan setup program, one for saving the user-defined defaults, and the other to close the *Setup* form.

- MapPlan is not supported at this time and is grayed out.
- Save Changes immediately saves changes to the default paths to a SECPOP2000 configuration file (secpop.cfg). This file is read the next time SECPOP2000 is started and the default values that were previously saved are restored.
- Close closes the *Setup* form. Unsaved changes are not saved to the SECPOP2000 configuration file but are used for the present SECPOP2000 session.

3.9 Exiting SECPOP2000

Selecting *File, Exit* from the main menu exits the SECPOP2000 program. The user is asked to confirm whether the SECPOP2000 program should be exited (see Figure 3-22). Exiting SECPOP2000 causes all unsaved information to be lost.

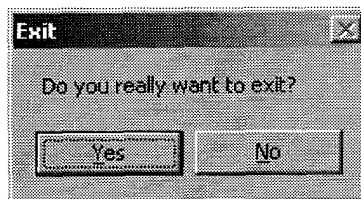

Figure 3-22 Exit Confirmation Form

4 Computational Methodology

The SECPOP2000 code uses block-level census data to calculate the population counts for each of the userdefined grid (rosette) sections, county-level census data to calculate land fraction data, and county-level census data plus other economic information published by the Federal Government to calculate economic data. The methodology involved can be broken down into (1) the algorithms used within the code to accomplish this purpose and (2) the database structures used for the block and county-level databases. Subsections 4.1 through 4.3 discuss the algorithms in detail. Subsection 4.4 discusses the database structures.

4.1 Population Count and Density Algorithms

For a user-defined site location and radial grid, SECPOP2000 establishes longitude-latitude boundaries that just encompass the grid. The census data file is a binary file sorted primarily by descending longitude (west to east) and secondarily by descending latitude (north to south). An iterative algorithm is used (within the POINTR subroutine) to find the westernmost point in the census data file that lies on or to the east of the western longitude boundary. For that data point and each subsequent data point read from the census data file, SECPOP2000 determines whether the point lies between the north and south latitudinal boundaries. When a point is found to lie between the established boundaries, the distance of that point from the site is calculated using the distance formula to determine if in fact the point lies within the outer limit of the grid. If the point meets the distance criteria, it is then processed to determine the exact grid element in which it lies based on its radial distance and direction from the site. The population associated with that data point is then added to the population in the appropriate element of the array TOTPOP. The TOTPOP array contains an array element for each grid section.

The algorithm used to determine the longitude-latitude boundaries of the grid is discussed in Subsection 4.1.1. The iterative algorithm used to determine the westernmost point in the census data file lying on or to the east of the western longitude boundary is discussed in Subsection 4.1.2. Finally, the algorithms used to determine if a data point lies within the grid and to determine the specific grid element within which any point lies are discussed in Subsection 4.1.3.

Regional calculations performed in SECPOP90 use the same algorithms described below except that there is no need to determine within which rosette section the population lies. The population density is calculated directly using the population and area of each census block. This option is disabled in SECPOP2000.

4.1.1 Boundaries Algorithm

The heart of the algorithm lies within the subroutine GETDIS, which finds the distance (in km) per degree latitude and per degree longitude for a specific geodetic latitude. Within the GETDIS subroutine, the geodetic latitude is first converted to radians. The corresponding latitude in the master coordinate system, which is geocentric, is then calculated using the following equation:

$$\theta_{GC} = \tan^{-1} \left[\left(\frac{R_{ep}}{R_{eq}} \right)^2 \tan \theta_{GD} \right] \quad 4-1$$

where

- θ_{GC} = the geocentric latitude (radians)
- R_{ep} = the polar radius of the earth, 6256.8 km
- R_{eq} = the equatorial radius of the earth, 6378.1 km
- θ_{GD} = the geodetic latitude (radians)

The geocentric radius, R_{GC} , is then calculated using the equation:

$$R_{GC} = \frac{R_{eq} R_{ep}}{\sqrt{R_{eq}^2 \sin^2 \theta_{GC} + R_{ep}^2 \cos^2 \theta_{GC}}} \quad 4-2$$

The distance (km) per degree latitude, $DPDLAT$, and the distance (km) per degree longitude, $DPDLON$, are derived using the following equations:

$$DPDLAT = R_{GC} \frac{\sin \theta_{GC}}{\sin \theta_{GD}} \cdot \left(\frac{\pi}{180} \right) \quad 4-3$$

$$DPDLON = R_{GC} \cos \theta_{GC} \cdot \left(\frac{\pi}{180} \right) \quad 4-4$$

It can be shown that if the west-east longitudinal boundaries are established on a latitude that intersects the site, the entire rosette lies between those same two longitudinal boundaries. The distance to those longitudinal boundaries can be found by dividing the outer radius of the grid by $DPDLON$, the distance per degree longitude at the geodetic latitude of the site.

Finding the north and south latitudinal boundaries is more complex. The distance per degree latitude decreases with increasing latitude. To ensure that the boundaries encompass the entire grid, distance per degree latitude, $DPDLAT$, is determined at the Tropic of Cancer for the half of the grid lying below the latitude of the site, and the distance per degree latitude, $DPDLAT$, determined at the site is used for the half of the grid north of the site. As a result, the north and south boundaries are always outside the grid, but this is acceptable since the boundaries are used only to eliminate the census data points that will not undergo further processing.

4.1.2 First Element Location Algorithm

An iterative “divide and conquer” algorithm is used to determine the first element in the census data file that lies on or to the east of the western longitudinal boundary of the grid. The set of records in the census data file is divided into two halves and it is determined in which half the western boundary lies. The procedure is then repeated concentrating on that half of the set. This is continued until one of two situations occurs. If two adjacent points are found which straddle the boundary, the easternmost record is marked. If a point is found that lies on the western boundary,

the records are searched backward sequentially until the first of the data elements is found that lies on the boundary and that point is marked.

4.1.3 Specific Grid Element Determination

When a census data element is found to lie within the longitudinal and latitudinal boundaries of the grid, a SECPOP algorithm calculates the surface distance between the census data element's reference point and the site. If the distance is less than the outer radius of the rosette, then the census element lies within the region of interest. Surface distance is calculated using the two-dimensional distance formula based on longitudinal and latitudinal distances. Longitudinal distance is calculated by multiplying the difference in longitudes between the site and the element by the value of DPDLON calculated for the site. Similarly, latitudinal distance is calculated by multiplying the difference in latitudes by an average DPDLAT. Since values for DPDLAT vary significantly with latitude, the value used is the average of values calculated for the site and for the element location. The census data element is then located within a radial ring based on this surface distance.

Once it is determined that a data element lies within the grid, it is then necessary to determine in which of the 16 sectors the data element lies. The angle (measured clockwise from true north) of a line from the site to the data element is found as follows:

$$\theta_{de} = \tan^{-1} \left(\frac{x}{y} \right) \quad 4-5$$

where

- θ_{de} = the angle made between a line from the site to the data element and true north
- x = the distance from the longitude of the data element to the longitude of the site
- y = the distance from the latitude of the data element to the latitude of the site

This value, θ_{de} , is then used to determine the specific directional element in which the data element lies.

4.2 Land Fraction Algorithms

In addition to location and population, every record in the block-level database also includes the area of the block and a code to indicate which county in the U.S. the block resides. This additional information is used by both the land-fraction algorithm and the economic-factors algorithms to estimate land fractions and economic factors respectively.

County-level databases contain the land-fraction data for every county in the continental U.S. The sources for the 1990 and 2000 economic factors and the sources of the data are described in Table 4.1.

Table 4.1 County Level Data File Variables and Data Sources

Variable	Description	Source for COUNTY90.DAT	Source for COUNTY97.DAT
FRMFRC	Fraction of land devoted to farming in the region	1992 Census of Agriculture, Geographic Area Series I B County-Level Data U.S. Department of Commerce Economics and Statistics Administration Bureau of the Census.	1997 Census of Agriculture Data Files Supplied by the U.S. Department of Commerce Economics and Statistics Administration Bureau of the Census.
DPF	Fraction of farm sales resulting from dairy production in the region	1992 Census of Agriculture Geographic Area Series I B County-Level Data U.S. Department of Commerce Economics and Statistics Administration Bureau of the Census.	1997 Census of Agriculture Data Files Supplied by the U.S. Department of Commerce Economics and Statistics Administration Bureau of the Census.
ASFP	Annual average farm sales for the region (\$/hectare)	1992 Census of Agriculture, Geographic Area Series 1B, County-Level Data, U.S. Department of Commerce, Economics and Statistics Administration, Bureau of the Census	1997 Census of Agriculture Data Files Supplied by the U.S. Department of Commerce Economics and Statistics Administration Bureau of the Census.
VFRM	Average farmland value for the region (\$/hectare)	1992 Census of Agriculture, Geographic Area Series 1B, County-Level Data, U.S. Department of Commerce, Economics and Statistics Administration, Bureau of the Census.	1997 Census of Agriculture Data Files Supplied by the U.S. Department of Commerce Economics and Statistics Administration Bureau of the Census.
VNFRM	Average non-farm value for the region (\$/person)	1993 and 1994 Statistical Abstract of the United States, U.S. Dept. of Commerce, Economics and Statistics Admin., Bureau of the Census, 1994 County and City Data Book, U.S. Dept. of Commerce, Bureau of the Census, Data User Services Div.	1998 and 1999 Statistical Abstract of the United States, U.S. Dept. of Commerce, Economics and Statistics Admin., Bureau of the Census, 1999 County and City Data Book, U.S. Dept. of Commerce, Bureau of the Census, Data User Services Div.

The area of the blocks cannot be used to determine section land fractions directly for two reasons. First, the area given is only the landmass - no area for the water mass is given at the block level. Second, there is no simple way to aggregate the block areas to determine how much of a rosette section they “fill up” since the geometry of the blocks is unknown. Instead the area of the blocks is used to weight the county-level land fraction data.

During a site-specific calculation, a running sum for each rosette section is made of the total area of the blocks that lie within each section and a running sum is made of all of the weighted land fraction data. At the end of the calculation, the sum of the weighted land fractions is divided by the sum of the block areas. This is equivalent to the following formula for the land fraction for rosette section i, j:

$$FRCLND(i, j) = \frac{\sum_n A_{Block} \times FRCLND(County_{Block})}{\sum_n A_{Block}}$$

4-6

where

FRCLND(i, j) = the estimated land fraction for the rosette section defined by sector i and radii j and $j-1$ (unless $j = 1$, then the section is defined only by i and j - i.e., the innermost sections of the rosette),

FRCLND($County_{Block}$) = the land fraction of the county in which the present census block resides,

A_{Block} = the area of the present census block, and

n = the number of census blocks that reside in section i, j of the rosette.

Note: in areas where census blocks tend to be large—lakes, deserts, national and state parks – it is possible that no census block centroid lies within a rosette section and the resulting land fraction is estimated to be 0. While this is appropriate in a lake, it does not represent desert regions accurately. The user may need to edit the output data manually in such cases to obtain a better estimate.

4.3 Economic Factors Algorithms

SECPOP2000 estimates the economic factors that are defined in the Site Data File. The economic factors are calculated for the user-defined (or default) economic regions. The region inside the innermost radius is normally considered to be the exclusion region. While SECPOP2000 calculates values for this region, they are likely to be considerably different from the real values for the exclusion area if that area mostly contains of the nuclear reactor site.

The algorithm used to calculate the economic factors is very similar to that used in Section 4.2. The only difference is that the values are accumulated for each economic region instead of each rosette section. The countylevel database has values for each economic factor. The Economic Factor (ET) for each economic region, i , is calculated using the following equation:

$$EF(i) = \frac{\sum A_{Block} \times EF(County_{Block})}{\sum_n A_{Block}} \quad 4-7$$

where

$EF(i)$ = the estimated economic factor for the economic region i ,

$EF(County_{Block})$ = the economic factor of the county in which the present census block resides,

A_{Block} = the area of a census block, and

n = the number of census blocks that belong to economic region i .

4.4 Database Structure

The two main databases used by SECPOP90 are the block-level census and county-level census databases, CENSUS90.DAT and COUNTY90.DAT. The block-level census database contains over six million records - a record for every census block in the continental U.S. at the time of the 1990 census. The county-level census database contains over three thousand records, one for every county in the continental United States.

Similarly, the two main databases used by SECPOP2000 are the block-level census and county-level census databases, CENSUSOO.DAT and COUNTY97.DAT. The block-level census database contains almost eight million records, one for each block in the continental United States at the time of the 2000 census. The county-level census database contains over three thousand records, one for every county in the continental United States. The sections below describe the databases in more detail.

4.4.1 Block-Level Database

The 1990 block-level census data is stored in a binary file, CENSUS90.DAT, that contains 6,660,337 records. Each record is 12 bytes long and contains the following five pieces of information:

- (1) a 2-byte integer code for the longitude of the geometric centroid of the census block,
- (2) a 2-byte integer code for the latitude of the geometric centroid of the census block,
- (3) a 2-byte integer for the residential population that resides within the census block,
- (4) a 4-byte integer for the land area (0.001 km) of the census block, and
- (5) a 2-byte integer code for the county that the census block resides in.

The integer codes for the longitude and latitude were derived to reduce the storage required for the block-level database. The longitude can be calculated using the following formula:

$$\text{longitude} = (\text{integer_code} + 91993) / 1000.0$$

The latitude can be calculated using the following formula:

$$\text{latitude} = (\text{integer_code} + 16610) / 1000.0$$

The integer code for the county is the index to the county-level database and is the first field in each record of that database. More information on the county-level database can be found in the next sub-section. Details on how the block-level database was constructed and verified can be found in Section 5. 1.

The 2000 block-level census data is stored in a binary file of the same format, but that file contains 7,938,746 records.

4.4.2 County-Level Database

The 1990 and 1997 county-level census data is stored in a fixed-width format ASCII text file, COUNTY90.DAT, which contains 3,111 records and one header line, and COUNTY97.DAT, which also contains 3,111 records and one header line. Each record contains the following 10 pieces of information:

CountyCode index to the county-level database,
 State two-letter abbreviation of the state in which the county lies,
 CountyName name of the county,
 FRCLND fraction of area that is land in the county,
 FRMFRC fraction of land devoted to farming in the county,
 DPF fraction of farm sales resulting from dairy production in the county,
 ASFP annual-average farm sales for the county (\$/hectare),
 VFRM average farmland value for the county (\$/hectare),
 VNFRM average non-farm value for the county (\$/person), and
 Notes various notes concerning exemptions to the data.

A sample of this database is shown in Table 4.2. The 1997 database follows the same format.

Table 4.2 Excerpt From the 1990 County-Level Database

CountyCode	State	CountyName	FRCLND	FRMFRC	DPF	ASFP	VFRM	VNFRM	Notes
1	ME	Androscoggin County	0.945790	0.206791	0.125332	3216	4532	109414	0
2	ME	Aroostook County	0.976975	0.078229	0.027361	908	2062	93633	0
3	ME	Cumberland County	0.686591	0.100777	0.233237	730	6779	144689	0
ù	ù	ù	ù	ù	ù	ù	ù	ù	ù
3109	CA	Ventura County	0.835891	0.271368	0.001479	5147	17519	145082	1
3110	CA	Yolo County	0.989805	0.800826	0.002811	1115	5551	133615	1
3111	CA	Yuba County	0.979641	0.581876	0.029790	1142	6226	84089	0

5 Software Development

5.1 Block-Level Census Database

This section describes how the data for the block-level database were extracted and how the results were verified to ensure the integrity of the data after each step of the process.

The block-level data and some county-level data (area of land and water) for 1990 were extracted from the CDROM set of the *Census of Population and Housing, 1990: Public Law (P.L.) 94-171, Data Technical Documentation /prepared by the Bureau of the Census. --Washington: The Bureau, 1991[sic]*.

The block-level data and some county-level data (area of land and water) for 2000 were extracted from the DVD *Census 2000 Summary File 1, Census Population and Housing/prepared by the U. S. Census Bureau, September 2001*.

Both data files, *CENSUS90.DAT* and *CENSUS00.DAT*, are random access binary files. Both work with SECPOP2000. They also work with SECPOP90, except that the 2000 census database is too large to be completely read by SECPOP90. The 2000 census data contains 7,938,746 blocks in the contiguous United States versus 6,660,335 blocks in the 1990 census data. The difference in number of blocks between the 1990 and 2000 databases reflects the population increase in the United States over the ten years separating the two census activities. This issue is discussed further in 5.1.4.3.

Some geographical adjustments were made in compiling the 2000 database to be as consistent as possible with the algorithms used in SECPOP90. One adjustment involves the addition of two new blocks in Clallam County in Washington State. This area contains the western-most land in the contiguous United States. The two new blocks have centroids west of the longitude boundary that is hard coded in SECPOP90. Since neither of these blocks contains a permanent population, they were omitted in compiling the *CENSUS00.DAT* file. In fact, the new data file ignores approximately 226,000 similar blocks that contain neither land area nor population.

Other changes between 1990 and 2000 affected the compilation of the county database. The city of Miami, Florida, merged with Dade County to form the Miami-Dade County. This new entity was given the SECPOP90 county code for the old Dade County. The county area of South Boston City, Virginia, no longer exists. Population and area were subsumed into other Virginia counties. Yellowstone National Park is no longer considered a county. Population and area were subsumed into other Wyoming counties.

5.1.1 Construction of the 1990 Block-Level Census Database

The PL 94-171 files are stored on ten CD-ROMs in dBase III format. The first step in the construction of the census-level database (*CENSUS90.DAT*, located in the SECPOP\CENSUS directory) was to extract the necessary information from the dBase files and store it in binary format. There is a dBase file for each state and the District of Columbia. The name of these files is

PL9417nn.DBF, where *nn* is the postal code for the state or district. The format of the dBase census records is specified in another dBase file, PL94STRU.DBF, which is also included on the CD-ROMs. Table 5.1 shows the format of the state files. Note that all fields are of type character string. All of the source code referenced in this subsection can be found in the SECPOP90 Manual (Reference 1, Appendix G).

Table 5.1 dBase III Census Record Format

Name	Type	Length	Decimal Count	Description
FILEID	C	8	0	File Identification
STUSAB*	C	2	0	State/US Abbreviation
SUMLEV*	C	3	0	Summary Level
GEOCOMP	C	2	0	Geographic Component
CHARITER	C	3	0	Characteristic Iteration
LOGRECNU	C	6	0	Logical Record Number
LOGRECPN	C	4	0	Logical Record Part Number
PARTREC	C	4	0	Total Number of Parts in Record
ANRC	C	2	0	Alaska Native Regional Corporation
AIANACE	C	4	0	Indian/Alaska Native Area (Census)
AIANAFP	C	5	0	American Indian/Alaska Native Area (FIPS)
AIANACC	C	2	0	American Indian/Alaska Native Area Class Code
ARTLI	C	1	0	American Indian Reservation Trust Land Indicator Code
BLCK	C	4	0	Block
BLCKGR	C	1	0	Block Group
TRACTBNA	C	6	0	Census Tract/Block Numbering Area
CONGDIS	C	2	0	Congressional District (101 st Congress)
CONCITCE	C	1	0	Consolidated City (Census)
CONCITFP	C	5	0	Consolidated City (FIPS)
CONCITCC	C	2	0	Consolidated City Class Code

Name	Type	Length	Decimal Count	Description
CONCITSC	C	2	0	Consolidated City Population Size Code
CMSA	C	0	0	Consolidated Metropolitan Statistical Area
CNTY*	C	3	0	County
CNTYSC	C	2	0	County Population Size Code
COUSUBCE	C	3	0	County Subdivision (Census)
COUSUBFP	C	5	0	County Subdivision (FIPS)
COUSUBCC	C	2	0	County Subdivision Class Code
COUSUBSC	C	2	0	County Subdivision Population Size Code
DIVIS	C	1	0	Division
EXTCITIN	C	1	0	Extended City Indicator
INTUC	C	15	0	Internal Use Code
MSACMSA	C	4	0	Metropolitan Statistical Area/Consol. Metro. Statistical Area
MSACMSAS	C	2	0	MSA/CMSA Population Size Code
PLACECE	C	4	0	Place (Census)
PLACEFP	C	5	0	Place (FIPS)
PLACECC	C	2	0	Place Class Code
PLACEDC	C	1	0	Place Description Code
PLACESC	C	2	0	Place Population Size Code
PMSA	C	4	0	Primary Metropolitan Statistical Area
REG	C	1	0	Region
STATECE*	C	2	0	State (Census)
STATEFP	C	2	0	State (FIPS)
URBANRUR	C	1	0	Urban/Rural
URBAREA	C	4	0	Urbanized Area

Name	Type	Length	Decimal Count	Description
UASC	C	2	0	Urbanized Area Population Size Code
SAC1	C	5	0	Special Area Code (1)
SAC2	C	5	0	Special Area Code (2)
SAC3	C	4	0	Special Area Code (3) Voting District Code
SAC4	C	4	0	Special Area Code (4)
SAC5	C	3	0	Special Area Code (5)
SAC6	C	3	0	Special Area Code (6)
SAC7	C	2	0	Special Area Code (7)
SAC8	C	2	0	Special Area Code (8)
SAC9	C	1	0	Special Area Code (9) Land/Water Area Code
SAC10	C	1	0	Special Area Code (10) Actual/Pseudo Voting District Code
AREALAND*	N	10	0	Area (land)
AREAWAT*	N	10	0	Area (water)
ANPSADPI*	C	66	0	Area Name/PSAD Term/Part Indicator
FUNCSTAT	C	1	0	Functional Status Code
GCUNI	C	1	0	Geographic Change User Note Indicator
HUIOO	N	9	0	Housing Unit Count (100%)
INTPTLAT*	C	9	0	Internal Point (latitude)
INTPTLNG*	C	10	0	Internal Point (longitude)
PARTFLAG	C	1	0	Part Flag
PSADC	C	2	0	Political/Statistical Area Description Code
POP100*	N	9	0	Population Count (100%)
SPFLAG	C	1	0	Special Flag

Name	Type	Length	Decimal Count	Description
IP001_0001	N	9	0	Population Table 1, Item 1
IP002_0001	N	9	0	Population Table 2, Item 1
IP002_0002	N	9	0	Population Table 2, Item 2
IP002_0003	N	9	0	Population Table 2, Item 3
IP002_0004	N	9	0	Population Table 2, Item 4
IP002_0005	N	9	0	Population Table 2, Item 5
IP003_0001	N	9	0	Population Table 3, Item 1
IP003_0002	N	9	0	Population Table 3, Item 2
IP003_0003	N	9	0	Population Table 3, Item 3
IP003_0004	N	9	0	Population Table 3, Item 4
IP003_0005	N	9	0	Population Table 3, Item 5
IP004_0001	N	9	0	Population Table 4, Item 1
IP004_0002	N	9	0	Population Table 4, Item 2
IP004_0003	N	9	0	Population Table 4, Item 3
IP004_0004	N	9	0	Population Table 4, Item 4
IP004_0005	N	9	0	Population Table 4, Item 5
IP004_0006	N	9	0	Population Table 4, Item 6
IP005_0001	N	9	0	Population Table 5, Item 1

*Indicates field used in block or county-level census database.

To extract the necessary information from the dBase state files, a highly modified version of the QuickBasic program included in the CD-ROMs' README file (see Figure 5- 1) was written, CONVERT1.BAS. This Basic program extracted both the block and county-level information and stored it in two separate files, BLOCK_1.BIN and COUNTY_1.TXT, respectively. The data stored in BLOCK_1.BIN was converted from the dBase text format to Visual Basic's native binary representation. Each record in BLOCK_1.BIN was 19 bytes long and contained the longitude and latitude of the census block geographical centroid (4 bytes each), population (4 bytes), area (4 bytes), state census number (1 byte), and county census number (2 bytes).

```

'
'
'-----
'      dBASE To ASCII Conversion
'-----
'Users without database management software who wish to convert the files to
'ASCII can follow this example. This is Microsoft QuickBASIC 4.5 code, Tests
'on a 286 PC took about 1 1/2 minutes per thousand records reading from CD-ROM
'and writing to hard disk.

TYPE Structure
  Flag AS STRING * 1
  Record AS STRING * 516
END TYPE

DIM PL94171 AS Structure

OPEN "e:\p19417vt.dbf" FOR BINARY AS #1
OPEN "c:\p19417vt.txt" FOR OUTPUT AS #2

SEEK #1, 2947

DO
  GET #1, , PL94171
  IF EOF(1) THEN EXIT DO
  PRINT #2, PL94171.Record
LOOP

CLOSE #1, #2
END
'
'-----

```

Figure 5-1 PL94-71 README File dBase to ASCII Conversion Program

The second part of the block-level conversion process was to create a second binary file, BLOCK_2.BIN that contains the same information as BLOCK_1.BIN but in an encoded format so that the data records are smaller (BLOCK_1.BIN was 126 Mbytes, BLOCK_2.BIN was 80 Mbytes) and easier to use. The encoding for the latitude and longitude is discussed in Section 4.4.1. The encoding of the county code was performed using a lookup table in the CONVERT2.BAS program. This was necessary because the county code used in the census uses designators that are unique within each state but not throughout the country. The code generated for the county designator of each block is also the county index to the county-level database. The codes were ordered by the census state-level designator as the primary key and the census county designator as the secondary key. Furthermore, since each county had a unique designator in BLOCK_2.BIN, the state designator was not stored in BLOCK_2.BIN. That information can be obtained by performing a table lookup in the county-level database. SECPOP90 has no need for that information at present.

The next part of the creation of the block-level census database was to sort the records by longitude and latitude. This was done in a two-step process using two FORTRAN programs, SORTBIN1.FOR and SORTBIN2.FOR. SORTBIN1.FOR first sorted the BLOCK_2.BIN file by separating it into 30 separate files based on a census block's longitude. SORTBIN2.FOR then individually sorted the 30 files by longitude and latitude, writing the results of each sorted file to BLOCK_3.B1N. The SORTBIN2.FOR program contains an error. It incorrectly sorts files that contain records with both positive and negative longitudes. (Negative and positive longitudes were present in the intermediate BLOCK_n.BIN files because of the encoding of the longitude from 32 to 16 bit integers.) Fortunately, this case only existed in one of the 30, BLOCK_2.BIN files. The database was corrected during the Verification testing (see Section 5.1.2). The SORTBIN2.FOR program was not corrected and still contains the error.

The final step was the concatenation of duplicate records by the FORTRAN program REMOVEDUP.FOR. Two records were considered duplicates if they shared the same longitude, latitude, and county code. When such records were found, their areas and population counts were added together and a single record was created to represent the duplicate records. The final resulting database was written to BLOCK_4.BIN, which was then renamed to *CENSUS90.DAT*.

5.1.2 Construction of the 2000 Block-Level Census Database

The first step in the construction of the block-level database (*CENSUS00.DAT*, located in the SECPop\CENSUS directory) was to extract the necessary information from the DVD and store it in binary format. The DVD comes with a data engine. Figure 5-2 shows the user interface for the engine. The window on the left illustrates the selection of data at the block level. Note the exclusion of Alaska and Hawaii. The right window contains the data output for each block.

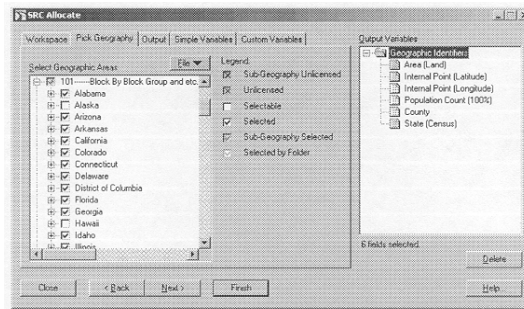

Figure 5-2 Commercial Data Engine User Interface

Figure 5-3 illustrates the output for a single block from a county in Alabama. Note the list of other blocks for that county on the left.

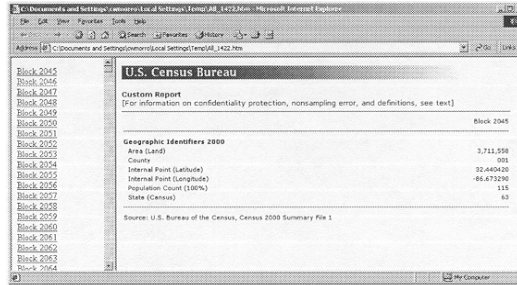

Figure 5-3 Output for a Single Block

In addition to the visual output shown in Figure 5-3, the data engine produced a comma separated variable (CSV) file DVD_OUT.CSV that contains data for all contiguous states. Appendix G contains the Visual Basic for Applications program used in an Excel spreadsheet to convert this CSV file into the SECPOP2000 file, *CENSUSOO.DAT*. The program first reads block level information from the CSV file. It converts it to a form compatible with SECPOP2000 and discards blocks that contain neither land area nor people. There were 225,972 of these, similar to the finding for SECPOP90. The program also finds and outputs blocks that are beyond the longitudinal limits of the contiguous states. There were two of these, neither of which had population nor land area. Viable blocks (7,938,746 in all) were output to an unsorted database UNSORT_BLOCKOO.DAT readable by SECPOP2000. The program used an indexed recursive Quicksort routine to create the final database.

5.1.3 Verification of the 1990 Block-Level Census Database

Upon completion of each of the steps described in 5. 1. 1, diagnostic output was produced to verify that the conversion programs were operating correctly, and additional testing was performed to verify that the block-level census data integrity was maintained. (No effort was made to determine the integrity of the initial data on the PL 94-171 CD ROMs. For a discussion of the Census Bureau's level-of-confidence in their data, see www.census.gov/main/www/cen2000.html.) All of the source code referenced in this section can be found in the SECPOP90 Manual (Reference 1, Appendix H).

After the first conversion of the dBase CD-ROM data, the TEST1.BAS basic program was executed to read in all of the census block records and print out a summary of all of the county and state populations and land areas. The summary results agreed with the state and county populations and were always less than or equal to the state and county land areas. (Aggregated block-level census land areas are usually less than county or state land areas because of the differences in tabulating the two area types. Comparisons were done using a spreadsheet. A sample of Rhode Island census block longitudes and latitudes from the CD-ROM database files was compared with those in BLOCK_1.BIN and were in agreement.

After the second conversion of the BLOCK_1.BIN data and the creation of the BLOCK_2.BIN database, the TEST2.BAS program was executed to print out a sample of 71 records from both the BLOCK_1.BIN and BLOCK_2.BIN databases. The results were examined by hand and were found

to be in agreement. The file lengths of the two databases were also examined to ensure that they contained the same number of records.

After the sorting of the BLOCK_2.BIN database was completed and the BLOCK_3.BIN file was generated, the TEST3.BAS program was executed to print out the records for Washington County, Maine. These were compared with the same records found in the CD-ROM database files and were in agreement. The file lengths of the two databases, BLOCK_2.BIN and BLOCK_3.BIN, were compared to ensure that they contained the same number of records. The file lengths were equal.

A repeat of testing done after the first conversion was performed on the final BLOCK_4.BIN database using a modified version of TEST1.BAS named TEST4.BAS. The summary results agreed with the original data files from the PL 94-171 CD-ROMs. The Rhode Island data also agreed and the number of records remaining in BLOCK_4.BIN was equal to the initial number of records minus the duplicate records. BLOCK_4.BIN's name was changed to *CENSUS90.DAT*, which did not alter the data in any way. A final test to ensure that the database records were sorted correctly, TEST5.BAS, was performed. It was discovered that a section of records were out of order. Two programs, FIX1.BAS and FIX2.BAS were run to further diagnose and correct the database. TEST5.BAS was rerun. The error was corrected and there were no other records found out of order.

5.1.4 Verification of the 2000 Block-Level Census Database

Testing on the new database file includes the following four tests against the US Census Bureau's Census 2000 data on DVD (Reference 2):

Test 1: Sequential test to ensure blocks are sorted west to east

Test 2: Comparison of state area and population against US Census Bureau Summaries

Test 3: Comparison of county area and population against Summaries

Test 4: Numerous comparisons using SECPOP90 and CENSUS00.dat to compare to US Census Bureau estimates at known locations

Verification tests 1 through 3 were run as Visual Basic code behind the spreadsheet as the front end to facilitate comparisons. Verification test 4 was intended to show that the 2000 census data file works with SECPOP90, and that this combination can reproduce population counts based on U.S. Census Bureau software. These tests used output from SECPOP90 and results displayed in HTML format from the U.S. Census Bureau DVD. The source code used for the verification tests are listed in Appendix G.

Table 5.2 summarizes the results of the verification tests run on the CENSUS00.DAT file. The verification tests ensure the file contains the correct information in the proper format and demonstrates that the new data file works correctly with SECPOP90.

Table 5.2 CENSUS00.DAT Verification Summary

Verification	Description	Results
Test 1	Sequential test to ensure blocks are sorted west to east	Blocks are sorted sequentially
Test 2	Comparison of state area and population against USBC Summaries	State populations match exactly and total contiguous state areas match to within 2 square miles (5.3 km ³).
Test 3	Comparison of county area and population against USBC Summaries	County populations match exactly, and total of contiguous county areas match to within 2 square miles (5.3 km ³).
Test 4	Match of SECPOP90 runs using CENSUS00.DAT against U.S. Census Bureau results	Maximum error 1.42%

5.1.4.1 Verification Test 1

The object of this test is to sequentially read blocks of data to ensure that the blocks are correctly sorted in west-to-east order. Output included the number of data blocks read, and information regarding blocks (if any) out of sequence.

Results:

- The program read block data sequentially first to last from the data file.
- Test reports zero blocks out of sequence.

The spreadsheet 2000 CensusDB V&V.xls provides a detailed listing of the program code used to generate Table 5.3, as well as detailed summaries of the results. This file is contained on the SECPOP2000 CD.

5.1.4.2 Verification Tests 2 and 3

The object is to verify that the CENSUS00.DAT data file contains correct data for all census blocks by comparing state and county population and area totals extracted from the CENSUS00.DAT file with summaries provided by the U.S. Census Bureau.

The code in 2000 CensusDB V&V.xls for subroutine "Test - 4" incorporates both Tests 2 and 3. It sequentially extracts census-block information from the data file. Based on the county code contained in each block of data, the test code allocates both population and area to the appropriate state. In parallel, the same area and population data is added to the appropriate county totals. U.S.

Census Bureau summaries came directly from the database software distributed with the Census 2000 DVD.

Table 5.3 shows a summary of the results for Test 2, the state-by-state comparison. State populations agreed exactly. An acceptably small error was observed in area estimates, probably caused by rounding. This assertion is confirmed by computational experiments, which indicate that the error drops with increased numerical precision. The 2000 census reports areas to the nearest square meter. SECPOP2000 represents areas to the nearest 0.000386 mile² (0.001 km²).

Table 5.3 Test 2 Results: State-by-State Comparison

Source	Population	Area (mile ²)
Census00.dat	279,583,437	2,959,062.52
Census 2000 DVD	279,583,437	2,959,064.56
Difference for total	0	-2.05
Maximum by state	0	0.09
Minimum by state	0	-0.22
Average for states	0	-0.04
Std. Deviation for states	0	0.06

Table 5.4 provides a summary of the results for the county-by-county data from Test 3. As in Test 2, populations agreed exactly for all counties. Also as with Test 2, errors exist in the county area totals due to rounding. The total difference in the integrated area agrees exactly with the value from Test 2. Statistics on differences are smaller reflecting the finer level of detail in the county-by-county comparison.

Table 5.4 Test 3 Results: County-by-County Comparison

Source	Population	Area (mile ²)
Census00.DAT	279,583,437	2,959,062.52
Census 2000 DVD	279,593,437	2,959,064.56
Difference for total	0	-2.05
Maximum by state	0	0.05
Minimum by state	0	-0.07
Average for states	0	0.00
Std Deviation for states	0	0.04

5.1.4.3 Verification Test 4

The object of this test is to use the 2000 census data file with SECPOP90 to show that the combination can reproduce population counts from the U.S. Census Bureau software. The test compares population estimates within a ten-mile radius of selected sites. The sites were chosen almost at random, with preference given to those sites that were expected to have the highest populations. Due to the file size issues discussed below, preference is given to sites in the eastern United States, as this was the more difficult task.

Combining the *CENSUS00.DAT* files with SECPOP90 required an increase in the number of census blocks, which makes the *CENSUS00.DAT* file larger than its predecessor. The original SECPOP90 contains hard-coded limits on file size. While the original program reads the new data file, it only reads the first 6,660,335 of its 7,938,746 records. Data files are sorted by longitude to read from west to east. Hence, the SECPOP90 program stops reading data from *CENSUS00.DAT* at approximately Wheeling, West Virginia.

In order to perform the verification, it was necessary to break *CENSUS00.DAT* into two files - the full file spanning the full continent, and a shorter file starting at approximately Albuquerque, New Mexico, and covering all points East from there. Figure 5-4 shows the directory structure needed to accommodate three different, but identically named, data files.

The complex directory structure is necessary because SECPOP90 is hard wired to read a single data file name (*CENSUS90.DAT*), but accepts user-specified directories. Note that the data file in directory *~\CENSUS_E*, covering all points east of Albuquerque, NM, has almost the same length as the original data file in *~\CENSUS*. The data file in *~\CENSUS_W* is larger, containing the information for the complete 2000 census.

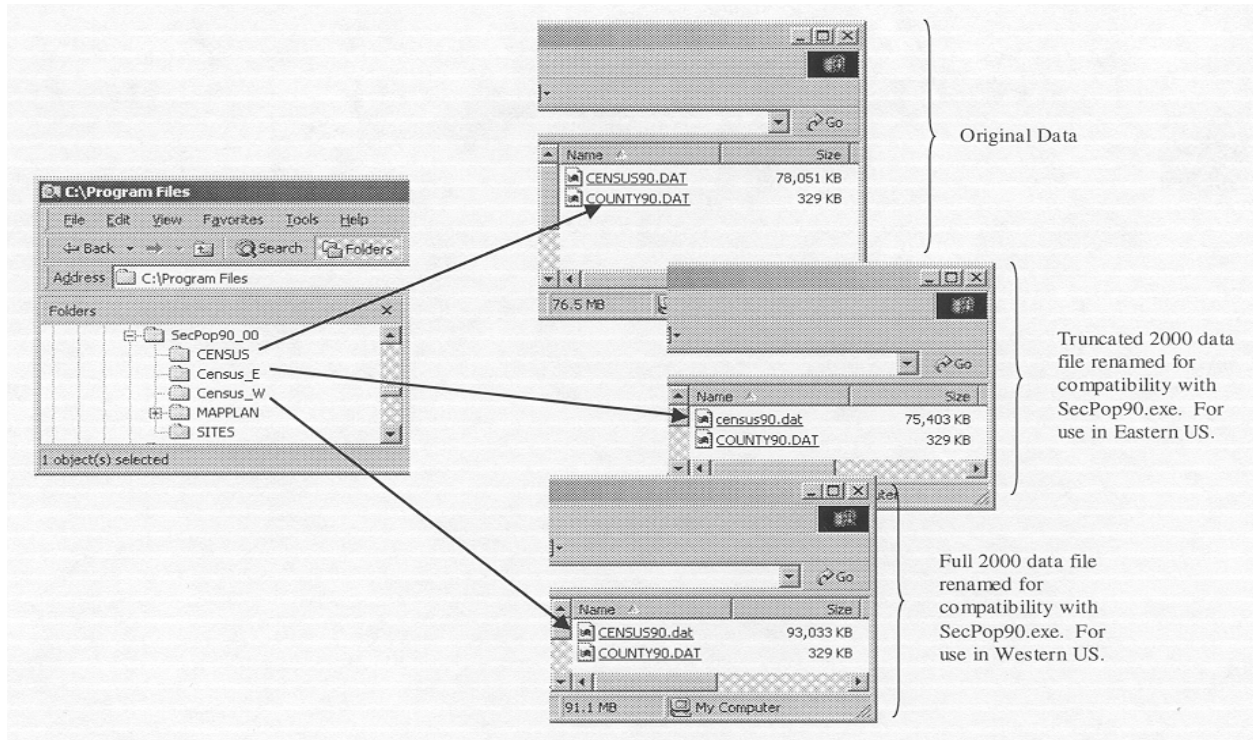

Figure 5-4 Verification Directory Structure

Table 5.5 summarizes the results. The table compares estimated population within a 10-mile radius for selected locations using SECPOP90 in combination with the census 2000 data with population estimates from the database software distributed with the U.S. Census Bureau DVD. With the exception of two of the 23 sites, agreement was within 0.6%. The Three Mile Island site had a 1.16% error, and Turkey Point had an error of 1.42%. All error calculations assume that the Census DVD provides the correct numbers.

The software on the DVD reports decimal fractions of people, which are rounded to integers in the above table. This indicates that it prorates blocks that are only partially within the 10-mile radius. SECPOP90, on the other hand, either completely includes or excludes blocks based on the location of each block's internal reference point. (The U.S. Census Bureau provides the latitude and longitude of an internal point for each census block. This point is usually the geographic centroid.) This difference in algorithms explains the small errors in the SECPOP90 results.

Table 5.5 Ten Mile Comparison with Census Bureau Using SECPOP90 Program and CENSUS00.DAT file

Site Name	SECPop90/00	Census 2000	Percent Error	Absolute Error
Calvert Cliffs	38,918	38,868	0.13%	50
Catawba	141,378	141,231	0.10%	147
Dresden	64,513	64,508	0.01%	5
Duane Arnold	112,772	113,209	-0.39%	437
Grand Gulf	7,635	7,630	0.07%	5
Hope Creek/Salem	34,130	34,153	-0.07%	23
Kewanee	9,829	9,829	0.00%	0
LaSalle	13,678	13,678	0.00%	0
Limerick	212,218	212,423	-0.10%	205
McGuire	2,333	2,337	-0.17%	4
Millstone	116,807	117,051	-0.21%	244
Oconee	71,185	71,178	0.01%	7
Peach Bottom	41,296	41,134	0.39%	162
Sequoyah	83,011	83,057	-0.06%	46
South Texas	2,777	2,777	0.00%	0
St. Lucie	160,911	160,247	0.41%	664
Surry	117,233	117,918	-0.58%	685
Three Mile Island	189,430	187,256	1.16%	2174
Turkey Point	106,716	105,218	1.42%	1498
Waterford	80,755	80,885	-0.16%	130
Zion	262,098	261,113	0.38%	985

5.2 County-Level Census Database

The county-level census database was constructed with data from several sources. The PL 94-171 CD-ROM data files (see 5.1.1); *Census of Agriculture, 1992: Final County Files* [machine-readable datafile] conducted by the Bureau of the Census, Washington: The Bureau [producer and distributor], 1993 [sic]; *County and City Data Book 1994* on CD-ROM [machine-readable datafiles] prepared by the Bureau of the Census Washington: The Bureau [producer and distributor], 1995 [sic]; and 1993, 1994 *Statistical Abstract of the United States*, U.S. Department of Commerce, Economics and Statistics Administration, Bureau of the Census.

5.2.1 Construction of the 1990 County-Level Census Database

Land and water areas were extracted from the PL 94-171 CD-ROM data files (refer to Section 5.1.1 for details). The area data was imported into a spreadsheet and the county land fraction, FRCLND, was calculated by dividing the land area by the sum of the land and water areas. The county population data was also extracted for verification purposes but it was not used in the county-level database. There were no exceptions, omissions, or special treatment for any of the data items extracted from the PL 94-171 CD-ROM data files.

The agricultural data was extracted from the 1992 Census of Agriculture CD-ROM Geographic Area Series 113 using a program that was included on the CD-ROM called EXTRACT. The EXTRACT program allowed the data items described in Table 5.6 to be extracted for each state and saved to a file that was then imported into a spreadsheet.

It is important to note that for many of the counties one or more of the above data items were not available due to the confidentiality requirements of the census. In most cases estimates were made for the undisclosed amount by distributing the excess acreage or dollars evenly among the undisclosed farms. The excess acreage or dollars were determined by subtracting the sum of the disclosed amounts from the state totals provided. This method was chosen because the number of farms and dairy farms in a county was always provided, allowing the estimates to be made in a straightforward manner. Other more complicated methods such as apportioning the excess by acreage or estimating county values by surrounding county values did not provide any more reasonable or trusted estimates. In a small number of cases (particularly when undisclosed values were for small farms in heavily populated areas, e.g.; Queens, New York, or San Francisco, California), it was clear that average dollars per farm or acre were excessive. The District of Columbia has no agricultural products.

Table 5.6 Census of Agriculture Data Items

Item	Description
010001	Farms (number)
010002	Land in farms (acres)
010004	Estimated market value of land& buildings. Average/farm (\$)
010006	Estimated market value of all machinery. Average/farm (\$)
010019	Market value of agriculture products sold (\$1,000)
020064	Dairy products, (farms)
020065	Dairy products, (\$1,000)

From the Census of Agriculture Data, four agricultural values (these are the agricultural economic values defined for MACCS2) were calculated for each county. They are as follows:

- FRMFRC fraction of land devoted to farming in the county
- DPF fraction of farm sales resulting from dairy production in the county
- ASFP annual average farm sales for the county (\$ / hectare)
- VFRM average farmland value for the county (\$ / hectare). This includes the average value of farmland, buildings, and machinery

The fifth economic value calculated for each county is the average of non-farm value (\$ / person), VNFRM (also a MACCS2 economic value). The methodology used to calculate this value for each county is equivalent to that described by Sprung et al. (Reference 2) First a value of VNFRM is calculated for the entire United States. Then estimates of county values are made using the following equation:

$$VNFRM_{County} = VNFRM_{US} \left(\frac{PCI_{County}}{PCI_{US}} \right) \quad 5-1$$

where

- $VNFRM_{\text{County}}$ = average non-farm value for the county (\$ / person),
 $VNFRM_{\text{us}}$ = average non-farm value for the United States (\$ / person) ,
 PCI_{County} = per capita income for the county (\$ / person), and
 PCI_{US} = per capita income for the United States (\$ / person).

The values for the per capita income were extracted from the 1994 County and City Data Book CD-ROM database files. They were imported directly into Access and then modified to contain only the per capita information and the associated footnotes that indicated exceptions and omissions to the data. From Access, the data was then imported into a spreadsheet where it was incorporated into the rest of the county-level database. The exceptions to the data consisted of incidents where two or more counties or independent cities (county-like entities that have no other county affiliation) reported per capita income figures jointly. In all such cases, equal per capita income amounts were applied to all joined counties. $VNFRM_{\text{us}}$ is calculated using the equation:

$$VNFRM_{\text{US}} = \frac{RTW_{\text{US}} + VSL_{\text{US}} - VFA_{\text{US}} + VFHP_{\text{US}}}{POP_{\text{US}}} \quad 5-2$$

where

- RTW_{us} = reproducible tangible wealth for the United States (\$),
 VSL_{us} = value of suburban land in the United States (\$),
 VFA_{us} = value of farm assets in the United States (\$),
 $VFHP_{\text{us}}$ = value of farm household possessions in the United States(\$), and
 POP_{US} = population of the United States (persons).

VSL_{us} is calculated using the equation:

$$VSL_{\text{US}} = UBL_{\text{US}} \cdot MHV_{\text{US}} \cdot LPA_{\text{US}} \cdot FLV_{\text{US}} \quad 5-3$$

where

- UBL_{us} = amount urban and built-up land in the United States (acres),
 MHV_{us} = median housing value for the United States (\$ / house),
 LPA_{us} = average number of housing lots per acre (houses / acre), and
 FLV_{us} = average fraction of house cost due to land value.

The values and the sources for the variables used in producing $VNFRM_{\text{us}}$ were all obtained from the 1993 and 1994 Statistical Abstract of the United States, except for LPA_{us} and FLV_{us} which were obtained from NUREG/CR 4551 (see Reference 2) and are equal to 5.0 houses / acre and 0.2 respectively. For details on the remaining values see Appendix D and E.

5.2.2 Changes in the County-Level Database with the 1997 Economic Census

An economic census performed in 1997 was used to create a new county-level database, COUNTY97.DAT. While this new file uses the same algorithms as the original, COUNTY90.DAT, unavoidable differences arose with the input parameters. Table 5.7 summarizes the results of calculations for both 1990 and 1997. Notes referenced on the table discuss both sources of data for 1997 and how the resulting information differs with that used in 1990. As the table shows, differences are significant enough that direct comparison of COUNTY90 and COUNTY97 data is discouraged.

Table 5.7 Variation in COUNTY90.DAT and COUNTY97.DAT Parameters

Description	Variable	1990	1997	Units	Notes
Reproducible Tangible Wealth	RTW _{us}	2.5652E+13	2.4883E+13	\$ of the Day	1
Urban and Built-up Land	UBL _{us}	85,964,103	98,251,700	Acres	2
Median Housing Value	MHV _{us}	79,100	98,815	\$ of the Day	3
Total Farm Assets	VFA _{us}	1.0037E+12	1.0530E+12	\$ of the Day	4
Farm Household Possessions	VFHP _{us}	4.6400E+10	-	\$ of the Day	5
Population	POP _{us}	248,719,873	281,421,906	Persons	6
Typical Lot Size		0.2	0.2	Acres	7
Houses per Acre	LPA _{us}	5	5	Houses/acre	
Land - Fraction of Housing Value	FLV _{us}	0.2	0.2	Fraction	8
U.S Per Capita Income	PCI _{us}	18,696	25,412	\$/Person	9
Value of Suburban Land	VSL _{us}	6.79976E+12	9.7087E+12	\$ of the Day	
Average Non-Farm Value for the United States	VNFRM _{us}	126,626	187,462	\$/Person	

Notes:

1. Value for RTW_{us} came from the document "Fixed Reproducible Tangible Wealth in the United States Revised Estimates for 1995-97 and Summary Estimates for 1925-97," The Survey of Current Business, September 1998. See Appendix E, Table E.1 for an example of this information.

The 1997 county-level database uses Net Fixed Reproducible Tangible Wealth instead of Gross Fixed Reproducible Tangible Wealth as was used the 1990 version. Gross values ignore the depreciation of aging assets. As of 1996, the United States no longer estimates Gross Fixed Reproducible Tangible Wealth. Before that year both the net and the gross

values were published. In a telephone conference call with Leonard Loebach of the Bureau of Economic Analysis, Mr Loebach stated that creating gross values now would be extremely difficult, and probably misleading. In his opinion, using non-depreciated values for tangible wealth unjustifiably overestimates the consequences of losing these assets.

In 1996 the Bureau of Economic Analysis revised the way the U.S. calculates depreciation. For 1990 data, this effectively raised Net Fixed Reproducible Tangible Wealth 20% over what was previously published.

2. Values for UBL_{us} came from the Natural Resources Conservation Service's document, "Summary Report, 1997 National Resources Inventory, Revised December 2000," available at web site [http://www.nrcs.usda.gov/tgchnical/NRI /1997/summary report](http://www.nrcs.usda.gov/tgchnical/NRI/1997/summary%20report). Figure 5-5 illustrates the trend, and its relation to previous data. See also Appendix E, Table E.2.

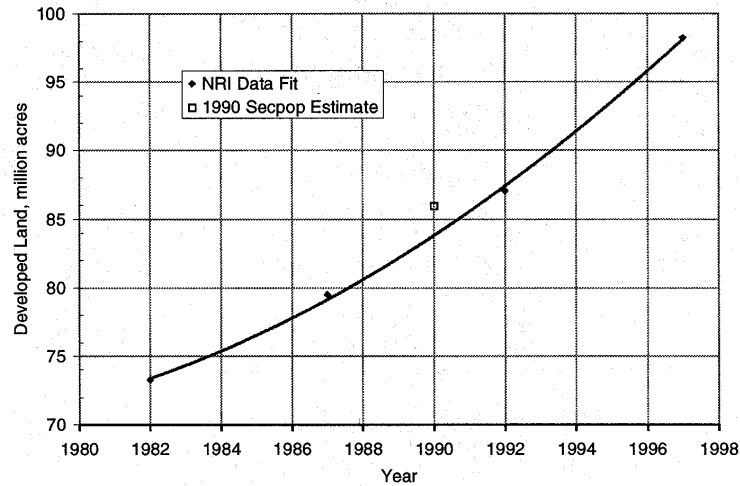

Figure 5-5 Developed Land Trends

3. Median housing costs shown in Figure 5-6 came from the 1991, 93, 95, 97 and 99 editions of the publication US Census Bureau, American Housing Survey Tables 3-14 (Appendix E, Table E.3).

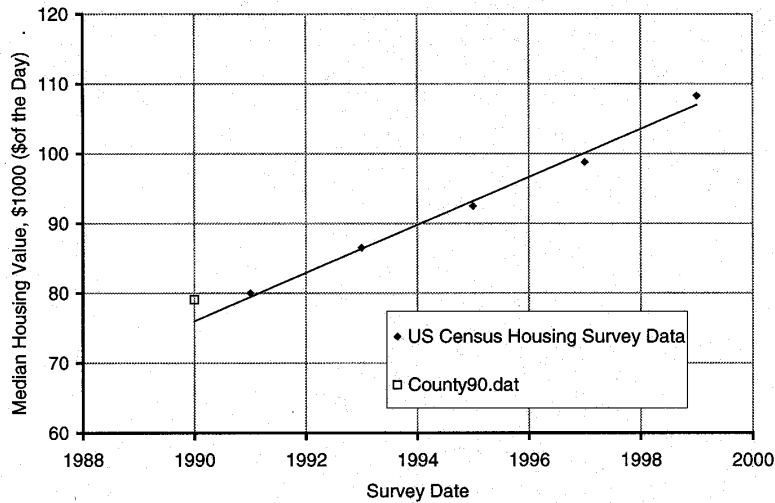

Figure 5-6 Median Housing Values, 1991 through 1999

4. Total U.S. farm assets come from the USDA/Economic Research Service. Ken Erickson stated in a telephone conversation that the current practice at the USDA is to exclude all “non-business” components from their balance sheets. This means the exclusion of household goods, personal financial assets, houses and real estate associated with houses. Figure 5-7 illustrates the impact of this current practice on the value used for VFA_{US} . The value of personal farm family possessions is no longer reported. See Appendix E, Table E.4.

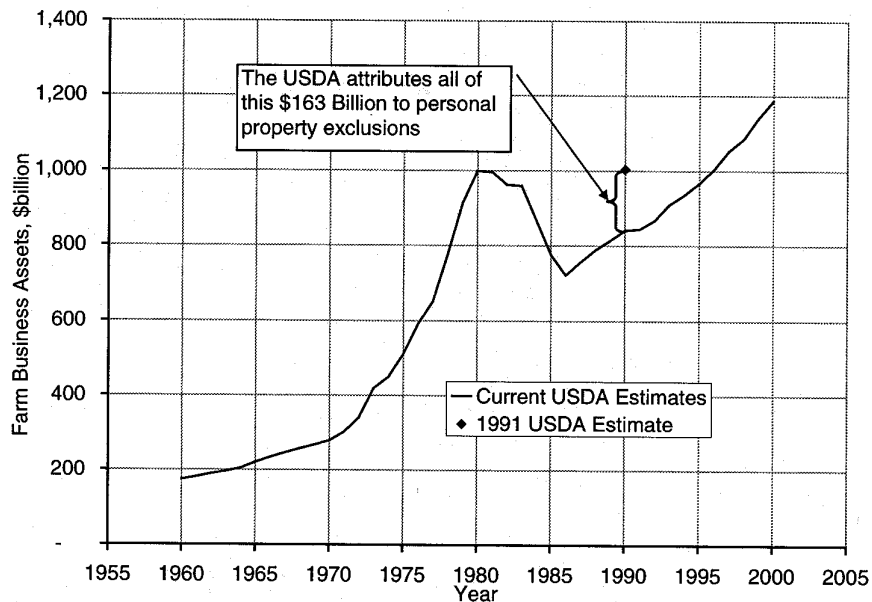

Figure 5-7 VFA_{US} , United States Farm Business Assets Trend

5. Since the exclusions discussed above address the intent of variable $VFHP_{us}$ its value is set to zero in 1997. However, this introduces differences. As shown in Figure 5-7, personal property exclusions total \$163 billion for 1990 data. The value of $VFHP_{us}$ used for the 1990 county level data was \$46 billion, the value of household goods alone. The difference, if applied to 1997 data, means a change of less than 1% in the calculated value of $VNFRM_{us}$. Also, it can be argued that the earlier method double accounted for farm housing and other personal assets.
6. Population data was derived from the DVD. This DVD uses the Census 2000 Summary File 1 US Data, as discussed on the U.S. Census web site <http://www.census.gov/Press-Release/www/2001/sumfile1.html>.

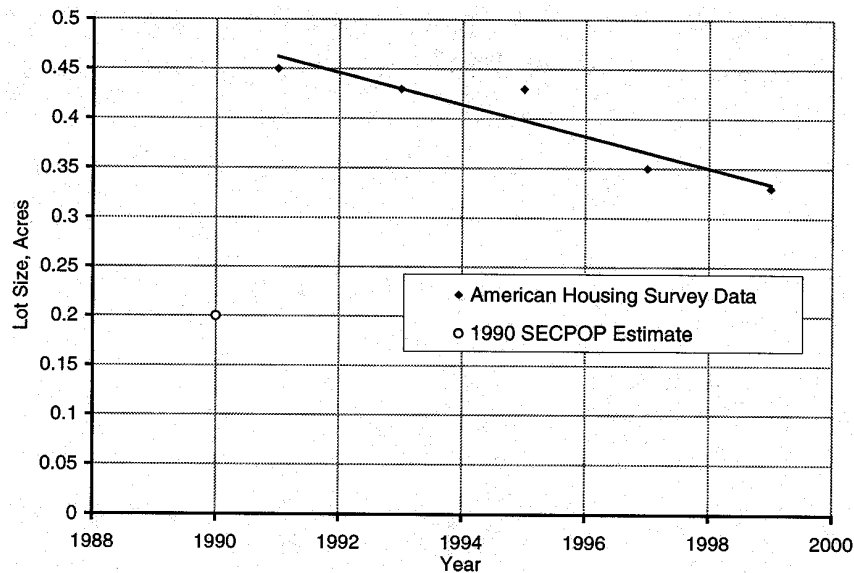

Figure 5-8 Median Lot Size for American Homes

7. The 1997 value in Table 5.7 assumes the same median lot size for U.S. homes as was used earlier (0.2 acre/house). From Figure 5-8, this value differs significantly from the information published in the American Housing Survey. This lower number was retained because it provides consistency with earlier work.
8. Unlike other items, land value as a fraction of housing value is not a statistic published by the United States. Thus, we adhered to the document referenced originally: NUREG/CR 4551, published in 1990.
9. Data on per capita income came from the U. S. Department of Commerce, Bureau of Economic Analysis CA1-3 tables, available as comma separated variable files at the web site <http://www.bea.izov/bea/regionalreis/cal3.html>. These files were downloaded and imported into a spreadsheet for incorporation into the database.

5.2.3 Verification of the County-Level Census Database

Unlike the construction of the block-level database, the construction of the county-level database did not require the creation of any additional programs for conversion or sorting. The tools used were Excel, Access, and the EXTRACT program provided by the Bureau of Census. It is assumed that these programs functioned properly. However, after every operation and/or manipulation of the county-level data, checks were made to ensure that each county had the proper number of records and that all individual county amounts totaled (or other appropriate operation) to the state aggregate amounts.

5.3 Verification of the SECPOP90 Code

Verification of the SECPOP90 code concentrated on the accuracy of the results of the site-specific population calculations. There are several justifications for this approach. First, the regional calculations use the same algorithms as the site-specific calculations; therefore, the regional calculations are indirectly verified by the verification of the site-specific calculations. Second, there is no real way to verify the site-specific economic data that were derived from the county-level database. The economic values are estimates and should only be used for relative evaluations.

5.3.1 Internal Verification

The first step in the verification of the SECPOP90 code was to use the first 36 data points on the census data file to enable the code developer to readily verify that the population for each of those data points was correctly placed on a magnified grid close to the “site.” The “site” was placed at each of the “corners” of the data as well as at the “middle” of the data. SECPOP90 was found to work correctly in each case.

The SECPOP90 code was then exercised using the 1990 census data and the results contrasted with the results when the SECPOP code was exercised using the 1980 census data for five sites. The sites selected were distributed throughout the continental United States. It was found that the differences were, for the most part, well within differences that would have been predicted simply because of the population growth over the past 10 years.

Final internal verification efforts involved comparing the results obtained from the VAX/VMS system FORTRAN code version with the results obtained using the PC Visual Basic. The results were in good agreement.

5.3.2 External Verification for the SECPOP90 Code

A survey of U.S. commercial nuclear power plants identified those plants that have provided the NRC with updated population information based on the 1990 census data. Licensees for 12 plants have provided this information. Of these 12 plants, four only provided the total population within a specific distance from the plant. The others provided the information in tables, graphs, or both, within 16 rings. The ring distances vary among plants. Licensee submittals may not be accurate;

a deviation from the licensee's number(s) is not necessarily an error. In several plants, the licensee's population totals within a ring or sector (or both in one case) have been found to be incorrect. One licensee appears to have averaged the number of people within a ring, which is not accurate.

The following table shows the results for the total populations as reported by the licensees, as calculated by SECPOP90, and as percent of reported $[\frac{\text{as calculated by SECPOP90}}{\text{as reported by the licensees}}] \times 100\%$. Superscripts in Table 5.8 correspond to reference numbers.

Table 5.8 Total Reported and Calculated Populations

Plant Name	Reported	SECPop90	Percent of Reported
Fitzpatrick ⁴	44,231	39,443	89%
Millstone 1 ⁵	3,363,745	2,780,995	83%
Monticello ⁶	2,273,213	2,416,872	106%
*Nine Mile Point ⁷	924,000	908,835	98%
*Oyster Creek ⁸	96,718	101,433	105%
*Peach Bottom APS ⁹	10,257,315	6,803,644	66%
DC Cook ¹⁰	52,953	51,070	96%
Diablo Canyon ¹¹	374,701	376,012	100%
Fort Calhoun ¹²	760,431	772,086	102%
Prairie Island ¹³	25,342	24,969	99%
Turkey Point ¹⁴	2,613,535	2,602,834	100%

* These plants only provided total population within a radius.

As shown above, on a total population basis, all of the results are in reasonable agreement. The program also provides the typical rosettes that show the populations in relation to the plant site. Examples of the rosettes for Millstone 1, Monticello, and Diablo Canyon are shown below. The results can also be provided as a MACCS site file for direct use in MACCS calculations. An example of this type of output is shown in Section 3.6.3.

Also included are population tables (see Appendix F) generated from licensee information and SECPOP90 output. These tables show the actual population by ring segment and the percent difference from the licensee's reported values. As with all percent results, caution should be used when interpreting the information. For example: at DC Cook, ring 1, south sector, the licensee

reported 5 people while SECPOP90 calculated 20 people, a 400% difference with no practical effects.

Generally, SECPOP90 calculates the total population in each ring and each sector reasonably well. However, the ring-segment population can have a large deviation from the licensee's values. Assuming that the licensee's values are accurate, this can be caused by the code's identification of the census block centroid. The entire population for a census block is counted in the rosette section in which the centroid of the block resides. This can be seen in the Diablo Canyon tables in the NW and NNW segments from 10 through 50 miles.

Another factor is the level of detail for the census data that the licensee used. If the level of detail was at the county, city, or block group level, the reported values are different. As previously mentioned, one licensee (Monticello) used average data for rings 2 through 6. The reasonableness of the results in both the ring and sector attests to the fact that the ring-segment-to-ring-segment differences are not significant. The one exception seems to be low population sites with scattered population, like Turkey Point. In these cases the percent differences are large. In such cases, engineering judgment is needed to assess the impact of the low population on the health effects of interest.

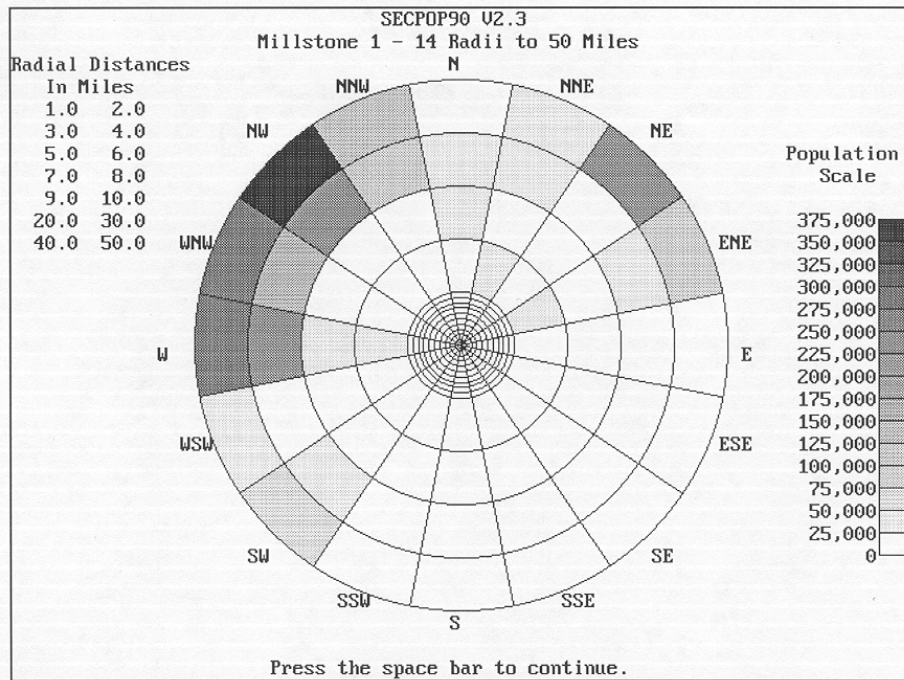

Figure 5-9 Millstone Rosette

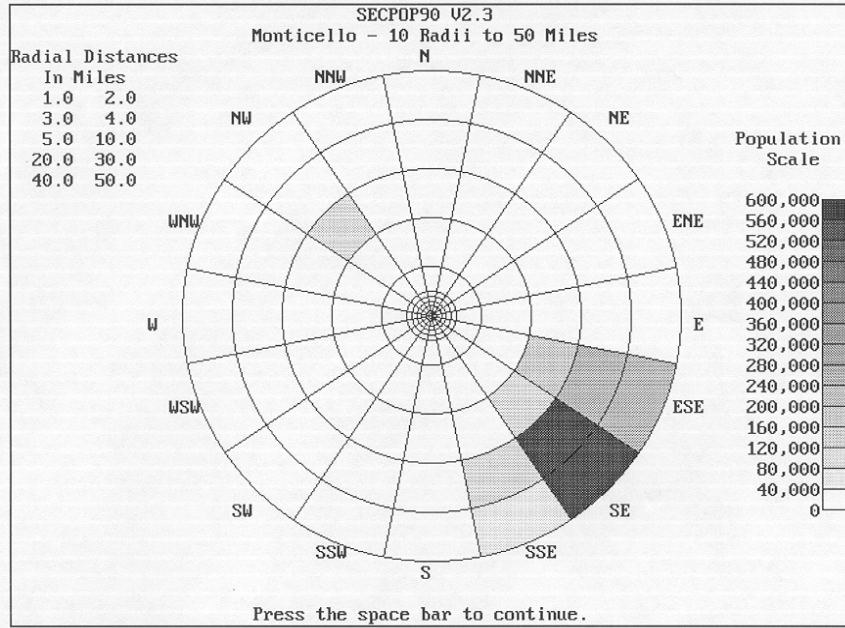

Figure 5-10 Monticello Rosette

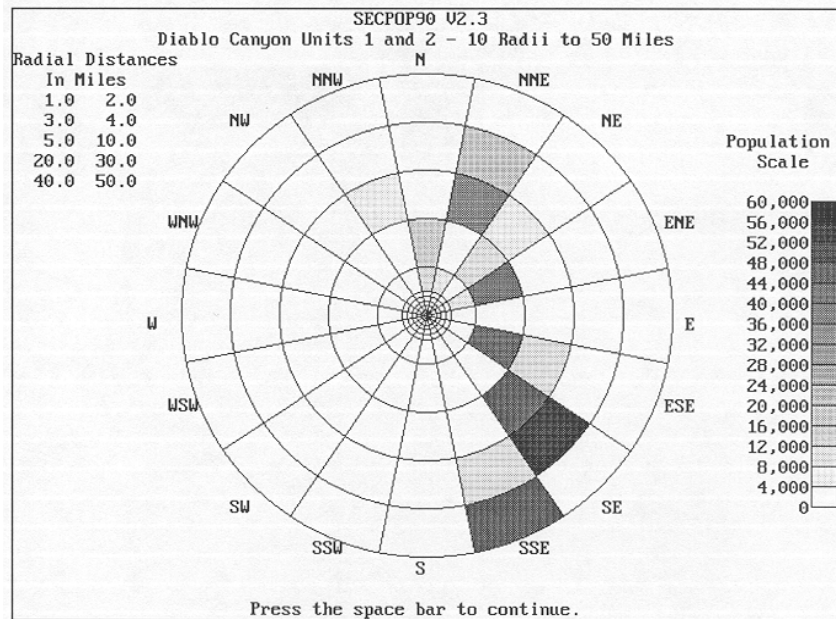

Figure 5-11 Diablo Canyon Rosette

5.4 Verification of the SECPOP2000 Code

Verification of the SECPOP2000 code concentrated on the accuracy of the results of the site-specific population calculations. There are several justifications for this approach. First, regional calculations are not supported in SECPOP2000. Second, there is no real way to verify the site-specific economic data that were derived from the county-level database. The economic values are estimates and should only be used for relative evaluations.

5.4.1 Internal Verification

The U.S. Census data engine can estimate population within a user-specified circle. This allows comparison with SECPOP2000 totals for the same circle. The data in Table 5.9 illustrate one such comparison using the San Onofre site. Percent differences are large, 8.9%, for the first circle containing population. Differences drop rapidly, tending to values less than 1%, for larger radii.

Table 5.9 San Onofre Circles Comparison Cumulative Population

Radius (miles)	US Census Database	SECPop2000	Absolute Difference (%)
1	0	0	0.00%
2	0	0	0.00%
3	1,262	1,375	8.94%
4	6,267	6,393	2.01%
5	26,059	26,558	1.91%
6	41,638	41,773	0.32%
7	47,433	47,658	0.48%
8	54,847	55,290	0.81%
9	66,524	66,619	0.14%
10	75,588	75,796	0.27%
15	221,674	224,767	1.40%
20	700,026	700,633	0.09%
30	1,735,315	1,748,970	0.79%
40	4,064,777	4,097,536	0.81%
50	7,559,279	7,622,370	0.83%

These differences are inherent to the algorithms used by the two programs. SECPOP2000 allocates population by whole census blocks. The U. S. Census data engine, on the other hand, returns population estimates resolved to decimal fractions of a whole person, indicating that it somehow interpolates block populations. Blocks in the San Clemente area just to the north contain around 100 people, so at small radii inclusion or exclusion of one block can have a significant impact. For example, the almost 9% difference listed for the three mile radius circle results from a difference of only 113 people or about one census block. Subsequent discussion refers to this type of error as whole-block-precision error.

Figure 5-12 contains a plot of the Table 5.9 data. As expected from the above table, population estimates almost overlaid each other. The figure also illustrates the downward trend of relative difference with increasing radius.

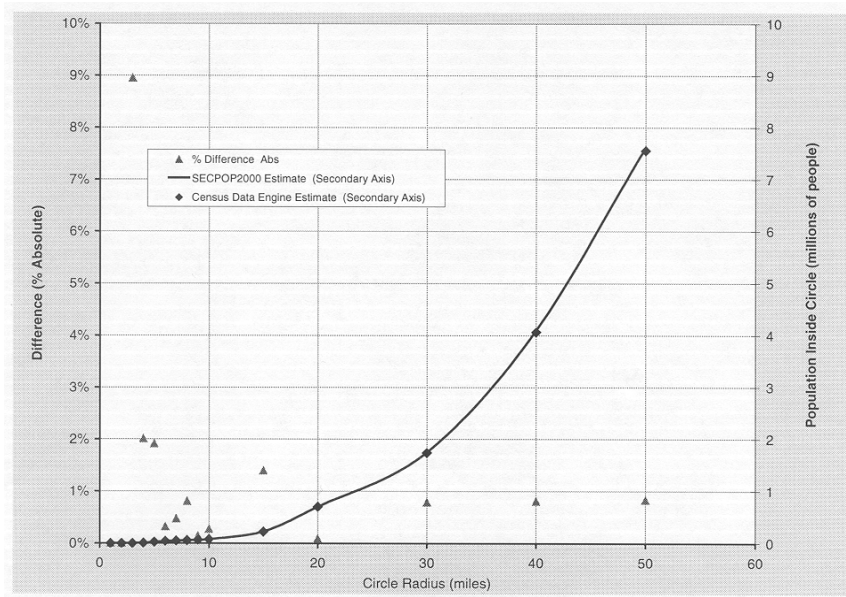

Figure 5-12 San Onofre Circles Comparison

Table 5. 10 summarizes results for a sector-by-sector comparison of the San Onofre site. The data engine supplied by the Bureau of Census can be extended, with some effort, to find populations within irregular polygons. This functionality, originally intended to support voting district restructuring, works with sectors as well. The process requires the creation of closed areas using Arc-Info or similar mapping software. These polygons can be translated into shape files interpretable by the data engine. Sectors were laid out based on radii of 5 and 50 miles using Arc-Info, and saved these shapes to a file. The Census Bureau data engine, using these shapes, generated the population estimates shown in the leftmost group of three columns in Table 5.10. These numbers compare well with the information generated by SECPOP2000 as listed in the center three columns. The last three columns show the percent difference between the two data sources. Variances were generally within 4%, with most less than 2%. Significant errors arose in the WNW,

NW, and NNW sectors, especially for small radii. In addition to the whole-block-precision error discussed above, evidence exists that errors exist with the polygon creation process, as described below.

Table 5.10 San Onofre Sector by Sector Comparison

Sector \ Radii(mi)	CENSUS/SNL			SECPOP2000			Error (abs)		
	5	50	Wedge Sum	5	50	Wedge Sum	5	50	Wedge Sum
N	-	830,817	830,817	-	827,723	827,723		0.37%	0.37%
NNE	-	450,919	450,919	-	458,979	458,979		1.79%	1.79%
NE	-	252,939	252,939	-	247,910	247,910		1.99%	1.99%
ENE	-	110,752	110,752	-	111,977	111,977		1.11%	1.11%
E	11,471	50,189	61,660	11,471	50,441	61,912	0.00%	0.50%	0.41%
ESE	-	329,090	329,090	-	332,716	332,716		1.10%	1.10%
SE	-	784,194	784,194	-	779,497	779,497		0.60%	0.60%
SSE	-	500,553	500,553	-	485,503	485,503		3.01%	3.01%
S	-	-	-	-	-	-			
SSW	-	-	-	-	-	-			
SW	-	-	-	-	-	-			
WSW	-	-	-	-	-	-			
W	-	3,464	3,464	-	3,464	3,464		0.00%	0.00%
WNW	530	56,458	56,988	427	61,226	61,653	19.43%	8.45%	8.19%
NW	9,470	2,659,247	2,668,717	12,348	2,628,229	2,640,577	30.39%	1.17%	1.05%
NNW	1,520	1,548,781	1,550,301	2,312	1,608,147	16,104,559	52.11%	3.83%	3.88%
Radius Sum	22,991	7,577,403	7,600,394	26,558	7,595,812	7,622,370	15.51%	0.24%	0.29%

SECPOP2000 estimates the total population for all sixteen sectors within a 5-mile radius at 26,558 people. The table also shows the U.S. Census database estimates the people within the same 5-mile radius is 26,059, indicating a difference of less than 2%. This value is about 12% larger than the Table 5.10 radius sum of 22,991 people. Even a 12% error is acceptable for MACCS calculations, where the overall uncertainties in consequence predictions are significantly greater than 12%. The problem essentially disappears with larger radii. The SNL/Census total for a 50-mile radius is within 0.5% of the U.S. Census estimate for the same size circle.

Finally, Figure 5-17 provides a visual example of SECPOP2000's capability for the San Onofre site.

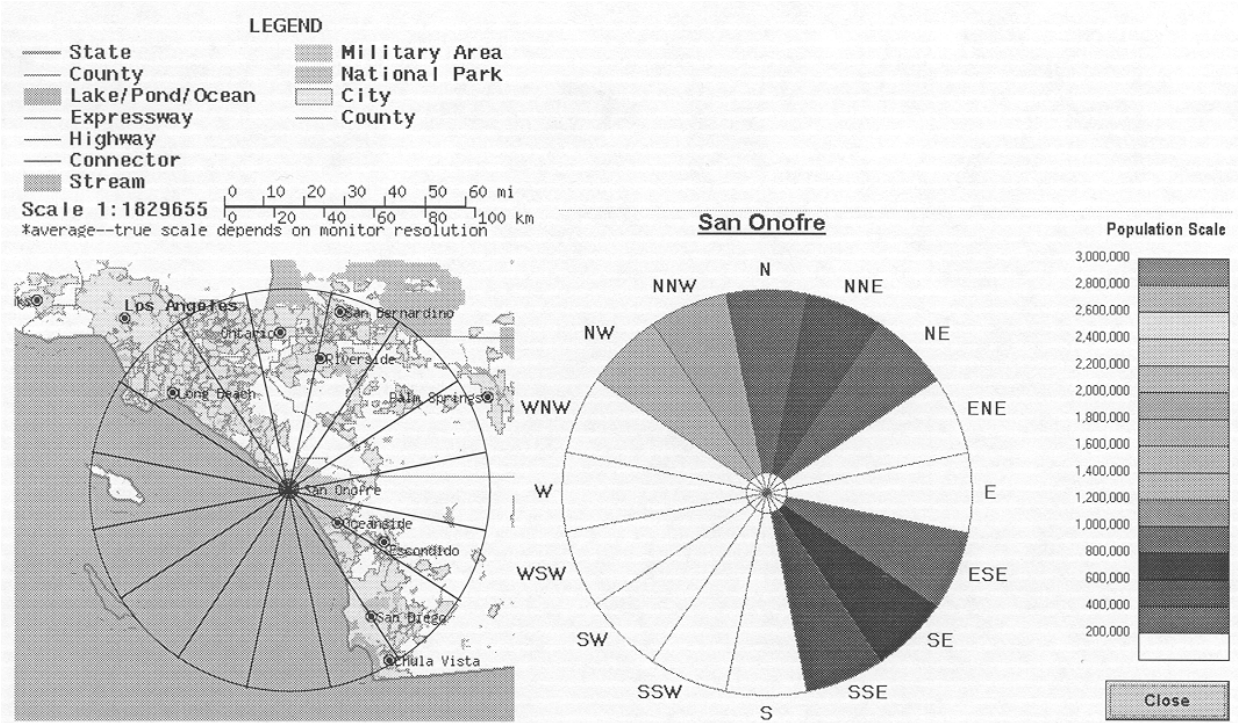

Figure 5-13 San Onofre Rosette Visualization Example

The figure shows a map on the left with a radial grid showing the sixteen sectors superimposed. A SECPOP2000 rosette appears on the right side of the figure. The rosette uses the same radii used in Table 5.10, 5 miles and 50 miles with a 1-mile dead zone. Both the rosette and the grid were sized to match the map. The rosette's population scale has increments of 200,000 people. As would be expected the NW sector, covering much of Long Beach and Los Angeles shows the highest population. Clockwise progression demonstrates a drop in population density through suburbs of Los Angeles to the San Bernardino Valley. The ENE and E sectors reflect the low (less than 200,000) populations of the desert areas outside of Palm Springs. Similar patterns emerge for the Oceanside-San Diego area. Catalina Island, which is directly west of San Onofre, exists entirely within the W sector. As Table 5.10 shows, all West sector estimates are identical at 3,464 people. Figure 5-18 contains a map/rosette graphic based on the Peach Bottom site in Eastern Pennsylvania. Radii here were chosen so that every sector contains approximately 50 square miles. The maximum radius is 50 miles. The rosette picks up the high populations in Baltimore to the SSW and SW directions. It shows higher populations to the east toward the Philadelphia suburbs and Northern Delaware. It also shows the distributed suburban and small town populations to the north.

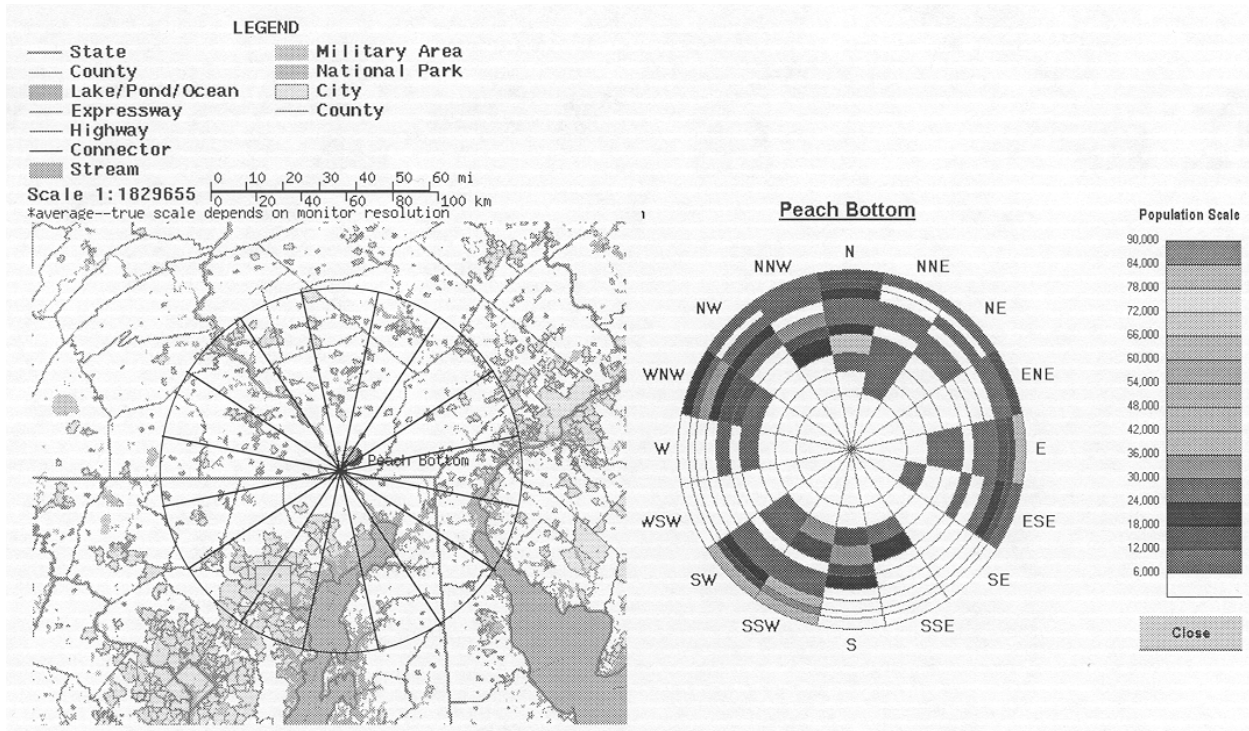

Figure 5-14 Peach Bottom Rosette Visualization Example

Figure 5-19 plots population estimates for increasing circles using SECPOP2000 and the Census data engine. As with San Onofre, the estimates match with percent differences consistently less than 1%. As before, differences trend downward with increasing radius.

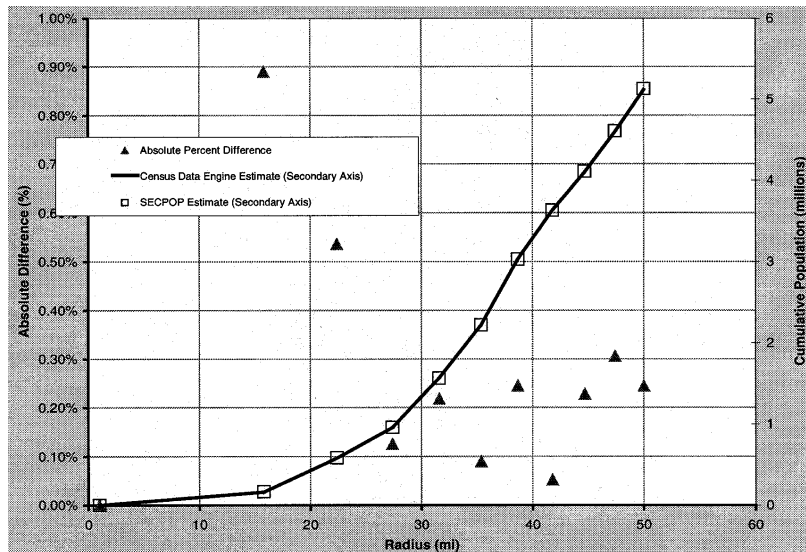

Figure 5-15 Peach Bottom Circles Comparison

5.4.2 External Verification of the SECPOP2000 Code

A survey of U.S. commercial nuclear power plants identified those plants that have provided the NRC with updated population information based on the 2000 census data. Licensees for two plants have provided this information. One of these plants only provided information out to 10 miles and there were few people within the 10 miles. An additional 20 plants estimated the population for the year 2000. Some of these estimates are very crude. Of these 20 plants, 10 provided reasonable data; that is, they did not use the same number of people in multiple adjacent sectors. The data was provided in tables, graphs or both, by rings of 16 segments. The ring distances vary among plants. Licensee submittals may not be accurate; a deviation from the licensee's number(s) is not necessarily an error. In several plants, the licensee's population totals within a ring or sector have been found to be incorrect. More than one licensee appears to have averaged the number of people within some rings.

The following table shows the results for the total populations as reported by the licensees, as calculated by SECPOP2000, and as percent of reported $[(\text{as calculated by SECPOP2000}) / (\text{as reported by the licensees})] \times 100$. Superscripts in Table 5.11 correspond to reference numbers.

Table 5.11 Total Reported and Calculated Populations for a 60-Mile Radius

Plant Name	Reported	SECPop2000	Percent of Reported	Census Data Used
Browns Ferry ¹⁵	952,689	1,059,559	111%	2000
Columbia ¹⁶	333,112	360,534	108%	1980
Cook ¹⁷	4,207,374	4,252,575	101%	Not Specified
Grand Gulf ¹⁸	321,319	330,449	102%	1970
Limerick ¹⁹	7,109,077	7,603,283	106%	1970
Point Beach ²⁰	459,871	479,864	104%	1980
Robinson ²¹	872,775	802,184	92%	1980
Seabrook ²²	4,426,080	4,167,639	94%	1980
South Texas ²³	352,092	255,118	73%	1980
Susquehanna ²⁴	1,647,043	1,686,422	102%	Not Specified
River Bend ²⁵	1,008,616	856,667	85%	1970

As shown above, on a total population basis, all of the results are in reasonable agreement. Only one plant, D.C. Cook, was reported in the SECPOP90 manual (September 1997) and is in this

edition. The SECPOP90 manual reported the 10-mile population with a value of 96% (from Table 5.8 for 60 miles) of reported as compared with the 2000 census value of 101% (from Table 5.11). Generally, the percent of reported improved from SECPOP90 to SECPOP2000. SECPOP90 tended to underestimate the population while SECPOP2000 tends to slightly overestimate the population. SECPOP2000 also provides the typical rosettes, which show the populations graphically in relation to the plant site. Examples of the rosettes for Columbia Power Station, Limerick Generating Station, River Bend Station, and St. Lucie are shown below. The results can also be provided as a MACCS2 site file for direct use in MACCS2 calculations. An example of this type of output is shown in Section 3.6.3.

Also included are population tables (see Appendix F) generated from licensee information and SECPOP2000 output. These tables show the actual population by ring segment and the percent difference from the licensee's reported values. As with all percent results, caution should be used when interpreting the information. For example: at DC Cook, ring 1, east-northeast sector, the licensee reported 9 people while SECPOP2000 calculated 43 people, a 478% difference with little practical effect.

Generally, SECPOP2000 calculates the total population in each ring and each sector reasonably well. However, the ring-segment population can have a large deviation from the licensee's values. Assuming that the licensee's values are accurate, this can be caused by the fact that SECPOP2000 effectively places the entire block population at the block's centroid. An example of this is in Browns Ferry, ring 3, south and south-southwest sectors. The licensee reported 10 and 32 people (42 total), respectively, while SECPOP2000 reported 58 and 0 people (58 total), respectively.

Another factor is the level of detail for the census data that the licensee used. If the level of detail was at the county, city, or block group level, the reported values are different. As previously mentioned, some licensees used average data for rings. The reasonableness of the results in both the ring and sector attests to the fact that the ring-segment-to-ring-segment differences are not significant. For low population sites with scattered population, the percent differences could become large. If they do become large, it is not clear what effect this may have on MACCS2 calculations. In such cases, engineering judgment is needed to assess the impact of the low population on the health effects of interest, with consideration being given to the meteorology selected (wind rose).

There is a significant difference in the way licensees have projected population estimates. This can be seen by reviewing the population distribution patterns developed. For example, River Bend estimated the 2000 population distributions from the 1970 Census data. The River Bend population table (see Appendix F) has areas shaded for patterns of low, medium, intermediate and high populations. A review of these patterns indicates that while the absolute numbers may not match, the patterns are very similar between the licensee's projected population distribution and SECPOP2000's calculated population distribution. In contrast to River Bend is South Texas. While South Texas used the 1980 census data and the patterns are similar, the comparison with the SECPOP2000 results is not as good. For this assessment, it is the pattern that is important for all plants, but especially for those who only provided estimated population distributions.

An important issue that became obvious in this assessment is the importance of the exact physical location of the center point for the calculation. One plant, not reported here, was investigated in an attempt to match the population distributions. The coordinates initially provided were over the ocean. Other coordinates were obtained from other sources and none of them were accurate. By using commercial mapping software, the correct coordinates were obtained. This resulted in greatly improved population distribution patterns. This underscores two points to keep in mind when performing SECPOP2000 calculations: (1) the offsite consequences calculated by MACCS2 are potentially, significantly affected by inaccuracy in identification of the latitude and longitude, and (2) review of the SECPOP2000 population distribution pattern for reasonableness is essential for confidence that the latitude and longitude values are correct.

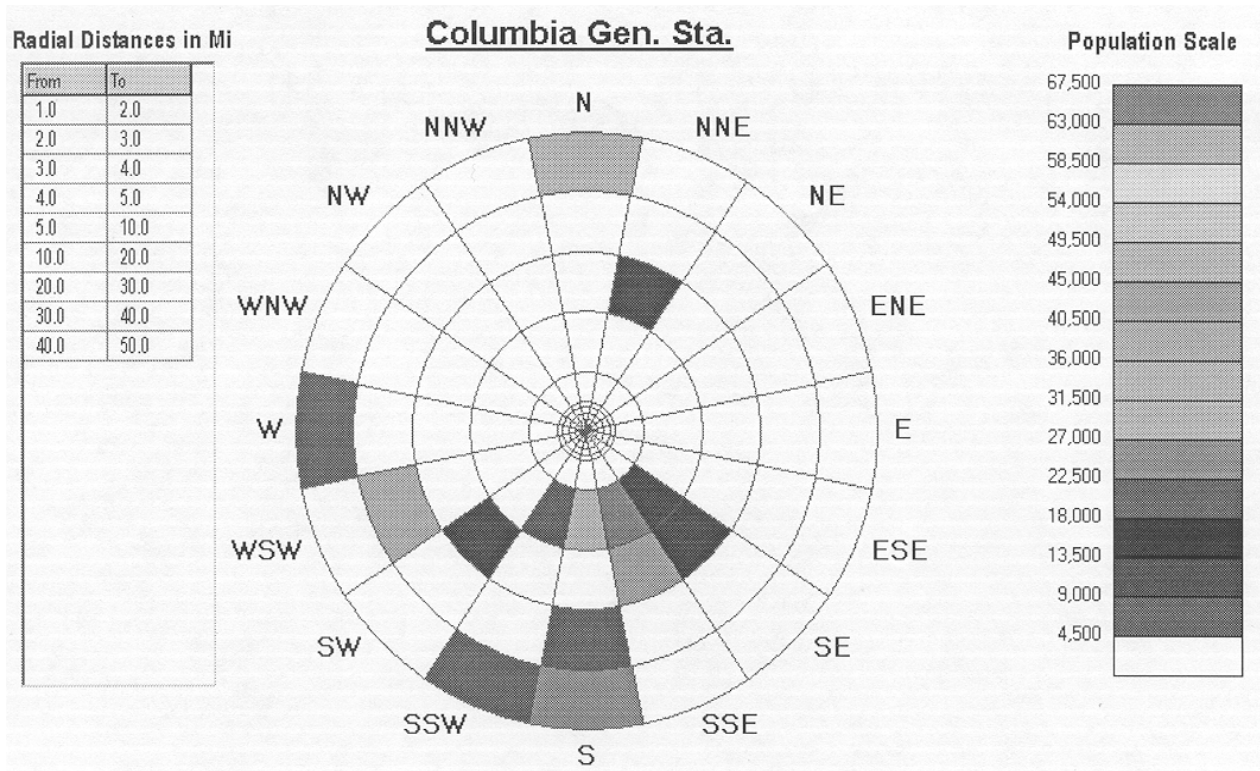

Figure 5-16 Columbia Power Station Rosette

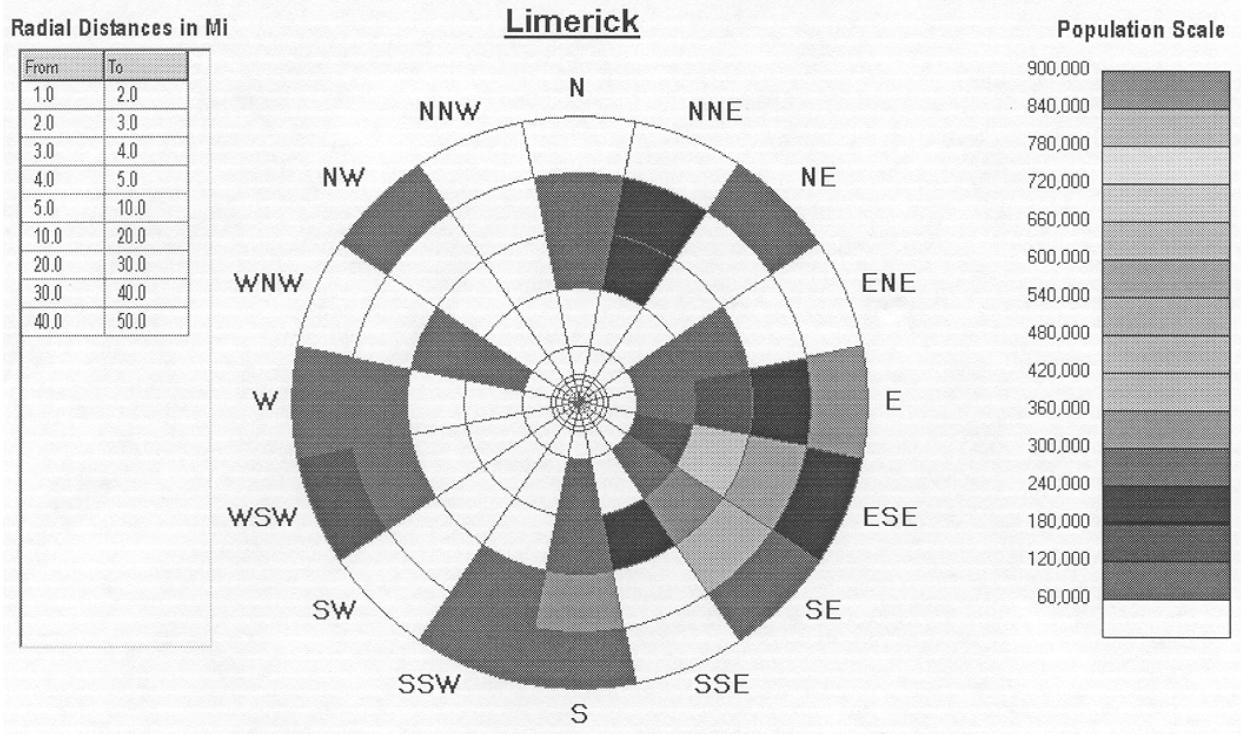

Figure 5-17 Limerick Rosette

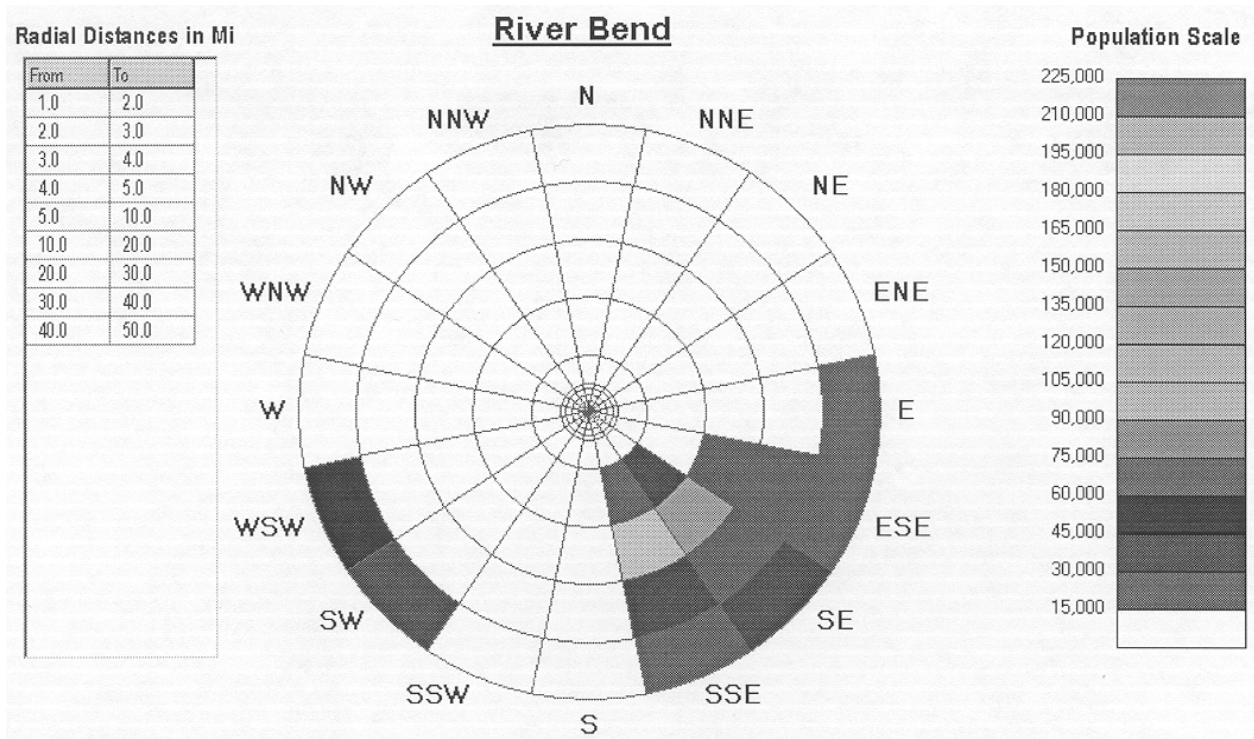

Figure 5-18 River Bend Rosette

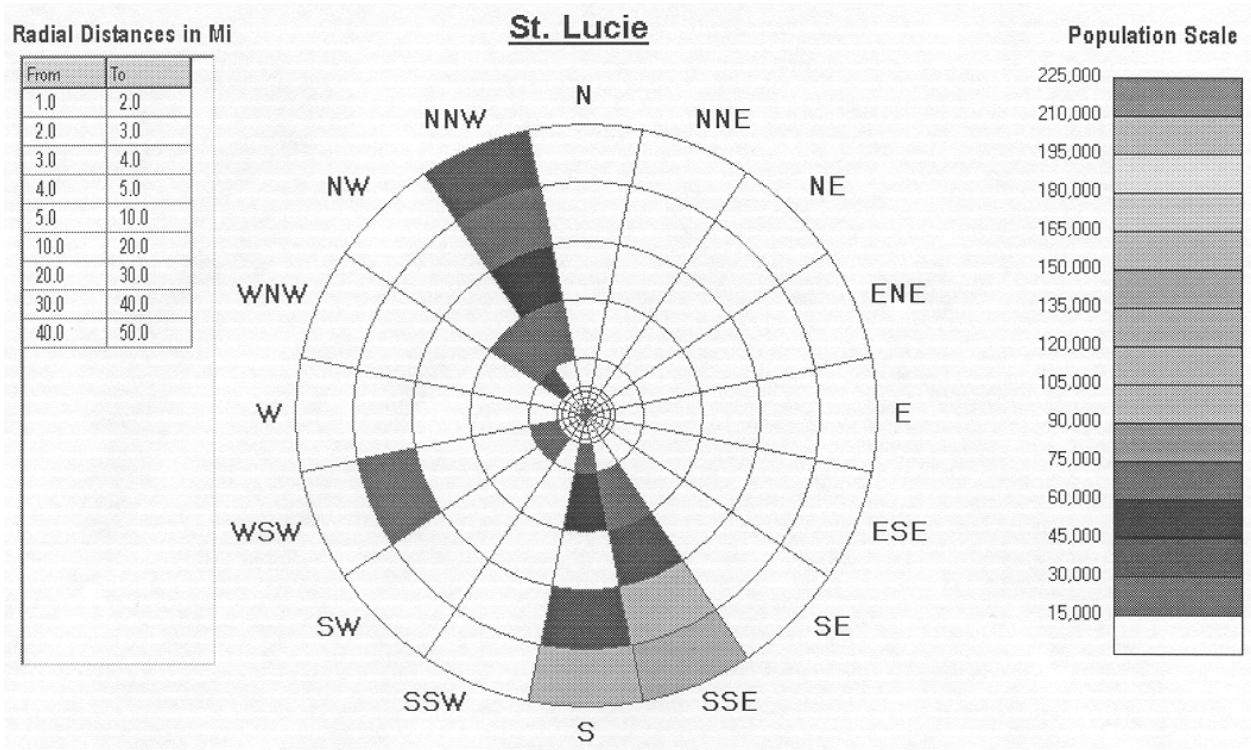

Figure 5-19 St. Lucie Rosette

6 References

1. Humphreys, S.L., Rollstin, J.A., Ridgely, J.N., SECPOP90: Sector Population, Land Fraction and Economic Estimation Program, NUREG/CR-6525 or Sand93-4032, 1993
2. Census 2000 Summary File1; Census of Population and Housing, U.S. Department of Commerce Economics and Statistics Administrations, U.S. Census Bureau; DVD issued September 2001. V1-D00-S1AS-08-US1.
3. Sprung, J.L., Rollstin, J.A., Helton, J.C., Jow, H-N, Evaluation of Severe Accident Risks: Quantification of Major Input Parameters, NUREG/CR-455 1, SAND86-1309, Vo12, Rev. 1, Part 7, U.S. Nuclear Regulatory Commission, Washington, DC, December 1990, pg. 5-4
4. James A. FitzPatrick Emergency Plan, Volume 1, Revision 2, dated September 9, 1992.
5. Millstone I Updated Final Safety Analysis Report, Chapter 2, Revision 6, dated May 1993.
6. Monticello Final Safety Analysis Report, Tables 2.2-1 and 2.2-2, Revision 11, dated December 199 1.
7. Nine Mile Point 2 Safety Evaluation Report, dated August 7, 1991, TAC Number 69095 [50 Mile radius].
8. Oyster Creek, GPU submittal dated May 19, 1992, C321-92-2118 [10 Mile radius].
9. Peach Bottom Atomic Power Station, Philadelphia Electric Company submittal dated May 21, 1992, Accession Number 9206020160 [60 Mile radius].
10. DC Cook Final Safety Analysis Report, Page 2.1-8 and Figure 2.1-5, updated July 1993.
11. Diablo Canyon Final Safety Analysis Report, Chapter 2, Revision 8, dated September 1992.
12. Fort Calhoun Station Radiological Emergency Response Plan, Section J, Figures J-6 through J-8, Pages 24 through 26.
13. Evacuation Time Estimates for the Prairie Island Nuclear Plant Plume Exposure Pathway Emergency Planning Zone, Table 3. 1, Page 3-3, dated December 1992.
14. Turkey Point Final Safety Analysis Report, Tables 2.4-1 and 2.4-3, Revision 10, dated July 1992.
15. Browns Ferry Final Safety Analysis Report, Tables 2.1-4 and 2.1-5.
16. Columbia Power Station (formerly Washington Nuclear Project (WNP-2)) Final Safety Analysis Report, Amendment 53, Table 2.1-1.

17. D.C. Cook Final Safety Analysis Report, Revision 16. 1, Table 2.2-7.
18. Grand Gulf Nuclear Station Final Safety Evaluation Report, Tables 2. 1 -1 and 2.1-3.
19. Limerick Generating Station Final Safety Analysis Report, Tables 2.1-5 and 2.1-12.
20. Point Beach Final Safety Analysis Report, Revision 1, Figures 2.3-1 and 2.3-2.
21. H.B. Robinson Final Safety Analysis Report, Tables 2.1.3-1 and 2.1.3-2.
22. Seabrook Final Safety Analysis Report, Tables 2.1-2 and 2.1-4.
23. South Texas Final Safety Analysis Report, Table 2.1-1.
24. Susquehanna Steam Electric Station Final Safety Analysis Report, Revision 54, Tables 2.1-19 and 2.1-20.
25. River Bend Final Safety Analysis Report, Tables 2.1-6 and 2.1-13, Revision dated August 1987.

Appendix A Site List

Table A-1 lists all the site files provided with the SECPOP2000 CD in the SECPOP\Sites directory. It should be noted that neither Sandia National Laboratories nor the NRC warrants that these coordinates are accurate.

Table A.1 SECPOP2000 Site File Listing

Advanced Medical Systems.sit	Hematite - Combustion Engr.sit	Prairie Island.sit
Arkansas.sit	Honeywell.sit	Quad Cities.sit
Beaver Valley.sit	Hope Creek.sit	Rancho Seco.sit
Big Rock Point.sit	Idaho NatL Engineering And Environ.sit	Richland Framatome.sit
Braidwood.sit	Indian Point.sit	River Bend.sit
Browns Ferry.sit	Indian Point 2.sit	Robinson.sit
Brunswick.sit	Joseph M Farley.sit	Safety Light Corp.sit
Bwx Technologies.sit	Kewaunee.sit	Salem.sit
Byron.sit	Lacrosse.sit	San Onofre.sit
Callaway.sit	Lasalle.sit	Seabrook.sit
Calvert Cliffs.sit	Limerick.sit	Sequoyah.sit
Catawba.sit	Maine Yankee.sit	Shearon Harris.sit
Clinton.sit	Mallinckrodt.sit	South Texas.sit
Columbia Gen Sta.sit	Mcguire.sit	Squibb.sit
Comanche Peak.sit	Millstone.sit	St Lucie.sit
Cooper.sit	Monticello.sit	Surry.sit
Crystal River.sit	Morris General Electric.sit	Susquehanna.sit
Davis-Besse.sit	Nine Mile Point.sit	Three Mile Island.sit
Diablo Canyon.sit	North Anna.sit	Trojan.sit
Donald C Cook.sit	Nuclear Fuel Services.sit	Turkey Point.sit
Dresden.sit	Oak Ridge.sit	Vermont Yankee.sit
Duane Arnold.sit	Oconee.sit	Virgil Summer.sit
Fermi.sit	Oyster Creek.sit	Vogtle.sit
Fitzpatrick.sit	Paducah.sit	Waterford.sit
Ft Calhoun.sit	Palisades.sit	Watts Bar.sit
General Atomics.sit	Palo Verde.sit	Westinghouse Elec Corp.sit
Ginna.sit	Peach Bottom.sit	Wilmington Ge.sit
Grand Gulf.sit	Perry.sit	Wolf Creek.sit
Haddem Neck.sit	Pilgrim.sit	Yankee Rowe.sit
Hanford Meteorological Tower.sit	Point Beach.sit	Zion.sit
Hatch.sit	Portsmouth.sit	

Appendix B MACCS2 Site Data File Format

The following is taken directly from and referenced to NUREG/CR 6613, *Code Manual for MACCS2: User's Guide, Volume 1*, pp. A-6 – A-16, May 1998 for the user's convenience.

In the Site Data file, the user specifies the population distribution and land use information for the region surrounding the site. Contained in the Site Data file are the geometry data used for the site (spatial intervals), population distribution, fraction of the area that is land, watershed data for the liquid pathways model, information on agricultural land use and growing seasons, and regional economic information. An example of a Site Data file is provided in NUREG/CR-4691, Volume 1, Appendix D.2.

The user specifies in the EARLY input file whether a Site Data file is to be used (see variable POPFLG in Subsection 6.3). If a Site Data file is not being used, the population density applied in the EARLY and CHRONC modules is specified in the EARLY input file. It is not possible for the user to supply differing population data for the two modules.

The Site Data file used in MACCS2 is a formatted file. The data must appear exactly as described below and in exactly the same order. In contrast to the input files for MACCS2, which are processed by a free-format input processor, the Site Data file is processed with fixed format FORTRAN READ statements.

The use of fixed format READ statements requires that the user exercise special attention to line up the data items in their proper fields. Any numeric items specified in exponential format (*e.g.*, 1.E-6) must be right-justified in the field because trailing blanks are processed as zeroes in the FORTRAN READ statements.

In contrast to the ATMOS, EARLY, and CHRONC user input files, where every value is verified by the code to ensure that it lies within a range of allowable values, the verification performed on the Site Data is only partially complete. Some of the input parameters on this file are rigorously checked to ensure that they fall within the allowed range, while other values are not checked at all.

It is recommended that the user exercise scrupulous care in constructing a Site Data file. It is very important that all items appear in their proper fields and that all numeric values lie within the range of acceptable values. Failure to conform to these requirements may lead to the generation of spurious results.

When code users edited the population counts in the Site Data file using text editors, there were several occurrences where the code diagnosed an input conversion error and aborted execution, and it has proved very difficult to identify and remedy the problem. A possible explanation for these problems is the inadvertent inclusion of nonprintable ASCII characters or control codes in the file. A likely culprit appears to be the TAB character (ASCII code decimal 9). Control codes such as the TAB can be treated differently by different text editors, or their handling can vary, depending on user-specified editor settings.

In order to aid users in identifying the cause of these problems, and maximize the portability of the Site Data file across computer platforms, MACCS2 incorporates a test for nonprintable characters in the site data file. If any such characters are found to be present, their location on the input data line is indicated, and further execution is terminated.

The ANSI standard for FORTRAN 77 does not specify how the TAB and other control codes should be handled if they are encountered during formatted input operations. The set of processor characters handled by standard FORTRAN 77 is limited to the blank, numeric digits, upper case letters, and the following twelve symbols: '+-*/(),.:=\$'. However, it seems logical to extend this set to include all of the printable characters that can be generated by a IBM PC-AT-compatible keyboard; that is, the characters with decimal ASCII control codes between 32 (blank) and 126 (~). As a result, the definition of allowable characters in the site data file is that it can be allowed to contain all of the characters having decimal ASCII control codes between 32 and 126, inclusive.

A sample MACCS2 site data file is listed in Figure B-1. The first two records of the site data file contain identification information. Up to 80 characters may be used on each line. This header information is printed on the output listing.

Following the descriptive text fields, there are six data records that specify the amount of data that is being supplied on the file. The values defined on these data records must be consistent with the MACCS2 model definition data defined by the ATMOS, EARLY, and CHRONC input files. The value of the Site Data file input variable and the corresponding ATMOS, EARLY, and CHRONC variable must be identical. If any inconsistencies are detected, execution of the program is terminated.

The data are input as integers and the format is as follows:

<u>Line</u>	<u>Colu</u>	Fortran Format <u>Descriptor</u>	Site-File <u>Variable</u>	<u>Identification</u>	MACCS2 <u>Variable</u>	Allowed <u>Range</u>
3	1-4	I4	NSPDTS	No. of spatial intervals	NUMRAD	2-35
4	1-4	I4	NWDIR	No. of wind directions	NUMCOR	16-16
5	1-4	I4	NCPGZN	No. of food crops	NFICRP	1-10
6	1-4	I4	NWPISO	No. of water radionuclides	NUMWPI	1-10
7	1-4	I4	NWTRSH	No. of watersheds	NUMWPA	1-4
8	1-4	I4	NECRGN	No. of economic regions	N.A.	1-99

Eight blocks of site data follow the introductory block described above. Each of these data blocks is introduced by a separator line that identifies the block of data to follow. The first line of each data block must be the separator for that block. The first character (column 1) of the separator line is ignored and the following 22 characters must match the identification field for that specific data block.

The following character separators identify the eight blocks of data:

- 26. SPATIAL DISTANCES
- 27. POPULATION
- 28. LAND FRACTION
- 29. REGION INDEX
- 30. WATERSHED INDEX
- 31. CROP SEASON AND SHARE
- 32. WATERSHED DEFINITION
- 33. REGIONAL ECONOMIC DATA

34.

MACCS SITE DATA FILE
SAMPLE SITE FILE FOR MACCS2 DOCUMENTATION

26 SPATIAL INTERVALS
16 WIND DIRECTIONS
7 CROP CATEGORIES
4 WATER PATHWAY ISOTOPES
2 WATERSHEDS
59 ECONOMIC REGIONS

SPATIAL DISTANCES

0.16	0.52	1.21	1.61	2.13	3.22	4.02	4.83
5.63	8.05	11.27	16.09	20.92	25.75	32.19	40.23
48.28	64.37	80.47	112.65	160.93	241.14	321.87	563.27
804.67	1609.34						

POPULATION

0.	0.	0.	0.	0.	0.	4.	5.
6.	25.	3341.	7107.	2173.	0.	1305.	474.
2252.	2945.	5403.	20169.	112004.	3431358.	1355700.	2742710.
2487346.	104331.						
0.	0.	0.	0.	1.	2.	9.	13.
15.	63.	1667.	3550.	1330.	1072.	3198.	2425.
515.	9469.	5317.	7120.	13586.	198785.	1058744.	20508438.
3290082.	830354.						
0.	0.	0.	0.	0.	0.	5.	6.
8.	31.	822.	1752.	4543.	1713.	1597.	2296.
6535.	1775.	0.	8555.	48596.	119411.	233382.	3003954.
7620063.	1169436.						
0.	0.	0.	0.	0.	0.	1.	1.
2.	11.	543.	1157.	3820.	1621.	3364.	0.
0.	129.	6679.	11858.	0.	0.	0.	0.
0.	0.						
0.	0.	0.	0.	0.	0.	0.	0.
0.	0.	4798.	10202.	10348.	10480.	9570.	0.
0.	2317.	1756.	0.	0.	0.	0.	0.
0.	0.						
0.	0.	0.	0.	0.	0.	1.	1.
1.	7.	8316.	17684.	16340.	30419.	39474.	74998.
24195.	80412.	57477.	0.	0.	0.	0.	0.
0.	0.						
0.	0.	0.	0.	0.	0.	0.	0.
0.	0.	0.	0.	1722.	6433.	36763.	20632.
126203.	372471.	68327.	8599.	6339.	1057.	0.	0.
0.	0.						
0.	0.	0.	0.	0.	0.	2.	2.
3.	13.	127.	273.	1649.	4571.	3441.	7838.
11747.	19019.	3360.	36387.	10447.	12402.	0.	0.

**Figure B-1 MACCS/MACCS2 sample Site Data file
(continued on following page)**

0.	0.																
0.	0.	5.	4.	8.	23.	14.	20.										
23.	93.	301.	650.	0.	0.	1264.	4065.										
1106.	14665.	4071.	18006.	37417.	89072.	81626.	0.										
0.	0.																
0.	0.	0.	0.	0.	0.	19.	25.										
29.	117.	45.	105.	0.	510.	951.	1521.										
1223.	17636.	4926.	30765.	53265.	289674.	216165.	479431.										
280809.	8801784.																
0.	0.	0.	0.	1.	2.	14.	20.										
23.	93.	155.	338.	125.	1079.	0.	1355.										
2765.	154.	5296.	21409.	62228.	523803.	479588.	1538059.										
1526840.	3099458.																
0.	0.	0.	0.	1.	2.	14.	20.										
23.	93.	110.	240.	1056.	0.	50.	1396.										
915.	3153.	4132.	16295.	35596.	239712.	709522.	2845970.										
3957581.	10560254.																
3.	13.	127.	273.	1649.	4571.	3441.	7838.										
11747.	19019.	3360.	36387.	10447.	12402.	0.	0.										
0.	0.																
0.	0.	5.	4.	8.	23.	14.	20.										
23.	93.	301.	650.	0.	0.	1264.	4065.										
1106.	14665.	4071.	18006.	37417.	89072.	81626.	0.										
0.	0.																
0.	0.	0.	0.	0.	0.	19.	25.										
29.	117.	45.	105.	0.	510.	951.	1521.										
1223.	17636.	4926.	30765.	53265.	289674.	216165.	479431.										
280809.	8801784.																
0.	0.	0.	0.	1.	2.	14.	20.										
23.	93.	155.	338.	125.	1079.	0.	1355.										
2765.	154.	5296.	21409.	62228.	523803.	479588.	1538059.										
1526840.	3099458.																
0.	0.	0.	0.	1.	2.	14.	20.										
23.	93.	110.	240.	1056.	0.	50.	1396.										
915.	3153.	4132.	16295.	35596.	239712.	709522.	2845970.										
3957581.	10560254.																
0.	0.	0.	0.	0.	0.	25.	33.										
38.	154.	30.	70.	450.	0.	980.	517.										
155.	66531.	40902.	9557.	44818.	194801.	376828.	1492286.										
2250273.	12145932.																
0.	0.	0.	0.	0.	0.	7.	9.										
12.	47.	31.	69.	0.	380.	281.	445.										
1986.	32459.	183133.	193630.	30369.	203275.	94113.	1328987.										
5086913.	19537940.																
0.	0.	0.	0.	0.	0.	0.	0.										
0.	0.	223.	477.	0.	1026.	609.	2575.										
2794.	6593.	96857.	107328.	47585.	156826.	101785.	4175263.										
7535605.	9667977.																
0.	0.	0.	0.	0.	0.	15.	20.										
23.	92.	2503.	5326.	3508.	1826.	1884.	275.										
3965.	2084.	6270.	10765.	103787.	970659.	472558.	1396088.										
1969210.	73968.																
LAND FRACTION																	
1.00	1.00	0.00	0.00	0.00	0.00	0.00	0.00	0.00	0.80	1.00	1.00	0.95	0.75	0.70	0.85		
1.00	0.85	0.70	0.75	0.55	0.70	0.60	1.00	1.00	0.95								
1.00	1.00	1.00	1.00	0.90	0.70	0.40	0.00	0.00	0.45	1.00	0.95	0.40	0.60	1.00	1.00		
0.90	0.45	0.60	0.20	0.50	0.50	0.30	0.25	0.50	0.60								
1.00	1.00	1.00	1.00	1.00	1.00	0.00	0.00	0.00	0.05	1.00	1.00	0.20	1.00	0.70	0.30		
0.85	0.20	0.00	0.20	0.00	0.00	0.00	0.00	0.00	0.00								
1.00	1.00	1.00	1.00	1.00	0.80	0.10	0.00	0.00	0.00	1.00	1.00	0.75	0.30	0.40	0.00		

**Figure B-1 MACCS/MACCS2 sample Site Data file
(continued on following page)**

CROP SEASON AND SHARE						
1	PASTURE	90.	270.	0.41		
2	STORED FORAGE	150.	240.	0.13		
3	GRAINS	150.	240.	0.21		
4	GRN LEAFY VEGETABLES	150.	240.	0.002		
5	OTHER FOOD CROPS	150.	240.	0.004		
6	LEGUMES AND SEEDS	150.	240.	0.15		
7	ROOTS AND TUBERS	150.	240.	0.003		
WATERSHED DEFINITION						
1	SR-89			5.0E-6	0.0	
2	SR-90			5.0E-6	0.0	
3	CS-134			5.0E-6	0.0	
4	CS-137			5.0E-6	0.0	
REGIONAL ECONOMIC DATA						
1	ALA	.354	.040	459.	1824.	62000.
2	ARIZ	.516	.104	110.	682.	74000.
3	ARK	.483	.041	466.	2049.	61000.
4	CALIF	.330	.144	1022.	4394.	93000.
5	COLO	.522	.048	211.	971.	83000.
6	CONN	.160	.294	1605.	4980.	107000.
7	DEL	.534	.042	1723.	3428.	82000.
8	FLA	.375	.080	832.	3341.	80000.
9	GA	.363	.060	613.	1885.	73000.
10	IDAHO	.279	.144	343.	1562.	61000.
11	ILL	.806	.044	709.	3900.	86000.
12	IND	.713	.079	611.	3283.	72000.
13	IOWA	.938	.060	695.	3133.	73000.
14	KANS	.917	.035	281.	1204.	81000.
15	KY	.571	.112	482.	1838.	61000.
16	LA	.354	.074	459.	3284.	61000.
17	MAINE	.079	.260	662.	1133.	70000.
18	MD	.429	.216	956.	4489.	93000.
19	MASS	.136	.249	1349.	2563.	97000.
20	MICH	.313	.247	658.	2187.	81000.
21	MINN	.597	.223	516.	2111.	82000.
22	MISS	.470	.054	403.	2084.	53000.
23	MO	.703	.102	322.	1647.	76000.
24	MONT	.657	.030	61.	563.	65000.
25	NEBR	.962	.031	318.	1148.	75000.
26	NEV	.127	.139	63.	601.	84000.
27	N.H.	.096	.482	518.	2018.	87000.
28	N.J.	.203	.129	1399.	6477.	102000.
29	N.MEX	.590	.144	53.	473.	63000.
30	N.Y.	.310	.589	711.	1378.	94000.
31	N.C.	.352	.065	860.	2658.	68000.
32	N.DAK	.924	.048	164.	948.	69000.
33	OHIO	.602	.175	581.	2686.	76000.
34	OKLA	.751	.060	204.	1508.	67000.
35	OREG	.292	.111	236.	1203.	73000.
36	PA	.303	.447	855.	2534.	78000.
37	R.I.	.108	.213	1062.	6438.	80000.
38	S.C.	.290	.084	472.	1843.	62000.
39	S.DAK	.915	.091	145.	587.	65000.
40	TENN	.509	.153	360.	1850.	66000.
41	TEX	.816	.064	164.	1492.	74000.
42	UTAH	.225	.259	123.	1286.	60000.
43	VT	.286	.789	628.	1472.	73000.
44	VA	.382	.198	371.	2075.	84000.
45	WASH	.377	.154	476.	1948.	82000.
46	W.VA	.246	.224	150.	1728.	58000.
47	WIS	.517	.591	723.	1751.	76000.
48	WYO	.561	.028	43.	380.	70000.
49	BRIT COL	.377	.154	476.	1948.	60000.
50	OCEAN	.000	.000	0.	0.	0.
51	SASKAT	.657	.030	61.	563.	60000.
52	MANITOBA	.924	.048	164.	948.	60000.
53	ONTARIO	.597	.223	516.	2111.	60000.
54	QUEBEC	.310	.589	711.	1378.	60000.
55	NOVA SCOT	.079	.260	662.	1133.	60000.
56	BAJA CAL	.330	.144	1022.	4394.	10000.
57	SONORA	.516	.104	110.	682.	10000.
58	CHIHUAHUA	.590	.144	53.	473.	10000.
59	COAHUILA	.816	.064	164.	1492.	10000.
END						

Figure B-1 MACCS/MACCS2 sample Site Data file

B.1 Spatial Distances Data Block

The spatial distance data define the spatial grid for which the population and land use data are specified. The data define the distance in kilometers to the endpoints of the spatial intervals. The areas between the spatial interval endpoints within each of the 16 wind direction sectors are referred to as spatial elements. This grid definition must agree with the grid defined in the ATMOS input file (see the variable SPAEND in Subsection 5.3). A relative error of 10% in the endpoint distances is allowed. For larger discrepancies in the geometry data, the error flag is set and execution terminates upon completion of the Site Data file input processing.

The first line of the spatial distance data block contains the 22-character separator beginning with SPATIAL DISTANCES in column 2. Next, the endpoint distances in kilometers are specified, eight values per line, using the format described below. As many lines as are needed to define the spatial distances are used. The minimum spacing between adjacent spatial intervals is 0.1 km.

A maximum of eight interval endpoints may be input per line within ten column intervals; *i.e.*, the first interval endpoint would be input in columns 1–10, the second interval endpoint would be input in columns 11–20, etc. The data are read as a real numbers with two decimal places. The format used to process the data is as follows:

<u>Columns</u>	<u>Fortran Format Descriptor</u>	<u>Site-File Variable</u>	<u>Identification</u>	<u>MACCS2 Variable</u>	<u>Allowed Range</u>
1-80	8E10.2	SPDSTS	Spatial interval endpoints (km)	SPAEND	0.001-999.0

B.2 Population Data Block

The population data for each element in the spatial grid is defined here. The first line of the data block contains the 22-character separator beginning with POPULATION in column 2. Next, the number of people in each element is given for the first wind sector. (The first wind sector is assumed to be centered on north.) The population data are specified, eight values per line, using the format described below. As many lines as needed to cover all the spatial elements in the sector are used. Proceeding in a clockwise rotation, the population data for the second (NNE) and subsequent sectors follow. Data for all 16-wind directions (sectors) must be provided. Data for each sector begin on a new line.

The population data are input as a real number although no fractional numbers are stored. The population data for up to eight spatial elements may be defined per line and the data are input per ten column intervals; *i.e.*, the population in the first element would be input in columns 1–10, the population in the second element would be input in columns 11–20, etc. The format used to process the data is as follows:

<u>Columns</u>	<u>Fortran Format Descriptor</u>	<u>Site-File Variable</u>	<u>Identification</u>	<u>Allowed Range</u>
1-80	8E10.0	POP DAT	Population data	0.0 - 1.E9

If the user specifies that fraction of the people or fraction of the time weighting is to be performed (see variable WTNAME in Subsection 6.6.8, the new code functions exactly the same as MACCS 1.5.11.1. In cases where the SUMPOP option is selected, the processing and interpretation of population data are treated in a different manner, as described below.

For each emergency response scenario (of the up to three allowed) defined in the EARLY input file, a distinct population distribution must be supplied in the Site Data file. In MACCS 1.5.11.1, the population data block is delimited with the header record POPULATION (see Figure B 3-1 in Appendix B) beginning at column 2, followed by the population data.

When the SUMPOP option is selected, the header cards for each population data block are POPULATION1, POPULATION2, and POPULATION3, corresponding to the respective emergency-response scenarios, all beginning at column 2. An error will result if the number of population data blocks does not equal the number of emergency-response scenarios defined in the EARLY input file.

B.3 Land Fraction Data Block

The fraction of each spatial element that is land (as opposed to lakes, oceans, *etc.*) must be defined. The first line of the data block contains the 22-character separator beginning with LAND FRACTION in column 2. Next, the fraction of area that is land in each radial spatial interval of the first sector is given. All values must be between 0 and 1. A value of 0 means the element has no land; a value of 1 means the element is all land. The land fraction data are specified, 16 values per line, with the format described below. As many lines as needed to define all the spatial intervals in the sector are used. The land fraction data for the second and subsequent sectors follow in a clockwise rotation. Data for all 16-wind direction sectors must be provided. The data for each sector begin on a new line.

The land fraction data are read as a real number and land fractions are input every five columns. The format used to process the data is as follows:

<u>Columns</u>	<u>Fortran Format Descriptor</u>	<u>Variable</u>	<u>Identification</u>	<u>Allowed Range</u>
1-80	16F5.2	FRCLND	Land Fraction	0.0-1.0

B.4 Region Index Data Block

In this data block the user assigns a user-defined economic region to each of the spatial intervals. The economic regions are defined in the Regional Economic data block. Subsection A.3.8 contains a description of the types of economic data that can be defined for each economic region.

The first line in the Region Index data block contains the 22-character separator beginning with REGION INDEX in column 2. The next line contains two-digit integers associating a region index with each of the spatial elements in the first sector. The data are specified with the format defined below. All of the region indices for one sector are input on one line. The region indices for the second and subsequent sectors are on the following lines, a new line for each sector in a clockwise rotation. A total of 16 lines are required. For example, a region index of 09 means that economic data for region number nine is used for the spatial element.

The format used to process the data is as follows:

<u>Columns</u>	Fortran Format <u>Descriptor</u>	<u>Variable</u>	Site-File <u>Identification</u>	<u>Allowed Range</u>
1-80	40I2		INDREG	Region Index 1 - NECRGN

B.5 Watershed Index Data Block

Each of the spatial intervals in the grid must be associated with one of the watershed classes. The definition of the watershed classes is provided in Subsection A.3.7. The watershed identification data block begins with the 22-character separator beginning with WATERSHED INDEX in column 2. The next line contains two-digit integers associating a watershed type with each of the spatial elements in the first sector. The data are specified with the format defined below.

All of the watershed type indices for one wind sector fit on a single line. The watershed indices for the second and subsequent sectors are on the following lines, a new line for each sector in a clockwise rotation. A total of 16 lines are required. For example, a watershed index of 1 means that the water ingestion factor for watershed type 1 is used for all material deposited on that spatial element. A watershed index of 2 means that the water ingestion factor for watershed type 2 is used for all material deposited on that spatial element.

The format used to process the data is as follows:

<u>Columns</u>	Fortran Format <u>Descriptor</u>	Site-File <u>Variable</u>	<u>Identification</u>	<u>Allowed Range</u>
1-80	40I2	INDWTR	Watershed Index	1-NWTRSH

B.6 Crop and Season Share Data Block

The length of the growing season and the average fraction of the farmland area at the site devoted to each crop type must be specified. These fractions need not sum to exactly 1, but their sum should not exceed a value of 1. If these values sum to a value less than 1, that sum indicates the fraction of farmland in production in an average year (some fraction of farmland may be fallow). Data must be given for each of the crop categories. The data block begins with the separator CROP SEASON AND SHARE in column 2.

The format used to process the data is as follows:

<u>Columns</u>	<u>Fortran Format Descriptor</u>	<u>Site-File Variable</u>	<u>Identification</u>	<u>Allowed Range</u>
1-4	I4	I	Crop Index	1-NCPGZN
6-25	A20	CROP	Crop Name	Not Applicable
26-30	F5.0	GBEG	Day of the Year the Growing Season Begins	1.0-GEND
31-35	F5.0	GEND	Day of the Year the Growing Season Ends	GBEG-365.0
36-45	F10.0	FRCLCP	Fraction of the Site-Averaged Farmland Devoted to this Crop	0.0-1.0

B.7 Watershed Definition Data Block

The data block begins with the 22-character separator beginning with WATERSHED DEFINITION in column 2. For each of the radionuclides considered in the liquid pathways model, an initial wash off fraction and an annual wash off rate (year^{-1}) must be specified together with an ingestion factor (Bq ingested/Bq in water) for each of the NUMWPA (NWTRSH) watershed classes.

The format used to process the data is as follows:

<u>Columns</u>	<u>Fortran Format Descriptor</u>	<u>Site-File Variable</u>	<u>Identification</u>	<u>Allowed Range</u>
1-4	I4	I	Radionuclide Index	1-NWPISO
6-13	A8	NMISO	Radionuclide Name	Not Applicable
16-25	E10.1	DEFAULT	Obsolete: No Longer Used	Not Applicable
26-35	E10.1	DEFAULT	Obsolete: No Longer Used	Not Applicable
36-45	E10.1	WTRINF (1)	Ingestion Factor for Watershed Class 1	0.0-1.0
46-55	E10.1	WTRINF (2)	Ingestion Factor for Watershed Class 2	0.0-1.0

56-65	E10.1	WTRINF (3)	Ingestion Factor for Watershed Class 3	0.0-1.0
66-75	E10.1	WTRINF (4)	Ingestion Factor for Watershed Class 4	0.0-1.0

B.8 Regional Economic Data Block

Economic data must be specified for each of the economic regions. The data block begins with the separator REGIONAL ECONOMIC DATA in column 2. An economic region is typically identified with an existing county, a state, or country to provide an indication of the source of the data or the type of geographical area it is intended to represent. The economic regions defined in this section are identified with spatial elements in the Region Index data block.

The format used to process this data is as follows:

<u>Columns</u>	<u>Format Edit Descriptor</u>	<u>Site-File Variable</u>	<u>Identification</u>	<u>Allowed Range</u>
1-4	I4	I	Region Index Number	1-NECRGN
6-15	A10	NMRGN	Name of the Region	Not Applicable
21-25	F5.3	FRMFRC	Fraction of Land Devoted to Farming in Region	0.0-1.0
26-30	F5.3	DPF	Fraction of Farm Sales Resulting from Dairy Production in Region	0.0-1.0
31-40	F10.1	ASFP	Total Annual Farm Sales for the Region (dollars/hectare)	0.0-1.E9
41-50	F10.1	VFRM	Farmland Property Value for the Region (dollars/hectare)	0.0-1.E9
51-60	F10.1	VNFRM	Non-farm Property Value for the Region (dollars/person)	0.0-1.E9

Appendix C 1990-2000 County Inventory Changes

The following documents from the U.S Census Bureau summarizes the changes in the inventory of counties between 1990 and 2000 census. The Miami-Dade County was given the same county ID code as the original Dade County.

1. Denali Borough, Alaska-a new county equivalent, effective December 7, 1990, organized from parts of Southeast Fairbanks and Yukon-Koyukuk Census Areas. The FIPS code for the new entity is: (02) 068.
2. Skagway-Hoonah-Angoon Census Area, Alaska-a new census area formed from part of the 1990 deleted Skagway-Yakutat-Angoon census area and from parts of Haines Borough, Juneau City and Borough, and Sitka City and Borough. The FIPS code for the new entity is: (02) 232.
3. Skagway-Yakutat-Angoon Census Area, Alaska-deleted after the 1990 census. Yakutat City and Borough organized from part of the territory, most of the remainder of the territory makes up the Census 2000 census area: Skagway-Hoonah-Angoon. The FIPS code for the deleted entity was: (02) 231.
4. Yakutat City and Borough, Alaska-a new county equivalent, effective September 9, 1992. The FIPS code for the new entity is: (02) 282.
5. Miami-Dade County, Florida-name changed from Dade County, effective November 13, 1997. The FIPS code for the newly named entity is: (12) 086. The FIPS code for the old entity was: (12) 025.
6. Yellowstone National Park County, Montana-deleted, effective November 7, 1997. Territory added to Gallatin and Park Counties.
7. South Boston City, Virginia-changed from an independent city to a town in Halifax County, Virginia, effective June 30, 1995. The FIPS code for the old entity was: (51) 780.

Appendix D Statistical Abstracts (1990)

This appendix contains the following values and source information for the parameters used in estimating the value of non-farm assets (VNFRM, \$ / person).

Table D.1 1993 & 1994 Statistical Abstract of the U.S.

Reproducible Tangible Wealth (1990):	\$ 2.5652E+13
Urban and Built-Up Land (1987):	77,187,303 acres
Urban and Built-Up Land (1992):	91,815,303 acres
Urban and Built-Up Land (1990 Straight Line approx.):	85,964,103 acres
Median Housing Value (1990):	\$ 79,100
Total Farm Assets (1990):	\$ 1.0036E+12
Farm Household Possessions (1990):	\$ 4.6400E+10
Population (1990) :	248,709,873 persons

Table D.2 NUREG/CR-4551 Volume 2, Revision 1, Part 7

Typical Suburban Lot Size:	0.2 acres
Land – Fraction of Housing Value:	20 %
Average non-farm value for the U.S. (1990):	\$126,632/person

Table D.3 1994 County and City Data Book

U.S. Per Capita Income (1990):	\$18,696/person
--------------------------------	-----------------

No. 754. Gross and Net Stock of Fixed Reproducible Tangible Wealth in Current and Constant (1987) Dollars

(In billions of dollars. AS of December 31)

ITEM	1970	1980	1981	1982	1983	1984	1985	1986	1987	1988	1989	1990	1991
CURRENT DOLLARS													
Gross stock, total	4,428	14,306	15,670	16,527	17,277	18,259	19,330	20,503	21,774	22,966	24,361	25,652	26,699
Private	2,689	9,364	10,387	11,005	11,477	12,082	12,747	13,536	14,388	15,078	16,022	16,894	17,489
Nonresidential equipment	679	2,389	2,723	2,939	3,067	3,214	3,374	3,599	3,775	4,010	4,257	4,543	4,674
Nonresidential structures	790	2,683	3,032	3,247	3,376	3,573	3,783	3,951	4,156	4,478	4,755	4,964	5,110
Residential	1,219	4,292	4,632	4,818	5,034	5,296	5,590	5,986	6,457	6,590	7,010	7,387	7,705
Government	1,060	2,979	3,141	3,237	3,368	3,568	3,772	3,916	4,083	4,306	4,516	4,713	4,904
Equipment	274	488	543	583	621	657	695	732	764	814	873	949	1,018
Structures	785	2,491	2,599	2,654	2,748	2,911	3,077	3,184	3,319	3,492	3,643	3,764	3,886
Federal	424	885	968	1,018	1,067	1,119	1,176	1,227	1,269	1,325	1,394	1,469	1,543
Military	276	493	535	566	601	638	678	715	738	776	818	873	927
State and local	636	2,094	2,173	2,219	2,301	2,449	2,596	2,690	2,814	2,981	3,122	3,244	3,361
Consumer durable goods	680	1,963	2,142	2,285	2,433	2,608	2,811	3,051	3,303	3,582	3,823	4,045	4,306
Net stock, total	2,708	8,619	9,374	9,792	10,172	10,734	11,367	12,063	12,803	13,458	14,245	14,936	15,412
Private	1,674	5,814	6,413	6,737	6,987	7,348	7,752	8,224	8,729	9,108	9,650	10,130	10,412
Government	662	1,790	1,875	1,921	1,991	2,105	2,224	2,311	2,414	2,542	2,665	2,775	2,877
Consumer durable goods	372	1,014	1,086	1,134	1,194	1,281	1,391	1,527	1,660	1,808	1,930	2,031	2,123
CONSTANT (1987) DOLLARS													
Gross stock, total	12,476	17,469	17,963	18,370	18,845	19,441	20,091	20,753	21,400	22,062	22,717	23,339	23,849
Private	8,131	11,585	11,936	12,217	12,523	12,909	13,322	13,728	14,112	14,504	14,886	15,245	15,522
Nonresidential equipment	1,839	3,009	3,126	3,206	3,285	3,396	3,518	3,633	3,737	3,855	3,979	4,093	4,179
Nonresidential structures	2,411	3,255	3,384	3,506	3,606	3,729	3,870	3,983	4,088	4,191	4,293	4,398	4,477
Residential	3,881	5,321	5,427	5,505	5,632	5,783	5,934	6,112	6,286	6,458	6,614	6,754	6,866
Government	3,001	3,544	3,603	3,648	3,705	3,770	3,849	3,934	4,026	4,115	4,204	4,307	4,403
Equipment	662	625	630	634	647	670	698	730	768	802	837	879	917
Structures	2,339	2,918	2,972	3,014	3,058	3,100	3,152	3,204	3,259	3,313	3,367	3,428	3,487
Federal	1,141	1,122	1,138	1,142	1,156	1,177	1,204	1,233	1,266	1,293	1,319	1,351	1,379
Military	723	641	643	644	652	668	691	716	743	767	786	813	831
State and local	1,860	2,421	2,465	2,506	2,549	2,593	2,645	2,701	2,760	2,822	2,885	2,956	3,025
Consumer durable goods	1,344	2,340	2,424	2,505	2,617	2,762	2,920	3,091	3,262	3,444	3,627	3,787	3,924
Net stock, total	7,691	10,524	10,755	10,902	11,112	11,441	11,823	12,214	12,577	12,942	13,293	13,598	13,785
Private	5,074	7,198	7,384	7,499	7,642	7,866	8,112	8,346	8,558	8,774	8,980	9,157	9,258
Government	1,884	2,123	2,148	2,166	2,191	2,223	2,269	2,320	2,380	2,430	2,482	2,537	2,587
Consumer durable goods	733	1,203	1,223	1,236	1,278	1,352	1,442	1,547	1,639	1,738	1,831	1,903	1,940

Source: U.S. Bureau of Economic Analysis, Survey of Current Business, January and August 1992.

No. 1104. Balance Sheet of the Farming Sector
in Current and Constant (1987) Dollars

in billions of dollars, except as indicated. As of December 31.
Includes farm operator households.
See Historical Statistics, Colonial Times to 1970,
series K 204-219, for data before revisions¹

ITEM	1970	1975	1980	1981	1982	1983	1984	1985	1986	1987	1988	1989	1990	1991
CURRENT DOLLARS														
Assets	324.3	579.5	1,089.0	1,088.9	1,056.2	1,063.6	975.7	892.8	847.7	911.3	951.5	985.8	1,003.6	1,004.1
Physical assets:														
Real estate	224.5	421.0	850.1	851.7	819.1	829.3	735.0	657.0	613.0	658.6	682.2	703.9	711.4	705.6
Nonreal estate	76.6	127.2	199.6	196.3	194.4	189.6	193.0	186.5	181.0	196.1	212.1	223.6	231.5	232.9
Livestock and poultry ¹	23.7	29.4	60.6	53.5	53.0	49.5	49.5	46.3	47.8	58.0	62.2	66.2	70.9	68.4
Machinery, motor vehicles	34.4	63.1	86.9	92.5	92.6	92.1	91.1	88.3	86.1	84.5	86.1	89.2	88.6	88.0
Crops stored	8.5	20.5	32.7	29.5	25.8	23.6	26.1	22.9	16.3	17.5	23.3	23.4	22.8	23.6
Household furnishings, equipment	10.0	14.2	19.4	20.8	23.0	24.4	24.3	27.8	28.7	32.9	37.0	42.2	46.4	50.4
Purchased inputs	(NA)	(NA)	(NA)	(NA)	(NA)	(NA)	2.0	1.2	2.1	3.2	3.5	2.6	2.8	2.5
Financial assets	23.2	31.4	39.3	40.9	42.8	44.6	47.7	49.3	53.8	56.7	57.2	58.3	60.8	65.6
Investment in cooperatives	7.2	13.0	19.3	20.6	21.9	22.8	24.3	24.3	24.4	25.3	25.1	26.3	27.5	28.4
Other financial assets	16.0	18.4	20.0	20.3	20.9	21.8	23.4	25.0	29.4	31.4	32.1	32.0	33.3	37.2
Claims	324.3	579.5	1,089.0	1,088.9	1,056.2	1,063.6	975.7	892.8	847.7	911.3	951.5	985.8	1,003.6	1,004.1
Debt	52.8	91.5	178.7	195.4	203.1	206.5	204.3	187.9	166.6	153.7	148.5	146.0	145.1	147.0
Real estate debt	30.5	49.9	97.5	107.2	111.3	113.7	112.3	105.7	95.9	87.7	83.0	80.5	78.4	79.1
Nonreal estate debt	22.3	41.6	81.2	88.2	91.8	92.7	92.0	82.2	70.8	66.0	65.6	65.5	66.7	67.8
Equity	271.5	488.0	910.3	893.5	853.1	857.1	771.4	704.9	681.0	757.6	802.9	839.8	858.5	857.1
Farm debt/asset ratio (percent)	16.3	15.8	16.4	17.9	19.2	19.4	20.9	21.0	19.7	16.9	15.6	14.8	14.5	14.6
CONSTANT (1987) DOLLARS ²														
Assets	923.9	1,177.7	1,518.8	1,380.1	1,260.4	1,219.7	1,072.2	945.8	874.8	911.3	915.8	908.6	886.6	852.3
Debt	150.3	185.9	249.3	247.7	242.4	236.8	224.5	199.0	171.9	153.7	142.9	134.6	128.2	124.8
Equity	773.6	991.8	1,269.6	1,132.4	1,018.0	982.9	847.7	746.7	702.8	757.6	772.8	774.0	758.4	727.6

NA Not available.

¹ Excludes horses and mules

² Constant dollar figures are based on
gross domestic product implicit price deflators for year.

Source: U.S. Dept. of Agriculture, Economic Research Service,
Economic Indicators of the Farm Sector:
National Financial Summary, 1991.

Appendix E Statistical Abstracts (2000)

Selected County Level Database Sources

Table E.1 Fixed Reproducible Tangible Wealth

Current-Cost Net Stock of Fixed Reproducible Tangible Wealth, 1925-1997
(Billions of dollars; yearend estimates)

Yearend	Total	Fixed private capital					Government-owned fixed capital			Durable goods
		Total	Nonresidential			Residential	Total	Federal	State and local	
			Total	Equipment	Structures					
1987...	15,503.2	10,796.1	5,528.4	2,062.5	3,465.8	5,267.7	3,200.2	938.8	2,261.3	1,506.9
1988...	16,501.3	11,500.3	5,897.6	2,195.5	3,702.1	5,602.7	3,359.6	993.7	2,365.9	1,641.1
1989...	17,447.4	12,149.4	6,238.3	2,322.0	3,916.3	5,911.1	3,534.6	1,041.9	2,492.7	1,763.4
1990...	18,283.7	12,706.7	6,559.4	2,452.2	4,107.3	6,147.3	3,710.7	1,089.6	2,621.1	1,866.3
1991...	18,717.5	12,955.2	6,696.7	2,519.5	4,177.2	6,258.5	3,827.2	1,126.6	2,700.6	1,935.1
1992...	19,479.8	13,484.1	6,892.7	2,590.0	4,302.7	6,591.4	3,990.7	1,168.9	2,821.8	2,005.0
1993...	20,517.9	14,198.8	7,215.6	2,686.7	4,528.9	6,983.1	4,201.2	1,227.0	2,974.3	2,107.9
1994...	21,716.6	15,064.5	7,598.7	2,823.1	4,775.6	7,465.8	4,425.8	1,263.0	3,162.8	2,226.3
1995...	22,705.5	15,736.1	7,957.1	2,980.2	4,976.9	7,779.0	4,652.5	1,294.9	3,357.6	2,317.0
1996...	23,766.4	16,496.7	8,311.2	3,116.5	5,194.7	8,185.5	4,863.7	1,326.9	3,536.8	2,406.0
1997...	24,883.3	17,316.3	8,725.3	3,257.8	5,467.5	8,590.9	5,074.7	1,334.7	3,740.1	2,492.3

Source: Department of Commerce
Bureau of Economic Analysis
Survey of Current Business, September 1998
Fixed Reproducible Tangible Wealth in the United States
Revised Estimates for 1995-1997 and Summary Estimates for 1925-1997

Table E.2 Non-Federal Land Use

Surface area of non-federal and federal land and water areas, by state and year (data per 1,000 acres)

State	Year	Federal land	Water areas	Non-federal land			Total Surface Area
				Developed	Rural	Total	
Alabama	1982	949	1,167	1,617	29,691	31,308	33,424
	1987	950	1,181	1,807	29,485	31,292	33,424
	1992	970	1,201	1,937	29,316	31,253	33,424
	1997	998	1,223	2,252	28,950	31,203	33,424
Arizona	1982	31,005	183	1,089	40,688	41,776	72,964
	1987	30,790	185	1,271	40,718	41,989	72,964
	1992	30,426	187	1,378	40,974	42,351	72,964
	1997	30,426	189	1,491	40,858	42,349	72,964
Arkansas	1982	3,042	819	1,143	29,033	30,180	34,037
	1987	3,049	853	1,180	28,955	30,135	34,037
	1992	3,103	859	1,240	28,835	30,075	34,037
	1987	3,103	887	1,409	28,638	30,048	34,037
	ù	ù	ù	ù	ù	ù	ù
Total	1982	399,484	48,714	73,146	1,422,686	1,495,932	1,944,130
	1987	399,886	49,894	79,505	1,414,846	1,494,350	1,944,130
	1992	401,988	49,490	87,035	1,405,617	1,492,652	1,944,130
	1997	402,138	49,980	98,252	1,393,760	1,492,011	1,944,130

Source: United States Department of Agriculture
Natural Resources Conservation Service
Summary Report, 1997 National Resources Inventory, Revised December 2000

Table E.4 Farm Business Balance Sheet
(\$1,000)

Obs	year	ASSETSEX Farm business assets	REALASET Farm business real estate assets	DEBTEX Farm bus. debt	LIVPLTRY Livestock & poultry	MACHEX Machinery & equip.	CROPVALU Crops stored	PINPUTS Purchased inputs	COOPS Investments in cooperatives	FINANCEX Other financial assets
1	1960	174,350,621	123,280,588	22,445,666	15,607,597	19,068,447	6,359,991	-	4,205,998	5,828,000
2	1961	181,632,680	129,098,372	24,138,318	16,428,026	19,270,293	6,471,987	-	4,506,003	5,857,999
3	1962	188,869,521	134,613,549	26,665,409	17,306,979	19,902,285	6,527,710	-	4,648,999	5,869,999
4	1963	196,694,882	142,352,799	29,560,942	15,864,578	20,372,604	7,408,814	-	4,966,086	5,730,001
5	1964	204,238,278	150,485,891	32,157,241	14,469,305	21,247,171	7,012,635	-	5,177,277	5,845,999
6	1965	220,816,733	161,523,750	35,810,786	17,584,671	22,428,938	7,892,957	-	5,422,417	5,964,000
7	1966	234,023,352	171,233,796	39,223,095	18,973,530	24,067,400	8,107,008	-	5,677,618	5,964,000
8	1967	246,072,268	180,942,163	42,206,120	18,845,528	26,310,099	8,016,152	-	5,848,325	6,110,001
9	1968	257,161,486	189,389,620	43,921,577	20,249,055	27,744,429	7,393,262	-	6,101,120	6,284,000
10	1969	267,822,833	195,309,483	46,420,826	22,838,634	28,634,424	8,278,635	-	6,384,658	6,376,999
11	1970	278,823,017	202,418,084	48,752,694	23,705,761	30,363,932	8,700,574	-	7,133,665	6,501,001
12	1971	301,760,579	217,562,381	53,235,123	27,263,869	32,434,437	9,950,744	-	7,898,148	6,651,000
13	1972	339,933,242	243,002,154	58,704,291	33,679,316	34,644,363	12,949,001	-	8,716,410	6,941,998
14	1973	418,493,944	298,300,204	67,632,068	42,370,002	39,670,899	21,379,362	-	9,650,479	7,122,998
15	1974	449,181,774	335,556,231	75,852,876	24,567,475	48,454,284	22,515,224	-	11,217,558	6,871,002
16	1975	510,786,251	383,559,733	85,012,889	29,356,695	57,417,010	20,535,165	-	12,973,792	6,943,856
17	1976	590,716,644	456,539,437	96,065,406	29,047,508	63,275,288	20,584,873	-	14,322,409	6,947,129
18	1977	651,508,184	509,308,292	110,855,215	31,931,218	69,319,937	20,443,929	-	13,469,867	7,034,941
19	1978	777,199,166	601,773,350	127,400,000	50,105,786	78,292,679	23,800,687	-	16,089,753	7,136,911
20	1979	913,693,178	706,063,788	151,550,508	61,386,773	90,935,257	29,876,331	-	18,147,105	7,283,924
21	1980	999,022,607	782,820,206	166,823,658	60,633,203	96,063,978	32,831,043	-	19,316,744	7,357,433
22	1981	996,114,107	785,561,827	182,381,057	53,544,275	99,338,245	29,511,813	-	20,598,166	7,559,781
23	1982	962,488,412	750,023,252	188,806,397	52,993,051	103,853,544	25,885,600	-	21,946,965	7,786,000
24	1983	959,300,463	753,422,021	191,070,494	49,540,878	101,707,295	23,746,340	-	22,808,533	8,075,396
25	1984	867,818,227	661,750,215	193,787,208	49,525,922	95,851,857	26,128,956	1,977,708	24,259,572	8,323,997
26	1985	775,907,920	586,183,377	177,598,686	46,259,169	86,076,967	22,904,647	1,209,905	24,291,386	8,982,469
27	1986	722,017,255	542,407,974	156,970,416	47,751,409	79,030,183	16,279,821	2,067,461	24,430,692	10,049,715
28	1987	756,478,653	563,678,553	144,410,594	57,976,580	78,686,234	17,828,174	3,152,586	25,295,890	9,860,636
29	1988	788,525,961	582,311,234	139,566,639	62,211,338	80,976,413	23,651,022	3,459,087	25,564,564	10,352,303
30	1989	813,732,033	600,132,423	137,859,113	66,212,752	84,091,237	23,936,470	2,574,448	26,342,300	10,442,403
31	1990	840,608,570	619,149,242	137,961,610	70,856,057	86,297,864	23,178,199	2,807,525	27,455,235	10,864,448
32	1991	844,164,925	624,769,055	139,217,506	68,119,760	85,889,842	22,238,486	2,610,686	28,721,136	11,815,960
33	1992	868,139,356	640,790,777	139,052,269	70,962,162	85,182,096	24,208,624	3,946,492	29,428,892	13,620,313
34	1993	909,837,323	677,577,860	141,963,720	72,778,679	86,059,155	23,325,867	3,789,677	31,009,334	15,296,751
35	1994	935,765,812	704,137,647	146,799,669	67,912,189	87,804,032	23,297,793	5,036,668	32,071,823	15,505,460
36	1995	967,222,127	740,491,454	150,769,146	57,778,086	89,073,363	27,445,606	3,371,612	34,086,991	14,975,015
37	1996	1,004,540,797	769,535,894	156,073,748	60,314,851	89,601,793	31,692,878	4,361,891	34,916,938	14,116,552
38	1997	1,053,007,586	808,228,876	165,413,493	67,075,193	90,437,004	32,670,319	4,900,372	35,745,509	13,950,313
39	1998	1,085,297,900	840,421,559	172,862,459	63,391,480	91,729,424	29,939,741	5,036,407	40,515,352	14,263,937
40	1999	1,140,783,810	886,404,774	176,431,314	73,177,382	92,329,465	28,273,037	4,025,651	41,937,687	14,635,814
41	2000	1,188,260,080	929,453,515	183,977,584	76,825,534	92,038,510	27,932,428	4,895,713	42,955,068	14,159,312

Source: United States Department of Agriculture
Economic Research Service
Ken Erickson

Appendix F Population Tables

This appendix contains the population tables described in Subsection 5.4.2 External Verification. There are three tables for each licensee. The first table is the SECPOP2000 estimated population. The second table is the licensee's reported population. And the third table is a comparison of the SECPOP2000 estimated population as a percent of the licensee reported population.

Browns Ferry 11 Rings to 60 Miles

SPATIAL DISTANCES

Ring: 1 2 3 4 5 10 20 30 40 50 60

SECPop2000 POPULATION

												Total	
N	0	24	0	37	129	1,380	2,380	3,494	14,011	5,618	14,731	41,804	N
NNE	0	3	27	342	198	1,632	5,303	3,480	4,153	4,856	18,620	38,614	NNE
NE	0	0	0	7	189	5,015	16,521	11,230	9,254	14,323	5,790	62,329	NE
ENE	0	0	160	90	234	1,486	15,285	27,645	30,881	7,951	4,933	88,665	ENE
E	0	23	75	20	63	1,590	6,064	94,203	91,500	8,584	8,636	210,758	E
ESE	0	0	57	0	3	116	1,082	4,257	17,646	13,218	29,646	66,025	ESE
SE	0	0	0	0	0	7,578	35,950	9,532	8,513	22,700	16,116	100,389	SE
SSE	0	0	0	0	0	4,729	19,810	15,445	25,036	25,301	15,707	106,028	SSE
S	0	0	58	0	6	1,719	6,525	2,659	6,113	8,992	20,562	46,634	S
SSW	0	0	0	118	123	1,772	7,689	1,370	2,822	4,727	12,553	31,174	SSW
SW	0	0	0	81	25	1,058	4,915	2,718	3,649	14,649	5,640	32,735	SW
WSW	0	0	11	44	50	157	3,491	3,968	16,625	4,325	4,206	32,877	WSW
W	0	26	46	35	0	94	3,082	10,929	33,651	4,249	3,123	55,235	W
WNW	0	0	0	11	0	71	3,086	16,709	45,896	7,176	2,508	75,457	WNW
NW	0	0	0	0	21	572	5,704	7,459	5,777	4,483	6,163	30,179	NW
NNW	0	107	263	14	83	1,245	2,791	3,147	17,431	10,329	5,246	40,656	NNW
Totals:	0	183	697	799	1,124	30,214	139,678	218,245	332,958	161,481	174,180	1,059,559	
Density	0	15	31	33	36	105	137	138	144	113	94	People/Sq Mile	

Licensee's Reported Population

N	40	0	0	85	137	1,382	2,981	3,196	11,933	4,249	13,976	37,979	N
NNE	0	13	23	160	56	1,565	2,846	4,621	3,882	4,441	13,730	31,337	NNE
NE	0	3	23	45	127	4,708	13,791	7,681	7,861	14,539	4,393	53,171	NE
ENE	0	40	89	105	45	1,807	9,533	32,224	18,816	8,182	5,404	76,245	ENE
E	0	0	23	7	33	1,638	16,390	50,939	93,693	6,788	9,386	178,897	E
ESE	0	0	13	0	0	127	2,549	5,323	27,594	11,760	26,153	73,519	ESE
SE	0	0	0	0	0	8,777	22,981	7,642	8,618	22,346	13,553	83,917	SE
SSE	0	0	0	0	0	2,584	31,794	13,802	22,132	20,718	12,446	103,476	SSE
S	0	0	10	12	45	1,520	4,762	2,610	6,332	5,658	18,430	39,379	S
SSW	0	0	32	39	184	1,315	6,226	1,143	2,596	4,756	11,180	27,471	SSW
SW	0	0	0	15	108	828	5,590	2,414	3,454	13,338	4,578	30,325	SW
WSW	0	0	10	19	71	238	3,383	2,849	13,329	4,720	4,584	29,203	WSW
W	0	82	15	8	17	76	3,687	10,801	29,581	5,813	2,547	52,627	W
WNW	0	0	4	8	26	37	1,960	7,951	49,491	5,368	3,570	68,415	WNW
NW	0	0	78	9	62	853	4,158	7,301	6,275	4,530	5,394	28,660	NW
NNW	0	196	189	65	82	1,426	2,357	3,051	16,033	10,460	4,209	38,068	NNW
Totals:	40	334	509	577	993	28,881	134,988	163,548	321,620	147,666	153,533	952,689	
Density	13	30	31	29	31	100	132	117	130	102	84	People/Sq Mile	

SECPop2000 as Percent of Reported

N	*	**		43.5%	94.2%	99.9%	79.8%	109.3%	117.4%	132.2%	105.4%	110.1%	N
NNE		23.1%	117.4%	213.8%	353.6%	104.3%	186.3%	75.3%	107.0%	109.3%	135.6%	123.2%	NNE
NE		*	15.6%	148.8%	106.5%	119.8%	146.2%	117.7%	98.5%	131.8%	117.2%	117.2%	NE
ENE		*	179.8%	85.7%	520.0%	82.2%	160.3%	85.8%	164.1%	97.2%	91.3%	116.3%	ENE
E		**	326.1%	285.7%	190.9%	97.1%	37.0%	184.9%	97.7%	126.5%	92.0%	117.8%	E
ESE			438.5%		**	91.3%	42.4%	80.0%	63.9%	112.4%	113.4%	89.8%	ESE
SE						86.3%	156.4%	124.7%	98.8%	101.6%	118.9%	119.6%	SE
SSE						183.0%	62.3%	111.9%	113.1%	122.1%	126.2%	102.5%	SSE
S			580.0%	*	13.3%	113.1%	137.0%	101.9%	96.5%	158.9%	111.6%	118.4%	S
SSW			*	302.6%	66.8%	134.8%	123.5%	119.9%	108.7%	99.4%	112.3%	113.5%	SSW
SW				540.0%	23.1%	127.8%	87.9%	112.6%	105.6%	109.8%	123.2%	107.9%	SW
WSW			110.0%	231.6%	70.4%	66.0%	103.2%	139.3%	124.7%	91.6%	91.8%	112.6%	WSW
W		31.7%	306.7%	437.5%	*	123.7%	83.6%	101.2%	113.8%	73.1%	122.6%	105.0%	W
WNW			*	137.5%	*	191.9%	157.4%	210.1%	92.7%	133.7%	70.3%	110.3%	WNW
NW			*	*	33.9%	67.1%	137.2%	102.2%	92.1%	99.0%	114.3%	105.3%	NW
NNW		54.6%	139.2%	21.5%	101.2%	87.3%	118.4%	103.1%	108.7%	98.7%	124.6%	106.8%	NNW
	*	54.8%	136.9%	138.5%	113.2%	104.6%	103.5%	133.4%	103.5%	109.4%	113.4%	111.2%	

* The licensee reported people in the ring segment but SECPop90 did not locate anyone in the ring segment.

** SECPop90 located people in the ring segment but the licensee did not report anyone in the ring segment.

Licensee data from FSAR, Tables 2.1-4 and 2.1-5. From 2000 Census data.

Run Date: 07/10/02

Columbia 7 Rings to 50 Miles (WNP2)

		SPATIAL DISTANCES								
Ring:		3	5	10	20	30	40	50	Total	
SECPOP2000 POPULATION										
N	0	0	103	126	848	1,044	30,189	32,310	N	
NNE	0	0	44	805	10,941	3,702	679	16,171	NNE	
NE	0	11	254	1,456	476	236	734	3,167	NE	
ENE	4	38	360	916	3,133	370	186	5,007	ENE	
E	0	0	262	541	72	134	103	1,112	E	
ESE	0	0	517	511	248	1,001	206	2,483	ESE	
SE	0	0	383	10,017	12,282	410	1,291	24,383	SE	
SSE	0	0	174	63,802	42,898	265	222	107,361	SSE	
S	0	0	203	33,479	881	6,495	25,288	66,346	S	
SSW	0	0	498	6,392	149	191	6,275	13,505	SSW	
SW	0	0	0	1,656	9,115	1,166	196	12,133	SW	
WSW	0	0	0	24	1,893	36,252	3,646	41,815	WSW	
W	0	0	0	0	92	1,204	20,963	22,259	W	
WNW	0	0	0	0	190	2,757	0	2,947	WNW	
NW	0	0	0	0	562	2,869	550	3,981	NW	
NNW	0	0	0	0	478	3,257	1,819	5,554	NNW	
Totals:	4	49	2,798	119,725	84,258	61,353	92,347	360,534		
Density	0	1	9	98	73	53	46	People/Sq Mile		

Licensee's Reported Population

N	0	0	77	398	2,055	1,127	21,572	25,229	N
NNE	0	0	152	397	7,123	3,983	1,121	12,776	NNE
NE	0	48	224	588	2,274	745	1,275	5,154	NE
ENE	0	56	177	855	1,786	475	375	3,724	ENE
E	0	56	257	544	220	141	268	1,486	E
ESE	0	56	341	576	305	182	961	2,421	ESE
SE	0	9	536	5,821	6,738	497	2,349	15,950	SE
SSE	0	0	308	70,917	36,360	955	2,072	110,612	SSE
S	0	0	483	45,434	975	6,368	17,708	70,968	S
SSW	0	0	809	1,922	1,426	529	2,972	7,658	SSW
SW	0	0	25	894	7,737	786	476	9,918	SW
WSW	0	0	0	1,108	1,908	26,890	965	30,871	WSW
W	0	0	0	0	1,429	4,273	22,176	27,878	W
WNW	0	0	0	0	297	1,579	2,043	3,919	WNW
NW	0	0	0	0	48	836	905	1,789	NW
NNW	0	0	0	0	218	1,899	642	2,759	NNW
Totals:	0	225	3,389	129,454	70,899	51,265	77,880	333,112	
Density	0	3	12	106	72	51	42	People/Sq Mile	

SECPOP2000 as Percent of Reported

N		133.8%	31.7%	41.3%	92.6%	139.9%	128.1%	N	
NNE		28.9%	202.8%	153.6%	92.9%	60.6%	126.6%	NNE	
NE	**	22.9%	113.4%	247.6%	20.9%	31.7%	57.6%	NE	
ENE	**	67.9%	203.4%	107.1%	175.4%	77.9%	49.6%	ENE	
E	*	101.9%	99.4%	32.7%	95.0%	38.4%	74.8%	E	
ESE	*	151.6%	88.7%	81.3%	550.0%	21.4%	102.6%	ESE	
SE	*	71.5%	172.1%	182.3%	82.5%	55.0%	152.9%	SE	
SSE		56.5%	90.0%	118.0%	27.7%	10.7%	97.1%	SSE	
S		42.0%	73.7%	90.4%	102.0%	142.8%	93.5%	S	
SSW		61.6%	332.6%	10.4%	36.1%	211.1%	176.4%	SSW	
SW	*	185.2%	117.8%	148.3%	41.2%	122.3%	122.3%	SW	
WSW		2.2%	99.2%	134.8%	377.8%	135.5%	135.5%	WSW	
W		6.4%	28.2%	94.5%	79.8%	79.8%	79.8%	W	
WNW		64.0%	174.6%	*	75.2%	75.2%	75.2%	WNW	
NW		1170.8%	343.2%	60.8%	222.5%	222.5%	222.5%	NW	
NNW		219.3%	171.5%	283.3%	201.3%	201.3%	201.3%	NNW	
Totals:	**	21.8%	82.6%	92.5%	118.8%	119.7%	118.6%	108.2%	

* The licensee reported people in the ring segment but SECPOP90 did not locate anyone in the ring segment Run Date: 07/10/02

Cook Nuclear Plant 11 Rings to 60 Miles

SPATIAL DISTANCES

Ring:	1	2	3	4	5	10	20	30	40	50	60	Total	
SECPop2000 POPULATION													
N	0	0	0	0	0	0	0	0	0	0	0	0	N
NNE	22	0	98	178	1,226	11,720	10,316	2,553	11,851	10,268	41,227	89,459	NNE
NE	6	4	275	1,877	2,706	14,915	24,083	18,142	11,426	14,447	31,688	119,569	NE
ENE	43	122	428	616	198	3,840	4,420	6,641	19,116	34,666	188,051	258,141	ENE
E	0	32	79	170	256	1,104	12,253	14,192	7,705	20,766	19,223	75,780	E
ESE	0	65	258	413	1,095	1,508	17,363	18,872	63,053	32,929	21,305	156,861	ESE
SE	0	131	289	105	154	599	13,710	184,606	77,496	58,905	22,142	358,137	SE
SSE	11	149	1,123	450	289	820	3,457	26,247	13,646	27,013	11,491	84,696	SSE
S	14	126	595	428	579	1,533	6,979	6,786	8,719	14,735	11,215	51,709	S
SSW	0	2	337	20	0	2,311	4,531	39,499	12,102	8,486	11,823	79,111	SSW
SW	0	0	0	0	0	0	4,560	42,141	30,930	180,976	149,979	408,586	SW
WSW	0	0	0	0	0	0	0	0	0	26,366	1,120,385	1,146,751	WSW
W	0	0	0	0	0	0	0	0	0	0	1,423,775	1,423,775	W
WNW	0	0	0	0	0	0	0	0	0	0	0	0	WNW
NW	0	0	0	0	0	0	0	0	0	0	0	0	NW
NNW	0	0	0	0	0	0	0	0	0	0	0	0	NNW
Totals:	96	631	3,482	4,257	6,503	38,350	101,672	359,679	256,044	429,557	3,052,304	4,252,575	
Density	31	58	149	168	191	170	123	182	153	153	376	People/Sq Mile	

Licensee's Reported Population

N	3	0	0	0	0	0	0	0	0	0	0	3	N
NNE	15	11	58	452	1,003	14,873	17,912	3,829	14,574	9,981	37,198	99,906	NNE
NE	12	25	340	2,017	2,518	13,770	22,769	18,275	12,351	13,580	34,091	119,748	NE
ENE	9	111	184	264	356	3,053	4,699	6,399	19,857	28,604	179,627	243,163	ENE
E	0	88	121	156	181	1,461	13,241	15,985	8,053	24,230	19,133	82,649	E
ESE	0	75	160	441	871	1,391	19,654	20,340	76,005	34,875	18,568	172,380	ESE
SE	3	107	260	160	193	703	12,280	184,094	58,265	48,499	19,032	323,596	SE
SSE	5	171	897	297	235	922	3,254	18,563	12,349	26,036	11,463	74,192	SSE
S	8	88	978	282	238	1,359	7,396	6,320	8,829	13,869	12,762	52,129	S
SSW	4	34	108	62	31	2,254	4,634	37,403	11,439	10,056	9,566	75,591	SSW
SW	0	0	0	0	0	0	4,425	43,353	26,184	188,025	156,452	418,439	SW
WSW	0	0	0	0	0	0	0	0	0	17,125	1,210,464	1,227,589	WSW
W	0	0	0	0	0	0	0	0	0	0	1,317,989	1,317,989	W
WNW	0	0	0	0	0	0	0	0	0	0	0	0	WNW
NW	0	0	0	0	0	0	0	0	0	0	0	0	NW
NNW	0	0	0	0	0	0	0	0	0	0	0	0	NNW
Totals:	59	710	3,106	4,131	5,626	39,786	110,264	354,561	247,906	414,880	3,026,345	4,207,374	
Density	19	61	137	159	174	170	130	183	152	150	372	People/Sq Mile	

SECPop2000 as Percent of Reported

N	*											*	N
NNE	146.7%	*	169.0%	39.4%	122.2%	78.8%	57.6%	66.7%	81.3%	102.9%	110.8%	89.5%	NNE
NE	50.0%	16.0%	80.9%	93.1%	107.5%	108.3%	105.8%	99.3%	92.5%	106.4%	93.0%	99.9%	NE
ENE	477.8%	109.9%	232.6%	233.3%	55.6%	125.8%	94.1%	103.8%	96.3%	121.2%	104.7%	106.2%	ENE
E		36.4%	65.3%	109.0%	141.4%	75.6%	92.5%	88.8%	95.7%	85.7%	100.5%	91.7%	E
ESE		86.7%	161.3%	93.7%	125.7%	108.4%	88.3%	92.8%	83.0%	94.4%	114.7%	91.0%	ESE
SE	*	122.4%	111.2%	65.6%	79.8%	85.2%	111.6%	100.3%	133.0%	121.5%	116.3%	110.7%	SE
SSE	220.0%	87.1%	125.2%	151.5%	123.0%	88.9%	106.2%	141.4%	110.5%	103.8%	100.2%	114.2%	SSE
S	175.0%	143.2%	60.8%	151.8%	243.3%	112.8%	94.4%	107.4%	98.8%	106.2%	87.9%	99.2%	S
SSW	*	5.9%	312.0%	32.3%	*	102.5%	97.8%	105.6%	105.8%	84.4%	123.6%	104.7%	SSW
SW							103.1%	97.2%	118.1%	96.3%	95.9%	97.6%	SW
WSW										154.0%	92.6%	93.4%	WSW
W											108.0%	108.0%	W
WNW													WNW
NW													NW
NNW													NNW
	162.7%	88.9%	112.1%	103.1%	115.6%	96.4%	92.2%	101.4%	103.3%	103.5%	100.9%	101.1%	

* The licensee reported people in the ring segment but SECPop90 did not locate anyone in the ring segment.

** SECPop90 located people in the ring segment but the licensee did not report anyone in the ring segment.

Licensee data from FSAR, Revision 16.1, Table 2.1-7. ESTIMATED.

Run Date: 07/10/02

Grand Gulf 10 Rings to 50 Miles

SPATIAL DISTANCES

Ring: 1 2 3 4 5 10 20 30 40 50

SECPop2000 POPULATION

											Total	
N	0	14	0	0	0	10	171	578	786	1,184	2,743	N
NNE	0	0	0	0	29	3	5,195	32,449	3,433	723	41,832	NNE
NE	0	14	0	0	27	56	1,801	4,859	4,897	3,019	14,673	NE
ENE	0	17	0	64	0	123	244	3,253	4,626	66,151	74,478	ENE
E	0	0	0	113	56	102	567	1,531	4,018	14,053	20,440	E
ESE	0	10	0	0	336	840	981	277	5,726	8,482	16,652	ESE
SE	0	0	0	10	776	2,582	1,177	637	2,720	21,634	29,536	SE
SSE	0	14	5	37	122	571	1,189	579	3,261	2,536	8,314	SSE
S	0	0	0	0	0	34	2,186	4,740	1,970	11,330	10,260	S
SSW	0	0	4	0	22	1,357	1,191	1,804	25,607	4,413	34,398	SSW
SW	0	0	0	0	0	74	51	1,223	16,912	3,665	21,925	SW
WSW	0	0	0	0	0	56	1,671	342	1,863	2,095	6,027	WSW
W	0	0	0	0	0	123	346	321	4,267	2,694	7,751	W
WNW	0	0	0	0	0	6	2,386	97	4,527	11,244	18,260	WNW
NW	0	0	0	0	0	28	130	62	2,364	5,989	8,573	NW
NNW	0	0	0	0	0	0	95	11,204	667	2,621	14,587	NNW
Totals:	0	69	9	224	1,368	5,965	19,381	63,956	87,644	151,833	330,449	
Density	0	5	3	6	21	24	21	32	36	42	People/Sq Mile	

Licensee's Reported Population

N	4	63	12	0	0	0	279	1,538	1,033	1,534	4,463	N
NNE	12	12	0	0	0	141	3,039	39,796	3,431	1,141	47,572	NNE
NE	4	4	4	12	71	344	2,207	6,538	5,032	4,850	19,066	NE
ENE	0	0	20	8	32	325	356	4,540	5,452	12,839	23,572	ENE
E	4	24	44	51	51	299	717	2,117	4,393	12,347	20,047	E
ESE	8	8	31	0	208	253	916	691	5,506	8,358	15,979	ESE
SE	0	4	8	44	1,334	1,827	840	807	2,029	17,967	24,860	SE
SSE	3	8	0	35	90	631	1,369	729	2,214	2,304	7,383	SSE
S	0	4	0	4	0	337	1,345	3,264	1,758	1,688	8,400	S
SSW	0	4	4	0	0	494	1,237	2,229	38,750	4,220	46,938	SSW
SW	4	0	0	0	0	317	917	2,881	21,535	5,665	31,319	SW
WSW	0	0	0	0	0	138	2,077	1,003	2,689	3,125	9,032	WSW
W	0	0	0	0	0	246	493	642	6,711	4,321	12,413	W
WNW	0	0	0	0	5	88	2,373	729	7,877	9,314	20,386	WNW
NW	8	0	0	0	0	171	478	233	3,030	8,377	12,297	NW
NNW	8	20	0	0	0	85	164	12,046	1,122	4,147	17,592	NNW
Totals:	55	151	123	154	1,791	5,696	18,807	79,783	112,562	102,197	321,319	
Density	18	16	12	10	29	25	21	38	44	41	People/Sq Mile	

SECPop2000 as Percent of Reported

N	*	22.2%	*			**	61.3%	37.6%	76.1%	77.2%	61.5%	N
NNE	*	*			**	2.1%	170.9%	81.5%	100.1%	63.4%	87.9%	NNE
NE	*	350.0%	*	*	38.0%	16.3%	81.6%	74.3%	97.3%	62.2%	77.0%	NE
ENE	*	**	*	800.0%	*	37.8%	68.5%	71.7%	84.8%	515.2%	316.0%	ENE
E	*	*	*	221.6%	109.8%	34.1%	79.1%	72.3%	91.5%	113.8%	102.0%	E
ESE	*	125.0%	*		161.5%	332.0%	107.1%	40.1%	104.0%	101.5%	104.2%	ESE
SE	*	*	*	22.7%	58.2%	141.3%	140.1%	78.9%	134.1%	120.4%	118.8%	SE
SSE	*	175.0%	**	105.7%	135.6%	90.5%	86.9%	79.4%	147.3%	110.1%	112.6%	SSE
S	*	*	*	*		10.1%	162.5%	145.2%	112.1%	78.8%	122.1%	S
SSW	*	*	100.0%		**	274.7%	96.3%	80.9%	66.1%	104.6%	73.3%	SSW
SW	*	*	*	*		23.3%	5.6%	42.5%	78.5%	64.7%	70.0%	SW
WSW	*	*	*	*		40.6%	80.5%	34.1%	69.3%	67.0%	66.7%	WSW
W	*	*	*	*		50.0%	70.2%	50.0%	63.6%	62.3%	62.4%	W
WNW	*	*	*	*	*	6.8%	100.5%	13.3%	57.5%	120.7%	89.6%	WNW
NW	*	*	*	*		16.4%	27.2%	26.6%	78.0%	71.5%	69.7%	NW
NNW	*	*	*	*		*	57.9%	93.0%	59.4%	63.2%	82.9%	NNW
	*	45.7%	7.3%	145.5%	76.4%	104.7%	103.1%	80.2%	77.9%	148.6%	102.8%	

* The licensee reported people in the ring segment but SECPop90 did not locate anyone in the ring segment.

** SECPop90 located people in the ring segment but the licensee did not report anyone in the ring segment.

Licensee data from FSAR, Tables 2.1-1 and 2.1-3. ESTIMATED from 1970 Census data.

Run Date: 07/11/02

Limerick 10 Rings to 50 Miles

SPATIAL DISTANCES

Ring:	1	2	3	4	5	10	20	30	40	50	Total	
SECPop2000 POPULATION												
N	0	929	3,762	1,084	2,098	7,089	16,360	94,948	67,678	38,768	232,716	N
NNE	0	778	1,216	202	776	3,098	21,170	187,371	183,761	53,324	451,696	NNE
NE	0	39	93	482	356	5,292	32,235	21,947	34,805	60,340	155,589	NE
ENE	17	108	1,981	1,390	526	9,049	70,035	64,333	27,402	55,569	230,410	ENE
E	0	532	279	1,447	904	10,999	99,782	157,718	233,494	349,431	854,586	E
ESE	139	251	1,127	2,574	1,452	19,453	133,950	685,042	576,972	184,600	1,605,560	ESE
SE	25	254	512	6,644	3,791	12,577	103,458	872,952	449,859	286,513	1,736,585	SE
SSE	8	154	595	1,662	859	21,029	47,515	239,831	36,914	24,887	373,454	SSE
S	0	414	298	406	203	4,352	89,249	80,026	309,142	75,960	560,050	S
SSW	71	348	262	560	962	2,612	57,125	30,466	83,129	67,248	242,783	SSW
SW	50	342	192	433	529	2,426	27,752	41,046	26,590	26,267	125,627	SW
WSW	0	489	291	901	689	2,523	11,863	27,476	110,624	131,104	285,960	WSW
W	121	662	704	581	843	2,439	9,211	37,202	69,010	81,386	202,159	W
WNW	24	54	635	6,304	2,341	10,756	109,856	103,392	26,462	43,509	303,333	WNW
NW	0	241	4,030	9,289	2,543	3,942	14,755	33,941	18,803	61,333	148,877	NW
NNW	0	817	1,306	2,078	1,691	13,832	11,016	22,336	9,087	31,735	93,898	NNW
Totals:	455	6,412	17,283	36,037	20,563	131,468	855,332	2,700,027	2,263,732	1,571,974	7,603,283	
Density	145	546	854	1,197	1,028	676	850	1,333	1,200	968	People/Sq Mile	

Licensee's Reported Population

N	64	756	990	440	834	3,499	16,837	58,743	62,871	29,786	174,820	N
NNE	51	1,205	270	529	225	2,690	27,473	205,566	198,282	44,225	480,516	NNE
NE	51	45	223	370	306	4,134	21,141	23,177	30,320	59,686	139,453	NE
ENE	13	64	220	421	252	5,691	58,184	61,422	24,904	47,162	198,333	ENE
E	22	166	300	431	463	5,672	76,172	102,127	209,526	389,831	784,710	E
ESE	32	198	329	297	641	10,213	144,573	542,450	572,224	137,627	1,408,584	ESE
SE	6	408	156	5,365	4,491	7,566	89,099	844,309	550,741	224,521	1,726,662	SE
SSE	0	224	336	3,141	1,871	24,749	33,947	256,615	39,309	25,600	385,792	SSE
S	3	404	390	194	401	4,557	85,945	42,015	368,752	26,026	528,687	S
SSW	14	720	363	604	316	2,179	47,295	30,036	54,130	55,746	191,403	SSW
SW	81	214	241	367	353	2,102	9,915	40,738	13,566	21,947	89,524	SW
WSW	54	211	628	540	1,881	2,239	9,931	28,797	85,157	155,924	285,362	WSW
W	41	139	2,068	1,786	1,243	2,640	4,564	20,260	58,108	87,041	177,890	W
WNW	45	354	3,314	12,268	3,927	10,844	139,379	82,329	29,560	33,205	315,225	WNW
NW	22	319	2,073	7,384	1,450	4,435	5,078	19,391	19,088	70,460	129,700	NW
NNW	38	788	1,913	1,370	1,444	7,261	14,581	18,059	8,347	39,276	93,077	NNW
Totals:	537	6,215	13,814	35,507	20,098	100,471	784,114	2,376,034	2,324,885	1,448,063	7,109,738	
Density	171	537	727	1,116	970	562	765	1,180	1,126	905	People/Sq Mile	

SECPop2000 as Percent of Reported

N	*	122.9%	380.0%	246.4%	251.6%	202.6%	97.2%	161.6%	107.6%	130.2%	133.1%	N	
NNE	*	64.6%	450.4%	38.2%	344.9%	115.2%	77.1%	91.1%	120.6%	120.6%	94.0%	NNE	
NE	*	86.7%	41.7%	130.3%	116.3%	128.0%	152.5%	94.7%	114.8%	101.1%	111.6%	NE	
ENE	130.8%	168.8%	900.5%	330.2%	208.7%	159.0%	120.4%	104.7%	110.0%	117.8%	116.2%	ENE	
E	*	320.5%	93.0%	335.7%	195.2%	193.9%	131.0%	154.4%	111.4%	89.6%	108.9%	E	
ESE	434.4%	126.8%	342.6%	866.7%	226.5%	190.5%	92.7%	126.3%	100.8%	134.1%	114.0%	ESE	
SE	416.7%	62.3%	328.2%	123.8%	84.4%	166.2%	116.1%	103.4%	81.7%	127.6%	100.6%	SE	
SSE	**	68.8%	177.1%	52.9%	45.9%	85.0%	140.0%	93.5%	93.9%	97.2%	96.8%	SSE	
S	*	102.5%	76.4%	209.3%	50.6%	95.5%	103.8%	190.5%	83.8%	291.9%	105.9%	S	
SSW	507.1%	48.3%	72.2%	92.7%	304.4%	119.9%	120.8%	101.4%	153.6%	120.6%	126.8%	SSW	
SW	61.7%	159.8%	79.7%	118.0%	149.9%	115.4%	279.9%	100.8%	196.0%	119.7%	140.3%	SW	
WSW	*	231.8%	46.3%	166.9%	36.6%	112.7%	119.5%	95.4%	129.9%	84.1%	100.2%	WSW	
W	295.1%	476.3%	34.0%	32.5%	67.8%	92.4%	201.8%	183.6%	118.8%	93.5%	113.6%	W	
WNW	53.3%	15.3%	19.2%	51.4%	59.6%	99.2%	78.8%	125.6%	89.5%	131.0%	96.2%	WNW	
NW	*	75.5%	194.4%	125.8%	175.4%	88.9%	290.6%	175.0%	98.5%	87.0%	114.8%	NW	
NNW	*	103.7%	68.3%	151.7%	117.1%	190.5%	75.6%	123.7%	108.9%	80.8%	100.9%	NNW	
		84.7%	103.2%	125.1%	101.5%	102.3%	130.9%	109.1%	113.6%	97.4%	108.6%	106.9%	

* The licensee reported people in the ring segment but SECPop90 did not locate anyone in the ring segment.

** SECPop90 located people in the ring segment but the licensee did not report anyone in the ring segment.

Licensee data from FSAR, Tables 2.1-5 and 2.1-12. ESTIMATED from 1970 Census data.

Run Date: 07/11/02

Point Beach 9 Rings to 40 Miles

SPATIAL DISTANCES

Ring:	1	2	3	4	5	10	20	30	40	Total	
SECPOP2000 POPULATION											
N	0	0	0	2	18	391	4,382	4,612	6,304	15,709	N
NNE	0	0	0	0	0	0	0	2,554	7,948	10,502	NNE
NE	0	0	0	0	0	0	0	0	0	0	NE
ENE	0	0	0	0	0	0	0	0	0	0	ENE
E	0	0	0	0	0	0	0	0	0	0	E
ESE	0	0	0	0	0	0	0	0	0	0	ESE
SE	0	0	0	0	0	0	0	0	0	0	SE
SSE	0	24	49	14	0	14	0	0	0	101	SSE
S	0	36	49	28	212	4,178	0	0	0	4,503	S
SSW	0	0	46	19	39	8,907	33,057	3,578	61,842	107,488	SSW
SW	0	16	33	16	56	1,806	7,821	5,153	14,074	28,975	SW
WSW	0	25	0	51	74	1,624	3,867	6,559	9,902	22,102	WSW
W	0	25	0	32	176	568	2,470	3,986	48,257	55,514	W
WNW	0	44	0	53	59	422	4,299	80,277	51,711	136,865	WNW
NW	0	25	40	64	82	487	2,667	51,797	32,642	87,804	NW
NNW	2	0	71	27	18	437	4,349	4,696	701	10,301	NNW
Totals:	2	195	288	306	734	18,834	62,912	163,212	233,381	479,864	
Density	1	16	17	16	19	65	66	87	95	People/Sq Mile	

Licensee's Reported Population

N	0	0	4	19	4	379	5,195	7,651	8,586	21,838	N
NNE	0	0	0	0	0	0	0	282	6,513	6,795	NNE
NE	0	0	0	0	0	0	0	0	0	0	NE
ENE	0	0	0	0	0	0	0	0	0	0	ENE
E	0	0	0	0	0	0	0	0	0	0	E
ESE	0	0	0	0	0	0	0	0	0	0	ESE
SE	0	0	0	0	0	0	0	0	0	0	SE
SSE	0	30	111	140	2	0	0	0	0	283	SSE
S	0	12	36	40	35	8,951	0	0	0	9,074	S
SSW	4	16	20	47	48	10,622	28,767	3,625	53,433	96,582	SSW
SW	0	8	24	28	64	1,843	10,003	5,513	14,550	32,033	SW
WSW	0	32	23	29	58	1,840	3,477	7,765	11,718	24,942	WSW
W	0	24	27	44	55	728	2,701	4,651	39,072	47,302	W
WNW	4	28	23	29	51	457	4,146	58,424	39,266	102,428	WNW
NW	0	20	75	15	44	529	2,871	79,131	26,297	108,982	NW
NNW	0	20	75	27	41	513	3,817	4,332	787	9,612	NNW
Totals:	8	190	418	418	402	25,862	60,977	171,374	200,222	459,871	
Density	3	16	22	21	18	87	70	92	91	People/Sq Mile	

SECPOP2000 as Percent of Reported

N												
NNE												
NE												
ENE												
E												
ESE												
SE												
SSE		80.0%	44.1%	10.0%	*	**						35.7%
S		300.0%	136.1%	70.0%	605.7%	46.7%						49.6%
SSW	*	*	230.0%	40.4%	81.3%	83.9%	114.9%	98.7%	115.7%			111.3%
SW			137.5%	57.1%	87.5%	98.0%	78.2%	93.5%	96.7%			90.5%
WSW			*	175.9%	127.6%	88.3%	111.2%	84.5%	84.5%			88.6%
W			*	72.7%	320.0%	78.0%	91.4%	85.7%	123.5%			117.4%
WNW	*		*	182.8%	115.7%	92.3%	103.7%	137.4%	131.7%			133.6%
NW			53.3%	426.7%	186.4%	92.1%	92.9%	65.5%	124.1%			80.6%
NNW	**	*	94.7%	100.0%	43.9%	85.2%	113.9%	108.4%	89.1%			107.2%
	25.0%	102.6%	68.9%	73.2%	182.6%	72.8%	103.2%	95.2%	116.6%			104.3%

* The licensee reported people in the ring segment but SECPOP90 did not locate anyone in the ring segment. Run Date: 07/15/02

** SECPOP90 located people in the ring segment but the licensee did not report anyone in the ring segment.

1. licensee data from FSAR. REvision 1. Figures 2.3-1 & 2.3-2. ESTIMATED from 1980 Census data.

River Bend 10 Rings to 50 Miles

SPATIAL DISTANCES

Ring: 1 2 3 4 5 10 20 30 40 50

SECPop2000 POPULATION

											Total	
N	0	196	132	73	21	759	1,070	4,571	857	3,163	10,842	N
NNE	16	0	112	8	0	511	403	1,175	3,015	1,148	6,388	NNE
NE	0	0	0	2	22	2,398	2,237	2,949	2,274	3,350	13,232	NE
ENE	35	17	0	72	0	2,087	4,729	3,621	1,773	4,316	16,650	ENE
E	0	0	44	4	0	289	2,593	2,857	3,853	16,281	25,921	E
ESE	0	0	16	41	5	720	9,162	19,194	15,334	15,136	59,628	ESE
SE	0	4	0	0	9	1,953	36,488	157,195	71,995	40,104	287,718	SE
SSE	0	0	89	0	0	202	21,524	168,848	40,939	22,332	253,051	SSE
S	0	0	0	0	0	670	2,526	6,634	14,265	2,374	26,469	S
SSW	2	0	0	0	114	1,099	4,247	3,932	105	3,233	12,732	SSW
SW	0	0	0	0	0	3,161	4,208	1,480	1,614	52,743	43,206	SW
WSW	0	0	0	0	0	4,994	401	2,249	3,252	46,039	56,935	WSW
W	0	0	0	0	0	0	1,353	2,042	1,969	3,307	8,671	W
WNW	0	4	297	570	0	17	168	1,967	4,833	14,746	22,602	WNW
NW	0	19	250	655	825	847	438	5,543	221	891	9,689	NW
NNW	0	420	4	0	244	604	702	763	61	135	2,933	NNW
Totals:	53	660	944	1,425	1,240	20,311	92,219	365,017	165,460	209,338	856,667	
Density	17	57	59	61	55	78	93	170	129	109	People/Sq Mile	

Licensee's Reported Population

N	0	109	103	37	444	622	871	2,771	1,328	4,377	10,662	N
NNE	15	291	34	48	7	280	638	1,081	2,319	2,480	7,193	NNE
NE	8	26	19	0	72	3,058	3,221	3,597	2,900	3,433	16,334	NE
ENE	0	36	19	25	76	1,543	4,935	4,151	2,415	3,352	16,552	ENE
E	6	14	0	26	17	306	3,810	6,983	3,254	16,285	30,701	E
ESE	3	0	23	96	23	902	22,667	25,251	17,925	20,579	87,472	ESE
SE	0	0	5	0	148	2,710	47,403	130,981	63,761	33,889	278,897	SE
SSE	0	0	3	0	0	492	40,340	218,957	41,898	36,149	338,039	SSE
S	0	5	0	0	0	1,199	3,664	8,332	14,566	5,390	33,156	S
SSW	0	0	0	9	333	1,207	3,654	4,715	3,364	8,997	22,279	SSW
SW	0	0	0	0	0	5,173	4,385	2,995	7,404	25,654	45,611	SW
WSW	0	0	0	3	3	5,056	1,784	3,206	5,889	42,799	58,740	WSW
W	0	0	2	0	6	0	1,719	3,803	2,998	5,967	14,495	W
WNW	0	0	214	918	27	27	777	1,903	5,967	14,074	23,907	WNW
NW	29	24	117	1,216	520	485	2,288	5,955	1,783	4,662	17,079	NW
NNW	19	164	103	40	36	549	1,000	1,040	1,690	2,858	7,499	NNW
Totals:	80	669	642	2,418	1,712	23,609	143,356	425,724	179,461	230,945	1,008,616	
Density	25	60	49	76	70	93	137	212	155	128	People/Sq Mile	

SECPop2000 as Percent of Reported

N		179.8%	128.2%	197.3%	4.7%	122.0%	122.8%	165.0%	64.5%	72.3%	101.7%	N
NNE	106.7%	*	329.4%	16.7%	*	182.5%	63.2%	108.7%	130.0%	46.3%	88.8%	NNE
NE	*	*	*	**	30.6%	78.4%	69.5%	82.0%	78.4%	97.6%	81.0%	NE
ENE	**	47.2%	*	288.0%	*	135.3%	95.8%	87.2%	73.4%	128.8%	100.6%	ENE
E	*	*	**	15.4%	*	94.4%	68.1%	40.9%	118.4%	100.0%	84.4%	E
ESE	*	*	69.6%	42.7%	21.7%	79.8%	40.4%	76.0%	85.5%	73.6%	68.2%	ESE
SE		**	*		6.1%	72.1%	76.9%	104.7%	112.9%	118.3%	103.2%	SE
SSE			2966.7%			41.1%	53.1%	77.1%	95.6%	61.8%	74.9%	SSE
S		*				55.9%	68.9%	79.6%	97.9%	44.0%	79.8%	S
SSW	**			*	34.2%	91.1%	116.2%	83.4%	3.1%	35.9%	57.1%	SSW
SW				*		61.1%	96.0%	49.4%	21.8%	127.6%	94.7%	SW
WSW				*	*	98.8%	22.5%	70.1%	55.2%	107.6%	96.9%	WSW
W			*	*	*		78.7%	53.7%	65.7%	55.4%	59.8%	W
WNW		**	138.8%	62.1%	*	63.0%	21.6%	103.4%	81.0%	104.8%	94.5%	WNW
NW	*	79.2%	213.7%	53.9%	158.7%	174.6%	19.1%	93.1%	12.4%	19.1%	56.7%	NW
NNW	*	256.1%	3.9%	*	677.8%	110.0%	70.2%	73.4%	3.6%	4.7%	39.1%	NNW
	66.3%	98.7%	147.0%	58.9%	72.4%	86.0%	64.3%	85.7%	92.2%	90.6%	84.9%	

* The licensee reported people in the ring segment but SECPop90 did not locate anyone in the ring segment.

** SECPop90 located people in the ring segment but the licensee did not report anyone in the ring segment.

Licensee data from FSAR, August 1987, Tables 2.1-6 and 2.1-13. ESTIMATED from 1970 Census data.

Run Date: 07/16/02

Robinson 10 Rings to 50 Miles

SPATIAL DISTANCES

Ring:	1	2	3	4	5	10	20	30	40	50	Total	
SECPop2000 POPULATION												
N	0	0	0	85	125	245	1,101	5,290	10,832	7,574	25,252	N
NNE	0	27	341	211	163	536	2,318	7,005	6,203	21,649	38,453	NNE
NE	0	30	195	161	66	829	1,289	10,439	7,595	23,046	43,650	NE
ENE	0	249	163	72	238	1,355	2,706	4,488	16,424	24,937	50,632	ENE
E	0	20	392	745	771	3,180	3,072	931	2,501	24,346	35,958	E
ESE	33	167	102	518	1,724	6,145	16,164	27,216	7,986	16,034	76,089	ESE
SE	0	45	133	746	1,754	3,601	4,614	49,884	14,108	8,229	83,114	SE
SSE	39	0	304	512	225	1,290	4,733	5,170	8,390	14,255	34,918	SSE
S	61	0	70	175	118	577	1,733	3,770	5,143	10,119	21,766	S
SSW	90	76	112	20	60	498	8,111	4,885	74,894	12,849	101,595	SSW
SW	121	173	171	137	116	356	2,332	5,219	8,312	9,378	26,315	SW
WSW	133	55	328	55	100	185	1,523	18,952	17,373	60,703	99,407	WSW
W	9	30	55	23	11	308	2,284	2,255	2,890	3,768	11,633	W
WNW	0	12	12	0	43	614	863	7,957	13,344	26,434	49,279	WNW
NW	114	22	5	2	86	843	1,166	3,003	12,348	21,857	39,446	NW
NNW	0	0	10	128	0	31	810	8,578	7,526	47,594	64,677	NNW
Totals:	600	906	2,393	3,590	5,600	20,593	54,819	165,042	215,869	332,772	802,184	
Density	191	120	138	149	167	107	70	90	93	102	People/Sq Mile	

Licensee's Reported Population

N	0	0	10	0	94	263	2,370	6,210	11,000	10,200	30,147	N
NNE	0	104	196	221	88	361	2,680	6,550	7,630	29,700	47,530	NNE
NE	0	56	74	56	64	527	2,770	11,900	10,300	23,900	49,647	NE
ENE	6	45	226	244	219	1,320	3,700	14,300	17,300	32,100	69,460	ENE
E	20	88	339	657	1,550	4,730	3,220	3,480	6,520	23,300	43,904	E
ESE	6	186	330	387	2,220	10,100	18,000	21,300	13,600	18,700	84,829	ESE
SE	0	35	265	860	1,640	3,370	5,120	67,600	12,900	15,600	107,390	SE
SSE	0	14	353	573	528	1,430	5,760	9,180	10,400	22,000	50,238	SSE
S	31	0	79	56	56	679	2,570	4,450	6,750	10,600	25,271	S
SSW	107	222	39	17	82	591	5,940	4,640	70,700	11,000	93,338	SSW
SW	82	247	170	44	124	351	2,380	4,950	10,500	14,000	32,848	SW
WSW	130	159	329	84	50	256	3,070	16,600	10,600	28,500	59,778	WSW
W	130	14	19	33	22	246	2,420	5,490	2,900	414	11,688	W
WNW	130	14	4	0	37	153	1,250	8,790	9,850	38,300	58,528	WNW
NW	0	39	64	42	42	1,280	1,140	5,650	12,000	22,100	42,357	NW
NNW	0	14	70	10	0	18	1,230	7,540	8,340	48,600	65,822	NNW
Totals:	642	1,237	2,567	3,284	6,816	25,675	63,620	198,630	221,290	349,014	872,775	
Density	204	150	157	154	185	128	83	107	104	111	People/Sq Mile	

SECPop2000 as Percent of Reported

N			*	**	133.0%	93.2%	46.5%	85.2%	98.5%	74.3%	83.8%	N
NNE		26.0%	174.0%	95.5%	185.2%	148.5%	86.5%	106.9%	81.3%	72.9%	80.9%	NNE
NE		53.6%	263.5%	287.5%	103.1%	157.3%	46.5%	87.7%	73.7%	96.4%	87.9%	NE
ENE	*	553.3%	72.1%	29.5%	108.7%	102.7%	73.1%	31.4%	94.9%	77.7%	72.9%	ENE
E	*	22.7%	115.6%	113.4%	49.7%	67.2%	95.4%	26.8%	38.4%	104.5%	81.9%	E
ESE	550.0%	89.8%	30.9%	133.9%	77.7%	60.8%	89.8%	127.8%	58.7%	85.7%	89.7%	ESE
SE		128.6%	50.2%	86.7%	107.0%	106.9%	90.1%	73.8%	109.4%	52.8%	77.4%	SE
SSE	**		86.1%	89.4%	42.6%	90.2%	82.2%	56.3%	80.7%	64.8%	69.5%	SSE
S		196.8%		88.6%	312.5%	210.7%	85.0%	67.4%	84.7%	76.2%	95.5%	S
SSW		84.1%	34.2%	287.2%	117.6%	73.2%	84.3%	136.5%	105.3%	116.8%	108.8%	SSW
SW		147.6%	70.0%	100.6%	311.4%	93.5%	101.4%	98.0%	105.4%	79.2%	80.1%	SW
WSW		102.3%	34.6%	99.7%	65.5%	200.0%	72.3%	49.6%	114.2%	163.9%	213.0%	WSW
W		6.9%	214.3%	289.5%	69.7%	50.0%	125.2%	94.4%	41.1%	99.7%	910.1%	W
WNW	*	85.7%	300.0%		116.2%	401.3%	69.0%	90.5%	135.5%	69.0%	84.2%	WNW
NW	**	56.4%	7.8%	4.8%	204.8%	65.9%	102.3%	53.2%	102.9%	98.9%	93.1%	NW
NNW			14.3%	1280.0%		172.2%	65.9%	113.8%	90.2%	97.9%	98.3%	NNW
		93.5%	73.2%	93.2%	109.3%	82.2%	86.2%	83.1%	97.6%	95.3%	91.9%	

* The licensee reported people in the ring segment but SECPop90 did not locate anyone in the ring segment.

** SECPop90 located people in the ring segment but the licensee did not report anyone in the ring segment.

Licensee data from FSAR, Tables 2.1.3-1 and 2.1.3-2. ESTIMATED from 1980 Census data.

Run Date: 07/11/02

Seabrook 10 Rings to 50 Miles

SPATIAL DISTANCES

Ring:	1	2	3	4	5	10	20	30	40	50	Total	
SECPop2000 POPULATION												
N	0	6	222	1,212	930	4,503	18,596	48,973	30,662	11,555	116,659	N
NNE	0	36	1,498	2,819	594	6,977	37,177	13,619	24,595	54,548	141,863	NNE
NE	29	47	688	2,381	1,261	1,429	1,257	414	1	158	7,665	NE
ENE	0	403	1,171	428	0	0	0	0	0	0	2,002	ENE
E	0	559	83	0	0	0	0	0	0	0	642	E
ESE	0	756	13	0	0	0	0	0	0	0	769	ESE
SE	163	140	374	0	0	2,645	4,177	0	0	0	7,499	SE
SSE	68	560	463	1,189	570	1,788	6,981	27,814	0	0	39,433	SSE
S	139	412	692	715	1,515	7,714	24,518	196,181	54,682	190,470	477,038	S
SSW	65	690	1,126	584	337	12,369	25,814	132,772	859,576	812,351	1,845,684	SSW
SW	10	1,035	385	206	3,833	8,159	84,691	243,547	162,839	123,527	628,232	SW
WSW	234	234	475	493	2,924	10,245	57,568	67,747	146,085	52,054	338,059	WSW
W	0	474	1,483	330	347	3,130	23,379	67,400	103,784	27,269	227,596	W
WNW	144	146	98	117	436	2,824	17,017	21,508	95,495	37,194	174,979	WNW
NW	0	337	277	253	192	12,018	9,182	8,059	19,164	24,562	74,044	NW
NNW	0	190	234	571	545	5,927	26,181	25,886	15,379	10,562	85,475	NNW
Totals:	852	6,025	9,282	11,298	13,484	77,083	335,006	858,097	1,512,262	1,344,250	4,167,639	
Density	271	547	572	546	521	376	361	464	562	531	People/Sq Mile	

Licensee's Reported Population

N	20	100	760	1,150	760	9,420	27,400	32,700	22,300	6,900	101,510	N
NNE	0	0	2,780	3,250	720	12,260	34,800	11,500	18,300	43,300	126,910	NNE
NE	0	110	1,290	2,220	1,400	2,000	2,800	0	0	0	9,820	NE
ENE	0	730	1,350	180	0	0	0	0	0	0	2,260	ENE
E	0	780	0	0	0	0	0	0	0	0	780	E
ESE	0	1,530	0	0	0	0	0	0	0	0	1,530	ESE
SE	0	90	730	0	0	0	8,900	900	0	0	10,620	SE
SSE	20	150	360	360	570	4,790	14,800	24,300	0	0	45,350	SSE
S	210	410	750	620	1,100	8,400	20,500	189,000	107,500	227,900	556,390	S
SSW	410	460	510	540	440	9,920	22,300	177,600	957,100	883,600	2,052,880	SSW
SW	100	1,110	430	250	3,620	12,920	73,100	204,600	194,000	140,400	630,530	SW
WSW	0	1,110	1,020	370	3,710	9,030	28,700	125,800	151,200	41,200	362,140	WSW
W	170	1,120	410	530	1,330	4,510	24,300	63,600	118,800	30,800	245,570	W
WNW	210	90	320	90	1,080	4,730	16,300	16,200	72,700	40,600	152,320	WNW
NW	30	280	190	150	150	8,550	13,200	4,200	12,100	19,800	58,650	NW
NNW	30	340	190	280	480	7,600	16,900	20,700	15,900	6,400	68,820	NNW
Totals:	1,200	8,410	11,090	9,990	15,360	94,130	304,000	871,100	1,669,900	1,440,900	4,426,080	
Density	382	765	732	611	586	446	353	465	594	564	People/Sq Mile	

SECPop2000 as Percent of Reported

N	*	6.0%	29.2%	105.4%	122.4%	47.8%	67.9%	149.8%	137.5%	167.5%	114.9%	N
NNE		**	53.9%	86.7%	82.5%	56.9%	106.8%	118.4%	134.4%	126.0%	111.8%	NNE
NE	**	42.7%	53.3%	107.3%	90.1%	71.5%	44.9%	**	**	**	78.1%	NE
ENE		55.2%	86.7%	237.8%							88.6%	ENE
E		71.7%	**								82.3%	E
ESE		49.4%	**								50.3%	ESE
SE	**	155.6%	51.2%				29.7%	464.1%			70.6%	SE
SSE	340.0%	373.3%	128.6%	330.3%	100.0%	37.3%	47.2%	114.5%			87.0%	SSE
S	66.2%	100.5%	92.3%	115.3%	137.7%	91.8%	119.6%	103.8%	50.9%	83.6%	85.7%	S
SSW	15.9%	150.0%	220.8%	108.1%	76.6%	124.7%	115.8%	74.8%	89.8%	91.9%	89.9%	SSW
SW	10.0%	93.2%	89.5%	82.4%	105.9%	63.2%	115.9%	119.0%	83.9%	88.0%	99.6%	SW
WSW	**	21.1%	46.6%	133.2%	78.8%	113.5%	200.6%	53.9%	96.6%	126.3%	93.4%	WSW
W	*	42.3%	361.7%	62.3%	26.1%	69.4%	96.2%	106.0%	87.4%	88.5%	92.7%	W
WNW	68.6%	162.2%	30.6%	130.0%	40.4%	59.7%	104.4%	132.8%	131.4%	91.6%	114.9%	WNW
NW	*	120.4%	145.8%	168.7%	128.0%	140.6%	69.6%	191.9%	158.4%	124.1%	126.2%	NW
NNW	*	55.9%	123.2%	203.9%	113.5%	78.0%	154.9%	125.1%	96.7%	165.0%	124.2%	NNW
		71.0%	71.6%	83.7%	113.1%	87.8%	81.9%	110.2%	98.5%	90.6%	93.3%	

* The licensee reported people in the ring segment but SECPop90 did not locate anyone in the ring segment.

** SECPop90 located people in the ring segment but the licensee did not report anyone in the ring segment.

Licensee data from FSAR, Tables 2.1-2 and 2.1-4. ESTIMATED from 1980 Census data.

Run Date: 07/11/02

South Texas 10 Rings to 50 Miles

SPATIAL DISTANCES

Ring:	1	2	3	4	5	10	20	30	40	50	Total	
SECPop2000 POPULATION												
N	0	0	15	0	0	32	1,261	462	14,305	5,315	21,390	N
NNE	0	0	0	0	0	148	21,628	1,073	2,445	10,992	36,286	NNE
NE	0	0	0	0	31	83	747	6,969	11,567	25,850	45,247	NE
ENE	0	0	0	0	0	439	235	2,606	17,612	60,494	81,386	ENE
E	0	0	0	0	3	31	83	1,117	87	9	1,330	E
ESE	0	0	0	126	47	46	2	0	0	0	221	ESE
SE	0	0	0	17	100	380	13	0	0	0	510	SE
SSE	0	0	0	0	0	167	105	0	0	0	272	SSE
S	0	0	0	0	0	0	0	0	0	0	0	S
SSW	0	0	0	0	0	0	1	0	0	0	1	SSW
SW	0	0	0	0	0	67	42	0	1,111	458	1,678	SW
WSW	0	0	1	0	6	98	5,954	1,046	14,507	3,560	25,172	WSW
W	0	0	0	0	9	131	266	682	1,559	3,558	6,205	W
WNW	0	0	0	0	0	511	1,228	416	9,746	1,275	13,176	WNW
NW	0	0	0	19	30	206	486	794	1,485	221	3,241	NW
NNW	0	0	0	0	0	34	463	3,459	12,922	2,125	19,003	NNW
Totals:	0	0	16	162	226	2,373	32,514	18,624	87,346	113,857	255,118	
Density	0	0	1	4	5	9	28	19	28	32	255,118	People/Sq Mile

Licensee's Reported Population

N	0	0	5	0	0	36	3,661	2,584	17,385	7,094	30,765	N
NNE	0	0	0	0	0	107	26,651	2,392	7,957	9,416	46,523	NNE
NE	0	0	0	0	0	44	2,914	9,566	25,124	21,160	58,808	NE
ENE	0	0	0	0	4	576	2,201	4,198	26,855	79,928	113,762	ENE
E	0	0	0	3	0	56	1,153	1,425	0	431	3,068	E
ESE	0	0	0	134	98	77	312	0	0	0	621	ESE
SE	0	0	0	61	70	550	0	0	0	0	681	SE
SSE	0	0	0	0	0	178	60	0	0	0	238	SSE
S	0	0	0	0	0	0	0	0	0	0	0	S
SSW	0	0	0	0	3	8	201	0	0	0	212	SSW
SW	0	0	0	0	16	77	259	0	2,234	1,679	4,265	SW
WSW	0	0	7	3	25	143	6,227	1,653	14,383	11,254	33,695	WSW
W	0	0	0	0	15	151	801	974	2,426	5,140	9,507	W
WNW	0	0	0	0	38	481	944	1,840	9,146	3,125	15,574	WNW
NW	0	0	0	0	24	292	1,056	1,606	2,409	2,762	8,149	NW
NNW	0	0	0	15	13	8	169	5,749	16,111	4,159	26,224	NNW
Totals:	0	0	12	216	306	2,784	46,609	31,987	124,030	146,148	352,092	
Density	0	0	0	5	7	11	40	29	41	45	352,092	People/Sq Mile

SECPop2000 as Percent of Reported

N		300.0%				88.9%	34.4%	17.9%	82.3%	74.9%	69.5%	N		
NNE						138.3%	81.2%	44.9%	30.7%	116.7%	78.0%	NNE		
NE					**	188.6%	25.6%	72.9%	46.0%	122.2%	76.9%	NE		
ENE					*	76.2%	10.7%	62.1%	65.6%	75.7%	71.5%	ENE		
E					*	55.4%	7.2%	78.4%	**	2.1%	43.4%	E		
ESE					94.0%	48.0%	59.7%	0.6%			35.6%	ESE		
SE					27.9%	142.9%	69.1%	**			74.9%	SE		
SSE						93.8%	175.0%				114.3%	SSE		
S												S		
SSW						*	*	0.5%			0.5%	SSW		
SW						*	87.0%	16.2%	49.7%	27.3%	39.3%	SW		
WSW						14.3%	24.0%	68.5%	95.6%	63.3%	100.9%	WSW		
W						*	60.0%	86.8%	33.2%	70.0%	64.3%	W		
WNW						*	106.2%	130.1%	22.6%	106.6%	40.8%	WNW		
NW						**	125.0%	70.5%	46.0%	49.4%	61.6%	NW		
NNW						*	425.0%	274.0%	60.2%	80.2%	51.1%	NNW		
Totals:						133.3%	75.0%	73.9%	85.2%	69.8%	58.2%	70.4%	77.9%	72.5%

* The licensee reported people in the ring segment but SECPop90 did not locate anyone in the ring segment.

** SECPop90 located people in the ring segment but the licensee did not report anyone in the ring segment.

Licensee data from FSAR, Table 2.1-1. ESTIMATED from 1980 Census data.

Run Date: 07/11/02

Susquehanna 10 Rings to 50 Miles

SPATIAL DISTANCES

Ring: 1 2 3 4 5 10 20 30 40 50

SECPop2000 POPULATION

	1	2	3	4	5	10	20	30	40	50	Total	
N	0	46	5	695	930	1,429	4,711	567	6,467	6,583	21,433	N
NNE	33	23	0	37	53	2,411	17,067	10,295	16,896	9,603	56,418	NNE
NE	0	0	114	169	139	3,406	115,889	79,316	145,553	38,992	383,578	NE
ENE	0	0	0	68	46	2,063	18,143	4,732	13,539	19,271	57,862	ENE
E	23	55	73	142	73	1,333	7,021	3,538	17,133	50,335	79,726	E
ESE	4	0	205	118	203	1,627	13,411	5,451	25,623	52,600	99,242	ESE
SE	27	88	0	216	126	3,928	37,761	28,431	38,535	229,868	338,980	SE
SSE	0	14	0	107	64	3,007	7,434	15,905	14,566	64,335	105,432	SSE
S	76	57	103	193	45	701	15,584	37,188	26,146	29,184	109,277	S
SSW	0	160	93	107	126	783	3,312	26,191	13,681	17,696	62,149	SSW
SW	0	172	130	116	1,536	800	2,582	27,489	15,978	15,232	64,035	SW
WSW	0	275	52	549	4,616	11,492	25,603	17,225	37,894	33,524	131,230	WSW
W	0	51	157	51	302	1,740	5,971	5,834	29,945	15,022	59,073	W
WNW	0	35	46	36	29	697	3,686	3,797	18,009	65,477	91,812	WNW
NW	0	134	183	0	151	1,110	2,196	1,284	1,402	1,240	7,700	NW
NNW	0	0	0	0	132	1,705	1,594	902	4,299	9,843	18,475	NNW
Totals:	163	1,110	1,161	2,604	8,571	38,232	281,965	268,145	425,666	658,805	1,686,422	
Density	52	101	86	100	173	165	266	213	204	215	People/Sq Mile	

Licensee's Reported Population

N	40	15	49	1,159	2,215	1,200	3,800	1,800	7,300	5,000	22,578	N
NNE	0	17	30	0	0	1,800	16,900	16,100	19,700	9,400	63,947	NNE
NE	0	0	166	199	379	10,000	83,300	109,100	177,400	41,900	422,444	NE
ENE	0	15	38	70	97	1,500	31,500	37,500	12,400	9,600	92,720	ENE
E	0	57	23	43	79	1,200	11,500	1,300	6,900	32,100	53,202	E
ESE	24	27	64	182	177	2,300	12,300	3,200	7,300	31,300	56,874	ESE
SE	44	249	151	149	13	2,900	41,600	27,000	34,400	198,600	305,106	SE
SSE	40	157	38	93	47	3,700	11,500	25,300	10,700	52,700	104,275	SSE
S	36	150	30	142	10	1,900	9,400	30,800	38,900	29,200	110,568	S
SSW	4	249	45	86	123	1,000	5,500	46,100	13,400	21,500	88,007	SSW
SW	4	15	344	93	1,560	2,000	1,600	19,800	25,900	14,800	66,116	SW
WSW	4	61	340	116	4,181	12,800	21,700	23,700	29,700	39,400	132,002	WSW
W	4	31	60	96	187	1,500	4,200	4,700	21,200	15,600	47,578	W
WNW	12	42	45	103	267	700	3,900	2,100	8,500	43,000	58,669	WNW
NW	16	73	94	0	97	900	1,600	1,600	2,000	2,000	8,380	NW
NNW	20	19	15	0	23	1,000	1,600	1,100	3,300	7,500	14,577	NNW
Totals:	248	1,177	1,532	2,531	9,455	46,400	261,900	351,200	419,000	553,600	1,647,043	
Density	79	113	105	109	190	195	257	239	218	210	People/Sq Mile	

SECPop2000 as Percent of Reported

N	*	306.7%	10.2%	60.0%	42.0%	119.1%	124.0%	31.5%	88.6%	131.7%	94.9%	N
NNE	**	135.3%	*	**	**	133.9%	101.0%	63.9%	85.8%	102.2%	88.2%	NNE
NE			68.7%	84.9%	36.7%	34.1%	139.1%	72.7%	82.0%	93.1%	90.8%	NE
ENE		*	*	97.1%	47.4%	137.5%	57.6%	12.6%	109.2%	200.7%	62.4%	ENE
E	**	96.5%	317.4%	330.2%	92.4%	111.1%	61.1%	272.2%	248.3%	156.8%	149.9%	E
ESE	16.7%	*	320.3%	64.8%	114.7%	70.7%	109.0%	170.3%	351.0%	168.1%	174.5%	ESE
SE	61.4%	35.3%	*	145.0%	969.2%	135.4%	90.8%	105.3%	112.0%	115.7%	111.1%	SE
SSE	*	8.9%	*	115.1%	136.2%	81.3%	64.6%	62.9%	136.1%	122.1%	101.1%	SSE
S	211.1%	38.0%	343.3%	135.9%	450.0%	36.9%	165.8%	120.7%	67.2%	99.9%	98.8%	S
SSW	*	64.3%	206.7%	124.4%	102.4%	78.3%	60.2%	56.8%	102.1%	82.3%	70.6%	SSW
SW	*	1146.7%	37.8%	124.7%	98.5%	40.0%	161.4%	138.8%	61.7%	102.9%	96.9%	SW
WSW	*	450.8%	15.3%	473.3%	110.4%	89.8%	118.0%	72.7%	127.6%	85.1%	99.4%	WSW
W	*	164.5%	261.7%	53.1%	161.5%	116.0%	142.2%	124.1%	141.3%	96.3%	124.2%	W
WNW	*	83.3%	102.2%	35.0%	10.9%	99.6%	94.5%	180.8%	211.9%	152.3%	156.5%	WNW
NW	*	183.6%	194.7%	*	155.7%	123.3%	137.3%	80.3%	70.1%	62.0%	91.9%	NW
NNW	*	*	*	*	573.9%	170.5%	99.6%	82.0%	130.3%	131.2%	126.7%	NNW
		65.7%	94.3%	75.8%	102.9%	90.7%	82.4%	107.7%	76.4%	101.6%	119.0%	

* The licensee reported people in the ring segment but SECPop90 did not locate anyone in the ring segment.

** SECPop90 located people in the ring segment but the licensee did not report anyone in the ring segment.

Licensee data from FSAR, Revision 54, Tables 2.1-19 & 2.1-20. ESTIMATED.

Run Date: 07/15/02

Appendix G Census File Creation and Testing Source Code

The VBA subroutines in Section G.1 are designed for use as macros in a spreadsheet *Census DBase Conversion.xls*. They were used to create the census file *CENSUS00.dat*. Similarly, the VBA subroutines in Section G.2 were used as macros in a spreadsheet *2000 CensusDB V&V.xls*. They were used to verify and validate the census file *CENSUS00.dat*.

G.1 Module: “Census_File_Convert”

```
Attribute VB_Name = "Census_File_Test"
Option Explicit

Type Block_Data
    longit As Integer
    latit As Integer
    pop As Integer
    area As Long
    ccode As Integer
End Type

Sub MakeStateList()

    Dim A As Range
    Set A = ActiveCell
    Dim dire As String
    Dim fname As String
    Dim n As Integer
    Dim state
    Dim ccode
    Dim county

    dire = "C:\Documents and Settings\cwmorro\My Documents\SecPop00\Convert"
    fname = dire & "\State Codes.csv"

    Close #1
    Open fname For Input As #1

    Do While Not EOF(1)
        n = n + 1
        Input #1, state, county, ccode
        A.Offset(n, 0).Value = ccode
        A.Offset(n, 1).Value = state
        A.Offset(n, 2).Value = county
    Loop
    Close #1

End Sub

Sub Test1()

    Dim A As Range
    Dim pop(3200) As Double
    Dim area(3200) As Double
    Dim directory As String
    Dim X As Block_Data
    Dim n As Long
    Dim nbyte As Long
    Dim fname As String
    Dim i As Integer

    Set A = ThisWorkbook.Worksheets("sheet3").Range("a1")

    directory = "C:\Documents and Settings\cwmorro\My Documents\SecPop00\Census Data Files"
    fname = directory & "\sort_Block00.dat"
    Close #1
    Open fname For Binary As #1

    With A
        Do While Not EOF(1)
            If n Mod 100000 = 0 Then
                A.Value = n
            End If
            n = n + 1
        Loop
    End With

End Sub
```

```

        End If
        n = n + 1
        nbyte = 12 * n - 11
        Get #1, nbyte, X
        pop(X.ccode) = pop(X.ccode) + X.pop
        area(X.ccode) = area(X.ccode) + X.area
    Loop
    Close #1

    For i = 1 To 3200
        A.Offset(i, 0) = i
        A.Offset(i, 1) = pop(i)
        A.Offset(i, 2) = area(i) / 1000
    Next i
End With

End Sub

Sub Test3()

    Dim A As Range
    Dim pop(3200) As Double
    Dim area(3200) As Double
    Dim area2(3200) As Double
    Dim area3(3200) As Double
    Dim directory As String
    Dim X As Block_Data
    Dim n As Long
    Dim fname1 As String
    Dim fname2 As String
    Dim i As Integer
    Dim ib As Long
    Dim name, key, arealand, Intptlat, Intptlon, Pop100, county, StateCe

    Set A = ActiveCell

    directory = "C:\Documents and Settings\cwmorro\My Documents\SecPop00\Census Data Files"
    fname1 = directory & "\sort_Block00.dat"
    fname2 = "C:\Program Files\SecPop90\CENSUS" & "\CENSUS90.DAT"
    Close #1
    Close #2
    Open fname1 For Binary As #1
    Open fname2 For Binary As #2

    Input #2, name, key, arealand, Intptlat, Intptlon, Pop100, county, StateCe

    With A
        Do While Not EOF(1)
            If n Mod 100000 = 0 Then
                A.Value = n
            End If
            n = n + 1
            Get #1, , X
            pop(X.ccode) = pop(X.ccode) + X.pop
            area(X.ccode) = area(X.ccode) + X.area / 1000#
        Loop
        Close #1
        n = 0
        Do While Not EOF(2)
            If n Mod 100000 = 0 Then
                A.Value = n
            End If
            n = n + 1
            Let ib = n * 12 - 11
            Get #2, ib, X
            pop(X.ccode) = pop(X.ccode) + X.pop
            area2(X.ccode) = area2(X.ccode) + X.area / 1000#
        Loop

        For i = 1 To 3200
            A.Offset(i, 0) = i
            A.Offset(i, 1) = pop(i)
            A.Offset(i, 2) = area(i)
            A.Offset(i, 3) = area2(i)
        Next i
    End With

End Sub

```



```

Sub test2()

    Dim A As Range
    Dim ThisLong As Integer
    Dim LastLong As Integer
    Dim Blockfile1 As String
    Dim directory As String
    Dim i As Long
    Dim n As Long
    Dim X As Block_Data

    directory = "C:\Documents and Settings\cwmorro\My Documents\SecPop00\Census Data Files"
    Set A = ActiveCell

    Blockfile1 = directory & "\Sort_Block00.dat"

    Close #1
    Open Blockfile1 For Binary As #1

    LastLong = 32767

    With A
        Do While Not EOF(1)
            i = i + 1
            Get #1, 12 * (i - 1) + 1, X
            ThisLong = X.longit
            If i Mod 100000 = 0 Then A.Value = i
            If (ThisLong > LastLong) Then
                If EOF(1) Then Exit Do
                n = n + 1
                A.Offset(n, 0) = i
                A.Offset(n, 2) = ThisLong
                A.Offset(n, 1) = LastLong
            End If
            LastLong = ThisLong
        Loop
        A.Value = i
    End With
End Sub

Sub Test4()

    Dim A As Range
    Dim CountyPop(3200) As Double
    Dim CountyArea(3200) As Double
    Dim StatePop(100) As Double
    Dim StateArea(100) As Double
    Dim directory As String
    Dim StateList(3200) As Integer
    Dim X As Block_Data
    Dim n As Long
    Dim nbyte As Long
    Dim fname As String
    Dim i As Integer

    Set A = ThisWorkbook.Worksheets("State List").Range("A1")
    With A
        For i = 1 To UBound(StateList)
            StateList(i) = .Offset(i, 1).Value
        Next i
    End With

    Set A = ActiveCell

    directory = "C:\Documents and Settings\cwmorro\My Documents\SecPop00\Census Data Files"
    fname = directory & "\sort_Block00.dat"
    Close #1
    Open fname For Binary As #1

    With A
        Do While Not EOF(1)
            If n Mod 100000 = 0 Then
                A.Value = n
            End If
            n = n + 1
            nbyte = 12 * n - 11
            Get #1, nbyte, X
            CountyPop(X.ccode) = CountyPop(X.ccode) + X.pop
            CountyArea(X.ccode) = CountyArea(X.ccode) + X.area
        Loop
    End With
End Sub

```

```
        StatePop(StateList(X.ccode)) = StatePop(StateList(X.ccode)) + X.pop
        StateArea(StateList(X.ccode)) = StateArea(StateList(X.ccode)) + X.area
    Loop
    Close #1
    For i = 1 To 3200
        A.Offset(i, 0) = i
        A.Offset(i, 1) = CountyPop(i)
        A.Offset(i, 2) = CountyArea(i) / 1000
    Next i
    For i = 1 To 100
        A.Offset(i, 5) = i
        A.Offset(i, 6) = StatePop(i)
        A.Offset(i, 7) = StateArea(i) / 1000
    Next i
    End With
End Sub
```

G.2 Module: "Census_File_Test"

```
Attribute VB_Name = "Census_File_Test"
Option Explicit

Type Block_Data
    longit As Integer
    latit As Integer
    pop As Integer
    area As Long
    ccode As Integer
End Type

Sub MakeStateList()

    Dim A As Range
    Set A = ActiveCell
    Dim dire As String
    Dim fname As String
    Dim n As Integer
    Dim state
    Dim ccode
    Dim county

    dire = "C:\Documents and Settings\cwmorro\My Documents\SecPop00\Convert"
    fname = dire & "\State Codes.csv"

    Close #1
    Open fname For Input As #1

    Do While Not EOF(1)
        n = n + 1
        Input #1, state, county, ccode
        A.Offset(n, 0).Value = ccode
        A.Offset(n, 1).Value = state
        A.Offset(n, 2).Value = county
    Loop
    Close #1

End Sub

Sub Test1()

    Dim A As Range
    Dim pop(3200) As Double
    Dim area(3200) As Double
    Dim directory As String
    Dim X As Block_Data
    Dim n As Long
    Dim nbyte As Long
    Dim fname As String
    Dim i As Integer

    Set A = ThisWorkbook.Worksheets("sheet3").Range("a1")

    directory = "C:\Documents and Settings\cwmorro\My Documents\SecPop00\Census Data Files"
    fname = directory & "\sort_Block00.dat"
    Close #1
    Open fname For Binary As #1

    With A
        Do While Not EOF(1)
            If n Mod 100000 = 0 Then
                A.Value = n
            End If
            n = n + 1
            nbyte = 12 * n - 11
            Get #1, nbyte, X
            pop(X.ccode) = pop(X.ccode) + X.pop
            area(X.ccode) = area(X.ccode) + X.area
        Loop
    Close #1

    For i = 1 To 3200
        A.Offset(i, 0) = i
        A.Offset(i, 1) = pop(i)
        A.Offset(i, 2) = area(i) / 1000
    Next i

End Sub
```

```

End With

End Sub

Sub Test3()

Dim A As Range
Dim pop(3200) As Double
Dim area(3200) As Double
Dim area2(3200) As Double
Dim area3(3200) As Double
Dim directory As String
Dim X As Block_Data
Dim n As Long
Dim fname1 As String
Dim fname2 As String
Dim i As Integer
Dim ib As Long
Dim name, key, arealand, Intptlat, Intptlon, Pop100, county, StateCe

Set A = ActiveCell

directory = "C:\Documents and Settings\cwmorro\My Documents\SecPop00\Census Data Files"
fname1 = directory & "\sort_Block00.dat"
fname2 = "C:\Program Files\SecPop90\CENSUS" & "\CENSUS90.DAT"
Close #1
Close #2
Open fname1 For Binary As #1
Open fname2 For Binary As #2

Input #2, name, key, arealand, Intptlat, Intptlon, Pop100, county, StateCe

With A
Do While Not EOF(1)
    If n Mod 100000 = 0 Then
        A.Value = n
    End If
    n = n + 1
    Get #1, , X
    pop(X.ccode) = pop(X.ccode) + X.pop
    area(X.ccode) = area(X.ccode) + X.area / 1000#
Loop
Close #1
n = 0
Do While Not EOF(2)
    If n Mod 100000 = 0 Then
        A.Value = n
    End If
    n = n + 1
    Let ib = n * 12 - 11
    Get #2, ib, X
    pop(X.ccode) = pop(X.ccode) + X.pop
    area2(X.ccode) = area2(X.ccode) + X.area / 1000#
Loop

For i = 1 To 3200
    A.Offset(i, 0) = i
    A.Offset(i, 1) = pop(i)
    A.Offset(i, 2) = area(i)
    A.Offset(i, 3) = area2(i)
Next i
End With

End Sub

Sub test2()

Dim A As Range
Dim ThisLong As Integer
Dim LastLong As Integer
Dim Blockfile1 As String
Dim directory As String
Dim i As Long
Dim n As Long
Dim X As Block_Data

directory = "C:\Documents and Settings\cwmorro\My Documents\SecPop00\Census Data Files"
Set A = ActiveCell

```

```

Blockfile1 = directory & "\Sort_Block00.dat"

Close #1
Open Blockfile1 For Binary As #1

LastLong = 32767

With A
  Do While Not EOF(1)
    i = i + 1
    Get #1, 12 * (i - 1) + 1, X
    ThisLong = X.longit
    If i Mod 100000 = 0 Then A.Value = i
    If (ThisLong > LastLong) Then
      If EOF(1) Then Exit Do
      n = n + 1
      A.Offset(n, 0) = i
      A.Offset(n, 2) = ThisLong
      A.Offset(n, 1) = LastLong
    End If
    LastLong = ThisLong
  Loop
  A.Value = i
End With
End Sub

Sub Test4()

  Dim A As Range
  Dim CountyPop(3200) As Double
  Dim CountyArea(3200) As Double
  Dim StatePop(100) As Double
  Dim StateArea(100) As Double
  Dim directory As String
  Dim StateList(3200) As Integer
  Dim X As Block_Data
  Dim n As Long
  Dim nbyte As Long
  Dim fname As String
  Dim i As Integer

  Set A = ThisWorkbook.Worksheets("State List").Range("A1")
  With A
    For i = 1 To UBound(StateList)
      StateList(i) = .Offset(i, 1).Value
    Next i
  End With

  Set A = ActiveCell

  directory = "C:\Documents and Settings\cwmorro\My Documents\SecPop00\Census Data Files"
  fname = directory & "\sort_Block00.dat"
  Close #1
  Open fname For Binary As #1

  With A
    Do While Not EOF(1)
      If n Mod 100000 = 0 Then
        A.Value = n
      End If
      n = n + 1
      nbyte = 12 * n - 11
      Get #1, nbyte, X
      CountyPop(X.ccode) = CountyPop(X.ccode) + X.pop
      CountyArea(X.ccode) = CountyArea(X.ccode) + X.area
      StatePop(StateList(X.ccode)) = StatePop(StateList(X.ccode)) + X.pop
      StateArea(StateList(X.ccode)) = StateArea(StateList(X.ccode)) + X.area
    Loop
  Close #1

  For i = 1 To 3200
    A.Offset(i, 0) = i
    A.Offset(i, 1) = CountyPop(i)
    A.Offset(i, 2) = CountyArea(i) / 1000
  Next i
  For i = 1 To 100
    A.Offset(i, 5) = i
  Next i
End Sub

```

```
        A.Offset(i, 6) = StatePop(i)
        A.Offset(i, 7) = StateArea(i) / 1000
    Next i
End With
End Sub
```

Appendix H SECPOP2000 Source Code

The following sections contain source code listings for the modules, forms and class structures that make up the executable file "SECPOP2000.exe"

H.1 Visual Basic Code Module: CALCCODE.BAS

```
Attribute VB_Name = "CalcCode"
'*****
' Module: CalcCode
'
' Project: SECPOP
'
' Description: This module contains the subroutines necessary to allocate CENSUS DATA
' to a population matrix. The subroutines take user specifications from
' other modules to determine the census file, location and areal extent
' to use for this analysis. Based on this information, this module populates
' a sector population, sector area and sector economic matrices. This data
' provides the basis for output as MACCS input files or other uses.
'
' Modification History
' Date By Description
'-----
' 20020110 cwm Incorporated '90 version into '00 project.
' 20020110 cwm Modified popcalc sub to accept any size database files.
'*****

' GLOSSARY OF VARIABLES:
' AMINLA = LATITUDE OF TROPIC OF CANCER
' BNDRYE = LONGITUDE OF EASTERNMOST POINT ON GRID
' BNDRYN = LATITUDE OF NORTHERNMOST POINT ON GRID
' BNDRYS = LATITUDE OF SOUTHERNMOST POINT ON GRID
' BNDRYW = LONGITUDE OF WESTERNMOST POINT ON GRID
' DELLAT = DIFFERENCE IN LATITUDE FROM SITE TO GRID BOUNDARIES
' DELLON = DIFFERENCE IN LONGITUDE FROM SITE TO GRID BOUNDARIES
' DISMAX = MAXIMUM RADIAL DISTANCE FOR GRID (KM)
' DPDLAT = DISTANCE PER DEGREE LATITUDE (KM)
' DPDLON = DISTANCE PER DEGREE LONGITUDE (KM)
' NUMDIR = NUMBER OF RADIAL DIRECTIONS IN GRID
' NUMRAD = NUMBER OF RADIAL DISTANCES DESIGNATED
' OFFSET = RADIANS TO END OF FIRST RADIAL DIRECTION
' RADDIS = ARRAY OF RADIAL DISTANCES IN MACCS GRID
' SCALE = POPULATION SCALING FACTOR (MULTIPLIER) FOR SITE
' SDPDLA = DISTANCE PER DEGREE LATITUDE AT THE SITE
' SDPDLO = DISTANCE PER DEGREE LONGITUDE AT THE SITE
' SITID$ = SITE IDENTIFIER
' SLAT = SITE LATITUDE IN DECIMAL DEGREES
' SLON = SITE LONGITUDE IN DECIMAL DEGREES
' sector_population = ARRAY OF POPULATION FOUND IN EACH GRID ELEMENT
' XLON = LONGITUDE OF POINT READ FROM CENSUS DATA FILE
' YLAT = LATITUDE OF POINT READ FROM CENSUS DATA FILE

' EXTERNALS:
' GETDIR = DETERMINES THE RADIAL DIRECTION OF A POINT (XLON,YLAT)
' FROM THE SITE AT (SLON,SLAT)
' GETDIS = DETERMINES THE DISTANCE (KM) PER DEGREE FOR BOTH
' LATITUDE AND LONGITUDE AT A GIVEN LATITUDE
' GETRAD = DETERMINES THE RADIAL SECTOR IN WHICH POINT (XLON,
```

```

'          YLAT) LIES RELATIVE TO THE SITE (SLAT,SLON)
'   POINTR = FINDS THE FIRST RECORD IN THE SORTED DATA FILE IN
'          WHICH THE POINT LIES ON OR TO THE EAST OF THE WESTERN
'          BOUNDARY OF THE GRID '$INCLUDE: 'SECP90.BI'

Option Explicit

Function DIST(X, Y)

    DIST = Sqr(X ^ 2! + Y ^ 2!)

End Function

Sub GETDIR(ylat, idir As Integer)

'   THIS SUBROUTINE RETURNS THE DIRECTIONAL ELEMENT IN WHICH POINT
'   (XLON,YLAT) LIES

'   GLOSSARY OF VARIABLES:
'   ANGLI = ANGLE OF RIGHT SIDE OF THE RADIAL DIRECTION CONSIDERED
'   ANGLO = ANGLE OF LEFT SIDE OF THE RADIAL DIRECTION CONSIDERED
'   IDIR  = RADIAL DIRECTION IN WHICH POINT (XLON,YLAT) LIES
'   OFFSET = ANGLE OF RIGHT SIDE OF RADIAL DIRECTION 1
'   SLAT  = LATITUDE OF SITE
'   SLON  = LONGITUDE OF SITE
'   THETA = CLOCKWISE ANGLE FROM NORTH AT WHICH POINT (XLON,YLAT)
'          LIES RELATIVE TO THE SITE
'   XLON  = LONGITUDE OF THE SITE
'   YLAT  = LATITUDE OF THE SITE
'
'
Dim offset As Double
Dim AVDPD As Double
Dim DX As Double
Dim DY As Double
Dim THETA As Double
Dim k As Double
Dim j As Double
Dim L As Double

Dim ANGLO As Double
Dim ANGLI As Double
Dim i As Integer
'Dim idir As Integer

offset = 3.1416 / 16!

idir = 0
If (slat = ylat) Then
    idir = 5
    If (slon <= xlon) Then
        idir = idir + 8
    End If
Else
    AVDPD = (sdpdla + dpdlat) / 2!
    DX = dpdlon * (slon - xlon)
    DY = AVDPD * (ylat - slat)
    THETA = Atn(DX / DY)
    If ((Abs(THETA) < offset) Or (THETA = offset)) Then
        idir = 1
        If (ylat < slat) Then
            idir = idir + 8
        End If
    End If
End If

```



```

      End If
Else
  j = 1
  For i = 1 To 3
    k = i * 2 + 1
    L = i * 2 - 1
    j = j + 1
    ANGLO = offset * L
    ANGHI = offset * k
    If ((ANGLO < Abs(THETA)) And (Abs(THETA) < ANGHI)) Then
      If (THETA > 0!) Then
        idir = j
        If (ylat < slat) Then
          idir = idir + 8
        End If
      Else
        idir = 18 - j
        If (ylat < slat) Then
          idir = idir - 8
        End If
      End If
    End If
  Next i
End If
End If

If (idir = 0) Then
  If (THETA > 0!) Then
    idir = 5
    If (xlon > slon) Then
      idir = idir + 8
    End If
  Else
    idir = 13
    If (xlon < slon) Then
      idir = idir - 8
    End If
  End If
End If

End Sub

Sub GETDIS(Y As Single)

' THIS SUBROUTINE RETURNS THE DISTANCE PER DEGREE LATITUDE AND
' DISTANCE PER DEGREE LONGITUDE AT THE GEODETIC LATITUDE (SLAT)

' GLOSSARY OF VARIABLES:
' COSGC = COSINE OF GEOCENTRIC ANGLE
' COS2GC = SQUARE OF COSGC
' DGTORD = CONVERSION FACTOR FOR DEGREES TO RADIANS
' DPDLAT = DISTANCE PER DEGREE LATITUDE AT SLAT (KM)
' DPDLON = DISTANCE PER DEGREE LONGITUDE AT SLON (KM)
' GDRLA = GEODETIC LATITUDE IN RADIANS

' QLAT = GEODETIC LATITUDE OF POINT CONSIDERED
' RE2 = SQUARE OF EQUATORIAL RADIUS OF EARTH
' RGD = RADIUS OF GEODETIC LATITUDE CIRCLE (KM)
' RLONG = RADIUS OF LONGITUDE "CIRCLE" (KM)
' RP2 = SQUARE OF POLAR RADIUS OF EARTH
' RPROD = PRODUCT OF EQUATORIAL AND POLAR RADII
' SINGC = SINE OF GEOCENTRIC ANGLE
' SIN2GC = SQUARE OF SINGC
' THGC = GEOCENTRIC ANGLE CORRESPONDING TO THE GEODETIC

```

```

'          LATITUDE

Dim RE, RE2, RP, RP2, RRATIO, RPROD, GDRLA, THGC, SINGC, SIN2GC, COSGC, COS2GC
Dim RGC, RGD, RLONG

' DEFINE CONSTANTS

RE = 6378.137
RE2 = RE ^ 2!
RP = 6356.7523142
RP2 = RP ^ 2!
RRATIO = RP2 / RE2
RPROD = RE * RP

' FIND THE GEODETIC LATITUDE IN RADIANS

GDRLA = Y * DgToRd

' FIND THE GEODETIC LATITUDE IN THE MASTER COORDINATE SYSTEM

THGC = Atn(RRATIO * Tan(GDRLA))
SINGC = Sin(THGC)
SIN2GC = SINGC ^ 2!
COSGC = Cos(THGC)
COS2GC = COSGC ^ 2!

' FIND THE GEOCENTRIC RADIUS (KM)

RGC = RPROD / Sqr(RE2 * SIN2GC + RP2 * COS2GC)

' FIND THE RADIUS OF THE LONGITUDE "CIRCLE"

RLONG = RGC * COSGC

' FIND THE GEODETIC RADIUS

RGD = RLONG * (Tan(THGC) / Sin(GDRLA))

'FIND THE DISTANCE PER DEGREE LATITUDE AND LONGITUDE (KM)

dpdlat = RGD * DgToRd
dpdlon = RLONG * DgToRd

End Sub

Sub GETRAD(ylat, numrad As Integer, irad As Integer)

' THIS SUBROUTINE GETS THE RADIAL SPATIAL ELEMENT IN WHICH THE
' POINT (XLON,YLAT) LIES

' GLOSSARY OF VARIABLES:
' AVDPD = AVERAGE DISTANCE PER DEGREE LATITUDE BETWEEN THE SITE
'        AND A POINT AT LATITUDE YLAT
' DELX  = DIFFERENCE IN LONGITUDE BETWEEN A POINT AT (XLON,
'        YLAT) AND THE SITE
' DELY  = DIFFERENCE IN LATITUDE BETWEEN A POINT AT (XLON,YLAT)
'        AND THE SITE
' DISMAX = RADIUS OF THE FULL MACCS GRID
' DISTST = DISTANCE FROM POINT (XLON,YLAT) TO THE SITE
' IRAD   = THE RADIAL SECTOR OF THE MACCS GRID IN WHICH POINT
'        (XLON, YLAT) LIES
' RADDIS = ARRAY OF RADIAL DISTANCES OF THE MACCS GRID BEING USED
' SLAT   = LATITUDE OF THE SITE
' SLON   = LONGITUDE OF THE SITE

```

```

Dim DELX, AVDPD, DELY, DISTST, JRAD

DELX = Abs(slon - xlon) * dpdlon
AVDPD = (sdpdla + dpdlat) / 2!
DELY = Abs(slat - ylat) * AVDPD

DISTST = DIST(DELX, DELY)

irad = 0

If (DISTST <= dismax) Then
  If (DISTST <= raddis(1)) Then
    irad = 1
  ElseIf (numrad >= 2) Then
    For JRAD = 2 To numrad
      If ((DISTST > raddis(JRAD - 1)) And (DISTST <= raddis(JRAD))) Then
        irad = JRAD
        Exit For
      End If
    Next JRAD
  End If
End If

End Sub

Sub POINTR(ByVal bndryw, census_file As Long, ylat, ipop As Integer, area As Long, county_code As
Integer, ibyte As Long)

' THIS SUBROUTINE FINDS THE FIRST RECORD IN THE CENSUS DATA FILE
' WHICH IS AT THE WESTERN BOUNDARY OF THE GRID

' GLOSSARY OF VARIABLES:
' ALAT = POINT LATITUDE IN DECIMAL NOTATION
' ALON = POINT LONGITUDE IN DECIMAL NOTATION
' BNDRYW = LONGITUDE OF WESTERN BOUNDARY OF GRID
' ILAT = CODED INTEGER REPRESENTATION OF LATITUDE OF POINT
' IN CENSUS DATA FILE
' ILOM = CODED INTEGER REPRESENTATION OF LONGITUDE OF POINT
' IN CENSUS DATA FILE
' ILONW = CODED INTEGER REPRESENTATION OF WESTERN BOUNDARY
' LONGITUDE OF GRID
' XLON = LONGITUDE OF FIRST CENSUS DATA POINT LOCATED ON OR
' WITHIN THE MACCS GRID
' YLAT = LATITUDE OF FIRST CENSUS DATA POINT LOCATED ON OR
' WITHIN THE MACCS GRID
Dim Numrec As Long

Numrec = Number_of_Records

*****
' ROUTINE TO READ FROM RANDOM ACCESS BINARY FILE *
*****

Dim MIDREC As Long, NBYTE As Long
Dim IBEG As Long, IEND As Long
Dim ILONW As Long, ilon, JLON, ilat, CEND$
Dim A As Block_Data

ILONW = bndryw * 1000 - longitude_offset
Get #census_file, 1, rec
ilon = rec.longit
If (ilon > ILONW) Then
  IBEG = 1

```

```

        IEND = Numrec
        icode = 1
    Else
        icode = 1
        GoTo process
    End If

ReadRecord:

MIDREC = Int((IBEG + IEND) / 2)
NBYTE = icode
icode = ((MIDREC - 1) * record_length) + 1
If (NBYTE <> icode) Then
    Get #census_file, icode, rec
    ilon = rec.longit
    If (ilon > ILONW) Then
        IBEG = MIDREC
        GoTo ReadRecord
    ElseIf (ilon = ILONW) Then
        GoTo FindFirst
    ElseIf (ilon < ILONW) Then
        A = rec
        icode = icode - record_length
        Get #census_file, icode, rec
        JLON = rec.longit
        If (JLON < ILONW) Then
            IEND = MIDREC
            GoTo ReadRecord
        ElseIf (JLON = ILONW) Then
            GoTo FindFirst
        ElseIf (JLON > ILONW) Then
            icode = icode + record_length
            rec = A
            GoTo process
        End If
    End If
Else
    MsgBox "Site not within Continental US.", vbOK, "Error"
    Exit Sub
End If

' Find the first point inside the western boundary

FindFirst:

icode = icode - record_length
A = rec
Get #census_file, icode, rec
ilon = rec.longit
If (ilon = ILONW) Then
    GoTo FindFirst
Else
    If (ilon > ILONW) Then
        icode = icode + record_length
        rec = A
        GoTo process
    End If
End If

' When find the first point process the information

process:

ilon = rec.longit

```

```

    ilat = rec.latit
    ipop = rec.pop
    area = rec.area
    county_code = rec.ccode

    xlon = (ilon + longitude_offset) / 1000!
    ylat = (ilat + latitude_offset) / 1000!
End Sub

Sub PopCalc()

    Dim TempString As String
    Dim census_file As Long, county_file As Long, debug_file As Long
    Dim NUMLIN As Integer, INUM As Integer, B$, JBEG As Integer
    Dim JEND As Integer, NLEFT As Integer, C$
    Dim L1$, L2$, L3$, L4$, L5$, L6$, L7$, LA1 As Integer, LA2 As Integer
    Dim LA3 As Integer, LO1 As Integer, LO2 As Integer, LO3 As Integer
    Dim D$, DELLON, DELLAT, ilon As Integer, ilat As Integer
    Dim NP1, NP2, NP3, NP4, NP5, NP6, NP7, NP8, CEND$
    Dim ILIN As Integer, i As Integer, j As Integer, m As Integer
    Dim events_open As Integer, average_counter As Integer
    Dim start_file_pos As Long, end_file_pos As Long
    Dim num_records As Long, num_processed As Long, census_records As Long
    Dim hours As Integer, minutes As Integer, seconds As Single
    Dim time_begin As Long, time_end As Long, total_time As Long
    Dim prev_seconds As Single
    ' Dim WestMost As Variant
    ' Dim EastMost As Variant

    'Open census data file, located at the position specified (qqqcensus)
    'by the user in the setup form

    TempString = frmSetup.txtData_path.text & "\" & frmSetup.txtCensus_Database
    census_file = FreeFile
    If Dir$(TempString) = "" Then
        MsgBox "The census file (" & TempString & ") cannot be found. Please check the directory
    " & _
        "specified on the Setup form."
        Exit Sub
    Else
        Open TempString For Binary Access Read As #census_file Len = 32767
        End If
        Number_of_Records = LOF(census_file) / record_length

        'Initialize the county data arrays to their startup values
        'These arrays contain various types of county economic
        'data and state abbreviations.

        frmCalculate.txtStatus.text = "Reading county information."
        ipop = 0
        TempString = App.path & "\" & frmSetup.txtData_path.text + "\COUNTY90.DAT"
        TempString = frmSetup.txtData_path.text + "\COUNTY90.DAT"
        TempString = frmSetup.txtData_path.text & "\" & frmSetup.txtCounty_Database.text
        county_file = FreeFile
        Open TempString For Input Access Read As #county_file

        'Read in the header line. County_state(0) is used as a dummy variable.
        Line Input #county_file, county_state(0)

        'Read in the rest of the file.

```

```

For i = 1 To Number_of_Counties
  If EOF(county_file) Then Exit For
  Input #county_file, county_code
  county_state(i) = Input$(2, #county_file)
  'county_name(i) = Input$(4, #county_file)
  county_name(i) = Input$(max_county_name_length, #county_file)
  Input #county_file, county_frclnd(i)
  Input #county_file, county_frmfrc(i)
  Input #county_file, county_dpf(i)
  Input #county_file, county_asfp(i)
  Input #county_file, county_vfrm(i)
  Input #county_file, county_vnfrm(i)
  'Skip over the notes.
  Line Input #county_file, county_state(0)
Next i

Close (county_file)

aminla = 23.45

'Initialize RADDIS array to the values in the radial distance array so
'that the values can be changed locally without affecting other modules.

For i = 1 To number_of_radii
  If frmProblem_Data.optKilometers.Value = True Then
    raddis(i) = radial_distance(i)
  Else
    raddis(i) = radial_distance(i) * miles_to_kilometers
  End If
Next i

'Initialize the population and land fraction sector arrays and economics
'region arrays to zero.

For i = 1 To number_of_segments Step 1
  For j = 1 To number_of_radii Step 1
    sector_population(i, j) = 0
    sector_area(i, j) = 0
    sector_frclnd(i, j) = 0
  Next j
Next i

For i = 0 To number_econ_regions
  econ_data(i).region_area = 0
  econ_data(i).region_frmfrc = 0
  econ_data(i).region_dpf = 0
  econ_data(i).region_asfp = 0
  econ_data(i).region_vfrm = 0
  econ_data(i).region_vnfrm = 0
Next i

'Set local constants for number of raddii and distance of farthest radii.

numrad = number_of_radii
dismax = raddis(numrad)

ProcessSite:

'Reading interactive input.

sitid$ = frmSite_Data.txtSite_Name.text
L1$ = frmSite_Data.txtLatitude_Degrees.text
L2$ = frmSite_Data.txtLatitude_Minutes.text
L3$ = frmSite_Data.txtLatitude_Seconds.text

```

```

L4$ = frmSite_Data.txtLongitude_Degrees.text
L5$ = frmSite_Data.txtLongitude_Minutes.text
L6$ = frmSite_Data.txtLongitude_Seconds.text
L7$ = frmProblem_Data.txtPopulation_multiplier.text

'Convert interactive input strings into numeric values.

LA1 = Int(Val(L1$))
LA2 = Int(Val(L2$))
LA3 = Int(Val(L3$))
LO1 = Int(Val(L4$))
LO2 = Int(Val(L5$))
LO3 = Int(Val(L6$))
Scaled = Val(L7$)

'Convert Degree/Minute/Second designation to decimal degrees.

slat = Val(L1$) + Val(L2$) / 60! + Val(L3$) / 3600!
slon = Val(L4$) + Val(L5$) / 60! + Val(L6$) / 3600!

'Check to assure Site within U.S.

Get #census_file, 1, rec
'
WestMost = rec.longit
WestMost = (WestMost + longitude_offset) / 1000!
'
Get #census_file, ((Number_of_Records - 1) * record_length) + 1, rec
EastMost = rec.longit
EastMost = (EastMost + longitude_offset) / 1000!
'
If slon < EastMost Then
'
MsgBox "Site East of Continental US.", vbOK, "Error"
frmCalculate.Visible = False
Exit Sub
'
ElseIf slon > WestMost Then
'
MsgBox "Site West of Continental US.", vbOK, "Error"
frmCalculate.Visible = False
Exit Sub
'
End If
'

'Find the longitude-latitude boundaries of grid.
'Set distance per degree latitude for site.

Call GETDIS(slat)
sdpdla = dpdlat

'Set eastern and western boundaries. These boundaries determine which
'records are searched in the census file.

DELLON = dismax / dpdlon
bndryw = Int((slon + DELLON) * 1000 + 0.5) / 1000
bndrye = Int((slon - DELLON) * 1000 + 0.5) / 1000

'Find distance change per degree latitude at some minimum latitude
'(AMINLA).

Call GETDIS(aminla)

'Set northern and southern boundaries. These boundaries do not affect
'which records are searched, but do determine whether or not a point
'is inside of the circle being analyzed.

DELLAT = dismax / sdpdla
bndryn = Int((slat + DELLAT) * 1000 + 0.5) / 1000
DELLAT = dismax / dpdlat

```

```

bndryx = Int((slat - DELLAT) * 1000 + 0.5) / 1000

'Find the last record in the file with the longitude within the
'longitudinal boundaries of the grid. This record is used to
'estimate the run time for the problem.

xlon = 0!
ylat = 0!
area = 0&
county_code = 0
Call POINTR(ByVal bndrye, census_file, ylat, ipop, area, county_code, iblyte)
end_file_pos = iblyte
If (xlon = 0!) Then
    end_file_pos = LOF(census_file)
End If

frmCalculate.txtStatus.text = "Searching for first census record."

ipop = 0
'Find the first record in the file with the longitude within the
'longitudinal boundaries of the grid.

ipop = 0
xlon = 0!
ylat = 0!
area = 0&
county_code = 0
Call POINTR(ByVal bndryw, census_file, ylat, ipop, area, county_code, iblyte)
If (xlon = 0!) Then
    GoTo finishup
End If
start_file_pos = iblyte

'Determine number of records to be scanned in census file (this
'number is used in determining estimated run time for a problem).

num_records = ((end_file_pos - start_file_pos) / record_length)

'Verify that the starting position is within the specified
'longitude and latitude. If so, read in and process the data
'from the first specified record in the census database.

idir = 0
irad = 0

If ((xlon <= bndryw) And (xlon >= bndrye)) Then
    If ((ylat <= bndryn) And (ylat >= bndrys)) Then

        'Determine the distance between the specified site and the first
        'location in the census database.

        Call GETDIS(ylat)
        Call GETRAD(ylat, numrad, irad)

        'If the point is outside of the outermost radius of the circle,
        'read in and process the next record ...

        If (irad = 0) Then
            GoTo Continuel
        Else

```



```

'Otherwise, determine in which sector the block lies.

Call GETDIR(ylat, idir)

'Set the population of the sector to the population of the
'block.

sector_population(idir, irad) = ipop * Scaled
sector_area(idir, irad) = area
sector_frclnd(idir, irad) = area * county_frclnd(county_code)

'Set the regional economic data by setting each of the
'appropriate elements in the user defined data type.

econ_data(region_index(irad, idir - 1)).region_area = area
econ_data(region_index(irad, idir - 1)).region_frmfrc = area *
county_frmfrc(county_code)
econ_data(region_index(irad, idir - 1)).region_dpf = area *
county_dpf(county_code)
econ_data(region_index(irad, idir - 1)).region_asfp = area *
county_asfp(county_code)
econ_data(region_index(irad, idir - 1)).region_vfrm = area *
county_vfrm(county_code)
econ_data(region_index(irad, idir - 1)).region_vnfrm = area *
county_vnfrm(county_code)

'Set number of census records processed thus far.

census_records = 1

End If

End If

End If

Continuel:

'Update labels on calculate form, and begin timer to estimate
'the run time of the calculation

frmCalculate.txtStatus.text = "Processing census records."
time_begin = Timer

'Read each subsequent record in the data file until the first record
'with a longitude outside of the longitudinal boundaries

readit:

'If end of file is reached, finish the economic calculations and exit.

If (EOF(census_file)) Then
  GoTo finishup
End If

'Change to get statement with binary file, and Go to the next record.

ibyte = ibyte + record_length

'Read the data from that record, split it into its constituent pieces,
'and convert those peices from file format to program format. This
'portion of code is done by the ptrntr function for the first record.

Get #census_file, ibyte, rec

```

```

ilon = rec.longit
ilat = rec.latit
ipop = rec.pop
area = rec.area
county_code = rec.ccode
xlon = (ilon + longitude_offset) / 1000!
ylat = (ilat + latitude_offset) / 1000!

'Check and see if the point is within the lat and long boundaries of
'the circle.

If ((xlon <= bndryw) And (xlon >= bndrye)) Then
  If ((ylat <= bndryn) And (ylat >= bndrys)) Then

    'if so, then determine the distance between the point and the
    'center of the circles.

    idir = 0
    irad = 0
    Call GETDIS(ylat)
    Call GETRAD(ylat, numrad, irad)

    'If the point lies outside of the farthest radii, proceed to the
    'next point.

    If (irad = 0) Then
      GoTo Continue2
    Else

      'Determine which sector the point lies in.

      Call GETDIR(ylat, idir)

      'Add the population of the block to the total population of
      'the sector in which it lies.

      sector_population(idir, irad) = sector_population(idir, irad) + (ipop * Scaled)
      sector_area(idir, irad) = sector_area(idir, irad) + area
      sector_frclnd(idir, irad) = sector_frclnd(idir, irad) + (area *
county_frclnd(county_code))

      'Increment the regional economic data by incrementing each of
      'the appropriate elements in the user defined data type.

      econ_data(region_index(irad, idir - 1)).region_area =
econ_data(region_index(irad, idir - 1)).region_area + area
      econ_data(region_index(irad, idir - 1)).region_frmfrc =
econ_data(region_index(irad, idir - 1)).region_frmfrc + (area * county_frmfrc(county_code))
      econ_data(region_index(irad, idir - 1)).region_dpf = econ_data(region_index(irad,
idir - 1)).region_dpf + (area * county_dpf(county_code))
      econ_data(region_index(irad, idir - 1)).region_asfp =
econ_data(region_index(irad, idir - 1)).region_asfp + (area * county_asfp(county_code))
      econ_data(region_index(irad, idir - 1)).region_vfrm =
econ_data(region_index(irad, idir - 1)).region_vfrm + (area * county_vfrm(county_code))
      econ_data(region_index(irad, idir - 1)).region_vnfrm =
econ_data(region_index(irad, idir - 1)).region_vnfrm + (area * county_vnfrm(county_code))

      'Increment the number of records processed.

      census_records = census_records + 1

      If (census_records <= 1000) Then

```

```

idir; irad

        'PRINT #debug_file, USING "###.### ##.### ##### ## ##"; xlon; ylat; ipop;
End If
If census_records Mod 100 = 0 Then

    'Process any user events that may have occurred while
    'calculating. At this point in time only the close
    'calculation button is allowed.

    events_open = DoEvents()

    'If the user has selected close from the calculate
    'form, then close the census file and exit the
    'subroutine.

    If (leave_calculation) Then
        Close #census_file
        leave_calculation = False
        Exit Sub
    End If

    'Update the number of census records displayed
    'status line.

    frmCalculate.txtStatus.text = _
        LTrim$(Str$(census_records)) + _
        " census records processed."

    'Read the timer.

    time_end = Timer

    'Determine how many census records have been read
    '(including those which were not actually
    'processed).

    num_processed = _
        ((iByte - start_file_pos) / record_length)

    'Determine the average time per record and how long
    'to process all remaining records.

    total_time = (((time_end - time_begin) * _
        (num_records - num_processed)) / num_processed)

    'Convert time from seconds to hours/minutes/seconds.

    hours = total_time \ 3600
    minutes = (total_time \ 60) - (hours * 60)
    seconds = _
        (total_time - ((hours * 60 + minutes) * 60))

    'If the time has changed by more than 5 seconds,
    'then update the display.

    If (Abs(seconds - prev_seconds) > 5) Then

        If hours = 0 Then
            frmCalculate.txtTime.text = _
                "Minutes:" + Str$(minutes) + _
                " Seconds:" + Str$(seconds)
        Else
            frmCalculate.txtTime.text = _

```

```

        "Hours:" + Str$(hours) + _
        "  Minutes:" + Str$(minutes) + _
        "  Seconds:" + Str$(seconds)
    End If

    prev_seconds = seconds
End If

End If

End If

End If

GoTo readit

Else

    GoTo finishup

End If

Continue2:

    GoTo readit

finishup:

    'Close census data file, and update display labels.

    Close #census_file
    'CLOSE #debug_file

    frmCalculate.txtStatus.text = "Calculating economic data."

    'Determine the land fraction values for each sector.

    For i = 1 To number_of_segments Step 1
        For j = 1 To number_of_radii Step 1
            If (sector_area(i, j) <> 0) Then
                sector_frclnd(i, j) = sector_frclnd(i, j) / sector_area(i, j)
            Else
                sector_frclnd(i, j) = 0
            End If
        Next j
    Next i

    'Determine the economic values for each region.

    For i = 1 To number_econ_regions Step 1
        If (econ_data(i).region_area <> 0) Then
            econ_data(i).region_frmfrc = econ_data(i).region_frmfrc / econ_data(i).region_area
            econ_data(i).region_dpfc = econ_data(i).region_dpfc / econ_data(i).region_area
        End If
    Next i

```

```

    econ_data(i).region_asfp = econ_data(i).region_asfp / econ_data(i).region_area
    econ_data(i).region_vfrm = econ_data(i).region_vfrm / econ_data(i).region_area
    econ_data(i).region_vnfrm = econ_data(i).region_vnfrm / econ_data(i).region_area

Else

    econ_data(i).region_frmfrc = 0
    econ_data(i).region_dpf = 0
    econ_data(i).region_asfp = 0
    econ_data(i).region_vfrm = 0
    econ_data(i).region_vnfrm = 0

End If

Next i

'Update the user display for the final time letting the user know
'That we are finished and the total number of census records
'processed.

frmCalculate.txtStatus.text = "Finished, " + _
    LTrim$(Str$(census_records)) + " processed."

'CLOSE (debug_file)

End Sub

```

H.2 Visual Basic Code Module: Cmndlg.bas

```
Attribute VB_Name = "Cmndlg"
'''Option Explicit
'''
'''$INCLUDE: 'secpop90.bi'
'''
-----
''' Visual Basic for MS-DOS Common Dialog Toolkit
'''
''' The Common Dialog Toolkit (CMNDLG.BAS and CMNDLGF.FRM)
''' provides support for the following dialogs:
'''     FileOpen
'''     FileSave
'''     FilePrint
'''
''' Support for each dialog is provided via procedures with
''' these same names that create the corresponding dialog
''' and return user input to your program. These procedures
''' only provide the user interface and return user input.
''' They do not actually carry out the corresponding actions
''' such as opening the file. Detailed descriptions of
''' these procedures are contained in the comment headers
''' above each.
'''
''' All common dialogs are created from the same form (CMNDLGF.FRM).
''' The necessary controls for each dialog are children of
''' a container picture box for the dialog. Thus the
''' form (CMNDLGF.FRM) contains a picture box with
''' appropriate controls for common dialog listed above.
''' When a particular common dialog is created and displayed,
''' the container picture box for that dialog is made visible
''' (thus all controls on that picture box become visible)
''' and the form is centered and sized to match the
''' container picture box.
'''
''' To use these common dialogs in your programs, include
''' CMNDLG.BAS and CMNDLGF.FRM in your program or use the
''' supplied library (CMNDLG.LIB, CMNDLGA.LIB - AltMath version
''' for Professional Edition only) and Quick library (CMNDLG.QLB)
''' and call the appropriate procedure to invoke the dialog
''' you need.
'''
''' Copyright (C) 1982-1992 Microsoft Corporation
'''
''' You have a royalty-free right to use, modify, reproduce
''' and distribute the sample applications and toolkits provided with
''' Visual Basic for MS-DOS (and/or any modified version)
''' in any way you find useful, provided that you agree that
''' Microsoft has no warranty, obligations or liability for
''' any of the sample applications or toolkits.
'''
-----
''' FileOpen common dialog support routine
'''
''' Displays Open dialog which allows users to select a
''' file from disk. This procedure only provides
''' the user interface and returns user input. It does
''' not actually carry out the corresponding action.
'''
''' Parameters:
'''     FileName - returns the name (without path) of the
'''               file the user wants to open. To supply
```

```

''''
''''      default filename in dialog, assign default
''''      to FileName then pass it to this procedure.
'''' PathName - returns the path (without filename) of
'''' the file the user wants to open. To supply
'''' default path in dialog, assign default to
'''' PathName then pass it to this procedure.
'''' Note, only pass a valid drive and path. Do
'''' not include a filename or file pattern.
'''' DefaultExt - sets the default search pattern for the
'''' File Listbox. Default pattern when DefaultExt
'''' is null is *.*. To specify a different
'''' search pattern (i.e. *.BAS), assign new
'''' value to DefaultExt then pass it to this
'''' procedure.
'''' DialogTitle - sets the dialog title. Default title
'''' when DialogTitle is null is "Open". To
'''' specify a different title (i.e. "Open My File"),
'''' assign new value to DialogTitle then pass it to
'''' this procedure.
'''' ForeColor - sets the dialog foreground color. Does not affect
'''' SCREEN.ControlPanel color settings.
'''' BackColor - sets the dialog background color. Does not affect
'''' SCREEN.ControlPanel color settings.
'''' Flags - unused. Use this to customize dialog action if needed.
'''' Cancel - returns whether or not user pressed the dialog's Cancel
'''' button. True (-1) means the user cancelled the dialog.
''''
''''Sub FileOpen(filename As String, pathname As String, _
'''' DefaultExt As String, DialogTitle As String, forecolor As Integer, _
'''' backcolor As Integer, Flags As Integer, Cancel As Integer)
''''
''''      ' Set up error handling for option validation.
''''      On Local Error GoTo FileOpenError
''''
''''      ' Set form caption.
''''      If DialogTitle = "" Then
''''          frmCmnDlg.caption = "Open"
''''      Else
''''          frmCmnDlg.caption = DialogTitle
''''      End If
''''
''''      ' Determine search pattern for file listbox.
''''      If DefaultExt <> "" Then
''''          frmCmnDlg.filOpenList.Pattern = DefaultExt
''''      Else
''''          frmCmnDlg.filOpenList.Pattern = *.*
''''      End If
''''
''''      ' Determine default path.
''''      If pathname <> "" Then
''''          ' Set drive and path for file-system controls.
''''          ' Set Directory listbox path. If PathName is different
''''          ' than current path, PathChange event will be triggered
''''          ' which updates Drive listbox drive and File listbox path.
''''          frmCmnDlg.dirOpenList.Path = pathname
''''      End If
''''      ' Display current path to the user.
''''      frmCmnDlg.lblOpenPath.caption = frmCmnDlg.filOpenList.Path
''''
''''      ' Determine default filename to display in edit field.
''''      If filename <> "" Then
''''          frmCmnDlg.txtOpenFile.text = UCase$(filename)
''''      Else
''''          frmCmnDlg.txtOpenFile.text = frmCmnDlg.filOpenList.Pattern

```

```

''' End If
'''
''' ' Set default and cancel command buttons.
frmCmnDlg.cmdOpenOK.Default = True
frmCmnDlg.cmdOpenCancel.Cancel = True
'''
''' ' Size and position Open/Save container.
frmCmnDlg.pctFileOpen.BorderStyle = 0
frmCmnDlg.pctFileOpen.Visible = True
'''
''' ' Size and center dialog.
frmCmnDlg.Move frmCmnDlg.Left, frmCmnDlg.Top, frmCmnDlg.pctFileOpen.Width + 2,
frmCmnDlg.pctFileOpen.Height + 2
''' frmCmnDlg.Move (Screen.Width - frmCmnDlg.Width) \ 2, ((Screen.Height - frmCmnDlg.Height) \
2) - 2
'''
''' ' Set dialog colors.
frmCmnDlg.forecolor = forecolor
frmCmnDlg.backcolor = backcolor
frmCmnDlg.pctFileOpen.forecolor = forecolor
frmCmnDlg.pctFileOpen.backcolor = backcolor
frmCmnDlg.lblOpenFile.forecolor = forecolor
frmCmnDlg.lblOpenFile.backcolor = backcolor
frmCmnDlg.txtOpenFile.forecolor = forecolor
frmCmnDlg.txtOpenFile.backcolor = backcolor
frmCmnDlg.lblOpenPath.forecolor = forecolor
frmCmnDlg.lblOpenPath.backcolor = backcolor
frmCmnDlg.filOpenList.forecolor = forecolor
frmCmnDlg.filOpenList.backcolor = backcolor
frmCmnDlg.drivOpenList.forecolor = forecolor
frmCmnDlg.drivOpenList.backcolor = backcolor
frmCmnDlg.dirOpenList.forecolor = forecolor
frmCmnDlg.dirOpenList.backcolor = backcolor
frmCmnDlg.cmdOpenOK.backcolor = backcolor
frmCmnDlg.cmdOpenCancel.backcolor = backcolor
'''
''' ' Display dialog modally.
frmCmnDlg.Show 1
'''
''' ' Determine if user canceled dialog.
If frmCmnDlg.cmdOpenCancel.Tag <> "FALSE" Then
''' Cancel = True
''' ' If not, return FileName and PathName.
Else
''' Cancel = False
''' filename = frmCmnDlg.txtOpenFile.text
''' pathname = frmCmnDlg.filOpenList.Path
''' frmCmnDlg.cmdOpenCancel.Tag = ""
End If
'''
''' ' Hide or unload dialog and return control to user's program.
' (Hide if user chose to preload form for performance.)
If Left$(frmCmnDlg.Tag, 1) = "H" Then
''' frmCmnDlg.pctFileOpen.Visible = False
''' frmCmnDlg.Hide
Else
''' Unload frmCmnDlg
End If
'''
''' Exit Sub
'''
'''' Option error handling routine.
'''' Ignore errors here and let dialog's controls
'''' handle the errors.

```



```

'''FileOpenError:
'''   Select Case Err
'''   Case 7:
'''       MsgBox "Out of memory.  Can't load dialog.", 0, "FileOpen"
'''       Cancel = True
'''       Exit Sub
'''   Case Else
'''       Resume Next
'''   End Select
'''End Sub
'''
''' FilePrint common dialog support routine
'''
''' Displays Print dialog which allows users to select
''' Print destination (PRINTER.PrintTarget) and the
''' number of copies to print.  This procedure only provides
''' the user interface and returns user input.  It does
''' not actually carry out the corresponding action.
'''
''' Parameters:
'''   Copies - returns the number of copies (1 to 99) the user wants
'''             to print.  To supply default number of copies
'''             in dialog, assign default to Copies then
'''             pass it to this procedure (default when Copies
'''             is 0 is 1).
'''   ForeColor - sets the dialog foreground color.  Does not affect
'''             SCREEN.ControlPanel color settings.
'''   BackColor - sets the dialog background color.  Does not affect
'''             SCREEN.ControlPanel color settings.
'''   Cancel - returns whether or not user pressed the dialog's Cancel
'''             button.  True (-1) means the user cancelled the dialog.
'''
'''Sub FilePrint(Copies As Integer, forecolor As Integer, backcolor As Integer, Cancel As
Integer)
'''
'''   Dim i As Integer
'''
'''   On Local Error GoTo FilePrintError
'''
'''   frmCmnDlg.caption = "Print"           ' Set form caption.
'''
'''   ' Determine default number of copies.
'''   If Copies = 0 Then
'''       frmCmnDlg.txtPrintCopies.text = "1"
'''   Else
'''       frmCmnDlg.txtPrintCopies.text = Str$(Copies)
'''   End If
'''
'''   ' Set default and cancel command buttons.
'''   frmCmnDlg.cmdPrintOK.Default = True
'''   frmCmnDlg.cmdPrintCancel.Cancel = True
'''
'''   ' Size and position Print container.
'''   frmCmnDlg.pctFilePrint.BorderStyle = 0
'''   frmCmnDlg.pctFilePrint.Visible = True
'''
'''   ' Size and center dialog.
'''   frmCmnDlg.Move frmCmnDlg.Left, frmCmnDlg.Top, frmCmnDlg.pctFilePrint.Width + 2,
frmCmnDlg.pctFilePrint.Height + 2
'''   frmCmnDlg.Move (Screen.Width - frmCmnDlg.Width) \ 2, ((Screen.Height - frmCmnDlg.Height) \
2) - 2
'''
'''   ' Set dialog colors.
'''   frmCmnDlg.forecolor = forecolor

```

```

'''
frmCmnDlg.backcolor = backcolor
'''
frmCmnDlg.pctFilePrint.forecolor = forecolor
'''
frmCmnDlg.pctFilePrint.backcolor = backcolor
'''
frmCmnDlg.lblPrintCopies.forecolor = forecolor
'''
frmCmnDlg.lblPrintCopies.backcolor = backcolor
'''
frmCmnDlg.txtPrintCopies.forecolor = forecolor
'''
frmCmnDlg.txtPrintCopies.backcolor = backcolor
'''
frmCmnDlg.txtPrintFile.forecolor = forecolor
'''
frmCmnDlg.txtPrintFile.backcolor = backcolor
'''
frmCmnDlg.fraPrintTarget.forecolor = forecolor
'''
frmCmnDlg.fraPrintTarget.backcolor = backcolor
'''
For i% = 0 To 3
'''
    frmCmnDlg.optPrintTarget(i%).forecolor = forecolor
'''
    frmCmnDlg.optPrintTarget(i%).backcolor = backcolor
'''
Next i%
'''
For i% = 0 To 1
'''
    frmCmnDlg.optPrintAppend(i%).forecolor = forecolor
'''
    frmCmnDlg.optPrintAppend(i%).backcolor = backcolor
'''
Next i%
'''
frmCmnDlg.lblPrintAppend.forecolor = forecolor
'''
frmCmnDlg.lblPrintAppend.backcolor = backcolor
'''
frmCmnDlg.cmdPrintOK.backcolor = backcolor
'''
frmCmnDlg.cmdPrintCancel.backcolor = backcolor
'''
'''
' Display dialog modally.
'''
frmCmnDlg.Show 1
'''
'''
' Determine if user canceled dialog.
'''
If frmCmnDlg.cmdPrintCancel.Tag <> "FALSE" Then
'''
    Cancel = True
'''
' If not, return number of copies to print.
'''
Else
'''
    Cancel = False
'''
    If Val(frmCmnDlg.txtPrintCopies.text) > 99 Then
'''
        Copies = 99
'''
    ElseIf Val(frmCmnDlg.txtPrintCopies.text) < 1 Then
'''
        Copies = 1
'''
    Else
'''
        Copies = Val(frmCmnDlg.txtPrintCopies.text)
'''
    End If
'''
    frmCmnDlg.cmdPrintCancel.Tag = ""
'''
End If
'''
'''
' Hide or unload dialog and return control to user's program.
'''
' (Hide if user chose to preload form for performance.)
'''
If Left$(frmCmnDlg.Tag, 1) = "H" Then
'''
    frmCmnDlg.pctFilePrint.Visible = False
'''
    frmCmnDlg.Hide
'''
Else
'''
    Unload frmCmnDlg
'''
End If
'''
'''
Exit Sub
'''
'''
'''
Error handling routine.
'''
FilePrintError:
'''
    Select Case Err
'''
        Case 7:
'''
            MsgBox "Out of memory. Can't load dialog.", 0, "FindPrint"
'''
            Cancel = True
'''
            Exit Sub
'''
        Case Else
'''
            Resume Next
'''
    End Select
'''

```

```

'''End Sub
'''
''' FileSave common dialog support routine
'''
''' Displays Save dialog which allows users to specify
''' filename for subsequent file save operation.
''' This procedure only provides the user interface and
''' returns user input. It does not actually carry out
''' the corresponding action.
'''
''' Parameters:
'''   FileName - returns the name (without path) of the
'''             file for the save operation. To supply
'''             default filename in dialog, assign default
'''             to FileName then pass it to this procedure.
'''   PathName - returns the path (without filename) of
'''             the file for the save operation. To supply
'''             default path in dialog, assign default to
'''             PathName then pass it to this procedure.
'''             Note, only pass a valid drive and path. Do
'''             not include a filename or file pattern.
'''   DefaultExt - sets the default search pattern for the
'''             File Listbox. Default pattern when DefaultExt
'''             is null is "*.*". To specify a different
'''             search pattern (i.e. "*.BAS"), assign new
'''             value to DefaultExt then pass it to this
'''             procedure.
'''   DialogTitle - sets the dialog title. Default title
'''             when DialogTitle is null is "Save As". To
'''             specify a different title (i.e. "Save My File"),
'''             assign new value to DialogTitle then pass it to
'''             this procedure.
'''   ForeColor - sets the dialog foreground color. Does not affect
'''             SCREEN.ControlPanel color settings.
'''   BackColor - sets the dialog background color. Does not affect
'''             SCREEN.ControlPanel color settings.
'''   Flags - unused. Use this to customize dialog action if needed.
'''   Cancel - returns whether or not user pressed the dialog's Cancel
'''            button. True (-1) means the user cancelled the dialog.
'''
'''Sub FileSave(filename As String, pathname As String, DefaultExt As String, DialogTitle As
String, forecolor As Integer, backcolor As Integer, Flags As Integer, Cancel As Integer)
'''   ' Set up error handling for option validation.
'''   On Local Error GoTo FileSaveError
'''
'''   ' Set form caption.
'''   If DialogTitle = "" Then
'''       frmCmnDlg.caption = "Save As"
'''   Else
'''       frmCmnDlg.caption = DialogTitle
'''   End If
'''   frmCmnDlg.Tag = frmCmnDlg.Tag + "SAVE"           ' Set form tag for common unload
procedure.
'''
'''   ' Determine search pattern for file listbox.
'''   If DefaultExt <> "" Then
'''       frmCmnDlg.filOpenList.Pattern = DefaultExt
'''   Else
'''       frmCmnDlg.filOpenList.Pattern = "*.*"
'''   End If
'''
'''   ' Determine default path.
'''   If pathname <> "" Then
'''       ' If the path ends with a backslash, remove it.

```

```

'''
    If Right$(pathname, 1) = "\" Then
'''
        pathname = Left$(pathname, Len(pathname) - 1)
'''
    End If
'''
    ' Set drive and path for file-system controls.
'''
'''
    ' Set File listbox path. If PathName is different
'''
    ' than current path, PathChange event will be triggered
'''
    ' which updates Drive listbox drive and Directory listbox path.
'''
    frmCmnDlg.filOpenList.Path = pathname
'''
End If
'''
' Display current path to the user.
'''
frmCmnDlg.lblOpenPath.caption = frmCmnDlg.filOpenList.Path
'''
'''
' Determine default filename to display in edit field.
'''
If filename <> "" Then
'''
    frmCmnDlg.txtOpenFile.text = UCase$(filename)
'''
Else
'''
    frmCmnDlg.txtOpenFile.text = frmCmnDlg.filOpenList.Pattern
'''
End If
'''
'''
' Set default and cancel command buttons.
'''
frmCmnDlg.cmdOpenOK.Default = True
'''
frmCmnDlg.cmdOpenCancel.Cancel = True
'''
'''
' Size and position Open/Save container.
'''
frmCmnDlg.pctFileOpen.BorderStyle = 0
'''
frmCmnDlg.pctFileOpen.Visible = True
'''
'''
' Size and center dialog.
'''
frmCmnDlg.Move frmCmnDlg.Left, frmCmnDlg.Top, frmCmnDlg.pctFileOpen.Width + 2,
frmCmnDlg.pctFileOpen.Height + 2
'''
    frmCmnDlg.Move (Screen.Width - frmCmnDlg.Width) \ 2, ((Screen.Height - frmCmnDlg.Height) \
2) - 2
'''
'''
' Set dialog colors.
'''
frmCmnDlg.forecolor = forecolor
'''
frmCmnDlg.backcolor = backcolor
'''
frmCmnDlg.pctFileOpen.forecolor = forecolor
'''
frmCmnDlg.pctFileOpen.backcolor = backcolor
'''
frmCmnDlg.lblOpenFile.forecolor = forecolor
'''
frmCmnDlg.lblOpenFile.backcolor = backcolor
'''
frmCmnDlg.txtOpenFile.forecolor = forecolor
'''
frmCmnDlg.txtOpenFile.backcolor = backcolor
'''
frmCmnDlg.lblOpenPath.forecolor = forecolor
'''
frmCmnDlg.lblOpenPath.backcolor = backcolor
'''
frmCmnDlg.filOpenList.forecolor = forecolor
'''
frmCmnDlg.filOpenList.backcolor = backcolor
'''
frmCmnDlg.drivOpenList.forecolor = forecolor
'''
frmCmnDlg.drivOpenList.backcolor = backcolor
'''
frmCmnDlg.dirOpenList.forecolor = forecolor
'''
frmCmnDlg.dirOpenList.backcolor = backcolor
'''
frmCmnDlg.cmdOpenOK.backcolor = backcolor
'''
frmCmnDlg.cmdOpenCancel.backcolor = backcolor
'''
'''
' Display dialog modally.
'''
frmCmnDlg.Show 1
'''
'''
' Determine if user canceled dialog.
'''
If frmCmnDlg.cmdOpenCancel.Tag <> "FALSE" Then
'''
    Cancel = True
'''
' If not, return FileName and PathName.
'''
Else
'''
    Cancel = False
'''
    filename = frmCmnDlg.txtOpenFile.text
'''

```

```

'''      pathname = frmCmnDlg.filOpenList.Path
'''      frmCmnDlg.cmdOpenCancel.Tag = ""
'''      End If
'''
'''      ' Hide or unload dialog and return control to user's program.
'''      ' (Hide if user chose to preload form for performance.)
'''      If Left$(frmCmnDlg.Tag, 1) = "H" Then
'''          frmCmnDlg.pctFileOpen.Visible = False
'''          frmCmnDlg.Hide
'''          frmCmnDlg.Tag = "H"          ' Reset tag.
'''      Else
'''          Unload frmCmnDlg
'''      End If
'''
'''      Exit Sub
'''
'''
'''      Option error handling routine.
'''      Ignore errors here and let dialog's controls
'''      handle the errors.
'''      FileSaveError:
'''      Select Case Err
'''          Case 7:          ' Out of memory.
'''              MsgBox "Out of memory. Can't load dialog.", 0, "FileSave"
'''              Cancel = True
'''              Exit Sub
'''          Case Else
'''              Resume Next
'''      End Select
'''      End Sub
'''

```

H.3 Visual Basic Code Module: Const.bas

```
Attribute VB_Name = "Const"
'Microsoft Visual Basic constants. Unused (by SECP90) constants are
'commented out to save memory.

'-----
' Visual Basic for MS-DOS Constant Include File
'
' Include file that contains constant definitions
' for enumerated form or control property values and
' event procedure, method, and function parameter values.
'
' This file can be included and used as is in your applications.
' Each constant definition reduces the amount of memory available
' for your application, however, so for best results, include only
' those constant definitions you plan to use in your application.
' In addition, some of the constant definitions below may conflict with
' variable definitions in your existing programs.
'
' Some constants below are commented out because they
' have duplicates (for example, NONE appears in several
' places).
'
' Copyright (C) 1982-1992 Microsoft Corporation
'
' You have a royalty-free right to use, modify, reproduce
' and distribute the sample applications and toolkits provided with
' Visual Basic for MS-DOS (and/or any modified version)
' in any way you find useful, provided that you agree that
' Microsoft has no warranty, obligations or liability for
' any of the sample applications or toolkits.
'-----

'''' -----
'''' General
'''' -----
''''
'''' Booleans
''''CONST TRUE = -1
''''CONST FALSE = 0
''''
'''' -----
'''' Event parameters
'''' -----
''''
'''' Button and Shift (KeyDown, KeyUp, MouseDown, MouseMove, MouseUp)
''''CONST SHIFT_MASK = 1
''''CONST CTRL_MASK = 2
''''CONST ALT_MASK = 4
''''CONST LEFT_BUTTON = 1
''''CONST RIGHT_BUTTON = 2
''''
'''' KeyCode (KeyDown, KeyUp)
''''CONST KEY_BACK = 8
''''CONST KEY_TAB = 9
''''CONST KEY_CLEAR = 12
''''Const KEY_RETURN = 13      ' Enter key
''''CONST KEY_SHIFT = 16
''''CONST KEY_CONTROL = 17
''''CONST KEY_MENU = 18      ' Alt key
''''CONST KEY_PAUSE = 19
```

```

''''CONST KEY_CAPITAL = 20          ' Caps lock key
''''CONST KEY_ESCAPE = 27
''''Const KEY_SPACE = 32
''''CONST KEY_PRIOR = 33           ' Page up key
''''CONST KEY_NEXT = 34           ' Page down key
''''CONST KEY_END = 35
''''CONST KEY_HOME = 36
''''CONST KEY_LEFT = 37
''''Const KEY_UP = 38
''''CONST KEY_RIGHT = 39
''''Const KEY_DOWN = 40
''''CONST KEY_SELECT = 41
''''CONST KEY_PRINT = 42
''''CONST KEY_EXECUTE = 43
''''CONST KEY_SNAPSHOT = 44
''''CONST KEY_INSERT = 45
''''CONST KEY_DELETE = 127        ' Delete key returns 46 in Visual
''''                                ' Basic for Windows.
''''CONST KEY_HELP = 47
''''
'''' KeyCode parameter in KeyDown and KeyUp event procedures
'''' returns the same value as KeyAscii in the KeyPress event
'''' procedure for keys corresponding to ASCII printable
'''' characters (A-Z, a-z, 0-9, ~,[,],{,},+,, etc). Return
'''' values will be the ASCII value of the character (see
'''' ASCII Character Codes topic in Help). Extended ASCII
'''' characters can be returned via KeyCode and KeyAscii
'''' by holding down the ALT key, entering the ASCII number
'''' of the extended ASCII character, then releasing the
'''' ALT key. Note, the NumLock key must be on if the numeric
'''' keypad is used.
''''
''''CONST KEY_NUMPAD0 = 48
''''CONST KEY_NUMPAD1 = 49
''''CONST KEY_NUMPAD2 = 50
''''CONST KEY_NUMPAD3 = 51
''''CONST KEY_NUMPAD4 = 52
''''CONST KEY_NUMPAD5 = 53
''''CONST KEY_NUMPAD6 = 54
''''CONST KEY_NUMPAD7 = 55
''''CONST KEY_NUMPAD8 = 56
''''CONST KEY_NUMPAD9 = 57
''''CONST KEY_MULTIPLY = 42
''''CONST KEY_ADD = 43
''''CONST KEY_SUBTRACT = 45
''''CONST KEY_DECIMAL = 46
''''CONST KEY_DIVIDE = 47
''''CONST KEY_F1 = 112
''''CONST KEY_F2 = 113
''''CONST KEY_F3 = 114
''''CONST KEY_F4 = 115
''''CONST KEY_F5 = 116
''''CONST KEY_F6 = 117
''''CONST KEY_F7 = 118
''''CONST KEY_F8 = 119
''''CONST KEY_F9 = 120
''''CONST KEY_F10 = 121
''''CONST KEY_F11 = 122
''''CONST KEY_F12 = 123
''''CONST KEY_NUMLOCK = 144
''''CONST KEY_SCRLOCK = 145
''''
'''' State (DragOver)
''''CONST ENTER = 0

```

```

''''CONST LEAVE = 1
''''CONST OVER = 2
''''
''''-----
'''' Function parameters
''''-----
''''
'''' MSGBOX parameters
''''Const vbOK = 0           ' OK button only
''''CONST vbOKCancel = 1     ' OK and Cancel buttons
''''CONST vbAbortRetryIgnore = 2 ' Abort, Retry, and Ignore buttons
''''Const vbYesNoCancel = 3  ' Yes, No, and Cancel buttons
''''Const vbYesNo = 4        ' Yes and No buttons
''''CONST vbRetryCancel = 5  ' Retry and Cancel buttons
''''
''''Const vbDefaultButton1 = 0           ' First button is default
''''Const vbDefaultButton2 = 256        ' Second button is default
''''CONST vbDefaultButton3 = 512        ' Third button is default
''''
'''' MSGBOX return values
''''CONST IDOK = 1                 ' OK button pressed
''''Const IDCANCEL = 2             ' Cancel button pressed
''''CONST IDABORT = 3              ' Abort button pressed
''''CONST IDRETRY = 4              ' Retry button pressed
''''CONST IDIGNORE = 5             ' Ignore button pressed
''''Const vbYes = 6                ' Yes button pressed
''''Const vbNo = 7                 ' No button pressed
''''
''''-----
'''' Method parameters
''''-----
''''
'''' DRAG (controls)
''''CONST CANCEL_DRAG = 0
''''CONST BEGIN_DRAG = 1
''''CONST END_DRAG = 2
''''
'''' SHOW (form)
''''Const MODELESS = 0
''''Const = 1
''''
''''-----
'''' Property values
''''-----
''''
'''' Alignment (label)
''''CONST LEFT_JUSTIFY = 0         ' 0 - Left Justify
''''CONST RIGHT_JUSTIFY = 1        ' 1 - Right Justify
''''CONST CENTER = 2              ' 2 - Center
''''
'''' BackColor, ForeColor (form, controls)
''''
''''Const BLACK = 0
''''Const BLUE = 1
''''CONST GREEN = 2
''''Const CYAN = 3
''''CONST RED = 4
''''Const MAGENTA = 5
''''CONST BROWN = 6
''''Const WHITE = 7
''''CONST GRAY = 8
''''CONST BRIGHT_BLUE = 9
''''CONST BRIGHT_GREEN = 10

```



```

'''Const BRIGHT_CYAN = 11
'''CONST BRIGHT_RED = 12
'''CONST PINK = 13
'''CONST YELLOW = 14
'''Const BRIGHT_WHITE = 15
'''
''' BorderStyle (form)
'''CONST NONE = 0 ' 0 - None
'''CONST FIXED_SINGLE = 1 ' 1 - Fixed Single
'''CONST SIZABLE_SINGLE = 2 ' 2 - Sizable Single
'''CONST FIXED_DOUBLE = 3 ' 3 - Fixed Double
'''CONST SIZABLE_DOUBLE = 4 ' 4 - Sizable Double
'''CONST FIXED_SOLID = 5 ' 5 - Fixed Solid
'''CONST SIZABLE_SOLID = 6 ' 6 - Sizable Solid
'''
''' BorderStyle (label, picture box, text box)
'''CONST NONE = 0 ' 0 - None
'''CONST SINGLE_LINE = 1 ' 1 - Single Line
'''CONST DOUBLE_LINE = 2 ' 2 - Double Line
''' ' (label and picture box only)
'''
''' DragMode (controls)
'''CONST MANUAL = 0 ' 0 - Manual
'''CONST AUTOMATIC = 1 ' 1 - Automatic
'''
''' FormType (form - Multiple Document Interface (MDI) vs Single Document
''' Interface (SDI) applications)
'''CONST NORMAL = 0 ' 0 - Normal
''' ' (Normal form in SDI
''' ' applications, child form in
''' ' MDI applications)
'''CONST MDI = 1 ' 1 - MDI (Container form in
''' ' MDI application)
'''
''' MousePointer (form, controls)
'''CONST DEFAULT = 0 ' 0 - Default (Same
''' ' MousePointer as container
''' ' object's MousePointer)
'''CONST BLOCK = 1 ' 1 - Block (ASCII 219)
'''CONST CROSSHAIR = 2 ' 2 - Cross (ASCII 197)
'''CONST IBEAM = 3 ' 3 - I-Beam (ASCII 73)
'''CONST ICON = 4 ' 4 - Icon (ASCII 002)
'''CONST SIZE_POINTER = 5 ' 5 - Size (ASCII 015)
'''CONST LEFT_ARROW = 6 ' 6 - Left Arrow (ASCII 027)
'''CONST SIZE_N_S = 7 ' 7 - Size North South
''' ' (ASCII 018)
'''CONST RIGHT_ARROW = 8 ' 8 - Right Arrow (ASCII 026)
'''CONST SIZE_W_E = 9 ' 9 - Size West East
''' ' (ASCII 029)
'''CONST UP_ARROW = 10 ' 10 - Up Arrow (ASCII 024)
'''CONST HOURGLASS = 11 ' 11 - Hourglass (ASCII 088)
'''CONST DOWN_ARROW = 12 ' 12 - Down Arrow (ASCII 025)
'''
''' ScrollBar (text box)
'''CONST NONE = 0 ' 0 - None
'''CONST HORIZONTAL = 1 ' 1 - Horizontal
'''CONST VERTICAL = 2 ' 2 - Vertical
'''CONST BOTH = 3 ' 3 - Both
'''
''' Value (check box)
'''CONST UNCHECKED = 0 ' 0 - Unchecked
'''CONST CHECKED = 1 ' 1 - Checked
'''CONST GRAYED = 2 ' 2 - Grayed
'''

```

```

'''' WindowState (form)
''''CONST NORMAL = 0           ' 0 - Normal
''''CONST MINIMIZED = 1       ' 1 - Minimized
''''CONST MAXIMIZED = 2       ' 2 - Maximized
''''
'''' SCREEN.ControlPanel array elements
''''CONST ACCESSKEY_FORECOLOR = 0           ' Access key foreground
''''                                         ' color (0-15).
''''Const ACTIVE_BORDER_BACKCOLOR = 1       ' Active border background
''''                                         ' color (0-15).
''''Const ACTIVE_BORDER_FORECOLOR = 2       ' Active border foreground
''''                                         ' color (0-15).
''''Const ACTIVE_WINDOW_SHADOW = 3          ' Active window shadow
''''                                         ' effect (Boolean).
''''CONST COMBUTTON_FORECOLOR = 4           ' Command button foreground
''''                                         ' color (0-15).
''''CONST DESKTOP_BACKCOLOR = 5             ' Desktop background
''''                                         ' color (0-15).
''''CONST DESKTOP_FORECOLOR = 6            ' Desktop foreground
''''                                         ' color (0-15).
''''Const DESKTOP_PATTERN = 7              ' Desktop fill pattern
''''                                         ' (ASCII 0-255).
''''CONST DISABLED_ITEM_FORECOLOR = 8       ' Disabled menu/dialog item
''''                                         ' foreground color (0-15).
''''Const MENU_BACKCOLOR = 9               ' Menu background color (0-15).
''''Const MENU_FORECOLOR = 10              ' Menu foreground color (0-15).
''''CONST MENU_SELECTED_BACKCOLOR = 11     ' Menu selected item background
''''                                         ' color (0-15).
''''CONST MENU_SELECTED_FORECOLOR = 12     ' Menu selected item foreground
''''                                         ' color (0-15).
''''Const SCROLLBAR_BACKCOLOR = 13          ' Scrollbar background
''''                                         ' color (0-15).
''''Const SCROLLBAR_FORECOLOR = 14         ' Scrollbar foreground
''''                                         ' color (0-15).
''''CONST THREE_D = 15                    ' 3-D effect for controls with
''''                                         ' borders (Boolean).
''''Const TITLEBAR_BACKCOLOR = 16          ' Titlebar background
''''                                         ' color (0-15).
''''Const TITLEBAR_FORECOLOR = 17         ' Titlebar foreground
''''                                         ' color (0-15).
''''
''''

```

'11/30/01: SECPop90 specific constants have been moved to Secpop90.bas.

```

'Public Const number_of_segments = 16
'Public Const max_econ_regions = 99
'Public Const min_econ_regions = 2
'Public Const max_number_of_radii = 35
'Public Const max_county_name_length = 27
'Public Const record_length = 12
'Public Const longitude_offset = 91993
'Public Const latitude_offset = 16610&
'Public Const number_of_records = 6660337
'Public Const number_of_counties = 3111
'Public Const miles_to_kilometers = 1.60934721869
'Public Const kilometers_to_miles = 0.6213699495
'Public Const max_layers = 10
'Public Const seconds_in_a_day = 86400
'ssPublic Const pi = 3.14159265358979

```

H.4 Visual Basic Code Module: FormsPosition.bas

```
Attribute VB_Name = "FormsPosition"  
Option Explicit
```

```
Public Sub SetFormPosition()
```

```
    Dim FormsTop As Integer  
    Dim FormsLeft As Integer
```

```
    FormsTop = 50
```

```
    FormsLeft = 50
```

```
    ' Me.Top = FormsTop
```

```
    ' Me.Left = FormsLeft
```

```
End Sub
```

H.5 Visual Basic Code Module: GridUtils.bas

```
Attribute VB_Name = "GridUtils"
'''Option Explicit
'''
'''Public Function StoreUserData(Bookmark As Variant, _
'''                               Col As Integer, _
'''                               Userverval As Variant, _
'''                               gridarray() As String, _
'''                               maxrow As Integer, _
'''                               maxcol As Integer) As Boolean
'''
'''StoreUserData is called from UnboundWriteData to
'''write the newly changed information in the grid to
'''the array. This function is called once for each
'''field that needs to be stored. The grid cell that
'''this function is called to store is specified in
'''the same way as in GetUserData.
'''
'''    Dim Index As Long
'''
'''    ' Figure out which row the bookmark refers to
'''    Index = IndexFromBookmark(Bookmark, False, maxrow)
'''    If Index < 0 Or Index >= maxrow Or Col < 0 Or _
'''        Col >= maxcol Then
'''        ' Cell position is invalid, so just return null
'''        ' to indicate failure
'''        StoreUserData = False
'''    Else
'''        StoreUserData = True
'''        gridarray(Col, Index) = Userverval
'''    End If
'''
'''End Function
'''
'''Public Sub TDBGridUnboundWriteData(ByVal RowBuf As TrueOleDBGrid70.RowBuffer, _
'''                                   WriteLocation As Variant, _
'''                                   gridarray() As String, _
'''                                   maxrow As Integer, _
'''                                   maxcol As Integer)
'''
'''RowBuf is the row buffer from which you retrieve the
'''data to be stored in the data source. Since only one
'''row can be updated at a time, RowBuf.RowCount always
'''equals 1 here. If a particular column in the row has
'''not been changed, its element in the RowBuf.Value
'''array will be Null.
'''
'''WriteLocation is a bookmark that identifies the row
'''to be updated.
'''
'''Assume that a function StoreUserData(bookmark, col,
'''value) takes a row bookmark, a column index, and a
'''variant with the appropriate data to be stored in an
'''array or database. The function returns True if the
'''data is acceptable and can be stored, False otherwise.
'''
'''Loop over all the columns of the row, storing non-Null
'''values
'''
'''    Dim i As Integer
'''
'''    For i = 0 To RowBuf.ColumnCount - 1
```

```

'''''' If Not IsNull(RowBuf.Value(0, i)) Then
''''''     If Not StoreUserData(WriteLocation, i, _
''''''         RowBuf.Value(0, i), gridarray, maxrow, maxcol) Then
''''''         RowBuf.RowCount = 0 ' Tell the grid the
''''''             ' update failed. so
''''''             Exit Sub           ' so exit the event.
''''''     End If
'''''' End If
'''''' Next i
'''''' End Sub

'''''' Public Function GetNewBookmark(maxrow As Long) As Variant
'''''' Public Function GetNewBookmark(maxrow As Integer) As Variant
'''''' GetNewBookmark is called when we need to create a
'''''' bookmark for a newly added record (row).
''''''
'''''' Reserve space for the new row in the array
'''''' ReDim Preserve gridarray(0 To maxcol - 1, 0 To maxrow)
''''''
'''''' Since the row index of the last record is (MaxRow - 1),
'''''' the next available index for the row to be added is
'''''' (MaxRow), so create a bookmark for the new row using
'''''' MaxRow as an index.
'''''' GetNewBookmark = MakeBookmark(maxrow)
''''''
'''''' Increment the number of rows in our dataset
'''''' maxrow = maxrow + 1
''''''
'''''' Calibrate the scroll bars based on the new dataset
'''''' size.
'''''' TDBGrid1.ApproxCount = maxrow
'''''' End Function

'''''' Public Sub TDBGridUnboundReadData(ByVal RowBuf As TrueOleDBGrid70.RowBuffer, _
'''''' StartLocation As Variant, _
'''''' ByVal ReadPriorRows As Boolean, _
'''''' gridarray() As String, _
'''''' maxrow As Integer, _
'''''' maxcol As Integer)
''''''
'''''' RowBuf is the row buffer where you place the data and
'''''' the bookmarks for the rows that the grid is requesting
'''''' to display. It will also hold the number of rows that
'''''' were successfully supplied to the grid.
''''''
'''''' StartLocation is a bookmark which specifies the row
'''''' before or after the desired data, depending on the
'''''' value of ReadPriorRows. If we are reading rows after
'''''' StartLocation (ReadPriorRows = False), then the first
'''''' row of data the grid wants is the row after
'''''' StartLocation, and if we are reading rows before
'''''' StartLocation (ReadPriorRows = True) then the first
'''''' row of data the grid wants is the row before
'''''' StartLocation.
''''''
'''''' ReadPriorRows is a boolean value indicating whether
'''''' we are reading rows before (ReadPriorRows = True) or
'''''' after (ReadPriorRows = False) StartLocation.
''''''
'''''' Dim Bookmark As Variant
'''''' Dim i As Long, RelPos As Long
'''''' Dim j As Integer, RowsFetched As Integer

```

```

''''''
'''''' Get a bookmark for the start location
'''''' Bookmark = StartLocation
''''''
'''''' If ReadPriorRows Then
''''''     RelPos = -1 ' Requesting data in rows prior to
''''''               ' StartLocation
'''''' Else
''''''     RelPos = 1 ' Requesting data in rows after
''''''               ' StartLocation
'''''' End If
''''''
'''''' RowsFetched = 0
'''''' For i = 0 To RowBuf.RowCount - 1
''''''     ' Get the bookmark of the next available row
''''''     Bookmark = GetRelativeBookmark(Bookmark, RelPos, maxrow)
''''''
''''''     ' If the next row is BOF or EOF, then stop
''''''     ' fetching and return any rows fetched up to this
''''''     ' point.
''''''     If IsNull(Bookmark) Then Exit For
''''''
''''''     ' Place the record data into the row buffer
''''''     For j = 0 To RowBuf.ColumnCount - 1
''''''         RowBuf.Value(i, j) = GetUserData(Bookmark, j, gridarray(), _
''''''                                         maxrow, maxcol)
''''''     Next j
''''''
''''''     ' Set the bookmark for the row
''''''     RowBuf.Bookmark(i) = Bookmark
''''''
''''''     ' Increment the count of fetched rows
''''''     RowsFetched = RowsFetched + 1
'''''' Next i
''''''
'''''' Tell the grid how many rows we fetched
'''''' RowBuf.RowCount = RowsFetched
''''''
''''''End Sub
''''''
''''''Public Function MakeBookmark(Index As Long) As Variant
'''''' This support function is used only by the remaining
'''''' support functions. It is not used directly by the
'''''' unbound events. It is a good idea to create a
'''''' MakeBookmark function such that all bookmarks can be
'''''' created in the same way. Thus the method by which
'''''' bookmarks are created is consistent and easy to
'''''' modify. This function creates a bookmark when given
'''''' an array row index.
''''''
'''''' Since we have data stored in an array, we will just
'''''' use the array index as our bookmark. We will convert
'''''' it to a string first, using the CStr function.
''''''
'''''' MakeBookmark = CStr(Index)
''''''
''''''End Function
''''''
''''''Public Function IndexFromBookmark(Bookmark As Variant, _
'''''' ReadPriorRows As Boolean, maxrow As Integer) As Long
''''''
'''''' This support function is used only by the remaining
'''''' support functions. It is not used directly by the
'''''' unbound events.

```

```

''''''
'''''' This function is the inverse of MakeBookmark. Given
'''''' a bookmark, IndexFromBookmark returns the row index
'''''' that the given bookmark refers to. If the given
'''''' bookmark is Null, then it refers to BOF or EOF. In
'''''' such a case, we need to use ReadPriorRows to
'''''' distinguish between the two. If ReadPriorRows = True,
'''''' the grid is requesting rows before the current
'''''' location, so we must be at EOF, because no rows exist
'''''' before BOF. Conversely, if ReadPriorRows = False,
'''''' we must be at BOF.
''''''
'''''' Dim Index As Long
''''''
'''''' If IsNull(Bookmark) Then
''''''     If ReadPriorRows Then
''''''         ' Bookmark refers to EOF. Since (MaxRow - 1)
''''''         ' is the index of the last record, we can use
''''''         ' an index of (MaxRow) to represent EOF.
''''''         IndexFromBookmark = maxrow
''''''     Else
''''''         ' Bookmark refers to BOF. Since 0 is the
''''''         ' index of the first record, we can use an
''''''         ' index of -1 to represent BOF.
''''''         IndexFromBookmark = -1
''''''     End If
'''''' Else
''''''     ' Convert string to long integer
''''''     Index = Val(Bookmark)
''''''
''''''     ' Check to see if the row index is valid:
''''''     ' (0 <= Index < MaxRow).
''''''     ' If not, set it to a large negative number to
''''''     ' indicate that the bookmark is invalid.
''''''     If Index < 0 Or Index >= maxrow Then Index = -9999
''''''     IndexFromBookmark = Index
'''''' End If
'''''' End Function
''''''
'''''' Public Function GetRelativeBookmark(Bookmark As Variant, _
''''''                                     RelPos As Long, _
''''''                                     maxrow As Integer) As Variant
''''''
'''''' GetRelativeBookmark is used to get a bookmark for a
'''''' row that is a given number of rows away from the given
'''''' row. This specific example will always use either -1
'''''' or +1 for a relative position, since we will always be
'''''' retrieving either the row previous to the current one,
'''''' or the row following the current one.
''''''
'''''' IndexFromBookmark expects a Bookmark and a Boolean
'''''' value: this Boolean value is True if the next row to
'''''' read is before the current one [in this case,
'''''' (RelPos < 0) is True], or False if the next row to
'''''' read is after the current one [(RelPos < 0) is False].
'''''' This is necessary to distinguish between BOF and EOF
'''''' in the IndexFromBookmark function if our bookmark is
'''''' Null. Once we get the correct row index from
'''''' IndexFromBookmark, we simply add RelPos to it to get
'''''' the desired row index and create a bookmark using
'''''' that index.
''''''
'''''' Dim Index As Long
''''''

```

```

'''''' Index = IndexFromBookmark(Bookmark, RelPos < 0, maxrow) + RelPos
'''''' If Index < 0 Or Index >= maxrow Then
''''''     ' Index refers to a row before the first or after
''''''     ' the last, so just return Null.
''''''     GetRelativeBookmark = Null
'''''' Else
''''''     GetRelativeBookmark = MakeBookmark(Index)
'''''' End If
''''''End Function
''''''
''''''Public Function GetUserData(Bookmark As Variant, _
''''''    Col As Integer, _
''''''    gridarray() As String, _
''''''    maxrow As Integer, _
''''''    maxcol As Integer) As Variant
''''''
'''''' In this example, GetUserData is called by
'''''' UnboundReadData to ask the user what data should be
'''''' displayed in a specific cell in the grid. The grid
'''''' row the cell is in is the one referred to by the
'''''' Bookmark parameter, and the column it is in it given
'''''' by the Col parameter. GetUserData is called on a
'''''' cell-by-cell basis.
''''''
'''''' Dim Index As Long
''''''
'''''' Figure out which row the bookmark refers to
'''''' Index = IndexFromBookmark(Bookmark, False, maxrow)
''''''
'''''' If Index < 0 Or Index >= maxrow Or _
''''''     Col < 0 Or Col >= maxcol Then
''''''     ' Cell position is invalid, so just return null
''''''     ' to indicate failure
''''''     GetUserData = Null
'''''' Else
''''''     GetUserData = gridarray(Col, Index)
''''''     Print #22, "col = " & Col & " row = " & Index & " " & gridarray(Col, Index)
'''''' End If
''''''End Function
''''''
''''''
''''''Public Sub TDBGridUnboundGetRelativeBookmark(StartLocation As Variant, _
''''''    ByVal OFFSET As Long, _
''''''    NewLocation As Variant, _
''''''    ApproximatePosition As Long, _
''''''    maxrow As Integer)
''''''
'''''' Dim Index As Long
''''''
'''''' If StartLocation is NULL, then we are positioning
'''''' from either BOF or EOF. Once we determine the
'''''' correct index for StartLocation, we will simply add
'''''' the offset to get the correct destination row.
'''''' If IsNull(StartLocation) Then
''''''     If OFFSET < 0 Then
''''''         ' The row to position to is before the current
''''''         ' one, therefore we must be at EOF (There are
''''''         ' no rows before BOF). Since (MaxRow-1) is
''''''         ' the index of the last record, we can use an
''''''         ' index of (MaxRow) to represent EOF.
''''''         Index = maxrow + OFFSET
''''''     Else
''''''         ' The row to position to is after the current

```



```

''''''
''''''      ' one, therefore we must be at BOF (There are
''''''      ' no rows after EOF). Since 0 is the index of
''''''      ' the first record, we can use an index of -1
''''''      ' to represent BOF.
''''''      Index = -1 + OFFSET
''''''      End If
'''''' Else
''''''      ' We are not at BOF or EOF, so just get the index
''''''      ' of the current row and add the offset to it.
''''''      Index = Val(StartLocation) + OFFSET
''''''      End If
''''''
'''''' Is the new Index valid?
'''''' If Index >= 0 And Index < maxrow Then
''''''      ' Here, 0 <= Index < MaxRow, so the new location is
''''''      ' valid.
''''''      ApproximatePosition = Index
''''''      NewLocation = MakeBookmark(Index)
'''''' Else
''''''      ' The new index is out-of-bounds -- the new location
''''''      ' refers to a position before the first record or
''''''      ' after the last one. Thus the index is invalid,
''''''      ' and we return Null.
''''''      NewLocation = Null
''''''      End If
''''''
'''''' End Sub

```

H.6 Visual Basic Code Module: InIt.bas

```
Attribute VB_Name = "InIt"
'*****
' Module:  Init
'
' Project:  SECPop
'
' Description:  This module contains initialization statements to be called on
'              program initiation
'
' Modification History
' Date      By      Description
'-----
' 20020303 cwm  Changed initial value of number_of_radrii variable.
' 20020310 ss   Added declarations needed to show the browse window
'              Added the code to find all available census files and
'              show them on the setup form
'*****

Option Explicit

Public Type economic_data
    region_area As Long
    region_frmfrc As Single
    region_dpf As Single
    region_asfp As Single
    region_vfrm As Single
    region_vnfrm As Single
End Type

Public Type Block_Data
    longit As Integer
    latit As Integer
    pop As Integer
    area As Long
    ccode As Integer
End Type

Public Const MainTitle = "SECPop2000 - SECTOR POPulation and Economic Estimator - Version 3.11"

'SECPop specific constants.

Public Const number_of_segments = 16
Public Const max_econ_regions = 99
Public Const min_econ_regions = 2
Public Const max_number_of_radrii = 35
Public Const max_county_name_length = 27
Public Const record_length = 12
Public Const longitude_offset = 91993
Public Const latitude_offset = 16610&
' cwm Public Const number_of_records = 6660337
Public Const Number_of_Counties = 3200
Public Const miles_to_kilometers = 1.60934721869
Public Const kilometers_to_miles = 0.6213699495
Public Const max_layers = 10
Public Const seconds_in_a_day = 86400
Public Const pi = 3.14159265358979
Public Const KEY_RETURN = 13

'Define all of the dynamic arrays used in SECPop.

Public radial_distance(max_number_of_radrii) As Single
```

```

Public raddis(max_number_of_radII) As Single
Public regional_radII(max_number_of_radII) As Single
Public population(max_number_of_radII) As Long
Public population_threshold(max_number_of_radII) As Long

Public region_index(max_number_of_radII, _
    number_of_segments) As Integer
Public econ_data(max_econ_regions) As economic_data

Public sector_population(number_of_segments, _
    max_number_of_radII) As Long
Public sector_area(number_of_segments, _
    max_number_of_radII) As Long
Public sector_frclnd(number_of_segments, _
    max_number_of_radII) As Single

Public county_state(Number_of_Counties) As String * 2 'defining # of characters as two since it
won't change
Public county_name(Number_of_Counties) As String * max_county_name_length
Public county_frclnd(Number_of_Counties) As Single
Public county_frmfrc(Number_of_Counties) As Single
Public county_dpf(Number_of_Counties) As Single
Public county_asfp(Number_of_Counties) As Single
Public county_vfrm(Number_of_Counties) As Single
Public county_vnfrm(Number_of_Counties) As Single

Public directions(number_of_segments) As String

Public layer_number(max_layers) As Integer
Public data_flag(max_layers) As Integer
Public display_flag(max_layers) As Integer
Public active_layer(max_layers) As Integer
Public layer_name(max_layers) As String
Public pts_color(max_layers) As Integer
Public pts_type(max_layers) As Integer
Public pts_size(max_layers) As Integer
Public pts_mode(max_layers) As Integer
Public lines_color(max_layers) As Integer
Public lines_type(max_layers) As Integer
Public lines_size(max_layers) As Integer
Public lines_mode(max_layers) As Integer
Public polyg_color(max_layers) As Integer
Public polyg_type(max_layers) As Integer
Public polyg_size(max_layers) As Integer
Public polyg_mode(max_layers) As Integer
Public text_color(max_layers) As Integer
Public text_type(max_layers) As Integer
Public text_size(max_layers) As Integer
Public text_mode(max_layers) As Integer
Public BaseDirectory As String

Public radial_area(max_number_of_radII) As Single

Public Number_of_Records As Long 'cwm
Public leave_calculation As Integer
Public rec As Block_Data 'cwm
Public xlon As Single, ylat As Single
Public ipop As Integer, area As Long, county_code As Integer
Public idir As Integer, irad As Integer, ibyte As Long

Public number_of_radII As Integer, numrad As Integer
Public Population_multiplier As Single
Public Scaled As Single

```

```

Public slon As Single, slat As Single
Public dismax As Single, sitid$
Public dpdlat As Single, dpdlon As Single, sdpdla As Single
Public bndryw As Single, bndrye As Single
Public bndryn As Single, bndrys As Single
Public aminla As Single
Public DgToRd As Single 'qqq
Public BaseDir As String 'qqq
'Public region_index() As Integer,
Public number_econ_regions As Integer
'Public econ_data() As economic_data
Public table_type As Integer
Public x_position As Integer
Public y_position As Integer

```

```

Public InitSiteFilePath As String
Public InitProblemFilePath As String
Public InitOutputFilePath As String

```

```

Public InitSiteFilePathChanged As Boolean
Public InitProblemFilePathChanged As Boolean
Public InitOutputFilePathChanged As Boolean

```

```

.....
' Copyright ©1996-2002 VBnet, Randy Birch, All Rights Reserved.
' Some pages may also contain other copyrights by the author.
.....
' You are free to use this code within your own applications,
' but you are expressly forbidden from selling or otherwise
' distributing this source code without prior written consent.
' This includes both posting free demo projects made from this
' code as well as reproducing the code in text or html format.
.....

```

```

Public Type BROWSEINFO
    hOwner           As Long
    pidlRoot         As Long
    pszDisplayName   As String
    lpszTitle        As String
    ulFlags          As Long
    lpfm             As Long
    lParam           As Long
    iImage           As Long
End Type

```

```

Public Const BIF_RETURNONLYFSDIRS = &H1
Public Const BIF_DONTGOBELOWDOMAIN = &H2
Public Const BIF_STATUSTEXT = &H4
Public Const BIF_RETURNFSANCESTORS = &H8
Public Const BIF_BROWSEFORCOMPUTER = &H1000
Public Const BIF_BROWSEFORPRINTER = &H2000
Public Const MAX_PATH = 260

```

```

Public Declare Function SHGetPathFromIDLList Lib "shell32" _
    Alias "SHGetPathFromIDLListA" _
    (ByVal pidl As Long, _
    ByVal pszPath As String) As Long

```

```

Public Declare Function SHBrowseForFolder Lib "shell32" _
    Alias "SHBrowseForFolderA" _
    (lpBrowseInfo As BROWSEINFO) As Long

```

```

Public Declare Sub CoTaskMemFree Lib "ole32" _
    (ByVal pv As Long)

```

'--end block--'

Public Sub Initializations()

Dim i As Integer
Dim j As Integer

Dim strCensusFile As String
Dim strCountyFile As String
Dim strFname As String
Dim strFnames(50) As String

'Define variables local to this event procedure.

Dim filenum As Integer, TempString As String

'Set up error handler for errors in the configuration
'file, and load in the various parameters from the
'setup file into the setup form. These parameters
'are set by the user in the exit menu under setup.
'Because input will not interact directly with forms,
'tempstring is used as a buffer for file data.

'Load in the forms that we need to keep permanently in memory.

Load frmProblem_Data
frmMain.mnuSave_ProblemCom.Enabled = False
frmMain.mnuSave_As_ProblemCom.Enabled = False

Load frmSite_Data
frmMain.mnuSave_Sitecom.Enabled = False
frmMain.mnuSave_as_Sitecom.Enabled = False

Load frmSetup
InitSiteFilePathChanged = True
InitProblemFilePathChanged = True
InitOutputFilePathChanged = True

```
' frmDisclaimer.Show  
' On Local Error GoTo configerr  
'  
' 'Check and see if config file exists.  
' tempstring = App.path & "\SECPOP.CFG"  
' If Len(Dir$(tempstring)) <> 0 Then  
' If Len(Dir$("SECPOP.CFG")) <> 0 Then  
'  
' 'Open file and read in the data from it.  
'  
' filenum = FreeFile  
' Open "SECPOP.CFG" For Input As filenum  
' Open tempstring For Input As filenum  
' Input #filenum, tempstring  
' frmSetup.txtSite_Path.text = tempstring  
' Input #filenum, tempstring  
' frmSetup.txtProblem_path.text = tempstring  
' Input #filenum, tempstring  
' frmSetup.txtOutput_path.text = tempstring  
' Input #filenum, tempstring  
' frmSetup.txtData_path.text = tempstring
```

```

'      Input #filenum, tempstring
'      If (tempstring = "MACCS") Then
'          frmSetup.optMACCS.Value = True
'      Else
'          frmSetup.optCSV.Value = True
'      End If
'      Input #filenum, tempstring
'      frmSetup.txtCensus_Database.text = tempstring
'      Close #filenum
'
'else if config file doesn't exist use defaults.
'
Else
    'Defaults set in form.
'
End If
'
'Turn off error handler.
'
On Local Error GoTo 0
'
' check if census file on setup form is legit.
' if not, give message and show setup form
'
Load frmSetup
strFname = frmSetup.txtData_path.text & "\" & frmSetup.txtCensus_Database.text
'
On Error Resume Next
strCensusFile = Dir$(strFname)
On Error GoTo 0
If strCensusFile = "" Then
    MsgBox "SecPop cannot find the census file: " & vbCrLf & _
        strFname & vbCrLf & vbCrLf & _
        "You will need to either place the census file in " & _
        "the CENSUS directory, or manually edit the SECPOP.CFG " & _
        "file to point to the directory where the CENSUS file " & _
        "is located. " & vbCrLf & vbCrLf & _
        "SecPop will end."
    frmSetup.Show
End
End If
'
'get all census files for combo box on setup form,
'
strFname = App.path & "\census\census*.dat"
'
strCensusFile = Dir$(strFname)
If strCensusFile = "" Then
    MsgBox "SecPop cannot find the census file: " & _
        strFname & vbCrLf & _
        "SecPop will end."
'
End
Else
    i = -1
    strCensusFile = Dir$(App.path & "\census\census*.dat")
    While strCensusFile <> ""
        i = i + 1
        strFnames(i) = UCase(strCensusFile)
        strCensusFile = Dir$
    Wend
End If
'
For j = 0 To i

```

```

        frmSetup.cboCensus_Database.AddItem strFnames(j)
    Next j

    'set caption to show which census file is being used
    frmMain.caption = MainTitle & " (" & _
        frmSetup.txtCensus_Database.text & ")"

    'County file
    strFname = frmSetup.txtData_path.text & "\" & frmSetup.txtCounty_Database.text

    On Error Resume Next
    strCountyFile = Dir$(strFname)
    On Error GoTo 0
    If strCountyFile = "" Then
        MsgBox "SecPop cannot find the economic file: " & vbCrLf & _
            strFname & vbCrLf & _
            "SecPop will end."
        frmSetup.Show
    End
End If

'get all census files for combo box on setup form,
'
'   strFname = App.path & "\census\census*.dat"
'
'   strCensusFile = Dir$(strFname)
'   If strCensusFile = "" Then
'       MsgBox "SecPop cannot find the census file: " & _
'           strFname & vbCrLf & _
'           "SecPop will end."
'   End
'   Else
'       i = -1
'       strCountyFile = Dir$(App.path & "\census\county*.dat")
'       While strCountyFile <> ""
'           i = i + 1
'           strFnames(i) = UCase(strCountyFile)
'           strCountyFile = Dir$
'       Wend
'   End If

For j = 0 To i
    frmSetup.cboCounty_Database.AddItem strFnames(j)
Next j

'set up default dirs

InitSiteFilePath = frmSetup.txtSite_Path
InitProblemFilePath = frmSetup.txtProblem_path
InitOutputFilePath = frmSetup.txtOutput_path

With frmMain.dlgSecpop
    .CancelError = True
End With

'Initialize to zero the radial distance array.
'
'   For i = 1 To max_number_of_radial
'       radial_distance(i) = 0.1
'   Next i

```

```

radial_distance(1) = 0.1
For i = 2 To max_number_of_radii
    radial_distance(i) = 0
Next i

'Reset the number of radii to 0

number_of_radii = 1

'Data for radii to be used for the regional calculations.

'Data 1, 2, 3, 4, 5, 6, 7, 8, 9, 10
'Data 11, 12, 13, 14, 15, 16, 17, 18, 19, 20
'Data 30, 40, 50, 60, 70, 80, 90
'Data 100, 110, 120, 130, 140, 150, 160, 170

'Data for forms which display the compass points.

'Data "N", "NNE", "NE", "ENE", "E", "ESE", "SE", "SSE", "S", "SSW", "SW"
'Data "WSW", "W", "WNW", "NW", "NNW"

'Initialize the radii used for regional calculations.

'bem-array defined
regional_radii(0) = 1
regional_radii(1) = 2
regional_radii(2) = 3
regional_radii(3) = 4
regional_radii(4) = 5
regional_radii(5) = 6
regional_radii(6) = 7
regional_radii(7) = 8
regional_radii(8) = 9
regional_radii(9) = 10
regional_radii(10) = 11
regional_radii(11) = 12
regional_radii(12) = 13
regional_radii(13) = 14
regional_radii(14) = 15
regional_radii(15) = 16
regional_radii(16) = 17
regional_radii(17) = 18
regional_radii(18) = 19
regional_radii(19) = 20
regional_radii(20) = 30
regional_radii(21) = 40
regional_radii(22) = 50
regional_radii(23) = 60
regional_radii(24) = 70
regional_radii(25) = 80
regional_radii(26) = 90
regional_radii(27) = 100
regional_radii(28) = 110
regional_radii(29) = 120
regional_radii(30) = 130
regional_radii(31) = 140
regional_radii(32) = 150
regional_radii(33) = 160
regional_radii(34) = 170

'bem-array defined
directions(0) = "N"
directions(1) = "NNE"
directions(2) = "NE"

```



```
directions(3) = "ENE"  
directions(4) = "E"  
directions(5) = "ESE"  
directions(6) = "SE"  
directions(7) = "SSE"  
directions(8) = "S"  
directions(9) = "SSW"  
directions(10) = "SW"  
directions(11) = "WSW"  
directions(12) = "W"  
directions(13) = "WNW"  
directions(14) = "NW"  
directions(15) = "NNW"  
  
DgToRd = pi / 180#  
  
frmRosette.blnInputDataChanged = True  
  
Exit Sub  
  
'configerr:  
'  
'   'If config file format is screwed up use defaults.  
'  
'   Close filenum  
'   Exit Sub  
  
End Sub
```

H.7 Visual Basic Code Module: MainModule.bas

```
Attribute VB_Name = "MainModule"
Option Explicit

'*****
' Module: MainModule
'
' Project: SECPOP
'
' Description:
'
' Modification History
' Date      By      Description
' -----  --  -----
'
'*****

Public Sub Main()

    'Initialize variables
    Initializations

    frmMain.Show
    frmDisclaimer.Show

End Sub
```

H.8 Visual Basic Code Module: Mp_setup.bas

```
Attribute VB_Name = "Mp_setup"  
'qqq ChDir "mapplan"  
'qqq Shell "setup.exe"  
'qqq ChDir ".."  
'qqq RUN "secpop90"
```

H.9 Visual Basic Code Module: Outpcode1.bas

```
Attribute VB_Name = "Outpcode"
'*****
' Module: Outpcode
'
' Project: SECPOP
'
' Description: This module contains the subroutines necessary to output a
'             MACCS input file in:
'             MACCS Compatible Format
'             CSV format
'             Screen
'             Hard Copy
'
' Modification History
' Date      By      Description
'-----
' 20020131  cwm    Incorporated '90 version into '00 project.
' 20020213  cwm    Changed print control to dlgsecpop
' 20020213  cwm    Incorporated print to file as means of saving file.
' 20020319  cwm    upgraded print to file and fixed table print bug
' 20020610  cwm    changed print to file utility to stop trailing commas
'             change print to printer so left characters print first for long lines
'*****

Option Explicit

Sub print_MACCS_input_file(f, MorC)

    'This routine prints SECPOP output in MACCS compatible form or in
    'a quotation mark comma delimited form. It can be used to print to
    'a printer or a file.

    Dim quote As String, comma As String
    Dim blank As String, degree As String
    Dim i As Integer, j As Integer
    Dim Out As String

    'Set quote and comma strings to null if MACCS input file format is
    'selected or to '"' and ',' if comma separated variable (CSV) format
    'is selected.

    If (MorC = "MACCS") Then
        quote = ""
        comma = ""
        blank = " "
        degree = Chr$(100) 'Set degree character to "d" for reduced F77 ASCII set.
    ElseIf (MorC = "CSV") Then
        quote = """"
        comma = ","
        blank = " "
        degree = Chr$(176)
    Else
        quote = ""
        comma = ""
        blank = " "
        degree = Chr$(100)
    End If

    'Enable local error checking for things like printer off line, etc.
```

```

On Local Error GoTo print_maccs_error

'Initialize RADDIS array to Kilometers.
For i = 1 To number_of_radri Step 1
    If (frmProblem_Data.optKilometers.Value = True) Then
        raddis(i) = radial_distance(i)
    Else
        raddis(i) = radial_distance(i) * miles_to_kilometers
    End If
Next i

'Print (or save) results.
'Print the first line.

'Previous version was SECPOP90 V2.3
Print #f, blank; "SECPop V3.11 ";
' If (frmSetup.optMACCS.Value) Then
' If MorC = "MACCS" Then
'     Print #f, "MACCS ";
' ElseIf (frmSetup.optCSV.Value) Then
' ElseIf MorC = "CSV" Then
'     Print #f, "CSV ";
' Else
'     Print #f, "MACCS ";
' End If
Print #f, "Site Data File for"; blank;
Print #f, LTrim$(RTrim$(frmSite_Data.txtSite_Name.text))

'Print the second line.
Out = " Lat: " _
    & InsertSpace(2, Val(frmSite_Data.txtLatitude_Degrees.text)) & degree _
    & InsertSpace(2, Val(frmSite_Data.txtLatitude_Minutes.text)) & "' " _
    & InsertSpace(2, Val(frmSite_Data.txtLatitude_Seconds.text)) & "' " _
    & " Long: " _
    & InsertSpace(3, Val(frmSite_Data.txtLongitude_Degrees.text)) & degree _
    & InsertSpace(2, Val(frmSite_Data.txtLongitude_Minutes.text)) & "' " _
    & InsertSpace(2, Val(frmSite_Data.txtLongitude_Seconds.text)) & "' " _
    & " Population multiplier: " _
    & Format(Val(frmProblem_Data.txtPopulation_multiplier.text), "###0.0000") _
    & " " & Format$(Now, "mm/dd/yyyy")
Print #f, Out

'     Print #f, quote; blank; "Lat:"; quote; comma; blank;
'     Print #f, InsertSpace(2, Val(frmSite_Data.txtLatitude_Degrees.text)); comma; quote; degree;
quote; comma;
'     Print #f, InsertSpace(2, Val(frmSite_Data.txtLatitude_Minutes.text)); comma; quote; "'";
quote; comma;
'     Print #f, InsertSpace(2, Val(frmSite_Data.txtLatitude_Seconds.text)); comma; quote; "'";
quote; comma;
'     Print #f, quote; comma; blank; quote;
'
'     Print #f, "Long:"; quote; comma; blank;
'     Print #f, InsertSpace(3, Val(frmSite_Data.txtLongitude_Degrees.text)); comma; quote; degree;
quote; comma;
'     Print #f, InsertSpace(2, Val(frmSite_Data.txtLongitude_Minutes.text)); comma; quote; "'";
quote; comma;
'     Print #f, InsertSpace(2, Val(frmSite_Data.txtLongitude_Seconds.text)); comma; quote; "'";
quote; comma; blank;

```

```

'
'   Print #f, "Population multiplier:"; quote; comma; blank;
'   Print #f, Format(Val(frmProblem_Data.txtPopulation_multiplier.text), "###0.0000"); comma;
blank; blank; blank; quote;
'
'   Print #f, Format$(Now, "mm/dd/yyyy"); quote
'Print the data block sizes.

Out = Justify(4, number_of_radii, "##")
Print #f, Out; comma; blank; "SPATIAL INTERVALS"

Out = Justify(4, number_of_segments, "##")
Print #f, Out; comma; blank; "WIND DIRECTIONS"
Out = Justify(4, 7#, "##")
Print #f, Out; comma; blank; "CROP CATEGORIES"

Out = Justify(4, 4#, "##")
Print #f, Out; comma; blank; "WATER PATHWAY ISOTOPES"

Out = Justify(4, 1#, "##")
Print #f, Out; comma; blank; "WATERSHEDS"

Out = Justify(4, number_econ_regions, "##")
Print #f, Out; comma; blank; "ECONOMIC REGIONS"

'Print the geometry data block.

Print #f, quote; blank; "SPATIAL DISTANCES      KILOMETERS"; quote
For i = 1 To number_of_radii Step 1
  If ((i Mod 8) = 0) Then
    Print #f, Justify(10, raddis(i), "0.00")
  ElseIf i = number_of_radii Then
    Print #f, Justify(10, raddis(i), "0.00")
  Else
    Print #f, Justify(10, raddis(i), "0.00"); comma;
  End If
Next i

'   'Go to the next line if necessary.
'   If ((number_of_radii Mod 8) <> 0) Then
'     Print #f,
'   End If

'Print the population data block.
'Out = blank & "POPULATION"
Print #f, quote; blank; "POPULATION"; quote
Print #f, blank; "POPULATION"

For i = 1 To number_of_segments Step 1
  For j = 1 To number_of_radii Step 1
    Out = Justify(10, sector_population(i, j), "0.")
    If ((j Mod 8) = 0) Then
      Print #f, Out
    ElseIf j = number_of_radii Then
      Print #f, Out
    Else
      Print #f, Out; comma;
    End If
  Next j
  'Go to the next line if necessary.
Next i

'Print the land fraction block.

```

```

Print #f, quote; blank; "LAND FRACTION"; quote

For i = 1 To number_of_segments Step 1
  For j = 1 To number_of_radri Step 1
    Out = Justify(5, sector_frclnd(i, j), "0.00")
    If ((j Mod 16) = 0) Then
      Print #f, Out
    ElseIf j = number_of_radri Then
      Print #f, Out
    Else
      Print #f, Out; comma;
    End If
  Next j
Next i

'Print the region identification block.

Print #f, quote; blank; "REGION INDEX"; quote
For i = 0 To (number_of_segments - 1) Step 1
  For j = 1 To number_of_radri Step 1
    Out = Justify(2, region_index(j, i), "#0")
    If ((j Mod 38) = 0) Then
      Print #f, Out
    ElseIf j = number_of_radri Then
      Print #f, Out
    Else
      Print #f, Out; comma;
    End If
  Next j
Next i

'Print the (dummy) watershed identification block.

Print #f, quote; blank; "WATERSHED INDEX"; quote
For i = 1 To number_of_segments Step 1
  For j = 1 To number_of_radri - 1 Step 1
    Out = Justify(2, 1, "#0")
    Print #f, Out; comma;
  Next j
  Print #f, Justify(2, 1, "#0")
Next i

'Print the (dummy) agricultural data block.
Print #f, quote; blank; "CROP SEASON AND SHARE"; quote

'   Print #f, Justify(4, 1, "##"); comma;
'   Print #f, quote; blank; "NONE"; quote; comma;
'   Print #f, Justify(5, 1#, "0."); comma;
'   Print #f, Justify(5, 1#, "0.");
'   Print #f, Justify(8, 0, "0.0000")

Print #f, Justify(4, 1, "##"); comma;
Print #f, quote; blank; "PASTURE"; quote; comma;
Print #f, Justify(5, 90#, "00."); comma;
Print #f, Justify(5, 270#, "000.");
Print #f, Justify(8, 0.41, "0.0000")

Print #f, Justify(4, 2, "##"); comma;
Print #f, quote; blank; "STORED FORAGE"; quote; comma;
Print #f, Justify(5, 150#, "000."); comma;
Print #f, Justify(5, 240#, "000.");
Print #f, Justify(8, 0.13, "0.0000")

Print #f, Justify(4, 3, "##"); comma;
Print #f, quote; blank; "GRAINS"; quote; comma;

```

```

Print #f, Justify(5, 150#, "000."); comma;
Print #f, Justify(5, 240#, "000.");
Print #f, Justify(8, 0.21, "0.0000")

Print #f, Justify(4, 4, "##"); comma;
Print #f, quote; blank; "GRN LEAFY VEGETABLES"; quote; comma;
Print #f, Justify(5, 150#, "000."); comma;
Print #f, Justify(5, 240#, "000.");
Print #f, Justify(8, 0.002, "0.0000")

Print #f, Justify(4, 5, "##"); comma;
Print #f, quote; blank; "OTHER FOOD CROPS"; quote; comma;
Print #f, Justify(5, 150#, "000."); comma;
Print #f, Justify(5, 240#, "000.");
Print #f, Justify(8, 0.004, "0.0000")

Print #f, Justify(4, 6, "##"); comma;
Print #f, quote; blank; "LEGUMES AND SEEDS"; quote; comma;
Print #f, Justify(5, 150#, "000."); comma;
Print #f, Justify(5, 240#, "000.");
Print #f, Justify(8, 0.15, "0.0000")

Print #f, Justify(4, 7, "##"); comma;
Print #f, quote; blank; "ROOTS AND TUBERS"; quote; comma;
Print #f, Justify(5, 150#, "000."); comma;
Print #f, Justify(5, 240#, "000.");
Print #f, Justify(8, 0.003, "0.0000")

'Print the (dummy) watershed data block.

Print #f, quote; blank; "WATERSHED DEFINITION -- INITIAL AND ANNUAL WASHOFF AND INGESTION
FACTORS"; quote

Print #f, Justify(4, 1#, "0"); comma; quote; blank;
Print #f, "Sr-89"; quote; comma;
Print #f, Justify(10, 0.000005, "0.00E+00"); comma;
Print #f, Justify(10, 0#, "0.0")

Print #f, Justify(4, 2#, "0"); comma; quote; blank;
Print #f, "Sr-90"; quote; comma;
Print #f, Justify(10, 0.000005, "0.00E+00"); comma;
Print #f, Justify(10, 0#, "0.0")

Print #f, Justify(4, 3#, "0"); comma; quote; blank;
Print #f, "Cs-134"; quote; comma;
Print #f, Justify(10, 0.000005, "0.00E+00"); comma;
Print #f, Justify(10, 0#, "0.0")

Print #f, Justify(4, 4#, "0"); comma; quote; blank;
Print #f, "Cs-137"; quote; comma;
Print #f, Justify(10, 0.000005, "0.00E+00"); comma;
Print #f, Justify(10, 0#, "0.0")

'Print the regional economic data block.

Print #f, quote; blank; "REGIONAL ECONOMIC DATA"; quote

For i = 1 To number_econ_regions Step 1
  Print #f, Justify(4, i, "##"); comma;

  If i = 1 Then
    Print #f, quote; blank; "EXCLUSION"; quote; comma;
  Else

```



```

        Print #f, quote; blank; "REGION_"; Justify(2, i, "00"); quote; comma;
    End If

    Print #f, Justify(10, econ_data(i).region_frmfrc, "0.000"); comma;
    Print #f, Justify(10, econ_data(i).region_dpfc, "0.000"); comma;
    Print #f, Justify(10, econ_data(i).region_asfp, "0.0"); comma;
    Print #f, Justify(10, econ_data(i).region_vfrm, "0.0"); comma;
    Print #f, Justify(10, econ_data(i).region_vnfrm, "0.0")
Next i

Exit Sub

'Error return.
print_maccs_error:

    'If there is a problem, tell the user and exit function.
    MsgBox Error$(Err)

    Exit Sub

End Sub

Sub Print_Problem_File_to_Printer()
    'This function creates a temporary file, and then
    'writes into that file the information for the user
    'to view on the screen. This file is then sent to a
    'text form, where the user can view it and scroll
    'the various parts of the data.

    Dim filenum As Integer
    Dim Filename1 As String
    Dim Filename2 As String
    Dim strHeader1 As String
    Dim strHeader2 As String
    Dim strFooter1 As String
    Dim strFooter2 As String
    Dim i As Integer
    Dim iPageNO As Integer
    Dim Pathname As String
    Dim iCopy As Integer
    Dim PtF As Boolean

    Unload frmDisclaimer

    'set up page format strings
    strHeader1 = "SECPop"
    Call parse_path_and_file(frmProblem_Data.caption, Pathname, strHeader2)
    strFooter2 = Format(Time, "m/d/yy h:mm")

    'Write the actual data to file.
    Filename1 = "$$TEMP$$.$$$$"
    filenum = FreeFile
    Open Filename1 For Output As filenum
    Call Create_Temp_Problem_File(filenum)
    Close #filenum

    'Reset to printer the destination of info generated
    'by the print_MACCS_input function.

    On Error GoTo PrintErrHandler
    With frmMain.dlgSecpop

```

```

        .Flags = cd1PDHidePrintToFile
        .DialogTitle = "Print Problem File"
        .ShowPrinter
        iCopy = .Copies
        PtF = .Flags
    End With

    If PtF Then
        'If print to file checked
        With frmMain.dlgSecpop
            .Flags = 0
            .Flags = cd1OFNOverwritePrompt
            .DialogTitle = "Save Problem File"
            .Filename = StripExt(.Filename)
            .Filter = "All Files (*.*)|*.*|" & _
                "MACCS Files (*.inp)|*.inp|" & _
                "Comma Separated Variables (*.csv)|*.csv|" & _
                "Text Files(*.txt)|*.txt|" & _
                "Site Files (*.sit)|*.sit|" & _
                "Problem Files (*.prb)|*.prb|"
            .FilterIndex = 6      'Default filter = *.prb
            .Filename = ""
            .ShowSave
            Filename2 = .Filename
        End With
        Name Filename1 As Filename2      ' Move and rename file
        Close filenum
    Else
        'otherwise
        filenum = FreeFile
        Open Filename1 For Input As filenum
        For i = 1 To iCopy
            Close #filenum
            filenum = FreeFile
            Open Filename1 For Input As filenum
            Call PrinterUtility(strHeader1, strHeader2, strFooter1, strFooter2, filenum)
        Next i
        Close filenum
        Kill Filename1
    End If

Exit Sub

PrintErrorHandler:

'Deal with errors such as printer is off line or file not found.

'MsgBox "Device error - check printer or other print device."
Exit Sub

End Sub

Sub Create_Temp_Problem_File(problem_file)

Dim i As Integer
Dim j As Integer

Print #problem_file, "SECPOP V3.0"
Print #problem_file, "Site File: "
Print #problem_file, frmProblem_Data.txtSite_File_Name.text
Print #problem_file, "Number of Radii:"
Print #problem_file, Format(number_of_radii, "##")
Print #problem_file, "Units of Measure:"
If frmProblem_Data.optKilometers.Value = True Then
    Print #problem_file, "Kilometers"

```

```

Else: Print #problem_file, "Miles"

End If

Print #problem_file, "Radial Distances:"
For i = 1 To number_of_radii Step 1
    Print #problem_file, Format(radial_distance(i), "####.0000")
Next i

Print #problem_file, "Population Multiplier:"
Print #problem_file, Format(Val(frmProblem_Data.txtPopulation_multiplier.text), "####.0000")
Print #problem_file, "Number of Economic regions:"
Print #problem_file, Format(number_econ_regions, "##")
Print #problem_file, "Economic regions:"
For i = 0 To (number_of_segments - 1)
    For j = 1 To number_of_radii
        Print #problem_file, Format(region_index(j, i), "00");
        Print #problem_file, " ";
    Next j
    Print #problem_file, ""
Next i
Print #problem_file, "Problem Remarks:"
Print #problem_file, frmProblem_Data.txtProblem_Remarks.text

End Sub

Sub Print_Site_File_To_Printer()
'This function creates a temporary file, and then
'writes into that file the information for the user
'to view on the screen. This file is then sent to a
'text form, where the user can view it and scroll
'the various parts of the data.

Dim filenum As Integer
Dim Filename1 As String
Dim Filename2 As String
Dim strHeader1 As String
Dim strHeader2 As String
Dim strFooter1 As String
Dim strFooter2 As String
Dim i As Integer
Dim iPageNO As Integer
Dim Pathname As String
Dim iCopy As Integer
Dim PtF As Boolean

Unload frmDisclaimer

'set up page format strings
strHeader1 = "SECPOP"
Call parse_path_and_file(frmProblem_Data.caption, Pathname, strHeader2)
strFooter2 = Format(Time, "m/d/yy h:mm")

'Write the actual data to file.
Filename1 = "$$TEMP$$.$$$$"
filenum = FreeFile
Open Filename1 For Output As filenum
Call Create_Temp_Site_File(filenum)
Close #filenum

'Reset to printer the destination of info generated
'by the print_MACCS_input function.

On Error GoTo PrintErrHandler
With frmMain.dlgSecpop

```

```

        .Flags = cd1PDHidePrintToFile
        .DialogTitle = "Print Site File"
        .ShowPrinter
        iCopy = .Copies
        PtF = .Flags
    End With

    If PtF Then
        'If print to file checked
        With frmMain.dlgSecpop
            .Flags = 0
            .Flags = cd1OFNOverwritePrompt
            .DialogTitle = "Save Site File"
            .Filename = StripExt(.Filename)
            .Filter = "All Files (*.*)|*.*|" & _
                "MACCS Files (*.inp)|*.inp|" & _
                "Comma Separated Variables (*.csv)|*.csv|" & _
                "Text Files(*.txt)|*.txt|" & _
                "Site Files (*.sit)|*.sit|" & _
                "Problem Files (*.prb)|*.prb|"
            .FilterIndex = 5 'Default filter = *.sit
            .Filename = ""
            .ShowSave
            Filename2 = .Filename
        End With
        Name Filename1 As Filename2 ' Move and rename file
        Close filenum
    Else
        'otherwise
        filenum = FreeFile
        Open Filename1 For Input As filenum
        For i = 1 To iCopy
            Close #filenum
            filenum = FreeFile
            Open Filename1 For Input As filenum
            Call PrinterUtility(strHeader1, strHeader2, strFooter1, strFooter2, filenum)
        Next i
        Close filenum
        Kill Filename1
    End If

    Exit Sub

PrintErrorHandler:

'Deal with errors such as printer is off line or file not found.
'MsgBox "Device error - check printer or other print device."
Exit Sub

End Sub

Sub Create_Temp_Site_File(f)

'This routine prints SECPOP site data to a temporary file for printing.

Print #f, "Site Name:"
Print #f, frmSite_Data.txtSite_Name.text
Print #f, "Site Coordinates:"
Print #f, "Longitude (Degrees, Minutes, Seconds)"
Print #f, " "; Val(frmSite_Data.txtLongitude_Degrees.text);
Print #f, " "; Val(frmSite_Data.txtLongitude_Minutes.text);
Print #f, " "; Val(frmSite_Data.txtLongitude_Seconds.text)
Print #f, "Latitude (Degrees, Minutes, Seconds)"
Print #f, " "; Val(frmSite_Data.txtLatitude_Degrees.text);
Print #f, " "; Val(frmSite_Data.txtLatitude_Minutes.text);

```

```

Print #f, "          "; Val(frmSite_Data.txtLatitude_Seconds.text)
Print #f, "Site Remarks:"
Print #f, frmSite_Data.txtSite_Remarks.text

End Sub

Private Function Justify(Columns, Value, FormatString As String)
    Dim strX As String

    If IsNumeric(Value) Then
        strX = Format(Value, FormatString)
    Else
        strX = Value
    End If

    If (Columns - Len(strX) >= 0) Then
        Justify = Space(Columns - Len(strX)) & strX
    ElseIf (Columns - Len(strX) < 0) Then
        Justify = String(Columns, "*")
    End If

End Function

Private Function InsertSpace(length, number) As String

    Dim TempString As String
    Dim FormatLength As Integer

    If number = 0 Then
        InsertSpace = " 0"
    Else
        TempString = Format(number, "#")
        FormatLength = length - Len(TempString)
        If FormatLength > 0 Then
            InsertSpace = String(FormatLength, " ") & TempString
        Else
            InsertSpace = TempString
        End If
    End If

End Function

Sub Print_MaCCS_File_To_Printer(MorC)
    'This function creates a temporary file, and then
    'writes into that file the information for the user
    'to view on the screen. This file is then sent to a
    'text form, where the user can view it and scroll
    'the various parts of the data.

    Dim filenum As Integer
    Dim Filename1 As String
    Dim Filename2 As String
    Dim strHeader1 As String
    Dim strHeader2 As String
    Dim strFooter1 As String
    Dim strFooter2 As String
    Dim i As Integer
    Dim iPageNO As Integer
    Dim Pathname As String
    Dim iCopy As Integer
    Dim PtF As Boolean

```

```

Unload frmDisclaimer

'If problem is not loaded, tell user and exit subroutine
If frmProblem_Data.txtRadial_Distance1.text = "" Then
    MsgBox "Data is not yet available - Site file has not been loaded"
    Exit Sub
End If

'set up page format strings
strHeader1 = "SECPOP2000"
Call parse_path_and_file(frmProblem_Data.caption, Pathname, strHeader2)
strFooter2 = Format(Time, "m/d/yy h:mm")
strFooter2 = Date & " " & Time

'Write the actual data to a new file.
Filename1 = "$$TEMP$$.$$$$"
filenum = FreeFile
Open Filename1 For Output As filenum
If MorC = "MACCS" Then
    Call print_MACCS_input_file(filenum, "MACCS")
Else
    Call print_MACCS_input_file(filenum, "CSV")
End If
Close #filenum

'Reset to printer the destination of info generated
'by the print_MACCS_input function.

On Error GoTo PrintErrHandler
With frmMain.dlgSecpop
    .Flags = cdLPDHidePrintToFile
    .DialogTitle = "Print MACCS File"
    .ShowPrinter
    iCopy = .Copies
    PtF = .Flags
End With

filenum = FreeFile
Open Filename1 For Input As filenum
For i = 1 To iCopy
    Close #filenum
    filenum = FreeFile
    Open Filename1 For Input As filenum
    Call PrinterUtility(strHeader1, strHeader2, strFooter1, strFooter2, filenum)
Next i
Close filenum
Kill Filename1

Exit Sub

PrintErrHandler:

'Deal with errors such as printer is off line or file not found.

'MsgBox "Device error - check printer or other print device."
Close filenum
Kill Filename1
Exit Sub

End Sub

Sub PrinterUtility(strHeader1, strHeader2, strFooter1, strFooter2, filenum)

Dim LineString As String

```

```

Printer.Print
Printer.Font = "courier new"
Printer.FontSize = 10
Printer.ScaleMode = 5
Printer.ScaleHeight = 9

'Print first page header
Printer.CurrentY = 0.5
Printer.CurrentX = (Printer.ScaleWidth - Printer.TextWidth(strHeader1)) / 2
Printer.Print strHeader1
Printer.CurrentY = 0.5
Printer.CurrentX = Printer.ScaleWidth - Printer.TextWidth(strHeader2) - 1
Printer.Print strHeader2

'Print first page footer
strFooter1 = "Page " & CStr(Printer.Page)
Printer.CurrentY = Printer.ScaleHeight - 0.5
Printer.CurrentX = (Printer.ScaleWidth - Printer.TextWidth(strFooter1)) / 2
Printer.Print strFooter1

Printer.CurrentY = Printer.ScaleHeight - 0.5
Printer.CurrentX = Printer.ScaleWidth - Printer.TextWidth(strFooter2) - 1
Printer.Print strFooter2

'Print MACCS file to paper
Printer.CurrentY = 1
Do While Not EOF(filenum)
    Printer.CurrentX = 1
    Line Input #filenum, LineString
    Do
        If Len(LineString) > 80 Then
            Printer.Print Left(LineString, 80)
            LineString = Right(LineString, Len(LineString) - 80)
            Printer.CurrentX = 1
        Else
            Printer.Print LineString
            Exit Do
        End If
    Loop
    If Printer.CurrentY + 1 >= Printer.ScaleHeight Then
        'print new page header, footer
        Printer.NewPage
        Printer.CurrentY = 0.5
        Printer.CurrentX = (Printer.ScaleWidth - Printer.TextWidth(strHeader1)) / 2
        Printer.Print strHeader1

        Printer.CurrentY = 0.5
        Printer.CurrentX = Printer.ScaleWidth - Printer.TextWidth(strHeader2) - 1
        Printer.Print strHeader2

        strFooter1 = "Page " & CStr(Printer.Page)
        Printer.CurrentY = Printer.ScaleHeight - 0.5
        Printer.CurrentX = (Printer.ScaleWidth - Printer.TextWidth(strFooter1)) / 2
        Printer.Print strFooter1

        Printer.CurrentY = Printer.ScaleHeight - 0.5
        Printer.CurrentX = Printer.ScaleWidth - Printer.TextWidth(strFooter2) - 1
        Printer.Print strFooter2

        Printer.CurrentY = 1
    End If
Loop
Printer.EndDoc
End Sub

```

```

Sub SaveResultsToFile(MorC)

' This event procedure saves the results so that they are not lost when
' the program is exited. For this function to work, a problem must be
' loaded, along with the data that corresponds to that problem

Dim filenum As Integer
Dim Flags As Integer
Dim FName As String
Dim Fext As String
Dim DotNo As Integer

' If problem is not loaded, tell user and exit subroutine
If frmProblem_Data.txtRadial_Distance1.text = "" Then
    MsgBox "Data is not yet available - Site file has not been loaded"
    Exit Sub
End If

Unload frmDisclaimer

On Error GoTo ErrHandler

frmMain.dlgSecpop.Flags = 0
With frmMain.dlgSecpop
    .CancelError = True ' Set CancelError is True
    .Flags = cdLOFNHideReadOnly ' Set flags
    .Flags = cdLOFNHideReadOnly & cdLOFNOverwritePrompt ' Set flags
    .Filter = "All Files (*.*)|*.*|" & _
        "MACCS Files (*.inp)|*.inp|" & _
        "Comma Separated Variables (*.csv)|*.csv|" & _
        "Text Files (*.txt)|*.txt|" & _
        "Site Files (*.sit)|*.sit|" & _
        "Problem Files (*.prb)|*.prb|"

    If MorC = "CSV" Then
        .FilterIndex = 3 ' Default filter = *.csv
        .DialogTitle = "Save Output as CSV file"
    Else
        .FilterIndex = 2 ' Default filter = *.inp
        .DialogTitle = "Save Output as MACCS file"
    End If

    .Filename = ""
    If InitOutputFilePathChanged = True Then
        .InitDir = frmSetup.txtOutput_path.text
        InitOutputFilePathChanged = False
    Else
        .InitDir = InitOutputFilePath
    End If
    .ShowSave ' Display the Save dialog box
    FName = .Filename
End With

' verify that file type has not changed
Fext = Mid(FName, InStrRev(FName, "."), Len(FName))
If Fext = ".inp" Then
    frmSetup.optMACCS.Value = True
    frmSetup.optCSV.Value = False
ElseIf Fext = ".csv" Then
    frmSetup.optCSV.Value = True
    frmSetup.optMACCS.Value = False
Else
    frmSetup.optMACCS.Value = True
End If

```



```

On Local Error GoTo save_results_error

'If file already exists, delete it (to prevent appending to it)
If Dir$(Fname) <> "" Then Kill Fname
filenum = FreeFile
Open Fname For Output As filenum

'Call print function to print maccs data to the file

Call print_MACCS_input_file(filenum, MorC)

Close #filenum
'Turn off local error checking

On Local Error GoTo 0

Exit Sub

ErrorHandler:
'User pressed the Cancel button
Exit Sub

save_results_error:
'If any kind of error occurs, inform the user and exit subroutine
MsgBox "A file error has ocured. Please check all filenames and devices"
Exit Sub

End Sub

Sub Create_Temp_Table_File(f)

'This routine prints the displayed population table.

Dim degree As String
Dim pages As Integer
Dim radius As Integer
Dim first_radius As Integer
Dim last_radius As Integer
Dim i As Integer, j As Integer, k As Integer
Dim L As Integer, m As Integer, n As Integer
Dim sum As Long
Dim TempString As String

'Set quote and comma strings to null if MACCS input file format is
'selected or to '"' and ',' if comma separated variable (CSV) format
'is selected.

degree = Chr$(248)

pages = (number_of_radii + 1) \ 6
If (((number_of_radii + 1) Mod 6) <> 0) Then
    pages = pages + 1
End If

If (table_type = 1) Then
    Print #f, "SECPOP V3.0 " & "Population Data"
Else
    Print #f, "SECPOP V3.0 " & "Cumulative Population Data"
End If

Print #f, "Date: " & Format$(Now, "mm/dd/yyyy") & " Time:" & Format$(Now, "hh:mm:ss")
Print #f, "Site Name: " & Trim(frmSite_Data.txtSite_Name.text)

TempString = "Latitude: " & Format(frmSite_Data.txtLatitude_Degrees.text, "##") & degree _

```

```

        & Format(frmSite_Data.txtLatitude_Minutes.text, "##") & "' " _
        & Format(frmSite_Data.txtLatitude_Seconds.text, "##") & "' " & " " _
        & "Longitude: " & Format(frmSite_Data.txtLongitude_Degrees.text, "###") & degree
Print #f, TempString
Print #f, "Population Multiplier: " & Format(frmProblem_Data.txtPopulation_multiplier.text,
"#####.#####")

radius = 1

For j = 1 To pages
    'Print out the radii header row.

    If (frmProblem_Data.optKilometers.Value) Then
        TempString = "Radii(km)      "
    Else
        TempString = "Radii(mi)      "
    End If

    'Print out the radii, setting the loop min and max to
    'the radii to be printed for this page. Note: the final
    'radii column is the sum column.

    first_radius = radius
    If ((radius + 5) <= (number_of_radii + 1)) Then
        last_radius = radius + 5
    Else
        last_radius = number_of_radii + 1
    End If

    For k = first_radius To last_radius Step 1
        If (k <> (number_of_radii + 1)) Then
            TempString = TempString & Justify(10, radial_distance(k), "0.0000")
        Else
            TempString = TempString & "          Sum"
        End If
    Next k

    Print #f, TempString

    'Print out the direction and the (cumulative)
    'population values. The last column is the sum of the
    'population values.

    For k = 1 To number_of_segments Step 1
        TempString = directions(k - 1) & String(15 - Len(directions(k - 1)), " ")

        For L = first_radius To last_radius
            If (L <> (number_of_radii + 1)) Then
                If (table_type = 1) Then
                    TempString = TempString & Justify(10, sector_population(k, L), "0")
                Else
                    sum = 0
                    For m = 1 To L Step 1
                        sum = sum + sector_population(k, m)
                    Next m
                    TempString = TempString & Justify(10, sum, "0")
                End If
            Else
                sum = 0
            End If
        Next L
    Next k

```

```

        For m = 1 To number_of_radri Step 1
            sum = sum + sector_population(k, m)
        Next m
        TempString = TempString & Justify(10, sum, "0")
    End If
Next L
Print #f, TempString
Next k

TempString = "Sum" & String(12, " ")
For L = first_radius To last_radius Step 1
    If (L <> (number_of_radri + 1)) Then
        sum = 0
        If (table_type = 1) Then
            For m = 1 To number_of_segments Step 1
                sum = sum + sector_population(m, L)
            Next m
        Else
            For m = 1 To number_of_segments Step 1
                For n = 1 To L Step 1
                    sum = sum + sector_population(m, n)
                Next n
            Next m
        End If
        TempString = TempString & Justify(10, sum, "#")
    Else
        sum = 0
        For m = 1 To number_of_segments Step 1
            For n = 1 To number_of_radri Step 1
                sum = sum + sector_population(m, n)
            Next n
        Next m
        TempString = TempString & Justify(10, sum, "#")
    End If
Next L
Print #f, TempString

radius = last_radius + 1

Next j

End Sub

Sub Print_Table_File_to_Printer()
    'This function creates a temporary file, and then
    'writes into that file the information for the user
    'to view on the screen. This file is then sent to a
    'text form, where the user can view it and scroll
    'the various parts of the data.

    Dim filenum As Integer
    Dim Filename1 As String
    Dim Filename2 As String
    Dim strHeader1 As String
    Dim strHeader2 As String
    Dim strFooter1 As String
    Dim strFooter2 As String
    Dim i As Integer
    Dim iPageNO As Integer
    Dim Pathname As String
    Dim iCopy As Integer
    Dim PtF As Boolean

    Unload frmDisclaimer

```

```

'set up page format strings
strHeader1 = "SECPop2000"
Call parse_path_and_file(frmProblem_Data.caption, Pathname, strHeader2)
strFooter2 = Format(Time, "m/d/yy h:mm")
strFooter2 = Date & " " & Time

'Write the actual data to file.
Filename1 = "$TEMP$.$$$"
filenum = FreeFile
Open Filename1 For Output As filenum
Call Create_Temp_Table_File(filenum)
Close #filenum

'Reset to printer the destination of info generated
'by the print_MACCS_input function.

On Error GoTo PrintErrorHandler
With frmMain.dlgSecpop
    .Flags = cdlPDHHidePrintToFile
    .DialogTitle = "Print Problem File"
    .ShowPrinter
    iCopy = .Copies
    PtF = .Flags
End With

If PtF Then
    'If print to file checked
    With frmMain.dlgSecpop
        .Flags = 0
        .Flags = cdlOFNOverwritePrompt
        .DialogTitle = "Save Table to File"
        .Filename = StripExt(.Filename)
        .Filter = "All Files (*.*)|*.*|" & _
            "MACCS Files (*.inp)|*.inp|" & _
            "Comma Separated Variables (*.csv)|*.csv|" & _
            "Text Files(*.txt)|*.txt|" & _
            "Site Files (*.sit)|*.sit|" & _
            "Problem Files (*.prb)|*.prb|"
        .FilterIndex = 4      'Default filter = *.txt
        .Filename = ""
        .ShowSave
        Filename2 = .Filename
    End With
    Name Filename1 As Filename2      ' Move and rename file
    Close filenum
Else
    'otherwise
    filenum = FreeFile
    Open Filename1 For Input As filenum
    For i = 1 To iCopy
        Close #filenum
        filenum = FreeFile
        Open Filename1 For Input As filenum
        Call PrinterUtility(strHeader1, strHeader2, strFooter1, strFooter2, filenum)
    Next i
    Close filenum
    Kill Filename1
End If

Exit Sub

PrintErrorHandler:
'Deal with errors such as printer is off line or file not found.

```

```
'MsgBox "Device error - check printer or other print device."  
Exit Sub  
  
End Sub  
  
Private Function StripExt(name)  
  
    Dim X As Integer  
  
    X = InStr(1, name, ".")  
    If X <> 0 Then  
        StripExt = Mid(name, 1, X - 1)  
    Else  
        StripExt = name  
    End If  
  
End Function
```

H.10 Visual Basic Code Module: Probcode.bas

```
Attribute VB_Name = "Probcode"
'*****
' Module: ProbCode
'
' Project: SECPOP
'
' Description:
'
' Modification History
' Date      By      Description
' -----
'
'
'*****

Option Explicit

Sub browse_site_file()

    On Error GoTo DialogError

    With frmMain.dlgSecpop
        .Filter = "Site Files (*.sit)|*.sit|All Files|*.*"
        .DialogTitle = "Select a Site file to open"
        .FilterIndex = 1
        .Filename = ""
        .InitDir = InitSiteFilePath
        If InitSiteFilePathChanged = True Then
            .InitDir = frmSetup.txtSite_Path.text
            InitSiteFilePathChanged = False
        Else
            .InitDir = InitSiteFilePath
        End If
        .ShowOpen
    End With

    'reset init dir

    InitSiteFilePath = Left(frmMain.dlgSecpop.Filename, _
        (InStrRev(frmMain.dlgSecpop.Filename, "\") - 1))

    'this procedure allows the user to view and select previously created
    'site files when creating a new problem.

    Dim Flags As Integer, Cancel As Integer
    Dim FName As String
    Static Pathname As String
    FName = frmMain.dlgSecpop.Filename

    'Initialize file dialogue box.

    frmProblem_Data.txtSite_File_Name.text = FName

    'Mark file as modified.

    ' frmMain.mnuSave_ProblemCom.Enabled = True
    ' frmMain.mnuSave_As_ProblemCom.Enabled = True
```

```

If (InStr(frmProblem_Data.caption, " (Modified)") = 0) Then
    frmProblem_Data.caption = frmProblem_Data.caption + " (Modified)"
End If

'Call procedure to open site file and read in values.

open_site_from_problem (Fname)

'If cancel was selected in file dialogue box, reset focus to
'site file name.

frmProblem_Data.txtSite_File_Name.SetFocus

DialogError:
'User pressed the Cancel button
Exit Sub

End Sub

Sub default_regions()

Dim h As Integer, i As Integer, j As Integer, k As Integer
Dim m As Integer, n As Integer
Dim num_sectors As Integer
Dim dividend As Integer, remainder As Integer

num_sectors = ((number_of_radial - 1) * number_of_segments) + 1
k = 2
frmProblem_Data.lblNumber_of_regions.Tag = Str$(number_of_radial)

For i = 0 To (number_of_segments)
    region_index(1, i) = 1
Next i

If (num_sectors <= max_econ_regions) Then

    number_econ_regions = num_sectors

    For i = 0 To (number_of_segments)
        For j = 2 To (number_of_radial)
            region_index(j, i) = k
            k = k + 1
        Next j
    Next i
Else
    remainder = Fix((number_of_radial - 1) Mod 6)
    If remainder = 0 Then
        dividend = Fix((number_of_radial - 1) / 6)
    Else: remainder = Fix((number_of_radial - 1) Mod 5)
        dividend = Fix((number_of_radial - 1) / 5)
    End If

    For h = 0 To (number_of_segments)
        m = 2
        If (remainder > dividend) Then
            For m = 2 To (remainder + 1)
                region_index(m, h) = k
            Next m
            k = k + 1
        End If

        For i = 1 To 5
            For j = m To (m + dividend - 1)
                region_index(j, h) = k
            Next j
        Next h
    End For
End Sub

```

```

                m = j
                k = k + 1
            Next i

            If remainder <= dividend Then
                For i = m To (number_of_radii)
                    region_index(i, h) = k
                Next i
                k = k + 1
            End If
        Next h
        number_econ_regions = 97
    End If

    frmProblem_Data.lblNumber_of_regions.caption = Str$(number_econ_regions)
End Sub

Sub new_problem()

    'This procedure initializes a new problem to default settings
    'and opens the problem form.

    Dim i As Integer, j As Integer
    'Initialize settings to default.

    frmProblem_Data.lblNumber_of_regions.caption = ""
    For i = 0 To number_of_segments - 1
        For j = 2 To max_number_of_radii
            region_index(j, i) = 0
        Next j
    Next i

    '
    ' frmMain.mnuSave_ProblemCom.Enabled = False
    ' frmMain.mnuSave_As_ProblemCom.Enabled = False
    ' frmProblem_Data.cmdSave.Enabled = False
    ' frmProblem_Data.cmdSave_As.Enabled = False
    frmProblem_Data.caption = CurDir$ + "\" + "NEW_PROB.PRB"
    '
    ' frmProblem_Data.txtSite_File_Name.text = (frmSetup.txtSite_Path.text + "\*.SIT")
    frmProblem_Data.txtSite_File_Name.text = frmSite_Data.caption
    frmProblem_Data.vsbRadius_Number.Value = 1
    frmProblem_Data.txtRadial_Distance1.text = ""
    frmProblem_Data.txtRadial_Distance2.text = ""
    frmProblem_Data.txtRadial_Distance3.text = ""
    frmProblem_Data.txtPopulation_multiplier.text = "1.000"
    frmProblem_Data.txtProblem_Remarks.text = ""
    frmProblem_Data.optKilometers.Tag = "Previously_True"
    frmProblem_Data.optKilometers.Value = True
    frmProblem_Data.optKilometers.Tag = ""

    For i = 0 To max_number_of_radii Step 1
        radial_distance(i) = 0
    Next i

    number_of_radii = 0
    number_econ_regions = 0
    '
    ' x_position = 0
    ' y_position = 0

    'Show new problem form

    frmProblem_Data.Show
End Sub

```



```

Sub open_problem()

    On Error GoTo DialogError

    With frmMain.dlgSecpop
        .Flags = 0
        .Filter = "Problem Files (*.PRB)|*.PRB|All Files|*.*"
        .DialogTitle = "Select a Problem file to open"
        .FilterIndex = 1
        .Filename = ""
        .InitDir = InitProblemFilePath
    If InitProblemFilePathChanged = True Then
        .InitDir = frmSetup.txtProblem_path.text
        InitProblemFilePathChanged = False
    Else
        .InitDir = InitProblemFilePath
    End If
        .ShowOpen
    End With

    'reset init dir

    InitProblemFilePath = Left(frmMain.dlgSecpop.Filename, _
        (InStrRev(frmMain.dlgSecpop.Filename, "\") - 1))

        'Open a previously created problem from file.

        Dim site_file_name As String, longitude As String, latitude As String, units_of_measure
As String
        Dim site_name As String, site_remarks As String, problem_remarks As String, dummy As
String
        Dim longitude_degrees As Integer, longitude_minutes As Integer, longitude_seconds As
Integer
        Dim latitude_degrees As Integer, latitude_minutes As Integer, latitude_seconds As Integer
        Dim i As Integer, j As Integer
        Dim Flags As Integer, Cancel As Integer
        Dim Fname As String
        Static Pathname As String

        'Define as constants the file handle numbers for problem and site files,
        'and the file buffer size.

        Const problem_file = 10, site_file = 20, file_buffer = 1024

        'Initialize file dialog box.

'qqq         DefaultExt = "*.PRB"
'qqq         DialogTitle = "Problem Open"
'qqq         Pathname = frmSetup.txtProblem_path.text
'qqq         BackColor = WHITE
'qqq         ForeColor = BLACK

        'Enable local error checking for file errors.

'qqq         On Local Error GoTo open_prob_error

        'Open file dialog box.

'qqq         Call FileOpen(fname, pathname, DefaultExt, DialogTitle, forecolor, backcolor, Flags,
Cancel)

        'If user does not select cancel from file dialogue box.

```

```

'qqq      If Not Cancel Then

            'if fname is not in current directory, add path.

            If Pathname <> "" Then Fname = Pathname + "\" + Fname

            Fname = frmMain.dlgSecpop.FileName

            'Reset the table position variables.

            x_position = 0
            y_position = 0

            'Open filename and read problem information into temporary variables.

            Open Fname For Input Access Read Lock Write As #problem_file Len = file_buffer
            Line Input #problem_file, dummy
            Line Input #problem_file, dummy
            Line Input #problem_file, site_file_name
            Line Input #problem_file, dummy
            Input #problem_file, number_of_radial
            Line Input #problem_file, dummy
            Line Input #problem_file, units_of_measure
            Line Input #problem_file, dummy
            For i = 1 To number_of_radial Step 1
                Input #problem_file, radial_distance(i)
            Next i
            For i = number_of_radial + 1 To max_number_of_radial Step 1
                radial_distance(i) = 0#
            Next i
            Line Input #problem_file, dummy
            Input #problem_file, Population_multiplier
            Line Input #problem_file, dummy
            Input #problem_file, number_econ_regions
            Line Input #problem_file, dummy
            For i = 0 To number_of_segments - 1
                For j = 1 To number_of_radial
                    Input #problem_file, region_index(j, i)
                Next j
            Next i
            Line Input #problem_file, dummy
            Line Input #problem_file, problem_remarks
            Close problem_file

            'Transfer information from temporary variables to correct
            'form locations.

            frmProblem_Data.caption = Fname
            frmProblem_Data.txtSite_File_Name.text = site_file_name
            If units_of_measure = "Kilometers" Then
                frmProblem_Data.optKilometers.Tag = "Reading In File"
                frmProblem_Data.optKilometers.Value = True
                frmProblem_Data.optKilometers.Tag = ""
            Else
                frmProblem_Data.optMiles.Tag = "Reading In File"
                frmProblem_Data.optMiles.Value = True
                frmProblem_Data.optMiles.Tag = ""
            End If
            frmProblem_Data.vsbRadius_Number.Value = 1
            frmProblem_Data.txtRadial_Distance1.text = Trim(Right$(" " +
            Format$(radial_distance(1), "0.0000;0.0000; " ), 9))
            frmProblem_Data.txtRadial_Distance2.text = Trim(Right$(" " +
            Format$(radial_distance(2), "0.0000;0.0000; " ), 9))
            frmProblem_Data.txtRadial_Distance3.text = Trim(Right$(" " +
            Format$(radial_distance(3), "0.0000;0.0000; " ), 9))

```

```

        frmProblem_Data.txtPopulation_multiplier.text = Trim(Right$(" " +
Format$(Population_multiplier, "0.0000;0.0000; " ), 9))
        frmProblem_Data.txtProblem_Remarks.text = problem_remarks

        'If a site file is listed, call function to read in site data.

        If site_file_name <> "" Then
            open_site_from_problem (site_file_name)
        End If

        'Set the number of economic regions to new value, and re-paint
        'data form.

        frmProblem_Data.lblNumber_of_regions.Tag = Str$(number_of_radii)
        frmProblem_Data.lblNumber_of_regions.caption = Str$(number_econ_regions)

        frmProblem_Data.caption = Fname

        'If problem data form is not visible, show it.

        If (frmProblem_Data.Visible = False) Then
            frmProblem_Data.Show
        End If

'qqq        End If
''''''        Exit Sub

'qqq open_prob_error:

        'On error, inform the user, and exit subroutine.

'qqq        MsgBox Error$(Err), vbOK, "Error"
'qqq        'MSGBOX "File error - check spelling of file names."
'qqq        Exit Sub
DialogError:
        'User pressed the Cancel button

        frmProblem_Data.Show

        Exit Sub
End Sub

Sub open_site_from_problem(file_name As String)

        'Open site from problem and fill site form with data from file.

        Dim site_name As String, site_remarks As String, dummy As String
        Dim longitude_degrees As Integer, longitude_minutes As Integer, longitude_seconds As
Integer
        Dim latitude_degrees As Integer, latitude_minutes As Integer, latitude_seconds As Integer

        'Declare as constant the file handle number for site file and the
        'file buffer size.

        Const site_file = 20, file_buffer = 1024

        'Enable local error checking.

        On Local Error GoTo open_site_problem_file_error

        'Open site file named on problem form, and read input into
        'temporary variables.

        Open file_name For Input Access Read Lock Write As #site_file Len = file_buffer

```

```

Line Input #site_file, dummy
Line Input #site_file, site_name
Line Input #site_file, dummy
Line Input #site_file, dummy
Input #site_file, longitude_degrees
Input #site_file, longitude_minutes
Input #site_file, longitude_seconds
Line Input #site_file, dummy
Input #site_file, latitude_degrees
Input #site_file, latitude_minutes
Input #site_file, latitude_seconds
Line Input #site_file, dummy
Line Input #site_file, site_remarks
Close site_file

'Transfer values from temp variables to site form.

frmSite_Data.caption = file_name
frmSite_Data.txtSite_Name.text = site_name
frmSite_Data.txtLongitude_Degrees.text = Trim(Str$(longitude_degrees))
frmSite_Data.txtLongitude_Minutes.text = Trim(Str$(longitude_minutes))
frmSite_Data.txtLongitude_Seconds.text = Trim(Str$(longitude_seconds))
frmSite_Data.txtLatitude_Degrees.text = Trim(Str$(latitude_degrees))
frmSite_Data.txtLatitude_Minutes.text = Trim(Str$(latitude_minutes))
frmSite_Data.txtLatitude_Seconds.text = Trim(Str$(latitude_seconds))
frmSite_Data.txtSite_Remarks.text = site_remarks

'verify lat and long
verify_input (2)

Exit Sub

open_site_problem_file_error:

'If there is a problem, tell the user, and return to the form where
'a correction can be made.

If frmProblem_Data.Visible = False Then
    frmProblem_Data.Show
    MsgBox "Error: Unable to Open Site File."
    frmProblem_Data.txtSite_File_Name.SetFocus
    frmProblem_Data.Hide
Else
    MsgBox "Unable to Open Site File.", vbOK, "File Error"
    frmProblem_Data.txtSite_File_Name.SetFocus
End If
Exit Sub

End Sub

'Sub paint_region(x_offset As Integer, y_offset As Integer)
'
'    Dim i As Integer, j As Integer, k As Integer, X As Integer, Y As Integer
'    Dim directions() As String
'    frmRegion.lblnum_regions.caption = Str$(number_econ_regions)
'    frmRegion.lblnum_radial.caption = Str$(number_of_radial)
'
'    If frmProblem_Data.optMiles.Value = True Then
'        frmRegion.lblUnits.caption = "Miles"
'    Else: frmRegion.lblUnits.caption = "Kilometers"
'    End If
'
'    x_position = x_position + x_offset
'    y_position = y_position + y_offset
'
'

```

```

'
'   If (number_of_radri < 8) Then
'       x_position = 0
'       If (x_offset <> 0) Then
'           Exit Sub
'       End If
'   ElseIf (x_position < 0) Then
'       x_position = 0
'       Exit Sub
'   ElseIf ((x_position + 7) > number_of_radri) Then
'       x_position = x_position - 1
'       Exit Sub
'   End If
'
'   For i = 1 To 7
'       X = x_position + i
'       If radial_distance(X) = 0 Then
'           frmRegion.lblRdist(i - 1).caption = ""
'       Else: frmRegion.lblRdist(i - 1).caption = Left$(Str$(radial_distance(X)), 4)
'       End If
'   Next i
'
'   k = 0
'
'   For i = 0 To 6
'       If (i = 0) And ((y_position = 16) Or (y_position = -16)) Then
'           y_position = 0
'       End If
'       If ((i + y_position) > 15) And (y_position > 9)) Then
'           Y = (i + y_position - 16)
'       ElseIf ((y_position < 0) And ((y_position + i) < 0)) Then
'           Y = (i + y_position + 16)
'       Else
'           Y = (i + y_position)
'       End If
'       frmRegion.lblSector(i).caption = directions(Y + 1)
'
'       For j = 1 To 7
'           X = j + x_position
'           If ((radial_distance(X) = 0) Or (region_index(X, Y) = 0)) Then
'               frmRegion.txtsector(k).text = ""
'               frmRegion.txtsector(k).Enabled = True
'           ElseIf (X = 1) Then
'               frmRegion.txtsector(k).Enabled = False
'               frmRegion.txtsector(k).text = Right$("      " +
Str$(region_index(X, Y)), 6)
'           Else: frmRegion.txtsector(k).text = Right$("      " +
Str$(region_index(X, Y)), 6)
'               frmRegion.txtsector(k).Enabled = True
'           End If
'           k = k + 1
'       Next j
'   Next i
'
'End Sub

```

```

Sub print_problem()
    On Error GoTo DialogError

    frmMain.dlgSecpop.Flags = 0
    frmMain.dlgSecpop.ShowPrinter

    'Print the data on a problem form.

```

```

'qqq      Dim ForeColor As Integer, BackColor As Integer
          Dim Copies As Integer, Cancel As Integer, i As Integer, j As Integer
          Dim file_name As String, latitude As String, longitude As String, site_file_name As
String,    problem_remarks As String
'qqq      date AS STRING (this can probably be deleted after updating code
'          Copies = 1
          'Define as constants the margins for printing.

          Const left_margin = 10
          Const text_width = 40

          'Execute once for each copy desired by the user.

'          For i = 1 To Copies
          For i = 1 To frmMain.dlgSecpop.Copies

              'Send data to printer.

              Printer.Print Tab(left_margin); "File Name:";
              file_name = frmProblem_Data.caption
              Call print_text(file_name, text_width, left_margin + Len("Population
Multiplier:  "))

              Printer.Print
              Printer.Print Tab(left_margin); "Site File Name:";
              site_file_name = frmProblem_Data.txtSite_File_Name.text
              Call print_text(site_file_name, text_width, left_margin + Len("Population
Multiplier:  "))

              Printer.Print
              Printer.Print Tab(left_margin); "Number of Radii:";
              Printer.Print " "; Tab(left_margin + Len("Population Multiplier:  "));
number_of_radii

              Printer.Print
              Printer.Print Tab(left_margin); "Radial Distances:";
              For j = 1 To number_of_radii Step 1
                  Printer.Print " "; Tab(left_margin + Len("Population
Multiplier:  ")); radial_distance(j)
              Next j
              Printer.Print
              Printer.Print Tab(left_margin); "Population Multiplier Factor:";
              Printer.Print " "; Tab(left_margin + Len("Population Multiplier:
")); Val(frmProblem_Data.txtPopulation_multiplier.text)
              Printer.Print
              Printer.Print Tab(left_margin); "Problem Remarks:";
              problem_remarks = frmProblem_Data.txtProblem_Remarks.text
              Call print_text(problem_remarks, text_width, left_margin +
Len("Population Multiplier:  "))
              Printer.NewPage
          Next i

          'Tell printer that it is at the end of the document.
          Printer.EndDoc

'qqq      End If

          Exit Sub

problem_print_error:

          'If an error occurs, the user is notified, and the sub routine exited.

          MsgBox "Device error: Check printer or other print device."
          Exit Sub

DialogError:
          'User pressed the Cancel button

```

```

Exit Sub

End Sub

Sub save_as_problem()
On Error GoTo DialogError

With frmMain.dlgSecpop
.Filter = "Problem Files (*.prb)|*.prb|All files|*.*"
.FilterIndex = 1
.DialogTitle = "Save File As"
.FileName = ""
.Flags = cdlOFNOverwritePrompt
.DefaultExt = ".prb"
.InitDir = InitProblemFilePath
If InitProblemFilePathChanged = True Then
.InitDir = frmSetup.txtProblem_path.text
InitProblemFilePathChanged = False
Else
.InitDir = InitProblemFilePath
End If
.ShowSave
End With

'reset init dir

InitProblemFilePath = Left(frmMain.dlgSecpop.FileName, _
(InStrRev(frmMain.dlgSecpop.FileName, "\") - 1))

'Allow the user to specify a new name for a file that is being saved.

Dim problem_name As String, problem_remarks As String, dummy As String, caption As String
Dim longitude_degrees As Integer, longitude_minutes As Integer, longitude_seconds As
Integer
Dim latitude_degrees As Integer, latitude_minutes As Integer, latitude_seconds As Integer
'qqq Dim ForeColor As Integer, BackColor As Integer
Dim Flags As Integer, Cancel As Integer
Dim FName As String, Pathname As String
'qqq Dim DefaultExt As String, DialogTitle As String
Dim temp As Integer
Const problem_file = 10, file_buffer = 1024

'Verify that the user has entered valid input into all necessary fields
'Do not save until all input is correct.

temp = verify_input(1)

If temp = 0 Then
frmProblem_Data.txtSite_File_Name.SetFocus
Exit Sub
ElseIf temp = -1 Then
frmProblem_Data.txtPopulation_multiplier.SetFocus
Exit Sub
ElseIf temp = -2 Then
frmProblem_Data.txtRadial_Distance1.SetFocus
Exit Sub
ElseIf temp = -3 Then
frmProblem_Data.txtRadial_Distance2.SetFocus
Exit Sub
ElseIf temp = -4 Then
MsgBox "Setting Economic regions to default values"
Call default_regions
End If

```

```

'Break fname into two pieces - path and fname.
caption = frmMain.dlgSecpop.FileName
'qqq      caption = frmProblem_Data.caption
Call parse_path_and_file(caption, Pathname, Fname)

'Initialize file dialogue box.

'qqq      DefaultExt = "*.PRB"
'qqq      Pathname = frmSetup.txtProblem_path.text
'qqq      DialogTitle = "Save As Problem"
'qqq      BackColor = WHITE
'qqq      ForeColor = BLACK

'Open file dialogue box.

'qqq      Call FileSave(fname, Pathname, DefaultExt, DialogTitle, ForeColor, BackColor,
Flags, Cancel)

'If the user did not select cancel in the file dialogue box
'then proceed.

'qqq      If Not Cancel Then

          'If the file is not in the current directory, add the path to it.

          If Pathname <> "" Then Fname = Pathname + "\" + Fname
          frmProblem_Data.caption = Fname

          'Call the function to save the problem.

          Call save_problem

'qqq      End If
DialogError:
'User pressed the Cancel button
Exit Sub

End Sub

Sub save_problem()

'Save problem data into previously named file.

Dim caption As String, i As Integer, j As Integer
Dim Fname As String, Pathname As String, TempString As String
Dim temp As Integer, filenum As Integer
Const problem_file = 20, file_buffer = 1024
Dim tempstr As String

'Remove the path from the fname.

caption = frmProblem_Data.caption
Call parse_path_and_file(caption, Pathname, Fname)

'If it is a never-before-named problem, then call save as.

If Fname = "NEW_PROB.PRB" Then
    Call save_as_problem
Else

'''      i = InStr(frmProblem_Data.caption, " (Modified)")
'''      If i <> 0 Then
'''          TempStr = Mid$(frmProblem_Data.caption, 1, i - 1)
'''      Else
'''          TempStr = frmProblem_Data.caption

```



```

'''
'''
'''
vbCrLf & _
'''
'''
End If

i = MsgBox(TempStr & " already exists. Would you like to overwrite this file? " &
          " (If not please select Save As).", vbYesNoCancel)
If i = vbYes Then

'Verify that all of the data inputed by the user is correct. If not,
'go back and demand a correction.

temp = verify_input(1)

If temp = 0 Then
    frmProblem_Data.txtSite_File_Name.SetFocus
    Exit Sub
ElseIf temp = -1 Then
    frmProblem_Data.txtPopulation_multiplier.SetFocus
    Exit Sub
ElseIf temp = -2 Then
    frmProblem_Data.txtRadial_Distance1.SetFocus
    Exit Sub
ElseIf temp = -3 Then
    frmProblem_Data.txtRadial_Distance2.SetFocus
    Exit Sub
ElseIf temp = -4 Then
    MsgBox "Setting Economic regions to default values"
    Call default_regions
End If

If Pathname <> "" Then
    Fname = Pathname + "\" + Fname
End If

'Enable local error correction.

On Local Error GoTo prob_save_error

'Open output file, and write information to it.

Open Fname For Output Access Write Lock Read Write As #problem_file Len =
file_buffer
Print #problem_file, "SECCPOP Version Beta 3.0"
Print #problem_file, "Site File: "
Print #problem_file, frmProblem_Data.txtSite_File_Name.text
Print #problem_file, "Number of Radii:"
Print #problem_file, Format(number_of_radii, "##")
Print #problem_file, "Units of Measure:"
If frmProblem_Data.optKilometers.Value = True Then
    Print #problem_file, "Kilometers"
Else: Print #problem_file, "Miles"
End If
Print #problem_file, "Radial Distances:"
For i = 1 To number_of_radii Step 1
    Print #problem_file, Format(radial_distance(i), "#####.0000")
Next i
Print #problem_file, "Population Multiplier:"
Print #problem_file, Format(Val(frmProblem_Data.txtPopulation_multiplier.text),
"#####.0000")
Print #problem_file, "Number of Economic regions:"
Print #problem_file, Format(number_econ_regions, "##")
Print #problem_file, "Economic regions:"
For i = 0 To (number_of_segments - 1)
    For j = 1 To number_of_radii
        Print #problem_file, Format(region_index(j, i), "00");
        Print #problem_file, " ";
    
```

```

        Next j
        Print #problem_file, ""
    Next i
    Print #problem_file, "Problem Remarks:"
    Print #problem_file, frmProblem_Data.txtProblem_Remarks.text
    Close problem_file

    'Rename the problem window to the file name.

    frmProblem_Data.caption = FName

'
    Else
'
        frmMain.mnuSave_ProblemCom.Enabled = True
        frmMain.mnuSave_As_ProblemCom.Enabled = True
'
        frmProblem_Data.cmdSave.Enabled = True
        frmProblem_Data.cmdSave_As.Enabled = True
'
    End If

End If

'If problem form is visible, set the focus to close.

If frmProblem_Data.Visible = True Then frmProblem_Data.cmdClose.SetFocus

Exit Sub

prob_save_error:

    'If an error occurs, tell the user and exit the subroutine.

    MsgBox "A FILE ERROR HAS OCCURRED. PLEASE CHECK ALL FILE NAMES. (File may be
readonly.)"
    Exit Sub

End Sub

```

H.11 Visual Basic Code Module: ReadFile.bas

```
Attribute VB_Name = "ReadFile"
'*****
' Module: Readfile
'
' Project: SECPOP
'
' Description: Subroutine to read back in MACCS files to review
'              rosettes and use other utilities
'
' Modification History
' Date      By      Description
'-----
' 20020213  cwm      Created module
' 20020610  cwm      Created ability to read both CSV and MACCS file formats
'*****

Option Explicit

Sub ReadPreviousOutput()
    'Load in previously saved output data so that the user
    'can view it again, in any of the standard forms.

    Dim tempinteger As Integer, tempsingle As Single
    Dim filenum As Integer, i As Integer, j As Integer, k As Integer
    Dim TempString As String
    Dim Flags As Integer, Cancel As Integer
    Dim FName As String
    Static Pathname As String
    Dim DefaultExt As String, DialogTitle As String
    Dim CSVorMACCS As String

    Unload frmDisclaimer
    On Error GoTo Previous_Error

    frmMain.dlgSecpop.Flags = 0
    With frmMain.dlgSecpop
        .CancelError = True      ' Set CancelError is True
        .Flags = cdIOFNHideReadOnly ' Set flags
        .Filter = "All Files (*.*)|*.*|" & _
            "MACCS Files (*.inp)|*.inp|" & _
            "Comma Separated Variables (*.csv)|*.csv|" & _
            "Text Files (*.txt)|*.txt|All Files|*.*"

        If frmSetup.optCSV.Value = True Then
            .FilterIndex = 3      'Default filter = *.csv
        Else
            .FilterIndex = 2      'Default filter = *.inp
        End If
        .Filename = ""
        .FilterIndex = 2
        .DialogTitle = "Load Previous Data"
        .InitDir = InitOutputFilePath
    If InitOutputFilePathChanged = True Then
        .InitDir = frmSetup.txtOutput_path.text
        InitOutputFilePathChanged = False
    Else
        .InitDir = InitOutputFilePath
    End If
    .ShowOpen ' Display the fileopen dialog box
    FName = .Filename
End With
```

```

'reset init dir

InitOutputFilePath = Left(frmMain.dlgSecpop.FileName, _
(InStrRev(frmMain.dlgSecpop.FileName, "\") - 1))

frmSite_Data.caption = " "

filenum = FreeFile
Open Fname For Input As filenum
Line Input #filenum, TempString 'TempString = Input$(80, #filenum) 'Read in the header
information.
Close filenum

i = InStr(1, TempString, "CSV")
j = InStr(1, TempString, "MAC")
If i > 0 Then
    Call ReadPreviousCSVOutput(Fname)
ElseIf j > 0 Then
    Call ReadPreviousMACCSOutput(Fname)
Else
    MsgBox "ERROR: SECPOP cannot determine if the specified file is " & vbCrLf & _
"CSV or MACCS format. The program looks for the word CSV" & vbCrLf & _
"or MACCS in the first line to decide." & vbCrLf & vbCrLf & _
"The specified file's first line reads: " & vbCrLf & vbCrLf & _
TempString

End If

Previous_Error:

'If there is an error, identify type if possible,
'inform the user of the problem, and leave subroutine.

If (Err = 62) Then
    MsgBox "Error: Attempt has been made to read past the end of file. Data file has been
ccorrupted."
ElseIf (Err = 53) Or (Err = 75) Or (Err = 76) Or (Err = 55) Then
    MsgBox "Invalid filename or path, or file access denied"
ElseIf (Err = 61) Or (Err = 68) Or (Err = 71) Or (Err = 72) Then
    MsgBox "The disk drive is not ready, or a file error has occured"
Else
    End If
Exit Sub

End Sub

Sub ReadPreviousMACCSOutput(Fname)

'Load in previously saved output data so that the user
'can view it again, in any of the standard forms.

Dim tempinteger As Integer, tempsingle As Single
Dim NbrCropCategories As Integer, NbrWaterPathwayIsotopes As Integer
Dim filenum As Integer, i As Integer, j As Integer, k As Integer
Dim TempString As String
Dim ForeColor As Integer, BackColor As Integer
Dim Flags As Integer, Cancel As Integer
Static Pathname As String
Dim DefaultExt As String, DialogTitle As String

'Unload frmDisclaimer
On Error GoTo Previous_Error
,
' frmMain.dlgSecpop.Flags = 0

```

```

With frmMain.dlgSecpop
  .CancelError = True      ' Set CancelError is True
  .Flags = cdLOFNHideReadOnly ' Set flags
  .Filter = "All Files (*.*)|*.*|" & _
            "MACCS Files (*.inp)|*.inp|" & _
            "Comma Separated Variables (*.csv)|*.csv|" & _
            "Text Files (*.txt)|*.txt|All Files|*.*"

  If frmSetup.optCSV.Value = True Then
    .FilterIndex = 3      'Default filter = *.csv
  Else
    .FilterIndex = 2      'Default filter = *.inp
  End If
  .Filename = ""
  .DialogTitle = "Load Previous Data"
  .InitDir = InitOutputFilePath
  If InitOutputFilePathChanged = True Then
    .InitDir = frmSetup.txtOutput_path.text
    InitOutputFilePathChanged = False
  Else
    .InitDir = InitOutputFilePath
  End If
  .ShowOpen ' Display the fileopen dialog box
  FName = .Filename
End With

'reset init dir

InitOutputFilePath = Left(frmMain.dlgSecpop.Filename, _
                          (InStrRev(frmMain.dlgSecpop.Filename, "\") - 1))

frmSite_Data.caption = " "

filenum = FreeFile
Open FName For Input As filenum

TempString = Input$(40, #filenum) 'Read in the header information.
Line Input #filenum, TempString
frmSite_Data.txtSite_Name.text = TempString

TempString = Input$(6, #filenum)
TempString = Input$(2, #filenum)
frmSite_Data.txtLatitude_Degrees.text = LTrim$(TempString)
TempString = Input$(1, #filenum)
TempString = Input$(2, #filenum)
frmSite_Data.txtLatitude_Minutes.text = LTrim$(TempString)
TempString = Input$(1, #filenum)
TempString = Input$(2, #filenum)
frmSite_Data.txtLatitude_Seconds.text = LTrim$(TempString)

TempString = Input$(9, #filenum)
TempString = Input$(3, #filenum)
frmSite_Data.txtLongitude_Degrees.text = LTrim$(TempString)
TempString = Input$(1, #filenum)
TempString = Input$(2, #filenum)
frmSite_Data.txtLongitude_Minutes.text = LTrim$(TempString)
TempString = Input$(1, #filenum)
TempString = Input$(2, #filenum)
frmSite_Data.txtLongitude_Seconds.text = LTrim$(TempString)

TempString = Input$(26, #filenum)
Input #filenum, tempsingle
Line Input #filenum, TempString

```

```

frmProblem_Data.txtPopulation_multiplier.text = Str$(tempsingle)

'Pull in various numbers and strings from the file,
'discarding extraneous labels and information.

Input #filenum, tempsingle
number_of_radrii = tempsingle

'Discard next 5 lines from file
'
' For i = 1 To 5 Step 1
'     Line Input #filenum, TempString
' Next i

Line Input #filenum, TempString ' spatial intervals
Line Input #filenum, TempString ' wind directions
Input #filenum, NbrCropCategories
Line Input #filenum, TempString ' crop categories
Input #filenum, NbrWaterPathwayIsotopes
Line Input #filenum, TempString ' water pathway isotopes
Line Input #filenum, TempString ' watersheds

'Determine number of economic regions.

Input #filenum, tempsingle
number_econ_regions = tempsingle
Line Input #filenum, TempString

'Fill number of radii array from file data.

Line Input #filenum, TempString

For i = 1 To number_of_radrii
    Input #filenum, tempsingle
    radial_distance(i) = tempsingle
Next i

'Fill total population array for each segment and radii.

Line Input #filenum, TempString

For i = 1 To number_of_segments
    For j = 1 To number_of_radrii
        Input #filenum, tempsingle
        sector_population(i, j) = tempsingle
    Next j
Next i

'Fill fraction land array for each segment and radii.

Line Input #filenum, TempString

For i = 1 To number_of_segments
    For j = 1 To number_of_radrii
        Input #filenum, tempsingle
        sector_frclnd(i, j) = tempsingle
    Next j
Next i

'Fill region index array.

Line Input #filenum, TempString

For i = 0 To (number_of_segments - 1)
    For j = 1 To number_of_radrii

```

```

        TempString = Input$(2, #filenum)
        If Val(TempString) = 0 Then
            TempString = Input$(2, #filenum)
        End If
        region_index(j, i) = Val(TempString)
    Next j
Next i
Line Input #filenum, TempString

'Suck in and throw away the dummy watershed indices.

Line Input #filenum, TempString
For i = 1 To number_of_segments
    Line Input #filenum, TempString
Next i

'Suck in and throw away the dummy crop season and share info.

For i = 1 To NbrCropCategories + 1
    Line Input #filenum, TempString
Next i

'Suck in and throw away the dummy watershed definition.

For i = 1 To NbrWaterPathwayIsotopes + 1
    Line Input #filenum, TempString
Next i

'Fill regional data array structs.

Line Input #filenum, TempString
For i = 1 To number_econ_regions
    Input #filenum, tempsingle
    TempString = Input$(10, #filenum)
    Input #filenum, tempsingle
    econ_data(i).region_frmfrc = tempsingle
    Input #filenum, tempsingle
    econ_data(i).region_dpf = tempsingle
    Input #filenum, tempsingle
    econ_data(i).region_asfp = tempsingle
    Input #filenum, tempsingle
    econ_data(i).region_vfrm = tempsingle
    Input #filenum, tempsingle
    econ_data(i).region_vnfrm = tempsingle
Next i

Close filenum

'Update site and problem form captions and remarks.

'   frmSite_Data.caption = FName
frmSite_Data.txtSite_Remarks.text = ""
'   frmProblem_Data.caption = FName
frmProblem_Data.txtProblem_Remarks.text = ""

frmProblem_Data.caption = CurDir$ + "\" + "NEW_PROB.PRB"
frmProblem_Data.txtSite_File_Name.text = (CurDir$ + "\"*.SIT")
'   frmProblem_Data.txtSite_File_Name.text = (frmSetup.txtSite_Path.text + "\"*.SIT")

'Update problem form radial distances, units, and number of regions.

frmProblem_Data.txtRadial_Distance1.text = Str$(radial_distance(1))
frmProblem_Data.txtRadial_Distance2.text = Str$(radial_distance(2))
frmProblem_Data.txtRadial_Distance3.text = Str$(radial_distance(3))

```

```

frmProblem_Data.optKilometers.Tag = "ReadingIn"
frmProblem_Data.optKilometers.Value = True
frmProblem_Data.optKilometers.Tag = ""
frmProblem_Data.lblNumber_of_regions.caption = _
    Str$(number_econ_regions)

'verify lat and long on site data form
verify_input (2)

frmRosette.blnInputDataChanged = False

Exit Sub

Previous_Error:

'If there is an error, identify type if possible,
'inform the user of the problem, and leave subroutine.

If (Err = 62) Then
    MsgBox "Error: Attempt has been made to read past the end of file. Data file has been
ccorrupted."
ElseIf (Err = 53) Or (Err = 75) Or (Err = 76) Or (Err = 55) Then
    MsgBox "Invalid filename or path, or file access denied"
ElseIf (Err = 61) Or (Err = 68) Or (Err = 71) Or (Err = 72) Then
    MsgBox "The disk drive is not ready, or a file error has occurred"
Else
    End If
Exit Sub

End Sub

Sub ReadPreviousCSVOutput(Fname)

'Load in previously saved output data so that the user
'can view it again, in any of the standard forms.

Dim tempinteger As Integer, tempsingle As Single
Dim NbrCropCategories As Integer, NbrWaterPathwayIsotopes As Integer
Dim fileenum As Integer, i As Integer, j As Integer, k As Integer
Dim TempString As String
Dim ForeColor As Integer, BackColor As Integer
Dim Flags As Integer, Cancel As Integer
Static Pathname As String
Dim DefaultExt As String, DialogTitle As String

'Unload frmDisclaimer
On Error GoTo Previous_Error

'
' frmMain.dlgSecpop.Flags = 0
' With frmMain.dlgSecpop
'     .CancelError = True ' Set CancelError is True
'     .Flags = cdLOFNHideReadOnly ' Set flags
'     .Filter = "All Files (*.*)|*.*|" & _
'         "MACCS Files (*.inp)|*.inp|" & _
'         "Comma Separated Variables (*.csv)|*.csv|" & _
'         "Text Files(*.txt)|*.txt|All Files|*.*"
'
'     If frmSetup.optCSV.Value = True Then
'         .FilterIndex = 3 'Default filter = *.csv
'     Else
'         .FilterIndex = 2 'Default filter = *.inp
'     End If
'     .Filename = ""
'     .DialogTitle = "Load Previous Data"
'     .InitDir = InitOutputFilePath
'

```



```

'       If InitOutputFilePathChanged = True Then
'           .InitDir = frmSetup.txtOutput_path.text
'           InitOutputFilePathChanged = False
'       Else
'           .InitDir = InitOutputFilePath
'       End If
'       .ShowOpen ' Display the fileopen dialog box
'       FName = .Filename
'       End With
'
'       'reset init dir
'
'       InitOutputFilePath = Left(frmMain.dlgSecpop.Filename, _
'                               (InStrRev(frmMain.dlgSecpop.Filename, "\") - 1))
'
'       frmSite_Data.caption = " "
'
'       filenum = FreeFile
'       Open FName For Input As filenum
'
'       TempString = Input$(40, #filenum) 'Read in the header information.
'       Line Input #filenum, TempString
'       frmSite_Data.txtSite_Name.text = TempString
'
'
'       TempString = Input$(6, #filenum)
'       TempString = Input$(2, #filenum)
'       frmSite_Data.txtLatitude_Degrees.text = LTrim$(TempString)
'       TempString = Input$(1, #filenum)
'       TempString = Input$(2, #filenum)
'       frmSite_Data.txtLatitude_Minutes.text = LTrim$(TempString)
'       TempString = Input$(1, #filenum)
'       TempString = Input$(2, #filenum)
'       frmSite_Data.txtLatitude_Seconds.text = LTrim$(TempString)
'
'
'       TempString = Input$(9, #filenum)
'       TempString = Input$(3, #filenum)
'       frmSite_Data.txtLongitude_Degrees.text = LTrim$(TempString)
'       TempString = Input$(1, #filenum)
'       TempString = Input$(2, #filenum)
'       frmSite_Data.txtLongitude_Minutes.text = LTrim$(TempString)
'       TempString = Input$(1, #filenum)
'       TempString = Input$(2, #filenum)
'       frmSite_Data.txtLongitude_Seconds.text = LTrim$(TempString)
'
'
'       TempString = Input$(26, #filenum)
'       Input #filenum, tempsingle
'       Line Input #filenum, TempString
'       frmProblem_Data.txtPopulation_multiplier.text = Str$(tempsingle)
'
'       'Pull in various numbers and strings from the file,
'       'discarding extraneous labels and information.
'
'       Input #filenum, tempsingle
'       number_of_radii = tempsingle
'
'       'Discard next 5 lines from file
'
'       For i = 1 To 5 Step 1
'           Line Input #filenum, TempString
'       Next i
'
'       Line Input #filenum, TempString ' spatial intervals
'       Line Input #filenum, TempString ' wind directions

```

```

Input #filenum, NbrCropCategories
Line Input #filenum, TempString ' crop categories
Input #filenum, NbrWaterPathwayIsotopes
Line Input #filenum, TempString ' water pathway isotopes
Line Input #filenum, TempString ' watersheds

'Determine number of economic regions.

Input #filenum, tempsingle
number_econ_regions = tempsingle
Line Input #filenum, TempString

'Fill number of radii array from file data.

Line Input #filenum, TempString

For i = 1 To number_of_radii
    Input #filenum, tempsingle
    radial_distance(i) = tempsingle
Next i

'Fill total population array for each segment and radii.

Line Input #filenum, TempString

For i = 1 To number_of_segments
    For j = 1 To number_of_radii
        Input #filenum, tempsingle
        sector_population(i, j) = tempsingle
    Next j
Next i

'Fill fraction land array for each segment and radii.

Line Input #filenum, TempString

For i = 1 To number_of_segments
    For j = 1 To number_of_radii
        Input #filenum, tempsingle
        sector_frclnd(i, j) = tempsingle
    Next j
Next i

'Fill region index array.

Line Input #filenum, TempString

For i = 0 To (number_of_segments - 1)
    For j = 1 To number_of_radii
        TempString = Input$(2, #filenum)
        If Val(TempString) = 0 Then
            TempString = Input$(2, #filenum)
        End If
        region_index(j, i) = Val(TempString)
    Next j
Next i
Line Input #filenum, TempString

'Suck in and throw away the dummy watershed indices.

Line Input #filenum, TempString
For i = 1 To number_of_segments
    Line Input #filenum, TempString
Next i

```

```

'Suck in and throw away the dummy crop season and share info.
For i = 1 To NbrCropCategories + 1
    Line Input #filenum, TempString
Next i

'Suck in and throw away the dummy watershed definition.
For i = 1 To NbrWaterPathwayIsotopes + 1
    Line Input #filenum, TempString
Next i

'Fill regional data array structs.

Line Input #filenum, TempString
For i = 1 To number_econ_regions
    Input #filenum, tempsingle
    TempString = Input$(10, #filenum)
    Input #filenum, tempsingle
    econ_data(i).region_frmfrc = tempsingle
    Input #filenum, tempsingle
    econ_data(i).region_dpf = tempsingle
    Input #filenum, tempsingle
    econ_data(i).region_asfp = tempsingle
    Input #filenum, tempsingle
    econ_data(i).region_vfrm = tempsingle
    Input #filenum, tempsingle
    econ_data(i).region_vnfrm = tempsingle
Next i

Close filenum

'Update site and problem form captions and remarks.

' frmSite_Data.caption = FName
frmSite_Data.txtSite_Remarks.text = ""
' frmProblem_Data.caption = FName
frmProblem_Data.txtProblem_Remarks.text = ""

frmProblem_Data.caption = CurDir$ + "\" + "NEW_PROB.PRB"
frmProblem_Data.txtSite_File_Name.text = (CurDir$ + "\"*.SIT")
' frmProblem_Data.txtSite_File_Name.text = (frmSetup.txtSite_Path.text + "\"*.SIT")

'Update problem form radial distances, units, and number of regions.

frmProblem_Data.txtRadial_Distance1.text = Str$(radial_distance(1))
frmProblem_Data.txtRadial_Distance2.text = Str$(radial_distance(2))
frmProblem_Data.txtRadial_Distance3.text = Str$(radial_distance(3))

frmProblem_Data.optKilometers.Tag = "ReadingIn"
frmProblem_Data.optKilometers.Value = True
frmProblem_Data.optKilometers.Tag = ""
frmProblem_Data.lblNumber_of_regions.caption = _
    Str$(number_econ_regions)

'verify lat and long on site data form
verify_input (2)

frmRosette.blnInputDataChanged = False

Exit Sub

Previous_Error:

'If there is an error, identify type if possible,

```

```
'inform the user of the problem, and leave subroutine.

If (Err = 62) Then
    MsgBox "Error: Attempt has been made to read past the end of file. Data file has been
ccorrupted."
    ElseIf (Err = 53) Or (Err = 75) Or (Err = 76) Or (Err = 55) Then
        MsgBox "Invalid filename or path, or file access denied"
    ElseIf (Err = 61) Or (Err = 68) Or (Err = 71) Or (Err = 72) Then
        MsgBox "The disk drive is not ready, or a file error has ocured"
    Else
    End If
Exit Sub

End Sub
```

H.12 Visual Basic Code Module: Rptable1.bas

```
Attribute VB_Name = "Rptable1"
Option Explicit

'This function calculates and displays all of the fields for table one.

Sub paint_table()

    Dim i As Integer, j As Integer, k As Integer

    Dim sum As Long

    'These two constants are the number of radii and sectors displayed.

    Const max_radii_displayed = 4
    Const max_sectors_displayed = 6

    'Set the table caption to reflect the table type.

    If (table_type = 1) Then

        frmTable_1.caption = "Population Table"

    Else

        frmTable_1.caption = _
            "Cumulative (By Direction) Population Table"

    End If

    'Determine the unit of measure.

    '!!!!!!

    If (frmProblem_Data.optKilometers.Value) Then
        frmTable_1.lblDistance_Heading.caption = _
            "Radii (Kilometers)"
    Else
        frmTable_1.lblDistance_Heading.caption = "Radii (Miles)"
    End If

    'Verify that coordinates are within array.

    If (x_position < 1) Then
        x_position = 1
    ElseIf (number_of_radii <= max_radii_displayed) Then
        x_position = 1
    ElseIf ((x_position + max_radii_displayed - 1) > _
        number_of_radii) Then
        x_position = number_of_radii - max_radii_displayed + 1
    End If

    If (y_position < 1) Then
        y_position = 1
    ElseIf ((y_position + max_sectors_displayed + 1) > _
        number_of_segments) Then
        y_position = number_of_segments - max_sectors_displayed + 1
    End If
```

```

'Fill the radii label values.
For i = 0 To max_radii_displayed - 1 Step 1
    If ((x_position + i) <= number_of_radii) Then
        frmTable_1.lblDistance_array(i).caption = _
            Format$(radial_distance(x_position + i), "###0.0000")
    Else
        frmTable_1.lblDistance_array(i).caption = ""
    End If
Next i

'Fill the direction label values.
For i = 0 To max_sectors_displayed - 1 Step 1
    frmTable_1.lblSector_array(i).caption = _
        directions(y_position + i)
Next i

'Fill the population sector label values with either the population
'data or the cumulative population data depending on which table
'type we're displaying. Also calculate and fill the sector sum
'labels.
For i = 0 To max_sectors_displayed - 1 Step 1
    sum = 0
    frmTable_1.lblValue_array(i).caption = ""
    For j = 1 To number_of_radii Step 1
        sum = sum + sector_population(y_position + i, j)
        If ((j >= x_position) And _
            (j <= (x_position + max_radii_displayed - 1))) Then
            If (table_type = 1) Then
                frmTable_1.lblValue_array(i).caption = _
                    frmTable_1.lblValue_array(i).caption + _
                    Right$(Format$(sector_population(_
                        y_position + i, j), "#####0"), 10)
            Else
                frmTable_1.lblValue_array(i).caption = _
                    frmTable_1.lblValue_array(i).caption + _
                    Right$(Format$(sum, "#####0"), 10)
            End If
        End If
    Next j
    frmTable_1.lblCsum_array(i).caption = Format$(sum, "#####0")
Next i

```

```

'Calculate and fill the radial sum labels.
For i = 0 To max_radai_displayed - 1 Step 1
    If ((x_position + i) <= number_of_radai) Then
        sum = 0
        If (table_type = 1) Then
            For j = 1 To number_of_segments Step 1
                sum = sum + sector_population(j, x_position + i)
            Next j
        Else
            For j = 1 To number_of_segments Step 1
                For k = 1 To (x_position + i) Step 1
                    sum = sum + sector_population(j, k)
                Next k
            Next j
        End If
        frmTable_1.lblRsum_array(i).caption = _
            Format$(sum, "#####0")
    Else
        frmTable_1.lblRsum_array(i).caption = ""
    End If
Next i

'Calculate and fill the total sum label.
sum = 0
For i = 1 To number_of_segments Step 1
    For j = 1 To number_of_radai Step 1
        sum = sum + sector_population(i, j)
    Next j
Next i
frmTable_1.lblTotal.caption = Format$(sum, "#####0")

End Sub

```

H.13 Visual Basic Code Module: Run_mppr.bas

```
Attribute VB_Name = "Run_mppr"  
'qqq ChDir "mapplan"  
'qqq Shell "mppr.exe . map_out.spc"  
'qqq ChDir ".."  
'qqq RUN "secpop90"
```

H.14 Visual Basic Code Module: Savedata.bas

```
Attribute VB_Name = "Savedata"
'*****
' Module: Readfile
'
' Project: SECPOP
'
' Description: Module no longer used
'
' Modification History
' Date      By      Description
' -----  ---  -----
' 20020213  cwm    Made module obsolete
'*****

'Option Explicit
'
'Sub save_data()
'  Dim filenum As Integer
'  Dim ForeColor As Integer, BackColor As Integer
'  Dim Flags As Integer, Cancel As Integer
'  Dim Filename As String, Pathname As String
'  Dim DefaultExt As String, DialogTitle As String
'  DefaultExt = "*.DAT"
'  DialogTitle = "Save Data"
'
'  If frmProblem_Data.txtRadial_Distancel.text = "" Then
'    MsgBox "Data is not yet available - Site file has not been loaded"
'    Exit Sub
'  End If
'
'  Call FileSave(Filename, Pathname, DefaultExt, DialogTitle, 7, 1, Flags, Cancel)
'  If Not Cancel Then
'    If Pathname <> "" Then Filename = Pathname + "\" + Filename
'
'    On Local Error GoTo errfix
'    frmSaving.Show
'    Printer.PrintTarget = Filename
'    Call print_MACCS_input_file
'    Printer.PrintTarget = ""
'    Close filenum
'    Unload frmSaving
'  End If
'  Exit Sub
'
'errfix:
'  MsgBox "A FILE ERROR HAS OCCURRED. PLEASE CHECK ALL FILE NAMES"
'  Exit Sub
'End Sub
```

H.15 Visual Basic Code Module: Sitecode.bas

```
Attribute VB_Name = "Sitecode"
Option Explicit

'This module allows the user to create, edit, and and view site files

Sub new_site()

    'This module initializes the new site form to its default values,
    'and shows the form.

    frmMain.mnuSave_Sitecom.Enabled = False
    frmMain.mnuSave_as_Sitecom.Enabled = False
    frmSite_Data.caption = CurDir$ + "\" + "NEW_SITE.SIT"
    frmProblem_Data.txtSite_File_Name.text = "NEW_SITE.SIT"
    frmSite_Data.txtSite_Name.text = ""
    frmSite_Data.txtLongitude_Degrees.text = ""
    frmSite_Data.txtLongitude_Minutes.text = ""
    frmSite_Data.txtLongitude_Seconds.text = ""
    frmSite_Data.txtLatitude_Degrees.text = ""
    frmSite_Data.txtLatitude_Minutes.text = ""
    frmSite_Data.txtLatitude_Seconds.text = ""
    frmSite_Data.txtSite_Remarks.text = ""
    frmSite_Data.Show

End Sub

Sub open_site()

    On Error GoTo DialogError

    With frmMain.dlgSecpop
        .Filter = "Site Files (*.sit)|*.sit|All Files|*.*"
        .FilterIndex = 1
        .DialogTitle = "Select a file to open"
        .Filename = ""
        .InitDir = InitSiteFilePath
        If InitSiteFilePathChanged = True Then
            .InitDir = frmSetup.txtSite_Path.text
            InitSiteFilePathChanged = False
        Else
            .InitDir = InitSiteFilePath
        End If
        .ShowOpen
    End With

    'reset init dir

    InitSiteFilePath = Left(frmMain.dlgSecpop.Filename, _
        (InStrRev(frmMain.dlgSecpop.Filename, "\") - 1))

    'This routine opens a previously created site file.

    Dim site_name As String, site_remarks As String, dummy As String
    Dim longitude_degrees As Integer, longitude_minutes As Integer, longitude_seconds As Integer
    Dim latitude_degrees As Integer, latitude_minutes As Integer, latitude_seconds As Integer
    Dim Flags As Integer, Cancel As Integer
    Dim Fname As String
    Static Pathname As String
    Const site_file = 20, file_buffer = 1024
```

```

'If file is not in current directory then add path to fname.

If Pathname <> "" Then Fname = Pathname + "\" + Fname

'Open site file and read in the site data, placing it into temp variables.
Fname = frmMain.dlgSecpop.Filename
Open Fname For Input Access Read Lock Write As #site_file Len = file_buffer
Line Input #site_file, dummy
Line Input #site_file, site_name
Line Input #site_file, dummy
Line Input #site_file, dummy
Input #site_file, longitude_degrees
Input #site_file, longitude_minutes
Input #site_file, longitude_seconds
Line Input #site_file, dummy
Input #site_file, latitude_degrees
Input #site_file, latitude_minutes
Input #site_file, latitude_seconds
Line Input #site_file, dummy
Line Input #site_file, site_remarks
Close site_file

'Set window caption to fname.

frmSite_Data.caption = Fname

'Move file values from temporary variables to the correct form locations.

frmProblem_Data.txtSite_File_Name.text = Fname
frmSite_Data.txtSite_Name.text = site_name
frmSite_Data.txtLongitude_Degrees.text = Trim(Str$(longitude_degrees))
frmSite_Data.txtLongitude_Minutes.text = Trim(Str$(longitude_minutes))
frmSite_Data.txtLongitude_Seconds.text = Trim(Str$(longitude_seconds))
frmSite_Data.txtLatitude_Degrees.text = Trim(Str$(latitude_degrees))
frmSite_Data.txtLatitude_Minutes.text = Trim(Str$(latitude_minutes))
frmSite_Data.txtLatitude_Seconds.text = Trim(Str$(latitude_seconds))
frmSite_Data.txtSite_Remarks.text = site_remarks

'If site form is not visible, show it.

If (frmSite_Data.Visible = False) Then
    frmSite_Data.Show
End If

'verify lat and long
verify_input (2)

DialogError:

'User pressed the Cancel button

frmSite_Data.Show
Exit Sub

End Sub

Sub save_as_site()

On Error GoTo DialogError

With frmMain.dlgSecpop
    .Filter = "Site Files (*.sit)|*.sit|All files|*.*"
    .FilterIndex = 1
    .DialogTitle = "Save File As"

```

```

        .Filename = ""
        .Flags = cdIOFNOverwritePrompt
        .DefaultExt = ".sit"
        .InitDir = InitSiteFilePath
    ' If InitSiteFilePathChanged = True Then
        .InitDir = frmSetup.txtSite_Path.text
        InitSiteFilePathChanged = False
    Else
        .InitDir = InitSiteFilePath
    End If
    .ShowSave
End With

'reset init dir

InitSiteFilePath = Left(frmMain.dlgSecpop.Filename, _
                        (InStrRev(frmMain.dlgSecpop.Filename, "\") - 1))

'Save a site file using a new name.
Const site_file = 20, file_buffer = 1024

Dim site_name As String, site_remarks As String, dummy As String, caption As String
Dim longitude_degrees As Integer, longitude_minutes As Integer, longitude_seconds As Integer
Dim latitude_degrees As Integer, latitude_minutes As Integer, latitude_seconds As Integer
Dim Flags As Integer, Cancel As Integer
Dim Fname As String, Pathname As String
Dim temp As Integer

'Check validity of data entered by user, warn user if there is a problem.
temp = verify_input(2)

'Set default file to name of site window.
caption = frmSite_Data.caption
caption = frmMain.dlgSecpop.Filename

'Remove path from fname.
Call parse_path_and_file(caption, Pathname, Fname)

'If file is not in the current directory, then add the path to
'the fname.
If Pathname <> "" Then Fname = Pathname + "\" + Fname
frmSite_Data.caption = caption
frmProblem_Data.txtSite_File_Name.text = caption
' frmSite_Data.caption = Fname
' frmProblem_Data.txtSite_File_Name.text = Fname

'Call function to save the data.
Call save_site

DialogError:
'User pressed the Cancel button
Exit Sub

End Sub

Sub save_site()

```

```

'Save data from a site form.

'Declare as constant the site file handle and the file buffer size.

Const site_file = 20, file_buffer = 1024
Dim i As Integer
Dim Fname As String, Pathname As String

'Set default fname to name of site window.
Fname = frmSite_Data.caption

'Enable local error checking.

On Local Error GoTo site_save_error

'If the site has not yet been named, call save as.

If Fname = "" Then
    Call save_as_site
    Exit Sub
End If

'Open the site file and send the site info to it.

Open Fname For Output Access Write Lock Read Write As #site_file Len = file_buffer
Print #site_file, "Site Name:"
Print #site_file, frmSite_Data.txtSite_Name.text
Print #site_file, "Site Coordinates:"
Print #site_file, "Longitude (Degrees, Minutes, Seconds)"
Print #site_file, "          "; Val(frmSite_Data.txtLongitude_Degrees.text);
Print #site_file, "          "; Val(frmSite_Data.txtLongitude_Minutes.text);
Print #site_file, "          "; Val(frmSite_Data.txtLongitude_Seconds.text)
Print #site_file, "Latitude (Degrees, Minutes, Seconds)"
Print #site_file, "          "; Val(frmSite_Data.txtLatitude_Degrees.text);
Print #site_file, "          "; Val(frmSite_Data.txtLatitude_Minutes.text);
Print #site_file, "          "; Val(frmSite_Data.txtLatitude_Seconds.text)
Print #site_file, "Site Remarks:"
Print #site_file, frmSite_Data.txtSite_Remarks.text
Close site_file

'Reset window names to match site file name.

frmSite_Data.caption = Fname
frmProblem_Data.txtSite_File_Name.text = Fname

Exit Sub

site_save_error:

'If an error occurs, inform the user and exit sub.

MsgBox "Error opening or creating site file"
Exit Sub

End Sub

```

H.16 Visual Basic Code Module: Types.bas

```
Attribute VB_Name = "Types"
'*****
' Module: Types
'
' Project: SECPOP
'
' Description: This module was made obsolete by InIt module
'
' Modification History
' Date      By      Description
' -----  --  -----
' 20020303 cwm  rendered obsolete
'
'*****

'Type economic_data
'
'   region_area As Long
'   region_frmfrc As Single
'   region_dpfc As Single
'   region_asfp As Single
'   region_vfrm As Single
'   region_vnfrm As Single
'
'End Type
```

H.17 Visual Basic Code Module: Utility.bas

```
Attribute VB_Name = "Utility"
Option Explicit

'Various general purpose utilities:
'1. Print stuff to a non-Form screen.
'2. Print stuff to the printer.
'3. Verify the user's input in one of several forms.
'4. Copy from one file to another.

Sub parse_path_and_file(caption As String, path_name As String, file_name As String)

    'This routine removes the path from a file name. This is necessary when
    'passing a default filename to a file dialog box.

    Dim temp As String
    Dim modified_location As Integer
    Dim slash_found As Integer, slash_location As Integer

    'Remove the modified specifier from the file name if necessary.

    modified_location = InStr(caption, " (Modified)")
    If modified_location <> 0 Then
        temp = Mid$(caption, 1, modified_location - 1)
    Else
        temp = caption
    End If

    'Search backward from the end of the string to the first slash,
    'and record the position of the first slash.

    slash_found = False
    slash_location = Len(temp)
    While ((Not slash_found) And (slash_location > 0))
        If Mid$(temp, slash_location, 1) = "\" Then
            slash_found = True
        Else
            slash_location = slash_location - 1
        End If
    Wend

    'If a slash was found, break the name into two parts - path and file.

    If slash_found = True Then
        path_name = Mid$(temp, 1, slash_location - 1)
        file_name = Mid$(temp, slash_location + 1)
    Else
        path_name = ""
        file_name = temp
    End If

End Sub

Sub print_text(text As String, text_width As Integer, left_margin As Integer)

    'This routine prints formatted text strings in a non-form environment.

    Dim next_line As String, character As String
    Dim character_location As Integer, character_found As Integer
```

```

'Execute loop while the length of text is greater
'than the user defined size.

While (Len(text) > text_width)

    'Put next string of length user has requested into next line.

    next_line = Left$(text, text_width)
    character_found = False
    character_location = text_width

    'Scan input string for special characters ( <cr>, -, and " ").

    While ((Not character_found) And (character_location > 0))
        character = Mid$(next_line, character_location, 1)
        If ((character = " ") Or (character = "-") Or (character = Chr$(13))) Then
            character_found = True
        Else
            character_location = character_location - 1
        End If
    Wend

    'Process special characters found in string.

    If character_found Then
        Printer.Print Tab(left_margin); Left$(next_line, character_location - 1);
        If character = "-" Then
            Printer.Print character
        Else
            Printer.Print
        End If
        character_found = False
        text = Mid$(text, character_location + 1)
    Else

        'If no characters found, then print string.

        Printer.Print Tab(left_margin); next_line
        text = Mid$(text, text_width + 1)

    End If

Wend

Printer.Print Tab(left_margin); text

End Sub

Function verify_input(which_form As Integer) As Integer

    Dim filenum As Integer
    Dim TempString As String, i As Integer, j As Integer

    'Define constants representing which form is calling for input
    'verification.

    Const PROBLEM = 1, SITE = 2, REGIONAL_CALC = 3

    'Decide which form is calling, analyze the input on that form,
    'display a message if necessary, and return a value to the calling
    'function.

    verify_input = 0

```



```

Select Case which_form

Case PROBLEM

'Enable local error checking for the new problem form to deal
'with disk related errors check for the file then reset local
'error checking.

On Local Error GoTo problem_bad_file_name
filenum = FreeFile
Open frmProblem_Data.txtSite_File_Name.text For Input As #filenum
Close filenum
On Local Error GoTo 0

If Val(frmProblem_Data.txtPopulation_multiplier.text) <= 0 Then

    MsgBox "Error: Population multiplier must greater than 0.  "
    verify_input = -1

ElseIf Val(frmProblem_Data.txtPopulation_multiplier.text) > 9999.9999 Then

    MsgBox "Error: Population multiplier must be less than 10000"
    verify_input = -1

ElseIf (radial_distance(1) <= 0) Then

    MsgBox "Error: Radial distance 1 must be greater than 0."
    verify_input = -2

ElseIf (radial_distance(2) <= 0) Then

    MsgBox "Error: Radial distance 2 must be greater than 0."
    verify_input = -3

ElseIf (Val(frmProblem_Data.lblNumber_of_regions.caption) < 2 Or
Val(frmProblem_Data.lblNumber_of_regions.caption) > 99) Then

    MsgBox "Invalid Economic region settings"
    verify_input = -4

Else

    'Everything's O.K.
    verify_input = 1

End If

Case SITE

If (Val(frmSite_Data.txtLatitude_Degrees.text) > 47) Or _
(Val(frmSite_Data.txtLatitude_Degrees.text) < 24) Or _
(Val(frmSite_Data.txtLongitude_Degrees.text) > 125) Or _
(Val(frmSite_Data.txtLongitude_Degrees.text) < 67) Then ' longitude degs
originally 172

    MsgBox "Warning: The Site that you have specified is outside of the " & _
"continental United States.  " & vbCrLf & _
"Data near the site may not be available." & vbCrLf & vbCrLf & _
"Values within the continental United States are as follows:  " & _
vbCrLf & vbCrLf & _
"Latitude:    from 24 to 47" & vbCrLf & _
"Longitude:   from 67 to 125"
    verify_input = -1

Else

```

```

'Everything's O.K.
verify_input = 1

End If

'''
'''
Case REGIONAL_CALC
'''
'''
If ((Val(frmMake_a_Circle.txtRadii.text) < 1) Or _
(Val(frmMake_a_Circle.txtRadii.text) > 170)) Then
'''
'''
MsgBox _
'''
"Radii of Circles value must be greater than or" + _
Chr$(13) + Chr$(10) + _
"equal to 1 mile and less than or equal to 170" + _
Chr$(13) + Chr$(10) + _
"miles.", vbOK, "Error"
'''
'''
verify_input = 0
'''
'''
ElseIf ((Val(frmMake_a_Circle.txtSpacing.text) < 1) Or _
(Val(frmMake_a_Circle.txtSpacing.text) > 340)) Then
'''
'''
MsgBox _
'''
"Longitudinal Spacing of Circles value must" + _
Chr$(13) + Chr$(10) + _
"be greater than or equal to 1 mile and less" + _
Chr$(13) + Chr$(10) + _
"than or equal to 340 miles.", vbOK, "Error"
'''
'''
verify_input = -1
'''
'''
ElseIf ((Val(frmMake_a_Circle.txtThreshold.text) < 1) Or _
(Val(frmMake_a_Circle.txtThreshold.text) > 20000)) Then
'''
'''
MsgBox _
'''
"Population Density Threshold value must be" + _
Chr$(13) + Chr$(10) + _
"greater than or equal to 1 person per square" + _
Chr$(13) + Chr$(10) + _
"mile and less than or equal to 20000 persons" + _
Chr$(13) + Chr$(10) + _
"per square mile.", vbOK, "Error"
'''
'''
verify_input = -2
'''
'''
ElseIf (frmMake_a_Circle.txtInput_Map.text = "") Then
'''
'''
MsgBox _
'''
"Input Map Name missing. Please enter a valid" + _
Chr$(13) + Chr$(10) + _
"filename.", vbOK, "Error"
'''
'''
verify_input = -3
'''
'''
Else
'''
'''
'Enable local error checking for regional calc form
On Local Error GoTo regional_file_error
filenum = FreeFile
Open frmMake_a_Circle.txtInput_Map.text _
For Input As filenum
Close filenum
On Local Error GoTo 0
'If we got here then everything's O.K.
'''
'''

```

```

'''          verify_input = 1
'''
'''          End If

End Select

Exit Function

problem_bad_file_name:

MsgBox "Error: Unable to open site file - check file name. "
verify_input = -1
'   verify_input = 0
Exit Function

regional_file_error:

MsgBox _
    "Input Map Name invalid. Please enter a valid" + _
    Chr$(13) + Chr$(10) + _
    "filename.", vbOK, "Error"

verify_input = -3

Exit Function

End Function

Sub copy_file(input_filename As String, output_filename As String)

Dim i As Long
Dim my_byte As String * 1
Dim input_filenum As Integer, output_filenum As Integer

On Local Error GoTo error_return

input_filenum = FreeFile
Open input_filename For Binary Access Read As #input_filenum

output_filenum = FreeFile

'Truncate output file to 0 length if it already existed.
Open output_filename For Output Access Write As #output_filenum
Close (output_filenum)

Open output_filename For Binary Access Write As #output_filenum

For i = 1 To LOF(input_filenum) Step 1
    Get #input_filenum, , my_byte
    Put #output_filenum, , my_byte
Next i

Close (input_filenum)
Close (output_filenum)

normal_return:

Exit Sub

error_return:

MsgBox Error$(Err)
Exit Sub

End Sub

```

H.18 Visual Basic Code Module: Utility_Rosette.bas

```
Attribute VB_Name = "Utility_Rosette"
Option Explicit

' This module was extracted from the Microsoft web site.
' It includes:
'   - CaptureScreen - captures the entire screen.
'   - CaptureForm - captures the form including title bar and border.
'   - CaptureClient - captures all visible controls on the active form.
'   - CaptureActiveWindow - captures the currently active window
'   - PrintPictureToFitPage - adjusts size of picture to fit paper
'   - and all other functions and api calls to support the above.
'
' Only CaptureClient is used in SecPop. The others are included
' for completeness and may be used later.

-----
'
' Visual Basic 4.0 16/32 Capture Routines
'
' This module contains several routines for capturing windows into a
' picture. All the routines work on both 16 and 32 bit Windows
' platforms.
' The routines also have palette support.
'
' CreateBitmapPicture - Creates a picture object from a bitmap and
' palette.
' CaptureWindow - Captures any window given a window handle.
' CaptureActiveWindow - Captures the active window on the desktop.
' CaptureForm - Captures the entire form.
' CaptureClient - Captures the client area of a form.
' CaptureScreen - Captures the entire screen.
' PrintPictureToFitPage - prints any picture as big as possible on
' the page.
'
' NOTES
'   - No error trapping is included in these routines.
'
-----

Option Base 0

Private Type PALETTEENTRY
    peRed As Byte
    peGreen As Byte
    peBlue As Byte
    peFlags As Byte
End Type

Private Type LOGPALETTE
    palVersion As Integer
    palNumEntries As Integer
    palPalEntry(255) As PALETTEENTRY ' Enough for 256 colors.
End Type

Private Type GUID
    Data1 As Long
    Data2 As Integer
    Data3 As Integer
    Data4(7) As Byte
End Type
```

```

#If Win32 Then

Private Const RASTERCAPS As Long = 38
Private Const RC_PALETTE As Long = &H100
Private Const SIZEPALETTE As Long = 104

Private Type RECT
    Left As Long
    Top As Long
    Right As Long
    Bottom As Long
End Type

Private Declare Function CreateCompatibleDC Lib "GDI32" ( _
    ByVal hDC As Long) As Long
Private Declare Function CreateCompatibleBitmap Lib "GDI32" ( _
    ByVal hDC As Long, ByVal nWidth As Long, _
    ByVal nHeight As Long) As Long
Private Declare Function GetDeviceCaps Lib "GDI32" ( _
    ByVal hDC As Long, ByVal iCapability As Long) As Long
Private Declare Function GetSystemPaletteEntries Lib "GDI32" ( _
    ByVal hDC As Long, ByVal wStartIndex As Long, _
    ByVal wNumEntries As Long, lpPaletteEntries As PALETTEENTRY) _
    As Long
Private Declare Function CreatePalette Lib "GDI32" ( _
    lpLogPalette As LOGPALETTE) As Long
Private Declare Function SelectObject Lib "GDI32" ( _
    ByVal hDC As Long, ByVal hObject As Long) As Long
Private Declare Function BitBlt Lib "GDI32" ( _
    ByVal hDCDest As Long, ByVal XDest As Long, _
    ByVal YDest As Long, ByVal nWidth As Long, _
    ByVal nHeight As Long, ByVal hDCSrc As Long, _
    ByVal XSrc As Long, ByVal YSrc As Long, ByVal dwRop As Long) _
    As Long
Private Declare Function DeleteDC Lib "GDI32" ( _
    ByVal hDC As Long) As Long
Private Declare Function GetForegroundWindow Lib "USER32" () _
    As Long
Private Declare Function SelectPalette Lib "GDI32" ( _
    ByVal hDC As Long, ByVal hPalette As Long, _
    ByVal bForceBackground As Long) As Long
Private Declare Function RealizePalette Lib "GDI32" ( _
    ByVal hDC As Long) As Long
Private Declare Function GetWindowDC Lib "USER32" ( _
    ByVal hWnd As Long) As Long
Private Declare Function GetDC Lib "USER32" ( _
    ByVal hWnd As Long) As Long
Private Declare Function GetWindowRect Lib "USER32" ( _
    ByVal hWnd As Long, lpRect As RECT) As Long
Private Declare Function ReleaseDC Lib "USER32" ( _
    ByVal hWnd As Long, ByVal hDC As Long) As Long
Private Declare Function GetDesktopWindow Lib "USER32" () As Long

Private Type PicBmp
    Size As Long
    Type As Long
    hBmp As Long
    hPal As Long
    Reserved As Long
End Type

Private Declare Function OleCreatePictureIndirect _
    Lib "olepro32.dll" (PicDesc As PicBmp, RefIID As GUID, _
    ByVal fPictureOwnsHandle As Long, IPic As IPicture) As Long

```

```

#ElseIf Win16 Then

Private Const RASTERCAPS As Integer = 38
Private Const RC_PALETTE As Integer = &H100
Private Const SIZEPALETTE As Integer = 104

Private Type RECT
    Left As Integer
    Top As Integer
    Right As Integer
    Bottom As Integer
End Type

Private Declare Function CreateCompatibleDC Lib "GDI" ( _
    ByVal hDC As Integer) As Integer
Private Declare Function CreateCompatibleBitmap Lib "GDI" ( _
    ByVal hDC As Integer, ByVal nWidth As Integer, _
    ByVal nHeight As Integer) As Integer
Private Declare Function GetDeviceCaps Lib "GDI" ( _
    ByVal hDC As Integer, ByVal iCapability As Integer) As Integer
Private Declare Function GetSystemPaletteEntries Lib "GDI" ( _
    ByVal hDC As Integer, ByVal wStartIndex As Integer, _
    ByVal wNumEntries As Integer, _
    lpPaletteEntries As PALETTEENTRY) As Integer
Private Declare Function CreatePalette Lib "GDI" ( _
    lpLogPalette As LOGPALETTE) As Integer
Private Declare Function SelectObject Lib "GDI" ( _
    ByVal hDC As Integer, ByVal hObject As Integer) As Integer
Private Declare Function BitBlt Lib "GDI" ( _
    ByVal hDCDest As Integer, ByVal XDest As Integer, _
    ByVal YDest As Integer, ByVal nWidth As Integer, _
    ByVal nHeight As Integer, ByVal hDCSrc As Integer, _
    ByVal XSrc As Integer, ByVal YSrc As Integer, _
    ByVal dwRop As Long) As Integer
Private Declare Function DeleteDC Lib "GDI" ( _
    ByVal hDC As Integer) As Integer
Private Declare Function GetForegroundWindow Lib "USER" _
    Alias "GetActiveWindow" () As Integer
Private Declare Function SelectPalette Lib "USER" ( _
    ByVal hDC As Integer, ByVal hPalette As Integer, ByVal _
    bForceBackground As Integer) As Integer
Private Declare Function RealizePalette Lib "USER" ( _
    ByVal hDC As Integer) As Integer
Private Declare Function GetWindowDC Lib "USER" ( _
    ByVal hWnd As Integer) As Integer
Private Declare Function GetDC Lib "USER" ( _
    ByVal hWnd As Integer) As Integer
Private Declare Function GetWindowRect Lib "USER" ( _
    ByVal hWnd As Integer, lpRect As RECT) As Integer
Private Declare Function ReleaseDC Lib "USER" ( _
    ByVal hWnd As Integer, ByVal hDC As Integer) As Integer
Private Declare Function GetDesktopWindow Lib "USER" () As Integer

Private Type PicBmp
    Size As Integer
    Type As Integer
    hBmp As Integer
    hPal As Integer
    Reserved As Integer
End Type

Private Declare Function OleCreatePictureIndirect _
    Lib "oc25.dll" (PictDesc As PicBmp, RefIID As GUID, _
    ByVal fPictureOwnsHandle As Integer, IPic As IPicture) _
    As Integer

```

```

#End If
'
' .....
' CreateBitmapPicture
'   - Creates a bitmap type Picture object from a bitmap and
'     palette.
'
' hBmp
'   - Handle to a bitmap.
'
' hPal
'   - Handle to a Palette.
'   - Can be null if the bitmap doesn't use a palette.
'
' Returns
'   - Returns a Picture object containing the bitmap.
' .....
'
#If Win32 Then
    Public Function CreateBitmapPicture(ByVal hBmp As Long, _
        ByVal hPal As Long) As Picture

        Dim r As Long
#ElseIf Win16 Then
    Public Function CreateBitmapPicture(ByVal hBmp As Integer, _
        ByVal hPal As Integer) As Picture

        Dim r As Integer
#End If

    Dim Pic As PicBmp
    ' IPicture requires a reference to "Standard OLE Types."
    Dim IPic As IPicture
    Dim IID_IDispatch As GUID

    ' Fill in with IDispatch Interface ID.
    With IID_IDispatch
        .Data1 = &H20400
        .Data4(0) = &HC0
        .Data4(7) = &H46
    End With

    ' Fill Pic with necessary parts.
    With Pic
        .Size = Len(Pic)           ' Length of structure.
        .Type = vbPicTypeBitmap   ' Type of Picture (bitmap).
        .hBmp = hBmp              ' Handle to bitmap.
        .hPal = hPal              ' Handle to palette (may be null).
    End With

    ' Create Picture object.
    r = OleCreatePictureIndirect(Pic, IID_IDispatch, 1, IPic)

    ' Return the new Picture object.
    Set CreateBitmapPicture = IPic
End Function

' .....
'
' CaptureWindow
'   - Captures any portion of a window.
'
' hWndSrc
'   - Handle to the window to be captured.
'
' Client

```

```

' - If True CaptureWindow captures from the client area of the
' window.
' - If False CaptureWindow captures from the entire window.
' LeftSrc, TopSrc, WidthSrc, HeightSrc
' - Specify the portion of the window to capture.
' - Dimensions need to be specified in pixels.
'
' Returns
' - Returns a Picture object containing a bitmap of the specified
' portion of the window that was captured.
' .....
' .....
'
#If Win32 Then
Public Function CaptureWindow(ByVal hWndSrc As Long, _
    ByVal Client As Boolean, ByVal LeftSrc As Long, _
    ByVal TopSrc As Long, ByVal WidthSrc As Long, _
    ByVal HeightSrc As Long) As Picture

    Dim hDCMemory As Long
    Dim hBmp As Long
    Dim hBmpPrev As Long
    Dim r As Long
    Dim hDCSrc As Long
    Dim hPal As Long
    Dim hPalPrev As Long
    Dim RasterCapsScrn As Long
    Dim HasPaletteScrn As Long
    Dim PaletteSizeScrn As Long
#ElseIf Win16 Then
Public Function CaptureWindow(ByVal hWndSrc As Integer, _
    ByVal Client As Boolean, ByVal LeftSrc As Integer, _
    ByVal TopSrc As Integer, ByVal WidthSrc As Long, _
    ByVal HeightSrc As Long) As Picture

    Dim hDCMemory As Integer
    Dim hBmp As Integer
    Dim hBmpPrev As Integer
    Dim r As Integer
    Dim hDCSrc As Integer
    Dim hPal As Integer
    Dim hPalPrev As Integer
    Dim RasterCapsScrn As Integer
    Dim HasPaletteScrn As Integer
    Dim PaletteSizeScrn As Integer
#End If
Dim LogPal As LOGPALETTE

' Depending on the value of Client get the proper device context.
If Client Then
    hDCSrc = GetDC(hWndSrc) ' Get device context for client area.
Else
    hDCSrc = GetWindowDC(hWndSrc) ' Get device context for entire
    ' window.
End If

' Create a memory device context for the copy process.
hDCMemory = CreateCompatibleDC(hDCSrc)
' Create a bitmap and place it in the memory DC.
hBmp = CreateCompatibleBitmap(hDCSrc, WidthSrc, HeightSrc)
hBmpPrev = SelectObject(hDCMemory, hBmp)

' Get screen properties.
RasterCapsScrn = GetDeviceCaps(hDCSrc, RASTERCAPS) ' Raster
' capabilities.

```



```

HasPaletteScrn = RasterCapsScrn And RC_PALETTE           ' Palette
                                                         ' support.
PaletteSizeScrn = GetDeviceCaps(hDCSrc, SIZEPALETTE)    ' Size of
                                                         ' palette.

' If the screen has a palette make a copy and realize it.
If HasPaletteScrn And (PaletteSizeScrn = 256) Then
    ' Create a copy of the system palette.
    LogPal.palVersion = &H300
    LogPal.palNumEntries = 256
    r = GetSystemPaletteEntries(hDCSrc, 0, 256, _
        LogPal.palPalEntry(0))
    hPal = CreatePalette(LogPal)
    ' Select the new palette into the memory DC and realize it.
    hPalPrev = SelectPalette(hDCMemory, hPal, 0)
    r = RealizePalette(hDCMemory)
End If

' Copy the on-screen image into the memory DC.
r = BitBlt(hDCMemory, 0, 0, WidthSrc, HeightSrc, hDCSrc, _
    LeftSrc, TopSrc, vbSrcCopy)

' Remove the new copy of the on-screen image.
hBmp = SelectObject(hDCMemory, hBmpPrev)

' If the screen has a palette get back the palette that was
' selected in previously.
If HasPaletteScrn And (PaletteSizeScrn = 256) Then
    hPal = SelectPalette(hDCMemory, hPalPrev, 0)
End If

' Release the device context resources back to the system.
r = DeleteDC(hDCMemory)
r = ReleaseDC(hWndSrc, hDCSrc)

' Call CreateBitmapPicture to create a picture object from the
' bitmap and palette handles. Then return the resulting picture
' object.
Set CaptureWindow = CreateBitmapPicture(hBmp, hPal)
End Function

.....
'
' CaptureScreen
' - Captures the entire screen.
'
' Returns
' - Returns a Picture object containing a bitmap of the screen.
.....
Public Function CaptureScreen() As Picture
    #If Win32 Then
        Dim hWndScreen As Long
    #ElseIf Win16 Then
        Dim hWndScreen As Integer
    #End If

    ' Get a handle to the desktop window.
    hWndScreen = GetDesktopWindow()

    ' Call CaptureWindow to capture the entire desktop give the handle
    ' and return the resulting Picture object.

    Set CaptureScreen = CaptureWindow(hWndScreen, False, 0, 0, _
        Screen.Width \ Screen.TwipsPerPixelX, _
        Screen.Height \ Screen.TwipsPerPixelY)

```

```

End Function

'
' .....
' CaptureForm
'   - Captures an entire form including title bar and border.
' frmSrc
'   - The Form object to capture.
' Returns
'   - Returns a Picture object containing a bitmap of the entire
'     form.
' .....
Public Function CaptureForm(frmSrc As Form) As Picture
' Call CaptureWindow to capture the entire form given its window
' handle and then return the resulting Picture object.
Set CaptureForm = CaptureWindow(frmSrc.hWnd, False, 0, 0, _
    frmSrc.ScaleX(frmSrc.Width, vbTwips, vbPixels), _
    frmSrc.ScaleY(frmSrc.Height, vbTwips, vbPixels))
End Function

'
' .....
' CaptureClient
'   - Captures the client area of a form.
' frmSrc
'   - The Form object to capture.
' Returns
'   - Returns a Picture object containing a bitmap of the form's
'     client area.
' .....
Public Function CaptureClient(frmSrc As Form) As Picture
' Call CaptureWindow to capture the client area of the form given
' its window handle and return the resulting Picture object.
Set CaptureClient = CaptureWindow(frmSrc.hWnd, True, 0, 0, _
    frmSrc.ScaleX(frmSrc.ScaleWidth, frmSrc.ScaleMode, vbPixels), _
    frmSrc.ScaleY(frmSrc.ScaleHeight, frmSrc.ScaleMode, vbPixels))
End Function

'
' .....
' CaptureActiveWindow
'   - Captures the currently active window on the screen.
' Returns
'   - Returns a Picture object containing a bitmap of the active
'     window.
' .....
Public Function CaptureActiveWindow() As Picture
#If Win32 Then
    Dim hWndActive As Long
    Dim r As Long
#ElseIf Win16 Then
    Dim hWndActive As Integer
    Dim r As Integer
#End If
Dim RectActive As RECT

' Get a handle to the active/foreground window.
hWndActive = GetForegroundWindow()

```

```

' Get the dimensions of the window.
r = GetWindowRect(hWndActive, RectActive)

' Call CaptureWindow to capture the active window given its
' handle and return the Resulting Picture object.
Set CaptureActiveWindow = CaptureWindow(hWndActive, False, 0, 0, _
    RectActive.Right - RectActive.Left, _
    RectActive.Bottom - RectActive.Top)
End Function

'-----
' PrintPictureToFitPage
' - Prints a Picture object as big as possible.
'
' Prn
' - Destination Printer object.
'
' Pic
' - Source Picture object.
'-----

Public Sub PrintPictureToFitPage(Prn As Printer, Pic As Picture)
    Const vbHiMetric As Integer = 8
    Dim PicRatio As Double
    Dim PrnWidth As Double
    Dim PrnHeight As Double
    Dim PrnRatio As Double
    Dim PrnPicWidth As Double
    Dim PrnPicHeight As Double

    ' Determine if picture should be printed in landscape or portrait
    ' and set the orientation.
    If Pic.Height >= Pic.Width Then
        Prn.Orientation = vbPRORPortrait ' Taller than wide.
    Else
        Prn.Orientation = vbPRORLandscape ' Wider than tall.
    End If

    ' Calculate device independent Width-to-Height ratio for picture.
    PicRatio = Pic.Width / Pic.Height

    ' Calculate the dimentions of the printable area in HiMetric.
    PrnWidth = Prn.ScaleX(Prn.ScaleWidth, Prn.ScaleMode, vbHiMetric)
    PrnHeight = Prn.ScaleY(Prn.ScaleHeight, Prn.ScaleMode, vbHiMetric)
    ' Calculate device independent Width to Height ratio for printer.
    PrnRatio = PrnWidth / PrnHeight

    ' Scale the output to the printable area.
    If PicRatio >= PrnRatio Then
        ' Scale picture to fit full width of printable area.
        PrnPicWidth = Prn.ScaleX(PrnWidth, vbHiMetric, Prn.ScaleMode)
        PrnPicHeight = Prn.ScaleY(PrnWidth / PicRatio, vbHiMetric, _
            Prn.ScaleMode)
    Else
        ' Scale picture to fit full height of printable area.
        PrnPicHeight = Prn.ScaleY(PrnHeight, vbHiMetric, Prn.ScaleMode)
        PrnPicWidth = Prn.ScaleX(PrnHeight * PicRatio, vbHiMetric, _
            Prn.ScaleMode)
    End If

    ' Print the picture using the PaintPicture method.
    Prn.PaintPicture Pic, 0, 0, PrnPicWidth, PrnPicHeight
End Sub
'-----

```

H.19 Visual Basic Form Module: About.frm

```
VERSION 5.00
Begin VB.Form frmAbout
    Caption           = "SecPop2000"
    ClientHeight     = 6450
    ClientLeft       = 60
    ClientTop        = 345
    ClientWidth      = 8490
    Icon             = "About.frx":0000
    LinkTopic        = "Form1"
    MDIChild         = -1 'True
    ScaleHeight      = 6450
    ScaleWidth       = 8490
    Begin VB.Label Label11
        Caption       = "SECPop2000 - SECTOR POPulation and Economic Estimator"
        BeginProperty Font
            Name       = "MS Sans Serif"
            Size      = 12
            Charset   = 0
            Weight    = 700
            Underline = 0 'False
            Italic    = 0 'False
            Strikethrough = 0 'False
        EndProperty
        Height       = 705
        Left        = 900
        TabIndex    = 8
        Top         = 930
        Width       = 5235
    End
    Begin VB.Label Label10
        Caption       = "JNR@NRC.gov"
        BeginProperty Font
            Name       = "MS Sans Serif"
            Size      = 9.75
            Charset   = 0
            Weight    = 700
            Underline = 0 'False
            Italic    = 0 'False
            Strikethrough = 0 'False
        EndProperty
        Height       = 235
        Left        = 1050
        TabIndex    = 7
        Top         = 4635
        Width       = 2370
    End
    Begin VB.Label Label7
        Caption       = "Nuclear Regulatory Commission"
        BeginProperty Font
            Name       = "MS Sans Serif"
            Size      = 9.75
            Charset   = 0
            Weight    = 700
            Underline = 0 'False
            Italic    = 0 'False
            Strikethrough = 0 'False
        EndProperty
        Height       = 235
        Left        = 1050
        TabIndex    = 6
        Top         = 4020
        Width       = 3525
    End
End
```

```

Begin VB.Label Label6
  Caption      = "John N. Ridgely"
  BeginProperty Font
    Name       = "MS Sans Serif"
    Size       = 9.75
    Charset    = 0
    Weight     = 700
    Underline  = 0 'False
    Italic     = 0 'False
    Strikethrough = 0 'False
  EndProperty
  Height      = 235
  Left       = 1050
  TabIndex   = 5
  Top        = 3735
  Width      = 2370
End
Begin VB.Label Label5
  Caption      = "(301)415-6555"
  BeginProperty Font
    Name       = "MS Sans Serif"
    Size       = 9.75
    Charset    = 0
    Weight     = 700
    Underline  = 0 'False
    Italic     = 0 'False
    Strikethrough = 0 'False
  EndProperty
  Height      = 235
  Left       = 1050
  TabIndex   = 4
  Top        = 4305
  Width      = 2370
End
Begin VB.Label Label4
  Caption      = "Version: 3.11"
  BeginProperty Font
    Name       = "MS Sans Serif"
    Size       = 12
    Charset    = 0
    Weight     = 700
    Underline  = 0 'False
    Italic     = 0 'False
    Strikethrough = 0 'False
  EndProperty
  Height      = 375
  Left       = 900
  TabIndex   = 3
  Top        = 1995
  Width      = 3930
End
Begin VB.Label Label2
  Caption      = "Developed for the NRC by Sandia National Laboratories, June 2002"
  BeginProperty Font
    Name       = "MS Sans Serif"
    Size       = 9.75
    Charset    = 0
    Weight     = 700
    Underline  = 0 'False
    Italic     = 0 'False
    Strikethrough = 0 'False
  EndProperty
  Height      = 495
  Left       = 900
  TabIndex   = 2
  Top        = 2670

```

```

        Width          = 6195
    End
    Begin VB.Label Label1
        Caption          = "Contact: "
        BeginProperty Font
            Name          = "MS Sans Serif"
            Size          = 9.75
            Charset       = 0
            Weight        = 700
            Underline     = 0 'False
            Italic        = 0 'False
            Strikethrough = 0 'False
        EndProperty
        Height           = 225
        Left             = 900
        TabIndex         = 1
        Top              = 3420
        Width            = 2370
    End
    Begin VB.Label mnuTitle
        Caption          = "Secpop2000"
        BeginProperty Font
            Name          = "MS Sans Serif"
            Size          = 24
            Charset       = 0
            Weight        = 700
            Underline     = 0 'False
            Italic        = 0 'False
            Strikethrough = 0 'False
        EndProperty
        Height           = 600
        Left             = 900
        TabIndex         = 0
        Top              = 225
        Width            = 2850
    End
End
Attribute VB_Name = "frmAbout"
Attribute VB_GlobalNameSpace = False
Attribute VB_Creatable = False
Attribute VB_PredeclaredId = True
Attribute VB_Exposed = False
Option Explicit

```

H.20 Visual Basic Form Module: Circle.frm

```
VERSION 5.00
Begin VB.Form frmMake_a_Circle
    Appearance       = 0    'Flat
    BackColor        = &H80000004&
    BorderStyle      = 1    'Fixed Single
    Caption          = "Regional Population Densities Above The Threshold"
    ClientHeight     = 4680
    ClientLeft       = 1005
    ClientTop        = 570
    ClientWidth      = 6300
    ControlBox       = 0    'False
    BeginProperty Font
        Name          = "MS Sans Serif"
        Size          = 8.25
        Charset       = 0
        Weight        = 700
        Underline     = 0    'False
        Italic        = 0    'False
        Strikethrough = 0    'False
    EndProperty
    ForeColor        = &H00000000&
    MaxButton        = 0    'False
    MinButton        = 0    'False
    PaletteMode      = 1    'UseZOrder
    ScaleHeight      = 4680
    ScaleWidth       = 6300
    StartUpPosition = 1    'CenterOwner
    Begin VB.TextBox txtSpacing
        Appearance     = 0    'Flat
        BackColor      = &H80000004&
        ForeColor      = &H00000000&
        Height         = 720
        Left           = 2808
        TabIndex       = 3
        Top            = 720
        Width          = 2268
    End
    Begin VB.TextBox txtThreshold
        Appearance     = 0    'Flat
        BackColor      = &H80000004&
        ForeColor      = &H00000000&
        Height         = 720
        Left           = 216
        TabIndex       = 5
        Top            = 2400
        Width          = 2268
    End
    Begin VB.TextBox txtInput_Map
        Appearance     = 0    'Flat
        BackColor      = &H80000004&
        ForeColor      = &H00000000&
        Height         = 720
        Left           = 2808
        TabIndex       = 7
        Top            = 2400
        Width          = 2268
    End
    Begin VB.CommandButton cmdInput_files
        Appearance     = 0    'Flat
        BackColor      = &H00808000&
        Caption        = "&Files"
        Height         = 720
        Left           = 5184
    End
End
```

```

    TabIndex      = 8
    Top           = 2400
    Width        = 756
End
Begin VB.OptionButton optPoints
    Appearance    = 0 'Flat
    BackColor     = &H80000004&
    Caption       = "&Points"
    ForeColor     = &H00000000&
    Height       = 240
    Left          = 3888
    TabIndex     = 10
    TabStop      = 0 'False
    Top          = 3360
    Width        = 1080
End
Begin VB.OptionButton optCircles
    Appearance    = 0 'Flat
    BackColor     = &H80000004&
    Caption       = "&Circles"
    ForeColor     = &H00000000&
    Height       = 240
    Left         = 2484
    TabIndex     = 9
    Top          = 3360
    Value        = -1 'True
    Width        = 1296
End
Begin VB.CommandButton cmdCalculate_Regional
    Appearance    = 0 'Flat
    BackColor     = &H00808000&
    Caption       = "C&alculate"
    Height       = 720
    Left         = 1080
    TabIndex     = 11
    Top          = 3840
    Width        = 1836
End
Begin VB.CommandButton cmdClose
    Appearance    = 0 'Flat
    BackColor     = &H00808000&
    Cancel        = -1 'True
    Caption       = "C&lose"
    Height       = 720
    Left         = 3240
    TabIndex     = 12
    Top          = 3840
    Width        = 1836
End
Begin VB.TextBox txtRadii
    Appearance    = 0 'Flat
    BackColor     = &H80000004&
    ForeColor     = &H00000000&
    Height       = 720
    Left         = 216
    TabIndex     = 1
    Top          = 720
    Width        = 2268
End
Begin VB.Label Label7
    Appearance    = 0 'Flat
    AutoSize     = -1 'True
    BackColor     = &H80000004&
    Caption       = "Display results as:"
    ForeColor     = &H00000000&
    Height       = 240

```



```

        Left           = 216
        TabIndex      = 13
        Top           = 3360
        Width         = 2052
    End
    Begin VB.Label Label2
        Appearance     = 0 'Flat
        BackColor      = &H80000004&
        Caption        = "&Input Map Name:"
        ForeColor      = &H00000000&
        Height         = 240
        Left           = 3132
        TabIndex      = 6
        Top           = 2160
        Width         = 1512
    End
    Begin VB.Label Label1
        Appearance     = 0 'Flat
        BackColor      = &H80000004&
        Caption        = "&Radii of Circles (mi):"
        ForeColor      = &H00000000&
        Height         = 240
        Left           = 216
        TabIndex      = 0
        Top           = 480
        Width         = 2268
    End
    Begin VB.Label Label3
        Alignment       = 2 'Center
        Appearance     = 0 'Flat
        BackColor      = &H80000004&
        Caption        = "Longitudinal &Spacing of Circles (mi):"
        ForeColor      = &H00000000&
        Height         = 480
        Left           = 2808
        TabIndex      = 2
        Top           = 240
        Width         = 2160
    End
    Begin VB.Label Label4
        Alignment       = 2 'Center
        Appearance     = 0 'Flat
        BackColor      = &H80000004&
        Caption        = "Population &Density Threshold (People/Square mi):"
        ForeColor      = &H00000000&
        Height         = 720
        Left           = 324
        TabIndex      = 4
        Top           = 1680
        Width         = 1944
    End
End
Attribute VB_Name = "frmMake_a_Circle"
Attribute VB_GlobalNameSpace = False
Attribute VB_Creatable = False
Attribute VB_PredeclaredId = True
Attribute VB_Exposed = False
'''Option Explicit
'''
'''$INCLUDE: 'secpop90.bi'
'''
'''This form deals with much of the overhead associated with regional
'''calculations, including the user interface parsing the data into a
'''usable format, and reporting the status of the calculation.
'''
'''Private Sub cmdCalculate_Regional_Click()

```

```

'''
'''
'Declare a few local variables. Most of these variables are required
'to put the data in a format acceptable to mapplan.
'''
'''
Dim TempString As String, tempchar As String
'''
Dim orig_input As String
'''
Dim number_of_circle_segments As Integer, i As Integer
'''
Dim x_int As Integer, y_int As Integer, spacing As Double
'''
Dim rotation_increment As Double, radii As Double, X As Double
'''
Dim y_radius As Double, y_space As Double
'''
Dim y0 As Double, y2 As Double
'''
Dim x_radius As Double, x_space As Double
'''
Dim x0 As Double, x1 As Double, x2 As Double
'''
Dim xmin As Integer, ymin As Integer
'''
Dim xmax As Integer, ymax As Integer
'''
Dim two As Integer, max_points As Integer
'''
Dim last_x As Integer, last_y As Integer
'''
Dim map_name As String, link_field As String, OFFSET As Integer
'''
Dim input_map As String, output_map As String
'''
Dim output_database As String
'''
Dim min_longitude As Double, min_latitude As Double
'''
Dim max_longitude As Double, max_latitude As Double
'''
Dim longitude_factor As Double, latitude_factor As Double
'''
Dim number_of_layers As Integer
'''
Dim number_of_map_records As Long, number_of_data_records As Long
'''
Dim bytes_in_map_header As Integer, bytes_in_data_header As Integer
'''
Dim bytes_in_map_record As Integer, bytes_in_data_record As Integer
'''
Dim mid1 As String * 18, layerno As String * 3
'''
Dim object_type As String * 1
'''
Dim stp_x As String * 5, stp_y As String * 5, no_elm As String * 3
'''
Dim pos_off As String * 8, nop As String * 5
'''
Dim object_xmin As String * 5
'''
Dim object_ymin As String * 5, object_xmax As String * 5
'''
Dim object_ymax As String * 5, deleted As String * 1
'''
Dim mid2 As String * 8, density As String * 1
'''
Dim vector_offset As Long
'''
Dim threshold As Single
'''
Dim exceeded As Integer
'''
Dim total_circles As Long, number_of_circles As Long
'''
Dim rows As Long, row0 As Long, row1 As Long
'''
Dim m As Double, previous As Double
'''
Dim time_begin As Single, time_end As Single, total_time As Single
'''
Dim hours As Integer, minutes As Integer, seconds As Single
'''
Dim reply As Integer
'''
'''
'Check for valid input from the user.
'''
'''
Select Case verify_input(3)
'''
Case 0
'''
    frmMake_a_Circle.txtRadii.SetFocus
'''
    Exit Sub
'''
Case -1
'''
    frmMake_a_Circle.txtSpacing.SetFocus
'''
    Exit Sub
'''
Case -2
'''
    frmMake_a_Circle.txtThreshold.SetFocus
'''
    Exit Sub
'''
Case -3
'''
    frmMake_a_Circle.txtInput_Map.SetFocus
'''
    Exit Sub
'''
End Select
'''
'''
'Start timer.
'''
'''
time_begin = Timer
'''
'''

```

```

'''
'Put filenames into an acceptable format.
'''
'Remove extension from input map name, if necessary. This section
'''
'allows the user to enter file names on frmMake_a_circle with or
'''
'without extension. If an extension is present, it is temporarily
'''
'removed from the file name, so that secpop can append the necessary
'''
'extensions for the various map files. The filename and extension
'''
'offered by the user are preserved.
'''
TempString = ""
For i = 1 To (Len(frmMake_a_Circle.txtInput_Map.text))
'''
tempchar = Mid$(frmMake_a_Circle.txtInput_Map.text, i, 1)
'''
If tempchar = "." Then
'''
Exit For
'''
Else
'''
TempString = TempString + tempchar
'''
End If
'''
Next i
'''
orig_input = frmMake_a_Circle.txtInput_Map.text
'''
frmMake_a_Circle.txtInput_Map.text = TempString
'''
'Set up final error checking to catch file names that are too long
'''
'and anything else that may have slipped by.
'''
On Local Error GoTo regional_file_error
'''
'Read in the user input. Convert miles to kilometers.
'''
spacing = Val(frmMake_a_Circle.txtSpacing.text) * _
'''
miles_to_kilometers
'''
threshold = Val(frmMake_a_Circle.txtThreshold.text) / _
'''
(miles_to_kilometers ^ 2)
'''
'Set the radii to be equal to 1 mile increments out to 20 miles
'''
'and 10 mile increments after that. 170 miles is the largest
'''
'possible radii. Convert the miles to kilometers.
'''
radii = Val(txtRadii.text)
'''
For i = 1 To max_number_of_radii Step 1
'''
If (regional_radii(i) < radii) Then
'''
raddis(i) = regional_radii(i) * miles_to_kilometers
'''
Else
'''
raddis(i) = radii * miles_to_kilometers
'''
numrad = i
'''
Exit For
'''
End If
'''
Next i
'''
radii = radii * miles_to_kilometers
'''
'Intialize popultion threshold array.
'''
For i = 1 To numrad Step 1
'''
population_threshold(i) = Fix(threshold * pi * _
'''
(raddis(i) ^ 2)) + 1
'''
Next i
'''
input_map = frmMake_a_Circle.txtInput_Map.text
'''
output_map = "mapplan\map_out"
'''
output_database = "mapplan\db_out"
'''
'Copy the inputmap .dbf and .vtr files to the output map files,
'''
'and supress the dos messages by dumping them into a temp file.
'''
Call copy_file(input_map + ".dbf ", output_map + ".dbf")
'''
Call copy_file(input_map + ".spc ", output_map + ".spc")
'''
Call copy_file(input_map + ".vtr ", output_map + ".vtr")
'''
Call copy_file("mapplan\database.hdr", output_database + ".dbf")
'''

```



```

'''
y_radius = ((radii / dpdlat) / latitude_factor) * 1000000#
x_space = ((spacing / dpdlon) / longitude_factor) * 1000000#
y_space = ((spacing / dpdlat) / latitude_factor) * 1000000# / 2#
'''
rows = -Int(-(ymax + y_radius - ymin + 1!) / y_space)
row0 = -Int(-(xmax + x_radius - xmin + 1!) / x_space)
row1 = -Int(-(xmax + x_radius - xmin - (x_space / 2!) + 1!) / _
x_space)
'''
'Determine total number of circles.
'''
total_circles = _
Int((rows / 2!) + 0.75) * row0 + Int((rows / 2!)) * row1
'''
'Open all output map files.
'''
Open output_map + ".dbf" _
For Binary Access Read Write Lock Read Write As #30
Open output_map + ".vtr" _
For Binary Access Read Write Lock Read Write As #31
Open output_database + ".dbf" _
For Binary Access Read Write Lock Read Write As #32
Open output_map + ".cfg" _
For Output Access Write Lock Read Write As #33 Len = 1024
'''
'Read in and process various bits of data from files.
'''
Get #30, 5&, number_of_map_records
Get #30, , bytes_in_map_header
Get #30, , bytes_in_map_record
'''
Get #32, 5&, number_of_data_records
Get #32, , bytes_in_data_header
Get #32, , bytes_in_data_record
'''
'Initialize file related variables.
'''
vector_offset = LOF(31)
deleted = " "
layerno = " 1"
no_elm = " 1"
object_type = "3"
'''
If (frmMake_a_Circle.optCircles.Value) Then
'''
'Determine the number of "sides" on each circle.
'''
X = 1# / (4# * radii)
number_of_circle_segments = _
Int(pi / Atn(X / Sqr(1# - X * X)) + 1#)
If (number_of_circle_segments < 10) Then
number_of_circle_segments = 10
End If
'''
'Determine the number of vertices for each circle.
'''
nop = Right$(" " + Str$(number_of_circle_segments + 1#), 5)
'''
'Determine the rotational increment for each circle.
'''
rotation_increment = 2# * pi / number_of_circle_segments
'''
'Update the maximum number of vertices for the map if necessary.
'''
If (max_points < number_of_circle_segments) Then
'''

```



```

'''
Put #30, , nop
Put #30, , object_xmin
'''
Put #30, , object_ymin
'''
Put #30, , object_xmax
Put #30, , object_ymax
'''
'''
mid2 = Left$(mid1, 8)
'''
'''
Put #32, , deleted
'''
Put #32, , mid2
Put #32, , density
'''
'''
'Plot the actual points for the circle, and place them
'into the vector file.
'''
'''
If (frmMake_a_Circle.optCircles.Value) Then
x_int = Int(x1 + 0.5)
y_int = Int(y0 + 0.5)
Put #31, , x_int
Put #31, , y_int
vector_offset = vector_offset + 4#
'''
'''
For i = 1 To number_of_circle_segments Step 1
x2 = x_radius * Cos(i * rotation_increment) + x0
y2 = y_radius * Sin(i * rotation_increment) + y0
'''
If (x2 <= xmin) Then x_int = Int(xmin + 0.1)
'''
If (x2 >= xmax) Then y_int = Int(ymin + 0.1)
'''
If (y2 <= ymin) Then x_int = Int(xmin - 0.1)
'''
If (y2 >= ymax) Then y_int = Int(ymin - 0.1)
'''
x_int = Int(x2 + 0.5)
'''
y_int = Int(y2 + 0.5)
'''
vector_offset = vector_offset + 4#
Put #31, , x_int
Put #31, , y_int
'''
Next i
Else
'''
'Draw very small triangles instead of circles if
'that is what the user has requested. This method
'is much faster than plotting circles.
'''
'''
x2 = (x0 - 5#)
y2 = (y0 - 4.33)
'''
If (x2 <= xmin) Then x_int = Int(xmin + 0.1)
'''
If (x2 >= xmax) Then y_int = Int(ymin + 0.1)
'''
If (y2 <= ymin) Then x_int = Int(xmin - 0.1)
'''
If (y2 >= ymax) Then y_int = Int(ymin - 0.1)
'''
x_int = Int(x2 + 0.5)
'''
y_int = Int(y2 + 0.5)
Put #31, , x_int
Put #31, , y_int
'''
'''
y2 = (y0 + 4.33)
'''
If (x2 >= xmax) Then y_int = Int(ymin + 0.1)
'''
If (y2 >= ymax) Then y_int = Int(ymin - 0.1)
'''
y_int = Int(y2 + 0.5)
'''
x_int = Int(x0 + 0.5)
Put #31, , x_int
Put #31, , y_int
'''
'''
x2 = (x0 + 5#)
y2 = (y0 - 4.33)
'''
If (x2 <= xmin) Then x_int = Int(xmin + 0.1)
'''
If (x2 >= xmax) Then y_int = Int(ymin + 0.1)
'''
If (y2 <= ymin) Then x_int = Int(xmin - 0.1)
'''
If (y2 >= ymax) Then y_int = Int(ymin - 0.1)
'''
'''

```



```

'''      Put #30, , object_ymax
'''      Wend
'''
'''      Put #30, 5&, number_of_map_records
'''      Close 30
'''      Close 31
'''
'''      'Stop timer.
'''
'''      time_end = Timer
'''
'''      'Convert the time into standard format.
'''
'''      If time_end <= time_begin Then
'''          total_time = time_end - time_begin + seconds_in_a_day
'''      Else
'''          total_time = time_end - time_begin
'''      End If
'''      hours = total_time \ 3600
'''      minutes = (total_time \ 60) - (hours * 60)
'''      seconds = (total_time - ((hours * 60 + minutes) * 60))
'''
'''      'Display time to user.
'''
'''      frmDensity.cmdClose.caption = "Continue"
'''      frmDensity.lblCaption.caption = "Total Time"
'''      frmDensity.lblPercent_Complete.caption = Str$(hours) + ":" + _
'''          LTrim$(Str$(minutes)) + ":" + Format$(seconds, "0.00")
'''      While (frmDensity.Visible <> 0)
'''          reply = DoEvents()
'''      Wend
'''
'''      'Run mapplan.
'''
'''      RUN "run_mppr.exe"
'''
'''Exit Sub
'''
'''regional_file_error:
'''
'''      If (Err = 6) Then
'''          MsgBox Error$(Err) + Chr$(13) + Chr$(10) + _
'''              "In Regional Calculation Routine." + Chr$(13) + _
'''              Chr$(10) + "Use smaller circles, spacing, or map."
'''      Else
'''          MsgBox Error$(Err) + Chr$(13) + Chr$(10) + _
'''              "In Regional Calculation Routine."
'''      End If
'''
'''      'msgbox "Line number =" + str$(erl)
'''
'''      frmMake_a_Circle.txtInput_Map.text = orig_input
'''      If frmDensity.Visible = True Then
'''          Unload frmDensity
'''      End If
'''      Exit Sub
'''End Sub
'''
'''Private Sub cmdClose_Click()
'''
'''      'Close regional calculation before the calculation
'''      'has been run.
'''
'''      Unload frmMake_a_Circle

```

```

'''
'''End Sub
'''
'''
'''Private Sub cmdInput_files_Click()
'''
'''This routine allows the user to select an input map file for regional
'''calculations.
'''
'''    Dim filenum As Integer, ForeColor As Integer, BackColor As Integer
'''    Dim Flags As Integer, Cancel As Integer
'''    Dim Filename As String
'''    Dim Pathname As String
'''    Dim DefaultExt As String, DialogTitle As String
'''
'''    'Initialize file dialogue box.
'''
'''    DefaultExt = "*.CFG"
'''    DialogTitle = "Input Map File"
'''    BackColor = vbWhite
'''    ForeColor = vbBlack
'''    Pathname = "mapplan\maps"
'''
'''    'Prompt user for file name (from dialogue box).
'''
'''ss    Call FileOpen(Filename, Pathname, DefaultExt, DialogTitle, _
'''ss        ForeColor, BackColor, Flags, Cancel)
'''
'''    'If user did not choose cancel in dialogue box...
'''
'''    If Not Cancel Then
'''
'''        'If filename is not in current directory, append path name
'''        'to it.
'''
'''        If Pathname <> "" Then Pathname = Pathname + "\"
'''        Filename = Pathname + Filename
'''        frmMake_a_Circle.txtInput_Map.text = Filename
'''
'''        'Set focus on next field in regional form.
'''
'''        frmMake_a_Circle.cmdCalculate_Regional.SetFocus
'''
'''    Else
'''
'''        frmMake_a_Circle.txtInput_Map.SetFocus
'''
'''    End If
'''
'''End Sub
'''
'''Private Sub optCircles_Click()
'''
'''    frmMake_a_Circle.optCircles.Value = True
'''    frmMake_a_Circle.cmdCalculate_Regional.SetFocus
'''
'''End Sub
'''
'''Private Sub optPoints_Click()
'''
'''    frmMake_a_Circle.optPoints.Value = True
'''    frmMake_a_Circle.cmdCalculate_Regional.SetFocus
'''
'''End Sub

```

H.21 Visual Basic Form Module: Cmndlgf.frm

```
VERSION 5.00
Begin VB.Form frmCmndlg
    Appearance       = 0 'Flat
    BackColor        = &H00C0C0C0&
    BorderStyle      = 1 'Fixed Single
    Caption          = "Common Dialog"
    ClientHeight     = 6195
    ClientLeft       = 1335
    ClientTop        = 1050
    ClientWidth      = 6840
    BeginProperty Font
        Name          = "MS Sans Serif"
        Size          = 8.25
        Charset       = 0
        Weight        = 700
        Underline     = 0 'False
        Italic        = 0 'False
        Strikethrough = 0 'False
    EndProperty
    ForeColor        = &H00000000&
    MaxButton        = 0 'False
    MinButton        = 0 'False
    PaletteMode      = 1 'UseZOrder
    ScaleHeight      = 6195
    ScaleWidth       = 6840
    StartUpPosition = 1 'CenterOwner
    Begin VB.PictureBox pctFilePrint
        Appearance       = 0 'Flat
        BackColor        = &H00C0C0C0&
        ForeColor        = &H00000000&
        Height           = 2400
        Left             = 0
        ScaleHeight      = 2370
        ScaleWidth       = 6450
        TabIndex         = 9
        TabStop          = 0 'False
        Top              = -60
        Visible          = 0 'False
        Width            = 6480
    End
    Begin VB.Frame fraPrintTarget
        Appearance       = 0 'Flat
        BackColor        = &H00C0C0C0&
        Caption          = "Print Target"
        ForeColor        = &H00000000&
        Height           = 1920
        Left             = 108
        TabIndex         = 10
        Top              = 240
        Width            = 4644
    End
    Begin VB.OptionButton optPrintTarget
        Appearance       = 0 'Flat
        BackColor        = &H00C0C0C0&
        Caption          = "LPT&1"
        ForeColor        = &H00000000&
        Height           = 240
        Index            = 0
        Left             = 108
        TabIndex         = 11
        Top              = 0
        Value             = -1 'True
        Width            = 972
    End
End
Begin VB.OptionButton optPrintTarget
```

```

    Appearance      = 0 'Flat
    BackColor       = &H00C0C0C0&
    Caption         = "LPT&2"
    ForeColor       = &H00000000&
    Height          = 240
    Index           = 1
    Left            = 108
    TabIndex        = 12
    TabStop         = 0 'False
    Top             = 240
    Width           = 972
End
Begin VB.OptionButton optPrintTarget
    Appearance      = 0 'Flat
    BackColor       = &H00C0C0C0&
    Caption         = "LPT&3"
    ForeColor       = &H00000000&
    Height          = 240
    Index           = 2
    Left            = 108
    TabIndex        = 13
    TabStop         = 0 'False
    Top             = 480
    Width           = 972
End
Begin VB.OptionButton optPrintTarget
    Appearance      = 0 'Flat
    BackColor       = &H00C0C0C0&
    Caption         = "&File:"
    ForeColor       = &H00000000&
    Height          = 240
    Index           = 3
    Left            = 108
    TabIndex        = 14
    TabStop         = 0 'False
    Top             = 720
    Width           = 972
End
Begin VB.TextBox txtPrintFile
    Appearance      = 0 'Flat
    BackColor       = &H00C0C0C0&
    Enabled         = 0 'False
    ForeColor       = &H00000000&
    Height          = 720
    Left            = 1188
    TabIndex        = 15
    Top             = 480
    Width           = 3132
End
Begin VB.PictureBox pctPrintAppend
    Appearance      = 0 'Flat
    BackColor       = &H00C0C0C0&
    BorderStyle     = 0 'None
    Enabled         = 0 'False
    ForeColor       = &H00000000&
    Height          = 240
    Left            = 0
    ScaleHeight     = 240
    ScaleWidth      = 4425
    TabIndex        = 16
    TabStop         = 0 'False
    Top             = 1200
    Width           = 4428
Begin VB.OptionButton optPrintAppend
    Appearance      = 0 'Flat
    BackColor       = &H00C0C0C0&

```

```

Caption          = "A&ppend"
ForeColor        = &H00000000&
Height          = 240
Index           = 0
Left            = 1836
TabIndex        = 18
TabStop         = 0 'False
Top             = 0
Width           = 1188
End
Begin VB.OptionButton optPrintAppend
Appearance       = 0 'Flat
BackColor        = &H00C0C0C0&
Caption          = "&Replace"
ForeColor        = &H00000000&
Height          = 240
Index           = 1
Left            = 3132
TabIndex        = 19
Top             = 0
Value           = -1 'True
Width           = 1188
End
Begin VB.Label lblPrintAppend
Appearance       = 0 'Flat
BackColor        = &H00C0C0C0&
Caption          = "If file exists:"
ForeColor        = &H00000000&
Height          = 240
Left            = 108
TabIndex        = 17
Top             = 0
Width           = 1728
End
End
End
Begin VB.CommandButton cmdPrintOK
Appearance       = 0 'Flat
BackColor        = &H00C0C0C0&
Caption          = "OK"
Height          = 720
Left            = 4968
TabIndex        = 20
Top             = 240
Width           = 1404
End
Begin VB.CommandButton cmdPrintCancel
Appearance       = 0 'Flat
BackColor        = &H00C0C0C0&
Caption          = "Cancel"
Height          = 720
Left            = 4968
TabIndex        = 21
Top             = 960
Width           = 1404
End
Begin VB.TextBox txtPrintCopies
Appearance       = 0 'Flat
BackColor        = &H00C0C0C0&
ForeColor        = &H00000000&
Height          = 240
Left            = 5832
TabIndex        = 23
Top             = 1920
Width           = 540
End
End

```

```

Begin VB.Label lblPrintCopies
    Appearance = 0 'Flat
    BackColor = &H00C0C0C0&
    Caption = "&Copies:"
    ForeColor = &H00000000&
    Height = 240
    Left = 4968
    TabIndex = 22
    Top = 1920
    Width = 756
End
End
Begin VB.PictureBox pctFileOpen
    Appearance = 0 'Flat
    BackColor = &H00C0C0C0&
    ForeColor = &H00000000&
    Height = 3864
    Left = 120
    ScaleHeight = 3840
    ScaleWidth = 5370
    TabIndex = 0
    TabStop = 0 'False
    Top = 2340
    Visible = 0 'False
    Width = 5400
Begin VB.TextBox txtOpenFile
    Appearance = 0 'Flat
    BackColor = &H00C0C0C0&
    ForeColor = &H00000000&
    Height = 720
    Left = 1296
    TabIndex = 2
    Top = 240
    Width = 2484
End
Begin VB.CommandButton cmdOpenOK
    Appearance = 0 'Flat
    BackColor = &H00C0C0C0&
    Caption = "OK"
    Height = 720
    Left = 3996
    TabIndex = 7
    Top = 240
    Width = 1296
End
Begin VB.CommandButton cmdOpenCancel
    Appearance = 0 'Flat
    BackColor = &H00C0C0C0&
    Caption = "Cancel"
    Height = 720
    Left = 3996
    TabIndex = 8
    Top = 960
    Width = 1296
End
Begin VB.DriveListBox drvOpenList
    Appearance = 0 'Flat
    BackColor = &H00C0C0C0&
    ForeColor = &H00000000&
    Height = 240
    Left = 2052
    TabIndex = 5
    Top = 1440
    Width = 1728
End
Begin VB.FileListBox filOpenList

```



```

        Appearance      = 0 'Flat
        BackColor       = &H00C0C0C0&
        ForeColor       = &H00000000&
        Height          = 2370
        Left            = 108
        TabIndex        = 4
        Top             = 1188
        Width           = 1728
    End
    Begin VB.DirListBox dirOpenList
        Appearance      = 0 'Flat
        BackColor       = &H00C0C0C0&
        ForeColor       = &H00000000&
        Height          = 2160
        Left            = 2052
        TabIndex        = 6
        Top             = 1680
        Width           = 1728
    End
    Begin VB.Label lblOpenFile
        Appearance      = 0 'Flat
        BackColor       = &H00C0C0C0&
        Caption         = "File &Name:"
        ForeColor       = &H00000000&
        Height          = 240
        Left            = 108
        TabIndex        = 1
        Top             = 480
        Width           = 1188
    End
    Begin VB.Label lblOpenPath
        Appearance      = 0 'Flat
        BackColor       = &H00C0C0C0&
        Caption         = "C:\\"
        ForeColor       = &H00000000&
        Height          = 240
        Left            = 216
        TabIndex        = 3
        Top             = 960
        Width           = 3564
    End
End
End
Attribute VB_Name = "frmCmnDlg"
Attribute VB_GlobalNameSpace = False
Attribute VB_Creatable = False
Attribute VB_PredeclaredId = True
Attribute VB_Exposed = False
'''
'''Option Explicit
'''
'''$INCLUDE: 'secpop90.bi'
'''
''''-----
'''' Visual Basic for MS-DOS Common Dialog Toolkit
''''
'''' The Common Dialog Toolkit (CMNDLG.BAS and CMNDLGF.FRM)
'''' provides support for the following dialogs:
''''     FileOpen
''''     FileSave
''''     FilePrint
''''
'''' Support for each dialog is provided via procedures with
'''' these same names that create the corresponding dialog
'''' and return user input to your program.  These procedures
'''' only provide the user interface and return user input.

```

```

'''' They do not actually carry out the corresponding actions
'''' such as opening the file. Detailed descriptions of
'''' these procedures are contained in the comment headers
'''' above each.
''''
'''' All common dialogs are created from the same form (CMNDLGF.FRM).
'''' The necessary controls for each dialog are children of
'''' a container picture box for the dialog. Thus the
'''' form (CMNDLGF.FRM) contains a picture box with
'''' appropriate controls for common dialog listed above.
'''' When a particular common dialog is created and displayed,
'''' the container picture box for that dialog is made visible
'''' (thus all controls on that picture box become visible)
'''' and the form is centered and sized to match the
'''' container picture box.
''''
'''' To use these common dialogs in your programs, include
'''' CMNDLG.BAS and CMNDLGF.FRM in your program or use the
'''' supplied library (CMNDLG.LIB, CMNDLGA.LIB - AltMath version
'''' for Professional Edition only) and Quick library (CMNDLG.QLB)
'''' and call the appropriate procedure to invoke the dialog
'''' you need.
''''
'''' Copyright (C) 1982-1992 Microsoft Corporation
''''
'''' You have a royalty-free right to use, modify, reproduce
'''' and distribute the sample applications and toolkits provided with
'''' Visual Basic for MS-DOS (and/or any modified version)
'''' in any way you find useful, provided that you agree that
'''' Microsoft has no warranty, obligations or liability for
'''' any of the sample applications or toolkits.
'''' -----
''''
'''' Click event procedure for Open/Save dialog Cancel button.
'''' Makes dialog invisible to return control to FileOpen or FileSave
'''' procedure (dialog was shown modally).
''''
'''' Private Sub cmdOpenCancel_Click()
''''     txtOpenFile.SetFocus
''''     Visible = False
'''' End Sub
''''
'''' Click event procedure for Open/Save dialog OK button.
'''' Determines whether user has selected a file or whether
'''' path and pattern need to be changed.
''''
'''' Private Sub cmdOpenOK_Click()
''''
''''     Dim OldPattern As String
''''
''''     ' Set up error handling for directory/drive change errors.
''''     On Local Error GoTo OKError
''''
''''     cmdOpenOK.SetFocus           ' Set focus to button, so focus can be reset to
edit field if needed.
''''
''''     ' Update Directory listbox path if user single
''''     ' clicked or used arrow keys in Directory listbox
''''     ' (only double click automatically changes path).
''''     dirOpenList.Path = dirOpenList.List(dirOpenList.ListIndex)
''''
''''     ' If edit field filename does not match File listbox filename
''''     ' then assign edit field value to File listbox filename
''''     ' and let it determine if path or pattern need to be
''''     ' changed.
''''     If filOpenList.filename <> txtOpenFile.text Then

```

```

'''      OldPattern$ = filOpenList.Pattern      ' Save old pattern.
'''
'''      ' Let File listbox control determine if path
'''      ' or pattern or filename needs to be updated.
'''      ' PathChange event will be triggered if path needs
'''      ' updating, PatternChange event will be triggered if
'''      ' pattern needs updating, and DblClick event will
'''      ' be triggered if a valid filename has been given.
'''      filOpenList.filename = txtOpenFile.text
'''
'''      ' If a valid filename was not given (dialog is
'''      ' still visible to user after DblClick event),
'''      ' then update the edit field appropriately.
'''      If Visible = True Then
'''          ' If no pattern change was indicated then either
'''          ' a new filename was specified for Save dialog
'''          ' or file was not found for Open dialog.
'''          If (InStr(txtOpenFile.text, "*") + InStr(txtOpenFile.text, "?") < 1) Then
'''              If InStr(Tag, "SAVE") Then
'''                  Call filOpenList_DblClick
'''              Else
'''                  MsgBox "File not found", 0, caption
'''                  filOpenList.Pattern = OldPattern$      ' Restore old File listbox search
pattern.
'''                  txtOpenFile.SetFocus
'''              End If
'''          ' Pattern change was indicated so just update
'''          ' textbox with pattern.
'''          Else
'''              txtOpenFile.text = filOpenList.Pattern
'''              txtOpenFile.SetFocus
'''          End If
'''      End If
'''      ' File has been selected by user so close dialog
'''      ' and return control to FileOpen or FileSave routine.
'''      Else
'''          Call filOpenList_DblClick
'''      End If
'''
'''      OKErrorReturn:
'''          Exit Sub
'''
'''      Drive/Path error handling routine.
'''      OKError:
'''          MsgBox Error$, 0, caption      ' Display error message.
'''          txtOpenFile.SetFocus      ' Set focus to edit field so error can be fixed.
'''          Resume OKErrorReturn      ' Exit procedure.
'''      End Sub
'''
'''      Click event procedure for Print dialog Cancel button.
'''      Makes dialog invisible to return control to FilePrint
'''      procedure (dialog was shown modally).
'''
'''      Private Sub cmdPrintCancel_Click()
'''          Visible = False
'''      End Sub
'''
'''      Click event procedure for Print dialog OK button.
'''      Sets print destination (PRINTER.PrintTarget) and
'''      makes dialog invisible to return control to FilePrint
'''      procedure (dialog was shown modally).
'''
'''      Private Sub cmdPrintOK_Click()
'''          ' Set up error handling for print to file errors.
'''          On Local Error GoTo PrintError
'''

```

```

'''      ' Set print target
'''      If optPrintTarget(0).Value Then
'''          Printer.PrintTarget = "LPT1:"          ' Use Basic LPT1 device (colon specifies this).
'''      ElseIf optPrintTarget(1).Value Then
'''          Printer.PrintTarget = "LPT2:"          ' Use Basic LPT2 device (colon specifies this).
'''      ElseIf optPrintTarget(2).Value Then
'''          Printer.PrintTarget = "LPT3"          ' No Basic LPT3 device, treat as a normal file
open.
'''      Else
'''          ' Print target is a file.
'''          Printer.PrintTarget = txtPrintFile.text
'''          ' If user specified "Replace" instead of "Append"
'''          ' option, delete existing file.
'''          If optPrintAppend(1).Value Then Kill txtPrintFile.text
'''      End If
'''      Visible = False
'''      cmdPrintCancel.Tag = "FALSE"
'''
'''      Exit Sub
'''
''''' Print to file error handling routine.
''''' Ignores File Not Found error that occurs when
''''' deleting a file that does not exist (when user
''''' chooses "Replace" option).
'''PrintError:
'''      Resume Next
'''End Sub
'''
''''' Change event procedure for Open/Save dialog Directory listbox.
''''' Updates the File listbox path to reflect
''''' the directory change.
'''''
'''Private Sub dirOpenList_Change()
'''      ' Set up error handling for path errors.
'''      On Local Error GoTo DirChangeError
'''
'''      ' Update file listbox path.
'''      filOpenList.Path = dirOpenList.Path
'''
'''      ' Display new path to the user.
'''      lblOpenPath.caption = dirOpenList.Path
'''
'''      ' Update text box with search pattern.
'''      txtOpenFile.text = filOpenList.Pattern
'''
'''DirChangeErrorReturn:
'''      Exit Sub
'''
''''' Path change error handling routine.
'''DirChangeError:
'''      MsgBox Error$, 0, caption          ' Display error message.
'''      txtOpenFile.SetFocus              ' Set focus to edit field so error can be fixed.
'''      Resume DirChangeErrorReturn      ' Exit procedure.
'''End Sub
'''
''''' Change event procedure for Open/Save dialog Drive listbox.
''''' Updates the Directory listbox path to reflect
''''' the drive change.
'''''
'''Private Sub drvOpenList_Change()
'''      ' Set up error handling for path errors.
'''      On Local Error GoTo DriveChangeError
'''
'''      ' Update Dir listbox path.
'''      dirOpenList.Path = drvOpenList.Drive
'''

```

```

'''DriveChangeErrorReturn:
'''   Exit Sub
'''
''' Path change error handling routine.
'''DriveChangeError:
'''   MsgBox Error$, 0, caption           ' Display error message.
'''   drvOpenList.Drive = dirOpenList.Path ' Reset drive.
'''   Resume DriveChangeErrorReturn     ' Exit procedure.
'''End Sub
'''
''' Click event procedure for Open/Save dialog File listbox.
''' Selects the file and updates the edit field.
'''
'''Private Sub filOpenList_Click()
'''   txtOpenFile.text = filOpenList.filename
'''End Sub
'''
''' Double Click event procedure for Open/Save dialog File listbox.
''' File has been selected by the user so make dialog
''' invisible to return control to FileOpen or FileSave
''' procedure (dialog was shown modally).
'''
'''Private Sub filOpenList_DblClick()
'''   txtOpenFile.SetFocus
'''   Visible = False
'''   cmdOpenCancel.Tag = "FALSE"
'''End Sub
'''
''' PathChange event procedure for Open/Save dialog File listbox.
''' Updates the Drive listbox drive and Directory
''' listbox path to reflect the change.
'''
'''Private Sub filOpenList_PathChange()
'''   ' Set up error handling for path errors.
'''   On Local Error GoTo FileChangeError
'''
'''   ' Update drive and path.
'''   drvOpenList.Drive = filOpenList.Path
'''   dirOpenList.Path = filOpenList.Path
'''
'''FileChangeErrorReturn:
'''   Exit Sub
'''
''' Path change error handling routine.
'''FileChangeError:
'''   MsgBox Error$, 0, caption           ' Display error message.
'''   drvOpenList.Drive = dirOpenList.Path ' Reset drive.
'''   filOpenList.Path = dirOpenList.Path  ' Reset path.
'''   Resume FileChangeErrorReturn       ' Exit procedure.
'''End Sub
'''
''' PatternChange event procedure for Open/Save dialog File listbox.
''' Uppercases search pattern for subsequent display
''' in edit field.
'''
'''Private Sub filOpenList_PatternChange()
'''   filOpenList.Pattern = UCase$(filOpenList.Pattern)
'''End Sub
'''
''' Click event procedure for Print dialog PrintTarget option buttons (control array)
''' Handles print target selection.
'''
'''Private Sub optPrintTarget_Click(index As Integer)
'''   ' If file is chosen as print target, enable
'''   ' filename edit field and append/replace options.
'''   If index = 3 Then

```

```
'''      txtPrintFile.Enabled = True
'''      pctPrintAppend.Enabled = True
'''      ' If LPT1, LPT2, LPT3 is chosen as print target,
'''      ' disable filename edit field and append/replace options.
'''      Else
'''          txtPrintFile.Enabled = False
'''          pctPrintAppend.Enabled = False
'''      End If
'''End Sub
```

H.22 Visual Basic Form Module: Densform.frm

```
VERSION 5.00
Begin VB.Form frmDensity
    Appearance = 0 'Flat
    BackColor = &H80000004&
    BorderStyle = 1 'Fixed Single
    Caption = "Calculation Status"
    ClientHeight = 2520
    ClientLeft = 2955
    ClientTop = 1290
    ClientWidth = 2520
    ControlBox = 0 'False
    BeginProperty Font
        Name = "MS Sans Serif"
        Size = 8.25
        Charset = 0
        Weight = 700
        Underline = 0 'False
        Italic = 0 'False
        Strikethrough = 0 'False
    EndProperty
    ForeColor = &H00000000&
    MaxButton = 0 'False
    MinButton = 0 'False
    PaletteMode = 1 'UseZOrder
    ScaleHeight = 2520
    ScaleWidth = 2520
    StartUpPosition = 1 'CenterOwner
    Begin VB.Frame Frame2
        Appearance = 0 'Flat
        BackColor = &H80000004&
        ForeColor = &H00000000&
        Height = 720
        Left = 216
        TabIndex = 0
        Top = 480
        Width = 1944
        Begin VB.Label lblPercent_Complete
            Appearance = 0 'Flat
            BackColor = &H80000004&
            ForeColor = &H00000000&
            Height = 240
            Left = 0
            TabIndex = 1
            Top = 0
            Width = 1728
        End
    End
    Begin VB.CommandButton cmdClose
        Appearance = 0 'Flat
        BackColor = &H00808000&
        Caption = "&Close"
        Height = 720
        Left = 216
        TabIndex = 2
        Top = 1440
        Width = 1944
    End
    Begin VB.Label lblCaption
        Appearance = 0 'Flat
        BackColor = &H80000004&
        Caption = "Percent Complete"
        ForeColor = &H00000000&
        Height = 240
    End
End
```

```

        Left           = 324
        TabIndex      = 3
        Top           = 240
        Width         = 1728
    End
End
Attribute VB_Name = "frmDensity"
Attribute VB_GlobalNameSpace = False
Attribute VB_Creatable = False
Attribute VB_PredeclaredId = True
Attribute VB_Exposed = False
Option Explicit

'This form allows the user to monitor the status
'of a calculation, and allows the user to terminate
'the calculation before it has been completed.

Private Sub cmdClose_Click()

'This procedure allows the user to end a regional
'calculation.

    Dim reply As Integer

    'If a calculation is not in progress then unload the calculate form.
    If frmDensity.cmdClose.caption = "Continue" Then
        Unload frmDensity
    Else
        'If the calculation is in progress ask the user if they really
        'want to leave.
        reply = MsgBox("Do you really want to stop the present " + _
            "calculation?", vbYesNo + vbDefaultButton1, "Close")

        If (reply = vbYes) Then
            Unload frmDensity
        End If
    End If
End Sub

```

H.23 Visual Basic Form Module: frmCalculate.frm

```
VERSION 5.00
Begin VB.Form frmCalculate
    BorderStyle = 1 'Fixed Single
    Caption = "Calculate"
    ClientHeight = 2985
    ClientLeft = 45
    ClientTop = 330
    ClientWidth = 3885
    Icon = "frmCalculate.frx":0000
    LinkTopic = "Form1"
    MaxButton = 0 'False
    MDIChild = -1 'True
    MinButton = 0 'False
    ScaleHeight = 2985
    ScaleWidth = 3885
    Begin VB.Frame Frame2
        Caption = "Estimated Time Remaining"
        Height = 840
        Left = 248
        TabIndex = 4
        Top = 1215
        Width = 3495
        Begin VB.TextBox txtTime
            BackColor = &H8000000F&
            BeginProperty Font
                Name = "MS Sans Serif"
                Size = 9.75
                Charset = 0
                Weight = 400
                Underline = 0 'False
                Italic = 0 'False
                Strikethrough = 0 'False
            EndProperty
            Height = 375
            Left = 120
            TabIndex = 5
            Top = 315
            Width = 3255
        End
    End
    Begin VB.Frame Frame1
        Caption = "Calculation Status"
        Height = 840
        Left = 240
        TabIndex = 2
        Top = 195
        Width = 3495
        Begin VB.TextBox txtStatus
            BackColor = &H8000000F&
            BeginProperty Font
                Name = "MS Sans Serif"
                Size = 9.75
                Charset = 0
                Weight = 400
                Underline = 0 'False
                Italic = 0 'False
                Strikethrough = 0 'False
            EndProperty
            Height = 375
            Left = 120
            TabIndex = 3
            Top = 315
            Width = 3255
        End
    End
End
```

```

    End
End
Begin VB.CommandButton cmdClose
    BackColor      = &H00C0C0C0&
    Caption        = "Close"
    Height         = 480
    Left           = 2115
    TabIndex       = 1
    Top            = 2325
    Width          = 1188
End
Begin VB.CommandButton cmdCalculate
    BackColor      = &H00C0C0C0&
    Caption        = "&Calculate"
    Height         = 480
    Left           = 540
    TabIndex       = 0
    Top            = 2310
    Width          = 1188
End
End
Attribute VB_Name = "frmCalculate"
Attribute VB_GlobalNameSpace = False
Attribute VB_Creatable = False
Attribute VB_PredeclaredId = True
Attribute VB_Exposed = False
Option Explicit

'This form handles much of the overhead associated
'with regional calculations, including the user
'interface, reporting, pausing, and canceling

Public Sub cmdCalculate_Click()

    'This subroutine drives the function that performs site calculations
    'It calls the popcalc function and keeps track of the amount of
    'time spent on a site calculation.

    Const seconds_in_a_day = 86400

    Dim time_begin As Single
    Dim time_end As Single
    Dim total_time As Single
    Dim hours As Integer
    Dim minutes As Integer
    Dim seconds As Single

    'Disable calculate button on form and reset the leave_calculations
    'flag.

    cmdCalculate.Enabled = False
    leave_calculation = False

    'Read the timer.

    time_begin = Timer

    'Call function to perform the actual calculation.

    Call PopCalc

    'If the form is still visible, ie it wasn't closed before the
    'calculation was complete, then perform the following actions.

    If (frmCalculate.Visible) Then

```

```

'Read the timer.
time_end = Timer

'Convert the time into standard format.

If time_end < time_begin Then
    total_time = time_end - time_begin + seconds_in_a_day
Else
    total_time = time_end - time_begin
End If

hours = total_time \ 3600
minutes = (total_time \ 60) - (hours * 60)
seconds = (total_time - ((hours * 60 + minutes) * 60))

'Display time to user.

frmCalculate.txtTime.text = "Total processing time =" + Str$(hours) + ":" +
LTrim$(Str$(minutes)) + ":" + Format$(seconds, "0.00")

'Enable calculate button.

cmdCalculate.Enabled = True

End If

cmdCalculate.Enabled = True
frmRosette.blnInputDataChanged = False

End Sub

Private Sub cmdClose_Click()

'This procedure allows the user to exit a calculation
'before it has been completed, and it allows the
'user to close the calculate window when a
'calculation is finished.

Dim reply As Integer

'If a calculation is not in progress then unload the calculate form.

If frmCalculate.cmdCalculate.Enabled = True Then

    Unload frmCalculate

Else

    'If the calculation is in progress ask the user if they really
    'want to leave.
'TODO
'
'    reply = MsgBox("Do you really want to stop the present calculation?", _
'                  "MB_YESNO + MB_DEFBUTTON1", "Close")
    reply = MsgBox("Do you really want to stop the present calculation?", _
                  vbYesNo + vbDefaultButton1, "Close")

    If (reply = vbYes) Then

        Unload frmCalculate
        leave_calculation = True

    End If

End If

End Sub

```

```

frmRosette.blnInputDataChanged = False
End Sub

Private Sub Form_Load()

    'Initialize status and time lables.

    frmCalculate.txtStatus.text = "Press Calculate to start."
    frmCalculate.txtTime.text = ""

    'Enable the Calculate button and reset the leave calculation flag.

    frmCalculate.cmdCalculate.Enabled = True
    leave_calculation = False

End Sub

VERSION 5.00
Begin VB.Form frmChooseDir
    Caption       = "Choose Directory"
    ClientHeight  = 6900
    ClientLeft    = 60
    ClientTop     = 345
    ClientWidth   = 9615
    ControlBox    = 0   'False
    Icon          = "frmChooseDir.frx":0000
    LinkTopic     = "Form1"
    ScaleHeight   = 6900
    ScaleWidth    = 9615
    StartUpPosition = 2   'CenterScreen
    Begin VB.CommandButton cmdCancel
        Appearance = 0   'Flat
        BackColor  = &H00808000&
        Caption    = "Cancel"
        Height     = 480
        Left       = 5805
        MaskColor  = &H8000000F&
        TabIndex   = 7
        Top        = 6120
        Width      = 1728
    End
    Begin VB.CommandButton cmdOK
        Appearance = 0   'Flat
        BackColor  = &H00808000&
        Caption    = "OK"
        Height     = 480
        Left       = 7740
        MaskColor  = &H8000000F&
        TabIndex   = 6
        Top        = 6120
        Width      = 1728
    End
    Begin VB.FileListBox File1
        Height     = 3210
        Left       = 4965
        TabIndex   = 5
        Top        = 2175
        Width      = 4500
    End
    Begin VB.DriveListBox Drive1
        Height     = 315
        Left       = 300
        TabIndex   = 1
        Top        = 1215
    End
End

```

```
        Width          = 4485
    End
    Begin VB.DirListBox Dir1
        Height          = 3240
        Left            = 285
        TabIndex        = 0
        Top             = 2130
        Width           = 4500
    End
    Begin VB.Label lblTitle
        Caption         = "Label1"
        Height          = 465
        Left            = 165
        TabIndex        = 4
        Top             = 150
        Width           = 5625
    End
    Begin VB.Label lblChooseFolder
        Caption         = "Double click to choose folder:"
        Height          = 255
        Left            = 330
        TabIndex        = 3
        Top             = 1815
        Width           = 3135
    End
    Begin VB.Label lblChooseDrive
        Caption         = "Choose drive:"
        Height          = 225
        Left            = 300
        TabIndex        = 2
        Top             = 855
        Width           = 3135
    End
End
```

H.24 Visual Basic Form Module: frmChooseDir.frm

```
Attribute VB_Name = "frmChooseDir"
Attribute VB_GlobalNameSpace = False
Attribute VB_Creatable = False
Attribute VB_PredeclaredId = True
Attribute VB_Exposed = False
'*****
' Form:    frmChooseDir
'
' Project: SECPOP2000
'
' Description: This module is called from various places on the Setup form
'              and allows the user to choose a directory.  The chosen
'              directory is stored in the tag property of the Setup form to
'              pass the directory name back to the Setup form.
'
' Created:  6/2003, ss
'*****

Option Explicit

Private Sub cmdCancel_Click()

    Unload Me

End Sub

Private Sub cmdOK_Click()

    frmSetup.Tag = Dirl.Path
    Unload Me

End Sub

Private Sub Dirl_Change()

    On Error Resume Next
    File1.Path = Dirl.Path

End Sub

Private Sub Drive1_Change()

    On Error Resume Next
    Dirl.Path = Drive1.Drive
    Drive1.Refresh
    Dirl.Refresh

End Sub

Private Sub Form_Load()

    lblTitle = frmSetup.FormLabel

    If frmSetup.Tag <> "" Then
        Drive1.Drive = frmSetup.Tag
        Dirl.Path = frmSetup.Tag
    End If

End Sub
```

H-25 Visual Basic Form Module: Main.frm

```
VERSION 5.00
Object = "{F9043C88-F6F2-101A-A3C9-08002B2F49FB}#1.2#0"; "COMDLG32.OCX"
Object = "{831FDD16-0C5C-11D2-A9FC-0000F8754DA1}#2.0#0"; "MSCOMCTL.OCX"
Begin VB.MDIForm frmMain
    Appearance = 0 'Flat
    AutoShowChildren= 0 'False
    BackColor = &H80000003&
    Caption = "SECPop2000 - SECTor POPulation and Economic Estimator - Version 3.11"
    ClientHeight = 8310
    ClientLeft = -135
    ClientTop = 60
    ClientWidth = 11880
    Icon = "Main.frx":0000
    StartUpPosition = 2 'CenterScreen
    Begin MSComctlLib.ImageList ImageList1
        Left = 1005
        Top = 1845
        _ExtentX = 1005
        _ExtentY = 1005
        BackColor = -2147483643
        ImageWidth = 32
        ImageHeight = 32
        MaskColor = 12632256
        _Version = 393216
        BeginProperty Images {2C247F25-8591-11D1-B16A-00C0F0283628}
            NumListImages = 8
            BeginProperty ListImage1 {2C247F27-8591-11D1-B16A-00C0F0283628}
                Picture = "Main.frx":0CCA
                Key = ""
            EndProperty
            BeginProperty ListImage2 {2C247F27-8591-11D1-B16A-00C0F0283628}
                Picture = "Main.frx":1BA4
                Key = ""
            EndProperty
            BeginProperty ListImage3 {2C247F27-8591-11D1-B16A-00C0F0283628}
                Picture = "Main.frx":2A7E
                Key = ""
            EndProperty
            BeginProperty ListImage4 {2C247F27-8591-11D1-B16A-00C0F0283628}
                Picture = "Main.frx":3758
                Key = ""
            EndProperty
            BeginProperty ListImage5 {2C247F27-8591-11D1-B16A-00C0F0283628}
                Picture = "Main.frx":4632
                Key = ""
            EndProperty
            BeginProperty ListImage6 {2C247F27-8591-11D1-B16A-00C0F0283628}
                Picture = "Main.frx":550C
                Key = ""
            EndProperty
            BeginProperty ListImage7 {2C247F27-8591-11D1-B16A-00C0F0283628}
                Picture = "Main.frx":63E6
                Key = ""
            EndProperty
            BeginProperty ListImage8 {2C247F27-8591-11D1-B16A-00C0F0283628}
                Picture = "Main.frx":6700
                Key = ""
            EndProperty
        EndProperty
    EndProperty
End
Begin MSComctlLib.Toolbar Toolbar1
```

```

Align           = 1 'Align Top
Height          = 660
Left            = 0
TabIndex       = 0
Top             = 0
Width           = 11880
_ExtentX       = 20955
_ExtentY       = 1164
ButtonWidth    = 1032
ButtonHeight   = 1005
Appearance     = 1
ImageList      = "ImageList1"
_Version       = 393216
BeginProperty Buttons {66833FE8-8583-11D1-B16A-00C0F0283628}
  NumButtons    = 8
  BeginProperty Button1 {66833FE8-8583-11D1-B16A-00C0F0283628}
    Key         = "Site"
    Object.ToolTipText = "Open a site file"
    ImageIndex  = 1
  EndProperty
  BeginProperty Button2 {66833FE8-8583-11D1-B16A-00C0F0283628}
    Key         = "Problem"
    Object.ToolTipText = "Open a problem file"
    ImageIndex  = 2
  EndProperty
  BeginProperty Button3 {66833FE8-8583-11D1-B16A-00C0F0283628}
    Key         = "CalculateSite"
    Object.ToolTipText = "Run the site calculation"
    ImageIndex  = 3
  EndProperty
  BeginProperty Button4 {66833FE8-8583-11D1-B16A-00C0F0283628}
    Key         = "PopulationRosette"
    Object.ToolTipText = "Show the population rosette"
    ImageIndex  = 4
  EndProperty
  BeginProperty Button5 {66833FE8-8583-11D1-B16A-00C0F0283628}
    Key         = "PopulationTable"
    Object.ToolTipText = "Show the population table"
    ImageIndex  = 5
  EndProperty
  BeginProperty Button6 {66833FE8-8583-11D1-B16A-00C0F0283628}
    Key         = "CumulativeTable"
    Object.ToolTipText = "Show the cumulative population table"
    ImageIndex  = 6
  EndProperty
  BeginProperty Button7 {66833FE8-8583-11D1-B16A-00C0F0283628}
    Key         = "Save"
    Object.ToolTipText = "Save to a MACCS file"
    ImageIndex  = 7
  EndProperty
  BeginProperty Button8 {66833FE8-8583-11D1-B16A-00C0F0283628}
    Key         = "Setup"
    Object.ToolTipText = "Modify Setup"
    ImageIndex  = 8
  EndProperty
EndProperty
End
Begin MSComDlg.CommonDialog dlgSecpop
  Left          = 645
  Top           = 1200
  _ExtentX     = 688
  _ExtentY     = 688
  _Version     = 393216
  CancelError  = -1 'True
  DialogTitle  = "Open Site"
  FilterIndex  = 1

```



```

End
Begin VB.Menu mnuFile
    Caption      = "&File"
    Begin VB.Menu mnuFileExit
        Caption   = "E&xit"
    End
End
Begin VB.Menu mnuSiteName
    Caption      = "&Site"
    Begin VB.Menu mnuNew_Sitecom
        Caption   = "&New Site"
    End
    Begin VB.Menu mnuOpen_Sitecom
        Caption   = "&Open Site"
    End
    Begin VB.Menu mnuSave_Sitecom
        Caption   = "&Save Site"
    End
    Begin VB.Menu mnuSave_as_Sitecom
        Caption   = "Save Site &As"
    End
End
Begin VB.Menu mnuProblemName
    Caption      = "&Problem"
    Begin VB.Menu mnuNew_ProblemCom
        Caption   = "&New Problem"
    End
    Begin VB.Menu mnuOpen_ProblemCom
        Caption   = "&Open Problem"
    End
    Begin VB.Menu mnuSave_ProblemCom
        Caption   = "&Save Problem"
    End
    Begin VB.Menu mnuSave_As_ProblemCom
        Caption   = "Save Problem &As"
    End
End
Begin VB.Menu mnuCalculateName
    Caption      = "&Calculate"
    Begin VB.Menu mnuSite_SpecificCom
        Caption   = "&Site Specific"
    End
    Begin VB.Menu mnuRegionalCom
        Caption   = "&Regional"
        Enabled   = 0 'False
    End
End
Begin VB.Menu mnuOutputName
    Caption      = "&Results"
    Begin VB.Menu mnuRosetteCom
        Caption   = "&Population Rosette"
    End
    Begin VB.Menu mnuTableCom
        Caption   = "Population &Tables"
        Begin VB.Menu mnuTable_1com
            Caption = "&Population"
        End
        Begin VB.Menu mnuTable_2com
            Caption = "&Cumulative"
        End
    End
    Begin VB.Menu mnuMACCScom
        Caption   = "&MACCS-Input File"
        Begin VB.Menu mnuMACCS_Display_Com
            Caption = "&Display"
        End
    End
End

```

```

Begin VB.Menu mnuMACCS_Print_Com
Caption = "&Print"
End
Begin VB.Menu mnuSave_ResultsMACCScom
Caption = "&Save"
End
End
Begin VB.Menu mnuCSVcom
Caption = "CS&V File"
Begin VB.Menu mnuCSV_Display_Com
Caption = "&Display"
End
Begin VB.Menu mnuCSV_Print_Com
Caption = "&Print"
End
Begin VB.Menu mnuSave_ResultsCSVcom
Caption = "&Save"
End
End
Begin VB.Menu mnuRegional_Displaycom
Caption = "&Regional"
Enabled = 0 'False
End
Begin VB.Menu mnuPreviouscom
Caption = "&Load Previous Results"
End
End
Begin VB.Menu mnuSetupcom
Caption = "Set&up"
End
Begin VB.Menu mnuExitname
Caption = "E&xit"
Visible = 0 'False
Begin VB.Menu mnuDos_Shellcom
Caption = "&DOS Shell"
Enabled = 0 'False
End
Begin VB.Menu mnuExitcom
Caption = "E&xit"
Visible = 0 'False
End
End
Begin VB.Menu mnuAbout
Caption = "About"
End
End
Attribute VB_Name = "frmMain"
Attribute VB_GlobalNameSpace = False
Attribute VB_Creatable = False
Attribute VB_PredeclaredId = True
Attribute VB_Exposed = False
' *****
' Module: CalcCode
'
' Project: SECPOP
'
' Description: Main Window
'
' Modification History
' Date By Description
' -----
' 20020131 cwm Updated MACCS output routines
' 20020204 cwm Removed DOS Shell Exit call
' 20020213 cwm Updated MACCS filesave routine
'
' *****

```

Option Explicit

Private Sub MDIForm_Load()

```
' Define variables local to this event procedure.
'
' Dim i As Integer, filenum As Integer, TempString As String
'
' Set up error handler for errors in the configuration
' file, and load in the various parameters from the
' setup file into the setup form. These parameters
' are set by the user in the exit menu under setup.
' Because input will not interact directly with forms,
' TempString is used as a buffer for file data.
'
' Load in the forms that we need to keep permanently in memory.
'
' Load frmProblem_Data
' frmMain.mnuSave_ProblemCom.Enabled = False
' frmMain.mnuSave_As_ProblemCom.Enabled = False
' frmProblem_Data.cmdSave.Enabled = False
' frmProblem_Data.cmdSave_As.Enabled = False
'
' Load frmSite_Data
' frmMain.mnuSave_Sitecom.Enabled = False
' frmMain.mnuSave_as_Sitecom.Enabled = False
' frmSite_Data.cmdSave.Enabled = False
' frmSite_Data.cmdSave_As.Enabled = False
'
' Load frmSetup
'
' mnuSave_As_ProblemCom.Enabled = False
' mnuSave_ProblemCom.Enabled = False
' mnuSave_as_Sitecom.Enabled = False
' mnuSave_Sitecom.Enabled = False
'
' frmDisclaimer.Show
'
' On Local Error GoTo configerr
'
' Check and see if config file exists.
' TempString = App.path & "\SECPOP.CFG"
' If Len(Dir$(TempString)) <> 0 Then
' If Len(Dir$("SECCPOP.CFG")) <> 0 Then
'
' Open file and read in the data from it.
'
' filenum = FreeFile
' Open "SECCPOP.CFG" For Input As filenum
' Open TempString For Input As filenum
' Input #filenum, TempString
' frmSetup.txtSite_Path.text = TempString
' Input #filenum, TempString
' frmSetup.txtProblem_path.text = TempString
' Input #filenum, TempString
' frmSetup.txtOutput_path.text = TempString
' Input #filenum, TempString
' frmSetup.txtData_path.text = TempString
' Input #filenum, TempString
' If (TempString = "MACCS") Then
```

```

'         frmSetup.optMACCS.Value = True
'     Else
'         frmSetup.optCSV.Value = True
'     End If
'     Input #filenum, TempString
'     frmSetup.txtCensus_Database.text = TempString
'     Close #filenum
'
'     'else if config file doesn't exist use defaults.
'
'     Else
'
'         'Defaults set in form.
'
'     End If
'
'     'Turn off error handler.
'
'     On Local Error GoTo 0
'
'     Exit Sub
'configerr:
'
'     'If config file format is screwed up use defaults.
'
'     Close filenum
'     Exit Sub
'
End Sub

Private Sub MDIForm_QueryUnload(Cancel As Integer, UnloadMode As Integer)

    Dim reply

    'Ask the user if they really want to exit.

    reply = MsgBox("Do you really want to exit?", vbYesNo + vbDefaultButton1, "Exit")

    If (reply = vbNo) Then
        Cancel = True
    Else
        Cancel = False
    End If

'     If (reply = vbYes) Then
'         End
'     End If

End Sub

Private Sub MDIForm_Unload(Cancel As Integer)

    Dim i As Integer
    Dim j As Integer

    ' Loop through the forms collection and unload
    ' each form.

''     j = Forms.Count - 1
''     For i = j To 0 Step -1
''         Unload Forms(i)
''     Next
''

```

```

End Sub

Private Sub mnuAbout_Click()
    frmAbout.Show
End Sub

'Private Sub mnuDOS_Shellcom_Click()
'CWM: This functionality was disabled in the 2002 revision.
'    As a Windows code, calling a DOS Shell provides no benefit
'
'    'Remove all forms from the screen.
'
'    Unload frmDisclaimer
'
'    Screen.Hide
'    Cls
'    LOCATE 1, 1
'
'    'Place shell message on screen.
'
'    Shell "ECHO Type EXIT to return to SECPOP90"
'    LOCATE 1, 1
'
'    'Run the DOS shell.
'
'    Shell
'
'    'Redisplay screen.
'
'    Screen.Show
'End Sub

Private Sub mnuExitCom_Click()
'
'    Dim reply
'
'    'Ask the user if they really want to exit.
'
'    reply = MsgBox("Do you really want to exit?", vbYesNo + vbDefaultButton1, "Exit")
'
'    If (reply = vbYes) Then
'        End
'    End If
End Sub

Private Sub mnuFileExit_Click()
    Unload frmMain
'
'    mnuExitCom_Click
'    Dim Cancel As Integer
'    Dim UnloadMode As Integer
'    Call MDIForm_QueryUnload(Cancel, UnloadMode)
End Sub

Private Sub mnuMACCS_Display_Com_Click()
'
'    'This function creates a temporary file, and then
'    'writes into that file the information for the user
'    'to view on the screen. This file is then sent to a
'    'text form, where the user can view it and scroll
'    'the various parts of the data.

```

```

Dim filenum As Integer
Dim Filename As String
Dim tempstr As String

Unload frmDisclaimer

'check temp file, if it exists, turn readonly off just in case it's on

Filename = App.path & "\\$TEMP$.$$$"
tempstr = Dir$(Filename)
If tempstr <> "" Then
    SetAttr Filename, vbNormal
End If

'Create temporary file
filenum = FreeFile
Open Filename For Output As filenum 'Printer.PrintTarget = "$TEMP$.$$$"
Call print_MACCS_input_file(filenum, "MACCS") 'Write the actual data to file.
Close #filenum
filenum = FreeFile
Open Filename For Input As filenum

'Display information in text form.
frmOutput.txtOutput.text = ""
frmOutput.txtOutput.text = Input$(LOF(filenum), filenum)
frmOutput.caption = "MACCS Site Data File"
frmOutput.Show
frmOutput.ZOrder

Close filenum 'Close and delete temporary file.
Kill Filename

End Sub

Private Sub mnuCSV_Display_Com_Click()

'This function creates a temporary file, and then
'writes into that file the information for the user
'to view on the screen. This file is then sent to a
'text form, where the user can view it and scroll
'the various parts of the data.

Dim filenum As Integer
Dim Filename As String
Dim tempstr As String

Unload frmDisclaimer

'check temp file, if it exists, turn readonly off just in case it's on

Filename = App.path & "\\$TEMP$.$$$"
tempstr = Dir$(Filename)
If tempstr <> "" Then
    SetAttr Filename, vbNormal
End If

'Create temporary file
filenum = FreeFile
Open Filename For Output As filenum 'Printer.PrintTarget = "$TEMP$.$$$"
Call print_MACCS_input_file(filenum, "CSV") 'Write the actual data to file.
Close #filenum
filenum = FreeFile
Open Filename For Input As filenum

```

```

'Display information in text form.

frmOutput.txtOutput.text = ""
frmOutput.txtOutput.text = Input$(LOF(filename), filename)
frmOutput.caption = "CSV Site Data File"
frmOutput.Show
frmOutput.ZOrder

Close filename 'Close and delete temporary file.
Kill filename

End Sub

Private Sub mnuMACCS_Print_Com_Click()

' This event calls a subroutine in module Outpcode that produces
' a hard copy of the MACCS file

Call Print_MaCCS_File_To_Printer("MACCS")

End Sub

Private Sub mnuCSV_Print_Com_Click()

' This event calls a subroutine in module Outpcode that produces
' a hard copy of the MACCS file

Call Print_MaCCS_File_To_Printer("CSV")

End Sub

Private Sub mnuSaveCom_Click()
Dim MaccsOrCSV As String

' This event calls a subroutine in module Outpcode that produces
' a hard copy of the MACCS file

MaccsOrCSV = "MACCS"
Call SaveResultsToFile(MaccsOrCSV)

End Sub

Private Sub mnuNew_ProblemCom_Click()

'This function asks the user if they want to review
'previously entered data or create a new problem.

Dim i As Integer, reply As Integer

Unload frmDisclaimer

'If no problem has already been loaded, drop user
'directly into the new problem form.

If frmProblem_Data.caption = "" Then
Call new_problem

'Otherwise ask user if they want to review the old
'data. If they do, then show it, otherwise call
'the new problem form.
Else

reply = MsgBox("Do you wish to review the previous problem data?", vbYesNoCancel, "New
Problem")
If reply = vbYes Then

```

```

        frmProblem_Data.Show
    ElseIf reply = vbNo Then
        Call new_problem
    End If
    frmProblem_Data.ZOrder

End If

'   frmMain.mnuSave_ProblemCom.Enabled = False
'   frmMain.mnuSave_As_ProblemCom.Enabled = False

    frmMain.mnuSave_ProblemCom.Enabled = True
    frmMain.mnuSave_As_ProblemCom.Enabled = True

End Sub

Private Sub mnuNew_SiteCom_Click()

    'This function asks the user if they want to review
    'previous data or create a new site.

    Dim reply As Integer

    Unload frmDisclaimer

    'If no data has been entered, go directly to new site form.

    If frmSite_Data.caption = "" Then

        Call new_site

    Else

        'If data has been entered, ask the user if they want to see it.
        'If yes, then show old data, otherwise go to new site form.

        reply = MsgBox("Do you wish to review the previous site data?", vbYesNoCancel, "New
Site")
        If reply = vbYes Then
            frmSite_Data.Show
        ElseIf reply = vbNo Then
            Call new_site
        End If
        frmSite_Data.ZOrder

    End If

'   frmMain.mnuSave_Sitecom.Enabled = False
'   frmMain.mnuSave_as_Sitecom.Enabled = False

    frmMain.mnuSave_Sitecom.Enabled = True
    frmMain.mnuSave_as_Sitecom.Enabled = True

End Sub

Private Sub mnuOpen_ProblemCom_Click()

    'This subroutine allows the user to look at a previously
    'created problem data or review problem data that has already
    'been loaded.

    Dim reply As Integer
    Dim tempstr As Integer

    Unload frmDisclaimer

```



```

'If data has not yet been entered, go directly to the
'open problem function.

If frmProblem_Data.caption = "" Then

    Call open_problem

'Otherwise, ask the user if they want to review the
'previous problem data.  If so, show it to them, otherwise
'call open problem.

Else

    reply = MsgBox("Do you wish to review the previous problem data?", vbYesNoCancel, "Open
Problem File")
    If reply = vbYes Then
        frmProblem_Data.Show
        frmProblem_Data.ZOrder
    ElseIf reply = vbNo Then
        Call open_problem
    End If

End If

'    frmMain.mnuSave_ProblemCom.Enabled = False
'    frmMain.mnuSave_As_ProblemCom.Enabled = False

    frmMain.mnuSave_ProblemCom.Enabled = True
    frmMain.mnuSave_As_ProblemCom.Enabled = True

End Sub

Private Sub mnuOpen_SiteCom_Click()

'This subroutine allows the user to look at a previously
'created site data or review site data that has already
'been loaded.

Dim reply As Integer

Unload frmDisclaimer

'If data has not yet been entered, go directly to the
'open site function.

If frmSite_Data.caption = "" Then

    Call open_site

'Otherwise, ask the user if they want to review the
'previous site data.  If so, show it to them, otherwise
'call open site.

Else

    reply = MsgBox("Do you wish to review the previous site data?", vbYesNoCancel, "Open Site
File")
    If reply = vbYes Then
        frmSite_Data.Show
    ElseIf reply = vbNo Then
        Call open_site
    End If
    frmSite_Data.ZOrder

End If

```

```

'   frmMain.mnuSave_Sitecom.Enabled = False
'   frmMain.mnuSave_as_Sitecom.Enabled = False

   frmMain.mnuSave_Sitecom.Enabled = True
   frmMain.mnuSave_as_Sitecom.Enabled = True

End Sub

Private Sub mnuPreviouscom_Click()

'Load in previously saved output data so that the user
'can view it again, in any of the standard forms.

   Unload frmDisclaimer
   Call ReadPreviousOutput 'Readfile Module
   Unload frmRosette

End Sub

'Private Sub mnuRegionalCom_Click()
'
'   'Call the forms and functions which handle the
'   'regional calculations
'
'   Unload frmDisclaimer
'
'   'load form which prompts user for certain input
'   'necessary for regional calculations
'
'   Load frmMake_a_Circle
'   frmMake_a_Circle.Show
'End Sub

'Private Sub mnuRegional_Displaycom_Click()
'
'   Unload frmDisclaimer
'
'   'Display regional calculation results.
'
'   RUN "run_mppr.exe"
'End Sub

Private Sub mnuRosetteCom_Click()

   Unload frmDisclaimer

   'Draw the Rosette graph.

   frmRosette.Show
   frmRosette.ZOrder

End Sub

Private Sub mnuSave_As_ProblemCom_Click()

'   'This event procedure calls the save as problem subroutine
'   'which saves the problem data with a new file name.

   Unload frmDisclaimer

'   frmMain.mnuSave_ProblemCom.Enabled = False
'   frmMain.mnuSave_As_ProblemCom.Enabled = False

```

```

    Call save_as_problem
End Sub

Private Sub mnuSave_As_SiteCom_Click()
    'This subroutine calls the save as site subroutine which saves
    'the site data with a new file name.

    Unload frmDisclaimer

    Call save_as_site
End Sub

Private Sub mnuSave_ProblemCom_Click()
    'This subroutine calls the save problem subroutine
    'which saves the problem data.

    Unload frmDisclaimer

    frmMain.mnuSave_ProblemCom.Enabled = False
    frmMain.mnuSave_As_ProblemCom.Enabled = False

    Call save_problem

    frmProblem_Data.cmdSave_Click
End Sub

Private Sub mnuSave_Resultscom_Click()
    '
    ' This event procedure calls the sub SaveResultsToFile
    '(Outpcode module). Depending on the default site
    'specific output file format, the file is either saved as a MACCS
    'file (*.inp) or a comma separated variables file (*.csv). User
    'also has the option of changing format during the save process.
    '
    Call SaveResultsToFile
    '
End Sub

Private Sub mnuSave_ResultsMACCScom_Click()
    'This event procedure calls the sub SaveResultsToFile
    '(Outpcode module). Depending on the default site
    'specific output file format, the file is either saved as a MACCS
    'file (*.inp) or a comma separated variables file (*.csv). User
    'also has the option of changing format during the save process.

    Call SaveResultsToFile("MACCS")
End Sub

Private Sub mnuSave_ResultsCSVcom_Click()
    'This event procedure calls the sub SaveResultsToFile
    '(Outpcode module). Depending on the default site
    'specific output file format, the file is either saved as a MACCS
    'file (*.inp) or a comma separated variables file (*.csv). User
    'also has the option of changing format during the save process.

    Call SaveResultsToFile("CSV")
End Sub

```

```

Private Sub mnuSave_SiteCom_Click()

    'This subroutine calls the save site subroutine
    'which saves the site data.

    Dim i As Integer
    '
    ' i = MsgBox(frmMain.dlgSecpop.Filename & " already exists. Would you like to overwrite this
file? " & _
    '           " (If not please select Save As).", vbYesNoCancel)
    '
    ' If i = vbYes Then
    '
    '     frmMain.mnuSave_Sitecom.Enabled = False
    '     frmMain.mnuSave_as_Sitecom.Enabled = False
    '
    '     Call save_site
    '
    ' End If

    frmSite_Data.cmdSave_Click

End Sub

Private Sub mnusetupcom_Click()

    'This subroutine shows the setup form. This
    'form allows the user to set up paths and file
    'saving formats.

    Unload frmDisclaimer

    frmSetup.Show
    frmSetup.ZOrder

End Sub

Private Sub mnuSite_specificCom_Click()

    Unload frmDisclaimer

    'This subroutine checks to see if there is enough data to perform
    'site calculations, and if so, calls the form to do the actual math.
    'For further documentation, see frmCalculate.

    'Verify that there are radial distances and coordinates.

    If ((number_of_radii = 0) Or _
        (Val(frmProblem_Data.txtPopulation_multiplier.text) = 0)) Or _
        frmProblem_Data.txtSite_File_Name.text = "" Then
        MsgBox "Unable to calculate populations." + Chr$(KEY_RETURN) + "Problem Data form is
incomplete.", vbOK, "Calculation Error"
    ElseIf ((Val(frmSite_Data.txtLongitude_Degrees.text) = 0) Or
        (Val(frmSite_Data.txtLatitude_Degrees.text) = 0)) Then
        MsgBox "Unable to calculate populations." + Chr$(KEY_RETURN) + " Site Data form is
incomplete.", vbOK, "Calculation Error"
    Else
        Load frmCalculate
        frmCalculate.Show
        frmCalculate.ZOrder ' bring form to top
        frmCalculate.cmdCalculate_Click
    End If

End Sub

```

```

Private Sub mnuTable_1com_Click()

    'This event procedure allows the user to view data
    'in tabular format by showing the first table
    'form. This form must be loaded and unloaded each
    'time that it is displayed so that the values
    'displayed will be updated. For further documentation
    'see frmTable_1.

    Unload frmDisclaimer

    table_type = 1
    ' Load frmTable_1
    ' frmTable_1.Show
    Unload frmPopulationTables
    ' frmPopulationTables.caption = "Population Table - " & frmSite_Data.txtSite_Name.text

    frmPopulationTables.Show
    frmPopulationTables.ZOrder

End Sub

Private Sub mnuTable_2com_Click()

    'This event procedure allows the user to view data
    'in tabular format by showing the second table
    'form. This form must be loaded and unloaded each
    'time that it is displayed so that the values
    'displayed will be updated. For further documentation
    'see frmTable_1.

    Unload frmDisclaimer

    table_type = 2
    ' Load frmTable_1
    ' frmTable_1.Show
    Unload frmPopulationTables
    ' frmPopulationTables.caption = "Cumulative (By Direction) Population Table - " &
    frmSite_Data.txtSite_Name.text
    frmPopulationTables.Show
    frmPopulationTables.ZOrder

End Sub

Private Sub Toolbar1_ButtonClick(ByVal Button As MSComctlLib.Button)

    Select Case Button.Key

        Case "Site"

            mnuOpen_SiteCom_Click

        Case "Problem"

            mnuOpen_ProblemCom_Click

        Case "CalculateSite"

            mnuSite_specificCom_Click

        Case "PopulationRosette"

            mnuRosetteCom_Click

        Case "PopulationTable"

```

```
        mnuTable_1com_Click
    Case "CumulativeTable"
        mnuTable_2com_Click
    Case "Save"
        mnuSaveCom_Click
    Case "Setup"
        mnusetupcom_Click
End Select
End Sub
```

H.26 Visual Basic Form Module: Outpform.frm

```
VERSION 5.00
Begin VB.Form frmOutput
    Appearance = 0 'Flat
    BackColor = &H80000004&
    BorderStyle = 1 'Fixed Single
    Caption = "MACCS Site Data File"
    ClientHeight = 5820
    ClientLeft = 150
    ClientTop = 570
    ClientWidth = 10200
    BeginProperty Font
        Name = "MS Sans Serif"
        Size = 8.25
        Charset = 0
        Weight = 700
        Underline = 0 'False
        Italic = 0 'False
        Strikethrough = 0 'False
    EndProperty
    ForeColor = &H00000000&
    Icon = "Outpform.frx":0000
    MaxButton = 0 'False
    MDIChild = -1 'True
    MinButton = 0 'False
    PaletteMode = 1 'UseZOrder
    ScaleHeight = 5820
    ScaleWidth = 10200
    Begin VB.TextBox txtOutput
        Appearance = 0 'Flat
        BackColor = &H00FFFFFF&
        BeginProperty Font
            Name = "Courier New"
            Size = 9.75
            Charset = 0
            Weight = 700
            Underline = 0 'False
            Italic = 0 'False
            Strikethrough = 0 'False
        EndProperty
        ForeColor = &H00000000&
        Height = 4905
        Left = 180
        MultiLine = -1 'True
        ScrollBars = 3 'Both
        TabIndex = 1
        Top = 120
        Width = 9900
    End
    Begin VB.CommandButton cmdClose
        Appearance = 0 'Flat
        BackColor = &H00808000&
        Cancel = -1 'True
        Caption = "Close"
        Default = -1 'True
        Height = 480
        Left = 8895
        TabIndex = 0
        Top = 5205
        Width = 1188
    End
End
End
```

```

Attribute VB_Name = "frmOutput"
Attribute VB_GlobalNameSpace = False
Attribute VB_Creatable = False
Attribute VB_PredeclaredId = True
Attribute VB_Exposed = False

Option Explicit

'Output is displayed on this form.
'it is basically just a text viewer with a close box
'attached to allow the user to leave.

Private Sub cmdClose_Click()

    'This command allows the user to close the output
    'text box.

    frmOutput.Hide
End Sub

```

H.27 Visual Basic Form Module: PopulationTable.frm

```

VERSION 5.00
Object = "{0D623638-DBA2-11D1-B5DF-0060976089D0}#7.0#0"; "tdbg7.ocx"
Begin VB.Form frmPopulationTables
    Appearance = 0 'Flat
    AutoRedraw = -1 'True
    BackColor = &H80000004&
    BorderStyle = 1 'Fixed Single
    Caption = "Population Table"
    ClientHeight = 5820
    ClientLeft = 30
    ClientTop = 570
    ClientWidth = 9600
    BeginProperty Font
        Name = "MS Sans Serif"
        Size = 8.25
        Charset = 0
        Weight = 700
        Underline = 0 'False
        Italic = 0 'False
        Strikethrough = 0 'False
    EndProperty
    ForeColor = &H00000000&
    Icon = "PopulationTable.frx":0000
    MaxButton = 0 'False
    MDIChild = -1 'True
    MinButton = 0 'False
    PaletteMode = 1 'UseZOrder
    ScaleHeight = 5820
    ScaleWidth = 9600
    Tag = "5055"
    Begin TrueDBGrid70.TDBGrid TDBGrid1
        Height = 4110
        Left = 45
        TabIndex = 3
        Top = 930
        Width = 9495
        _ExtentX = 16748
        _ExtentY = 7250
        _LayoutType = 0
        _RowHeight = -2147483647
        _WasPersistedAsPixels = 0
        Columns(0)._VlistStyle = 0
    End
End

```



```

Columns(0)._MaxComboItems= 5
Columns(0).DataField= ""
Columns(0)._PropDict= "_MaxComboItems,516,2;_VlistStyle,514,3"
Columns(1)._VlistStyle= 0
Columns(1)._MaxComboItems= 5
Columns(1).DataField= ""
Columns(1)._PropDict= "_MaxComboItems,516,2;_VlistStyle,514,3"
Columns.Count = 2
Splits(0)._UserFlags= 0
Splits(0).RecordSelectorWidth= 503
Splits(0).DividerColor= 13160660
Splits(0).SpringMode= 0 'False
Splits(0)._PropDict= "_ColumnProps,515,0;_UserFlags,518,3"
Splits(0)._ColumnProps(0)= "Columns.Count=2"
Splits(0)._ColumnProps(1)= "Column(0).Width=3281"
Splits(0)._ColumnProps(2)= "Column(0).DividerColor=0"
Splits(0)._ColumnProps(3)= "Column(0)._WidthInPix=3175"
Splits(0)._ColumnProps(4)= "Column(0).Order=1"
Splits(0)._ColumnProps(5)= "Column(1).Width=3281"
Splits(0)._ColumnProps(6)= "Column(1).DividerColor=0"
Splits(0)._ColumnProps(7)= "Column(1)._WidthInPix=3175"
Splits(0)._ColumnProps(8)= "Column(1).Order=2"
Splits.Count = 1
PrintInfos(0)._StateFlags= 3
PrintInfos(0).Name= "piInternal 0"
PrintInfos(0).PageHeaderFont=
"Size=8.25,Charset=0,Weight=700,Underline=0,Italic=0,Strikethrough=0,Name=MS Sans Serif"
PrintInfos(0).PageFooterFont=
"Size=8.25,Charset=0,Weight=700,Underline=0,Italic=0,Strikethrough=0,Name=MS Sans Serif"
PrintInfos(0).PageHeaderHeight= 0
PrintInfos(0).PageFooterHeight= 0
PrintInfos.Count= 1
DataMode = 2
DefColWidth = 0
HeadLines = 1
FootLines = 1
MultipleLines = 0
CellTipsWidth = 0
DeadAreaBackColor= 13160660
RowDividerColor = 13160660
RowSubDividerColor= 13160660
DirectionAfterEnter= 1
MaxRows = 250000
_PropDict =
"_ExtentX,2003,3;_ExtentY,2004,3;_LayoutType,512,2;_RowHeight,16,3;_StyleDefs,513,0;_WasPersisted
AsPixels,516,2"
_StyleDefs(0) = "_StyleRoot:id=0,.parent=-
1,.alignment=3,.valignment=0,.bgcolor=&H80000005&"
_StyleDefs(1) = ":id=0,.fgcolor=&H80000008&,.wraptext=0,.locked=0,.transparentBmp=0"
_StyleDefs(2) =
":id=0,.fgpicPosition=0,.bgpicMode=0,.appearance=0,.borderSize=0,.ellipsis=0"
_StyleDefs(3) = ":id=0,.borderColor=&H80000005&,.borderType=0,.bold=-
1,.fontSize=825,.italic=0"
_StyleDefs(4) = ":id=0,.underline=0,.strikethrough=0,.charset=0"
_StyleDefs(5) = ":id=0,.fontname=MS Sans Serif"
_StyleDefs(6) = "Style:id=1,.parent=0,.namedParent=33,.bold=-1,.fontSize=825,.italic=0"
_StyleDefs(7) = ":id=1,.underline=0,.strikethrough=0,.charset=0"
_StyleDefs(8) = ":id=1,.fontname=MS Sans Serif"
_StyleDefs(9) = "CaptionStyle:id=4,.parent=2,.namedParent=37"
_StyleDefs(10) = "HeadingStyle:id=2,.parent=1,.namedParent=34,.bold=-
1,.fontSize=825,.italic=0"
_StyleDefs(11) = ":id=2,.underline=0,.strikethrough=0,.charset=0"
_StyleDefs(12) = ":id=2,.fontname=MS Sans Serif"
_StyleDefs(13) = "FooterStyle:id=3,.parent=1,.namedParent=35,.bold=-
1,.fontSize=825,.italic=0"
_StyleDefs(14) = ":id=3,.underline=0,.strikethrough=0,.charset=0"

```

```

        _StyleDefs(15) = " :id=3,.fontname=MS Sans Serif"
        _StyleDefs(16) =
"InactiveStyle:id=5,.parent=2,.bgcolor=&H8000000F&,.fgcolor=&H80000012&"
        _StyleDefs(17) = "SelectedStyle:id=6,.parent=1,.namedParent=36"
        _StyleDefs(18) = "EditorStyle:id=7,.parent=1"
        _StyleDefs(19) = "HighlightRowStyle:id=8,.parent=1,.namedParent=38"
        _StyleDefs(20) = "EvenRowStyle:id=9,.parent=1,.namedParent=39"
        _StyleDefs(21) = "OddRowStyle:id=10,.parent=1,.namedParent=40"
        _StyleDefs(22) = "RecordSelectorStyle:id=11,.parent=2"
        _StyleDefs(23) = "FilterBarStyle:id=12,.parent=1,.namedParent=42"
        _StyleDefs(24) = "Splits(0).Style:id=13,.parent=1"
        _StyleDefs(25) = "Splits(0).CaptionStyle:id=22,.parent=4"
        _StyleDefs(26) = "Splits(0).HeadingStyle:id=14,.parent=2"
        _StyleDefs(27) = "Splits(0).FooterStyle:id=15,.parent=3"
        _StyleDefs(28) = "Splits(0).InactiveStyle:id=16,.parent=5"
        _StyleDefs(29) = "Splits(0).SelectedStyle:id=18,.parent=6"
        _StyleDefs(30) = "Splits(0).EditorStyle:id=17,.parent=7"
        _StyleDefs(31) = "Splits(0).HighlightRowStyle:id=19,.parent=8"
        _StyleDefs(32) = "Splits(0).EvenRowStyle:id=20,.parent=9"
        _StyleDefs(33) = "Splits(0).OddRowStyle:id=21,.parent=10"
        _StyleDefs(34) = "Splits(0).RecordSelectorStyle:id=23,.parent=11"
        _StyleDefs(35) = "Splits(0).FilterBarStyle:id=24,.parent=12"
        _StyleDefs(36) = "Splits(0).Columns(0).Style:id=28,.parent=13"
        _StyleDefs(37) = "Splits(0).Columns(0).HeadingStyle:id=25,.parent=14"
        _StyleDefs(38) = "Splits(0).Columns(0).FooterStyle:id=26,.parent=15"
        _StyleDefs(39) = "Splits(0).Columns(0).EditorStyle:id=27,.parent=17"
        _StyleDefs(40) = "Splits(0).Columns(1).Style:id=32,.parent=13"
        _StyleDefs(41) = "Splits(0).Columns(1).HeadingStyle:id=29,.parent=14"
        _StyleDefs(42) = "Splits(0).Columns(1).FooterStyle:id=30,.parent=15"
        _StyleDefs(43) = "Splits(0).Columns(1).EditorStyle:id=31,.parent=17"
        _StyleDefs(44) = "Named:id=33:Normal"
        _StyleDefs(45) = " :id=33,.parent=0"
        _StyleDefs(46) = "Named:id=34:Heading"
        _StyleDefs(47) =
":id=34,.parent=33,.valignment=2,.bgcolor=&H8000000F&,.fgcolor=&H80000012&"
        _StyleDefs(48) = " :id=34,.wraptext=-1"
        _StyleDefs(49) = "Named:id=35:Footing"
        _StyleDefs(50) =
":id=35,.parent=33,.valignment=2,.bgcolor=&H8000000F&,.fgcolor=&H80000012&"
        _StyleDefs(51) = "Named:id=36:Selected"
        _StyleDefs(52) = " :id=36,.parent=33,.bgcolor=&H8000000D&,.fgcolor=&H8000000E&"
        _StyleDefs(53) = "Named:id=37:Caption"
        _StyleDefs(54) = " :id=37,.parent=34,.alignment=2"
        _StyleDefs(55) = "Named:id=38:HighlightRow"
        _StyleDefs(56) = " :id=38,.parent=33,.bgcolor=&H8000000D&,.fgcolor=&H8000000E&"
        _StyleDefs(57) = "Named:id=39:EvenRow"
        _StyleDefs(58) = " :id=39,.parent=33,.bgcolor=&HFFFF00&"
        _StyleDefs(59) = "Named:id=40:OddRow"
        _StyleDefs(60) = " :id=40,.parent=33"
        _StyleDefs(61) = "Named:id=41:RecordSelector"
        _StyleDefs(62) = " :id=41,.parent=34"
        _StyleDefs(63) = "Named:id=42:FilterBar"
        _StyleDefs(64) = " :id=42,.parent=33"
End
Begin VB.CommandButton cmdprint
    Appearance = 0 'Flat
    BackColor = &H00808000&
    Caption = "&Print"
    Height = 480
    Left = 7665
    TabIndex = 0
    Top = 5250
    Width = 1728
End
Begin VB.CommandButton cmdexit
    Appearance = 0 'Flat

```

```

        BackColor      = &H00808000&
        Caption       = "&Close"
        Height        = 480
        Left          = 5820
        TabIndex      = 1
        Top           = 5250
        Width         = 1728
    End
Begin VB.Label lblDistance_Heading
    Alignment        = 2 'Center
    Appearance       = 0 'Flat
    BackColor        = &H80000004&
    Caption          = "Radii (Kilometers)"
    BeginProperty Font
        Name          = "MS Sans Serif"
        Size          = 12
        Charset       = 0
        Weight        = 700
        Underline     = 0 'False
        Italic        = 0 'False
        Strikethrough = 0 'False
    EndProperty
    ForeColor        = &H00000000&
    Height           = 360
    Left             = 3555
    TabIndex        = 2
    Top              = 435
    Width            = 2295
End
End
Attribute VB_Name = "frmPopulationTables"
Attribute VB_GlobalNameSpace = False
Attribute VB_Creatable = False
Attribute VB_PredeclaredId = True
Attribute VB_Exposed = False
Option Explicit

Dim MaxCol As Integer
Dim MaxRow As Integer
Dim GridArray() As String
Dim Sink As New GridClass

'This is the actual table form for table 1. See rptable_1 for more
'info.

Private Sub cmdExit_Click()

    'Remove table 1 from memory.

    ' Unload frmTable_1
    Unload Me

End Sub

Private Sub cmdPrint_Click()

    Call Print_Table_File_to_Printer

End Sub

Private Sub Form_Load()

    Me.Top = 50
    Me.Left = 200

```

```

End Sub

Private Sub Form_Activate()

    Unload frmDisclaimer

    Dim sum As Long
    Dim i As Integer
    Dim j As Integer
    Dim k As Integer

    Dim row As Long, col As Integer
    Dim C As TrueDBGrid70.Column
    Dim Cols As TrueDBGrid70.Columns

    Dim blnFirstTime As Boolean

    blnFirstTime = True

'    check to see if anything (problem or site info) has changed

    If frmRosette.blnInputDataChanged = True Then
        For i = 0 To number_of_segments
            For j = 0 To max_number_of_radii
                sector_population(number_of_segments, max_number_of_radii)
                sector_population(i, j) = 0
            Next j
        Next i
    End If

    If table_type = 1 Then
        frmPopulationTables.caption = "Population Table - " & frmSite_Data.txtSite_Name.text
    Else
        frmPopulationTables.caption = "Cumulative (By Direction) Population Table - " &
        frmSite_Data.txtSite_Name.text
    End If

    If (frmProblem_Data.optKilometers.Value) Then
        lblDistance_Heading.caption = "Radii (Kilometers)"
    Else
        lblDistance_Heading.caption = "Radii (Miles)"
    End If

'    row = CLng(txtIn(0).text)
'    col = CInt(txtIn(1).text)
    col = number_of_radii + 2 ' 35 ' one column
    row = number_of_segments + 2 ' 16

    MaxCol = number_of_radii + 2 ' 35 ' one column
    MaxRow = number_of_segments + 2 ' 16

    Screen.MousePointer = vbHourglass

'    Initialize storage
    Sink.SetDims row, col

'fill the grid (gridarray) with directions
    For i = 0 To row - 3
        Sink.Value(i, 0) = directions(i)
    Next i
'    GridArray(0, row - 1) = "Sum"
    Sink.Value(row - 1, 0) = "Sum"

```

```

'fill the grid (gridarray) with data
For i = 0 To MaxRow - 3
    sum = 0
    For j = 1 To MaxCol - 1
        For j = 1 To MaxCol - 2
            sum = sum + sector_population(i + 1, j)
            If (table_type = 1) Then
                GridArray(j, i) = Str(sector_population(i + 1, j))
                Sink.Value(i, j) = Str(sector_population(i + 1, j))
            Else
                GridArray(j, i) = Str(sum)
                Sink.Value(i, j) = Str(sum)
            End If
        Next j
        GridArray(MaxCol - 1, i) = sum
        Sink.Value(i, MaxCol - 1) = Str(sum)
    Next i

'calculate and fill the radial sum labels
    For i = 1 To MaxCol - 1
        For i = 1 To MaxCol - 2
            sum = 0
            If (table_type = 1) Then
                For j = 1 To number_of_segments
                    sum = sum + sector_population(j, i)
                Next j
            Else
                For j = 1 To number_of_segments
                    For k = 1 To i
                        sum = sum + sector_population(j, k)
                    Next k
                Next j
            End If

            GridArray(i, MaxRow - 1) = sum
            Sink.Value(MaxRow - 1, i) = Str(sum)
        Next i

'calculate and filll the total sum label
sum = 0
    For i = 1 To MaxCol - 1
        For i = 1 To MaxCol - 2
            For j = 1 To number_of_segments
                sum = sum + sector_population(j, i)
            Next j
        Next i
        GridArray(MaxCol - 1, MaxRow - 1) = sum
        Sink.Value(MaxRow - 1, MaxCol - 1) = Str(sum)

' Make sure no events are fired for the grid yet
Sink.Attach Nothing

Set Cols = TDBGrid1.Columns

' Remove all columns
While Cols.Count
    Cols.Remove 0
Wend
TDBGrid1.ReBind

```

```

' Add columns to the grid
For col = 0 To Sink.ColCount - 1
  Set C = Cols.Add(col)
  C.Visible = True
  C.Width = 1000
  C.Locked = True
  If col = 0 Then
    C.caption = "Sectors"
  ElseIf col = Sink.ColCount - 1 Then
    C.caption = "Sum"
    C.Width = 1200
  Else
    C.caption = Str(radial_distance(col))
  End If
Next col

If blnFirstTime Then

  blnFirstTime = False

' set misc parameters

TDBGrid1.Columns(0).BackColor = &HC0C0C0
TDBGrid1.Columns(0).DividerStyle = 8 ' double line dividing col 0 and col 1
TDBGrid1.RecordSelectors = False

' remove existing splits
For i = 1 To TDBGrid1.Splits.Count - 1
  TDBGrid1.Splits.Remove 0
Next i

' set splits

Dim s As TrueDBGrid70.Split
Set s = TDBGrid1.Splits.Add(0)
Set s = TDBGrid1.Splits.Add(0)

Set Cols = TDBGrid1.Splits(0).Columns ' sector column
For i = 1 To MaxCol - 1
  Cols(i).Visible = False
Next i

Set Cols = TDBGrid1.Splits(1).Columns ' data columns
Cols(0).Visible = False
Cols(MaxCol - 1).Visible = False

Set Cols = TDBGrid1.Splits(2).Columns ' sum column
For i = 0 To MaxCol - 2
  Cols(i).Visible = False
Next i

TDBGrid1.Splits(0).AllowSizing = False
TDBGrid1.Splits(1).AllowSizing = True
TDBGrid1.Splits(2).AllowSizing = True

TDBGrid1.Splits(0).SizeMode = dbgNumberOfColumns
TDBGrid1.Splits(1).SizeMode = dbgNumberOfColumns
TDBGrid1.Splits(2).SizeMode = dbgNumberOfColumns

TDBGrid1.Splits(0).Size = 1
TDBGrid1.Splits(1).Size = MaxCol - 2
TDBGrid1.Splits(1).Size = 7
TDBGrid1.Splits(2).Size = 1

```

```

' Calibrate the VScroll bar
TDBGrid1.ApproxCount = Sink.RowCount

End If

' Initialise the class
Sink.Attach TDBGrid1

' Reinitialize the grid
TDBGrid1.Bookmark = Null
TDBGrid1.ReBind

Screen.MousePointer = vbDefault

.....

'
MaxCol = number_of_radrii + 2      ' 35  ' one column
MaxRow = number_of_segments + 2    ' 16
'
'
'   region table:      maxcol = number_of_radrii + 1  (10)
'                   maxrow = 16
'   gridarray(maxcol10,maxrow16)
'
' make gridarray with 1 dummy column to overcome apparent bug
'   ReDim gridarray(0 To maxcol + 1, 0 To maxrow) ' need 1 more col and 2 more rows for sums
'   ReDim GridArray(0 To MaxCol, 0 To MaxRow) ' need 1 more col and 2 more rows for sums
'
' fill the grid (gridarray) with directions
For i = 0 To MaxRow - 3
    GridArray(0, i) = directions(i)
Next i
GridArray(0, MaxRow - 1) = "Sum"

For i = 0 To 18
    sum = 0
    For j = 1 To 12
        GridArray(j, i) = "hi"
    Next j
Next i

' fill the grid (gridarray) with data

For i = 0 To MaxRow - 3
    sum = 0
    For j = 1 To MaxCol - 1
        sum = sum + sector_population(i + 1, j)
        If (table_type = 1) Then
            GridArray(j, i) = Str(sector_population(i + 1, j))
        Else
            GridArray(j, i) = Str(sum)
        End If
    Next j
    GridArray(MaxCol - 1, i) = sum
Next i

' calculate and fill the radial sum labels

For i = 1 To MaxCol - 1
    sum = 0
    If (table_type = 1) Then

```

```

      For j = 1 To number_of_segments
        sum = sum + sector_population(j, i)
      Next j
    Else
      For j = 1 To number_of_segments
        For k = 1 To i
          sum = sum + sector_population(j, k)
        Next k
      Next j
    End If

    GridArray(i, MaxRow - 1) = sum
  Next i

  'calculate and filll the total sum label
  sum = 0
  For i = 1 To MaxCol - 1
    For j = 1 To number_of_segments
      sum = sum + sector_population(j, i)
    Next j
  Next i
  GridArray(MaxCol - 1, MaxRow - 1) = sum

  'set up grid
  'remove existing columns
  While TDBGrid1.Columns.Count <> 0
    TDBGrid1.Columns.Remove 0
  Wend

  'add new columns
  Dim c As TrueOleDBGrid70.Column
  For i = 0 To MaxCol - 2
    Set c = TDBGrid1.Columns.Add(i)
    c.caption = Str(radial_distance(i))
    c.Width = 1000
    c.Visible = True
    c.Locked = True
    TDBGrid1.Columns(i).Locked = True
  Next i
  Set c = TDBGrid1.Columns.Add(MaxCol - 1)
  c.caption = "Sum"
  c.Visible = True
  c.Width = 1000
  c.Locked = True
  TDBGrid1.Columns(maxcol - 1).Locked = True

  Set c = TDBGrid1.Columns.Add(MaxCol)
  c.caption = "dummy"
  c.Width = 1000
  c.Visible = True
  c.Locked = True
  TDBGrid1.Columns(maxcol - 1).Locked = True

  'set various parameters of the grid
  TDBGrid1.ApproxCount = 18

  TDBGrid1.Columns(0).caption = "Sectors"
  TDBGrid1.Columns(0).DividerStyle = 8 ' double line dividing col 0 and col 1

```



```

'
TDBGrid1.Columns(0).Locked = True
TDBGrid1.Columns(1).Locked = True
'
'   TDBGrid1.ApproxCount = maxrow
'
TDBGrid1.Columns(0).BackColor = &HC0C0C0
TDBGrid1.Columns(1).ForeColor = &H808080
'
'Initialize current cell position to upper left corner:
'
TDBGrid1.row = 0
TDBGrid1.col = 0
TDBGrid1.Refresh
'
'   Open "gridtest.txt" For Output As 22
End Sub

'Private Sub hsbRadii_Change()
'
'   x_position = hsbRadii.Value
'   Call paint_table
'
'End Sub

'Private Sub vsbSectors_Change()
'
'   y_position = vsbSectors.Value
'   Call paint_table
'
'End Sub

'''Private Sub TDBGrid1_UnboundReadData(ByVal RowBuf As TrueOleDBGrid70.RowBuffer, _
'''                                     StartLocation As Variant, _
'''                                     ByVal ReadPriorRows As Boolean)
'''
''' UnboundReadData is fired by an unbound grid whenever
''' it requires data for display. This event will fire
''' when the grid is first shown, when Refresh or ReBind
''' is used, when the grid is scrolled, and after a
''' record in the grid is modified and the user commits
''' the change by moving off of the current row. The
''' grid fetches data in "chunks", and the number of rows
''' the grid is asking for is given by RowBuf.RowCount.
'''
'''   Call TDBGridUnboundReadData(RowBuf, _
'''                               StartLocation, _
'''                               ReadPriorRows, _
'''                               GridArray(), _
'''                               MaxRow, _
'''                               MaxCol)
'''End Sub

'''Private Sub TDBGrid1_UnboundGetRelativeBookmark(StartLocation As Variant, _
'''                                               ByVal offset As Long, _
'''                                               NewLocation As Variant, _
'''                                               ApproximatePosition As Long)
'''
''' TDBGrid1 calls this routine each time it needs to
''' reposition itself. StartLocation is a bookmark
''' supplied by the grid to indicate the "current"
''' position -- the row we are moving from. Offset is
''' the number of rows we must move from StartLocation
''' in order to arrive at the desired destination row.
''' A positive offset means the desired record is after

```

```

'''' the StartLocation, and a negative offset means the
'''' desired record is before StartLocation.
'''
''' Call TDBGridUnboundGetRelativeBookmark(StartLocation, _
''' offset, _
''' NewLocation, _
''' ApproximatePosition, _
''' MaxRow)

Private Sub Form_Unload(Cancel As Integer)
    Set Sink = Nothing
End Sub

'''
'''End Sub
'''
'''Private Function GetNewBookmark(MaxRow As Long) As Variant
'''Private Function GetNewBookmark(maxrow As Integer) As Variant
''' GetNewBookmark is called when we need to create a
''' bookmark for a newly added record (row).
'''
''' Reserve space for the new row in the array
''' ReDim Preserve gridarray(0 To maxcol - 1, 0 To maxrow)
'''
''' Since the row index of the last record is (MaxRow - 1),
''' the next available index for the row to be added is
''' (MaxRow), so create a bookmark for the new row using
''' MaxRow as an index.
''' GetNewBookmark = MakeBookmark(MaxRow)
'''
''' Increment the number of rows in our dataset
''' MaxRow = MaxRow + 1
'''
''' Calibrate the scroll bars based on the new dataset
''' size.
''' TDBGrid1.ApproxCount = MaxRow
'''End Function
'''
'''
Private Sub TDBGrid1_Click()

End Sub

```

H.28 Visual Basic Form Module: Probform.frm

```
VERSION 5.00
Begin VB.Form frmProblem_Data
    Appearance = 0 'Flat
    BackColor = &H80000004&
    BorderStyle = 1 'Fixed Single
    ClientHeight = 5820
    ClientLeft = 2040
    ClientTop = 2610
    ClientWidth = 9585
    BeginProperty Font
        Name = "MS Sans Serif"
        Size = 8.25
        Charset = 0
        Weight = 700
        Underline = 0 'False
        Italic = 0 'False
        Strikethrough = 0 'False
    EndProperty
    ForeColor = &H00000000&
    Icon = "Probform.frx":0000
    MaxButton = 0 'False
    MDIChild = -1 'True
    MinButton = 0 'False
    PaletteMode = 1 'UseZOrder
    ScaleHeight = 5820
    ScaleWidth = 9585
    Tag = "Problem_Data"
    Visible = 0 'False
    Begin VB.Frame Frame2
        Caption = "Pro&bblem Remarks:"
        Height = 1065
        Left = 660
        TabIndex = 26
        Top = 3840
        Width = 8175
        Begin VB.TextBox txtProblem_Remarks
            BackColor = &H80000004&
            ForeColor = &H00000000&
            Height = 600
            Left = 120
            MultiLine = -1 'True
            TabIndex = 6
            Top = 330
            Width = 7920
        End
    End
    Begin VB.Frame Frame5
        BackColor = &H80000004&
        Caption = "Populaton Multiplier"
        Height = 1440
        Left = 630
        TabIndex = 25
        Top = 2070
        Width = 1905
        Begin VB.TextBox txtPopulation_multiplier
            BackColor = &H80000004&
            ForeColor = &H00000000&
            Height = 285
            Left = 630
            TabIndex = 1
            Top = 495
        End
    End
End
```

```

        Width          = 735
    End
End
Begin VB.CommandButton cmdClose
    Appearance      = 0 'Flat
    BackColor       = &H00808000&
    Cancel          = -1 'True
    Caption         = "&Close"
    Height          = 480
    Left            = 2130
    MaskColor       = &H8000000F&
    TabIndex        = 8
    Tag             = "Close"
    Top             = 5250
    Width           = 1728
End
Begin VB.CommandButton cmdPrint
    Appearance      = 0 'Flat
    BackColor       = &H00808000&
    Caption         = "&Print"
    Height          = 480
    Left            = 7665
    MaskColor       = &H8000000F&
    TabIndex        = 11
    Top             = 5235
    Width           = 1728
End
Begin VB.CommandButton cmdSave_As
    Appearance      = 0 'Flat
    BackColor       = &H00FFFFFF&
    Caption         = "Save &As"
    Height          = 480
    Left            = 5820
    MaskColor       = &H8000000F&
    TabIndex        = 10
    Top             = 5250
    Width           = 1728
End
Begin VB.CommandButton cmdSave
    Appearance      = 0 'Flat
    BackColor       = &H00808000&
    Caption         = "&Save"
    Height          = 480
    Left            = 3975
    MaskColor       = &H8000000F&
    TabIndex        = 9
    Top             = 5250
    Width           = 1728
End
Begin VB.CommandButton cmdOpen
    Appearance      = 0 'Flat
    BackColor       = &H00808000&
    Caption         = "P&roblems"
    Height          = 480
    Left            = 285
    MaskColor       = &H8000000F&
    TabIndex        = 7
    Tag             = "Open"
    Top             = 5250
    Width           = 1728
End
Begin VB.Frame fraRadial_Distances
    BackColor       = &H80000004&
    Caption         = "Radial &Distances"
    Height          = 1440
    Left            = 2850

```

```

TabIndex      = 15
Top           = 2070
Width        = 2220
Begin VB.VScrollBar vsbRadius_Number
    Height     = 840
    Left       = 1560
    Max        = 35
    Min        = 1
    TabIndex   = 16
    TabStop    = 0 'False
    Top        = 360
    Value      = 1
    Width      = 225
End
Begin VB.TextBox txtRadial_Distance3
    Alignment   = 1 'Right Justify
    Appearance  = 0 'Flat
    BackColor   = &H80000004&
    BorderStyle = 0 'None
    ForeColor   = &H00000000&
    Height      = 285
    Left        = 465
    MultiLine   = -1 'True
    TabIndex    = 13
    TabStop     = 0 'False
    Top         = 930
    Width       = 990
End
Begin VB.TextBox txtRadial_Distance2
    Alignment   = 1 'Right Justify
    Appearance  = 0 'Flat
    BackColor   = &H80000004&
    BorderStyle = 0 'None
    ForeColor   = &H00000000&
    Height      = 285
    Left        = 465
    MultiLine   = -1 'True
    TabIndex    = 12
    TabStop     = 0 'False
    Top         = 645
    Width       = 990
End
Begin VB.TextBox txtRadial_Distance1
    Alignment   = 1 'Right Justify
    Appearance  = 0 'Flat
    BackColor   = &H80000004&
    BorderStyle = 0 'None
    ForeColor   = &H00000000&
    Height      = 285
    Left        = 480
    MultiLine   = -1 'True
    TabIndex    = 2
    Top         = 360
    Width       = 990
End
Begin VB.Label lblRadius3
    Appearance  = 0 'Flat
    BackColor   = &H80000004&
    Caption     = " 3"
    ForeColor   = &H00000000&
    Height      = 240
    Left        = 240
    TabIndex    = 19
    Top         = 952
    Width       = 210
End

```

```

Begin VB.Label lblRadius2
    Appearance = 0 'Flat
    BackColor = &H80000004&
    Caption = " 2"
    ForeColor = &H00000000&
    Height = 240
    Left = 240
    TabIndex = 18
    Top = 667
    Width = 210
End
Begin VB.Label lblRadius1
    Appearance = 0 'Flat
    AutoSize = -1 'True
    BackColor = &H80000004&
    Caption = " 1"
    ForeColor = &H00000000&
    Height = 195
    Left = 240
    TabIndex = 17
    Top = 360
    Width = 180
End
End
Begin VB.Frame Frame1
    BackColor = &H80000004&
    Caption = "Radial Units"
    Height = 1440
    Left = 5385
    TabIndex = 14
    Top = 2070
    Width = 1320
    Begin VB.OptionButton optKilometers
        Caption = "&KM"
        Height = 240
        Left = 300
        TabIndex = 3
        TabStop = 0 'False
        Top = 465
        Value = -1 'True
        Width = 756
    End
    Begin VB.OptionButton optMiles
        Caption = "&MI"
        Height = 240
        Left = 300
        TabIndex = 4
        Top = 825
        Width = 756
    End
End
End
Begin VB.Frame Frame3
    BackColor = &H80000004&
    Caption = "Site File &Name:"
    Height = 1215
    Left = 675
    TabIndex = 20
    Top = 405
    Width = 8175
    Begin VB.CommandButton cmdBrowse
        Appearance = 0 'Flat
        BackColor = &H00808000&
        Caption = "Browse"
        Height = 480
        Left = 6675
        TabIndex = 0
    End

```

```

        Tag           = "Browse"
        Top           = 600
        Width         = 1245
    End
    Begin VB.TextBox txtSite_File_Name
        Appearance     = 0 'Flat
        BackColor      = &H80000004&
        BorderStyle    = 0 'None
        ForeColor      = &H00000000&
        Height         = 480
        Left           = 105
        Locked         = -1 'True
        MultiLine      = -1 'True
        TabIndex       = 21
        TabStop        = 0 'False
        Top           = 420
        Width          = 6345
    End
End
Begin VB.Frame Frame4
    BackColor      = &H80000004&
    Caption        = "Economic Regions"
    Height         = 1440
    Left           = 7020
    TabIndex       = 22
    Top           = 2070
    Width          = 1815
    Begin VB.CommandButton cmdEdit_regions
        Appearance     = 0 'Flat
        BackColor      = &H00808000&
        Caption        = "&Edit Regions"
        Height         = 480
        Left           = 285
        TabIndex       = 5
        Top           = 840
        Width          = 1245
    End
    Begin VB.Label Label1
        Alignment      = 2 'Center
        AutoSize       = -1 'True
        Caption        = "Number"
        Height         = 195
        Left           = 120
        TabIndex       = 24
        Top           = 360
        Width          = 675
        WordWrap       = -1 'True
    End
    Begin VB.Label lblNumber_of_regions
        Alignment      = 2 'Center
        Appearance     = 0 'Flat
        AutoSize       = -1 'True
        BackColor      = &H80000000&
        Caption        = " "
        ForeColor      = &H00000000&
        Height         = 195
        Left           = 1095
        TabIndex       = 23
        Top           = 360
        Width          = 585
    End
End
End
Attribute VB_Name = "frmProblem_Data"
Attribute VB_GlobalNameSpace = False
Attribute VB_Creatable = False

```

```

Attribute VB_PredeclaredId = True
Attribute VB_Exposed = False
*****
' Form: Problem Data
'
' Project: SECPOP
'
' Description: Create Problem
'
'
' Modification History
' Date      By      Description
'-----
' 20020213  cwm    added header and updated kilometer/mile conversion
'-----
*****

Option Explicit

'This form allows the user to create, edit, and save different problems

Private Sub cmdBrowse_Click()

    'This routine marks the problem form as modified, and if the
    'enter key is pressed, it attempts to open the site file and read in
    'the appropriate site data.

    Dim site_file_name As String

    ' frmMain.mnuSave_ProblemCom.Enabled = True
    ' frmMain.mnuSave_As_ProblemCom.Enabled = True

    If (InStr(frmProblem_Data.caption, " (Modified)") = 0) Then
        frmProblem_Data.caption = frmProblem_Data.caption + " (Modified)"
    End If

    ' If keyascii = KEY_RETURN Then
    '     keyascii = 0
    '     site_file_name = txtSite_File_Name.text
    '     open_site_from_problem (site_file_name)
    ' End If

    'Call the function which allows the user to see which
    'site files are available. For more info, see browse_site_file.

    Call browse_site_file

    frmRosette.blnInputDataChanged = True

End Sub

Private Sub cmdClose_Click()

    'This routine allows the user to close the problem
    'window without saving.

    ' Dim temp As Integer, filenum As Integer
    ' Dim tempstring As String
    '
    ' 'Verify that all of the data entered by the user
    ' 'is valid.
    ' temp = verify_input(1)
    '
    ' 'Remove the problem data form from the screen.
    '
    ' frmProblem_Data.Hide

```



```

Unload Me
End Sub

Private Sub cmdEdit_regions_Click()
    If (number_of_radii < 2) Then
        MsgBox "Error: At least two radii must be specified before regions are edited."
        Exit Sub
    ElseIf (InStr(frmProblem_Data.caption, " (Modified)") = 0) Then
        frmProblem_Data.caption = frmProblem_Data.caption + " (Modified)"
        frmMain.mnuSave_ProblemCom.Enabled = True
        frmMain.mnuSave_As_ProblemCom.Enabled = True
    End If

    If (number_econ_regions = 0) Or (number_econ_regions > max_econ_regions) Or
(number_econ_regions < min_econ_regions) Then
        Call default_regions
    End If

    frmRegion.Show
End Sub

Private Sub cmdOpen_Click()
    'This routine allows the user to open a previously
    'defined problem from the problem form. For more
    'info see the open_problem procedure

    Call open_problem
End Sub

Private Sub cmdPrint_Click()
    'This routine allows the user to print the data in
    'a problem file. For more information
    'see the Print_Problem_File_to_Printer procedure in the Outpcode module.

    Call print_problem
    Call Print_Problem_File_to_Printer
End Sub

Private Sub cmdSave_As_Click()
    'This routine allows the user to save a file by a
    'new name. For more information, see the
    'save_as_problem procedure.

    frmMain.mnuSave_ProblemCom.Enabled = False
    frmMain.mnuSave_As_ProblemCom.Enabled = False

    Call save_as_problem
End Sub

'Private Sub cmdSave_Click()
Public Sub cmdSave_Click()
    'This routine allows the user to save data entered
    'in a problem form. For more information,

```

```

'see the save_problem procedure.

Dim i As Integer
Dim tempstr As String

i = InStr(frmSite_Data.caption, "NEW_PROB")
If i <> 0 Then
    Call cmdSave_As_Click
Else

    'Remove the modified specifier from the file name if necessary.

    i = InStr(frmProblem_Data.caption, " (Modified)")
    If i <> 0 Then
        tempstr = Mid$(frmProblem_Data.caption, 1, i - 1)
    Else
        tempstr = frmProblem_Data.caption
    End If
    frmProblem_Data.caption = tempstr

    i = MsgBox(tempstr & " already exists. Would you like to overwrite this file? " & vbCrLf
& _
                " (If not please select Save As).", vbYesNoCancel)
    If i = vbYes Then

        frmMain.mnuSave_ProblemCom.Enabled = False
        frmMain.mnuSave_As_ProblemCom.Enabled = False

        Call save_problem

    End If
End If
End Sub

Private Sub Form_QueryUnload(Cancel As Integer, UnloadMode As Integer)

    'This routine allows the user to close the problem
    'window without saving.

    Dim temp As Integer, filenum As Integer
    Dim TempString As String

    If UnloadMode <> vbFormMDIForm Then 'vbformmdi form: the mdi parent is closing
        'Verify that all of the data entered by the user
        'is valid.
        temp = verify_input(1)
        If temp <> 1 Then
            frmProblem_Data.Hide
            Cancel = True
        End If
    End If

    frmMain.mnuSave_ProblemCom.Enabled = False
    frmMain.mnuSave_As_ProblemCom.Enabled = False

End Sub

Private Sub Form_Unload(Cancel As Integer)

    'This routine allows the user to close the problem
    'window without saving.

    '
    '
    Dim temp As Integer, filenum As Integer
    Dim TempString As String
    '
    '
    'Verify that all of the data entered by the user

```

```

' is valid.
' temp = verify_input(1)
'
' Remove the problem data form from the screen.
'
' frmProblem_Data.Hide
' Load frmProblem_Data
' frmProblem_Data.Show

End Sub

Private Sub optKilometers_Click()

' This event procedure allows the user to convert miles to kilometers if
' necessary, and it allows the user to specify which unit measures
' should be in.

Dim i As Integer, j As Integer, reply As Integer, TempString As String, tempchar As String

If (InStr(frmProblem_Data.caption, " (Modified)") = 0) Then
    frmProblem_Data.caption = frmProblem_Data.caption + " (Modified)"
End If

' frmMain.mnuSave_ProblemCom.Enabled = True
' frmMain.mnuSave_As_ProblemCom.Enabled = True

' First check to see if there are values for Radial Distances
If txtRadial_Distance1.text = "" Then Exit Sub

' Ask if a conversion is necessary.

If (optKilometers.Tag = "") Then ' tag is not blank when a file is being read in
    reply = MsgBox("Do you wish to convert any existing radial" + Chr$(13) + " distances
from Miles to Kilometers?", vbYesNoCancel + vbDefaultButton2, "Conversion")
    If reply = vbYes Then

        For i = 1 To number_of_radii
            If (radial_distance(i) < 0.125) And (radial_distance(i) <> 0) Then
                MsgBox "Error: unable to convert to kilometers distances of less than .125
miles."
                optMiles.Tag = "DoNotCheck"
                optMiles.Value = True
                optMiles.Tag = ""
                optMiles.SetFocus
                Exit Sub
            ElseIf radial_distance(i) > 6213 Then
                MsgBox "Error: unable to convert to kilometers distances of more than 6213
miles."
                optMiles.Tag = "DoNotCheck"
                optMiles.Value = True
                optMiles.Tag = ""
                optMiles.SetFocus
                Exit Sub
            End If
        Next i

' If conversion is requested, perform the math.

For i = 1 To number_of_radii Step 1

    radial_distance(i) = Round(radial_distance(i) _
        * miles_to_kilometers, 5)

```

```

'''          tempstring = Str$(radial_distance(i) * miles_to_kilometers)
'''          tempchar = "0"
'''
'''
'''          'Examine the converted number, and round it to three digits
'''          'after the decimal point.
'''
'''          For j = 1 To (Len(tempstring) - 3)
'''              If (Mid$(tempstring, j, 1) = ".") Then
'''                  tempchar = Mid$(tempstring, j + 4, 1)
'''                  tempstring = Left$(tempstring, j + 3)
'''              End If
'''          Next j
'''
'''          radial_distance(i) = Val(tempstring)
'''
'''          If (radial_distance(i) >= 9999) Then
'''              radial_distance(i) = 9999
'''          ElseIf (radial_distance(i) <= 0.1) Then
'''              radial_distance(i) = 0.1
'''          End If
'''
'''          If (Val(tempchar) <= 5) Then radial_distance(i) = radial_distance(i) + 0.001
'''
'''      Next i
'''
'''      'Change the radial distances already listed to new unit of
'''      'measure.
'''
'''      frmProblem_Data.txtRadial_Distance1.text = Right$(" " +
Format$(radial_distance(vsbRadius_Number.Value), "0.0000;0.0000; " +
frmProblem_Data.txtRadial_Distance2.text = Right$(" " +
Format$(radial_distance(vsbRadius_Number.Value + 1), "0.0000;0.0000; " +
frmProblem_Data.txtRadial_Distance3.text = Right$(" " +
Format$(radial_distance(vsbRadius_Number.Value + 2), "0.0000;0.0000; " +
'''
'''      ElseIf reply = vbNo Then
'''
'''          For i = 1 To number_of_radii
'''              If (radial_distance(i) < 0.1) Or (radial_distance(i) > 9999) Then
'''                  MsgBox "Error: Radial distance out of bounds"
'''                  optMiles.Tag = "DoNotCheck"
'''                  optMiles.Value = True
'''                  optMiles.Tag = ""
'''                  optMiles.Tag = "Previously_True"
'''                  optMiles.SetFocus
'''                  Exit Sub
'''              End If
'''          Next i
'''
'''      End If
'''
'''      'If necessary, mark which unit is recognized as being the
'''      'previous unit.
'''
'''      If reply <> vbCancel Then
'''
'''          optKilometers.Tag = "Previously_True"
'''          optMiles.Tag = ""
'''
'''          'Mark form as modified.
'''
'''          frmMain.mnuSave_ProblemCom.Enabled = True
'''          frmMain.mnuSave_As_ProblemCom.Enabled = True
'''          If (InStr(frmProblem_Data.caption, " (Modified)") = 0) Then
'''              frmProblem_Data.caption = frmProblem_Data.caption + " (Modified)"

```

```

        End If

    Else

        'if cancel, then don't change anything on form.

        optMiles.Tag = "Previously_True"
        optMiles.Value = True
        optMiles.Tag = ""
        optMiles.SetFocus
    '

    End If

End If

'''
For i = 1 To number_of_radrii
'''
    If (radial_distance(i) < 0.125) And (radial_distance(i) <> 0) Then
'''
        MsgBox "Error: unable to convert to kilometers distances of less than .125 miles."
'''
        Exit Sub
'''
    ElseIf radial_distance(i) > 6213 Then
'''
        MsgBox "Error: unable to convert to kilometers distances of more than 6213 miles."
'''
        Exit Sub
'''
    End If
'''
Next i

'''
If frmProblem_Data.optKilometers.Tag <> "Previously_True" Then
'''
    For i = 1 To number_of_radrii Step 1
'''
        radial_distance(i) = Round(radial_distance(i) _
'''
            * miles_to_kilometers, 5)
'''
'''
        If (radial_distance(i) >= 9999) Then
'''
            radial_distance(i) = 9999
'''
        ElseIf (radial_distance(i) <= 0.1) Then
'''
            radial_distance(i) = 0.1
'''
        End If
'''
    Next i

'''
    'Change the radial distances already listed to new unit of
'''
    'measure.
'''
'''
    frmProblem_Data.txtRadial_Distance1.text = Right$(" " +
Format$(radial_distance(vsbRadius_Number.Value), "0.0000;0.0000; " ), 9)
'''
    frmProblem_Data.txtRadial_Distance2.text = Right$(" " +
Format$(radial_distance(vsbRadius_Number.Value + 1), "0.0000;0.0000; " ), 9)
'''
    frmProblem_Data.txtRadial_Distance3.text = Right$(" " +
Format$(radial_distance(vsbRadius_Number.Value + 2), "0.0000;0.0000; " ), 9)
'''
'''
    End If
'''
'''
    frmProblem_Data.optKilometers.Tag = "Previously_True"
'''
    frmProblem_Data.optMiles.Tag = ""
'''

frmRosette.blnInputDataChanged = True

End Sub

Private Sub optMiles_Click()

    'This event procedure allows the user to convert miles to kilometers if
    'necessary, and it allows the user to specify which unit measures
    'should be in.

    ' Dim i As Integer

```

```

'   Dim j As Integer

Dim i As Integer, j As Integer, reply As Integer, TempString As String, tempchar As String

If (InStr(frmProblem_Data.caption, " (Modified)") = 0) Then
    frmProblem_Data.caption = frmProblem_Data.caption + " (Modified)"
End If

'   frmMain.mnuSave_ProblemCom.Enabled = True
'   frmMain.mnuSave_As_ProblemCom.Enabled = True

'First check to see if there are values for Radial Distances

If txtRadial_Distance1.text = "" Then Exit Sub

'Allow the user to convert kilometers to miles or enter data in miles.

'If user has changed units then proceed.

If (optMiles.Tag = "") Then ' tag is not blank when a file is being read in
    reply = MsgBox("Do you wish to convert any existing radial" + Chr$(13) + " distances
from Kilometers to Miles?", vbYesNoCancel + vbDefaultButton2, "Conversion")

    'If user wishes to convert numbers to new units, then proceed.

    If reply = vbYes Then

        For i = 1 To number_of_radii
            If (radial_distance(i) <= 0.2) And (radial_distance(i) <> 0) Then
                kilometers."
                MsgBox "Error: unable to convert to miles distances of less than .2
                optKilometers.Tag = "DoNotCheck"
                optKilometers.Value = True
                optKilometers.Tag = ""
                optKilometers.SetFocus
                Exit Sub
            ElseIf radial_distance(i) > 9999 Then
                kilometers."
                MsgBox "Error: unable to convert to miles distances of more than 9999
                optKilometers.Tag = "DoNotCheck"
                optKilometers.Value = True
                optKilometers.Tag = ""
                optKilometers.SetFocus
                Exit Sub
            End If
        Next i

        For i = 1 To number_of_radii Step 1

            radial_distance(i) = Round(radial_distance(i) _
                / miles_to_kilometers, 5)

'''
            tempchar = "0"
            tempstring = Str$(radial_distance(i) * kilometers_to_miles)
            'Analyze converted number and round it to three decimal
            'places.
            For j = 1 To (Len(tempstring) - 3)
                If (Mid$(tempstring, j, 1) = ".") Then
                    tempchar = Mid$(tempstring, j + 4, 1)
                    tempstring = Left$(tempstring, j + 3)
                End If
            End If

```

```

'''
'''         Next j
'''
'''         radial_distance(i) = Val(tempstring)

'''         If (radial_distance(i) >= 6212.999) Then
'''             radial_distance(i) = 6213
'''         ElseIf (radial_distance(i) <= 0.07) Then
'''             radial_distance(i) = 0.07
'''         End If

'''         If Val(tempchar) > 4 Then radial_distance(i) = radial_distance(i) + 0.001

'''     Next i

'''     'Write new radial distances to problem form.

'''     frmProblem_Data.txtRadial_Distance1.text = Right$(" " +
Format$(radial_distance(vsbRadius_Number.Value), "0.0000;0.0000; " + " ), 9)
'''     frmProblem_Data.txtRadial_Distance2.text = Right$(" " +
Format$(radial_distance(vsbRadius_Number.Value + 1), "0.0000;0.0000; " + " ), 9)
'''     frmProblem_Data.txtRadial_Distance3.text = Right$(" " +
Format$(radial_distance(vsbRadius_Number.Value + 2), "0.0000;0.0000; " + " ), 9)

'''     ElseIf reply = vbNo Then

'''         For i = 1 To number_of_radial
'''             If (radial_distance(i) < 0.07) Or (radial_distance(i) > 6213) Then
'''                 MsgBox "Error: Radial distance out of bounds"
'''                 optKilometers.Tag = "DoNotCheck"
'''                 optKilometers.Value = True
'''                 optKilometers.Tag = ""
'''                 optKilometers.Tag = "Previously_True"
'''                 optKilometers.SetFocus
'''                 Exit Sub
'''             End If
'''         Next i

'''     End If

'''     'If user has not canceled, update which unit was previously used.

'''     If reply <> vbCancel Then
'''         optMiles.Tag = "Previously_True"
'''         optKilometers.Tag = ""

'''         'Mark form as modified.

'''         frmMain.mnuSave_ProblemCom.Enabled = True
'''         frmMain.mnuSave_As_ProblemCom.Enabled = True
'''         If (InStr(frmProblem_Data.caption, " (Modified)") = 0) Then
'''             frmProblem_Data.caption = frmProblem_Data.caption + " (Modified)"
'''         End If
'''     Else

'''         'If cancel is selected, leave values as they were.

'''         optKilometers.Tag = "DoNotCheck"
'''         optKilometers.Value = True
'''         optKilometers.Tag = ""
'''         optKilometers.SetFocus

'''     End If

''' End If

''' 'Current_Units is a public string variable

```

```

'''
'''
For i = 1 To number_of_radii
'''
If (radial_distance(i) < 0.1) And (radial_distance(i) <> 0) Then
'''
MsgBox "Error: unable to convert to miles distances of less than .1 kilometers."
'''
Exit Sub
'''
ElseIf radial_distance(i) > 9999 Then
'''
MsgBox "Error: unable to convert to miles distances of more than 9999 kilometers."
'''
Exit Sub
'''
End If
'''
Next i
'''
'''
'''
If frmProblem_Data.optMiles.Tag <> "Previously_True" Then
'''
For i = 1 To number_of_radii Step 1
'''
radial_distance(i) = Round(radial_distance(i) _
'''
/ miles_to_kilometers, 5)
'''
'''
If (radial_distance(i) > 6213) Then
'''
radial_distance(i) = 6213
'''
ElseIf (radial_distance(i) < 0.125) Then
'''
radial_distance(i) = 0.125
'''
End If
'''
Next i
'''
'''
'Change the radial distances already listed to new unit of
'''
'measure.
'''
'''
frmProblem_Data.txtRadial_Distance1.text = Right$(" " +
Format$(radial_distance(vsbRadius_Number.Value), "0.0000;0.0000; " ), 9)
'''
frmProblem_Data.txtRadial_Distance2.text = Right$(" " +
Format$(radial_distance(vsbRadius_Number.Value + 1), "0.0000;0.0000; " ), 9)
'''
frmProblem_Data.txtRadial_Distance3.text = Right$(" " +
Format$(radial_distance(vsbRadius_Number.Value + 2), "0.0000;0.0000; " ), 9)
'''
End If
'''
'''
frmProblem_Data.optMiles.Tag = "Previously_True"
'''
frmProblem_Data.optKilometers.Tag = ""

frmRosette.blnInputDataChanged = True

End Sub

'Private Sub optMiles_GotFocus()
'
' Allow the user to convert kilometers to miles or enter data in miles.
'
' Dim i As Integer
' Dim j As Integer
'
' If user has changed units then proceed.
'
' If (optMiles.Tag <> "Previously_True") Then
' reply = MsgBox("Do you wish to convert any existing radial" + Chr$(13) + " distances
from Kilometers to Miles?", vbYesNoCancel + vbDefaultButton2, "Conversion")
'
' If user wishes to convert numbers to new units, then proceed.
'
' If reply = vbYes Then
'
' For i = 1 To number_of_radii
' If (radial_distance(i) <= 0.2) And (radial_distance(i) <> 0) Then
kilometers."
' MsgBox "Error: unable to convert to miles distances of less than .2
'
' optKilometers.Value = True
' optKilometers.SetFocus
'
'
'
'

```



```

'
'           Exit Sub
ElseIf radial_distance(i) > 9999 Then
    MsgBox "Error: unable to convert to miles distances of more than 9999
kilometers."
    optKilometers.Value = True
    optKilometers.SetFocus
    Exit Sub
End If
Next i

For i = 1 To number_of_radri Step 1
    tempchar = "0"
    TempString = Str$(radial_distance(i) * kilometers_to_miles)

    'Analyze converted number and round it to three decimal
    'places.

    For j = 1 To (Len(TempString) - 3)
        If (Mid$(TempString, j, 1) = ".") Then
            tempchar = Mid$(TempString, j + 4, 1)
            TempString = Left$(TempString, j + 3)
        End If
    Next j

    radial_distance(i) = Val(TempString)

    If (radial_distance(i) >= 6212.999) Then
        radial_distance(i) = 6213
    ElseIf (radial_distance(i) <= 0.07) Then
        radial_distance(i) = 0.07
    End If

    If Val(tempchar) > 4 Then radial_distance(i) = radial_distance(i) + 0.001
Next i

'Write new radial distances to problem form.

    frmProblem_Data.txtRadial_Distance1.text = Right$(" " +
Format$(radial_distance(vsbRadius_Number.Value), "0.0000;0.0000; " ), 9)
    frmProblem_Data.txtRadial_Distance2.text = Right$(" " +
Format$(radial_distance(vsbRadius_Number.Value + 1), "0.0000;0.0000; " ), 9)
    frmProblem_Data.txtRadial_Distance3.text = Right$(" " +
Format$(radial_distance(vsbRadius_Number.Value + 2), "0.0000;0.0000; " ), 9)

ElseIf reply = vbNo Then
    For i = 1 To number_of_radri
        If (radial_distance(i) < 0.07) Or (radial_distance(i) > 6213) Then
            MsgBox "Error: Radial distance out of bounds"
            optKilometers.Value = True
            optKilometers.Tag = "Previously_True"
            optKilometers.SetFocus
            Exit Sub
        End If
    Next i
End If

'If user has not cancelled, update which unit was previously used.

If reply <> vbCancel Then
    optMiles.Tag = "Previously_True"
    optKilometers.Tag = ""

    'Mark form as modified.

    frmMain.mnuSave_ProblemCom.Enabled = True
    frmMain.mnuSave_As_ProblemCom.Enabled = True

```

```

'         If (InStr(frmProblem_Data.caption, " (Modified)") = 0) Then
'             frmProblem_Data.caption = frmProblem_Data.caption + " (Modified)"
'         End If
'     Else
'
'         'If cancel is selected, leav values as they were.
'
'         optKilometers.Value = True
'         optKilometers.SetFocus
'
'     End If
' End If
'End Sub

Private Sub txtPopulation_multiplier_KeyPress(keyascii As Integer)

' This routine marks a problem form as modified if keys are pressed in
' the population multiplier field.

'     frmMain.mnuSave_ProblemCom.Enabled = True
'     frmMain.mnuSave_As_ProblemCom.Enabled = True

'     If (InStr(frmProblem_Data.caption, " (Modified)") = 0) Then
'         frmProblem_Data.caption = frmProblem_Data.caption + " (Modified)"
'     End If

'     frmRosette.blnInputDataChanged = True

End Sub

Private Sub txtPopulation_multiplier_Validate(Cancel As Boolean)

' If Val(txtPopulation_multiplier.text) > 100 Then
'     MsgBox "Please enter a value for Population Multiplier that is less " & _
'         "than or equal to 100"
'     txtPopulation_multiplier.text = ""
'     Cancel = True
' End If

End Sub

Private Sub txtProblem_Remarks_KeyPress(keyascii As Integer)

' This routine marks a problem as modified if keys are pressed, and
' deals with the enter key being pressed.

' If enter key is pressed, display message.

' If keyascii = KEY_RETURN Then

'     'Erase keystroke.

'     keyascii = 0
'     MsgBox "Sorry, no hard returns allowed." + Chr$(13) + "Words will wrap automatically.",
vbOK, "Error"

'     'Mark problem form as modified.

' Else

'     frmMain.mnuSave_ProblemCom.Enabled = True
'     frmMain.mnuSave_As_ProblemCom.Enabled = True

```

```

        If (InStr(frmProblem_Data.caption, " (Modified)") = 0) Then
            frmProblem_Data.caption = frmProblem_Data.caption + " (Modified)"
        End If
    End If
End Sub

Private Sub txtProblem_Title_KeyPress(keyascii As Integer)
    'This routine marks the problem form as modified if a key is pressed
    'within the title field.  It also deals with the user pressing enter.

    'If the user presses the enter key, display warning message.
    If keyascii = KEY_RETURN Then
        'Erase keystroke.
        keyascii = 0
        MsgBox "Sorry, no hard returns allowed." + Chr$(13) + "Words will wrap automatically.",
vbOK, "Error"
    Else
        'Mark problem form as modified.
        frmMain.mnuSave_ProblemCom.Enabled = True
        frmMain.mnuSave_As_ProblemCom.Enabled = True

        If (InStr(frmProblem_Data.caption, " (Modified)") = 0) Then
            frmProblem_Data.caption = frmProblem_Data.caption + " (Modified)"
        End If
    End If
End Sub

Private Sub txtRadial_Distance1_KeyDown(KeyCode As Integer, Shift As Integer)
    'This routine allows the user to scroll up and down on the list of
    'radial distances.

    'If up arrow on keyboard has been pressed then scroll up one entry.
    If KeyCode = vbKeyUp Then
        If vsbRadius_Number.Value > 1 Then
            Call txtRadial_Distance1_LostFocus
            vsbRadius_Number.Value = vsbRadius_Number.Value - 1
        Else
            Call txtRadial_Distance1_LostFocus
        End If
    'If down arrow has been pressed, scroll down one position.
    ElseIf KeyCode = vbKeyDown Then
        txtRadial_Distance2.SetFocus
    End If

    If (InStr(frmProblem_Data.caption, " (Modified)") = 0) Then
        frmProblem_Data.caption = frmProblem_Data.caption + " (Modified)"
    End If

```

```

' frmMain.mnuSave_ProblemCom.Enabled = True
' frmMain.mnuSave_As_ProblemCom.Enabled = True

frmRosette.blnInputDataChanged = True

End Sub

Private Sub txtRadial_Distance1_KeyPress(keyascii As Integer)

' This routine marks the problem form as modified if a key is pressed
' in the distance1 field.

' frmMain.mnuSave_ProblemCom.Enabled = True
' frmMain.mnuSave_As_ProblemCom.Enabled = True

If (InStr(frmProblem_Data.caption, " (Modified)") = 0) Then
    frmProblem_Data.caption = frmProblem_Data.caption + " (Modified)"
End If

If keyascii = KEY_RETURN Then
    txtRadial_Distance2.SetFocus
End If

End Sub

Private Sub txtRadial_Distance1_LostFocus()

' This routine sorts the entries in the radial distance list so that they
' appear in ascending order, and updates the list

Dim temp As Double, units As Integer
Dim zero_found As Integer, radius_zero As Integer
Dim radius_edited As Integer, i As Integer, j As Integer
Dim tempchar As String, TempString As String

' Record the value of the newly edited radius into the radial
' distance array.

radius_edited = Val(lblRadius1.caption)
radial_distance(radius_edited) = Val(txtRadial_Distance1.text)

' Examine the Rradius, and round it to three digits after the decimal.

TempString = Str$(radial_distance(radius_edited))
For j = 1 To (Len(TempString) - 3)
    If (Mid$(TempString, j, 1) = ".") Then
        tempchar = Mid$(TempString, j + 4, 1)
        TempString = Left$(TempString, j + 3)
    End If
Next j
radial_distance(radius_edited) = Val(TempString)

' Check to see if the radius is within acceptable limits for maccs
' compatibility.

If (radial_distance(radius_edited) = 0) Then
    radius_zero = True
ElseIf TypeOf Screen.ActiveControl Is OptionButton Then
ElseIf (optMiles.Value = True) Then
    If (radial_distance(radius_edited) > 6213) Then
        MsgBox "Error: this program can't process radii greater than 6213 Miles."
        radial_distance(radius_edited) = 0
        txtRadial_Distance1.text = ""
        radius_zero = True
    ElseIf (radial_distance(radius_edited) < 0.0699) Then

```

```

        MsgBox "Error: this program can't process radii smaller than .07 Miles."
        radial_distance(radius_edited) = 0
        txtRadial_Distance1.text = ""
        radius_zero = True
    End If
Else
    If (radial_distance(radius_edited) > 9999) Then
        MsgBox "Error: this program can't process radii greater than 9999 Kilometers."
        radial_distance(radius_edited) = 0
        txtRadial_Distance1.text = ""
        radius_zero = True
    ElseIf (radial_distance(radius_edited) < 0.099) Then
        MsgBox "Error: this program can't process radii smaller than .1 Kilometers."
        radial_distance(radius_edited) = 0
        txtRadial_Distance1.text = ""
        radius_zero = True
    End If
End If

'If radius is not equal to zero, check to see if it is equal to
'any previous radial distance. If it is, set it equal to zero.

If Not radius_zero Then
    For i = 1 To radius_edited - 1 Step 1
        If radial_distance(radius_edited) = radial_distance(i) Then
            radial_distance(radius_edited) = 0
            radius_zero = True
            Exit For
        End If
    Next i
End If

'If distance is still not equal to zero, check to see if it is equal
'to any following radial distance. If it is, set it equal to zero.

If Not radius_zero Then
    For i = radius_edited + 1 To max_number_of_radii Step 1
        If radial_distance(radius_edited) = radial_distance(i) Then
            radial_distance(i) = 0
            radius_zero = True
            Exit For
        End If
    Next i
End If

'Use standard sorting algorithm to put radii in ascending order.

For i = 1 To max_number_of_radii - 1 Step 1
    For j = i + 1 To max_number_of_radii Step 1
        If (radial_distance(j) <> 0) Then
            If ((radial_distance(i) > radial_distance(j)) Or (radial_distance(i) = 0)) Then
                temp = radial_distance(i)
                radial_distance(i) = radial_distance(j)
                radial_distance(j) = temp
                If (Not radius_zero) Then
                    If i = radius_edited Then
                        radius_edited = j
                    ElseIf j = radius_edited Then
                        radius_edited = i
                    End If
                End If
            End If
        End If
    Next j
Next i

```

```

'Determine where list of radii ends.

For i = 1 To max_number_of_radii Step 1
    If radial_distance(i) = 0 Then
        Exit For
    End If
Next i

'Determine number of radii.

number_of_radii = i - 1

If radius_edited > max_number_of_radii - 2 Then
    radius_edited = max_number_of_radii - 2
End If

'Update user display (problem form).

lblRadius1.caption = Right$(Str$(radius_edited), 2)
txtRadial_Distance1.text = Right$(" " + Format$(radial_distance(radius_edited),
"0.0000;0.0000; " ), 9)
lblRadius2.caption = Right$(Str$(radius_edited + 1), 2)
txtRadial_Distance2.text = Right$(" " + Format$(radial_distance(radius_edited + 1),
"0.0000;0.0000; " ), 9)
lblRadius3.caption = Right$(Str$(radius_edited + 2), 2)
txtRadial_Distance3.text = Right$(" " + Format$(radial_distance(radius_edited + 2),
"0.0000;0.0000; " ), 9)

vsbRadius_Number.Value = radius_edited

If (Val(frmProblem_Data.lblNumber_of_regions.Tag) <> number_of_radii) Then
    Call default_regions
End If

End Sub

Private Sub txtRadial_Distance2_KeyDown(KeyCode As Integer, Shift As Integer)

'If an arrow key is pressed, then call the distance 1 function
'to scroll radial distances up or down.

If KeyCode = vbKeyUp Then
    txtRadial_Distance1.SetFocus
ElseIf KeyCode = vbKeyDown Then
    txtRadial_Distance3.SetFocus
End If

If (InStr(frmProblem_Data.caption, " (Modified)") = 0) Then
    frmProblem_Data.caption = frmProblem_Data.caption + " (Modified)"
End If

'    frmMain.mnuSave_ProblemCom.Enabled = True
'    frmMain.mnuSave_As_ProblemCom.Enabled = True

frmRosette.blnInputDataChanged = True

End Sub

Private Sub txtRadial_Distance2_KeyPress(keyascii As Integer)

'This routine marks the problem form as modified, and goes to the next
'radii if enter is pressed.

'    frmMain.mnuSave_ProblemCom.Enabled = True
'    frmMain.mnuSave_As_ProblemCom.Enabled = True

```

```

If (InStr(frmProblem_Data.caption, " (Modified)") = 0) Then
    frmProblem_Data.caption = frmProblem_Data.caption + " (Modified)"
End If

If keyascii = KEY_RETURN Then
    keyascii = 0
    txtRadial_Distance3.SetFocus
End If

End Sub

Private Sub txtRadial_Distance2_LostFocus()

    'See radial_Distance1_lostfocus for documentation of this routine.

    Dim temp As Double
    Dim zero_found As Integer, radius_zero As Integer
    Dim radius_edited As Integer, i As Integer, j As Integer
    Dim TempString As String, tempchar As String

    radius_edited = Val(lblRadius2.caption)
    radial_distance(radius_edited) = Val(txtRadial_Distance2.text)

    TempString = Str$(radial_distance(radius_edited))
    For j = 1 To (Len(TempString) - 3)
        If (Mid$(TempString, j, 1) = ".") Then
            tempchar = Mid$(TempString, j + 4, 1)
            TempString = Left$(TempString, j + 3)
        End If
    Next j
    radial_distance(radius_edited) = Val(TempString)

    If (radial_distance(radius_edited) = 0) Then
        radius_zero = True
    ElseIf TypeOf Screen.ActiveControl Is OptionButton Then
    ElseIf (optMiles.Value = True) Then
        If (radial_distance(radius_edited) > 6213) Then
            MsgBox "Error: this program can't process radii greater than 6213 Miles."
            radial_distance(radius_edited) = 0
            txtRadial_Distance2.text = ""
            radius_zero = True
        ElseIf (radial_distance(radius_edited) < 0.0695) Then
            MsgBox "Error: this program can't process radii smaller than .07 Miles."
            radial_distance(radius_edited) = 0
            radius_zero = True
        End If
    Else
        If (radial_distance(radius_edited) > 9999) Then
            MsgBox "Error: this program can't process radii greater than 9999 Kilometers."
            radial_distance(radius_edited) = 0
            txtRadial_Distance2.text = ""
            radius_zero = True
        ElseIf (radial_distance(radius_edited) < 0.099) Then
            MsgBox "Error: this program can't process radii smaller than .1 Kilometers."
            radial_distance(radius_edited) = 0
            txtRadial_Distance2.text = ""
            radius_zero = True
        End If
    End If

    If Not radius_zero Then
        For i = 1 To radius_edited - 1 Step 1
            If radial_distance(radius_edited) = radial_distance(i) Then
                radial_distance(radius_edited) = 0
                radius_zero = True
            Exit For
        End For
    End If

```

```

        End If
    Next i
End If

If Not radius_zero Then
    For i = radius_edited + 1 To max_number_of_radii Step 1
        If radial_distance(radius_edited) = radial_distance(i) Then
            radial_distance(radius_edited) = 0
            radius_zero = True
            Exit For
        End If
    Next i
End If

For i = 1 To max_number_of_radii - 1 Step 1
    For j = i + 1 To max_number_of_radii Step 1
        If (radial_distance(j) <> 0) Then
            If ((radial_distance(i) > radial_distance(j)) Or (radial_distance(i) = 0)) Then
                temp = radial_distance(i)
                radial_distance(i) = radial_distance(j)
                radial_distance(j) = temp
                If (Not radius_zero) Then
                    If i = radius_edited Then
                        radius_edited = j
                    ElseIf j = radius_edited Then
                        radius_edited = i
                    End If
                End If
            End If
        End If
    Next j
Next i

i = 1
zero_found = False

While ((Not zero_found) And (i <= max_number_of_radii))
    If radial_distance(i) = 0 Then
        zero_found = True
    Else
        i = i + 1
    End If
Wend

number_of_radii = i - 1

If radius_edited > max_number_of_radii - 1 Then
    radius_edited = max_number_of_radii - 1
ElseIf radius_edited < 2 Then
    radius_edited = 2
End If

lblRadius1.caption = Right$(Str$(radius_edited - 1), 2)
txtRadial_Distance1.text = Right$(" " + Format$(radial_distance(radius_edited - 1),
"0.0000;0.0000; " ), 9)
lblRadius2.caption = Right$(Str$(radius_edited), 2)
txtRadial_Distance2.text = Right$(" " + Format$(radial_distance(radius_edited),
"0.0000;0.0000; " ), 9)
lblRadius3.caption = Right$(Str$(radius_edited + 1), 2)
txtRadial_Distance3.text = Right$(" " + Format$(radial_distance(radius_edited + 1),
"0.0000;0.0000; " ), 9)

vsbRadius_Number.Value = radius_edited - 1

If (Val(frmProblem_Data.lblNumber_of_regions.Tag) <> number_of_radii) Then
    Call default_regions

```



```

'sss      Call paint_region(0, 0)
End If

End Sub

Private Sub txtRadial_Distance3_KeyDown(KeyCode As Integer, Shift As Integer)

    'See txtRadial_distance1_keydown for documentation of this routine.

    If KeyCode = vbKeyUp Then
        txtRadial_Distance2.SetFocus
    ElseIf KeyCode = vbKeyDown Then
        If vsbRadius_Number.Value < max_number_of_radii - 2 Then
            Call txtRadial_Distance3_LostFocus
            vsbRadius_Number.Value = vsbRadius_Number.Value + 1
        Else
            Call txtRadial_Distance3_LostFocus
        End If
    End If

    If (InStr(frmProblem_Data.caption, " (Modified)") = 0) Then
        frmProblem_Data.caption = frmProblem_Data.caption + " (Modified)"
    End If

    '    frmMain.mnuSave_ProblemCom.Enabled = True
    '    frmMain.mnuSave_As_ProblemCom.Enabled = True

    frmRosette.blnInputDataChanged = True

End Sub

Private Sub txtRadial_Distance3_KeyPress(keyascii As Integer)

    'See frmtxtRadial_distance1_keypress for documentation of this function.

    '    frmMain.mnuSave_ProblemCom.Enabled = True
    '    frmMain.mnuSave_As_ProblemCom.Enabled = True

    If (InStr(frmProblem_Data.caption, " (Modified)") = 0) Then
        frmProblem_Data.caption = frmProblem_Data.caption + " (Modified)"
    End If

    If keyascii = KEY_RETURN Then
        Call txtRadial_Distance3_LostFocus
        If vsbRadius_Number.Value < max_number_of_radii - 2 Then
            vsbRadius_Number.Value = vsbRadius_Number.Value + 1
        End If
    End If

End Sub

Private Sub txtRadial_Distance3_LostFocus()

    'See txtRadial_distance1_lostfocus for documentation of this function.

    Dim temp As Double
    Dim zero_found As Integer, radius_zero As Integer
    Dim radius_edited As Integer, i As Integer, j As Integer
    Dim TempString As String, tempchar As String

    radius_edited = Val(lblRadius3.caption)
    radial_distance(radius_edited) = Val(txtRadial_Distance3.text)

    TempString = Str$(radial_distance(radius_edited))
    For j = 1 To (Len(TempString) - 3)

```

```

    If (Mid$(TempString, j, 1) = ".") Then
        tempchar = Mid$(TempString, j + 4, 1)
        TempString = Left$(TempString, j + 3)
    End If
Next j
radial_distance(radius_edited) = Val(TempString)

If (radial_distance(radius_edited) = 0) Then
    radius_zero = True
ElseIf TypeOf Screen.ActiveControl Is OptionButton Then
ElseIf (optMiles.Value = True) Then
    If (radial_distance(radius_edited) > 6213) Then
        MsgBox "Error: this program can't process radii greater than 6213 Miles."
        radial_distance(radius_edited) = 0
        radius_zero = True
    ElseIf (radial_distance(radius_edited) < 0.0695) Then
        MsgBox "Error: this program can't process radii smaller than .07 Miles."
        radial_distance(radius_edited) = 0
        radius_zero = True
    End If
Else
    If (radial_distance(radius_edited) > 9999) Then
        MsgBox "Error: this program can't process radii greater than 9999 Kilometers."
        radial_distance(radius_edited) = 0
        radius_zero = True
    ElseIf (radial_distance(radius_edited) < 0.099) Then
        MsgBox "Error: this program can't process radii smaller than .1 Kilometers."
        radial_distance(radius_edited) = 0
        radius_zero = True
    End If
End If

If Not radius_zero Then
    For i = 1 To radius_edited - 1 Step 1
        If radial_distance(radius_edited) = radial_distance(i) Then
            radial_distance(radius_edited) = 0
            radius_zero = True
            Exit For
        End If
    Next i
End If

If Not radius_zero Then
    For i = radius_edited + 1 To max_number_of_radii Step 1
        If radial_distance(radius_edited) = radial_distance(i) Then
            radial_distance(radius_edited) = 0
            radius_zero = True
            Exit For
        End If
    Next i
End If

For i = 1 To max_number_of_radii - 1 Step 1
    For j = i + 1 To max_number_of_radii Step 1
        If (radial_distance(j) <> 0) Then
            If ((radial_distance(i) > radial_distance(j)) Or (radial_distance(i) = 0)) Then
                temp = radial_distance(i)
                radial_distance(i) = radial_distance(j)
                radial_distance(j) = temp
                If (Not radius_zero) Then
                    If i = radius_edited Then
                        radius_edited = j
                    ElseIf j = radius_edited Then
                        radius_edited = i
                    End If
                End If
            End If
        End If
    Next j
Next i

```

```

        End If
    End If
Next j
Next i

i = 1
zero_found = False

While ((Not zero_found) And (i <= max_number_of_radii))
    If radial_distance(i) = 0 Then
        zero_found = True
    Else
        i = i + 1
    End If
Wend

number_of_radii = i - 1

If radius_edited < 3 Then
    radius_edited = 3
End If

If number_of_radii <= max_number_of_radii Then
    lblRadius1.caption = Right$(Str$(radius_edited - 2), 2)
    txtRadial_Distance1.text = Right$(" " + Format$(radial_distance(radius_edited - 2),
"0.0000;0.0000; " ), 9)
    lblRadius2.caption = Right$(Str$(radius_edited - 1), 2)
    txtRadial_Distance2.text = Right$(" " + Format$(radial_distance(radius_edited - 1),
"0.0000;0.0000; " ), 9)
    lblRadius3.caption = Right$(Str$(radius_edited), 2)
    txtRadial_Distance3.text = Right$(" " + Format$(radial_distance(radius_edited),
"0.0000;0.0000; " ), 9)

    vsbRadius_Number.Value = radius_edited - 2
Else
    lblRadius1.caption = Right$(Str$(radius_edited - 3), 2)
    txtRadial_Distance1.text = Right$(" " + Format$(radial_distance(radius_edited - 3),
"0.0000;0.0000; " ), 9)
    lblRadius2.caption = Right$(Str$(radius_edited - 2), 2)
    txtRadial_Distance2.text = Right$(" " + Format$(radial_distance(radius_edited - 2),
"0.0000;0.0000; " ), 9)
    lblRadius3.caption = Right$(Str$(radius_edited - 1), 2)
    txtRadial_Distance3.text = Right$(" " + Format$(radial_distance(radius_edited - 1),
"0.0000;0.0000; " ), 9)

    vsbRadius_Number.Value = radius_edited - 3
End If

If (Val(frmProblem_Data.lblNumber_of_regions.Tag) <> number_of_radii) Then
    Call default_regions
'sss    Call paint_region(0, 0)
End If

End Sub

'Private Sub txtSite_File_Name_Change()
'
'    'This routine marks the problem form as modified, and if the
'    'enter key is pressed, it attempts to open the site file and read in
'    'the appropriate site data.
'
'    Dim site_file_name As String
'
'    frmMain.mnuSave_ProblemCom.Enabled = True
'    frmMain.mnuSave_As_ProblemCom.Enabled = True
'    cmdSave.Enabled = True

```

```

' cmdSave_As.Enabled = True
'
' If (InStr(frmProblem_Data.caption, " (Modified)") = 0) Then
'     frmProblem_Data.caption = frmProblem_Data.caption + " (Modified)"
' End If
'
' If keyascii = KEY_RETURN Then
'     keyascii = 0
'     site_file_name = txtSite_File_Name.text
'     open_site_from_problem (site_file_name)
' End If
'End Sub

Private Sub txtSite_File_Name_KeyPress(keyascii As Integer)
'
' This routine marks the problem form as modified, and if the
' enter key is pressed, it attempts to open the site file and read in
' the appropriate site data.
'
' Dim site_file_name As String
'
' frmMain.mnuSave_ProblemCom.Enabled = True
' frmMain.mnuSave_As_ProblemCom.Enabled = True
' cmdSave.Enabled = True
' cmdSave_As.Enabled = True
'
' If (InStr(frmProblem_Data.caption, " (Modified)") = 0) Then
'     frmProblem_Data.caption = frmProblem_Data.caption + " (Modified)"
' End If
'
' If keyascii = KEY_RETURN Then
'     keyascii = 0
'     site_file_name = txtSite_File_Name.text
'     open_site_from_problem (site_file_name)
' End If
'End Sub

Private Sub txtSite_File_Name_LostFocus()
' Check and see if the site file name is correct, and if it is read
' in the site data.
'
' Dim site_file_name As String
'
' If frmProblem_Data.Visible Then
'     If (Screen.ActiveControl.Tag <> "Browse") And _
'         (Screen.ActiveControl.Tag <> "Hiding Form") And _
'         (Screen.ActiveControl.Tag <> "Open") And _
'         (Screen.ActiveControl.Tag <> "Close") Then
'         site_file_name = txtSite_File_Name.text
'         open_site_from_problem (site_file_name)
'     End If
'     If Screen.ActiveControl.Tag = "Hiding Form" Then
'         Screen.ActiveControl.Tag = ""
'     End If
' End If
'End Sub

Private Sub vsbRadius_Number_Change()
' This function updates the problem form when a user has changed it.
' It simply puts the correct values for radii back in the correct places.

```

```

'It is called whenever the scroll bar on the radii box is moved.

Dim radius_number(3) As String
Dim i As Integer

If (vsbRadius_Number.Value <= max_number_of_radii - 2) Then
    radius_number(1) = Right$(Str$(vsbRadius_Number.Value), 2)
    radius_number(2) = Right$(Str$(vsbRadius_Number.Value + 1), 2)
    radius_number(3) = Right$(Str$(vsbRadius_Number.Value + 2), 2)

    lblRadius1.caption = radius_number(1)
    txtRadial_Distance1.text = Right$(" " +
Format$(radial_distance(vsbRadius_Number.Value), "0.0000;0.0000;    "), 9)

    lblRadius2.caption = radius_number(2)
    txtRadial_Distance2.text = Right$(" " + Format$(radial_distance(vsbRadius_Number.Value
+ 1), "0.0000;0.0000;    "), 9)

    lblRadius3.caption = radius_number(3)
    txtRadial_Distance3.text = Right$(" " + Format$(radial_distance(vsbRadius_Number.Value
+ 2), "0.0000;0.0000;    "), 9)
End If

End Sub

```

H.29 Visual Basic Form Module: Region.frm

```
VERSION 5.00
Object = "{0D623638-DBA2-11D1-B5DF-0060976089D0}#7.0#0"; "tdbg7.ocx"
Begin VB.Form frmRegion
    Appearance = 0 'Flat
    AutoRedraw = -1 'True
    BackColor = &H80000004&
    BorderStyle = 1 'Fixed Single
    Caption = "Region"
    ClientHeight = 5820
    ClientLeft = 45
    ClientTop = 330
    ClientWidth = 9810
    BeginProperty Font
        Name = "MS Sans Serif"
        Size = 8.25
        Charset = 0
        Weight = 700
        Underline = 0 'False
        Italic = 0 'False
        Strikethrough = 0 'False
    EndProperty
    ForeColor = &H00000000&
    Icon = "Region.frx":0000
    MaxButton = 0 'False
    MDIChild = -1 'True
    MinButton = 0 'False
    PaletteMode = 1 'UseZOrder
    ScaleHeight = 5820
    ScaleWidth = 9810
    Begin TrueDBGrid70.TDBGrid TDBGrid1
        Height = 4110
        Left = 165
        TabIndex = 10
        Top = 930
        Width = 8280
        _ExtentX = 14605
        _ExtentY = 7250
        _LayoutType = 0
        _RowHeight = -2147483647
        _WasPersistedAsPixels = 0
        Columns(0)._VlistStyle = 0
        Columns(0)._MaxComboItems = 5
        Columns(0).DataField = ""
        Columns(0)._PropDict = "_MaxComboItems,516,2;_VlistStyle,514,3"
        Columns(1)._VlistStyle = 0
        Columns(1)._MaxComboItems = 5
        Columns(1).DataField = ""
        Columns(1)._PropDict = "_MaxComboItems,516,2;_VlistStyle,514,3"
        Columns.Count = 2
        Splits(0)._UserFlags = 0
        Splits(0).RecordSelectorWidth = 503
        Splits(0).DividerColor = 13160660
        Splits(0).SpringMode = 0 'False
        Splits(0)._PropDict = "_ColumnProps,515,0;_UserFlags,518,3"
        Splits(0)._ColumnProps(0) = "Columns.Count=2"
        Splits(0)._ColumnProps(1) = "Column(0).Width=3281"
        Splits(0)._ColumnProps(2) = "Column(0).DividerColor=0"
        Splits(0)._ColumnProps(3) = "Column(0)._WidthInPix=3175"
        Splits(0)._ColumnProps(4) = "Column(0).Order=1"
        Splits(0)._ColumnProps(5) = "Column(1).Width=3281"
        Splits(0)._ColumnProps(6) = "Column(1).DividerColor=0"
    End
End
```

```

Splits(0)._ColumnProps(7)= "Column(1)._WidthInPix=3175"
Splits(0)._ColumnProps(8)= "Column(1).Order=2"
Splits.Count = 1
PrintInfos(0)._StateFlags= 3
PrintInfos(0).Name= "piInternal 0"
PrintInfos(0).PageHeaderFont=
"Size=8.25,Charset=0,Weight=700,Underline=0,Italic=0,Strikethrough=0,Name=MS Sans Serif"
PrintInfos(0).PageFooterFont=
"Size=8.25,Charset=0,Weight=700,Underline=0,Italic=0,Strikethrough=0,Name=MS Sans Serif"
PrintInfos(0).PageHeaderHeight= 0
PrintInfos(0).PageFooterHeight= 0
PrintInfos.Count= 1
DataMode = 2
DefColWidth = 0
HeadLines = 1
FootLines = 1
MultipleLines = 0
CellTipsWidth = 0
DeadAreaBackColor= 13160660
RowDividerColor = 13160660
RowSubDividerColor= 13160660
DirectionAfterEnter= 1
MaxRows = 250000
_PropDict =
"_ExtentX,2003,3;_ExtentY,2004,3;_LayoutType,512,2;_RowHeight,16,3;_StyleDefs,513,0;_WasPersisted
AsPixels,516,2"
_StyleDefs(0) = "_StyleRoot:id=0,.parent=-"
1,.alignment=3,.valignment=0,.bgcolor=&H80000005&"
_StyleDefs(1) = ":id=0,.fgcolor=&H80000008&,.wraptext=0,.locked=0,.transparentBmp=0"
_StyleDefs(2) =
":id=0,.fgpicPosition=0,.bgpicMode=0,.appearance=0,.borderSize=0,.ellipsis=0"
_StyleDefs(3) = ":id=0,.borderColor=&H80000005&,.borderType=0,.bold=-"
1,.fontSize=825,.italic=0"
_StyleDefs(4) = ":id=0,.underline=0,.striketrough=0,.charset=0"
_StyleDefs(5) = ":id=0,.fontname=MS Sans Serif"
_StyleDefs(6) = "Style:id=1,.parent=0,.namedParent=33,.bold=-1,.fontSize=825,.italic=0"
_StyleDefs(7) = ":id=1,.underline=0,.striketrough=0,.charset=0"
_StyleDefs(8) = ":id=1,.fontname=MS Sans Serif"
_StyleDefs(9) = "CaptionStyle:id=4,.parent=2,.namedParent=37"
_StyleDefs(10) = "HeadingStyle:id=2,.parent=1,.namedParent=34,.bold=-"
1,.fontSize=825,.italic=0"
_StyleDefs(11) = ":id=2,.underline=0,.striketrough=0,.charset=0"
_StyleDefs(12) = ":id=2,.fontname=MS Sans Serif"
_StyleDefs(13) = "FooterStyle:id=3,.parent=1,.namedParent=35,.bold=-"
1,.fontSize=825,.italic=0"
_StyleDefs(14) = ":id=3,.underline=0,.striketrough=0,.charset=0"
_StyleDefs(15) = ":id=3,.fontname=MS Sans Serif"
_StyleDefs(16) =
"InactiveStyle:id=5,.parent=2,.bgcolor=&H8000000F&,.fgcolor=&H80000012&"
_StyleDefs(17) = "SelectedStyle:id=6,.parent=1,.namedParent=36"
_StyleDefs(18) = "EditorStyle:id=7,.parent=1"
_StyleDefs(19) = "HighlightRowStyle:id=8,.parent=1,.namedParent=38"
_StyleDefs(20) = "EvenRowStyle:id=9,.parent=1,.namedParent=39"
_StyleDefs(21) = "OddRowStyle:id=10,.parent=1,.namedParent=40"
_StyleDefs(22) = "RecordSelectorStyle:id=11,.parent=2,.namedParent=41"
_StyleDefs(23) = "FilterBarStyle:id=12,.parent=1,.namedParent=42"
_StyleDefs(24) = "Splits(0).Style:id=13,.parent=1"
_StyleDefs(25) = "Splits(0).CaptionStyle:id=22,.parent=4"
_StyleDefs(26) = "Splits(0).HeadingStyle:id=14,.parent=2"
_StyleDefs(27) = "Splits(0).FooterStyle:id=15,.parent=3"
_StyleDefs(28) = "Splits(0).InactiveStyle:id=16,.parent=5"
_StyleDefs(29) = "Splits(0).SelectedStyle:id=18,.parent=6"
_StyleDefs(30) = "Splits(0).EditorStyle:id=17,.parent=7"
_StyleDefs(31) = "Splits(0).HighlightRowStyle:id=19,.parent=8"
_StyleDefs(32) = "Splits(0).EvenRowStyle:id=20,.parent=9"
_StyleDefs(33) = "Splits(0).OddRowStyle:id=21,.parent=10"

```

```

_StyleDefs(34) = "Splits(0).RecordSelectorStyle:id=23,.parent=11"
_StyleDefs(35) = "Splits(0).FilterBarStyle:id=24,.parent=12"
_StyleDefs(36) = "Splits(0).Columns(0).Style:id=28,.parent=13"
_StyleDefs(37) = "Splits(0).Columns(0).HeadingStyle:id=25,.parent=14"
_StyleDefs(38) = "Splits(0).Columns(0).FooterStyle:id=26,.parent=15"
_StyleDefs(39) = "Splits(0).Columns(0).EditorStyle:id=27,.parent=17"
_StyleDefs(40) = "Splits(0).Columns(1).Style:id=32,.parent=13"
_StyleDefs(41) = "Splits(0).Columns(1).HeadingStyle:id=29,.parent=14"
_StyleDefs(42) = "Splits(0).Columns(1).FooterStyle:id=30,.parent=15"
_StyleDefs(43) = "Splits(0).Columns(1).EditorStyle:id=31,.parent=17"
_StyleDefs(44) = "Named:id=33:Normal"
_StyleDefs(45) = ":id=33,.parent=0"
_StyleDefs(46) = "Named:id=34:Heading"
_StyleDefs(47) =
":id=34,.parent=33,.valignment=2,.bgcolor=&H8000000F&,.fgcolor=&H80000012&"
_StyleDefs(48) = ":id=34,.wraptext=-1"
_StyleDefs(49) = "Named:id=35:Footing"
_StyleDefs(50) =
":id=35,.parent=33,.valignment=2,.bgcolor=&H8000000F&,.fgcolor=&H80000012&"
_StyleDefs(51) = "Named:id=36:Selected"
_StyleDefs(52) = ":id=36,.parent=33,.bgcolor=&H8000000D&,.fgcolor=&H8000000E&"
_StyleDefs(53) = "Named:id=37:Caption"
_StyleDefs(54) = ":id=37,.parent=34,.alignment=2"
_StyleDefs(55) = "Named:id=38:HighlightRow"
_StyleDefs(56) = ":id=38,.parent=33,.bgcolor=&H8000000D&,.fgcolor=&H8000000E&"
_StyleDefs(57) = "Named:id=39:EvenRow"
_StyleDefs(58) = ":id=39,.parent=33,.bgcolor=&HFFFF00&"
_StyleDefs(59) = "Named:id=40:OddRow"
_StyleDefs(60) = ":id=40,.parent=33"
_StyleDefs(61) = "Named:id=41:RecordSelector"
_StyleDefs(62) = ":id=41,.parent=34"
_StyleDefs(63) = "Named:id=42:FilterBar"
_StyleDefs(64) = ":id=42,.parent=33"
End
Begin VB.Frame Frame1
    Appearance = 0 'Flat
    BackColor = &H80000004&
    Caption = "Regions"
    ForeColor = &H00000000&
    Height = 720
    Left = 8550
    TabIndex = 6
    Top = 990
    Width = 1188
    Begin VB.Label lblnum_regions
        Alignment = 1 'Right Justify
        Appearance = 0 'Flat
        BackColor = &H80000004&
        Caption = "99"
        ForeColor = &H00000000&
        Height = 240
        Left = 405
        TabIndex = 7
        Top = 315
        Width = 330
    End
End
Begin VB.CommandButton cmdSort
    Appearance = 0 'Flat
    BackColor = &H00808000&
    Caption = "&Sort"
    Height = 480
    Left = 7665
    TabIndex = 0
    Top = 5250
    Width = 1728

```



```

End
Begin VB.CommandButton cmdDefault
    Appearance = 0 'Flat
    BackColor = &H00808000&
    Caption = "De&fault"
    Height = 480
    Left = 5820
    TabIndex = 1
    Top = 5250
    Width = 1728
End
Begin VB.CommandButton cmdClear
    Appearance = 0 'Flat
    BackColor = &H00808000&
    Caption = "Clea&r"
    Height = 480
    Left = 3975
    TabIndex = 2
    Top = 5250
    Width = 1728
End
Begin VB.CommandButton cmdClose
    Appearance = 0 'Flat
    BackColor = &H00808000&
    Caption = "&Close"
    Height = 480
    Left = 2130
    TabIndex = 3
    Top = 5250
    Width = 1728
End
Begin VB.Frame Frame2
    Appearance = 0 'Flat
    BackColor = &H80000004&
    Caption = "Radii"
    ForeColor = &H00000000&
    Height = 720
    Left = 8550
    TabIndex = 8
    Top = 1815
    Width = 1188
    Begin VB.Label lblnum_radii
        Alignment = 1 'Right Justify
        Appearance = 0 'Flat
        BackColor = &H80000004&
        Caption = "50"
        ForeColor = &H00000000&
        Height = 240
        Left = 405
        TabIndex = 9
        Top = 285
        Width = 330
    End
End
Begin VB.Label lblRadial_Distances
    Alignment = 1 'Right Justify
    Appearance = 0 'Flat
    AutoSize = -1 'True
    BackColor = &H80000004&
    Caption = "Radial Distances in "
    BeginProperty Font
        Name = "MS Sans Serif"
        Size = 12
        Charset = 0
        Weight = 700
        Underline = 0 'False
    EndProperty

```

```

        Italic           = 0   'False
        Strikethrough    = 0   'False
    EndProperty
    ForeColor           = &H00000000&
    Height              = 300
    Left                = 2895
    TabIndex            = 4
    Top                 = 405
    Width               = 2415
End
Begin VB.Label lblUnits
    Appearance          = 0   'Flat
    AutoSize            = -1  'True
    BackColor           = &H80000004&
    Caption             = "Miles"
    BeginProperty Font
        Name             = "MS Sans Serif"
        Size              = 12
        Charset           = 0
        Weight            = 700
        Underline         = 0   'False
        Italic            = 0   'False
        Strikethrough     = 0   'False
    EndProperty
    ForeColor           = &H00000000&
    Height              = 300
    Left                = 5310
    TabIndex            = 5
    Top                 = 405
    Width               = 750
End
End
Attribute VB_Name = "frmRegion"
Attribute VB_GlobalNameSpace = False
Attribute VB_Creatable = False
Attribute VB_PredeclaredId = True
Attribute VB_Exposed = False
'*****
' Form: frmRegion
'
' Project: SECPOP
'
' Description: This form allows the user to display and edit region data.
'
'
' Modification History
' Date      By      Description
' -----
' 20020118  ss      Changed the display of the region data from being drawn on
'                  the form using textboxes, to being loaded into a data grid.
'*****

Option Explicit

Dim MaxRow As Integer
Dim MaxCol As Integer
Dim i As Integer
Dim j As Integer
Dim k As Integer
Dim GridArray() As String
Dim Sink As New GridClass

Private Sub cmdClear_Click()

    Dim i As Integer, j As Integer

```

```

number_econ_regions = 0
frmProblem_Data.lblNumber_of_regions.caption = 0
lblnum_regions = ""

For i = 2 To MaxCol - 1
    For j = 0 To MaxRow - 1
        GridArray(i, j) = " "
        Sink.Value(j, i) = "0"
        region_index(i, j) = 0
    Next j
Next i
TDBGrid1.Refresh

End Sub

Private Sub cmdClose_Click()

    Unload Me

    For i = 1 To MaxCol - 1
        For j = 0 To MaxRow - 1
            If GridArray(i, j) <> " " Then
                region_index(i, j) = CInt(GridArray(i, j))
                region_index(i, j) = CInt(Sink.Value(j, i))
            End If
        Next j
    Next i

    Call cmdSort_Click
    If frmRegion.cmdSort.Tag = "F" Then
        Exit Sub
    Else
        Unload frmRegion
    End If

End Sub

Private Sub cmdDefault_Click()

    Call default_regions

    For i = 1 To MaxCol - 1
        For j = 0 To MaxRow - 1
            GridArray(i, j) = Str(region_index(i, j))
            Sink.Value(j, i) = Str(region_index(i, j))
        Next j
    Next i
    TDBGrid1.Refresh
    lblnum_regions = number_econ_regions

End Sub

Private Sub cmdSort_Click()

    'Renumber the economic regions so that all numbers are contiguous

    Dim i As Integer, j As Integer, m As Integer, n As Integer
    Dim current_region As Integer, start_number_of_sectors As Integer
    Dim previous_value As Integer

    For i = 0 To number_of_segments - 1
        For j = 1 To number_of_radial
            If (region_index(j, i) <= 0) Then

```

```

        MsgBox "Error: Every sector must be part of a region"
        frmRegion.cmdSort.Tag = "F"
        Exit Sub
    End If
Next j
Next i
frmRegion.cmdSort.Tag = "Y"

current_region = 2

For i = 0 To number_of_segments - 1
    For j = 2 To number_of_radII
        If (region_index(j, i) >= current_region) Then
            previous_value = region_index(j, i)
            For m = i To number_of_segments - 1
                For n = 2 To number_of_radII
                    If (region_index(n, m) = previous_value) Then
                        region_index(n, m) = current_region
                    ElseIf (region_index(n, m) = current_region) Then
                        region_index(n, m) = 100 + current_region
                    End If
                Next n
            Next m
            current_region = current_region + 1
        End If
    Next j
Next i

number_econ_regions = current_region - 1
frmProblem_Data.lblNumber_of_regions.caption = Str$(number_econ_regions)
lblnum_regions = number_econ_regions

For i = 1 To MaxCol - 1
    For j = 0 To MaxRow - 1
        GridArray(i, j) = Str(region_index(i, j))
        Sink.Value(j, i) = Str(region_index(i, j))
    Next j
Next i

'   TDBGrid1.Update
'   TDBGrid1.DataChanged
'   TDBGrid1.EmptyRows
'   TDBGrid1.Refresh

End Sub

Private Sub Form_Load()

    Dim row As Long, col As Integer
    Dim C As TrueDBGrid70.Column
    Dim Cols As TrueDBGrid70.Columns

    ' set form's position

    Dim FormsTop As Integer
    Dim FormsLeft As Integer
    FormsTop = 50
    FormsLeft = 50
    Me.Top = FormsTop
    Me.Left = FormsLeft

    lblnum_regions = number_econ_regions
    lblnum_radII = number_of_radII

```

```

'maxcol = UBound(region_index, 1) ' 35
MaxCol = number_of_radial + 1
MaxRow = UBound(region_index, 2) ' 16
col = number_of_radial + 1
row = UBound(region_index, 2) ' 16

Screen.MousePointer = vbHourglass

' Initialize storage
Sink.SetDims row, col

' fill one grid (gridarray) with both directions and data
'
'   ReDim GridArray(0 To MaxCol - 1, 0 To MaxRow)
'
'   For i = 0 To MaxRow - 1
'       GridArray(0, i) = directions(i)
'   Next i
'   For i = 0 To MaxRow - 1
'       Sink.Value(i, 0) = directions(i)
'   Next i

'   For i = 1 To MaxCol - 1
'       For j = 0 To MaxRow - 1
'           Sink.Value(j, i) = Str(region_index(i, j))
'           GridArray(i, j) = Str(region_index(i, j))
'       Next j
'   Next i

' Make sure no events are fired for the grid yet
Sink.Attach Nothing

Set Cols = TDBGrid1.Columns

' Remove all columns
While Cols.Count
    Cols.Remove 0
Wend
TDBGrid1.ReBind

' Add columns to the grid
For col = 0 To Sink.ColCount - 1
    Set C = Cols.Add(col)
    C.Visible = True
    C.Width = 1000
    If col = 0 Then
        C.caption = "Sectors"
    Else
        C.caption = Str(radial_distance(col))
    End If
End For
Next col

'set various parameters of the grid

TDBGrid1.Columns(0).DividerStyle = 8 ' double line dividing col 0 and col 1

TDBGrid1.Columns(0).Locked = True
TDBGrid1.Columns(1).Locked = True

'
TDBGrid1.ApproxCount = MaxRow

TDBGrid1.Columns(0).BackColor = &HC0C0C0
TDBGrid1.Columns(1).ForeColor = &H808080

TDBGrid1.RecordSelectors = False

```

```

'Initialize current cell position to upper left corner:
TDBGrid1.row = 0
TDBGrid1.col = 0

'set splits

Dim s As TrueDBGrid70.Split
Set s = TDBGrid1.Splits.Add(0)

Set Cols = TDBGrid1.Splits(0).Columns ' sector column
For i = 1 To MaxCol - 1
    Cols(i).Visible = False
Next i

Set Cols = TDBGrid1.Splits(1).Columns ' data columns
Cols(0).Visible = False
' Cols(MaxCol - 1).Visible = False

TDBGrid1.Splits(0).Size = 1
TDBGrid1.Splits(1).Size = MaxCol - 1

' Initialise the class
Sink.Attach TDBGrid1

' Reinitialize the grid
TDBGrid1.Bookmark = Null
TDBGrid1.ReBind

' Calibrate the VScroll bar
TDBGrid1.ApproxCount = Sink.RowCount
' TDBGrid1.SetFocus
Screen.MousePointer = vbDefault

End Sub

Private Sub Form_Unload(Cancel As Integer)

    For i = 1 To MaxCol - 1
        For j = 0 To MaxRow - 1
            ' If GridArray(i, j) <> " " Then
            '     region_index(i, j) = CInt(GridArray(i, j))
            '     region_index(i, j) = CInt(Sink.Value(j, i))
            ' End If
        Next j
    Next i

    Call cmdSort_Click
    If frmRegion.cmdSort.Tag = "F" Then
        Exit Sub
    Else
        Unload frmRegion
    End If

    Set Sink = Nothing

    ' frmMain.mnuSave_ProblemCom.Enabled = True
    ' frmMain.mnuSave_As_ProblemCom.Enabled = True
    ' frmProblem_Data.cmdSave.Enabled = True
    ' frmProblem_Data.cmdSave_As.Enabled = True
    '

End Sub

Private Sub TDBGrid1_BeforeColUpdate(ByVal ColIndex As Integer, _
    OldValue As Variant, _

```

```

Cancel As Integer)

' check for valid input
If TDBGrid1.text <> "" Then
    If Cint(TDBGrid1.text) < 2 Or _
        Cint(TDBGrid1.text) > 99 Then
        ' schedule the PostEvent event
        TDBGrid1.PostMsg 1
        Cancel = True
    End If
Else
    ' schedule the PostEvent event
    TDBGrid1.PostMsg 1
    Cancel = True
End If

End Sub

Private Sub TDBGrid1_KeyPress(keyascii As Integer)

' If (KeyAscii >= 48 And KeyAscii <= 57) Or KeyAscii = 8 Then ' 0-9 or backspace
If (keyascii >= 48 And keyascii <= 57) Or _
    keyascii = vbKeyBack Then ' 0-9 or backspace
    'continue
Else
    MsgBox "Values must be between 2 and 99. "
    keyascii = 0
    Beep
End If

End Sub

Private Sub TDBGrid1_LostFocus()

    TDBGrid1.Update '(forces update of underlying database)
    For i = 1 To MaxCol - 1
        For j = 0 To MaxRow - 1
            region_index(i, j) = Cint(Sink.Value(j, i))
            region_index(i, j) = Cint(GridArray(i, j))
        Next j
    Next i

End Sub

Private Sub TDBGrid1_PostEvent(ByVal MsgId As Integer)

    If MsgId = 1 Then MsgBox "Values must be between 2 and 99. " & _
        "This cell will revert back to it's original value."

End Sub

```

H.30 Visual Basic Form Module: Rosette_frm1.frm

```
VERSION 5.00
Object = "{0D623638-DBA2-11D1-B5DF-0060976089D0}#7.0#0"; "tdbg7.ocx"
Begin VB.Form frmRosette
    Appearance = 0 'Flat
    AutoRedraw = -1 'True
    BackColor = &H80000005&
    BorderStyle = 1 'Fixed Single
    Caption = " Rosette"
    ClientHeight = 6960
    ClientLeft = 7020
    ClientTop = 2430
    ClientWidth = 11670
    BeginProperty Font
        Name = "Arial Narrow"
        Size = 9
        Charset = 0
        Weight = 400
        Underline = 0 'False
        Italic = 0 'False
        Strikethrough = 0 'False
    EndProperty
    FontTransparent = 0 'False
    Icon = "Rosette_frm1.frx":0000
    LinkTopic = "Form1"
    MaxButton = 0 'False
    MDIChild = -1 'True
    MinButton = 0 'False
    ScaleHeight = 348
    ScaleMode = 2 'Point
    ScaleWidth = 583.5
    Begin VB.PictureBox pctCapture
        AutoSize = -1 'True
        Height = 510
        Left = 1845
        ScaleHeight = 450
        ScaleWidth = 435
        TabIndex = 45
        TabStop = 0 'False
        Top = 5820
        Visible = 0 'False
        Width = 495
    End
    Begin VB.CommandButton cmdSave
        Cancel = -1 'True
        Caption = "Save to File"
        Default = -1 'True
        BeginProperty Font
            Name = "Arial"
            Size = 11.25
            Charset = 0
            Weight = 700
            Underline = 0 'False
            Italic = 0 'False
            Strikethrough = 0 'False
        EndProperty
        Height = 540
        Left = 90
        Style = 1 'Graphical
        TabIndex = 2
        ToolTipText = "Saves this form in bitmap form."
        Top = 6300
    End
End
```



```

        Width          = 1650
    End
Begin VB.CommandButton cmdPrint
    Caption           = "Print"
    BeginProperty Font
        Name           = "Arial"
        Size           = 11.25
        Charset        = 0
        Weight         = 700
        Underline      = 0 'False
        Italic         = 0 'False
        Strikethrough  = 0 'False
    EndProperty
    Height           = 540
    Left             = 90
    Style            = 1 'Graphical
    TabIndex         = 1
    ToolTipText      = "Sends this form to a printer."
    Top              = 5670
    Width           = 1650
End
Begin TrueDBGGrid70.TDBGrid TDBGrid1
    Height           = 5130
    Left            = 90
    TabIndex        = 44
    TabStop         = 0 'False
    Top             = 405
    Width           = 1680
    _ExtentX        = 2963
    _ExtentY        = 9049
    _LayoutType     = 0
    _RowHeight      = -2147483647
    _WasPersistedAsPixels= 0
    Columns(0)._VlistStyle= 0
    Columns(0)._MaxComboItems= 5
    Columns(0).DataField= ""
    Columns(0)._PropDict= "_MaxComboItems,516,2;_VlistStyle,514,3"
    Columns(1)._VlistStyle= 0
    Columns(1)._MaxComboItems= 5
    Columns(1).DataField= ""
    Columns(1)._PropDict= "_MaxComboItems,516,2;_VlistStyle,514,3"
    Columns.Count   = 2
    Splits(0)._UserFlags= 0
    Splits(0).RecordSelectorWidth= 503
    Splits(0).DividerColor= 12632256
    Splits(0).SpringMode= 0 'False
    Splits(0)._PropDict= "_ColumnProps,515,0;_UserFlags,518,3"
    Splits(0)._ColumnProps(0)= "Columns.Count=2"
    Splits(0)._ColumnProps(1)= "Column(0).Width=2196"
    Splits(0)._ColumnProps(2)= "Column(0).DividerColor=0"
    Splits(0)._ColumnProps(3)= "Column(0)._WidthInPix=2117"
    Splits(0)._ColumnProps(4)= "Column(0).Order=1"
    Splits(0)._ColumnProps(5)= "Column(1).Width=2196"
    Splits(0)._ColumnProps(6)= "Column(1).DividerColor=0"
    Splits(0)._ColumnProps(7)= "Column(1)._WidthInPix=2117"
    Splits(0)._ColumnProps(8)= "Column(1).Order=2"
    Splits.Count    = 1
    PrintInfos(0)._StateFlags= 3
    PrintInfos(0).Name= "piInternal 0"
    PrintInfos(0).PageHeaderFont=
    PrintInfos(0).PageFooterFont=
    "Size=9,Charset=0,Weight=400,Underline=0,Italic=0,Strikethrough=0,Name=Arial Narrow"
    PrintInfos(0).PageHeaderHeight= 0
    PrintInfos(0).PageFooterHeight= 0
    PrintInfos.Count= 1

```

```

DataMode = 2
DefColWidth = 0
HeadLines = 1
FootLines = 1
MultipleLines = 0
CellTipsWidth = 0
DeadAreaBackColor= 16777215
RowDividerColor = 12632256
RowSubDividerColor= 12632256
DirectionAfterEnter= 1
MaxRows = 250000
_PropDict =
"_ExtentX,2003,3;_ExtentY,2004,3;_LayoutType,512,2;_RowHeight,16,3;_StyleDefs,513,0;_WasPersisted
AsPixels,516,2"
_StyleDefs(0) = "_StyleRoot:id=0,.parent=-
1,.alignment=3,.valignment=0,.bgcolor=&H80000005&"
_StyleDefs(1) = ":id=0,.fgcolor=&H80000008&,.wraptext=0,.locked=0,.transparentBmp=0"
_StyleDefs(2) =
":id=0,.fgpicPosition=0,.bgpicMode=0,.appearance=0,.borderSize=0,.ellipsis=0"
_StyleDefs(3) =
":id=0,.borderColor=&H80000005&,.borderType=0,.bold=0,.fontSize=900,.italic=0"
_StyleDefs(4) = ":id=0,.underline=0,.strikethrough=0,.charset=0"
_StyleDefs(5) = ":id=0,.fontName=Arial Narrow"
_StyleDefs(6) = "Style:id=1,.parent=0,.namedParent=33,.bold=0,.fontSize=900,.italic=0"
_StyleDefs(7) = ":id=1,.underline=0,.strikethrough=0,.charset=0"
_StyleDefs(8) = ":id=1,.fontName=Arial Narrow"
_StyleDefs(9) = "CaptionStyle:id=4,.parent=2,.namedParent=37"
_StyleDefs(10) =
"HeadingStyle:id=2,.parent=1,.namedParent=34,.bold=0,.fontSize=900,.italic=0"
_StyleDefs(11) = ":id=2,.underline=0,.strikethrough=0,.charset=0"
_StyleDefs(12) = ":id=2,.fontName=Arial Narrow"
_StyleDefs(13) =
"FooterStyle:id=3,.parent=1,.namedParent=35,.bold=0,.fontSize=900,.italic=0"
_StyleDefs(14) = ":id=3,.underline=0,.strikethrough=0,.charset=0"
_StyleDefs(15) = ":id=3,.fontName=Arial Narrow"
_StyleDefs(16) =
"InactiveStyle:id=5,.parent=2,.bgcolor=&H8000000F&,.fgcolor=&H80000012&"
_StyleDefs(17) = "SelectedStyle:id=6,.parent=1,.namedParent=36"
_StyleDefs(18) = "EditorStyle:id=7,.parent=1"
_StyleDefs(19) = "HighlightRowStyle:id=8,.parent=1,.namedParent=38"
_StyleDefs(20) = "EvenRowStyle:id=9,.parent=1,.namedParent=39"
_StyleDefs(21) = "OddRowStyle:id=10,.parent=1,.namedParent=40"
_StyleDefs(22) = "RecordSelectorStyle:id=11,.parent=2,.namedParent=41"
_StyleDefs(23) = "FilterBarStyle:id=12,.parent=1,.namedParent=42"
_StyleDefs(24) = "Splits(0).Style:id=13,.parent=1"
_StyleDefs(25) = "Splits(0).CaptionStyle:id=22,.parent=4"
_StyleDefs(26) = "Splits(0).HeadingStyle:id=14,.parent=2"
_StyleDefs(27) = "Splits(0).FooterStyle:id=15,.parent=3"
_StyleDefs(28) = "Splits(0).InactiveStyle:id=16,.parent=5"
_StyleDefs(29) = "Splits(0).SelectedStyle:id=18,.parent=6"
_StyleDefs(30) = "Splits(0).EditorStyle:id=17,.parent=7"
_StyleDefs(31) = "Splits(0).HighlightRowStyle:id=19,.parent=8"
_StyleDefs(32) = "Splits(0).EvenRowStyle:id=20,.parent=9"
_StyleDefs(33) = "Splits(0).OddRowStyle:id=21,.parent=10"
_StyleDefs(34) = "Splits(0).RecordSelectorStyle:id=23,.parent=11"
_StyleDefs(35) = "Splits(0).FilterBarStyle:id=24,.parent=12"
_StyleDefs(36) = "Splits(0).Columns(0).Style:id=28,.parent=13"
_StyleDefs(37) = "Splits(0).Columns(0).HeadingStyle:id=25,.parent=14"
_StyleDefs(38) = "Splits(0).Columns(0).FooterStyle:id=26,.parent=15"
_StyleDefs(39) = "Splits(0).Columns(0).EditorStyle:id=27,.parent=17"
_StyleDefs(40) = "Splits(0).Columns(1).Style:id=32,.parent=13"
_StyleDefs(41) = "Splits(0).Columns(1).HeadingStyle:id=29,.parent=14"
_StyleDefs(42) = "Splits(0).Columns(1).FooterStyle:id=30,.parent=15"
_StyleDefs(43) = "Splits(0).Columns(1).EditorStyle:id=31,.parent=17"
_StyleDefs(44) = "Named:id=33:Normal"
_StyleDefs(45) = ":id=33,.parent=0"

```

```

        _StyleDefs(46) = "Named:id=34:Heading"
        _StyleDefs(47) =
":id=34,.parent=33,.valignment=2,.bgcolor=&H8000000F&,.fgcolor=&H80000012&"
        _StyleDefs(48) = ":id=34,.wraptext=-1"
        _StyleDefs(49) = "Named:id=35:Footing"
        _StyleDefs(50) =
":id=35,.parent=33,.valignment=2,.bgcolor=&H8000000F&,.fgcolor=&H80000012&"
        _StyleDefs(51) = "Named:id=36:Selected"
        _StyleDefs(52) = ":id=36,.parent=33,.bgcolor=&H8000000D&,.fgcolor=&H8000000E&"
        _StyleDefs(53) = "Named:id=37:Caption"
        _StyleDefs(54) = ":id=37,.parent=34,.alignment=2"
        _StyleDefs(55) = "Named:id=38:HighlightRow"
        _StyleDefs(56) = ":id=38,.parent=33,.bgcolor=&H8000000D&,.fgcolor=&H8000000E&"
        _StyleDefs(57) = "Named:id=39:EvenRow"
        _StyleDefs(58) = ":id=39,.parent=33,.bgcolor=&HFFFF00&"
        _StyleDefs(59) = "Named:id=40:OddRow"
        _StyleDefs(60) = ":id=40,.parent=33"
        _StyleDefs(61) = "Named:id=41:RecordSelector"
        _StyleDefs(62) = ":id=41,.parent=34"
        _StyleDefs(63) = "Named:id=42:FilterBar"
        _StyleDefs(64) = ":id=42,.parent=33"
End
Begin VB.ListBox List1
    Appearance = 0 'Flat
    BeginProperty DataFormat
        Type = 1
        Format = "#,##0.00"
        HaveTrueFalseNull= 0
        FirstDayOfWeek = 0
        FirstWeekOfYear = 0
        LCID = 1033
        SubFormatType = 1
    EndProperty
    Height = 270
    Index = 1
    IntegralHeight = 0 'False
    Left = 840
    TabIndex = 34
    TabStop = 0 'False
    Top = 585
    Width = 735
End
Begin VB.ListBox List1
    Appearance = 0 'Flat
    CausesValidation= 0 'False
    Height = 270
    Index = 0
    IntegralHeight = 0 'False
    ItemData = "Rosette_frm1.frx":0CCA
    Left = 120
    List = "Rosette_frm1.frx":0CCC
    TabIndex = 33
    TabStop = 0 'False
    Top = 585
    Width = 735
End
Begin VB.CommandButton CancelButton
    Caption = "Close"
    BeginProperty Font
        Name = "Arial"
        Size = 11.25
        Charset = 0
        Weight = 700
        Underline = 0 'False
        Italic = 0 'False
        Strikethrough = 0 'False
    EndProperty

```

```

EndProperty
Height      = 540
Left       = 9900
Style     = 1 'Graphical
TabIndex  = 0
Top       = 6300
Width     = 1650
End
Begin VB.PictureBox Picture1
AutoRedraw = -1 'True
AutoSize   = -1 'True
BackColor  = &H8000000E&
BorderStyle = 0 'None
BeginProperty Font
Name       = "MS Sans Serif"
Size      = 8.25
Charset   = 0
Weight    = 400
Underline = 0 'False
Italic    = 0 'False
Strikethrough = 0 'False
EndProperty
ForeColor  = &H80000007&
Height    = 6525
Left      = 2025
ScaleHeight = 435
ScaleMode = 3 'Pixel
ScaleWidth  = 457
TabIndex   = 3
TabStop    = 0 'False
Top       = 405
Width     = 6855
Begin VB.Label Direction
Alignment  = 2 'Center
AutoSize   = -1 'True
BackColor  = &H8000000E&
BackStyle  = 0 'Transparent
Caption    = "NE"
BeginProperty Font
Name       = "MS Sans Serif"
Size      = 12
Charset   = 0
Weight    = 700
Underline = 0 'False
Italic    = 0 'False
Strikethrough = 0 'False
EndProperty
Height    = 300
Index     = 2
Left      = 5445
TabIndex  = 41
Top       = 1080
Width     = 405
End
Begin VB.Label Direction
Alignment  = 2 'Center
AutoSize   = -1 'True
BackColor  = &H8000000E&
BackStyle  = 0 'Transparent
Caption    = "SE"
BeginProperty Font
Name       = "MS Sans Serif"
Size      = 12
Charset   = 0
Weight    = 700
Underline = 0 'False

```

```

        Italic           = 0 'False
        Strikethrough    = 0 'False
    EndProperty
    Height               = 300
    Index                = 6
    Left                 = 5490
    TabIndex             = 40
    Top                  = 5205
    Width                = 405
End
Begin VB.Label Direction
    Alignment            = 2 'Center
    AutoSize             = -1 'True
    BackColor            = &H8000000E&
    BackStyle            = 0 'Transparent
    Caption              = "SSE"
    BeginProperty Font
        Name              = "MS Sans Serif"
        Size              = 12
        Charset           = 0
        Weight            = 700
        Underline         = 0 'False
        Italic            = 0 'False
        Strikethrough     = 0 'False
    EndProperty
    Height               = 300
    Index                = 7
    Left                 = 4380
    TabIndex             = 39
    Top                  = 5910
    Width                = 720
End
Begin VB.Label Direction
    Alignment            = 2 'Center
    AutoSize             = -1 'True
    BackColor            = &H8000000E&
    BackStyle            = 0 'Transparent
    Caption              = "SSW"
    BeginProperty Font
        Name              = "MS Sans Serif"
        Size              = 12
        Charset           = 0
        Weight            = 700
        Underline         = 0 'False
        Italic            = 0 'False
        Strikethrough     = 0 'False
    EndProperty
    Height               = 300
    Index                = 15
    Left                 = 1635
    TabIndex             = 38
    Top                  = 5910
    Width                = 645
End
Begin VB.Label Direction
    Alignment            = 2 'Center
    AutoSize             = -1 'True
    BackColor            = &H8000000E&
    BackStyle            = 0 'Transparent
    Caption              = "SW"
    BeginProperty Font
        Name              = "MS Sans Serif"
        Size              = 12
        Charset           = 0
        Weight            = 700
        Underline         = 0 'False

```

```

        Italic           = 0 'False
        Strikethrough    = 0 'False
    EndProperty
    Height              = 300
    Index               = 14
    Left                = 855
    TabIndex            = 30
    Top                 = 5205
    Width               = 405
End
Begin VB.Label Direction
    Alignment           = 2 'Center
    AutoSize            = -1 'True
    BackColor           = &H8000000E&
    BackStyle           = 0 'Transparent
    Caption             = "WSW"
    BeginProperty Font
        Name             = "MS Sans Serif"
        Size             = 12
        Charset          = 0
        Weight           = 700
        Underline        = 0 'False
        Italic           = 0 'False
        Strikethrough    = 0 'False
    EndProperty
    Height              = 300
    Index               = 13
    Left                = 30
    TabIndex            = 29
    Top                 = 4320
    Width               = 705
End
Begin VB.Label Direction
    Alignment           = 2 'Center
    AutoSize            = -1 'True
    BackColor           = &H8000000E&
    BackStyle           = 0 'Transparent
    Caption             = "W"
    BeginProperty Font
        Name             = "MS Sans Serif"
        Size             = 12
        Charset          = 0
        Weight           = 700
        Underline        = 0 'False
        Italic           = 0 'False
        Strikethrough    = 0 'False
    EndProperty
    Height              = 300
    Index               = 12
    Left                = 270
    TabIndex            = 28
    Top                 = 3210
    Width               = 285
End
Begin VB.Label Direction
    Alignment           = 2 'Center
    AutoSize            = -1 'True
    BackColor           = &H8000000E&
    BackStyle           = 0 'Transparent
    Caption             = "WNW"
    BeginProperty Font
        Name             = "MS Sans Serif"
        Size             = 12
        Charset          = 0
        Weight           = 700
        Underline        = 0 'False

```

```

        Italic           = 0 'False
        Strikethrough    = 0 'False
    EndProperty
    Height              = 300
    Index              = 11
    Left                = 90
    TabIndex           = 27
    Top                = 2085
    Width              = 705
End
Begin VB.Label Direction
    Alignment           = 2 'Center
    AutoSize           = -1 'True
    BackColor          = &H8000000E&
    BackStyle          = 0 'Transparent
    Caption            = "NW"
    BeginProperty Font
        Name            = "MS Sans Serif"
        Size            = 12
        Charset         = 0
        Weight          = 700
        Underline       = 0 'False
        Italic          = 0 'False
        Strikethrough   = 0 'False
    EndProperty
    Height             = 300
    Index             = 10
    Left              = 915
    TabIndex          = 26
    Top               = 1080
    Width             = 465
End
Begin VB.Label Direction
    Alignment           = 2 'Center
    AutoSize           = -1 'True
    BackColor          = &H8000000E&
    BackStyle          = 0 'Transparent
    Caption            = "NNW"
    BeginProperty Font
        Name            = "MS Sans Serif"
        Size            = 12
        Charset         = 0
        Weight          = 700
        Underline       = 0 'False
        Italic          = 0 'False
        Strikethrough   = 0 'False
    EndProperty
    Height             = 300
    Index             = 9
    Left              = 1830
    TabIndex          = 25
    Top               = 450
    Width             = 645
End
Begin VB.Label Direction
    Alignment           = 2 'Center
    AutoSize           = -1 'True
    BackColor          = &H8000000E&
    BackStyle          = 0 'Transparent
    Caption            = "S"
    BeginProperty Font
        Name            = "MS Sans Serif"
        Size            = 12
        Charset         = 0
        Weight          = 700
        Underline       = 0 'False

```

```

        Italic           = 0 'False
        Strikethrough    = 0 'False
    EndProperty
    Height               = 300
    Index                = 8
    Left                 = 3270
    TabIndex             = 24
    Top                  = 6195
    Width                = 225
End
Begin VB.Label Direction
    Alignment            = 2 'Center
    AutoSize             = -1 'True
    BackColor            = &H8000000E&
    BackStyle            = 0 'Transparent
    Caption              = "ESE"
    BeginProperty Font
        Name              = "MS Sans Serif"
        Size              = 12
        Charset           = 0
        Weight            = 700
        Underline         = 0 'False
        Italic            = 0 'False
        Strikethrough     = 0 'False
    EndProperty
    Height               = 300
    Index                = 5
    Left                 = 6030
    TabIndex             = 23
    Top                  = 4320
    Width                = 585
End
Begin VB.Label Direction
    Alignment            = 2 'Center
    AutoSize             = -1 'True
    BackColor            = &H8000000E&
    BackStyle            = 0 'Transparent
    Caption              = "E"
    BeginProperty Font
        Name              = "MS Sans Serif"
        Size              = 12
        Charset           = 0
        Weight            = 700
        Underline         = 0 'False
        Italic            = 0 'False
        Strikethrough     = 0 'False
    EndProperty
    Height               = 300
    Index                = 4
    Left                 = 6240
    TabIndex             = 22
    Top                  = 3210
    Width                = 225
End
Begin VB.Label Direction
    Alignment            = 2 'Center
    AutoSize             = -1 'True
    BackColor            = &H8000000E&
    BackStyle            = 0 'Transparent
    Caption              = "ENE"
    BeginProperty Font
        Name              = "MS Sans Serif"
        Size              = 12
        Charset           = 0
        Weight            = 700
        Underline         = 0 'False

```



```

        Italic          = 0 'False
        Strikethrough   = 0 'False
    EndProperty
    Height             = 300
    Index              = 3
    Left               = 6015
    TabIndex           = 21
    Top                = 2085
    Width              = 585
End
Begin VB.Label Direction
    Alignment          = 2 'Center
    AutoSize           = -1 'True
    BackColor          = &H8000000E&
    BackStyle          = 0 'Transparent
    Caption            = "NNE"
    BeginProperty Font
        Name            = "MS Sans Serif"
        Size            = 12
        Charset         = 0
        Weight          = 700
        Underline       = 0 'False
        Italic          = 0 'False
        Strikethrough   = 0 'False
    EndProperty
    Height             = 300
    Index              = 1
    Left               = 4380
    TabIndex           = 20
    Top                = 450
    Width              = 585
End
Begin VB.Label Direction
    Alignment          = 2 'Center
    AutoSize           = -1 'True
    BackColor          = &H8000000E&
    BackStyle          = 0 'Transparent
    Caption            = "N"
    BeginProperty Font
        Name            = "MS Sans Serif"
        Size            = 12
        Charset         = 0
        Weight          = 700
        Underline       = 0 'False
        Italic          = 0 'False
        Strikethrough   = 0 'False
    EndProperty
    Height             = 300
    Index              = 0
    Left               = 3270
    TabIndex           = 19
    Top                = 225
    Width              = 195
End
Begin VB.PictureBox Picture2
    Appearance         = 0 'Flat
    BackColor          = &H80000005&
    BorderStyle        = 0 'None
    BeginProperty Font
        Name            = "MS Sans Serif"
        Size            = 8.25
        Charset         = 0
        Weight          = 400
        Underline       = 0 'False
        Italic          = 0 'False
    EndProperty

```

```

    Strikethrough = 0 'False
EndProperty
ForeColor = &H80000008&
Height = 6255
Left = 8955
ScaleHeight = 6255
ScaleWidth = 2640
TabIndex = 4
TabStop = 0 'False
Top = 15
Width = 2640
Begin VB.Label Label1
    Alignment = 1 'Right Justify
    Appearance = 0 'Flat
    BackColor = &H80000005&
    Caption = "0"
    BeginProperty Font
        Name = "MS Sans Serif"
        Size = 8.25
        Charset = 0
        Weight = 400
        Underline = 0 'False
        Italic = 0 'False
        Strikethrough = 0 'False
    EndProperty
    ForeColor = &H80000008&
    Height = 255
    Index = 0
    Left = 60
    TabIndex = 37
    Top = 5880
    Width = 1200
End
Begin VB.Label Label1
    Alignment = 1 'Right Justify
    AutoSize = -1 'True
    BackColor = &H80000009&
    Caption = "Label1"
    BeginProperty Font
        Name = "MS Sans Serif"
        Size = 8.25
        Charset = 0
        Weight = 400
        Underline = 0 'False
        Italic = 0 'False
        Strikethrough = 0 'False
    EndProperty
    Height = 255
    Index = 1
    Left = 60
    TabIndex = 36
    Top = 5520
    Width = 1200
End
Begin VB.Label Label2
    BackColor = &H8000000E&
    Caption = "Population Scale"
    BeginProperty Font
        Name = "Arial Narrow"
        Size = 12
        Charset = 0
        Weight = 700
        Underline = 0 'False
        Italic = 0 'False
        Strikethrough = 0 'False
    EndProperty

```

```

Height      = 285
Left        = 960
TabIndex    = 32
Top         = 45
Width       = 1725
End
Begin VB.Label Label1
Alignment   = 1 'Right Justify
BackColor   = &H80000009&
Caption     = "Label1"
BeginProperty Font
Name        = "MS Sans Serif"
Size        = 8.25
Charset     = 0
Weight      = 400
Underline   = 0 'False
Italic      = 0 'False
Strikethrough = 0 'False
EndProperty
ForeColor   = &H80000008&
Height      = 255
Index       = 15
Left        = 60
TabIndex    = 31
Top         = 480
Width       = 1200
End
Begin VB.Label Label1
Alignment   = 1 'Right Justify
BackColor   = &H80000009&
Caption     = "Label1"
BeginProperty Font
Name        = "MS Sans Serif"
Size        = 8.25
Charset     = 0
Weight      = 400
Underline   = 0 'False
Italic      = 0 'False
Strikethrough = 0 'False
EndProperty
ForeColor   = &H80000008&
Height      = 255
Index       = 14
Left        = 60
TabIndex    = 17
Top         = 840
Width       = 1200
End
Begin VB.Shape Shape1
FillColor   = &H000000FF&
FillStyle   = 0 'Solid
Height      = 375
Index       = 14
Left        = 1380
Top         = 600
Width       = 1215
End
Begin VB.Label Label1
Alignment   = 1 'Right Justify
BackColor   = &H80000009&
Caption     = "Label1"
BeginProperty Font
Name        = "MS Sans Serif"
Size        = 8.25
Charset     = 0
Weight      = 400

```

```

        Underline      = 0 'False
        Italic         = 0 'False
        Strikethrough  = 0 'False
    EndProperty
    ForeColor          = &H80000008&
    Height             = 255
    Index              = 13
    Left               = 60
    TabIndex           = 16
    Top                = 1200
    Width              = 1200
End
Begin VB.Label Label1
    Alignment          = 1 'Right Justify
    BackColor          = &H80000009&
    Caption            = "Label1"
    BeginProperty Font
        Name           = "MS Sans Serif"
        Size           = 8.25
        Charset        = 0
        Weight         = 400
        Underline      = 0 'False
        Italic         = 0 'False
        Strikethrough  = 0 'False
    EndProperty
    ForeColor          = &H80000008&
    Height             = 255
    Index              = 12
    Left               = 60
    TabIndex           = 15
    Top                = 1560
    Width              = 1200
End
Begin VB.Label Label1
    Alignment          = 1 'Right Justify
    BackColor          = &H80000009&
    Caption            = "Label1"
    BeginProperty Font
        Name           = "MS Sans Serif"
        Size           = 8.25
        Charset        = 0
        Weight         = 400
        Underline      = 0 'False
        Italic         = 0 'False
        Strikethrough  = 0 'False
    EndProperty
    ForeColor          = &H80000008&
    Height             = 255
    Index              = 11
    Left               = 60
    TabIndex           = 14
    Top                = 1920
    Width              = 1200
End
Begin VB.Label Label1
    Alignment          = 1 'Right Justify
    BackColor          = &H80000009&
    Caption            = "Label1"
    BeginProperty Font
        Name           = "MS Sans Serif"
        Size           = 8.25
        Charset        = 0
        Weight         = 400
        Underline      = 0 'False
        Italic         = 0 'False
        Strikethrough  = 0 'False
    EndProperty

```

```

EndProperty
ForeColor      = &H80000008&
Height        = 255
Index         = 10
Left          = 60
TabIndex      = 13
Top           = 2280
Width         = 1200
End
Begin VB.Label Label1
Alignment      = 1 'Right Justify
BackColor      = &H80000009&
Caption        = "Label1"
BeginProperty Font
Name           = "MS Sans Serif"
Size          = 8.25
Charset        = 0
Weight         = 400
Underline      = 0 'False
Italic         = 0 'False
Strikethrough  = 0 'False
EndProperty
ForeColor      = &H80000008&
Height        = 255
Index         = 9
Left          = 60
TabIndex      = 12
Top           = 2640
Width         = 1200
End
Begin VB.Label Label1
Alignment      = 1 'Right Justify
BackColor      = &H80000009&
Caption        = "Label1"
BeginProperty Font
Name           = "MS Sans Serif"
Size          = 8.25
Charset        = 0
Weight         = 400
Underline      = 0 'False
Italic         = 0 'False
Strikethrough  = 0 'False
EndProperty
ForeColor      = &H80000008&
Height        = 255
Index         = 8
Left          = 60
TabIndex      = 11
Top           = 3000
Width         = 1200
End
Begin VB.Label Label1
Alignment      = 1 'Right Justify
BackColor      = &H80000009&
Caption        = "Label1"
BeginProperty Font
Name           = "MS Sans Serif"
Size          = 8.25
Charset        = 0
Weight         = 400
Underline      = 0 'False
Italic         = 0 'False
Strikethrough  = 0 'False
EndProperty
ForeColor      = &H80000008&
Height        = 255

```

```

Index          = 7
Left           = 60
TabIndex      = 10
Top           = 3360
Width         = 1200
End
Begin VB.Label Label1
Alignment      = 1 'Right Justify
BackColor      = &H80000009&
Caption        = "Label1"
BeginProperty Font
    Name        = "MS Sans Serif"
    Size        = 8.25
    Charset     = 0
    Weight      = 400
    Underline   = 0 'False
    Italic      = 0 'False
    Strikethrough = 0 'False
EndProperty
ForeColor      = &H80000008&
Height        = 255
Index         = 6
Left          = 60
TabIndex      = 9
Top           = 3720
Width         = 1200
End
Begin VB.Label Label1
Alignment      = 1 'Right Justify
BackColor      = &H80000009&
Caption        = "Label1"
BeginProperty Font
    Name        = "MS Sans Serif"
    Size        = 8.25
    Charset     = 0
    Weight      = 400
    Underline   = 0 'False
    Italic      = 0 'False
    Strikethrough = 0 'False
EndProperty
ForeColor      = &H80000008&
Height        = 255
Index         = 5
Left          = 60
TabIndex      = 8
Top           = 4080
Width         = 1200
End
Begin VB.Label Label1
Alignment      = 1 'Right Justify
BackColor      = &H80000009&
Caption        = "Label1"
BeginProperty Font
    Name        = "MS Sans Serif"
    Size        = 8.25
    Charset     = 0
    Weight      = 400
    Underline   = 0 'False
    Italic      = 0 'False
    Strikethrough = 0 'False
EndProperty
ForeColor      = &H80000008&
Height        = 255
Index         = 4
Left          = 60
TabIndex      = 7

```

```

    Top          = 4440
    Width        = 1200
End
Begin VB.Label Label1
    Alignment    = 1 'Right Justify
    BackColor    = &H80000009&
    Caption      = "Label1"
    BeginProperty Font
        Name      = "MS Sans Serif"
        Size      = 8.25
        Charset   = 0
        Weight    = 400
        Underline = 0 'False
        Italic    = 0 'False
        Strikethrough = 0 'False
    EndProperty
    ForeColor    = &H80000008&
    Height       = 255
    Index        = 3
    Left         = 60
    TabIndex     = 6
    Top          = 4800
    Width        = 1200
End
Begin VB.Label Label1
    Alignment    = 1 'Right Justify
    BackColor    = &H80000009&
    Caption      = "Label1"
    BeginProperty Font
        Name      = "MS Sans Serif"
        Size      = 8.25
        Charset   = 0
        Weight    = 400
        Underline = 0 'False
        Italic    = 0 'False
        Strikethrough = 0 'False
    EndProperty
    ForeColor    = &H80000008&
    Height       = 255
    Index        = 2
    Left         = 60
    TabIndex     = 5
    Top          = 5160
    Width        = 1200
End
Begin VB.Shape Shape1
    FillColor    = &H008080FF&
    FillStyle    = 0 'Solid
    Height       = 375
    Index        = 13
    Left         = 1380
    Top          = 960
    Width        = 1215
End
Begin VB.Shape Shape1
    FillColor    = &H000080FF&
    FillStyle    = 0 'Solid
    Height       = 375
    Index        = 12
    Left         = 1380
    Top          = 1320
    Width        = 1215
End
Begin VB.Shape Shape1
    FillColor    = &H00004080&
    FillStyle    = 0 'Solid

```

```

    Height      = 375
    Index       = 11
    Left        = 1380
    Top         = 1680
    Width       = 1215
End
Begin VB.Shape Shape1
    FillColor   = &H00FFFFFF&
    FillStyle   = 0 'Solid
    Height      = 375
    Index       = 10
    Left        = 1380
    Top         = 2040
    Width       = 1215
End
Begin VB.Shape Shape1
    FillColor   = &H0000C0C0&
    FillStyle   = 0 'Solid
    Height      = 375
    Index       = 9
    Left        = 1380
    Top         = 2400
    Width       = 1215
End
Begin VB.Shape Shape1
    FillColor   = &H0000FF00&
    FillStyle   = 0 'Solid
    Height      = 375
    Index       = 8
    Left        = 1380
    Top         = 2760
    Width       = 1215
End
Begin VB.Shape Shape1
    FillColor   = &H0000C000&
    FillStyle   = 0 'Solid
    Height      = 375
    Index       = 7
    Left        = 1380
    Top         = 3120
    Width       = 1215
End
Begin VB.Shape Shape1
    FillColor   = &H00FFFF00&
    FillStyle   = 0 'Solid
    Height      = 375
    Index       = 6
    Left        = 1380
    Top         = 3480
    Width       = 1215
End
Begin VB.Shape Shape1
    FillColor   = &H00C0C000&
    FillStyle   = 0 'Solid
    Height      = 375
    Index       = 5
    Left        = 1380
    Top         = 3840
    Width       = 1215
End
Begin VB.Shape Shape1
    FillColor   = &H00FF0000&
    FillStyle   = 0 'Solid
    Height      = 375
    Index       = 4
    Left        = 1380

```



```

        Top           = 4200
        Width        = 1215
    End
    Begin VB.Shape Shape1
        FillColor     = &H00800000&
        FillStyle     = 0 'Solid
        Height        = 375
        Index         = 3
        Left          = 1380
        Top           = 4545
        Width         = 1215
    End
    Begin VB.Shape Shape1
        FillColor     = &H00C000C0&
        FillStyle     = 0 'Solid
        Height        = 375
        Index         = 2
        Left          = 1380
        Top           = 4920
        Width         = 1215
    End
    Begin VB.Shape Shape1
        FillColor     = &H00800080&
        FillStyle     = 0 'Solid
        Height        = 375
        Index         = 1
        Left          = 1380
        Top           = 5280
        Width         = 1215
    End
    Begin VB.Shape Shape1
        BackColor     = &H00FFFFFF&
        BorderColor   = &H00000000&
        FillColor     = &H00FFFFFF&
        FillStyle     = 0 'Solid
        Height        = 375
        Index         = 0
        Left          = 1380
        Top           = 5640
        Width         = 1215
    End
End
Begin VB.Label lblTo
    BackColor       = &H80000005&
    Caption         = "To"
    Height          = 210
    Left            = 855
    TabIndex        = 43
    Top             = 345
    Visible         = 0 'False
    Width           = 690
End
Begin VB.Label lblFrom
    BackColor       = &H80000005&
    Caption         = "From"
    Height          = 210
    Left            = 120
    TabIndex        = 42
    Top             = 345
    Visible         = 0 'False
    Width           = 690
End
Begin VB.Label DistanceLabel
    BackColor       = &H80000009&
    Caption         = "DistanceLabel"
    BeginProperty Font

```

```

        Name           = "Arial Narrow"
        Size           = 12
        Charset        = 0
        Weight         = 700
        Underline      = 0 'False
        Italic         = 0 'False
        Strikethrough  = 0 'False
    EndProperty
    Height            = 285
    Left              = 15
    TabIndex          = 35
    Top               = 45
    Width             = 2160
End
Begin VB.Label TitleBlock
    Alignment         = 2 'Center
    AutoSize          = -1 'True
    BackColor         = &H80000009&
    Caption           = "Blank Rosette"
    BeginProperty Font
        Name           = "Arial"
        Size           = 15.75
        Charset        = 0
        Weight         = 700
        Underline      = -1 'True
        Italic         = 0 'False
        Strikethrough  = 0 'False
    EndProperty
    ForeColor         = &H80000008&
    Height            = 360
    Left              = 2430
    TabIndex          = 18
    Top               = -30
    Width             = 5835
End
End
Attribute VB_Name = "frmRosette"
Attribute VB_GlobalNameSpace = False
Attribute VB_Creatable = False
Attribute VB_PredeclaredId = True
Attribute VB_Exposed = False
'*****
' Module: frmRosette
'
' Project: SECPop
'
' Description: This module contains the subroutines necessary to output a
'              MACCS input file in:
'              MACCS Compatible Format
'              CSV format
'              Screen
'              Hard Copy
'
' Modification History
' Date      By      Description
' -----
' 20020131  cwm    Updated Rosette, fixed some format problems
' 20020227  cwm    Fixed Rosette empty start error
'*****

Option Explicit

Dim MaxRow As Integer
Dim MaxCol As Integer

```

```

Dim i As Integer
Dim j As Integer
Dim k As Integer
Dim GridArray() As String
Dim Sink As New GridClass
Public blnInputDataChanged As Boolean ' indicates that the user has changed
                                      ' something with the problem or site
                                      ' data since the last display of
                                      ' the rosette

Private Sub CancelButton_click()
    Unload Me
End Sub

Private Sub cmdPrint_Click()

    Dim iCopy As Integer

    CancelButton.Visible = False
    cmdprint.Visible = False
    cmdSave.Visible = False
    TDBGrid1.Height = 286.5

    frmRosette.Refresh
    Set pctCapture.Picture = Nothing
    Set pctCapture.Picture = CaptureClient(Me)

    frmMain.dlgSecpop.Flags = cdlPDHidePrintToFile
    frmMain.dlgSecpop.CancelError = True

    On Error Resume Next

    frmMain.dlgSecpop.ShowPrinter
    iCopy = frmMain.dlgSecpop.Copies

    If Err.number <> cdlCancel Then ' user did not click on cancel
        For i = 1 To iCopy
            PrintPictureToFitPage Printer, pctCapture.Picture
            Printer.EndDoc
        Next i
    End If

    On Error GoTo 0

    CancelButton.Visible = True
    cmdprint.Visible = True
    cmdSave.Visible = True
    TDBGrid1.Height = 256.5

End Sub

Private Sub cmdSave_Click()

    CancelButton.Visible = False
    cmdprint.Visible = False
    cmdSave.Visible = False
    TDBGrid1.Height = 286.5

    On Error Resume Next

    With frmMain.dlgSecpop
        .Filter = "Bitmap Files (*.bmp)|*bmp|All files|*.*"
        .FilterIndex = 1
    End With

```

```

        .DialogTitle = "Save File As"
        .Filename = ""
        .Flags = cdlOFNOverwritePrompt
        .DefaultExt = ".bmp"
        .CancelError = True

    If InitOutputFilePathChanged = True Then
        .InitDir = frmSetup.txtOutput_path.text
        InitOutputFilePathChanged = False
    Else
        .InitDir = InitOutputFilePath
    End If
    .ShowSave
End With

If Err.number <> cdlCancel Then ' user did not click on cancel

    'reset init dir

    InitOutputFilePath = Left(frmMain.dlgSecpop.Filename, _
        (InStrRev(frmMain.dlgSecpop.Filename, "\") - 1))

    frmRosette.Refresh
    Set pctCapture.Picture = Nothing
    Set pctCapture.Picture = CaptureClient(Me)
    SavePicture pctCapture.Image, frmMain.dlgSecpop.Filename

End If

On Error GoTo 0

CancelButton.Visible = True
cmdprint.Visible = True
cmdSave.Visible = True
TDBGrid1.Height = 256.5

End Sub

Private Sub Form_Activate()

    Dim row As Long, col As Integer
    Dim C As TrueDBGrid70.Column
    Dim Cols As TrueDBGrid70.Columns

    ' build rosette, but only if a calculation has been done subsequent
    ' to the user changing any data on the forms.

    If frmRosette.blnInputDataChanged = True Then
        For i = 0 To number_of_segments
            For j = 0 To max_number_of_radii
                ' sector_population(number_of_segments, max_number_of_radii)
                sector_population(i, j) = 0
            Next j
        Next i
    End If

    Call Rosette

    ' build grid

    MaxRow = number_of_radii
    MaxCol = 2
    col = 2
    row = number_of_radii

    ' Initialize storage

```

```

Sink.SetDims row - 1, col

For i = 1 To number_of_radii - 1
    Sink.Value(i - 1, 0) = Format(radial_distance(i), " ###.0 ")
    Sink.Value(i - 1, 1) = Format(radial_distance(i + 1), " ###.0 ")
'     Sink.Value(1, i) = Str(region_index(i, j))
'     GridArray(i, j) = Str(region_index(i, j))
Next i

'     For i = 1 To number_of_radii - 1
'         List1(0).List(i - 1) = Format(radial_distance(i), " ###.0 ")
'         List1(1).List(i - 1) = Format(radial_distance(i + 1), " ###.0 ")
'     Next i

' Make sure no events are fired for the grid yet
Sink.Attach Nothing

Set Cols = TDBGrid1.Columns

' Remove all columns
While Cols.Count
    Cols.Remove 0
Wend
TDBGrid1.ReBind

' Add columns to the grid
For col = 0 To 1
    Set C = Cols.Add(col)
    C.Visible = True
    C.Width = 40
    If col = 0 Then
        C.caption = "From"
    Else
        C.caption = "To"
    End If
Next col

TDBGrid1.Columns(0).Locked = True
TDBGrid1.Columns(1).Locked = True

TDBGrid1.RecordSelectors = False
TDBGrid1.ScrollBars = dbgAutomatic

'Initialize current cell position to upper left corner:
'     TDBGrid1.row = 0
'     TDBGrid1.col = 0

' Initialise the class
Sink.Attach TDBGrid1

' Reinitialize the grid
TDBGrid1.Bookmark = Null
TDBGrid1.ReBind

' Calibrate the VScroll bar
TDBGrid1.ApproxCount = Sink.RowCount

TDBGrid1.Width = 92

End Sub

Private Sub Rosette()
    'This sub is the heart of the SecPop Rosette drawing routine.

```

```

Dim Rad As Double          'radial distance normalized to pixels
Dim i As Integer          'loop counter
Dim j As Integer          'loop counter
Dim k As Integer          'index used to invert lookup of populations.
Dim Pie_start As Double   'Start location of segment in radians
Dim Pie_end As Double     'End location of segment in radians
Dim PopColors(14) As Long 'Vector containing the scale of colors
Dim Paint_Index As Integer 'Index working with PopColors vector to output color
Dim Max_Pop As Long       'Maximum population
Dim Max_Distance As Double 'Equivalent to the distance of the largest radius
Dim Scale_Interval As Long 'Interval between population increments

Const side As Double = 225 'Number of pixels in 1/2 the side of the rosette picture box
Const side As Double = 270 'Number of pixels in 1/2 the side of the rosette picture box
Const pi As Double = 3.14159265359
Const CircleEnd As Double = -2 * pi

Call SetScale(Scale_Interval, Max_Pop) 'Returns parameters used to set fill color
Call DistancesList 'Outputs list of radius distances on right
Call Legend(PopColors, Scale_Interval) 'Outputs Population Scale Legend
TitleBlock.caption = frmSite_Data.txtSite_Name.text

'Begin drawing Rosette Segments. Program works from the outside in,
'drawing pie charts at progressively smaller radii.
Picture1.ScaleMode = vbPixels
For i = number_of_radrii To 1 Step -1
    Pie_start = (0.25 + 1 / 32) * 2 * pi
    Rad = i / number_of_radrii
    For j = 1 To number_of_segments
        'Set Segment Fill Color
        k = 17 - j
        Paint_Index = Int(15 * sector_population(k, i) / Max_Pop)
        If Paint_Index = 15 Then Paint_Index = 14
        If i = 1 Then Paint_Index = 0
        Picture1.FillColor = PopColors(Paint_Index)
        Picture1.FillStyle = 0

        'Calculate Radius normalized to pixels
        Max_Distance = radial_distance(number_of_radrii)
        Rad = (0.9 * side * radial_distance(i) / Max_Distance) * 0.9
        Rad = 0.9 * side * radial_distance(i) / Max_Distance

        'Set begin/end of pie segment and draw.
        Pie_end = (1 / number_of_segments)
        Let Pie_end = Pie_start - Pie_end * CircleEnd
        If Pie_end > 2 * pi Then Pie_end = Pie_end - 2 * pi
        Picture1.Circle (side, side), Rad, 255, -Pie_start, -Pie_end
        Pie_start = Pie_end
    Next j
Next i

End Sub

Sub DistancesList()
Dim i As Integer
Dim ir As Integer

If frmProblem_Data.optMiles.Value = True Then
    DistanceLabel.caption = "Radial Distances in " & "Mi"
Else
    DistanceLabel.caption = "Radial Distances in " & "Km"
End If

If number_of_radrii <= 5 Then
    ir = 5
Else

```

```

        ir = number_of_radrii
    End If

    List1(0).Height = 13.5 * (ir - 1)
    List1(1).Height = 13.5 * (ir - 1)
    '
    '
    For i = 1 To number_of_radrii - 1
        List1(0).List(i - 1) = Format(radial_distance(i), " ###.0 ")
        List1(1).List(i - 1) = Format(radial_distance(i + 1), " ###.0 ")
    Next i

End Sub

Sub SetScale(Scale_Interval, Max_Pop)

    Dim i As Integer
    Dim j As Integer

    For i = 1 To number_of_segments
        For j = 1 To number_of_radrii
            If Max_Pop < sector_population(i, j) Then
                Max_Pop = sector_population(i, j)
            End If
        Next j
    Next i

    If Max_Pop <= 15 Then
        Scale_Interval = 1
        Max_Pop = 15
    ElseIf Max_Pop <= 150 Then
        Scale_Interval = 10
        Max_Pop = 150
    ElseIf Max_Pop <= 1500 Then
        Scale_Interval = 100
        Max_Pop = 1500
    Else
        Scale_Interval = 7.5 * (10 ^ (Int(Log(Max_Pop) / Log(10)) - 1))
        Max_Pop = Scale_Interval * (Int(Max_Pop / Scale_Interval) + 1)
        Scale_Interval = Max_Pop / 15
    End If

End Sub

Sub Legend(PopColors, Scale_Interval)

    Dim A As Long
    Dim i As Integer

    PopColors(0) = RGB(255, 255, 255)
    PopColors(1) = RGB(170, 0, 255)
    PopColors(2) = RGB(85, 0, 255)
    PopColors(3) = RGB(0, 0, 255)
    PopColors(4) = RGB(0, 85, 255)
    PopColors(5) = RGB(0, 170, 255)
    PopColors(6) = RGB(0, 255, 255)
    PopColors(7) = RGB(0, 255, 170)
    PopColors(8) = RGB(0, 255, 85)
    PopColors(9) = RGB(0, 255, 0)
    PopColors(10) = RGB(85, 255, 0)
    PopColors(11) = RGB(170, 255, 0)
    PopColors(12) = RGB(255, 255, 0)
    PopColors(13) = RGB(255, 170, 0)
    PopColors(14) = RGB(255, 85, 0)

    For i = 0 To 14

```

```
        Shape1(i).FillColor = PopColors(i)
    Next i

    A = 0
    For i = 0 To 15
        Labell(i).caption = A
        Labell(i).caption = Format(A, "###,###,###,###,###")
        A = A + Scale_Interval
    Next i

End Sub

Private Sub Form_Load()

    Me.Top = 10
    Me.Left = 10

End Sub
```

H.31 Visual Basic Form Module: Setup.frm

```
VERSION 5.00
Begin VB.Form frmSetup
    Appearance = 0 'Flat
    BackColor = &H80000004&
    BorderStyle = 1 'Fixed Single
    Caption = "Setup"
    ClientHeight = 5820
    ClientLeft = 210
    ClientTop = 330
    ClientWidth = 9585
    BeginProperty Font
        Name = "MS Sans Serif"
        Size = 8.25
        Charset = 0
        Weight = 700
        Underline = 0 'False
        Italic = 0 'False
        Strikethrough = 0 'False
    EndProperty
    ForeColor = &H00000000&
    Icon = "Setup.frx":0000
    MaxButton = 0 'False
    MDIChild = -1 'True
    MinButton = 0 'False
    PaletteMode = 1 'UseZOrder
    ScaleHeight = 5820
    ScaleWidth = 9585
    Begin VB.Frame fraCensusFile
        Caption = "Databases:"
        Height = 1620
        Left = 4890
        TabIndex = 21
        Top = 1695
        Width = 4560
        Begin VB.TextBox Text4
            Appearance = 0 'Flat
            BackColor = &H80000004&
            BorderStyle = 0 'None
            ForeColor = &H00000000&
            Height = 200
            Left = 435
            Locked = -1 'True
            TabIndex = 27
            Text = "Economic:"
            Top = 930
            Width = 900
        End
        Begin VB.TextBox Text3
            Appearance = 0 'Flat
            BackColor = &H80000004&
            BorderStyle = 0 'None
            BeginProperty Font
                Name = "MS Sans Serif"
                Size = 8.25
                Charset = 0
                Weight = 400
                Underline = 0 'False
                Italic = 0 'False
                Strikethrough = 0 'False
            EndProperty
            ForeColor = &H00000000&
```

```

Height          = 270
Left           = 660
Locked         = -1 'True
TabIndex       = 26
Text           = "Choose one:"
Top            = 1215
Width          = 900
End
Begin VB.ComboBox cboCounty_Database
Height         = 315
Left           = 1665
Style          = 2 'Dropdown List
TabIndex       = 6
Top            = 1170
Width          = 2250
End
Begin VB.TextBox txtCounty_Database
Appearance     = 0 'Flat
BackColor      = &H80000004&
BorderStyle    = 0 'None
BeginProperty Font
    Name        = "MS Sans Serif"
    Size        = 8.25
    Charset     = 0
    Weight      = 400
    Underline   = 0 'False
    Italic      = 0 'False
    Strikethrough = 0 'False
EndProperty
ForeColor      = &H00000000&
Height         = 200
Left           = 1635
Locked         = -1 'True
TabIndex       = 25
Text           = "Database"
Top            = 930
Width          = 2340
End
Begin VB.TextBox Text1
Appearance     = 0 'Flat
BackColor      = &H80000004&
BorderStyle    = 0 'None
ForeColor      = &H00000000&
Height         = 200
Left           = 420
Locked         = -1 'True
TabIndex       = 24
Text           = "Census:"
Top            = 270
Width          = 900
End
Begin VB.TextBox txtCensus_Database
Appearance     = 0 'Flat
BackColor      = &H80000004&
BorderStyle    = 0 'None
BeginProperty Font
    Name        = "MS Sans Serif"
    Size        = 8.25
    Charset     = 0
    Weight      = 400
    Underline   = 0 'False
    Italic      = 0 'False
    Strikethrough = 0 'False
EndProperty
ForeColor      = &H00000000&
Height         = 200

```

```

Left          = 1650
Locked       = -1 'True
TabIndex     = 23
Text        = "Database"
Top         = 270
Width      = 2340
End
Begin VB.ComboBox cboCensus_Database
Height      = 315
Left       = 1650
Style     = 2 'Dropdown List
TabIndex  = 5
Top       = 510
Width    = 2250
End
Begin VB.TextBox txtChoose_Database
Appearance = 0 'Flat
BackColor  = &H80000004&
BorderStyle = 0 'None
BeginProperty Font
    Name      = "MS Sans Serif"
    Size     = 8.25
    Charset  = 0
    Weight   = 400
    Underline = 0 'False
    Italic   = 0 'False
    Strikethrough = 0 'False
EndProperty
ForeColor  = &H00000000&
Height    = 270
Left     = 645
Locked   = -1 'True
TabIndex = 22
Text    = "Choose one:"
Top     = 570
Width  = 900
End
End
Begin VB.Frame fraData_Path
BackColor = &H80000004&
Caption  = "&Location of Databases:"
Height  = 1335
Left    = 4830
TabIndex = 18
Top     = 255
Width  = 4575
Begin VB.ComboBox cboCountyDatabase
Height      = 315
Left       = 870
Style     = 2 'Dropdown List
TabIndex  = 3
Top       = 885
Visible   = 0 'False
Width    = 2250
End
End
Begin VB.CommandButton cmdData_Path
Caption = "Browse..."
BeginProperty Font
    Name      = "MS Sans Serif"
    Size     = 8.25
    Charset  = 0
    Weight   = 400
    Underline = 0 'False
    Italic   = 0 'False
    Strikethrough = 0 'False
EndProperty

```

```

        Height      = 375
        Left        = 3360
        TabIndex    = 4
        Top         = 855
        Width       = 1095
    End
    Begin VB.TextBox txtData_path
        Appearance   = 0 'Flat
        BackColor    = &H80000004&
        BorderStyle  = 0 'None
        BeginProperty Font
            Name      = "MS Sans Serif"
            Size     = 8.25
            Charset  = 0
            Weight   = 400
            Underline = 0 'False
            Italic   = 0 'False
            Strikethrough = 0 'False
        EndProperty
        ForeColor    = &H00000000&
        Height       = 270
        Left         = 150
        Locked       = -1 'True
        TabIndex     = 20
        Text         = "CENSUS"
        Top          = 495
        Width        = 3780
    End
End
Begin VB.Frame fraOutput_Path
    BackColor      = &H80000004&
    Caption        = "Default &Output File Path:"
    Height         = 1335
    Left           = 90
    TabIndex      = 17
    Top            = 3450
    Width          = 4575
    Begin VB.CommandButton cmdOutput_Path
        Caption      = "Browse..."
        BeginProperty Font
            Name      = "MS Sans Serif"
            Size     = 8.25
            Charset  = 0
            Weight   = 400
            Underline = 0 'False
            Italic   = 0 'False
            Strikethrough = 0 'False
        EndProperty
        Height       = 375
        Left        = 3375
        TabIndex    = 2
        Top         = 795
        Width       = 1095
    End
    Begin VB.TextBox txtOutput_path
        Appearance   = 0 'Flat
        BackColor    = &H80000004&
        BorderStyle  = 0 'None
        BeginProperty Font
            Name      = "MS Sans Serif"
            Size     = 8.25
            Charset  = 0
            Weight   = 400
            Underline = 0 'False
            Italic   = 0 'False
            Strikethrough = 0 'False
        EndProperty
    End
End

```

```

        EndProperty
        ForeColor      =   &H00000000&
        Height         =   360
        Left           =   120
        Locked         =   -1 'True
        TabIndex       =   19
        Text           =   "SITES"
        Top            =   480
        Width          =   3780
    End
End
Begin VB.Frame fraProb_path
    BackColor      =   &H80000004&
    Caption        =   "Default &Problem File Path:"
    Height         =   1620
    Left           =   105
    TabIndex       =   15
    Top            =   1695
    Width          =   4575
    Begin VB.CommandButton cmdProb_Path
        Caption      =   "Browse..."
        BeginProperty Font
            Name       =   "MS Sans Serif"
            Size        =   8.25
            Charset     =   0
            Weight      =   400
            Underline   =   0 'False
            Italic      =   0 'False
            Strikethrough = 0 'False
        EndProperty
        Height        =   375
        Left          =   3360
        TabIndex      =   1
        Top           =   840
        Width         =   1095
    End
    Begin VB.TextBox txtProblem_path
        Appearance    =   0 'Flat
        BackColor     =   &H80000004&
        BorderStyle   =   0 'None
        BeginProperty Font
            Name       =   "MS Sans Serif"
            Size        =   8.25
            Charset     =   0
            Weight      =   400
            Underline   =   0 'False
            Italic      =   0 'False
            Strikethrough = 0 'False
        EndProperty
        ForeColor     =   &H00000000&
        Height        =   270
        Left          =   135
        Locked        =   -1 'True
        TabIndex      =   16
        Text          =   "SITES"
        Top           =   480
        Width         =   3780
    End
End
Begin VB.Frame fraSite_Path
    BackColor      =   &H80000004&
    Caption        =   "&Default Site File Path:"
    Height         =   1335
    Left           =   120
    TabIndex       =   14
    Top            =   255

```

```

Width = 4575
Begin VB.TextBox txtSite_Path
Appearance = 0 'Flat
BackColor = &H80000004&
BorderStyle = 0 'None
BeginProperty Font
Name = "MS Sans Serif"
Size = 8.25
Charset = 0
Weight = 400
Underline = 0 'False
Italic = 0 'False
Strikethrough = 0 'False
EndProperty
ForeColor = &H00000000&
Height = 195
Left = 120
Locked = -1 'True
TabIndex = 11
Text = "SITES"
Top = 495
Width = 3780
End
Begin VB.CommandButton cmdSite_Path
Caption = "Browse..."
BeginProperty Font
Name = "MS Sans Serif"
Size = 8.25
Charset = 0
Weight = 400
Underline = 0 'False
Italic = 0 'False
Strikethrough = 0 'False
EndProperty
Height = 375
Left = 3360
TabIndex = 0
Top = 855
Width = 1095
End
Begin VB.CommandButton cmdMapplan_Setup
Appearance = 0 'Flat
BackColor = &H00E0E0E0&
Caption = "M&apPlan"
Enabled = 0 'False
Height = 480
Left = 1275
TabIndex = 12
TabStop = 0 'False
Top = 5250
Width = 1728
End
Begin VB.CommandButton cmdSave_Settings
Appearance = 0 'Flat
BackColor = &H00E0E0E0&
Caption = "&Save Changes"
Height = 480
Left = 3525
TabIndex = 9
Top = 5250
Width = 1728
End
Begin VB.CommandButton cmdCancel
Appearance = 0 'Flat
BackColor = &H00E0E0E0&

```

```

Cancel      = -1 'True
Caption     = "&Close"
Default     = -1 'True
Height      = 480
Left        = 5925
TabIndex   = 10
Top         = 5250
Width       = 1728
End
Begin VB.Frame fraOutput_Format
BackColor   = &H80000004&
Caption     = "Site-Specific Output File Format:"
Enabled     = 0 'False
Height      = 1335
Left        = 4920
TabIndex   = 13
Top         = 3450
Visible     = 0 'False
Width       = 4620
Begin VB.OptionButton optCSV
Caption     = "CS&V"
Enabled     = 0 'False
Height      = 240
Left        = 2400
TabIndex   = 8
TabStop     = 0 'False
Top         = 600
Width       = 756
End
Begin VB.OptionButton optMACCS
Caption     = "&MACCS"
Enabled     = 0 'False
Height      = 240
Left        = 990
TabIndex   = 7
Top         = 600
Value       = -1 'True
Width       = 972
End
End
End
Attribute VB_Name = "frmSetup"
Attribute VB_GlobalNameSpace = False
Attribute VB_Creatable = False
Attribute VB_PredeclaredId = True
Attribute VB_Exposed = False
Option Explicit

Private Sub cboCensus_Database_Click()

    txtCensus_Database.text = cboCensus_Database.text
    frmMain.caption = MainTitle & " (" & cboCensus_Database.text & ")"

End Sub

Private Sub cboCounty_Database_Click()
    txtCounty_Database.text = cboCounty_Database.text
End Sub

'This form allows the user to set certain paths which will be remembered
'by the program until they are changed. These paths include input and
'output directories, among other things. Setup also allows the user to
'specify which file format they would like to use with their output
'data files - MACCS input file or comma seperated variable formats.

Private Sub cmdCancel_Click()

```

```

        'If the user selects the cancel button from setup, the setup form is
        'hidden, but the changes are retained until the program is exited.

        frmSetup.Hide

    End Sub

    Private Sub cmdData_Path_Click()

        Dim strFolderName As String
        strFolderName = GetFolderName(strFolderName)
        If strFolderName <> "" Then
            txtData_path.text = strFolderName
        End If

    End Sub

    Private Sub cmdMapplan_Setup_Click()

        '   RUN "mp_setup.exe"

    End Sub

    Private Sub cmdOutput_Path_Click()

        Dim strFolderName As String
        '   txtOutput_path.text = GetFolderName(strFolderName)

        strFolderName = GetFolderName(strFolderName)
        If strFolderName <> "" Then
            txtOutput_path.text = strFolderName
        End If

    End Sub

    Private Sub cmdProb_Path_Click()

        '   Dim strFolderName As String
        '   txtProblem_path.text = GetFolderName(strFolderName)

        Dim strFolderName As String

        strFolderName = GetFolderName(strFolderName)
        If strFolderName <> "" Then
            txtProblem_path.text = strFolderName
        End If

    End Sub

    Private Sub cmdSave_Settings_Click()

        'This routine saves setup data to a file so that the program has
        'access to it every time the program is run.

        Dim filenum As Integer
        Dim strFileName As String

        'Locate first free file handle.

        filenum = FreeFile

        'Open file (called secpop.cfg) and output all of the data to it.
        strFileName = App.path & "\SECPop.CFG"
        '   Open "SECPop00.CFG" For Output As #filenum
        Open strFileName For Output As #filenum
    
```



```

Print #filenum, frmSetup.txtSite_Path.text
Print #filenum, frmSetup.txtProblem_path.text
Print #filenum, frmSetup.txtOutput_path.text
Print #filenum, frmSetup.txtData_path.text
'   If frmSetup.optMACCS.Value = True Then
'       Print #filenum, "MACCS"
'   Else
'       Print #filenum, "CSV"
'   End If
Print #filenum, frmSetup.txtCensus_Database.text
Print #filenum, frmSetup.txtCounty_Database.text
Close #filenum

End Sub

Private Sub cmdSite_Path_Click()

    Dim strFolderName As String

    strFolderName = GetFolderName(strFolderName)
    If strFolderName <> "" Then
        txtSite_Path.text = strFolderName
    End If

'    txtSite_Path.text = GetFolderName
'    txtSite_Path.text = GetFolderName(strFolderName)

End Sub

Private Sub Frame1_DragDrop(Source As Control, X As Single, Y As Single)

End Sub

Private Sub Combo1_Change()

End Sub

Private Sub Label1_Click()

End Sub

Private Sub Text2_Change()

End Sub

Private Sub Form_Load()

    Dim TempString As String
    Dim filenum As Integer

'    frmDisclaimer.Show
'    On Local Error GoTo configerr

'Check and see if config file exists.
TempString = App.path & "\SECPOP.CFG"
If Len(Dir$(TempString)) <> 0 Then
'    If Len(Dir$("SECPop.CFG")) <> 0 Then

        'Open file and read in the data from it.

        filenum = FreeFile
        Open "SECPop.CFG" For Input As filenum
        Open TempString For Input As filenum
        Input #filenum, TempString
        frmSetup.txtSite_Path.text = TempString
        Input #filenum, TempString

```

```

    frmSetup.txtProblem_path.text = TempString
    Input #filenum, TempString
    frmSetup.txtOutput_path.text = TempString
    Input #filenum, TempString
    frmSetup.txtData_path.text = TempString
    Input #filenum, TempString
    '
    '   If (TempString = "MACCS") Then
    '       frmSetup.optMACCS.Value = True
    '
    '   Else
    '       frmSetup.optCSV.Value = True
    '   End If
    Input #filenum, TempString
    frmSetup.txtCensus_Database.text = TempString
    Input #filenum, TempString
    frmSetup.txtCounty_Database.text = TempString
    Close #filenum

'else if config file doesn't exist use defaults.
Else
    'Defaults set in form.

End If

'Turn off error handler.

On Local Error GoTo 0
configerr:
    'If config file format is screwed up use defaults.

    Close filenum
    Exit Sub

End Sub

Private Sub txtData_path_KeyPress(keyascii As Integer)

    'Convert all input to upper case.

    Dim C As String
    C = Chr$(keyascii)

    keyascii = Asc(UCase$(C$))

End Sub

Private Sub txtOutput_path_Change()

    InitOutputFilePath = frmSetup.txtOutput_path
    InitOutputFilePathChanged = True

End Sub

Private Sub txtOutput_path_KeyPress(keyascii As Integer)

    'Convert all input to upper case.

    Dim C As String
    C = Chr$(keyascii)

    keyascii = Asc(UCase$(C$))

```

```

        'set up default dirs
        InitOutputFilePath = frmSetup.txtOutput_path
End Sub
Private Sub txtProblem_path_Change()
    InitProblemFilePath = txtProblem_path.text
    InitProblemFilePathChanged = True
End Sub
Private Sub txtProblem_path_KeyPress(keyascii As Integer)
    'Convert all input to upper case.
    Dim C As String
    C = Chr$(keyascii)
    keyascii = Asc(UCase$(C$))
    InitProblemFilePath = frmSetup.txtProblem_path
End Sub
Private Sub lblSite_Path_KeyPress(keyascii As Integer)
    'Convert all input to upper case.
    Dim C As String
    C = Chr$(keyascii)
    keyascii = Asc(UCase$(C$))
End Sub
'Public Function GetFolderName() As String
Public Function GetFolderName(strFileName As String) As String
.....
' Copyright ©1996-2002 VBnet, Randy Birch, All Rights Reserved.
' Some pages may also contain other copyrights by the author.
.....
' You are free to use this code within your own applications,
' but you are expressly forbidden from selling or otherwise
' distributing this source code without prior written consent.
' This includes both posting free demo projects made from this
' code as well as reproducing the code in text or html format.
.....

    Dim bi As BROWSEINFO
    Dim pidl As Long
    Dim path As String
    Dim pos As Integer

    'Fill the BROWSEINFO structure with the
    'needed data. To accomodate comments, the
    'With/End With syntax has not been used, though
    'it should be your 'final' version.

    'hwnd of the window that receives messages
    'from the call. Can be your application

```

```

'or the handle from GetDesktopWindow().
bi.hOwner = Me.hWnd

'Pointer to the item identifier list specifying
'the location of the "root" folder to browse from.
'If NULL, the desktop folder is used.
bi.pidlRoot = 0&

'message to be displayed in the Browse dialog
bi.lpszTitle = "Select your Windows\System\ directory"

'the type of folder to return.
bi.ulFlags = BIF_RETURNONLYFSDIRS
'
bi.ulFlags = BIF_RETURNONLYFSDIRS + BIF_USENEWUI

'show the browse for folders dialog
pidl = SHBrowseForFolder(bi)

'the dialog has closed, so parse & display the
'user's returned folder selection contained in pidl
path = Space$(MAX_PATH)

If SHGetPathFromIDList(ByVal pidl, ByVal path) Then
    pos = InStr(path, Chr$(0))
    GetFolderName = Left(path, pos - 1)
End If

Call CoTaskMemFree(pidl)

End Function

Private Sub txtSite_Path_Change()

    'set up default dirs

    InitSiteFilePath = frmSetup.txtSite_Path
    InitSiteFilePathChanged = True

End Sub

```

H.32 Visual Basic Form Module: Siteform.frm

```

VERSION 5.00
Begin VB.Form frmSite_Data
    Appearance       = 0 'Flat
    BackColor        = &H80000004&
    BorderStyle      = 1 'Fixed Single
    ClientHeight     = 5820
    ClientLeft      = 2115
    ClientTop       = 2625
    ClientWidth     = 9645
    BeginProperty Font
        Name          = "MS Sans Serif"
        Size          = 8.25
        Charset       = 0
        Weight        = 700
        Underline     = 0 'False
        Italic        = 0 'False
        Strikethrough = 0 'False
    EndProperty
    ForeColor        = &H00000000&
    Icon             = "Siteform.frx":0000
    LockControls    = -1 'True
    MaxButton       = 0 'False

```

```

MDIChild      = -1 'True
MinButton     = 0  'False
PaletteMode   = 1  'UseZOrder
ScaleHeight   = 5820
ScaleWidth    = 9645
Begin VB.Frame Frame5
    Caption     = "Site &Name:"
    Height      = 855
    Left        = 1260
    TabIndex    = 15
    Top         = 225
    Width       = 6735
    Begin VB.TextBox txtSite_Name
        BackColor = &H80000004&
        ForeColor  = &H00000000&
        Height     = 360
        Left       = 150
        MultiLine  = -1 'True
        TabIndex   = 0
        Top        = 330
        Width      = 6450
    End
End
Begin VB.Frame Frame4
    BackColor    = &H80000004&
    Caption      = "Site Coordinates:"
    Height       = 1935
    Left         = 1245
    TabIndex     = 14
    Top          = 1305
    Width        = 6735
    Begin VB.TextBox txtLongitude_Seconds
        BackColor = &H80000004&
        ForeColor  = &H00000000&
        Height     = 285
        Left       = 4875
        TabIndex   = 6
        Top        = 1335
        Width      = 540
    End
    Begin VB.TextBox txtLongitude_Minutes
        BackColor = &H80000004&
        ForeColor  = &H00000000&
        Height     = 285
        Left       = 4875
        TabIndex   = 5
        Top        = 1005
        Width      = 540
    End
    Begin VB.TextBox txtLongitude_Degrees
        BackColor = &H80000004&
        ForeColor  = &H00000000&
        Height     = 285
        Left       = 4875
        TabIndex   = 4
        Top        = 645
        Width      = 555
    End
    Begin VB.TextBox txtLatitude_Seconds
        BackColor = &H80000004&
        ForeColor  = &H00000000&
        Height     = 285
        Left       = 2160
        TabIndex   = 3
        Top        = 1335
        Width      = 540
    End
End

```

```

End
Begin VB.TextBox txtLatitude_Minutes
    BackColor      = &H80000004&
    ForeColor      = &H00000000&
    Height         = 285
    Left           = 2160
    TabIndex       = 2
    Top            = 1005
    Width          = 540
End
Begin VB.TextBox txtLatitude_Degrees
    BackColor      = &H80000004&
    ForeColor      = &H00000000&
    Height         = 285
    Left           = 2160
    TabIndex       = 1
    Top            = 645
    Width          = 540
End
Begin VB.Label Label2
    Caption        = "Lon&gitude"
    Height         = 225
    Left           = 3510
    TabIndex       = 23
    Top            = 375
    Width          = 1290
End
Begin VB.Label Label7
    Appearance     = 0 'Flat
    BackColor      = &H80000004&
    Caption        = "Seconds"
    ForeColor      = &H00000000&
    Height         = 240
    Left           = 3900
    TabIndex       = 22
    Top            = 1350
    Width          = 750
End
Begin VB.Label Label6
    Appearance     = 0 'Flat
    BackColor      = &H80000004&
    Caption        = "Minutes"
    ForeColor      = &H00000000&
    Height         = 240
    Left           = 3900
    TabIndex       = 21
    Top            = 1020
    Width          = 750
End
Begin VB.Label Label5
    Appearance     = 0 'Flat
    BackColor      = &H80000004&
    Caption        = "Degrees"
    ForeColor      = &H00000000&
    Height         = 240
    Left           = 3900
    TabIndex       = 20
    Top            = 675
    Width          = 750
End
Begin VB.Label Label1
    Caption        = "&Latitude"
    Height         = 225
    Left           = 735
    TabIndex       = 19
    Top            = 375

```

```

        Width           = 1290
    End
    Begin VB.Label Label10
        Appearance       = 0 'Flat
        BackColor        = &H80000004&
        Caption          = "Seconds"
        ForeColor        = &H00000000&
        Height           = 240
        Left             = 1200
        TabIndex         = 18
        Top              = 1350
        Width            = 750
    End
    Begin VB.Label Label9
        Appearance       = 0 'Flat
        BackColor        = &H80000004&
        Caption          = "Minutes"
        ForeColor        = &H00000000&
        Height           = 240
        Left             = 1200
        TabIndex         = 17
        Top              = 1020
        Width            = 750
    End
    Begin VB.Label Label8
        Appearance       = 0 'Flat
        BackColor        = &H80000004&
        Caption          = "Degrees"
        ForeColor        = &H00000000&
        Height           = 240
        Left             = 1200
        TabIndex         = 16
        Top              = 675
        Width            = 750
    End
    End
    Begin VB.Frame Frame1
        Caption          = "Site &Remarks:"
        Height           = 1335
        Left             = 1260
        TabIndex         = 13
        Top              = 3420
        Width            = 6735
        Begin VB.TextBox txtSite_Remarks
            BackColor     = &H80000004&
            ForeColor     = &H00000000&
            Height        = 960
            Left          = 150
            MultiLine     = -1 'True
            ScrollBars    = 2 'Vertical
            TabIndex      = 7
            Top           = 255
            Width         = 6435
        End
    End
    Begin VB.CommandButton cmdOpen
        Appearance       = 0 'Flat
        BackColor        = &H00E0E0E0&
        Caption          = "S&ites"
        Height           = 480
        Left             = 285
        TabIndex         = 8
        Top              = 5250
        Width            = 1635
    End
    End
    Begin VB.CommandButton cmdSave

```

```

        Appearance      = 0 'Flat
        BackColor       = &H00E0E0E0&
        Caption         = "&Save"
        Height          = 480
        Left             = 3928
        TabIndex        = 10
        Top              = 5250
        Width           = 1728
    End
    Begin VB.CommandButton cmdSave_As
        Appearance      = 0 'Flat
        BackColor       = &H00E0E0E0&
        Caption         = "Save &As"
        Height          = 480
        Left             = 5796
        TabIndex        = 11
        Top              = 5250
        Width           = 1728
    End
    Begin VB.CommandButton cmdPrint
        Appearance      = 0 'Flat
        BackColor       = &H00E0E0E0&
        Caption         = "&Print"
        Height          = 480
        Left             = 7665
        TabIndex        = 12
        Top              = 5250
        Width           = 1728
    End
    Begin VB.CommandButton cmdClose
        Appearance      = 0 'Flat
        BackColor       = &H00E0E0E0&
        Caption         = "&Close"
        Height          = 480
        Left             = 2070
        TabIndex        = 9
        Top              = 5250
        Width           = 1728
    End
End
Attribute VB_Name = "frmSite_Data"
Attribute VB_GlobalNameSpace = False
Attribute VB_Creatable = False
Attribute VB_PredeclaredId = True
Attribute VB_Exposed = False
Option Explicit

'This form allows the user to view and edit site files.

Private Sub cmdClose_Click()

    Dim FName As String

    'This routine checks to see if the user has entered
    'valid input and then unloads the site form. If the
    'user data is incorrect, the program generates
    'a warning.

    Dim temp As Integer

    ' (txtLatitude_Degrees.text = "" And _
    '   txtLatitude_Minutes.text = "" And _
    '   txtLatitude_Seconds.text = "" And _
    '   txtLongitude_Degrees.text = "" And _
    '   txtLongitude_Minutes.text = "" And _
    '   txtLongitude_Seconds.text = "" Then

```



```

'         frmSite_Data.caption = ""
'
'
'
'   If FName <> "" And _
'     (txtLatitude_Degrees.text = "" And _
'       txtLatitude_Minutes.text = "" And _
'       txtLatitude_Seconds.text = "" And _
'       txtLongitude_Degrees.text = "" And _
'       txtLongitude_Minutes.text = "" And _
'       txtLongitude_Seconds.text = "") Then
'
'   If FName <> "" Then
'     temp = verify_input(2)
'   Else
'     frmSite_Data.Hide
'   End If
'
'   temp = verify_input(2)
'
'   frmSite_Data.Hide
'
'   Unload Me
'
End Sub

Private Sub cmdOpen_Click()
'   This routine calls the function which opens a
'   previously created site file.
'
'   Call open_site
'
End Sub

Private Sub cmdPrint_Click()
'   This routine calls a procedure in module "OutPcode" which prints a hardcopy of
'   the information in a site file
'
'   Call print_site
'   Print_Site_File_To_Printer
'
End Sub

Private Sub cmdSave_As_Click()
'   This routine calls a procedure which saves a file
'   by a new name.
'
'   frmMain.mnuSave_Sitecom.Enabled = False
'   frmMain.mnuSave_as_Sitecom.Enabled = False
'
'   Call save_as_site
'
End Sub

'Private Sub cmdSave_Click()
Public Sub cmdSave_Click()
'   This routine calls a procedure which saves a
'   site file.
'
'   Dim i As Integer
'   Dim tempstr As String
'
'   'check if a new file

```

```

i = InStr(frmSite_Data.caption, "NEW_SITE")
If i <> 0 Or frmSite_Data.caption = " (Modified)" Or frmSite_Data.caption = " " Then
    Call cmdSave_As_Click
Else
    'Remove the modified specifier from the file name if necessary.

    i = InStr(frmSite_Data.caption, " (Modified)")
    If i <> 0 Then
        tempstr = Mid$(frmSite_Data.caption, 1, i - 1)
    Else
        tempstr = frmSite_Data.caption
    End If
    frmSite_Data.caption = tempstr

    i = MsgBox(tempstr & " already exists. Would you like to overwrite this file? " & vbCrLf
& _
        " (If not please select Save As).", vbYesNoCancel)
    If i = vbYes Then

        frmMain.mnuSave_Sitecom.Enabled = False
        frmMain.mnuSave_as_Sitecom.Enabled = False

        Call save_site

    End If
End If

'
'check if a new file
'
i = InStr(frmSite_Data.caption, "NEW_SITE")
If i <> 0 Then
    Call cmdSave_As_Click
End If
'
'
'Remove the modified specifier from the file name if necessary.
'
i = InStr(frmSite_Data.caption, " (Modified)")
If i <> 0 Then
    TempStr = Mid$(frmSite_Data.caption, 1, i - 1)
Else
    TempStr = frmSite_Data.caption
End If
'
i = MsgBox(TempStr & " already exists. Would you like to overwrite this file? " & vbCrLf &
'
'
' (If not please select Save As).", vbYesNoCancel)
'
If i = vbYes Then
'
    frmMain.mnuSave_Sitecom.Enabled = False
    frmMain.mnuSave_as_Sitecom.Enabled = False
    cmdSave.Enabled = False
    cmdSave_As.Enabled = False
'
    Call save_site
'
End If
'
End Sub

Private Sub Form_QueryUnload(Cancel As Integer, UnloadMode As Integer)

    frmMain.dlgSecpop.FilterIndex = 1

```

```

'This routine checks to see if the user has entered
'valid input and then unloads the site form. If the
'user data is incorrect, the program generates
'a warning.

Dim temp As Integer

' if all fields are blank, don't verify

If txtLatitude_Degrees.text = "" And _
   txtLatitude_Minutes.text = "" And _
   txtLatitude_Seconds.text = "" And _
   txtLongitude_Degrees.text = "" And _
   txtLongitude_Minutes.text = "" And _
   txtLongitude_Seconds.text = "" Then
   frmSite_Data.caption = ""
Else
   If UnloadMode <> vbFormMDIForm Then 'vbformmdiform: the mdi parent is closing
      temp = verify_input(2)
      frmSite_Data.Hide
      Cancel = True
   End If
End If

frmMain.mnuSave_Sitecom.Enabled = False
frmMain.mnuSave_as_Sitecom.Enabled = False

'   frmSite_Data.Hide
'   Cancel = True

End Sub

Private Sub txtLatitude_Degrees_Change()

   frmRosette.blnInputDataChanged = True

End Sub

Private Sub txtLatitude_Degrees_KeyPress(keyascii As Integer)

   'Verify that the latitude degrees are a number,
   'that the final number is two digits or shorter,
   'and mark the Site file as modified.

'   If ((keyascii < 48) Or (keyascii > 57) Or (Len(frmSite_Data.txtLatitude_Degrees.text) >= 2))
And (keyascii <> 8) And keyascii <> 127 Then
'   If ((keyascii < 48) Or (keyascii > 57) Or (Len(frmSite_Data.txtLatitude_Degrees.text) > 1))
And (keyascii <> 8) And keyascii <> 127 Then
'   If ((keyascii < 48) Or (keyascii > 57) Or (Len(frmSite_Data.txtLatitude_Degrees.text) > 1))
Then
'   If ((keyascii < 48) Or (keyascii > 57) Or  Then

   If (keyascii >= 48 And keyascii <= 57) Or keyascii = 8 Then ' 0-9 or backspace

'   frmMain.mnuSave_Sitecom.Enabled = True
'   frmMain.mnuSave_as_Sitecom.Enabled = True

   If (InStr(frmSite_Data.caption, " (Modified)") = 0) Then
      frmSite_Data.caption = frmSite_Data.caption + " (Modified)"
   End If
   If (InStr(frmProblem_Data.txtSite_File_Name.text, " (Modified)") = 0) Then
      frmProblem_Data.txtSite_File_Name.text = frmSite_Data.caption
   End If

'   If txtLatitude_Degrees <> "" And txtLongitude_Degrees <> "" Then

```

```

'         verify_input (2)
'         End If

Else
    keyascii = 0
    Beep
End If

frmRosette.blnInputDataChanged = True
End Sub

Private Sub txtLatitude_Degrees_LostFocus()

'     If txtLatitude_Degrees <> "" And txtLongitude_Degrees <> "" Then
'         verify_input (2)
'     End If

End Sub

Private Sub txtLatitude_Degrees_Validate(Cancel As Boolean)

    If txtLatitude_Degrees <> "" And txtLongitude_Degrees <> "" Then
        verify_input (2)
    End If

End Sub

Private Sub txtLatitude_Minutes_Change()

    frmRosette.blnInputDataChanged = True

End Sub

Private Sub txtLatitude_Minutes_KeyPress(keyascii As Integer)

    'For documentation, see latitude degrees.

    If (keyascii >= 48 And keyascii <= 57) Or keyascii = 8 Then ' 0-9 or backspace
'
'         frmMain.mnuSave_Sitecom.Enabled = True
'         frmMain.mnuSave_as_Sitecom.Enabled = True

        If (InStr(frmSite_Data.caption, " (Modified)") = 0) Then
            frmSite_Data.caption = frmSite_Data.caption + " (Modified)"
        End If
        If (InStr(frmProblem_Data.txtSite_File_Name.text, " (Modified)") = 0) Then
            frmProblem_Data.txtSite_File_Name.text = frmSite_Data.caption
        End If

    Else

        keyascii = 0
        Beep

    End If

    frmRosette.blnInputDataChanged = True

End Sub

Private Sub txtLatitude_Minutes_Validate(Cancel As Boolean)

    If frmSite_Data.txtLatitude_Minutes <> "" Then
        If frmSite_Data.txtLatitude_Minutes.text > 60 Then
            MsgBox "Please enter a value for latitude minutes that is less or equal to 60"

```

```

        frmSite_Data.txtLatitude_Minutes.text = ""
        Cancel = True
    End If
End If

End Sub

Private Sub txtLatitude_Seconds_Change()
    frmRosette.blnInputDataChanged = True
End Sub

Private Sub txtLatitude_Seconds_KeyPress(keyascii As Integer)
    'For documentation, see latitude degrees.
    If (keyascii >= 48 And keyascii <= 57) Or keyascii = 8 Then ' 0-9 or backspace
'        frmMain.mnuSave_Sitecom.Enabled = True
'        frmMain.mnuSave_as_Sitecom.Enabled = True

        If (InStr(frmSite_Data.caption, " (Modified)") = 0) Then
            frmSite_Data.caption = frmSite_Data.caption + " (Modified)"
        End If
        If (InStr(frmProblem_Data.txtSite_File_Name.text, " (Modified)") = 0) Then
            frmProblem_Data.txtSite_File_Name.text = frmSite_Data.caption
        End If

    Else

        keyascii = 0
        Beep

    End If

    frmRosette.blnInputDataChanged = True
End Sub

Private Sub txtLatitude_Seconds_Validate(Cancel As Boolean)
    If frmSite_Data.txtLatitude_Seconds <> "" Then
        If frmSite_Data.txtLatitude_Seconds.text > 60 Then
            MsgBox "Please enter a value for latitude seconds that is less or equal to 60"
            frmSite_Data.txtLatitude_Seconds.text = ""
            Cancel = True
        End If
    End If
End Sub

Private Sub txtLongitude_Degrees_Change()
    frmRosette.blnInputDataChanged = True
End Sub

Private Sub txtLongitude_Degrees_KeyPress(keyascii As Integer)
    If (keyascii >= 48 And keyascii <= 57) Or keyascii = 8 Then ' 0-9 or backspace
'        frmMain.mnuSave_Sitecom.Enabled = True
'        frmMain.mnuSave_as_Sitecom.Enabled = True

        If (InStr(frmSite_Data.caption, " (Modified)") = 0) Then

```

```

        frmSite_Data.caption = frmSite_Data.caption + " (Modified)"
    End If
    If (InStr(frmProblem_Data.txtSite_File_Name.text, " (Modified)") = 0) Then
        frmProblem_Data.txtSite_File_Name.text = frmSite_Data.caption
    End If

'
'   If txtLatitude_Degrees <> "" And txtLongitude_Degrees <> "" Then
'       verify_input (2)
'   End If

Else

    keyascii = 0
    Beep

End If

    frmRosette.blnInputDataChanged = True

End Sub

Private Sub txtLongitude_Degrees_LostFocus()

'   If txtLatitude_Degrees <> "" And txtLongitude_Degrees <> "" Then
'       verify_input (2)
'   End If

End Sub

Private Sub txtLongitude_Degrees_Validate(Cancel As Boolean)

    If txtLatitude_Degrees <> "" And txtLongitude_Degrees <> "" Then
        verify_input (2)
    End If

End Sub

Private Sub txtLongitude_Minutes_Change()

    frmRosette.blnInputDataChanged = True

End Sub

Private Sub txtLongitude_Minutes_KeyPress(keyascii As Integer)

    'For documentation, see longitude degrees.

    If (keyascii >= 48 And keyascii <= 57) Or keyascii = 8 Then ' 0-9 or backspace

'       frmMain.mnuSave_Sitecom.Enabled = True
'       frmMain.mnuSave_as_Sitecom.Enabled = True

        If (InStr(frmSite_Data.caption, " (Modified)") = 0) Then
            frmSite_Data.caption = frmSite_Data.caption + " (Modified)"
        End If
        If (InStr(frmProblem_Data.txtSite_File_Name.text, " (Modified)") = 0) Then
            frmProblem_Data.txtSite_File_Name.text = frmSite_Data.caption
        End If

    Else

        keyascii = 0
        Beep

    End If

```

```

frmRosette.blnInputDataChanged = True
End Sub
Private Sub txtLongitude_Minutes_Validate(Cancel As Boolean)

    If frmSite_Data.txtLongitude_Minutes <> "" Then
        If frmSite_Data.txtLongitude_Minutes.text > 60 Then
            MsgBox "Please enter a value for longitude minutes that is less or equal to 60"
            frmSite_Data.txtLongitude_Minutes.text = ""
            Cancel = True
        End If
    End If
End Sub
Private Sub txtLongitude_Seconds_Change()

    frmRosette.blnInputDataChanged = True
End Sub
Private Sub txtLongitude_Seconds_KeyPress(keyascii As Integer)

    'For documentation, see longitude degrees.

    ' 48 = 0
    ' 57 = 9
    ' 8 = backspace

    If (keyascii >= 48 And keyascii <= 57) Or keyascii = 8 Then ' 0-9 or backspace
        frmMain.mnuSave_Sitecom.Enabled = True
        frmMain.mnuSave_as_Sitecom.Enabled = True

        If (InStr(frmSite_Data.caption, " (Modified)") = 0) Then
            frmSite_Data.caption = frmSite_Data.caption + " (Modified)"
        End If
        If (InStr(frmProblem_Data.txtSite_File_Name.text, " (Modified)") = 0) Then
            frmProblem_Data.txtSite_File_Name.text = frmSite_Data.caption
        End If

    Else

        keyascii = 0
        Beep

    End If

    frmRosette.blnInputDataChanged = True
End Sub
Private Sub txtLongitude_Seconds_Validate(Cancel As Boolean)

    If frmSite_Data.txtLongitude_Seconds <> "" Then
        If frmSite_Data.txtLongitude_Seconds.text > 60 Then
            MsgBox "Please enter a value for longitude seconds that is less or equal to 60"
            frmSite_Data.txtLongitude_Seconds.text = ""
            Cancel = True
        End If
    End If
End Sub

```

```

Private Sub txtSite_Name_Change()
    frmRosette.blnInputDataChanged = True
End Sub

Private Sub txtSite_Name_KeyPress(keyascii As Integer)

    'Disable the return key in the site field, and mark
    'the site form as modified.

    If keyascii = KEY_RETURN Then

        keyascii = 0
        MsgBox "Sorry, no hard returns allowed." + Chr$(13) + "Words will wrap automatically.",
vbOK, "Error"

    Else

'        frmMain.mnuSave_Sitecom.Enabled = True
'        frmMain.mnuSave_as_Sitecom.Enabled = True

        If (InStr(frmSite_Data.caption, " (Modified)") = 0) Then
            frmSite_Data.caption = frmSite_Data.caption + " (Modified)"
        End If
        If (InStr(frmProblem_Data.txtSite_File_Name.text, " (Modified)") = 0) Then
            frmProblem_Data.txtSite_File_Name.text = frmSite_Data.caption
        End If

    End If

    frmRosette.blnInputDataChanged = True
End Sub

Private Sub txtSite_Remarks_KeyPress(keyascii As Integer)

    'Disable the enter key in the remarks field, and
    'Mark the site form as modified.
    If keyascii = KEY_RETURN Then

        keyascii = 0
        MsgBox "Sorry, no hard returns allowed." + Chr$(13) + "Words will wrap automatically.",
vbOK, "Error"

    Else

'        frmMain.mnuSave_Sitecom.Enabled = True
'        frmMain.mnuSave_as_Sitecom.Enabled = True

        If (InStr(frmSite_Data.caption, " (Modified)") = 0) Then
            frmSite_Data.caption = frmSite_Data.caption + " (Modified)"
        End If
        If (InStr(frmProblem_Data.txtSite_File_Name.text, " (Modified)") = 0) Then
            frmProblem_Data.txtSite_File_Name.text = frmSite_Data.caption
        End If

    End If

End Sub

```

H-33 Visual Basic Form Module: Table1.frm

```
VERSION 5.00
Begin VB.Form frmTable_1
    Appearance = 0 'Flat
    AutoRedraw = -1 'True
    BackColor = &H80000004&
    BorderStyle = 1 'Fixed Single
    Caption = "Population Table"
    ClientHeight = 4680
    ClientLeft = 30
    ClientTop = 570
    ClientWidth = 8355
    BeginProperty Font
        Name = "MS Sans Serif"
        Size = 8.25
        Charset = 0
        Weight = 700
        Underline = 0 'False
        Italic = 0 'False
        Strikethrough = 0 'False
    EndProperty
    ForeColor = &H00000000&
    MaxButton = 0 'False
    MinButton = 0 'False
    PaletteMode = 1 'UseZOrder
    ScaleHeight = 4680
    ScaleWidth = 8355
    StartUpPosition = 1 'CenterOwner
    Begin VB.Frame Frame1
        Appearance = 0 'Flat
        BackColor = &H80000004&
        ForeColor = &H00000000&
        Height = 4320
        Left = 108
        TabIndex = 31
        Top = 0
        Width = 6696
    End
    Begin VB.HScrollBar hsbRadii
        Height = 240
        Left = 216
        Max = 50
        Min = 1
        TabIndex = 29
        Top = 4080
        Value = 1
        Width = 6480
    End
    Begin VB.VScrollBar vsbSectors
        Height = 3840
        Left = 6696
        Max = 16
        Min = 1
        TabIndex = 30
        Top = 240
        Value = 1
        Width = 108
    End
    Begin VB.CommandButton cmdexit
        Appearance = 0 'Flat
        BackColor = &H00808000&
        Caption = "&Close"
```

```

    Default      = -1 'True
    Height       = 720
    Left         = 7020
    TabIndex     = 1
    Top          = 1440
    Width        = 972
End
Begin VB.CommandButton cmdprint
    Appearance    = 0 'Flat
    BackColor     = &H00808000&
    Caption       = "&Print"
    Height        = 720
    Left          = 7020
    TabIndex     = 0
    Top           = 2160
    Width         = 972
End
Begin VB.Label lblCsum_array
    Alignment     = 1 'Right Justify
    Appearance    = 0 'Flat
    BackColor     = &H00808000&
    Caption       = "123Sum789"
    ForeColor     = &H00000000&
    Height        = 240
    Index         = 4
    Left          = 5508
    TabIndex     = 32
    Top           = 2880
    Width         = 972
End
Begin VB.Label lblCsum_array
    Alignment     = 1 'Right Justify
    Appearance    = 0 'Flat
    BackColor     = &H00808000&
    Caption       = "123Sum789"
    ForeColor     = &H00000000&
    Height        = 240
    Index         = 5
    Left          = 5508
    TabIndex     = 33
    Top           = 3360
    Width         = 972
End
Begin VB.Label lblCsum_array
    Alignment     = 1 'Right Justify
    Appearance    = 0 'Flat
    BackColor     = &H00808000&
    Caption       = "123Sum789"
    ForeColor     = &H00000000&
    Height        = 240
    Index         = 3
    Left          = 5508
    TabIndex     = 24
    Top           = 2400
    Width         = 972
End
Begin VB.Label lblCsum_array
    Alignment     = 1 'Right Justify
    Appearance    = 0 'Flat
    BackColor     = &H00808000&
    Caption       = "123Sum789"
    ForeColor     = &H00000000&
    Height        = 240
    Index         = 2
    Left          = 5508
    TabIndex     = 25

```

```

        Top           = 1920
        Width         = 972
End
Begin VB.Label lblCsum_array
    Alignment        = 1 'Right Justify
    Appearance       = 0 'Flat
    BackColor        = &H00808000&
    Caption          = "123Sum789"
    ForeColor        = &H00000000&
    Height           = 240
    Index            = 1
    Left             = 5508
    TabIndex         = 26
    Top              = 1440
    Width            = 972
End
Begin VB.Label lblCsum_array
    Alignment        = 1 'Right Justify
    Appearance       = 0 'Flat
    BackColor        = &H00808000&
    Caption          = "123Sum789"
    ForeColor        = &H00000000&
    Height           = 240
    Index            = 0
    Left             = 5508
    TabIndex         = 27
    Top              = 960
    Width            = 972
End
Begin VB.Label lblTotal
    Alignment        = 1 'Right Justify
    Appearance       = 0 'Flat
    BackColor        = &H00808000&
    Caption          = "SumSum789"
    ForeColor        = &H00000000&
    Height           = 240
    Left             = 5508
    TabIndex         = 34
    Top              = 3840
    Width            = 972
End
Begin VB.Label Label21
    Appearance       = 0 'Flat
    AutoSize         = -1 'True
    BackColor        = &H00808000&
    Caption          = "Sum"
    ForeColor        = &H00000000&
    Height           = 240
    Left             = 5832
    TabIndex         = 9
    Top              = 480
    Width            = 324
End
Begin VB.Label lblCumulative_Header
    Appearance       = 0 'Flat
    AutoSize         = -1 'True
    BackColor        = &H00808000&
    Caption          = "Sum"
    ForeColor        = &H00000000&
    Height           = 240
    Left             = 324
    TabIndex         = 14
    Top              = 3840
    Width            = 324
End
Begin VB.Label lblSector_array

```

```

    Appearance      = 0 'Flat
    BackColor       = &H00808000&
    Caption         = "A"
    ForeColor       = &H00000000&
    Height          = 240
    Index           = 0
    Left            = 324
    TabIndex        = 15
    Top             = 960
    Width           = 324
End
Begin VB.Label lblSector_array
    Appearance      = 0 'Flat
    BackColor       = &H00808000&
    Caption         = "B"
    ForeColor       = &H00000000&
    Height          = 240
    Index           = 1
    Left            = 324
    TabIndex        = 16
    Top             = 1440
    Width           = 324
End
Begin VB.Label lblSector_array
    Appearance      = 0 'Flat
    BackColor       = &H00808000&
    Caption         = "C"
    ForeColor       = &H00000000&
    Height          = 240
    Index           = 2
    Left            = 324
    TabIndex        = 17
    Top             = 1920
    Width           = 324
End
Begin VB.Label lblSector_array
    Appearance      = 0 'Flat
    BackColor       = &H00808000&
    Caption         = "D"
    ForeColor       = &H00000000&
    Height          = 240
    Index           = 3
    Left            = 324
    TabIndex        = 18
    Top             = 2400
    Width           = 324
End
Begin VB.Label lblSector_array
    Appearance      = 0 'Flat
    BackColor       = &H00808000&
    Caption         = "E"
    ForeColor       = &H00000000&
    Height          = 240
    Index           = 4
    Left            = 324
    TabIndex        = 19
    Top             = 2880
    Width           = 324
End
Begin VB.Label lblSector_array
    Appearance      = 0 'Flat
    BackColor       = &H00808000&
    Caption         = "F"
    ForeColor       = &H00000000&
    Height          = 240
    Index           = 5

```

```

    Left           = 324
    TabIndex      = 28
    Top           = 3360
    Width         = 324
End
Begin VB.Label lblRsum_array
    Alignment     = 1 'Right Justify
    Appearance    = 0 'Flat
    BackColor     = &H00808000&
    Caption       = "Sum456789"
    ForeColor     = &H00000000&
    Height        = 240
    Index         = 0
    Left          = 972
    TabIndex      = 20
    Top           = 3840
    Width         = 972
End
Begin VB.Label lblRsum_array
    Alignment     = 1 'Right Justify
    Appearance    = 0 'Flat
    BackColor     = &H00808000&
    Caption       = "Sum456789"
    ForeColor     = &H00000000&
    Height        = 240
    Index         = 1
    Left          = 2052
    TabIndex      = 21
    Top           = 3840
    Width         = 972
End
Begin VB.Label lblRsum_array
    Alignment     = 1 'Right Justify
    Appearance    = 0 'Flat
    BackColor     = &H00808000&
    Caption       = "Sum456789"
    ForeColor     = &H00000000&
    Height        = 240
    Index         = 2
    Left          = 3132
    TabIndex      = 22
    Top           = 3840
    Width         = 972
End
Begin VB.Label lblRsum_array
    Alignment     = 1 'Right Justify
    Appearance    = 0 'Flat
    BackColor     = &H00808000&
    Caption       = "Sum456789"
    ForeColor     = &H00000000&
    Height        = 240
    Index         = 3
    Left          = 4212
    TabIndex      = 23
    Top           = 3840
    Width         = 972
End
Begin VB.Label lblDistance_array
    Alignment     = 1 'Right Justify
    Appearance    = 0 'Flat
    BackColor     = &H00808000&
    Caption       = "1000.0000"
    ForeColor     = &H00000000&
    Height        = 240
    Index         = 0
    Left          = 972

```

```

    TabIndex      = 10
    Top           = 480
    Width        = 972
End
Begin VB.Label lblDistance_array
    Alignment     = 1 'Right Justify
    Appearance    = 0 'Flat
    BackColor     = &H00808000&
    Caption       = "2000.0000"
    ForeColor     = &H00000000&
    Height       = 240
    Index        = 1
    Left         = 2052
    TabIndex     = 11
    Top          = 480
    Width       = 972
End
Begin VB.Label lblDistance_array
    Alignment     = 1 'Right Justify
    Appearance    = 0 'Flat
    BackColor     = &H00808000&
    Caption       = "3000.0000"
    ForeColor     = &H00000000&
    Height       = 240
    Index        = 2
    Left         = 3132
    TabIndex     = 12
    Top          = 480
    Width       = 972
End
Begin VB.Label lblDistance_array
    Alignment     = 1 'Right Justify
    Appearance    = 0 'Flat
    BackColor     = &H00808000&
    Caption       = "4000.0000"
    ForeColor     = &H00000000&
    Height       = 240
    Index        = 3
    Left         = 4212
    TabIndex     = 13
    Top          = 480
    Width       = 972
End
Begin VB.Label lblValue_array
    Appearance    = 0 'Flat
    BackColor     = &H00808000&
    BorderStyle   = 1 'Fixed Single
    Caption       = " 123456789 123456789 123456789 123456789 "
    ForeColor     = &H00000000&
    Height       = 720
    Index        = 0
    Left         = 756
    TabIndex     = 2
    Top          = 720
    Width       = 4644
End
Begin VB.Label lblValue_array
    Appearance    = 0 'Flat
    BackColor     = &H00808000&
    BorderStyle   = 1 'Fixed Single
    Caption       = " 123456789 123456789 123456789 123456789 "
    ForeColor     = &H00000000&
    Height       = 720
    Index        = 1
    Left         = 756
    TabIndex     = 3

```

```

        Top           = 1200
        Width         = 4644
    End
    Begin VB.Label lblValue_array
        Appearance     = 0 'Flat
        BackColor      = &H00808000&
        BorderStyle    = 1 'Fixed Single
        Caption        = " 123456789 123456789 123456789 123456789 "
        ForeColor      = &H00000000&
        Height         = 720
        Index          = 2
        Left           = 756
        TabIndex       = 4
        Top           = 1680
        Width          = 4644
    End
    Begin VB.Label lblValue_array
        Appearance     = 0 'Flat
        BackColor      = &H00808000&
        BorderStyle    = 1 'Fixed Single
        Caption        = " 123456789 123456789 123456789 123456789 "
        ForeColor      = &H00000000&
        Height         = 720
        Index          = 3
        Left           = 756
        TabIndex       = 5
        Top           = 2160
        Width          = 4644
    End
    Begin VB.Label lblValue_array
        Appearance     = 0 'Flat
        BackColor      = &H00808000&
        BorderStyle    = 1 'Fixed Single
        Caption        = " 123456789 123456789 123456789 123456789 "
        ForeColor      = &H00000000&
        Height         = 720
        Index          = 4
        Left           = 756
        TabIndex       = 6
        Top           = 2640
        Width          = 4644
    End
    Begin VB.Label lblValue_array
        Appearance     = 0 'Flat
        BackColor      = &H00808000&
        BorderStyle    = 1 'Fixed Single
        Caption        = " 123456789 123456789 123456789 123456789 "
        ForeColor      = &H00000000&
        Height         = 720
        Index          = 5
        Left           = 756
        TabIndex       = 7
        Top           = 3120
        Width          = 4644
    End
    End
    Begin VB.Label lblDistance_Heading
        Alignment      = 2 'Center
        Appearance     = 0 'Flat
        BackColor      = &H00808000&
        Caption        = "Radii (Kilometers)"
        ForeColor      = &H00000000&
        Height         = 240
        Left           = 2160
        TabIndex       = 8
        Top           = 240
        Width          = 1944
    End

```

```

    End
End
Attribute VB_Name = "frmTable_1"
Attribute VB_GlobalNameSpace = False
Attribute VB_Creatable = False
Attribute VB_PredeclaredId = True
Attribute VB_Exposed = False
'''Option Explicit
'''
'''$INCLUDE: 'secpop90.bi'
'''
'''This is the actual table form for table 1. See rptable_1 for more
'''info.
'''
'''Private Sub cmdExit_Click()
'''
'''    'Remove table 1 from memory.
'''
'''    Unload frmTable_1
'''
'''End Sub
'''Private Sub cmdPrint_Click()
'''
'''    'This routine prints the displayed population table.
'''
'''    Dim ForeColor As Integer, BackColor As Integer
'''    Dim Copies As Integer, Cancel As Integer
'''    Dim quote As String, comma As String
'''    Dim blank As String, degree As String
'''    Dim pages As Integer, radius As Integer
'''    Dim first_radius As Integer, last_radius As Integer
'''    Dim i As Integer, j As Integer, k As Integer
'''    Dim L As Integer, m As Integer, n As Integer
'''    Dim sum As Long
'''
'''
'''    'Set quote and comma strings to null if MACCS input file format is
'''    'selected or to "" and ',' if comma separated variable (CSV) format
'''    'is selected.
'''
'''    If (frmSetup.optMACCS.Value) Then
'''        quote = ""
'''        comma = ""
'''        blank = " "
'''    ElseIf (frmSetup.optCSV.Value) Then
'''        quote = """"
'''        comma = ","
'''        blank = " "
'''    Else
'''        quote = ""
'''        comma = ""
'''        blank = " "
'''    End If
'''
'''    'Set degree character.
'''
'''    degree = Chr$(248)
'''
'''    'Set colors for Dialog box
'''
'''    BackColor = vbWhite
'''    ForeColor = vbBlack
'''
'''    'Call the standard print dialog.
'''
'''

```



```

''' Call FilePrint(Copies, ForeColor, BackColor, Cancel)
'''
''' 'If cancel is not selected by user in the printer dialogue box,
''' 'then proceed.
'''
''' If (Not Cancel) Then
'''
'''     'Enable local error checking.
'''
'''     On Local Error GoTo table1_printer_error
'''
'''     'If the user is printing to a printer adjust the margins so that
'''     'there are no extra line feeds after the lines that have 80
'''     'columns otherwise prepend the output path to the printer
'''     'target.
'''
'''     If ((Printer.PrintTarget = "LPT1:") Or _
'''         (Printer.PrintTarget = "LPT2:") Or _
'''         (Printer.PrintTarget = "LPT3:")) Then
'''
'''         width printer.PrintTarget, 81
'''
'''     Else
'''
'''         Printer.PrintTarget = frmSetup.txtOutput_path.text + _
'''             "\" + Printer.PrintTarget
'''
'''     End If
'''
'''     'Determine the number of "pages" that need to be printed per
'''     'copy. A single page is considered to be 16 directions and a
'''     'sum row long, by at most 6 radii or 5 radii and a sum column.
'''
'''     pages = (number_of_radii + 1) \ 6
'''     If ((number_of_radii + 1) Mod 6) <> 0) Then
'''         pages = pages + 1
'''     End If
'''
'''     'Execute loop once for each copy requested by the user.
'''
'''     For i = 1 To Copies Step 1
'''
'''         'Print the first line.
'''
'''         Printer.Print quote;
'''         Printer.Print "SECP90 V2.3 ";
'''         If (table_type = 1) Then
'''             Printer.Print "Population Data";
'''         Else
'''             Printer.Print "Cumulative Population Data";
'''         End If
'''         Printer.Print quote;
'''         Printer.Print
'''
'''         'Print the second line.
'''
'''         Printer.Print quote;
'''         Printer.Print "Date:";
'''         Printer.Print quote; comma; blank;
'''         Printer.Print quote;
'''         Printer.Print Format$(Now, "mm/dd/yyyy");
'''         Printer.Print quote; comma; blank; blank; blank;
'''         Printer.Print quote;
'''         Printer.Print "Time:";
'''         Printer.Print quote; comma; blank;
'''         Printer.Print quote;

```

```

'''
Printer.Print Format$(Now, "hh:mm:ss");
Printer.Print quote;
Printer.Print
'''
'Print the third line.
'''
Printer.Print quote;
Printer.Print "Site Name:";
Printer.Print quote; comma; blank;
Printer.Print quote;
Printer.Print _
    LTrim$(RTrim$(frmSite_Data.txtSite_Name.text));
Printer.Print quote;
Printer.Print
'''
'Print the fourth line.
'''
Printer.Print quote;
Printer.Print "Latitude:";
Printer.Print quote; comma; blank;
Printer.Print USING; "##"; _
    Val(frmSite_Data.txtLatitude_Degrees.text);
Printer.Print comma;
Printer.Print quote;
Printer.Print degree;
Printer.Print quote; comma;
Printer.Print USING; "##"; _
    Val(frmSite_Data.txtLatitude_Minutes.text);
Printer.Print comma;
Printer.Print quote;
Printer.Print "'";
Printer.Print quote; comma;
Printer.Print USING; "##"; _
    Val(frmSite_Data.txtLatitude_Seconds.text);
Printer.Print comma;
Printer.Print quote;
Printer.Print "'";
Printer.Print quote; comma; blank; blank; blank;
Printer.Print quote;
Printer.Print "Longitude:";
Printer.Print quote; comma; blank;
Printer.Print USING; "###"; _
    Val(frmSite_Data.txtLongitude_Degrees.text);
Printer.Print comma;
Printer.Print quote;
Printer.Print degree;
Printer.Print quote; comma;
Printer.Print USING; "##"; _
    Val(frmSite_Data.txtLongitude_Minutes.text);
Printer.Print comma;
Printer.Print quote;
Printer.Print "'";
Printer.Print quote; comma;
Printer.Print USING; "##"; _
    Val(frmSite_Data.txtLongitude_Seconds.text);
Printer.Print comma;
Printer.Print quote;
Printer.Print "'";
Printer.Print quote;
Printer.Print
'''
'Print the fifth line.
'''
Printer.Print quote;
Printer.Print "Population Multiplier:";
Printer.Print quote; comma; blank;
'''

```



```

'''      Exit Sub
'''
'''table1_printer_error:
'''
'''      'If there is a problem, tell the user and exit the subroutine.
'''
'''      MsgBox Error$(Err)
'''
'''      Exit Sub
'''
'''End Sub
'''Private Sub Form_Load()
'''
'''      'Perform first call to paint table to initialize the table.
'''
'''      Unload frmDisclaimer
'''
'''      x_position = 1
'''      y_position = 1
'''      Call paint_table
'''
'''End Sub
'''Private Sub hsbRadii_Change()
'''
'''      x_position = hsbRadii.Value
'''      Call paint_table
'''
'''End Sub
'''Private Sub vsbSectors_Change()
'''
'''      y_position = vsbSectors.Value
'''      Call paint_table
'''
'''End Sub

Private Sub cmdPrint_Click()

    Call Print_Table_File_to_Printer

End Sub

```

H.34 Visual Basic Form Module: Welcome.frm

```
VERSION 5.00
Begin VB.Form frmDisclaimer
    Appearance = 0 'Flat
    AutoRedraw = -1 'True
    BorderStyle = 1 'Fixed Single
    Caption = "Welcome"
    ClientHeight = 6915
    ClientLeft = 1110
    ClientTop = 810
    ClientWidth = 9570
    BeginProperty Font
        Name = "Times New Roman"
        Size = 12
        Charset = 0
        Weight = 700
        Underline = 0 'False
        Italic = 0 'False
        Strikethrough = 0 'False
    EndProperty
    ForeColor = &H00000000&
    Icon = "Welcome.frx":0000
    MaxButton = 0 'False
    MDIChild = -1 'True
    MinButton = 0 'False
    PaletteMode = 1 'UseZOrder
    ScaleHeight = 6915
    ScaleWidth = 9570
    Begin VB.CommandButton Command1
        Caption = "OK"
        Height = 465
        Left = 7560
        TabIndex = 0
        Top = 6285
        Width = 1575
    End
    Begin VB.Label Label4
        BackColor = &H80000004&
        BackStyle = 0 'Transparent
        Caption = $"Welcome.frx":0CCA
        Height = 2505
        Left = 300
        TabIndex = 3
        Top = 930
        Width = 9075
    End
    Begin VB.Label Label2
        BackColor = &H80000004&
        BackStyle = 0 'Transparent
        Caption = $"Welcome.frx":0F5B
        Height = 2670
        Left = 315
        TabIndex = 2
        Top = 3465
        Width = 9030
    End
    Begin VB.Label Label1
        BackStyle = 0 'Transparent
        Caption = "Welcome to SECPOP2000"
        BeginProperty Font
            Name = "Times New Roman"
            Size = 15.75
        EndProperty
    End
End
```

```

        Charset          = 0
        Weight           = 700
        Underline        = 0 'False
        Italic           = 0 'False
        Strikethrough    = 0 'False
    EndProperty
    Height              = 345
    Left                = 3075
    TabIndex            = 1
    Top                 = 300
    Width               = 4035
End
Begin VB.Image Image1
    Height              = 4485
    Left                = 270
    Picture             = "Welcome.frx":1216
    Top                 = 120
    Visible             = 0 'False
    Width               = 4500
End
End
Attribute VB_Name = "frmDisclaimer"
Attribute VB_GlobalNameSpace = False
Attribute VB_Creatable = False
Attribute VB_PredeclaredId = True
Attribute VB_Exposed = False
'This is just your general purpose information and disclaimer message
'which is displayed at the beginning of the program.

Private Sub Command1_Click()
    Unload Me
End Sub

Private Sub Form_KeyPress(keyascii As Integer)

    Unload frmDisclaimer

End Sub

Private Sub Form_Load()

    Me.Top = 50
    Me.Left = 1000

End Sub

Private Sub Form_LostFocus()

    Unload frmDisclaimer

End Sub

Private Sub lblNotice_Click()

    Unload frmDisclaimer

End Sub

```

H.36 Visual Basic Class Module: GridClass.cls

```
VERSION 1.0 CLASS
BEGIN
    MultiUse = -1 'True
    Persistable = 0 'NotPersistable
    DataBindingBehavior = 0 'vbNone
    DataSourceBehavior = 0 'vbNone
    MSTransactionMode = 0 'NotAnMTSObject
END
Attribute VB_Name = "GridClass"
Attribute VB_GlobalNameSpace = False
Attribute VB_Creatable = True
Attribute VB_PredeclaredId = False
Attribute VB_Exposed = False
Option Explicit

Private WithEvents TDBG As TrueDBGrid70.TDBGGrid
Attribute TDBG.VB_VarHelpID = -1
Private GridArray() As Variant
Private MaxCol As Integer
Private MaxRow As Long

Public Sub Attach(g As TrueDBGrid70.TDBGGrid)
    Set TDBG = g
End Sub

' Returns number of rows
Public Property Get RowCount()
    RowCount = MaxRow
End Property

' Returns number of columns
Public Property Get ColCount()
    ColCount = MaxCol
End Property

' Retrieves value from our array
Public Property Get Value(ByVal Rows As Long, ByVal Cols As Integer)
    Value = GridArray(Cols, Rows)
End Property

' Sets value from array
Public Property Let Value(ByVal Rows As Long, ByVal Cols As Integer, ByVal Val As Variant)
    GridArray(Cols, Rows) = Val
End Property

' Initialises array
Public Sub SetDims(ByVal Rows As Long, ByVal Cols As Integer)
    If Rows <= 0 And Cols > 0 Then
        ReDim GridArray(0 To Cols - 1, 0)
    ElseIf Rows <= 0 And Cols <= 0 Then
        ReDim GridArray(0, 0)
    ElseIf Rows > 0 And Cols <= 0 Then
        ReDim GridArray(0, 0 To Rows - 1)
    Else
        ReDim GridArray(0 To Cols - 1, 0 To Rows - 1)
    End If

    MaxRow = Rows
    MaxCol = Cols
End Sub
```



```

' Fired when a new record is added

Private Sub TDBG_UnboundAddData(ByVal RowBuf As TrueDBGrid70.RowBuffer, NewRowBookmark As
Variant)
    Dim col As Integer

    On Error GoTo NoAdd

    ' Add one row
    MaxRow = MaxRow + 1
    ReDim Preserve GridArray(0 To MaxCol - 1, 0 To MaxRow - 1)

    ' Cells that have been modified are non Null
    For col = 0 To RowBuf.ColumnCount - 1
        If Not IsNull(RowBuf.Value(0, col)) Then
            GridArray(col, MaxRow - 1) = RowBuf.Value(0, col)
        Else
            ' Fill in a default value
            GridArray(col, MaxRow - 1) = TDBG.Columns(col).DefaultValue
        End If
    Next col

    ' Return the bookmark for this row
    NewRowBookmark = MaxRow - 1

    ' Calibrate the VScroll bar
    TDBG.ApproxCount = MaxRow

Exit Sub
NoAdd:
    RowBuf.RowCount = 0
End Sub

'' Fired upon deleting a row
Private Sub TDBG_UnboundDeleteRow(Bookmark As Variant)
    Dim row As Long, col As Integer
    '
    ' On Error GoTo NoDelete
    ' MaxRow = MaxRow - 1
    '
    ' Shift all rows up by one
    For row = Bookmark To MaxRow - 1
        For col = 0 To MaxCol - 1
            GridArray(col, row) = GridArray(col, row + 1)
        Next col
    Next row
    '
    ' Resize the array
    If MaxRow > 0 Then
        ReDim Preserve GridArray(0 To MaxCol - 1, 0 To MaxRow - 1)
    Else
        ReDim Preserve GridArray(0 To MaxCol - 1, 0)
    End If
    '
    ' Calibrate the VScroll bar
    TDBG.ApproxCount = MaxRow
Exit Sub
'
'NoDelete:
'    Bookmark = Null
'End Sub

' Fired when the grid needs a bookmark or data

```

```

Private Sub TDBG_UnboundReadDataEx(ByVal RowBuf As TrueDBGrid70.RowBuffer, StartLocation As
Variant, ByVal offset As Long, ApproximatePosition As Long)
    Dim ColIndex As Integer, j As Integer
    Dim RowsFetched As Integer, i As Long
    Dim NewPosition As Long, Bookmark As Long
    Dim StartRow As Long

    Dim Cols As Long, Rows As Long
    Cols = RowBuf.ColumnCount - 1
    Rows = RowBuf.RowCount - 1

    RowsFetched = 0

    If IsNull(StartLocation) Then
        ' StartLocation refers to either BOF (-1) or EOF (MaxRow)
        StartRow = IIf(offset < 0, MaxRow + offset, -1 + offset)
    Else
        ' StartLocation is an actual bookmark
        StartRow = StartLocation + offset
    End If

    For i = 0 To Rows
        Bookmark = StartRow + i
        ' If we are out of bounds quit this loop
        If Bookmark < 0 Or Bookmark >= MaxRow Then Exit For

        ' Fill the RowBuffer with data
        For j = 0 To Cols
            ColIndex = RowBuf.ColumnIndex(i, j)
            RowBuf.Value(i, j) = GridArray(ColIndex, Bookmark)
        Next j

        ' Assign a bookmark for this row
        RowBuf.Bookmark(i) = Bookmark
        ' Increment number of rows fetched
        RowsFetched = RowsFetched + 1
    Next i

    RowBuf.RowCount = RowsFetched

    ' Callibrate the VScroll bar
    If StartRow >= 0 Then ApproximatePosition = StartRow
End Sub

' Fired when the user modifies an existing row

Private Sub TDBG_UnboundWriteData(ByVal RowBuf As TrueDBGrid70.RowBuffer, WriteLocation As
Variant)
    Dim col As Integer

    On Error GoTo NoWrite

    ' Write modified cells
    For col = 0 To RowBuf.ColumnCount - 1
        If Not IsNull(RowBuf.Value(0, col)) Then
            GridArray(col, WriteLocation) = RowBuf.Value(0, col)
        End If
    Next col

Exit Sub
NoWrite:
    RowBuf.RowCount = 0
End Sub

```

