

User Guide for the Drawdown-Limited, Multi-Node Well (MNW) Package for the U.S. Geological Survey's Modular Three-Dimensional Finite-Difference Ground-Water Flow Model, Versions MODFLOW-96 and MODFLOW-2000

By K.J. HALFORD *and* R.T. HANSON

U.S. GEOLOGICAL SURVEY

Open-File Report 02-293

Prepared in cooperation with the

SANTA CLARA VALLEY WATER DISTRICT

3013-42

Sacramento, California
2002

U.S. DEPARTMENT OF THE INTERIOR

GALE A. NORTON, *Secretary*

U.S. GEOLOGICAL SURVEY

Charles G. Groat, *Director*

Any use of trade, product, or firm names in this publication is for descriptive purposes only and does not imply endorsement by the U.S. Government.

For additional information write to:

District Chief
U.S. Geological Survey
Placer Hall—Suite 2012
Sacramento, CA 95819-6129
<http://ca.water.usgs.gov/>

Copies of this report can be purchased from:

U.S. Geological Survey
Information Services
Building 810
Box 25286, Federal Center
Denver, CO 80225-0286

CONTENTS

Preface	1
Abstract	2
Introduction	2
Wellbore Flow in Analytic Solutions.....	2
Wellbore Flow Measurements	2
Significance of Nonuniform Wellbore Flow.....	3
Previous Modeling of Multi-Aquifer Wells.....	3
Modeling Multi-Aquifer Wells	3
Purpose and Scope	4
Multi-Node Well (MNW) Package Capabilities.....	4
Implementation of Drawdown-Limited, MNW Package.....	6
Drawdown-Pumping Constraints in MNW Package	10
Applicability and Limitations	12
Input Instructions for MNW Package	12
Input Data for MNW Package.....	13
Explanation of Fields Used in MNW Package Input.....	13
Output Data for MNW Package	15
Example Problem	15
MNW Data Input for Example Problem	20
Selected Model Output for Example Problem	21
References Cited	24
Appendix	27

FIGURES

Figure 1.	Diagram showing flow patterns that can be induced by a multi-aquifer well and simulated by the MNW Package	5
Figure 2.	Diagram showing limitations on well discharge rates owing to aquifer characteristics, well construction, and influence of other wells	6
Figure 3.	Diagram showing approximate relation between cell size and effective external radius (r_0)	7
Figure 4.	Schematic of a multi-node well completed in three producing zones and a resistor network approximation of the multi-node well.....	9
Figure 5.	Graph showing total discharge or recharge from a single node of a multi-node well as a function of head in the cell.....	11
Figure 6.	Graph showing total discharge or recharge from a single node of a multi-node well as a function of head in the cell with constrained pumping or injection rates	11
Figure 7.	Diagram showing results from example problem for MNW Package.....	16
Figure 8.	Diagram showing simulated discharges and water levels for the multi-node wells	17
Figure 9.	Diagram showing net discharge and node-by-node discharge from well A	18
Figure 10.	Diagram showing volumetric budget at the end of stress period 5 for the example problem	19

CONVERSION FACTORS, VERTICAL DATUM, AND ACRONYMS

CONVERSION FACTORS AND VERTICAL DATUM

	Multiply	By	To obtain
	foot (ft)	0.3048	meter
	foot squared per day (ft ² /d)	0.09290	meter squared per day
	cubic foot per day (ft ³ /d)	0.02832	cubic meter per day
	inch per year (in/yr)	25.4	millimeter per year
	square mile (mi ²)	2.590	square kilometer

Sea level: In this report, "sea level" refers to the National Geodetic Vertical Datum of 1929 (NGVD of 1929)—a geodetic datum derived from a general adjustment of the first-order level nets of both the United States and Canada, formerly called Sea Level Datum of 1929.

Altitude, as used in this report, refers to distance above or below sea level.

***Transmissivity:** The standard unit for transmissivity is cubic foot per day per square foot times foot of aquifer thickness [(ft³/d)/ft²]ft. In this report, the mathematically reduced form, foot squared per day (ft²/d), is used for convenience.

Concentrations of chemical constituents in water are given either in milligrams per liter (mg/L) or micrograms per liter (µg/L).

Acronyms

CWC cell-to-well conductance

MODFLOW three-dimensional finite-difference modular ground-water flow model,

MODPATH post-processing program for MODFLOW

MNW drawdown limited, Multi-Node Well Program

Q net discharge

*Q*_{frcmn} minimum pumping rates

*Q*_{frcmx} specified threshold

USGS U.S. Geological Survey

User Guide for the Drawdown-Limited, Multi-Node Well (MNW) Package for the U.S. Geological Survey's Modular Three-Dimensional Finite-Difference Ground-Water Flow Model, Versions MODFLOW-96 and MODFLOW-2000

By K.J. HALFORD *and* R.T. HANSON

PREFACE

This report presents a computer program for simulating multi-node wells in the U.S. Geological Survey (USGS) ground-water model, MODFLOW. The performance of this computer program has been tested in models of hypothetical ground-water flow systems; however, future applications of the programs could reveal errors that were not detected in the test simulations. Users are requested to notify the USGS if errors are found in the report or in the computer program. Correspondence regarding the report or program should be sent to:

U.S. Geological Survey
Water Resources Division
333 W. Nye Ln., Room 203
Carson City, NV 89706

Although this program has been used by the USGS, no warranty, expressed or implied, is made by the USGS or the United States Government as to the accuracy and functioning of the program and related program material. Nor shall the fact of distribution constitute any such warranty, and no responsibility is assumed by the USGS in connection therewith.

The computer program documented in this report is part of the MODFLOW-96 and MODFLOW-2000 ground-water flow models. These and other ground-water programs are available from the USGS at World Wide Web address:

<http://h2o.usgs.gov/software/>
or by anonymous ftp file transfer from directory /pub/software/ground_water/modflow at Internet address h2o.usgs.gov

ABSTRACT

A computer program called the drawdown-limited, Multi-Node Well (MNW) Package was developed for the U.S. Geological Survey three-dimensional finite-difference modular ground-water flow model, commonly referred to as MODFLOW. The MNW Package allows MODFLOW users to simulate wells that extend beyond a single model node. Multi-node wells can simulate wells that are completed in multiple aquifers or in a single heterogeneous aquifer, partially penetrating wells, and horizontal wells. Multi-aquifer wells dynamically distribute flow between nodes under pumping, recharging, or unpumped conditions. Variations in intraborehole flow can be simulated with the MNW Package, which is limited by how finely an aquifer system has been discretized vertically. Simulated discharge from single-node and multi-node wells also can be drawdown limited, which is user specified for pumping or recharging conditions. The MNW Package also has the ability to track potential mixes of a water-quality attribute. Simulated wellbore flow can be compared with measured wellbore flow, which provides another constraint for model calibration.

INTRODUCTION

Simulation of pumpage by wells is a fundamental and widely used feature of ground-water models such as MODFLOW. Current simulation capability of wells in MODFLOW, however, is limited to withdrawal at specified rates from individual cells. Pumpage from aquifer systems commonly is complex. Heads in aquifers that surround a well are likely to vary along the length of a screen that penetrates multiple aquifers or has a long horizontal extent. When pumping, recharge, or no user-specified inflow or outflow occurs in wells that are screened across multiple aquifers or in a single aquifer, there can be significant hydraulic effects on the ground-water flow system. The Multi-Node Well (MNW) Package is designed to help simulate wells with well screens that span multiple layers or horizontal groups of cells within a layer.

Wellbore Flow in Analytic Solutions

The effects of pumping on water levels was first assessed with analytical solutions (Theis, 1935; Hantush, 1956) that assumed uniform wellbore flow to simplify the mathematical formulation. Even the extensions of these solutions into the effects from pumping in wells completed across multiple aquifers maintained the assumptions of uniform wellbore flow (Papadopoulos, 1966; Neuman and Witherspoon, 1969; Hunt, 1985).

Wellbore Flow Measurements

Even though analytic solutions have treated wellbore flow as a uniformly distributed flow, the nonuniform distribution of wellbore flow in water wells has long been recognized. Early examples of measurements and techniques were applied to water-supply wells by Meinzer (1932) and Livingston and Lynch (1937). Well-screen manufacturers also have recommended the measurement of wellbore flow for wells completed across multiple aquifers (Johnson, 1961). Flow profiles within a pumped well are affected mostly by pump placement, well-screen location, and the hydraulic-conductivity distribution of the aquifers that are penetrated by the well. The effects of nonuniform wellbore flow on aquifer tests of wells that penetrate multiple aquifers also has been identified (Hanson and Nishikawa, 1996). More recently, the measurement of wellbore flow from water-supply wells completed in multi-layered aquifer systems has been used to apportion modeled pumpage between layers for multi-layer wells in the simulation of regional-scale ground-water flow (Hanson and others, 2002).

Further advances in the technology used to measure wellbore flow have now made it possible to measure flow under pumping and nonpumping conditions. These data have become an important part of local and regional hydrologic studies. For example, flow data under pumping and nonpumping conditions combined with water-level measurements can constrain the estimate of aquifer properties (Molz and others, 1989; Kabala, 1994; Hanson and Nishikawa, 1996; Paillet, 2001)

Significance of Nonuniform Wellbore Flow

Nonuniform wellbore flow and intraborehole flow can create complex flow patterns that are difficult to conceptualize and that potentially can affect water levels beyond the pumped well. For example, intraborehole flow was measured in large agricultural wells (Izbicki and others, 1999) and for injection of water in seawater intrusion barrier systems (Newhouse and Hanson, 2000). The natural flow of water and the potential flow path of related contaminants can also be affected by intraborehole flow (Newhouse and Hanson, 2002). Intraborehole flow and nonuniform wellbore flow during pumping also can affect chemical sampling of ground water (Reilly and others, 1989), especially as water-level differences between aquifers in multiple-aquifer systems change through time (Izbicki and others, 1999).

Previous Modeling of Multi-Aquifer Wells

The need for simulating wells in which water is pumped from multiple aquifers in the simulation of ground-water flow was recognized prior to the development of digital models when electric analog models were used to simulate ground-water flow (Herbert and Rushton, 1966; Prickett, 1967). The feature was first developed in digital models for the simulation of petroleum reservoirs (Peaceman, 1978, 1983; Kuniatsky and Hillestad, 1990). The initial formulation of a multi-aquifer well package for ground-water flow models was developed by Bennett and others (1982) and was initially implemented for the U.S. Geological Survey's MODFLOW, by McDonald (1984, 1986). Additional approaches have been developed for the finite-element simulation of well bore flow with wellbore storage (Sudicky and others, 1995). Subsequent studies have implemented versions of the undocumented well package of McDonald (Kontis and Mandle, 1988; Groschen, 1994) for specific studies of regional multi-aquifer systems. More recently, testing of this initial version of the multi-aquifer well package suggests that the approach yields a reasonable approximation to wells in which water is pumped from multiple aquifers (Neville and Tonkin, 2001).

Modeling Multi-Aquifer Wells

The effects of dynamic changes in the distribution of pumpage and of intraborehole flow are not only important to regional flow models but also can affect the simulation of local ground-water flow and related contaminant transport or contaminant reclamation. For example, intraborehole flow, as in supply wells, also can occur in monitoring wells that have multiple well screens or long well screens that straddle several aquifers within a local ground-water flow system.

Many previously modeled regional flow systems could benefit from the simulation of wells with pumpage from multiple aquifers. These regional flow systems commonly have large head differences between aquifers in layered aquifer systems. The implementation of a multiple-aquifer well pumpage allows the separation of flow between layers that occurs through the wellbores from flow that would occur through the aquifer material. When large head differences occur between aquifer systems, intraborehole flow through water-supply wells may provide the main pathway for flow between aquifers or aquifer systems. Large head differences can drive downward intraborehole flow in the recharge portions of regional flow systems and in discharge portions of regional flow systems where there is deep pumpage.

A package is needed for MODFLOW that can simulate wells that are completed in multiple aquifers or in a single heterogeneous aquifer, partially penetrating wells, and horizontal wells because the effects of dynamic changes in the distribution of pumpage and intraborehole flow can significantly alter ground-water flow. The MNW package can simulate the nonuniform distribution of pumpage or injection in wells screened in multiple aquifers, the intraborehole flow in wells that are not pumped or injected, and the dynamic changes in the distribution of wellbore inflow for wells completed in aquifer systems that sustain significant development or changing water-level differences between aquifers.

Purpose and Scope

This report, prepared in cooperation with the Santa Clara Water District, describes the organization, structure, and use of a drawdown-limited, Multi-Node Well Program (MNW) Package for use with the computer program MODFLOW. The theory and implementation of the multi-node, drawdown-limited well package are also described. This package supplements the original Well Package developed for MODFLOW but provides the additional capability of simulating multi-node wellbore flow from pumping, injection (that is, recharging), or intraborehole flow from inter-node water-level differences under nonpumping and pumping conditions. This package also provides the capabilities to simulate vertical and horizontal wells and to limit the rate of pumping with user-specified limits to drawdown in each pumped well.

MULTI-NODE WELL (MNW) PACKAGE CAPABILITIES

The drawdown-limited, multi-node well package (MNW Package) was developed to simulate discharging and recharging wells in MODFLOW-96 (Harbaugh and McDonald, 1996) and MODFLOW-2000 (Harbaugh and others, 2000) more realistically than does the original Well Package (McDonald and Harbaugh, 1988). For the purposes of this report, the node represents the centroid of a model cell. Discharging wells are simulated by the original Well Package as a specified, volumetric discharge from a single cell with no consideration for drawdown limitations. Recharging wells are simulated by the original Well Package in the same fashion as are discharging wells, except the specified volumetric rate is positive instead of negative. The MNW Package simulates wells that are screened across multiple producing zones and limits the range of water-level change in the well.

The multi-node aspect of the MNW Package allows for the appropriate simulation of flow contributions to a single well from multiple producing zones. Because of water-level differences that can exist between producing zones, the flow contribution from each zone is not necessarily proportional to the transmissivity of each producing zone (Bennett and others, 1982). Consider the example of two aquifers (shown in fig. 1) in which transmissivities are the same and a higher potentiometric surface exists in the lower aquifer. If a well is screened across the two aquifers, the higher potentiometric surface of the lower aquifer causes more water to be contributed from the lower aquifer than from the upper aquifer. In addition, water-level differences between aquifers can induce cross-flow between aquifers even when there is no discharge from a well (fig. 1) or even under pumping conditions.

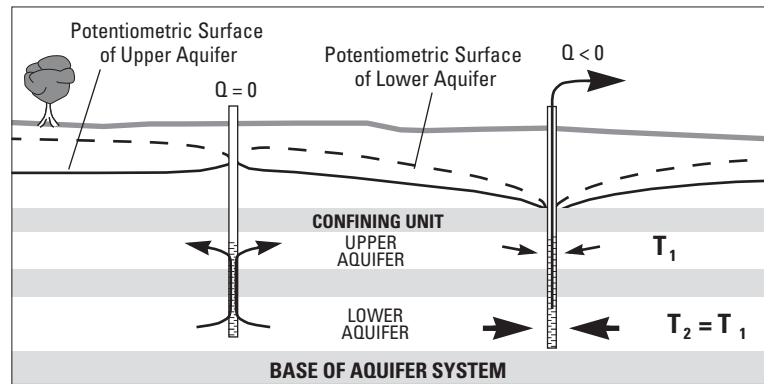

Figure 1. Flow patterns that can be induced by a multi-aquifer well and simulated by the MNW Package.

The MNW Package simulates multi-node contributions to a well, instead of exclusively multi-layer contributions, to allow flexibility. In most cases, the simulation of a well with multiple producing zones can be described as multi-layer because the column and row indices are the same for all the well cells. Horizontal wells, rate-specified drains, and manifolded wells differ because these features generally intersect or connect multiple cells in the same layer. The MNW Package can simulate these configurations even when coupled nodes are not adjacent to one another.

The multi-node aspect of the MNW Package can enhance model calibration and ground-water management capabilities of MODFLOW. If wells with multiple producing zones exist in the aquifer system being simulated, model calibration may be improved when a multi-node well is simulated with the MNW Package. The discharge rate from the well may be known but the apportionment of water from or between the well cells may not be known or may change with further ground-water development through time. An incorrect or fixed apportionment of water from the well cells will produce errors which may adversely affect estimates of hydraulic properties. The MNW Package simulates the apportionment of water from or between the well cells, and can automatically reflect the changing estimates of the hydraulic conductivity distribution as the flow model is being calibrated or as the simulation changes the saturated thickness. The simulation results, in turn, can be compared with measured wellbore flow data as an additional constraint in the calibration process (Hanson and Nishikawa, 1996). Correct apportionment of water in multi-node wells is important for managing ground-water quality because the water quality of the discharging well reflects the flow-rate-weighted water quality of each contributing zone (Izbicki and others, 1999). Correct apportionment is also important for determining the economic limit for the depth of water-supply wells (Gossell and others, 1999).

Water-level changes in wells can be limited to simulate constraints imposed on discharging wells by the depths of pump settings and screen intakes and on recharging wells by the land surface or the maximum injection head. This drawdown constraint is especially useful for predictive scenarios and ground-water management analysis where the future stresses and interaction between wells are not known. The maximum discharge rate for an individual well is limited by the drawdown within that well, which is a function of the hydraulic conductivity of the surrounding aquifer, frictional energy loss owing to formation damage from drilling, and entrance losses from flow through the well screen. Nearby wells also can contribute to the drawdown in a pumped well and thereby additionally limit the discharge from a well. For example, well BM1 (fig. 2) is screened deeper and discharges more water than do the neighboring wells PA1 and PA2. The maximum discharge rate for well PA1 has been reduced and well PA2 has been rendered inoperative because of the water-table decline caused by discharge from well BM1.

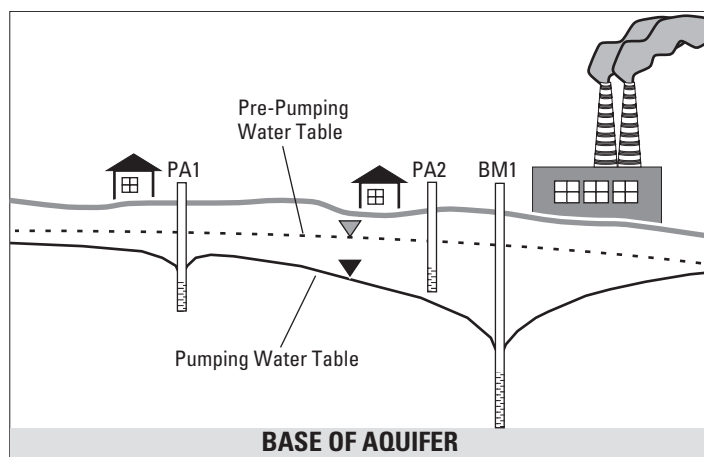

Figure 2. Limitations on well discharge rates owing to aquifer characteristics, well construction, and influence of other wells.

Water-quality requirements are an additional constraint imposed when optimizing a ground-water-management problem that are affected by multi-aquifer wellbore flow. The MNW Package can facilitate tracking a single water-quality parameter (such as the concentration of chloride or dissolved solids) associated with each well node for multi-aquifer and single-aquifer wells. The concentration of the water-quality parameter is flow-rate-weighted averaged within M groups specified by the user. The concentration of the m^{th} group is:

$$\bar{c}_m = \frac{\sum_{n=1}^N c_n Q_n ITEST_n}{\sum_{n=1}^N Q_n ITEST_n} \quad (1)$$

where,

	N	is the number of well nodes.
	c_n	is the concentration of the water-quality parameter in the n^{th} node.
	Q_n	is the flow rate to the n^{th} node.
	$ITEST_n$	is a binary switch for the n^{th} node. If node n is part of the m^{th} group, then
	Q_n	< 0 (wellbore inflow), and $c_n \geq 0$, $ITEST_n$
		is equal to 1.
	Otherwise $ITEST_n$	is equal to 0.

Implementation of Drawdown-Limited, MNW Package

Both the drawdown-limiting and multi-node components of the MNW Package are dependent on a model that simulates the head difference between the cell and the well so that the head in the well can be simulated. Cell-to-well drawdown is simulated with Jacob's (1947) general well-loss equation as modified by Rorabaugh (1953).

$$h_{WELL} - h_n = A Q_n + B Q_n + C Q_n^P \quad (2)$$

where,

h_{WELL}	is the head in the well (L),
h_n	is the head in the n^{th} cell (L),
Q_n	is flow between the n^{th} cell and the well (L^3 / T),
A	is linear aquifer-loss coefficient (T / L^2),
B	is linear well-loss coefficient (T / L^2),
C	is nonlinear well-loss coefficient ($T^P / L^{(3P-1)}$), and
P	is power of the nonlinear discharge component of well loss that usually varies between 1.5 and 3.5 (Rorabaugh, 1953)

The linear aquifer-loss coefficient (A) defines head loss between an effective external radius (Peaceman, 1983) at the cell node and the well radius (fig. 3). Head loss is simulated with the Thiem equation (Bennett and others, 1982; Fanchi and others, 1987). In using the Thiem equation (Thiem, 1906), it is assumed that a well is vertical, the screen fully penetrates a cell, and flow between the cell and well is steady-state for the time period used to solve the general ground-water flow equations in MODFLOW (McDonald and Harbaugh, 1988).

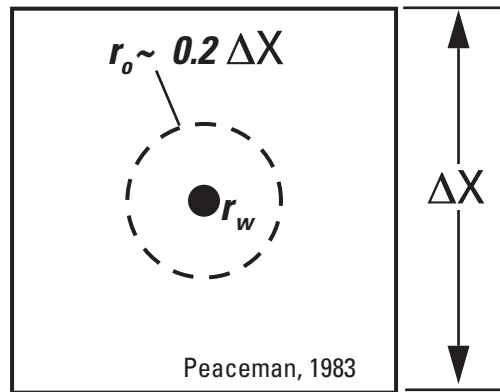
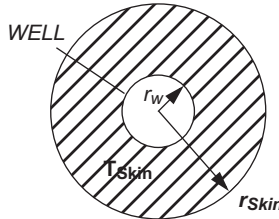

Figure 3. Approximate relation between cell size and effective external radius (r_o)

The linear well-loss coefficient (B) collectively defines head loss from flow through formation damaged during well drilling, the gravel pack, and the well screen. The coefficient B can be used directly to define head loss or can be recast in terms of a dimensionless “skin” coefficient ($Skin$ in eq. 3), which is a term commonly used in petroleum engineering and hydrology (Earlougher, 1977; Cooley and Cunningham, 1979). The skin effect can be pictured as occurring across a cylinder of radius, r_{Skin} , around the well with a finite radius, r_w , and a transmissivity, T_{Skin} , that differs from the formation transmissivity, T . The skin coefficient can then be described in terms of a transmissivity contrast (T/T_{Skin}) over the finite difference between r_w and r_{Skin} or by

$$Skin = \left(\frac{T}{T_{Skin}} - 1 \right) \ln \left(\frac{r_{Skin}}{r_w} \right) \text{ where,} \quad (3)$$

The linear relation between the skin coefficient and the reduction of hydraulic conductivity around the wellbore is best illustrated by example. For an annular ring of damaged formation, where $r_{Skin} = 2r_w$, skin values of 1, 2, or 4 will yield T/T_{Skin} values of 2.5, 3.9, and 6.7, respectively. The skin coefficient is equal to zero or negative if T_{Skin} is equal to or greater than T .

The nonlinear well-loss coefficient (C) defines head loss from any turbulent flow near the well (Rorabaugh, 1953). The coefficient C and power term (P) typically are estimated at specific wells through the application of step-drawdown tests. Because this additional nonlinear term may cause numerical problems or may not be needed, the user has the option of eliminating the nonlinear well-loss term for any multi-node well.

Flows between model cells and well nodes are defined by the general well-loss model (eq. 2). After the constants in equation 2 are collected and the power term is linearized, flow to the n^{th} node is defined by the head difference between the cell and the well times a conductance or by

$$Q_n = (h_{WELL} - h_n)CWC_n \quad (4)$$

where,

h_{WELL}	is the head in the well (L),
h_n	is the head in the n^{th} cell (L),
CWC_n	is the n^{th} cell-to-well conductance (L^2/T), which can be specified directly by the user or defined by:

$$CWC_n = [A + B + CQ_n^{(P-1)}]^{-1} = \left[\frac{\ln \left(\frac{r_o}{r_w} \right)}{2\pi \sqrt{T_X T_Y}} + \frac{Skin}{2\pi \sqrt{T_X T_Y}} + CQ_n^{(P-1)} \right]^{-1} \quad (5)$$

where,

T_X	is the transmissivity along a model row (L^2/T),
T_Y	is the transmissivity along a model column (L^2/T),
r_w	is the radius of the well (L),
r_o	is the effective external radius (L) that corresponds with the head in a cell, which Peaceman (1983) defined as

$$r_o = 0.28 \frac{\sqrt{\Delta x^2 \frac{T_Y}{T_X} + \Delta y^2 \frac{T_X}{T_Y}}}{4 \sqrt{\frac{T_Y}{T_X}} + 4 \sqrt{\frac{T_X}{T_Y}}} \quad (6)$$

where,

Δx is the width of the model column (L), and

Δy is the width of the model row (L),

If $T_X = T_Y$, eq. 6 simplifies to $r_o = 0.14 \sqrt{\Delta x^2 + \Delta y^2}$.

Discharge to horizontal wells also can be simulated, except that equation 5 is not a good estimator of cell-to-well conductance (CWC). Suitable equations for estimating CWC of horizontal wells are not well defined. Kawecki (2000) defines general equations for flow to horizontal wells from petroleum literature but does not discuss their use for defining CWC or r_o . Users can experiment with defining CWC external to MODFLOW and directly specifying appropriate CWC values in the MNW Package input.

The head in a multi-node well is assumed to be the same for all nodes (Bennett and others, 1982; Fanchi and others, 1987). In practice, the head in the well does vary along the length of the screen from the friction of flow within the wellbore. Although these head losses in the well can be significant (Cooley and Cunningham, 1979), they are usually small relative to head losses induced by the well screen and by formation damage (Rutledge, 1991). Flow to a multi-node well with a single head in the well is analogous to a series of resistors wired to a common electrical connection (fig. 4), where flow between the n^{th} cell and the well is controlled by the n^{th} cell-to-well conductance (CWC_n). The example shown in figure 4 demonstrates that well discharge (-960 L³/T) from the multi-aquifer flow system and downward intraborehole flow (113 L³/T) between aquifers can occur simultaneously within a single multi-aquifer well. This example also demonstrates that the well discharge is not simply proportional to the transmissivities of the multiple aquifers screened by the well.

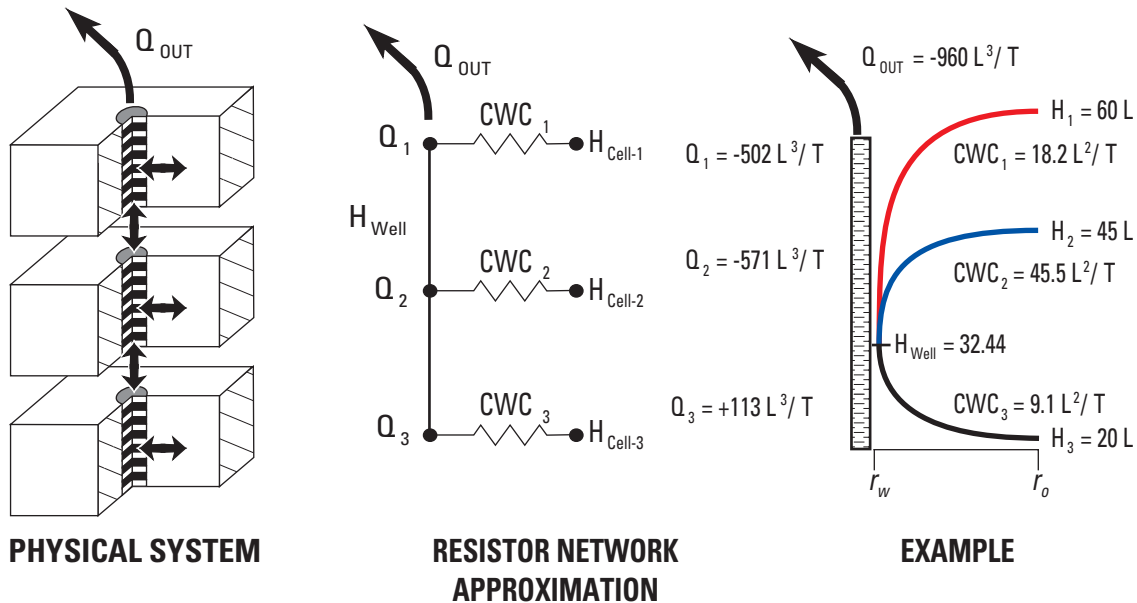

Figure 4. Schematic of a multi-node well completed in three producing zones and a resistor network approximation of the multi-node well.

The net flow to a multi-node well is simulated by summing the flow component to each node (Bennett and others, 1982; Fanchi and others, 1987), which is defined by equation 4 and the common head in each node. After the terms are collected and rearranged, the net flow rate between a multi-node well and the ground-water system is

$$Q = h_{WELL} \sum_{n=NB}^{NE} CWC_n - \sum_{n=NB}^{NE} CWC_n h_n \quad (7)$$

where,

Q	is the net flow between the well and the ground-water system,
NB	is the first node of a multi-node well, and
NE	is the last node of a multi-node well.

Although h_{WELL} is common to all the nodes in a multi-node well, h_{WELL} is not known. Estimates of h_{WELL} are needed to estimate the flow rate to each cell and to test that the drawdown does not exceed user-specified limits. Rearranging equation 7 gives the head in the well:

$$h_{WELL} = \frac{\sum_{n=NB}^{NE} CWC_n h_n + Q}{\sum_{n=NB}^{NE} CWC_n} \quad (8)$$

Estimates of h_{WELL} and Q_n lag an iteration behind estimates of h_n because equations 7 and 8 are solved explicitly assuming that h_n is known. This causes slow convergence of the solver if the MNW cells are incorporated in MODFLOW as a general-head boundary (subtract CWC_n from $HCOF$ and subtract $CWC_n * h_{WELL}$ from RHS). Convergence is accelerated by alternately incorporating the MNW cells as specified rates in odd iterations (subtract Q_n from RHS) and as general-head boundaries in even iterations.

Implementation of the Thiem approximation in the MNW Package was tested by duplicating the inflows to a well and the water level in the well shown in figure 3 with a simple MODFLOW model. The MNW Package replicated the results shown in figure 3 that were calculated independently using the Thiem equation.

Drawdown-Pumping Constraints in MNW Package

Discharging wells become drawdown limited when the target rate causes h_{WELL} to fall below a user defined limit (h_{lim}). If a well is drawdown limited and h_n remains above h_{lim} , the flow rate will be simulated with equation 4 and h_{WELL} is specified as h_n (fig. 5). Wells are not allowed to reverse signs and change from discharging to recharging during any stress period. Therefore, if h_n falls below h_{lim} , no net discharge will be simulated from the well. If the net discharge from a multi-node well falls to 0, cross-flow between aquifers will still be simulated. Recharging wells are limited in the same manner, but the signs are reversed (fig. 5). Multi-node and single-node wells can be treated as drawdown limited.

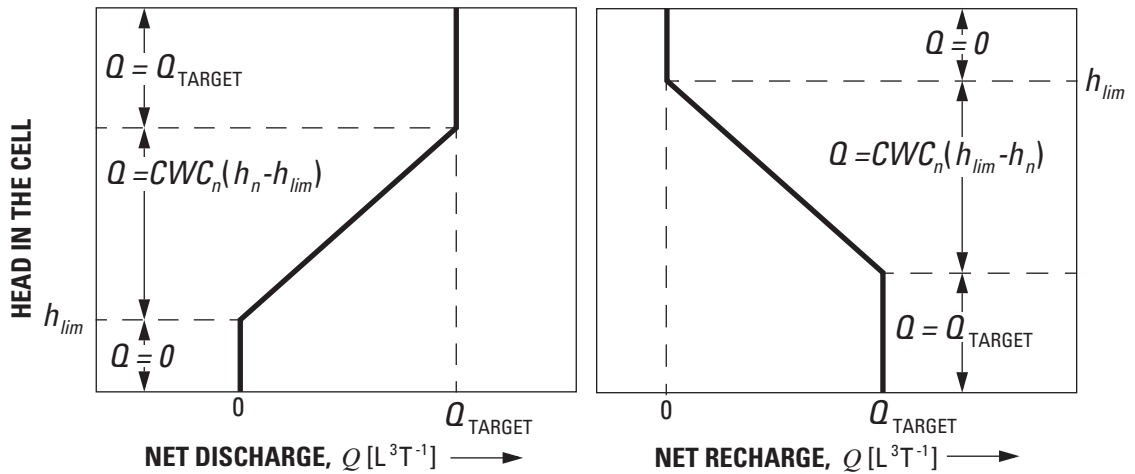

Figure 5. Total discharge or recharge from a single node of a multi-node well as a function of head in the cell.

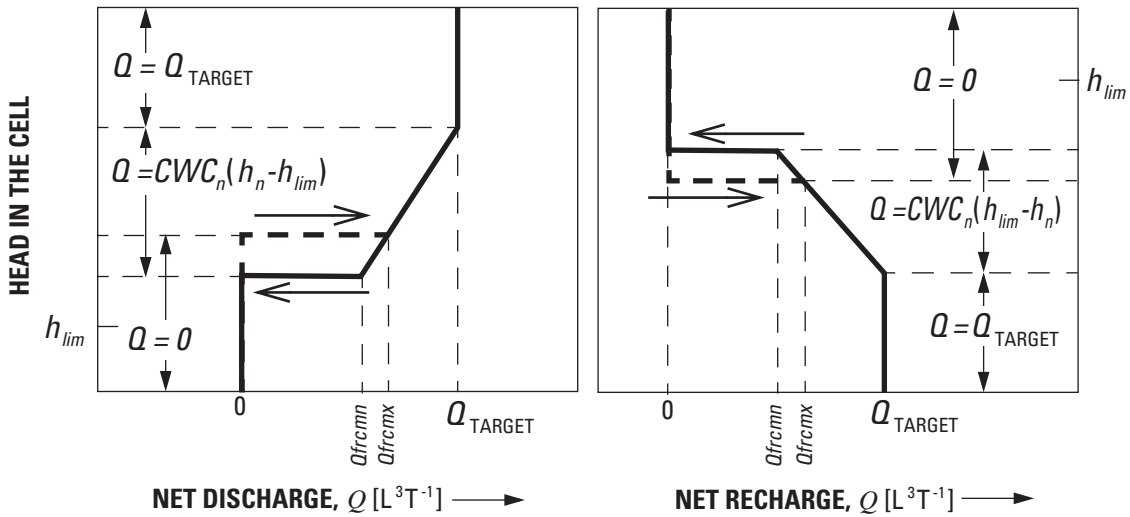

Figure 6. Total discharge or recharge from a single node of a multi-node well as a function of head in the cell with constrained pumping or injection rates.

Smoothly varying pumping rates from a specified discharge to 0 (fig. 5) is an impractical mode of operation for most pumps. This practical limitation was addressed by specifying minimum pumping rates (Q_{frcmn}) that represent the lower limit of the fixed range of pump capacity typical of supply wells. Discharge is reduced to 0 if total discharge falls below a specified minimum pumping rate (fig. 6). As with the unconstrained case, recharging wells are limited in the same manner but the signs are reversed (fig. 6).

Pumpage from a constrained well is restored if the potential pumping rate exceeds a specified threshold (Q_{frcmx}). The threshold Q_{frcmx} is different from and greater than the minimum pumping rate Q_{frcmn} to avoid oscillating pumping rates, which could produce instability in solving the ground-water flow equation (fig. 6). Q_{frcmn} and Q_{frcmx} can be specified either as rates or as a percentage of the net discharge (Q).

Applicability and Limitations

Short-term transient effects between cell and well are not simulated because the head difference between the cell and the well are simulated with the Thiem equation. Transient changes in head differences generally are unimportant relative to the scale of flow in a model cell. These effects typically persist for less than 1 day after changing the pumping rate for a well. For example, quasi-steady-state conditions occur about an hour after changing the discharge from a cell that is 2,500 ft (foot) on a side, has a transmissivity of 2,500 ft²/d, and has a storage coefficient of 0.001.

Short-term transient effects are important for analyzing aquifer tests and the MNW Package is not recommended for this application. Simulation of aquifer tests from multi-aquifer wells are best analyzed with a finely discretized grid that is focused on the pumped well as was completed, for example, by Hanson and Nishikawa (1996). The pumped well can be simulated as a high-conductivity zone (K-wellbore $\sim 10^6$ times greater than the surrounding aquifer) with a specific yield of 1 (Barrash and Dougherty, 1997; Halford, 1997).

Multi-node wells with cell-to-well conductances that are “too great” tend to make MODFLOW numerically unstable. Cell-to-well conductances increase as cell size is decreased, which also decreases the effective external radius (r_o). Cell-to-well conductances become greater as r_o approaches r_w and are undefined if r_o is less than or equal to r_w . For these small cells, a pumped well should be simulated as a high-conductivity zone as cell area approaches the cross-sectional area of a well.

Estimation of an effective external radius (r_o) is problematic when multiple wells are specified in a cell. Numerical experiments show that replacing a single well with four symmetrically distributed wells in a cell reduces $\ln(r_o/r_w)$ to 89 percent of $\ln(r_o/r_w)$ for a single well. Further subdivision of the stress over 16 symmetrically distributed wells in a cell changed $\ln(r_o/r_w)$ to 88 percent of $\ln(r_o/r_w)$ for a single well. Errors in estimating r_o are even less important if the well-loss coefficients B and C are non-zero. These results suggest that it is probably better to not make corrections for multiple wells in a cell. Finer discretization is needed if resolution of the water-level distribution is of interest.

Combined head losses owing to well construction, skin, and partial penetration are generally as significant as head losses between a well and an effective external radius (r_o). The relative significance of well construction increases as the number of multi-node wells assigned to a cell increases because r_o will tend to decrease.

INPUT INSTRUCTIONS FOR MNW PACKAGE

Input for the multi-node, drawdown-limited well package (MNW Package) is initiated by specifying MNW1 in the NAME file (Harbaugh and McDonald, 1996). Data is read from MNW Package input files as 256-character-wide, alphanumeric records to facilitate the addition of comments within the model input files and the use of keys to identify input variables. All integer, real, and character variables are read from the alphanumeric records. The records are initially read by the subroutine NCREAD. Records that begin with a ‘#’ sign in the first column are treated as comment records, are not passed to any other routines, and are discarded. Once NCREAD has acquired a valid data record, the record is checked for a ‘!’ sign that designates the beginning of any in-line comments on a data-input record. If a ‘!’ sign is detected, the ‘!’ sign and all text to the right of the ‘!’ sign are removed from the record before passing it to any other routines.

Alphanumeric strings are used in the MNW Package to identify variables (keys) and make logical decisions (flags). Specification of these keys and flags is case insensitive because all letters are capitalized before performing any logical tests. Keys precede the variable to be read, which is acquired by identifying the key and reading the first value that follows the key. Logical decisions are based on the presence (true) or absence (false) of a flag. In this report, bold, upper-case letters are used to denote the part of the key that is tested. Key:data pairs that are not delimited by parentheses are mandatory and must be included, and Key:data pairs that are delimited within parentheses and are optional because default values are used if they are not specified by the user.

Input Data for MNW Package

The MNW Package reads input data for each simulation and for each stress period as follows:

FOR EACH SIMULATION:

- | | | | | | |
|--------------|----------------------------|--------------|---------|----------------------|-------------------|
| 1. Data: | MXMNW | IWL2CB | IWELPT | REFERENCE SP: kspref | (Required record) |
| Format: | Integer | Integer | Integer | Alphanumeric key | |
| 2. Data: | LOSSTYPE | (PLOSSMNW) | | | (Required record) |
| Format: | Alphanumeric | Real | | | |
| 3a. KEY:DATA | FILE:filename | WEL1:iunw1 | | | (Optional record) |
| Format: | Alphanumeric header record | | | | |
| 3b. KEY:DATA | FILE:filename | BYNODE:iunby | ALLTIME | | (Optional record) |
| Format: | Alphanumeric header record | | Flag | | |
| 3c. KEY:DATA | FILE:filename | QSUM:iunqs | ALLTIME | | (Optional record) |
| Format: | Alphanumeric header record | | Flag | | |

FOR EACH STRESS PERIOD:

- | | | | | | | | | | | |
|----------------------|-------|----------------------------|------------------|--------------------|---------|------|------|------|-----------|--------------|
| 4. Data: | ITMP | ADD | | | | | | | | |
| Format: | I10 | Alphanumeric key | | | | | | | | |
| 5. Data: | Layer | Row | Column | Qdes (MN or MULTI) | QWval | Rw | Skin | Hlim | Href (DD) | Iwgrp |
| Format | I10 | I10 | I10 | F10.0 Flag | Real | Real | Real | Real | Real | Flag Integer |
| 5. (Continued) Data: | Cp: | C | (QCUT or Q-%CUT: | Qfrcmn, Qfrcmx) | DEFAULT | | | | | |
| Format | | Real | | Real | Real | Flag | | | | |
| 5. (Continued) Data: | SITE: | MNWsite | | | | | | | | |
| Format | | Alphanumeric header record | | | | | | | | |

NOTE: The first four values in data item 5 for the variables Layer, Row, Column, and Qdes are read initially as a free format. If this fails, the four values are read as fixed format entries from the first 40 columns. In all instances these values must be specified. The following eight values for the remaining variables are optional, space-delimited or comma-delimited entries but must be entered in the sequence specified for item 5. The alphanumeric flags **MN** and **DD** can appear anywhere between columns 41 and 256, inclusive. Input item 5 normally consists of one record for each well cell defined or modified. If ITMP is 0 or less, item 5 is not read and should not be specified.

Explanation of Fields Used in MNW Package Input

- MXMNW is the maximum number of well cells to be defined.

IWL2CB is a flag and a unit number.
 If IWL2CB > 0, it is the unit number on which cell-by-cell flow terms will be recorded whenever ICBCFL is set.
 If IWL2CB = 0, cell-by-cell flow terms will not be printed or recorded.
 If IWL2CB < 0, well recharge, water-levels in the well and cell, drawdown in the well, and the flow-rate-weighted water-quality value of the IQWGRP will be printed whenever ICBCFL is set.

IWELPT is a flag. If IWELPT is not equal to 0, no well information will be printed.
- LOSSTYPE is a flag to determine the user-specified model for well loss.
 If LOSSTYPE is set to SKIN, head loss is defined with skin. Model is linear.
 If LOSSTYPE is set to LINEAR, head loss is defined with coefficient **B**. Model is linear.
 If LOSSTYPE is set to NONLINEAR, head loss is defined with coefficients **B** and **C**. Model is nonlinear.

- REF:kspref** = is the set of water levels in the HNEW matrix at the beginning of the stress period *kspref* that will be used as default reference values for calculating drawdown. *Kspref* defaults to 1 if it is not specified by the user.
- 3a. FILE:filename** = is the name of an auxiliary output file.
- WEL1:iunw1** = is a unit number. *Filename* will be written to unit number *iunw1*. Output is a WEL1 input file with the flow rates specified at the end of each stress period.
- 3b. BYNODE:iunby** = is a unit number. *Filename* will be written to unit number *iunby*. Output is flow rate at each well node.
- 3c. QSUM:iunqs** = is a unit number. *Filename* will be written to unit number *iunqs*. Output is total flow rate from each multi-node well.

(**ALLTIME**) a flag that indicates flow rates should be written to BYNODE or QSUM at every time step regardless of the settings in the output control (OC) file.

- 4. ITMP** is a flag.
- If $ITMP < 0$, wells from previous stress period will be reused and input from item 4 will not be read.
- If $ITMP = 0$, no wells will be simulated and input from item 4 will not be read.
- If $ITMP > 0$, is the number of records of drawdown-limited well data that will be read for the current stress period. If the key **ADD** is not detected on record 3, the maximum number of drawdown-limited wells for the current stress period will be ITMP. If the key **ADD** is detected on record 3, ITMP wells will be added to the existing list of drawdown-limited wells.
- ADD** a flag that indicates whether or not the well cells read for the current stress period will augment or replace the well cells that were previously defined.
- 5. Layer** is the layer number of the model cell that contains the well.
- Row** is the row number of the model cell that contains the well.
- Column** is the column number of the model cell that contains the well.
- Qdes** is the desired volumetric pumping or recharge rate. A positive value indicates recharge and a negative value indicates discharge. The actual volumetric recharge rate will range from 0 to *Qdes* and is not allowed to switch directions between discharge and recharge conditions during any stress period.
- (**MN**) a flag that indicates this entry is part of a multi-node well. The flag **MN** is not included on the first entry of a multi-node well and is exclusive of the flag **MULTI**.
- (**MULTI**) a flag that indicates this entry is the end of a multi-node well and all intervening nodes between this entry and the previous **MULTI** flag are part of a multi-node well. Intervening nodes will be assigned the same cell-to-well conductance that was specified in this entry. The flag **MULTI** is not included on the first entry of a multi-node well and is exclusive of the flag **MN**.
- QWval** is the water-quality value that is to be flow-rate averaged amongst wells in the same *Iqwgrp*. Negative water-quality values and positive flow terms are not averaged. Water-quality values can be respecified for each stress period.
- Rw** is a flag and a variable used to define the cell-to-well conductance.
- If $Rw > 0$, The variable represents the radius of the well and the cell-to-well conductance is calculated with eq. 5 as formulated by Peaceman (1983).
- If $Rw = 0$, the head in the cell is assumed to be equivalent to the head in the well and the cell-to-well conductance is set to 1,000 times the transmissivity of the cell. The cell is **NOT** allowed to be part of a multi-node well.
- If $Rw < 0$, the absolute value of the variable is the cell-to-well conductance.

<u>Skin</u>	defines the friction losses to the well owing to the screen and to formation damage. The variable is either a skin or the coefficient B depending on the LOSSTYPE, and is used in eq. 5 when $R_w > 0$.
<u>Hlim</u>	is the limiting water level, which is a minimum for discharging wells and a maximum for recharging wells. If the flag DD is set, the value of $Hlim$ read is a drawdown from the reference elevation. For $Q_{des} < 0$, $Hlim = Href - Hlim$ and for $Q_{des} > 0$, $Hlim = Href + Hlim$.
<u>Href</u>	is the reference elevation. If the value of $Href$ read is greater than the maximum water level from the HNEW matrix at the beginning of the stress period $kspref$, $Href$ is set to the simulated water level at the location of the drawdown-limited well.
(DD)	a flag that indicates the value of $Hlim$ read is a drawdown or build-up from the reference elevation.
<u>lqwgrp</u>	is a water-quality group identifier. Flow-rate averaged water-quality values are reported for each group of wells with the same $lqwgrp$ and $Qwval$ entries that are not negative.
Cp:C	is coefficient for nonlinear head losses (eqn. 2). The variable is used only when the LOSSTYPE is NONLINEAR. Default value is 0 if not specified.
QCUT	a flag that indicates pumping limits will be specified as a rate (L^3/T).
Q-%CUT	a flag that indicates pumping limits will be specified as a percentage of the specified rate.
<u>Qfrcmn</u>	minimum pumping rate that a well must exceed to remain active.
<u>Qfrcmx</u>	minimum potential pumping rate that must be exceeded to reactivate a well.
DEFAULT	a flag that sets this entry of $Qfrcmn$ and $Qfrcmx$ as the new default values.
(SITE:	is an optional label for identifying wells. An individual file of time, discharge, water level
MNWsite)	in well, concentration, net-inflow, net-outflow, and node-by-node flows will be written for each well with a unique MNWsite label. Individual well files are tab delimited. Only one label should be applied to a multi-node well.

Output Data for MNW Package

Simulation results from the MNW Package can be reported to three auxiliary files in addition to the main MODFLOW listing. One auxiliary file is a WEL1 approximation that can be used in post-processing programs, such as MODPATH (Pollock, 1994), that currently only recognize WEL1 input files. Only discharges from the last time step of each stress period are reported because input to the WEL1 package is limited to a specified discharge for each stress period. Water-level, discharge, and water-quality information for plotting time series are recorded to the other two auxiliary files. Information for individual well nodes are recorded to one file, and information for multi-node wells are recorded to the other auxiliary file.

EXAMPLE PROBLEM

The system consists of two aquifers that are separated by a 50-foot-thick confining unit. The upper aquifer is unconfined, has a hydraulic conductivity of 60 ft/d, and has a uniform base of 50 ft above the datum. The lower aquifer is confined and has a transmissivity of 15,000 ft²/d. Storage coefficients of 0.05 and 0.0001 were assigned to layers 1 and 2, respectively. The 66-mi² area of the test problem was divided into 21 rows of 14 columns (fig. 7). Uniform, square cells that measured 2,500 ft on a side were used throughout the simulated area. Specified heads and drains are assigned in layer 1 (fig. 7) and are maintained at the same elevations for all stress periods (Appendix). Data sets for the test problem, including input for all model packages, are given in the Appendix.

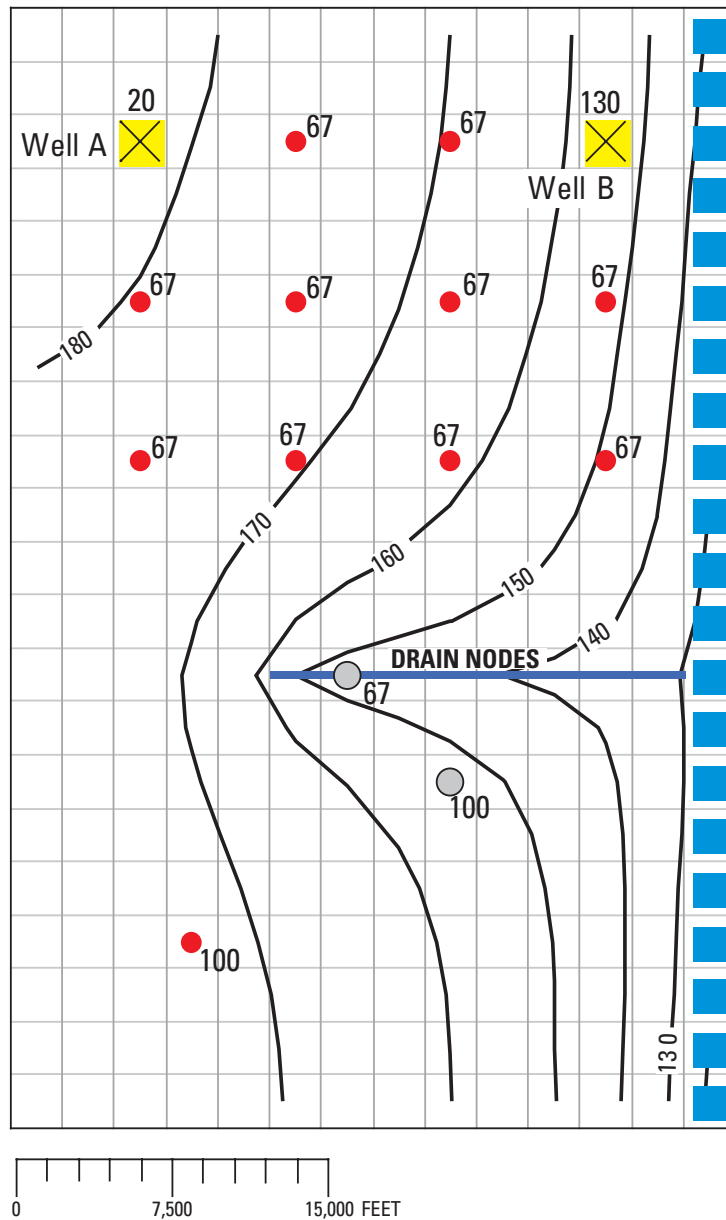

EXPLANATION	
—140—	PREDEVELOPMENT POTENTIOMETRIC CONTOUR--Shows altitude at which water level would have stood in tightly cased wells. Contour interval 10 feet. Datum is arbitrary.
● 67	PUMPED WELL--Number is specified discharge from layer 1 in thousands of cubic feet per day.
○ 67	PUMPED WELL--Number is specified discharge from layer 2 in thousands of cubic feet per day.
⊠ 20	MULTI-NODE WELL--Number is desired discharge from layers 1 and 2 in thousands of cubic feet per day. Simulated discharge can be less because of drawdown limits.
■	SPECIFIED HEAD--Water level was assigned in layer 1.

Figure 7. Results from example problem for MNW Package.

A period of 1,000,970 days was simulated with 5 stress periods. The first two stress periods simulated steady-state conditions, which were achieved by having each stress period be 500,000 days long. Recharge during stress periods 1 and 2 was a uniform 7 inches per year (in./yr). No pumpage was extracted during stress period 1 but multi-node wells were simulated. About 950,000 ft³/d of pumpage was extracted during stress period 2; this is about 35 percent of the total volumetric budget. Transient conditions were simulated during stress periods 3, 4, and 5, which were periods of 60, 180, and 730 days, respectively. Uniform recharge rates of 2, 0, and 12 in./yr, respectively, were applied during stress periods 3, 4, and 5. In addition to the simulation of two multi-node wells (wells A and B), there are 15 other single-node wells that have a combined discharge of 935,350 ft³/d for stress periods 2 through 5.

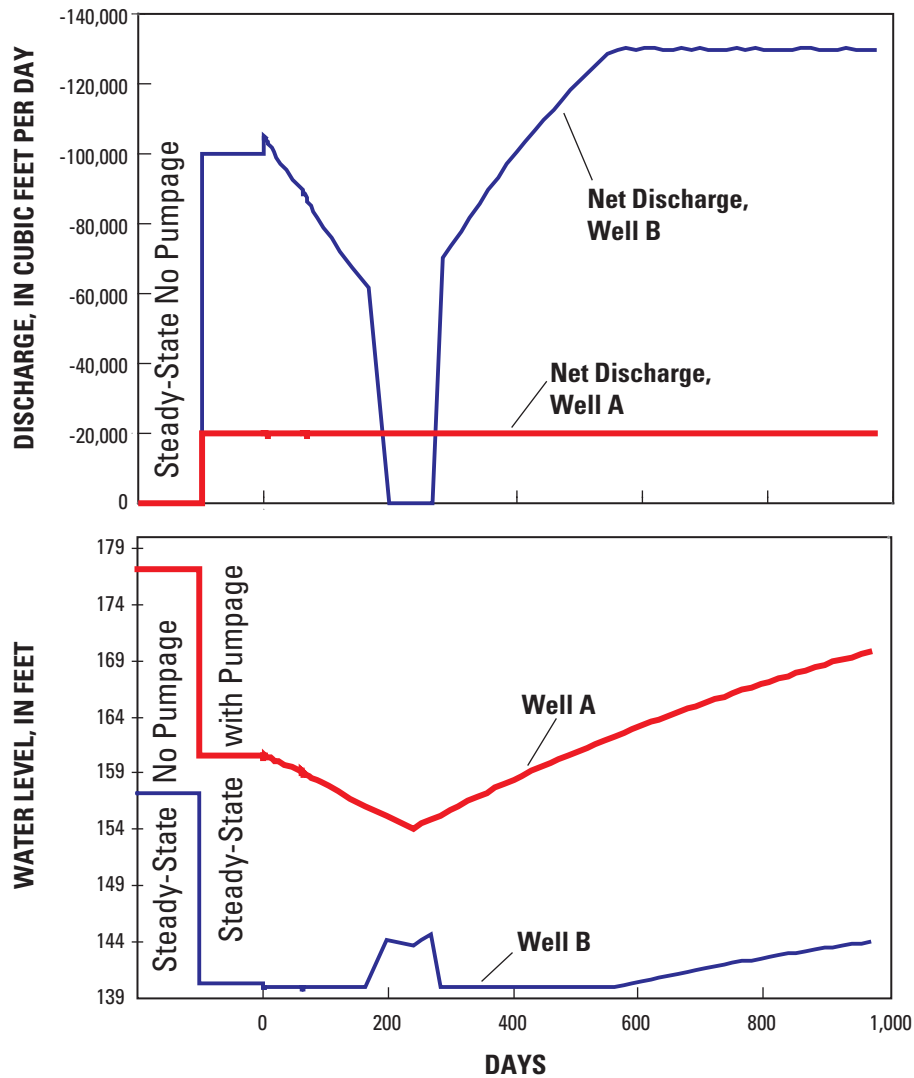

Figure 8. Simulated discharges and water levels for the multi-node wells.

Two wells that were screened in the upper and lower aquifers were simulated to demonstrate the effects of multi-node wells and rate constraints on simulated discharges and water levels. This example uses the simple skin coefficient for well losses. Discharge at well A was specified at 0 ft³/d for stress period 1, and was specified at 20,000 ft³/d for stress periods 2 through 5. Discharge from well A was never constrained because the simulated water level was always above the drawdown limit. Discharge from well A was constant during each stress period throughout the simulation, but the pumping water level in well A does change as the water levels in the aquifers change (fig. 8). Discharge at well B was specified at 0 ft³/d for stress period 1, 100,000 ft³/d for stress period 2, and 130,000 ft³/d for stress periods 3 through 5. However, discharge from well B varies and is less than the desired discharge for the first 560 days because water levels are constrained by a minimum drawdown of 140 ft. Discharge from well B ceased after 170 days, when the potential discharge was less than Q_{frcmn} , and did not resume until after 280 days, when the potential discharge was greater than Q_{frcmx} .

The multi-node wells were an active part of the flow system for the entire period of simulation. Flow from layers 1 and 2 in well A varied for the entire transient period while the net discharge remained a constant 20,000 ft³/d (fig. 9). Even without any pumpage from well A, about 16,000 ft³/d moved through the well as intraborehole flow from the upper aquifer to the lower aquifer.

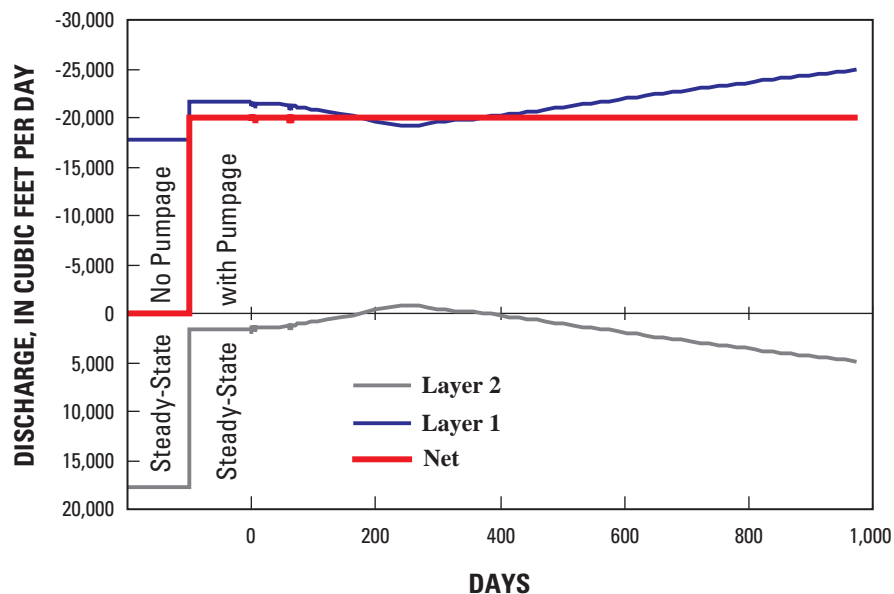

Figure 9. Net discharge and node-by-node discharge from well A.

Discharge-weighted water quality is reported for several “qw zones” (*qwzn*) and for the multi-node wells. The water-quality source is user specified and is assumed to be a constant through time for this example. There are three qw-zones that may reflect the general water quality of a group of wells, such as a wellfield. The values of average flow at the end of stress period 5 for the three qw-zones were about 330 mg/L, 214 mg/L, and 174 mg/L, respectively. The multi-node well A, which is part of group 1, generally remains constant in water-quality value because all the water is coming from the upper layer. There is some variation in water quality at well A from about 190 to 350 days (the end of stress period 3 and stress period 4) when the distribution of inflow changes.

Multi-node wells appear in the volumetric budget as the “MNW” term (fig. 10). Multi-node wells occur in both the inflow and the outflow portions of the volumetric summary. The total rate of outflow from multi-node wells was 1,089,286 ft³/d and the total inflow was about 3,336 ft³/d, which yields a net discharge rate of 1,085,950 ft³/d. This demonstrates how there can still be net discharge with intraborehole flow occurring between selected model layers in multi-node wells.

VOLUMETRIC BUDGET FOR ENTIRE MODEL AT END OF TIME STEP 50 IN STRESS PERIOD 5			

CUMULATIVE VOLUMES	L**3	RATES FOR THIS TIME STEP	L**3/T
-----		-----	
IN:		IN:	
---		---	
STORAGE =	4469447680.0000	STORAGE =	0.0000
CONSTANT HEAD =	0.0000	CONSTANT HEAD =	0.0000
DRAINS =	0.0000	DRAINS =	0.0000
RECHARGE =	2.7335E+12	RECHARGE =	4777500.0000
MNW =	10135074816.0000	MNW =	3336.1003
TOTAL IN =	2.7481E+12	TOTAL IN =	4780836.0000
OUT:		OUT:	
----		----	
STORAGE =	1204805376.0000	STORAGE =	1058231.1250
CONSTANT HEAD =	1.4675E+12	CONSTANT HEAD =	1685863.1250
DRAINS =	799880642560.0000	DRAINS =	947453.3125
RECHARGE =	0.0000	RECHARGE =	0.0000
MNW =	479563481088.0000	MNW =	1089286.0000
TOTAL OUT =	2.7481E+12	TOTAL OUT =	4780833.5000
IN - OUT =	-3670016.0000	IN - OUT =	2.5000
PERCENT DISCREPANCY =	0.00	PERCENT DISCREPANCY =	0.00

Figure 10. Volumetric budget at the end of stress period 5 for the example problem.

MNW Data Input for Example Problem

```

120      -90      0      REFERENCE SP = 2
Well model will use SKIN !! Other options are Linear and NonLinear:2.00 --Exponent can range from 1.5-3.5
FILE:t.wll          WELL:91
FILE:t.ByNode      BYNODE:92          ALLTIME
FILE:t.Qsum        QSUM:93           ALLTIME
#
# 17
# 1      3      3      0      395      0.5      1      SITE:Well-A
# 2      3      3      0      MN 200      0.5      1
# 1      3      6      0      304      0.0      1
# 1      3      9      0      240      -5000.0      1
# 1      3      12     0      175      0.5      1      SITE:Well-B
# 2      3      12     0      MN 175      0.5      1
# 1      6      3      0      302      0.0      1
# 1      6      6      0      230      0.5      1
# 1      6      9      0      180      0.5      1
# 1      6      12     0      145      0.5      1
# 1      9      3      0      244      0.5      1
# 1      9      6      0      189      0.5      1
# 1      9      9      0      147      0.5      1
# 1      9      12     0      119      0.5      1
# 2      15     9      0      -1
# 2      13     7      0      -1      SITE:Simple-C
# 1      18     4      0      -1.
#
# Multi-node switch      Switch to specify Hlim      Auxiliary
#                          |      as difference from Href      definitions
#                          |      Specified by user
# lay      row      col      Q      Conc      rw      Skin      Hlim      Href      lqwgrp
# -+-----1-----2-----3-----4-----5-----6-----7-----8-----9
# 17
# 1      3      3      -.2000E+05      395      0.5      1      DD 50      1.e16      1
# 2      3      3      .0000      MN 200      0.5      1      DD 50      1.e16      1      SITE:Well-A
# 1      3      6      -.6685E+05      304      1.0      1      DD 20      1.e16      1
# 1      3      9      -.6685E+05      240      -5000.0      1      DD 25      1.e16      1
# 1      3      12     -.0000E+05      100      0.5      1      140      1.e16      1
# 2      3      12     -.1000E+06      MN 500      0.5      1      140      1.e16      1      SITE:Well-B
# 1      6      3      -.6685E+05      302      0.15     1      DD 20      1.e16      2
# 1      6      6      -.6685E+05      230      0.5      1      DD 50      1.e16      2
# 1      6      9      -.6685E+05      180      0.5      1      DD 50      1.e16      2
# 1      6      12     -.6685E+05      145      0.5      1      115      1.e16      2
# 1      9      3      -.6685E+05      244      0.5      1      DD 50      1.e16      3
# 1      9      6      -.6685E+05      189      0.5      1      DD 50      1.e16      3
# 1      9      9      -.6685E+05      147      0.5      1      DD 50      1.e16      3
# 1      9      12     -.6685E+05      119      0.5      1      115      1.e16      3
# <--FIXED FORMAT or delimited -----> | <----- Space, comma, or tab delimited only ---->
# 2      15     9      -.1003E+06      -1
# 2      13     7      -.6685E+05      -1      SITE:Simple-C
# 1      18     4      -.1003E+06      -1.
# ----- SP 3 ----- Begin Transient simulation -----
# 17
# 1      3      3      -.2000E+05      395      0.5      1      DD 50      1.e16      1      SITE:Well-A      Q-%cut:45. 65. Default
# 2      3      3      .0000      MN 200      0.5      1      DD 50      1.e16      1
# 1      3      6      -.6685E+05      304      1.0      1      DD 20      1.e16      1
# 1      3      9      -.6685E+05      240      -5000.0      1      DD 25      1.e16      1
# 1      3      12     -.0000E+05      100      0.5      1      140      1.e16      1      SITE:Well-B
# 2      3      12     -.1300E+06      MN 500      0.5      1      140      1.e16      1
# 1      6      3      -.6685E+05      302      0.5      1      DD 25      1.e16      2      Qcut: -15e3 -25e3
# 1      6      6      -.6685E+05      230      0.5      1      DD 50      1.e16      2
# 1      6      9      -.6685E+05      180      0.5      1      DD 50      1.e16      2
# 1      6      12     -.6685E+05      145      0.5      1      115      1.e16      2
# 1      9      3      -.6685E+05      244      0.5      1      DD 50      1.e16      3
# 1      9      6      -.6685E+05      189      0.5      1      DD 50      1.e16      3
# 1      9      9      -.6685E+05      147      0.5      1      DD 50      1.e16      3
# 1      9      12     -.6685E+05      119      0.5      1      115      1.e16      3
# 2      15     9      -.1003E+06      -1
# 2      13     7      -.6685E+05      -1      SITE:Simple-C
# 1      18     4      -.1003E+06      -1.
# ----- SP 4 -----
# -1
# ----- SP 5 -----
# -1

```

Stress Period 1

MNW PERIOD = 1 STEP = 15										
Entry	LAY	ROW	COL	Q	H-Well	H-Cell	DD	QW-Avg	s-LINEAR	s-NonLINEAR
1	1	3	3	-16088.6	177.188	179.785	-.100000E+32	395.000	2.59695	0.00000
2	2	3	3	16088.6	177.188	175.839	-22.8124	-1.00000	-1.34817	0.00000
3	1	3	6	0.00000	176.634	176.634	-23.3657	0.00000	0.129417E-05	0.00000
4	1	3	9	0.00000	169.531	169.531	-30.4688	0.00000	-.274058E-06	0.00000
5	1	3	12	3991.81	157.326	156.541	-.100000E+32	-1.00000	-.784912	0.00000
6	2	3	12	-3991.98	157.326	157.660	-42.6741	175.000	0.334515	0.00000
7	1	6	3	0.00000	178.979	178.979	-21.0210	0.00000	-.472688E-05	0.00000
8	1	6	6	0.00000	174.811	174.811	-25.1886	0.00000	-.443754E-05	0.00000
9	1	6	9	0.00000	167.428	167.428	-32.5721	0.00000	-.375635E-05	0.00000
10	1	6	12	0.00000	154.084	154.084	-45.9159	0.00000	-.747423E-05	0.00000
11	1	9	3	0.00000	176.412	176.412	-23.5876	0.00000	-.657984E-05	0.00000
12	1	9	6	0.00000	170.884	170.884	-29.1158	0.00000	0.543034E-05	0.00000
13	1	9	9	0.00000	162.899	162.899	-37.1008	0.00000	0.185337E-05	0.00000
14	1	9	12	0.00000	150.287	150.287	-49.7128	0.00000	-.414245E-05	0.00000
15	2	15	9	0.00000	155.541	155.541	-44.4589	-1.00000	0.721031E-05	0.00000
16	2	13	7	0.00000	159.971	159.971	-40.0285	-1.00000	-.107316E-05	0.00000
17	1	18	4	0.00000	172.702	172.702	-27.2983	-1.00000	0.876453E-05	0.00000

Multi-Node Rates & Average QW

Site Identifier	ENTRY: Begin	End	Q-Total	H-Well	DD	QW-Avg
Well-A	1	2	-.605469E-01	177.188	-22.8124	395.000
Well-B	5	6	-.171387	157.326	-42.6741	175.000

Stress Period 2

MNW PERIOD = 2 STEP = 15										
Entry	LAY	ROW	COL	Q	H-Well	H-Cell	DD	QW-Avg	s-LINEAR	s-NonLINEAR
1	1	3	3	-20144.2	160.632	164.323	-.100000E+32	338.601	3.69133	0.00000
2	2	3	3	144.044	160.632	160.620	-19.1525	338.601	-.120744E-01	0.00000
3	1	3	6	-22255.3	156.634	160.484	-20.0000	338.601	3.84954	0.00000
4	1	3	9	-45773.9	144.531	153.686	-25.0000	338.601	9.15477	0.00000
5	1	3	12	-28435.6	140.000	146.193	-.100000E+32	338.601	6.19280	0.00000
6	2	3	12	-67732.6	140.000	145.676	-16.5410	338.601	5.67577	0.00000
7	1	6	3	-17024.7	158.979	162.628	-20.0001	194.155	3.64938	0.00000
8	1	6	6	-66850.0	142.705	155.926	-32.1068	194.155	13.2211	0.00000
9	1	6	9	-66850.0	136.005	150.009	-31.4225	194.155	14.0033	0.00000
10	1	6	12	-66850.0	126.334	141.619	-27.7502	194.155	15.2855	0.00000
11	1	9	3	-66850.0	145.405	158.332	-31.0076	174.750	12.9274	0.00000
12	1	9	6	-66850.0	139.655	153.222	-31.2290	174.750	13.5673	0.00000
13	1	9	9	-66850.0	132.699	147.119	-30.2001	174.750	14.4200	0.00000
14	1	9	12	-66850.0	123.165	138.915	-27.1221	174.750	15.7504	0.00000
15	2	15	9	-100300.	144.109	144.116	-11.4321	-1.00000	0.668116E-02	0.00000
16	2	13	7	-66850.0	147.758	147.762	-12.2139	-1.00000	0.445374E-02	0.00000
17	1	18	4	-100300.	155.869	155.885	-16.8325	-1.00000	0.157747E-01	0.00000

Multi-Node Rates & Average QW

Site Identifier	ENTRY: Begin	End	Q-Total	H-Well	DD	QW-Avg
Well-A	1	2	-20000.2	160.632	-19.1525	395.000
Well-B	5	6	-96168.2	140.000	-16.5410	381.726

Stress Period 3

MNW PERIOD = 3 STEP = 15										
Entry	LAY	ROW	COL	Q	H-Well	H-Cell	DD	QW-Avg	s-LINEAR	s-NonLINEAR
1	1	3	3	-19807.6	159.296	162.969	-.100000E+32	346.243	3.67318	0.00000
2	2	3	3	-192.317	159.296	159.312	-20.4889	346.243	0.160884E-01	0.00000
3	1	3	6	0.00000	160.155	160.155	-16.4793	346.243	-.238685E-05	0.00000
4	1	3	9	-40177.1	144.531	152.567	-24.9999	346.243	8.03535	0.00000
5	1	3	12	-23541.5	140.000	145.181	-.100000E+32	346.243	5.18143	0.00000
6	2	3	12	-59365.3	140.000	144.975	-16.5410	346.243	4.97462	0.00000
7	1	6	3	-33825.9	153.979	160.398	-25.0001	201.886	6.41894	0.00000
8	1	6	6	-66850.0	141.151	154.547	-33.6601	201.886	13.3955	0.00000
9	1	6	9	-66850.0	134.451	148.648	-32.9765	201.886	14.1965	0.00000
10	1	6	12	-66850.0	124.880	140.376	-29.2038	201.886	15.4958	0.00000
11	1	9	3	-66850.0	143.828	156.925	-32.5847	174.750	13.0975	0.00000
12	1	9	6	-66850.0	138.090	151.842	-32.7937	174.750	13.7513	0.00000
13	1	9	9	-66850.0	131.127	145.753	-31.7719	174.750	14.6257	0.00000
14	1	9	12	-66850.0	121.687	137.662	-28.6006	174.750	15.9756	0.00000
15	2	15	9	-100300.	142.946	142.952	-12.5956	-1.00000	0.668630E-02	0.00000
16	2	13	7	-66850.0	146.563	146.567	-13.4086	-1.00000	0.445248E-02	0.00000
17	1	18	4	-100300.	154.470	154.486	-18.2315	-1.00000	0.159948E-01	0.00000

Multi-Node Rates & Average QW

Site Identifier	ENTRY: Begin	End	Q-Total	H-Well	DD	QW-Avg
Well-A	1	2	-19999.9	159.296	-20.4889	393.125
Well-B	5	6	-82906.8	140.000	-16.5410	386.419

Stress Period 4

MNW PERIOD = 4 STEP = 15										
Entry	LAY	ROW	COL	Q	H-Well	H-Cell	DD	QW-Avg	s-LINEAR	s-NonLINEAR
1	1	3	3	-17939.8	154.182	157.672	-.100000E+32	385.206	3.49046	0.00000
2	2	3	3	-2060.15	154.182	154.354	-25.6029	385.206	0.172634	0.00000
3	1	3	6	0.00000	155.256	155.256	-21.3780	385.206	0.427500E-05	0.00000
4	1	3	9	0.00000	150.002	150.002	-19.5296	385.206	0.346480E-05	0.00000
5	1	3	12	1793.47	143.885	143.484	-.100000E+32	385.206	-.401908	0.00000
6	2	3	12	-1793.28	143.885	144.036	-12.6555	385.206	0.150262	0.00000
7	1	6	3	0.00000	156.332	156.332	-22.6469	185.000	-.615278E-05	0.00000
8	1	6	6	-66850.0	135.077	149.195	-39.7343	185.000	14.1182	0.00000
9	1	6	9	-66850.0	128.749	143.696	-38.6787	185.000	14.9468	0.00000
10	1	6	12	-66850.0	120.703	136.831	-33.3813	185.000	16.1285	0.00000
11	1	9	3	-66850.0	137.512	151.332	-38.9005	174.750	13.8204	0.00000
12	1	9	6	-66850.0	131.937	146.456	-38.9476	174.750	14.5192	0.00000
13	1	9	9	-66850.0	125.307	140.740	-37.5923	174.750	15.4336	0.00000
14	1	9	12	-66850.0	117.325	133.997	-32.9623	174.750	16.6726	0.00000
15	2	15	9	-100300.	138.954	138.960	-16.5876	-1.00000	0.668091E-02	0.00000
16	2	13	7	-66850.0	142.364	142.368	-17.6077	-1.00000	0.445276E-02	0.00000
17	1	18	4	-100300.	148.783	148.800	-23.9186	-1.00000	0.169172E-01	0.00000

Multi-Node Rates & Average QW

Site Identifier	ENTRY: Begin	End	Q-Total	H-Well	DD	QW-Avg
Well-A	1	2	-20000.0	154.182	-25.6029	374.913
Well-B	5	6	0.194946	143.885	-12.6555	500.000

Stress Period 5

MNW PERIOD = 5 STEP = 50										
Entry	LAY	ROW	COL	Q	H-Well	H-Cell	DD	QW-Avg	s-LINEAR	s-NonLINEAR
1	1	3	3	-23336.0	170.016	173.960	-.100000E+32	329.578	3.94381	0.00000
2	2	3	3	3336.10	170.016	169.736	-9.76880	329.578	-.279588	0.00000
3	1	3	6	-66850.0	156.982	167.825	-19.6522	329.578	10.8427	0.00000
4	1	3	9	-66850.0	147.918	161.288	-21.6135	329.578	13.3700	0.00000
5	1	3	12	-39958.8	143.222	151.472	-.100000E+32	329.578	8.24964	0.00000
6	2	3	12	-90041.3	143.222	150.767	-13.3190	329.578	7.54516	0.00000
7	1	6	3	-66850.0	158.350	170.019	-20.6286	214.250	11.6686	0.00000
8	1	6	6	-66850.0	153.448	165.566	-21.3633	214.250	12.1182	0.00000
9	1	6	9	-66850.0	146.204	159.047	-21.2240	214.250	12.8427	0.00000
10	1	6	12	-66850.0	133.589	147.895	-20.4948	214.250	14.3057	0.00000
11	1	9	3	-66850.0	156.588	168.414	-19.8248	174.750	11.8267	0.00000
12	1	9	6	-66850.0	150.561	162.958	-20.3237	174.750	12.3979	0.00000
13	1	9	9	-66850.0	142.746	155.963	-20.1528	174.750	13.2164	0.00000
14	1	9	12	-66850.0	130.372	145.098	-19.9156	174.750	14.7264	0.00000
15	2	15	9	-100300.	151.280	151.287	-4.26085	-1.00000	0.669519E-02	0.00000
16	2	13	7	-66850.0	155.410	155.414	-4.56197	-1.00000	0.445956E-02	0.00000
17	1	18	4	-100300.	166.594	166.608	-6.10785	-1.00000	0.143399E-01	0.00000

Multi-Node Rates & Average QW

Site Identifier	ENTRY: Begin	End	Q-Total	H-Well	DD	QW-Avg
Well-A	1	2	-19999.9	170.016	-9.76880	395.000
Well-B	5	6	-130000.	143.222	-13.3190	377.050

REFERENCES CITED

- Barrash, W. and Dougherty, M.E., 1997, Modeling axially symmetric and nonsymmetric flow to a well with MODFLOW, and application to Goddard2 well test, Boise, Idaho: *Ground Water*, vol. 35, no. 4, p. 602–611.
- Bennett, G.D., Kontis, A.L., and Larson, S.P., 1982, Representation of multiaquifer well effects in three-dimensional ground-water flow simulation: *Ground Water*, vol. 20, no.3, p. 334–341.
- Cooley, R.L., and Cunningham, A.B., 1979, Consideration of energy loss in theory of flow to wells: *Journal of Hydrology*, vol. 43, p. 161–184.
- Earlougher, Jr., R.C., 1977, *Advances in well test analysis*: Society of Petroleum Engineers of AIME, Dallas, 264 p.
- Fanchi, J.R., Kennedy, J.E., and Dauben, D.L., 1987, *BOAST II: A Three- Dimensional, Three-Phase Black Oil Applied Simulation Tool*, U.S. Department of Energy Report DOE/BC/-88/2/SP.
- Gossell, M.A., Nishikawa, T., Hanson, R.T., Izbicki, J.A., Tabidian, M.A., and Bertine, K., 1999, Application of flowmeter and depth-dependent water quality data for improved production well construction: *Ground Water*, vol. 37, no. 5, p. 729–735.
- Groschen, G.E., 1994, Simulation of groundwater flow and the movement of saline water in the Hueco Bolson aquifer, El Paso, Texas and adjacent areas: U.S. Geological Survey Open-File Report 92-171, 87 p.
- Halford, K.J., 1997, Effects of Unsaturated Zone on Aquifer Test Analysis in a Shallow-Aquifer System: *Ground Water*, vol. 35, no.3, p. 512–522.
- Hanson, R.T., Martin, P., and Koczot, K.M., 2002, Simulation of Ground-water/surface-water flow in the Santa Clara-Calleguas ground-water basin, Ventura County, California: U.S. Geological Survey Water Resources-Investigations Report WRIR02-4136, ?? p.
- Hanson, R.T., and Nishikawa T.N., 1996, Combined use of flowmeter and time-drawdown data to estimate hydraulic conductivities in layered aquifer systems: *Ground Water*, vol. 34, no. 1, p. 84–94.
- Hantush, M.S., 1956, Analysis of data from pumping tests in leaky aquifers: *American Geophysical Union Transactions*, vol. 37, no. 6, p. 702–714.
- Harbaugh, A.W., Banta. E.R., Hill, M.C., and McDonald, M.G., 2000, MODFLOW-2000, the U.S. Geological Survey modular ground-water model—User guide to modularization concepts and the ground-water flow process: U.S. Geological Survey Open-File Report 00-92, 121 p.
- Harbaugh, A.W., and McDonald, M.G., 1996, Programmer’s documentation for MODFLOW-96, an update to the U.S. Geological Survey modular finite-difference ground-water flow model: U.S. Geological Survey Open-File Report 96-486, 220 p.
- Herbert, R., and Rushton, K.R., 1966, Ground water flow studies by resistance networks, *Geotechnique*, v. 16, pp. 53–75.
- Hunt, B., 1985, Flow to a well in a multiaquifer system: *Water Resources Research*, vol. 21, no. 11, p. 1637–1641.
- Izbicki, J.A., Christiansen, A.H., and Hanson, R.T., 1999, U.S. Geological Survey combined well-bore flow and depth-dependent water sampler: U.S. Geological Survey Fact Sheet 196-99, 2 p.
- Jacob, C.E., 1947, Drawdown test to determine effective radius of artesian well: *Transactions of the American Society of Civil Engineers*, vol. 112, p 1047–1070.
- Johnson, 1961, Dual-aquifer wells pose problem: *The Johnson National Drillers Journal*, January–February, 1961, 5 p.
- Kabala, Z.J., 1994, Measuring distribution of hydraulic conductivity and specific storativity by the double flowmeter test: *Water Resources Research*, vol. 30, no. 3, p. 685–690.
- Kawecki, M.W. 2000. Transient flow to a horizontal water well, *Ground Water*, vol 38, no. 6, p. 842–850.
- Kontis, A.L., and Mandle, R.J., 1988, Modification of a three-dimensional, ground-water flow model to account for variable density and effects of multiaquifer wells: U.S. Geological Survey Water-Resources Investigations Report 87-4265, 78 p.
- Kuniansky, J., and Hillestad, J.G., 1990, Reservoir simulation using bottomhole pressure boundary conditions: *Society of Petroleum Engineers Journal*, Vol. 20, No. 12, pp. 473–486.
- Livingston, P., and Lynch, W., 1937, Methods of locating salt-water leaks in water wells: U.S. Geological Survey Water-Supply Paper 796-A, 20 p.
- McDonald, M.G., 1984, Development of a multi-aquifer well option for a modular ground-water flow model: proceedings of National Water Well Association conference Practical applications of ground-water models, p. 786–796.
- McDonald, M.G., 1986, Development of a multi-aquifer well option for a modular groundwater flow model, in *Groundwater Hydrology, Contamination, and Remediation*, R.M. Khanbilvardi and J. Fillos, eds., Scientific Publications Co., p. 383–398.

- McDonald, M.G. and Harbaugh, A.W., 1988, A modular three-dimensional finite-difference ground-water flow model, U.S. Geological Survey Techniques of Water-Resources Investigations, book 6, chap. A1, 576 p.
- Meinzer, O.E., 1932, Outline of methods for estimating ground-water supplies: U.S. Geological Survey Water-Supply Paper 638, 125 p.
- Molz, F.J., Morin, R.H., Hess, A.E., Melville, J.G., and Guven, O., 1989, The impeller meter for measuring aquifer permeability variations: Evaluation and comparison with other tests: *Water Resources Research*, vol. 25, no. 7, p. 1677–1683.
- Neuman, S.P., and Witherspoon, P.A., 1969, Theory of flow in a confined two aquifer system: *Water Resources Research*, vol. 5, no. 4, p. 803–816.
- Neville, C.J., and Tonkin, M.J., 2001, Representation of multiaquifer wells in MODFLOW: Proceedings of MODFLOW 2001 and other modeling Odysseys, September, 2001, Golden, Colorado, Vol. 1, pp. 51–59
- Newhouse, M.W., and Hanson, R.T., 2000, Application of three-dimensional borehole flow measurements to the analysis of seawater intrusion and barrier injection systems, Los Angeles, California: Proceedings of the Minerals and Geotechnical Logging Society annual meeting, October 2000, Golden, Colorado, p. 281–292.
- , 2002, Three-dimensional flow measurements of ground water in uncased wells completed in volcanic basalts, Mountain Home Air Force Base, Idaho: U.S. Geological Survey Water-Resources Investigation Report 01-4259, 13 p.
- Paillet, F.L., 2001, Hydraulic head applications of flow logs in the study of heterogeneous aquifers: *Ground Water*, vol. 39, no. 5, p. 667–675.
- Papadopoulos, I.S., 1966, Nonsteady flow to multiaquifer wells: *Journal of Geophysical Research*, vol. 71, no. 20, p. 4791–4797.
- Peaceman, D.W., 1978, Interpretation of well-block pressures in numerical reservoir simulation: *Society of Petroleum Engineers Journal*, Vol. 18, No. 3, pp. 183–194.
- , 1983, Interpretation of well-block pressures in numerical reservoir simulation with nonsquare grid blocks and anisotropic permeability: *Society of Petroleum Engineers Journal*, p. 531–543.
- Pollock, D.W. 1994. User's Guide for MODPATH/MODPATH-PLOT, Version 3: A particle tracking post-processing package for MODFLOW, the U.S. Geological Survey finite-difference ground-water flow model: US Geological Survey Open-File Report 94-464, 6 ch.
- Prickett, T.A., 1967, Designing pumping well characteristics into electrical analog models: *Ground Water*, vol. 5, no. 4, p. 38–46.
- Reilly, T.E., Franke, O.L., Bennett, G.D., 1989, Bias in groundwater samples caused by wellbore flow: *Journal of Hydraulic Engineering*, vol. 115, no. 2, p. 270–276.
- Rorabaugh, M.I., 1953, Graphical and theoretical analysis of step-drawdown test of artesian well: *Proceedings of American Society of Civil Engineers*, vol. 79, no. 362, 23 p.
- Rutledge, A.T, 1991, An axisymmetric finite-difference flow model to simulate drawdown in and around a pumped well: U.S. Geological Survey Water-Resources Investigations Report 90-4098, 33 p.
- Sudicky, E.A., Unger, A.J.A., and Lacombe, S., 1995, A noniterative technique for the direct implementation of well bore boundary conditions in three-dimensional heterogeneous formations: *Water Resources Research*, vol. 31, no. 2, p. 411–415.
- Theis, C.V., 1935, The relation between the lowering of the piezometric surface and the rate and duration of discharge of a well using ground-water storage: *American Geophysical Union Transactions*, 16th Ann. Mtg., pt. 2, p. 519–524.
- Thiem, G., 1906, *Hydrologische Methoden*, Leipzig, 55 p.

APPENDIX: INPUT DATA FOR EXAMPLE PROBLEM MODFLOW 96

The test problem illustrates basic features of the multi-node, drawdown-limited MNW Package. Details of the test problem and results are discussed in the section titled "Example Problem."

Name File Input Data Set

```
LIST 6 mnw_exmpl.lst
BAS 5 mnw_exmpl.bas
BCF 10 mnw_exmpl.bcf
MNL 75 mnw_exmpl.MNW
DRN 77 mnw_exmpl.drn
RCH 72 mnw_exmpl.rch
PCG 74 mnw_exmpl.pcg
CHD 76 mnw_exmpl.chd
OC 71 mnw_exmpl.oc
DATA(BINARY) 89 OUTPUT.ufh
DATA(BINARY) 90 OUTPUT.cbc
```

Basic (BAS) Package Input Data Set

```
3D, Transient aquifer to demonstrate MNW package
>>>>>>>>>
      2      21      14      5      4
10 0 77 6 0 0 0 72 0 0 0 71 74 0 0 0 0 0 76 0 0 75
      0      1
      0      1      (16I5)      -7
      0      2      (16I5)      -7
    999.
      0      200. (6g14.6)      -3
      0      200. (6g14.6)      -3
1000.00      15 1.30000
1000.00      15 1.30000
   60.0      15 1.30000
  180.0      15 1.30000
  730.1      50 1.00000
```

Block-Centered Flow (BCF) Package Input Data Set

```
0          90      .0000      0      .0000      0      0
1 0 Laycon 1-unconfined, 0-Confined
0      1.00 (6g14.6)
0      2500. (6g14.6)
0      2500. (6g14.6)
0 0.05 (6e12.4)
0      60. (6e12.4)
0      50. (6e12.4)
0 .20E-03 (6e12.4)
0 1.0E-04 (6e12.4)
0 15000. (6e12.4)
0      XY Anisotropy
0      DX
0      DY
7 !! Specific Yield
7 !! ft/d
7      BASE
7 !! 0.01 ft/d * 1/50 ft
7      STOR
7 !! Transmissivity ft2/d
```

1	6	6	-.6685E+05	230	0.5	0	DD 50	1.e16	2	ZONE:106
1	6	9	-.6685E+05	180	0.5	0	DD 50	1.e16	2	ZONE:107
1	6	12	-.6685E+05	145	0.5	0	115	1.e16	2	ZONE:108
1	9	3	-.6685E+05	244	0.5	0	DD 50	1.e16	3	ZONE:109
1	9	6	-.6685E+05	189	0.5	0	DD 50	1.e16	3	ZONE:110
1	9	9	-.6685E+05	147	0.5	0	DD 50	1.e16	3	ZONE:111
1	9	12	-.6685E+05	119	0.5	0	115	1.e16	3	ZONE:112
2	15	9	-.1003E+06	-1						
2	13	7	-.6685E+05	-1						
1	18	4	-.1003E+06	-1.						
#	_____		SP 4	_____						
	-1									
#	_____		SP 5	_____						
	-1									

Drain Package (DRN) Input Data Set

50	90			
8				
1	13	13	128	10000
1	13	12	128	10000
1	13	11	129	10000
1	13	10	129	10000
1	13	9	130	10000
1	13	8	130	10000
1	13	7	131	10000
1	13	6	131	10000
-1		SP 2		
-1		SP 3		
-1		SP 4		
-1		SP 5		

Recharge (RCH) Package Input Data Set

1	90	6		
3	0		7 in/yr	1
0	0.001600	(6e14.6)		-7
3	0		7 in/yr	2
0	0.001600	(6e14.6)		-7
3	0		2 in/yr	3
0	0.000457	(6e14.6)		-7
3	0		0 in/yr	4
0	0.000000	(6e14.6)		-7
3	0		12 in/yr	5
0	0.002800	(6e14.6)		-7

PCG2 Package Input Data Set

18	90	1				
0.001101	0.911000	1.	2	1	0	
HCLOSE	RCLOSE	RELAX	NBPOL	IPRPCG	MUTPCG	DAMP

Time-Variant Specified-Head (CHD) Package Input Data Set

50	90			
21				
1	1	14	139	139
1	2	14	138	138
1	3	14	137	137
1	4	14	136	136
1	5	14	135	135
1	6	14	134	134
1	7	14	133	133
1	8	14	132	132
1	9	14	131	131
1	10	14	130	130
1	11	14	129	129
1	12	14	128	128
1	13	14	127	127
1	14	14	126	126
1	15	14	125	125
1	16	14	124	124
1	17	14	123	123
1	18	14	122	122
1	19	14	121	121
1	20	14	120	120
1	21	14	119	119
-1		SP 2		
-1		SP 3		
-1		SP 4		
-1		SP 5		

Output Control (OC) Package Input Data Set

2	2	89	00		
0	-0	-0	0	incode, ihddfl, ibudfl, icbcfl	
1	0	1	+0	hdpr, ddpr, hds, dds	
-1	-0	-0	0	2	
-1	-0	-0	0	3	
-1	-0	-0	0	4	
-1	-0	-0	0	5	
-1	-0	-0	0	6	
-1	-0	-0	0	7	
-1	-0	-0	0	8	
-1	-0	-0	0	9	
-1	-0	-0	0	10	
-1	-0	-0	0	11	
-1	-0	-0	0	12	
-1	-0	-0	0	13	
-1	-0	-0	0	14	
-1	1	1	1	15	SP 1
-1	-0	-0	0	1	
-1	-0	-0	0	2	
-1	-0	-0	0	3	

-1	-0	-0	0	4	
-1	-0	-0	0	5	
-1	-0	-0	0	6	
-1	-0	-0	0	7	
-1	-0	-0	0	8	
-1	-0	-0	0	9	
-1	-0	-0	0	10	
-1	-0	-0	0	11	
-1	-0	-0	0	12	
-1	-0	-0	0	13	
-1	-0	-0	0	14	
-1	1	1	1	15	SP 2
-1	-0	-0	0	1	
-1	-0	-0	0	2	
-1	-0	-0	0	3	
-1	-0	-0	0	4	
-1	-0	-0	0	5	
-1	-0	-0	0	6	
-1	-0	-0	0	7	
-1	-0	-0	0	8	
-1	-0	-0	0	9	
-1	-0	-0	0	10	
-1	-0	-0	0	11	
-1	-0	-0	0	12	
-1	-0	-0	0	13	
-1	-0	-0	0	14	
-1	1	1	1	15	SP 3
-1	-0	-0	0	1	
-1	-0	-0	0	2	
-1	-0	-0	0	3	
-1	-0	-0	0	4	
-1	-0	-0	0	5	
-1	-0	-0	0	6	
-1	-0	-0	0	7	
-1	-0	-0	0	8	
-1	-0	-0	0	9	
-1	-0	-0	0	10	
-1	-0	-0	0	11	
-1	-0	-0	0	12	
-1	-0	-0	0	13	
-1	-0	-0	0	14	
-1	1	1	1	15	SP 4
-1	-0	-0	0	1	
-1	-0	-0	0	2	
-1	-0	-0	0	3	
-1	-0	-0	0	4	
-1	-0	-0	0	5	
-1	-0	-0	0	6	
-1	-0	-0	0	7	
-1	-0	-0	0	8	
-1	-0	-0	0	9	
-1	-0	-0	0	10	
-1	-0	-0	0	11	
-1	-0	-0	0	12	

-1	-0	-0	0	13
-1	-0	-0	0	14
-1	-0	-0	0	15
-1	-0	-0	0	16
-1	-0	-0	0	17
-1	-0	-0	0	18
-1	-0	-0	0	19
-1	-0	-0	0	20
-1	-0	-0	0	21
-1	-0	-0	0	22
-1	-0	-0	0	23
-1	-0	-0	0	24
-1	-0	-0	0	25
-1	-0	-0	0	26
-1	-0	-0	0	27
-1	-0	-0	0	28
-1	-0	-0	0	29
-1	-0	-0	0	30
-1	-0	-0	0	31
-1	-0	-0	0	32
-1	-0	-0	0	33
-1	-0	-0	0	34
-1	-0	-0	0	35
-1	-0	-0	0	36
-1	-0	-0	0	37
-1	-0	-0	0	38
-1	-0	-0	0	39
-1	-0	-0	0	40
-1	-0	-0	0	41
-1	-0	-0	0	42
-1	-0	-0	0	43
-1	-0	-0	0	44
-1	-0	-0	0	45
-1	-0	-0	0	46
-1	-0	-0	0	47
-1	-0	-0	0	48
-1	-0	-0	0	49
-1	1	1	1	50

SP 5

