

**Investigation of Fire, Fatality, and Injuries
Eugene Island Block 108
December 23, 1998**

**Gulf of Mexico
Off the Louisiana Coast**



**U.S. Department of the Interior
Minerals Management Service
Gulf of Mexico OCS Regional Office**

**Investigation of Fire, Fatality, and Injuries
Eugene Island Block 108
December 23, 1998**

**Gulf of Mexico
Off the Louisiana Coast**

Frank Pausina
Tom Basey
Michael Hebert

Contents

Investigation and Report

Authority, 1
Procedures, 1

Introduction

Background, 4
Brief Description of Accident, 4

Findings

Descriptions of Platforms, 5

Platform No. 3, 5
Platform B, 6
Platform A, 6

Electronically Collected Pressure Readings, 6
Series of Shut-in Events, 6
Preliminary Activities, 7

Platform A, 8
Platform B, 8

The Accident, 9
Platform No. 3 Pressure Analysis, 11
UPRC Accident Investigation, 12
Coroner's Report, 12
Personnel/Training, 13
Safety Plans/Procedures, 14

Conclusions

Accident, 16
Causes, 16

Mechanical, 16
Personnel, 17
Management, 19

Recommendations, 21

Appendix

Attachment 1, Location of Lease OCS-G 3811, Eugene Island Block 108
Attachment 2, Simplified Schematic of Platform No. 3
Attachment 3, Simplified Schematic of Platform B
Attachment 4, Simplified Schematic of Platform A
Attachment 5, Photograph of Platform No. 3
Attachment 6, Photograph of Check Valve After Accident
Attachment 7, Photograph of Pig Launcher After Accident

Investigation and Report

Authority

An accident that resulted in one fatality and two injuries occurred on Union Pacific Resources Company's (UPRC) Platform No. 3, Eugene Island Block 108, Lease OCS-G 3811 in the Gulf of Mexico, offshore the State of Louisiana, on December 23, 1998, at approximately 1430 hours. Pursuant to Section 208, Subsections 22 (d), (e), and (f), of the Outer Continental Shelf Lands Act, as amended in 1978, and the Department of the Interior Regulations 30 CFR Part 250, the Minerals Management Service (MMS) is required to investigate and prepare a public report of this accident. By memorandum dated January 25, 1999, the following MMS personnel were named to the investigative panel (panel):

Frank Pausina, Office of Safety Management, New Orleans, Louisiana (Chairman)

Tom Basey, Lafayette District Office, Lafayette, Louisiana

Mike Hebert, Lafayette District Office, Lafayette, Louisiana

Procedures

On December 24, 1998, Tom Basey took aerial photographs of Platform No. 3 and visited Eugene Island Block 120 Central Facility.

On December 28, 1998, Mike Hebert and Raymond Johnson of the MMS Lafayette District visited Eugene Island Block 108 Platform No. 3 (Platform No. 3) and obtained statements at the Central Facility from personnel involved in rescue operations on the day of the accident.

On June 16, 1999, the panel visited Eugene Island Block 107 Platforms A and B (Platforms A and B, respectively).

The panel received from the United States Coast Guard (USCG) statements taken by the USCG from rescue personnel and the employees injured in the accident.

The panel received a transcript of a statement taken by a legal representative of UPRC of one of the injured employees.

The panel received a report of an investigation of the accident conducted by a UPRC contracted consultant. The contents and conclusions of the report represent UPRC's position on the accident.

The panel received from UPRC a listing of electronically recorded pressure readings from pertinent locations involved in the accident.

The panel conducted a formal hearing on June 29, 1999, at the MMS offices in Lake Charles, Louisiana, during which the following individuals were questioned:

John Doty, Tex Air

Douglas Broussard, Grasso Production Management Inc. (Grasso)

Timothy Gilblom, UPRC

Thomas Cook, Grasso

On July 29, 1999, the panel chairman spoke with a member of the Terrebonne Parish Coroner's Office regarding the cause of death of the employee who died as a result of the accident.

The panel chairman spoke at various times throughout the investigation with a representative of the USCG to discuss details of the case.

The panel met at various times throughout the investigative effort and, after having considered all of the information available, produced this report.

Introduction

Background

Lease OCS G-3811 covers approximately 5,000 acres and is located in Eugene Island Block 108, Gulf of Mexico, off the Louisiana coast. *For lease location, see Attachment 1.* The lease was issued effective June 6, 1978. UPRC became the designated operator of the lease in June 1998. At the time of the accident Grasso was contracted to operate Platform No. 3.

Brief Description of Accident

On the afternoon of December 23, 1998, a manual wing valve on Eugene Island Block 108 Platform No. 3 was in the process of being opened against a closed shutdown valve on another platform when gas escaped from a check valve and a pig launcher. The check valve and launcher were located in a section of piping whose pressure rating was less than the shut-in tubing pressure (SITP). The escaping gas was ignited by an unknown source, causing both contract employees and a helicopter pilot to jump from the platform into the Gulf. One contract employee and the helicopter pilot were injured while the other contract employee drowned.

Findings

Descriptions of Platforms

For a simplified schematic of Eugene Island Block 108 Platform No. 3 (Platform No. 3) and Eugene Island Block 107 Platforms A and B (Platform A and Platform B, respectively), see Attachments 2, 3, and 4. The attachments were entered as a consolidated schematic into the aforementioned hearing as Exhibit No. 2. For illustrative purposes, the individual attachments have been modified from their original form as they appeared in the exhibit.

Platform No.3:

Eugene Island Block 108 No. 3 well is a producing gas well with a flowing tubing pressure of approximately 5,100 psi and a shut-in tubing pressure of approximately 7,600 psi. The wellhead, flowline segments 1, 2, and 3, and associated equipment are rated for 15,000 psi. Flowline segment 4, its associated equipment, and the departing pipeline are rated for a maximum allowable working pressure of 2,200 psi. For the purpose of this report, the pertinent equipment on Platform No. 3 comprises the surface controlled subsurface safety valve (SCSSV), the master surface safety valve (SSV), the manual wing valve, the wing shut-down valve (SDV), the pressure safety high low (PSHL) sensors, the flow safety valve (FSV), the pig launcher, and the safety device relay panel. Each of the PSHL's sensors independently activates both the SSV and SDV. The FSV and the pig launcher are located in flowline segment No. 4. The SSV, SDV, and the SCSSV are activated by the platform's Emergency Shut Down system (ESD) even when the relays are pinned out. A bean choke separates segments 1 and 2. Adjustable manual chokes separate segments 2 and 3 and segments 3 and 4.

For a photograph of Platform No. 3, see Attachment 5. The SSV, SDV, manual wing valve, PSHL sensing points, FSV, pig launcher, and pressure gauges are located on the well deck.

Platform B:

The pipeline departing Platform No. 3 crosses Platform B en route to Platform A. On Platform B, the pipeline is equipped with a boarding SDV, which is activated in part by a PSHL sensor.

A panel contains in part the SDV/PSHL relay valve. Another pipeline, carrying production from Well B-1, which is produced on Platform B, departs Platform B for Platform A.

Platform A: The pipelines from Platform B are equipped with boarding SDV's on Platform A which are activated by safety devices on the platform.

**Electronically
Collected Pressure
Readings**

Platforms A, B, and No. 3 are equipped with a Supervisory Control and Data Acquisition (SCADA) system, which provides, in part, constant electronically collected pressure readings from various locations on the platforms. This, in turn, provides an historical record of the occurrences on the day of the accident with respect to pressure readings and the conclusions that can be drawn from those readings regarding the status of certain devices on the platforms. The pertinent locations for which pressure was recorded are labeled in Attachments 2, 3, and 4 as points 1 through 10 and will be referred to as sensing points 1 through 10.

**Series of Shut-in
Events**

The following description of shut-in events is evidenced from the electronically collected pressure readings.

At approximately 1044 hours on the day of the accident, an upset event occurred on Platform A that resulted in the closing of the boarding pipeline SDV's on Platform A. The time at which this occurred is evidenced by the time of the substantial pressure decrease detected at the separator's PSHL sensing point on Platform A and the pressure increases shortly following at the pressure sensing points on Platform B. The closing of the SDV on Platform A resulted in a pressure buildup in the pipeline section from Platforms B to A. When the pressure in the pipeline exceeded that of the PSH sensor settings on Platform B, the boarding pipeline SDV on Platform B closed. Given the time of the substantial pressure increase at the PSHL sensing point on Platform B, the SDV on Platform B closed at approximately 1047 hours. The closing of this SDV caused a pressure buildup in the pipeline upstream of Platform B, which similarly

resulted in the closing of the SSV and SDV on Platform No. 3 when the pipeline pressure exceeded that of the PSH sensor settings on Platform No. 3. Similarly, given the time of the substantial pressure increase as recorded at the PSHL sensing point on Platform No. 3, the SSV and SDV closed at approximately 1052 hours.

Preliminary Activities

After the cascading effects of the above-described pressure buildups had shut-in Platforms A, B, and No.3, a Grasso employee, henceforth referred to as Employee 1, was notified of the shut-ins and directed to bring the platforms back in service. Employee 1, together with another Grasso employee who was working with him on a platform in Eugene Island Block 162 at the time of the notification, henceforth referred to as Employee 2, was flown by helicopter to Platform A. Employee 1 was in charge of the operation. The day of the accident was a crew change day for both Employees 1 and 2. Both were to be flown to the beach on the helicopter's last flight of the day.

Platform A:

At approximately 1349 hours on the day of the accident, Employees 1 and 2 arrived on Platform A for the purpose of initiating the process of bringing Platforms A, B, and No. 3 back on production. Employee 2 stated that he was not told by Employee 1 of the method by which the platform was to be brought back in service neither while en route to Platform A nor upon arriving on the platform. He stated that he was to assist Employee 1 and that he was directed to obtain a water sample. Employee 1's activity while on Platform A was not clear from Employee 2's hearing testimony nor from his statements given shortly after the accident. The exact degree to which Employee 2 assisted Employee 1 in activities directly related to bringing the platforms back on production was also unclear. It is clear, however, that any direct assistance was at most minimal and at most limited to shutting in valves manually when directed by Employee 1 to do so. Recorded pressure readings indicate that the problems on Platform A were resolved and that the boarding pipeline SDV was opened. Employees 1 and 2 departed Platform A at

approximately 1411 hours. Employees 1 and 2 were on Platform A for approximately 22 minutes.

Platform B:

Employees 1 and 2 arrived on Platform B at approximately 1417 hours. When asked if Employee 1 explained to him what they were going to do on Platform B, Employee 2 stated that he was told that they needed to “do an MMS.” When asked if they were there to also open the SDV’s, he responded affirmatively. Employee 2 explained that doing “an MMS” consisted of his pressuring the PSHL sensors through the use of a hydraulic pump to see if the relays would trip at the proper pressures. He stated that eight sensors were successfully checked in that manner. Employee 2 was unable to explain in the hearing exactly what Employee 1 did at the relay panel or the positions of the relays and indicators. Employee 1 stated that the well on Platform B was flowing before they departed because Employee 1 would not have left the platform had it not been. At one point during his statements regarding his activities on Platform B, Employee 2 indicated that he was having difficulty remembering whether the activities he was describing with respect to “doing an MMS” had actually occurred on “162,” meaning on one of the platforms prior to his arrival on Platform A. Employees 1 and 2 departed Platform B at approximately 1423 hours. Employees 1 and 2 were on Platform B for approximately six minutes.

The Accident

Employees 1 and 2 arrived on Platform No. 3 at approximately 1427 hours. Employee 2 upon landing proceeded to the well deck and closed the manual wing valve in preparation for opening the SSV and SDV. Afterwards Employee 1, who was at the relay panel on the production deck, called to Employee 2 that the “panel was clear.” Employee 2 stated that he understood that to mean that the relays of the SSV and SDV were pinned open, thereby opening those valves. At that point Employee 2 turned the manual wing valve handle between two and four rounds. Employee 1 then went to the well deck and informed Employee 2 of helicopter problems and the possibility of spending the night on Platform No. 3. Employee 2 stated that it “was freezing

cold.” Employee 1 turned the manual wing valve handle about a quarter turn and gas was heard by Employee 2 to be flowing through the valve. At that point, Employee 2 left the well deck and proceeded to the heliport. He stated that he did not look at the pressure gauges while in the well deck area, did not see Employee 1 do so, was not told anything about pressure, did not know the normal operating pressure of the system, and was not told anything about the adjustable chokes. Employee 2 estimated that it took about two minutes for him to climb to the heliport, where he assisted the pilot in attempting to identify the source of the helicopter problem. Shortly after arriving on the heliport, both he and the pilot heard a loud noise, which was described by the pilot as the sound of pressure escaping. Within seconds of the noise a cloud of gas was observed, and within a few more seconds, the gas ignited, causing flames to rise around the edges of the heliport. From the recorded pressure data it appears that the fire began between approximately between 1431 and 1437 hours.

At that point the pilot jumped from the heliport into the Gulf and then inflated his life vest, which he had not taken off since landing on the platform. After unsuccessfully attempting to locate Employee 1, Employee 2 tried to inflate the helicopter’s liferaft but stopped when he noticed that the raft’s seam was torn. He then put on his life vest, which he had earlier taken off, inflated it, and jumped into the Gulf. The heliport is approximately 72 feet above the water. A short time after surfacing in the Gulf, the pilot observed for a moment Employee 1 attempting to swim with a degree of effort equal to his own; he did not see Employee 2. After being in the water for approximately 30 minutes, both Employee 2 and the pilot were taken aboard a motor vessel. Approximately ten minutes later, Employee 1 was retrieved by the same vessel. Moments later, Employee 1 was put on a helicopter that had landed on the back of the vessel. The pilot of this helicopter, who was directly overhead during the rescue operation, did not see CPR administered to Employee 1, nor did Employee 2 or the Tex Air pilot.

At approximately 1513 hours, Employee 1 was brought to Ocean Energy Inc.'s Eugene Island Block 120 Central Facility, where CPR was administered for approximately 30 minutes until such time that a USCG flight surgeon via radio communication with personnel on the central facility stated that CPR may be discontinued. It was reported to the flight surgeon that Employee 1 had been without a pulse since arriving on the facility about 30 minutes earlier. At approximately 1602 hours, Employee 2 and the pilot arrived at the central facility and were then taken to shore via helicopter for medical attention at 1850 hours. While on the boat and platform, Employee 2 complained of severe pain; the pilot's condition seemed much less severe.

Platform No. 3 Pressure Analysis

The normal operating pressure range at sensing points 5 and 6 was approximately 1,135 to 1,145 psi. At the time of the accident, the PSH sensors were set at approximately 1,517 psi. The closing of the SDV on Platform B caused the pressure at sensing point 5 to increase to 1,562 psi at 1052 hours, which precipitated the tripping of the relays and the closing of the SDV and SSV. After rising to 1,588 psi and 1,558 psi, respectively, the pressures at points 5 and 6 gradually decreased to 1,498 and 1,513 psi, respectively, at the time Employees 1 and 2 arrived at Platform No. 3. While the exact cause of the pressure decreases is not known, a leak in the boarding SDV is a possibility. Therefore, while on Platform No. 3, Employee 1, after Employee 2 closed the manual wing valve, would not have had to pin out the SSV and SDV relays to open the SSV and SDV, but rather just pull or reset the relay. The relay would have stayed in service, i.e., the SSV and SDV would have opened and remained so, and the indicator would have been green, indicating that the pressure was within the PSHL's sensor settings range. At 1437 hours pressure reached 4,050 psi and 3,657 psi at points 5 and 6, respectively. As previously stated, flowline segment 4 is rated for a maximum allowable working pressure of 2,200 psi.

UPRC Accident Investigation

UPRC personnel arrived on Platform No. 3 on the afternoon of

December 23, 1998, and found that the SCSSV, SSV, and SDV were in closed positions, the relays were tripped, the ESD's were activated on the well deck and the production deck but not on the heliport, and the manual wing valve was open. A post-accident pressure test of the flowline revealed that the pig launcher O-ring had ruptured and the FSV gasket had failed at the time of the accident. *For photographs of the FSV and pig launcher after the accident, see Attachments 6 and 7.* The safety panel was also tested after the accident and found to be functioning properly.

UPRC contracted a petroleum engineering consultant to investigate the accident. As previously stated in this report, the conclusions of that investigation represent UPRC's position on the accident.

Coroner's Report

The coroner's report lists the cause of death of Employee 1 as "Probable Drowning." The report states in part that Employee 1 suffered "first degree flash burns of the face, including the forehead with the front part of the hair singed." It also states that there was "some singeing of the hair on both hands up to the wrist." The chief investigator of the coroner's office stated that there was no substantial evidence to indicate that the fire contributed directly to the death of Employee 1.

Personnel/Training

Employee 1 was a Field Operator and had been employed by Grasso for about six years at the time of the accident. As a Field Operator he was responsible for general offshore operations including, but not limited to, performing platform safety inspections and bringing wells back on production. His safety record was described by Grasso management as excellent. Employee 1 had received training in production safety systems, crane operations, and first aid. He was described as a "very outstanding employee" by Grasso.

Employee 2 was a welder and had been employed by Grasso for about eight months at the time of the accident. Grasso management stated that they experienced no problems with his safety record and that he was doing a good job. He had received training in production safety systems. At the hearing, Employee 2 stated that he did not understand the cascading effect of pressure buildups and corresponding safety device activation that resulted in the Platforms A, B, and No. 3 being shut in.

Grasso management stated that other field operators who normally accompanied Employee 1 on this type of mission had offered to do so upon learning of the situation, but that Employee 1 in effect declined the offer and elected to have Employee 2 assist him in bringing the three platforms back on production. Employee 2 stated that he had previously assisted Employee 1 in bringing pipelines back on production. Grasso management stated that Employee 1 "was a trainer for us" and that is why "he (Employee 2) was out with (Employee 1) that day." Grasso stated that, as a result, since the time of the accident they have not modified their operating procedures with respect to who might perform tasks such as those involved in this accident.

UPRC management, in response to a panel question regarding the appropriateness of using a mechanic to assist in the activities involved in this incident, stated that UPRC feels that anyone who has received production safety system training is able to be taught that which is necessary to bring wells on line.

UPRC's management stated at the hearing that, in their opinion and contrary to Employee 2's statement, no "MMS" was performed by Employees 1 and 2 on Platform B on the day of the accident.

**Safety Plans/
Procedures**

UPRC's description of their safety program at the hearing is as follows:

1. At the time of the accident, UPRC had a safety and environmental management program (SEMP plan) and an employee safety handbook in effect. The handbook did not contain specific procedures for certain tasks. UPRC did two types of Job Safety Analyses (JSA) for certain procedures. Those for procedures requiring the same type of activity, i.e., unchanging specific steps for bringing a system on line, such as a dehydration system or a compressor, were in written form. For those procedures for which the activities varied, such as in the case of bringing a well on line, the JSA was in oral form because, according to UPRC management, the following of a written procedure was as likely to cause a problem as the likelihood of bringing it on correctly.

2. UPRC required Grasso, when acting in a general supervisory role, such as in operating a platform, to follow Grasso's safety plan "to the letter." However, Grasso employees, such as Employees 1 and 2, who were supplied to UPRC for the purpose of performing "daily tasks," were required to follow both Grasso and UPRC safety plans.

As part of their overall safety program, Grasso has a safety manual located on all of the platforms that they operate. Like UPRC's, the Grasso manual does not contain specific procedures for certain tasks. Employee 2 stated that he was not familiar with Grasso's safety handbook.

Conclusions

Accident

Based upon the preceding findings, it is the conclusion of this panel that at approximately 1430 hours on Platform No. 3, Employee 1, after resetting the safety relays for the SSV and SDV, opened the well's manual wing valve. The resulting pressure increase, due to the well being opened against an unopened boarding pipeline SDV on Platform B and the above referenced reset relays and the corresponding opened SSV and SDV on Platform No. 3, exceeded the working pressure of flowline segment No. 4, resulting in gas escaping from the pig launcher and FSV. Employee 1 then activated the ESD at the well deck level and climbed to the production deck level, where he activated the ESD at that level. While Employee 1 was on the production deck, an unknown source ignited the escaping gas. After receiving minor burns from the ignited gas, Employee 1 jumped from the production deck into the Gulf from a height of approximately 52 feet. With his life vest inflated and after making an attempt to swim from the platform, Employee 1 drowned for unknown reasons. Given the findings of the coroner's report and after communication with the coroner's office senior investigator, no conclusions can be drawn by the panel regarding the cause of the drowning.

Causes

Mechanical

The immediate mechanical cause of the accident is clearly the opening of the manual wing valve on Platform No. 3 against the closed but possibly leaking boarding SDV on Platform B with the SSV and SDV on Platform No. 3 opened. When the manual wing valve was opened, the pressure increased to a level in excess of the maximum allowable working pressure of the segment of piping containing the FSV and pig launcher, resulting in the failure of the pressure containment of those devices. Although the relays were reset and the SSV and SDV were opened at the time the wing valve was opened, the resultant pressure increase, while exceeding the PSH sensor settings and tripping the relays, occurred at a rapid enough rate such that the critical pressure causing the failures was reached prior to the closing of the SSV and SDV.

That the boarding SDV on Platform B was closed at the time of the accident is evidenced by the recorded pressure readings on Platform No. 3.

The degree to which the use of the adjustable chokes to bring the well back on production would have lessened the likelihood of the accident by increasing the time for the pressure to increase and Employee 1 to observe the pressure gauge is concluded to be minimal.

Personnel

It is clear that the mission of Employees 1 and 2 was to bring Platforms A, B, and No. 3 on line which, in part, definitely included the opening of the boarding SDV's on Platforms A and B and the bringing back on line of Well No. 3. Although he was aware of the need to open the boarding SDV on Platform B prior to opening Well No. 3, Employees 1 and 2 departed Platform B without having done so. It is concluded that this was an oversight by Employees 1 and 2 and a **major cause** of the accident.

After the manual wing valve was closed, Employee 1, upon pulling the relays for the SSV and SDV, very probably noticed that the relays remained set, i.e., did not trip, since the pressure in the line was within the range of the PSHL sensor settings. Employee 1 then very probably concluded that the pressures had fallen into the range of the PSH settings because the SDV on Platform B was open and the pressure was at a value close to the normal operation pressure of the system. Again, had Employee 1 viewed the pressure gauges he would have (a) noticed that the pressure, while within the range of the PSH settings, was still much greater than the normal operating pressure of the system; (b) concluded that the SDV was closed on Platform B; and (c) therefore would not have opened the manual wing valve. Therefore, while on Platform No. 3, Employee 1's failure to observe the pressure gauges is considered to be a **major cause** of the accident.

Employee 1 did not explain to Employee 2 in any detail the procedures to be followed that were necessary to bring the pipeline back on production safely. Employee 2 was not sure specifically what Employee 1 was doing at the safety panels with respect to the relays. Such lack of communication is not consistent with the trainer/trainee relationship between Employees 1 and 2 which, according to Grasso management, basically defined the reason for Employee 2 accompanying and assisting Employee 1 in bringing the pipeline back on production. An explanation by Employee 1 as to what exactly needed to be done and explicit directions to Employee 2 on how to accomplish their task could reasonably be expected to have heightened Employee 1's attention to the detail required to accomplish their mission safely, such as noticing that the SDV on Platform B was closed as they departed the platform and observing the pressure gauges on Platform No. 3. Therefore, the manner in which Employee 1 utilized Employee 2 is considered to be a **contributing cause** of the accident.

Although it appears that Employee 2 did not directly contribute to the accident, Employee 1's decision to not choose a more experienced operator to assist him is considered to be a **contributing cause** of the accident in that a more experienced operator could very reasonably be expected to have noticed Employee 1's aforementioned oversights.

Given the above-referenced lack of communication and the fact that more experienced operators offered to assist Employee 1, Employee 1's choice in selecting Employee 2 was apparently one of expediency, possibly influenced by a scheduled crew change, and possibly characterized the manner in which the duties were performed on Platforms B and No. 3. Therefore, it is concluded that Employee 1 possibly hastily performed his duties on Platforms No. 3 and B, and if so, constitutes a **possible contributing cause** of the accident.

Management

Although there were no specific procedures in either UPRC's or Grasso's safety literature with respect to bringing a well back on production, the degree to which the existence of such written

procedures would have substantially lessened the probability of the subject accident occurring is not known given (a) the expediency of Employee 1's choice of assistant, (b) Employee 2's unfamiliarity with Grasso's safety handbook, (c) the apparent hastiness with which Employee 1 performed his duties, and (d) the fact that the suddenness of Employees 1 and 2's response to the shutting in of the platforms precluded the referencing of any written procedures in a morning safety meeting.

However, notwithstanding UPRC management's assessment of the criteria for choosing written versus oral JSA's, the panel concludes that, while procedures for bringing wells back on production can vary with well and platform particulars, there are various basic safety considerations that are common to all such procedures and that can be listed in a safety/procedural guideline handbook. Even given that the existence of such listed procedures did not guarantee its referencing by Employees 1 and 2, their existence could arguably be expected to have at least heightened Employee 1's attention to the dangers involved in such operations. Therefore, the absence of such basic safety considerations can reasonably be viewed as a **contributing cause** of the accident.

Recommendations

The MMS should issue a Safety Alert to all lessees and operators containing the following:

1. A brief description of the accident appearing in this report.
2. A recommendation that operators analyze all potentially dangerous operational procedures for which written procedural guidelines have not been included in a safety/procedural guideline handbook, in an effort to determine which basic safety aspects of the procedures can be so included.

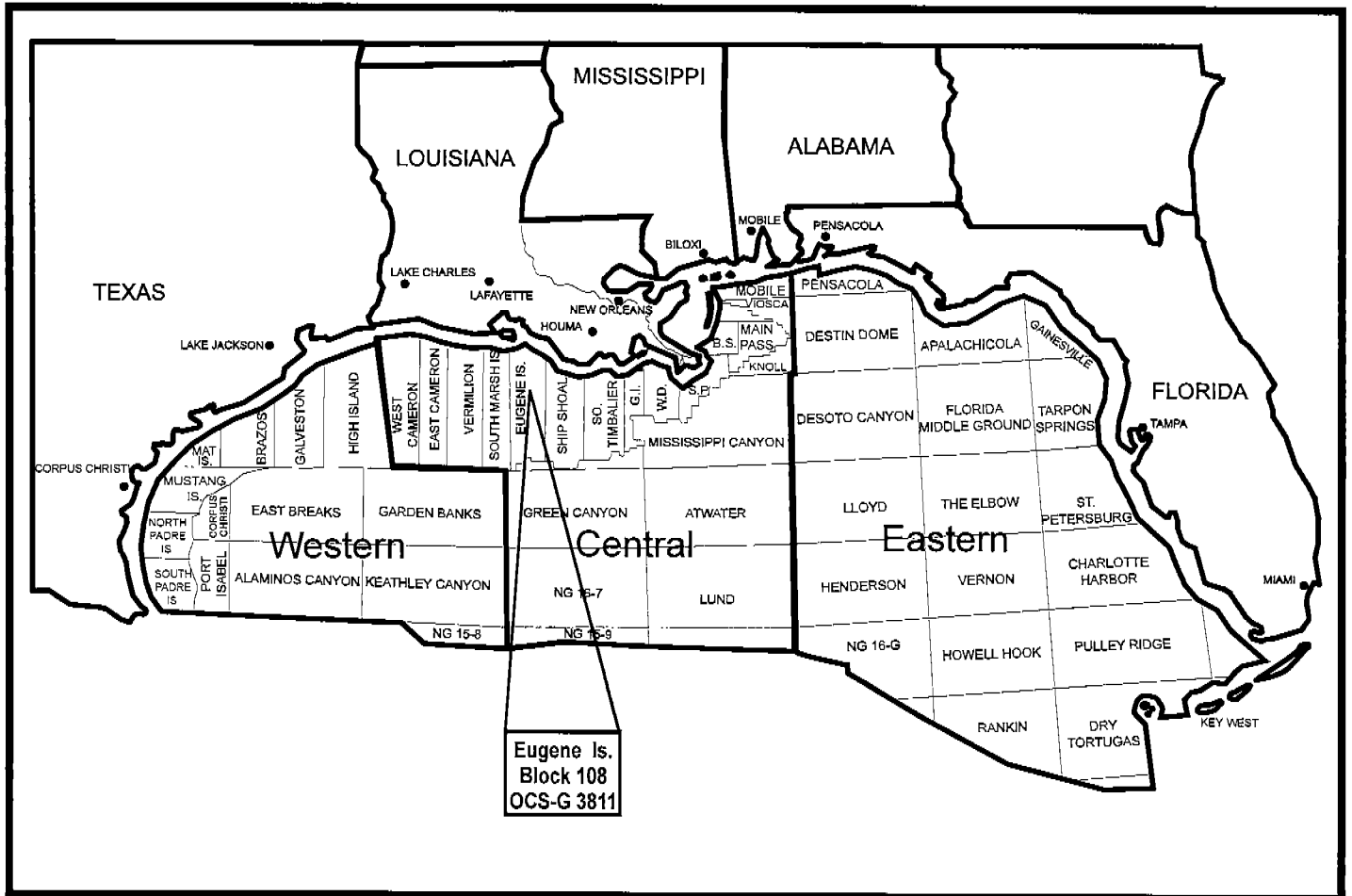

Location of Lease OCS-G 3811,
Eugene Island Block 108

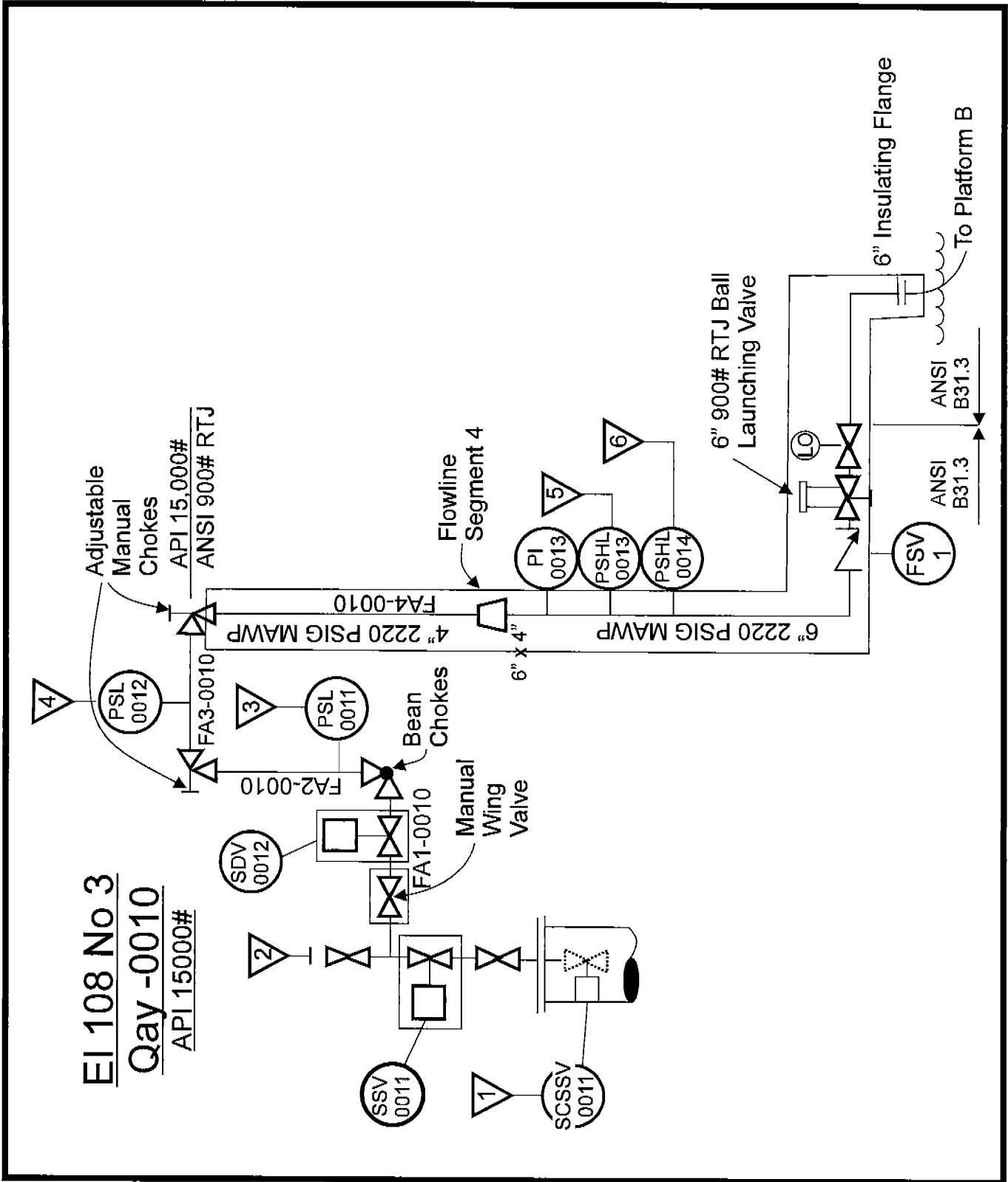

Simplified Schematic of Platform No.3

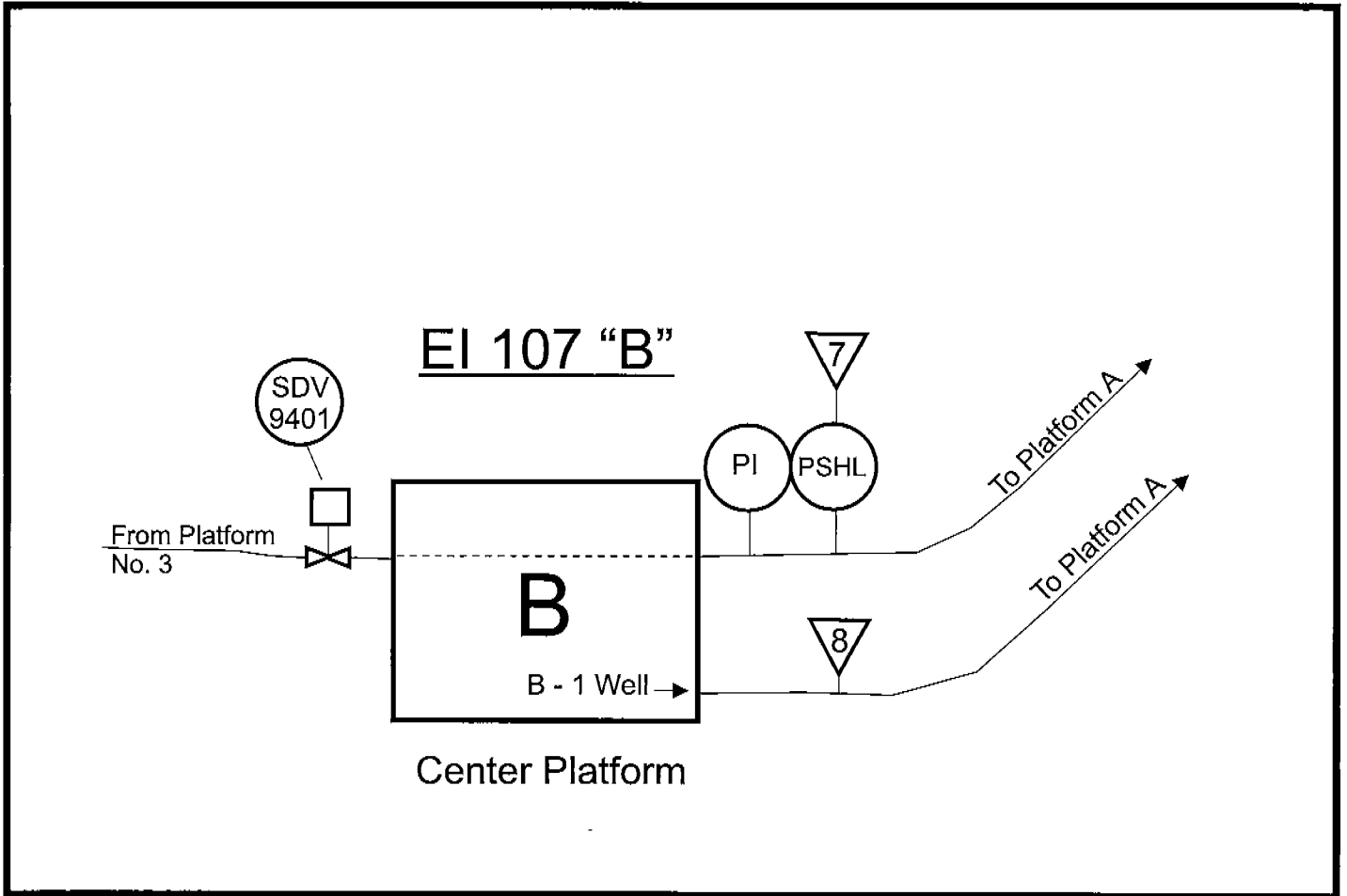

Simplified Schematic of Platform B

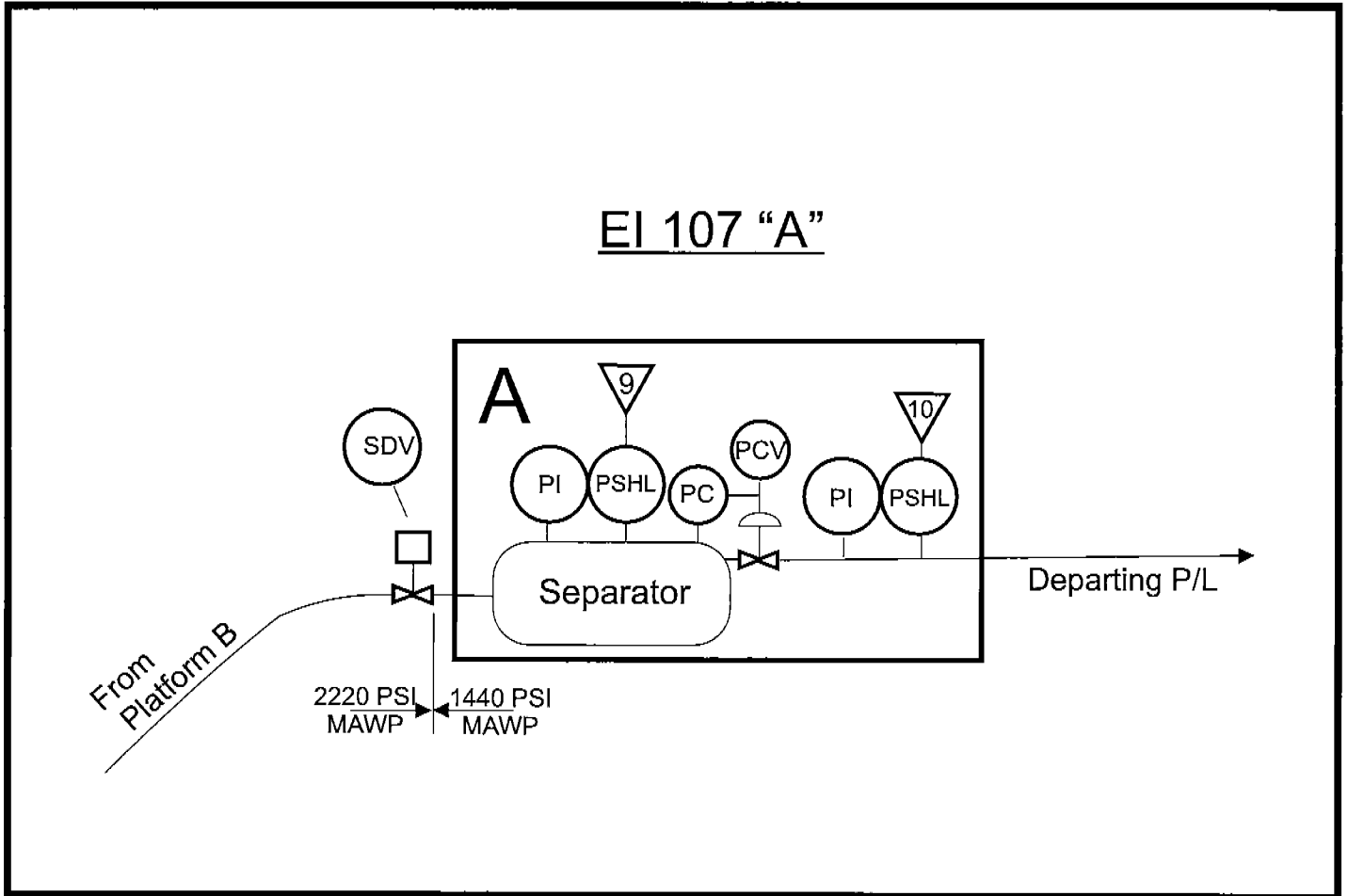

Simplified Schematic of Platform A

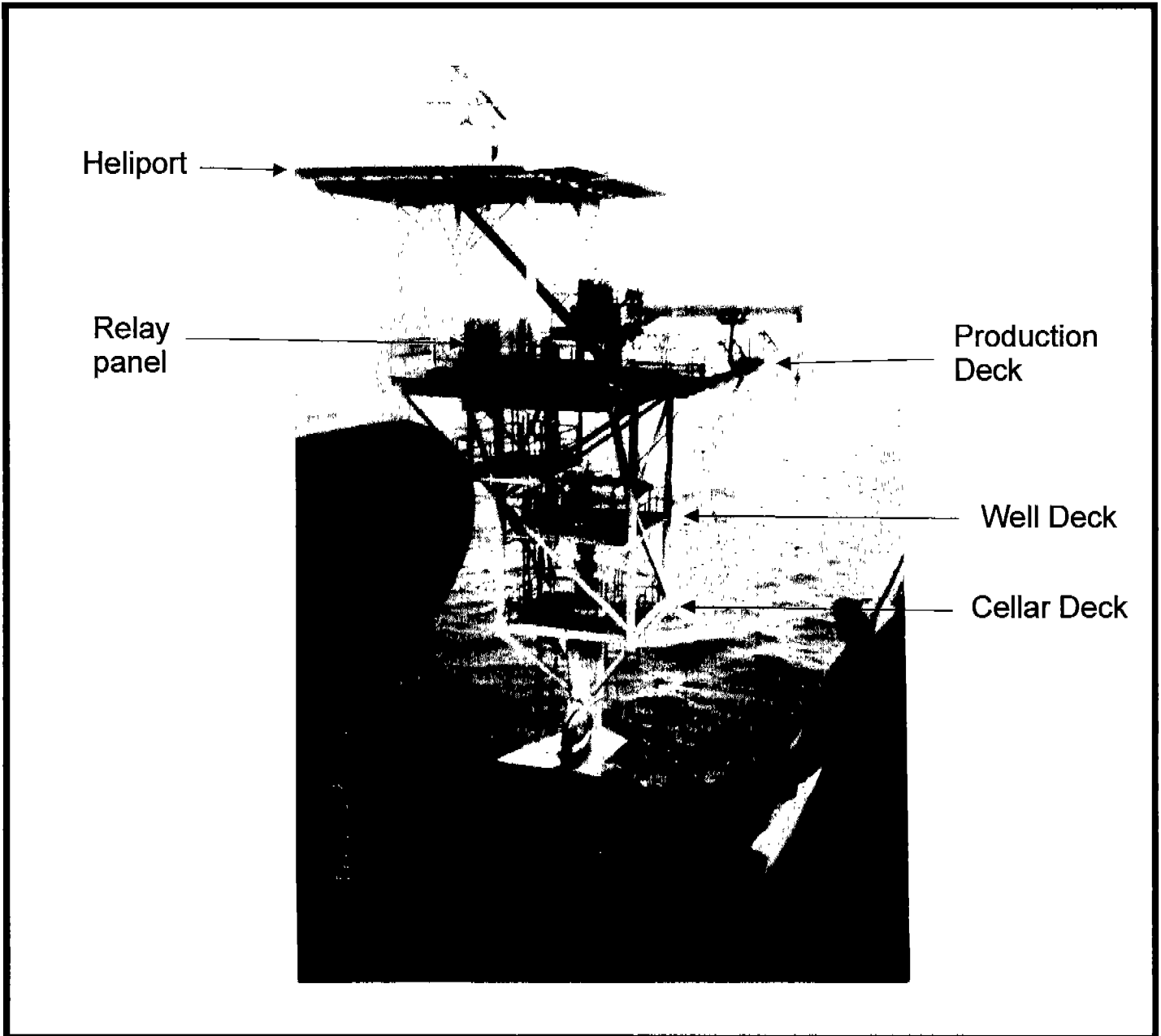

Photograph of Platform No. 3

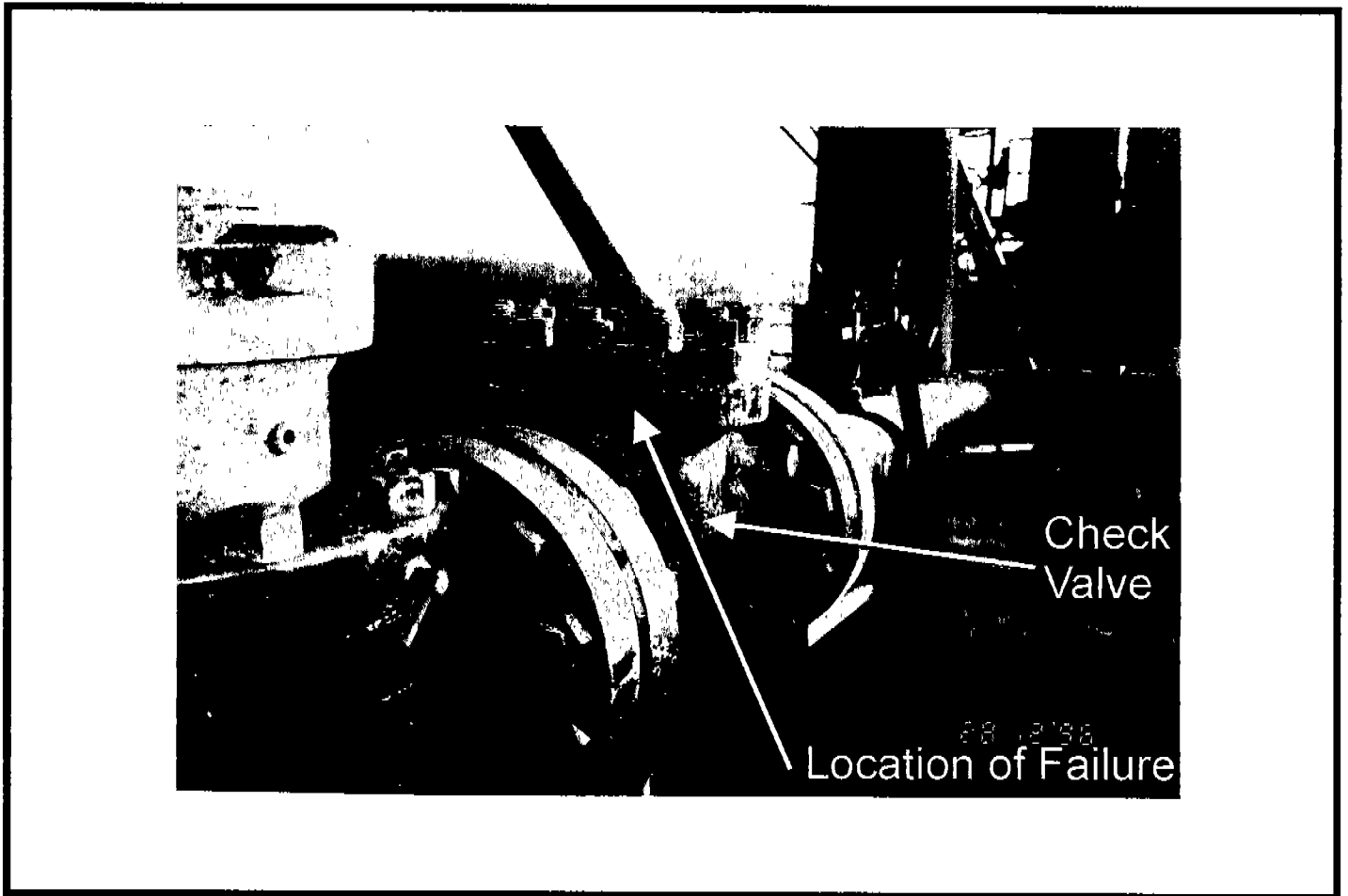

Photograph of Check Valve after Accident

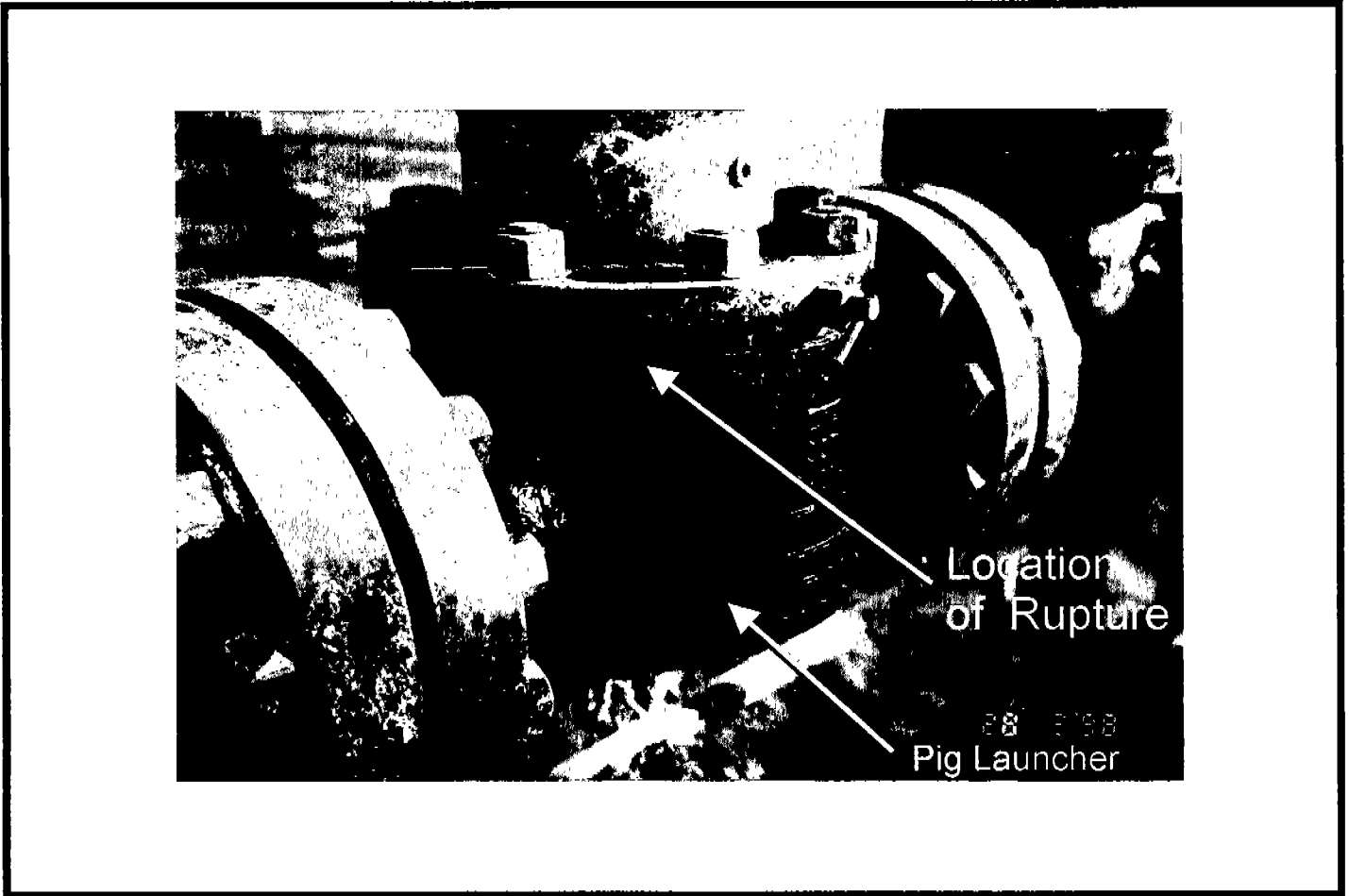

Photograph of Pig Launcher after Accident