



COMDTINST M5060.11A
MAR 29 1993

COMMANDANT INSTRUCTION M5060.11A

Subj: MARINE CORPS DRILL AND CEREMONIES MANUAL

1. PURPOSE. This instruction promulgates the Marine Corps Drill and Ceremonies Manual as a guide for manual of arms, drills, formations, and military ceremonies within the Coast Guard.
2. DIRECTIVES AFFECTED. COMDTINST M5060.11 is cancelled.
3. BACKGROUND. The Marine Corps Drill Ceremonies Manual and its predecessor, the Landing Party Manual, have been used for many years as an official reference and guide for planning and conducting drills and ceremonies for Coast Guard activities. This practice will be continued for reasons of efficiency and consistency between the naval services.
4. ACTION. Area and district commanders, commanders of maintenance and logistic commands, unit commanding officers and Commander, CG Activities Europe shall use enclosure (1) as a guide when planning and executing functions covered.

/s/ R. A. Appelbaum
Chief, Office of Law Enforcement and
Defense Operations

Encl: (1) SECNAVINST 5060.22 of 26 May 81 (Marine Corps
Drill and Ceremonies Manual NAVMC 2691)



DEPARTMENT OF THE NAVY
OFFICE OF THE SECRETARY
WASHINGTON, D.C. 20350-1000

SECNAVINST 5060.22
26 May 1981

SECNAV INSTRUCTION 5060.22

From: Secretary of the Navy

To: All Ships and Stations (less Marine Corps field addressees not having Navy personnel attached)

Subj: Drill and Ceremonies Manual and Interior Guard Manual; promulgation of

Ref: (a) SECNAV WASHINGTON 011824Z MAR 76 ALNAV 016/76 (cancelled 1 June 76)

Encl: (1) Marine Corps Drill and Ceremonies Manual, NAVMC 2691
(2) Marine Corps Interior Guard Manual, NAVMC 2691A

1. Purpose. To promulgate the Marine Corps Drill and Ceremonies Manual and Interior Guard Manual as replacements for the Landing Party Manual (LPM)
2. Cancellation. Chapters 2, 3, and 5 of the LPM (OPNAV P34-03, November 1960).
3. Background. Reference (a) cancelled those chapters of the LPM that required the organization and maintenance of ships' landing parties, leaving in effect the three chapters that address drill, ceremonies, and interior guard. Enclosures (1) and (2) replace those three chapters.
4. Action. Drill and ceremonies and interior guard procedures for the Department of the Navy shall be in accordance with the guidance in the enclosures. The enclosures have been previously distributed to Marine Corps activities.
5. Manual Revision Responsibility. Commandant Marine Corps (TRI) is responsible for upkeep and revision of the manuals. Individuals should address recommended changes to the manuals by means of the User Suggestion Forms contained in the manuals. Commands should address recommended changes to Commandant Marine Corps via the chain of command. For Navy commands changes to the Drill and Ceremonies Manual should be addressed through Chief of Naval Operations (Op-01) and to the Interior Guard Manual through Chief of Naval Operations (Op-04).

/s/ Robert J. Murray
Under Secretary of the Navy

Distribution
(See page 2)

28 Aug 1980

FOREWORD

1. PURPOSE

This publication, NAVMC 2691, Marine Corps Drill and Ceremonies Manual, furnishes information and describes procedures for close order drill and military ceremonies within the Marine Corps.

2. SCOPE

This Manual encompasses detailed procedures for all drill and ceremonies executed by troop elements ranging in size from the individual to the regiment.

3. SUPERSESION

None

4. CHANGES

Recommendations for improving this Manual are invited from commands as well as directly from individuals. The attached User Suggestion Form should be utilized by individuals and forwarded to Commandant of the Marine Corps (Code TRI), Headquarters, U.S. Marine Corps, Washington, D.C. 20380.

5. CERTIFICATION

Reviewed and approved this date.

/s/ A. A. SARDO
Brigadier General, U. S. Marine Corps
Director of Training

DISTRIBUTION: DG less 7000038
plus 70000.9 (100)

Copy to: 8145001

NAVMC 2691
1 MAR 1983

Change 1 to NAVMC 2691

1. Insert the attached page 12-3 and remove superseded page in NAVMC 2691, Marine Corps Drill and Ceremonies Manual.
2. This promulgation page shall be filed immediately following the basic promulgation page (FOREWORD) dated 28 August 1980.
3. Reviewed and approved this date.

/s/ J. L. DAY
Major General, U.S. Marine Corps
Deputy Chief of Staff for Training

DISTRIBUTION: DG less 7000038
plus 7000038 (100)

Copy to: 8145001

USER SUGGESTION FORM

From:

To: Commandant of the Marine Corps (Code TRI), Headquarters
U.S. Marine Corps, Washington, D.C. 20380

Subj: NAVMC 2691 , Marine Corps Drill and Ceremonies Manual:
recommendation(s) concerning

1. In accordance with the Foreword to NAVMC 2691, which invites individuals to submit suggestions concerning this NAVMC directly to the above addressee, the following unclassified recommendation(s) is(are) forwarded:

a. ITEM #1 (May be handwritten; if more space is required, use additional sheets and envelopes.)

(1) Portion of Manual: (Cite by paragraph and/or page number.)

(2) Comment: (Explain in sufficient detail to identify the points of the suggestion.)

(3) Recommendation: (State the exact wording desired to be inserted into the manual.)

b. ITEM #2

(1)

(2)

(3)

c. ITEM #3 (etc.)

(1)

(2)

(3)

MARINE CORPS DRILL AND CEREMONIES MANUAL
TABLE OF CONTENTS

PART I. DRILL

CHAPTER 1. INTRODUCTION TO DRILL

	<u>Para</u>	<u>Page</u>
General.....	1-1	1-1
Drill instructors.....	1-2	1-6
Instruction groups.....	1-3	1-6
Commands and the command voice.....	1-4	1-6
General rules for drill.....	1-5	1-9
Drill, by the numbers.....	1-6	1-11
Mass commands and individual commands from ranks.....	1-7	1-11
Cadence drill.....	1-8	1-12
Trick drill.....	1-9	1-12

CHAPTER 2. INDIVIDUAL INSTRUCTIONS WITHOUT ARMS

Positions.....	2-1	2-1
Steps and marching.....	2-2	2-8

CHAPTER 3. MANUAL OF ARMS WITH THE M16 RIFLE

Section I. Manual of arms with sling drawn tight

General.....	3-1	3-1
Order arms.....	3-2	3-3
Rest positions.....	3-3	3-4
Trail arms.....	3-4	3-5
Port arms from order arms.....	3-5	3-6
Right shoulder arms from order arms.....	3-6	3-8
Order arms from right shoulder arms.....	3-7	3-10
Left shoulder arms from order arms.....	3-9	3-13
Present Arms.....	3-10	3-14
Order arms from present arms.....	3-11	3-15
Rifle salute.....	3-12	3-17
Inspection arms (with and without magazine).....	3-13	3-18
Port arms from inspection arms (with and without magazine).....	3-14	3-20
Fix and unfix bayonets.....	3-15	3-21
Authorized movements in the manual of arms with the M16 rifle.....	3-16	3-21

Section II. Manual of arms movements while at sling arms

General.....	3-17	3-22
Sling arms.....	3-18	3-22
Un sling arms.....	3-19	3-24
Adjust slings.....	3-20	3-24
Salute at sling arms.....	3-21	3-24
Port arms from sling arms.....	3-22	3-25
Inspection arms from sling arms.....	3-23	3-26

CHAPTER 4. MANUAL OF ARMS WITH HANDGUNS

	<u>Para</u>	<u>Page</u>
Pistol manual of arms.....	4-1	4-1
Revolver manual of arms.....	4-2	4-4

CHAPTER 5. SWORD MANUAL

General rules.....	5-1	5-1
Draw sword.....	5-2	5-4
Present sword from carry or order sword.....	5-3	5-6
Order sword from present sword.....	5-4	5-9
Eyes right (left) from carry or order sword.....	5-5	5-10
Parade rest from order arms.....	5-6	5-11
At ease from any position of the sword.....	5-7	5-13
Rest from any position of the sword.....	5-8	5-14
To return to attention.....	5-9	5-14
Return sword from carry or order sword.....	5-10	5-14
Funeral carry.....	5-11	5-17

CHAPTER 6. GUIDON MANUAL

General rules.....	6-1	6-1
Positions of guidon.....	6-2	6-1

CHAPTER 7. SQUAD DRILL

General.....	7-1	7-1
To form the squad.....	7-2	7-2
To dismiss the squad.....	7-3	7-4
To count off.....	7-4	7-4
To align the squad.....	7-5	7-4
To obtain close interval from normal interval in line.....	7-6	7-5
To obtain normal interval from close interval in line.....	7-7	7-5
To obtain double-arm interval in line.....	7-8	7-5
To form column from in line and reform line.....	7-9	7-5
To march to the oblique.....	7-10	7-6
To march to the flank.....	7-11	7-7
To change the direction of a column.....	7-12	7-7
To form column of twos from single file.....	7-13	7-7
To form single file from column of twos.....	7-14	7-8
To stack arms.....	7-15	7-9
To take arms.....	7-16	7-12

CHAPTER 8. PLATOON DRILL

General.....	8-1	8-1
Formations.....	8-2	8-2
Posts of individuals.....	8-3	8-3
Rules for the guide.....	8-4	8-3
To form the platoon.....	8-5	8-4
To dismiss the platoon.....	8-6	8-5
To align the platoon.....	8-7	8-5
To form column from line.....	8-8	8-5
To march (form) at close interval in column.....	8-9	8-6
To march (form) at normal interval in column.....	8-10	8-7
To change the direction of a column.....	8-11	8-7
To form line from column.....	8-12	8-8
To march toward a flank.....	8-13	8-9
To stack arms.....	8-14	8-9
To open ranks.....	8-15	8-9
To close ranks.....	8-16	8-9

	<u>Para</u>	<u>Page</u>
To form for shelter tents.....	8-17	8-9
To form column of tows and single file and reform.....	8-18	8-10

CHAPTER 9. COMPANY DRILL

General.....	9-1	9-1
Rules for company drill.....	9-2	9-1
To form the company.....	9-3	9-2
Being in line, to form column and reform into line.....	9-4	9-5
Being in column, to change direction.....	9-5	9-6
Being in column at close interval, to form mass formation..	9-6	9-6
Being in column, to form extended mass formation.....	9-7	9-7
Being in mass or extended mass formation, to change direction.....	9-8	9-7
Being in mass or extended mass formation, to form columns..	9-9	9-8
Being in column, to form column of platoons in line.....	9-10	9-8
Being in column of platoons in line, to form column.....	9-11	9-10
Being in column, to form column of twos or files and reform	9-12	9-10
To align the company.....	9-13	9-11
To dismiss the company.....	9-14	9-11

CHAPTER 10. FORMATIONS OF THE BATTALION

General.....	10-1	10-1
Commands and orders.....	10-2	10-1
Staff.....	10-3	10-1
Formations.....	10-4	10-2
To form for inspections, drills, marches, or prior to participation in larger unit marches or ceremonies.....	10-5	10-2
To form in line with companies in line for battalion ceremonies	10-6	10-3
To form in line with companies in mass formation for battalion ceremonies.....	10-7	10-4
To form battalion in mass.....	10-8	10-4
To dismiss the battalion.....	10-9	10-4

CHAPTER 11. FORMATIONS OF THE REGIMENT

To form the regiment.....	11-1	11-1
Staff.....	11-2	11-2
To dismiss the regiment.....	11-3	11-2
Formations.....	11-4	11-2

PART II. CEREMONIES

CHAPTER 12. GENERAL INFORMATION

Arrangement of units in formation.....	12-1	12-1
Staff salutes.....	12-2	12-2
Place of formation.....	12-3	12-2
Organization and strength of units.....	12-4	12-2
Commands, drill movements, and unit formations.....	12-5	12-3

CHAPTER 13. REVIEWS

Elements of a review.....	13-1	13-1
Command of troops.....	13-2	13-1
Preparations.....	13-3	13-1
Troop formations.....	13-4	13-2
Forming for the review.....	13-5	13-2
Reviewing party.....	13-6	13-4
Ceremony for a review.....	13-7	13-5

	<u>Para</u>	<u>Page</u>
CHAPTER 14. PRESENTATION OF DECORATIONS AND INDIVIDUAL RETIREMENT		
General.....	14-1	14-1
Positioning of persons to be decorated and retirees.....	14-2	14-1
Presentation to reviewing officer.....	14-3	14-1
Presentaion of awards.....	14-4	14-2
CHAPTER 15. PARADES		
Battalion and regimental ceremonial parades.....	15-1	15-1
Battalion ceremonial parade.....	15-2	15-1
Regimental ceremonial parade.....	15-3	15-8
Change of command ceremony.....	15-4	15-8
Battalion and regimental ceremonial formations.....	15-5	15-9
Street parades.....	15-6	15-10
CHAPTER 16. NATIONAL AND ORGANIZATIONAL FLAGS		
General.....	16-1	16-1
Salutes.....	16-2	16-2
Hoisting, lowering, and folding the national ensign.....	16-3	16-2
Manual of the color(s).....	16-4	16-4
Color guard.....	16-5	16-8
Trooping the colors.....	16-6	16-12
CHAPTER 17. ESCORT OF HONOR		
General.....	17-1	17-1
Escort procedures.....	17-2	17-2
CHAPTER 16. HONORS		
Prescribed honors.....	18-1	18-1
Rendering honors to personages arriving for official visits ashore.....	18-2	18-1
Rendering honors to personages departing after official visits ashore.....	18-3	18-4
Honors to the national flag.....	18-4	18-4
Honors to the national emblem.....	18-5	18-5
Additional honors.....	18-6	18-5
CHAPTER 18. FUNERALS		
General.....	19-1	19-1
Duties of the officer in charge of the ceremony.....	19-2	19-2
Receiving the remains.....	19-3	19-4
Procession.....	19-4	19-7
At the grave.....	19-5	19-10
Memorial service honors.....	19-6	19-15
Conduct of funerals when military personnel are limited....	19-7	19-17
CHAPTER 19. INSPECTIONS		
General.....	20-1	20-1
Company formation.....	20-2	20-1
Inspection of personal field equipment in ranks.....	20-3	20-2
Inspecting officer other than company commander.....	20-4	20-3
Battalion inspections.....	20-5	20-3
Regimental inspection.....	20-6	20-4
Inspection of quarters or camp.....	20-7	20-5

CHAPTER 21. LOADING AND CEREMONIAL FIRING OF THE RIFLE

General rules.....	21-1	21-1
To load.....	21-2	21-1
To fire by volley.....	21-3	21-4
To unload.....	21-4	21-5

CHAPTER 22. MARINE CORPS BIRTHDAY CEREMONY

Procedures and guide.....	22-1	22-1
Variation.....	22-2	22-3

CHAPTER 23. RELIEF AND APPOINTMENT OF THE SERGEANT MAJOR

General.....	23-1	23-1
Occasion.....	23-2	23-1
Formation.....	23-3	23-1
Presentation of command to reviewing officer.....	23-4	23-1
Relief and appointment.....	23-5	23-1
Continuation of the review.....	23-6	23-1

PART I

DRILL

CHAPTER 1

INTRODUCTION TO DRILL

1-1. GENERAL

a. Purpose. A commander uses drill to:

- (1) Move his unit from one place to another in a standard, orderly manner.
- (2) Provide simple formations from which combat formations may be readily assumed.
- (3) Teach discipline by instilling habits of precision and automatic response to orders.
- (4) Increase the confidence of his junior officers and of his noncommissioned officers through the exercise of command, by the giving of proper commands, and by the control of drilling troops.
- (5) Give troops an opportunity to handle individual weapons.

b. Scope. This manual prescribes drill for general use. Diagrams shown must be adapted to the strength of the unit and available drill space.

c. Definitions.

(1) Element. An individual, squad, section, platoon, company, or other unit which is part of a larger unit.

(2) Formation. Arrangement of elements of a unit in line, in column, or in any other prescribed manner.

(3) Line. A formation in which the elements are side by side or abreast of each other. A section or platoon is in line when its squads are in line and one behind the other.

(4) Rank. A line of Marines or vehicles placed side by side.

(5) Column. A formation in which elements are placed one behind the other. A section or platoon is in column when members of each squad are one behind the other with the squads abreast of each other.

(6) File. A single column of Marines or vehicles one behind the other.

(7) Flank. The right or left extremity of a unit, either in line or in column. The element on the extreme right or left of the line. A direction at a right angle to the direction an element or a formation is facing.

(8) Depth. The space from head to rear of an element or a formation (see fig. 1-1). The depth of a man is considered to be 12 inches.

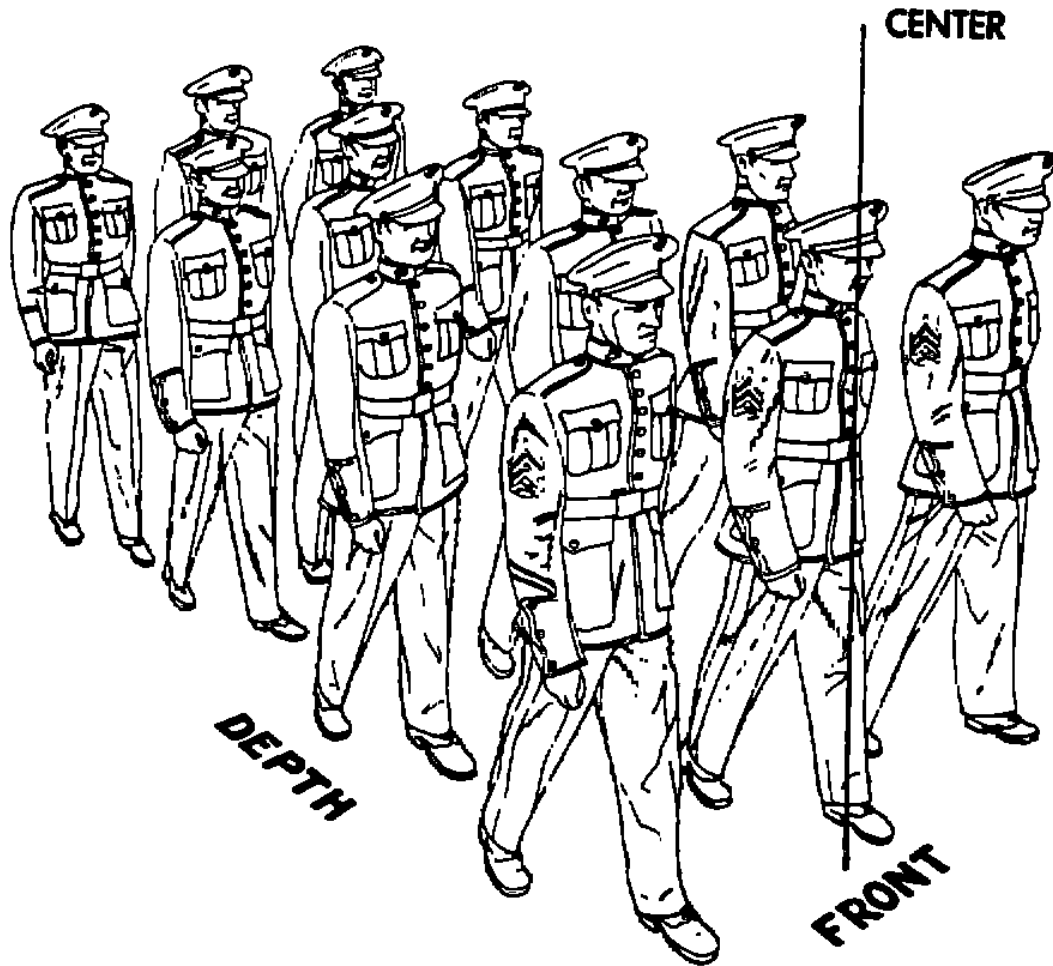

Figure 1-1.--Center, Depth, and Front.

(9) Front. The space occupied by an element or a formation, measured from one flank to the other (see fig. 1-1). The front of a man is considered to be 22 inches.

(10) Distance. Space between elements in the direction of depth. Between individuals, the space between your chest and the person to your front. Between vehicles, the space between the front end of a vehicle and the rear of the vehicle to its front. Between troops in formation (either on foot, mounted, or in vehicles), the space from the front of the rear unit to the rear of the unit in front. Platoon commanders, guides, and others whose positions in a formation are 40 inches from a rank are, themselves, considered a rank. otherwise, commanders and those with them are not considered in measuring distance between units. The color guard is not considered in measuring distance between subdivisions of the unit with which it is posted. In troop formations, the distance between ranks is 40 inches (see fig. 1-2).

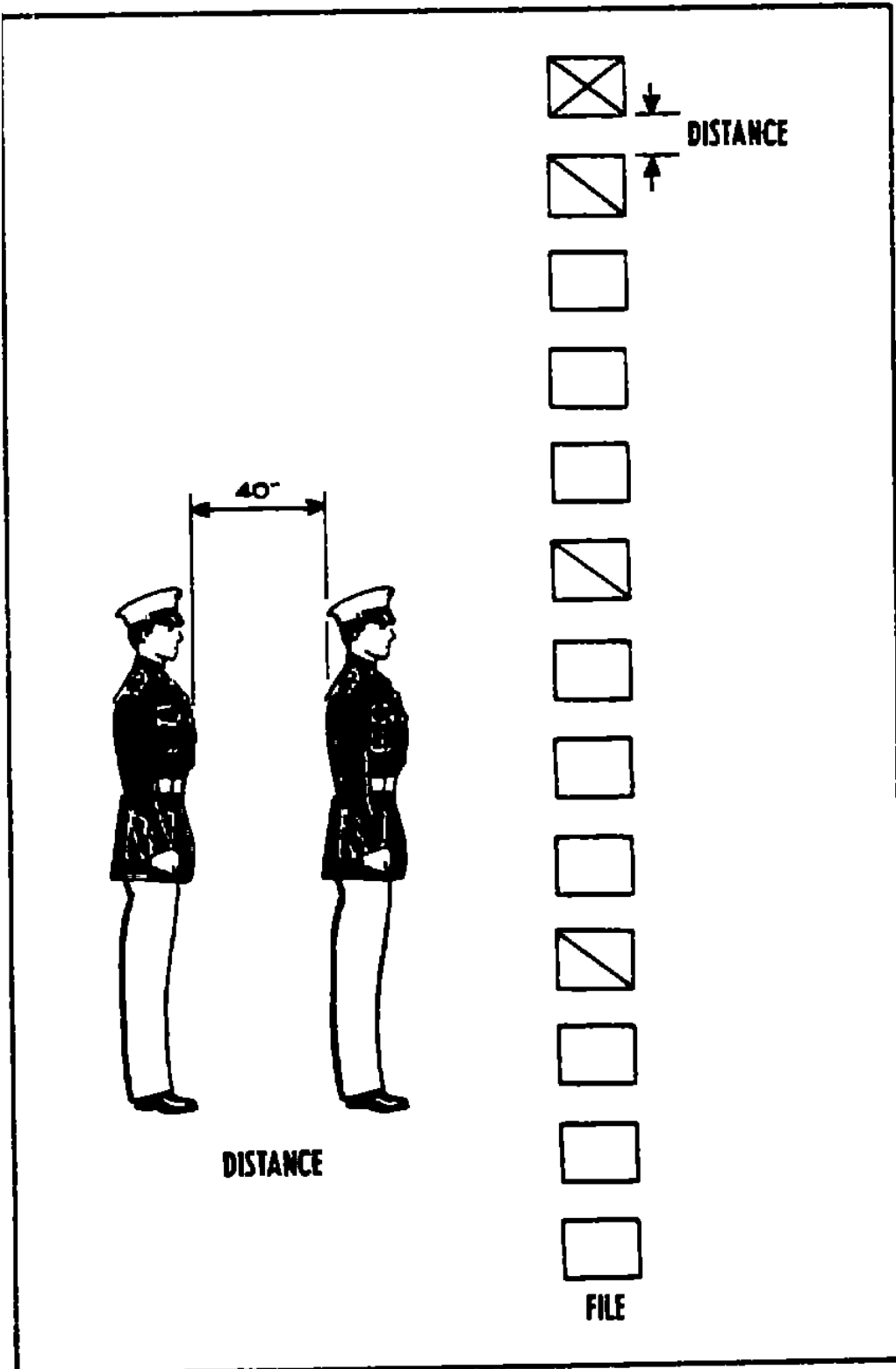

Figure 1-2. -- Distance and File.

(11) Interval. The lateral space between elements on one same line (see fig. 1-3). Interval is measure between individuals from shoulder to shoulder and between vehicles from hub to hub or track to track. It is measured between elements other than individuals and between formations from flank to flank. Unit commanders and those with them are not considered in measuring interval between elements of the unit. Normal interval between individuals is one arm's length. Close interval is the horizontal distance between shoulder and elbow when the left hand is placed on the left hip.

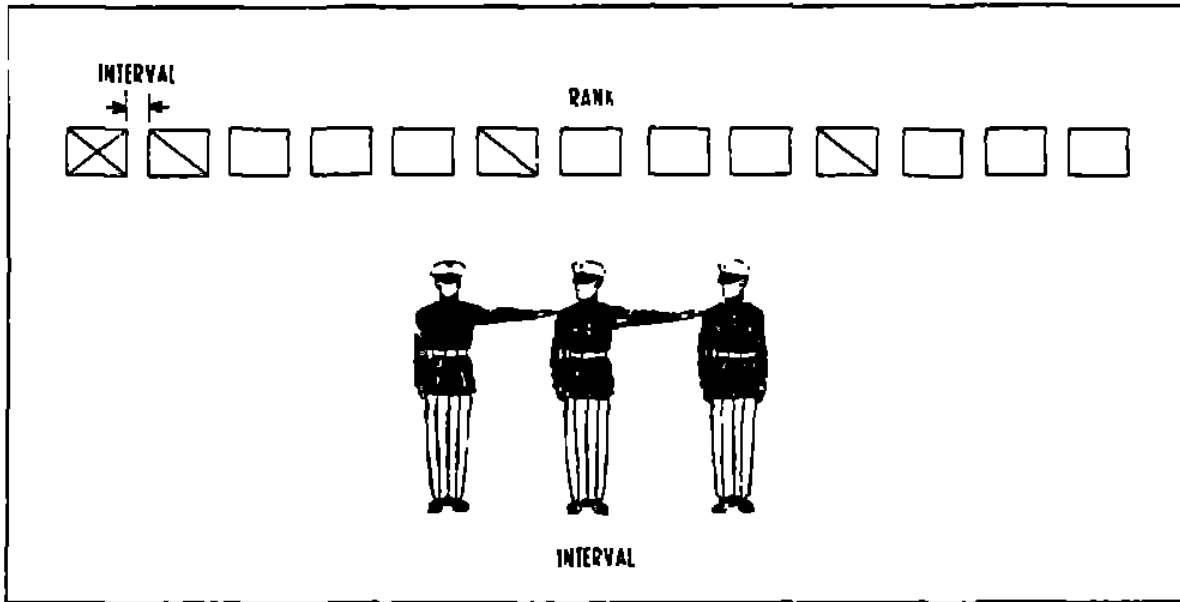

Figure 1-3.--Interval and Rank.

- (12) Alignment. The dressing of several elements on a straight line.
- (13) Base. The element on which a movement is regulated.
- (14) Guide. The individual (base) upon whom a formation, or other elements thereof, regulates its march. To guide: to regulate interval, direction, or alignment; to regulate cadence on a base file (right, left, or center).
- (15) Point of Rest. The point toward which all elements of a unit establish their dress or alignment.
- (16) Center. The middle element of a formation with an odd number of elements or the left center element of a formation with an even number of elements (see fig. 1-1).
- (17) Head. The leading element of a column.
- (18) Pace. The length of a full step in quick time, 30 inches.
- (19) Step. The distance from heel to heel between the feet of a marching man. The half step and back step are 15 inches. The right and left steps are 12 inches. The steps in quick and double time are 30 and 36 inches, respectively.
- (20) Cadence. A rhythmic rate of march at a uniform step.
- (21) Quick Time. Cadence at 120 steps (12, 15, or 30 inches in length) per minute. It is the normal cadence for drills and ceremonies.
- (22) Double Time. Cadence at 180 steps (36 inches in length) per minute.
- (23) Slow Time. Cadence at 60 steps per minute. Used for funerals only.
- (24) Left (Right). Extreme left (right) element or edge of a body of troops.
- (25) Mass Formation. The formation of a company or larger unit in which the major elements are in column at close interval and abreast at close interval.
- (26) Extended Mass Formation. The formation of a company or larger unit in which the major elements are in column at close or normal interval and abreast at a specified interval greater than normal interval.
- (27) Piece. An individual firearm such as a rifle.
- (28) Snap. In commands or signals, the quality that inspires immediate response. In drill, the immediate and smart execution of a movement.

1-2. DRILL INSTRUCTORS

Training personnel in drill is an important duty. From the beginning of his career, each officer and noncommissioned officer should take pride in being considered an efficient drill instructor. If he knows the drill regulations and how to instruct, he will gain the respect and confidence of those he commands.

a. In addition, a good drill instructor must:

(1) Follow regulations strictly, as an example to the Marines under instruction.

(2) Have energy, patience and spirit.

(3) Have military neatness and bearing.

(4) Watch his Marines constantly, immediately correcting any mistakes noted.

b. When the instructor corrects a movement, the individual or unit should immediately be required to repeat the movement properly. Troops should be reprimanded only as a last resort. Officers and noncommissioned officers should not be reprimanded in the presence of subordinates.

c. Before a drill period, an instructor should thoroughly study the movements to be executed.

d. The instructor's post is that of the commander. The instructor may place himself wherever he can best control the troops, make corrections, and ensure proper performance.

e. The instructor briefly explains and demonstrates each new movement prior to its execution by the troops. The troops should take proper positions unassisted. The instructor touches them only when absolutely necessary. Each position or movement must be thoroughly understood before another is attempted.

f. Drill periods should be short but frequent. Snap should be required in every movement.

1-3. INSTRUCTION GROUPS

a. The basic instruction group is the squad. Its size facilitates individual instruction (see chapter 7).

b. Marines who learn slowly should be placed in special squads. Such squads should be drilled by the best instructors available. These Marines should not be ridiculed.

1-4. COMMANDS AND THE COMMAND VOICE

a. There are two types of commands. The first, the preparatory command--such as FORWARD--indicates a movement is to be made. The second, the command of execution--such as MARCH!--causes the desired movement to be made. In some commands, such as FALL IN, AT EASE, and REST, the preparatory command and the command of execution are combined.

b. In this manual, preparatory commands are shown in CAPITAL LETTERS and commands of execution in UNDERLINED CAPITAL LETTERS. When movements by the numbers are discussed, the count in parentheses precedes the discussion.

c. When giving commands, the commander faces the troops. For company formations or larger, when commanding marching troops from the head of a column or massed formations, the commander marches backward while giving commands. When commanding a unit which is part of a larger unit, the leader turns his head to give commands, but does not face about except when the unit is halted and the smaller units are in line. In this case, the leader faces about to give all commands except to repeat preparatory commands, for which he only turns his head.

d. Commanders of platoons and larger units, when drilling as a part of a still larger unit, repeat all preparatory commands or give the proper new command or warning. There are two exceptions to this. The first is that no repetition is necessary for such commands as FALL IN or FALL OUT, REST, AT EASE, or any other command in which preparation and execution are combined. The second is that no repetition of command is necessary when a unit is in mass formation, except commands which cause the component units to act individually. An example of such a command is COLUMN OF THREES FROM THE RIGHT, MARCH. Squad leaders repeat preparatory commands or give the proper new command or warning only when squads act individually. When all squads in a platoon are to act together, such as in RIGHT, FACE, squad leaders do not repeat preparatory commands.

e. If at a halt, the commands for movements which involve marching at quick time in a direction other than to the direct front, such as COLUMN RIGHT, MARCH, are not prefaced by the preparatory command, FORWARD.

f. The only commands which use unit designations, such as company, as preparatory commands are ATTENTION and HALT. Such commands shall have no further designation added (e.g., FIRST BATTALION, ATTENTION). Commands shall be given only as stated herein. Troops should know their leaders' voices; therefore, additional designation is unnecessary.

g. A command must be given loud enough to be heard by all Marines in the unit.

(1) Good posture, proper breathing, and the correct use of throat and mouth muscles help develop a commander's voice. If commands are properly given, they will carry to all Marines in the unit. If a commander tries too hard, his neck muscles might tighten. This will result in squeaky, jumbled, and indistinct commands, and will later be the cause of hoarseness and sore throat.

(2) Projecting the voice enables one to be heard at maximum range without undue strain. To project a command, a commander must focus his voice on the most distant Marine. Good exercise for voice projection are:

(a) Yawning to get the feel of the open mouth and throat.

(b) Counting and saying the vowel sounds "oh" and "ah" in a full, firm voice.

(c) Giving commands at a uniform cadence, prolonging each syllable.

(d) When practicing, stand erect, breathe properly, keep the mouth open wide, and relax the throat.

(3) The diaphragm is the most important muscle in breathing. It is the large horizontal muscle which separates the chest from the abdomen. It automatically controls normal breathing, but must be developed to give commands properly. Deep breathing exercises are one good method of developing the diaphragm. Another is to take a deep breath, hold it, open the mouth, relax the throat muscles, and snap out a series of fast "hats" or "huts." These sounds should be made by expelling short puffs of air from the lungs. If properly done, you can feel the stomach muscles tighten as the sounds are made.

(4) The throat, mouth, and nose act as amplifiers. They give fullness to and help project the voice. In giving commands, the throat should be relaxed. The lower jaw and lips should be loose. The mouth should be open wide and the vowel sounds (a, e, i, o, u) should be prolonged. Consonants (letters other than vowels) and word endings should be cut and sharply cut off.

(5) The position of attention is the proper posture for giving commands (see fig. 1-4). A commander's posture will be noticed by his Marines. If it is unmilitary, his men are likely to copy it. Raising the hand to the mouth to aid in projecting commands is not proper.

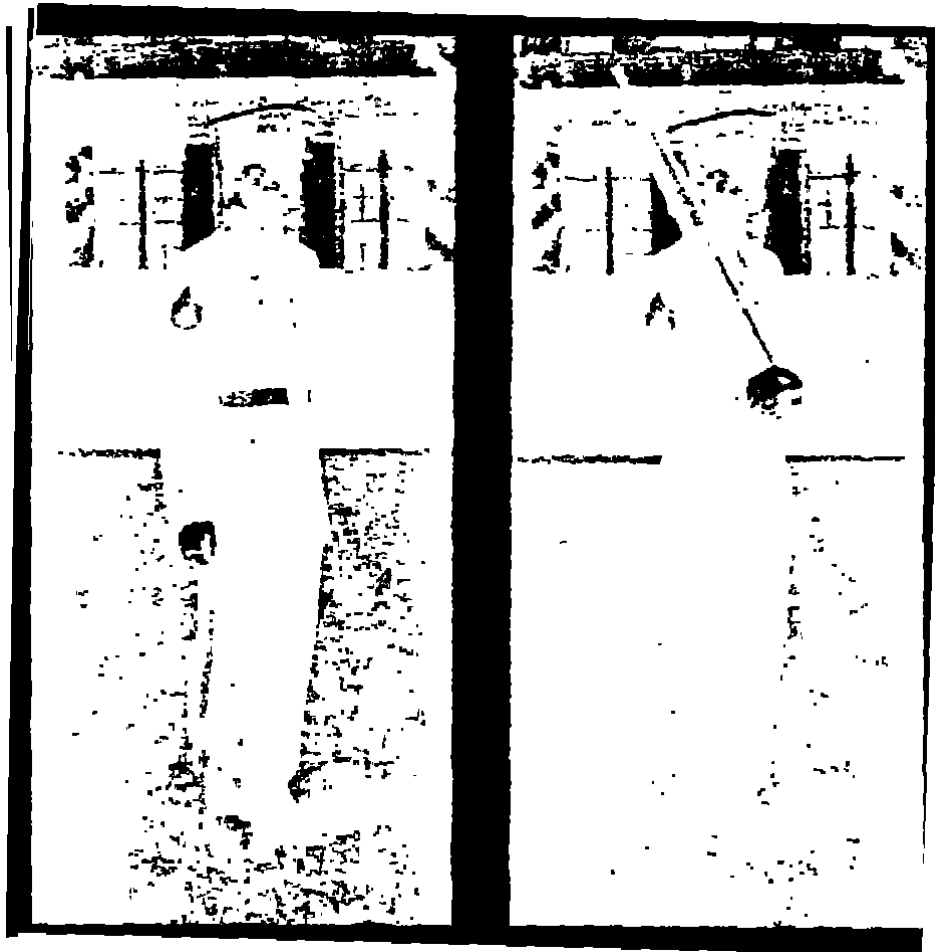

Figure 1-4.--Correct Posture for Giving Commands.

(6) Distinct commands inspire troops. Indistinct commands confuse them. All commands can be given correctly without loss of effect or cadence. To give distinct commands, you must emphasize enunciation; make full use of the tongue, lips, and lower jaw; practice giving commands slowly, carefully, and in cadence; and then increase the rate of delivery until the proper rhythm (120 beats per minute) is reached and each syllable is distinct.

(7) Inflection is the rise and fall in pitch, the tone changes of the voice.

(a) Preparatory commands should be delivered with a rising inflection, having begun near the level of the natural talking voice.

(b) A command of execution is given in a sharper and higher pitch than the tone of the preparatory command's last syllable. A good command of execution has no inflection. It must have snap. It should be delivered with sharp emphasis, ending like the crack of a whip. If properly given, Marines will react to it in the same manner.

(c) Commands such as FALL IN, in which the preparatory command and the command of execution are combined, are delivered without inflection. They are given in the uniform high pitch and loudness of a command of execution.

1-5. GENERAL RULES FOR DRILL

a. Certain drill movements may be made toward either flank. This manual explains such movements in one direction only. To move to the other direction, it is necessary to substitute the word "left" for "right" as shown in parentheses.

b. The command AS YOU WERE cancels a movement or order started but not completed. At this command, troops should resume their former positions.

c. While marching, guide is always maintained toward the right, except:

(1) Upon command GUIDE LEFT, or GUIDE CENTER, in which case guide is maintained toward the left, or center, until the command GUIDE RIGHT is given.

(2) Regardless of the direction in which alignment is established, at the command of execution for a drill movement involving marching, the direction toward which alignment is obtained is the flank toward which the movement is made. Upon completion of the drill movement, alignment will be in the direction established prior to commencing the movement.

(3) In a column of platoons, the guide of the leading platoon controls direction and distance, and maintains the cadence counted by the commander. Guides of the following platoons control distances and follow the direction and cadence set by the leading guide.

d. Slight changes in direction are made by:

(1) Adding "HALF" to the preparatory command for turning or column movements; for example, COLUMN HALF RIGHT (LEFT), MARCH changes direction 45 degrees.

(2) At the command INCLINE TO THE RIGHT (LEFT), the guide changes his direction of march slightly to the right (left).

e. Platoons in a company and Marines in a squad are numbered from right to left in line, as the troops face, and from front to rear in column. Squads in a platoon are numbered from front to rear in line and from left to right in column.

f. Posts of officers, noncommissioned officers, guidon bearers, and special units are shown in figures or explained later in the text.

(1) Change of post are made by the most direct route, except where others are prescribed. The movement is made as soon as possible after the command of execution. Persons who have duties in connection with the movement take their new posts after those duties have been performed. Military bearing must be maintained by individuals moving from one post to another or aligning units. All necessary facings and changes of direction must be made as if drilling.

(2) After the initial formation, guidon bearers and special units maintain their positions with respect to the flank or end of the organization with which they were originally posted.

(3) All officers or noncommissioned officers commanding armed troops will be armed. When giving commands, drilling troops, or making reports, the rifle will be carried at right shoulder arms, the sword will be carried at the carry sword position, and the pistol will be carried in the holster (see fig. 1-4). Facing movements by commanders of armed troops may be executed while at right shoulder arms.

g. Whenever drill movements are executed while troops are marching, the command of execution MARCH. Is given as the left foot strikes the deck if the movement is to the left, and as the right foot strikes the deck if the movement is to the right.

h. The cadence commands should be that of quick time, even though no marching is involved. Giving commands in unison while marching at quick time is a good exercise for teaching proper command cadence to troops. The pause between preparatory commands and those of execution should be adapted to the size and formation of the unit.

(1) The best pause to allow for a squad or platoon is one step between the two commands. For example:

ONE	TWO	THREE
COLUMN LEFT	(Step)	<u>MARCH</u>

(a) To develop the proper cadence for commands at a halt, count ONE, TWO, THREE, FOUR in quick time. Then given commands (RIGHT, FACE without interrupting the cadence:

ONE	TWO	THREE	FOUR
RIGHT,		<u>FACE</u>	

(b) Longer commands, such as BY THE RIGHT FLANK, MARCH, must be started so the preparatory command will end as the foot in the desired direction of movement strikes the deck. There is then a full count before the command of execution, which is given on the same foot. For example:

LEFT	RIGHT	LEFT	RIGHT
BY THE RIGHT FLANK,			<u>MARCH</u>

(2) For a company or larger unit, the intervals must be longer. This is necessary for leaders of component units to repeat preparatory commands or give warning or supplementary commands. The following example shows the proper cadence for the command RIGHT, FACE to a company:

ONE	TWO	THREE	FOUR
(Company Commander)	(Platoon Commander)		(Company Commander)
RIGHT	RIGHT		<u>FACE</u>

1-6. DRILL, BY THE NUMBERS

Drill movements may be divided into individual motions for instruction. When drills are executed by the numbers, the first motion is made on the command of execution. Subsequent motions are made in proper order on the commands TWO, THREE, FOUR, the number of counts depending upon the number of motions in the movement. To use this method, the command BY THE NUMBERS precedes the preparatory command. All movements are then executed by the numbers until the command WITHOUT NUMBERS is given.

1-7. MASS COMMANDS AND INDIVIDUAL COMMANDS FROM RANKS

a. Mass Commands. The use of mass commands in drill develops confidence and team spirit. It also teaches Marines to give and execute commands properly.

(1) The initial command is AT YOUR COMMAND. The instructor then gives a preparatory command which describes the movement he wants performed, for example, AT YOUR COMMAND, FACE THE PLATOON TO THE RIGHT, COMMAND. After this, all members of the platoon command RIGHT, FACE together and execute it. Another mass command example is AT YOUR COMMAND, CALL THE PLATOON TO ATTENTION, COMMAND. The troops command PLATOON, ATTENTION.

(2) Marching movements may be conducted in a similar manner as following:
ALL MOVEMENTS UNTIL FURTHER NOTICE WILL BEAT YOUR COMMAND.

(a) INSTRUCTOR: CALL THE PLATOON TO ATTENTION, COMMAND.
TROOPS: PLATOON, ATTENTION.

(b) INSTRUCTOR: FORWARD, COMMAND.
TROOPS: FORWARD, MARCH.

© INSTRUCTOR: BY THE RIGHT FLANK, COMMAND.
TROOPS: BY THE RIGHT FLANK, MARCH.

(3) Only simple movements with short preparatory commands are used to mass commands. Preparatory commands which require repetition by subordinate leaders are not used.

(4) When he wishes to return to normal drill methods, the instructor orders AT MY COMMAND.

b. Individual Commands From Ranks. As an aid in training Marines to give commands properly, Marines in ranks may be designated to give individual commands. This should be done only after a unit has learned to execute commands and give mass commands. The instructor designates the Marine who is to give the command by name or place in ranks. He may be designated while the unit is marching or halted. The instructor describes the movement to be made, as in mass commands, but does not add command. The designated Marine remains in his position and gives the appropriate command. He must execute the command with the unit. After the Marine has given several commands, the instructor should ask for comments about the performance.

c. Counting Cadence. Counting cadence by Marines in ranks teaches them group coordination and rhythm. The command is COUNT CADENCE, COUNT, the command of execution being given as the left foot hits the deck. All Marines then count cadence for 8 steps, starting when the left foot next strikes the deck. They should be required to do so in a firm, vigorous manner.

1-8. CADENCE DRILL

Cadence drill is an advanced form of drill. It is used only with Marines who have learned basic drill as prescribed in this manual. It provides variety for well trained troops. In cadence drill, the commander abbreviates preparatory commands and deletes the pause between the preparatory command and the command of execution. Each time a commander uses this form of drill, he must explain that he is departing from prescribed drill. Cadence drill is suitable only for platoons and smaller units. An example of cadence drill follows:

Count: ONE, TWO, THREE, FOUR, ONE, TWO,
THREE, FOUR

Step: LEFT, RIGHT, LEFT, RIGHT, LEFT, RIGHT, LEFT, RIGHT

Command: REAR, LEFT FLANK, RIGHT FLANK, MARCH

1-9. TRICK DRILL.

Trick drill may be used with troops who have thoroughly learned all prescribed drill and cadence drill. It is extremely complex and requires extensive training. Trick drills are not described in this manual. They are limited only by the imagination of the drill instructor.

CHAPTER 2

INDIVIDUAL INSTRUCTIONS WITHOUT ARMS

2-1. POSITIONS

a. Attention. The position of attention (see fig. 2-1) is the basic military position. This indicates that you are alert and ready for instructions. Come to attention with smartness and snap at the commands FALL IN or ATTENTION. Thereafter, you move only as ordered until given AT EASE, REST, FALL OUT, or you are dismissed. To come to attention:

- (1) Bring your left heel against the right.
- (2) Turn your feet out equally to form an angle of 45 degrees. Keep your heels on the same line and touching.
- (3) Your legs should be straight but not stiff at the knees.
- (4) Keep your hips and shoulders level and your chest lifted.
- (5) Your arms should hang naturally, thumbs along the trouser seams, palms facing inward toward your legs, and fingers joined in their natural curl.
- (6) Keep your head and body erect. Look straight ahead. Keep your mouth closed and your chin pulled in slightly.
- (7) Stand still and do not talk.

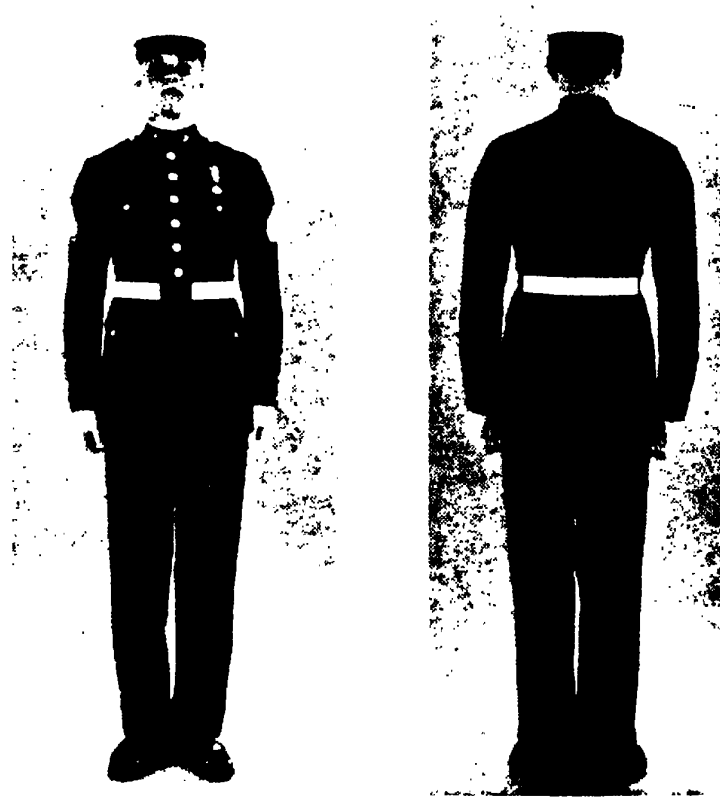

Figure 2-1.--Position of Attention.

b. Rests. There are four rests for halted troops. They are parade rest, at ease, rest, and fall out. All are executed from the position of attention.

(1) Parade Rest. (See fig. 2-2.) The command is PARADE, REST. It is executed in one count. At the command REST, move your left foot smartly 12 inches to the left. Both legs should be straight so your weight rest equally on each foot. At the same time, join hands behind your back with your right hand inside your left, palms to the rear just below the belt. The right hand loosely holds the left thumb. Fingers are extended and joined. Do not move and do not talk. Hold your head and eyes in the same position as you would if at attention.

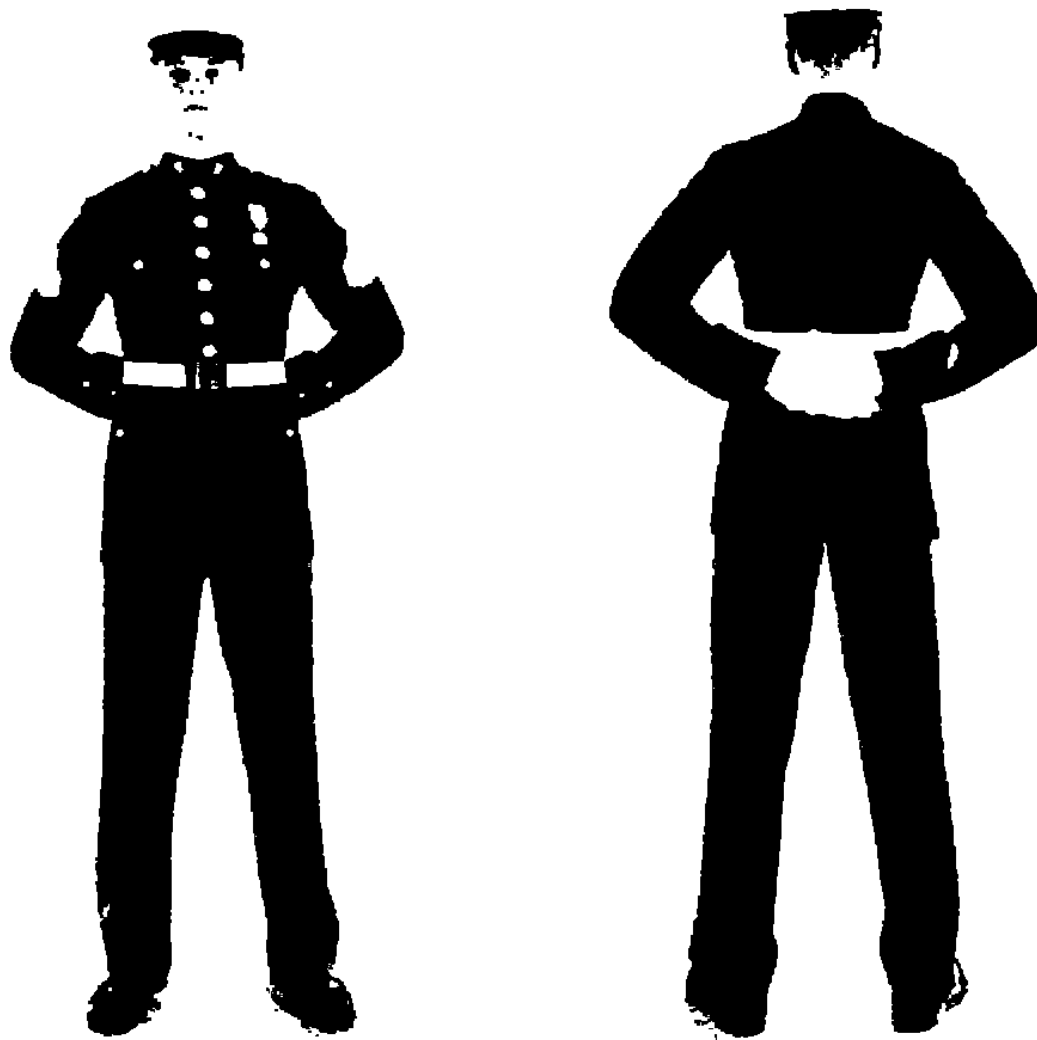

Figure 2-2.--Position of Parade Rest.

(2) At Ease. The command is AT EASE. It is executed in one count. At the command, keep your right foot in place. You may move about but must not talk. You may also be given this command when not in ranks. In this case, it means cease talking but continue whatever you were doing before the command.

(3) Rest. The command is REST. It is executed in one count. At the command, you may move and talk; however, keep your right foot in place.

(4) Fall Out. The command is FALL OUT. At the command, leave your position in ranks but remain nearby. When FALL IN is given, go back to your place in ranks and come to attention.

(5) Attention. SQUAD (PLATOON), ATTENTION may be given when you are halted, at parade rest, at ease, or rest. It may also be given when you are marching at route step or at ease.

(a) When given at parade rest, come to attention.

(b) When halted at ease or rest, take position of parade rest on the command SQUAD. When ATTENTION is given, come to that position.

(c) When marching at route step or at ease, get in step as soon as possible and continue marching at attention.

c. Eyes Right (Left).

(1) The command is EYES, RIGHT (LEFT). It may be given at a halt or while marching. The command to turn your head back to the position of attention is READY, FRONT.

(2) When RIGHT (LEFT) is given, turn your head smartly and look 45 degrees to the right (left).

(3) On the command FRONT, turn your head and eyes back smartly to the front. During reviews at which the reviewing officer troops the line, ready front will not be given after eyes right. At such ceremonies, turn your head and eyes smartly toward the reviewing officer upon the command RIGHT. As he passes to the left, follow the reviewing officer with your head and eyes until you are looking directly to the front.

(4) When marching, give the command, EYES, RIGHT on the right foot and the command EYES, LEFT on the left foot. Give the command READY, FRONT from eyes right on the left foot and the command READY, FRONT from eyes left on the right foot. For example:

LEFT	RIGHT	LEFT	RIGHT
	EYES		<u>RIGHT</u>
READY		<u>FRONT</u>	
EYES		<u>LEFT</u>	
	READY		<u>FRONT</u>

d. Facings.

(1) Facings are executed in the cadence of quick time. While facing, your arms should not swing out from your sides, but remain at the position of attention.

(2) RIGHT, FACE is a two-count movement (see fig. 2-3).

(a) On count one, (fig. 2-3b) at the command FACE, raise your left heel and right toe slightly. Turn to the right on your right heel and left toe. Keep your left leg straight but not stiff.

(b) On count two (fig. 2-3c), place the left foot smartly beside the right and stand at attention.

(3) LEFT, FACE is executed in the same manner described in subparagraph (2) above, substituting "left" for "right" and "right" for "left" (see fig. 2-4).

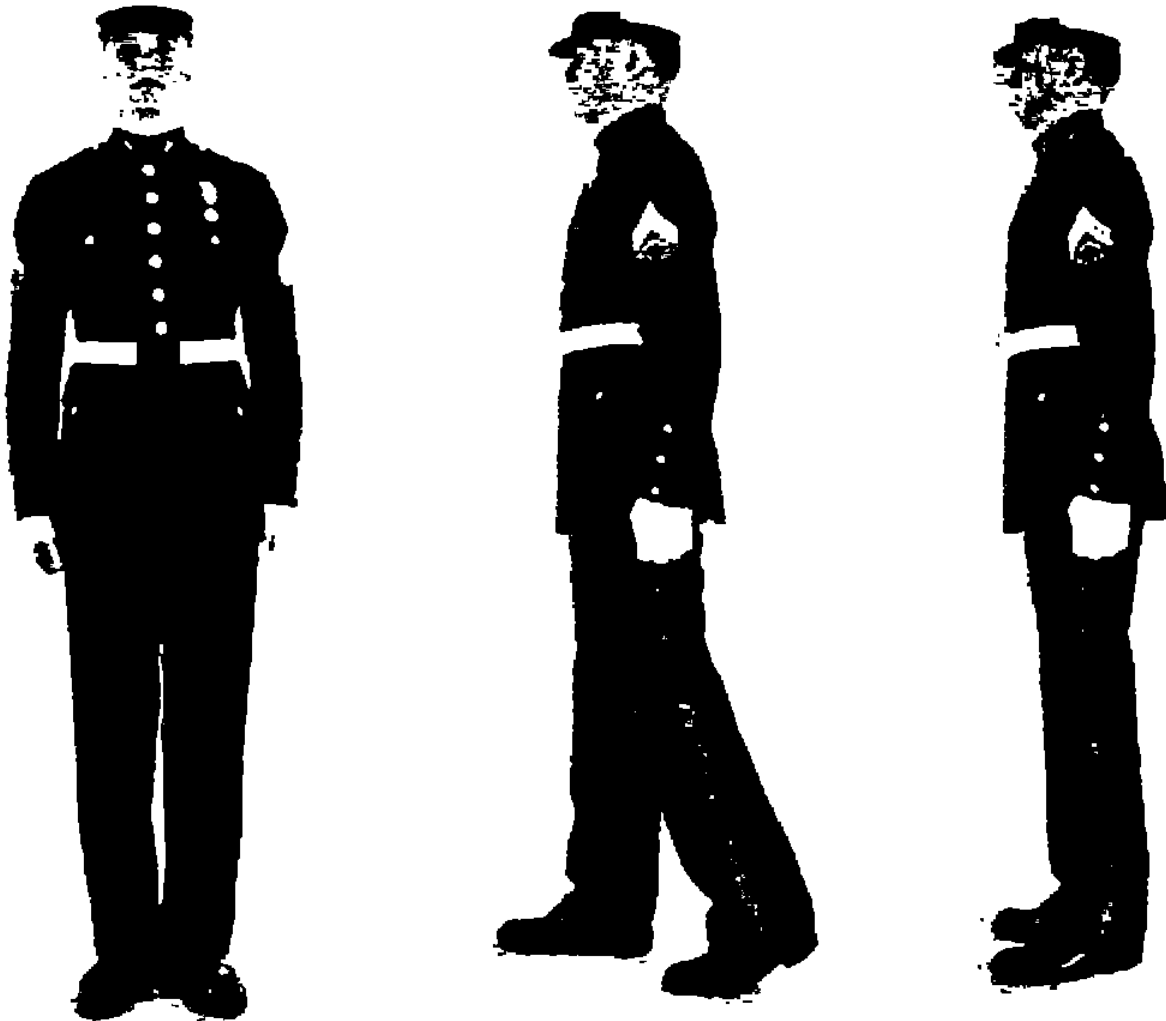

Figure 2-3.--Right Face.

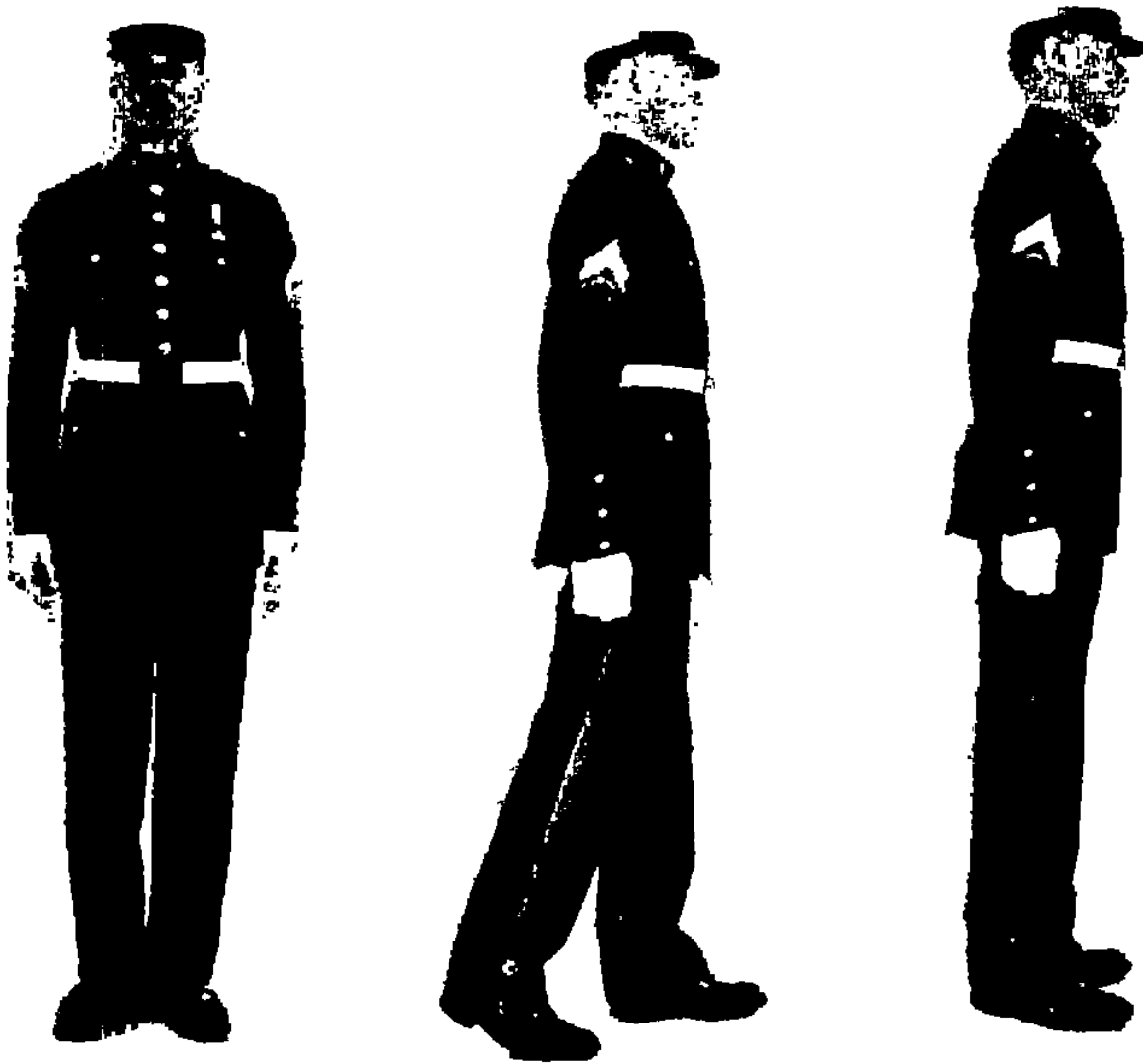

Figure 2-4.--Left Face.

(4) ABOUT, FACE is a two-count movement (see fig. 2-5).

(a) At the command ABOUT, shift your weight to your left leg without noticeable movement (fig. 2-5a).

(b) On count one (fig. 2-5b) at the command FACE, place your right toe half a foot length behind and slightly to the left of your heel. Do not change the position of your left foot. Rest most of your weight on the left heel.

(c) On count two (fig. 2-5c), turn smartly to the right until facing rear. The turn is made on the left heel and ball of the right foot. Your feet will be at attention when the turn is completed if your right toe was placed properly in the beginning.

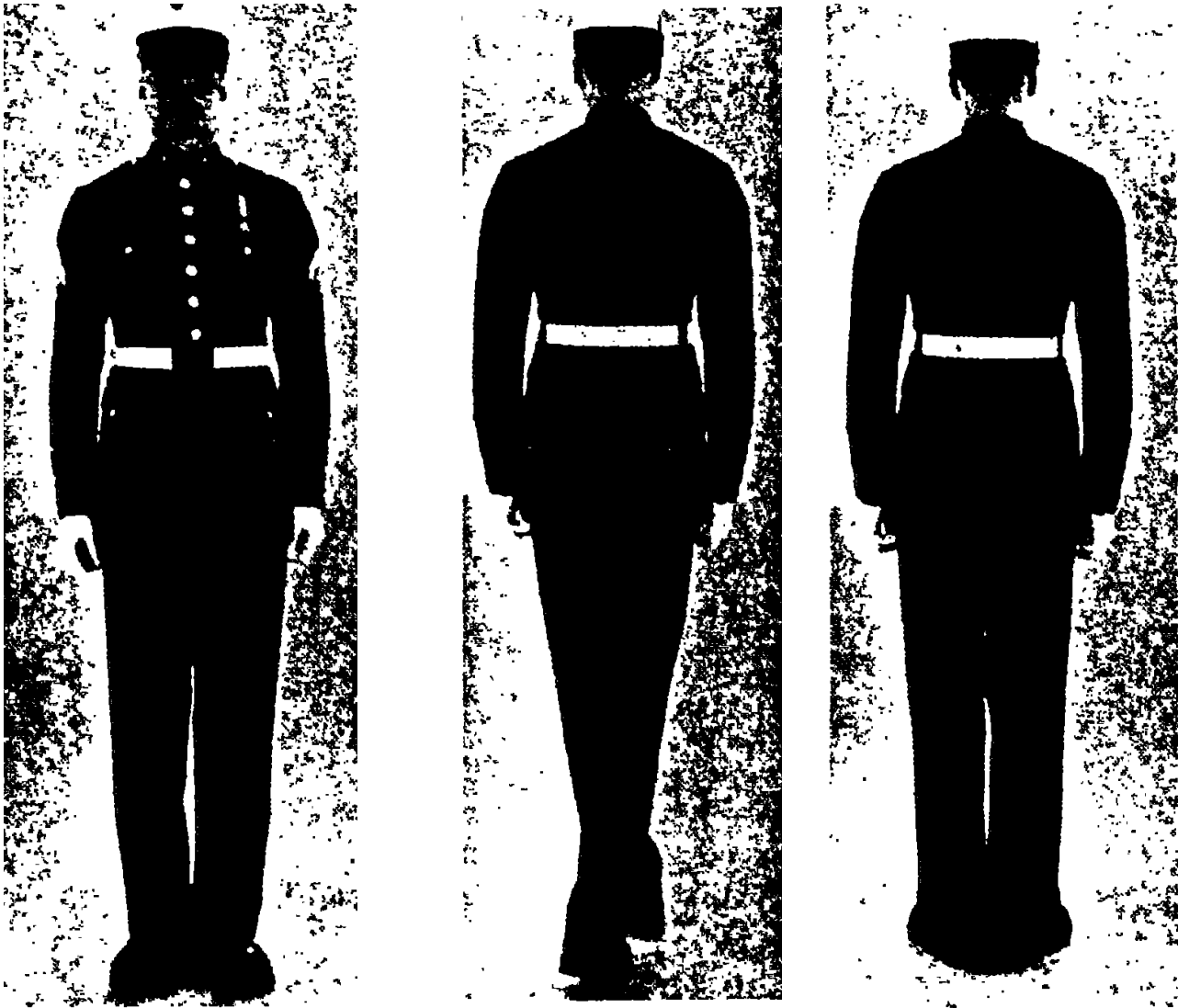

Figure 2-5.--About Face.

e. Hand Salute.

(1) The command is HAND, SALUTE; TWO. (See fig. 2-6.)

(a) When SALUTE is given, raise your right hand smartly in the most direct manner until the tip of your forefinger touches the lower part of the headdress above and slightly right of your right eye. Your thumb and fingers should be straight and touch each other. You should be able to see your entire palm when looking straight ahead. Your upper arm should be level with the deck and your forearm at a 45-degree angle. Your wrist and hand should be straight, a continuation of the line made by your forearm. At the same time, if not in ranks, turn your head and eyes toward the person or colors you are saluting.

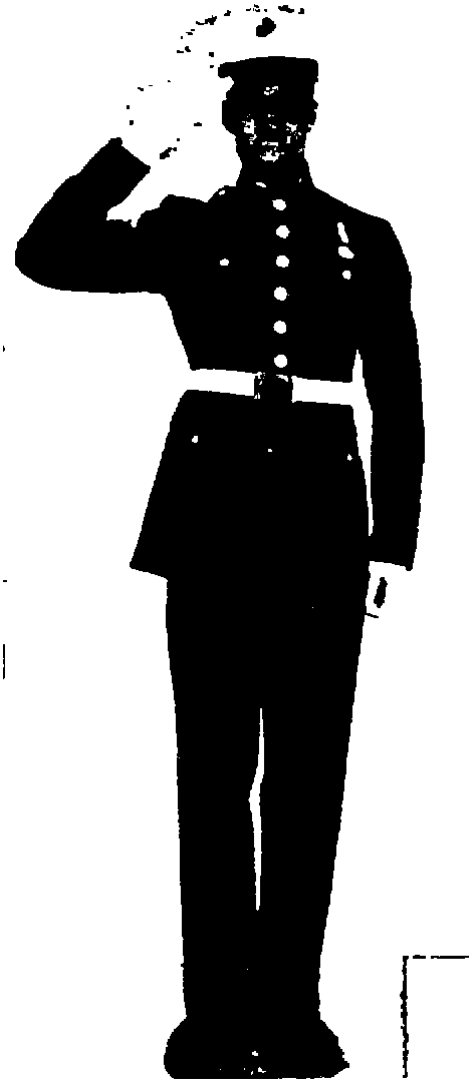

Figure 2-6.--Hand Salute.

(b) At the command TWO, return to attention. Move your hand smartly in the most direct manner back to its normal position by your side.

(c) To ensure simultaneous execution of the second movement of the hand salute when troops are in formation, the preparatory command READY will be used prior to the command of execution, TWO.

(2) You may salute without command from attention, while walking, or while seated in a vehicle. When walking, it is not necessary to halt to salute. Keep walking, but at attention. The salute is rendered when the person or color to be saluted is 6 paces distant, or at the nearest point of approach if it is apparent that the person or color is not going to approach within 6 paces. The salute will not be rendered if the person (color) to be saluted does not approach within 30 paces. Hold the first position of the salute until the person (color) saluted has passed or the salute is returned, then execute the second movement of the hand salute.

(3) When the command PRESENT, ARMS is given, if not armed, you execute the hand salute on the command ARMS. Stay at that position until the command ARMS or ORDER, ARMS is given.

2-2. STEPS AND MARCHING

a. General.

(1) With the exception of right step, all steps and marchings beginning from a halt start with the left foot.

(2) The instructor indicates the proper rhythm by counting cadence. He should do so only when necessary.

(3) To change direction on the march, both the preparatory command and the command of execution are given as the foot in the desired direction of the turn strikes the deck.

b. Quick Time.

(1) If at a halt, the command to march forward at quick time is FORWARD, MARCH.

(2) On FORWARD, shift your weight to the right leg without noticeable movement.

(3) On MARCH, step off smartly, left foot first, and walk straight ahead with 30-inch steps. Swing your arms easily in their natural arcs, 6 inches straight to the front and 3 inches to the rear. Do not overdo movements and do not march stiffly.

c. Double Time.

(1) DOUBLE TIME, MARCH may be given at a halt, while marching at quick time, or while marching in place. MARCH may be given as either foot hits the deck.

(2) When halted:

(a) At the command DOUBLE TIME, shift your weight to your right leg without noticeable movement.

(b) On MARCH, raise your forearms until level with the deck and make fists with the knuckles out. At the same time step off on the left foot and begin an easy run, taking 180 36-inch steps per minute.

(3) When marching at quick time:

(a) When the command MARCH is given, take one more 30-inch step.

(b) Step off in double time.

(4) To resume quick time, the command is QUICK TIME, MARCH.

(a) On MARCH, take one more double time step.

(b) Lower your arms and slow to quick time.

(5) When marching in place:

(a) Take one more step in mark time (or double time in place).

(b) Step off forward in double time.

d. Halt.

(1) The command is SQUAD (PLATOON, COMPANY, DETAIL), HALT. It is a two-count movement from quick time and three counts from double time. For quick time, double time, mark time, half step, or back step, the command of execution may be given as either foot strikes the deck.

(2) While marching at quick time or half step:

- (a) Take one more step after HALT.
- (b) Bring the rear heel forward against the other.

(3) While marching at double time:

- (a) Take one more double time step after HALT.
- (b) Take another at quick time.
- (c) Bring the rear heel forward against the other.

(4) When doing right (left) step:

- (a) The command HALT is given when heels are together.
- (b) Take one more step after HALT.
- (c) Bring your heels together.

(5) When marking time:

- (a) Take one more step after the command HALT.
- (b) Bring your heels together.

(6) When doing the back step:

- (a) Take one more back step after HALT.
- (b) Bring the forward heel back against the other.

e. Mark Time.

(1) To march in place at quick time, the command is MARK TIME, MARCH. The command may be given from the halt, marching at quick time, half step, or double time in place. It may be given as either foot strikes the deck.

(2) When halted:

(a) On the command MARK TIME, shift your weight to your right leg slightly without noticeable movement.

(b) On the command MARCH, beginning with your left foot, then alternating, raise each foot so that the ball of the foot is approximately 2 inches and the heel approximately 4 inches from the deck at a cadence of 120 steps per minute. At the same time, swing your arms naturally as in marching.

(3) When marching at quick time:

(a) On the command MARCH, take one more 30-inch step as if coming to a halt.

(b) Bring your heels together. Begin marking time without loss of cadence with the opposite foot.

(4) To resume the march at quick time, the command is FORWARD, MARCH.

(a) On the command MARCH, take one more step in place.

(b) Step off with a 30-inch step.

(5) When marching at double in place:

(a) On the command MARCH, take one more step in place at double time.

(b) Commence marking time.

f. Double Time in Place.

(1) The command is IN PLACE DOUBLE TIME, MARCH. It may be given while halted, while marching at double time, or while marking time.

(2) When halted:

(a) On the preparatory command, shift your weight to your right leg without noticeable movement.

(b) On the command MARCH, raise your arms for double time. Starting with the left foot, alternating and in place, raise your feet 6 inches above the deck at 180 steps per minute.

(3) When marching at double time:

(a) After MARCH, take two more double time steps.

(b) Bring your feet together and begin double timing in place without loss of cadence.

(4) The command DOUBLE TIME, MARCH resumes the march at double time.

(a) At MARCH, take two more steps in place.

(b) Step off with 180, 36-inch steps per minute.

(5) When marking time:

(a) On the command MARCH, take one more step in mark time.

(b) Commence marching at double time in place.

(6) The halt from in place double time is done the same as from double time.

g. Half Step.

(1) To march with 15-inch steps, the command is HALF STEP, MARCH. It may be commanded at the halt or when either foot strikes the deck while marching at quick time.

(2) At the halt:

(a) On the preparatory command, shift your weight to your right leg without noticeable movement.

(b) On the command MARCH, step off forward in quick time cadence with 15-inch steps. The balls of your feet should strike the deck before your heels. At the same time begin swinging your arms 6 inches to the front and 3 inches to the rear.

(3) Marching in quick time:

(a) On the command MARCH, take one more 30-inch step.

(b) Begin the 15-inch steps as explained above (para 2-2 g (2)).

(4) To resume quick time from half step, the command is FORWARD, MARCH. It may be given as either foot strikes the deck.

(a) On MARCH, take one more half step.

(b) Step off at quick time.

h. Side Step.

(1) The command RIGHT (LEFT) STEP, MARCH is given only when you are at a halt.

(2) At the command MARCH, move your right foot 12 inches to the right, then place your left foot beside your right. Repeat this movement at the rate of 120 steps a minute. Keep your legs straight, but not stiff. Hold your arms at attention.

i. Back Step.

(1) The command BACKWARD, MARCH is given only when you are at a halt.

(2) At the command MARCH, step off to the rear with your left foot and take 15-inch steps at a rate of 120 steps a minute. Swing your arms naturally.

j. To Face in Marching.

(1) This is an important part of the following movements: column right (left), by the right (left) flank, close, take interval, and extend. For instructional purposes, the command is BY THE RIGHT (LEFT) FLANK, MARCH.

(2) From a halt:

(a) On MARCH, turn to the right (left) on the ball of the right foot.

(b) Step off with your left foot in the new direction with a 30-inch step.

(3) While marching, the command of execution is given as the foot of the desired direction of movement hits the deck.

(a) On MARCH, without losing cadence, take one more step.

(b) Pivot to the right (left) and step off in the new direction. If commanded and executed properly, the pivot will be on the foot away from the desired direction of movement, and the first step in the new direction will be with the other foot. The pivot and step are done together in one count.

k. To About Face While Marching.

(1) The command is TO THE REAR, MARCH. It is given when the right foot strikes the deck. It may be commanded while marching at either quick time or double time.

(2) When at quick time:

(a) On the command MARCH, take one more step.

(b) Turn about to the right on the balls of both feet and immediately step off to the rear with your left foot. This is done without loss of cadence. When turning, the feet should be about 30 inches apart.

(3) When a double time:

(a) On MARCH, take two more steps then turn about to the right. This turn requires 4 steps in place at double time cadence.

(b) Then double time to the rear.

(4) To march to the rear from a halt:

(a) The command is TO THE REAR, MARCH.

(b) On MARCH, step off with the left foot.

(c) Turn about to the right on the balls of both feet and immediately step out to the rear with the left foot.

l. To March by the Flank.

(1) The command is BY THE RIGHT (LEFT) FLANK, MARCH. It is given only when marching, except when used for instructional purposes as in paragraph 2-2j, and as the foot in the direction of the movement strikes the deck.

(2) While at quick time:

(a) On MARCH, take one more step.

(b) Turn to the right (left) on the ball of the left (right) foot. At the same time, step off in the new direction with the right (left) foot.

(3) While double timing:

(a) On MARCH, take two steps and then turn to the right (left). This turn requires 2 steps in place at double time cadence.

(b) Double time in the new direction.

m. To Change Step.

(1) The command is CHANGE STEP, MARCH. It may be given while marching at quick or double time, marking time, or double-timing in place. The command of execution is given as the right foot strikes the deck.

(2) While marching at quick time or double time:

(a) On MARCH, take one more step, 30 or 36 inches, as appropriate.

(b) As your right foot comes forward to the next step, place the toe near the left heel and step out again with the left foot. This changes the cadence count, but not the rhythm.

(3) While marking quick time:

(a) On MARCH, lift and lower the left foot twice in succession.

(b) The second time it touches the deck, raise the right foot and continue marking time.

(4) While double timing in place:

(a) On MARCH, hop twice on the left foot.

(b) Continue double timing in place.

n. To March at Ease.

(1) The command is AT EASE, MARCH. It is given as either foot strikes the deck and only while marching at quick time.

(2) After MARCH, you are no longer required to march in cadence, but must keep interval and distance. Do not talk.

o. To March at Route Step.

(1) The command is ROUTE STEP, MARCH. It is commanded as either foot strikes the deck and only while marching at quick time.

(2) After MARCH, you are no longer required to march in cadence, but must keep interval and distance. You may talk, but in a low voice.

p. To Resume Marching at Quick Time From Route Step or at Ease.

(1) The command is SQUAD (PLATOON, COMPANY, DETAIL), ATTENTION.

(2) After commanding ATTENTION, the commander or instructor will count cadence until all troops are in step. Pick up the step as soon as possible and continue marching at attention.

q. To Give Commands While Marching at Ease or at Route Step.

(1) Commands which involve precision in execution will not be given until the command to resume marching at quick time has been given.

(2) When moving a unit from one place to another under circumstances which would render their execution in a precise manner inappropriate, commands may be given by arm-and-hand signals.

[BLANK PAGE]

CHAPTER 3

MANUAL OF ARMS WITH THE M16 RIFLE

Section I. MANUAL OF ARMS WITH SLING DRAWN TIGHT

3-1. GENERAL

a. All movements of the manual of arms are executed smartly and with snap.

b. Execute FALL IN with the rifle at order arms.

c. Facings, alignments, and short distance marching movements are executed at order arms. Side step, back step, open and close ranks, and close and extend are short-distance movements. Forward march may be given from order arms to march units forward for a short distance. When these movements are commanded while at order arms, it is necessary to come automatically to trail arms and step off on the command of execution for the movement. The rifle is returned to order arms upon halting.

d. Before a command for any marching movement (other than the executions stated in paragraph 3-1c) is given to armed troops, they are faced in the direction of march and their weapons brought to right (left) shoulder, port, or sling arms by the appropriate command. After a marching movement has been completed and it is desired to execute a facing movement, the command to order or unsling arms is given, followed by the command for the facing movement.

e. When at a position other than sling arms, the troops must come to port arms for double time. When the troops are in formation, the commander gives the appropriate commands.

f. Generally, the M16 rifle should be carried at sling arms except for ceremonies and drill periods.

g. Prior to commencement of the manual of arms, the magazine is removed, and the sling is drawn tight and positioned on the left side of the rifle. This configuration facilitates execution of the manual of arms. Figure 3-1 identifies the drill nomenclature for the M16 rifle.

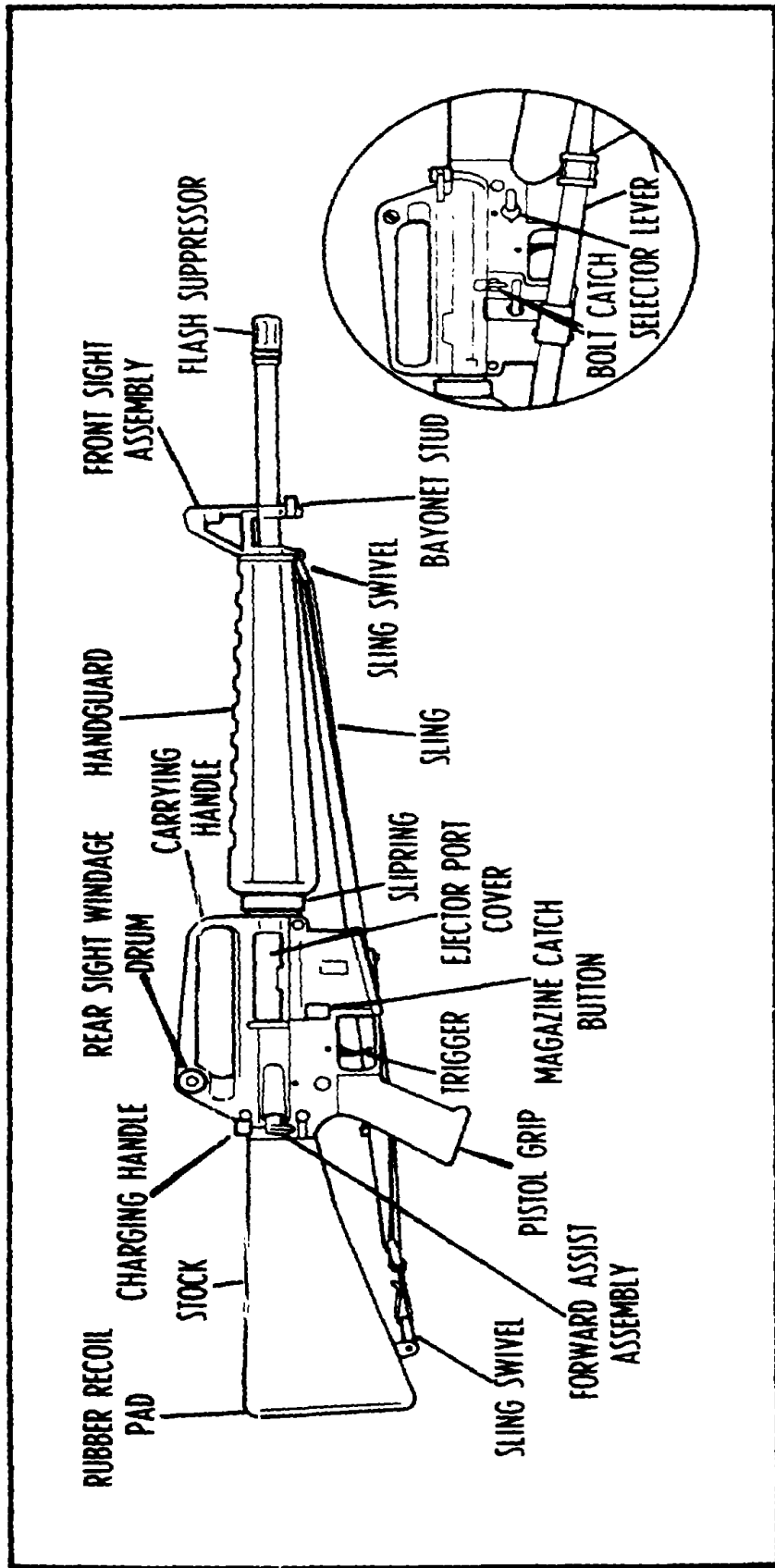

Figure 3-1.--Drill Nomenclature of the U.S. Rifle, 5.56mm, M16.

3-2. ORDER ARMS

a. Order arms is the position of the individual at attention with the rifle. It is assumed on the command ATTENTION from any of the rest positions except fall out. Order arms is assumed on the command FALL IN and on the command ORDER, ARMS from any position in the manual except inspection arms and sling arms.

b. The basic position of the rifle manual is order arms (see fig. 3-2). Properly executed, the butt of the rifle rests on the deck, and the stock rests along the outer edge of the right shoe. The pistol grip is to the front and the barrel is in a near vertical position. The rifle is grasped by the right hand at the junction of the front sight assembly and the barrel. The barrel rests in the "V" formed by the thumb and forefinger. The fingers are extended and joined and placed on line with the barrel. The thumb is placed along the trouser seam and the entire right arm is behind the rifle. This may cause a slight bend to the right arm of shorter troops. Those persons who are too tall to accomplish this may slide their hand up the barrel so that their posture remains erect.



Figure 3-2.--Order Arms.

3-3. REST POSITIONS

Rest positions with the rifle are commanded and executed as without arms, with the following exceptions and additions:

a. On the command PARADE, REST, the left foot is moved 12 inches to the left. The rifle butt is kept against the right foot. The grasp of the right hand is moved up the barrel to just below the flash suppressor with the fingers joined and curled with the forefinger touching the thumb. The right arm is straightened directly to the front so that the muzzle points forward and up (see fig. 3-3a). At the same time the left foot is moved, the left hand is placed behind the back just below the belt line with fingers and thumb extended and joined and the palm facing the rear (see fig. 3-3b).



a. Side View.



b. Rear View.

Figure 3-3.--Parade Rest.

b. On the command AT EASE or REST, the right foot remains in place and the rifle is held as in parade rest with the right arm relaxed slightly.

3-4. TRAIL ARMS

a. When at order arms and a command is given to move a unit a short distance, to face the unit, or to align the unit, trail arms is executed automatically on the command of execution for the movement. The rifle is returned to order arms gently and without command upon completion of the movement.

b. For training purposes, trail arms may be executed while halted at order arms. The command is TRAIL ARMS. At the command of execution ARMS, the rifle is raised vertically 3 inches off the deck. The wrist is kept straight with the thumb along the seam of the trousers (see fig. 3-4).



Figure 3-4.-- Trail Arms.

c. At the command ORDER ARMS, the rifle is gently and quietly lowered vertically to the position of order arms.

3-5. PORT ARMS FROM ORDER ARMS

- a. The command is PORT, ARMS.
- b. This is a two-count movement from order arms.

(1) At the command of execution and for the count of one, slide the right hand up and grasp the barrel near the flash suppressor. The fingers are joined and wrapped around the barrel with the thumb wrapped around the inboard portion. Without loss of motion, raise and carry the rifle diagonally across the front of the body until the right hand is level with and slightly to the left of the face. The right wrist is on the outboard portion of the front sight assembly. The elbow is held down without strain and nearly touches the handguard. The barrel is up and bisecting the angle formed by the neck and left shoulder. The pistol grip is to the left. The butt is in front of the right hip. At the same time, smartly grasp the handguard with your left hand just above the sling. The sling is included in the grasp. The fingers are joined and grasping the rifle. The little finger is in line with the sling with the thumb on the inboard side of the handguard. The left wrist and forearm are straight. The elbow is held in against the body (see fig. 3-5a).

(2) On the second count, release the grasp of the right hand and smartly regrasp the small of the stock. The fingers are joined and wrapped around the small of the stock with the thumb wrapped around the inboard portion. The right wrist and forearm are straight and parallel to the deck. The elbow is held into the side and the upper arm is in line with the back. The rifle is about 4 inches from the body (see fig. 3-5b).



a. Count One.



b. Count Two.

Figure 3-5.--Movements from Order Arms to Port Arms.

c. Port arms to order arms is a three-count movement.

(1) On the first count, at the command ORDER ARMS, the right hand is moved from the small of the stock and smartly regrasps the barrel. The palm of the right hand is to the rear. The fingers are joined and wrapped around the barrel with the thumb wrapped around the inboard portion. The little finger is just above the bayonet stud. The right wrist is on the outboard portion of the front sight assembly. The elbow is held down without strain and nearly touches the handguard (see fig. 3-6a).

(2) On the second count, lower the rifle initially with the left hand while changing the grasp of the right hand to the junction of the barrel and the front sight assembly as in the position of order arms. Without loss of motion, release the grasp of the left hand from the handguard and, with your right hand, carry the weapon to your right side until the butt is 3 inches from the deck. The barrel is in a vertical position and the pistol grip is to the front. At the same time guide the weapon with the left hand until the right thumb is on the trouser seam. The fingers of the left hand are extended and joined and touch the rifle near the flash suppressor. The palm of the left hand is toward the rear. The left wrist and forearm are straight and the left elbow is in against the body (see fig. 3-6b).

(3) On the third count, return the left hand to the left side at the position of attention. At the same time, gently lower the rifle to the deck with the right hand (see fig. 3-6c)

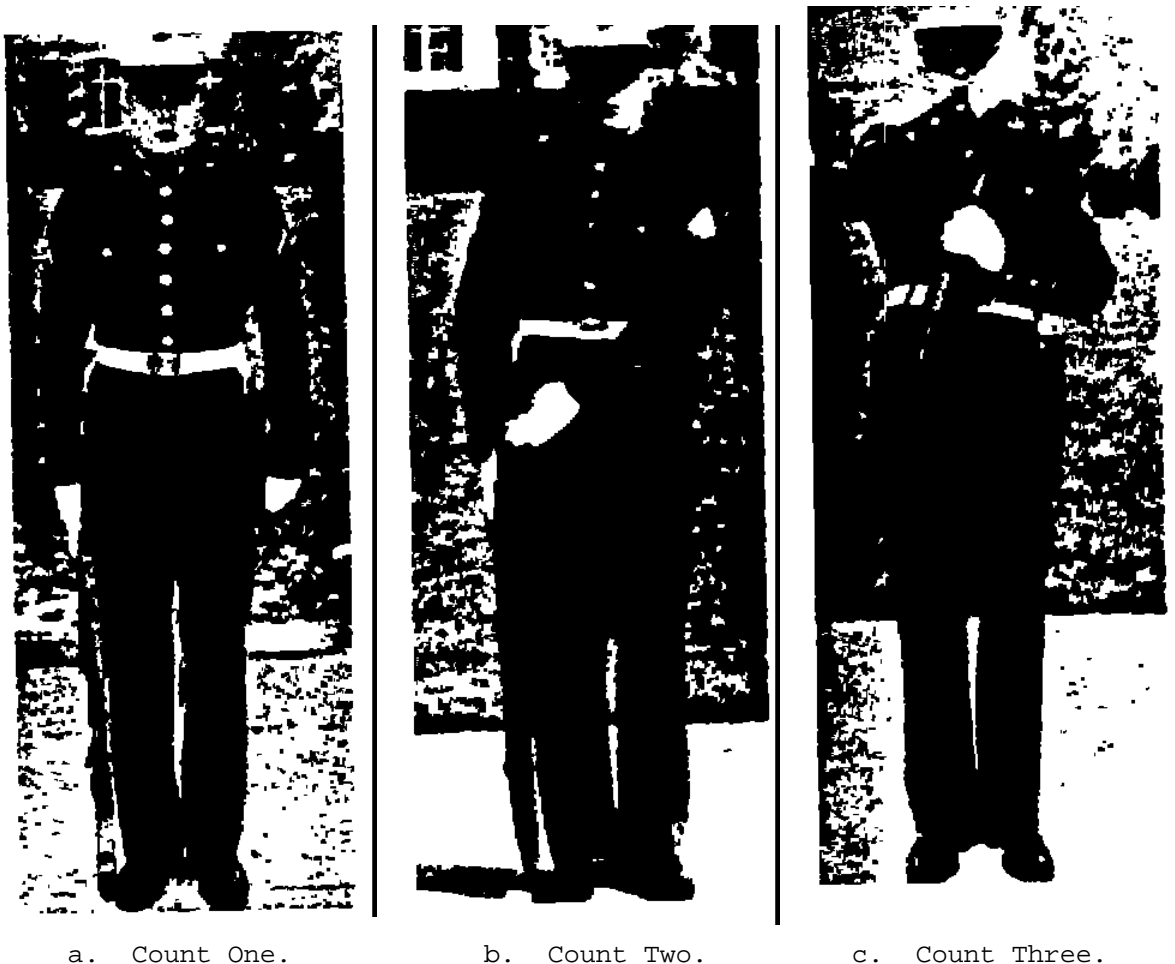

Figure 3-6.--Movements from Port Arms to Order Arms.

3-6. RIGHT SHOULDER ARMS FROM ORDER ARMS.

- a. The command is RIGHT SHOULDER, ARMS.
- b. This is a four-count movement from order arms.

(1) On the command of execution, ARMS, grasp the barrel of the weapon with the right hand. Without loss of motion, raise and carry the rifle diagonally across the front of the body until the right hand is level with and slightly to the left of the face. The right wrist and forearm are straight. The right elbow is held down without strain. The barrel is up and bisecting the angle formed by the neck and left shoulder. At the same time, grasp the handguard with the left hand (same as in count one for port arms) (see fig. 3-7a).

(2) On the second count, release the barrel with the right hand and grasp the butt placing the heel of the butt between the first two fingers. The heel will be visible between the index and middle fingers (see fig. 3-7b).

(3) On the third count, release the grasp of the left hand from the handguard and carry the rifle to the right side. The left hand remains in contact with the rifle in order to assist in the movement. At the same time, with the right hand, rotate the rifle a quarter turn counterclockwise and place the rifle into the right shoulder. Slide the left hand to the junction of the stock and receiver just below the charging handle. Guide the rifle into the shoulder with the left hand. The thumb and fingers are extended and joined with the palm turned toward the body. The first joint of the left forefinger touches the rear of the receiver. The left wrist and forearm are straight. The left elbow is held against the body. The grasp of the right hand is unchanged. The right wrist and forearm are straight and parallel to the deck. The elbow is held into the side with the upper arm in line with the back (see fig. 3-7c).

(4) On the fourth count, move your left hand back to the left side at the position of attention. The rifle is held at a 60 degree angle from the deck (see fig. 3-7d).



a. Count One.



b. Count Two.



6
c. Count Three.



44

d. Count Four.

Figure 3-7.--Movements from order Arms to Right Shoulder Arms.

3-7. ORDER ARMS FROM RIGHT SHOULDER ARMS

- a. The command is ORDER, ARMS.
- b. This is a four-count movement.

(1) At the command of execution and for the count of one, pull the rifle butt back quickly with the right hand so the rifle comes off the right shoulder. At the same time, with the right hand rotate the rifle a quarter turn clockwise so that the pistol grip is to the left. Allow the rifle to fall diagonally across the front of the body. Bring the left hand up and smartly grasp the handguard with the sling included in the grasp. The fingers are joined grasping the handguard. The little finger is in line with the sling but not touching it. The thumb is on the inboard side. The left wrist and forearm are straight. The elbow is held in against the body. The barrel is up, bisecting the angle formed by your neck and left shoulder. The butt is in front of the right hip. The grasp of the right hand has not changed. The right arm is nearly extended with the elbow held against the body (see fig. 3-8a).

(2) On the second count, release the grasp of the right hand from the butt and smartly regroups the barrel. The palm of the right hand is to the rear. The fingers are joined and wrapped around the barrel with the thumb wrapped around the inboard portion. The little finger is just above the bayonet stud. The right wrist is on the outboard portion of the front sight assembly (see fig. 3-8b).

(3) On the third count, lower the rifle initially with the left hand while changing the grasp of the right hand to the junction of the barrel and the front sight assembly as in the position of order arms. Without loss of motion, release the grasp of the left hand from the handguard and, with your right hand, carry the weapon to your right side until the butt is 3 inches from the deck. The barrel is in a vertical position and the pistol grip is to the front. At the same time, guide the weapon with the left hand until the right thumb is on the trouser seam. The fingers on the left hand are extended and joined and touching the rifle near the flash suppressor. The palm of the left hand is toward the rear. The left wrist and forearm are straight and the left elbow is in against the body (see fig. 3-8c).

(4) On the fourth count, return the left hand to the left side at the position of attention. At the same time, gently lower the rifle to the deck with the right hand (see fig. 3-8d).



a. Count One.



b. Count Two.



c. Count Three.

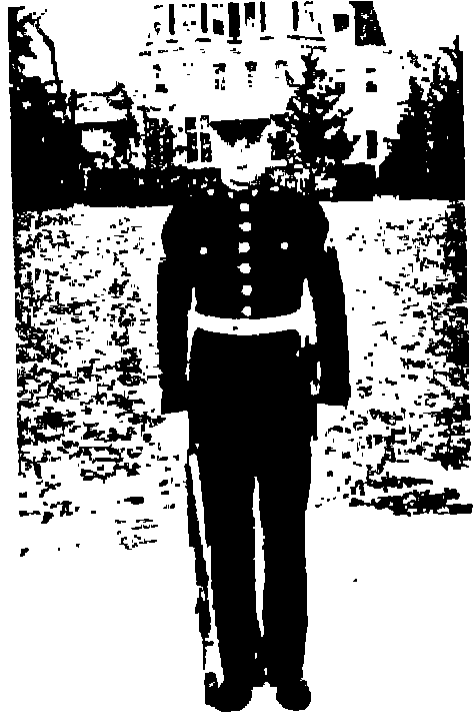

d. Count Four.

Figure 3-8.--Movements from Right Shoulder Arms to Order Arms.

3-8. LEFT SHOULDER ARMS FROM ORDER ARMS

a. The command is LEFT SHOULDER, ARMS.

b. This is a four-count movement from order arms.

(1) At the command ARMS, the rifle is brought to port arms on the first two counts (see figs. 3-9a and b).

(2) On the third count, release the grasp of the left hand from the handguard and, with the right hand, carry the rifle to the left side rotating it a quarter turn counterclockwise. Place it on the left shoulder. The elbow is held down without strain. At the same time, grasp the butt of the rifle with the left hand in the same manner as for right shoulder arms (see fig. 3-9c).

(3) On the fourth count, move your right hand back to the right side at the position of attention. The rifle is held at a 60 degree angle from the deck (see fig. 3-9d).



a. Count One.



b. Count Two.

Figure 3-9.--Movements from Order Arms to Left Shoulder Arms.



c. Count Three.



d. Count Four.

Figure 3-9.--Movements from Order Arms to Left Shoulder Arms cont.

3-9. MOVEMENTS FROM LEFT SHOULDER ARMS

a. Port arms from left shoulder arms is a two-count movement.

(1) On the first count, the right hand is moved up across the body and grasps the rifle at the stock below the charging handle (see fig. 3-10a).

(2) On the second count, the grasp of the left hand is released, and the rifle is brought from the shoulder diagonally across the body with the right hand and regripped at the handguard just above the sling with the left hand as in the position of port arms (see fig. 3-10b).



a. Count One.



b. Count Two.

Figure 3-10.-- Movements from Left *Shoulder Arms* to Port Arms.

b. Order arms and right shoulder arms from left shoulder arms are five-count movements. On the first two counts, the rifle is brought to port arms. On the last three counts, the rifle is brought to order arms or right shoulder arms as described in paragraphs 3-6 and 3-7.

3-10. PRESENT ARMS

a. The command is PRESENT, ARMS.

b. Order arms to present arms is a two-count movement.

(1) At the command of execution slide the right hand up and grasp the barrel near the flash suppressor. The fingers are joined and wrapped around the barrel. Without loss of motion, raise and carry the rifle to a vertical position centered on the body. The pistol grip is to the front. The wrist is on the right side of the front sight assembly. The elbow is held down without strain. At the same time, smartly grasp the rifle at the handguard with the left hand just above the sling. The sling is included in the grasp. The fingers are joined and wrapped around the handguard. The little finger is on line with the sling with the thumb on the inboard side of the handguard. The left wrist and forearm are straight and parallel to the deck. The elbow is held into the side with the upper arm on line with the back (see fig. 3-11a).

(2) On the second count, release the grasp of the right hand and regrasp the small of the stock. The charging handle rests on the thumb of the right hand. The fingers are extended and joined diagonally across the small of the stock. The right wrist and forearm remain straight. The elbow is held against the body. The rifle is 4 inches from the body (see fig. 3-11b).



a. Count One.



b. Count Two.

Figure 3-11.--Movements from Order Arms to Present Arms.

c. Port arms to present arms is executed in one count. The rifle is rotated clockwise with the right hand, the muzzle moves to the right, and the rifle is regripped above the sling with the left hand.

3-11. ORDER ARMS FROM PRESENT ARMS

- a. The command is ORDER, ARMS.
- b. Present arms to order arms is a three count movement.

(1) At the command of execution, release the grasp of the right hand from the small of the stock and regrasp the barrel. The palm of the right hand is to the left. The fingers are joined and wrapped around the barrel. The little finger is just above the bayonet stud. The wrist is on the right side of the front sight assembly. The elbow is held down without strain (see fig. 3-12a).

(2) On the second count, lower the rifle initially with the left hand while changing the grasp of the right hand to the junction of the barrel and the front sight assembly as in the position of order arms. Without loss of motion, release the grasp of the left hand from the handguard and, with the right hand, carry the weapon to the right side until the butt is 3 inches from the deck. The barrel is in a vertical position and the pistol grip is to the front. At the same time, guide the weapon into the right side with the left hand. The fingers of the left hand are extended and joined with the thumb along the hand. The tips of the forefinger and middle finger are touching metal at a point near the flash suppressor. The palm is towards the rear. The left wrist and forearm are straight. Guide the weapon into the right side so that the thumb of the right hand will be on the trouser seam and push back on the barrel until the toe of the stock is on line with the toe of the right shoe. The entire right arm is behind the rifle (see fig. 3-12b).

(3) On the third count, gently lower the rifle to the deck with the right hand so that the toe of the rifle is on line with the toe of the right shoe, and the barrel is in a near vertical position; at the same time smartly and in the most direct manner return the left hand to the side as in the position of attention. The thumb of the right hand remains along the trouser seam and the right arm remains behind the rifle (see fig. 3-12c).



a. Count One.

b. Count Two.

c. Count Three.

Figure 3-12.--Movements from Present Arms to Order Arms.

3-12. RIFLE SALUTE

a. This movement may be executed from order arms, trail arms, or left or right shoulder arms. The command is, RIFLE, SALUTE, and to terminate the salute the command is, READY, TWO. Both of these commands are one-count movements.

b. When at order arms, the left arm moves smartly across the body with the forearm and wrist straight, fingers extended and joined and palm down. The first joint of the forefinger touches the flash suppressor. When not in ranks, the head turns toward the person or colors saluted (see fig. 3-13). On READY, TWO, resume the position of attention.

c. When at trail arms, the movements are identical with those for saluting at order arms, except that the rifle is held in the trail arms position.

d. At right (left) shoulder arms, the left (right) arm moves across the body, fingers extended and joined, and palm down. The first joint of the forefinger touches the rear of the receiver just below the charging handle, and the forearm is held parallel to the deck (see fig. 3-13b). When not in ranks, the head and eyes turn toward the person or colors saluted. On READY, TWO, the position of attention is resumed.



a. Rifle Salute from Order Arms. b. Rifle Salute from Right Shoulder Arms.

Figure 3-13.--Rifle Salutes.

3-13. INSPECTION ARMS (WITH AND WITHOUT MAGAZINE)

a. The command is INSPECTION, ARMS.

b. Order arms to inspection arms is a seven-count movement.

(1) The first two counts are the same as the two-count movement from order arms to port arms (see figs. 3-14a and b).

(2) On the third count, release the grasp of the left hand from the handguard and regrasp the pistol grip. The fingers are joined and grasping the pistol grip. At the same time, place the thumb of the left hand over the lower portion of the bolt catch (see fig. 3-14c).

(3) On the fourth count, release the grasp of the right hand from the small of the stock and unlock the charging handle with the thumb and forefinger. The remaining three fingers are joined and placed on line with the forefinger just behind the charging handle. Sharply pull the charging handle to the rearmost position. At the same time, apply pressure to the bolt catch with the thumb of the left hand and lock the bolt to the rear (see fig. 3-14d).

(4) On the fifth count, push the charging handle forward until it is locked in its foremost position and grasp the small of the stock with the right hand (see fig. 3-14e).

(5) On the sixth count, elevate the rifle up and to the left rotating the rifle counterclockwise so that the chamber is visible. The ejection port will be at eye level. The right forearm will touch the stock and the weapon will be at approximately a 45 degree angle. At the same time, turn the head to the left and inspect the chamber to see that it is clear (see fig. 3-14f).

(6) On the seventh count, and after finding the chamber clear or clearing it, lower the rifle rotating it clockwise while turning the hand back to the front. Without loss of motion, release the grasp of the left hand from the pistol grip and regrasp the handguard resuming the position of port arms.

c. To execute inspection arms with the magazine in the weapon, remove the magazine with the left hand and place it between the clothing and the belt (left front) prior to count three.



a. Count One.



b. Count Two.



c. Count Three.



d. Count Four.

Figure 3-14.--Inspection Arms from Order Arms.



e. Count Five.



f. Count Six.

Figure 3-14.--Inspection Arms from Order arms cont.

3-14. PORT ARMS FROM INSPECTION ARMS (WITH AND WITHOUT MAGAZINE)

a. The command is PORT, ARMS.

b. PORT ARMS is the only command given from inspection arms. On the preparatory command of port, release the grasp of the left hand from the handguard and regrasp the weapon with the thumb and fingers, forming a "U" at the magazine well and trigger guard. Press the bolt catch and allow the bolt to go forward. With the fingertips, push upward and close the dust cover. Slide the left hand down and grasp the pistol grip. The fingers are joined and grasping the pistol grip. At the same time, place the thumb on the trigger so the tip of the thumb is outboard.

c. On the command of execution ARMS, pull the trigger with the thumb of the left hand. Then release the grasp of the left hand from the pistol grip and regrasp the lower portion of the handguard resuming the position of port arms.

d. If inspection arms is executed with the magazine, it is returned to the weapon immediately after pulling the trigger and before resuming port arms.

3-15. FIX AND UNFIX BAYONETS.

a. Fix Bayonets

(1) The command is FIX, BAYONETS.

(2) This is not a precision movement; therefore, there are no counts. On the command of execution, move the muzzle of the rifle to the left front and regrip the barrel with the left hand. With the right hand, unsnap the securing strap and withdraw the bayonet. Turn the point skyward and attach the bayonet to the weapon. While engaging the bayonet stud, with the base of the bayonet, grasp the handle and apply downward pressure until a click is heard. Apply limited upward pressure to ensure that the bayonet is seated securely. Resnap the scabbard securing strap, and then resume the position of order arms.

b. Unfix Bayonets.

(1) The command is UNFIX, BAYONETS.

(2) This is not a precision movement; therefore, there are no counts. On the command of execution, move the muzzle to the left and grasp it with the left hand. With the right hand unsnap the securing strap. Release the bayonet from the bayonet stud and remove the bayonet from the muzzle. Keeping your eyes on the bayonet point, return it to the scabbard and insert it with the ring facing to the front. Resnap the securing strap and then resume order arms.

3-16. AUTHORIZED MOVEMENTS IN THE MANUAL OF ARMS WITH THE M16 RIFLE

a. From Order Arms to:

- (1) Port Arms
- (2) Right Shoulder Arms
- (3) Left Shoulder Arms
- (4) Present Arms
- (5) Inspection Arms
- (6) Trail Arms
- (7) Rifle Salute
- (8) Rest Positions
- (9) Fix Bayonets
- (10) Sling Arms

b. From Port Arms to:

- (1) Right Shoulder Arms
- (2) Left Shoulder Arms
- (3) Order Arms
- (4) Present Arms

c. From Right Shoulder Arms to:

- (1) Left Shoulder Arms
- (2) Port Arms
- (3) Order Arms
- (4) Present Arms
- (5) Inspection Arms

d. From Left Shoulder Arms to:

- (1) Right Shoulder Arms
- (2) Port Arms
- (3) Order Arms
- (4) Present Arms
- (5) Inspection Arms

e. From Inspection Arms to Port Arms

f. From Present Arms to:

- (1) Order Arms
- (2) Port Arms (only when salute has been returned or the color has passed, without order)

Section II. MANUAL OF ARMS MOVEMENTS WHILE AT SLING ARMS

3-17. GENERAL

a. This section contains the procedures for executing manual of arms movements while at sling arms.

b. All individual or unit drill movements may be executed while at sling arms, except stack arms and unfix and fix bayonets.

c. Remain at sling arms during all rest movements.

d. Stack arms and fix and unfix bayonets (slings loose) are executed from unsling arms (order arms) only.

e. When in formation at sling arms, execute the hand salute on the command PRESENT, ARMS.

3-18. SLING ARMS

a. From Order Arms.

(1) From the order arms position (parade sling-slings tight), the command for sling arms is SLING, ARMS.

(2) This is not a precision movement; therefore, there are no counts. On the command of execution, slide the right hand up and grasp the barrel near the flash suppressor. Without loss of motion, raise the rifle to a vertical position where the butt is in front of the right hip with the muzzle pointing up and the pistol grip to the left. At the same time, grasp the rifle at the handguard just above the slinging with the left hand. The sling is included in the grasp. The fingers are joined. Place the butt on the right hip. If the rifle belt is worn, the butt will rest just above the belt. Release the grasp of the right hand and with the left hand move the rifle so that it will rest on the inside of the right elbow and cradle it there (see fig. 3-15). The muzzle points slightly to the right. Release the grasp of the left hand from the handguard and with both hands loosen the sling. After the sling

has been loosened, grasp the sling with your left hand and sling the rifle on the right shoulder in the most direct manner. Regrasp the sling with the right hand. With the exception of the right arm, return to the position of attention. The palm of the right hand is toward the sling. The fingers are joined. The fingers and thumb are wrapped around the sling with the knuckles forward. The wrist and forearm are straight and parallel to the deck. The elbow is holding the rifle in a vertical position and against the body (see fig. 3-16).



Figure 3-15. Cradle Rifle Inside Right Elbow.



Figure 3-16. Position of Sling Arms.

b. From Unsling Arms.

(1) From the unsling arms position (order arms with loose slings), the command for sling arms is SLING, ARMS.

(2) This is not a precision movement; therefore, there are no counts. On the command of execution, slide the right hand up and grasp the barrel near the flash suppressor. The fingers are joined and wrapped around the barrel with the thumb wrapped around the inboard portion. Without loss of motion, raise the rifle and grasp the sling with the left hand near the upper sling swivel.

Release the grasp of the right hand and, with the left hand, sling the rifle over the right shoulder in the most convenient manner. Regrasp the sling with the right hand. With the exception of the right arm, return to the position of attention. The palm of the right hand is toward the sling. The fingers are joined. The fingers and thumb of the right hand are wrapped around the sling with the knuckles forward. The wrist and forearm are straight and parallel to the deck. The elbow is holding the rifle in a vertical position and against the body.

3-19. UNSLING ARMS

a. The command is UNSLING, ARMS.

b. This is not a precision movement; therefore, there are no counts. On the command of execution, grasp the sling with the left hand in front of the armpit and unsling the rifle from the right shoulder in the most convenient manner. Grasp the rifle at the junction of the barrel and the front sight assembly. Release the grasp of the left hand from the sling and, with the right hand, carry the weapon to the right side until the butt is 3 inches from the deck. The barrel is in a vertical position. At the same time, guide the weapon with the left hand until the right thumb is on the trouser seam. The fingers of the left hand are extended and joined and touching the rifle near the flash suppressor. The palm of the left hand is toward the rear. The left wrist and forearm are straight and the left elbow is in against the body. Gently lower the rifle to the deck with the right hand and at the same time return the left hand to the left side at the position of attention.

3-20. ADJUST SLINGS

a. The command ADJUST, SLINGS is given when it is desired to tighten loose slings to the position of parade slings. This is not a precision movement; therefore, there are no counts.

b. From unsling arms (order arms), on the command of execution, the rifle is brought to a cradle position inside the right elbow as in the movement from order arms to sling arms. While in this position, the sling is tightened to parade sling. The rifle is then returned to order arms.

c. From sling arms, on the command of execution, grasp the sling with the left hand in front of the armpit and unsling the rifle from the right shoulder in the most convenient manner. Then place the butt on the right hip and cradle the rifle inside the right elbow. Tighten the sling to the parade sling position and automatically assume the position of order arms.

3-21. SALUTE AT SLING ARMS

a. To salute while at sling arms, the command is PRESENT, ARMS. On the command of execution, reach across the body with the left hand and grasp the sling just above the right hand. Release the right hand and execute the hand salute (see fig. 3-17).

b. To resume order arms, the command is ORDER ARMS. On the command of execution ARMS, lower the right hand smartly to the right side and regasp the sling at the original position. After grasping the sling with the right hand, release the sling with the left hand and return it smartly to the position of attention.



Figure 3-17.--Salute at Sling Arms.

3-22. PORT ARMS FROM SLING ARMS

a. The command is PORT, ARMS.

b. This is not a precision movement; therefore, there are no counts. On the command of execution, reach across the body with the left hand and grasp the sling at the shoulder. Lift the weapon (by the sling), swing it to the front of the body, and grasp the small of the stock with the right hand. Release the sling and regrasp the weapon just forward of the sling with the left hand. Keep the elbows into the side with the right forearm horizontal (see fig. 3-18).



Figure 3-18.--Port Arms From Sling Arms

c. To resume sling arms, the command is SLING, ARMS. On the command of execution, grasp the sling near the upper sling swivel with the left hand. Release the right hand and swing the weapon back onto the shoulder by inserting the right arm through the sling, immediately resuming the position of sling arms.

3-23. INSPECTION ARMS FROM SLING ARMS

a. The command is INSPECTION, ARMS.

b. This is not a precision movement; therefore, there are no counts. On the command of execution, move the left arm across the body and grasp the rifle by the pistol grip and place the thumb on the lower part of the bolt catch (see fig. 3-19a). Release the grasp on the sling and, with the left hand and arm supporting the weapon, bring the rifle to a position diagonally across the body, placing the right hand at the small of the stock (see fig. 3-19b). Unlock the charging handle with the thumb and pull it to the rear (see fig. 3-19c). Push the charging handle until it is locked in its foremost position and grasp the small of the stock with the right hand. Elevate the rifle up and to the left, at the same time rotating it ninety degrees so that the handgrip is pointing away from the body. At this time, visually inspect the chamber to see that it is clear (see fig. 3-19d). Return to port arms.



a. Grasp Pistol Grip.



b. Bring Rifle to Position Diagonally Across Body.



c. Unlock and Pull Charging Handle to Rear.



d. Elevate and Inspect Rifle.

Figure 3-19.--Inspection Arms from Sling Arms

[BLANK PAGE]

CHAPTER 4

MANUAL OF ARMS WITH HANDGUNS

4-1. PISTOL MANUAL OF ARMS

a. General Rules.

(1) When in ranks and armed with the pistol, facings, rests, open and close ranks, and alignments are executed as if unarmed

(2) The pistol manual of arms is not executed in cadence. It is a simple, quick, and safe method of handling the pistol.

(3) When in formation, remain at attention during all rifle manual movements except those listed below:

b. Present Arms From Attention (Pistol in Holster).

(1) The command is PRESENT, ARMS. It is executed in one count.

(2) On ARMS, execute the hand salute.

c. Attention (Pistol in Holster) From Present Arms.

(1) The command is ORDER, ARMS. It is executed in one count.

(2) On ARMS, return the right hand to its normal position by the right side.

d. Inspection Arms From Attention (Pistol in Holster).

(1) The command is INSPECTION, ARMS. It involves several movements which are executed rapidly and smartly without count. It may be executed only when halted at attention with pistol in holster (see fig. 4-1). Inspection arms is not executed with the pistol as part of the rifle manual except when the unit is formed and dismissed.



Figure 4-1. - Position of Attention Armed with Pistol.

(2) On ARMS, with the right hand, unbutton the holster flap, grasp the grip and pull the pistol from the holster. Raise the right hand to a position level with and 6 inches in front of the right shoulder. The grip should be held between the thumb and last three fingers, and the forefinger extended outside the trigger guard. The muzzle points forward and up at an angle of 30 degrees (see fig. 4-2).



Figure 4-2.-- Remove Pistol from the Holster and Raise to Vertical Position.



(3) Without lowering the muzzle or the right hand, turn the barrel slightly clockwise, look at the pistol, press the magazine catch with the right thumb, and remove the magazine with the left hand (see fig. 4-3). Turn the barrel back to the front. Place the magazine between the pistol belt and outer garment.

Figure 4-3.-- Remove Magazine.

(4) Without lowering the muzzle or the right hand, grasp the slide with the thumb and fingers of the left hand, thumb on the left side of the slide and pointing downward. Keep the left forearm parallel with the deck. Push the slide all the way to the rear and engage the slide stop in its notch with the right thumb (see fig. 4-4). Look into the chamber; if it is not empty, empty it. Take the magazine from under the belt with the left hand. Raise the left hand to the height of the belt, forearm parallel to the deck, elbow at the side, palm up, fingers extended and joined. Hold the magazine in the open hand, follower to the rear (see fig. 4-5).



Figure 4-4. Push Slide to Rear.



Figure 4-5. Position of Inspection Arms.

e. Attention (Pistol in Holster) From Inspection Arms.

(1) The command is PORT, ARMS. It is the only command which may be executed from inspection arms.

(2) On ARMS, return the magazine to a position between the belt and outer garment. With the thumb of the left hand, release the slide stop. Keep the muzzle up and squeeze the trigger. Remove the magazine from the belt with the left hand and insert into the pistol. Return the pistol to the holster and button the flap with the right hand.

4-2. REVOLVER MANUAL OF ARMS

a. General Rules. The general rules described in paragraph 4-1 for the pistol are applicable to the to the manual of arms for the revolver.

b. Present Arms From Attention (Revolver in Holster). Execute as described in paragraph 4-1b.

c. Attention (Revolver in Holster) From Present Arms. Execute as described in paragraph 4-1c.

d. Inspection Arms From Attention (Revolver in Holster).

(1) The command is INSPECTION, ARMS. It involves several movements which are executed rapidly and smartly without count. It may be executed only when halted at attention with revolver in holster. Inspection arms is not executed with the revolver as part of the rifle manual of arms except when the unit is formed and dismissed.

(2) On ARMS, with the right hand, unbutton the holster, grasp the grip, and pull the pistol from the holster. Raise the left hand to the front, forearm parallel to the deck, elbow at the side, palm up. Place the revolver cylinder in the left hand, latch up, barrel inclined to the left front and downward at an angle of about 30 degrees from the horizontal. Press the latch with the right thumb, push the cylinder out with the second finger of the left hand, and if necessary, eject any live rounds or empty shells by pressing the ejector rod head with the left thumb. Live rounds are placed in the belt with the right.

(3) Regrasp the grip with the right hand, holding it between the thumb and last three fingers, forefinger extended outside the trigger guard. Raise the right hand to a position level with and 6 inches in front of the right shoulder. the muzzle points forward and up at an angle of 30 degrees.

e. Attention (Revolver in Holster) From Inspection Arms.

(1) The command is PORT, ARMS. It is the only command which may be executed from inspection arms.

(2) On ARMS, push the cylinder in with the left hand, return the pistol to the holster, and button the flap with the right hand.

CHAPTER 5

SWORD MANUAL

5-1. GENERAL RULES

a. Officers and noncommissioned officers execute the sword manual in the same manner with the following exceptions:

(1) The officer's scabbard is rotated to draw or return sword. The Marine officer's scabbard is worn with the convex edge to the rear (see fig. 5-1), except when rotated 180 degrees to draw or return sword.

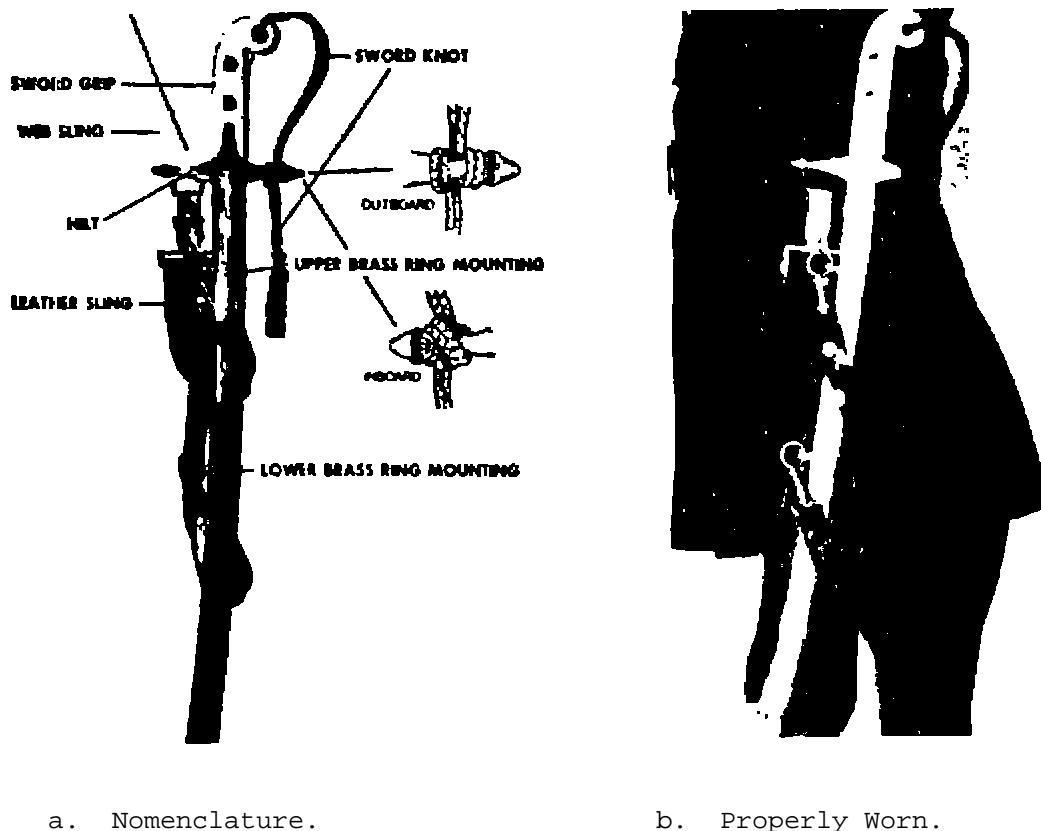

a. Nomenclature.

b. Properly Worn.

Figure 5-1.--Marine officer's Sword.

(2) The noncommissioned officer's scabbard is attached to a frog which prevents it from rotating. It is worn with the convex edge to the front and remains in that position during draw and return sword (see fig. 5-2).

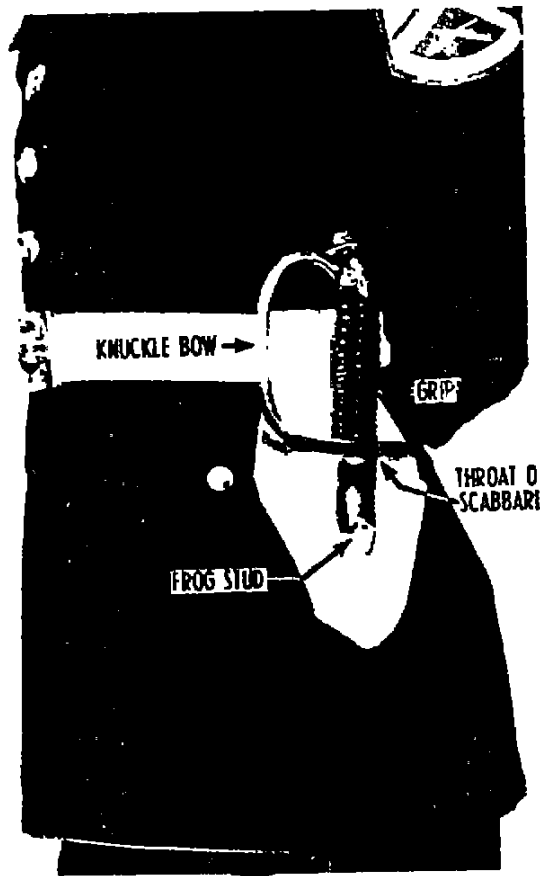

Figure 5-2.--Noncommissioned Officer's Sword.

b. Officers and noncommissioned officers draw and return sword, without command, when the commander of their unit does. Unless members of the commander's staff, they execute all other movements of the sword manual on the commander's command to the unit. Staff members execute all other movements on the commander's separate command to his staff. The sword will be drawn with armed troops, except when at ease, rest, route step, at ease march, or when inspecting troops. A unit commander, after being inspected, will return sword prior to accompanying the inspecting party, except during the inspection of an honor guard.

c. Carry sword is assumed when:

- (1) Giving commands.
- (2) Changing position in formation at quick time.
- (3) Addressing or being addressed by a senior.
- (4) The preparatory command for quick time has been given.
- (5) While marching at quick time.

(6) Any manual of arms movement has been ordered except parade rest, at ease, rest, present arms, or eyes right (left). When in formation with personnel to your front an normal distance or less (organization staffs excluded), remain at carry sword except during rest or at ease.

d. Present sword is assumed when:

(1) Saluting with the sword.

(2) The unit is presented to the colors or any person, or when the National Anthem, To The Color, Retreat, or Hail to the Chief is played.

(3) Executing eyes right (left) while marching past a reviewing officer or stand. If in the interior of a formation, remain at carry sword.

e. While marching with sword at the carry, both arms should swing 6 inches to the front and 3 inches to the rear. Do not hold the scabbard or sling.

f. While marching at double time, hold the sword diagonally across the chest with the sharp edge to the front. Hold the scabbard with the left hand just below the lower brass ring mounting/frog.

g. When calling roll, reading documents, or publishing orders to a formation, slip the fingers of the left hand between the sword grip and knot (officers) or guard (noncommissioned officers). Keep the left elbow against the side. Hold the document with both hands (see fig. 5-3).

h. When not in formation, keep the sword in its scabbard. Salute by executing the hand salute.



Figure 5-3.--Position for Reading Documents.

5-2. DRAW SWORD

a. The command is DRAW, SWORD.

b. On the preparatory command, DRAW:

(1) Officers. Grip the scabbard below the upper brass ring mounting with the left hand. Turn it clockwise 180 degrees. Tilt it forward to form an angle of 45 degrees with the deck. Take the sword grip in the right hand and pull it about 6 inches from the scabbard. The right forearm should now be parallel to the deck and the left hand holding the scabbard against the side (see fig. 5-4a and b).



a. Front View on DRAW.

b. Side View on DRAW.

c. Front View of First Step of Execution.

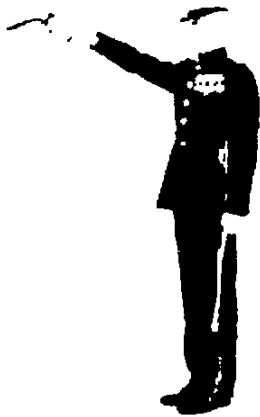

d. Side View of First Step of Execution.

e. Front View of Position of Carry Sword.

f. Side View of Position of Carry Sword.

Figure 5-4.--Movements to Draw sword for Officers.

(2) Noncommissioned Officers. Grip the scabbard just below the frog with the left hand. Tilt it forward to form a 45-degree angle with the deck. Take the grip in the right hand and raise it about 10 inches from the scabbard. The right forearm should now be parallel to the deck and the left hand holding the scabbard against the side (see fig. 5-5a and b).



a. Front View on DRAW.



b. Side View on DRAW.



c. Front View of First Step of Execution.

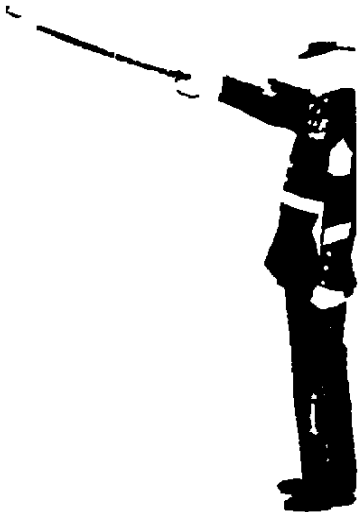

d. Side View of First Step of Execution.



e. Front View of position of Carry Sword.



f. Side View of Position of Carry Sword.

Figure 5-5.--Movements to Draw sword for Noncommissioned Officers.

c. On the command of execution, SWORD:

(1) Draw the sword smartly, raising the right arm to its full extent, directly to the front at an angle of about 45 degrees, the sword in a straight line with the arm, edge down; drop the left hand by the side (Officers see fig. 5-4c and d, NCO's see fig. 5-5c and d).

(2) Pause for one count.

(3) Bring the back of the blade against the shoulder seam of the coat, the blade vertical, back of the grip to the rear, the arm nearly extended, the thumb and forefinger embracing the lower part of the grip, the thumb against the trouser seam, and the fingers joined behind the end of the hilt. This is the position of carry sword (Officers see fig. 5-4e and f, NCO's see fig. 5-5e and f).

5-3. PRESENT SWORD FROM CARRY OR ORDER SWORD

a. The command is PRESENT, SWORD (ARMS). It may be given only when halted at order sword or carry sword. It is executed in two counts.

b. On PRESENT, raise the right hand to the level of and 6 inches in front of the neck. Keep the thumb on the left side of the grip, wrist straight, and elbow against the body. The blade should tilt forward at 30 degrees (see figs. 5-6b and 5-7b).

c. On SWORD (ARMS), bring the point down smartly, without whipping, to a position 3 inches above the deck and slightly right of the right foot. Straighten the arm so the guard (noncommissioned officers) or the acorn (officers) is against the trouser seam. The blade is inclined down and to the front with the sharp edge to the left. The thumb remains on the left side of the grip. (See figs. 5-6c and d and 5-7c).

d. When the sword is at carry or order sword, and it becomes necessary to salute, execute present sword. After the salute has been returned, come to order sword (then to carry sword if walking).

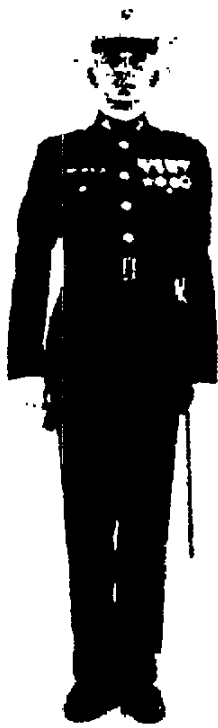

a. Carry Position.



b. Position on Command,
PRESENT.



c. Position of Present
Sword, Front View.



d. Position of Present
Sword, Side View.

Figure 5-6.--Movements for Present Sword from Carry or order Sword; Officers.



a. Carry Position.



b. Position on Command,
PRESENT.



c. Position of Present Sword, Front View.

Figure 5-7.--Movements for Present Sword from Carry or Order Sword; NCO's.

5-4. ORDER SWORD FROM PRESENT SWORD

a. The command is ORDER, SWORD (ARMS). It is executed in one count.

b. On SWORD (ARMS), turn the sharp edge down. In this position, the right arm hangs naturally with the thumb along the trouser seam. The blade slants down to the front with the point 3 inches from the deck (see figs. 5-8 and 5-9).

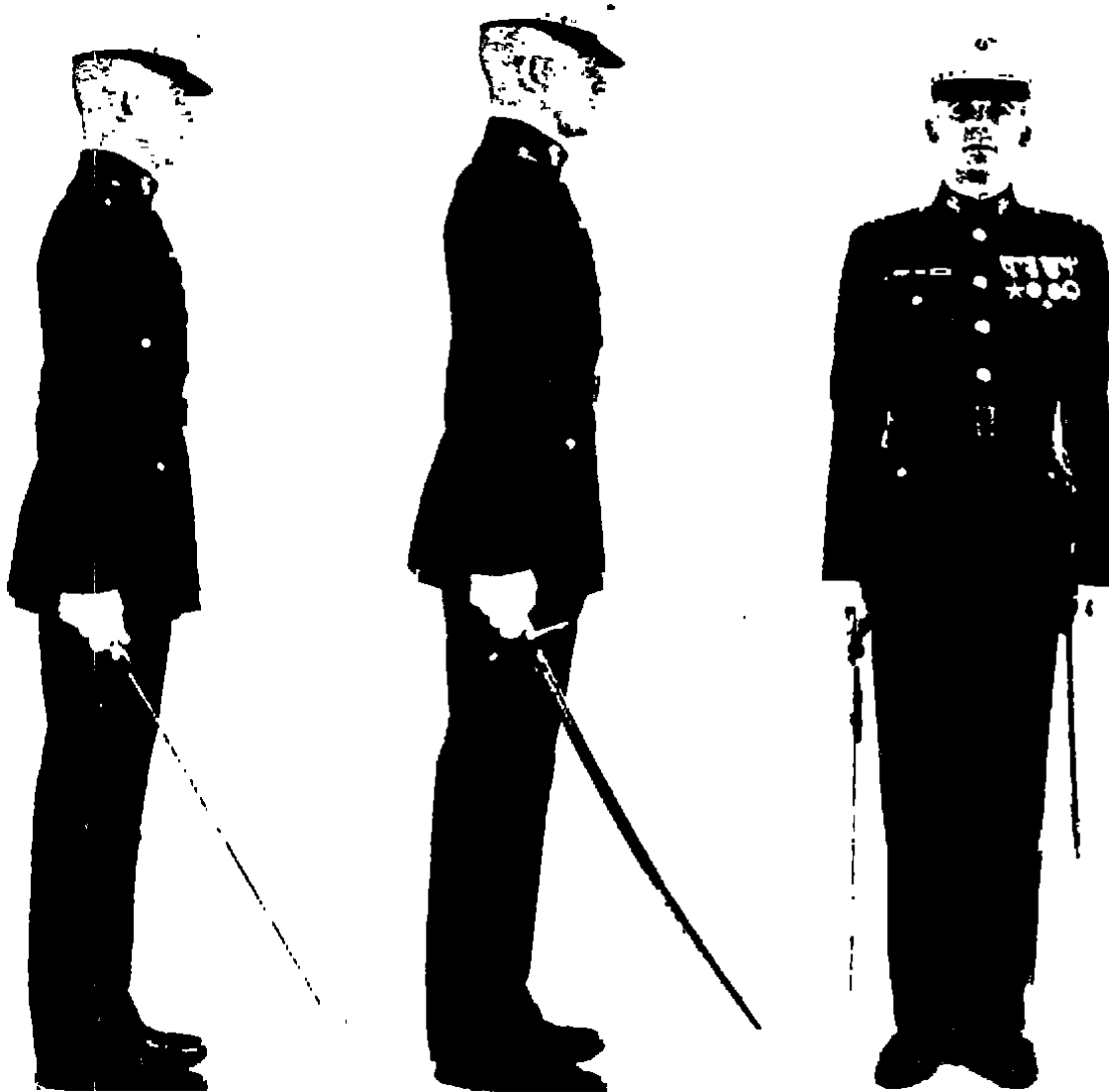

a. Position of Present Sword.

b. Position of Order Sword, Side View.

c. Position of Order Sword, Front View.

Figure 5-8.-- Order Sword from Present Sword Officers.

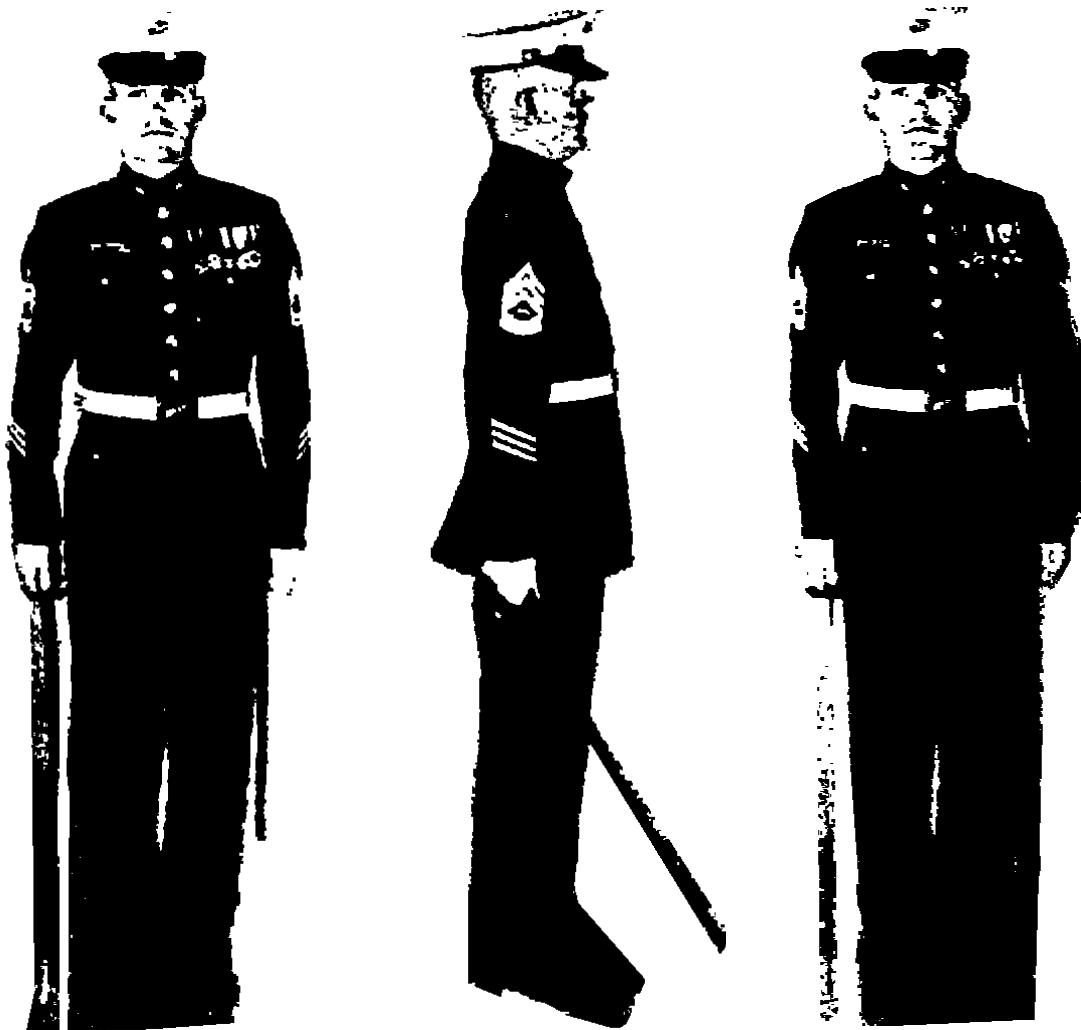

a. Position of Present Sword. b. Position of Order Sword, Side View. c. Position of Order Sword, Front View

Figure 5-9.--Order Sword from Present Sword; NCO's

5-5. EYES RIGHT (LEFT) FROM CARRY OR ORDER SWORD

a. The command is EYES, RIGHT (LEFT). It may be given only when halted at order sword or when marching at carry sword. It is executed in two counts.

b. On EYES, raise the right hand to the level of and 6 inches in front of the neck. Keep the thumb on the left side of the grip, wrist straight, and elbow against the body. The blade should tilt forward at 30 degrees.

c. On RIGHT (LEFT), bring the point down smartly, without whipping, to a position 3 inches above the deck and slightly right of the right foot. Straighten the arm so the guard (noncommissioned officers) or the acorn (officers) is against the trouser seam. The blade is slanted down and to the front, with the sharp edge to the left. The thumb remains on the left side of the grip. At the same time, turn the head and eyes 45 degrees to the right (left). If in extreme right (left) file, continue looking straight ahead (see figs. 5-10 and 5-11).

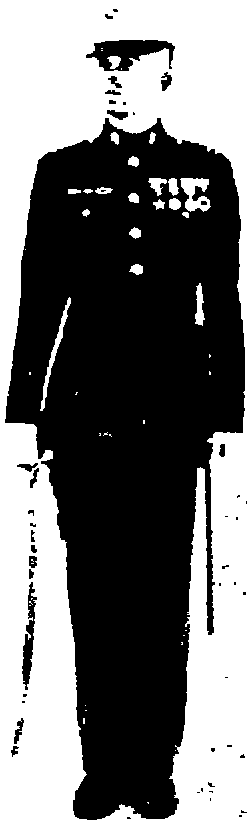

Figure 5-10.--Eyes right (Left)
from Carry or Order Sword:
Officers.



Figure 5-11.--Eyes Right (Left)
from Carry or Order Sword;
NCO's.

d. Order sword from eyes right (left):

(1) The command is READY, FRONT. It is executed in one count.

(2) On FRONT, turn the sharp edge of the sword down. At the same time, turn the head and eyes smartly to the front.

e. Carry sword from eyes right (left) (executed when on the march):

(1) The command is READY, FRONT. Execution is begun on the preparatory command.

(2) On READY, turn the sharp edge of the sword down.

(3) On FRONT, raise the sword to carry. At the same time, turn the head and eyes to the front.

5-6. PARADE REST FROM ORDER ARMS.

a. The command is PARADE REST. This command is normally given only from order sword, in which case it is executed in one count.

b. If given when at another position of the manual, come to order sword on the command PARADE.

c. On REST, move the left foot smartly 12 inches to the left. at the same time, lower the point of the Sword to the deck, place the left hand behind you, just below the belt (see figs. 5-12 and 5-13).



a. Front View.



b. Side View.

Figure 5-12.--Parade Rest from Order Sword; Officers.

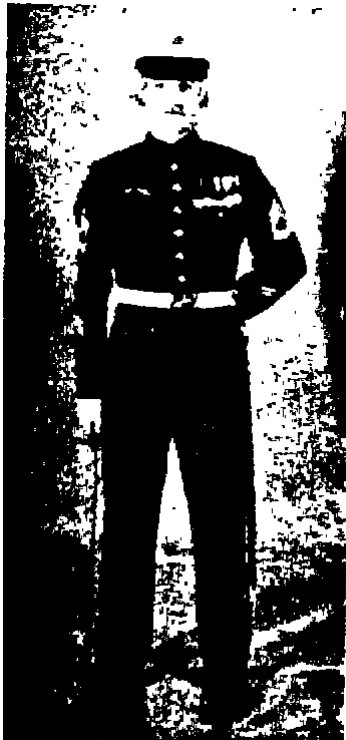

a. Front View.



b. Side View.

Figure 5-13.--Parade rest from Order Sword; NCO's

d. Order sword from parade rest:

(1) The command is PLATOON (COMPANY, DETAIL), ATTENTION. It is executed in one count.

(2) On ATTENTION, bring the left heel smartly against the right and the left hand back to the side. Raise the blade so the point is 3 inches from the deck.

5-7. AT EASE FROM ANY POSITION OF THE SWORD

a. The command is AT EASE. It may be given from any position of the sword.

b. On AT EASE, come to order sword if not already at that position. Then move the left foot 12 inches to the left and lower the point of the sword to the deck. Rest the weight equally on both feet with the legs straight. At the same time, place the left hand behind you. Keep the fingers straight and joined, the palm flat and facing rear. You may relax and, except for your right foot, move about. Do not talk. (See fig. 5-14).



Figure 5-14.--At Ease.

5-8. REST FROM ANY POSITION OF THE SWORD

The command is REST. It is executed in the same manner as at ease, the only difference being that you may talk.

5-9. TO RETURN TO ATTENTION

The command is PLATOON (COMPANY, DETAIL), ATTENTION. Execution is begun on the preparatory command.

a. On PLATOON (COMPANY, DETAIL), come to parade rest.

b. On ATTENTION, bring the left heel smartly against the right and the left hand to the side. Raise the blade so the point is 3 inches from the deck.

5-10. RETURN SWORD FROM CARRY OR ORDER SWORD

a. The command is RETURN, SWORD. Execution is begun on the preparatory command.

b. On the preparatory command, RETURN:

(1) Officers raise the right hand to a position 6 inches in front of the neck. Keep the thumb on the left side of the grip, wrist straight and elbow against the body. The sword should tilt forward at 30 degrees. At the same time, grasp the scabbard with the left hand just above the upper brass ring mounting. Tilt it forward and turn it clockwise 180 degrees. The scabbard should form a 45-degree angle with the deck. Then lower the sword point to a position just above the opening of the scabbard. Look down at the opening. Guide the point into the opening with the left thumb and forefinger until the right forearm is parallel to the deck. Then raise the head back to attention. The left hand holds the scabbard against the side (see fig. 5-15).



a. Raise Sword and Tilt Scabbard, Front View.

b. Raise Sword and Tilt Scabbard, Side View.

c. Insert Sword Into Scabbard.

Figure 5-15.--Movements for Return Sword from Carry or Order Sword; Officers.



d. Final Position on Preparatory Command, RETURN, Front View.

e. Final Position on Preparatory Command, RETURN, Side View.

Figure 5-15. Movements for Return Sword from Carry or Order Sword; Officers (contd).

(2) Noncommissioned officers raise the right hand to a position 6 inches in front of the neck. At the same time, grasp the scabbard with the left hand below the throat. Keep the thumb on the left side of the grip, wrist straight, and elbow against the body. Tilt the sword forward 30-degrees. Then lower the sword point to a position just above the opening of the scabbard. Look down at the opening. Guide the point into the opening with the left thumb and forefinger until the right hand is 10 inches from the scabbard. Then raise the head back to attention. The right forearm should now be straight and parallel across the body. The left hand holds the scabbard against the side (see fig. 5-16).



a. Raise Sword and Grasp Scabbard, Front View.



b. Raise Sword and Grasp Scabbard, Side View.



c. Insert Sword Into Scabbard.



d. Final Position on Preparatory Command, RETURN, Front View.



e. Final Position on Preparatory Command, RETURN, Side View.

Figure 5-16.--Movements for Return sword from Carry or Order Sword; NCO's.

c. On the command of execution, SWORD, push smartly-down on the sword and release the hand grip so it will slide all the way into the scabbard. In the same motion, bring the right hand back to the right side (officers must then turn the scabbard counterclockwise 180 degrees). Release the scabbard with the left hand.

5-11. FUNERAL CARRY

a. This position is assumed when marching for long distances such as funerals or street parades.

b. After initially stepping off at the carry, change the grip of the right hand so that the knuckle bow (noncommissioned officers) is between the index finger and the thumb, and the rest of the fingers curled (see fig. 5-17). On the Marine officers sword, the sword grip is between the index and middle fingers, and all fingers are curled around the hilt.

c. To return to normal carry, reach across the body with the left hand, forearm parallel to the deck, and grasp the blade with the thumb and index finger, and at the same time adjust the grip with the right hand.

d. Smartly cut the left hand back to the side.

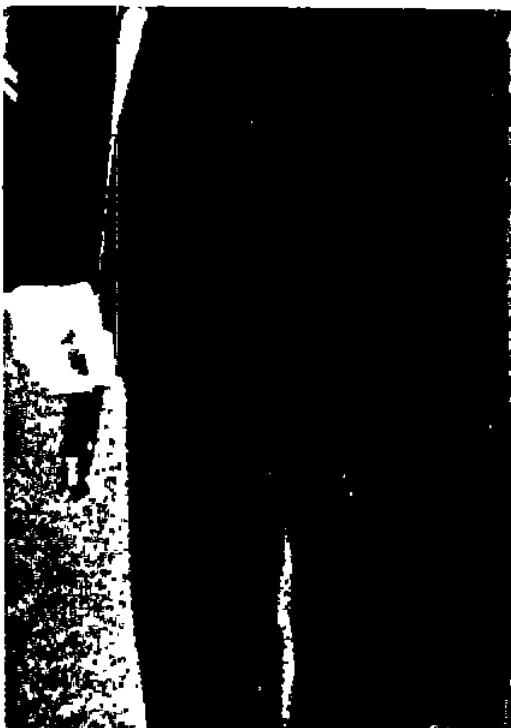

a. Front View.



b. Side View.

Figure 5-17.--Funeral Carry.

[BLANK PAGE]

CHAPTER 6

GUIDON MANUAL

6-1. GENERAL RULES

a. The guidon is a company identification flag. It is carried at ceremonies and at other times prescribed by the commander.

b. In garrison, the guidon may be displayed at company headquarters between morning and evening colors, except during inclement weather and when carried in formation.

c. In selecting a guidon bearer, the company commander should choose a man outstanding for his snap, bearing, appearance, and ability.

d. When acting as guidon bearer, the individual is considered under arms and will not carry a weapon.

e. The guidon is brought to present guidon, parade rest, and order guidon with the company.

f. When at route step or at ease march, the guidon may be carried in either hand. When at order guidon, bring the guidon to carry on the preparatory command for marching in quick time.

g. For marching at double time, on the preparatory command, hold the staff across the body with spearhead to the left. The right hand grasps the same spot as at carry. The right forearm is level with the deck and the elbow against the body. Grip the staff with the left hand in front of the point where the neck and left shoulder join. The flat side of the spearhead should face front.

6-2. POSITIONS OF GUIDON

a. Order Guidon. At order guidon, the ferrule rests on the deck, touching the right shoe to the right of the toe. Hold the staff in the "V" formed by the right thumb and fingers. The thumb and fingers should be straight with fingers touching. Keep the right arm behind the staff and the elbow slightly bent. The upper staff rests in the hollow of the right shoulder. The staff points straight up with the flat side of the spearhead facing front. Except for the right hand, the entire body is at attention (see fig. 6-1).



Figure 6-1.--Order Guidon.

b. Carry Guidon.

(1) This is the normal position of the guidon while marching at quick time. It is the same as order guidon except the ferrule is 6 inches above the deck (see fig. 6-2).



Figure 6-2.--Carry Guidon.

(2) From carry guidon, movements to present guidon, order guidon, and ready guidon may be executed.

c. Carry Guidon From Order Guidon.

(1) This is executed on a preparatory command, such as FORWARD, which requires moving to a new position. Execution is begun on the preparatory command.

(2) On the preparatory command, place the left hand on the staff 2 inches above the right.

(3) Loosen the grip of the right hand. Pull the staff up with the left hand until the ferrule is 6 inches above the deck. Hold the staff straight with the right hand.

(4) Move the left hand smartly back to the side.

d. Order Guidon From Carry Guidon.

(1) The command is ORDER, ARMS. It is executed in one count.

(2) On ARMS, allow the staff to slip through the right hand until the ferrule touches the deck.

e. Present Guidon From Order or Carry Guidon.

(1) From order guidon at the halt, the command is PRESENT, ARMS. From carry guidon on the march, the command is EYES, RIGHT. At officers center, the movement is executed at a halt, from carry, without command.

(2) Because the right hand is 6 inches lower on the staff at carry than at order, the ferrule will extend farther to the rear when at present guidon from order than it will at present guidon from carry.

(3) From order guidon, the command is PRESENT, ARMS. It is executed in one count.

(4) On ARMS, lower the guidon straight to the front, until the staff, resting in the pit of the right arm, is horizontal. As the staff is lowered, turn it to the right so the sharp edge of the spearhead faces down. Hold your right elbow firmly against the body (see fig. 6-3).



Figure 6-3.--Present Guidon.

(5) From carry guidon, the command is EYES, RIGHT (LEFT). It is executed in the same manner as from order guidon except that the head and eyes are turned right (left) 45 degrees as the guidon is lowered (see fig. 6-4).

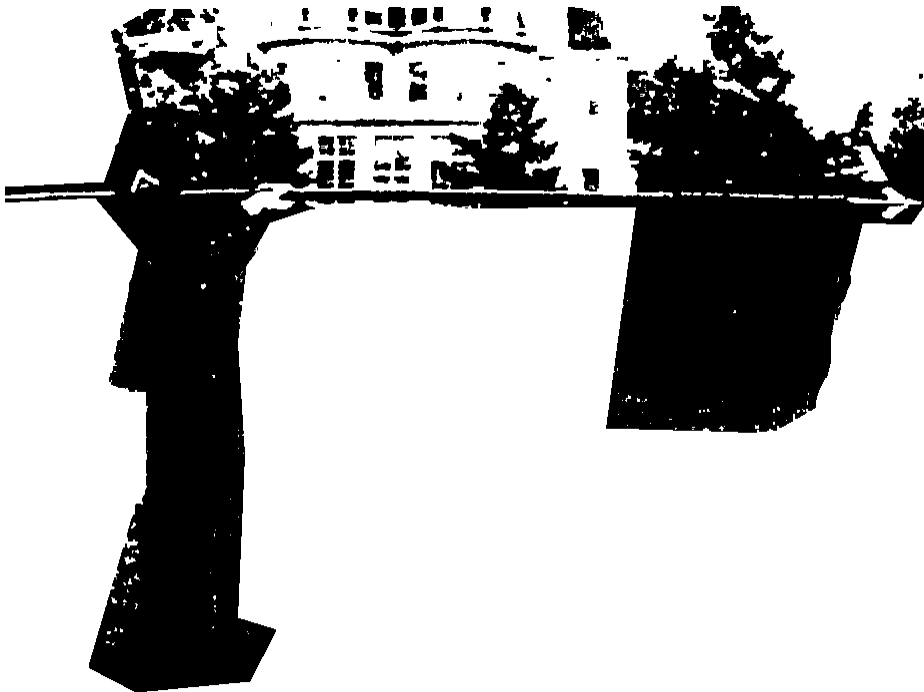

Figure 6-4.--Eyes Right with the Guidon.

f. Order Guidon and Carry Guidon From Present Guidon.

(1) To order guidon, the command is ORDER, ARMS. To carry guidon, the command is READY, FRONT.

(2) To order guidon, on ORDER, grasp the staff smartly and audibly with the left hand, palm up, at a point just forward of the right hand (see fig. 6-5). On ARMS, with the left hand, carry the guidon up and back to the position of carry guidon. At the same time, let the staff slide straight downward through the right hand until the ferrule rests on the deck, the left hand steadying the staff as it slides downward. Cut the left hand smartly back to its normal position at the left side.

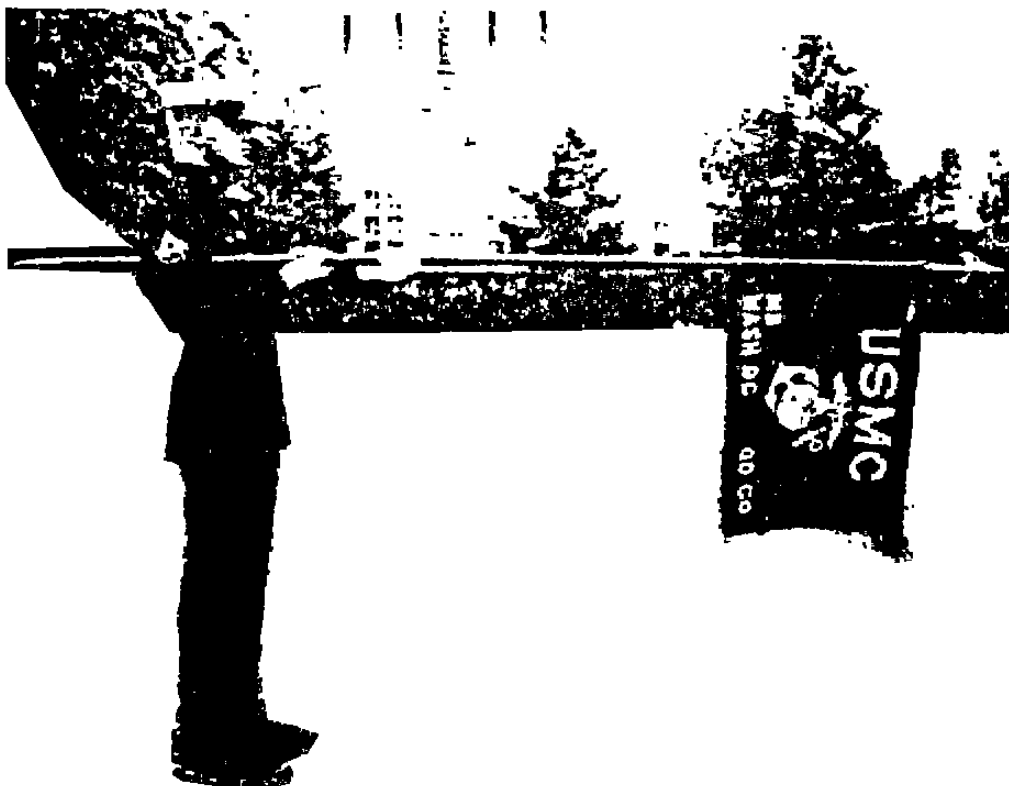

Figure 6-5.--Movements to Carry Guidon from Present Guidon.

(3) To carry guidon, on READY, grasp the staff smartly and audibly with the left hand, palm up, at a point just forward of the right hand. On FRONT, with the left hand, carry the guidon up and back to the position of carry guidon. Cut the left hand smartly away and turn your head and eyes smartly to the front.

g. Present Guidon From Carry Guidon at Officers Center. This movement is executed without command upon halting at officers center during a parade. It is executed in one count as explained in paragraph 6-2e(4). Hesitate for one count after halting. The movements should be completed on the fourth count after the command HALT.

h. Carry Guidon From Present Guidon at Officers Center.

(1) The command is CARRY, SWORD (READY, TWO if the officers are not armed with swords).

(2) This movement is executed in the same manner as described in paragraph 6-2f(3), except that the head and eyes are not turned, since they remain to the front.

i. Ready Guidon From Order or Carry Guidon.

(1) This movement is used as a signal for aiding troops in the execution of commands where hearing verbal commands is difficult. The guidon is brought to ready guidon on the preparatory command (see fig. 6-6). It is smartly lowered to order or carry guidon upon the command of execution.



Figure 6-6.--Ready Guidon.

(2) Ready guidon may be used as a signal for the execution of any command except present arms and eyes right (left), at which times, the guidon also renders honors.

j. Guidon Salute From Carry or Order Guidon.

(1) The command is GUIDON, SALUTE. It is executed in two counts.

(2) On SALUTE, move your left hand, palm down smartly to a position approximately 18 inches above the right hand with the left arm parallel to the deck. Keep the thumb and fingers straight and together. Touch the staff with the first joint of your forefinger. Turn your head and eyes toward the person being saluted (see fig. 6-7).

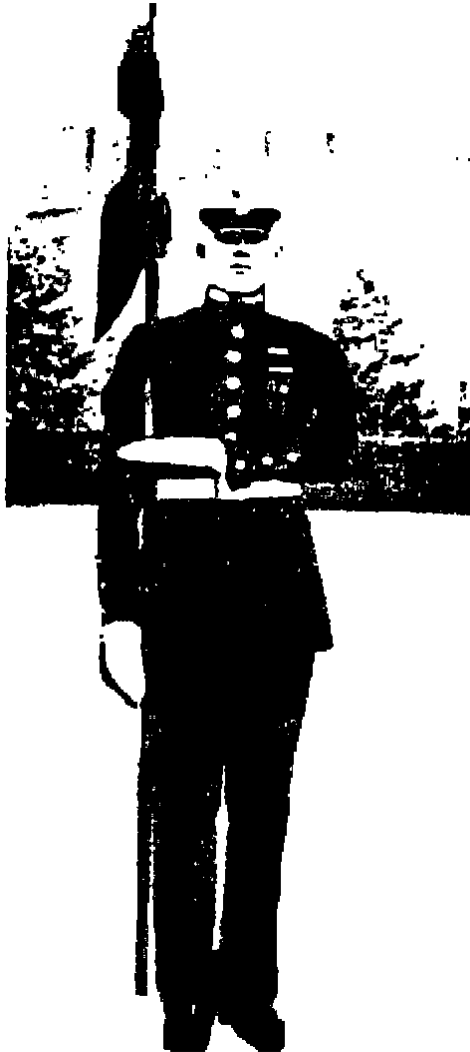

Figure 6-7.--Guidon Salute from Carry or Order Guidon.

(3) After your salute is returned, move your left hand smartly back to your side and look to the front.

k. Rest With the Guidon.

(1) Parade Rest From Order Guidon.

(a) The command is PARADE, REST. It is executed in one count, and may be given only when halted at attention.

(b) On REST, move your left foot smartly 12 inches to the left. Place your left hand behind you, just below the belt. Keep your left hand straight and touching, palm flat and facing rear. At the same time, straighten your right arm and your grasp, as shown in figure 6-8, so the staff of the guidon tilts forward at 30 degrees. The ferrule remains in the same position as at order guidon. The flat side of the spearhead remains facing front (see fig. 6-8).



Figure 6-8.--Parade Rest with the Guidon.

(2) At Ease From Any Position of the Guidon.

(a) The command is AT EASE. It is executed in one count.

(b) On the command, come to order guidon if not already at that position. Move your left foot smartly 12 inches to the left. Rest your weight equally on both feet with your legs straight. Place your left hand behind you, just below the belt. Keep your fingers straight and touching with your palm flat and facing rear. At the same time, straighten your right arm so the staff tilts forward at 30 degrees. The ferrule remains at the order. The flat side of the spearhead continues facing front.

(c) After assuming this position, you may relax and, except for your right foot and ferrule, move about. Do not talk.

(3) Rest From Any Position of the Guidon. The command is REST. It is executed in the same manner as at ease, the only exceptions being that you may talk and hold the staff in either hand.

(4) Fall Out From Order Guidon. The command is FALL OUT. It may be given only from order guidon. Upon the command, leave your position in ranks but remain nearby.

(5) Order Guidon From Rest Positions.

(a) From parade rest, at ease, and rest, the command is (SIZE OF UNIT), ATTENTION. On (UNIT), come to parade rest, if not already in that position. At ATTENTION, come smartly to order guidon.

(b) From fall out, the command is FALL IN. Upon the command, go back to your position in formation and stand at attention at order guidon.

[BLANK PAGE]

CHAPTER 7
SQUAD DRILL

7-1. GENERAL

a. Figure 7-1 shows the symbols used in this manual.

















	REGIMENTAL COMMANDER AND STAFF		PLATOON GUIDE
	BATTALION COMMANDER AND STAFF		SECTION LEADER OR CHIEF OF SECTION
	COMPANY COMMANDER		SQUAD LEADER
	EXECUTIVE OFFICER OR SECOND IN CHARGE		FIRE TEAM LEADER
	FIRST SERGEANT OR SERGEANT MAJOR		FILE CLOSER
	GUNNERY SERGEANT		RIFLEMAN
	PLATOON COMMANDER		COLORS
	PLATOON SERGEANT		GUIDON BEARER

Figure 7-1.--Symbols Used in This Manual.

b. A squad is a group of men formed for the purpose of instruction, discipline, control, and order.

c. Members of the squad take positions, move, and execute the manual of arms as stated in this manual. All men execute the movements at the same time.

d. Squads are kept intact when practicable. The normal formation for a squad is a single rank (squad in line) or single file (squad in column) (see fig 7-2). This permits variation in the number of men composing the squad. The first formation is always in line. Column formation may be taken from line formation. A squad, not a drill, may be marched in column of twos by forming in two ranks.

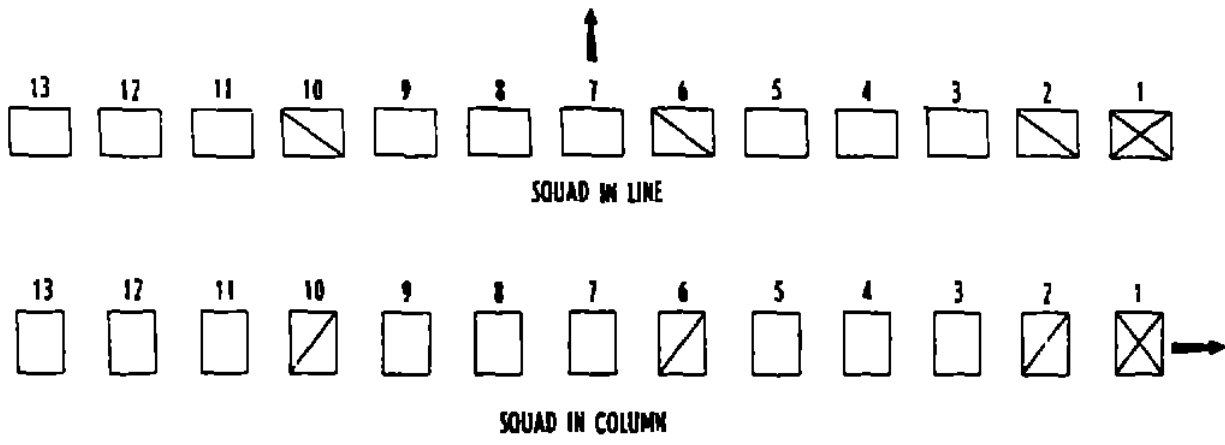

Figure 7-2.--Squad Formations.

e. The squad marches in line for minor changes of position only.

f. When the squad is armed with rifles:

(1) The command RIGHT (LEFT) SHOULDER, ARMS OR PORT (SLING), ARMS is given before commanding the squad to move, except for short distances, when the command TRAIL ARMS may be given.

(2) At the command SQUAD, HALT, remains at the position of right shoulder (left shoulder or port) arms until ORDER ARMS or some other manual is given.

7-2. TO FORM THE SQUAD

a. To form at normal intervals (see fig. 7-3), the command is FALL IN.

b. The squad forms in line on the left of the squad leader. Each member of the squad, except the left flank man, raises his left arm shoulder high in line with his body. Fingers are extended and joined, palm down. Each man except the squad leader turns his head and looks to the right. To obtain a normal interval, each man places himself in line so his right shoulder touches the fingertips of the man on his right. As soon as each man is in line with the man on his right, and the man on his left has obtained normal interval, he turns smartly and quickly to the position of attention.

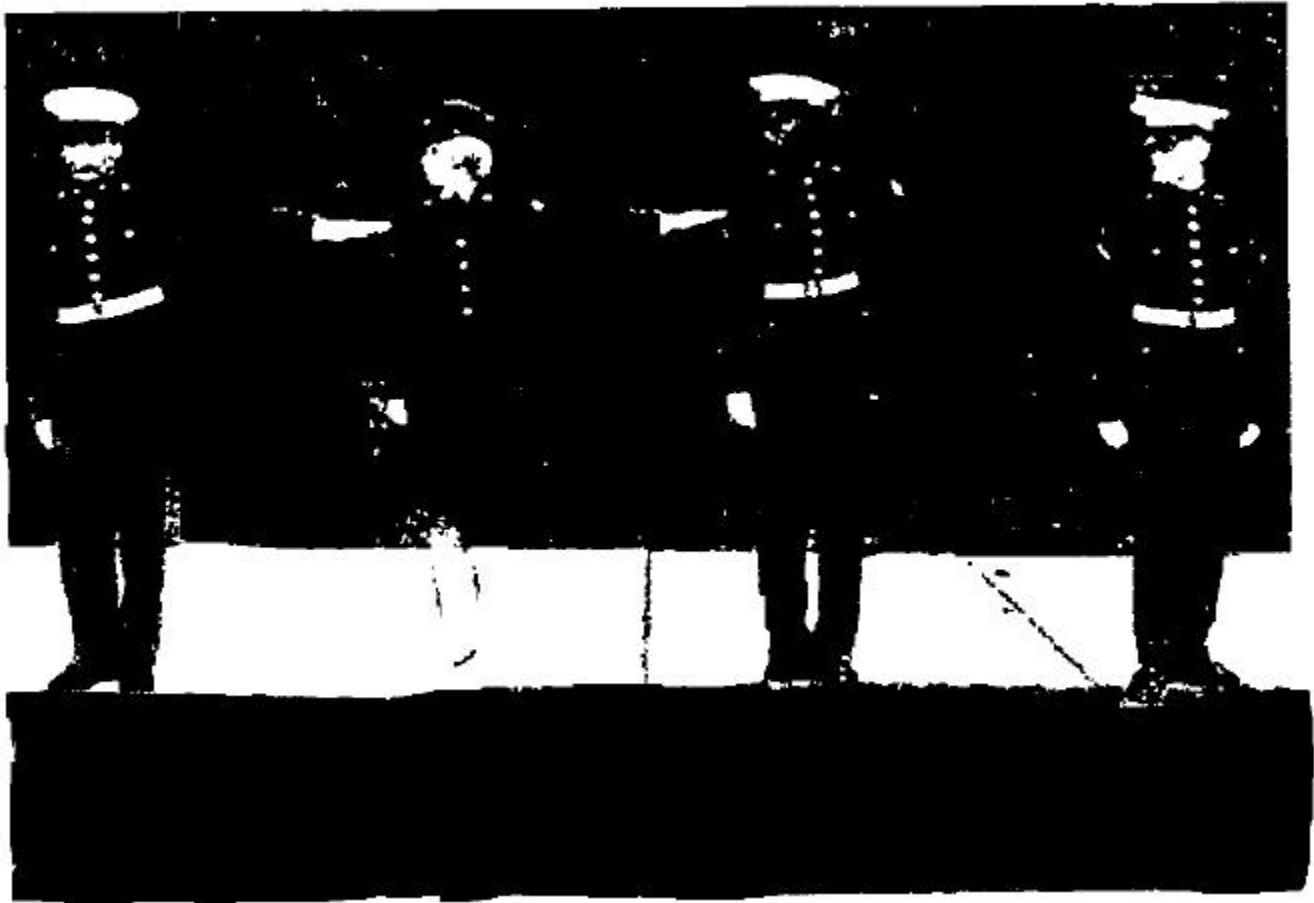

Figure 7-3.--Falling In at Normal Interval.

c. To form at close interval, the command is AT CLOSE INTERVAL, FALL IN (see fig. 7-4).

d. The squad forms in line on the left of the squad leader. Each member of the squad, except the left flank man, places his left hand on his hip, elbow in line with his body. He rests the heel of the palm on the hip with finger extended and joined and pointed down. Each man except the squad leader turns his head and looks to the right. To obtain close interval, he places himself in line so his right arm touches the elbow of the man on his right. As soon as each man is in line with the man on his right, and the man on his left has obtained close interval, he turns smartly and quickly to the position of attention.

e. If the squad is armed, men fall in with weapons at the position of order arms. Pieces are inspected at once.

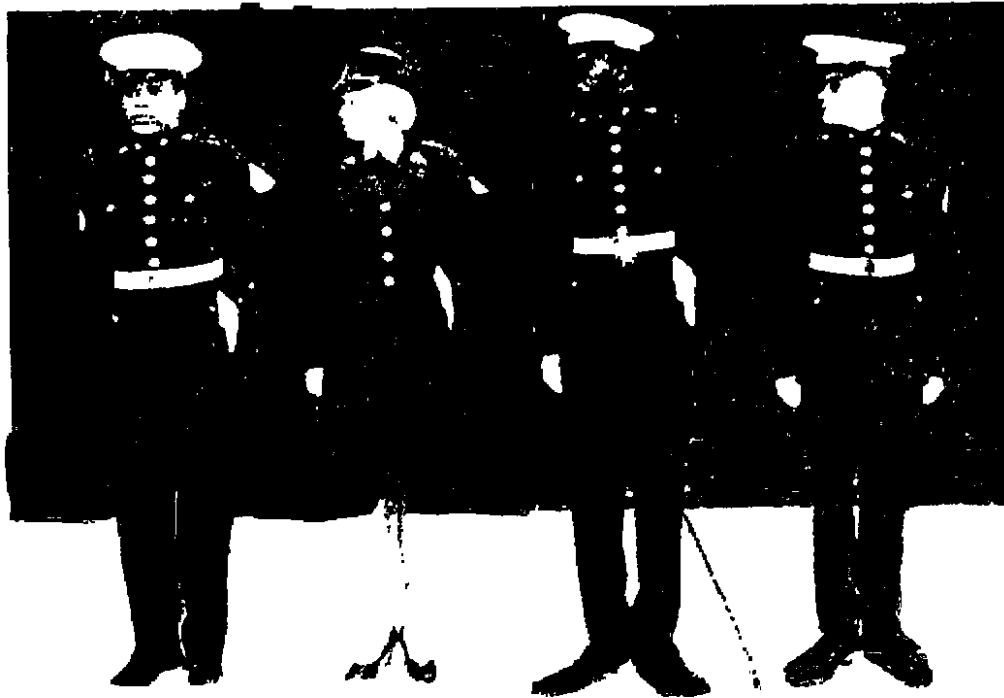

Figure 7-4.--Falling In at Close Interval.

7-3. TO DISMISS THE SQUAD

- a. The squad is dismissed only from a line with men at attention.
- b. Armed troops are dismissed with the commands INSPECTION, ARMS; PORT, ARMS; DISMISSED.
- c. Unarmed troops are dismissed with the command DISMISSED.

7-4. TO COUNT OFF

- a. In line, the command is COUNT OFF. At the command OFF, all men except the man on the right flank smartly turns their heads and look to the right. The right flank man shouts ONE. The man to his left shouts TWO. Each man shouts the next higher number after the man to his right has shouted a number. At the same time he shouts the number, each man smartly turns his head and looks to the front. Numbers are counted in cadence of quick time from man to man.
- b. In column, the command is FROM FRONT TO REAR, COUNT, OFF. Each man, starting with the front man, turns his head to the right and smartly shouts his number as he turns his head back to the front.

7-5. TO ALIGN THE SQUAD

- a. In line, the commands are DRESS RIGHT (LEFT), DRESS; READY, FRONT, or AT CLOSE INTERVAL, DRESS RIGHT (LEFT), DRESS; READY FRONT.
- b. These commands are given only when the squad is at approximately the same interval as the interval at which the dress is commanded.
- c. At the command DRESS, all men, except the right flank man, smartly turn their heads, look, and align themselves to the right. At the same time, all men except the left flank man smartly extend their arms shoulder high (or if at close interval, place their left hands on their hips). All men except

the squad leader position themselves by short steps until their right shoulders touch the fingertips of the men on their right (or right arms touch the elbows of the men on their right). The instructor places himself on line with the squad, 1 pace from the right (left) flank man, and faces down the line. He checks the alignment of the squad, ordering men, by name or number, to move back or forward as necessary. The instructor does not lean his body to be able to see down the line. He moves with short side steps as necessary to check alignment, constantly maintaining military bearing.

d. When the alignment is correct, the instructor faces to the right (left) in marching and moves 3 paces forward, halts, faces to the left (right), and commands READY, FRONT. At the command FRONT, men smartly and quickly lower their arms to their sides, turn their heads, and look to the front.

e. The left arm is used to obtain interval for both dress right and dress left.

f. In column, the command is COVER. At this command, men move as necessary to place themselves directly behind the men in front of them, still maintaining 40-inch distance.

7-6. TO OBTAIN CLOSE INTERVAL FROM NORMAL INTERVAL IN LINE

The command is CLOSE, MARCH. At the command MARCH, all men, except the right flank man, face to the right in marching, march forward until approximately a 4-inch interval has been obtained, halt, and face to the left. They then form at close interval by placing the left hand on the hip and dressing to the right. When the man on the left has obtained the proper interval, smartly lower the left hand to the side, and turn the head to the front.

7-7. TO OBTAIN NORMAL INTERVAL FROM CLOSE INTERVAL IN LINE

The command is EXTEND, MARCH. At the command MARCH, all men, except the right flank man, face to the left, march forward until approximate normal interval has been obtained, halt, and face to the right. They form at normal interval by extending the left arm at shoulder height and dressing to the right. When the man on the left has obtained proper interval, smartly lower the left arm to the side and turn head to the front.

7-8. TO OBTAIN DOUBLE-ARM INTERVAL IN LINE

a. From either close or normal interval, the command is TAKE INTERVAL TO THE LEFT (RIGHT) MARCH. At the command MARCH, men move as when extending, except that the double-arm interval is obtained by each man raising both arms (the right flank man raises only his left arm and the left flank man raises only his right arm) and touching the fingertips of the man on his right. Each man smartly lowers his right arm when he has proper interval, his left arm when the man on his left lowers his right arm. Each man smartly turns his head and looks to the front as he lowers his right arm. Armed troops are given this command only when at sling arms.

b. To obtain normal interval from double-arm interval, the command is ASSEMBLE TO THE RIGHT (LEFT), MARCH. Excute this movement similarly to closing, except form at normal interval.

7-9. TO FORM COLUMN FROM IN LINE AND REFORM LINE

a. Being in line at a halt, at the order, and at normal interval, to form column, the command is RIGHT, FACE. All members of the squad simultaneously face to the right, thereby forming column. The squad leader may then command RIGHT (LEFT) SHOULDER, or PORT, or SLING ARMS; FORWARD, (COLUMN RIGHT/LEFT), MARCH to cause the squad to march in column. (NOTE: As the squad becomes inverted if faced to the left, this should be done only for short movements.

Being in line to form column facing to the left, the squad should first form column by facing to the right, then execute necessary successive column movements until the column is faced in the desired direction.)

b. Being in line at close interval to form column, the squad is first extended to normal interval (see paragraph 7-7), then forms column by facing to the right as directed above.

c. Being in column at a halt and at the order, to form line, the command is LEFT, FACE.

7-10. TO MARCH TO THE OBLIQUE

a. When marching in any formation, the command is RIGHT (LEFT) OBLIQUE, MARCH. (The word OBLIQUE is pronounced to rhyme with strike.)

b. To teach men to march to the oblique, the instructor aligns the unit and has each man do half right (left) face. The instructor points out each man's position and explains that each man is to keep this position while marching. The position is kept by each man holding his shoulder parallel to the man in front.

c. At the command MARCH, given as the foot in the direction of the turn hits the deck, each man takes one more step forward, faces half right (left) in marching, and steps off at a 45-degree angle from his original direction of march (see fig. 7-5).

d. The command FORWARD, MARCH is given to resume original direction of march. It is given as the foot toward the original front hits the deck. At the command MARCH, each man faces half left (right) in marching and steps to the front.

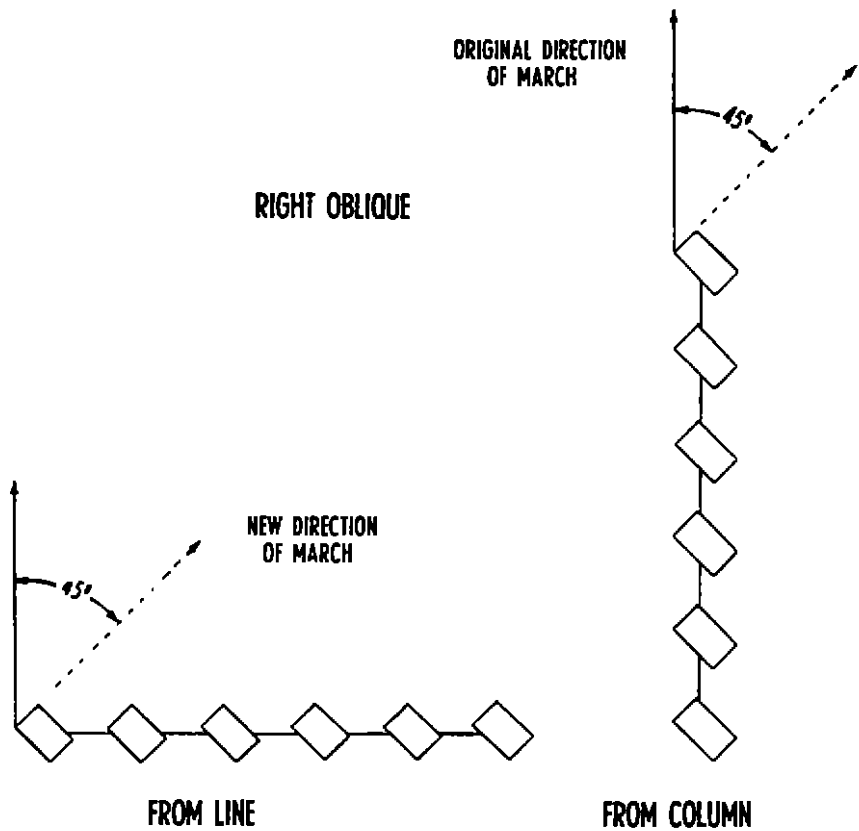

Figure 7-5.--Marching to Right Oblique.

e. The command HALT is given on the left foot when halting from right oblique and on the right foot when halting from left oblique. At the command HALT, each man takes one more step in the oblique direction, turns to the front on the toe of his right (left) foot, and places his left (right) foot besides his right (left) foot.

f. The command in PLACE, HALT is given as either foot hits the deck to halt the unit in the oblique temporarily for correcting errors. At the command HALT, each man halts in two counts as in quick time but remains facing in the oblique direction. The only command that can be given after halting in place is RESUME, MARCH. At that command, the movement continues in the oblique direction.

g. At half step or mark time while obliquing, resume the full step to the oblique on the command RESUME, MARCH.

7-11. TO MARCH TO THE FLANK

a. To move a column a short distance to the right or left while in march, the command is BY THE RIGHT (LEFT) FLANK, MARCH. The preparatory command and command of execution are given so they end when the foot in the direction of the turn hits the deck.

b. At the command MARCH, each man takes one more step, then faces to the right (left) in marching, and steps out with his right (left) foot in the new direction.

c. This command will not be given at a halt.

7-12. TO CHANGE THE DIRECTION OF A COLUMN

a. The command is COLUMN RIGHT (COLUMN LEFT, COLUMN HALF RIGHT, COLUMN HALF LEFT), MARCH.

b. When marching, the preparatory command and command of execution are given so they end as the foot in the direction of the turn hits the deck. At the command MARCH, the front man faces to the right (left) in marching and steps out with his right (left) foot in the direction of the turn. Other men in the column continue the march to the point where the front man pivoted. At that point they face successively to the right (left) in marching and continue in the direction of the turn.

c. When halted, at the command MARCH, the front man faces to the right (left) in marching by turning to the right (left) on his right toe and steps out with his left foot in the new direction. At the same time, all other men march forward and successively face to the right (left) in marching on the same pivot point used by the front man.

d. For slight changes of direction, the command is INCLINE TO THE RIGHT (LEFT). At that command, the front man changes direction as commanded. All other men do likewise when they come to the point on which the front man pivoted. This is not a precise movement. It is executed only when marching.

7-13. TO FORM COLUMN OF TWOS FROM SINGLE FILE

a. When the squad is halted in column, the command is COLUMN OF TWOS TO THE LEFT (RIGHT), MARCH.

b. On MARCH, the front man stands fast. Even-numbered men (counting from front to rear) face half left (right) in marching, take two steps, face half right (left) in marching, and move forward until beside and at normal interval from odd-numbered men who were in front of them. Each odd-numbered man, except the front man, marches forward and halts as he reaches normal distance from the odd-numbered man in front of him. All men required to move do so at the same time (see fig. 7-6).

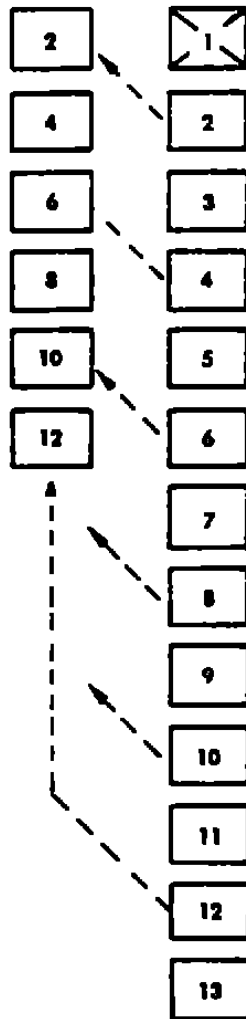

Figure 7-6.--Forming Column of Twos from Single File.

7-14. TO FORM SINGLE FILE FROM COLUMN OF TWOS

a. When the squad is halted in column of twos, the command is COLUMN OF FILES FROM THE RIGHT (LEFT), MARCH.

b. At the command MARCH, number one and two men (counting from front to rear) step off at the same time. The number one man moves forward and the number two man faces to the half right, moves two steps, faces to the half left in marching, and follows the number one man at normal distance. Remaining odd- and even- numbered men step off in pairs, execute the same movements as numbers one and two, and follow in file at normal distance (see fig. 7-7).

c. This movement is done only from a halt.

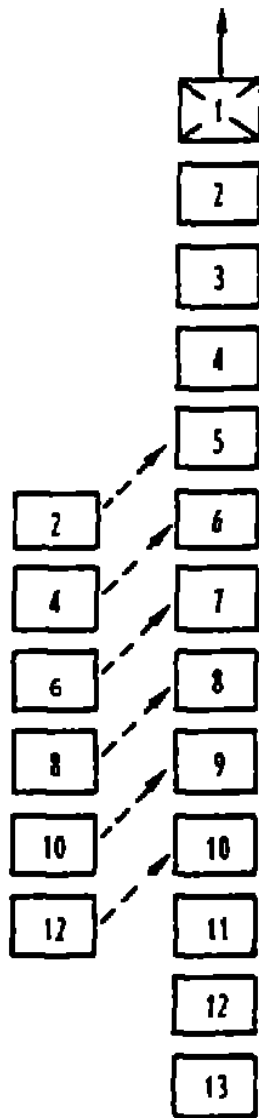

Figure 7-7.--Forming Single File from Column of Twos.

7-15. TO STACK ARMS

a. Before stacking arms, the squad must be given count off. Squad members numbering 3, 7, and 11 are designated stackmen. Additional stackmen may be designated, if necessary.

b. The squad leader will then command, PREPARE, SLINGS. On the command of execution, SLINGS, the designated stackmen place the butt of the weapon on their right hip and cradle the rifle in the crook of the right arm. They then tighten the sling (dust cover side) and adjust the sling to form a 4-inch loop next to the upper sling swivel. As soon as they have prepared the loop, they return to order arms.

c. When all stackmen have returned to order arms, the squad leader commands STACK, ARMS.

(1) On the command of execution, ARMS, the designated stackmen place their weapons directly in front of and centered on the body with the sights to the rear. The heel of the rifle butt is placed on the ground on line with the toes of their shoes. Each stackman grasps the rifle at the upper portion of the handguard with the left hand, keeping the rifle vertical at all times. The first two fingers of the left hand hold the inner part of the loop against the rifle. The stackman reaches across the front of the rifle with the right hand, grasps the outer part of the loop and holds it open for insertion of the other rifles (see fig. 7-8).

(2) On the command of execution, ARMS, the men to the left and right of the stackman perform the following movements simultaneously.

(a) The man on the stackman's right raises and centers his weapon, wrist shoulder high, with the magazine well facing to the front. He then grasps the handguard (midway) with his left hand, releases his right hand and regrasps the weapon at the small of the stock. He then lowers both arms, holding the weapon in a horizontal position with the muzzle to the left (see fig. 7-8).

(b) The man on the stackman's left raises and centers his rifle, wrist shoulder high, with the magazine well facing to the front. He then grasps the weapon at the small of the stock with the left hand, releases the right hand and regrasps the handguard (midway). He then lowers both arms, holding the weapon in a horizontal position with the muzzle to the right (see fig.7-8).

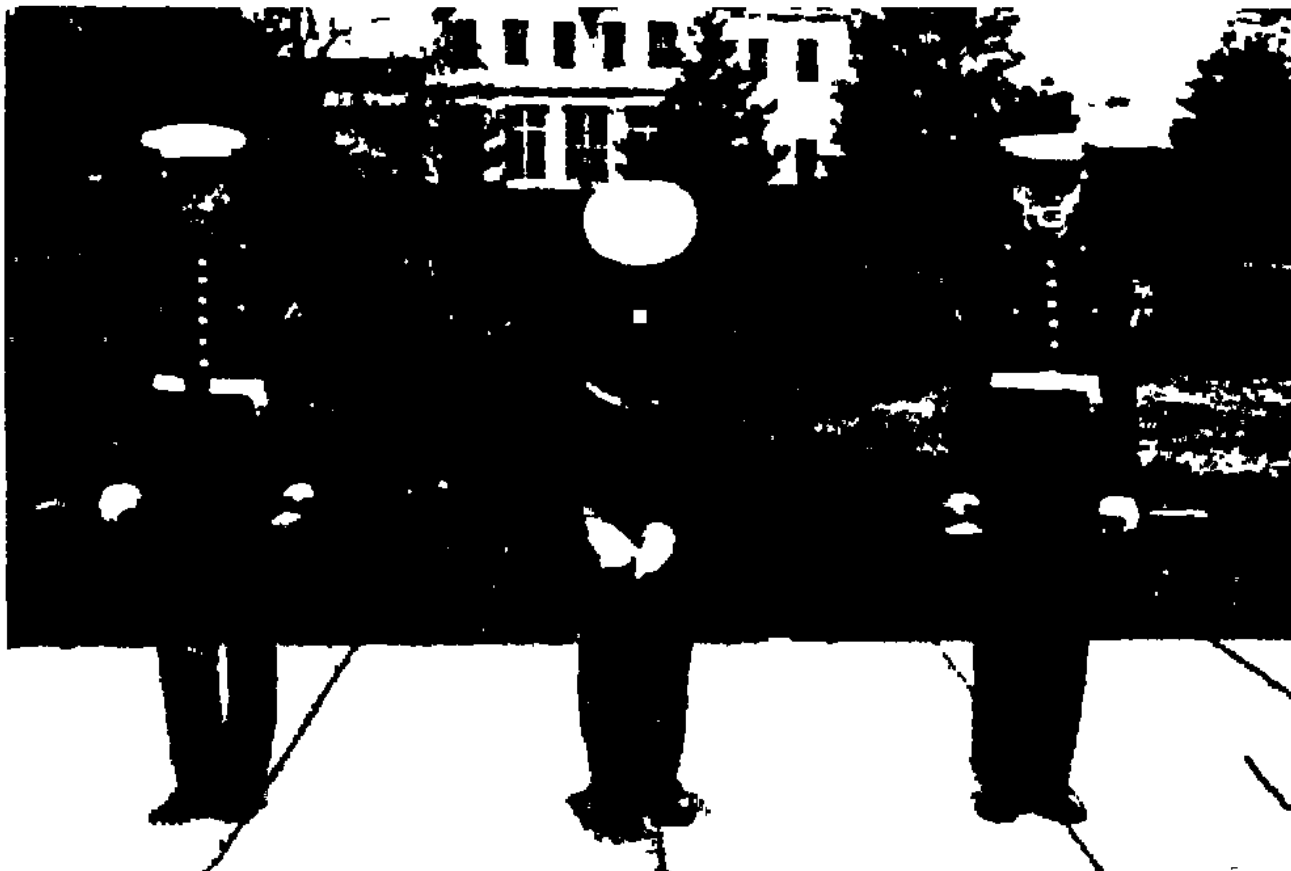

Figure 7-8. Position of Stackman and Men to His Right and Left At End of First Step in Stack Arms.

(3) As soon as the stackman has placed his rifle in position, both men move the foot nearest the stackman 18 inches to the oblique and toward the stackman. The man on the stackman's left inserts the muzzle of his rifle into the loop to a point approximately halfway between the flash suppressor and the front sight. He holds his weapon in this position until the man on the stackman's right inserts the muzzle of the rifle in a similar manner and above the other rifle (see fig. 7-9).

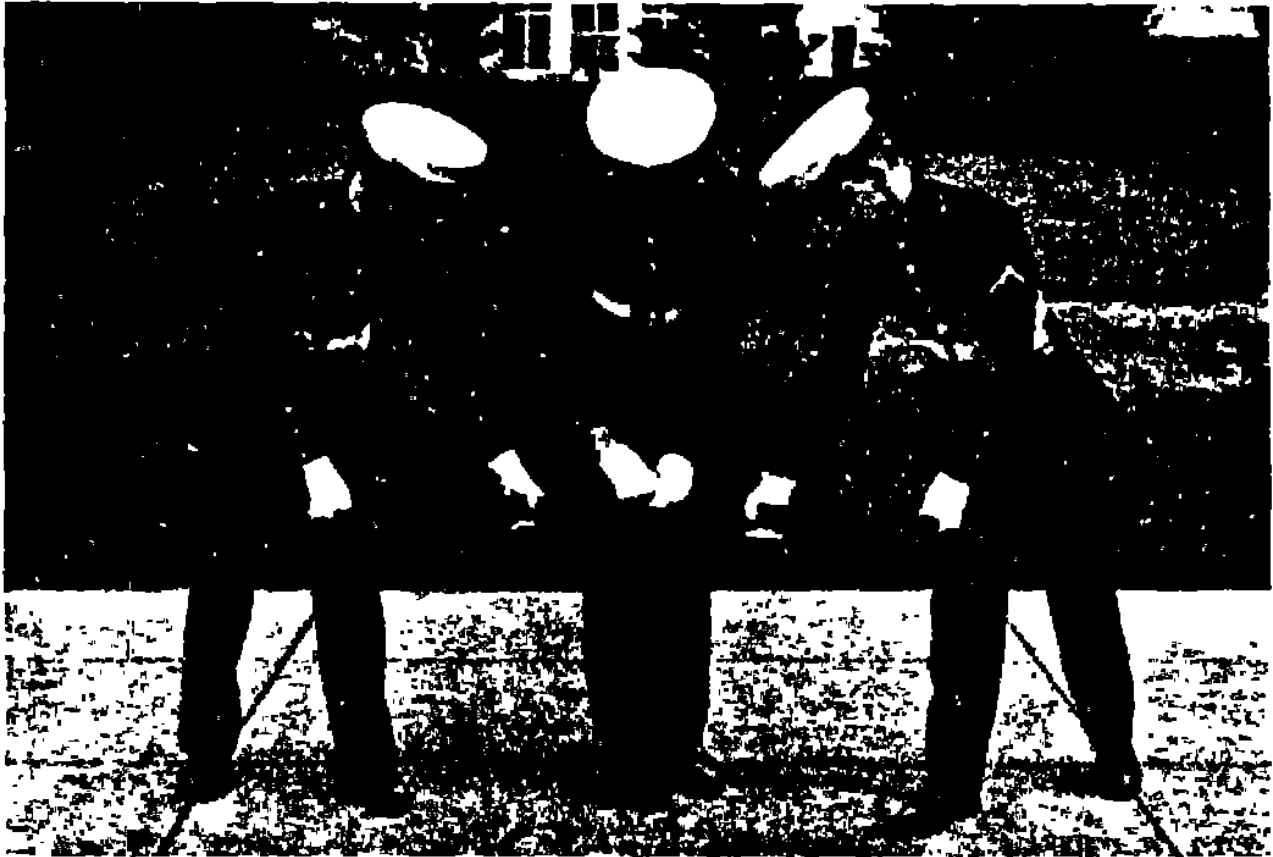

Figure 7-9.--Insert Rifles Into Stackman's Sling Loop.

(4) The butts of both rifles are swung outward and down to the ground until the stack is tight with the rifle butts on line and approximately 2 feet from the baseline. When the stack has been completed, all three men resume the position of attention (see fig. 7-10).

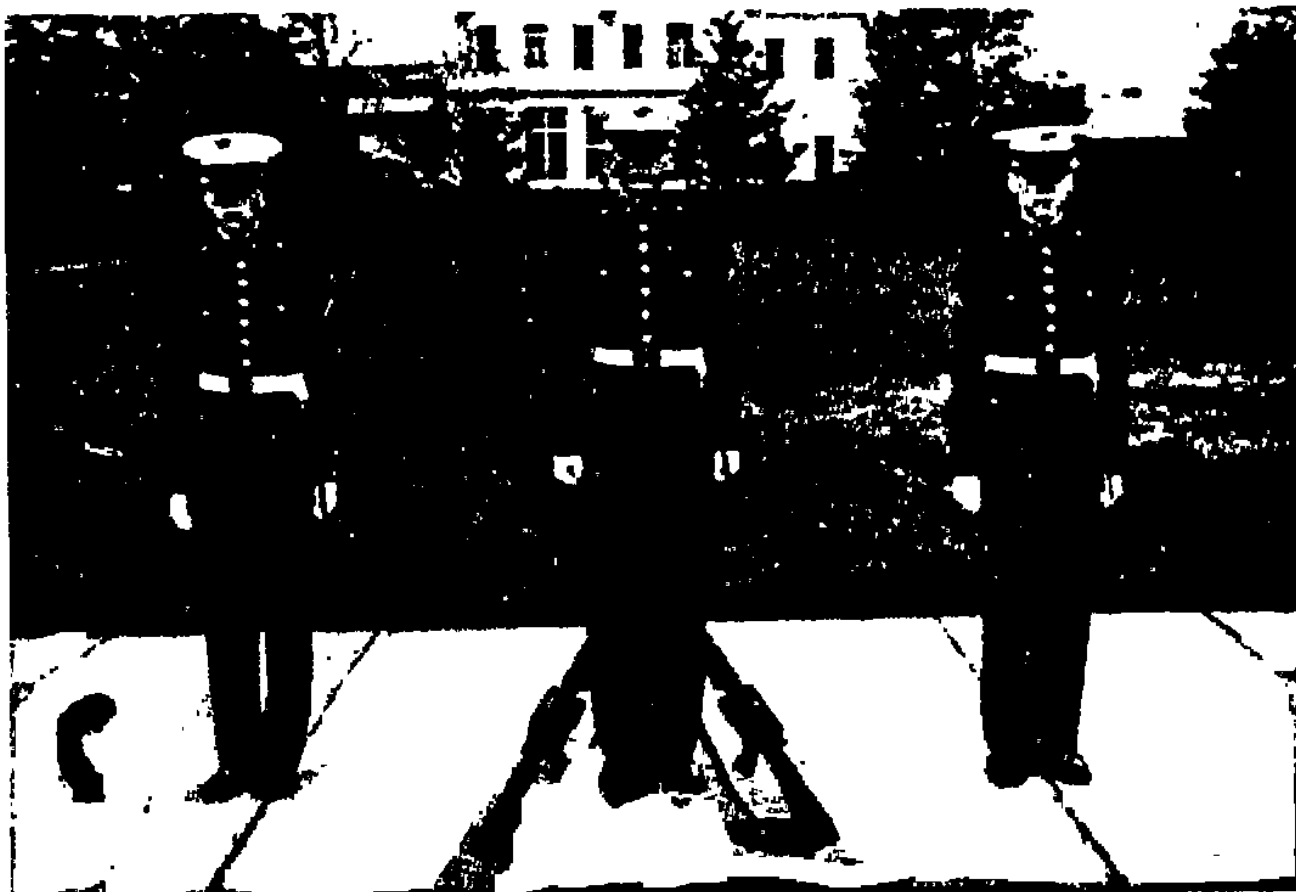

Figure 7-10.--Final Position of Stack Arms.

(5) Extra rifles are passed to the nearest stack on the right (right or left if stacked in column). The extra men grasp the barrel of the rifle, raise it vertically and extend their arm horizontally to the right front. The next man grasps the weapon at the handguard, moves it center of the body, grasps the barrel with the right hand, and extends the right arm horizontally to the right front. This action continues until the rifle reaches the stackman. The stackman places the rifle on the stack in a manner to prevent damage to the front sight assembly.

7-16. TO TAKE ARMS

a. The command is TAKE, ARMS.

b. On the command of execution, the men return extra rifles in the same manner as they were received. The stackman secures the stack and holds the loop in the same manner as for stacking rifles. The men on the left and right step to the oblique, reach down and regrasp their weapons, bringing them to a horizontal position. The man on the right frees his rifle first and resumes order arms or unsling arms. The man on the left frees his weapon and resumes order arms or unsling arms. The stackman cradles his weapon and adjusts the sling and sling keeper to its original position and then resumes the order or unsling arms position.

CHAPTER 8

PLATOON DRILL

8-1. GENERAL

a. The first phase of drill has been explained in earlier chapters of this manual. This chapter discusses the next phase, platoon drill. In platoon drill, the squad is merged with other squads into a platoon.

b. A platoon consists of a platoon headquarters and two or more squads or sections. Platoon headquarters consists of a platoon commander and one or more assistants.

c. A section normally forms and drills as part of a platoon. In this manual, the instructions given for the squad or platoon also apply to a section. A section, not subdivided into squads, forms and drills as a squad. A section that is divided into two or more squads, forms and drills as a platoon.

d. Squads in a platoon are numbered from front to rear in line and from left to right in column.

e. The platoon forms in two or more ranks with 40-inch distance between ranks. Movements in this section are described for columns of threes or fours and may be executed by either formation.

f. The platoon changes interval while in line and counts off in the same manner as the squad. Squad leaders are the base for these movements. Each Marine in rear of the first rank covers the corresponding Marine in the front rank in executing these movements. The guide moves to the right when interval is taken to the left, and he/she does not count off.

g. In platoon drill, if all members of the platoon are to execute a movement simultaneously, the movement is executed on the command of the platoon commander. In this case, squad leaders do not repeat or give any commands. When squads of the platoon are to execute a movement in successive order, such as forming column of twos (files) and reforming into column (of threes, etc.), squad leaders give appropriate supplemental commands for the movement of their squads.

h. Unless specified for the platoon to be at close interval, all changes in formation should be executed with normal interval and distance between files and ranks.

8-2. FORMATIONS

a. Column and line are the two formations for a platoon (see figs. 8-1 and 8-2).

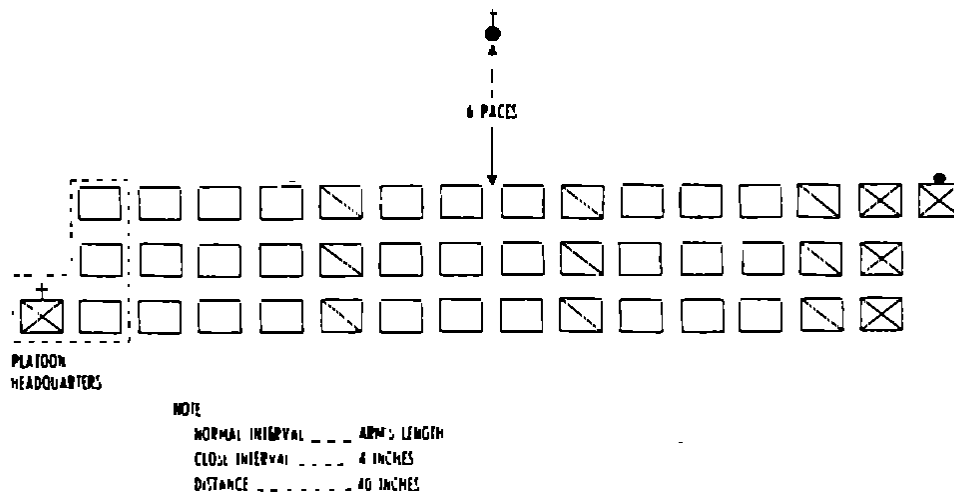

Figure 8-1.-- Platoon in Line at Normal Interval.

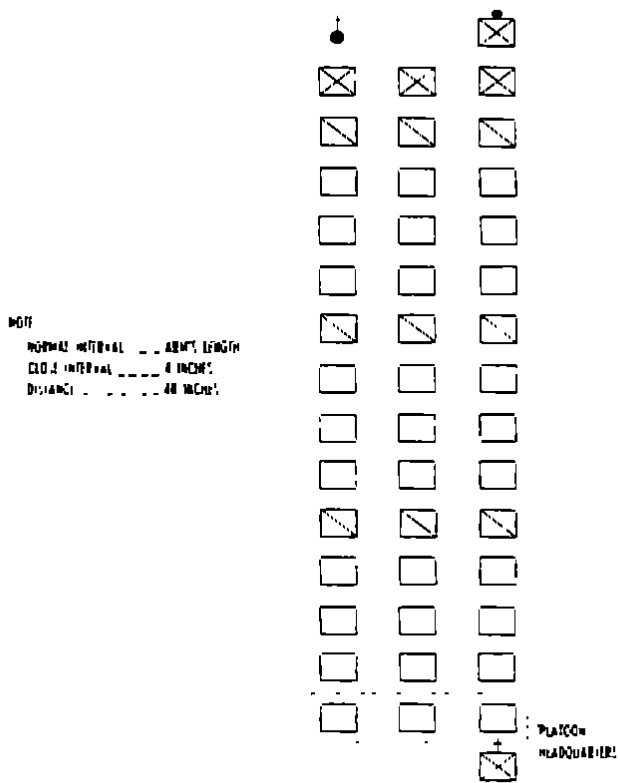

Figure 8-2.-- Platoon in Column at Normal Interval.

b. The platoon normally forms in line with the squad leaders on the right of their squads and the guide on the right of the first squad leader (see fig. 8-1). The platoon marches in line for short distances only.

8-3. POSTS OF INDIVIDUALS

a. In line, the platoon commander takes post 6 paces in front of the center of the front rank of the platoon (see fig. 8-1). In column, the platoon commander marches at the head of the left file of the platoon (see fig. 8-2).

b. When the platoon commander is present, the platoon sergeant takes post to the left file of the rear rank when the platoon is in line, and following the last member of the right file (squad) when in column. When the platoon commander is not present, after the platoon is formed, the platoon sergeant takes post and drills the platoon as prescribed for the platoon commander.

c. The platoon guide takes post as stated in paragraph 8-4.

d. Extra Marines may fall in on the left when the platoon is in line and in rear when in column.

8-4. RULES FOR THE GUIDE

a. Unless otherwise announced, guide is right, and the guide takes post on the right. In line, he/she is posted to the right of the squad leader of the first squad. In column, he/she is posted in front of the squad leader of the third squad.

b. In column, when it is desired to guide left, the command GUIDE LEFT is given. At this command, the guide and the platoon commander exchange positions. The guide crosses between the platoon commander and the platoon. To return the guide to normal position, GUIDE RIGHT is commanded. The guide and platoon commander return to their normal positions with the guide again passing between the platoon commander and the platoon. This movement may be made at a halt or in march. The base squad or base file is the one behind the guide.

c. The guide does not change his/her position at the command DRESS LEFT (RIGHT), DRESS.

d. When a platoon in line is given the command RIGHT, FACE, the platoon guide executes right face with the platoon. Then he/she immediately faces to the right in marching and marches to a position in front of the right squad leader, halts, and executes left face. If a platoon is given LEFT, FACE, the guide executes left face with the platoon but does not change his/her position within the platoon.

e. When a platoon in column is given the command COLUMN OF FILES FROM THE LEFT, MARCH, the guide, on the preparatory command, takes his/her position in front of the left squad leader so he/she is at the head of the column.

f. When a platoon in column is given the command COLUMN OF TWOS FROM THE LEFT, MARCH, the guide, on the preparatory command, takes his/her position in front of the second file from the left so he/she is at the head of the right file of the column. He/she does this by facing to the left as in marching and marches to a position in front of designated right squad leader, halts, and executes right face.

g. When reforming in a column of threes or fours from a file or column of twos, the guide posts himself/herself in his/her normal position when the movement is completed.

h. The guide sets the direction and cadence of the march. The leading Marine in each file is responsible for interval.

i. When a platoon is marching in column and the command to march by a flank or to the rear (BY THE RIGHT (LEFT) FLANK, MARCH or TO THE REAR, MARCH) is given, the guide executes the movement with the platoon but does not change his/her position with the platoon (see paragraph 9-10 for an exception).

j. The guide does not count off.

8-5. TO FORM THE PLATOON

a. The platoon forms in line at normal interval and distance between files and ranks (see fig. 8-1) on the command FALL IN. To form at close interval, the command is AT CLOSE INTERVAL, FALL IN, in which case the platoon forms in line with normal distance between ranks, but with close interval (4 inches) between files. The platoon is formed by the platoon sergeant or platoon commander as described below.

b. Forming the Platoon by the Platoon Sergeant.

(1) The platoon sergeant takes post 3 paces in front of the point where the center of the platoon will be, faces that point, draws sword if so armed, and commands FALL IN (AT CLOSE INTERVAL, FALL IN). At this command, the guide takes post so that the first rank, when aligned on him/her will be centered on and 3 paces from the platoon sergeant. The squad leader of the first squad falls in at normal (close) interval to the left of the guide. Other squad leaders fall in directly behind the squad leader of the first squad with 40 inches distance between them. The members of the squads fall in on their squad leaders at normal (close) interval as prescribed in squad drill, except that exact interval is taken only by the first squad (i.e., front rank). Marines in the rear squads (i.e., rear ranks) take approximate interval only so as to cover the corresponding member of the front rank. All personnel fall in at attention and, if armed with the rifle, at the position of order arms.

(2) When a report is appropriate, after all personnel are formed, the platoon sergeant commands REPORT. Remaining in position (at order arms if armed with the rifle), the squad leaders, in succession from front to rear, salute and report, "All present", or "Private _____ absent." The platoon sergeant then commands INSPECTION, ARMS; PORT, ARMS; ORDER, ARMS, if troops are armed with the rifle.

(3) If the platoon commander does not receive the platoon, the platoon sergeant takes three paces forward and assumes the post and duties of the platoon commander.

(4) When the platoon commander is present, the platoon sergeant faces the front after receiving the reports of the squad leaders and/or causing the platoon to execute inspection arms. When the platoon commander has taken post 6 paces front and center of the platoon (remaining with sword in scabbard if so armed), the platoon sergeant salutes and reports, "Sir, all present and accounted for," or, "Sir, _____ Marines absent." The platoon commander returns the salute and may discuss absentees and issue necessary instructions to the platoon sergeant. Next the platoon commander directs the platoon sergeant to TAKE YOUR POST, at which the platoon sergeant marches by the most direct route to his/her post on the left of the rear rank. The platoon commander then draws sword, if so armed.

c. Forming the Platoon by the Platoon Commander.

(1) When appropriate, the platoon may be formed by the platoon commander rather than the platoon sergeant. The procedures are the same except that the platoon commander takes post 6 paces in front of the point where the center of the platoon will be, faces that point, draws sword and commands FALL IN (AT CLOSE INTERVAL, FALL IN). The platoon then forms on the platoon commander, the platoon sergeant falling in on the left of the rear rank with sword drawn, if

so armed. The platoon commander then receives the report of the squad leaders and causes the platoon to execute inspection arms if troops are armed with the rifle.

8-6. TO DISMISS THE PLATOON

- a. The platoon is dismissed only from a line with Marines at attention.
- b. Armed troops are dismissed with the commands INSPECTION, ARMS; PORT, ARMS; DISMISSED.
- c. Unarmed troops are dismissed with the commands DISMISSED.
- d. The platoon sergeant usually dismisses the platoon.

8-7. TO ALIGN THE PLATOON

a. In line, the platoon is aligned as prescribed for the squad (see paragraph 7-5). The guide raises his left arm to obtain proper interval and looks to the front (to the left) and the squad leader of the first squad turns his/her head to the right (left) during alignment. Other squad leaders cover the first squad leader and look to the front during the alignment.

b. The platoon commander, on his/her own command of execution DRESS, faces half left, as in marching, and proceeds in the most direct route until positioned on line with the front rank and one pace from the extreme right flank Marine. When in position, the commander executes a halt, facing to the rear, and then executes a right face facing down the line. He/she aligns the front rank by commanding those Marines in advance or rear of the line to move forward or backward until in line. These Marines are designated by name or number. Those commanded to move will move the designated number of steps or will continue to move until receiving the command, STEADY. The platoon commander executes a series of short side steps to the right or left to identify a Marine. The commander must be in line with the rank when commanding a Marine to move. When he/she has verified the alignment of the first rank, he/she faces to the left (right) in marching, and marches straight to the front. He/she halts on line with each succeeding rank, executes right (left) face, and aligns on line with each succeeding rank, executes right (left) face, and aligns each squad. When the guide is in ranks for right dress, the platoon commander will be 2 paces from the squad leaders of succeeding ranks. After verifying the alignment of the rear rank, he/she faces to the right (left) in marching, marches straight to a point 3 paces beyond the front rank, halts, faces to the left (right), and commands READY, FRONT; COVER. Immediately after commanding COVER, the platoon commander marches by the most direct route and takes post 6 paces front and center of the platoon.

c. When aligning a platoon of well-drilled troops or when there is insufficient time to verify alignment, the platoon commander may command READY, FRONT; COVER from his/her normal post without verifying alignment.

d. When marching in column, the platoon is aligned by the command COVER. At that command, the base squad leader obtains 40- inch distance from the guide. Other squad leaders obtain proper interval from the base squad leader and align on him/her. Other Marines in the base squad execute the movement as in squad drill. At the same time, the remaining Marines of the platoon align on the base squad and cover their squad leaders.

8-8. TO FORM COLUMN FROM LINE

Being in line at a halt and at the order, to form column the command is RIGHT, FACE. All members of the platoon face to the right and form column, the platoon commander taking post in front of the left file and the guide in front of the right file (see fig. 8-1).

The platoon commander may then command RIGHT SHOULDER (LEFT SHOULDER, PORT, OR SLING) ARMS; FORWARD (COLUMN RIGHT/LEFT), MARCH to cause the platoon to march in column. (NOTE: As the platoon becomes inverted if faced to the left, this should only be done for short movements. Being in line to form column facing to the left, the platoon should first form column by facing to the right, then execute necessary successive column movements until the column is faced in the desired direction.)

8-9. TO MARCH (FORM) AT CLOSE INTERVAL IN COLUMN

a. When in column at normal interval, at a halt, or in march at quick time, to obtain close interval between files, the command is CLOSE, MARCH.

b. At a halt, on the command MARCH, members of the base squad stand still. Other Marines obtain close interval by doing right (left) step.

c. When marching, the command MARCH is given on the right foot when the base squad is on the right and on the left foot when the base squad is on the left. When the base squad is center, the command MARCH may be given on either foot. At the command MARCH, the base squad takes up the half step. Other squad(s) oblique toward the base squad until the interval between Marines is 4 inches. When squad members are abreast of the corresponding member of the base squad, they oblique to the front and take up the half step (see fig. 8-3). At the command FORWARD, MARCH, all squads resume the 30-inch step.

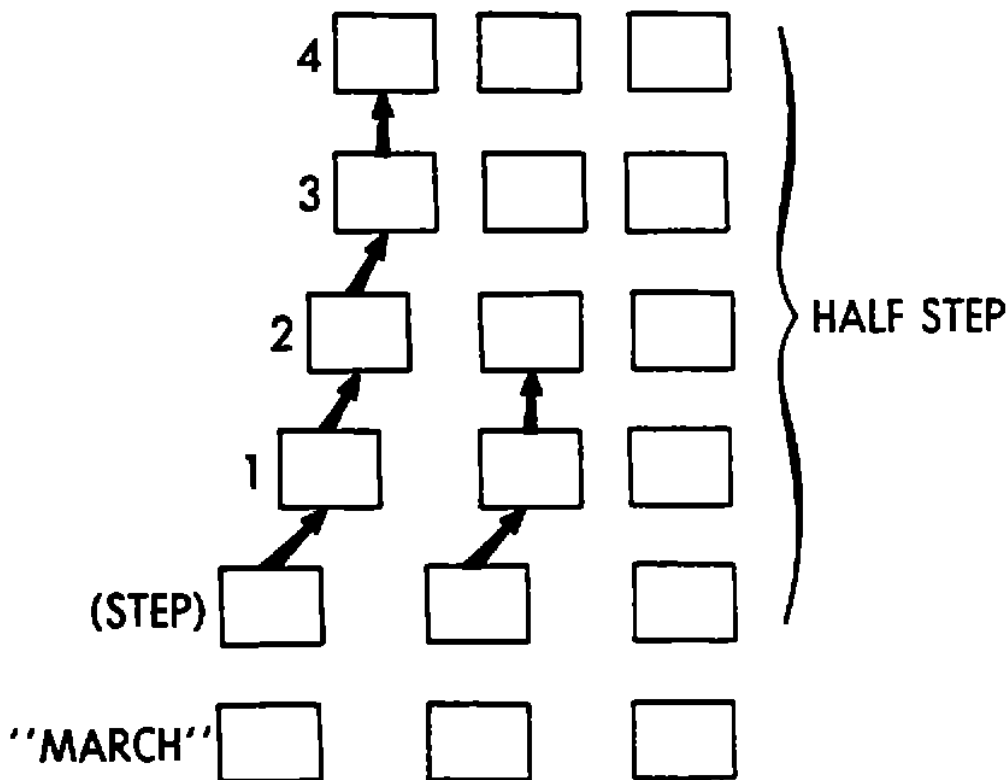

Figure 8-3. -- Close March (While Marching), right Squad Base.

8-10. TO MARCH (FORM) AT NORMAL INTERVAL IN COLUMN

a. When in column at close interval, at a halt, or in march at quick time, to obtain normal interval between files, the command is EXTEND, MARCH.

b. At a halt, on the command MARCH, members of the base squad stand still. Other Marines obtain normal interval by doing right (left) step.

c. When marching, the command MARCH, is given on the left foot when the base squad is on the right and on the right foot when the base squad is on the left. When the base squad is center, the command MARCH may be given on either foot. At the command MARCH, the base squad takes up the half step. Other squad(s) oblique away from the base squad until normal interval is obtained. When squad members are abreast of corresponding members of the base squad, they oblique to the front in marching and take up the half step. At the command FORWARD, MARCH, all squads resume the 30-inch step.

d. When the platoon executes flank movements from a column at close interval, squad(s) in rear of the squad which becomes the leading squad take up the half step, after doing the flank movement, until 40-inch distance is obtained between squads. After such a movement, the platoon maintains normal interval until close march is commanded.

8-11. TO CHANGE THE DIRECTION OF A COLUMN

a. The command is COLUMN RIGHT (COLUMN LEFT, COLUMN HALF RIGHT, or COLUMN HALF LEFT), MARCH. The base element during the turn is the squad on the flank in the direction of the turn. The pivot Marine for the movement is the first Marine in the base squad, excluding the platoon commander and guide.

b. When marching, the preparatory command and command of execution are given so they end on the foot in the direction of the turn. At the command MARCH, the pivot Marine faces to the right (left) in marching and steps out one full step with his/her right (left) foot in the direction of the turn. Then he/she half steps. When other Marines of his/her rank are abreast, he/she resumes the full step. Other Marines of the leading rank twice oblique to the right (left) without changing interval, place themselves abreast of the pivot Marine, and conform to his/her step. They execute the first oblique at the command of execution. The second oblique is executed when opposite their new line of march, so that when the oblique is completed, they will be marching toward the new front with proper interval. Ranks in rear of the leading rank execute the movement on the same ground and in the same way as the leading rank (see fig. 8-4).

c. When halted, at the command MARCH, the pivot Marine faces to the right (left) by turning to the right (left) on his/her right toe and steps one full step with his/her left foot in the new direction. Then he/she half steps. When other Marines of his/her rank are abreast, he/she resumes the full step. Other Marines of the leading rank twice oblique to the right (left) in marching without changing interval, place themselves abreast of the pivot Marine, and conform to his/her step. They execute the two obliques as when the column movement is ordered while marching. At the same time, all other Marines march forward and execute the movements as when marching.

d. During column movements, the platoon commander and guide smartly oblique in the direction of the turn, half step, and resume full step in a manner that places them in their proper positions in the formation for marching in the new direction.

e. For slight changes of direction, the command is INCLINE TO THE RIGHT (LEFT). At that command, the guide changes direction as commanded. This is not a precise movement. It is executed only while marching.

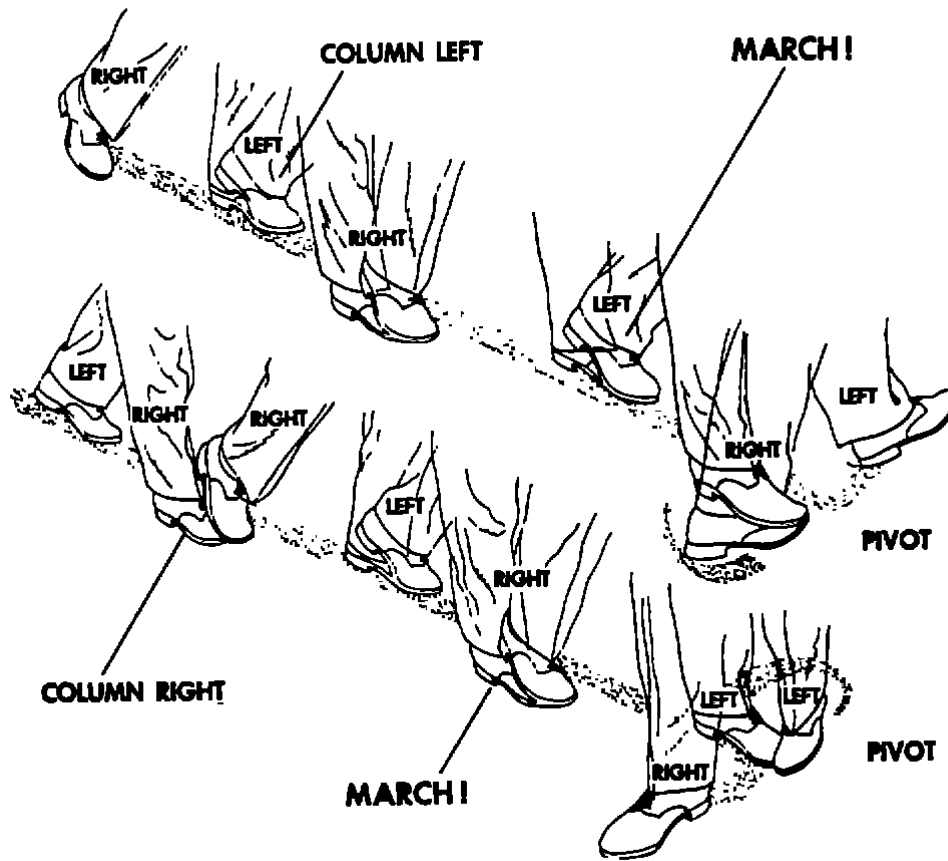
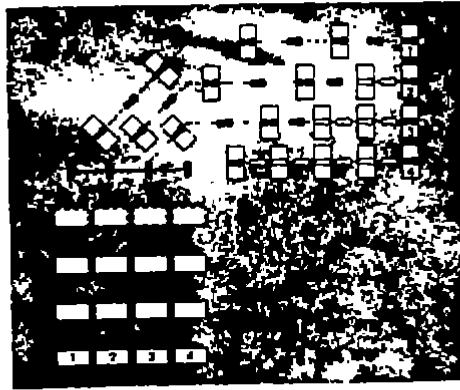

Figure 8-4. -- Executing Column Right (Left).

8-12. TO FORM LINE FROM COLUMN

Being at a halt and at the order in column, to form line, the platoon commander commands **LEFT, FACE**. At that command, all members of the platoon face to the left, the platoon commander moves by the most direct route to his/her post 6 paces front and center of the platoon, and the platoon guide takes post on the right of the front rank. (NOTE: When in column, if faced to the right, the platoon becomes inverted; therefore this should be done only for short movements.)

8-13. TO MARCH TOWARD A FLANK

a. The command is BY THE RIGHT (LEFT) FLANK, MARCH. It maybe given from any marching formation. It should not be given at a halt. The preparatory command and command of execution are given so they end as the foot in the direction of the turn hits the deck.

b. At the command MARCH, each Marine takes one more step, then faces to the right (left) in marching and steps out with his/her right (left) foot in the new direction. The platoon commander and guide execute the flanking movement with the platoon, but do not change their position within the platoon (for the one exception to this see paragraph 9-10).

c. When this movement is executed from a column at close interval, squad(s) in rear of the squad which becomes the leading squad take up the half step, after doing the flank movement, until a 40-inch distance is obtained between squads. After such a movement, the platoon maintains normal interval until close march is commanded.

d. This movement is used to move a column a short distance to the right or left.

8-14. TO STACK ARMS

Before stacking arms, ranks are opened. Arms are then stacked, on the command of the platoon commander, by each squad as prescribed in paragraph 7-15. The guide passes his/her rifle to the left, and it is placed, as an extra weapon, on the first stack of the first squad.

8-15. TO OPEN RANKS

The commands are OPEN RANKS, MARCH; READY, FRONT; COVER. They are given only in line. At the command MARCH, the front rank takes 2 paces forward, halts, and executes dress right. The second rank takes one pace forward, halts, and executes dress right. The third rank, if present, stands fast and executes dress right. Each succeeding rank present takes 2, 4, or 6 steps backward, halts, and executes dress right. The platoon commander verifies the alignment as for dress right. After verifying the alignment of the rear rank, he/she faces to the right in marching, moves 3 paces beyond the front rank, faces to the left, and commands READY, FRONT; COVER.

8-16. TO CLOSE RANKS

The command is CLOSE RANKS, MARCH. It may be given only from open ranks. At the command MARCH, the front rank stands fast; the second rank takes one pace forward and halts. Each succeeding rank present takes 2, 3, 4, or 5 paces forward and halts. Each Marine covers. The platoon commander gives the command to close ranks at the same position from which he/she commanded ready front. At the command MARCH, the platoon commander moves by the most direct route and posts 6 paces in front of the center of the platoon.

8-17. TO FORM FOR SHELTER TENTS

a. Shelter tents will be pitched in line and in formation only for the purpose of instruction and formal field inspections of equipment. Normally in bivouac, full use will be made of available cover and concealment and straight lines will be avoided.

b. The platoon forms in one line to pitch shelter tents. If sufficient space is not available, squad lines may be used.

c. Marines armed with rifles will sling arms prior to forming for shelter tents.

d. The platoon being in line, to form in one rank for pitching shelter tents, the commands are FORM FOR SHELTER TENTS TO THE LEFT, MARCH; TAKE INTERVAL TO THE LEFT, MARCH; COUNT OFF.

(1) At the command FORM FOR SHELTER TENTS TO THE LEFT, the second in command moves to a position on the right of the right Marine of the front rank. The messengers take positions on the left of the left Marine of the rear rank. The squad leader of the first squad commands STAND FAST and the squad leaders of the other squads give the supplementary command BY THE LEFT FLANK.

(2) At the command MARCH, all squads except the first face to the left in squads into line abreast of the squad(s) already on line by giving the commands BY THE RIGHT FLANK, MARCH and SQUAD, HALT.

(3) At the commands TAKE INTERVAL TO THE LEFT, MARCH; COUNT OFF, given by the platoon commander, the entire rank takes interval and counts off.

e. When directed by the platoon commander, the odd-numbered Marines draw their bayonets and thrust them into the ground alongside the outside of the left heel near the instep. The bayonet indicates the position of the front tent pole. Marines not equipped with bayonets mark the place with the left heel. Odd and even-numbered Marines (numbers 1 and 2, numbers 3 and 4, etc.) pitch tents together.

f. To assemble, the commands are ASSEMBLE TO THE RIGHT, MARCH; RIGHT, FACE; COLUMN OF TWOS (THREES, FOURS) TO THE RIGHT, MARCH. The second in command and messengers resume their normal posts.

8-18. TO FORM COLUMN OF TWOS AND SINGLE FILE AND REFORM

a. The platoon may be marched in column of twos and reform into column by the procedures given below. The change of column is always made from the halt.

(1) Being in column of threes, to form column of twos, the platoon commander commands COLUMN OF TWOS FROM THE RIGHT (LEFT), MARCH. On the preparatory command, the squad leaders give the following supplementary commands: the two right (left) squad leaders command, FORWARD; the remaining squad leader commands, COLUMN OF TWOS TO THE LEFT (RIGHT). On the platoon commander's command of execution, MARCH, the two right (left) squads march forward; the remaining squad forms column of twos to the left (right) as prescribed in squad drill (see paragraph 7-13) then, on commands of its squad leader, executes column half right (left) and column half left (right) so as to follow the two leading squads at normal distance in column (see fig. 8-5).

(2) Being in column of twos, to reform into column of threes, the platoon commander commands COLUMN OF THREES TO THE LEFT (RIGHT), MARCH. At the preparatory command, squad leaders give the following supplementary commands: the two leading squad leaders command, STAND FAST; and the remaining squad leader commands, COLUMN OF FILES FROM THE RIGHT (LEFT). On the platoon commander's command of execution, MARCH, the two leading squads stand fast; the rear squad forms single file from the right (left) as in squad drill (see paragraph 7-14), then on command of its squad leader, moves to its normal place beside the leading squads by executing a column half left (right) then column half right (left). It is halted by the squad leader when its leading file is on line with the leading rank of the platoon (see fig. 8-5).

b. The platoon, being at a halt, may be marched in single file then reform into column of threes in the same manner as forming into column of twos and reforming into column of threes by giving the following commands.

(1) Being in column of threes, to form column of files, the platoon commander commands COLUMN OF FILES FROM THE RIGHT (LEFT), MARCH. On the preparatory command, squad leaders give the following supplementary commands: right (left) squad leader, FORWARD; remaining squad leaders, STAND FAST. On the platoon commander's command of execution, MARCH, the right (left) squad marches forward; the remaining squads stand fast, then each in succession, on command of its squad leader, executes a column half right (left), then column half left (right), so as to march

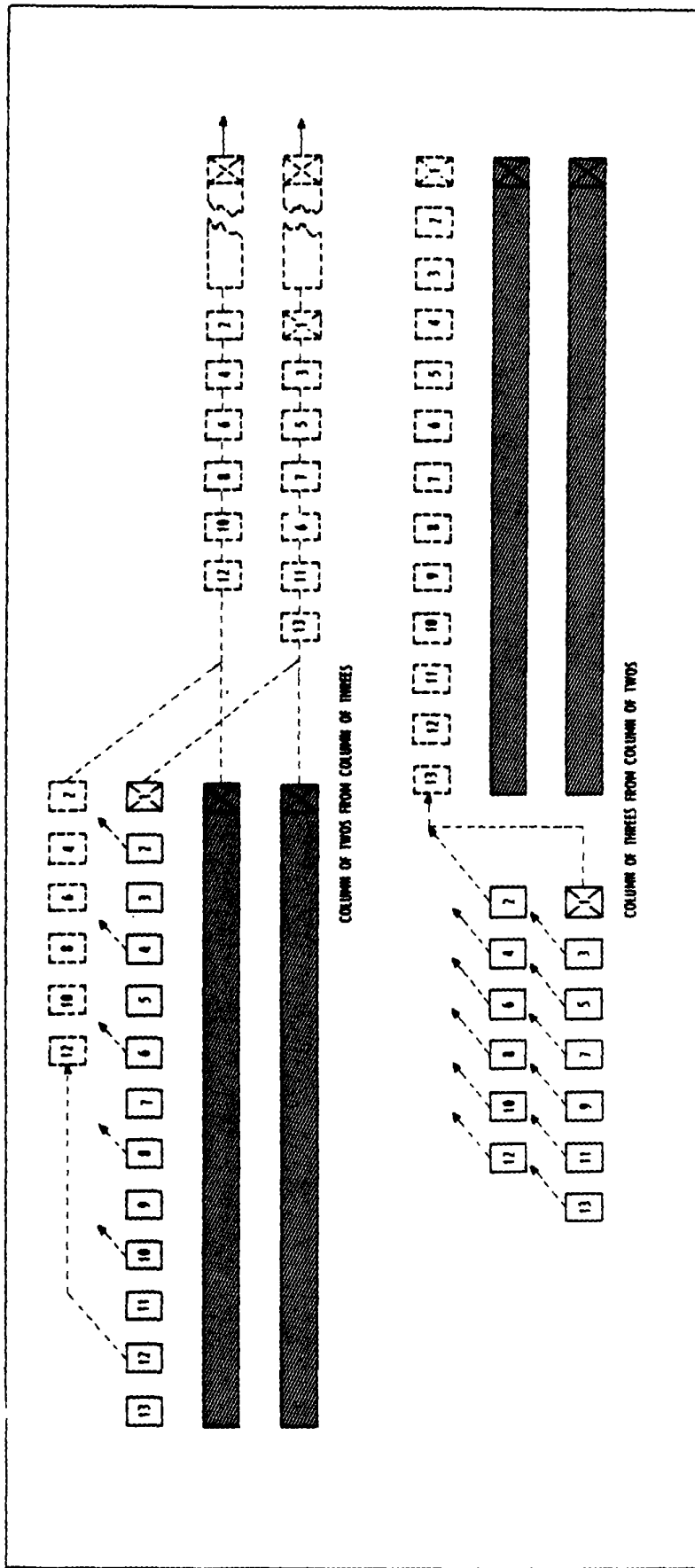

Figure 8-5. -- Column of Twos From Column of Threes and Reform.

at normal distance in single file behind the leading squad.

(2) Being in column of files, to reform column of threes, the platoon commander commands COLUMN OF THREES TO THE LEFT (RIGHT), MARCH. At the preparatory command, squad leaders give the following supplementary commands: leading squad leader, STAND FAST; second squad leader, COLUMN HALF LEFT (RIGHT); and third squad leader, FORWARD. On the platoon commander's command of execution, MARCH, the leading squad stands fast; the second squad executes a column half left (right), then on command, of its squad leader, a column half right (left) so as to march at normal interval abreast of the leading squad, then halts when the leading file is abreast of the front file of the leading squad. The third squad marches forward, then, on command of its squad leader, executes a column half left (right), column half right (left), and marches at normal interval alongside the second squad, halting when its leading file is abreast of the front rank of the platoon.

c. When marching in column of twos, the platoon commander is ahead of the left file and the right guide in front of the right file. When marching in single file, the guide leads the platoon, the platoon commander marching abreast of and to the left of the guide.

CHAPTER 9

COMPANY DRILL

9-1. GENERAL

a. A company consists of a company headquarters and two or more platoons.

b. For close-order drill and ceremonies, company headquarters personnel may be attached to platoons without interfering with the permanent squad organization. For marches, members of the company headquarters command group are formed as directed by the company commander or higher authority.

c. Formations used by the company are line, column (of threes, etc.), mass, extended mass, and column of platoons in line. In all these formations, the platoons which comprise the company will either be in line (each squad forming one rank) or in column (each squad forming one file). The company may also form column of twos or files in a manner similar to that prescribed for a platoon, in which case the platoons are arranged as in column, except that each platoon is in column of twos or files. Formation of the company for drills and ceremonies, to include posts of officers and key noncommissioned officers, are shown in figures 9-1 through 9-5.

(1) When the company commander is absent, the senior officer present with the company takes post and drills the company as prescribed for the company commander. In the absence of the first sergeant, the senior noncommissioned officer (normally the gunnery sergeant) takes post and performs the duties of first sergeant.

(2) When officers are not present, after the company is formed, the first sergeant, or in his/her absence, the next senior noncommissioned officer takes post and drills the company as prescribed for the company commander, and platoon sergeants takes post and perform the duties of platoon commanders. This also applies when, for any reason, the company commander directs the first sergeant (or senior noncommissioned officer) to take charge of the company for purposes other than dismissing the company. When this occurs, the officers retire and the first sergeant and platoon sergeants march by the most direct route to take post as the company commander and platoon commander, respectively.

(3) For drill and ceremonies, the following minimum key billets within the company must be filled by applying the above rules: company commander, guidon bearer, and first sergeant in the company headquarters; and a platoon commander, platoon sergeant, and guide for each platoon, plus one squad leader per squad within each platoon. (note: When officers are not present and the first sergeant and platoon sergeants are acting as company commander and commanders respectively, other noncommissioned officers need not be detailed to also act as first sergeant and/or platoon sergeants.)

(4) For drill and ceremonies, the company guidon is carried by the guidon bearer. In all formations, the guidon bearer is one pace to the rear and one pace to the left of the company commander or first sergeant, as appropriate. For marches in the field, the guidon is kept with company headquarters baggage unless otherwise directed. If carried on marches in the field, the guidon bearer takes post as described above for drill and ceremonies.

9-2. RULES FOR COMPANY DRILL

a. The platoon, rather than the company, is the basic drill unit. Only such formations are prescribed for the company as are necessary for marches, drills, and ceremonies.

b. In company drill, if all marines in the unit are to execute the same movement simultaneously, the platoon commanders repeat all preparatory commands of the company commander except:

(1) When commands such as FALL OUT are given, which combine the preparatory command of execution.

(2) When the preparatory command of the company is COMPANY, the platoon commanders give the preparatory command PLATOON.

(3) When in mass formation, platoon commanders repeat preparatory commands only when the order will require independent movement by a platoon.

(4) When the platoons of the company are to execute a movement in successive order, such as a column movement, the platoon commander of the first platoon to execute the movement repeats the company commander's preparatory command, and those of following platoons give an appropriate caution such as CONTINUE TO MARCH. Platoon commanders of following platoons repeat the company commander's preparatory command and command of execution at the proper time to cause their platoons to execute the movement on the same grounds the first platoon.

c. When commands involve movements of the company in which one platoon stands fast or continues the march, while one or more of the others do not, its commander commands STAND FAST or CONTINUE TO MARCH, as the case may be.

d. The company marches, executes change of direction, closes and extends intervals between squads in column, open and close ranks, and stacks and takes arms as in platoon drill.

e. The company executes marching in line only for minor changes in position.

f. Unless otherwise specified for the company to be at close interval, all changes in formation must be executed with files and ranks formed at normal interval and distance.

9-3. TO FORM COMPANY

a. At the command FALL IN, the company forms in line formation at normal interval and distance (see fig 9-1). If it is desired to form the company at close interval between files, the command AT CLOSE INTERVAL, FALL IN is given. In this case, the platoons form in line as shown in figure 9-1, but files within each platoon are at close interval (4 inches). The company forms at close interval only for roll calls or when space is limited. The company may be formed by its noncommissioned officers under charge of the first sergeant, or by its officers under command of the company commander, as described below.

b. Forming the Company by Noncommissioned Officers.

(1) The first sergeant takes post 9 paces in front of the point where the center of the company is to be, faces that point, draws sword if so armed, and commands FALL IN (AT CLOSE INTERVAL, FALL IN). At this command, the guidon bearer takes post facing the front one pace to the front and one pace to the right of the first sergeant (the first sergeant facing the company), and the company forms in line with platoons in line at normal (close) interval and 4 paces between platoons. Each platoon sergeant takes post 3 paces in front of and facing the point where the center of the platoon is to be, faces that point and draws sword if so armed. Each platoon then forms as prescribed in paragraph 8-5, under the supervision of the platoon sergeant.

(2) Platoon sergeants then command REPORT. Remaining in position (at order arms if armed with the rifle), the squad leaders, in succession from front to rear in each platoon, salute and report, "All present," or "Private _____ absent." Platoon sergeants then command INSPECTION, ARMS; PORT, ARMS; ORDER, ARMS if troops are armed with rifles, then face about to the front. If troops are not armed with rifles, the platoon sergeant immediately faces the front after receiving the reports of the squad leaders. (NOTE: If platoons cannot be formed in regularly organized squad prior to forming the company, the platoon sergeants command INSPECTION, ARMS; PORT, ARMS; RIGHT SHOULDER, ARMS, and call the roll. Each Marine answers "Here, and

comes to order arms as his/her name is called. The platoon sergeant then organizes the platoon into squads and faces the front. The manual of arms is omitted for personnel not armed with rifles.)

(3) After all platoon sergeants have completed receiving the reports of their squad leaders and are facing the front, the first sergeant commands REPORT, at which time the platoon sergeants, beginning with the right platoon, successively salute and report, "All present or accounted for" or "_____men absent." The first sergeant returns each salute individually. What occurs next depends upon whether the company commander and platoon commanders receive the company or not.

(a) If company officers do not receive the information, after receiving the reports of all the platoon sergeants, the first sergeant commands POST. On this command, the platoon sergeants and guidon bearer step forward three steps; simultaneously, the first sergeant faces about and steps forward three steps. The company is now formed with the first sergeant and platoon sergeants occupying the posts prescribed for the company commander and platoon commanders in figure 9-1.

(b) If company officers receive the formation, the company commander and platoon commanders normally observe the initial procedures from a location to the rear of where the company is forming (officers remain with swords in their scabbards, if so armed). In this case, after receiving the reports of the platoon sergeants, the first sergeant faces the front and awaits the arrival of the company commander. When the company commander has taken post 12 paces front and center of the company, the first sergeant salutes and reports "Sir, all present and accounted for," or "Sir,_____Marines absent." The company commander returns the salute, and may discuss absentees and issue necessary instructions to the first sergeant. Next, the company commander directs the first sergeants to TAKE YOUR POST, at which the guidon bearer marches forward 3 paces, and the first sergeant and platoon sergeants march by the most direct route to their posts, the former in rear of the company, the latter on the left of the rear rank of their platoons; simultaneously, the company executive officer takes post to the rear of the company and the platoon commanders take their posts 6 paces front and center of their platoons. After all officers are in position, if armed with the sword, the company commander draws swords; the company executive officer and platoon commanders draw sword with the company commander.

c. Forming the Company by Officers.

(1) Normally, the company is initially formed by the noncommissioned officers, then received by the officers as described in paragraph b above. This permits detailed musters to be taken by the noncommissioned officers. During the course of training, if the company has been dismissed for a short period of time, it may be initially reformed by the company commander to save time.

(2) When the company is initially formed by the company commander, the procedures are the same as forming with the noncommissioned officers, except that the company commander takes post 12 paces front and center and facing the point where the center of the company is to be, draws sword if so armed, and commands FALL IN. Platoon commanders then take post 6 paces front and center and facing the point where the center of their platoons will be, draw sword if so armed, form their platoons and receive the reports of their squad leaders, then face the front. After all platoon commanders have formed their platoons and are facing the front, the company commander commands REPORT, at which time each platoon commander, in succession from right to left, salutes and reports, "Sir, all present or accounted for," or "Sir, _____Marines absent."

9-4. BEING IN LINE, TO FORM COLUMN AND REFORM INTO LINE

a. Being at a halt and at the order in line, to form column, the company commander orders, **RIGHT, FACE**. After facing to the right, all officers, key noncommissioned officers, and the guidon bearer march by the most direct routes to their posts in column as shown in figure 9-2. The company commander may then cause the column to march (NOTE: As platoons and squads become inverted if the company is faced to the left, this should be done for short movements.)

b. Being at a halt and at the order in column, to form line, the company commander commands, **LEFT, FACE**. After facing to the left, all officers, key noncommissioned officers, and the guidon bearer march by the most direct routes to their posts in line as shown in figure 9-1. (NOTE: When in column, if the company is faced to the right, platoons and squads become inverted. Therefore, to form line facing the right, flank of a column, the company should first be marched by executing necessary changes in direction so that, after halting and facing to the left, line will be formed facing the desired direction.)

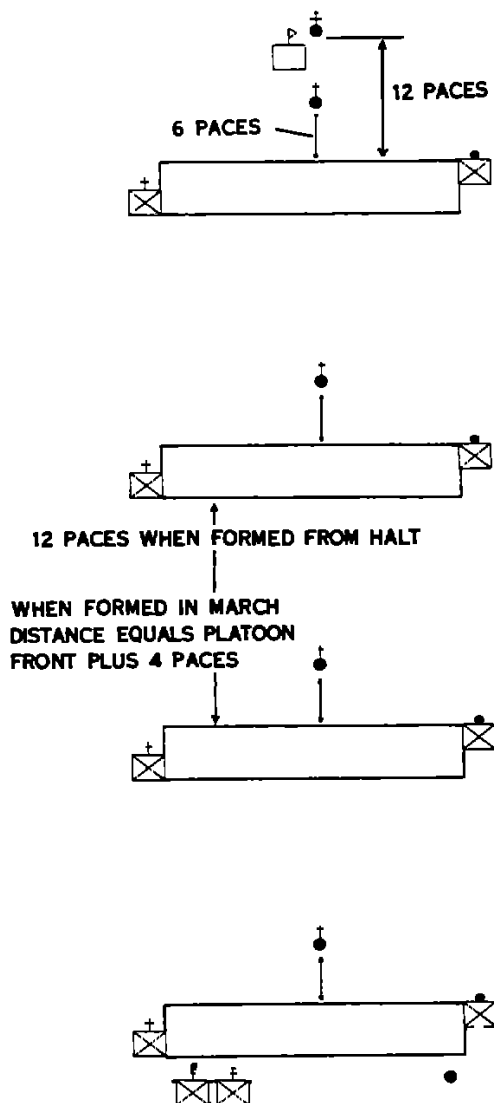

Figure 9-2.--Rifle Company in Column.

9-5. BEING IN COLUMN, TO CHANGE DIRECTION

a. Being at a halt or in march while in column, to change direction 90 degrees to the right (left), in the company commander orders COLUMN RIGHT (LEFT), MARCH. On the preparatory command, platoon commanders give the following supplementary commands: leading platoon commander, COLUMN RIGHT (LEFT); and remaining platoon commanders FORWARD, if initiated from a halt (CONTINUE THE MARCH, if initiated while marching). On the company commander's command of execution, MARCH, the leading platoon executes a column right (left). Succeeding platoons march forward and, on the commands of their platoon commanders, execute a column right (left) on the same ground as the leading platoon.

b. To execute a 45 degree change in direction, the execution is the same as above, except the command COLUMN HALF RIGHT (LEFT), MARCH is used. Platoon commanders give appropriate supplementary commands.

c. For slight changes in direction, on the command of the company commander to INCLINE TO the RIGHT (LEFT), the guide of the leading platoon changes direction as commanded. Succeeding platoons march forward and change direction on the same ground as the leading platoon. No supplementary commands are given by the platoon commanders.

9-6. BEING IN COLUMN AT CLOSE INTERVAL, TO FORM MASS FORMATION

a. Being at a halt in column at close interval, the company commander orders COMPANY MASS LEFT (RIGHT), MARCH. On the preparatory command, platoon commanders give the following supplementary commands: leading platoon commander, STAND FAST; remaining platoon commanders command, COLUMN HALF LEFT (RIGHT). On the company commanders command of execution, MARCH, the leading platoon stands fast, and the remaining platoons simultaneously execute a column half left (right). On commands of their platoon commanders, the remaining platoons then execute a column half right (left) so as to move into positions alongside the leading platoon at 4-inch intervals. Each platoon commander causes his/her platoon to mark time 4-8 counts when its leading rank is on line with the leading rank of the platoon already on line, then each platoon commander halts his/her platoon. This forms the company in mass, with 4-inch intervals between all adjacent platoons and files as shown in figure 9-3.

b. The company being in march in column at close interval, the commands are the same as given at the halt, except that on the preparatory command the leading platoon commander commands, MARK TIME. On the company commanders command of execution, MARCH, the leading platoon marks time 4-8 counts then halts on command of its platoon commander. The commands and movements for the remaining platoons are the same as for the movement from a halt.

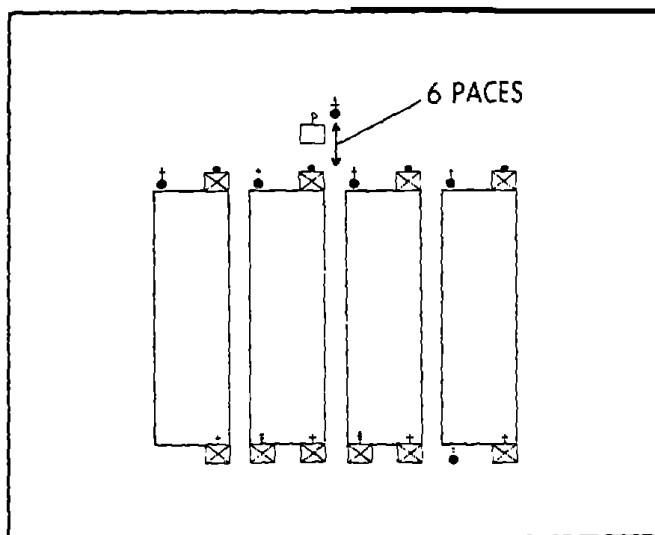
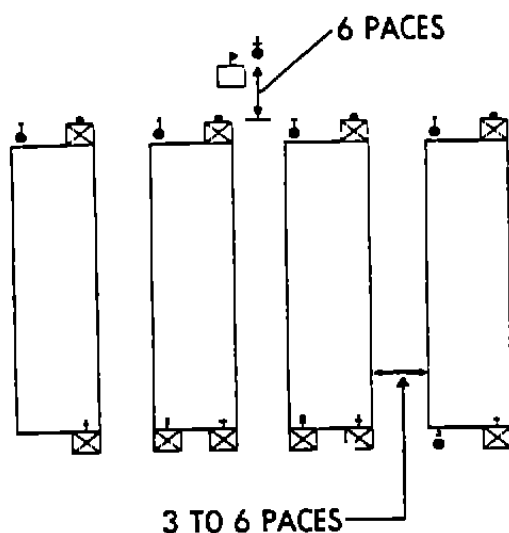

Figure 9-3.--Rifle Company in Mass Formation.

9-7. BEING IN COLUMN, TO FORM EXTENDED MASS FORMATION

At a halt or in march while in column, to form extended mass, the company commander orders COMPANY MASS (3 to 6) PACES LEFT (RIGHT), MARCH. On the preparatory command, each platoon commander gives the following supplementary commands: leading platoon commander commands, STAND FAST if initiated from a halt (MARK TIME if in march); remaining platoon commanders, COLUMN LEFT, (RIGHT). On the company commanders command of execution, MARCH, the leading platoon marks time (stands fast) 4-8 counts then is halted by its platoon commander; the remaining platoons simultaneously execute a column left (right), then, on commands of their platoon commanders, execute a column right (left). Then, when their front rank is on line with the front rank of the platoon(s) already on line, mark time 4-8 counts and halt in a manner similar to that prescribed for forming company mass in paragraph 9-6, except that the rear platoon(s) move into position abreast so as to be at 3 to 6 pace intervals, as was ordered (see fig. 9-4). This formation is used for drills and ceremonies if it is desired to increase the size of the mass in order to present a more impressive appearance. The company in this formation drills in the same manner as for mass formation, maintaining the specified interval between platoons.



9-8. BEING IN MASS OR EXTENDED MASS FORMATION, TO CHANGE DIRECTION

a. Being in mass or extended mass formation at a halt or in march, to change direction 90 degrees to the right (left), the company commander commands, RIGHT (LEFT) TURN, MARCH; FORWARD, MARCH. The right flank guide of the line of guides and platoon commanders is the pivot for this movement. At the command of execution, MARCH, for the right turn, the pivot faces to the right (left) in marching and takes up the half step. Other members of the first rank execute a right (left) oblique, advance until opposite their place in line, execute a second right (left) oblique, and upon arriving abreast of the pivot man, take up the half step. Each succeeding rank executes the movement on the same ground and in the same manner as the first rank. All take a full step at the command FORWARD, MARCH, which is given by the company commander after all members of the company have changed direction and have picked up the half step.

b. Being in mass or extended mass formation at a halt or in march, to change direction 45 degrees to the right (left), the company commander commands, HALF RIGHT (LEFT) TURN, MARCH; FORWARD, MARCH. This movement is executed in a similar manner for a right turn as described above, except that the pivot makes a half right (left) face in marching, and the members of each rank need execute only one right (left) oblique in marching.

9-9. BEING IN MASS OR EXTENDED MASS FORMATION, TO FORM COLUMN

a. Being at a halt in mass or extended mass formation, to form column, the commands are COLUMN OF THREES (FOURS, ETC.), RIGHT (LEFT) PLATOON, FORWARD (COLUMN RIGHT), MARCH. On the preparatory command, the platoon commanders give the following supplementary commands: right (left) platoon commander commands FORWARD (COLUMN RIGHT); and the remaining platoon commanders command, STAND FAST. On the company commander's command of execution, the right (left) platoon marches forward and the remaining platoons stand fast. When the leading platoon reaches an appropriate point, the next platoon, on commands of its platoon commander, executes necessary column movements so as to take up the march in column at a distance of 4 paces from the leading platoon. Remaining platoons, in succession, take up the march in column at distances of 4 paces in a similar manner.

b. Being in march in mass or extended mass formation, to form column, the company commander gives the same command as when initiated from a halt. In this case, on the preparatory command, the right (left) platoon commander commands, CONTINUE THE MARCH (COLUMN RIGHT), and the remaining platoon commanders command, MARK TIME. On the company commander's command of execution, the right (left) platoon continues the march (executes a column right) and the remaining platoons mark time. The platoon commanders of the remaining platoons cause their platoons to execute necessary column movements so as to follow in column behind the leading platoon at 4 pace distances in a similar manner as when movement is initiated from a halt.

9-10. BEING IN COLUMN, TO FORM COLUMN OF PLATOONS IN LINE

a. Being at a halt and at the order in column, to form column of platoons in line the company commander commands, COLUMN OF PLATOONS IN LINE, MARCH; LEFT, FACE. On the first preparatory command, platoon commanders give the following supplementary commands: leading platoon commander, STAND FAST; second platoon commander, COLUMN RIGHT; and all other platoon commanders, FORWARD. On the company commander's command of execution, MARCH, the leading platoon stands fast, the second platoon executes a column right and marches 12 paces past the right file of the leading platoon, then, on command of its platoon commander, executes a column left, and marches forward until its front rank is on line with the front rank of the leading platoon (now on its left), marks time 4-8 counts, and halts. Succeeding platoons march forward, executing a column right on the same ground as the leading platoon, then a column left, and finally marking time 4-8 counts and halting on line on commands of their platoon commanders so as to be at 12 pace intervals. When all platoons are halted on line, the company commander commands LEFT, FACE. All platoons execute a left face with each platoon commander moving by the most direct route to his/her post 6 paces front and center of the platoon, and each platoon guide takes post on the right of the front rank of each platoon; the company is then formed in column of platoons in line with 12 pace distances between platoons as shown in figure 9-5. The formation may be used for inspections and for the display of equipment.

b. Being in march in column, to form column of platoons in line, the commands are COLUMN OF PLATOONS IN LINE, LEADING PLATOON BY THE LEFT FLANK, MARCH. On the preparatory command, platoon commanders give the following supplementary commands the leading platoon commander commands, BY THE LEFT FLANK; the remaining platoon commanders command, CONTINUE THE MARCH. Simultaneously, on the preparatory command all platoon commanders incline to the left from their posts in column and half step so as to be as near as possible to a position 6 paces from and centered on the left file of their platoons prior to the company commander's command of execution, MARCH. At that command, the leading platoon executes a left flank march, its guide moving abreast of the front rank as rapidly as possible; succeeding platoons continue the march forward and, on commands of their platoon commanders, execute a left flank on the same ground and in the same manner as the leading platoon. Each platoon commander, after executing a left flank march, marches at a position 6 paces front and center of the platoon, and the company commander, guidon bearer, and company staff march in positions as shown in figure 9-5. In this formation which may be used for passing in review during ceremonies, the company marches in column of platoons in line, with the distance between each platoon equal to the length of each platoon plus four paces.

(NOTE: In forming column of platoons in line from a halt or in march, movements should always be made in the directions indicated above, otherwise platoons and squads become inverted.)

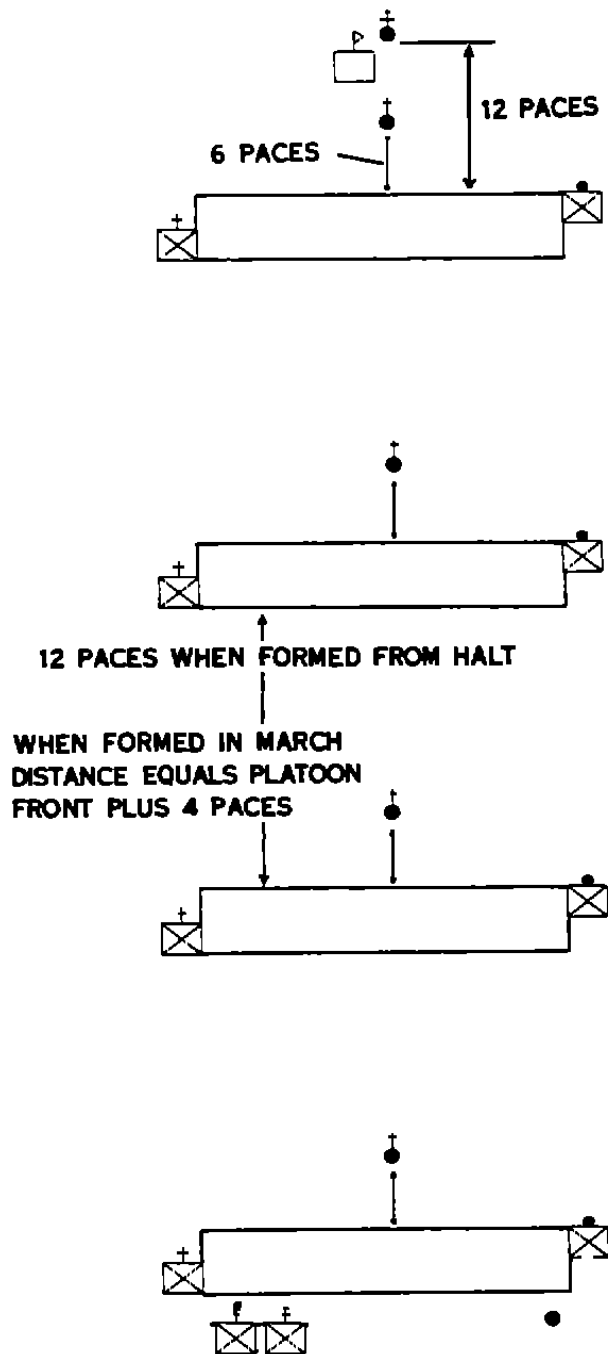

Figure 9-5. Rifle Company in Column of Platoons in Line (With Ranks Closed).

9-11. BEING IN COLUMN OF PLATOONS IN LINE, TO FORM COLUMN.

a. Being at the halt and at the order in column of platoons in line, to form column, the company commander commands, RIGHT, FACE, at which time all platoons, face to the right with platoon commanders and guides taking posts at the head of the left and right files respectively of their platoons. Next, the company commander orders, COLUMN OF THREES (FOURS, ETC.), LEFT PLATOON, FORWARD (COLUMN LEFT, MARCH. Thereafter, commands and procedures for executing this movement are the same as prescribed for forming column from mass or extended mass formation at the halt in paragraph 9-9.

b. Being in march in column of platoons in line, to form column, the commands are, COLUMN OF THREES (FOURS, ETC.), LEADING PLATOON, BY THE RIGHT FLANK, MARCH, or COLUMN OF THREES (FOURS, ETC.), LEADING PLATOON BY THE RIGHT FLANK, COLUMN LEFT, MARCH. On the preparatory command, platoon commanders give the following supplementary commands: lead platoon commander commands, BY THE RIGHT FLANK (BY THE RIGHT FLANK, COLUMN LEFT); remaining platoon commanders command, CONTINUE THE MARCH. On the company commander's command of execution, MARCH, the leading platoon executes a right flank (right flank, column left). Succeeding platoons continue the march forward, each, on the command of its platoon commander, executing a right flank (right flank, column left) on the same ground as the leading platoon, then following in trace of the leading platoon in column at 4 pace distances (see fig. 9-2). Officers, key noncommissioned officers, and the company guidon move by the most direct routes to their proper position in column.

(NOTE: In forming column from column of platoons in line at a halt or while marching, movement should always be made in the directions indicated above, otherwise platoons and squads become inverted.)

9-12. BEING IN COLUMN, TO FORM COLUMN OF TWOS OR FILES AND REFORM

a. Being at a halt in column, to form column of twos (files), the company commander commands, COLUMN OF TWOS (FILES) FROM THE RIGHT (LEFT), MARCH. On the preparatory command, platoon commanders and squad leaders give the following supplementary commands: leading platoon commander commands, COLUMN OF TWOS (FILES) FROM THE RIGHT (LEFT), after which the squad leaders of the leading platoon give appropriate supplementary commands to form the movement required as prescribed in paragraph 8-18; the remaining platoon commanders command, STAND FAST. On the company commander's command of execution, MARCH, the leading platoon marches forward in column of twos (files) as prescribed in platoon drill. Succeeding platoons march forward in column of twos (files) on the commands of their platoon commanders and squad leaders in the same manner as the leading platoon so as to follow the leading platoon in column at 4 pace distances.

b. Being at a halt in column of twos (files), to reform column (i.e., column of threes, etc.), the company commander commands, COLUMN OF THREES (FOURS, ETC.) TO THE LEFT (RIGHT), MARCH. On the preparatory command, the platoon commanders and squad leaders give the following supplementary commands: leading platoon commander commands, COLUMN OF THREES (FOURS, ETC.) TO THE LEFT (RIGHT), after which the squad leaders of the leading platoon give appropriate supplementary commands as prescribed in paragraph 8-18; the remaining platoon commanders command, STAND FAST. On the company commanders command of execution, MARCH, the leading platoon marches forward in column (of threes, etc.) as prescribed in platoon drill. Succeeding platoons march forward in column (of threes) on the commands of their platoon commanders and squad leaders in the same manner as the leading platoon so as to follow the leading platoon in column at 4 pace distances.

9-13. TO ALIGN THE COMPANY

a. To align the company when in line at a halt, the company commander commands, DRESS RIGHT (CENTER, LEFT). At the command DRESS RIGHT, the platoon commander of the base platoon aligns his platoon immediately by the commands DRESS RIGHT, DRESS; READY FRONT; COVER. After the platoon commander of the base platoon gives the command to align the platoon, the remaining platoon commanders will align their platoons in successive order. When DRESS CENTER is given, the commander of the center platoon, which is the base platoon for this movement, aligns the platoon to the center of the company. The base platoon for this movement is the second platoon in both three and four platoon companies. After the base platoon commander has aligned the platoon, the remaining platoon commanders will align their respective platoons on the base platoon by executing DRESS RIGHT (LEFT), READY FRONT, and COVER.

b. To align the company when in mass formation at a halt, the company commander commands AT CLOSE INTERVAL, DRESS RIGHT (LEFT), DRESS; READY FRONT; COVER. At the command DRESS, the alignment of each rank is verified promptly by the platoon commander of the base platoon. When the platoon commander resumes his post, the company commander commands, READY, FRONT; COVER.

c. To align the company when in column, the command is COVER. At that command, the second and following platoons obtain the proper 4-pace distances between platoons and cover on the files of the leading platoon. Each platoon aligns internally as prescribed in paragraph 8-7.

d. To align the company when in column of platoons in line at halt, the company commander commands, DRESS RIGHT. At this command, the leading platoon (which is the base platoon) is immediately aligned by its commander who commands, DRESS RIGHT, DRESS; READY, FRONT; COVER. After the platoon commander of the base platoon has given the command to align the platoon, the remaining platoon commanders in succession from front to rear give the command to align their platoons. Platoon commanders follow the procedures prescribed in paragraph 8-7, and ensure that the guides are covered on the guide of the leading platoon.

9-14. TO DISMISS THE COMPANY

a. The commands are FIRST SERGEANT, DISMISS THE COMPANY. The company being in line at a halt, at the command FIRST SERGEANT, the first sergeant moves by the most direct route to a point 3 paces from the company commander (9 paces in front of the center of the company), halts, and salutes. The company commander returns the salute and commands, DISMISS THE COMPANY. The first sergeant salutes; the company commander returns the salute, returns sword, if so armed, and falls out. Other officers of the company return sword, if so armed, and fall out at the same time. The platoon sergeants take their posts 3 paces in front of the centers of their platoons. The first sergeant, when his salute is returned by the company commander, executes about face. When the platoon sergeants have taken their positions, he commands INSPECTION, ARMS; PORT, ARMS; DISMISSED.

b. The company being in line at a halt, dismissal may also be ordered by the command DISMISS YOUR PLATOONS. The platoon commanders salute; the company commander returns the salute and falls out. The platoon commanders execute about face and command, PLATOON SERGEANT, DISMISS THE PLATOON. The platoon sergeant takes his post 3 paces in front of the center of his platoon and executes the commands as prescribed for the first sergeant when dismissing the company.

c. The first sergeant may cause platoons to be dismissed by the platoon sergeants by commanding DISMISS YOUR PLATOONS. The platoon sergeants salute; the first sergeant returns the salute and falls out. The platoon sergeants then execute about face and dismiss their platoons as prescribed in paragraph 8-6.

[BLANK PAGE]

CHAPTER 10

FORMATIONS OF THE BATTALION

10-1. GENERAL

a. The formations described in this chapter pertain to the infantry battalion. Using them as a guide, other units of corresponding size conform as appropriate.

b. When practicable, the formation and movement of the subdivisions of the battalion should be made clear to subordinate commanders before starting the movement.

c. The battalion drills by command for ceremonies where units of the battalion execute the manual, facings, and marching as one body at the command of execution of the battalion commander. These movements are executed by the battalion in a manner similar to that prescribed for the company.

d. To assume any formation, the battalion commander indicates the formation desired, the point where the right (left) of the battalion is to be, and the direction in which the line or column is to face. Formations should be such that, in approaching the line on which the battalion forms, columns and lines are either perpendicular or parallel to the front. Each company commander marches his company to its position in the most convenient manner.

e. Upon completing the movement ordered by the battalion commander, companies may be given AT EASE until another movement is ordered. After a ceremony has started, units remain at attention until ordered to stand at parade rest or at ease by the battalion commander or adjutant.

f. After a battalion is halted, its subdivisions make no movement to correct alignment or position unless so directed by the battalion commander.

g. When the battalion is presented to its commander or to a reviewing officer, the officer who makes the presentation faces the battalion and commands, PRESENT, ARMS. When all elements of his unit are at present arms, he faces the front and salutes. Members of his staff salute and terminate the salute with him.

h. When the battalion commander does not take the formation, the executive officer (or in his absence, the next senior officer) is commander of troops. The commander of troops takes post, gives all commands, and receives all salutes prescribed for the battalion commander.

10-2. COMMANDS AND ORDERS

a. The commands or orders of the battalion commander are given by voice, by bugle, by signal, or by means of staff officers or messengers who communicate them to commanders concerned.

b. Company commanders and platoon commanders give supplementary commands in the same manner as prescribed for company drill (paragraph 9-2).

10-3. STAFF

a. The staff of a commander forms 2 paces to his rear in one rank. Enlisted personnel form 2 paces in rear of the commissioned staff. If only one staff officer is present, he is posted 1 pace to the right and 2 paces to the rear of the commander. Staff officers usually are arranged with the adjutant on the right and the S-2, S-3, and S-4 on his left in that order, but the commander may cause them to be arranged in any order he desires. Enlisted personnel forming with the staff ordinarily are posted in order of rank from right to left.

b. When necessary to reduce the front of the staff while marching, it forms a column of twos under the direction of the senior staff officer and follows the commander.

c. When it is prescribed that the staff change its position in order to place itself in rear of the battalion commander (who has faced about, as when the battalion commander, having formed his battalion, faces the reviewing officer by facing about), the senior staff officer, by appropriate commands, causes the staff to execute left face, change direction to the right twice (column right), halt, and face to the right, placing it in its correct position.

d. When the battalion commander faces to the right (left) and marches off, the staff conforms by making a turn. The guide for the staff is right, except while a turn is in progress, during which time the guide is in the direction of the turn.

10-4. FORMATIONS

a. Formations for the battalion are shown in figures 10-1 to 10-5.

b. The color guard is posted to the left of the color company when the company is in line and in rear when the company is in column. The color company is posted in the battalion formation so that the color guard is in the approximate center of the formation (right or forward of center, if this is impossible).

c. The band is posted by the adjutant as indicated in figures 10-2, 10-3, and 10-5.

d. Attached units take position as directed by the battalion commander and conform to the formation and movements of the battalion.

e. In whatever direction the battalion faces, the companies are designated numerically from right to left in line and from head to rear in column; that is, first company, second company, third company, etc.

f. The terms "right" and "left" apply to actual right and left as the troops face.

g. The designation "center company" indicates the right center or the actual center company, according to whether the number of companies is even or odd.

h. Personnel of the battalion headquarters and service company may be attached to other companies of the battalion for ceremonies.

i. The battalion commander supervises the formation from such positions as will best enable him to correct alignments, intervals, and distances. With his staff (less the adjutant), he takes post in time to receive the report.

j. Any formation or combination of formations may be employed to meet existing conditions of space or purpose.

10-5. TO FORM FOR INSPECTIONS, DRILLS, MARCHES, OR PRIOR TO PARTICIPATION IN LARGER UNIT MARCHES OR CEREMONIES

a. At "Assembly" the companies are formed by their NCO's and officers at their designated locations as prescribed for company drill (paragraph 9-3). Company commanders then position their companies in the prescribed formation where the battalion is to form. If the colors are to be carried, the color guard and color company first receive the battalion colors (paragraph 16-5), then take position.

b. The adjutant takes post 6 paces to the right of and facing where the right flank of the battalion will rest when forming in line (or 6 paces in front of and facing the leading guide of the leading company in column), draws sword if so armed, and supervises the positioning of the companies.

(1) If a band or field music is not present at the time for "Adjutant's Call", the adjutant marches by the most direct route to a position midway between the line of company commanders and battalion commander when in line (or midway between the leading company commander and battalion commander in column), faces the battalion, and commands. BATTALION, ATTENTION. The adjutant then faces the battalion commander, salutes and reports, "Sir, the battalion is formed." The battalion commander returns the salute and orders TAKE YOUR POST, SIR. The adjutant passes to the battalion commander's right and takes his post in the staff. The battalion commander and staff then draw swords if so armed. Then appropriate commands are given to conduct the inspection, drill, or march. (If forming prior to participation in regimental/larger marches or ceremonies, the battalion awaits the second, or regimental "Adjutant's Call".

(2) If a band or field music is present, in lieu of bringing the battalion to attention by voice command, the adjutant may direct SOUND ATTENTION. After "Attention" is sounded, the companies are brought to attention in succession from right to left when in line (front to rear in column), but remain at the order. Next, the adjutant orders, SOUND ADJUTANT'S CALL. Companies stand fast while "Adjutant's Call" is sounded. The adjutant then takes post midway between the line of company commanders and battalion commander when in line (midway between the drum major and battalion commander when in column) and reports that the battalion is formed.

10-6. TO FORM IN LINE WITH COMPANIES IN LINE FOR BATTALION CEREMONIES

a. At "Assembly" the companies are formed by their NCO's and officers at their designated locations as prescribed in company drill (see paragraph 9-3). The color guard and color company, after forming, receive the battalion colors (see paragraph 16-5). The companies remain at their locations for assembly, or if directed by the battalion commander, move to positions closer to the battalion parade ground and await "Adjutant's Call" to form the battalion for the ceremony.

(1) The adjutant indicates the line on which the battalion is to form with two flags, one on each flank. He takes post on the line 6 paces from and facing where the right flank of the battalion will rest, and draws sword if so armed. When the band is present, at the designated time the adjutant orders the band: SOUND ATTENTION. At the sounding of attention, the companies are brought to attention and to right shoulder arms from front to rear or from right to left. After the entire battalion is at attention and at right shoulder arms, the adjutant orders the band: SOUND ADJUTANT'S CALL.

(2) Companies are marched from the left flank in column of threes (or fours) so as to arrive at positions parallel to and in rear of the line successively from right to left. The command of execution for their movement is so timed that they will step off at the first note of the march following adjutant's call. The line of march is sufficiently off the line on which the battalion is to form to permit the expeditious alignment of guides of the right company by the adjutant. As each company arrives in rear of its position, it is halted and faced to the left. The company commander then commands GUIDES ON LINE. At that command, the guide of each platoon moves out at double time (at port arms) to his position on the line indicated by the flags and faces the adjutant. The adjutant aligns the guides of the right company; the guides of other companies cover the guides already on the line. As soon as the guides have established themselves on the line, each company marches forward to its position and is aligned as prescribed in paragraph 9-13. The right man of the front rank places himself so the center of his chest touches the guide's arm.

(3) When all units have reached their position on the line, the band stops playing, and the adjutant moves by the most direct route to a position midway between the line of company commanders and the battalion commander and faces the battalion. When all units are dressed, the adjutant commands GUIDES, POSTS. At the command POSTS, the guides move to their normal positions in ranks. To do this, the guides take 1 step forward, face to the right in marching, halt, and about face. If prescribed for the ceremony, the adjutant next commands FIX, BAYONETS. After fixing bayonets, or after posting the guides if bayonets are not fixed, the ceremony proceeds as for a review in paragraph 13-5a(1), for a parade as in paragraph 15-2b(2), or for a formation as in paragraph 15-5, as appropriate.

b. If space or circumstances require, after forming at "Assembly", the companies may be directed to take their positions on the line of troops prior to "Adjutant's Call". In this case, procedures are as described above, except when "Attention" is sounded companies remain at order arms after being brought to attention, and at "Adjutant's Call" the companies stand fast (guides are not put on line). The adjutant then marches from the right of the line to his post front and center of, and facing the battalion. He causes the companies to dress to the right, fix bayonets (if prescribed), and the ceremony to proceed according to the type being conducted.

10-7. TO FORM IN LINE WITH COMPANIES IN MASS FORMATION FOR BATTALION CEREMONIES

a. The procedure is the same as in forming in line except that when marching on at "Adjutant's Call":

(1) Companies are marched from either flank in mass formation to their positions in line, the line of march being well in rear of the line on which the battalion is to form. When opposite its place in line, each company executes LEFT (RIGHT) TURN. As soon as this turn has been initiated, the company commander commands GUIDE OF RIGHT PLATOON ON LINE. At this command, the guide of the right platoon moves out at double time (at port arms) to the line indicated by the flags, halts, comes to order arms, and faces the adjutant. The guide indicates the right of the company.

(2) When all units are dressed, the adjutant commands GUIDES, POSTS. At the command POSTS, the guides move to their normal positions. To do this, the guides face to the left, take one step forward, and halt.

b. Companies may be marched to positions in column of threes (or fours) instead of in mass formation as above. The procedure is the same as above except that:

(1) As soon as the column movement has been initiated, the company commander orders GUIDE OF LEADING PLATOON ON LINE. The guide moves out to his position on the line, the company commander commands COMPANY MASS LEFT (COMPANY MASSES 3 to 6 PACES LEFT), MARCH, the command of execution being so timed that the leading platoon will halt just short of the line of guides. The remaining platoons successively move into position on the left of the leading platoon at the designated interval.

(2) At the command GUIDES, POSTS, the guides move to their normal positions in the manner stated in paragraph 10-7 a (2).

10-8. TO FORM BATTALION IN MASS

The procedure is the same as in forming in line except that companies are marched from either flank in column of threes (or fours) at close interval without distance between platoons, the line of march being well in rear of the line on which the battalion is to form. When opposite its place in line, each company commander executes column left (right). As soon as this column movement has been initiated, the company commander commands GUIDE OF LEADING PLATOON ON LINE. The guide moves out at double time (at port arms), the company is halted, and guides take their posts as described in paragraph 10-7.

10-9. TO DISMISS THE BATTALION

a. The battalion commander commands DISMISS YOUR COMPANIES. At this command, each company commander salutes the battalion commander. He returns the salutes. Each company commander marches his company to the place for dismissal and dismisses it as prescribed in paragraph 9-14. If colors were carried, the color company and color guard first return the colors in accordance with paragraph 16-5 before being dismissed.

b. The companies having marched off, the battalion commander dismisses his staff.

c. In case the battalion commander desires to release companies to their commanders, without prescribing that the companies promptly be dismissed, he commands TAKE CHARGE OF YOUR COMPANIES. Company commanders salute and the battalion commander returns the salute. The company commanders then take charge of their companies.

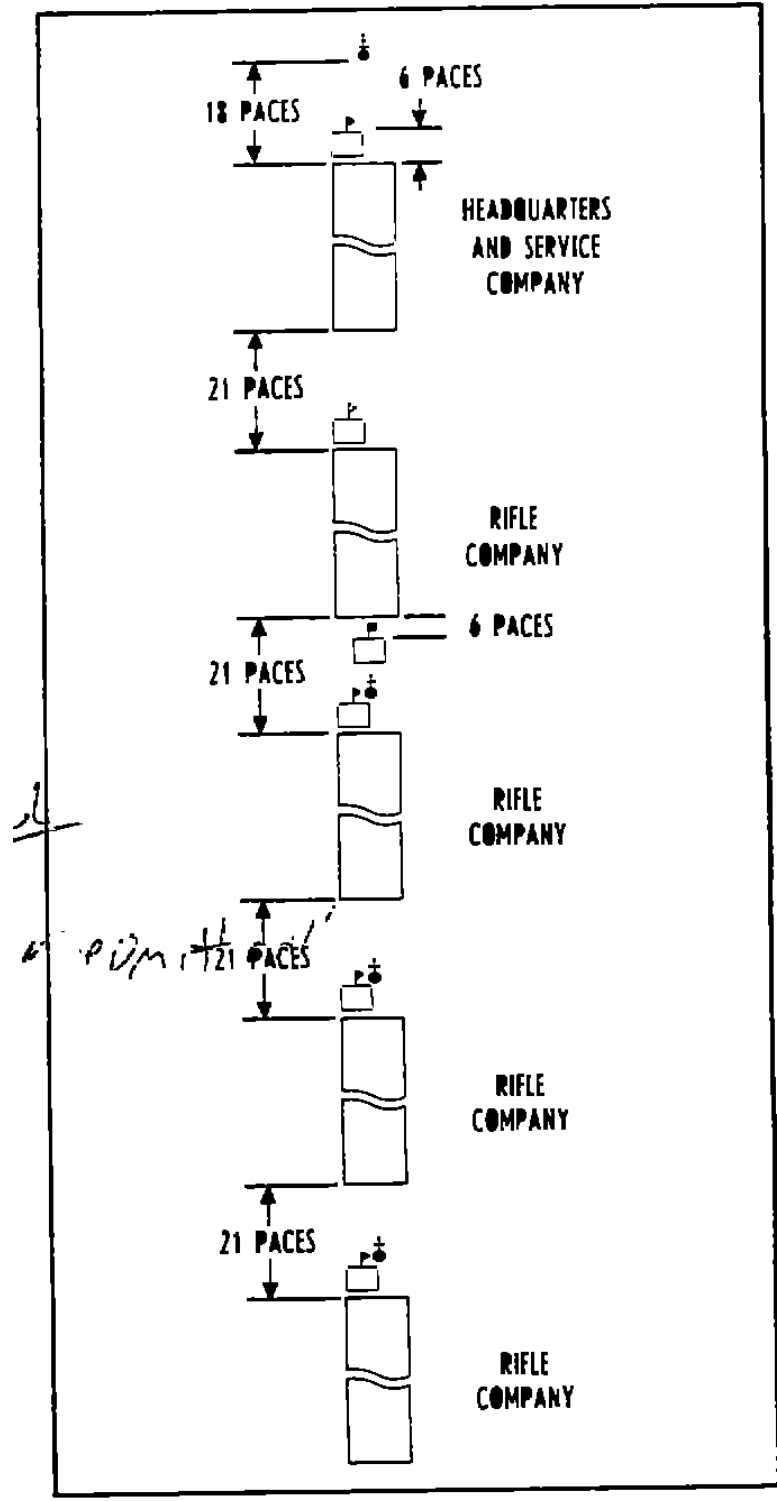

Figure 10-1. -Battalion in Column with Companies in Column.

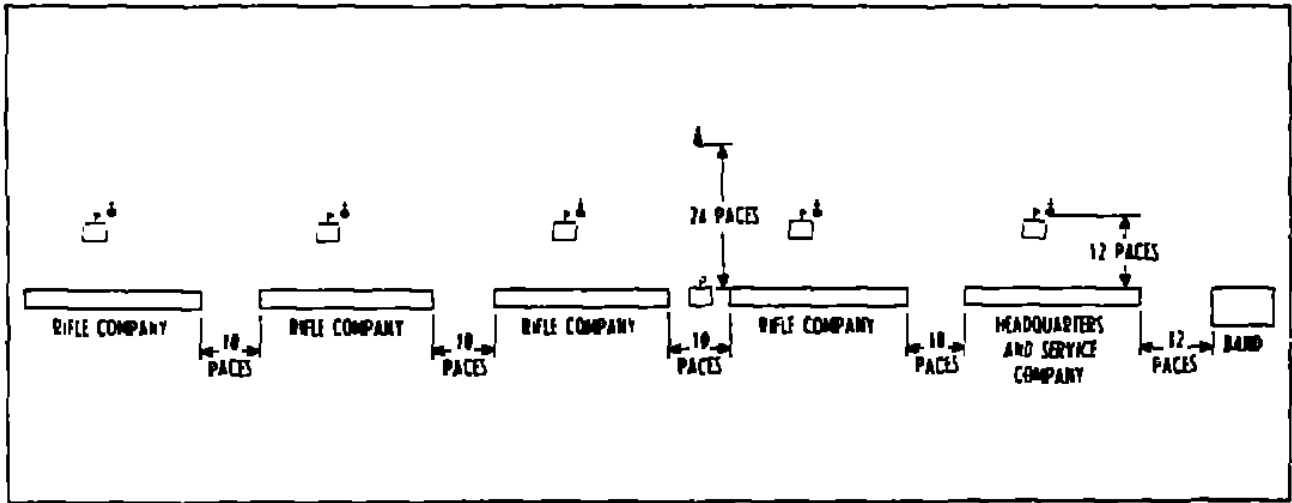

Figure 10-2. --Battalion in Line with Companies in Line

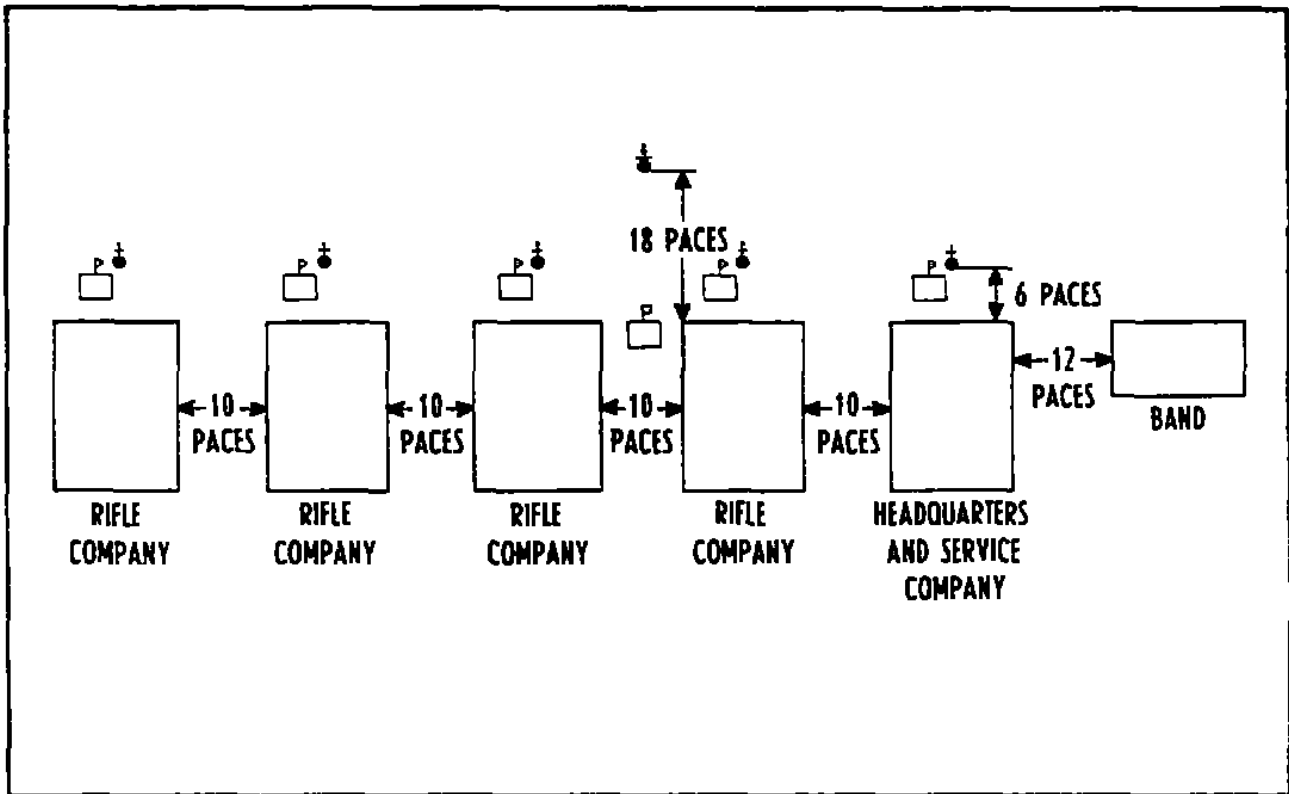

Figure 10-3. --Battalion in Line with Companies in Mass Formation.

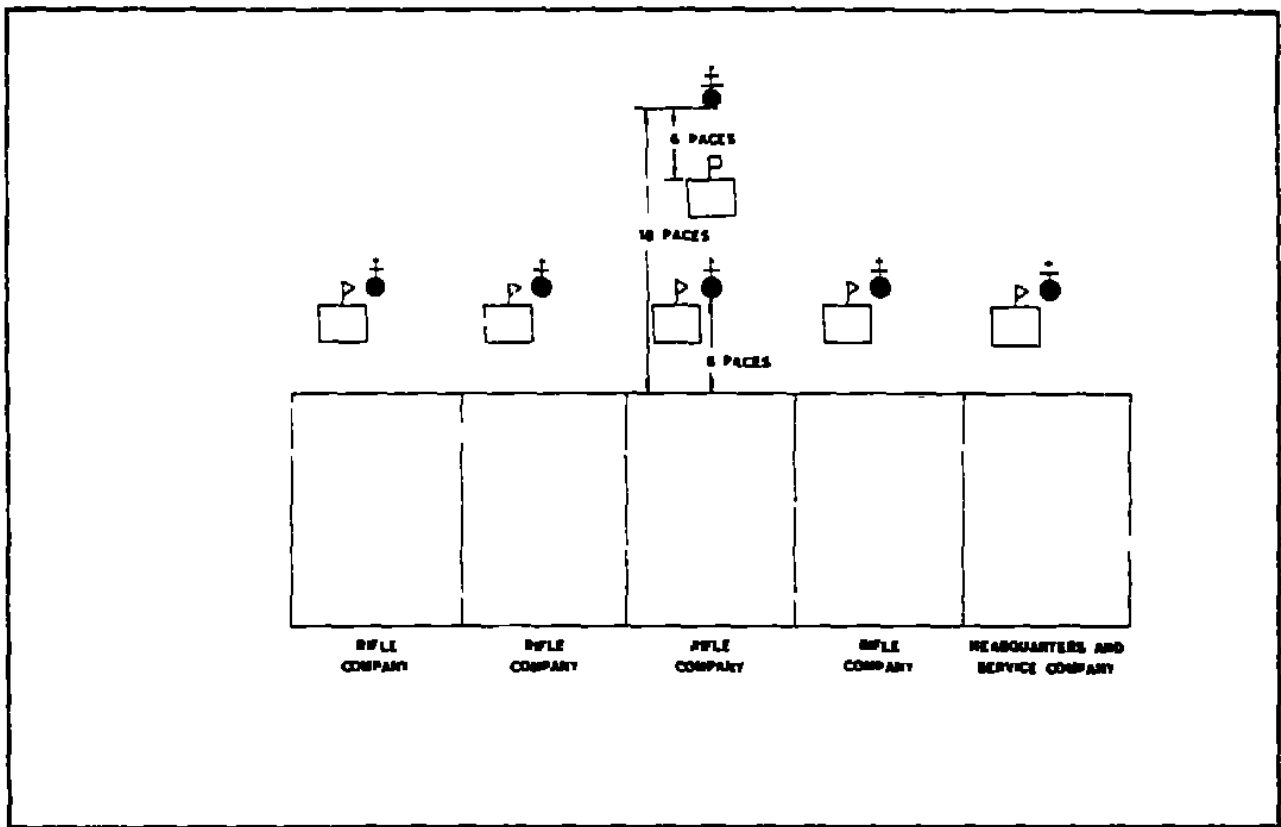

Figure 10-4.--Battalion in Mass Formation.

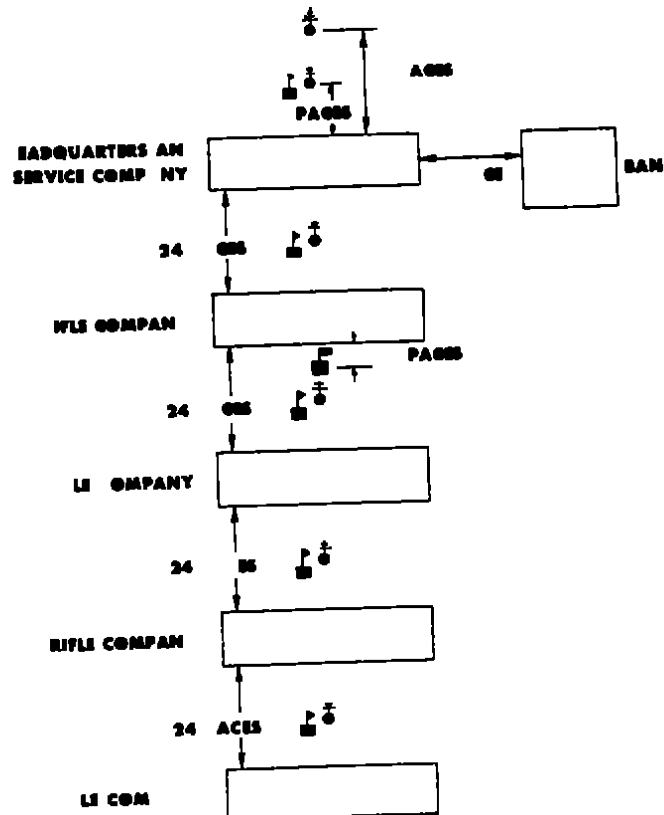

Figure 10-5.--Battalion in Column of Companies with Companies in Line.

[BLANK PAGE]

CHAPTER 11

FORMATIONS OF THE REGIMENT

11.1. TO FORM THE REGIMENT

a. The regiment does not drill by command. Its battalions form and march as directed by the regimental commander. When practicable, the formation and movement of the sub-divisions of the regiment should be made clear to subordinate commanders before starting the movement.

b. The regimental commander prescribes the formation, the uniform, individual and unit equipment, the place where the regiment is to form, the direction in which it will face, the hour of forming, location of the head of the column (or right of the line), and the order in column or line of the headquarters, band, battalions, special and attached units, and trains.

c. The regimental commander gives his orders by voice, by bugle, by signal, or in writing. They may be given directly to the officers concerned or communicated to them through his staff.

d. Before the regiment is formed, the regimental commander may cause the positions which are to be taken by the larger elements to be indicated by markers.

e. Upon completing a movement ordered by the regimental commander, battalions and independent companies may be given REST until another movement is ordered. After a ceremony has started, however, units remain at attention until ordered to stand at parade rest or at ease by the regimental commander or adjutant.

f. Prior to forming the regiment for any purpose, at the locations designated, each independent company forms at "Assembly" (see paragraph 9-3), and each battalion forms without its colors at the first, or its own, battalion "Adjutant's Call" (see paragraph 10-5). The color guard and color battalion, after forming, receive the regimental colors (see paragraph 16-5) prior to ceremonies or other prescribed occasions. All units then await the second or regimental "Adjutant's Call" to form the regiment.

g. To form for regimental ceremonies, the procedures described for forming battalions in line in paragraphs 10-6 and 10-7 or battalions in mass formation in paragraph 10-8 are followed, except as indicated below:

(1) The regimental adjutant takes post 8 paces from where the right flank of the regiment will rest, faces down the line, and draws sword if so armed. At the sounding of regimental "Adjutant's Call", the battalion adjutants take post on the line on which the regiment forms, each taking position so as to be 6 paces from and facing where the right flank of his battalion will rest. When all companies of a battalion are on line, its adjutant marches by the most direct route and takes post in the battalion staff.

(2) When all units of the regiment are on line, the regimental adjutant marches by the most direct route to a position midway between the line of battalion commanders and the regimental commander, and faces the regiment. After all units have completed dressing to the right, the regimental adjutant causes the guides to post (if units marched on at "Adjutant's Call") and bayonets to be fixed (if so prescribed). The ceremony then proceeds as for a review in paragraph 13-5a, as for a parade in paragraph 15-3, or as for a formation in paragraph 15-5, as appropriate.

h. To form for marches, or prior to participation in a larger unit ceremony, the regiment forms at its designated location at regimental "Adjutant's Call" (which may be by voice command or by music) according to the same procedures set forth for a battalion in paragraph 10-5, except commanders of battalions and independent companies report their arrival in the regimental formation to the regimental adjutant.

i. When the regimental commander or adjutant gives commands for drill movements to be executed by the troops, the command is given in a voice just loud enough to be distinctly heard by subordinate commanders and in a manner so as not to cause execution by the troops. Subordinate battalion and independent company commanders, in succession from right to left in line or front to rear in column, then give the necessary preparatory command and command of execution for the movement. For example, the regimental adjutant orders PRESENT ARMS in a manner which does not demand execution by the troops. Each subordinate battalion and independent company, in succession, executes the movement only when the command PRESENT, ARMS is given by its commander.

j. The color guard and color battalion are posted within the regimental formation in a similar manner to the posting of the color guard and color company within a battalion formation (paragraph 10-4b).

11.2. STAFF

The regimental staff forms, changes position, and marches in a manner similar to that prescribed for the battalion staff (see par. 10-3).

11-3. TO DISMISS THE REGIMENT

To dismiss the regiment, the regimental commander orders the battalion commanders to dismiss their organizations.

11-4. FORMATIONS

For formations of the regiment, see figures 11-1 through 11-4.

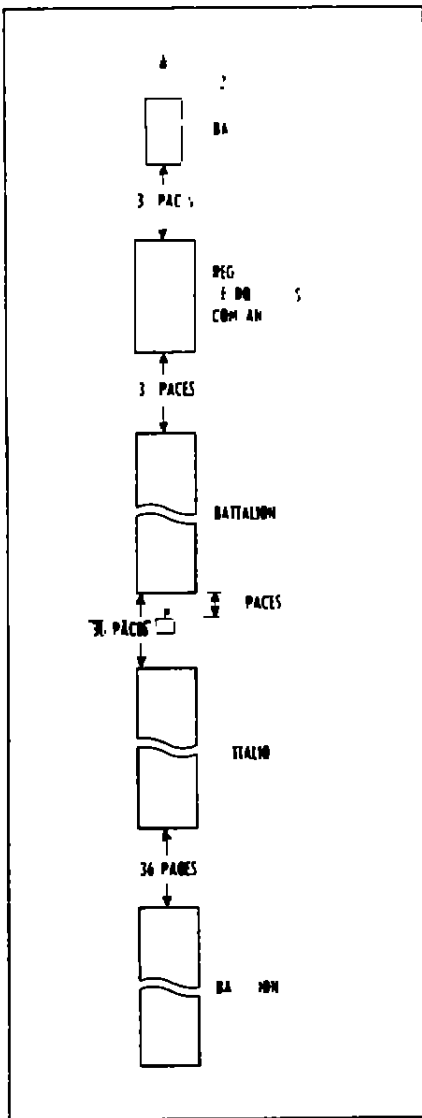

Figure 11-1.--Regiment in Column with Battalions in Column; Companies in Mass.

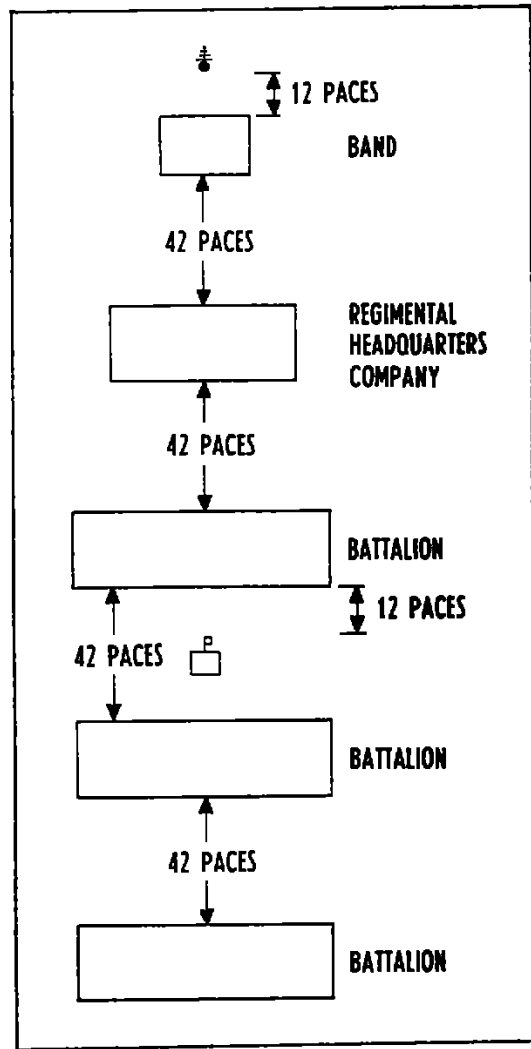

Figure 11-2.--Regiment in Column with Battalions in Mass Formation.

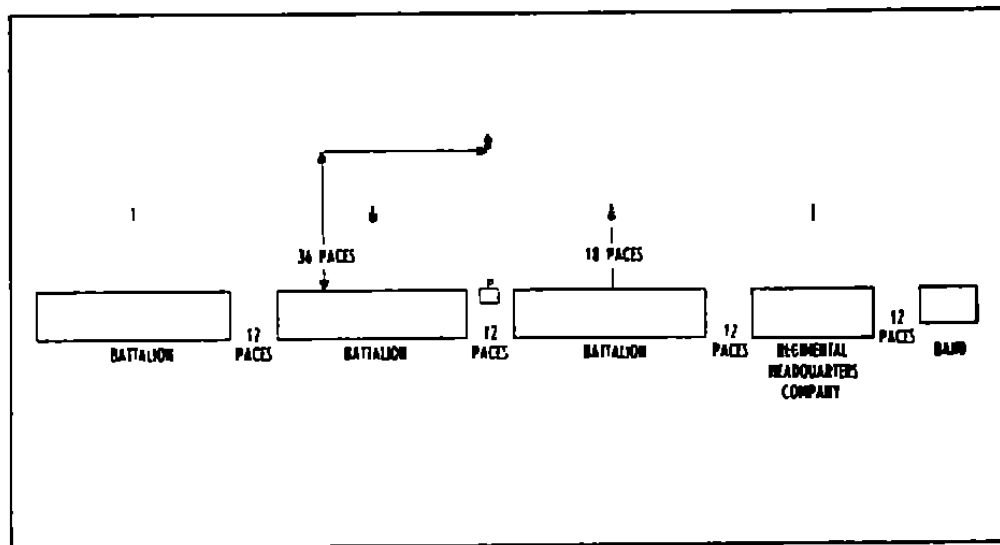

Figure 11-3.--Regiment in Line with Battalions in Mass Formation.

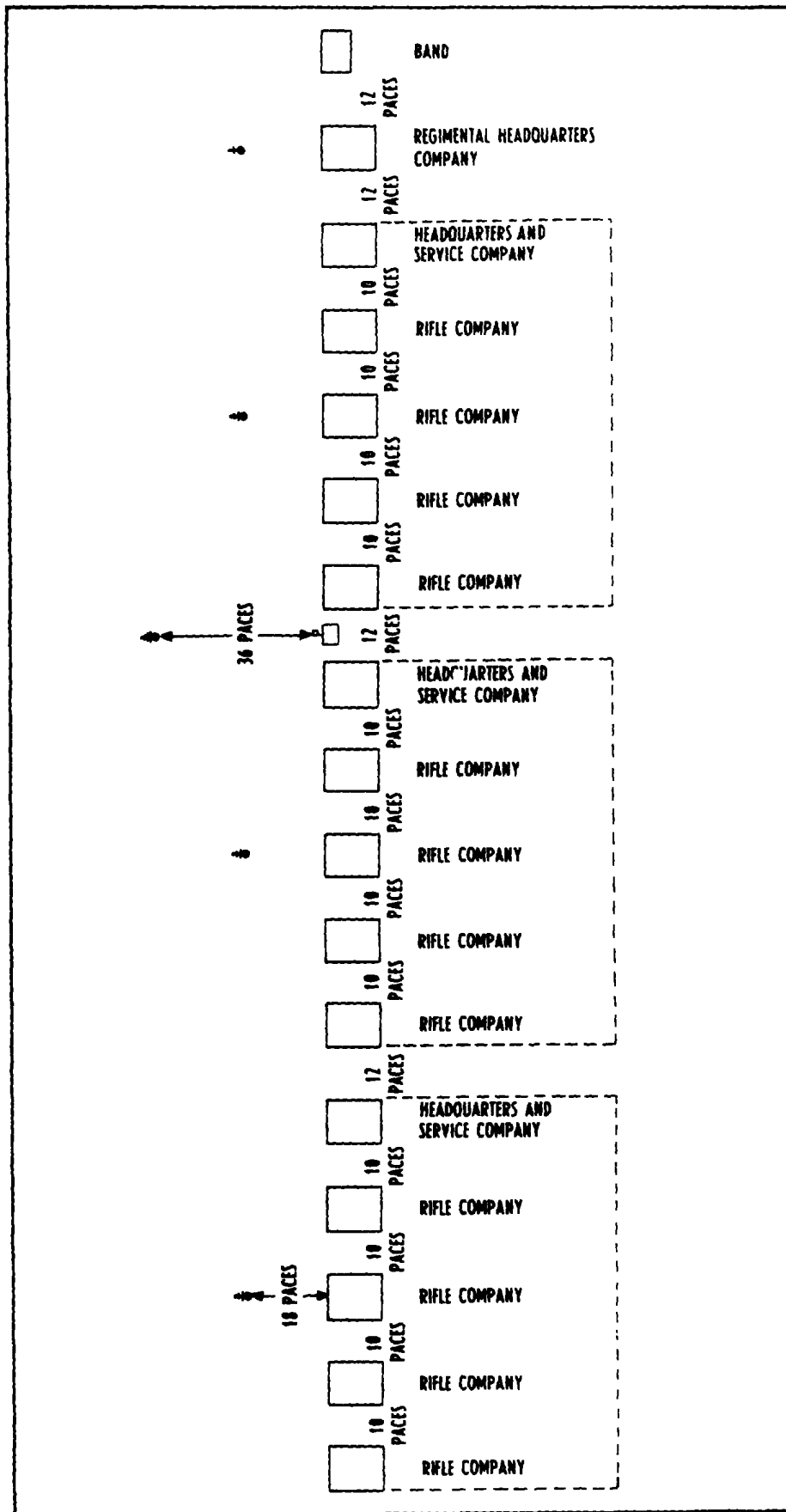

Figure 11-4.--Regiment in Line with Companies in Mass Formation.

PART II
CEREMONIES
CHAPTER 12
GENERAL INFORMATION

12-1. ARRANGEMENT OF UNITS IN FORMATION

a. In ceremonies involving the U.S. Marine Corps and U.S. Navy units, the Marine unit shall be on the right of the line or the head of the column. The senior line officer, regardless of service, functions as the commander of troops.

b. In ceremonies involving other services of the United States, the order of formation from right to left in line and front to rear in column is as indicated below. The senior line officer, regardless of service, functions as the commander of troops.

- (1) Cadets, United States Military Academy.
- (2) Midshipmen, United States Naval Academy.
- (3) Cadets, United States Air Force Academy.
- (4) Cadets, United States Coast Guard Academy.
- (5) United States Army.
- (6) United States Marine Corps.
- (7) United States Navy.
- (8) United States Air Force.
- (9) United States Coast Guard.
- (10) Army National Guard of the United States.
- (11) Army Reserve.
- (12) Marine Corps Reserve.
- (13) Naval Reserve.
- (14) Air National Guard of the United States.
- (15) Air Force Reserve.
- (16) Coast Guard Reserve.

(17) Other training organizations of the Army, Marine Corps, Navy, Air Force, and Coast Guard in that order, respectively.

(18) During any period when the United States Coast Guard shall operate as part of the United States Navy, The Cadets, United States Coast Guard Academy, the United States Coast Guard, and the Coast Guard Reserve shall take precedence, respectively, next after the Midshipmen, United States Naval Academy, the United States Navy; and the Naval Reserve.

c. When foreign troops are invited to participate in ceremonies within the territorial jurisdiction of the United States, they will be assigned a position of honor ahead of United States troops. A small detachment of United States troops will immediately precede the foreign troops as a guard of honor.

d. When troops of two or more foreign nations participate, the order of precedence among them will be determined, except for the provisions of the above subparagraph, by the commander of troops in accordance with one of the following methods, whichever is deemed most appropriate:

(1) The relative ranks of the commanders of the forces from which the ceremonial detachments are drawn.

(2) The relative ranks of the commanders of the ceremonial detachments.

(3) The alphabetical order in the English language of the names of the nations concerned.

e. After troops are formed, subordinate commanders and their staffs face front. The commander of troops and his/her staff face the command. The commander of troops and his/her staff face the front to present the command to the reviewing officer.

12-2. STAFF SALUTES

Members of the staff of the commander of troops salute, with the commander, on his/her separate command to the staff, at the following times:

a. When passing in review.

b. When rendering honors.

c. When passing or being passed by the National Color.

d. While the "National Anthem", "To the Colors", or "Hail to the Chief" is played. Salutes are also rendered when "Retreat" is played during reviews and all ceremonies, except at evening parade. At evening parade, "Retreat" is played immediately after "Sound Off" while the troops are at parade rest, and is therefore not saluted. In this case, after "Retreat", troops are brought to attention and salutes are rendered while the "National Anthem" is played to lower the national ensign.

e. At any other time the troops are brought to present arms.

12-3. PLACE OF FORMATION

a. At "Assembly", companies are formed and inspected by their company commanders at their designated locations.

b. At "Adjutant's Call," for a ceremony involving a single battalion, the battalion forms on its designated location and conducts the ceremony. For a regimental ceremony, at the first "Adjutant's Call," each battalion forms at its designated location and the battalion is reported to its commander. At the second sounding of "Adjutant's Call," the regiment is formed and the ceremony conducted.

c. For ceremonies conducted by organizations larger than a regiment, such as a division, at the second "Adjutant's Call," each regiment is formed and is reported to its commander. At the third "Adjutant's Call," the command is formed and the ceremony is conducted.

12-4. ORGANIZATION AND STRENGTH OF UNITS

a. For formations, reviews, and parades when maximum troop participation is desired, units are organized, in as much as practicable, according to their actual tables of organization. Size of units will vary according to actual strengths as will the number of companies in each battalion and platoons in each company. Similarly, the number of ranks in each platoon will vary according to the number of squads. For units not organized by table of organization into squads, they should be formed so that platoons are in three ranks in line and three files in column.

b. When the appearance of troops in formation is of primary concern, the organization and strength of participating units should be standardized. Each platoon should be organized so as to form in three ranks in line and three files in column. The strength of each platoon should be the same so that, when in line, all platoons occupy the same frontage.

12-5. COMMANDS, DRILL MOVEMENTS, AND UNIT FORMATIONS

a. During ceremonies, unit commanders give commands, units execute drill

movements, and units employ formations as prescribed in Part I for the squad, platoon, company, battalion, and regiment.

b. Formations for ceremonies may be modified by commanding officers when the nature of the ground or exceptional circumstances require such changes. Normally, modifications are generally limited to adjusting the paces specified for intervals and distances in a given formation to fit the ground used for conduct of the ceremony.

12-6. ADMINISTRATIVE DETAILS

The organization, uniform, arms, and equipment of units participating in ceremonies, along with any other necessary administrative information, are prescribed by the commander of troops, or may be prescribed by unit standing operating procedure to preclude the necessity of frequent repetition in individual ceremony orders.

12-7. NAVY CEREMONIES CONDUCTED INDOORS

When special circumstances, such as use of gymnasiums, hangars, and hangar bays dictate, the commanding officer may direct that participants and guests alike remain covered and render appropriate salutes as required by the particular ceremony. In such instances, commanding officers will detail the specific requirements for remaining covered and rendering appropriate salutes.

[BLANK PAGE]

CHAPTER 13

REVIEW

13-1. ELEMENTS OF A REVIEW

A review consists of four parts:

- a. Formation of troops.
- b. Presentation and honors.
- c. Inspection (trooping the line).
- d. March in review.

13-2. COMMAND OF TROOPS

The senior officer taking part in a ceremony is designated commander of troops. He is responsible for the formation, presentation, and march in review. When a commander reviews his own troops, he designates another officer as commander of troops. When the review is given for an important visitor or senior commander, the local commander designates another officer so he may accompany the visitor or senior during the review.

13-3. PREPARATIONS

The line on which troops are to form and along which they are to march is marked out or otherwise designated by the adjutant of the unit. The post of the reviewing officer, opposite the center of the line of troops, is marked on each flank with a flag. Figure 13-1 depicts the minimum marking for a review. Additional flat markers may be used to designate the subordinate unit commander's posts, unit guide posts, and turning points for approaching the line of troops.

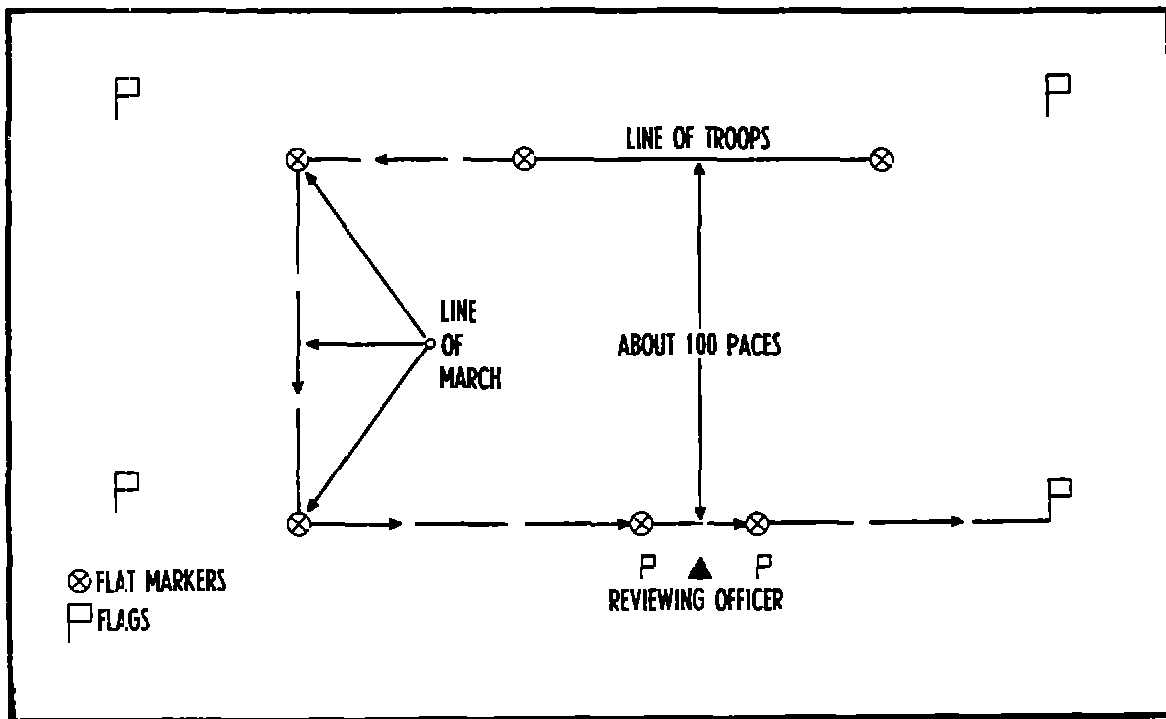

Figure 13-1.--Field Marking in Preparation for a Review.

13-4. TROOP FORMATIONS

a. Troops form in line for a review. Battalions and regiments may form in line with companies in line of with companies in mass formation (see Chapters 10 and 11). When space is limited, for reviews conducted by regiments and larger organizations, the formation may be in line with battalions and independent companies in mass formation. Such formations may be modified when necessary because of space available or other exceptional circumstances. The initial formation will also influence the formation in which troops are to march in review (see figure 13-2).

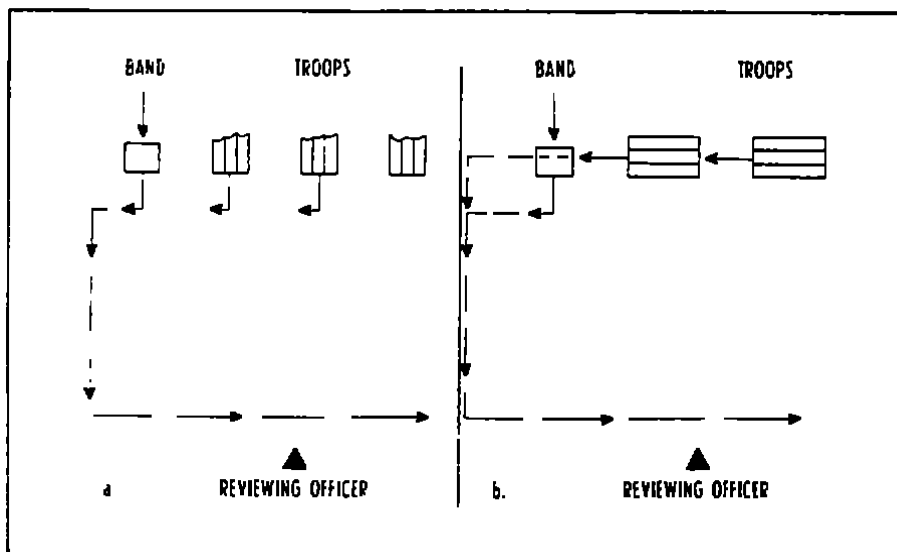

Figure 13-2.--Troop Formations.

b. In reviews involving two or more arms or types of organizations, troops are arranged as directed by the commander of troops. The following order, from right to left on line, may be used as a guide: infantry units, artillery, tanks, and motorized and service units. The provisions of paragraph 12-1 also apply in reviews consisting of unit from different services of the United States of foreign nations.

c. Arrangements should be made to provide for forming normal march columns after passing in review. An area should be designated where this can be accomplished without blocking the line of march of units which have not yet passed in review. Unless otherwise directed by the commander of troops, after passing in review, units revert to the control of their respective commanders.

13-5. FORMING FOR THE REVIEW

a. Forming for a Battalion or Regimental Review.

(1) To form for the review, prior to the Adjutant's Call, the commander of troops initially takes position with the staff 6 spaces in front of the reviewing area and facing the line of troops (remaining with swords in scabbards, if so armed). Otherwise, units march and form in line at Adjutant's Call for the review, or take their prescribed positions on the line of troops prior to Adjutant's Call, then, under supervision of the adjutant, are dressed to the right, guides are posted (if units marched on), bayonets fixed (if so prescribed), and the formation presented to the commander of troops, in the same manner as prescribed for forming a battalion for ceremonies in Chapter 10, and for a regiment in chapter 11. Prior to presenting the command to the commander of troops, the colors may be trooped as prescribed in paragraph 16-6, in which case, after the color guard has taken its position in line on the left of the color company (battalion), the

adjutant presents the formation to the commander of troops.

(NOTE: Also at Adjutant's Call to form for the review, the commander of troops and staff march from their positions as described above to a position midway between the line of troops and the reviewing area where they halt facing the line of troops (remaining with swords in scabbards).

(2) To present the command to the commander of troops, the adjutant still facing the troops and at his/her post midway between the line of company (battalion) commanders and the commander of troops, commands PRESENT, ARMS. When all troops are at present arms, the adjutant faces the commander of troops and reports, "Sir, the Parade is Formed". The commander of troops returns the salute and directs the adjutant to TAKE YOUR POST, SIR. The adjutant then marches around the commander of troops' right to his/her post in the staff, halts, faces the battalion (regiment), and comes to order sword. When the adjutant is in position, the commander of troops, with the staff (except the adjutant who already has swords drawn) draws sword. The commander of troops then commands ORDER, ARMS.

(3) If not at an evening review including "Retreat", after all troops are at the order, the commander of troops, still facing the troops, directs the senior staff officer to BOX THE STAFF in a voice only loud enough for the staff to hear. The senior staff officer then reverses the staff (see paragraph 10-3) so that it halts 2 paces from and facing the commander of troops (who remained facing the formation). The commander of troops next faces the front and waits for the reviewing officer to take post in the reviewing area (see paragraph 13-6). If appropriate, prior to facing the front, the commander of troops may command PARADE, REST, then bring the staff to parade rest, and wait for the reviewing officer to take position.

(4) If at evening review including "Retreat", after the command has been presented to the commander of troops and has returned to order arms, the staff does not reverse to face the front. Instead, the commander of troops commands PRESENT, ARMS, then, when all troops are at present arms, commands SOUND RETREAT (or gives a prearranged signal to the band or field music) at the time prescribed for evening colors. The bugles sound "Retreat" and the band plays the "National Anthem" immediately afterwards. The flag is lowered during the "National Anthem" as prescribed in paragraph 16-3. The commander of troops and staff, who saluted immediately after the troops presented arms, face the formation throughout, then, after the last note of the "National Anthem" terminate their salutes and the commander of troops commands ORDER, ARMS. The Staff is reversed as described above, and if appropriate, the commander of troops brings the command to parade rest. The commander of troops faces the reviewing area and waits for the reviewing officer to take post (see paragraph 13-6). (NOTE: To conduct retreat as part of an evening review, troops must be formed in sufficient time prior to sunset to permit the command to be presented and evening colors to be conducted at the proper time.)

b. Forming for Large Reviews.

(1) For reviews conducted by organizations larger than a regiment, such as a division, the same basic commands, procedures, and sequence of events prescribed above for a battalion or regimental review apply.

(2) Normally, in large reviews battalions and independent companies are in mass formation. Troop units take their positions on the line of troops prior to the "third"

Adjutant's Call being sounded to form for the review. In this regard, at the "second" Adjutant's Call, regiments may be formed, presented to their commanders, and reports received at their designated locations, or the "second" Adjutant's Call may be conducted so that the regiments are formed at their positions on the line of troops for the review. Regardless, in large reviews, the commander of troops should prescribe the routes of march and departure and arrival times. If the frontage of units has been measured and marked, they may arrive independently in any convenient order to occupy their places on line. If this is not done, units must form in succession from the right. Because of the time consumption involved in the latter method, the former is preferred.

(3) The commander of troops and adjutant of reviews conducted by organizations larger than a regiment give commands in the same manner as prescribed for a regiment in chapter 11, i.e., in a manner which does not require execution by the troops. In formations consisting of two or more regiments, the regimental commander repeats those commands requiring execution by the troops. Within each regiment, battalion and independent companies execute movements on the command of execution of their respective commanders. Independent battalions, not part of a regiment, execute movements on the command of their respective commanders. Movements are executed successively by units from right to left.

13-6. REVIEWING PARTY

a. After the staff has reversed and the commander of troops has faced the reviewing area, the reviewing officer, with his staff, moves to his post to receive the review.

b. The local commander, distinguished civilians, and the officer and enlisted staff take positions at their posts (see fig. 13-3) facing the troops. The officer who is senior, with his staff, will take position on the right.

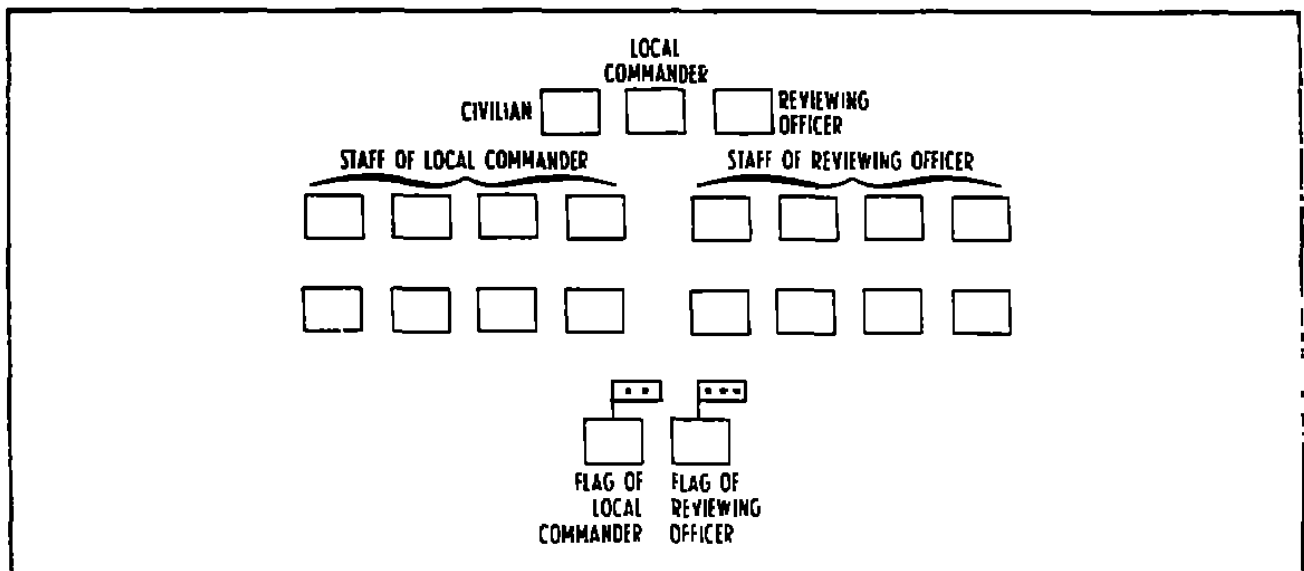

Figure 13-3.--Reviewing Party

c. An officer from the local commander's staff is designated to escort distinguished civilians to their positions. If a civilian is to receive the review, he takes his position on the right of the local commander. If necessary, he is given an explanation of the ceremony by his escort or the local commander.

13-7. CEREMONY FOR A REVIEW

a. Presentation and Honors.

(1) As the reviewing officer approaches his post, the commander of the troops brings his command to attention. When the unit is larger than a battalion, the commander uses the same order, ATTENTION, but in a manner and voice which do not demand execution by the troops. Subordinate commanders then successively, beginning with the right unit, bring their commands to attention.

(2) When the reviewing officer is in position, the commander of troops directs his command to present arms. When all units have presented arms, he faces the reviewing officer and salutes. His staff salutes with him (see fig. 13-4).

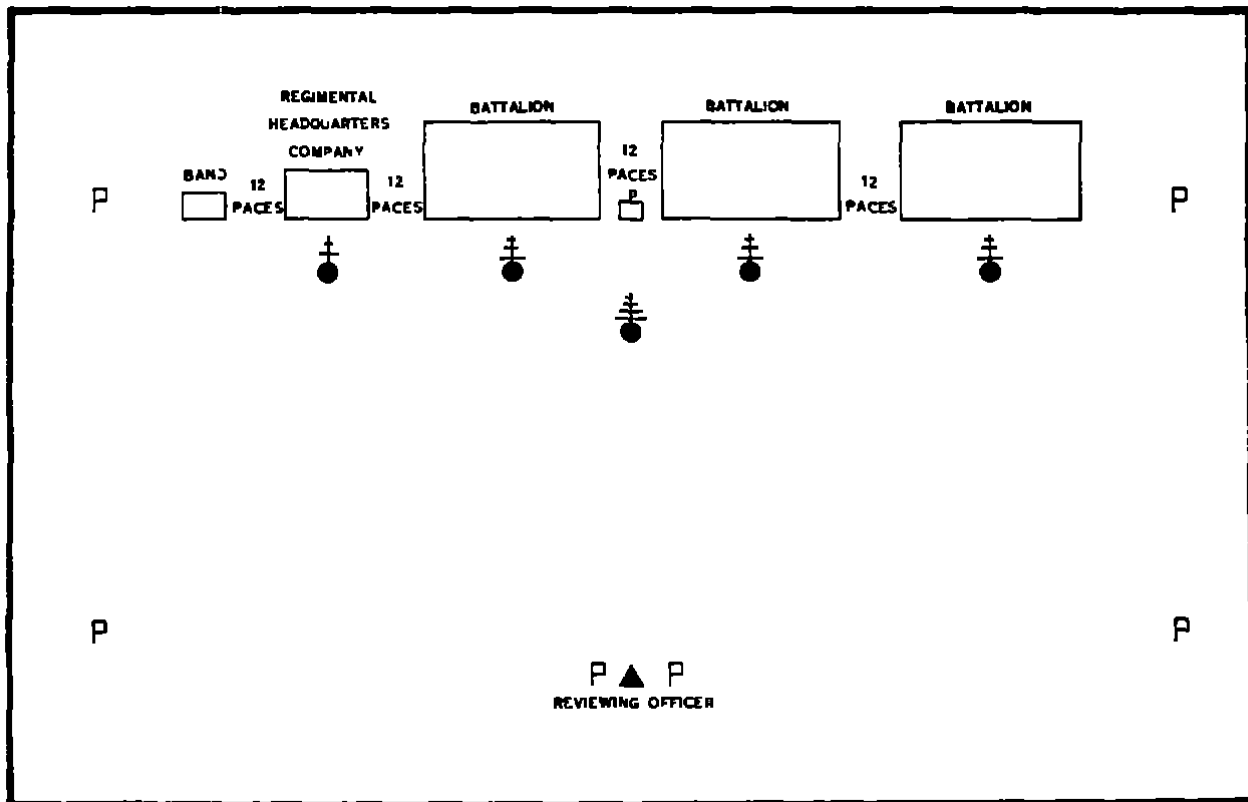

Figure 13-4--Regimental Review, Battalions in Mass Formation.

(3) If his rank so entitles him, honors to the reviewing officer are then rendered (see U.S. Navy Regulations). The band (a designated band near the center of the command is more than one band is present) or field music sounds the honors upon the salute of the commander of troops. When the honors are completed, the commander of troops terminates his salute (his staff with him) and brings his troops to order arms. If the formation consists of more than one battalion, he orders AT EASE.

(4) When artillery is present in the formation, or if saluting guns are available, and when the commanding officer deems it practicable, a salute may be fired. The first gun is fired following the last note of the honors. The firing detachment rejoins its unit after firing the last gun. For those entitled

to a gun salute, this honor may be rendered in addition to the salute described, in U.S. Navy Regulations. It should be limited to special ceremonial occasions.

(5) When the grade of the reviewing officer entitled him to the honor, each organizational color salutes with its command.

(6) The reviewing officer, his staff, and all military spectators in uniform and covered salute at the first note of the music. They hold their salutes until the music and gun salute are completed.

b. Inspection.

(1) After the honors, the reviewing officer and the local commander (host) move forward and halt 6 paces in front of the commander of troops. Staffs do not normally accompany the inspection party, but the reviewing officer may direct his staff, or any part of it, to accompany him to the post of the troop commander or throughout the inspection if he so desires. The commander of troops and the reviewing officer exchange salutes and the commander reports, "Sir, the Command is prepared for inspection." He then conducts the reviewing party around the formation. The commander of troops and the local commander (host) march to the right of the reviewing officer (on the side away from the troops). Beginning with the unit on the right of the line, they pass along the front of the line of troops to the left. The reviewing party passes immediately in front of the line of company commanders regardless of the size of the review, except when companies are in a line formation, in which case they pass immediately in front of the platoon commanders. They then pass around the rear of the troops. If staff members accompany the reviewing party, they follow their respective commanders in single file. If the inspection is to be made in vehicles, the reviewing party embarks at the post of the reviewing officer. The reviewing officer enters first and occupies the left rear position. The local commander (host) occupies the right rear position. If staffs are to accompany the reviewing party, the right front position in each vehicle is left vacant. The vehicle (approaching from the commander of troops' left) moves to the post of the commander of troops and stops. The commander of troops salutes, reports, and enters the vehicle, occupying the right front position. His staff occupies the vacant positions in the staff vehicles if staffs accompany the reviewing party, and flags remain at their posts. Upon departure of the reviewing party, the senior staff officer commands, "STAFF, PARADE, REST." After the inspection has been completed, the senior staff officer calls the staff to attention prior to the return of the commander of troops.

(2) The reviewing officer makes whatever general inspection of the command he may desire. A detailed inspection is not a party of the ceremony of review.

(3) The organizational band plays while the reviewing officer is passing around the troops.

(4) If the formation is standing at ease of parade rest, each massed unit is brought to attention and given eyes right by its commander upon the approach of the reviewing officer. As the reviewing officer passes to his front, each man turns his head and eyes to the left, following the reviewing officer, until he is looking straight to the front. Each man then stops the movement of his head and eyes and remains at attention. After the reviewing officer has passed each massed unit, its commander gives his troops parade rest. They remain at this position until the reviewing officer approaches the rear of the unit, at which time it is brought to attention and kept so until the reviewing party has passed. While the reviewing party is passing the front of a massed unit, its commander salutes; other officers do not. Except for the commander, personnel armed with the sword remain at order sword. The reviewing party salutes the national

color(s) when passing the front of the formation, but not when passing the rear. The color guard(s) executes eyes right when the reviewing officer passes the front of the formation in the same manner as other units, from order color. While the reviewing party is passing the rear of a massed unit, after the commander has called the unit to attention, he faces toward his unit until the party has passed.

(5) Upon arriving at the right of the band after passing around the line of troops, the commander of troops halts and salutes. The reviewing officer returns the salute. Then he returns to his original post. After the reviewing officer has passed him, the commander of troops returns to his post and faces the reviewing officer. If the reviewing party has inspected in vehicles, the first stop is made at the post of the commander of troops. Here, the commander of troops dismounts. The troop commander exchanges salutes with the reviewing officer (staff members do not). He then takes his post and the reviewing officer returns to his.

(6) After resuming his/her post, the commander of troops faces the command and orders the troops to attention. After the troops are at attention, presentation of decorations (see chapter 14) may be conducted and then the command is marched in review. If there is no presentation of decorations, the command immediately proceeds to march in review.

c. March in Review.

(1) After the reviewing officer has taken position back in the reviewing area and the troops are at attention, the commander of troops commands PASS IN REVIEW. On this command the band changes direction to that of the line of march and halts.

(2) If the review is being conducted by a battalion or regiment formed with companies in line or companies in mass formation, after the band is halted, troops march in review in the same manner as prescribed for a parade in paragraphs 15-2 or 15-3, as appropriate.

(3) If the review is being conducted by a regiment with battalions and independent companies in mass formation, or by a larger unit, the march in review is conducted as follows after the band has halted.

(a) The commander of the right battalion or independent company commands RIGHT SHOULDER, ARMS; RIGHT TURN, MARCH. The band steps off on the command of execution, MARCH, with the right battalion or independent company.

(b) Succeeding battalions and independent companies are brought to right shoulder arms and execute a right turn in succession from right to left by their commanders so as to follow at the prescribed distances.

(c) The band and each massed battalion or independent company change direction to follow the line of march on the commands of their respective commanders, without command of their regimental commanders or the commander of troops. Each turning point should have been previously marked as described in paragraph 13-3.

(d) The commander of troops and staff march so as to take position at the head of the band after the second change of direction. In a review conducted by a unit larger than a regiment, regimental commanders and their staffs initially march parallel with the line of troops and take position at the head of their regiments after the first change of direction in the line of march.

(e) The commander of troops and each battalion and regimental commander, with their staffs, salute and execute eyes right

when 6 paces from the nearest member of the reviewing party. They hold their salutes and eyes right positions until 6 paces beyond the reviewing party. The senior company commander in each massed battalion and commanders of massed companies command EYES, RIGHT, when 6 paces from the nearest member of the reviewing party. All officers, except those armed with the sword in the interior of a formation (other persons to the front and sides), salute. The salute and eyes right position is held until the massed unit is 6 paces past the reviewing party.

(f) The band (each band if more than one is present) executes column left when it has passed the reviewing stand. It then executes a second and third column left so it will end up in front of and facing the reviewing officer at least 12 paces from the left flank of the marching troops. It continues to play until its organization has passed. It then stops playing and follows the last unit of its organization from the parade area. The band of a following unit begins playing as soon as the preceding band has ceased playing. In large reviews, bands may alternate playing in order to rest the musicians. Another alternative is to mass bands and post them as one.

(g) The band leader and the drum major execute and terminate their salutes at the same time prescribed for other commanders.

(h) If the reviewing officer is entitled to a regimental color salute, the color salutes and terminates the salute at the same times prescribed for the commanders of massed units.

(i) After the last turning movement, while marching in review, the guide is toward the flank on which the reviewing officer is posted.

(j) After saluting the reviewing officer while marching in review, the commander of troops, followed by his staff, turns out of column and takes position on line with and to the right of the reviewing officer. If armed with the sword, he returns sword. The staff takes post in corresponding position besides the staff of the reviewing officer. The staff returns sword with their commander. The commander of troops orders HAND, SALUTE and READY, TWO at the appropriate times as the national color passes in review. When the rear element of his command has passed, the commander of troops faces the reviewing officer and renders a hand salute. When the salute has been returned, he and the staff draw sword and follow their command from the field. If the commander of troops and his staff are in vehicles, the vehicles are parked on the side of the reviewing officer toward the direction of march and in rear of the lines occupied by the reviewing officer and his staff.

(k) All individual in the reviewing stand salute the national color as it passes. When trooping the line, all members of the reviewing party salute the national color as they pass to its front.

(l) The reviewing officer returns the salutes of all commanders down to and including battalion commanders as they pass to his front while marching in review. Members of his staff donot return such salutes. For a battalion formation, he returns the salutes of the company commanders.

(4) After marching off the parade ground following the march in review, the color guard and color company (battalion) return the colors as prescribed in paragraph 16-5. Units march to their respective areas and are dismissed by their commanders.

CHAPTER 14

PRESENTATION OF DECORATIONS AND INDIVIDUAL RETIREMENT

14-1. GENERAL

a. Reviews, when practicable, are held on the following occasions:

- (1) The presentation of United States decorations.
- (2) The decoration of organizational colors.
- (3) The presentation of a foreign decoration.

(4) The retirement of an individual or a group of any rank. Local commanders should consider it appropriate, when only one distinguished individual is retiring, to allow that individual to participate as the reviewing officer. When the colors are marched forward, the retiree would position himself front and center of the colors. The local commander would then present the retirement orders and/or make appropriate remarks. The retiree would then return to the reviewing officer's post.

b. Formations and procedures for the reviews are as described in chapter 13 until the reviewing officer completes his inspection. At that time the procedures in this chapter are followed.

14-2. POSITIONING OF PERSONS TO BE DECORATED AND RETIREES

After the reviewing officer has inspected the troops and resumed his post, the commander of troops, from his post, does an about face and commands PERSONS TO BE DECORATED, RETIREES, AND ALL COLORS, CENTER, MARCH. On MARCH, persons to be decorated, retirees, and all colors move by the most direct route to the following posts:

a. Persons to be decorated and retirees form a single rank in the center of the command, 15 paces in front of the line of company commanders. They form according to the rank of the decoration to be conferred, the highest ranking decoration on the right. Those to receive similar decorations take position by seniority within each decoration group. Retirees not receiving decorations form to the left of persons being decorated.

b. Colors to be decorated form in a single rank 5 paces in front of the center of the line of persons to be decorated. The color to receive the highest decoration is on the right, the remainder to the left according to the rank of decorations to be conferred.

c. All other colors with color guards form in a single rank 5 paces behind the center of the line of persons to be decorated. Each color is in the same relative position as its parent organization within the formation for review.

14-3. PRESENTATION TO REVIEWING OFFICER

The commander of troop's staff, under the command of the senior staff officer, executes right face, moves to the right a sufficient distance to allow clearance for the colors and persons to be decorated, then halts, and executes left face. The commander of troops takes position 5 paces in front of the leading element of the group to be decorated or retired. He executes an about face and commands FORWARD, MARCH. Upon his command, the entire group marches forward and the band begins playing. The guide is center in all ranks. After the detachment has passed, the staff returns to its original position. When he has reached a point 10 paces from the

reviewing officer, the commander of the troops halts the group by the command DETACHMENT HALT (see fig. 14-1). The band stops playing as the detachment halts. The troop commander then salutes the reviewing officer and reports, "Sir, the persons (and/or colors) to be decorated/retired are present." The reviewing officer returns the salute and orders, "Present the command, Sir." The commander of troops returns to his post by the most direct route around the right flank of the persons and colors to be decorated. On reaching his post, he commands PRESENT, ARMS, faces about, and orders his staff to PRESENT, ARMS. The band plays the "National Anthem." If only a field music is present, he sounds "To the Colors." On completion of the music, the commander of troops brings the command to order arms. The persons to be decorated and/or retirees also salute with the command.

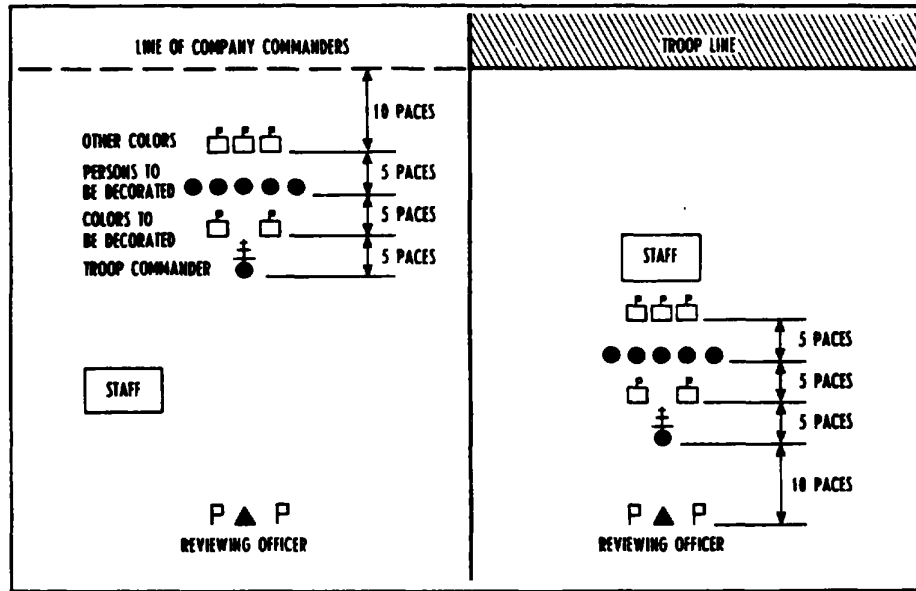

Figure 14-1.--Presentation of Decorations.

Figure 14-1.--Presentation of Decorations.

14-4. PRESENTATION OF AWARDS

a. A designated staff officer reads the orders and citations of the awards to be presented. In ceremonies involving many awards, the commanding officer may direct that such portions of orders and citations deemed appropriate be read. After the reading of the first citation, the reviewing officer, accompanied by designated necessary staff personnel, advances to the first color/person to be decorated. He attaches the appropriate streamers/decorations and then moves to the next color or person to be decorated and that citation is read. For awards to individuals, the reviewing officer attaches the appropriate decoration to the uniform over the left breast pocket and shakes hands with the person decorated. He will also shake hands with each retiree. Immediately after shaking hands, the person decorated or retiree salutes the reviewing officer. He returns the salute before proceeding to the next person.

b. After shaking hands with the last person, the reviewing officer resumes his post. The persons decorated/retirees, at the command of the senior, form line at normal interval on the left of the local commander, or as otherwise directed. The colors return to their posts by the most direct route. When the colors have taken their posts, the reviewing officer directs the commander of troops to march the command in review.

c. The march in review is conducted in accordance with paragraph 13-7c.

CHAPTER 15
PARADES

15-1. BATTALION AND REGIMENTAL CEREMONIAL PARADES

a. The appearance and movement of troops in formation are the primary considerations of a ceremonial parade. The preparation, the organization of troops, and the conduct of a ceremonial parade are similar to that for a review, except that the inspection by the reviewing officer is omitted. Consequently, a parade consists of three basic parts: formation of troops; presentation and honors to the reviewing officer; and march in review. Other differences are that during the formation of troops the band "Sounds Off" and troops the line, reports are received, orders are published by the adjutant, and officers and guidons are marched center. As with a review, bayonets may be fixed and the colors may be trooped, and at evening parade, retreat may be included as part of the ceremony. Decorations may also be presented during a parade after presentation and honors to the reviewing officer, and prior to the march in review.

b. Paragraphs 15-2 and 15-3 prescribe detailed commands and procedures for conducting battalion and regimental ceremonial parades, respectively. Normally, units larger than a regiment conduct a review (see Chapter 13), but these procedures may be adopted for parades conducted by larger organizations.

15-2. BATTALION CEREMONIAL PARADE

- a. The parade field is marked as prescribed for reviews in figure 13-1
- b. Formation of Troops.

(1) The commander of troops and staff initially take position facing the line of troops (with swords in scabbards) 6 paces in front of the reviewing area prior to Adjutant's Call. Under supervision of the adjutant, the battalion forms on the line of troops with companies in line or with companies in mass formation. To do so, companies march on at Adjutant's Call or take position on the line of troops prior to Adjutant's Call. Then companies dress to the right, guides are posted (if companies march on), and bayonets fixed (if prescribed) in the same manner as prescribed for forming for ceremonies in Chapter 10.

(NOTE: The commander of troops and staff, on the first note of the music following Adjutant's Call, march forward from their position in front of the reviewing area to a post midway between the reviewing area and line of troops and halt facing the troops (swords remaining in scabbards.)

(2) After the companies have completed dressing to the right and guides posted (if companies marched on at Adjutant's Call) and bayonets fixed (if prescribed), the adjutant, still facing the battalion from his/her post midway between the line of company commanders and the commander of troops, commands PARADE, REST; SOUND OFF. In the event the colors are trooped, prior to bringing the command to parade rest, the adjutant commands MARCH ON THE COLORS, and the ceremony prescribed in paragraph 16-6 is conducted. After the colors have been trooped, the adjutant commands, PARADE, REST; SOUND OFF.

(3) On the adjutant's command PARADE, REST, the companies come to parade rest, but the adjutant, commander of troops, and staff remain at attention. At the command SOUND OFF, the band plays "Sound Off" in place. Then it marches forward simultaneously with the first note of the march music. It executes a left turn in time to pass across the front of the line of troops midway between the adjutant and the line of company commanders. When the band has passed the left of the line of troops, it countermarches and returns over the same ground back to the right of the line. After it passes the right of the troops, it executes a right turn. When the entire band has passed beyond the front line of troops, it countermarches and halts in its original position. The band stops playing the march at the next ending and then repeats "Sound Off".

(4) If not an evening parade including Retreat, immediately after the band's last "Sound Off", the adjutant commands, BATTALION, ATTENTION; PRESENT, ARMS. The adjutant then faces about, salutes the commander of troops, and reports, "Sir, the parade is formed." The commander of troops returns the salute and directs the adjutant to TAKE YOUR POST, SIR. The adjutant marches around the right of the commander of troops, takes post in the staff, halts faces the battalion and comes to order sword. When the adjutant is in position, the commander of troops and staff draw swords (except the adjutant, who already has sword drawn).

(5) If at an evening parade including Retreat, immediately after the band halts and plays its last "Sound Off", "Retreat" is sounded by the field music. Following the last note of the music for "Retreat", the adjutant commands BATTALION, ATTENTION; PRESENT, ARMS. The adjutant continues facing the troops and salutes; the commander of troops and staff salute with the adjutant. Upon the adjutant's salute, the band plays the "National Anthem", and the flag is lowered as prescribed in paragraph 16-3. At the completion of the "National Anthem", the adjutant, commander of troops and staff terminate their salutes, and, with the troops still at present arms, the adjutant faces the commander of troops, salutes, and reports, "Sir, the parade is formed." The adjutant then takes post with the staff and the commander of troops and staff draw swords as described above.

(6) After drawing sword, with the troops still at present arms, the commander of troops commands, ORDER, ARMS. Following this, the commander of troops orders such movements of the manual of arms as desired. Normally, the commander of troops commands, PORT, ARMS; RIGHT SHOULDER, ARMS; PORT, ARMS; LEFT SHOULDER, ARMS; PORT, ARMS; ORDER, ARMS. Company officers and noncommissioned officers armed with the sword, come to carry sword on the first port arms and remain at carry sword throughout the exercise of the manual, returning to order sword when the troops come to order arms. The color guard and guidon bearers remain at the order during the manual of arms.

(7) The commander of troops then directs the adjutant, "RECEIVE THE REPORT, SIR." The adjutant, passing the troop commander's right, marches to his post, halfway between the troops and the commander, from which position he commands REPORT.

(a) On REPORT, the company commanders, in succession from right to left, salute and report, "___Company, all present or accounted for, "or"___Company, ___men and/or officers absent." The adjutant returns each salute after the report is completed. If armed with a sword, he returns to carry sword after each salute.

(b) The adjutant then faces the troop commander, salutes, and reports, "Sir, all present or accounted for, " or states the number of persons absent.

(8) The commander of troops salutes and directs the adjutant, "PUBLISH THE ORDERS, SIR." The adjutant executes an about face to face the troops and commands, ATTENTION TO ORDERS. The adjutant then publishes the orders; normally, most units publish orders similar to this: "Headquarters, ___Battalion, ___ Marines, (date) (month) (year), Officer of the Day today is (rank) (name); Officer of the Day tomorrow is (rank) (name). By order of (battalion commander's (name) (rank), United States Marine Corps (Reserve), Commanding." Other orders may be published if deemed appropriate. After publishing the orders, still facing the battalion, the adjutant immediately commands, OFFICERSCENTER..... MARCH. The adjutant pauses between each of these commands so as to allow the actions described below to occur. On the adjutant's own command of MARCH, the adjutant executes an about face as in marching and moves by the most direct route around the right of the commander of troops and resumes his/her post in the staff at order sword.

(a) On the adjutant's command OFFICERS, all company officers execute carry sword, and all guidon bearers execute carry guidon.

(b) On the adjutant's command CENTER, company commanders and guidon bearers face center. Simultaneously, when companies.

are in line formation, the platoon commanders face center; but when companies are in mass formation, the platoon commanders first take 1 pace forward, then face center. Extra officers and company executive officers move around their company's flank nearest the center and take posts in the rank formed by the platoon commanders.

(c) On MARCH, the band plays, officers and guidon bearers close to the center at close interval, halt, and individually face the troop commander. Company commanders, when closing to the center, must oblique slightly forward in order to close on a line 4 paces in front of that formed by the guidon bearers. Guidon bearers close on their own line and take position behind their respective company commanders. All other officers close on the line of platoon commanders.

(d) After all officers and guidon bearers have closed and faced forward, the senior officer commands FORWARD, MARCH. As they advance, the center officer of the leading rank is the guide. He guides toward the troop commander. The group is halted 6 paces from the troop commander by the senior officer. Officers not armed with the sword hesitate for one count after the command HALT and execute the hand salute. If armed with the sword, they execute present sword as prescribed in paragraph 5-3. Guidon bearers execute present guidon as prescribed in paragraph 6-2. All members of the party should be at salute on the fourth count after the command HALT. The troop commander, if the officers are armed with the sword, orders CARRY, SWORDS. On CARRY, the guidon bearers execute the first movement to carry guidon and the officers execute order sword. On SWORDS, guidon bearers complete carry guidon and the officers execute carry sword. If the officers are not armed with the sword, the troop commander orders READY, TWO. On READY, guidon bearer execute the first movement to carry guidon. On TWO, guidon bearers complete carry guidon and the officers terminate their hand salutes. The troop commander returns the salute. He terminates it on the same command which terminates those of the officers' party. Staff members do not salute at this time. The troop commander then gives whatever instructions to the officers he deems necessary.

(9) The commander of troops then commands, POSTS, MARCH.

(a) On POSTS, all officers and guidon bearers face about.

(b) On MARCH, they step off. The center officer is the guide as before. He guides toward the center of the battalion formation.

(c) The senior officer commands, OFFICERS, HALT. The command of execution HALT is timed so that, when companies are in line formation, the rank of platoon commanders is 6 paces from the line of troops; and when the companies are in mass formation, the platoon commanders are 2 paces from the line of troops. The senior officer then commands POSTS; MARCH.

1. On POSTS, officers and guidon bearers face in the direction of their companies.

2. On MARCH, officers step off in succession at 4-pace intervals, resume their posts, and execute order sword if so armed. Guidon bearers step off with their company commanders, resume their posts, and execute order guidon. The band stops playing when the last officer has resumed his post. During the execution of officers center and officers post, except when saluting, the troop commander remains at carry sword, if so armed.

(10) After the officers and guidon bearers have returned to their original positions with their companies, the commander of troops directs the

senior staff to BOX THE STAFF in a voice only loud enough for the staff to hear. The senior staff officer then reverses the staff (see paragraph 10-3) so that it halts 2 paces from and facing the commander of troops (who remained facing the battalion). The battalion commander faces the front and waits for the reviewing officer to take position in the reviewing area.

c. Presentation and Honors to the Reviewing Officer.

(1) After the staff has reversed and the commander of troops has faced the reviewing area, the reviewing officer, with his/her staff, moves to his/her post in the reviewing area to receive the review. The procedures in paragraph 13-6 apply with respect to the reviewing party.

(2) The battalion commander (if not acting as commander of troops) escorts the reviewing officer to position, taking post on the left of the latter. If the battalion commander is the commander of troops, the regimental commander or a senior officer may accompany the reviewing officer. If no officer has been designated to review the parade, the battalion commander acts as reviewing officer, the battalion executive officer (or other officer appointed by the battalion commander) acts as the commander of troops.

(3) When the reviewing officer is in position, the commander of troops faces the battalion and commands PRESENT, ARMS. The commander of troops then faces the reviewing officer and salutes, the staff also salutes. If the reviewing officer is so entitled, honors to the reviewing officer are rendered as appropriate to his/her rank (see U.S Navy Regulations). The band sounds honors, if appropriate, upon the salute of the commander of troops. After the reviewing officer returns the salute, the commander of troops and staff terminate their salutes. The commander of troops faces the battalion and commands ORDER, ARMS.

(NOTE: After the troops are at the order, presentation of decorations as prescribed in Chapter 14 may be conducted at this time. Then the command is marched in review. If presentation of decorations do not take place, the battalion marches in review.)

d. March in Review.

(1) The commander of troops, facing the battalion, commands, PASS IN REVIEW. On this command, the band changes direction to that of the line of march and halts.

(2) When the band is halted, if the battalion is formed in line with companies in mass formation, the commander of troops commands, RIGHT SHOULDER, ARMS; after the troops are at the right shoulder, the commander of troops then commands, COLUMN OF COMPANIES, RIGHT COMPANY, RIGHT TURN, MARCH. The band and the right company move out on the command of execution of the commander of troops.

(a) Other companies move out in succession and follow at the prescribed distance.

(b) The band and each company change direction to follow the line of march without command from the commander of troops. Each turning point should have been previously marked as described in paragraph 13-3.

(c) The commander of troops and his staff move into position at the head of the column after the second change of direction.

(d) The commander of troops with his staff, salutes, and executes eyes right when 6 paces from the nearest member of the reviewing party. They hold their salute and eyes right position until 6 paces beyond the reviewing party. The company commander in each company commands EYES, RIGHT when 6 paces from the nearest member of the reviewing party. All officers, except those armed with the sword in the interior of a formation (other persons to the front and sides), salute. Part I describes the salutes for men and officers according to their arms. The salute and eyes right position is held until the massed unit is 6 paces past the reviewing party.

(e) The band executes column left when it has passed the reviewing stand. It then executes a second and third column left so it will wind up in front of and facing the reviewing officer at least 12 paces from the left flank of the marching troops. It continues to play until the last company has passed. It then stops playing and follows the last company from the field.

(f) The band leader and the drum major execute and terminate their salutes at the same time prescribed for other commanders.

(g) If the reviewing officer is entitled to a color salute, the color salutes and terminates the salute at the same time prescribed for the commanders of massed units.

(h) After the last turning movement, while marching in review, the guide is toward the flank on which the reviewing officer is posted.

(i) After saluting the reviewing officer while marching in review, the commander of troops, followed by his staff, turns out of column and takes position in line with and to the right of the reviewing officer. If armed with the sword, he returns sword. The staff takes post behind him. They return swords with their commander. The commander of troops orders HAND, SALUTE AND READY, TWO at the appropriate times as the national color passes in review. When the rear element of his command has passed, the commander of troops faces the reviewing officer and renders a hand salute. When the salute has been returned, he and his staff draw sword and follow their command from the field.

(j) All individuals in the reviewing stand salute the national color as it passes.

(k) The reviewing officer returns the salutes of all commanders as they pass to his front while marching in review.

(3) If the battalion is in line with companies in line, when the band is halted, the commander of troops commands, RIGHT, FACE...RIGHT SHOULDER, ARMS ...FORWARD, MARCH.

(a) At the commander of troop's command RIGHT, FACE, the companies face right and company officers, senior noncommissioned officers, and platoon guides take their posts in the column (see fig 15-1).

(b) On FORWARD, MARCH, the entire battalion steps off and the band plays a quick march. Once the formation is underway, the parade proceeds the same as with companies in mass formation except:

1. If the battalion passes in review in column (of threes) as shown in figure 15-2, company commanders and platoon commanders give necessary commands to execute column movements along the line of march, without the command of the commander of troops. The leading platoon of each company executes EYES, RIGHT on the command of execution of the company commander, the remaining platoons in each company executes EYES, RIGHT on the commands of their platoon commanders.

2. If the battalion passes in review in column of platoons in line as shown in figure 15-3, the companies initially march in column of threes and on command of the company and platoon commanders, execute a column left at the first turn marker. The companies then form column of platoons in line on the march (see fig 9-5) with each platoon executing a left flank march on command of its platoon commander just as it reaches the second turn

marker. On passing the reviewing officer, the company commander and guidon bearer of each company execute EYES, RIGHT together, but each platoon (including the leading platoon of each company) executes EYES, RIGHT on command of its platoon commander. After passing in review, companies should reform column of threes on the march far enough away from the reviewing area so as not to interfere with the "eyes right" of companies marching in the rear.

(4) After marching off the parade ground following the march in review, the color guard and color company return the colors as prescribed in paragraph 16-5. Companies march to their respective areas and are dismissed.

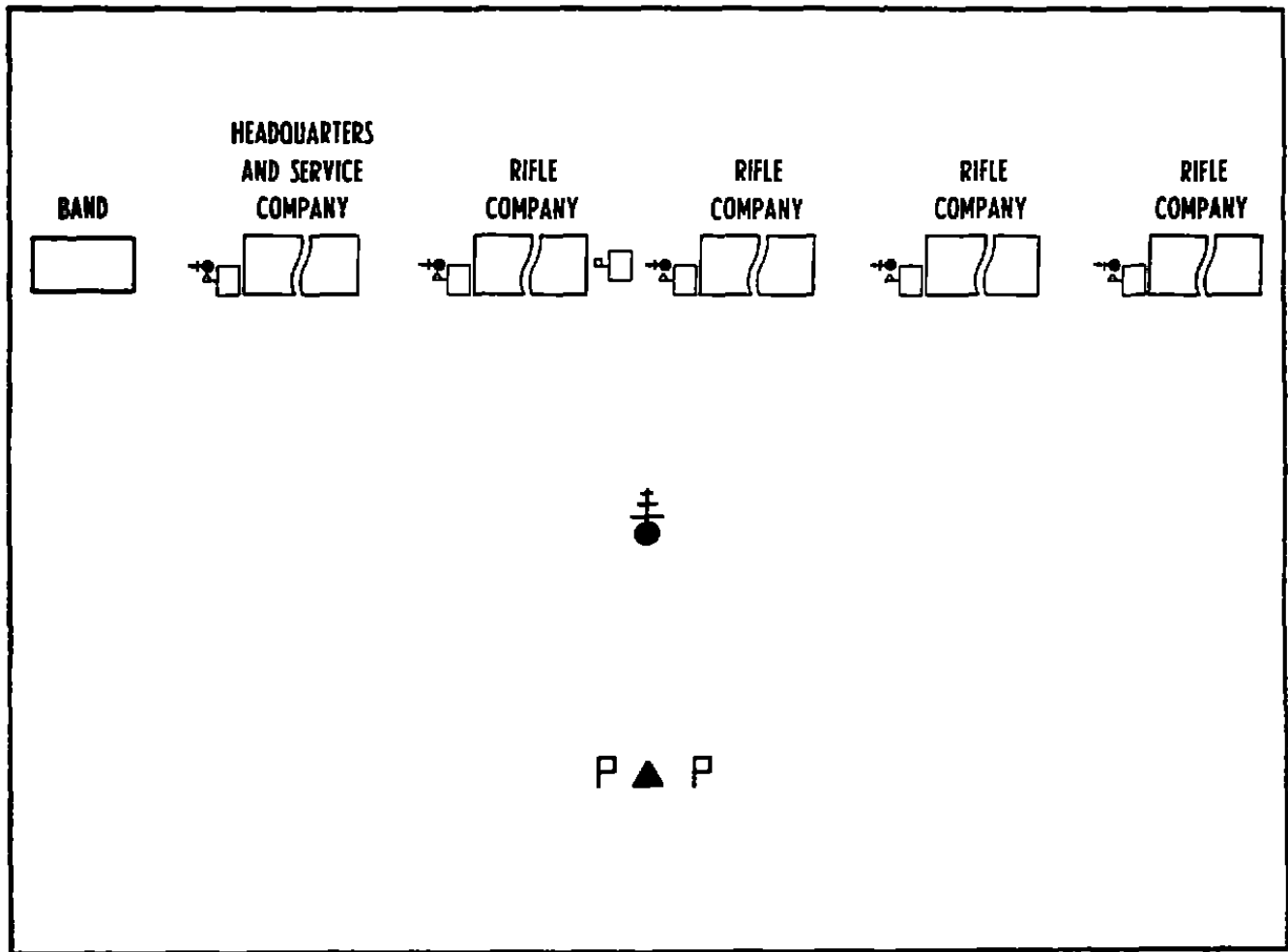

Figure 15-1.--Band Changes Direction

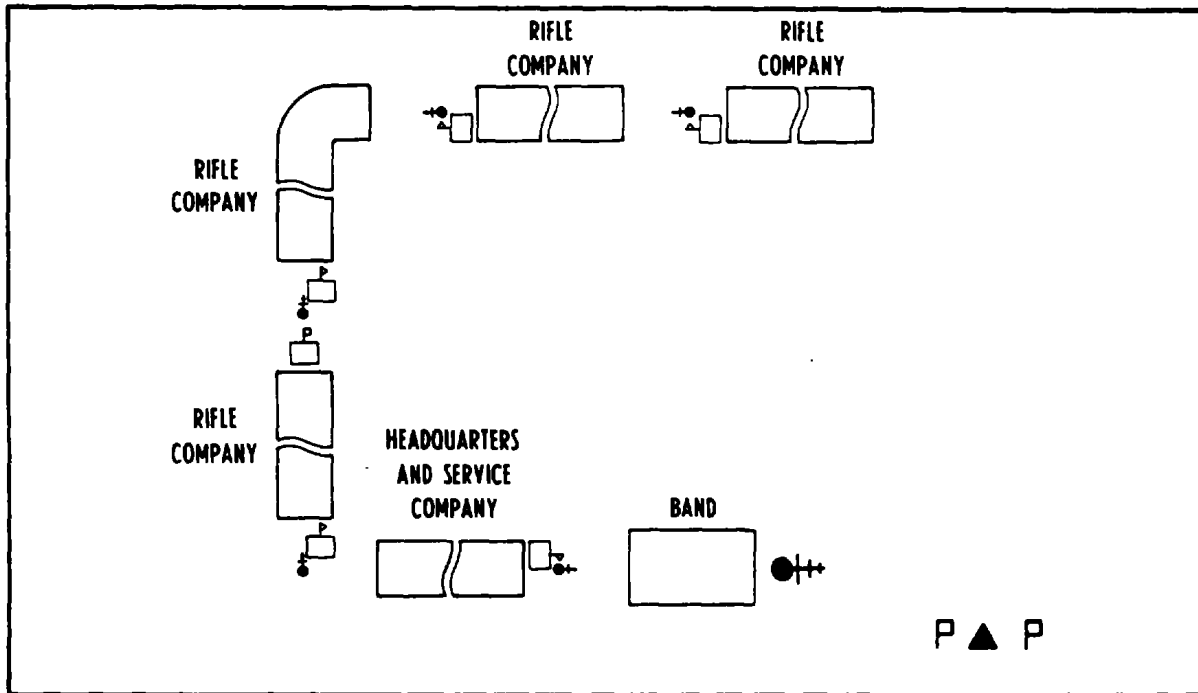

Figure 15-2.--Pass in Review, Companies in Column.

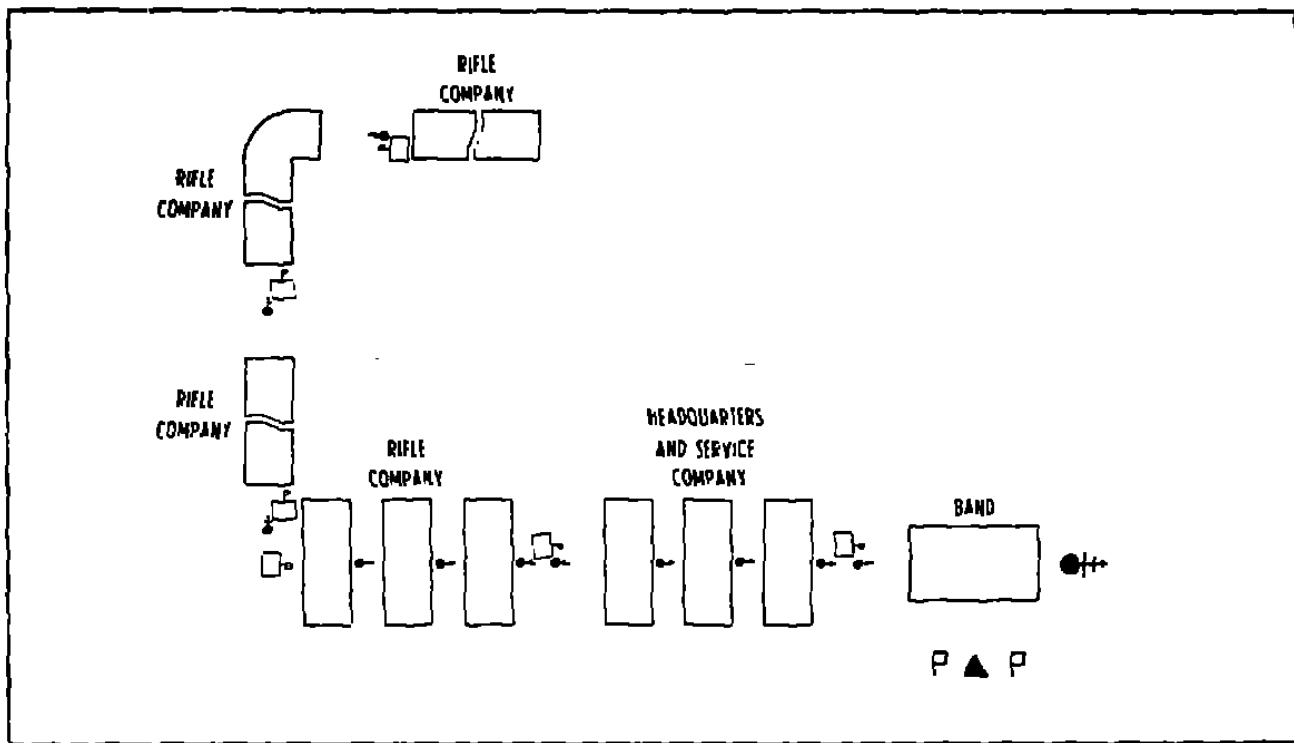

Fig 15-3.--Pass in Review, Companies in Column of Platoons in Line

15-3. REGIMENTAL CEREMONIAL PARADE

The regiment normally forms in line of battalions with companies in line or companies in mass formation to conduct a ceremonial parade. The parade proceeds as for the battalion (see paragraph 15-2) with the following exception:

a. Regiment is substituted for battalion in the description.

b. The companies and battalions march on at the "second" or, regimental Adjutant's Call, or form on the line of troops prior to regimental Adjutant's Call under supervision of the regimental adjutant as prescribed for forming for ceremonies in Chapter 11, up to the point where units have completed dressing to the right, guides are posted (if units marched on), and bayonets are fixed (if prescribed). "Sound Off" is then conducted and the remainder of the parade proceeds in the same manner as a battalion parade.

c. Battalions and independent companies execute present arms, order arms, parade rest, attention, and other movements of the manual of arms on the command of their respective battalion commanders or independent company commanders. Reports to the adjutant are made by battalion and independent company commanders.

d. In trooping the line, after "Sound Off", the band passes midway between the line of battalion commanders and the adjutant.

e. At officers center, battalion commanders and their staffs close center on the original line of battalion commanders. Company commanders oblique forward to close a line 4 paces behind the line of battalion staffs. Guidon bearers oblique forward to close on a line 4 paces behind the line of company commanders. The platoon commanders' rank obliques forward to close 4 paces behind the guidon bearers.

f. In the march in review, the commander of troops commands PASS IN REVIEW. On this command the band changes direction to that of the line of march and halts.

(1) If the parade is being conducted with companies in line formation, when the band is halted, the commander of the right battalion or independent company commands, RIGHT, FACE; RIGHT SHOULDER, ARMS, and column of threes is formed. Remaining battalions and independent companies form column of threes and come to right shoulder arms on commands of their battalion or independent company commanders in succession from right to left. When all units are at right shoulder arms, the commander of the right battalion or independent company commands, FORWARD, MARCH. The band steps off playing in this command. Succeeding battalions and independent companies step off on the commands of their respective commanders so as to follow at the prescribed distances.

(2) If companies are in mass formation, when the band is halted, the commander of the right battalion commands, RIGHT SHOULDER, ARMS; COLUMN OF COMPANIES, RIGHT COMPANY, RIGHT TURN, MARCH; should an independent company be on the right, its commander commands, RIGHT SHOULDER, ARMS; RIGHT TURN, MARCH. The band steps off playing with the right unit. Commanders of succeeding battalions and independent companies give similar commands to set their units in motion so as to follow at the prescribed distances.

(3) Initially, battalion commanders and their staffs march parallel to the line of troops and take position at the head of their battalions after the first change of direction. The commander of troops and staff take position at the head of the band after the second change of direction.

(4) Battalion commanders and their staffs execute eyes right in the same manner as the commander of troops and his/her staff. Companies march in review in mass formation, column of threes, or column of platoons in line executing changes in direction, flanking movements, and eyes right as appropriate in the same manner as in a battalion parade.

15-4. CHANGE OF COMMAND CEREMONY

The ceremony proceeds in the same manner as the battalion (regimental) ceremonial parade up to the point where the troop commander directs the adjutant, "Publish the orders, Sir."

a. The adjutant then faces the troops and commands ATTENTION TO ORDERS. The publishes pertinent excerpts from the outgoing commander's orders, followed by pertinent excerpts from the incoming commander's orders. Upon completion, he commands OFFICERS, CENTER, MARCH. The ceremony continues as described for the ceremonial parade until the officers have returned to their posts from officers center.

b. The outgoing and incoming commanding officers then take positions in the reviewing area. If the outgoing commanding officer is entitled to honors, they will be rendered at this point. When both have taken their proper positions (the present commanding officer on the right and the new commanding officer on his/her left), the troop commander directs the adjutant, "Deliver the color to the commanding officer." The adjutant returns sword, if so armed, take the most direct route to a position 2 paces in front of the color guard, salutes, and takes the organizational color from the junior color bearer. Carrying the color as nearly in the position of carry color as the can without a sling, he marches by the most direct route to a position 2 paces in front of the outgoing commanding officer.

c. The commanding officer of troops commands PRESENT, ARMS. On this order, the entire parade executes present arms, and the adjutant transfers the color to the outgoing commanding officer. The outgoing commanding officer passes the color to the incoming commanding officer. The adjutant salutes as the color is passing from one to the other. The passing of the color signifies the transfer of command. The new commanding officer then passes the color back to the adjutant, at which time the commanding officer of troops orders ORDER, ARMS. The old and new commanding officers face each other and exchange salutes and positions (right shoulder to right shoulder). The adjutant then returns the color to the color guard by the most direct route, salutes the colors, resumes his post in the staff, and draws sword. If the new commanding officer is entitled to honors, they will be rendered at this time.

d. The ceremony then continues as set forth in paragraph 15-2 or 15-3.

15-5. BATTALION AND REGIMENTAL CEREMONIAL FORMATIONS

a. For occasions in which ceremony is desired but the situation does not provide the opportunity or necessary space for maneuvering units as in a review or a parade, a battalion or regimental ceremonial formation may be conducted. One of several variations may be used according to the situation and type of ceremony desired.

b. One type of battalion (regimental) ceremonial formation is similar to that of a review, except that the march in review is omitted. The battalion (regimental) commander acts as reviewing officer and the executive officer (or other officer so appointed) acts as the commander of troops. Basically, the battalion or regiment forms in line with companies in line or companies in mass formation at Adjutant's Call for the formation in the same manner as for a review.

(1) For an evening formation including retreat, after the battalion (regiment) is presented to the commander of troops, the troops may be presented, "Retreat" sounded, and flag lowered while the "National Anthem" is played. A morning ceremonial formation may also be conducted in a manner similar to "Retreat" and evening colors. To conduct morning colors as part of the formation, after presenting the command, the commander of troops commands SOUND FIRST CALL TO COLORS; the field music sounds "First Call", followed immediately by the band playing the "National Anthem" to which the colors are raised.

(2) After the command is presented to the commander of troops, if morning/evening colors are not conducted, the commander of troops presents the command to the battalion (regimental) commander. If morning/evening colors are part of the ceremony, the commander of troops presents the command to the battalion (regimental) commander following the conduct of morning/evening colors.

(3) Presentation of decorations may then be conducted. The battalion (regiment) is then dismissed by the commander of troops. The color guard and color company (battalion) return the colors.

c. Another type of formation is conducted in the same manner as a ceremonial parade (see paragraphs 15-2 and 15-3), except that the march in review is omitted. The following additional modifications may be made:

(1) The band may "Sound Off" in place instead of marching. If evening colors is part of the formation, "Retreat" is sounded after the band's second "Sound Off", and the adjutant brings the command to attention and to present arms. Then the flag is lowered while the "National Anthem" is played. For a formation at morning colors, the procedure is similar, except after the second "Sound off", the field music sounds "First Call", then the adjutant brings the command to attention and present arms for the flag to be raised while the "National Anthem" is played. After colors, the adjutant may bring the troops to order arms and then dismiss the command, or while troops are still at present arms following colors, the adjutant presents the command to the commander of troops.

(2) The commander of troops presents the command to the battalion (regimental) commander. Then decorations may be presented as prescribed in Chapter 14.

(3) On completion of the ceremony, the command is dismissed. The color guard and color company return the colors.

d. In any of the above ceremonial formations, the battalion (regimental) commander may act as both the commander of troops and the reviewing officer. In this case, the following modifications are made:

(1) The adjutant presents the command to the battalion (regimental) commander after the troops are formed. The presentation normally made by the commander of troops to the reviewing officer is omitted.

(2) During the presentation of decorations, the adjutant performs those duties normally required of the commander of troops.

15-6. STREET PARADES

a. Street parades are commanded by a person designated as Grand Marshal. He appoints a chief of staff and aides, and he issues an order concerning formation, movement, and dismissal of the parade. This order includes:

(1) The names of his staff officers and when and where they are to report to him.

(2) The assignment of organizations and their order in brigades and divisions, and the names and assignment of brigade commanders and marshals of divisions.

(3) The streets upon which the brigades and divisions are to form, the direction their lines or columns face, where the right or head of columns rest, and the width of the fronts of the subdivisions in column.

(4) The times for each division to complete its forming and be ready to march.

(5) The time and place at and from which the head of the parade will move, the line of march, and the direction of guide.

(6) Honors to be paid during the march.

(7) Instructions for the dismissal of the parade.

(8) Instructions regarding uniform and equipment.

b. The Grand Marshal may review the parade at some point beyond the reviewing stand before its dismissal.

c. The order of precedence of units in street parades involving two or more services of the United States or of a foreign nation are the same as prescribed in paragraph 12-1. Veterans and patriotic organizations parade in the order prescribed by the Grand Marshal.

d. The Grand Marshal marches at the head of the parade. His staff, chief of staff on the right, marches 1 1/2 paces to the rear in one or more ranks. The Grand Marshal is usually preceded by mounted police and a platoon of dismounted police who clear the way. The marshal of the first division marches 24 paces in rear of the staff of the Grand Marshal.

(1) Odd-numbered divisions are usually formed in streets to the right of the line of march, the first division nearest the starting point. Even-numbered divisions are similarly formed on streets to the left of the line of march. Among formations which may be used for street parades are columns of threes (or fours) abreast and mass formation. Transportation marches in single column or columns of twos, threes, or fours, depending upon the width of the street.

(2) In long parades, rifles may be carried at sling arms with fixed bayonets.

[BLANK PAGE]

CHAPTER 16

NATIONAL AND ORGANIZATIONAL FLAGS

16-1. GENERAL

a. When flown from ships or craft of the Navy or from a flagstaff at commands ashore, the national flag will be displayed in accordance with the provisions of U.S. Navy Regulations. The national flag is also called "national ensign" or "ensign."

b. Designated Marine organizations, including divisions, regiments, and battalions, are equipped with a national flag and an organizational flag.

c. When mounted on a staff (pike) and carried by an individual on foot, or displayed or cased in a fixed location, the national flag is called the "national color" and the organizational flag is called the "organizational color." The term "color" means the national color only. The terms "colors" means both the national color and the organizational color.

d. When mounted on a vehicle, the national flag is called the "national standard" and the organizational flag is called the "organizational standard." The term "standard" means the national standard only. The term "standards" means both the national standard and the organizational standard.

e. In garrison or on board ship, the colors of an organization, when not in use, are kept by the commanding officer. Whenever practicable, colors should be kept uncased and displayed in the office of the commanding officer, or other appropriate place. They may be cased, however, by placing them within a protective covering and, in such case, are kept in his office. Colors which are kept cased and not used often should be unfurled and aired frequently.

f. The colors (standards) may be carried in any formation in which two or more companies participate, and in escorts and honor guards when ordered. Unless otherwise directed for special ceremonies, the national color will always be carried when the organizational color is carried, but the national color may be carried alone.

g. In regimental formations, only the colors (standards) of the regiment will be carried. When two or more separate battalions are formed as a regiment, only the colors (standards) of one battalion will be carried for the regiment.

h. In battalion formations, the colors (standards) will be posted with a designated color company and in regimental formations with a designated color company or color battalion. For the position of the color company within the battalion formation, see chapter 10. For the position of the color company or battalion within the regimental formation, see chapter 11. In any formation involving two or more organizations which could carry colors (standards) in that formation, the number of colors (standards) to be carried and their positions within the formation will be prescribed by the formation commander.

i. When the formation is broken up, the colors (standards) join the organization commander (or respective organization commanders, if more than one organization in the formation is carrying colors) or are dismissed.

j. When the organizational color is draped in mourning, the mourning shall consist of a black crepe streamer 7 feet long and about 12 inches wide. A bow knot, the loops of which are 6 inches long, is tied in the center. The streamer is attached by this knot to the upper ferrule, just below the spearhead.

k. Colors remain at order color during the manual or arms. Standards remain mounted with the staff vertical.

l. Colors (standards) are never allowed to touch the deck.

m. Color guards do not fix bayonets.

16-2. SALUTES

a. By the National Color (Standard). The national color (standard) renders no salute.

b. By the Organizational Color. In military ceremonies, the organizational color salutes while the "National Anthem," "To the Color," or "Retreat" (played in lieu of the "National Anthem" in the absence of a band), or "Hail to the Chief" is being played, and when rendering honors to the organizational commander or individual of higher rank, but in no other case. When marching, this salute is rendered when 6 paces from the reviewing stand or person to be saluted. Carry color is resumed when 6 paces beyond the reviewing stand or person to be saluted.

c. By the Organizational Standard. The organizational standard renders no salute.

d. Salutes to the National Flag. Salutes are rendered to the national flag in accordance with U.S. Navy Regulations and chapter 18 of this manual.

16-3. HOISTING, LOWERING, AND FOLDING THE NATIONAL ENSIGN

a. General.

(1) The ceremonial hoisting and lowering of the national ensign at 0800 and sunset, respectively, shall be accomplished ashore in accordance with the provisions of U.S. Navy Regulations and this paragraph.

(2) A detail consisting of a noncommissioned officer and two nonrated men of the guard will hoist and lower the ensign. This detail will be armed with sidearms, if the special equipment of the guard includes sidearms; otherwise, the pistol belt only will be worn.

(3) The commander of the guard ashore will see that the proper ensign is flown at the appropriate time and under all weather conditions. For different types of ensigns, see figure 16-1. For U.S. Marine Corps flag size standards, see MCO P10520.3, Flag Manual. Any member of the guard who observes any hazard to the ensign, such as loosened halyards, fouling, etc., will immediately report them to the commander of the guard.

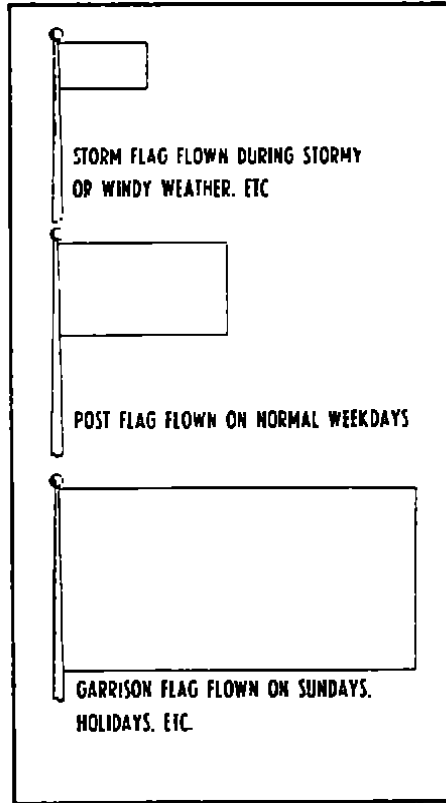

Figure 16-1.--Different Types of Ensigns.

b. Positions of the Ensign. The ensign is flown from the peak or truck of the mast, except when directed to be flown at half-mast. The ensign at half-mast is flown, when possible, with the middle point of its hoist opposite the middle point of the mast. The middle point of a guyed mast is midway between the truck of the mast and the point of attachment of the guys. The middle point of a mast with yardarm is midway between the truck of the mast and the yardarm. Technically, an ensign at any position other than at the truck of the mast is half-masted. Local conditions may require other positions. To half-mast the ensign, it is first hoisted to the truck and then lowered to the half-mast position.

c. Hoisting the Ensign. The detail assigned to hoist the ensign is formed in line at the guardhouse with the noncommissioned officer carrying the ensign in the center. It is then marched to the flagstaff, halted, and the ensign attached to the halyards. The halyards are manned by the two nonrated men who take positions on opposite sides of the staff facing it, so they will be able to hoist the ensign without fouling it. The noncommissioned officer continues to hold the ensign until it is hoisted clear of his grasp to prevent it from touching the deck. When the ensign is clear, he comes to attention and executes the first motion of the hand salute. The other members of the detail grasp the halyard in their left hand and execute the first motion of the hand salute after the ensign is hoisted. On the last note of the "National Anthem" or "To the Color," all members of the detail execute the second motion of the hand salute. If the ensign is to be half-masted, it is then lowered smartly to that position. The halyards are then secured to the cleat of the mast. The detail is again formed, marched to the guardhouse, and dismissed.

d. Lowering the Ensign. The detail is formed at the guardhouse, marched to the flagstaff, and the halyards manned in the same manner as for hoisting the ensign. On the first note of the "National Anthem" or "Retreat," the ensign is slowly lowered. If at half-mast, it is first hoisted smartly to the truck on the first note of the music and then slowly lowered. It is caught by the noncommissioned officer at the last note of the music. The ensign is detached from the halyards and folded as prescribed below. The halyards are secured to the mast, the detail is formed and marched to the guardhouse, and the ensign turned over to the commander of the guard.

e. Folding the Ensign. The ensign is folded in half the long way so the crease parallels the red and white stripes. It is folded in half again so the new crease parallels the red and white stripes and the blue field is to the outside. The fly end (away from the blue field) is folded up to the top so the single edge lies perpendicularly across the stripes. By repeatedly folding the thick triangle thus formed about the inboard edge of the triangle, the ensign is folded into the shape of a cocked hat (see fig. 16-2).

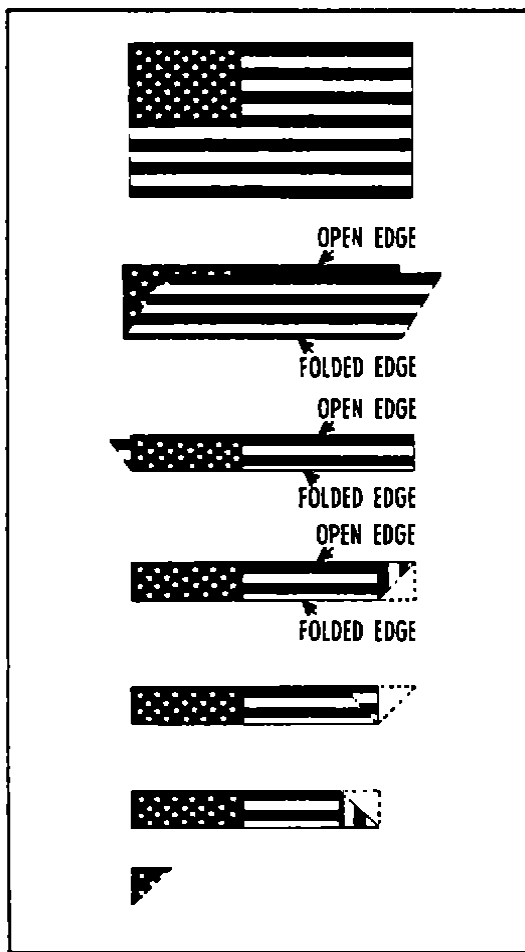

Figure 16-2.--Folding the Ensign.

16-4. MANUAL OF THE COLOR(S)

a. Order Color.

(1) At order color, the lower ferrule rests on the deck touching the outside edge of the right shoe just opposite the little toe. The staff is gripped from the

right in the "V" formed by the thumb and fingers on the right hand, back of the hand to the right front. The right elbow should be close to the side so the forearm will help support the staff. Hold the staff against the hollow of the shoulder so it points straight up. The rest of the body is at attention (see fig. 16-3).

(2) Color guards armed with rifles are at order arms when the colors are at the order.

b. Carry Color From Order Color.

(1) When changing from order color to carry color, the command is CARRY, COLOR.

(2) At the command CARRY, change the grip on the staff so as to grasp it from the rear between the thumb and fingers of the right hand, the fingers around the staff.

(3) At the command COLOR, raise the staff smartly with the right hand to a point where the lower ferrule is just above the sling socket. While raising it, keep the staff pointing straight up. Grasp the staff just above the lower ferrule with the left hand to steady it.

(4) Seat the lower ferrule in the sling socket. As the ferrule is seated, permit the right hand to slide down the staff to a position directly in front of the color bearer's face.

(5) Grip the staff firmly with the right hand and move the left hand smartly to the side. In this position, the right hand is directly in front of the face and the staff is inclined slightly to the front (see fig. 16-4).

(6) Color guards armed with rifles execute right and left shoulder arms at the command COLOR so that the rifles are on the outboard shoulder.



Figure 16-3.--Order Color.

Figure 16-4.--Carry Color.

c. Order Color From Carry Color.

(1) When changing from carry color to order color, the command is ORDER, COLOR (ARMS). Execution is begun on the preparatory command.

(2) At the command ORDER, grip the staff with the left hand below the right hand and remove the ferrule from the sling socket.

(3) At the command COLOR (ARMS), lower the ferrule to a point above the deck along the outside edge of the right toe; release the staff with the left hand and replace it above the right hand.

(4) Relax the right hand so the staff will slide down between the thumb and fingers. Then change the position of the color and the grip of the right hand to that described in paragraph 16-4a(1).

(5) Move the left hand smartly back to the left side.

d. Present Color From Order Color.

(1) To change from order color to present color the command is PRESENT, ARMS. Execution is begun on the preparatory command.

(2) At the command PRESENT, change the grip on the staff so as to grasp it firmly from the rear between the thumb and fingers of the right hand, the fingers around the staff.

(3) At the command ARMS, raise the staff smartly with the right hand to a point where the lower ferrule is just above the sling socket. While raising it, keep the staff pointing straight up. Grasp the staff just above the lower ferrule with the left hand to steady it.

(4) Seat the lower ferrule in the sling socket permitting the right hand to slide down the staff to a point where it is directly in front of the face. Grip the staff firmly with the right hand.

(5) Move the left arm smartly back to the side. In this position, the right hand is directly in front of the face, and the staff is perpendicular to the deck (see fig. 16-4).

(6) Lower the staff smartly to the front by straightening the right arm (see fig. 16-5).

(7) The national color bearer executes the movement to carry color upon the command PRESENT. The national color does not salute; Therefore, he remains in this position.

(8) Color guards armed with rifles execute present arms at the command ARMS.

e. Order Color From Present Color.

(1) When changing from present color to order color, the command is ORDER, COLOR (ARMS).

(2) At the command COLOR (ARMS), raise the staff so the right hand is again in front of the face and the staff is inclined slightly to the front. The national color bearer remains at carry color until the organizational color bearer comes to this position.

(3) Come to the position of order color as described in paragraph 16-4c.

f. Rests With the Color.

(1) The color bearers and color guards assume the parade rest position in lieu of at ease or rest. At ease or rest are not used by the color guard when carrying colors. The command is given from the position of order color only by the senior color bearer or person in charge of a formation with which colors are posted. It is executed in one count (see fig. 16-6).

(2) At the command REST, the left foot of color bearers is moved smartly to the left as in the position of parade rest for individuals. The left hand is placed behind the back with the forearm parallel to the deck.

(3) Color guards assume the position of parade rest as prescribed in chapter 3.



Figure 16-5.--Present Color.



Figure 16-6.--Parade Rest.

g. Eyes Right (left) From Carry or Order Color.

(1) The command is EYES, RIGHT (LEFT). It will be given only when halted at order color, or while marching at carry color.

(2) At the command RIGHT (LEFT), if at order color, turn the head and look 45 degrees to the right (left). If at carry color, the organizational color bearer also lowers the staff smartly to the front by straightening his right arm (if the person saluted is entitled to a salute by the organizational color). The right (left) man in the color guard and the national color bearer do not execute the command.

(3) When the reviewing officer of a parade is entitled to a salute by the organizational color, the salute is executed at the command RIGHT (LEFT).

h. Carry Color From Eyes Right (left).

(1) The command is READY, FRONT.

(2) At the command FRONT, the head and eyes are turned smartly to the left (right) so you are looking straight ahead. Those members of the color guard who do not execute eyes right (left) remain looking straight ahead.

(3) When the senior color bearer commands FRONT, if the organizational color saluted, it resumes the carry.

(4) During a review, when the reviewing officer troops the line, ready front will not be given after eyes right. During such a ceremony, each member of the color guard executing eyes right turns his head and eyes toward the reviewing officer upon the command RIGHT. He continues to look at him, turning his head and eyes to the left as the reviewing officer passes, until he is again facing directly to the front.

16-5. COLOR GUARD

a. General.

(1) The color guard consists of four men. Two noncommissioned officers are the color bearers, and two other men, junior to the color bearers, are the color guards. The color bearers are unarmed, but the color bearer carries the national color and commands the color guard. He gives the necessary commands for movements and rendering of honors. The junior color bearer carries the organizational color. When only the national color is carried, the color guard will include only one color bearer. The positions of individuals in the Marine Corps color guard, Navy- Marine Corps color guard, and joint armed forces color guard are as shown in figure 16-7.

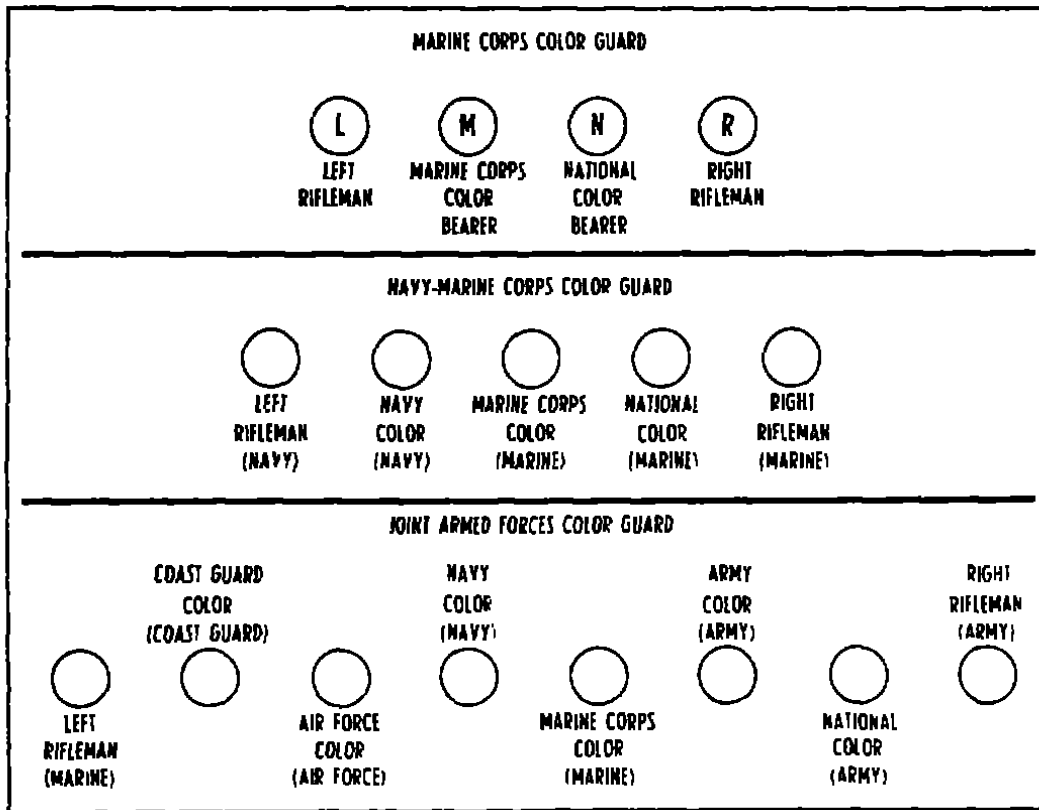

Figure 16-7.--Color Guards.

(2) The color guard is formed and marches in one rank at close interval with the color bearers in the center. The color guard does not execute to the rear march, about face, flanking movements, or fix bayonets. When any such commands are executed by the unit to which the color guard is attached, except fix bayonets, the senior color bearer orders an appropriate movement as described below.

b. Movements of the Color Guard.

(1) To face the color guard to the right (left):

(a) The command is RIGHT (LEFT) TURN, MARCH. It may be executed while halted, marking time, or marching.

(b) On the command MARCH, with the right (left) flank man acting as a stationary pivot, the color guard inclines to the right (left) until they face the new direction. When making the turn, at any one moment, all members of the color guard face the same direction (see fig. 16-8).

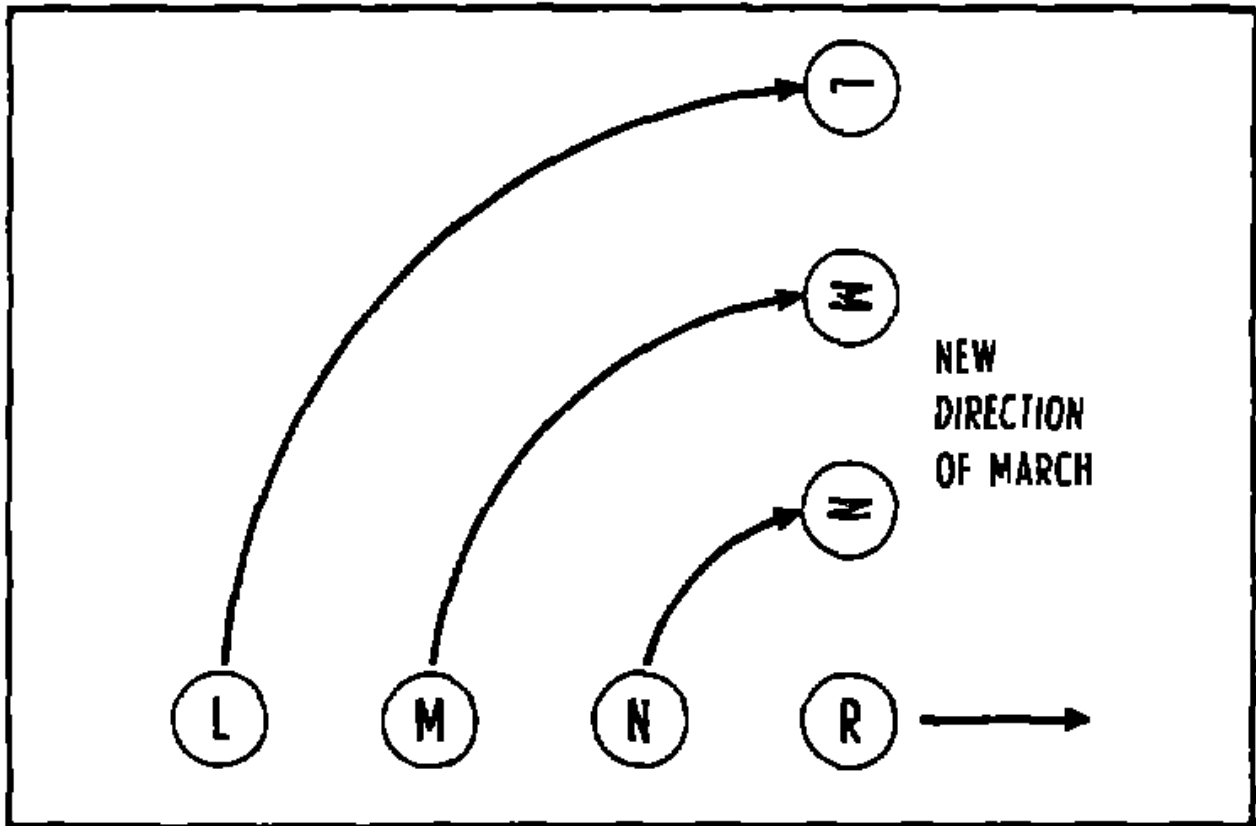

Figure 16-8.--Right Turn.

(2) To face the color guard to the rear:

(a) The command is COUNTERMARCH, MARCH. It may be executed while halted, marking time, or marching. When marking time or marching, the command is given as the left foot strikes the deck (see fig. 16-9).

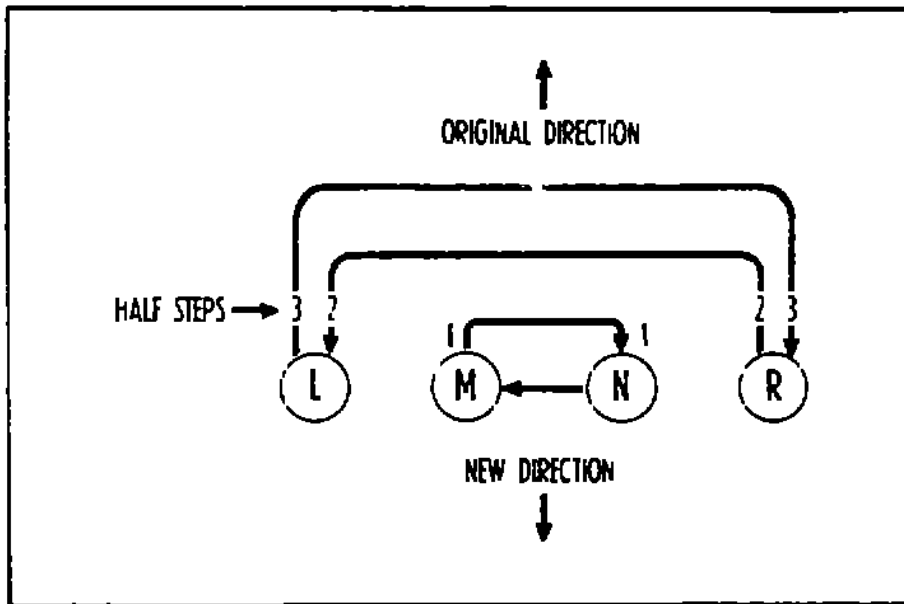

Figure 16-9.--Countermarch.

(b) At the command of execution, the entire color guard picks up the half-step. The national color bearer makes a small arc to his left, moving into the positions formerly occupied by the organizational color bearer, facing the new direction of march.

(c) The organizational color bearer makes an arc to his right and outside the national color bearer, moving into the position formerly occupied by the national color bearer, facing in the new direction of march.

(d) The right rifleman takes two half-steps forward, then moves in an arc to his left outside the organizational color bearer, moving into the position formerly occupied by the left rifleman, facing the new direction of march.

(e) The left rifleman takes three half-steps forward, then moves in an arc to his right outside the right rifleman, moving into position formerly occupied by the right rifleman, facing the new direction of march.

(f) Upon completion of this move, the color guard marks time until it is halted or until it receives the command FORWARD, MARCH.

c. Receiving the Colors by the Color Guard.

The color guard will use the following procedure in receiving colors:

(1) The color guard forms and marches to the place designated for receiving colors.

(2) The color guard is halted 3 paces from the adjutant and sergeant major, who have taken appropriate positions for the presentation of colors to the guard.

(3) The color guard then executes order arms upon the command of the senior color bearer.

(4) When the adjutant is ready to deliver colors, the senior color bearer orders present arms. At this command, the color bearers execute the hand salutes.

(5) The adjutant steps to his left oblique and transfers the national color to the senior color bearer, who terminates his salute in time to receive it at the position of carry color. The adjutant then steps back to his original position and salutes.

(6) Upon the adjutant's salute, the sergeant major steps to his right oblique and transfers the organizational color to the junior color bearer, who has terminated his salute with the senior color bearer, at the position of carry color. The sergeant major then steps back to his original position and salutes.

(7) When the sergeant major salutes, the senior color bearer commands order arms. The adjutant and sergeant major terminate their salutes as the color guard executes order arms.

(8) The senior color bearer then marches the color guard to the color company (battalion).

d. Receiving the Colors by the Color Company (Battalion). Prior to forming for a ceremony in which the colors are to participate, the colors are received by the color company (battalion) by means of the following ceremony:

(1) The company (battalion) is formed with its commander facing front.

(2) The color guard approaches and halts 10 paces in front of and facing the company (battalion) commander. It then executes order color.

(3) The company (battalion) commander faces about and orders PRESENT, ARMS, faces about again, and salutes. Upon this order, the color guards execute present arms (hand salute if armed with pistols) with the company (battalion); the color bearers execute carry color.

(4) The company (battalion) commander terminates his salute, faces about, and commands ORDER, ARMS. The color guard executes order color as the company terminates its present arms.

(5) The company (battalion) commander faces about and orders the color guard to take its post. When the color company (battalion) is in line or mass, the post of the guard is 6 paces to the left of the company (battalion). When the company (battalion) is in column, the post of the guard is 6 paces behind.

(6) When the color company joins the battalion, the color guard takes its appropriate post in the battalion formation. When the color battalion joins the regiment, the color guard takes its appropriate post in the regimental formation.

(7) When in formation, the color guard executes parade rest when the color company (battalion) executes at ease or rest.

e. Dismissing the Color Guard. In dismissing the color guard at the conclusion of a drill or ceremony, the procedure is as follows:

(1) The guard marches from its post and halts 10 paces in front of the facing the company (battalion) commander.

(2) The company (battalion) then executes present arms in the same manner described in paragraph 16-5d after which the color guard marches the colors to the quarters or office of the organizational commander.

(3) The color guard is received by and dismissed from organizations smaller than a company (e.g., funeral escort) in a similar manner.

f. Returning the Colors by the Color Guard. The color guard will use the following procedures when parting with the colors:

(1) The senior color bearer halts the guard 3 paces in front of the adjutant and sergeant major who have taken positions near the office or quarters of the organizational commander in time to receive the colors. The guard remains at carry color.

(2) When the color guard halts, the adjutant and sergeant major salute. The sergeant major steps to his right oblique and receives the organizational color from the junior color bearer. He then steps back to his original position.

(3) When the sergeant major is back in his position, the adjutant steps to his left oblique and receives the national color from the senior color bearer. He then steps back to his original position.

(4) When the adjutant is in position, the senior color bearer commands PRESENT ARMS (order arms first if the color guards are armed with rifles). At the command of execution, the adjutant faces about. The sergeant major passes behind the adjutant to a position at normal interval to his left. They then march to the office or quarters of the commanding officer, where they deposit the colors without further ceremony.

(5) When the colors are out of sight or 6 paces away, the senior color bearer commands ORDER, ARMS, and dismisses the guard or marches them back to the color company (battalion), whichever has been directed.

16-6. TROOPING THE COLORS

a. When it is desired to highlight the unit colors and have them formerly received by the entire battalion (or regiment) while forming for a review, parade, or any other ceremony, the ceremony for trooping the colors may be conducted. It is particularly appropriate to include as part of ceremonies conducted to coincide with an important event in the unit's history.

b. Procedures for trooping the colors are as follows:

(1) After forming at "Assembly," the color guard receives the battalion (regimental) colors as prescribed in paragraph 16-5. The color company may also receive the color guard in accordance with paragraph 16-5, or the color guard may take its position on the battalion (regimental) parade independently. In the former case, coincidental with Adjutant's Call, the color guard initially marches on with the color company then breaks out of formation so as to take post on the left flank of the line of troops. In the latter case, the color guard marches independently on the parade ground and takes post on the left flank of the line of troops at Adjutant's Call, or prior to Adjutant's Call, as appropriate (see fig.16-10). Regardless, after taking post on the left flank, the color guard comes to order color.

(2) The troops form at Adjutant's Call according to the commands and procedures prescribed for forming a battalion for ceremonies in Chapter 10 (the regiment in Chapter 11) up to the point where the units complete dressing to the right, the guides are posted (if units marched on), and bayonets are fixed (if so prescribed). Then, the adjutant facing the command and posted midway between the line of company (battalion) commanders and the battalion (regimental) commander, commands, MARCH ON THE COLORS. The band plays appropriate music while the color guard, coming to the carry, marches from its position on the left flank across the front of the battalion (regiment) along a line parallel to the line of troops and midway between the adjutant and line of company (battalion) commanders. On reaching a point in front of the adjutant, the color guard executes a left turn to face the adjutant and halts remaining at the carry. The adjutant then commands PRESENT, ARMS, and salutes the colors. The band plays either "To the Colors" or the "National Anthem." The battalion (regimental) commander and staff salute on the first note of the music, the adjutant commands ORDER, ARMS; POST THE COLORS. The color guard countermarches, moves to the line of troops on the left of the color company (battalion),

countermarches to the front, halts, and comes to order color.

(3) After the color guard is in position on the left of the color company (battalion), the adjutant commands PRESENT, ARMS, and face the commander of troops if at a review, and the ceremony proceeds as described in paragraph 13-5; if at a parade, the adjutant commands PARADE, REST; SOUND OFF, and the ceremony proceeds as described in paragraph 15-2 for a battalion (and 15-3 for a regiment).

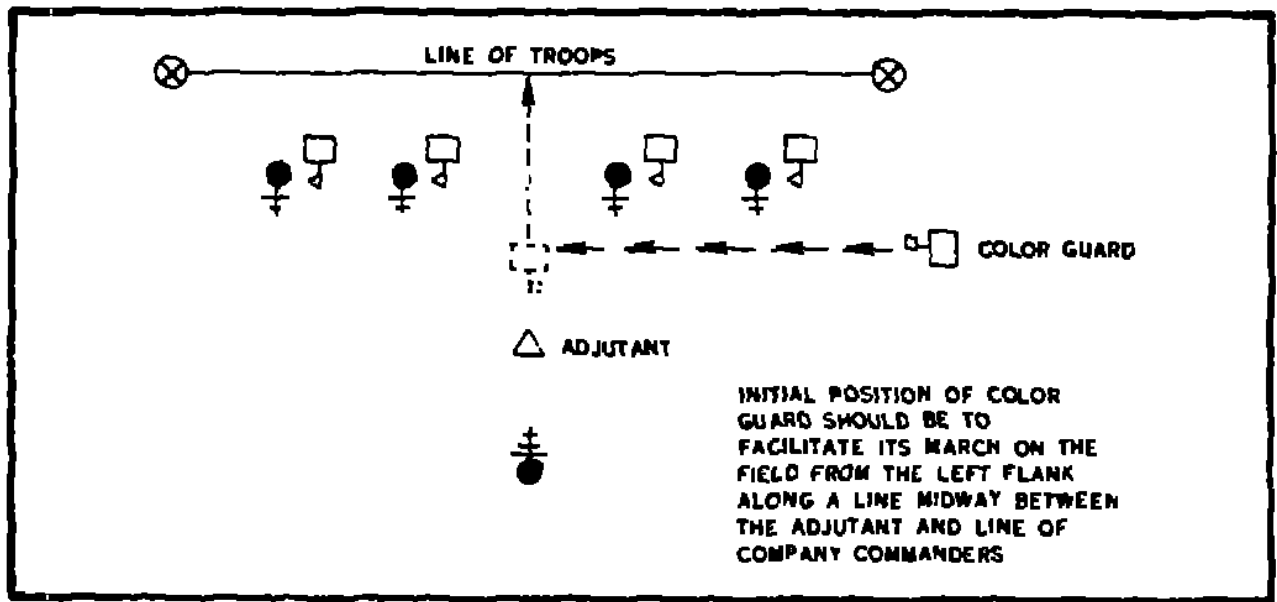

Figure 16-10.--Trooping the Colors.

[BLANK PAGE]

CHAPTER 17

ESCORT OF HONOR

17-1. GENERAL

Escorts of honor are detailed to receive and escort civilian and military persons of high rank. Troops ordered to this duty are selected for their military appearance and superior discipline.

17-2. ESCORT PROCEDURES

a. The escort is formed in line opposite the place where the person to be honored is to present himself. The band forms on the flank of the escort toward which it is to march. The escort is brought to attention upon the appearance of the person to be honored. When he has taken the position from which he will receive the honors, the escort is brought to present arms, and the honors due his rank are rendered. Upon completion of the honors, the escort is brought to order arms.

b. Ordinarily, the person so honored will, upon completion of the honors, inspect his escort. The escort then forms in column and takes up the march. The honored person, with his staff or retinue, takes position in rear of the column. When the person leaves the escort, it again forms in line; and when he has taken position from which to receive them, the same honors are rendered as upon his arrival.

c. When the position of the escort is a considerable distance from the point where the person to be honored is received--where a courtyard or wharf intervenes--a double line of sentries, facing inboard, is posted from that point to the escort. These sentries salute as the honored person passes their individual positions. In this case, an officer is detailed to accompany the honored person from his place of reception to the escort.

[BLANK PAGE]

CHAPTER 18

HONORS

18-1. PRESCRIBED HONORS

a. See U.S. Navy Regulations for tables of prescribed honors to be rendered afloat.

b. Except as set forth below, the same salutes, honors, and ceremonies, insofar as practicable, are rendered in connection with official visits to naval stations and Marine Corps posts and bases as are rendered on similar visits to Navy ships.

c. Normally, a unit other than the interior guard will be detailed as the honor guard at shore-based establishments. For a personage who merits the full guard, the honor guard will usually consist of at least two platoons of riflemen, a band, and colors. If sufficient personnel are not available to meet this requirement, the full guard will consist of not less than one platoon of riflemen. For a personage who merits the guard of the day, the honor guard will consist of one platoon of riflemen. The band and colors will not be included unless the guard consists of at least two platoons.

d. The following elements required in honors afloat are omitted when rendering honors ashore:

(1) Manning the rail.

(2) Piping alongside and over the side.

(3) Side boys.

18-2. RENDERING HONORS TO PERSONAGES ARRIVING FOR OFFICIAL VISITS ASHORE

a. See U.S. Navy Regulations for the appropriate musical honors, gun salutes, and display of personal or national flags.

b. Officers and noncommissioned officers will normally be armed with the sword for these ceremonies. At such locations where the sword is not required, those individuals will be armed with the pistol. Personnel so armed will execute the hand salute in lieu of present swords and, during the inspection of the honor guard, will execute inspection arms as the personage halts at their position.

c. The commanding officer, senior officer present, or the representative of either is the host and participates in the ceremony described herein. He ascertains from the visiting personage whether he desires to inspect the honor guard, or to pass around the honor guard as in a review, or to do neither. He also ascertains from the visiting personage whether, following any of the three alternatives above, he desires the honor guard to pass in review, or does not so desire. He then advises the personage of the action to be taken in the ceremony.

d. Prior to the arrival of the visiting personage, the honor guard will form on line at normal interval and at closed ranks. The band takes position to the right of, and on line with, the honor guard. The colors are posted in the center of the formation, excluding the band, and on line with the honor guard.

e. The field music sounds attention upon the appearance of the visiting personage, and the honor guard is called to attention. The host welcomes the personage and escorts him to a position directly in front of and facing the commander of the honor guard, and takes his position to the left of the personage. The distance of this position from that of the commander of the honor guard will depend on local conditions, but it should be sufficient to permit the band and honor guard to pass in review. If sufficient space is not available to permit the march in review, the host will so inform the personage. The commander of the honor guard then executes carry sword, faces about, brings the honor guard to present arms, faces about again, and presents sword.

f. As the commander of the honor guard executes present sword, the band plays the appropriate honors. If a gun salute is to be fired, it is begun immediately after the last note of music. During the rendering of honors and the firing of the gun salute, all observers in the vicinity of the honor guard formation stand at attention facing the personage, or if he is not in view, toward the honor guard formation. Observers in uniform shall salute during the playing of musical honors and the gun salute. The personage, the host, and members of the official parties of both also salute during the playing of musical honors and the firing of the gun salute.

g. If a personal flag or a foreign national flag is to be displayed during the visit, it is hoisted at the first note of music. If a foreign national flag is to be displayed during the gun salute, it is hoisted or unfurled at the sound of the first gun and hauled down, or furled, at the sound of the last. If the personage merits display of the national flag of the United States during the gun salute, it is not necessary to display another ensign if one is already flying from the flagstaff of the installation.

h. On completion of musical honors or the gun salute, the commander of the honor guard executes carry sword, faces about, brings the honor guard to order arms, faces about again, executes present sword, and reports, "Sir, the honor guard is formed."

i. If the personage desires to inspect the honor guard, the host escorts the personage to a position 3 paces in front of the position of the commander of the honor guard. The commander of the honor guard executes carry sword, faces about, and commands, PREPARE FOR INSPECTION. When all platoons have opened ranks, and platoon commanders are in position and facing to the front, the commander of the honor guard faces about, executes present sword, and reports, "Sir, the honor guard is prepared for your inspection." He guides the personage, accompanied by the host and others of the official party, through the inspection, remaining at carry sword. The inspection commences at the right front of the band and proceeds along the line of platoons. As the personage halts in front of a platoon commander, the platoon commander executes present sword and, after being personally inspected, executes carry sword, places himself on the right of the personage, and precedes him throughout the inspection of the platoon. Each man will execute the movements to inspection arms for his weapon as the personage to be honored approaches, regardless of whether this personage halts and faces him directly or not. Upon completion of the inspection of his platoon, the platoon commander, having led the personage down the rear of the last squad, executes column left and halts at the right front of his platoon. He exchanges salutes with the personage, permits the personage and host to pass in front of him, closes ranks, and resumes his post 6 paces in front of the platoon. Salutes are rendered by the inspecting party when passing in front of the colors, but not when passing them to the rear. After completing inspection of the platoon(s), the inspecting party passes around the rear of the formation and the right flank of the band to a point at the right front of the band. At this point, the commander of the honor guard halts, exchanges salutes with the personage, permits the personage and host to pass in front of him, returns to his post, and executes order sword. The band plays during the inspection of the honor guard.

j. If the personage does not desire to inspect, but merely to pass around the honor guard, the host escorts the personage directly towards the right front of the band. The commander of the honor guard executes carry sword, faces to the right as in marching, and proceeds to a point where he joins the personage and host. He guides the personage along the front of the band, across the front of the honor guard, along its left flank and rear, and ' around the right flank of the band. When the party reaches the right front of the band, the commander of the honor guard halts, exchanges salutes with the personage, permits the personage and host to pass in front of him, returns to his post, and executes order sword. The band plays throughout this procedure. Platoon commanders and personnel remain at attention. Salutes to the colors will be as described in paragraph 18-2i.

k. If the personage desires the honor guard to pass in review only, or to pass in review following an inspection or pass around, he will command, "March the guard in review, Sir." The commander of the honor guard executes carry sword, faces about, and commands, PASS IN REVIEW. On that command, the band changes direction to that of the line of march and halts. When the band has halted, the commander of the honor guard commands RIGHT, FACE; RIGHT SHOULDER, ARMS, and takes his position to the rear of the band and at the head of the column of troops, which position he maintains throughout the march in review. When in position, the commander of the honor guard commands FORWARD, MARCH, and the band and honor guard move off simultaneously. The commander of the honor guard salutes and executes eyes right when 6 paces from the position of the host and visiting personage, and terminates the salute and eyes right position when 6 paces beyond the host and personage. Platoon commanders, the band leader, the drum major, and the color guard execute and terminate salutes and eyes right in the same manner as the commander of the honor guard. The band executes column left when it has passed the position of the host and personage. It then executes a second and third column left so that it will end in the front of, and facing, the host and personage, and at least 12 paces from the flank of marching troops. The band continues to play, and marches off the field following the last unit of the honor guard. After passing in review, the commander of the honor guard marches the honor guard from the place of honors and dismisses the formation.

l. If the personage does not desire to have the honor guard pass in review, the commander of the honor guard executes carry sword, faces about, brings the honor guard to present arms, faces about, and executes present sword. When the personage returns the salute, the commander executes carry sword, faces about, brings the honor guard to order arms, faces about again, and executes order sword. The honor guard remains at attention until the personage departs.

m. The conduct of honor guard ceremonies as outlined above may be modified by commanding officers when the nature of the ground or exceptional circumstances require such changes.

n. Procedures for the conduct of joint Service honor guard will be as directed by the Service commander charged with the conduct of the ceremony.

o. The conduct of honor guard ceremonies at Marine Barracks, Washington, D. C. will be as prescribed by the Commandant of the Marine Corps.

18-3. RENDERING HONORS TO PERSONAGES DEPARTING AFTER OFFICIAL VISITS ASHORE

Honors are rendered upon the departure of a personage entitled to honors in the same manner in which they were rendered upon arrival with the following exceptions:

a. Generally, if the personage inspected the honor guard upon his arrival, the host advises him that another inspection on departure is not expected.

b. The honor guard will not pass in review.

c. Honors do not commence until the personage has completed his personal farewells.

d. If a gun salute is to be fired, it will begin just prior to the time the personage leaves the area where honors are rendered.

e. If a personal or foreign national flag has been flown during the visit, it will be hauled down upon the firing of the last gun.

18-4. HONORS TO THE NATIONAL FLAG

a. By Individuals.

(1) During morning colors and evening colors, salutes are rendered by individuals in accordance with U.S. Navy Regulations.

(2) When passed by or passing the national color (standard) uncased, all persons in the naval service in uniform and covered shall salute in accordance with paragraph 2-1e(2).

(3) Small flags carried by individuals and flags flying from flagstaffs (except during morning colors and evening colors) are not saluted.

(4) A folded flag being carried to morning colors or being returned from evening colors by a color detail will be considered as cased.

b. By Persons in Formation.

(1) During morning colors and evening colors, salutes are rendered by persons in formation in accordance with U.S. Navy Regulations.

(2) When passed by or passing the national color (standard) uncased, persons in formation are brought to attention or order arms if halted, or attention if marching. The formation commander shall render the salute for his unit, facing the color if the formation is halted. Persons in formation participating in a ceremony shall, on command, follow the procedure prescribed for the ceremony.

(3) Small flags carried by individuals and flags flying from flagstaffs (except during morning colors and evening colors) are not saluted.

(4) A folded flag being carried to morning colors or being returned from evening colors by a color detail will be considered as cased.

c. By Occupants of Vehicles.

During morning colors or evening colors or when passed by or passing an uncased national color, all vehicles in motion will be brought to a halt. Persons riding in such vehicles shall remain seated at attention. (See U.S. Navy Regulations.)

18-5. HONORS TO THE NATIONAL ANTHEM

For honors to the national anthem, see U.S. Navy Regulations.

18-6. ADDITIONAL HONORS

For prescribed honors due vessels passing close aboard, dignitaries embarked in boats passing close aboard, and ships passing Washington's tomb, see U.S. Navy Regulations.

[BLANK PAGE]

CHAPTER 19
FUNERALS

19-1. GENERAL

a. When not contrary to orders and regulations, the extent to which the naval service participates in a funeral depends upon the expressed wishes of the family of the deceased.

b. The composition and strength of the escort will be as prescribed in U.S. Navy Regulations or as modified by proper authority.

c. The military aspect of a funeral usually begins at one of the following places: home of the deceased, mortuary, railroad station, church or chapel, cemetery gates, or the grave. It may, however, begin at any designated place.

d. The ceremony starts when the remains are first received by the escort. Before that, the bodybearers may be detailed to conduct the remains wherever necessary.

e. In general, the escort receives the body at one of the following places:

(1) The designated place and conducts it to the place of services and then to the grave.

(2) The chapel before, and conducts it to the grave after, the services.

(3) The cemetery gates and conducts it to the grave.

(4) The grave.

f. Each time the bodybearers remove the remains:

(1) The escort is brought to present arms.

(2) The band renders prescribed honors, followed by appropriate music.

(3) The pallbearers salute.

(4) All observers in uniform, except the bodybearers, salute.

(5) All civilian-dressed naval personnel, except women, uncover and hold the headdress over the heart with the right hand. Women place the right hand over the heart without uncovering.

g. When the national color is draped on the casket, it shall be placed so the stars are at the head of the casket over the left shoulder of the deceased. Nothing shall rest on top of the national color. The color will be removed as the casket is being lowered into the grave, and in time so the color will not touch the ground.

h. The casket is always carried foot first, except in the case of a clergyman whose casket is carried into and out of the church or chapel head first.

i. Pallbearers may walk or ride, depending upon the distance to be covered.

j. The senior pallbearer will give necessary cautionary commands to the others in a low voice. All salute at the command PRESENT, ARMS, when given by the escort commander.

k. The personal flag of a deceased general or flag officer will be carried immediately in front of the hearse or caisson. If he was a unit commander or ship's captain, the command or commission pennant will also be carried.

l. If the entrance to the cemetery prevents the hearse or caisson from entering, the procession halts, the casket is removed, and the procession proceeds again.

m. When the deceased is entitled, the minute gun salute prescribed by U. S. Navy Regulations is fired. The first gun fires as the body enters the cemetery. Three volleys are fired at 5-second intervals as the casket is lowered into the grave.

n. When the band is playing a hymn and it becomes necessary to stop, it continues until the next stanza ending.

o. Uniformed officers in an official capacity will wear a mourning band on the left sleeve. If armed with the sword, its hilt will be affixed with the mourning knot.

p. Participation by fraternal or patriotic organizations is as follows:

(1) Fraternal or semimilitary organizations of which the deceased was a member may participate in the service if desired by the immediate family.

(2) If the ritual is military or semimilitary, the rites will begin immediately after the military ceremony. If it includes the firing of three volleys and Taps, these features of the military ceremony may be postponed until their appropriate places in the ritual, at which times the military firing party and bugler may render the honors.

q. When the body has been cremated, casket, body, and remains, as used herein, refer to the container of the ashes.

(1) For all phases of the funeral in which the cremated remains are carried by hand, one enlisted man will be detailed to carry the receptacle. Four enlisted men will be detailed as flag bearers. When the receptacle chapel to the conveyance, or from the conveyance to the grave, the flag bearers will follow the receptacle with the flag folded as prescribed in paragraph 16-3e and carried by the leading flag bearer on the right.

(2) When the receptacle has been placed on the stand before the chancel of the chapel, or when placed in the conveyance, the flag will be folded and placed inside it. If the caisson is equipped with a casket container for the receptacle, the open flag will be laid on the container as prescribed for a casket.

(3) When a hearse or caisson is not used, suitable transportation will be provided the receptacle bearer and flag bearers.

(4) When the remains are to be conducted to a crematory and the ashes interred with military honors at a later time, the ceremony will consist only of the escort to the crematory. Arms will be presented as the body is carried into the crematory. Volley firing and Taps are omitted. If the funeral is held at the crematory and no further military honors are anticipated, the volleys will be fired (if local ordinances permit) and Taps sounded outside the crematory.

19-2. DUTIES OF THE OFFICER IN CHARGE OF THE CEREMONY

a. The officer in charge should be detailed in sufficient time before the funeral to allow planning and prior arrangements. He will confer with the clergy and funeral director. Together they will ensure that all necessary arrangements have been made. The chaplain will perform the duties of officer in charge of the ceremony in case no other officer is so designated.

b. As soon as the service in the church or chapel has begun, the officer in charge will:

- (1) Make sure the hearse or caisson is ready to receive the casket at the front entrance.
- (2) Ensure a conveyance for flowers is posted at the side or rear entrance.
- (3) Arrange the cars for the clergy, pallbearers, and immediate family (if the procession is to ride) in the proper order (see fig. 19-1).

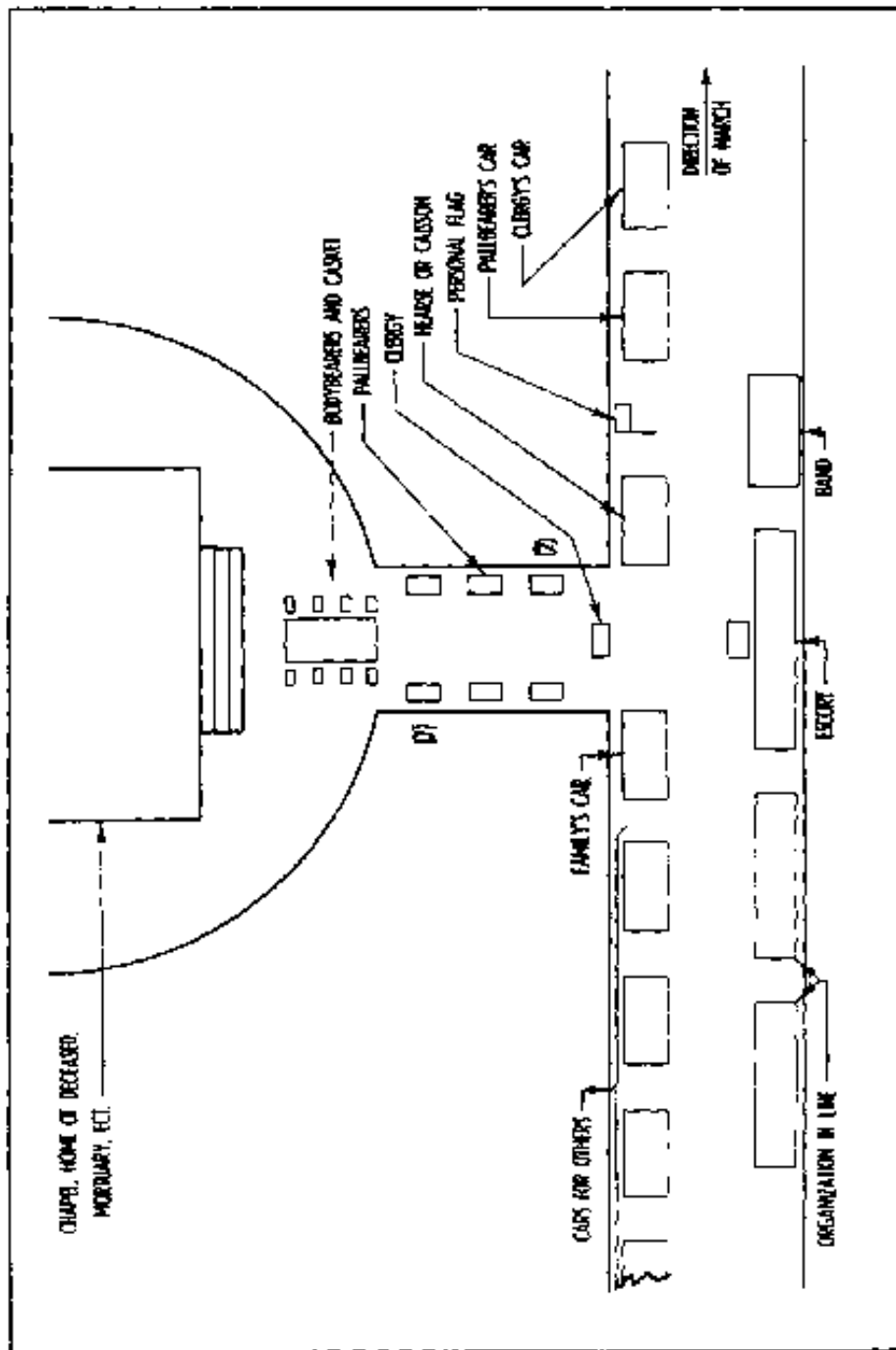

Figure 19-1.--Receiving the Remains from a Building.

(4) Designate four of the bodybearers to help carry the flowers out after the body has been placed in the conveyance. They should return through the side or rear door, at whichever the flower conveyance is parked. The remaining bodybearers will secure the casket on the caisson or hearse. After the flowers have been moved, the four designated bodybearers will take position in rear of the caisson or hearse.

c. When the body is transferred from the hearse to the caisson, the officer in charge will be in the vicinity. He will signal the escort commander when the transfer begins and when it is completed.

d. When the procession is in motion, the officer in charge will go to the grave and await the arrival of the funeral party. He will determine the positions for the band, escort, firing party (if separated from the escort), the bugler, and other units. Upon their arrival, he will direct these individuals and units to their proper positions at the grave.

e. After the units and individuals are in position at the grave, he will signal the bodybearers to carry the remains from the conveyance and the band and escort to render the honors.

f. When the widow or mother of the deceased is unaccompanied, the officer in charge will escort her from the car to the grave. When practicable, he will remain with her to render assistance until completion of the commitment.

g. After the commitment service, he will deliver the folded national color, used on the casket, to the family of the deceased.

h. When situations arise which are not covered in this manual, the officer in charge will use his own judgment.

i. Final decisions pertaining to troop handling or movement will be made by the officer in charge. All orders to troops participating in a funeral party will be given through him.

j. The officer in charge must cooperate with the funeral director engaged by the deceased's family. He must not arbitrarily assume the duties the funeral director is being paid to perform.

k. The officer in charge will explain the nature and significance of the volleys to the next of kin, or those representing the next of kin, and ascertain whether the volleys are desired.

19-3. RECEIVING THE REMAINS

Whenever the remains are received, the following procedure will govern (see figs. 19-1, 19-2, and 19-3):

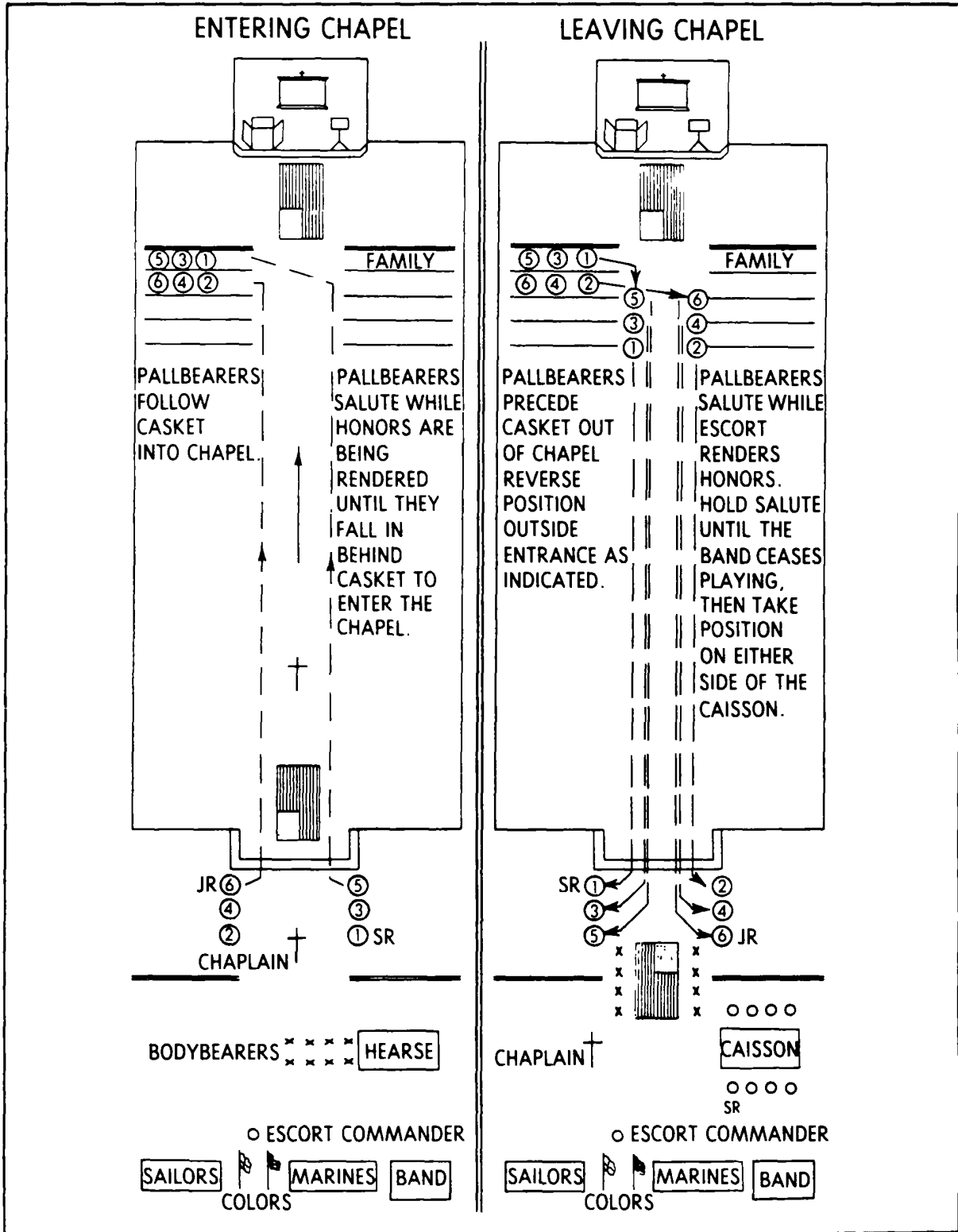

Figure 19-2.--Entering Chapel; Leaving Chapel.

Figure 19-2.--Entering Chapel; Leaving Chapel.

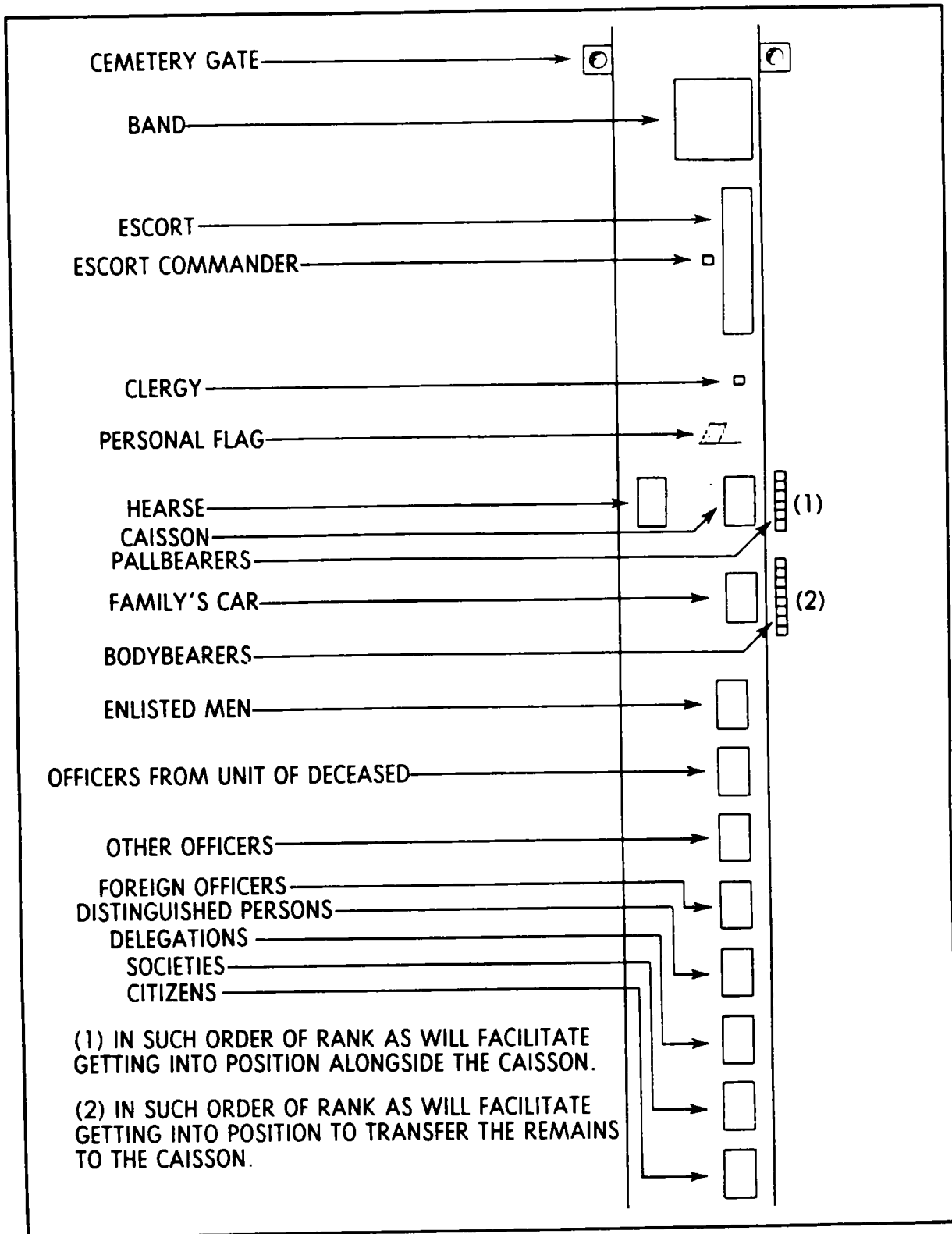

Figure 19-3.-- Receiving Remains at Cemetery Gates (Transferring Remains from Hearse or Caisson).

a. The escort is formed opposite the place where the remains are to be received. As they arrive, or when all is ready to receive the remains, the commander of the escort commands PRESENT, ARMS. After the remains have been received, the door to the hearse is closed, or the casket secured to the caisson, and the escort commander orders ORDER, ARMS.

b. The band is formed on the flank toward which the escort is to march. At the command of execution for present arms by the escort commander, the band will render musical honors if the deceased is entitled to such honors. Following this, they play appropriate music, stopping at the next stanza ending after order arms has been ordered.

c. The bearer of the personal flag of the deceased takes position and marches in front of the hearse or caisson.

d. Duties of the pallbearers are as follows:

(1) When the remains are received at the chapel before the services, form in two ranks facing inboard at the entrance with the juniors nearest the door. They must allow room between ranks for the casket to pass between them. As the casket is removed from the hearse or caisson, they execute the first movement of the hand salute. The second movement is executed as the casket passes, after which they face toward the door and follow the casket into the chapel. Seats are usually reserved for them among the left front pews.

(2) When the remains are received from a building (see fig. 19-1), assemble inside the building in column of twos, in reverse order of rank, junior to the left front, prepared to march out. They follow the clergy from the building (preceding the casket), open to allow the casket to pass between, halt, face inboard, and salute while the casket is passing. They remain at hand salute until the escort executes order arms. They then take their place in two columns of files on each side of the casket in inverse order of rank, junior to the left front, the leading person of each column opposite the front wheels of the hearse or caisson.

(3) When the remains are received at the cemetery gates (see fig. 19-3), they form in a single rank on the flank of the escort, opposite the hearse or caisson and in such order of rank that moving to position alongside the caisson is facilitated. They execute and terminate the hand salute on the commands for present and order arms by the escort commander. After present arms, they take their places beside the hearse or caisson as described in paragraph 19-3d(2).

e. The bodybearers, if not already with the remains, form on the left of the pallbearers. They leave the formation at the proper time to receive the casket and carry it to the chapel, caisson, or grave. They form, according to height, on each side of the casket. While indoors and not carrying the casket, they uncover. Outdoors they remain covered.

19-4. PROCESSION

a. After the remains have been placed in the hearse or caisson and all is ready, the officer in charge of the ceremony signals the escort commander. The escort commander puts the band and escort in motion. Elements in rear follow.

b. The procession forms in the following order (see fig. 19-4):

- (1) Escort commander.
- (2) Band or field music (bugler).
- (3) Escort in suitable formation.
- (4) Clergy.
- (5) Pallbearers if riding.
- (6) Personal flag if rated.

(7) Casket. If pallbearers are not riding, they form on either side of the hearse or caisson as described in paragraph 19-3d(2). If the pallbearers ride, the bodybearers take the place of the pallbearers.

- (8) Bodybearers in column of twos behind the hearse or caisson.
- (9) Family of the deceased.
- (10) Enlisted men.
- (11) Officers from the ship or organization of the deceased, in inverse order of rank.
- (12) Other officers in inverse order of rank.
- (13) Foreign officers.
- (14) Distinguished persons.
- (15) Delegations.
- (16) Societies.
- (17) Citizens.

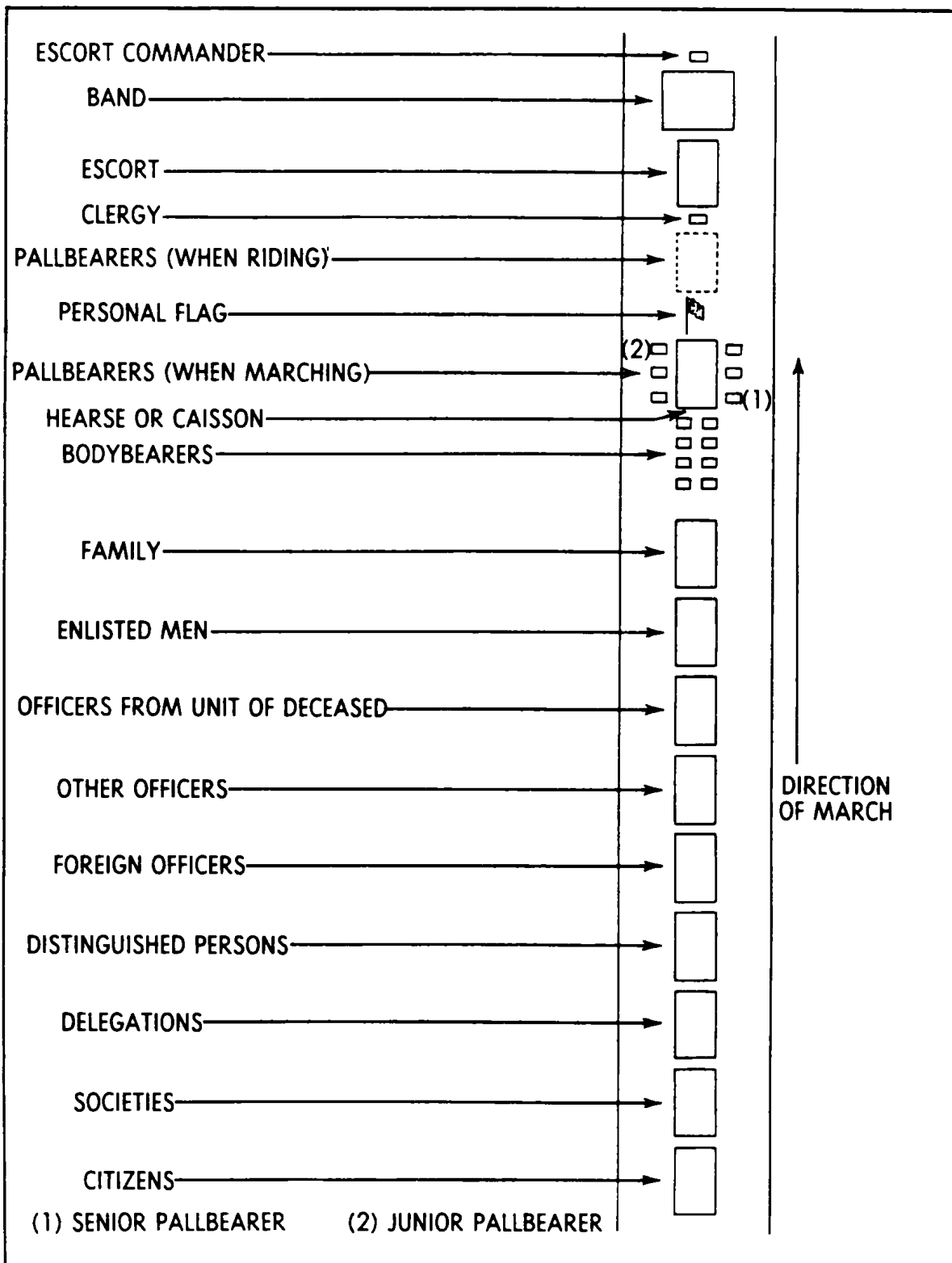

Figure 19-4.--Order of March of Funeral Procession.

Figure 19-4.--Order of March of Funeral Procession.

c. The procession marches in slow time to solemn music.

19-5. AT THE GRAVE

a. As the procession arrives at the grave, units turn out of column and take the following positions (see fig. 19-5):

(1) The band forms in line with and on the right of the escort.

(2) The escort forms in line facing the grave at a position indicated by the officer in charge of the ceremony. It should be at least 50 feet from the grave so the mourners will not be disturbed by the volleys. The terrain may dictate that the formation be inverted with the band on the left.

(3) The clergy forms between the hearse or caisson and the grave.

(4) The bearer of the personal flag of the deceased takes post between the clergy and the caisson or hearse.

(5) The pallbearers form in two ranks between the clergy and the grave. They face each other with the juniors nearest the grave. They allow room between their ranks to permit passage of the casket.

(6) The family of the deceased remains near the caisson or hearse.

(7) Other units form in separate lines near and facing the grave. Their positions are indicated by the officer in charge of ceremonies.

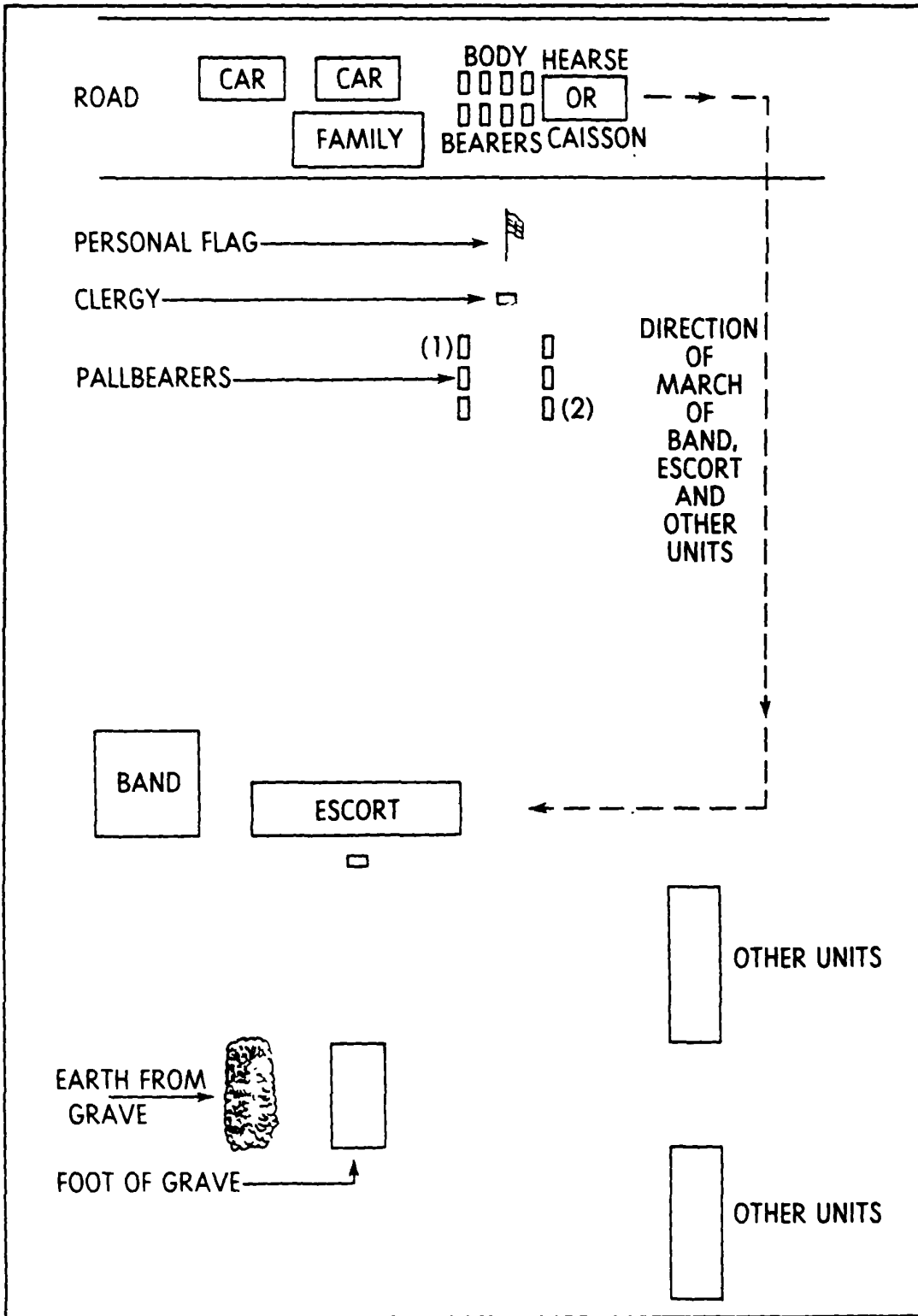

Figure 19-5.--Receiving the Remains at the Burial Ground.

Figure 19-5.--Receiving the Remains at the Burial Ground.

b. When all units are in position and upon signal of the officer in charge of the ceremony, the bodybearers remove the casket from the caisson or hearse. They carry it between the pallbearers and in front of the escort, then place it on the lowering device over the grave. They raise the national color by the corners and sides and hold it waist or shoulder high until the end of the services.

c. As the bodybearers remove the casket from the caisson or hearse (see fig. 19-6):

(1) The band renders prescribed honors, if rated, after which they play appropriate music. The music stops when the casket is placed on the lowering device.

(2) The escort presents arms until the casket is placed on the lowering device.

(3) The clergy precedes the personal flag and the casket to the grave.

(4) The flag bearer follows the clergy, preceding the casket, and takes position at the head of the grave. He remains there during the service.

(5) The pallbearers salute as the casket passes between them. When the casket has passed, they terminate the salute, face the grave, close interval, and follow the casket. Upon arrival at the grave, they form in two ranks facing the grave, usually just in rear and to one side of the clergy.

(6) The family of the deceased follows the pallbearers and takes position provided for it.

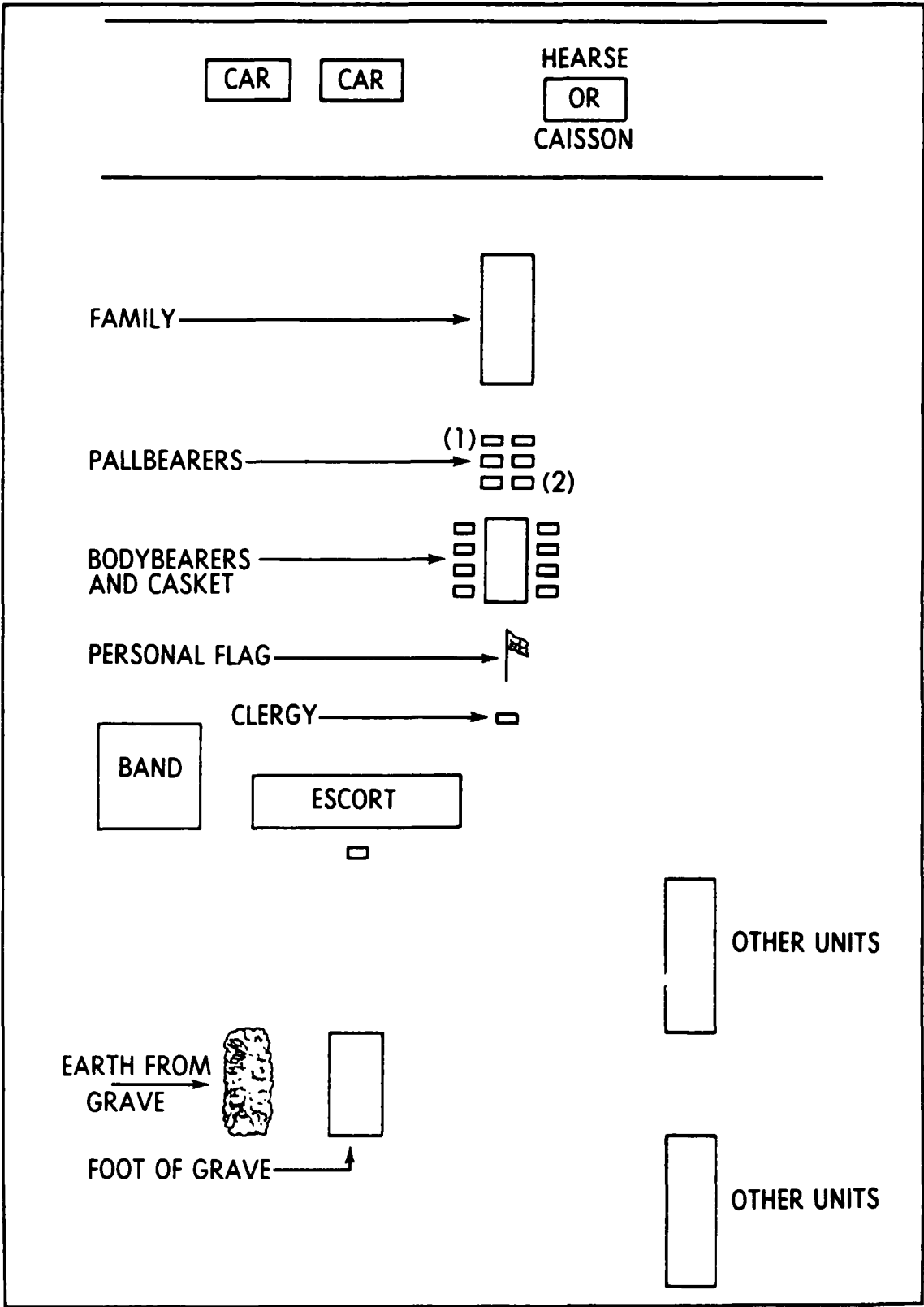

Figure 19-6.--March to the Grave.

Figure 19-6.--March to the Grave.

d. When the casket is placed on the lowering device and the family has arrived (see fig. 19-7):

- (1) The escort commander orders ORDER, ARMS; PARADE, REST. Members of the escort execute parade rest.
- (2) Pallbearers and other units execute parade rest on the escort commander's order.
- (3) The bodybearers remain in their positions, holding the national color so it will not touch the ground when the casket is lowered.
- (4) The clergy conducts the commitment services.

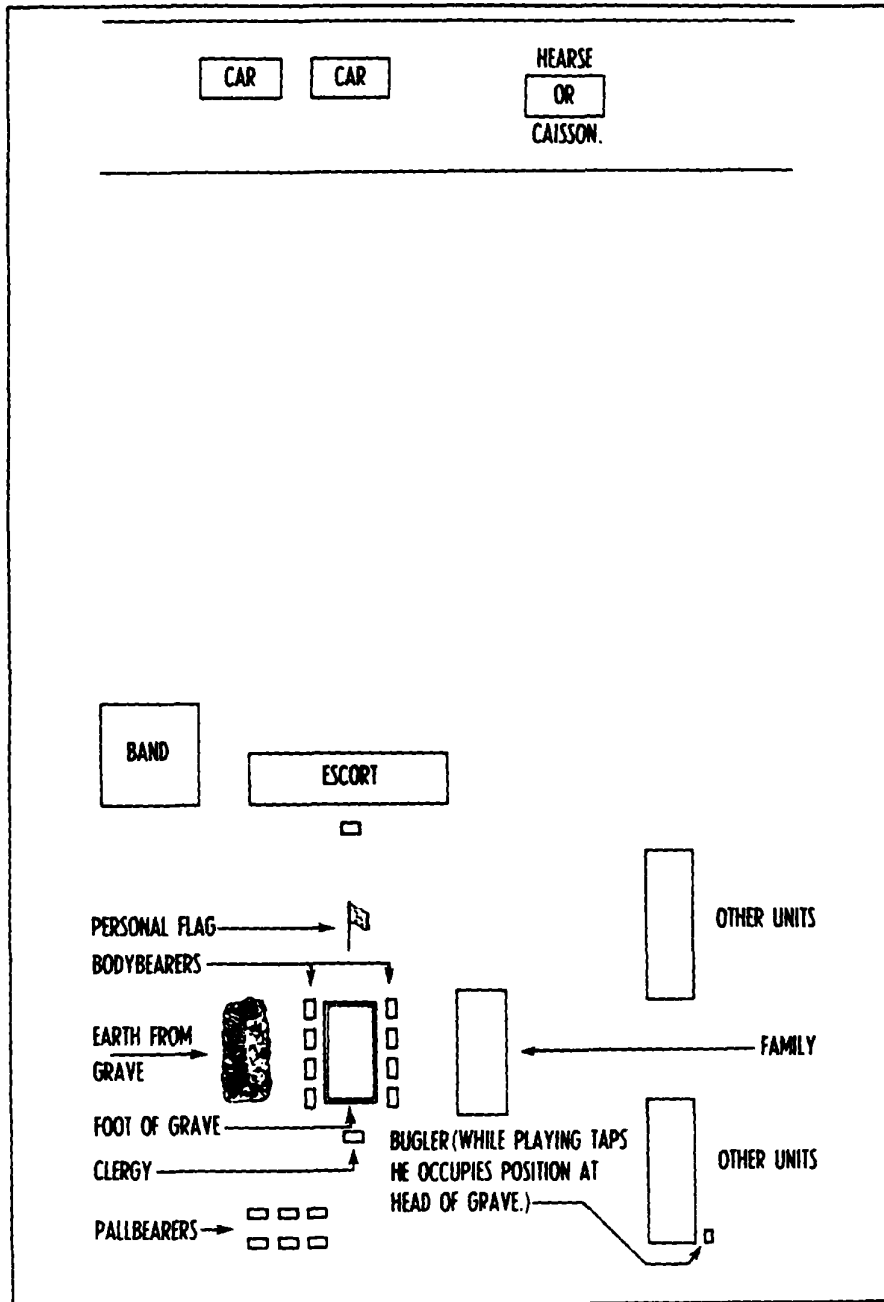

Figure 19-7.--A Distribution of Units at the Grave.

Figure 19-7.--A Distribution of Units at the Grave.

e. After the commitment services:

(1) The escort commander orders ESCORT, ATTENTION. He then commands ESCORT, PRESENT, ARMS. The noncommissioned officer in charge of the firing party then gives the command (see chapter 21) for the firing of volleys. The firing party executes present arms after completion of the three volleys. When sufficient troops are not available for a separate firing party, the front squad of the escort will be designated as the firing party.

(2) The pallbearers come to attention on the command of the escort commander and salute on his command for present arms.

(3) Other units are brought to attention and present arms at the same time as the escort.

(4) The clergy come to attention and, if in uniform, salute.

(5) The band leader comes to attention and salutes.

(6) The bearer of the personal flag of the deceased comes to attention and salutes. If necessary, he first steps aside to allow the field music to take his position for sounding Taps.

(7) The field music takes position at the head of the grave on the escort commander's order to present arms. (The officer in charge may direct that the field music assume a position forward of and to the flank of the escort rather than directly at the head of the grave). He salutes, and then sounds Taps immediately after the last volley and the firing party executes present arms. He salutes again, faces about, and rejoins his unit.

f. After the last note of Taps has sounded:

(1) The escort commander brings the entire escort to order arms and, after the color has been folded by the bodybearers and presented to the next of kin by the officer in charge, marches the escort and band to a suitable place for dismissal. The band does not play during the march from the grave. The rifles of the firing party are unloaded and inspected. If the escort and band continue in formation after leaving the cemetery, they remove all mourning and muffling from any colors that may be present. The band then plays march music.

(2) The pallbearers fall out and withdraw.

(3) The flag bearer folds the flag and rejoins his unit.

(4) The bodybearers fold the national color and give it to the officer in charge of the ceremony and march away.

(5) Other units march from the vicinity behind the escort.

19-6. MEMORIAL SERVICE HONORS

a. General. Upon the request of the next of kin, memorial services will be held for naval personnel whose remains have been declared nonrecoverable.

b. Honor Guard. The honor guard shall consist of the personnel listed in figure 19-8.

	FULL HONORS (OFFICERS ONLY)	HONORS (EN- LISTED, OFFICERS IF SO REQUESTED)
SQUAD LEADER	1	
SQUAD	12	
COLOR GUARD	4	4
FIELD MUSIC	1	1
OFFICER IN CHARGE (REPRESENTATIVE OF THE NAVAL DISTRICT COMMANDANT OR DISTRICT MARINE OFFICER)	1	1
CHAPLAIN (IF REQUESTED)	1	1
COLOR BEARER	1	1
TOTAL	21	8

Figure 19-8.--Honor Guard.

Figure 19-8.--Honor Guard.

c. Ceremony.

(1) The color bearer is present in the rear of the church or chapel before the arrival of the next of kin. At the exact time set for the services to begin (if next of kin has arrived), he carries the folded national color down the center aisle to the altar. He places it on the rostrum, where it remains throughout the ceremony, and retires to the wall on the left of the congregation. For the remainder of the services, he stands at attention, facing inward, just in front of the first pew.

(2) The honor guard, with color guard on their left, forms outside the church or chapel exit which will be used by the next of kin as he leaves. They remain at ease outside the church or chapel during the services. When Taps is sounded, they come to attention.

(3) The field music takes position in the vestibule or other room separate from the congregation.

(4) If requested by the next of kin, the chaplain conducts the services. Otherwise, the family minister or priest presides.

(5) At the conclusion of services, the field music sounds Taps.

(6) The chaplain presents the national color to the next of kin. If a family minister has officiated or the rank of the deceased requires, this duty is performed by the officer in charge.

(7) While presenting the flag, or after the flag has been presented by the chaplain, the officer in charge pays his respects and offers the condolences of the District Marine Officer.

(8) The chaplain speaks to the next of kin if he did not present the flag.

(9) The officer in charge escorts the next of kin from the church or chapel.

(10) The honor guard and color guard are called to attention by the squad leader (senior color bearer if squad is not present) upon the appearance of the next of kin. As the next of kin approaches to within 6 paces, the squad leader orders PRESENT, ARMS. The position of present arms is retained until the squad leader is directed to give order arms by the officer in charge. This will be after the next of kin has departed the vicinity.

(11) All participating personnel are dismissed.

19-7. CONDUCT OF FUNERALS WHEN MILITARY PERSONNEL ARE LIMITED

When personnel are limited, military honors for funerals may be efficiently rendered by a detail of eight men and one field music. The firing squad will stack arms at the place from which volleys will be fired, which should be approximately 50 feet from the head of the grave. They then will return to the hearse and convey the body to the grave. After placing the casket over the grave, six members of the party will take position as the firing squad while the remaining two men will remain at the grave and hold the flag over the casket during the service and rendition of military honors. The field music should take position approximately 50 feet from the head of the grave until the volleys have been fired, at the conclusion of which he shall sound Taps. Then the two men holding the flag shall fold it. The flag will be handed either to the Marine in charge of the detail or to the military escort commander. He will present it to the next of kin in a dignified manner with a short statement such as, "This flag is offered by a grateful nation in memory of the faithful service performed by your (relationship)."

[BLANK PAGE]

CHAPTER 20

INSPECTIONS

20-1. GENERAL

The company is the basic unit for inspection. Battalion, regimental, and higher commanders or inspecting officers inspect each company in its own area, or have it march to a specified place at a designated time for inspection. Under special conditions, an entire battalion or regiment may be inspected in one large formation.

20-2. COMPANY FORMATION

a. General. The company forms in line or in column of platoons in line as prescribed in chapter 9. If transportation is included, it forms 5 meters in rear of the troops. Drivers remain with their vehicles.

b. Procedure.

(1) When ready to inspect, the company commander commands PREPARE FOR INSPECTION. At this command, the platoon commanders open ranks by platoons. The right platoon executes the initial movement. The second platoon opens ranks when the front rank of the first platoon has been aligned. The third and subsequent platoons do not begin to open ranks until the front squad of the platoon to its right has been aligned. All platoon commanders align their squads on the corresponding squad of the platoon to their right. When the formation is a column of platoons in line, platoon commanders open ranks successively from front to rear without awaiting the alignment of the platoon to their front. They cause their units to cover the corresponding files to their front. In opening ranks and aligning their platoons, platoon commanders comply with the procedures prescribed for platoon drill. After verifying the alignment of the rear rank, each platoon commander faces to the right in marching, moves 3 paces beyond the front rank, faces the left, and commands READY, FRONT; COVER; after giving the command COVER, each platoon commander takes one step forward and faces to the front, thereby being in a position 3 paces in front of the right file of the front rank of their respective platoon. It is at this post that the platoon commander receives the inspecting officer.

(2) When all ranks have been opened, the company commander commands AT EASE. He then inspects the company. During the inspection, officers, noncommissioned officers, and guidon bearers not in ranks come to attention at order arms as the company commander approaches. After being inspected, they resume at ease. The company commander may direct the first sergeant to accompany him for the purpose of taking notes. The inspection begins at the head of the column or the right of the line. The company commander inspects the arms, equipment, dress, and appearance of the personnel. As he approaches each platoon, its commander brings his unit to attention and salutes. After being personally inspected, the platoon commander returns sword (if so armed) and places himself on the right of the company commander. He precedes the company commander during the entire inspection, down the front and rear of each squad. The company commander may direct that squads having been or not yet inspected be given at ease while he inspects others. In this case, the platoon commander complies and brings them to attention for inspection at the proper time.

(3) The inspection is made from right to left in the front, and from left to right in the rear of each rank. After inspecting the platoon commander, the company commander

moves around the platoon commander's left to a position in front of the right flank man in the first rank. He moves from man to man by stepping off to the right in marching, halting, and executing a left face. The platoon commander must move in the same manner so as not to be in the company commander's way.

(4) Each man executes the movements to inspection arms for his weapon immediately after the company commander has completed the left face movement and facing him.

(5) The company commander takes all individual weapons from the individual being inspected. He takes the rifle by grasping the handguard with his right hand. The man whose rifle is being inspected immediately drops his hands to his sides. After inspecting the weapon, the company commander hands it back with his right hand in the same position. The man smartly takes his weapon by grasping the center of the handguard just forward of the slipring with his left hand, closes the bolt, pulls the trigger, and returns the weapon to order arms as soon as he receives it. The company commander takes and returns other weapons in the most convenient manner. A detailed inspection will include bayonets and other equipment carried.

(6) Bayonets will be inspected when the company commander is in the rear of the rank. He will take and replace them without assistance from the man being inspected. The man will merely raise his left arm when the company commander takes and replaces the bayonet.

(7) Upon completion of the inspection of his platoon, the platoon commander, having led the company commander down the rear of the last squad, executes column left and halts when 3 paces beyond the right flank man of the first rank. He faces left, calls the entire platoon to attention, and then resumes his post, (see par. 20-2b(1)). The company commander passes to his right, faces to the left in marching, halts, and executes a left face. He then gives the platoon commander any instructions necessary. The platoon and company commanders exchange salutes and the latter proceeds to the next platoon.

(8) Upon completion of the inspection of each platoon, its commander faces left and orders CLOSE RANKS, MARCH. At the command MARCH, the platoon commander moves by the most direct route and takes his post 6 paces in front of the center of his platoon.

(9) The company commander may direct the platoon commanders to make the detailed inspection by the following order, PLATOON COMMANDERS, INSPECT YOUR PLATOONS. In this case, each platoon commander complies. They may direct their platoon sergeants to accompany them for the purpose of taking notes. The company commander will normally spot check individuals while platoon commanders are inspecting their platoons. In this case, men at ease will automatically come to attention upon his approach, and to inspection arms if he stops in front of them, regardless of whether they have been previously inspected.

20-3. INSPECTION OF PERSONAL FIELD EQUIPMENT IN RANKS

a. The company forms in column of platoons, in line for a preliminary rifle inspection. After the inspection of the first platoon, the company commander directs the platoon commander to prepare for inspection of equipment. Upon his departure to inspect the arms of the next platoon, the platoon commander orders FIRST SQUAD, 2 PACES FORWARD, MARCH; SECOND SQUAD, 1 PACE FORWARD, MARCH. He then causes the platoon to take interval, after which he commands UNSLING EQUIPMENT. Upon the completion of this, he orders DISPLAY EQUIPMENT.

b. At the command UNSLING EQUIPMENT, each man draws his bayonet and thrusts it into the ground, with his left hand, outside and against the left instep. The bayonet ring is to the front. Men not armed with the bayonet mark the place with their left heels. This is to mark the rear right corner of the individual's equipment layout. Each man armed with a shoulder weapon lays it on the ground with muzzle to the front, barrel to the left, and butt near the toe of his right foot. He then unslings his equipment and places it on the ground 1 foot in front of his feet. The top of the pack should be to the front and the side which faces rear when worn should be up. All men resume attention when finished.

c. At the command DISPLAY EQUIPMENT, packs are opened and equipment displayed as in current directives. The equipment is displayed in the interval to the left of each man. As he finishes arranging his equipment, each man resumes attention in his original position in ranks.

d. The company commander returns to the first platoon after inspecting the arms of the last. He passes along the ranks from right to left as before. When finished inspecting the platoon, he directs the platoon commander to have the packs rolled and proceeds the platoon to the next platoon to be inspected. The post of the platoon commander and his action during the company commander's arrival and departure is the same as described in paragraph 20-2b.

e. The platoon commander then commands ROLL PACKS. Each man assembles his equipment and rolls his pack. He places it in front of him, as described in paragraph 20-3b and comes to attention.

f. After all equipment is assembled and packs rolled, the platoon commander commands SLING EQUIPMENT. All men sling packs, fasten belts, and take arms. They then assume their original place in formation, at attention and order arms.

g. The platoon commander then causes the platoon to close interval and then close ranks, after which he gives REST or AT EASE.

h. In units such as weapons or headquarters and service companies which have special combat equipment, the company commander, after packs have been opened or after individual inspection, directs DISPLAY MACHINEGUN (MORTAR, or other) EQUIPMENT. Gun teams/squads under the direction of their leaders break ranks and lay out their weapons and accessories for inspection as described in the gun drill for that particular weapon. Headquarters personnel lay out their fire control, communication, or other equipment in a similar manner. Such equipment is displayed 3 paces from the squad's flank from which interval was taken. The rear of the equipment is placed on line with the rear of the individual field equipment.

20-4. INSPECTING OFFICER OTHER THAN COMPANY COMMANDER

Should the inspecting officer be other than the company commander, the latter will face the original front of his company after commanding AT EASE. Upon the approach of the inspecting officer, the inspection proceeds as previously explained. The company commander follows the inspecting officer.

20-5. BATTALION INSPECTIONS

a. The battalion is formed in column of companies with companies in line or in line with companies in line, as prescribed in chapter 10. Before the inspection, the battalion commander indicates whether crew-served weapons and special equipment are to be displayed. They may be laid out at the armory or left on their transportation for subsequent inspection.

b. When the companies are in position, the battalion commander commands PREPARE FOR INSPECTION. At this command, all companies prepare as described in paragraph 20-2. The color guard proceeds to a position 3 paces in rear of the battalion staff.

c. The battalion commander then commands REST, returns sword if so armed, and inspects his staff and color guard. The staff members come to attention without command, upon his approach, and execute order sword. When he approaches the color guard, after inspecting the staff, the staff members return sword and accompany him. The color guard is brought to attention by the senior color bearer. The color guard may be dismissed by the battalion commander as soon as inspected.

d. The battalion commander, beginning at the right of the line or at the head of the column, inspects the arms, equipment, dress, and appearance of the personnel in each company.

e. As the battalion commander approaches each company, its commander calls it to attention, faces the front, and salutes. As soon as he has been inspected, the company commander gives his unit REST, returns sword if so armed, and accompanies the battalion commander during the inspection. The inspection proceeds as described in paragraph 20-2.

f. The battalion commander may direct the company commanders to make the detailed inspections of their own companies, in which case he will usually spot check individuals throughout the battalion. In such a case, all men react as described in paragraph 20-2b upon the approach of the battalion commander. The battalion commander may also direct members of his staff to inspect individual companies, in which case company commanders react as described in paragraph 20-2.

g. After a company has been inspected, unless otherwise directed, it may be marched from the field and dismissed.

h. When desired, the battalion commander may direct companies not being inspected to stack arms, fall out, and await their turn in the immediate vicinity. In this case, company commanders so instructed must fall their men in and prepare for inspection in time so as not to delay the entire inspection.

i. If the inspecting officer is other than the battalion commander, the latter prepare the battalion for inspection in the same manner. Upon the approach of the inspecting officer, he brings the battalion to attention, faces the front, and salutes. After being personally inspected, the commander gives the battalion REST, returns sword, and accompanies the inspecting officer. The inspecting officer proceeds as previously prescribed for the battalion commander.

20-6. REGIMENTAL INSPECTION

Only in an exceptional situation will an entire regiment be inspected in one formation. However, when held, the principles are the same as for the battalion. The regiment may be formed in any manner suitable to the available space and ground. Battalions are prepared for inspection as described in paragraph 20-5. Upon the approach of the inspecting officer, each battalion commander brings his unit to attention and salutes. Battalion inspection then follows.

20-7. INSPECTION OF QUARTERS OR CAMP

a. General. In quarters, the men stand near their respective bunks uncovered and without equipment or arms. In camp or bivouac, they stand outside their tents covered but without equipment or arms. If inspection of individual equipment and/or clothing has been ordered, each man arranges the required articles as described in current directives.

b. Battalion. During the inspection of the quarters or camp of a company, the battalion commander is accompanied by the company commander and preceded by the first sergeant and field music. The first sergeant causes the field music to sound ATTENTION as the inspecting party approaches. In the absence of a field music, the first sergeant uses the voice command. Such other officers as may be designated accompany the battalion commander on his inspection.

c. Regimental. The procedure is the same as outlined in paragraph 20-7b. The regimental commander is accompanied by the battalion commander and commander of the company being inspected.

[BLANK PAGE]

CHAPTER 21

LOADING AND CEREMONIAL FIRING OF THE RIFLE

21-1. GENERAL RULES

a. For ceremonial firing, only the front rank of units larger than a squad executes the loading and firing.

b. Rifles are kept on SAFE while loaded.

c. Except during actual firing, loaded rifles are kept on SAFE without command until UNLOAD or INSPECTION, ARMS is ordered.

d. In order to enhance the appearance of the firing party magazines with three rounds will be inserted into the rifle out of view of spectators. (Two expended cartridges should be placed in the magazine below the three blank cartridge so that adequate tension will be placed on the spring.) A round not be placed in the chamber.

21-2. TO LOAD

a. With the unit at attention (see fig. 21-1), the command is WITH BLANK AMMUNITION, LOAD. The movements are executed quickly and smartly.



Figure 21-1.--Firing Party Ready for Ceremonial Firing.

b. On the command LOAD, members of firing party execute the following sequences of movements.

(1) Face half right (see fig. 21-2).

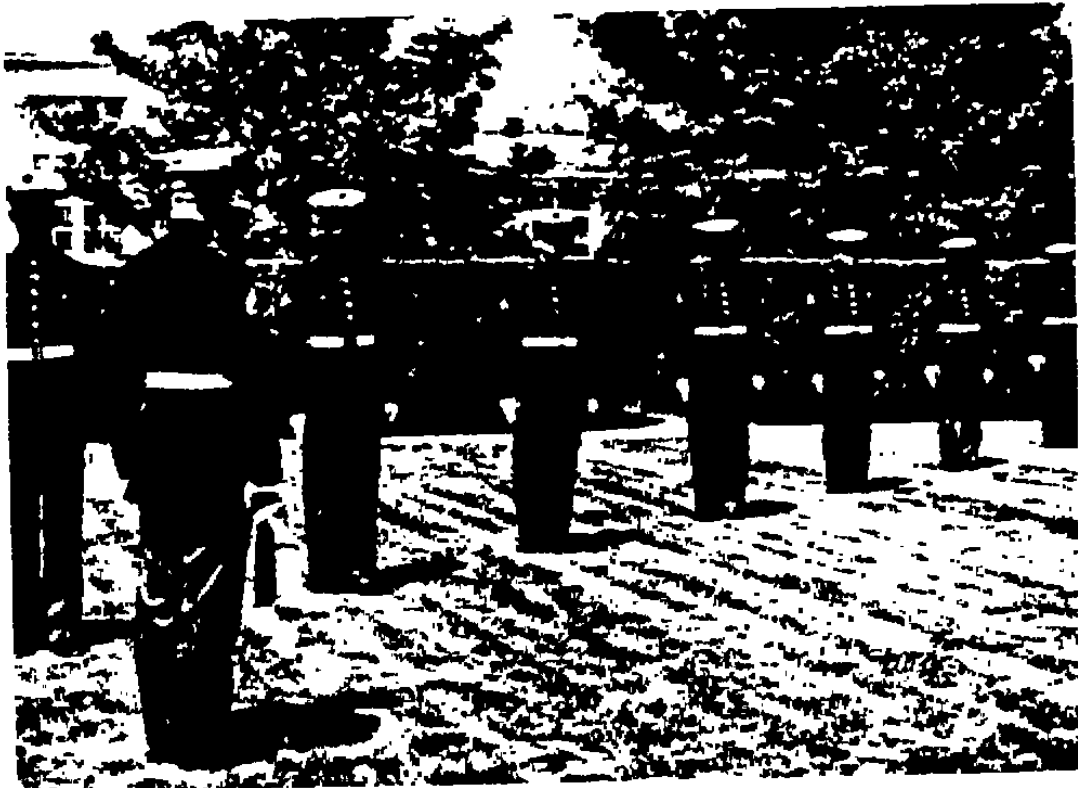

Figure 21-2.--Riflemen face Half Right.

(2) Move left foot 12 inches to the left (see fig. 21-3). The legs are kept straight so the weight of the body rests equally on both feet.

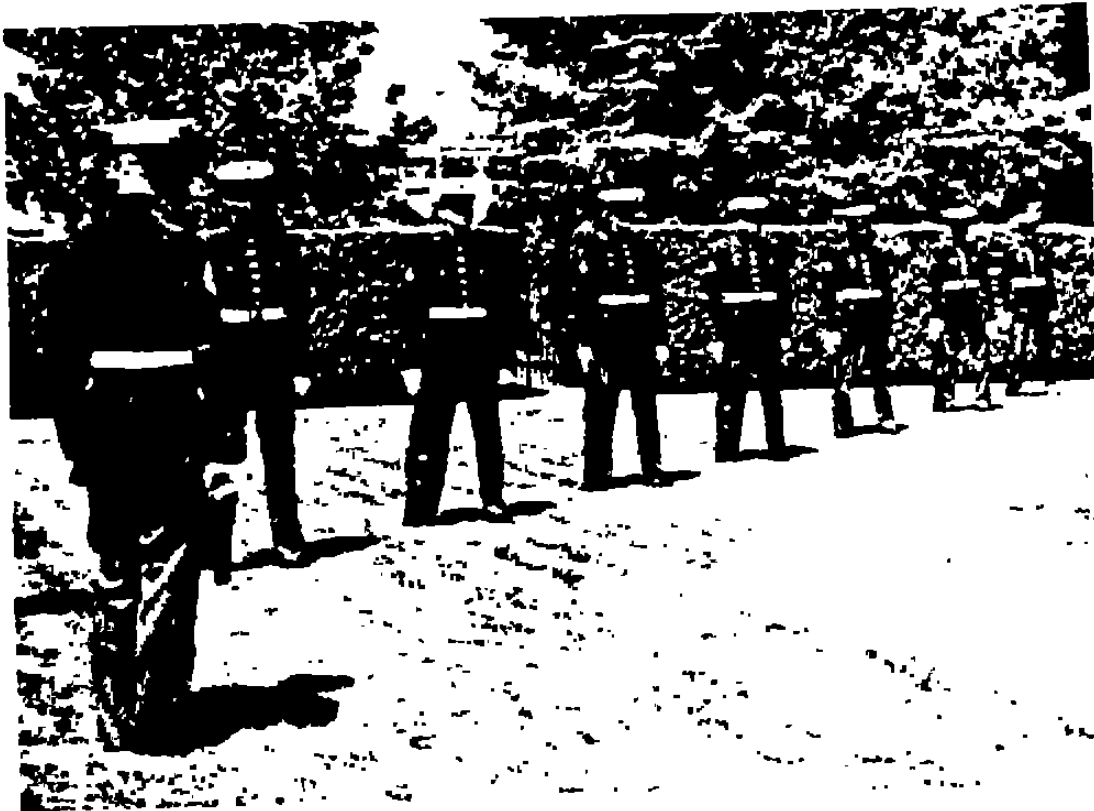

Figure 21-3.--Each Riflemen Places Left Foot 12 Inches to the Left.

(3) Raise the rifle with the right hand and grasp it at the handguard with the left hand (see fig. 21-4). This is the same as the first count of PORT ARMS.

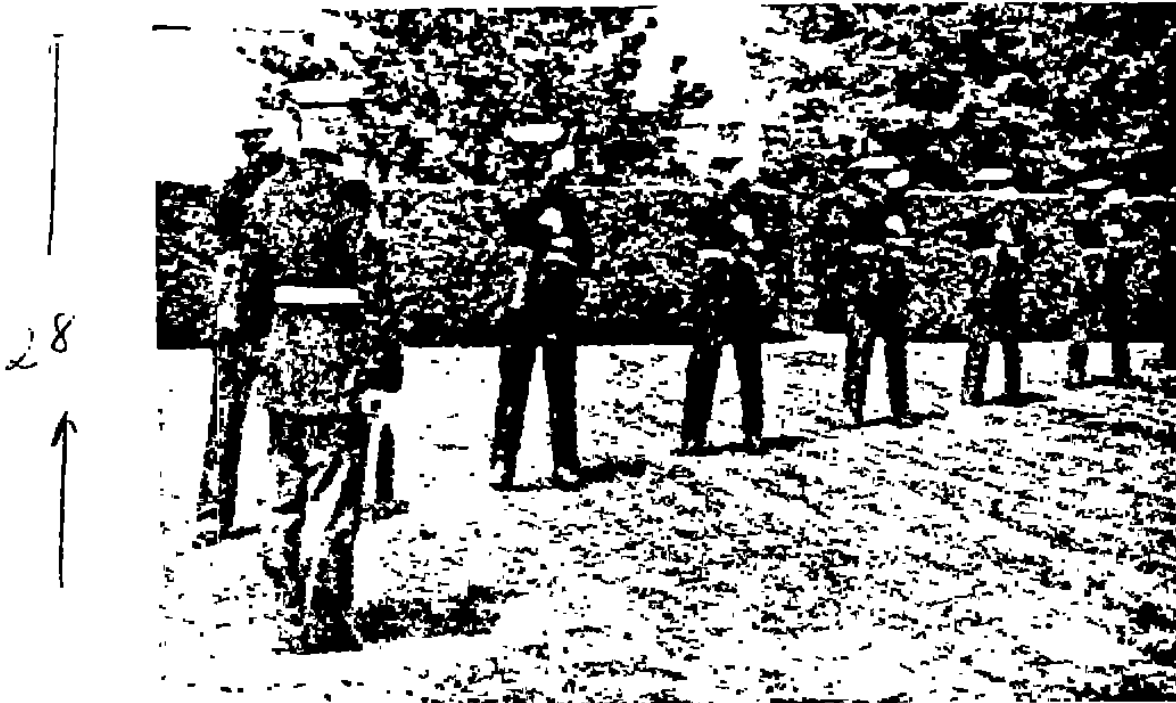

Figure 21-4.--Raise the rifle with Right Hand, Grasp Handguard with left hand.

(4) Move the right hand to the small of the stock (see fig. 21-5). This is the same as the second count of PORT ARMS. the rifle should now be in the position of port arms.



Figure 21-5.--Move Right hand to the small of the stock (PORT ARMS).

(5) Pull charging handle fully to the rear with the right hand (see fig. 21-6) and release it, thus placing a round in the chamber.

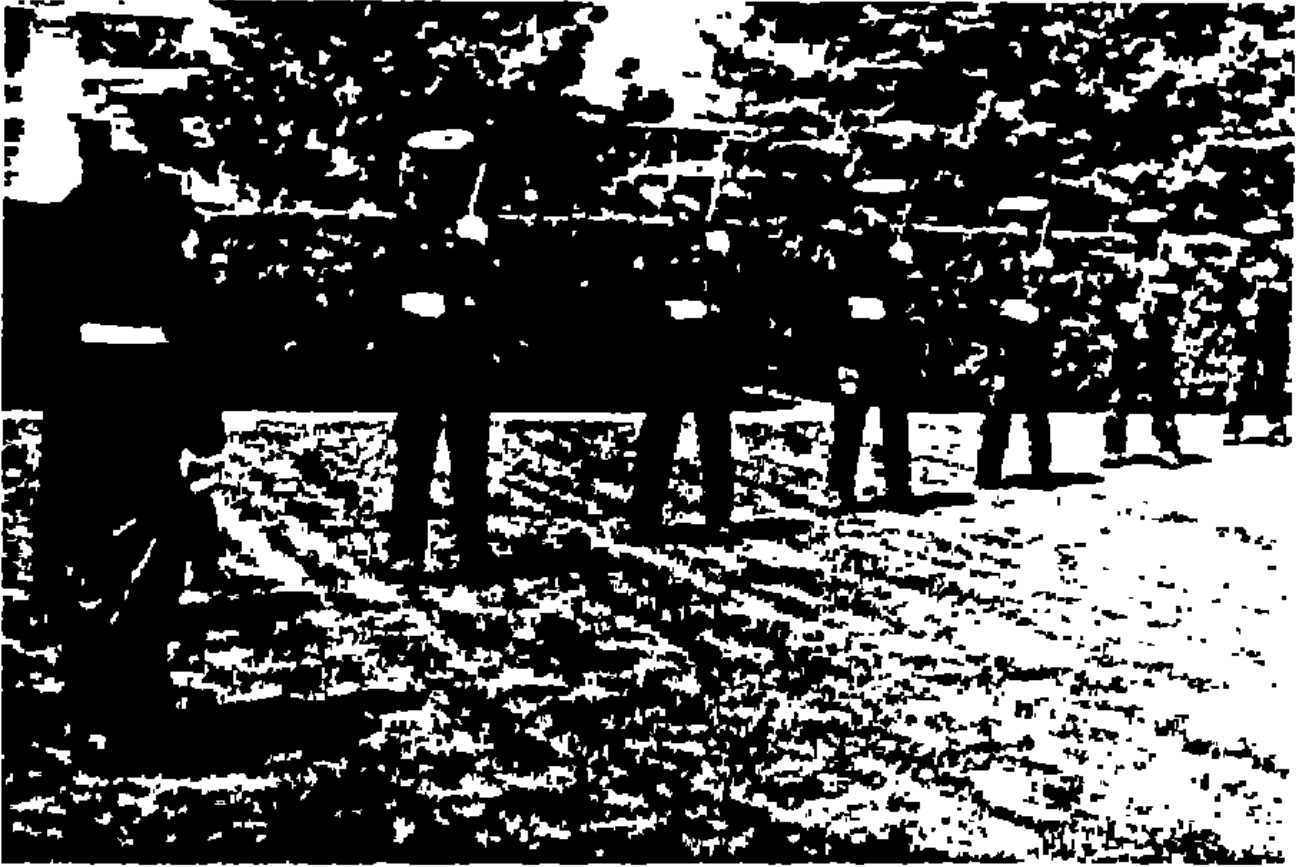

Figure 21-6.--Pull Charging Handle Fully to the Rear.

(6) Move the right hand to the pistol grip.

21-3. TO FIRE BY VOLLEY

a. After the rifles are loaded as described above, the noncommissioned officer in charge of the firing party orders READY; AIM; FIRE.

b. On READY, each rifleman moves the selector lever from SAFE to SEMI AUTOMATIC with the right thumb.

c. ON AIM, each rifleman raises the rifle to a position of 45 degrees from horizontal, places the butt firmly in the right shoulder, and rests the handguard in the "V" formed by the thumb and forefinger of the left hand. All fingers of the left hand are together and extended. The left wrist is straight. The right hand is wrapped around the pistol grip from the right. The right elbow is raised to near shoulder height. The head is turned 90 degrees to the left and held erect. Both eyes remain open with the right eye looking out over the front sight (see fig. 21-7).



Figure 21-7.--Firing party at Position of Fire.

d. On FIRE, squeeze the trigger quickly and lower the rifle to the position of port arms.

e. To continue the firing, the commands are AIM; FIRE. Each command is executed as explained above. To continue the firing with weapons without blank adapters, the commands READY, AIM, FIRE are again given. On the command READY, each rifleman manually chambers the next round. The execution of the commands AIM and FIRE are as described above.

f. After the last round has been fired, rifles are brought to the position of PORT ARMS. From this position, the command PRESENT, ARMS is given by the noncommissioned officer. The command is executed in three counts:

(1) With the left foot extended, pivot on the heel of the left foot and toe of the right, completing a left face.

(2) Bring the heel of the right foot smartly against the heel of the left foot.

(3) Move the weapon to present arms.

21-4 TO UNLOAD

a. The weapons will be unloaded and inspected as soon as possible after leaving the site of the ceremony and out of sight of spectators, if possible.

b. The command is UNLOAD. It is executed by removing the magazine and then performing inspection arms.

[BLANK PAGE]

CHAPTER 22

MARINE CORPS BIRTHDAY CEREMONY

22-1. PROCEDURE AND GUIDE

- a. The following procedure is prescribed as a guide for the conduct of the Marine Corps Birthday Ceremony. It is outlined on the basis of a Marine Corps post commanded by a general officer. At posts where no general officer is present, and in enlisted men's messes, modifications may be made as necessary to meet local conditions. Rehearsals must be conducted to ensure that the ceremony proceeds smoothly and precisely.
- b. At a time selected for the commencement of the ceremony, a field music sounds attention and the officer in charge requests guests to clear the center of the dance floor. The adjutant takes post at the front of the cleared area. Drummers and trumpeters and other participants in the ceremony form at the main entrance to the ballroom. Escort draws swords. The adjutant's sword remains in scabbard throughout the ceremony.
- c. On signal from the officer in charge, the doors to the ballroom are thrown open; the adjutant commands SOUND ADJUTANT'S CALL; the field music sounds ADJUTANT'S CALL; drummers take up the beat at the last note and, after a brief interval, drummers and trumpeters march onto the dance floor playing the "Foreign Legion March." Drummers and trumpeters march down a cleared lane to the far end of the dance floor, countermarch just in front of the adjutant, and followed by him, march back to the main entrance, countermarch again, and halt. Drummers and trumpeters then execute right and left step a sufficient distance to clear the entrance doorway. The adjutant moves behind the cake escort. The march is ceased upon the command of the drum major.
- d. The band or orchestra commences playing "Semper Fidelis." Two colonels of escort enter the ballroom together, march down the dance floor, and when an appropriate distance from the far end of the ballroom, turn right and left in marching and take station on each side of the cleared lane facing inboard. They are then followed by two lieutenant colonels, two majors, two captains, two first lieutenants, and two second lieutenants, each pair taking station at double arms interval, the two lines thus forming two long sides of a hollow rectangle. General officers, if present, or other ranking personnel, enter the ballroom in pairs by the main entrance, march down the line of escorts to the end of the ballroom, halt, face about, and form a third side of the rectangle, leaving two spaces vacant in the center of the lines. When all are in position, the band or orchestra ceases playing.
- e. The field music sounds "Attention." The commanding general and guest of honor, if one has been invited to participate, enter the ballroom together, march halfway down the line of escorts, and halt. The senior colonel of the escort commands PRESENT, ARMS. Officers of the escort salute. The appropriate musical honors will be rendered. The senior colonel of the escort commands ORDER, ARMS and the escort comes to the order. The commanding general and the guest of honor move to the end of the line of escort (without music), halt, and face about, taking position in the center of the line of general officers.
- f. The field music sounds "Attention." The color guard enters the ballroom, marches halfway down the line of escorts and halts, remaining at right shoulder arms. The senior colonel of the

escort commands PRESENT ARMS. The escort and color guard salute, and the band or orchestra plays the "National Anthem." The senior colonel of the escort then commands ORDER, ARMS. The escort comes to the order and the color guard returns to right shoulder arms. The color guard then marches forward to the end of the line of escorts, countermarches, and marches back down the line of escorts to a position in front of the drummers and trumpeters, then executes a second countermarch and halts. The color guard then executes left and right step, halting in front of the drummers and trumpeters.

g. The field music sounds "Attention." The band or orchestra plays "The Marines' Hymn" and the cake escorts (four second lieutenants) enter the ballroom. Between them they push a serving cart on which are placed the birthday cake and a Marine sword. The adjutant follows the cake. The cake escorts slowly roll the cake down the line of escorts to a position in front of the commanding general. The cake escorts then sidestep 1 pace, halt, and face inboard toward the cake. The band or orchestra ceases playing. The adjutant faces about and reads the traditional birthday message. He then retires by marching the length of the ballroom.

h. The commanding general steps forward, gives a short talk on the significance of the Marine Corps birthday, and introduces the guest of honor, if one is present. The guest of honor then makes a few remarks. When the addresses are completed, the senior cake escort steps forward, takes the sword from the cake cart, and passes it over his left forearm, grip forward, to the commanding general. The band or orchestra plays "Auld Lang Syne" while the first slice of cake is being cut. The commanding general places the first slice of cake on a plate handed to him by one of the cake escorts, and passes the plate to the guest of honor. After tasting the cake, the guest of honor returns the plate to one of the escorts who places it on the serving cart. The commanding general then cuts and presents pieces of cake to the oldest Marine present and the youngest Marine present, in that order.

i. Upon completion of this part of the ceremony, the color guard, upon order of the color sergeant, closes by executing right and left step and comes to right shoulder arms. The color sergeant commands FORWARD, MARCH and the band or orchestra commences playing "Semper Fidelis." The color guard then marches forward to the end of the line of escorts, countermarches, and marches between the line of escorts and out the entrance way. When the colors have cleared the dance floor, the commanding general with the guest of honor march forward between the line of escorts and out the entrance way. When they have cleared the entrance, they are followed in a similar manner by the remainder of the general officers, marching out in pairs.

j. As the last general officer clears the ballroom, the cake escort steps forward, faces right and left, and rolls the cake serving cart forward to the line where the general officers were standing. The cake escort then faces about toward the entrance and remains in position until the conclusion of the ceremony, when all members of the cake escort assist in passing the cake to the distinguished guests present.

k. Upon completion of the cake escort's movements, the two colonels come to carry swords, march forward to center line of the ballroom, face toward the entrance door, and march off the dance floor together through the entrance way. They are followed successively by the remainder of the escorts, the band or orchestra continuing to play until the last officers of the escort have cleared the dance floor. The band or orchestra ceases playing. The drummers and trumpeters close by side-stepping to the right and left, take up the beat, march the length of the dance floor, countermarch, and march back down the floor and out of the entrance way. As the last trumpeter clears the entrance way, the doors are closed, thus concluding the ceremony.

22-2. VARIATION

It is recognized that considerable variation must be made in this ceremony to conform with the configuration of the dance floor or in the absence of a band or field music. Examples are:

a. When the ceremony is conducted at posts where is no general officer commanding, the senior line officer will follow the procedure outlined above for the commanding general. At such posts, the escorts will be formed from appropriate ranks present.

b. When the ceremony is conducted at noncommissioned officer's or other enlisted messes, appropriate ranking noncommissioned officers will preside and form the escort.

c. Where the ballroom is of sufficient size, two officers or enlisted personnel of each rank will be assigned to the escort,

d. Where practicable, the following uniform will be worn:

(1) Officer, evening dress or blue dress.

(2) Enlisted, blue dress.

e. The birthday cake will be mounted on a mess serving cart or similar conveyance covered with scarlet and gold bunting.

f. Where swords are not available, escort will execute hand salute at appropriate commands.

g. Guests may be cleared from the center of the ballroom by stretching white lines, supported by second lieutenants or noncommissioned officers, moving from center line of dance floor toward either side to provide required space for the ceremony.

[BLANK PAGE]

CHAPTER 23
RELIEF AND APPOINTMENT OF THE SERGEANT MAJOR

23-1. GENERAL

Ceremonies for relief and appointment of sergeants major in the Marine Corps shall be conducted as prescribed in this chapter.

23-2. OCCASION

When practicable, the ceremony set forth below will be held upon the relief of the old and appointment of a new sergeant major within units of battalion size or larger.

23-3. FORMATION

The troops and reviewing party form and take position as prescribed for a review.

23-4. PRESENTATION OF COMMAND TO REVIEWING OFFICER

a. As the reviewing officer approaches his post, the commanding officer of troops brings his command to attention as in a review.

b. When the reviewing officer has returned his salute, the commanding officer of troops faces about and commands ORDER, ARMS.

23-5. RELIEF AND APPOINTMENT

a. The commanding officer of troops then commands SERGEANTS MAJOR, FRONT AND CENTER, MARCH.

b. The old sergeant major, in the staff of the commanding officer of troops, and the new sergeant major, behind the center company, march front and center individually. They take the most direct route to positions 6 paces front and center of the reviewing officer, the new to the left of the old at normal interval. As they march to this position, the band plays "The Marines' Hymn."

c. The reviewing officer directs his adjutant to publish the orders. The adjutant reads the orders of the old sergeant major, the orders of the new sergeant major, and then resumes his position on the staff.

d. When the adjutant has resumed his position, the old sergeant major marches to a position 2 paces in front of and facing the reviewing officer. He halts, salutes, and reports, "Sir, Sergeant Major (last name) reports as the old sergeant major." The reviewing officer returns the salute and commands, "You are relieved." The old sergeant major terminates his salute and takes position immediately to the left of the reviewing officer at normal interval.

e. The new sergeant major then takes the position just vacated by the old sergeant major. He salutes and reports, "Sir, Sergeant Major (last name) reports as the new sergeant major." The reviewing officer returns the salute. The new sergeant major terminates his salute.

f. The reviewing officer then commands, "Take your post." The new sergeant major salutes. When his salute is returned, he faces about and marches, by the most direct route, to the post for sergeant major on the staff of the commanding officer of troops.

23-6. CONTINUATION OF THE REVIEW

The ceremony then continues as for the review.

[BLANK PAGE]

-- end --

=====
FORMATTED BY:

U.S. Naval Sea Cadet Corps, Internet Development Group

MIDN Andrew S. Munoz, NSCC

<http://www.seacadets.org/idg/>

Report any typographical errors through the above address.

Text and graphics from U.S. Coast Guard Directives System 3.1 CD (March 1999)

=====