

U.S. Department
of Transportation

United States
Coast Guard



Merchant Marine Deck Examination Reference Material

OPERATING MANUAL FOR DEEP DRILLER

PLEASE NOTE

This manual has been prepared solely for use with MODU license examinations. The policies and procedures outlined should not be used as a guide for the operation of any specific unit. Use only the policies and procedures outlined in the manual developed specifically for the unit. Because this manual is incomplete, it should *not* be used as a model for preparing MODU operating manuals for compliance with 46 CFR 109.121.

Aug
1989

This publication contains information to be used in examinations for
merchant marine licenses and documents.

COMDTPUB P16721.29

INSTRUCTIONS

1. Some of the questions in the deck examination booklets require the use of mobile offshore drilling unit (MODU) reference material to answer the question. All of the material necessary to these questions is contained in the appropriate Merchant Marine Deck Examination Reference Book.
2. If a question requires the use of mobile offshore drilling unit reference materials, the stem of the question will make reference to the MODU in question. For example, if the question in your examination booklet is, "The center of flotation for the Deep Driller is located at the geometric center of the _____.", you must use The Merchant Marine Deck Examination Reference Book, THE OPERATING MANUAL FOR DEEP DRILLER to answer the question.
3. The Merchant Marine Deck Examination Reference Book, OPERATING MANUAL FOR DEEP DRILLER, has been prepared solely for use with MODU license examinations. The policies and procedures outlined should not be used as a guide for the operation of any specific unit. Use only the policies and procedures outlined in the manual developed specifically for the unit. Because this manual is incomplete it should not be used as a model for repairing MODU operating manuals for compliance with 46 CFR 109.121.
4. Applicants taking an examination who wish to make a comment or protest concerning any material in this publication should complete a Comment/Protest form for the question involved and give it to the examiner.
5. Individuals not taking an examination who wish to make a comment on any material in this publication should send a written comment, citing this publication and the appropriate page, and paragraph or illustration commented on, to:

Commandant (G-MVP-5)
U.S. Coast Guard
OPERATING MANUAL FOR DEEP DRILLER
2100 Second Street SW
Washington, DC 20593-0001

All written comments submitted by the general public will be reviewed prior to revising this publication. A heavy workload precludes the Merchant Marine Examination Branch from discussing comments over the telephone or responding to written comments. Your comments are welcomed and you will receive a letter or postcard indicating your comments were received.

CONTENTS

	PAGE
1.0 INTRODUCTION	
1.1 NATURE AND PURPOSE OF THE MANUAL	1-1
1.2 ARRANGEMENT OF MATERIAL	1-1
1.3 CLASSIFICATION	1-1
1.4 REGULATORY COMMENTS	1-2
1.5 OWNER, DESIGNER, BUILDER	1-2
1.6 OTHER VESSEL DATA	1-2
2.0 DESCRIPTION OF UNIT	
2.1 GENERAL DESCRIPTION	2-1
2.1.1 Special Steels	2-1
2.1.2 Corrosion Protection	2-1
2.1.3 Access for Inspection	2-1
2.2 GENERAL UNIT CHARACTERISTICS	2-2
2.2.1 Dimensions	2-2
2.2.2 Lightweight Data	2-3
2.2.3 Alterations to Deck Load	2-4
2.3 CAPACITIES	2-4
2.4 PIPING SYSTEMS	2-5
2.4.1 General	2-5
2.4.2 Ballast System	2-6
2.4.3 Bilge Dewatering System	2-7
2.4.4 Potable Water System	2-7
2.4.5 Drill Water System	2-7
2.4.6 Fuel Oil System	2-7

	PAGE
2.5 POWER GENERATION	2-7
2.6 MOORING EQUIPMENT	2-8
2.7 DRILLING EQUIPMENT	2-8
2.8 SUBSEA EQUIPMENT	2-8
3.0 OPERATING DATA AND STABILITY	
3.1 GENERAL INFORMATION	3-1
3.2 OPERATING INSTRUCTIONS	3-1
3.2.1 General	3-1
3.2.2 Ballasting/Deballasting/Variable Load Change	3-2
3.2.3 Operating Draft	3-5
3.2.4 Ice and Snow Loads	3-5
3.2.5 Transits	3-7
3.2.6 Severe Storm and Survival Draft	3-8
3.2.7 Time Required to Prepare for Storm	3-9
3.3 LIMITS OF SERVICE	3-10
3.3.1 Environmental	3-10
3.3.2 Critical Motion	3-10
3.3.3 Loads and Drafts	3-11
3.3.4 Unit Deck Loads	3-11
3.3.5 Maximum Allowable KG	3-12
3.3.6 Downflooding	3-12
3.4 STABILITY THEORY SUMMARY	3-13
3.5 HYDROSTATIC PROPERTIES	3-15
3.6 LOAD FORM CALCULATIONS	3-15
3.6.1 Definitions	3-15
3.6.2 Reference Planes	3-17
3.6.3 Table Entries	3-17
3.6.4 Anchor, Chain, and Chain Tension Corrections	3-17
3.6.5 Stability Calculations	3-19

5.0 RIG DATA

PAGE

Figure 1 - Profile view of Deep Driller	5-2
Figure 2 - Profile view of tank arrangements of the Deep Driller	5-3
Figures 3a & 3b - Ballast Control Panel Mimic Diagram	5-4&5
Figure 4 - Hull and deck load limits vs. draft	5-6
Figure 5 - Critical motion curves	5-7
Figure 6 - Main deck arrangement	5-8
Figure 7 - Upper deck arrangement	5-9
Figure 8 - Derrick floor arrangement	5-10
Figure 9 - Maximum allowable KG	5-11
Figure 10 - Downflooding angles	5-16
Figure 11 - Hydrostatic Properties	5-17
Figure 12 - Lightweight correction for deployed chain	5-22
Figure 13 - Vertical component of line tension	5-23
Figure 14 - Anchor chain catenary length	5-24
Figure 15 - Significant wave height - bow	5-25
Figure 16 - Significant wave height - beam	5-26
Figure 17 - Mooring analysis - 200 foot water depth	5-27
Figure 18 - Mooring analysis - 400 foot water depth	5-28
Figure 19 - Mooring analysis - 600 foot water depth	5-29

6.0 TANK TABLES

6.1 READY REFERENCE TABLE	6-3
---------------------------	-----

6.2 INDIVIDUAL TANKS

Ballast 1P & 1S	6-4
Ballast 2P & 2S	6-5
Ballast 3P & 3S	6-6
Fuel Oil 4P & 4S	6-7
Drill Water 5P & 5S	6-8
Fuel Oil 6P & 6S	6-9
Potable Water 7P & 7S	6-10
Ballast 8P & 8S	6-11
Ballast 9P & 9S	6-12
Ballast 10P & 10S	6-13
Ballast C1P & C1S	6-14
Ballast C2BP & C2BS / C2AP & C2AS	6-15
Ballast C3P & C3S	6-16
P-Tank Weights and Center of Gravity Locations	6-17
P-Tank Weight vs. Ullage Graph	6-18
P-Tank VCG vs. Ullage Graph	6-19

	PAGE
3.7 SAMPLE LOAD CALCULATIONS	3-22
3.7.1 Transit	3-23
3.7.2 Ballasting to Survival	3-29
3.7.3 Preparing to Drill	3-35
3.7.4 Drilling	3-41
3.7.5 Deballasting to Survival	3-47
3.7.6 Survival - Ice and Snow Loads	3-53
3.8 MOORING SYSTEM	3-59
3.8.1 Setting the Anchors	3-59
3.8.2 Required Pre-Tensions	3-59
3.8.3 Drilling Operations	3-60
3.8.4 Standby Operations	3-60
3.8.5 Disconnect Criteria	3-60
3.8.6 Maximum Chain Tension Due to Environment	3-60
4.0 DAMAGE CONTROL	4-1
4.1 GENERAL NOTES	4-1
4.2 DAMAGE CONTROL TEAM	4-2
4.3 DAMAGE CONTROL ACTIONS	4-2
4.4 PROCEDURES FOR UNEXPECTED LIST AND TRIM	4-3
4.5 WATERTIGHT INTEGRITY	4-8
4.6 RIG ABANDONMENT/EVACUATION	4-9
4.7 FIREFIGHTING	4-13

U.S. Department
of Transportation

United States
Coast Guard



Commandant (G-MVP)
United States Coast Guard

MAILING ADDRESS:
Washington, DC 20593-0001
Phone: (202) 267-2705

COMDTPUB P16721.29

2 NOV 1989

COMMANDANT PUBLICATION P16721.29

Subj: Merchant Marine Deck Examination Reference Book, OPERATING MANUAL FOR DEEP DRILLER.

1. PURPOSE. This publication contains reference material that may be needed by an applicant during an examination for a merchant marine deck license.
2. DISCUSSION.
 - a. Applicants for merchant marine deck licenses taking an examination to determine their professional qualifications may be required to answer examination questions which are based on the material in this publication.
 - b. The Coast Guard has converted to a computerized random generation system for creating examination modules. To streamline the process of creating module test booklets, where possible, the reference material needed to answer exam questions has been incorporated in Deck Examinations Reference Books. This allows applicants to view both the exam question and the reference material at the same time.
 - c. Copies of this publication will be provided by the Regional Examination Centers (RECs) when applicants take an examination. This publication is available to the general public but only copies provided by the RECs may be used when completing an examination.
 - d. The August 1989 edition of this publication contains all material required by questions in the question bank as of August 1989.

DISTRIBUTION - SDL No. 128

	a	b	c	d	e	f	g	h	i	j	k	l	m	n	o	p	q	r	s	t	u	v	w	x	y	z
A																										
B		1	1		1		1	1		1		1		1		1		1								
C					*								*													
D																										
E																										
F																										
G																										
H																										

• NON-STANDARD DISTRIBUTION:

* 2 NOV 1989

3. PROCEDURE. This publication will be made available to applicants taking a deck merchant marine examination. Applicants who have purchased copies of this publication from the Government Printing Office (GPO) may not use their personal copies during examinations. Each REC is to allow only the REC copies of this publication to be used in the exam room. The covers of this publication held by the RECs will be gray; the covers of this publication available to the public through GPO will be yellow.

4. ORDERING INFORMATION.

- a. Regional examination centers will be provided with an initial supply of this publication. Replacement and additional copies are available from Commandant (G-MVP-5), FTS 267-2705.
- b. The public and other Coast Guard units may order copies of this publication from the GPO at the following address:

Superintendent of Documents
U.S. Government Printing Office
Washington, D.C. 20402



J. D. SIPES
Rear Admiral, U.S. Coast Guard
Chief, Office of Marine Safety,
Security and Environmental Protection

NON-STANDARD DISTRIBUTION:

C:e Toledo, Juneau (5); Houston, New Orleans (30); Baltimore, San Francisco, Honolulu, Boston, Miami, Charleston, San Juan, Long Beach, Anchorage, Portland, Memphis, St. Louis, Puget Sound (2) (Only).

C:m New York (5); (Only).

SECTION 1.0

INTRODUCTION

1.1 NATURE AND PURPOSE OF THE MANUAL

This manual describes the operation of the semisubmersible drilling unit Deep Driller. The purpose is to ensure that the unit is operated safely within its inherent limitations. Personnel responsible for operation of the unit shall become familiar with the contents of this manual and shall endeavor to apply the safe operating principles described.

1.2 ARRANGEMENT OF MATERIAL

- Section 1.0 — Classification, Builder/Designer/ Owner and other pertinent vessel particulars
- Section 2.0 — General description of the various systems, equipment, and lightship data.
- Section 3.0 — Operating procedures, including operating restrictions, normal operating procedures, hydrostatics, and loading conditions. Sample loading conditions for various loading configurations are included.
- Section 4.0 — Damage control generalities and emergency procedures.
- Section 5.0 — Data and figures
- Section 6.0 — Tank tables

1.3 CLASSIFICATION

The Deep Driller has been built to comply with the American Bureau of Shipping “Rules for Building and Classing Mobile Drilling Units”, was surveyed during construction, and is classed as:

Maltese Cross A1, Circle M, Column Stabilized Drilling Unit Maltese Cross AMS
--

The Deep Driller also complies with the United States Public Health Service, Federal Communications Commission, United States Coast Guard and other regulatory requirements for U.S. Flag registration.

1.4 Regulatory Comments

The Deep Driller is classed for both hull and machinery, and is designed to meet or exceed single compartment lower hull and caisson damage stability requirements for all operating conditions. It is rated to 100 knot wind and 100 foot waves at survival draft. At operating draft of 60 feet, the unit is rated to 70 knot winds and 64 foot maximum wave heights.

This unit is certificated for the lightship condition and configuration, as reviewed and approved by the cognizant regulatory agencies. Any actions causing changes, such as repair of structural damage or structural alterations, removal or addition of equipment, shall immediately be brought to the certifying authority's attention, whenever possible, before such changes are made.

The Offshore Installation Manager (OIM) shall be designated by the owner in writing. This individual is responsible for the safe operation of the unit, and will comply with the provisions of the Certificate of Inspection, Stability Letter, and material in this Operations Manual.

1.5 OWNER, DESIGNER, BUILDER

Owner: Veritas Marine Services
1325 South Dairy Ashford
Houston, Texas

1.6 OTHER VESSEL DATA

Name: Deep Driller
Gross Tonnage: 5,022
Hull No.: 275984
Net Tonnage: 4,526
Official No.: 846208
Flag: United States
ABS I.D. No.: V7408
Port of Registry: Houston, TX
Year of Build: 1983

SECTION 2.0

DESCRIPTION OF UNIT

2.1 GENERAL DESCRIPTION

The Deep Driller is a six-column, column-stabilized semi-submersible drilling unit capable of world-wide drilling service. The basic configuration of this unit consists of two 260 foot barge-shaped lower hulls with three 32 foot diameter columns on each hull supporting the rectangular main deck platform. Accommodations, power generators, and drilling equipment are located on the main deck structure with the columns and lower hulls compartmented to provide for ballast and liquid variable load stowage.

A conventional eight-point spread mooring system locates the rig and allows the unit to drill to 25,000 feet in a maximum of 600 foot water depth.

Fully air conditioned quarters are provided for 79 persons. Winter weather protection of outside work spaces allow operations to continue efficiently under environmental extremes. The Deep Driller is designed to operate in a minimum air temperature of 14° F (-10° C) and a minimum sea temperature of 32° F (0° C).

2.1.1 Special Steels

The locations of special steels are shown in the Deep Driller drawing WSA-100-DD1. (Sheets 1-5).

2.1.2 Corrosion Protection

The unit's hull corrosion protection anodes are described in the Cathodic Protection Service Drawing WSA-110-DD2.

2.1.3 Access for Inspection

Access arrangements or facilities for inspection and maintenance of the primary and secondary structure are provided by conventional manhole covers, ladder ways, etc., noted in the Construction Portfolio.

Lower hull tanks and voids are accessed through manholes, most of which can only be reached when the unit is deballasted to transit draft.

Columns, cross bracings, and diagonal bracings are accessed through manholes, which, with the exception of the longitudinal diagonal braces, can be reached through the caisson regardless of operating draft. There are no special features for examining the transverse "K" brace to main deck box girder node connections.

The main deck box girders are accessed through manholes found in the corner columns. The girders can be reached regardless of operating conditions.

NOTE

The drawings referred to above are included in Volume 2 of the Deep Driller Operations Manual, which must be maintained aboard the unit.

2.2 GENERAL UNIT CHARACTERISTICS

2.2.1 Dimensions

Length of Lower Hulls Overall	260' 0"
Length of Upper Structure Overall (Includes heliport, excludes lifeboat)	231' 5"
Total Length of Vessel (Includes lower hull and upper structure)	260' 5"
Breadth Across Lower Hulls Overall	217' 1"
Breadth of Upper Structure Overall (Includes windlass foundations)	190' 7"
Breadth of Lower Hulls	50' 0"
Diameter of Columns	32' 0"
Depth - Baseline to Main Deck	111' 0"
Depth - Lower Hull	20' 0"
Draft - Maximum Loadline	60' 0"
Draft - Normal Drilling	60' 0"
Longitudinal Distance Between Draft Marks	164' 0"
Transverse Distance Between Draft Marks	122' 9"

Displacement at 60' 00" Draft (S.W.) 18,117.7 Long Tons

2.2.2 Lightweight Data

Lightweight data is as follows:

Displacement 9,732.90 Long Tons

True Mean Draft 16.19 Feet

Center of Gravity Location:

Vertical above Baseline 69.96 Feet

Transverse from C/L - 0.61 Feet (Port)

Longitudinal from - 0.69 Feet (Aft) from Amidships

The rig's lightweight includes the weight of the complete unit with all its permanent installed machinery, equipment and outfit including permanent ballast, spare parts normally retained on board, and liquids in machinery and piping to their normal working levels, but does not include liquids in storage or reserve tanks, items of consumable or variable loads, stores, or crew and their effects.

The lightweight condition includes:

1. Derrick fully rigged with traveling block in its lowest position.
2. Crane booms lowered and cradled; bridge crane aft of the well center.
3. Riser and guideline tensioner sheaves in their lowest position.
4. Anchors (LWT type, 15.4 tons each) bolstered in their racks and chain (3,500 feet each) stowed in chain lockers.
5. Loading hoses and mooring lines in their normally stowed position.
6. All machinery with liquids to normal operating level, e.g.:
 - a. EMD Cooling System
 - b. BOP Hydraulic System
 - c. Sewage System
 - d. Oil Separation System
 - e. Potable Water System
 - f. Drawworks Brake Cooling System
7. Tow bridles, both main and backup, in normally stowed position.
8. Drill line backup reel and riser and guideline tensioner backup reels and rigging included "as rigged".

9. BOP hydraulic control hoses, reels, pods, etc., included as stowed.
10. Rigging, winches, sheaves, etc., included in working condition.

Items not included in lightweight are:

1. All third-party equipment carried on rig, such as:
 - a. Schlumberger Unit, auxiliary generator, and contents.
 - b. Schlumberger Tool House and contents.
 - c. Cement pump and attachments.
 - d. Subsea TV camera winch.
 - e. Microwave mast and antenna.
2. Contents of all miscellaneous small tanks.
3. Contents of all store rooms, warehouses, and galley.
4. Anchor buoys.

2.2.3 Alterations to Deck Load

Alterations in weight and/or center of gravity location for structures or installed equipment must be kept by the OIM in a permanent record. These changes are to be treated as a variable load until a formal change to lightweight has been approved by the Coast Guard and the ABS. The most recent weight and center of gravity location from the permanent record shall be used in the daily calculations in the load form.

Until approved, the weights and center of gravity locations for the changes to lightweight shall be treated as deck load.

2.3 CAPACITIES

UPPER DECK

Pipe racks	Area	6,240 sq ft
	Weight	975 Long tons
Open deck	Area	4,590 sq ft
	Loading	250 lbs/sq ft

MAIN DECK

Open deck	Area	1,951 sq ft
	Loading	250 lbs/sq ft
Spider deck	Area	1,951 sq ft
	Loading	150 lbs/sq ft

HELIPORT

Overall length:	72.9 ft (22.2 m)
Rotor size:	62.0 ft (18.9 m)
Gross weight:	20.5 tons (2,298 kg)
Heliport size (across flats)	75.0 ft (23.1 m)

WEIGHT MATERIAL & CEMENT

Bulk cement (3 Tanks)	4,500 cu ft
Bulk mud (3 Tanks)	4,500 cu ft
Sack Stowage	6,000 sacks

LIQUIDS (MAIN DECK)

Drilling mud	1,422 bbls
Fuel oil (Two day tanks)	2,310 cu ft
Lube oil	58 bbls
Potable water (Two day tanks)	1,130 cu ft

GALLEY SUPPLIES

Refrigerated	1,260 cu ft
Dry stowage	1,183 sq ft

COLUMNS

Ballast	(7,131 L.T.)
---------	--------------

LOWER HULLS

Drill water	(1,075 L.T.)
Fuel oil (1,237 L.T.)	
Potable water	(382 L.T.)
Ballast	(7,863 L.T.)

2.4 PIPING SYSTEMS

2.4.1 General

The two lower hulls are subdivided to provide tanks for ballast, fuel oil, and fresh water. They are located to suit operating needs and to permit control of the unit's trim and list. The six columns provide additional ballast tanks. Pump rooms and sea chests are located in the lower hull, on the inboard side of the center column. Access to the pump rooms is provided by an elevator from the main deck. Ballast control is provided by an automated control console located in the control room on the main deck. Ballast soundings are obtained from remote level indicators in the ballast tanks.

2.4.2 Ballast System

Ballast is transferred on the Deep Driller by means of four ballast pumps, two in each hull. The pumps are identical deep-well salt water ballast pumps powered by 133 HP, 1800 RPM motors.

These pumps take suction from either of the ballast tanks and discharge overboard below water, or from the respective sea chest for discharge into the ballast tanks or at the main deck. This system can also supply the firewater system booster pumps.

The normal flow rate range of each pump is between 2700 and 3700 gpm. Additional flow can be obtained by operating both pumps. When operating both pumps, however, the following should be noted:

1. The danger of pump cavitation when pumping a single tank with two pumps is much greater due to the increased flow and suction line velocity. In general, when two pumps are used, multiple tanks should be pumped.
2. Operating two pumps does not double the flow. Since flow resistance increases exponentially with flow rate, two pumps will discharge only about 35-50% more water, while using twice the power.

Ballasting can be accomplished by pumping, but free flooding is faster at all reasonable drafts. Free flooding may be accomplished through the sea chest or overboard sea discharge. In no case should ballast be pumped into a tank when the tank approaches a full condition, since it is possible to exceed design stresses in tank bulkheads if ballast is pumped into the vent lines.

Normal dewatering from the half-full trim tanks (Numbers 1 or 10) can be accomplished at trim angles approaching 9 degrees provided a one-pump/one-tank or two-pump/two-tank configuration is used. If the pumps begin to cavitate at large trim angles, pump from tanks closer to the pump room, or counterflood to reduce the angle of trim. Pumping from the low hull using the crossover system is limited to about 2 degrees of list.

A 500 gpm saltwater service pump is also provided in each hull which supplies salt water to the upper deck, but can also be used for discharging into a ballast tank. Because the saltwater service pump takes suction from the sea, it cannot be used to dewater voids, pump room, or ballast tanks.

A single-pipe ballast cross-over system is provided between the salt water manifolds of the two lower hull pump rooms. By opening the cross-over valves in both of the pump rooms, a ballast pump is able to take suction from a tank on the opposite side. The water may be discharged overboard, at deck level, or placed in a ballast tank on the same side as the pump.

2.4.3 Bilge Dewatering System

Two bilge pumps are located in each pump room. These pumps take suction from the pump room, chain lockers, access trunks, void area, and cofferdam; and discharge overboard at the 80 foot level on the central column of each pontoon. In an emergency, the drill water pump may be used to supplement the bilge pumps. There is no cross feed connection in the two bilge dewatering systems.

2.4.4 Potable Water System

Potable water is provided to the lower hull storage tanks 7P and 7S from a deck fill line or from two evaporators located on the main deck. A 350 gpm transfer pump in each lower hull pump room takes suction from the storage tank and discharges into a service tank located at the 80 foot level of the center column. There is no cross feed connection between the two potable water day tanks.

2.4.5 Drill Water System

Two deep-well 500 gpm drill water transfer pumps, one in each pump room, take suction from either a lower hull drill water tank or emergency bilge. Discharge is either to the main deck services or the bilge overboard discharge. The main deck services include the mud system, drawworks brake cooling, air compressor cooling, cement unit, and washdown. A valve at the main-deck level permits discharge to the firewater system booster pumps. Drill water is provided to the lower hull storage tanks from a deck fill line.

A valve connection to the emergency bilge manifold allows the drillwater pump to be used for dewatering from the bilge manifold.

2.4.6 Fuel Oil System

Two fuel oil transfer pumps in each of the lower hull pump rooms take suction from the two hull storage tanks and discharge to metered service to the mud pits and cement pump as well as the two service tanks in the generator room. Fuel oil flows from the service tanks via fuel oil service pumps. Fuel oil is provided to the lower hull storage tanks through metered deck fill lines.

2.5 POWER GENERATION

Four GM EMD 16 cylinder 2200 Hp skids are located in the engine room. Each of these drives a 1550 KW, 600V, 3-phase, 60 Hz AC generator. A GE SCR drive system provides 750 V DC power to the various DC traction motors on drilling equipment throughout the unit. Two 1,000 KVA transformers distribute 480 V DC power to various auxiliary service power is also provided.

One GM 8 cylinder diesel 150 KW AC generator located in the forward deck house, port side, feeds a separate 480V and 120V emergency power distribution system.

2.6 MOORING EQUIPMENT

An eight point spread mooring system is provided to maintain the unit on location. Four double windlass units powered by 800 HP DC motors are located on the main deck, one at each corner of the platform. A Martin Decker indicating and recording system is provided to monitor the windlasses and chain tensions.

The eight 34,500 lb LWT type anchors are attached to the unit with 3,500 feet of three-inch chain (breaking strength 1,045,000 pounds). Extended bolster racks, located 25 feet above the baseline, facilitate racking of the anchors and minimize the potential for hull damage.

2.7 DRILLING EQUIPMENT

A Lee C. Moore 160 foot x 40 foot derrick is provided. In combination with the National 1625 DE drawworks equipped with 1-1/2 inch diameter wire rope, a 1,000,000 lb. hook load capacity is available with a 800,000 lb. setback load. Further items of drilling includes a Rucker drill string heave compensator and a National 49-1/2 inch C-495 rotary table.

Two National 12P-160 7-1/4 inch triplex mud pumps and a Halliburton cementing unit are provided, as well as three 1,000 gpm mud mix pumps to service the four mud pits. Other drilling equipment includes hydraulic power tongs, a wireline unit and a 10,000 psi choke-and-kill manifold with H2S trim.

Three deck cranes are provided to service working areas; a 120 foot boom National crane on the starboard side, a 120 foot boom National crane on the port side, and an 80 foot boom National crane aft.

2.8 SUBSEA EQUIPMENT

Two 10,000 psi 18-3/4 inch double-ram blowout preventers and a 5,000 psi 21-1/4 inch spherical preventer are carried on the unit. Riser tensioning is provided by six Rucker 80,000 lb. riser tensions; six 16,000 lb Rucker guideline tensioners are also fitted.

SECTION 3.0 OPERATING DATA AND STABILITY

3.1 GENERAL INFORMATION

The rig crew shall establish and maintain a daily log for the operation of the unit while in transit and on location.

The unit should be maintained in a level attitude during ballasting, deballasting, and drilling operations. The heights of the center of gravity corrected for free surface effects (KGL or KGT) shall be maintained less than the maximum allowed. These conditions shall be logged daily. Section 3.2 details individual conditions.

All hatches, doors, manholes, return lines, discharges and openings between watertight subdivision boundaries shall be kept closed as much as it is practical at all times.

3.2 OPERATING INSTRUCTIONS

3.2.1 General

This section describes the operating procedures necessary for safe operation of this unit.

The vessel has been found to be satisfactorily stable by the American Bureau of Shipping and the United States Coast Guard for unrestricted service with a maximum draft of 60'0" and a corrected KG less than the maximum allowable KG obtained from the table shown in Section 5, Figure 9 (p. 5-11).

The maximum allowed KG values, obtained from the table, were obtained from required intact and damage stability criteria. For all values of draft and load conditions, the calculated KG (corrected for free surface effects) must not exceed the Maximum Allowed KG obtained from the table at the corresponding draft.

The sample loading conditions shown in Section 3.7 represent typical loading conditions for each mode of operation which might occur during normal operations.

This unit has been designed to withstand operating criteria outlined in Section 3.3, Limits of Service.

The Offshore Installation Manager, OIM, shall be designated by the owner in writing. This individual is responsible for the safe operation of the unit, and will comply with the provisions of the Certificate of Inspection, Stability Letter, and material in this Operations Manual.

The complete emergency power system should be tested at least once a week along with emergency lighting to be assured of its capability to function during emergencies.

The ballast system, being so crucial to the survival of the crew and the unit, must be kept fully operational at all times.

Accumulation of marine growth on the submerged hulls and columns increases the power required to tow the unit and also increases forces from waves and currents. As no allowances have been made for the increased diameter of fouled columns and bracings, accumulations of marine growth should be removed as much as possible while floating on the lower hulls

Watertight hatches, manholes, doors, vent covers, sounding tube caps, valves and other fittings should remain closed except when in actual use in order to preserve reserve buoyancy.

3.2.2 Ballasting/Deballasting/Variable Load Changes

Before performing significant ballasting, deballasting, or variable load changes, stability shall be checked to ensure that during the entire operation the calculated KG, corrected for free surface effects, does not exceed the maximum allowable KG.

The free surface effect of slack tanks can cause an appreciable increase in the apparent vertical height of the center of gravity. The most favorable ballasting is achieved by keeping the number of slack tanks to a minimum. As a guide, no more than six of the ballast tanks should be slack simultaneously.

WARNING

While ballasting down, make sure the rig is level when the lower hulls become awash. Trim and list increase four to five times when the lower hulls are submerged.

When ballasting the vessel from transit draft, stability is severely reduced when the lower hulls become awash. Therefore, special attention shall be given to stability analysis of the vessel for drafts between 20 to 32 feet.

When reading about ballasting procedures, refer to the hull tank and piping diagrams in Section 5.

Tanks may be flooded from the sea through the overboard discharge and the Sea Chest. At all drafts, flooding through the Sea Chest or through the Overboard Discharge is faster than using the pumps. Both flooding sources must be used to avoid "equalizing" and is therefore the preferred method of ballasting.

The pumps may also take suction from the sea through the sea chest. When the Number 1 Pump takes suction from the sea through the Sea Chest, Valve 34 must be open. Similarly, when the Number 2 Pump takes suction from the sea, Valve 35 must be open. The water may be discharged through the Tank Fill Header into any of the ballast tanks. For this operation the Overboard Discharge (Valve 48) must be closed.

To reduce the possibility of the tank levels equalizing while pumping, at least one of the two isolation valves (Valves 34 and 35 in the Ballast Pump Suction Manifold) should be closed. Normally, the Number 1 Ballast Pump takes suction from tanks at the forward portion of the hull (Tanks 1, 2, 3, C1, C2A, and C2B), and the Number 2 Ballast Pump is used to pump from tanks in the aft portion of the hull (Tanks 8, 9, 10, and C3). In normal operations the isolation valves are closed, and the ballast pumps remain "dedicated" to either the forward or aft tanks.

When necessary, both ballast pumps on one side can be used to pump from tanks in the same quadrant of the hull. Under these conditions both isolation valves must be open. Care should be exercised as the possibility of "equalizing" exists.

When operating both pumps, the following should be noted:

1. The danger of pump cavitation when pumping a single tank with two pumps is much greater due to the increased flow and suction line velocity. In general, when two pumps are used, multiple tanks should be pumped.
2. Operating two pumps does not double the flow. Since flow resistance increases exponentially with flow rate, two pumps will discharge only about 35-50% more water, while using twice the power.

As a general procedure, the following outline can be used as a guide to raising and lowering the vessel.

Ballasting from Transit to Operating Draft

1. Begin ballasting by flooding into tanks 2P, 2S, 9P, and 9S. Use the Sea Chest for tanks 2P and 2S and the Overboard Discharge for tanks 9P and 9S.
2. Continue flooding 2P, 2S, 9P, and 9S until these tanks are pressed.
3. Flood 3P, 3S, 8P, and 8S until these tanks are also pressed. Use the Sea Chest to flood tanks 3P and 3S. The Overboard Discharge is used to flood tanks 8P and 8S.
4. If necessary, continue ballasting with 1P, 1S, 10P, and 10S until 60 foot draft is reached and vessel is level.
5. In some load conditions, it may also be necessary to use the ballast tanks in the center column.

Deballasting from Operating to Transit Draft

1. If the column tanks were used for ballasting, begin by deballasting from those tanks.
2. When the column tanks are empty, continue deballasting by pumping from tanks 3P, 3S, 8P, and 8S until empty.
3. Continue deballasting by pumping from tanks 2P, 2S, 9P, and 9S until empty.
4. Continue deballasting by pumping from tanks 1P, 1S, 10P, and 10S until vessel is at the designated draft.

3.2.3 Operating Draft

The vessel's motions, weather conditions, stability, and mooring line tensions shall be monitored at all times. See Section 3.2.6 for conditions requiring a change of draft for severe weather conditions.

Changes of draft and vessel inclination shall be adjusted by ballasting, deballasting, and transferring ballast.

1. For major load changes, the amount of ballast to maintain the vessel in a level attitude shall be computed in advance.
2. For moderate amounts of loads added, removed, or shifted, the draft and trim and list may be adjusted by adding or discharging ballast as required with a visual check on draft, trim, and list.
3. The operating draft shall not exceed 60 feet.

Total deck loads shall not exceed a maximum of 2,250 long tons subject to satisfactory vertical distribution. Amounts and center of gravity of variable loads shall be checked at least once a day. At drafts less than 45 feet, variable deck loads are limited to less than 2,250 long tons. See Section 5, Figure 4.

3.2.4 Ice and Snow Loads

In the event of accumulation of ice or snow on deck, it may be necessary to deballast to maintain a draft of less than 60' and to keep the KG less than the maximum allowed until the snow can be removed. Ice or snow should always be removed as soon as circumstances permit to avoid an excessive build up of loading which can adversely affect the stability of the unit.

Ice is generally considered excessive when it covers large areas with a thickness exceeding 3/4 inch. Snow deeper than six inches is generally considered excessive.

The maximum depth of snow in a single fall is assumed to be about ten inches with a density of about six pounds per cubic foot. It would most likely adhere and accumulate on horizontal and windward surfaces when the air temperature is just below 32° F (0° C).

Icing from sea spray can occur when the air temperature is below about 28° F (−2.2° C) and the wind is sufficiently strong for spray to be blown from the wave crests or to be thrown upward as waves break against the columns. In such conditions, little ice collects on the structure near the waterline as that portion is frequently washed by the somewhat warmer sea water. Also the upper portion receives little because of the decrease of amount of spray with height. Thicknesses of 3/4" to 3-1/4" could occur on the upward and windward facing surfaces between about 10 and 50 feet above the sea, with gradually decreasing amounts higher.

Icing from freezing rain forms a clear dense deposit with a density of about 56 pounds per cubic foot when large drops of rain impact on exposed surfaces with temperatures less than 32° F (0° C).

Freezing rain can occur in association with a warm front when warm moist air overrides cold air at the surface. Rain from the warmer air falls through the layer of air with temperatures less than freezing, becomes supercooled, and then freezes on impact.

Rime icing which forms a porous, granular appearance is lighter in weight with a density of about 30 pounds/cu ft. Furthermore, deposits greater than about 3-1/2" are unlikely. Rime icing can occur in prolonged exposure to supercooled cloud or fog droplets in the presence of moderate to strong winds and freezing temperatures.

Possible simultaneous occurrence of ice and snow due to the above causes could occur in the following combinations:

- sea spray plus freezing rain
- sea spray plus snow
- sea spray plus rime icing
- snow plus rime

The first is more likely to produce the largest accumulation and can be allowed for by assuming a maximum thickness of four inches of clear ice on upward and windward facing surfaces between about 10 and 50 feet above sea level, decreasing gradually above the 50 foot level to about two inches at the crown block. The density of ice will likely decrease with height from about 56 lb/cu ft at 10 feet to about 31 lb/cu ft at the top.

The variable deck load must account for the following assumed maximum ice weights:

<u>CONDITION</u>	<u>ICE WEIGHT</u>	<u>VCG</u>
Operating	313 L.T.	135 ft
Survival	359 L.T.	127 ft
Transit	440 L.T.	112 ft

Assuming a constant draft is maintained by deballasting as ice weights increase, the ice and snow accumulations results in an increase in the uncorrected KG of the rig can be calculated using this formula:

$$\text{VCG Increase} = \frac{W \times (\text{VCGi} - \text{VCGb})}{\Delta}$$

Where:

- W = Ice weight from the table above
- VCGi = VCG of the accumulated ice from the table above
- VCGb = VCG of the lower hull ballast discharged

Assuming that the discharged ballast has a VCG of 10', the following table shows the VCG increase to be applied to uncorrected KG when maximum ice is present.

<u>CONDITION</u>	<u>DRAFT</u>	<u>DISPLACEMENT</u>	<u>VCG RISE</u>
Operating	60.0 ft	18,118 L.T.	2.16 ft
Survival	45.0 ft	16,050 L.T.	2.62 ft
Transit	19.5 ft	12,233 L.T.	4.03 ft

3.2.5 Transits

Transits are made while floating on the lower hulls, or at a minimum, with the horizontal cross braces clear of the water.

WARNING

During a move, the unit should be ballasted to the 45 foot survival draft if heavy impacting of waves onto the horizontal braces occurs.

Prior to departure, the following operations shall be conducted:

1. Perform and check stability calculations of rig in the proposed transit configuration.
2. Secure crane booms in their cradles.
3. Secure all on-deck and drill-floor equipment.

4. Lower traveling block to its lowest position and secure.
5. Close and secure hatches, manholes, watertight doors, and vent covers that are not required to be open during the transit.
6. Ensure there is a minimum number of slack liquid tanks.

3.2.6 Severe Storm and Survival Draft

During normal drilling operations, the rig would be anchored and ballasted to the 60 foot draft. In this condition, should environmental conditions exceed the limits of service as detailed in Section 3.3.1 or waves approach within two feet of the underside of the spider deck, the unit must be deballasted to the 45 foot survival draft.

WARNING

Deballast to the 45 foot survival draft if waves approach within two feet of the spider deck.

Should sustained wind speeds exceed 50 knots, weather forecasts should be closely monitored and consider placing drilling operations in standby.

Before offset (the horizontal excursion from the wellhead as a percentage of the water depth) exceeds 4% or excessive motion precludes operations, preparations should commence to discontinue drilling operations, secure the well, and if necessary, deballast to survival draft.

If winds in excess of 70 knots are anticipated or experienced:

1. discontinue drilling operations.
2. remove hook or rotary loads.
3. disconnect riser.
4. secure the unit.
5. prepare to deballast to survival draft at 45 feet.
6. The time required to place the unit in a condition to withstand a severe storm depends on the configuration chosen for the 45-foot survival. The riser may be picked up and laid down in the riser storage rack or one or more joints picked up and the rest suspended. The drill pipe may also be tripped out at about 1,000 feet per hour and laid down or hung off. Slacking the guidelines and the four leeward anchors and readjusting the tensions so that all mooring lines are working equally requires about an hour. Deballasting to survival draft requires about an hour. For planning purposes, it is estimated that six hours would be required to place the rig in a storm survival configuration at survival draft.
7. If the unit will be unable to meet the 100-knot maximum allowable KG criteria, or if the seas approach within two feet of the spider deck, deballast to survival draft.

3.2.7 TIME REQUIRED TO PREPARE FOR PASSAGE OF SEVERE STORM

The survival draft is 45 feet and the maximum permissible KG at this draft is 62.09 feet. With the reduction in ballast weight necessary to reduce the vessel's draft, it may be necessary to reduce the upper hull load to keep within the allowable KG. A stability computation shall be made to determine if it is necessary to reduce some deck load.

The marine riser should be disconnected, pulled, and laid down. The riser tension will be zero, but the riser weight will be added in its normal stowage position on the riser rack. If the riser is left suspended from the drill floor, the weight of the riser and the lower marine riser package will be located at the drill floor for the purposes of the weight and stability computations. See Sample Load Form #5 for a typical loading configuration.

The option of hanging off the riser from the drill floor should be taken only when operating conditions are too severe to permit pulling the riser and laying it down. The drill string should either be hung off or tripped out and laid down in the pipe racks during a severe storm. Under nearly ideal conditions, about 1,000 feet of pipe can be picked up and laid down in an hour. As the motion increases, the time will increase.

Normally, it is not necessary to remove the liquid mud to reduce the vessel KG to acceptable limits. See Sample Load Form #5. However, in some loading situations, it will be necessary to remove the liquid mud. See Sample Load Form #6 in which 376 tons of ice and snow was added to the upper hull load. In this case, it was necessary to remove the mud.

When the mooring lines have been slacked about 20 feet and deballasting has begun, the time to deballast from 60 feet to 45 feet should not exceed an hour.

The basic steps in achieving the survival configuration are as follows:

1. Hang off the drill string, or alternatively, trip out the drill string and lay it down in the pipe racks.
2. Secure the well and displace the marine riser with sea water.
3. Pull the marine riser and lay it down in the riser stowage racks.
4. Slack mooring lines about 20 feet per line.
5. Deballast the vessel to 45 feet draft. Consolidate liquid loading to minimize free surface effects.
6. Properly secure equipment and materials including lifeboats and liferafts.
7. Inspect all safety equipment for readiness. Fill fuel oil day tanks.
8. Secure hatches, doors, and other fittings to maximize watertight integrity.

When placing the unit in survival mode from the ocean transit configuration, the principal action will consist of taking on ballast. Although the unit will be under tow, the speed of advance at survival draft during a storm will be essentially zero. The time required to ballast from transit to survival draft will be about two hours.

3.3 LIMITS OF SERVICE

3.3.1 Environmental

The vessel has been approved by the American Bureau of Shipping for the following specific environmental operational conditions:

<u>Draft</u>	<u>Max Wave Height</u>	<u>Max Wind Velocity</u>
19.0 ft	64 ft*	100 knots
45.0 ft	100 ft	100 knots
60.0 ft	64 ft	70 knots

*Provided that wave heights do not impact horizontal bracing.

3.3.2 Critical Motion

The critical motion curves, Section 5, Figure 5 (page 5-7), shows the maximum angle of roll or pitch which should not be exceeded in a given time period while in transit or while operating.

In these curves, the single amplitude roll (or pitch) angle, in degrees, is plotted against the full cycle period of roll (or pitch), in seconds. The single amplitude angle in roll, for example, is the instantaneous extreme angle displayed by the inclinometers during the time period from port side down through starboard side down and return to port side down. Any combination of single amplitude motion and full cycle period falling below the appropriate curve is considered satisfactory for a specific operation; either transit or drilling.

The transit curve assumes that the Deep Driller is at a draft of approximately 19.5 feet. The operating curve assumes that the vessel is at a draft of 60 feet with the maximum allowable weight in the setback area (800 kips or 357 long tons).

WARNING

Place the vessel in the 45 foot survival mode if motion approaches the critical motion limits.

3.3.3 Loads and Drafts

Under no circumstances is the load line draft of 60 feet, the legally permitted maximum, to be exceeded. At all times, the VCG of the unit, corrected for free surface effects, must always be less than the allowable KG for that draft.

Total deck loads shall not exceed a maximum of 2,250 long tons subject to satisfactory vertical distribution. Amounts and center of gravity of variable loads shall be checked at least once a day. At drafts less than 45 feet, variable deck loads are limited to less than 2,250 long tons.

Figure 4 in Section 5 (page 5-6) provides a guide for spot checking loading conditions. It shows an estimate of the lower hull liquids (drill water, potable water, fuel oil and ballast) which are likely to satisfy stability requirements at each draft with the maximum deck loads. To ensure that stability criteria has been met, particularly when loaded to near the maximum deck load limits, a detailed loading calculation is required.

3.3.4 Unit Deck Loads

Figures 6, 7, and 8 in Section 5 (pages 5-8 through 5-10) show the maximum loading, based on structural considerations, permitted in the spider deck area, main deck area, upper deck level, and the drill floor.

The maximum loading is also tabulated below:

Deck	Area	Loading	
Drill floor	Set back	800 kips	
	Quarters	150 psf	
Upper deck	Machinery roof	350 psf	
	Pipe rack	350 psf	
	Open deck	250 psf	
	Quarters	150 psf	
	Mud pump area	250 psf	
Main deck	Sack storage	500 psf	
	P-tank area	250 psf	
	Mud pit area	1,200 psf	
	Main engine area	250 psf	
	Tool storage	350 psf	
	General work	350 psf	
	Work areas	250 psf	
	Walkways	150 psf	
	Spider deck	General work	150 psf
		BOP support	300 kips

3.3.5 Maximum Allowable KG

Figure 9 in Section 5 (page 5-11) describes the KG limits for the unit based on approved criteria for 70-knot wind intact stability (which includes 50-knot wind damage stability), and 100-knot wind survival mode.

The reference KG for using this curve is the height of the center of gravity corrected for free surface effects (KGL or KGT), whichever is larger.

3.3.6 Downflooding

As a guide, Figure 10 in Section 5 shows the approximate combination of effective draft, list, and trim at which downflooding into the chain lockers may be expected to occur.

The drafts shown in the figure are “effective” drafts, which approximate the dynamic effects of heave, pitch, and roll. The effective draft used in the chart is defined as the actual draft plus one-half of the maximum wave height. Note that there are an infinite number of combinations of effective draft, list, and trim at which downflooding could occur.

For example, if the Deep Driller is operating at a draft of 60 feet, and the maximum wave heights are 20 feet, the effective draft is 70 feet. Under these conditions, a combination of list and trim at which downflooding could occur includes a list of 12° and a trim of 10°. Another combination is a list of 5° and a trim of approximately 17°.

The chart is intended to serve as a guide. In practice, caution should be exercised in the use of the chart since wave over-topping may occur before the predicted downflooding angles are reached.

3.4 STABILITY THEORY SUMMARY

Stability describes the tendency of a floating vessel to return to its original upright equilibrium position once displaced by an external force.

The stability of all floating vessel is determined by its weight (displacement) and the relationship between two points: the centers of buoyancy and gravity.

The buoyant force is defined as displacement. Displacement acts vertically upward through the center of buoyancy, B. The location of the center of buoyancy is at the centroid of the underwater volume and is shown in the tables of hydrostatic properties as a function of displacement.

By summing all the weights on the rig and their moments, including those for lightship, the total weight and the position of the center of gravity can be found. The total weight, also equal to displacement, acts vertically downward through the center of gravity, G.

For equilibrium, in the absence of external forces, these two equal, but opposite, forces must lie in the same vertical line. For the vessel to float in a level attitude, this means that the LCG must be equal in value to the LCB, and the TCG must be zero.

Consider a vessel initially upright with G on the centerline below the metacenter, M, heeled to the an external force (wind). A couple is formed by the weight and buoyancy forces acting through their respective centers. This couple forms a righting moment which tends to return the vessel to its original upright position. The amount of righting moment is the product of Δ and righting arm, GZ.

When the vessel is inclined, the vertical line of action of the buoyant force crosses the upright vertical centerline. For small angles of inclination, this intersection is

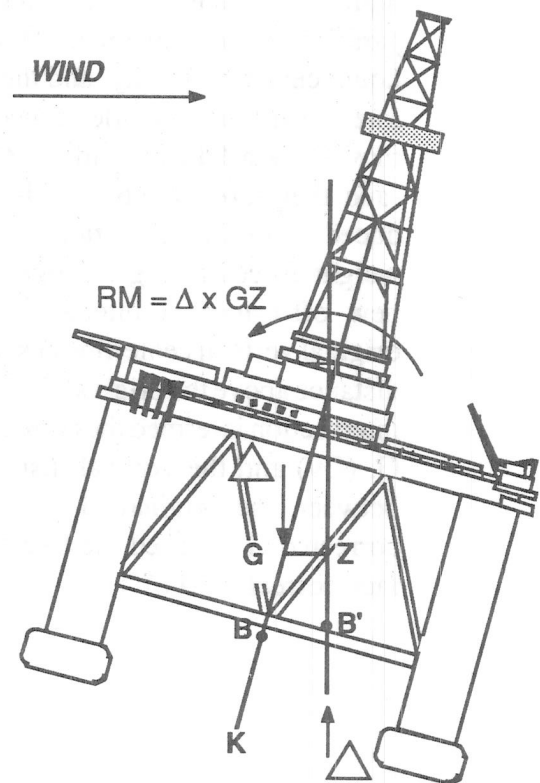

called the metacenter, M. At these small angles a right triangle, G-Z-M, is formed. Because of this triangle, GZ can be expressed trigonometrically in terms of the vertical distance between G and M, and the angle of inclination, Θ .

$$GZ = GM \times \sin \Theta$$

The location of G relative to M is important to stability. It is only with G below M that a righting moment is created as the vessel inclines. This righting moment tends to return the vessel to its original upright position. Under these conditions, stability is said to be positive. On the other hand, if G were above M, the moment created would tend to cause additional inclination. As such, the initial equilibrium position (upright) is unstable, and stability is said to be negative.

The discussion to this point has considered a center of gravity which is fixed as the vessel inclines. However, when liquids are present in partially full tanks, the center of gravity of the liquid shifts toward the low side. This new location of center of gravity for the liquid causes the vessel G to move parallel to the movement of the liquid center of gravity, and therefore toward the low side. Since G moves toward the low side, GZ — and therefore, stability — is reduced. The line of action of the weight forces acting through the new off-center G intersects the original vertical centerline at some distance above the original G. This intersection is termed the corrected G, (Gv) and the vertical distance between the original G and the corrected G is called the free surface correction (FSC).

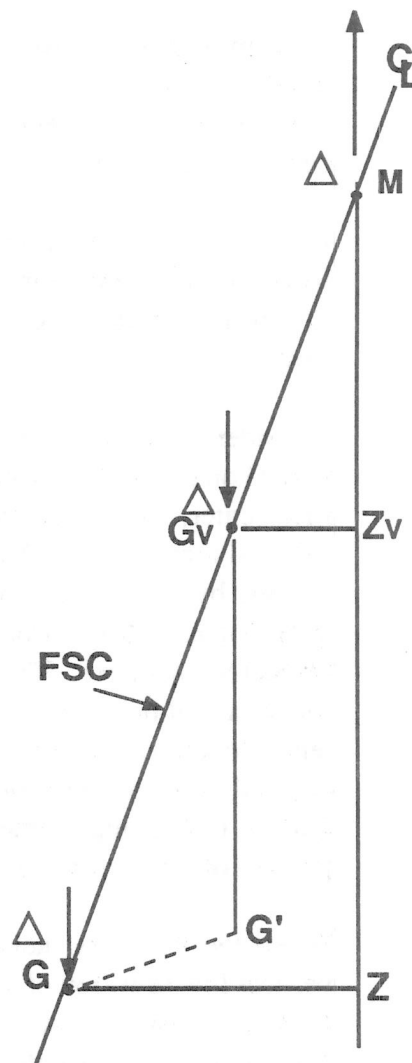

3.5 HYDROSTATICS PROPERTIES

The hydrostatics properties are the result of calculations based on the underwater form of the unit at even keel shown in the lines drawings. The properties are explained and shown in tabular form for the Deep Driller on page 5-17.

3.6 LOAD FORM CALCULATIONS

The Deep Driller load form should be completed on a daily basis during all modes of operations—whether moored or underway.

Precision of figures should be kept to the following standards:

Distances	Two decimal places
Weights	One decimal place
Moments	Nearest whole number



When “rounding”, use the next higher number if the digit one place beyond the above standards is 5 or more. Use the next lower number if the digit is 4 or smaller. For example, if the distance is computed to be 52.485 feet, round up to 52.49 feet. If the weight is calculated to be 102.94 tons, use 102.9 tons. If the moments are computed to be 3,456.5 ft-tons, use 3,457 ft-tons.

Longitudinal and transverse moments may be positive or negative quantities. Be careful when adding columns of positive and negative numbers. Errors can be reduced by prominently noting negative quantities with a minus sign.

3.6.1 Definitions

Many symbols, terms and abbreviations have been used throughout this operating manual and on the Deep Driller loading form. This is a list of the symbols, and their meanings:

Symbol	Term	Comments
Δ or DISPL	Displacement	Weight or displacement of unit.
Wt	Weight	Measured in long tons of 2,240 lbs.
VCG	Vertical Center of Gravity	Measured vertically upward from baseline (keel).
LCG	Longitudinal Center of Gravity	Measured fore and aft from amidships. Forward is positive; aft is negative.
TCG	Transverse Center of Gravity	Measured port and starboard from centerline. Starboard is positive; port is negative.
TPI	Tons per inch	The load change in tons which results in a draft change of one inch.

Symbol	Term	Comment
VM	Vertical Moment	Ft-long tons
LM	Longitudinal Moment	Ft-long tons
TM	Transverse Moment	Ft-long tons
KM	Height of the metacenter	Measured in feet above the keel. Metacenter may be longitudinal (KML) or transverse (KMT).
	Baseline	Molded; top of the keel plate.
	Amidships	Geometric longitudinal center of rig; Frame 27; center of middle column.
	Centerline	Geometric transverse center of rig.
FSML	Longitudinal Free Surface Moments	Ft-long tons; from tank tables for slack tank.
FSMT	Transverse Free Surface Moments	Ft-long tons; from tank tables for slack tank.
KG	Height of Center of Gravity	Same as VCG
KGL	Corrected KG	Includes longitudinal free surface effects
KGT	Corrected KG	Includes transverse free surface effects
LCB	Longitudinal Center of Buoyancy	Located at the geometric center of the underwater volume, measured in feet from amidships.
LCF	Longitudinal Center of Flotation	Located at the geometric center of the waterplane area, measured in feet from amidships.
MaxKG	Maximum allowable KG	Maximum permitted KG per operations manual
GML	Corrected Longitudinal Metacentric Height	Includes longitudinal free surface effects
GMT	Corrected Transverse Metacentric Height	Includes transverse free surface effects
L	Length	Longitudinal length between draft marks (164 feet)
B	Breadth	Transverse length between draft marks (122.8 feet)

3.6.2 Reference Planes

Distances aboard the rig are measured from the following reference planes:

Vertical measurements are made from an horizontal reference plane, or baseline, passing through the underside of the keel. Distances measured vertically upward from the keel are considered positive; distances below the keel are treated as negative quantities.

Longitudinal measurements are made from a transverse vertical plane passing through Frame 27 (amidships). Distances measured forward of amidships are considered positive. Those measured aft of amidships are considered negative.

Transverse measurements are made from a vertical plane passing through the longitudinal centerline of the vessel. Distances to starboard are considered as positive quantities. Those to port are considered as negative quantities.

3.6.3 Table Entries

For tank soundings use decimal feet. Determine weights corresponding to a given sounding through reference to the Tank Tables for the appropriate tank. Subtotal each group of tanks as necessary taking care not to confuse subtotals with other entries when adding for totals.

Enter lightship centers of gravity. The sum of all weight items in the "Summary" is designated Δ or DISPL.

With a known displacement, enter the hydrostatic tables to obtain the corresponding draft, LCB, KML, and KMT. Enter these data in the appropriate spaces in the form.

3.6.4 Anchor, Anchor Chain, and Chain Tension Corrections

Anchor Corrections

Lightship is established with anchors aboard in the stowed (bolstered) position. When moored, deduct 15.4 long tons for each of the eight deployed anchors, or a total of 123.2 long tons. Enter the weight of the deployed anchors in the anchor correction table of the variable load form.

Anchor-Chain Correction Tables

The length of anchor chain originally fitted is 3,500 feet. The weight of this amount of chain is included in lightship displacement. If the length of installed chain changes, weight and VCG corrections must be established. The weight of three-inch chain is one long ton per 25 feet or 89.6 lbs per foot.

The VCG of the deployed chain can be read directly from Figure 12 in Section 5 by selecting the appropriate chain length curve then determining the VCG with chain paid out equal to the addition. This change in lightship weight must be noted in the "Summary" table.

EXAMPLE

If the unit was fitted with 3,500 feet of chain and later the chain length was increased to 4,000 feet, the weight would increase by 500 feet per mooring line. Since there are eight mooring lines, the total length increased by 8×500 or 4,000 feet. The weight of the 4,000 feet of chain is $4000/25 = 160$ long tons.

The VCG of the additional length of chain on board is determined by entering the VCG curve for the new anchor chain length paid out. In this example, the VCG is 66.5 feet. This figure is read from the intersection of the 500 feet of chain paid out and the 4,000 feet of chain installed curve. Add the calculated additional weight and its VCG as a lightweight correction in the "Summary Table", using LCG and TCG as noted per anchor chain correction table.

While moored the deployed chain weight is deducted from the lightweight displacement. From the length of chain paid out, determine from the anchor-chain correction graph the weight reduction and the corrected VCG. Enter the values in the anchor-chain correction table on the load form.

Anchor Chain Tension Correction

When the unit is moored and held in position by its anchors, each anchor chain is tensioned, partly by its horizontal and partly by its vertical component of the total line tension, TA. With the unit in equilibrium (i.e., not moving), the horizontal forces cancel each other; however, the effect of the vertical component, TV, cannot be ignored, TA can be read directly from the chain tension indicator (kips). Knowing this tension together with the known water depth enables the vertical force component TV (long tons) for each anchor chain to be read directly from the Vertical Component of Line Tension Table (Figure 13 in Section 5). Enter the value TV in the anchor chain tension correction line on the loading form. This force is treated as an external load acting on the unit at the lower fairlead, 50' above the baseline.

Length of Chain Catenary

The length of the chain from the lower fairlead to the touchdown point can be read from the Anchor Chain - Catenary Length Table, Figure 14 in Section 5. For the water depth (assumes an operating draft of 60 feet) and chain tension, read directly the length of the catenary. Subtracting this value from the total length of chain installed yields the length of chain lying on the sea bottom.

3.6.5 Stability Calculations

Center of Gravity (VCG, LCG, and TCG)

Obtain the coordinates (VCG, LCG, and TCG) of the center of gravity for the vessel by dividing the sum of the vertical, longitudinal, and transverse moments (VM, LM, TM) by displacement, Δ .

$$VCG = \text{Total VM} / \Delta$$

$$LCG = \text{Total LM} / \Delta$$

$$TCG = \text{Total TM} / \Delta$$

Free Surface Corrections (FSCL and FSCT)

To obtain the longitudinal and transverse free surface corrections, divide the sum of the longitudinal and transverse free surface moments by displacement.

$$FSCL = \text{Total FSML} / \Delta$$

$$FSCT = \text{Total FSMT} / \Delta$$

Corrected KG (KGL and KGT)

Add the free surface corrections determined above to VCG to obtain the corrected height of the center of gravity.

$$KGL = VCG + FSCL$$

$$KGT = VCG + FSCT$$

Maximum Allowable KG (KGmax)

The maximum allowable KG for the draft in question is obtained from Figure 9 in Section 5.

Should either of the corrected KGs be greater than the maximum KG allowed, rig loading must be altered to reduce the height of the center of gravity.

Maintaining the corrected KG below the maximum allowed insures that sufficient righting moment exists to recover from wind overturning forces in both the intact and damaged stability condition.

Metacentric Heights (GML and GMT)

Reference to the hydrostatic tables at the known displacement or draft yields the heights of the metacenters (KML and KMT). Subtracting the corrected heights of the center of gravity from these metacenters yields the metacentric heights (GML and GMT).

$$GML = KML - KGL$$

$$GMT = KMT - KGT$$

There are at least three important uses of the metacentric height:

- (1) GM is used as an indication of initial static stability. If GM is positive, the upright initial equilibrium position is stable.
- (2) GM also indicates the stiffness of the vessel. If GM is large, the vessel is said to be stiff, and its motion is quick and rapid. If small, the vessel is said to be tender, and its motion is slow and easy, but to greater angles of inclination.
- (3) GM appears in the denominator of mathematical expressions for determining static list and trim.

Trim and List

Trim may be expressed as the difference between fore and aft drafts. Similarly, list is the difference between port and starboard drafts. Each may also be considered as the angle between the reference plane through the keel with the plane of flotation. For the Deep Driller, the sign convention defines positive trim as trim by the head. Negative trim is inclination to the stern. Similarly, positive list is defined as inclination to starboard. A negative value of list means the list is to the port side.

The trim and list in feet may be found using the following expressions:

$$\text{Trim}_{\text{FT}} = \frac{(\text{LCG} - \text{LCB}) L}{\text{GML}}$$

$$\text{List}_{\text{FT}} = \frac{\text{TCG} \times B}{\text{GMT}}$$

L and B refer to the longitudinal and transverse distances between draft marks. For the Deep Driller, L = 164 feet, and B = 122.8 feet.

The approximate angle of trim and list may be calculated using:

$$\text{Trim}^\circ = \frac{(\text{LCG} - \text{LCB}) 57.3}{\text{GML}}$$

$$\text{List}^\circ = \frac{\text{TCG} \times 57.3}{\text{GMT}}$$

(Although the accuracy of these formulas diminishes as angles of trim or list increase above 15°, use of this calculation method is sufficient.)

Drafts

The drafts at each of the four draft marks may be calculated using the values of trim and list in feet found from the expressions listed above to correct the draft at the center of flotation. Since the center of flotation, at drafts greater than 20 feet, is at amidships (where LCF = 0), the draft change due to a change in trim is equal at the forward and aft draft marks. Similarly, the draft change due to a change in list is also equal port and starboard.

$$\text{Draft}_{\text{PORT FWD}} = \text{Draft}_{\text{CF}} + 0.5 \text{ Trim} - 0.5 \text{ List}$$

$$\text{Draft}_{\text{STBD FWD}} = \text{Draft}_{\text{CF}} + 0.5 \text{ Trim} + 0.5 \text{ List}$$

$$\text{Draft}_{\text{PORT AFT}} = \text{Draft}_{\text{CF}} - 0.5 \text{ Trim} - 0.5 \text{ List}$$

$$\text{Draft}_{\text{STBD AFT}} = \text{Draft}_{\text{CF}} - 0.5 \text{ Trim} + 0.5 \text{ List}$$

3.7 SAMPLE LOAD CALCULATIONS

The following sample load calculation cases show the Deep Driller in representative loading configurations.

3.7.1 Ocean Transit

914.4 long tons deck load
19.22 feet draft
Level vessel
Under tow

3.7.2 Ballasting to Survival

914.4 long tons deck load
45.0 feet draft
Level vessel
Under tow

3.7.3 Preparing to Drill

1,723.1 long tons deck load
60.0 feet draft
Level vessel
Anchored in 600 feet water

3.7.4 Drilling

1,788.1 long tons deck load
60.0 feet draft
Level vessel
Anchored in 600 feet water

3.7.5 Deballasting to Survival

1,788.1 long tons deck load
45.0 feet survival draft
Level attitude
Anchored in 600 feet water

3.7.6 Survival - Ice/Snow Loads

1,423.0 long tons deck load
376 long tons of ice/snow loads for 3" thickness, starboard side to windward.
45.0 feet draft.
Anchored in 600 feet of water

**DEEP DRILLER
LOAD CALCULATION FORM**

TABLE 1 - SALT WATER BALLAST TANKS

TANK NO	SOUNDING Feet	WEIGHT L.Tons	VCG Ft	VM Ft-Tons	LCG Ft	LM Ft-Tons	TCG Ft	TM Ft-Tons	FSML Ft-Tons	FSMT Ft-Tons
1 Port	5.05	174.19	2.53	440	105.76	18422	-75.00	-13064	6707	1797
1 Stbd	3.72	128.31	1.86	239	105.76	13570	75.00	9623	6707	1797
2 Port	0.00	0.00	0.00	0	65.00	0	-87.25	0	0	0
2 Stbd	0.00	0.00	0.00	0	65.00	0	87.25	0	0	0
3 Port	0.00	0.00	0.00	0	64.98	0	-62.75	0	0	0
3 Stbd	0.00	0.00	0.00	0	64.98	0	62.75	0	0	0
8 Port	0.00	0.00	0.00	0	-62.50	0	-62.80	0	0	0
8 Stbd	0.00	0.00	0.00	0	-62.50	0	62.80	0	0	0
9 Port	0.00	0.00	0.00	0	-62.50	0	-87.20	0	0	0
9 Stbd	0.00	0.00	0.00	0	-62.50	0	87.20	0	0	0
10 Port	0.00	0.00	10.00	0	-106.00	0	-71.70	0	0	0
10 Stbd	0.00	0.00	10.00	0	-106.00	0	71.70	0	0	0
C1 Port	0.00	0.00	20.00	0	90.00	0	-75.00	0	0	0
C1 Stbd	0.00	0.00	20.00	0	90.00	0	75.00	0	0	0
C2A Port	0.00	0.00	60.00	0	0.00	0	-75.00	0	0	0
C2B Port	0.00	0.00	60.00	0	0.00	0	75.00	0	0	0
C2A Stbd	0.00	0.00	20.00	0	0.00	0	-75.00	0	0	0
C2B Stbd	0.00	0.00	20.00	0	0.00	0	75.00	0	0	0
C3 Port	0.00	0.00	20.00	0	-90.00	0	-75.00	0	0	0
C3 Stbd	0.00	0.00	20.00	0	-90.00	0	75.00	0	0	0
TOTAL		302.50		678		31992		-3441	13414	3594

TABLE 2 - FRESH WATER AND FUEL OIL TANKS

TANK NO	SOUNDING Feet	WEIGHT L.Tons	VCG Ft	VM Ft-Tons	LCG Ft	LM Ft-Tons	TCG Ft	TM Ft-Tons	FSML Ft-Tons	FSMT Ft-Tons
5 Port Drill Water	10.00	268.87	5.00	1344	20.00	5377	-62.75	-16871	3328	1396
5 Stbd Drill Water	10.00	268.87	5.00	1344	20.00	5377	62.75	16871	3328	1396
7 Port Potable Water	0.00	0.00	0.00	0	-26.50	0	-87.50	0	0	0
7 Stbd Potable Water	8.00	76.41	4.00	306	-26.50	-2025	87.50	6686	317	233
TOTAL FRESH WATER		614.14		2994		8730		6686	6973	3025
4 Port Fuel Oil	8.50	193.90	4.25	824	20.00	3878	-87.25	-16918	2835	1189
4 Stbd Fuel Oil	9.00	205.31	4.50	924	20.00	4106	87.25	17913	2835	1189
6 Port Fuel Oil	0.00	0.00	0.00	0	-8.50	0	-87.50	0	0	0
6 Stbd Fuel Oil	0.00	0.00	0.00	0	-8.50	0	87.50	0	0	0
TOTAL FUEL OIL		399.21		1748		7984		995	5670	2378

TABLE 3 - ANCHOR AND CHAIN CORRECTIONS

MOORING LINE NUMBER	WEIGHT L.Tons	VCG Ft	VM Ft-Tons	LCG Ft	LM Ft-Tons	TCG Ft	TM Ft-Tons		
#1 Anchor	0.00	25.00	0	85.00	0	-108.00	0		
#2 Anchor	0.00	25.00	0	102.00	0	-105.00	0		
#3 Anchor	0.00	25.00	0	102.00	0	105.00	0		
#4 Anchor	0.00	25.00	0	85.00	0	108.00	0		
#5 Anchor	0.00	25.00	0	-84.30	0	108.00	0		
#6 Anchor	0.00	25.00	0	-101.20	0	105.00	0		
#7 Anchor	0.00	25.00	0	-101.20	0	-105.00	0		
#8 Anchor	0.00	25.00	0	-84.30	0	-108.00	0		
Length payed out									
#1 Mooring Chain	0.00	0.00	63.50	0	87.70	0	-75.00	0	
#2 Mooring Chain	0.00	0.00	63.50	0	92.30	0	-75.00	0	
#3 Mooring Chain	0.00	0.00	63.50	0	92.30	0	75.00	0	
#4 Mooring Chain	0.00	0.00	63.50	0	87.70	0	75.00	0	
#5 Mooring Chain	0.00	0.00	63.50	0	-91.30	0	72.00	0	
#6 Mooring Chain	0.00	0.00	63.50	0	-87.00	0	76.30	0	
#7 Mooring Chain	0.00	0.00	63.50	0	-87.00	0	-76.30	0	
#8 Mooring Chain	0.00	0.00	63.50	0	-91.30	0	-72.00	0	
TOTAL ANCHOR & CHAIN	0.00	0.00	0	0	0	0	0		

TABLE 4 - EXTERNAL LOADS

MOORING LINE NUMBER	TENSION Kips	WEIGHT L.Tons	VCG Ft	VM Ft-Tons	LCG Ft	LM Ft-Tons	TCG Ft	TM Ft-Tons		
#1 Chain Tension	0.00	0.00	50.00	0	84.00	0	-91.00	0		
#2 Chain Tension	0.00	0.00	50.00	0	96.00	0	-91.00	0		
#3 Chain Tension	0.00	0.00	50.00	0	96.00	0	91.00	0		
#4 Chain Tension	0.00	0.00	50.00	0	84.00	0	91.00	0		
#5 Chain Tension	0.00	0.00	50.00	0	-84.00	0	91.00	0		
#6 Chain Tension	0.00	0.00	50.00	0	-96.00	0	91.00	0		
#7 Chain Tension	0.00	0.00	50.00	0	-96.00	0	-91.00	0		
#8 Chain Tension	0.00	0.00	50.00	0	-84.00	0	-91.00	0		
SUBTOTAL - CHAIN TENSION	0.00	0.00	0	0	0	0	0	0		
Hook Load	0.00	144.00	0	-26.00	0	0.00	0	0		
Riser Tension	0.00	138.00	0	-26.00	0	0.00	0	0		
Guideline Tension	0.00	125.90	0	-26.00	0	0.00	0	0		
TOTAL EXTERNAL LOAD	0.00	0.00	0	0	0	0	0	0		

TABLE 5 - TUBULARS AND DRILLING TOOLS

TUBULARS	QUANTITY Feet	WEIGHT L.Tons	VCG Ft	VM Ft-Tons	LCG Ft	LM Ft-Tons	TCG Ft	TM Ft-Tons		
Drill Pipe (5.5")	14400.00	135.00	130.00	17550	40.00	5400	5.00	675		
Misc (Pipe Rack)		32.00	130.00	4160	30.00	960	30.00	960		
Drill Collars (9")	240.00	24.64	129.00	3179	40.00	986	30.00	739		
Drill Collars (8")	920.00	58.73	130.00	7635	30.00	1762	-20.00	-1175		
Drill Collars (6.5")	960.00	41.14	129.00	5307	30.00	1234	-45.00	-1851		
Casing 30"	0.00	0.00	130.00	0	30.00	0	-40.00	0		
Casing 20"	0.00	0.00	130.00	0	30.00	0	-35.00	0		
Casing 13 3/8"	0.00	0.00	130.00	0	30.00	0	35.00	0		
Casing 9 5/8"	0.00	0.00	130.00	0	30.00	0	40.00	0		
Marine Riser Joints	600.00	67.50	125.00	8438	38.60	2606	-45.00	-3038		
Pups (5,10,10,15,25)	65.00	9.29	132.00	1226	42.00	390	45.00	418		
Slip Joint	1 unit	11.20	131.00	1467	-38.00	-426	-70.00	-784		
Ball Joint	1 unit	4.91	122.00	599	40.00	196	30.00	147		
Riser Racks		2.63	120.00	316	38.60	102	-45.00	-118		
Riser Handling Equip		29.46	129.00	3800	0.00	0	-5.00	-147		
Setback		0.00	189.70	0	-16.40	0	0.00	0		
TOTAL TUBULARS & TOOLS		416.50		53677		13210		-4174		

TABLE 6 - STORES AND SUPPLIES

ITEMS	WEIGHT L.Tons	VCG Ft	VM Ft-Tons	LCG Ft	LM Ft-Tons	TCG Ft	TM Ft-Tons		
Engineering Stores	3.00	115.00	345	-32.00	-96	-69.00	-207		
Electrician Stores	2.00	115.00	230	73.00	146	-66.00	-132		
Pump Stores	3.00	115.00	345	0.00	0	14.00	42		
Drilling Stores	25.00	85.00	2125	-90.00	-2250	75.00	1875		
Warehouse	12.00	115.00	1380	-52.00	-624	-56.00	-672		
Freezer	4.00	115.00	460	83.00	332	12.50	50		
Dry Stores	2.00	115.00	230	68.00	136	10.00	20		
Paint Locker	8.00	84.00	672	-10.00	-80	-85.00	-680		
Crew & Effects	10.00	119.00	1190	83.00	830	0.00	0		
Caissons 1P & 2S	22.00	88.00	1936	45.00	990	0.00	0		
TOTAL STORES & SUPPLIES	91.00		8913		-616		296		

TABLE 7 - BULK MATERIALS

TANK NO	ULLAGE Feet	WEIGHT L.Tons	VCG Ft	VM Ft-Tons	LCG Ft	LM Ft-Tons	TCG Ft	TM Ft-Tons		
P-Tank #1 - Cement	14.65	16.10	115.61	1862	-53.40	-860	52.60	847		
P-Tank #2 - Cement	12.15	24.58	116.88	2873	-66.90	-1644	52.60	1293		
P-Tank #3 - Cement	19.40	0.00	113.19	0	-80.40	0	52.60	0		
P-Tank #4 - Barite	15.40	19.54	115.23	2252	-53.40	-1044	68.60	1341		
P-Tank #5 - Barite	13.15	30.54	116.37	3554	-66.90	-2043	68.60	2095		
P-Tank #6 - Bentonite	19.40	0.00	113.19	0	-80.40	0	68.60	0		
Surge Tank #1		0.00	121.40	0	5.00	0	50.00	0		
Surge Tank #2		0.00	121.40	0	14.50	0	50.00	0		
Surge Tank #3		0.00	120.90	0	-30.10	0	58.80	0		
Sack Materials		10.00	115.00	1150	28.00	280	59.00	590		
TOTAL BULK & MATERIALS		100.76		11690		-5311		6165		

TABLE 8 - LIQUID MUD

PIT #	SOUND. Feet	Lbs. per Gallon	WEIGHT L.Tons	VCG Ft	VM Ft-Tons	LCG Ft	LM Ft-Tons	TCG Ft	TM Ft-Tons	FSML Ft-Tons	FSMT Ft-Tons
#4 Mud Pit	0	16.00	0.00	111.00	0	3.50	0	-2.50	0	0	0
#3 Mud Pit	0	16.00	0.00	111.00	0	18.50	0	-2.50	0	0	0
#2 Mud Pit	0	16.00	0.00	111.00	0	33.50	0	-2.50	0	0	0
#1 Reserve	0	16.00	0.00	111.00	0	48.50	0	-2.50	0	0	0
Slug Pit	0	16.00	0.00	111.00	0	18.50	0	4.80	0	0	0
Sandtrap			0.00	118.50	0	-41.00	0	27.30	0	0	0
#1 Return Tank			0.00	118.20	0	-34.40	0	27.30	0	0	0
#2 Return Tank			0.00	118.20	0	-27.40	0	27.30	0	0	0
TOTAL - LIQUID MUD			0.00		0		0		0	0	0

TABLE 9 - MISCELLANEOUS LOADS

ITEMS	WEIGHT L.Tons	VCG Ft	VM Ft-Tons	LCG Ft	LM Ft-Tons	TCG Ft	TM Ft-Tons		
TV Camera Equipment	2.70	113.00	305	-26.00	-70	14.00	38		
Diving Equipment	0.00	106.00	0	-72.00	0	0.00	0		
Schlumberger House	5.40	131.00	707	-25.00	-135	62.00	335		
Schlumberger Unit	17.20	141.20	2429	-25.00	-430	62.00	1066		
Cement Pump Unit	17.50	114.00	1995	18.00	315	54.60	956		
BOP Stack 89.30 LTons	89.30	111.50	9957	-76.00	-6787	6.00	536		
Lower Riser Assmby 53.60 LTons	53.60	107.00	5735	-76.00	-4074	-6.00	-322		
Anchor Buoy (Each) 3.94 LTons	31.52	108.00	3404	8.00	252	0.00	0		
Fork Lift Truck	3.60	115.00	414	28.00	101	58.00	209		
Oxy Acetylene	2.00	115.00	230	-32.00	-64	-69.00	-138		
Spare Plate	10.00	115.00	1150	-64.00	-640	-49.00	-490		
Test Equip & Burner Boom	14.00	124.00	1736	-40.00	-560	0.00	0		
Misc Sub Sea Equipment	10.00	106.00	1060	-84.00	-840	-32.40	-324		
Snow & Ice Loads	0.00	139.72	0	15.65	0	4.55	0		
TOTAL - MISC LOAD	256.82		29122		-12932		1866		

TABLE 10 - VESSEL SUMMARY

	WEIGHT L.Tons		VM Ft-Tons		LM Ft-Tons		TM Ft-Tons	FSML Ft-Tons	FSMT Ft-Tons
DECK LOAD SUMMARY									
Tubulars & Drill Tools (Table 5)	416.50		53677		13210		-4174	0	0
Stores & Supplies (Table 6)	91.00		8913		-616		296	0	0
Bulk Materials (Table 7)	100.76		11690		-5311		6165	0	0
Liquid Mud (Table 8)	0.00		0		0		0	0	0
Miscellaneous Loads (Table 9)	256.82		29122		-12932		1866	0	0
Misc Liquid Service Tanks	49.32		5288		841		-2451	19	17
SUBTOTAL-DECK LOAD	914.41		108690		-4808		1702	19	17
Lightweight									
Salt Water Ballast (Table 1)	302.50		678		31992		-3441	13414	3594
Fresh Water (Table 2)	614.14		2994		8730		6686	6973	3025
Fuel Oil - Lower Hull (Table 2)	399.21		1748		7984		995	5670	2378
Anchor & Chain Correc (Table 3)	0.00		0		0		0	0	0
Total External Load (Table 4)	0.00		0		-7215		0	0	0
Total Deck Load (Above)	914.41		108690		-4808		1702	109	47
TOTALS	11963.15		795025		37183		5	26076	9014

TABLE 11 - STABILITY SUMMARY

<p style="text-align: center;">FROM CALCULATIONS (Table 10)</p> <p>Displacement 11963.15 LT VCG 66.46 ft LCG 3.11 ft TCG 0.00 ft FSCL 2.18 ft FSCT 0.75 ft</p>	<p style="text-align: center;">FROM HYDRO TABLE</p> <p>LCB 3.09 ft LCF 4.83 ft Draft 19.13 ft KML 346.91 ft KMT 369.70 ft</p>	<p style="text-align: center;">MAXIMUM ALLOWABLE KG</p> <p>70K 75.00 ft 100 K 75.00 ft Water Depth 600 ft</p>
<p style="text-align: center;">LONGITUDINAL STABILITY</p> <p>KGL 68.64 ft GML 278.27 ft Trim 0.00 deg Trim 0.01 ft</p>	<p style="text-align: center;">DRAFTS</p> <p>Port Fwd 19.13 ft Stbd Fwd 19.13 ft Port Aft 19.12 ft Stbd Aft 19.12 ft</p>	<p style="text-align: center;">TRANSVERSE STABILITY</p> <p>KGT 67.21 ft GML 302.49 ft List 0.00 deg List 0.00 ft</p>

**DEEP DRILLER
LOAD CALCULATION FORM**

TABLE 1 - SALT WATER BALLAST TANKS

TANK NO	SOUNDING Feet	WEIGHT L.Tons	VCG Ft	VM Ft-Tons	LCG Ft	LM Ft-Tons	TCG Ft	TM Ft-Tons	FSML Ft-Tons	FSMT Ft-Tons
1 Port	6.04	208.33	3.02	629	105.76	22033	-75.00	-15625	6707	1797
1 Stbd	4.71	162.46	2.36	383	105.76	17182	75.00	12184	6707	1797
2 Port	20.00	688.42	10.00	6884	65.00	44747	-87.25	-60065	0	0
2 Stbd	20.00	688.42	10.00	6884	65.00	44747	87.25	60065	0	0
3 Port	8.99	309.38	4.50	1391	64.98	20104	-62.75	-19414	6666	1793
3 Stbd	7.32	251.91	3.66	922	64.98	16369	62.75	15807	6666	1793
8 Port	12.35	459.49	6.18	2837	-62.50	-28718	-62.80	-28856	8418	1938
8 Stbd	13.90	517.16	6.95	3594	-62.50	-32323	62.80	32478	8418	1938
9 Port	20.00	551.74	10.00	5517	-62.50	-34484	-87.20	-48112	0	0
9 Stbd	20.00	551.74	10.00	5517	-62.50	-34484	87.20	48112	0	0
10 Port	0.00	0.00	10.00	0	-106.00	0	-71.70	0	0	0
10 Stbd	0.00	0.00	10.00	0	-106.00	0	71.70	0	0	0
C1 Port	0.00	0.00	20.00	0	90.00	0	-75.00	0	0	0
C1 Stbd	0.00	0.00	20.00	0	90.00	0	75.00	0	0	0
C2A Port	0.00	0.00	60.00	0	0.00	0	-75.00	0	0	0
C2B Port	0.00	0.00	60.00	0	0.00	0	75.00	0	0	0
C2A Stbd	0.00	0.00	20.00	0	0.00	0	-75.00	0	0	0
C2B Stbd	0.00	0.00	20.00	0	0.00	0	75.00	0	0	0
C3 Port	0.00	0.00	20.00	0	-90.00	0	-75.00	0	0	0
C3 Stbd	0.00	0.00	20.00	0	-90.00	0	75.00	0	0	0
TOTAL		4389.06		34559		-3425		32478	43582	11056

TABLE 2 - FRESH WATER AND FUEL OIL TANKS

TANK NO	SOUNDING Feet	WEIGHT L.Tons	VCG Ft	VM Ft-Tons	LCG Ft	LM Ft-Tons	TCG Ft	TM Ft-Tons	FSML Ft-Tons	FSMT Ft-Tons
5 Port Drill Water	10.00	268.87	5.00	1344	20.00	5377	-62.75	-16871	3328	1396
5 Stbd Drill Water	10.00	268.87	5.00	1344	20.00	5377	62.75	16871	3328	1396
7 Port Potable Water	0.00	0.00	0.00	0	-26.50	0	-87.50	0	0	0
7 Stbd Potable Water	8.00	76.41	4.00	306	-26.50	-2025	87.50	6686	317	233
TOTAL FRESH WATER		614.14		2994		8730		6686	6973	3025
4 Port Fuel Oil	8.50	193.90	4.25	824	20.00	3878	-87.25	-16918	2835	1189
4 Stbd Fuel Oil	9.00	205.31	4.50	924	20.00	4106	87.25	17913	2835	1189
6 Port Fuel Oil	0.00	0.00	0.00	0	-8.50	0	-87.50	0	0	0
6 Stbd Fuel Oil	0.00	0.00	0.00	0	-8.50	0	87.50	0	0	0
TOTAL FUEL OIL		399.21		1748		7984		995	5670	2378

**FORM # 2
BALLAST TO
SURVIVAL**

TABLE 3 - ANCHOR AND CHAIN CORRECTIONS

MOORING LINE NUMBER	WEIGHT L.Tons	VCG Ft	VM Ft-Tons	LCG Ft	LM Ft-Tons	TCG Ft	TM Ft-Tons		
#1 Anchor	0.00	25.00	0	85.00	0	-108.00	0		
#2 Anchor	0.00	25.00	0	102.00	0	-105.00	0		
#3 Anchor	0.00	25.00	0	102.00	0	105.00	0		
#4 Anchor	0.00	25.00	0	85.00	0	108.00	0		
#5 Anchor	0.00	25.00	0	-84.30	0	108.00	0		
#6 Anchor	0.00	25.00	0	-101.20	0	105.00	0		
#7 Anchor	0.00	25.00	0	-101.20	0	-105.00	0		
#8 Anchor	0.00	25.00	0	-84.30	0	-108.00	0		
Length payed out									
#1 Mooring Chain	0.00	0.00	63.50	0	87.70	0	-75.00	0	
#2 Mooring Chain	0.00	0.00	63.50	0	92.30	0	-75.00	0	
#3 Mooring Chain	0.00	0.00	63.50	0	92.30	0	75.00	0	
#4 Mooring Chain	0.00	0.00	63.50	0	87.70	0	75.00	0	
#5 Mooring Chain	0.00	0.00	63.50	0	-91.30	0	72.00	0	
#6 Mooring Chain	0.00	0.00	63.50	0	-87.00	0	76.30	0	
#7 Mooring Chain	0.00	0.00	63.50	0	-87.00	0	-76.30	0	
#8 Mooring Chain	0.00	0.00	63.50	0	-91.30	0	-72.00	0	
TOTAL ANCHOR & CHAIN	0.00		0		0		0		

TABLE 4 - EXTERNAL LOADS

MOORING LINE NUMBER	TENSION Kips	WEIGHT L.Tons	VCG Ft	VM Ft-Tons	LCG Ft	LM Ft-Tons	TCG Ft	TM Ft-Tons		
#1 Chain Tension	0.00	0.00	50.00	0	84.00	0	-91.00	0		
#2 Chain Tension	0.00	0.00	50.00	0	96.00	0	-91.00	0		
#3 Chain Tension	0.00	0.00	50.00	0	96.00	0	91.00	0		
#4 Chain Tension	0.00	0.00	50.00	0	84.00	0	91.00	0		
#5 Chain Tension	0.00	0.00	50.00	0	-84.00	0	91.00	0		
#6 Chain Tension	0.00	0.00	50.00	0	-96.00	0	91.00	0		
#7 Chain Tension	0.00	0.00	50.00	0	-96.00	0	-91.00	0		
#8 Chain Tension	0.00	0.00	50.00	0	-84.00	0	-91.00	0		
SUBTOTAL - CHAIN TENSION		0.00		0		0		0		
Hook Load		0.00	144.00	0	-26.00	0	0.00	0		
Riser Tension		0.00	138.00	0	-26.00	0	0.00	0		
Guideline Tension		0.00	125.90	0	-26.00	0	0.00	0		
TOTAL EXTERNAL LOAD		0.00		0		0		0		

TABLE 5 - TUBULARS AND DRILLING TOOLS

TUBULARS	QUANTITY Feet	WEIGHT L.Tons	VCG Ft	VM Ft-Tons	LCG Ft	LM Ft-Tons	TCG Ft	TM Ft-Tons		
Drill Pipe (5.5")	14400.00	135.00	130.00	17550	40.00	5400	5.00	675		
Misc (Pipe Rack)		32.00	130.00	4160	30.00	960	30.00	960		
Drill Collars (9")	240.00	24.64	129.00	3179	40.00	986	30.00	739		
Drill Collars (8")	920.00	58.73	130.00	7635	30.00	1762	-20.00	-1175		
Drill Collars (6.5")	960.00	41.14	129.00	5307	30.00	1234	-45.00	-1851		
Casing 30"	0.00	0.00	130.00	0	30.00	0	-40.00	0		
Casing 20"	0.00	0.00	130.00	0	30.00	0	-35.00	0		
Casing 13 3/8"	0.00	0.00	130.00	0	30.00	0	35.00	0		
Casing 9 5/8"	0.00	0.00	130.00	0	30.00	0	40.00	0		
Marine Riser Joints	600.00	67.50	125.00	8438	38.60	2606	-45.00	-3038		
Pups (5,10,10,15,25)	65.00	9.29	132.00	1226	42.00	390	45.00	418		
Slip Joint	1 unit	11.20	131.00	1467	-38.00	-426	-70.00	-784		
Ball Joint	1 unit	4.91	122.00	599	40.00	196	30.00	147		
Riser Racks		2.63	120.00	316	38.60	102	-45.00	-118		
Riser Handling Equip		29.46	129.00	3800	0.00	0	-5.00	-147		
Setback		0.00	189.70	0	-16.40	0	0.00	0		
TOTAL TUBULARS & TOOLS		416.50		53677		13210		-4174		

TABLE 6 - STORES AND SUPPLIES

ITEMS	WEIGHT L.Tons	VCG Ft	VM Ft-Tons	LCG Ft	LM Ft-Tons	TCG Ft	TM Ft-Tons		
Engineering Stores	3.00	115.00	345	-32.00	-96	-69.00	-207		
Electrician Stores	2.00	115.00	230	73.00	146	-66.00	-132		
Pump Stores	3.01	115.00	346	0.00	0	14.00	42		
Drilling Stores	25.00	85.00	2125	-90.00	-2250	75.00	1875		
Warehouse	12.00	115.00	1380	-52.00	-624	-56.00	-672		
Freezer	4.00	115.00	460	83.00	332	12.50	50		
Dry Stores	2.00	115.00	230	68.00	136	10.00	20		
Paint Locker	8.00	84.00	672	-10.00	-80	-85.00	-680		
Crew & Effects	10.00	119.00	1190	83.00	830	0.00	0		
Caissons 1P & 2S	22.00	88.00	1936	45.00	990	0.00	0		
TOTAL STORES & SUPPLIES	91.01		8914		-616		296		

**FORM # 2
BALLAST TO
SURVIVAL**

TABLE 7 - BULK MATERIALS

TANK NO	ULLAGE Feet	WEIGHT L.Tons	VCG Ft	VM Ft-Tons	LCG Ft	LM Ft-Tons	TCG Ft	TM Ft-Tons		
P-Tank #1 - Cement	14.65	16.10	115.61	1862	-53.40	-860	52.60	847		
P-Tank #2 - Cement	12.15	24.58	116.88	2873	-66.90	-1644	52.60	1293		
P-Tank #3 - Cement	19.40	0.00	113.19	0	-80.40	0	52.60	0		
P-Tank #4 - Barite	15.40	19.54	115.23	2252	-53.40	-1044	68.60	1341		
P-Tank #5 - Barite	13.15	30.54	116.37	3554	-66.90	-2043	68.60	2095		
P-Tank #6 - Bentonite	19.40	0.00	113.19	0	-80.40	0	68.60	0		
Surge Tank #1		0.00	121.40	0	5.00	0	50.00	0		
Surge Tank #2		0.00	121.40	0	14.50	0	50.00	0		
Surge Tank #3		0.00	120.90	0	-30.10	0	58.80	0		
Sack Materials		10.00	115.00	1150	28.00	280	59.00	590		
TOTAL BULK & MATERIALS		100.76		11690		-5311		6165		

TABLE 8 - LIQUID MUD

PIT #	SOUND. Feet	Lbs. per Gallon	WEIGHT L.Tons	VCG Ft	VM Ft-Tons	LCG Ft	LM Ft-Tons	TCG Ft	TM Ft-Tons	FSML Ft-Tons	FSMT Ft-Tons
#4 Mud Pit	0	16.00	0.00	111.00	0	3.50	0	-2.50	0	0	0
#3 Mud Pit	0	16.00	0.00	111.00	0	18.50	0	-2.50	0	0	0
#2 Mud Pit	0	16.00	0.00	111.00	0	33.50	0	-2.50	0	0	0
#1 Reserve	0	16.00	0.00	111.00	0	48.50	0	-2.50	0	0	0
Slug Pit	0	16.00	0.00	111.00	0	18.50	0	4.80	0	0	0
Sandtrap			0.00	118.50	0	-41.00	0	27.30	0	0	0
#1 Return Tank			0.00	118.20	0	-34.40	0	27.30	0	0	0
#2 Return Tank			0.00	118.20	0	-27.40	0	27.30	0	0	0
TOTAL - LIQUID MUD			0.00		0		0		0	0	0

TABLE 9 - MISCELLANEOUS LOADS

ITEMS	WEIGHT L.Tons	VCG Ft	VM Ft-Tons	LCG Ft	LM Ft-Tons	TCG Ft	TM Ft-Tons			
TV Camera Equipment	2.70	113.00	305	-26.00	-70	14.00	38			
Diving Equipment	0.00	106.00	0	-72.00	0	0.00	0			
Schlumberger House	5.40	131.00	707	-25.00	-135	62.00	335			
Schlumberger Unit	17.20	141.20	2429	-25.00	-430	62.00	1066			
Cement Pump Unit	17.50	114.00	1995	18.00	315	54.60	956			
BOP Stack	89.30 LTons	89.30	111.50	9957	-76.00	-6787	6.00	536		
Lower Riser Assmly	53.60 LTons	53.60	107.00	5735	-76.00	-4074	-6.00	-322		
Anchor Buoy (Each)	3.94 LTons	31.52	108.00	3404	8.00	252	0.00	0		
Fork Lift Truck	3.60	115.00	414	28.00	101	58.00	209			
Oxy Acetylene	2.00	115.00	230	-32.00	-64	-69.00	-138			
Spare Plate	10.00	115.00	1150	-64.00	-640	-49.00	-490			
Test Equip & Burner Boom	14.00	124.00	1736	-40.00	-560	0.00	0			
Misc Sub Sea Equipment	10.00	106.00	1060	-84.00	-840	-32.40	-324			
Snow & Ice Loads	0.00	139.72	0	15.65	0	4.55	0			
TOTAL - MISC LOADS	256.82		29122		-12932		1866			

TABLE 10 - VESSEL SUMMARY

	WEIGHT L.Tons	VM Ft-Tons	LM Ft-Tons	TM Ft-Tons	FSML Ft-Tons	FSMT Ft-Tons
DECK LOAD SUMMARY						
Tubulars & Drill Tools (Table 5)	416.50	53677	13210	-4174	0	0
Stores & Supplies (Table 6)	91.01	8914	-616	296	0	0
Bulk Materials (Table 7)	100.76	11690	-5311	6165	0	0
Liquid Mud (Table 8)	0.00	0	0	0	0	0
Miscellaneous Loads (Table 9)	256.82	29122	-12932	1866	0	0
Misc Liquid Service Tanks	49.32	5288	841	-2451	19	17
SUBTOTAL-DECK LOAD	914.42	108691	-4808	1702	19	17
Lightweight	9732.90	680914	-6716	-5937		
Salt Water Ballast (Table 1)	4389.06	34559	35174	-3425	43582	11056
Fresh Water (Table 2)	614.14	2994	8730	6686	6973	3025
Fuel Oil - Lower Hull (Table 2)	399.21	1748	7984	995	5670	2378
Anchor & Chain Correc (Table 3)	0.00	0	0	0	0	0
Total External Load (Table 4)	0.00	0	0	0	0	0
Total Deck Load (Above)	914.42	108691	-4808	1702	109	47
TOTALS	16049.73	828907	40364	21	56244	16476

TABLE 11 - STABILITY SUMMARY

<p style="text-align: center;">FROM CALCULATIONS (Table 10)</p> <p>Displacement 16049.73 LT VCG 51.65 ft LCG 2.51 ft TCG 0.00 ft FSCL 3.50 ft FSCT 1.03 ft</p>	<p style="text-align: center;">FROM HYDRO TABLE</p> <p>LCB 2.51 ft LCF 0.00 ft Draft 45.00 ft KML 62.24 ft KMT 64.17 ft</p>	<p style="text-align: center;">MAXIMUM ALLOWABLE KG</p> <p>70K 62.24 ft 100 K 62.09 ft Water Depth 600 ft</p>
<p style="text-align: center;">LONGITUDINAL STABILITY</p> <p>KGL 55.15 ft GML 7.09 ft Trim 0.02 deg Trim 0.07 ft</p>	<p style="text-align: center;">DRAFTS</p> <p>Port Fwd 45.03 ft Stbd Fwd 45.04 ft Port Aft 44.96 ft Stbd Aft 44.97 ft</p>	<p style="text-align: center;">TRANSVERSE STABILITY</p> <p>KGT 52.67 ft GML 11.50 ft List 0.01 deg List 0.01 ft</p>

**DEEP DRILLER
LOAD CALCULATION FORM**

TABLE 1 - SALT WATER BALLAST TANKS

TANK NO	SOUNDING Feet	WEIGHT L.Tons	VCG Ft	VM Ft-Tons	LCG Ft	LM Ft-Tons	TCG Ft	TM Ft-Tons	FSML Ft-Tons	FSMT Ft-Tons
1 Port	7.57	261.11	3.79	988	105.76	27615	-75.00	-19583	6707	1797
1 Stbd	4.71	162.46	2.36	383	105.76	17182	75.00	12184	6707	1797
2 Port	20.00	688.42	10.00	6884	65.00	44747	-87.25	-60065	0	0
2 Stbd	20.00	688.42	10.00	6884	65.00	44747	87.25	60065	0	0
3 Port	20.00	688.28	10.00	6883	64.98	44724	-62.75	-43190	0	0
3 Stbd	20.00	688.28	10.00	6883	64.98	44724	62.75	43190	0	0
8 Port	20.00	744.12	10.00	7441	-62.50	-46508	-62.80	-46731	0	0
8 Stbd	20.00	744.12	10.00	7441	-62.50	-46508	62.80	46731	0	0
9 Port	20.00	551.74	10.00	5517	-62.50	-34484	-87.20	-48112	0	0
9 Stbd	20.00	551.74	10.00	5517	-62.50	-34484	87.20	48112	0	0
10 Port	7.51	282.32	13.76	3883	-106.00	-29925	-71.70	-20242	1733	4008
10 Stbd	2.33	87.59	11.17	978	-106.00	-9284	71.70	6280	1733	4008
C1 Port	0.00	0.00	20.00	0	90.00	0	-75.00	0	0	0
C1 Stbd	0.00	0.00	20.00	0	90.00	0	75.00	0	0	0
C2A Port	0.00	0.00	60.00	0	0.00	0	-75.00	0	0	0
C2B Port	0.00	0.00	60.00	0	0.00	0	75.00	0	0	0
C2A Stbd	0.00	0.00	20.00	0	0.00	0	-75.00	0	0	0
C2B Stbd	0.00	0.00	20.00	0	0.00	0	75.00	0	0	0
C3 Port	0.00	0.00	20.00	0	-90.00	0	-75.00	0	0	0
C3 Stbd	0.00	0.00	20.00	0	-90.00	0	75.00	0	0	0
TOTAL		6138.59		59683		22548		-21361	16880	11610

TABLE 2 - FRESH WATER AND FUEL OIL TANKS

TANK NO	SOUNDING Feet	WEIGHT L.Tons	VCG Ft	VM Ft-Tons	LCG Ft	LM Ft-Tons	TCG Ft	TM Ft-Tons	FSML Ft-Tons	FSMT Ft-Tons
5 Port Drill Water	10.00	268.87	5.00	1344	20.00	5377	-62.75	-16871	3328	1396
5 Stbd Drill Water	10.00	268.87	5.00	1344	20.00	5377	62.75	16871	3328	1396
7 Port Potable Water	8.00	76.41	4.00	306	-26.50	-2025	-87.50	-6686	317	233
7 Stbd Potable Water	0.00	0.00	0.00	0	-26.50	0	87.50	0	0	0
TOTAL FRESH WATER		614.14		2994		8730		-6686	6973	3025
4 Port Fuel Oil	8.50	193.90	4.25	824	20.00	3878	-87.25	-16918	2835	1189
4 Stbd Fuel Oil	9.00	205.31	4.50	924	20.00	4106	87.25	17913	2835	1189
6 Port Fuel Oil	0.00	0.00	0.00	0	-8.50	0	-87.50	0	0	0
6 Stbd Fuel Oil	0.00	0.00	0.00	0	-8.50	0	87.50	0	0	0
TOTAL FUEL OIL		399.21		1748		7984		995	5670	2378

**FORM # 3
PREPARING
TO DRILL**

TABLE 3 - ANCHOR AND CHAIN CORRECTIONS

MOORING LINE NUMBER	WEIGHT L.Tons	VCG Ft	VM Ft-Tons	LCG Ft	LM Ft-Tons	TCG Ft	TM Ft-Tons		
#1 Anchor	-15.40	25.00	-385	85.00	-1309	-108.00	1663		
#2 Anchor	-15.40	25.00	-385	102.00	-1571	-105.00	1617		
#3 Anchor	-15.40	25.00	-385	102.00	-1571	105.00	-1617		
#4 Anchor	-15.40	25.00	-385	85.00	-1309	108.00	-1663		
#5 Anchor	-15.40	25.00	-385	-84.30	1298	108.00	-1663		
#6 Anchor	-15.40	25.00	-385	-101.20	1558	105.00	-1617		
#7 Anchor	-15.40	25.00	-385	-101.20	1558	-105.00	1617		
#8 Anchor	-15.40	25.00	-385	-84.30	1298	-108.00	1663		
Length payed out									
#1 Mooring Chain	3000	-120.00	46.90	-5628	87.70	-10524	-75.00	9000	
#2 Mooring Chain	3000	-120.00	46.90	-5628	92.30	-11076	-75.00	9000	
#3 Mooring Chain	3000	-120.00	46.90	-5628	92.30	-11076	75.00	-9000	
#4 Mooring Chain	3000	-120.00	46.90	-5628	87.70	-10524	75.00	-9000	
#5 Mooring Chain	3000	-120.00	46.90	-5628	-91.30	10956	72.00	-8640	
#6 Mooring Chain	3000	-120.00	46.90	-5628	-87.00	10440	76.30	-9156	
#7 Mooring Chain	3000	-120.00	46.90	-5628	-87.00	10440	-76.30	9156	
#8 Mooring Chain	3000	-120.00	46.90	-5628	-91.30	10956	-72.00	8640	
TOTAL ANCHOR & CHAIN	-1083.20		-48104		-454		0		

TABLE 4 - EXTERNAL LOADS

MOORING LINE NUMBER	TENSION Kips	WEIGHT L.Tons	VCG Ft	VM Ft-Tons	LCG Ft	LM Ft-Tons	TCG Ft	TM Ft-Tons		
#1 Chain Tension	200.00	56.93	50.00	2847	84.00	4782	-91.00	-5181		
#2 Chain Tension	200.00	56.93	50.00	2847	96.00	5466	-91.00	-5181		
#3 Chain Tension	200.00	56.93	50.00	2847	96.00	5466	91.00	5181		
#4 Chain Tension	200.00	56.93	50.00	2847	84.00	4782	91.00	5181		
#5 Chain Tension	200.00	56.93	50.00	2847	-84.00	-4782	91.00	5181		
#6 Chain Tension	200.00	56.93	50.00	2847	-96.00	-5466	91.00	5181		
#7 Chain Tension	200.00	56.93	50.00	2847	-96.00	-5466	-91.00	-5181		
#8 Chain Tension	200.00	56.93	50.00	2847	-84.00	-4782	-91.00	-5181		
SUBTOTAL - CHAIN TENSION	455.48			22774		0		0		
Hook Load	0.00	144.00	0	-26.00	0	0.00	0	0		
Riser Tension	115.00	138.00	15870	-26.00	-2990	0.00	0	0		
Guideline Tension	22.50	125.90	2833	-26.00	-585	0.00	0	0		
TOTAL EXTERNAL LOAD	592.98		41477		-3575		0			

TABLE 5 - TUBULARS AND DRILLING TOOLS

TUBULARS	QUANTITY Feet	WEIGHT L.Tons	VCG Ft	VM Ft-Tons	LCG Ft	LM Ft-Tons	TCG Ft	TM Ft-Tons		
Drill Pipe (5.5")	14400	135.00	130.00	17550	40.00	5400	5.00	675		
Misc (Pipe Rack)		32.00	130.00	4160	30.00	960	30.00	960		
Drill Collars (9")	240	24.64	129.00	3179	40.00	986	30.00	739		
Drill Collars (8")	920	58.73	130.00	7635	30.00	1762	-20.00	-1175		
Drill Collars (6.5")	960	41.14	129.00	5307	30.00	1234	-45.00	-1851		
Casing 30"	0	0.00	130.00	0	30.00	0	-40.00	0		
Casing 20"	0	0.00	130.00	0	30.00	0	-35.00	0		
Casing 13 3/8"	4000	121.43	130.00	15786	30.00	3643	35.00	4250		
Casing 9 5/8"	8000	167.86	130.00	21821	30.00	5036	40.00	6714		
Marine Riser Joints	100	11.25	125.00	1406	38.60	434	-45.00	-506		
Pups (5,10,10,15,25)	15	2.14	132.00	283	42.00	90	45.00	96		
Slip Joint	1 unit	0.00	131.00	0	-38.00	0	-70.00	0		
Ball Joint	1 unit	0.00	122.00	0	40.00	0	30.00	0		
Riser Racks		2.63	120.00	316	38.60	102	-45.00	-118		
Riser Handling Equip		29.46	129.00	3800	0.00	0	-5.00	-147		
Setback		0.00	189.70	0	-16.40	0	0.00	0		
TOTAL TUBULARS & TOOLS		626.29		81244		19646		9637		

TABLE 6 - STORES AND SUPPLIES

ITEMS	WEIGHT L.Tons	VCG Ft	VM Ft-Tons	LCG Ft	LM Ft-Tons	TCG Ft	TM Ft-Tons		
Engineering Stores	3.00	115.00	345	-32.00	-96	-69.00	-207		
Electrician Stores	2.00	115.00	230	73.00	146	-66.00	-132		
Pump Stores	3.01	115.00	346	0.00	0	14.00	42		
Drilling Stores	25.00	85.00	2125	-90.00	-2250	75.00	1875		
Warehouse	12.00	115.00	1380	-52.00	-624	-56.00	-672		
Freezer	4.00	115.00	460	83.00	332	12.50	50		
Dry Stores	2.00	115.00	230	68.00	136	10.00	20		
Paint Locker	8.00	84.00	672	-10.00	-80	-85.00	-680		
Crew & Effects	20.00	119.00	2380	83.00	1660	0.00	0		
Caissons 1P & 2S	55.53	88.00	4887	45.00	2499	0.00	0		
TOTAL STORES & SUPPLIES	134.54		13055		1723		296		

TABLE 7 - BULK MATERIALS

TANK NO	ULLAGE Feet	WEIGHT L.Tons	VCG Ft	VM Ft-Tons	LCG Ft	LM Ft-Tons	TCG Ft	TM Ft-Tons		
P-Tank #1 - Cement	0.40	64.41	122.86	7913	-53.40	-3439	52.60	3388		
P-Tank #2 - Cement	0.40	64.41	122.86	7913	-66.90	-4309	52.60	3388		
P-Tank #3 - Cement	19.40	0.00	113.19	0	-80.40	0	52.60	0		
P-Tank #4 - Barite	0.40	92.83	122.86	11406	-53.40	-4957	68.60	6368		
P-Tank #5 - Barite	0.40	92.83	122.86	11406	-66.90	-6211	68.60	6368		
P-Tank #6 - Bentonite	7.40	24.10	119.30	2875	-80.40	-1937	68.60	1653		
Surge Tank #1		2.00	121.40	243	5.00	10	50.00	100		
Surge Tank #2		0.00	121.40	0	14.50	0	50.00	0		
Surge Tank #3		1.00	120.90	121	-30.10	-30	58.80	59		
Sack Materials		62.34	115.00	7169	28.00	1746	59.00	3678		
TOTAL BULK & MATERIALS		403.92		49045		-19128		25003		

TABLE 8 - LIQUID MUD

PIT #	SOUND. Feet	Lbs. per Gallon	WEIGHT L.Tons	VCG Ft	VM Ft-Tons	LCG Ft	LM Ft-Tons	TCG Ft	TM Ft-Tons	FSML Ft-Tons	FSMT Ft-Tons
#4 Mud Pit	8	16.00	106.67	115.00	12267	3.50	373	-2.50	-267	235	418
#3 Mud Pit	8	16.00	106.67	115.00	12267	18.50	1973	-2.50	-267	235	418
#2 Mud Pit	8	16.00	106.67	115.00	12267	33.50	3573	-2.50	-267	235	418
#1 Reserve	8	16.00	106.67	115.00	12267	48.50	5173	-2.50	-267	235	418
Slug Pit	0	16.00	0.00	111.00	0	18.50	0	4.80	0	0	0
Sandtrap			0.00	118.50	0	-41.00	0	27.30	0	0	0
#1 Return Tank			0.00	118.20	0	-34.40	0	27.30	0	0	0
#2 Return Tank			0.00	118.20	0	-27.40	0	27.30	0	0	0
TOTAL - LIQUID MUD			426.66		49066		11093		-1067	940	1672

TABLE 9 - MISCELLANEOUS LOADS

ITEMS	WEIGHT L.Tons	VCG Ft	VM Ft-Tons	LCG Ft	LM Ft-Tons	TCG Ft	TM Ft-Tons			
TV Camera Equipment	2.70	113.00	305	-26.00	-70	14.00	38			
Diving Equipment	0.00	106.00	0	-72.00	0	0.00	0			
Schlumberger House	5.40	131.00	707	-25.00	-135	62.00	335			
Schlumberger Unit	17.20	141.20	2429	-25.00	-430	62.00	1066			
Cement Pump Unit	17.50	114.00	1995	18.00	315	54.60	956			
BOP Stack	89.30 LTons	0.00	111.50	0	-76.00	0	6.00	0		
Lower Riser Assmby	53.60 LTons	0.00	107.00	0	-76.00	0	-6.00	0		
Anchor Buoy (Each)	3.94 LTons	0.00	108.00	0	8.00	0	0.00	0		
Fork Lift Truck	3.60	115.00	414	28.00	101	58.00	209			
Oxy Acetylene	2.00	115.00	230	-32.00	-64	-69.00	-138			
Spare Plate	10.00	115.00	1150	-64.00	-640	-49.00	-490			
Test Equip & Burner Boom	14.00	124.00	1736	-40.00	-560	0.00	0			
Misc Sub Sea Equipment	10.00	106.00	1060	-84.00	-840	-32.40	-324			
Snow & Ice Loads	0.00	139.72	0	15.65	0	4.55	0			
TOTAL - MISC LOAD	82.40		10026		-2323		1651			

TABLE 10 - VESSEL SUMMARY

		WEIGHT L.Tons	VM Ft-Tons	LM Ft-Tons	TM Ft-Tons	FSML Ft-Tons	FSMT Ft-Tons
DECK LOAD SUMMARY							
Tubulars & Drill Tools	(Table 5)	626.29	81244	19646	9637	0	0
Stores & Supplies	(Table 6)	134.54	13055	1723	296	0	0
Bulk Materials	(Table 7)	403.92	49045	-19128	25003	0	0
Liquid Mud	(Table 8)	426.66	49066	11093	-1067	940	1672
Miscellaneous Loads	(Table 9)	82.40	10026	-2323	1651	0	0
Misc Liquid Service Tanks		49.32	5288	841	-2451	19	17
SUBTOTAL-DECK LOAD		1723.14	207725	11852	33069	959	18702
Lightweight		9732.90	680914	-6716	-5937		
Salt Water Ballast	(Table 1)	6138.59	59683	22548	-21361	16880	11610
Fresh Water	(Table 2)	614.14	2994	8730	-6686	6973	3025
Fuel Oil - Lower Hull	(Table 2)	399.21	1748	7984	995	5670	2378
Anchor & Chain Correc	(Table 3)	-1083.20	-48104	-454	0	0	0
Total External Load	(Table 4)	592.98	41477	-3575	0	0	0
Total Deck Load	(Above)	1723.14	207725	11852	33069	1049	1719
TOTALS		18117.75	946436	40368	81	30482	18702

TABLE 11 - STABILITY SUMMARY

FROM CALCULATIONS (Table 10)	FROM HYDRO TABLE	MAXIMUM ALLOWABLE KG
Displacement 18117.75 LT VCG 52.24 ft LCG 2.23 ft TCG 0.00 ft FSCL 1.68 ft FSCT 1.03 ft	LCB 2.23 ft LCF 0.00 ft Draft 60.00 ft KML 61.13 ft KMT 62.84 ft	70K 58.50 ft 100 K 52.00 ft Water Depth 600 ft
LONGITUDINAL STABILITY	DRAFTS	TRANSVERSE STABILITY
KGL 53.92 ft GML 7.21 ft Trim 0.02 deg Trim 0.06 ft	Port Fwd 60.00 ft Stbd Fwd 60.06 ft Port Aft 59.94 ft Stbd Aft 60.00 ft	KGT 53.27 ft GML 9.57 ft List 0.03 deg List 0.06 ft

**DEEP DRILLER
LOAD CALCULATION FORM**

TABLE 1 - SALT WATER BALLAST TANKS

TANK NO	SOUNDING Feet	WEIGHT L.Tons	VCG Ft	VM Ft-Tons	LCG Ft	LM Ft-Tons	TCG Ft	TM Ft-Tons	FSML Ft-Tons	FSMT Ft-Tons
1 Port	7.27	250.76	3.64	912	105.76	26520	-75.00	-18807	6707	1797
1 Stbd	2.74	94.51	1.37	129	105.76	9995	75.00	7088	6707	1797
2 Port	20.00	688.42	10.00	6884	65.00	44747	-87.25	-60065	0	0
2 Stbd	20.00	688.42	10.00	6884	65.00	44747	87.25	60065	0	0
3 Port	20.00	688.28	10.00	6883	64.98	44724	-62.75	-43190	0	0
3 Stbd	20.00	688.28	10.00	6883	64.98	44724	62.75	43190	0	0
8 Port	20.00	744.12	10.00	7441	-62.50	-46508	-62.80	-46731	0	0
8 Stbd	20.00	744.12	10.00	7441	-62.50	-46508	62.80	46731	0	0
9 Port	20.00	551.74	10.00	5517	-62.50	-34484	-87.20	-48112	0	0
9 Stbd	20.00	551.74	10.00	5517	-62.50	-34484	87.20	48112	0	0
10 Port	5.19	195.10	12.60	2457	-106.00	-20681	-71.70	-13989	1733	4008
10 Stbd	1.28	48.12	10.64	512	-106.00	-5100	71.70	3450	1733	4008
C1 Port	0.00	0.00	20.00	0	90.00	0	-75.00	0	0	0
C1 Stbd	0.00	0.00	20.00	0	90.00	0	75.00	0	0	0
C2A Port	0.00	0.00	60.00	0	0.00	0	-75.00	0	0	0
C2B Port	0.00	0.00	60.00	0	0.00	0	75.00	0	0	0
C2A Stbd	0.00	0.00	20.00	0	0.00	0	-75.00	0	0	0
C2B Stbd	0.00	0.00	20.00	0	0.00	0	75.00	0	0	0
C3 Port	0.00	0.00	20.00	0	-90.00	0	-75.00	0	0	0
C3 Stbd	0.00	0.00	20.00	0	-90.00	0	75.00	0	0	0
TOTAL		5933.61		57461		27695		-22258	16880	11610

TABLE 2 - FRESH WATER AND FUEL OIL TANKS

TANK NO	SOUNDING Feet	WEIGHT L.Tons	VCG Ft	VM Ft-Tons	LCG Ft	LM Ft-Tons	TCG Ft	TM Ft-Tons	FSML Ft-Tons	FSMT Ft-Tons
5 Port Drill Water	10.00	268.87	5.00	1344	20.00	5377	-62.75	-16871	3328	1396
5 Stbd Drill Water	10.00	268.87	5.00	1344	20.00	5377	62.75	16871	3328	1396
7 Port Potable Water	8.00	76.41	4.00	306	-26.50	-2025	-87.50	-6686	317	233
7 Stbd Potable Water	0.00	0.00	0.00	0	-26.50	0	87.50	0	0	0
TOTAL FRESH WATER		614.14		2994		8730		-6686	6973	3025

4 Port Fuel Oil	8.50	193.90	4.25	824	20.00	3878	-87.25	-16918	2835	1189
4 Stbd Fuel Oil	9.00	205.31	4.50	924	20.00	4106	87.25	17913	2835	1189
6 Port Fuel Oil	0.00	0.00	0.00	0	-8.50	0	-87.50	0	0	0
6 Stbd Fuel Oil	0.00	0.00	0.00	0	-8.50	0	87.50	0	0	0
TOTAL FUEL OIL		399.21		1748		7984		995	5670	2378

**FORM # 4
DRILLING**

TABLE 3 - ANCHOR AND CHAIN CORRECTIONS

MOORING LINE NUMBER	WEIGHT L.Tons	VCG Ft	VM Ft-Tons	LCG Ft	LM Ft-Tons	TCG Ft	TM Ft-Tons		
#1 Anchor	-15.40	25.00	-385	85.00	-1309	-108.00	1663		
#2 Anchor	-15.40	25.00	-385	102.00	-1571	-105.00	1617		
#3 Anchor	-15.40	25.00	-385	102.00	-1571	105.00	-1617		
#4 Anchor	-15.40	25.00	-385	85.00	-1309	108.00	-1663		
#5 Anchor	-15.40	25.00	-385	-84.30	1298	108.00	-1663		
#6 Anchor	-15.40	25.00	-385	-101.20	1558	105.00	-1617		
#7 Anchor	-15.40	25.00	-385	-101.20	1558	-105.00	1617		
#8 Anchor	-15.40	25.00	-385	-84.30	1298	-108.00	1663		
Length payed out									
#1 Mooring Chain	3000	-120.00	46.90	-5628	87.70	-10524	-75.00	9000	
#2 Mooring Chain	3000	-120.00	46.90	-5628	92.30	-11076	-75.00	9000	
#3 Mooring Chain	3000	-120.00	46.90	-5628	92.30	-11076	75.00	-9000	
#4 Mooring Chain	3000	-120.00	46.90	-5628	87.70	-10524	75.00	-9000	
#5 Mooring Chain	3000	-120.00	46.90	-5628	-91.30	10956	72.00	-8640	
#6 Mooring Chain	3000	-120.00	46.90	-5628	-87.00	10440	76.30	-9156	
#7 Mooring Chain	3000	-120.00	46.90	-5628	-87.00	10440	-76.30	9156	
#8 Mooring Chain	3000	-120.00	46.90	-5628	-91.30	10956	-72.00	8640	
TOTAL ANCHOR & CHAIN		-1083.20		-48104		-454		0	

TABLE 4 - EXTERNAL LOADS

MOORING LINE NUMBER	TENSION Kips	WEIGHT L.Tons	VCG Ft	VM Ft-Tons	LCG Ft	LM Ft-Tons	TCG Ft	TM Ft-Tons		
#1 Chain Tension	200	56.93	50.00	2847	84.00	4782	-91.00	-5181		
#2 Chain Tension	200	56.93	50.00	2847	96.00	5466	-91.00	-5181		
#3 Chain Tension	200	56.93	50.00	2847	96.00	5466	91.00	5181		
#4 Chain Tension	200	56.93	50.00	2847	84.00	4782	91.00	5181		
#5 Chain Tension	200	56.93	50.00	2847	-84.00	-4782	91.00	5181		
#6 Chain Tension	200	56.93	50.00	2847	-96.00	-5466	91.00	5181		
#7 Chain Tension	200	56.93	50.00	2847	-96.00	-5466	-91.00	-5181		
#8 Chain Tension	200	56.93	50.00	2847	-84.00	-4782	-91.00	-5181		
SUBTOTAL - CHAIN TENS		455.48		22774		0		0		
Hook Load		120.00	144.00	17280	-26.00	-3120	0.00	0		
Riser Tension		135.00	138.00	18630	-26.00	-3510	0.00	0		
Guideline Tension		22.50	125.90	2833	-26.00	-585	0.00	0		
TOTAL EXTERNAL LOAD		732.98		61517		-7215		0		

TABLE 5 - TUBULARS AND DRILLING TOOLS

TUBULARS	QUANTITY Feet	WEIGHT L.Tons	VCG Ft	VM Ft-Tons	LCG Ft	LM Ft-Tons	TCG Ft	TM Ft-Tons		
Drill Pipe (5.5")	14400	135.00	130.00	17550	40.00	5400	5.00	675		
Misc (Pipe Rack)		32.00	130.00	4160	30.00	960	30.00	960		
Drill Collars (9")	240	24.64	129.00	3179	40.00	986	30.00	739		
Drill Collars (8")	920	58.73	130.00	7635	30.00	1762	-20.00	-1175		
Drill Collars (6.5")	960	41.14	129.00	5307	30.00	1234	-45.00	-1851		
Casing 30"	0	0.00	130.00	0	30.00	0	-40.00	0		
Casing 20"	0	0.00	130.00	0	30.00	0	-35.00	0		
Casing 13 3/8"	4000	121.43	130.00	15786	30.00	3643	35.00	4250		
Casing 9 5/8"	8000	167.86	130.00	21821	30.00	5036	40.00	6714		
Marine Riser Joints	100	11.25	125.00	1406	38.60	434	-45.00	-506		
Pups (5,10,10,15,25)	15	2.14	132.00	283	42.00	90	45.00	96		
Slip Joint	1 unit	0.00	131.00	0	-38.00	0	-70.00	0		
Ball Joint	1 unit	0.00	122.00	0	40.00	0	30.00	0		
Riser Racks		2.63	120.00	316	38.60	102	-45.00	-118		
Riser Handling Equip		29.46	129.00	3800	0.00	0	-5.00	-147		
Setback		35.00	189.70	6640	-16.40	-574	0.00	0		
TOTAL TUBULARS & TOOLS		661.29		87883		19072		9637		

TABLE 6 - STORES AND SUPPLIES

ITEMS	WEIGHT L.Tons	VCG Ft	VM Ft-Tons	LCG Ft	LM Ft-Tons	TCG Ft	TM Ft-Tons		
Engineering Stores	3.00	115.00	345	-32.00	-96	-69.00	-207		
Electrician Stores	2.00	115.00	230	73.00	146	-66.00	-132		
Pump Stores	3.00	115.00	345	0.00	0	14.00	42		
Drilling Stores	25.00	85.00	2125	-90.00	-2250	75.00	1875		
Warehouse	12.00	115.00	1380	-52.00	-624	-56.00	-672		
Freezer	4.00	115.00	460	83.00	332	12.50	50		
Dry Stores	2.00	115.00	230	68.00	136	10.00	20		
Paint Locker	8.00	84.00	672	-10.00	-80	-85.00	-680		
Crew & Effects	20.00	119.00	2380	83.00	1660	0.00	0		
Caissons 1P & 2S	55.53	88.00	4887	45.00	2499	0.00	0		
TOTAL STORES & SUPPLIES	134.53		13054		1723		296		

TABLE 7 - BULK MATERIALS

TANK NO	ULLAGE Feet	WEIGHT L.Tons	VCG Ft	VM Ft-Tons	LCG Ft	LM Ft-Tons	TCG Ft	TM Ft-Tons		
P-Tank #1 - Cement	0.40	64.41	122.86	7913	-53.40	-3439	52.60	3388		
P-Tank #2 - Cement	0.40	64.41	122.86	7913	-66.90	-4309	52.60	3388		
P-Tank #3 - Cement	19.40	0.00	113.19	0	-80.40	0	52.60	0		
P-Tank #4 - Barite	0.40	92.83	122.86	11406	-53.40	-4957	68.60	6368		
P-Tank #5 - Barite	0.40	92.83	122.86	11406	-66.90	-6211	68.60	6368		
P-Tank #6 - Bentonite	7.40	24.10	119.30	2875	-80.40	-1937	68.60	1653		
Surge Tank #1		2.00	121.40	243	5.00	10	50.00	100		
Surge Tank #2		0.00	121.40	0	14.50	0	50.00	0		
Surge Tank #3		1.00	120.90	121	-30.10	-30	58.80	59		
Sack Materials		62.34	115.00	7169	28.00	1746	59.00	3678		
TOTAL BULK & MATERIALS		403.92		49045		-19128		25003		

TABLE 8 - LIQUID MUD

PIT #	SOUND. Feet	Lbs. per Gallon	WEIGHT L.Tons	VCG Ft	VM Ft-Tons	LCG Ft	LM Ft-Tons	TCG Ft	TM Ft-Tons	FSML Ft-Tons	FSMT Ft-Tons
#4 Mud Pit	8	16.00	106.67	115.00	12267	3.50	373	-2.50	-267	235	418
#3 Mud Pit	8	16.00	106.67	115.00	12267	18.50	1973	-2.50	-267	235	418
#2 Mud Pit	8	16.00	106.67	115.00	12267	33.50	3573	-2.50	-267	235	418
#1 Reserve	8	16.00	106.67	115.00	12267	48.50	5173	-2.50	-267	235	418
Slug Pit	0	16.00	0.00	111.00	0	18.50	0	4.80	0	0	0
Sandtrap			8.00	118.50	948	-41.00	-328	27.30	218	7	7
#1 Return Tank			10.00	118.20	1182	-34.40	-344	27.30	273	7	7
#2 Return Tank			12.00	118.20	1418	-27.40	-329	27.30	328	12	8
TOTAL - LIQUID MUD			456.66		52615		10092		-248	966	1694

TABLE 9 - MISCELLANEOUS LOADS

ITEMS	WEIGHT L.Tons	VCG Ft	VM Ft-Tons	LCG Ft	LM Ft-Tons	TCG Ft	TM Ft-Tons		
TV Camera Equipment	2.70	113.00	305	-26.00	-70	14.00	38		
Diving Equipment	0.00	106.00	0	-72.00	0	0.00	0		
Schlumberger House	5.40	131.00	707	-25.00	-135	62.00	335		
Schlumbergef Unit	17.20	141.20	2429	-25.00	-430	62.00	1066		
Cement Pump Unit	17.50	114.00	1995	18.00	315	54.60	956		
BOP Stack 89.30 LTons	0.00	111.50	0	-76.00	0	6.00	0		
Lower Riser Assmby 53.60 LTons	0.00	107.00	0	-76.00	0	-6.00	0		
Anchor Buoy (Each) 3.94 LTons	0.00	108.00	0	8.00	0	0.00	0		
Fork Lift Ttruck	3.60	115.00	414	28.00	101	58.00	209		
Oxy Acetylene	2.00	115.00	230	-32.00	-64	-69.00	-138		
Spare Plate	10.00	115.00	1150	-64.00	-640	-49.00	-490		
Test Equip & Burner Boom	14.00	124.00	1736	-40.00	-560	0.00	0		
Misc Sub Sea Equipment	10.00	106.00	1060	-84.00	-840	-32.40	-324		
Snow & Ice Loads	0.00	139.72	0	15.65	0	4.55	0		
TOTAL - MISC LOAD	82.40		10026		-2323		1651		

TABLE 10 - VESSEL SUMMARY

	WEIGHT L.Tons	VM Ft-Tons	LM Ft-Tons	TM Ft-Tons	FSML Ft-Tons	FSMT Ft-Tons
DECK LOAD SUMMARY						
Tubulars & Drill Tools (Table 5)	661.29	87883	19072	9637	0	0
Stores & Supplies (Table 6)	134.53	13054	1723	296	0	0
Bulk Materiales (Table 7)	403.92	49045	-19128	25003	0	0
Liquid Mud (Table 8)	456.66	52615	10092	-248	966	1694
Miscellaneous Loads (Table 9)	82.40	10026	-2323	1651	0	0
Misc Liquid Service Tanks	49.32	5288	841	-2451	19	17
SUBTOTAL-DECK LOAD	1788.13	217911	10277	33888	985	1711
Lightweight						
Salt Water Ballast (Table 1)	9732.90	680914	-6716	-5937		
Fresh Water (Table 2)	5933.61	57461	27695	-22258	16880	11610
Fuel Oil - Lower Hull (Table 2)	614.14	2994	8730	-6686	6973	3025
Anchor & Chain Correc (Table 3)	399.21	1748	7984	995	5670	2378
Total External Load (Table 4)	-1083.20	-48104	-454	0	0	0
Total Deck Load (Above)	732.98	61517	-7215	0	0	0
TOTALS	18117.76	974441	40301	33888	1049	1719
				3	30508	18724

TABLE 11 - STABILITY SUMMARY

<p style="text-align: center;">FROM CALCULATIONS (Table 10)</p> <p>Displacement 18117.76 LT VCG 53.78 ft LCG 2.22 ft TCG 0.00 ft FSCL 1.68 ft FSCT 1.03 ft</p>	<p style="text-align: center;">FROM HYDRO TABLE</p> <p>LCB 2.23 ft LCF 0.00 ft Draft 60.00 ft KML 61.13 ft KMT 62.84 ft</p>	<p style="text-align: center;">MAXIMUM ALLOWABLE KG</p> <p>70K 58.50 ft 100 K 52.00 ft Water Depth 600 ft</p>
<p style="text-align: center;">LONGITUDINAL STABILITY</p> <p>KGL 55.47 ft GML 5.66 ft Trim -0.01 deg Trim -0.03 ft</p>	<p style="text-align: center;">DRAFTS</p> <p>Port Fwd 59.98 ft Stbd Fwd 59.99 ft Port Aft 60.01 ft Stbd AFt 60.02 ft</p>	<p style="text-align: center;">TRANSVERSE STABILITY</p> <p>KGT 54.82 ft GML 8.02 ft List 0.00 deg List 0.00 ft</p>

**DEEP DRILLER
LOAD CALCULATION FORM**

TABLE 1 - SALT WATER BALLAST TANKS

TANK NO	SOUNDING Feet	WEIGHT L.Tons	VCG Ft	VM Ft-Tons	LCG Ft	LM Ft-Tons	TCG Ft	TM Ft-Tons	FSML Ft-Tons	FSMT Ft-Tons
1 Port	0.00	0.00	0.00	0	105.76	0	-75.00	0	0	0
1 Stbd	0.00	0.00	0.00	0	105.76	0	75.00	0	0	0
2 Port	20.00	688.42	10.00	6884	65.00	44747	-87.25	-60065	0	0
2 Stbd	20.00	688.42	10.00	6884	65.00	44747	87.25	60065	0	0
3 Port	15.51	533.76	7.76	4139	64.98	34684	-62.75	-33494	6666	1793
3 Stbd	7.17	246.75	3.59	885	64.98	16034	62.75	15483	6666	1793
8 Port	11.87	441.64	5.94	2621	-62.50	-27602	-62.80	-27735	8418	1938
8 Stbd	11.14	414.47	5.57	2309	-62.50	-25905	62.80	26209	8418	1938
9 Port	20.00	551.74	10.00	5517	-62.50	-34484	-87.20	-48112	0	0
9 Stbd	20.00	551.74	10.00	5517	-62.50	-34484	87.20	48112	0	0
10 Port	0.00	0.00	10.00	0	-106.00	0	-71.70	0	0	0
10 Stbd	0.00	0.00	10.00	0	-106.00	0	71.70	0	0	0
C1 Port	0.00	0.00	20.00	0	90.00	0	-75.00	0	0	0
C1 Stbd	0.00	0.00	20.00	0	90.00	0	75.00	0	0	0
C2A Port	0.00	0.00	60.00	0	0.00	0	-75.00	0	0	0
C2B Port	0.00	0.00	60.00	0	0.00	0	75.00	0	0	0
C2A Stbd	0.00	0.00	20.00	0	0.00	0	-75.00	0	0	0
C2B Stbd	0.00	0.00	20.00	0	0.00	0	75.00	0	0	0
C3 Port	0.00	0.00	20.00	0	-90.00	0	-75.00	0	0	0
C3 Stbd	0.00	0.00	20.00	0	-90.00	0	75.00	0	0	0
TOTAL		4116.94		34757		17738		-19716	30168	7462

TABLE 2 - FRESH WATER AND FUEL OIL TANKS

TANK NO	SOUNDING Feet	WEIGHT L.Tons	VCG Ft	VM Ft-Tons	LCG Ft	LM Ft-Tons	TCG Ft	TM Ft-Tons	FSML Ft-Tons	FSMT Ft-Tons
5 Port Drill Water	10.00	268.87	5.00	1344	20.00	5377	-62.75	-16871	3328	1396
5 Stbd Drill Water	10.00	268.87	5.00	1344	20.00	5377	62.75	16871	3328	1396
7 Port Potable Water	8.00	76.41	4.00	306	-26.50	-2025	-87.50	-6686	317	233
7 Stbd Potable Water	0.00	0.00	0.00	0	-26.50	0	87.50	0	0	0
TOTAL FRESH WATER		614.14		2994		8730		-6686	6973	3025
4 Port Fuel Oil	8.50	193.90	4.25	824	20.00	3878	-87.25	-16918	2835	1189
4 Stbd Fuel Oil	9.00	205.31	4.50	924	20.00	4106	87.25	17913	2835	1189
6 Port Fuel Oil	0.00	0.00	0.00	0	-8.50	0	-87.50	0	0	0
6 Stbd Fuel Oil	0.00	0.00	0.00	0	-8.50	0	87.50	0	0	0
TOTAL FUEL OIL		399.21		1748		7984		995	5670	2378

TABLE 3 - ANCHOR AND CHAIN CORRECTIONS

MOORING LINE NUMBER	WEIGHT L.Tons	VCG Ft	VM Ft-Tons	LCG Ft	LM Ft-Tons	TCG Ft	TM Ft-Tons		
#1 Anchor	-15.40	25.00	-385	85.00	-1309	-108.00	1663		
#2 Anchor	-15.40	25.00	-385	102.00	-1571	-105.00	1617		
#3 Anchor	-15.40	25.00	-385	102.00	-1571	105.00	-1617		
#4 Anchor	-15.40	25.00	-385	85.00	-1309	108.00	-1663		
#5 Anchor	-15.40	25.00	-385	-84.30	1298	108.00	-1663		
#6 Anchor	-15.40	25.00	-385	-101.20	1558	105.00	-1617		
#7 Anchor	-15.40	25.00	-385	-101.20	1558	-105.00	1617		
#8 Anchor	-15.40	25.00	-385	-84.30	1298	-108.00	1663		
Length payed out									
#1 Mooring Chain	3000	-120.00	46.90	-5628	87.70	-10524	-75.00	9000	
#2 Mooring Chain	3000	-120.00	46.90	-5628	92.30	-11076	-75.00	9000	
#3 Mooring Chain	3000	-120.00	46.90	-5628	92.30	-11076	75.00	-9000	
#4 Mooring Chain	3000	-120.00	46.90	-5628	87.70	-10524	75.00	-9000	
#5 Mooring Chain	3000	-120.00	46.90	-5628	-91.30	10956	72.00	-8640	
#6 Mooring Chain	3000	-120.00	46.90	-5628	-87.00	10440	76.30	-9156	
#7 Mooring Chain	3000	-120.00	46.90	-5628	-87.00	10440	-76.30	9156	
#8 Mooring Chain	3000	-120.00	46.90	-5628	-91.30	10956	-72.00	8640	
TOTAL ANCHOR & CHAIN		-1083.20		-48104		-454		0	

TABLE 4 - EXTERNAL LOADS

MOORING LINE NUMBER	TENSION Kips	WEIGHT L.Tons	VCG Ft	VM Ft-Tons	LCG Ft	LM Ft-Tons	TCG Ft	TM Ft-Tons		
#1 Chain Tension	200	57.56	50.00	2878	84.00	4835	-91.00	-5238		
#2 Chain Tension	200	57.56	50.00	2878	96.00	5526	-91.00	-5238		
#3 Chain Tension	200	57.56	50.00	2878	96.00	5526	91.00	5238		
#4 Chain Tension	200	57.56	50.00	2878	84.00	4835	91.00	5238		
#5 Chain Tension	200	57.56	50.00	2878	-84.00	-4835	91.00	5238		
#6 Chain Tension	200	57.56	50.00	2878	-96.00	-5526	91.00	5238		
#7 Chain Tension	200	57.56	50.00	2878	-96.00	-5526	-91.00	-5238		
#8 Chain Tension	200	57.56	50.00	2878	-84.00	-4835	-91.00	-5238		
SUBTOTAL - CHAIN TENSION		460.47		23023		0		0		
Hook Load		0.00	144.00	0	-26.00	0	0.00	0		
Riser Tension		0.00	138.00	0	-26.00	0	0.00	0		
Guideline Tension		0.00	125.90	0	-26.00	0	0.00	0		
TOTAL EXTERNAL LOAD		460.47		23023		0		0		

TABLE 5 - TUBULARS AND DRILLING TOOLS

TUBULARS	QUANTITY Feet	WEIGHT L.Tons	VCG Ft	VM Ft-Tons	LCG Ft	LM Ft-Tons	TCG Ft	TM Ft-Tons		
Drill Pipe (5.5")	14400	135.00	130.00	17550	40.00	5400	5.00	675		
Misc (Pipe Rack)		32.00	130.00	4160	30.00	960	30.00	960		
Drill Collars (9")	240	24.64	129.00	3179	40.00	986	30.00	739		
Drill Collars (8")	920	58.73	130.00	7635	30.00	1762	-20.00	-1175		
Drill Collars (6.5")	960	41.14	129.00	5307	30.00	1234	-45.00	-1851		
Casing 30"	0	0.00	130.00	0	30.00	0	-40.00	0		
Casing 20"	0	0.00	130.00	0	30.00	0	-35.00	0		
Casing 13 3/8"	4000	121.43	130.00	15786	30.00	3643	35.00	4250		
Casing 9 5/8"	8000	167.86	130.00	21821	30.00	5036	40.00	6714		
Marine Riser Joints	600	67.50	125.00	8438	38.60	2606	-45.00	-3038		
Pups (5,10,10,15,25)	15	2.14	132.00	283	42.00	90	45.00	96		
Slip Joint	1 unit	0.00	131.00	0	-38.00	0	-70.00	0		
Ball Joint	1 unit	0.00	122.00	0	40.00	0	30.00	0		
Riser Racks		2.63	120.00	316	38.60	102	-45.00	-118		
Riser Handling Equip		29.46	129.00	3800	0.00	0	-5.00	-147		
Setback		0.00	189.70	0	-16.40	0	0.00	0		
TOTAL TUBULARS & TOOLS		682.54		88275		21818		7106		

TABLE 6 - STORES AND SUPPLIES

ITEMS	WEIGHT L.Tons	VCG Ft	VM Ft-Tons	LCG Ft	LM Ft-Tons	TCG Ft	TM Ft-Tons		
Engineering Stores	3.00	115.00	345	-32.00	-96	-69.00	-207		
Electrician Stores	2.00	115.00	230	73.00	146	-66.00	-132		
Pump Stores	3.01	115.00	346	0.00	0	14.00	42		
Drilling Stores	25.00	85.00	2125	-90.00	-2250	75.00	1875		
Warehouse	12.00	115.00	1380	-52.00	-624	-56.00	-672		
Freezer	4.00	115.00	460	83.00	332	12.50	50		
Dry Stores	2.00	115.00	230	68.00	136	10.00	20		
Paint Locker	8.00	84.00	672	-10.00	-80	-85.00	-680		
Crew & Effects	20.00	119.00	2380	83.00	1660	0.00	0		
Caissons 1P & 2S	55.53	88.00	4887	45.00	2499	0.00	0		
TOTAL STORES & SUPPLIES	134.54		13055		1723		296		

TABLE 7 - BULK MATERIALS

TANK NO	ULLAGE Feet	WEIGHT L.Tons	VCG Ft	VM Ft-Tons	LCG Ft	LM Ft-Tons	TCG Ft	TM Ft-Tons		
P-Tank #1 - Cement	0.40	64.41	122.86	7913	-53.40	-3439	52.60	3388		
P-Tank #2 - Cement	0.40	64.41	122.86	7913	-66.90	-4309	52.60	3388		
P-Tank #3 - Cement	19.40	0.00	113.19	0	-80.40	0	52.60	0		
P-Tank #4 - Barite	0.40	92.83	122.86	11406	-53.40	-4957	68.60	6368		
P-Tank #5 - Barite	0.40	92.83	122.86	11406	-66.90	-6211	68.60	6368		
P-Tank #6 - Bentonite	7.40	24.10	119.30	2875	-80.40	-1937	68.60	1653		
Surge Tank #1		2.00	121.40	243	5.00	10	50.00	100		
Surge Tank #2		0.00	121.40	0	14.50	0	50.00	0		
Surge Tank #3		1.00	120.90	121	-30.10	-30	58.80	59		
Sack Materials		62.34	115.00	7169	28.00	1746	59.00	3678		
TOTAL BULK & MATERIALS		403.92		49045		-19128		25003		

TABLE 8 - LIQUID MUD

PIT #	SOUND. Feet	Lbs. per Gallon	WEIGHT L.Tons	VCG Ft	VM Ft-Tons	LCG Ft	LM Ft-Tons	TCG Ft	TM Ft-Tons	FSML Ft-Tons	FSMT Ft-Tons
#4 Mud Pit	8	16.00	106.67	115.00	12267	3.50	373	-2.50	-267	235	418
#3 Mud Pit	8	16.00	106.67	115.00	12267	18.50	1973	-2.50	-267	235	418
#2 Mud Pit	8	16.00	106.67	115.00	12267	33.50	3573	-2.50	-267	235	418
#1 Reserve	8	16.00	106.67	115.00	12267	48.50	5173	-2.50	-267	235	418
Slug Pit	0	16.00	0.00	111.00	0	18.50	0	4.80	0	0	0
Sandtrap			8.00	118.50	948	-41.00	-328	27.30	218	7	7
#1 Return Tank			10.00	118.20	1182	-34.40	-344	27.30	273	7	7
#2 Return Tank			12.00	118.20	1418	-27.40	-329	27.30	328	12	8
TOTAL - LIQUID MUD			456.66		52615		10092		-248	966	1694

TABLE 9 - MISCELLANEOUS LOADS

ITEMS	WEIGHT L.Tons	VCG Ft	VM Ft-Tons	LCG Ft	LM Ft-Tons	TCG Ft	TM Ft-Tons		
TV Camera Equipment	2.70	113.00	305	-26.00	-70	14.00	38		
Diving Equipment	0.00	106.00	0	-72.00	0	0.00	0		
Schlumberger House	5.40	131.00	707	-25.00	-135	62.00	335		
Schlumberger Unit	17.20	141.20	2429	-25.00	-430	62.00	1066		
Cement Pump Unit	17.50	114.00	1995	18.00	315	54.60	956		
BOP Stack 89.30 LTons	0.00	111.50	0	-76.00	0	6.00	0		
Lower Riser Assmby 53.60 LTons	0.00	107.00	0	-76.00	0	-6.00	0		
Anchor Buoy (Each) 3.94 LTons	0.00	108.00	0	8.00	0	0.00	0		
Fork Lift Ttuck	3.60	115.00	414	28.00	101	58.00	209		
Oxy Acetylene	2.00	115.00	230	-32.00	-64	-69.00	-138		
Spare Plate	10.00	115.00	1150	-64.00	-640	-49.00	-490		
Test Equip & Burner Boom	14.00	124.00	1736	-40.00	-560	0.00	0		
Misc Sub Sea Equipment	10.00	106.00	1060	-84.00	-840	-32.40	-324		
Snow & Ice Loads	0.00	139.72	0	15.65	0	4.55	0		
TOTAL - MISC LOAD	82.40		10026		-2323		1651		

TABLE 10 - VESSEL SUMMARY

	WEIGHT L.Tons	VM Ft-Tons	LM Ft-Tons	TM Ft-Tons	FSML Ft-Tons	FSMT Ft-Tons
DECK LOAD SUMMARY						
Tubulars & Drill Tools (Table 5)	682.54	88275	21818	7106	0	0
Stores & Supplies (Table 6)	134.54	13055	1723	296	0	0
Bulk Materials (Table 7)	403.92	49045	-19128	25003	0	0
Liquid Mud (Table 8)	456.66	52615	10092	-248	966	1694
Miscellaneous Loads (Table 9)	82.40	10026	-2323	1651	0	0
Misc Liquid Service Tanks	49.32	5288	841	-2451	19	17
SUBTOTAL-DECK LOAD	1809.39	218304	13022	31357	985	1711
Lightweight						
Lightweight	9732.90	680914	-6716	-5937		
Salt Water Ballast (Table 1)	4116.94	34757	17738	-19716	30168	7462
Fresh Water (Table 2)	614.14	2994	8730	-6686	6973	3025
Fuel Oil - Lower Hull (Table 2)	399.21	1748	7984	995	5670	2378
Anchor & Chain Correc (Table 3)	-1083.20	-48104	-454	0	0	0
Total External Load (Table 4)	460.47	23023	0	0	0	0
Total Deck Load (Above)	1809.39	218304	13022	31357	1049	1719
TOTALS	16049.84	913637	40304	14	43976	14576

TABLE 11 - STABILITY SUMMARY

FROM CALCULATIONS (Table 10)		FROM HYDRO TABLE		MAXIMUM ALLOWABLE KG	
Displacement	16049.84 LT	LCB	2.51 ft	70K	62.24 ft
VCG	56.92 ft	LCF	0.00 ft	100 K	62.09 ft
LCG	2.51 ft	Draft	45.00 ft	Water Depth	600 ft
TCG	0.0 ft	KML	62.24 ft		
FSCL	2.73 ft	KMT	64.17 ft		
FSCT	0.91 ft				

LONGITUDINAL STABILITY		DRAFTS		TRANSVERSE STABILITY	
KGL	59.65 ft	Port Fwd	44.96 ft	KGT	57.83 ft
GML	2.58 ft	Stbd Fwd	44.98 ft	GML	6.34 ft
Trim	-0.02 deg	Port Aft	45.02 ft	List	0.01 deg
Trim	-0.06 ft	Stbd Aft	45.04 ft	List	0.02 ft

**DEEP DRILLER
LOAD CALCULATION FORM**

TABLE 1 - SALT WATER BALLAST TANKS

TANK NO	SOUNDING Feet	WEIGHT L.Tons	VCG Ft	VM Ft-Tons	LCG Ft	LM Ft-Tons	TCG Ft	TM Ft-Tons	FSML Ft-Tons	FSMT Ft-Tons
1 Port	0.00	0.00	0.00	0	105.76	0	-75.00	0	0	0
1 Stbd	0.00	0.00	0.00	0	105.76	0	75.00	0	0	0
2 Port	20.00	688.42	10.00	6884	65.00	44747	-87.25	-60065	0	0
2 Stbd	20.00	688.42	10.00	6884	65.00	44747	87.25	60065	0	0
3 Port	14.16	487.30	7.08	3450	64.98	31665	-62.75	-30578	6666	1793
3 Stbd	10.92	375.80	5.46	2052	64.98	24420	62.75	23582	6666	1793
8 Port	14.83	551.76	7.42	4091	-62.50	-34485	-62.80	-34651	8418	1938
8 Stbd	8.58	319.23	4.29	1369	-62.50	-19952	62.80	20047	8418	1938
9 Port	20.00	551.74	10.00	5517	-62.50	-34484	-87.20	-48112	0	0
9 Stbd	20.00	551.74	10.00	5517	-62.50	-34484	87.20	48112	0	0
10 Port	0.00	0.00	10.00	0	-106.00	0	-71.70	0	0	0
10 Stbd	0.00	0.00	10.00	0	-106.00	0	71.70	0	0	0
C1 Port	0.00	0.00	20.00	0	90.00	0	-75.00	0	0	0
C1 Stbd	0.00	0.00	20.00	0	90.00	0	75.00	0	0	0
C2A Port	0.00	0.00	60.00	0	0.00	0	-75.00	0	0	0
C2B Port	0.00	0.00	60.00	0	0.00	0	75.00	0	0	0
C2A Stbd	0.00	0.00	20.00	0	0.00	0	-75.00	0	0	0
C2B Stbd	0.00	0.00	20.00	0	0.00	0	75.00	0	0	0
C3 Port	0.00	0.00	20.00	0	-90.00	0	-75.00	0	0	0
C3 Stbd	0.00	0.00	20.00	0	-90.00	0	75.00	0	0	0
TOTAL		4214.42		35766		22175		-21600	30168	7462

TABLE 2 - FRESH WATER AND FUEL OIL TANKS

TANK NO	SOUNDING Feet	WEIGHT L.Tons	VCG Ft	VM Ft-Tons	LCG Ft	LM Ft-Tons	TCG Ft	TM Ft-Tons	FSML Ft-Tons	FSMT Ft-Tons
5 Port Drill Water	10.00	268.87	5.00	1344	20.00	5377	-62.75	-16871	3328	1396
5 Stbd Drill Water	10.00	268.87	5.00	1344	20.00	5377	62.75	16871	3328	1396
7 Port Potable Water	8.00	76.41	4.00	306	-26.50	-2025	-87.50	-6686	317	233
7 Stbd Potable Water	0.00	0.00	0.00	0	-26.50	0	87.50	0	0	0
TOTAL FRESH WATER		614.14		2994		8730		-6686	6973	3025
4 Port Fuel Oil	8.50	193.90	4.25	824	20.00	3878	-87.25	-16918	2835	1189
4 Stbd Fuel Oil	9.00	205.31	4.50	924	20.00	4106	87.25	17913	2835	1189
6 Port Fuel Oil	0.00	0.00	0.00	0	-8.50	0	-87.50	0	0	0
6 Stbd Fuel Oil	0.00	0.00	0.00	0	-8.50	0	87.50	0	0	0
TOTAL FUEL OIL		399.21		1748		7984		995	5670	2378

**FORM # 6
ICE AND
SNOW LOADS**

TABLE 3 - ANCHOR AND CHAIN CORRECTIONS

MOORING LINE NUMBER	WEIGHT L.Tons	VCG Ft	VM Ft-Tons	LCG Ft	LM Ft-Tons	TCG Ft	TM Ft-Tons		
#1 Anchor	-15.40	25.00	-385	85.00	-1309	-108.00	1663		
#2 Anchor	-15.40	25.00	-385	102.00	-1571	-105.00	1617		
#3 Anchor	-15.40	25.00	-385	102.00	-1571	105.00	-1617		
#4 Anchor	-15.40	25.00	-385	85.00	-1309	108.00	-1663		
#5 Anchor	-15.40	25.00	-385	-84.30	1298	108.00	-1663		
#6 Anchor	-15.40	25.00	-385	-101.20	1558	105.00	-1617		
#7 Anchor	-15.40	25.00	-385	-101.20	1558	-105.00	1617		
#8 Anchor	-15.40	25.00	-385	-84.30	1298	-108.00	1663		
Length payed out									
#1 Mooring Chain	3000	-120.00	46.90	-5628	87.70	-10524	-75.00	9000	
#2 Mooring Chain	3000	-120.00	46.90	-5628	92.30	-11076	-75.00	9000	
#3 Mooring Chain	3000	-120.00	46.90	-5628	92.30	-11076	75.00	-9000	
#4 Mooring Chain	3000	-120.00	46.90	-5628	87.70	-10524	75.00	-9000	
#5 Mooring Chain	3000	-120.00	46.90	-5628	-91.30	10956	72.00	-8640	
#6 Mooring Chain	3000	-120.00	46.90	-5628	-87.00	10440	76.30	-9156	
#7 Mooring Chain	3000	-120.00	46.90	-5628	-87.00	10440	-76.30	9156	
#8 Mooring Chain	3000	-120.00	46.90	-5628	-91.30	10956	-72.00	8640	
TOTAL ANCHOR & CHAIN	-1083.20		-48104		-454		0		

TABLE 4 - EXTERNAL LOADS

MOORING LINE NUMBER	TENSION Klps	WEIGHT L.Tons	VCG Ft	VM Ft-Tons	LCG Ft	LM Ft-Tons	TCG Ft	TM Ft-Tons		
#1 Chain Tension	200	57.56	50.00	2878	84.00	4835	-91.00	-5238		
#2 Chain Tension	200	57.56	50.00	2878	96.00	5526	-91.00	-5238		
#3 Chain Tension	200	57.56	50.00	2878	96.00	5526	91.00	5238		
#4 Chain Tension	200	57.56	50.00	2878	84.00	4835	91.00	5238		
#5 Chain Tension	200	57.56	50.00	2878	-84.00	-4835	91.00	5238		
#6 Chain Tension	200	57.56	50.00	2878	-96.00	-5526	91.00	5238		
#7 Chain Tension	200	57.56	50.00	2878	-96.00	-5526	-91.00	-5238		
#8 Chain Tension	200	57.56	50.00	2878	-84.00	-4835	-91.00	-5238		
SUBTOTAL - CHAIN TENSION		460.47		23023		0		0		
Hook Load		0.00	144.00	0	-26.00	0	0.00	0		
Riser Tension		0.00	138.00	0	-26.00	0	0.00	0		
Guideline Tension		0.00	125.90	0	-26.00	0	0.00	0		
TOTAL EXTERNAL LOAD		460.47		23023		0		0		

TABLE 5 - TUBULARS AND DRILLING TOOLS

TUBULARS	QUANTITY Feet	WEIGHT L.Tons	VCG Ft	VM Ft-Tons	LCG Ft	LM Ft-Tons	TCG Ft	TM Ft-Tons		
Drill Pipe (5.5")	14400.00	135.00	130.00	17550	40.00	5400	5.00	675		
Misc (Pipe Rack)		32.00	130.00	4160	30.00	960	30.00	960		
Drill Collars (9")	240.00	24.64	129.00	3179	40.00	986	30.00	739		
Drill Collars (8")	920.00	58.73	130.00	7635	30.00	1762	-20.00	-1175		
Drill Collars (6.5")	960.00	41.14	129.00	5307	30.00	1234	-45.00	-1851		
Casing 30"	0.00	0.00	130.00	0	30.00	0	-40.00	0		
Casing 20"	0.00	0.00	130.00	0	30.00	0	-35.00	0		
Casing 13 3/8"	4000.00	121.43	130.00	15786	30.00	3643	35.00	4250		
Casing 9 5/8"	8000.00	167.86	130.00	21821	30.00	5036	40.00	6714		
Marine Riser Joints	600.00	67.50	125.00	8438	38.60	2606	-45.00	-3038		
Pups (5,10,10,15,25)	15.00	2.14	132.00	283	42.00	90	45.00	96		
Slip Joint	1 unit	0.00	131.00	0	-38.00	0	-70.00	0		
Ball Joint	1 unit	0.00	122.00	0	40.00	0	30.00	0		
Riser Racks		2.63	120.00	316	38.60	102	-45.00	-118		
Riser Handling Equip		29.46	129.00	3800	0.00	0	-5.00	-147		
Setback		0.00	189.70	0	-16.40	0	0.00	0		
TOTAL TUBULARS & TOOLS		682.54		88275		21818		7106		

TABLE 6 - STORES AND SUPPLIES

ITEMS	WEIGHT L.Tons	VCG Ft	VM Ft-Tons	LCG Ft	LM Ft-Tons	TCG Ft	TM Ft-Tons		
Engineering Stores	3.00	115.00	345	-32.00	-96	-69.00	-207		
Electrician Stores	2.00	115.00	230	73.00	146	-66.00	-132		
Pump Stores	3.01	115.00	346	0.00	0	14.00	42		
Drilling Stores	25.00	85.00	2125	-90.00	-2250	75.00	1875		
Warehouse	12.00	115.00	1380	-52.00	-624	-56.00	-672		
Freezer	4.00	115.00	460	83.00	332	12.50	50		
Dry Stores	2.00	115.00	230	68.00	136	10.00	20		
Paint Locker	8.00	84.00	672	-10.00	-80	-85.00	-680		
Crew & Effects	20.00	119.00	2380	83.00	1660	0.00	0		
Caissons 1P & 2S	55.53	88.00	4887	45.00	2499	0.00	0		
TOTAL STORES & SUPPLIES	134.54		13055		1723		296		

**FORM # 6
ICE AND
SNOW LOADS**

TABLE 7 - BULK MATERIALS

TANK NO	ULLAGE Feet	WEIGHT L.Tons	VCG Ft	VM Ft-Tons	LCG Ft	LM Ft-Tons	TCG Ft	TM Ft-Tons		
P-Tank #1 - Cement	0.40	64.41	122.86	7913	-53.40	-3439	52.60	3388		
P-Tank #2 - Cement	0.40	64.41	122.86	7913	-66.90	-4309	52.60	3388		
P-Tank #3 - Cement	19.40	0.00	113.19	0	-80.40	0	52.60	0		
P-Tank #4 - Barite	0.40	92.83	122.86	11406	-53.40	-4957	68.60	6368		
P-Tank #5 - Barite	0.40	92.83	122.86	11406	-66.90	-6211	68.60	6368		
P-Tank #6 - Bentonite	7.40	24.10	119.30	2875	-80.40	-1937	68.60	1653		
Surge Tank #1		2.00	121.40	243	5.00	10	50.00	100		
Surge Tank #2		0.00	121.40	0	14.50	0	50.00	0		
Surge Tank #3		1.00	120.90	121	-30.10	-30	58.80	59		
Sack Materials		62.34	115.00	7169	28.00	1746	59.00	3678		
TOTAL BULK & MATERIALS		403.92		49045		-19128		25003		

TABLE 8 - LIQUID MUD

PIT #	SOUND. Feet	Lbs. per Gallon	WEIGHT L.Tons	VCG Ft	VM Ft-Tons	LCG Ft	LM Ft-Tons	TCG Ft	TM Ft-Tons	FSML Ft-Tons	FSMT Ft-Tons
#4 Mud Pit	0	16.00	0.00	111.00	0	3.50	0	-2.50	0	0	0
#3 Mud Pit	0	16.00	0.00	111.00	0	18.50	0	-2.50	0	0	0
#2 Mud Pit	0	16.00	0.00	111.00	0	33.50	0	-2.50	0	0	0
#1 Reserve	0	16.00	0.00	111.00	0	48.50	0	-2.50	0	0	0
Slug Pit	0	16.00	0.00	111.00	0	18.50	0	4.80	0	0	0
Sandtrap			0.00	118.50	0	-41.00	0	27.30	0	0	0
#1 Return Tank			0.00	118.20	0	-34.40	0	27.30	0	0	0
#2 Return Tank			0.00	118.20	0	-27.40	0	27.30	0	0	0
TOTAL - LIQUID MUD			0.00		0		0		0	0	0

TABLE 9 - MISCELLANEOUS LOADS

ITEMS	WEIGHT L.Tons	VCG Ft	VM Ft-Tons	LCG Ft	LM Ft-Tons	TCG Ft	TM Ft-Tons			
TV Camera Equipment	2.70	113.00	305	-26.00	-70	14.00	38			
Diving Equipment	0.00	106.00	0	-72.00	0	0.00	0			
Schlumberger House	5.40	131.00	707	-25.00	-135	62.00	335			
Schlumberger Unit	17.20	141.20	2429	-25.00	-430	62.00	1066			
Cement Pump Unit	17.50	114.00	1995	18.00	315	54.60	956			
BOP Stack	89.30 LTons	0.00	111.50	0	-76.00	0	6.00	0		
Lower Riser Assmby	53.60 LTons	0.00	107.00	0	-76.00	0	-6.00	0		
Anchor Buoy (Each)	3.94 LTons	0.00	108.00	0	8.00	0.00	0			
Fork Lift Truck	3.60	115.00	414	28.00	101	58.00	209			
Oxy Acetylene	2.00	115.00	230	-32.00	-64	-69.00	-138			
Spare Plate	10.00	115.00	1150	-64.00	-640	-49.00	-490			
Test Equip & Burner Boom	14.00	124.00	1736	-40.00	-560	0.00	0			
Misc Sub Sea Equipment	10.00	106.00	1060	-84.00	-840	-32.40	-324			
Snow & Ice Loads	359.00	127.00	45593	15.65	5618	4.55	1633			
TOTAL - MISC LOAD	441.40		55619		3295		3285			

TABLE 10 - VESSEL SUMMARY

	WEIGHT L.Tons	VM Ft-Tons	LM Ft-Tons	TM Ft-Tons	FSML Ft-Tons	FSMT Ft-Tons
DECK LOAD SUMMARY						
Tubulars & Drill Tools (Table 5)	682.54	88275	21818	7106	0	0
Stores & Supplies (Table 6)	134.54	13055	1723	296	0	0
Bulk Materials (Table 7)	403.92	49045	-19128	25003	0	0
Liquid Mud (Table 8)	0.00	0	0	0	0	0
Miscellaneous Loads (Table 9)	441.40	55619	3295	3285	0	0
Misc Liquid Service Tanks	49.32	5288	841	-2451	19	17
SUBTOTAL-DECK LOAD	1711.72	211282	8548	33238	19	17
Lightweight						
Lightweight	9732.90	680914	-6716	-5937		
Salt Water Ballast (Table 1)	4214.42	35766	22175	-21600	30168	7462
Fresh Water (Table 2)	614.14	2994	8730	-6686	6973	3025
Fuel Oil - Lower Hull (Table 2)	399.21	1748	7984	995	5670	2378
Anchor & Chain Correc (Table 3)	-1083.20	-48104	-454	0	0	0
Total External Load (Table 4)	460.47	23023	0	0	0	0
Total Deck Load (Above)	1711.72	211282	8548	33238	109	47
TOTALS	16049.65	907624	40266	11	42830	12882

TABLE 11 - STABILITY SUMMARY

FROM CALCULATIONS (Table 10)	FROM HYDRO TABLE	MAXIMUM ALLOWABLE KG
Displacement 16049.65 LT	LCB 2.51 ft	70K 62.24 ft
VCG 56.55 ft	LCF 0.00 ft	100 K 62.09 ft
LCG 2.51 ft	Draft 45.00 ft	Water Depth 600 ft
TCG 0.0 ft	KML 62.24 ft	
FSCL 2.67 ft	KMT 64.17 ft	
FSCT 0.80 ft		
LONGITUDINAL STABILITY		
KGL 59.22 ft	Port Fwd 44.91 ft	KGT 57.35 ft
GML 3.02 ft	Stbd Fwd 44.92 ft	GML 6.82 ft
Trim -0.06 deg	Port Aft 45.08 ft	List 0.01 deg
Trim -0.18 ft	Stbd Aft 45.09 ft	List 0.01 ft
DRAFTS		
TRANSVERSE STABILITY		

3.8.3 Drilling Operations

Normal drilling operations may continue to a maximum lower ball joint angle of four degrees (approximately 3% offset). Depending on the water depth, the maximum chain tension will equal or be less than 1/3 of the breaking strength (348 kips).

If conditions increase in severity, and the vessel approaches 5-6% offset, critical drilling operations should be suspended, and preparations begun to hang off and wait on weather. The leeward mooring lines may be slacked a nominal amount in order to reduce the vessel offset and high line tension.

3.8.4 Standby Operations

As the vessel offset approaches 10% and/or the lower ball joint angle approaches 10°, operations should go into the stand-by mode. The maximum anchor line tensions will be greater than 1/3 breaking strength (348 kips), but less than 1/2 breaking strength (522 kips). The riser is still connected, but the drilling mud has been displaced by sea water, and is ready to be disconnected. At least two leeward anchor chains are to be slacked completely.

3.8.5 Disconnect Criteria

If anchor line tensions exceed 1/2 breaking strength (522 kips), or it appears the lower ball joint angle will exceed 10°, the marine riser will be disconnected. At least two leeward anchor chains should be completely slacked. Once the minimum tension is achieved, continued slacking of chain will only place more chain on the bottom. A reserve of at least 200 feet should be maintained in the lockers to insure against losing the chain.

3.8.6 Maximum Chain Tension Due to Environment

The mooring system provides a restoring force that is equal to the environmental force. With a good prediction of the wind, waves, and current in a new location, a study could determine the capability of the mooring system to meet the environmental demands.

Using the Figures 15 and 16 in Section 5, the maximum anticipated forces which arise from the effect of wind, waves, and current may be determined by considering that the wind, waves, and current act at the same time and come from the same direction. Figure 15 considers that the environmental conditions act on the bow (or stern). In the second case, Figure 16 shows the effect of the environment when acting on the beam. The total force is determined from the charts in the two conditions for the wind, waves and current. These are then added, and the larger of the two is then used as the restoring force in subsequent investigations to determine offset and high line tension (mooring line with the most tension).

The mooring analysis curves in Figures 17, 18, and 19 are used to determine the predicted offset and high line tensions for a given water depth. Interpolation may be required for water depths between the values given on the mooring analysis curves.

These latter graphs show the values of offset, high-line tension, and the tensile force at the anchor corresponding to the restoring force with all lines working. Also shown on the graphs are the offsets and tensions with the two leeward lines completely slacked.

Example mooring analysis

In this example, the water depth is 600 feet, and that the following maximum environmental conditions exist:

Wind	90 knots (1 minute average)
Waves	60 feet (significant height)
Current	1 knot

The first step in the analysis determines the environmental forces which arise from the given environmental conditions. Using Figures 15 and 16, the values of the environmental forces are:

	<u>Bow</u>	<u>Beam</u>
Wind	600	550
Waves	160	155
Current	<u>25</u>	<u>55</u>
Total	785 kips	760 kips

The larger of the two forces (785 kips) is more conservative, and is used to enter the mooring analysis curves corresponding to a water depth of 600 feet, Figure 19.

Enter the mooring analysis graph with a restoring force of 785 kips. Read across to 785 kips on the restoring force (all lines working) line. Reading vertically downward gives the tension in the high line (HLT) as 470 kips. This is about 45% of the breaking strength of the chain. The HLT anchor load, with 3,000 feet of chain outboard, is 390 kips, and the offset is about 64 feet, or 11% of the water depth.

Under these conditions slacking the two leeward lines reduces the high line tensions and offset. In this case, completely slacking the two leeward lines reduces the tension in the most heavily loaded line to about 410 kips, the load on the HLT anchor to about 320 kips, and the offset to about 9% offset.

SECTION 4.0

DAMAGE CONTROL

4.1 GENERAL NOTES

In damage conditions, the most important consideration is the preservation of reserve buoyancy. The Deep Driller is designed so that in the event of flooding any one compartment, or two compartments where appropriate, it will achieve settled equilibrium. It will also be able to withstand the effect of 50-knot wind while in the damaged condition without causing downflooding through any openings, such as chain pipes, in a calm sea. In the analysis to determine these capabilities, the beneficial effects of countermeasures and mooring system were disregarded.

Effective control of damage requires that suitable resources, including adequately trained personnel, are properly managed during the crisis. Toward this end, a Damage Control Center is established and located in the ballast control room. During emergencies, it will be manned by the Offshore Installation Manager (OIM), Barge Supervisor (BS), Ballast Control Operators (BCO), Operating Company's Representative, Electrician, and Mechanic, and at least two designated roustabouts to serve as messengers.

There is sufficient equipment in the ballast control room for communication with all areas of the unit. The damage control plans, ships drawings, and other emergency plans are also readily available in the Ballast Control Room.

To maintain a high state of readiness against the possibility of damage and subsequent flooding, observe the following:

- Preserve reserve buoyancy.
- Maintain corrected KG less than the KG allowable.
- Minimize free surfaces. In general, there should be no more than six slack service liquid tanks (potable water, drill water, and fuel oil). Also, there should be no more than six slack lower-hull ballast tanks.
- Maintain draft at 60 feet or less.
- Keep deck hatches, manholes, and watertight doors closed and secured, except when in actual use.
- Cap all sounding tubes except when sounding that specific tank.

4.2 DAMAGE CONTROL TEAM

In the event of a damage emergency, a Damage Control Team will be formed at the Ballast Control Room. The team will consist of the following:

Barge Supervisor	Ballast Control Operator
Motorman	All welders
Electrician	Mechanic

4.3 DAMAGE CONTROL ACTIONS

One of the first actions to take in the case of unexpected inclination is to determine the cause. The inclination could be the result of open valves, a structural problem in a tank bulkhead, dumping of mud pits, repositioning of large weights, or possibly, external damage to the hull. In case of damage, the immediate objective should be to reduce the inclination and return the vessel to an acceptable draft. If the damage assessment indicates that the damaged area may be elevated out of the water, then corrective actions should include deballasting. The following actions and procedures may be used as guidelines to supplement the principles of good seamanship:

1. Pump from undamaged tanks containing ballast in the vicinity of the damage. If at transit draft, it is unlikely that adjacent tanks with liquids will exist, therefore prepare to pump from the damaged tank.
2. If the effect of pumping is insufficient, counterflood on the opposite corner.
3. Sound the general alarm.
4. Coordinate with the drill floor for preparations to disconnect.
5. Place wooden plug in the vent of the damaged tank and drive it home for an air-tight fit. The plug must be removed if a subsequent decision is made to pump from the damaged tank.
6. If the loss of the vessel is imminent, issue Maydays.
7. Alert any other vessels helicopters in the vicinity.
8. Advise the U.S. Coast Guard or other search and rescue agencies of the nature of the problem, and if required, request immediate assistance.

9. Attempt to reduce the possibility of panic by using the public address system to advise the crew of the nature of the problem. Consider mustering personnel in the recreation room. Personnel should report dressed properly, with their life jackets. Continually inform the crew of the progress being made to control the situation.
10. If necessary, evacuate non-essential personnel.
11. Predict the angle of inclination to determine the danger of uncontrolled downflooding.
12. Check that all remote-controlled watertight doors and valves, and other openings are closed.
13. Send qualified personnel to the two pump rooms. Close the manual valves between C2A and C2B.
14. Use Damage Control Team to inspect the severity of the damage to determine the cause of flooding and/or damage. Determine the repairs that could be used to preserve as much reserve buoyancy as possible.
15. Prepare to dump the liquid mud. If the mud is oil-based dump only in case the emergency is extreme.
16. Prepare to discharge the contents of the P-tanks.
17. Prepare to slack anchor tensions.
18. Prepare to counterflood on the opposite corner in order to raise the damaged area out of the sea.
19. Because stability could be adversely affected, maintain the vessel as level as possible with minimum free surfaces.

4.4 PROCEDURES FOR UNEXPECTED LIST AND TRIM

One of the first actions to take in the case of unexpected inclination is to determine the cause. The inclination could be the result of open valves, a structural problem in a tank bulkhead, dumping of mud pits, repositioning of large weights, or possibly, external damage to the hull. In case of damage, the immediate objective should be to reduce the inclination and return the vessel to an appropriate draft. If the damage assessment indicates that the damaged area may be elevated out of the water, then corrective actions should include deballasting.

It is vital to the safety of the Deep Driller to maintain watertight integrity, to prevent shifting of liquid and solid loads, and to maintain a level attitude with draft at or less than 60.0 feet.

If possible, the OIM should determine the cause of unexpected list or trim before taking any corrective action. Tank instrumentation in the control room should indicate flooding of a tank. Air escape from a suspected tank would also provide an indication of a flooding tank. In general, the unexpected list or trim will be toward the damage.

Unexpected list or trim often falls into one of the following three categories in which vessel inclination is:

1. increasing rapidly
2. increasing slowly
3. not increasing

The possible causes for unexpected list or trim are:

- 1. Flooding due to external causes**
 - a. hull damage
 - b. failure of hull penetration (valve or piping)
- 2. Flooding due to internal causes**
 - a. broken or corroded piping
 - b. open valve
 - c. failed check valve
 - d. ruptured tank bulkhead
- 3. Transfer of liquids**
 - a. discharged liquid mud
 - b. inadvertent (personnel error)
 - c. equalizing between tanks
 - d. consumed liquids (fuel and drill water)
- 4. Shift of non-liquid loads**
 - a. broken mooring line
 - b. consumed bulk materials
 - c. repositioning of heavy weights

5. Load form errors

- a. mathematics
- b. measurements
- c. weight estimate
- d. center of gravity estimates

6. Heel or trim due to environmental forces

CORRECTIVE ACTIONS

The immediate objective is to preserve reserve buoyancy, and then to reduce the inclination and return the rig to an appropriate draft. Thereafter, in case of external damages, a decision could be made to reduce draft to the extent that the damage is above the waterline.

When the unexpected inclination first occurs, the BCO on watch shall notify the Barge Supervisor and the OIM. The BS should immediately proceed to the Control Room or to the approximate damage location. The off-watch BCO, in the event of a General Alarm, should report immediately to the BS.

If there is rapid flooding into a tank or a void space which cannot be controlled by pumping, the inflow may be checked by closing the vent. Closure of the vent may be by one of the following:

- 1. Hammer home the wooden plug to an air tight fit.
- 2. Install a bolted blank flange in the vent piping.
- 3. If the tank is not a fuel tank (4P, 4S, 6P, or 6S), the vent can be temporary closed with a welded blank flange.

Tank vents for other than an actually flooded compartment should not be closed, except in an extreme emergency, as pumping could cause the compartments to rupture or collapse. In any case, tank vents on the high side should only be closed in the event of abandonment, as it prevents counterflooding.

In the case of external damage or cracks, or failure of piping in accessible locations, consider a temporary repair with any combination of "duc seal", quick-setting "splash zone", bedding and plywood rather than sealing off the compartment with consequent flooding.

Consider use of reliable portable pumps during flooding emergencies. The pumps should be maintained and tested periodically.

When the unit is at operating draft, there is considerable amount of ballast and ballast space which can be used to control trim, list and draft. Paying out additional mooring chain to reduce onboard weight, therefore, is not necessary.

Dumping of deck liquids is an advantage, if on the damaged (low) side of the rig, and other attempts to control list and trim have been unsuccessful.

Close all communicating valves on deck tanks, mud pits, salt water service, and drill water if flooding is severe and list or trim are large.

In the event of severe damage and very deep immersion, the watertight and weathertight doors, hatches and vents exposed to wave action should be closed. Vents on the high, undamaged, side such as required for essential services (such as running the powerplants), should remain open at the discretion of the OIM.

Within the three major categories of damage, corrective actions should include:

1. Inclination increasing rapidly

- a. Sound GENERAL ALARM and prepare to evacuate non-essential personnel, if deemed appropriate by the OIM.
- b. If the loss of the vessel is imminent, issue Maydays.
- c. Coordinate with the drill floor for preparations to disconnect.
- d. Alert the standby boat, other shipping, and helicopters in the vicinity.
- e. Advise the U.S. Coast Guard of the nature of the problem, and if required, request immediate assistance.
- f. Attempt to reduce the possibility of panic by using the public address system to advise the crew of the nature of the problem. Consider mustering personnel in the recreation room. Personnel should report dressed properly, with their life jackets. Continually inform the crew of the progress being made to controlling the situation.
- g. Establish that all remote-controlled and manually controlled watertight doors, valves, and other openings are closed and secured.

- h. Prepare to pump from tanks containing liquids which are adjacent to the damaged compartment. If necessary, counterflood on the opposite corner.
- i. If the flooding is in the pump room, and the bilge pumps cannot keep up with the inflow, the drill water pump should be used to supplement their performance.
- j. Send qualified personnel to the two pump rooms. Close the manual valves between C2A and C2B.
- k. Use Damage Control Team to inspect the severity of the damage. determine the cause of flooding and/or damage. Determine the repairs that could be used to preserve as much reserve buoyancy as possible.
- l. Prepare to discharge the contents of the P-tanks by using the rig air to pressurize the tanks.

2. Inclination increasing slowly

Corrective actions should include the following:

- a. Sound General Alarm and prepare to evacuate non-essential personnel, if deemed appropriate by the OIM.
- b. Determine that all remote-controlled and manually controlled watertight doors, valves, and other openings are closed and secured.
- c. Prepare to pump from compartments containing liquids adjacent to the damage. With inclination increasing slowly, the pump capacity may be greater than the inflow of seawater. In that case, consideration can be given to pumping from the damaged compartment.
- d. Install vent plug to stop or slow the ingress of water.
- e. If pumping is insufficient, counterflood into the opposite corner in order to maintain a level attitude.

3. Constant unexpected list or trim

Constant list or trim usually results from a miscalculation in the load form and could result from a mathematical error, or using the wrong weight or location.

It could also be due to false tank soundings. An obvious solution is to recheck the load form.

Other causes of constant list or trim could be the inadvertent transfer of a small quantity of liquid, a load shift, or environmental forces. A corrective action would be to assess the situation and, if required, re-level the rig through the transfer of liquids.

Transit condition

If extensive flooding occurs while in transit, due to damage or some other reason, such that flooding cannot be controlled, the choice of tank to pump from will be limited. Consider using both ballast pumps to pump from the damaged tank in order to slow the inflow.

4.5 WATERTIGHT INTEGRITY

All openings and vents on the main deck, such as hatches, ventilators, tank vents, and companionways are provided with a means of watertight closure. All such openings not needed should be secured in the closed position.

The watertight integrity of the following bulkheads and flats below the main deck or 111' 0" above the baseline shall be maintained watertight at all times:

1. Transverse bulkheads, frames 9, 19, 27 and 34 side to side, bottom shell to 20' 0" elevation in both lower hulls.
2. Transverse bulkheads frame 45, centerline to inboard side of shell, bottom shell to 20' 0" elevation in both lower hulls.
3. Longitudinal centerline bulkheads frame 9 and 27, and frame 34 to 47, port and starboard lower hulls, bottom shell to 20' 0" elevation.
4. All boundaries of pump rooms, port and starboard lower hulls and the cofferdam around the potable water tank.
5. All main deck openings to the six columns at 111 feet above the baseline elevation.
7. Horizontal watertight flats at 80 feet above baseline elevation, all columns port and starboard. Center columns also have flats at the 60 foot elevation.

4.6 RIG ABANDONMENT AND EVACUATION

This section contains information on the organization, duties, and responsibilities of all personnel in the event of an evacuation or abandon rig situation. The general procedures for evacuating or abandoning rig are also described in this section.

In this section evacuation is considered the orderly removal of non-essential and other personnel in the event of severe weather. Abandon rig is considered the removal of all hands because the loss of the rig is considered imminent.

The Offshore Installations Manager or, if he is incapacitated, the Barge Supervisor is responsible for the decision to evacuate or abandon rig. He must be familiar with the situation which could cause consideration of possible actions. He shall keep the appropriate shoreside facility advised of all considerations leading to a possible decision to evacuate or to abandon the rig. If time permits, collect the crew in a central location. Advise the crew in advance of the situation, review evacuation and survival procedures, and make a head count.

Evacuation

Should weather conditions include forecasts of winds in excess of 90 knots, consideration should be given to evacuation of the rig. Preparations for evacuation of the rig include:

1. Activate automatic foghorn.
2. Turn on navigation lights.
3. Start emergency generators.
4. Evacuate non-essential personnel. Notify appropriate shoreside facility of the departure time, identification of personnel, and expected arrival time at the shoreside base.
5. Inspect the Deep Driller for equipment and watertight doors and hatches properly secured.
6. Inspect that the mooring system is functioning properly.
7. Provide for security of the rig's log and other valuable documents.

8. With the exception of salt water service system, close all remote and manual valves.
9. Notify appropriate authorities that the unit is being left unattended for a temporary period due to weather conditions.

Abandonment

When the OIM or, if he is incapacitated, the Barge Supervisor makes the decision to proceed with abandonment, orders will be issued to abandon.

The Barge Supervisor assists the OIM in the evacuation procedures, is responsible for advising the OIM on the need for abandoning the unit, and assists the OIM in carrying out the evacuation procedures.

1. If time permits, issue order to prepare to abandon rig.

The Control Room watch shall sound seven or more short rings followed by one long ring on the general alarm, then make the following announcement over the PA system: "ALL HANDS PREPARE TO ABANDON, PROCEED TO YOUR ABANDON STATIONS, THIS IS NOT A DRILL." The alarm and announcement shall be repeated until assured that all hands have been alerted.

2. When preparations have been completed, the OIM or, if he is incapacitated, the Barge Supervisor shall order the abandonment of the unit.

The Control Room watch shall sound seven or more short blasts on the rig's fog horn followed by one long blast, supplemented by a similar signal on the general alarm system. This will be followed by an announcement over the PA system, "ALL HANDS ABANDON". The signal and announcement will be repeated until reasonably assured that all hands have been alerted.

3. Emergency Abandon Signals

The Control Room watch shall sound a continuous ringing of the general alarm system and simultaneous steady sounding of the foghorn, which shall indicate an emergency abandon situation. If time is available, or the situation dictates, an announcement will be made over the PA system. However, all hands are required to know that there may be no announcement in case the situation is so severe that immediate abandonment is necessary to reduce the loss of life. The emergency abandon signal shall not be used for drills.

4. Have Radio Operator issue distress signals and alert standby boat and helicopters.
5. When the abandon signal is sounded, crew members will put on warm clothing and lifejackets and proceed to their assigned boat station without delay.
6. Have persons in command of lifeboat stations report on assigned crew members not at the station, as well as those extra crew members that are present that should be at another station.

Every coxswain will have the boat's gripes (lashings) released to prepare the boat for lowering and directing personnel into the lifeboat.

All personnel are to be seated on the thwarts with their safety belts fastened. When this is not possible, personnel are to be seated as low as possible.

Mechanics or engineers assigned to each boat will ensure that engines are ready to be started when required.

7. When the order is given to abandon the unit (no boat is lowered except by order of the OIM), coxswains will lower boats by pulling down on the release wire.
8. When boats are waterborne, coxswains will release boat falls by means of RELEASE GEAR provided. Boat's engines should be running before entering the water.

When waterborne and falls released, boat will clear rig and pick up survivors who may be in the water.

9. Collect all lifeboats and life rafts together and distribute survivors evenly, if necessary.
10. If vessel was on station when emergency occurred (drilling, anchoring) communicate with, and make for standby vessel to transfer survivors, if possible.

If vessel was in transit, remain in the area of accident. Stream sea anchors as soon as possible and practical. One boat will take the lead.

Lifeboats

The Deep Driller is equipped with four Watercraft America lifeboats of 58-person capacity each. The lifeboats are totally enclosed, fire protected, and self-righting, and comply with applicable USCG regulations. The boats are motorized and capable of a speed of six knots. Fuel is stored in the boat for 24-hours at six knots.

1. Lowering the lifeboats

The lifeboats can be lowered from inside without a winch operator on deck. To lower, the coxswain pulls down on a wire entering the boat through the roof near the steering stand. While tension is maintained on the wire, the boat is lowered at a constant speed controlled by a centrifugal brake in the winch. When the wire is released, the winch immediately stops lowering.

2. Liferafts

In addition to the four motor lifeboats, the Deep Driller is equipped with four 25-person capacity liferafts (inflatable). Liferafts 1 and 2 are positioned forward; liferafts 3 and 4 are aft. If the lifeboats cannot be launched, all crew members are to proceed to the liferafts.

Emergency Radio Equipment

An emergency radiotelegraph (CW) transmitter is available and should be carried to one of the survival craft. The transmitter sends Morse Code (CW) signals generated by either manual or automatic keying on frequencies 500 KHz and 8364 KHz. Because the transmitter power is low, transmissions should coincide with the silent (for distress listening) periods observed on 500 KHz for three minutes in duration beginning at 15 and 45 minutes after each hour.

Each lifeboat is equipped with a marine radiotelephone. This radiotelephone should be used to communicate between lifeboats and may be used to send distress messages to nearby vessels. Distress (MAYDAY) messages should be sent on channel 16 (156.8 MHz).

Two of the lifeboats are fitted with Emergency Position Indicating Radiobeacons (EPIRB's). These should be turned on as soon as possible as they automatically transmit distress signals on 121.5 MHz and 243 MHz. These frequencies are monitored by aircraft and satellites. Also, search and rescue (SAR) aircraft are able to home on these beacons by using radio direction finders.

4.7 FIRE FIGHTING

It is the duty of the Offshore Installation Manager or Barge Supervisor to acquaint all personnel with the location and use of the various pieces of fire fighting apparatus and to hold periodic fire drills.

In the event of fire each person on board shall report to their assigned fire station or other stations as ordered by the person-in-charge.

SECTION 5.0

RIG DATA

This section contains the following Figures:

Page

5-2	Figure 1 - Profile view of Deep Driller
5-3	Figure 2 - Profile view of tank arrangements of the Deep Driller
5-4&5	Figures 3a & 3b - Tank and piping diagrams, port and starboard
5-6	Figure 4 - Hull and deck load limits vs. draft
5-7	Figure 5 - Critical motion curves
5-8	Figure 6 - Main deck arrangement
5-9	Figure 7 - Upper deck arrangement
5-10	Figure 8 - Derrick floor arrangement
5-11-15	Figure 9 - Maximum allowable KG
5-16	Figure 10 - Downflooding angles
5-17-21	Figure 11 - Hydrostatic Properties
5-22	Figure 12 - Lightweight correction for deployed chain
5-23	Figure 13 - Vertical component of line tension
5-24	Figure 14 - Anchor chain catenary length
5-25	Figure 15 - Significant wave height - bow
5-26	Figure 16 - Significant wave height - beam
5-27	Figure 17 - Mooring analysis - 200 foot water depth
5-28	Figure 18 - Mooring analysis - 400 foot water depth
5-29	Figure 19 - Mooring analysis - 600 foot water depth

Figure 1
Profile View - Deep Driller

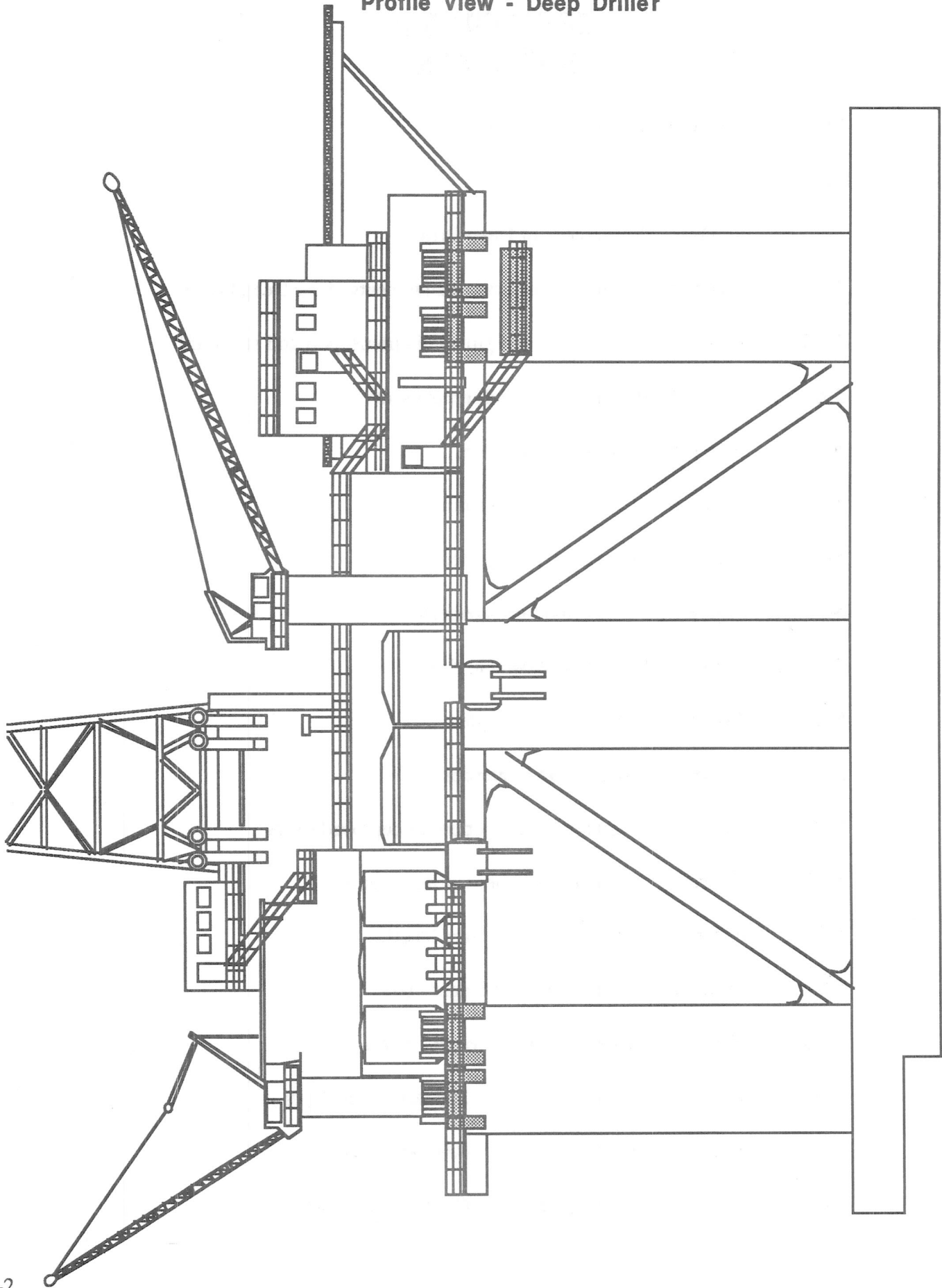
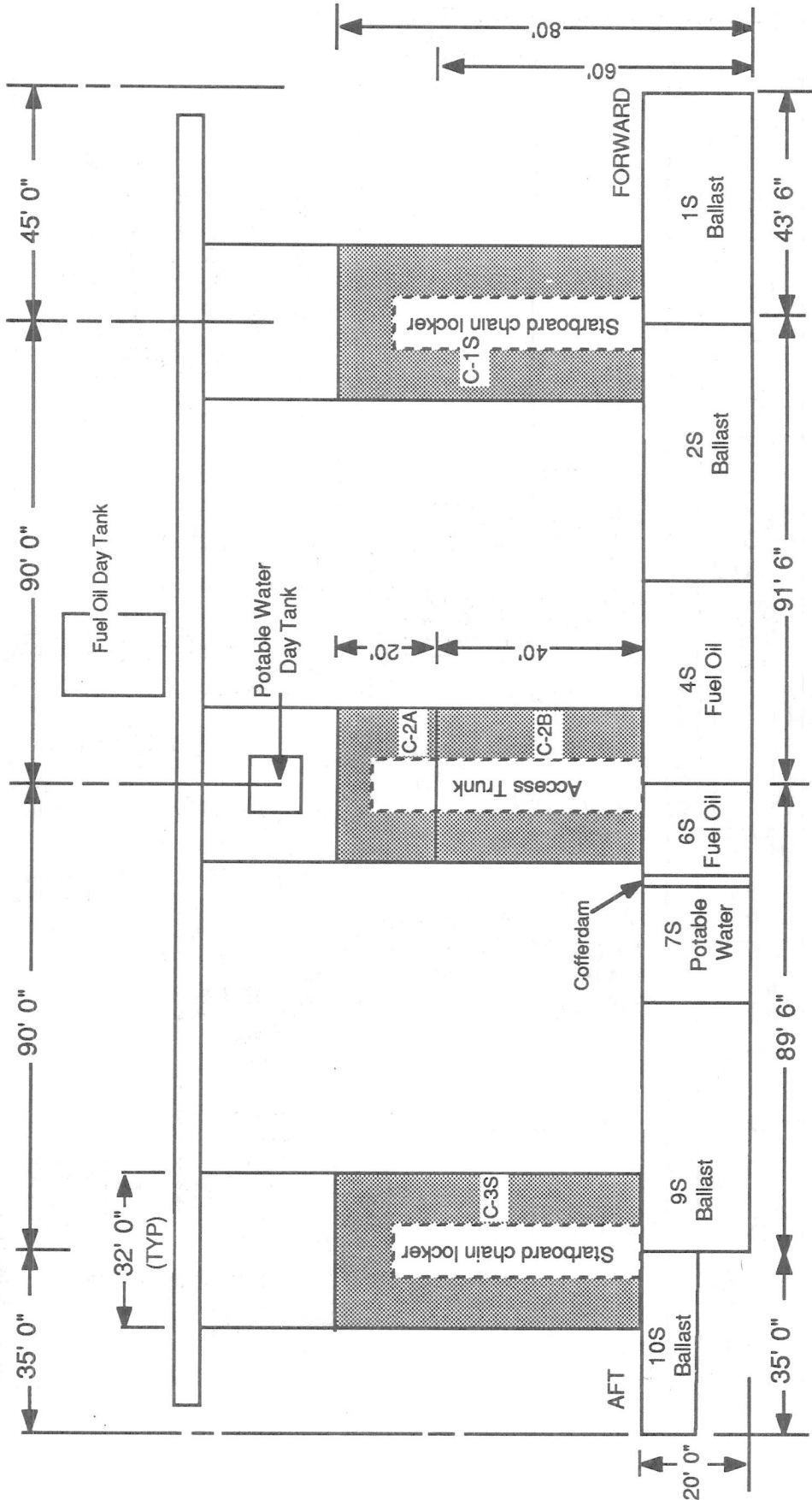

Figure 2
Profile View - Tank Arrangements



All dimensions in feet and inches SCALE 1:300 1" = 25'	DATE: August 1, 1988
	VIEW: Starboard Side
DEEP DRILLER	
General Arrangement - Tanks	

Figure 3a - Ballast Control Panel Mimic Diagram - Port

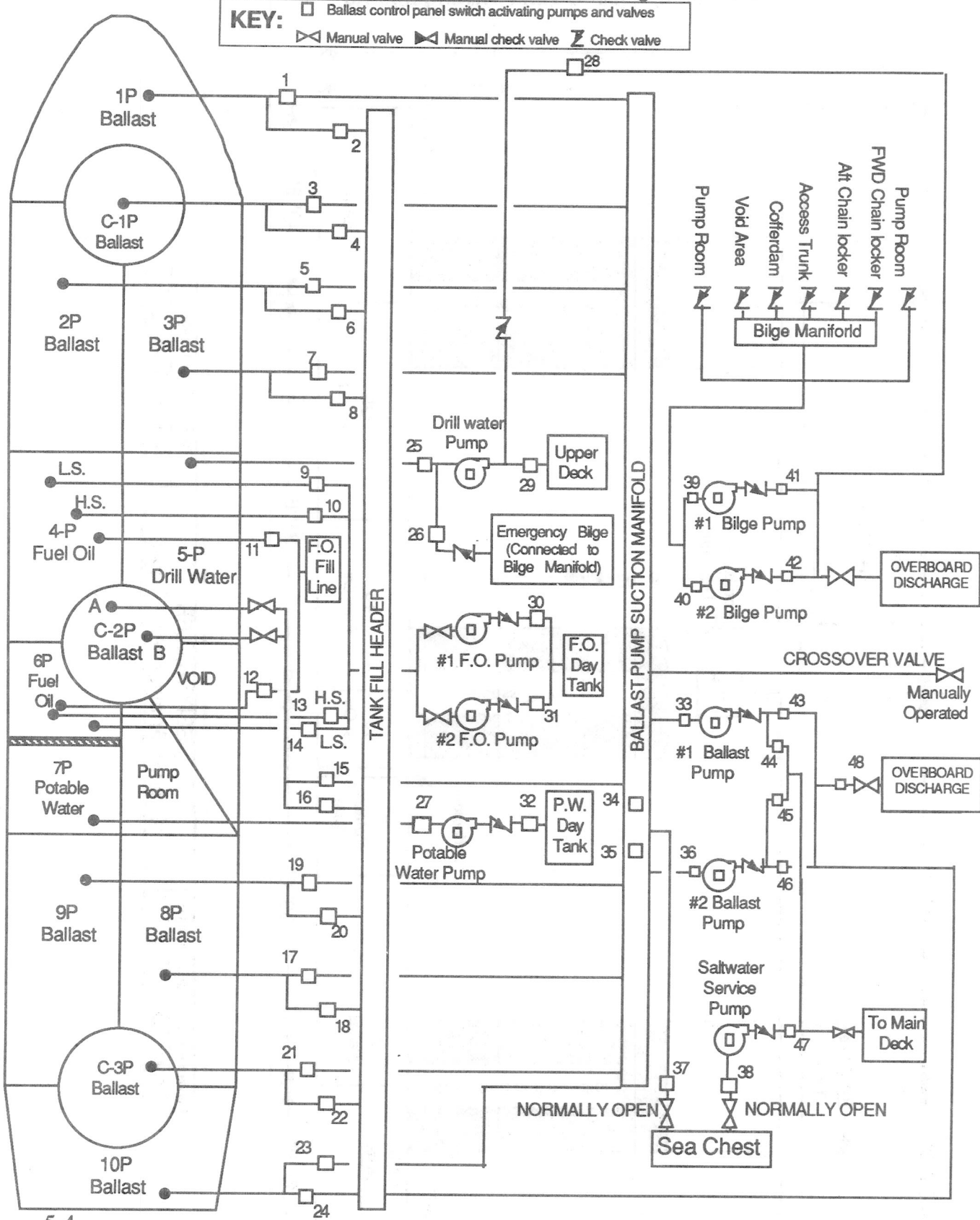

Figure 3b - Ballast Control Panel Mimic Diagram - Starboard

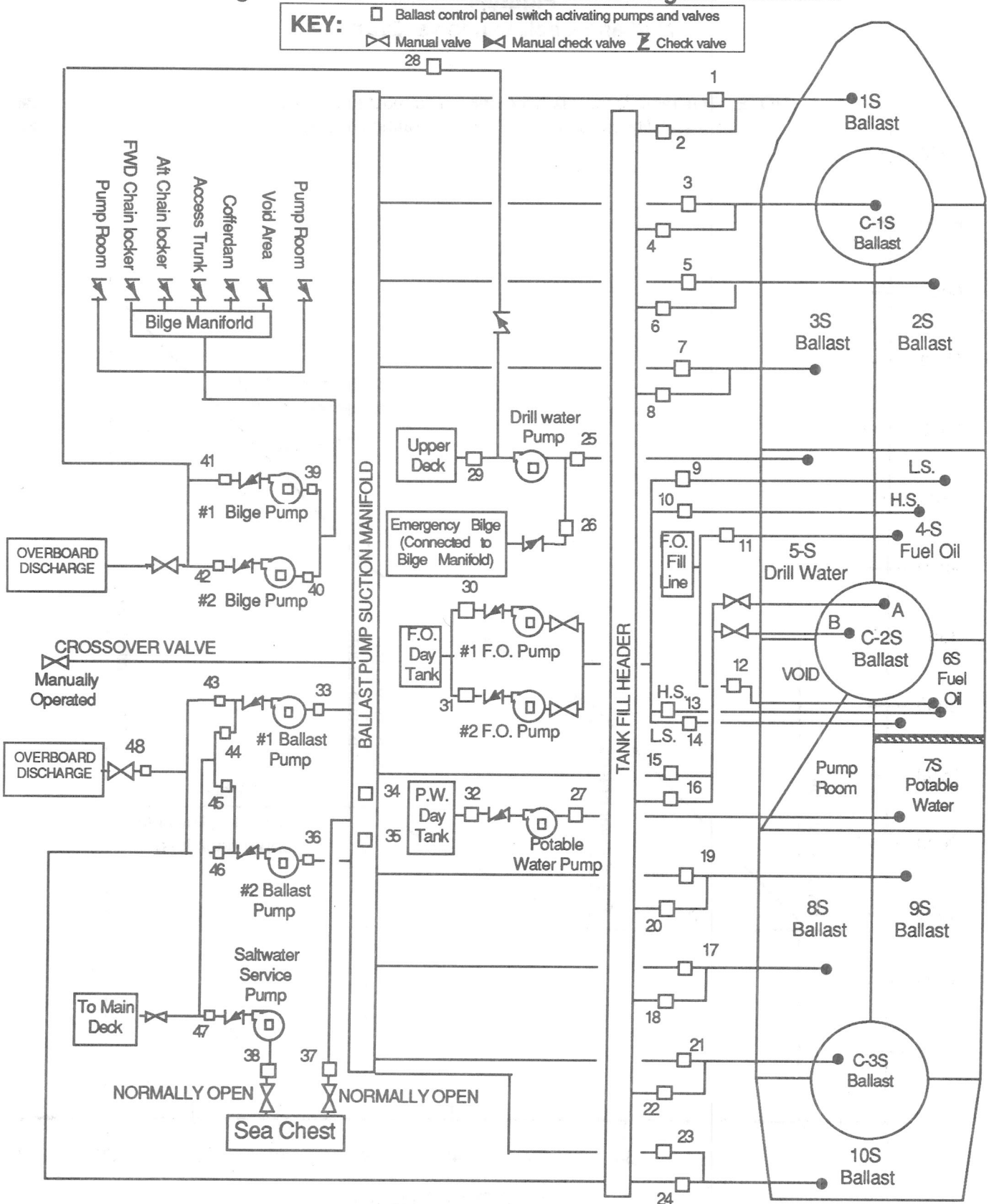

Figure 4
Hull and Deck Loads vs. Draft

NOTE: This table is for guidance only. You must perform a stability calculation for each operating condition.

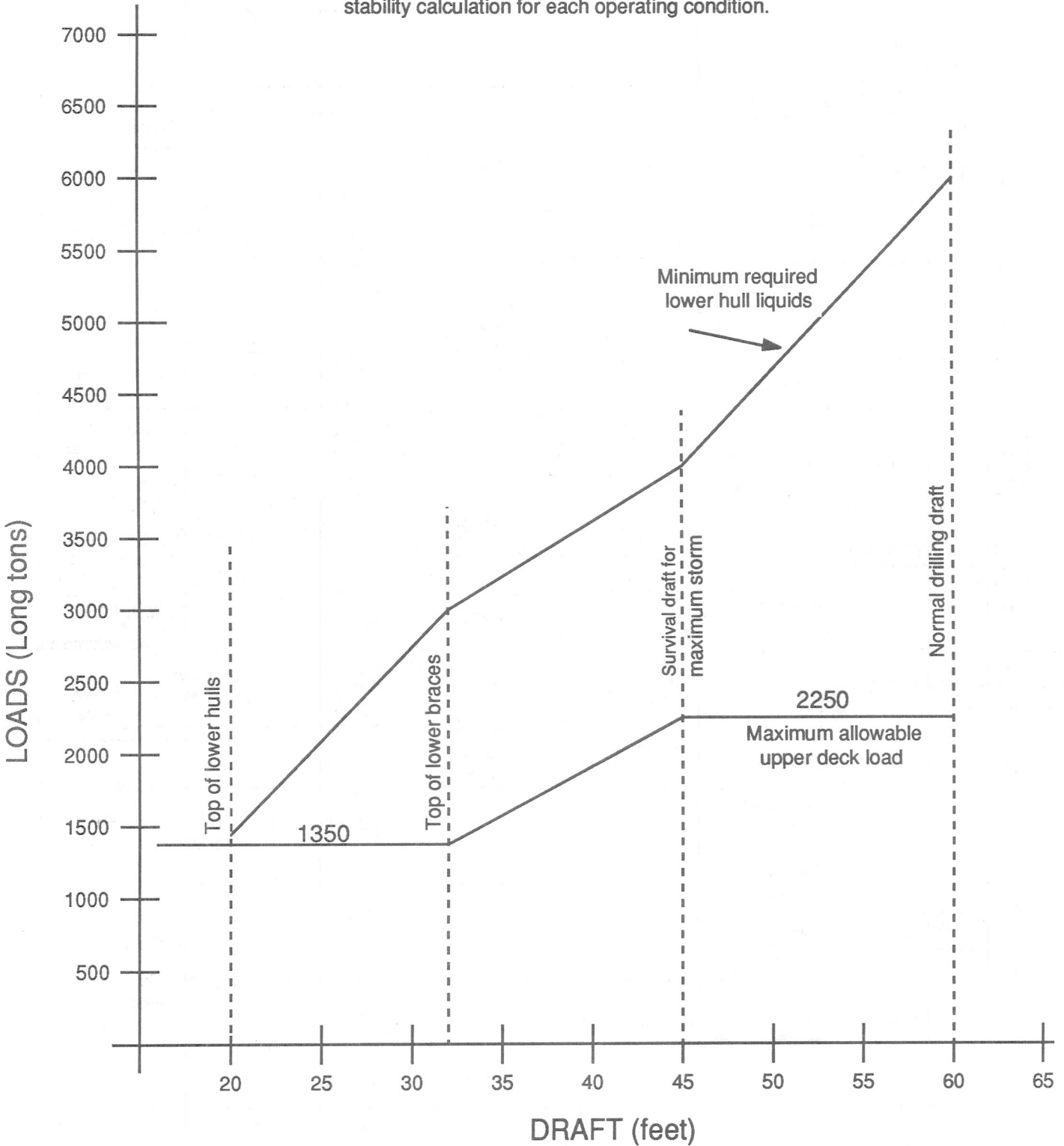

Figure 5
CRITICAL MOTION CURVES

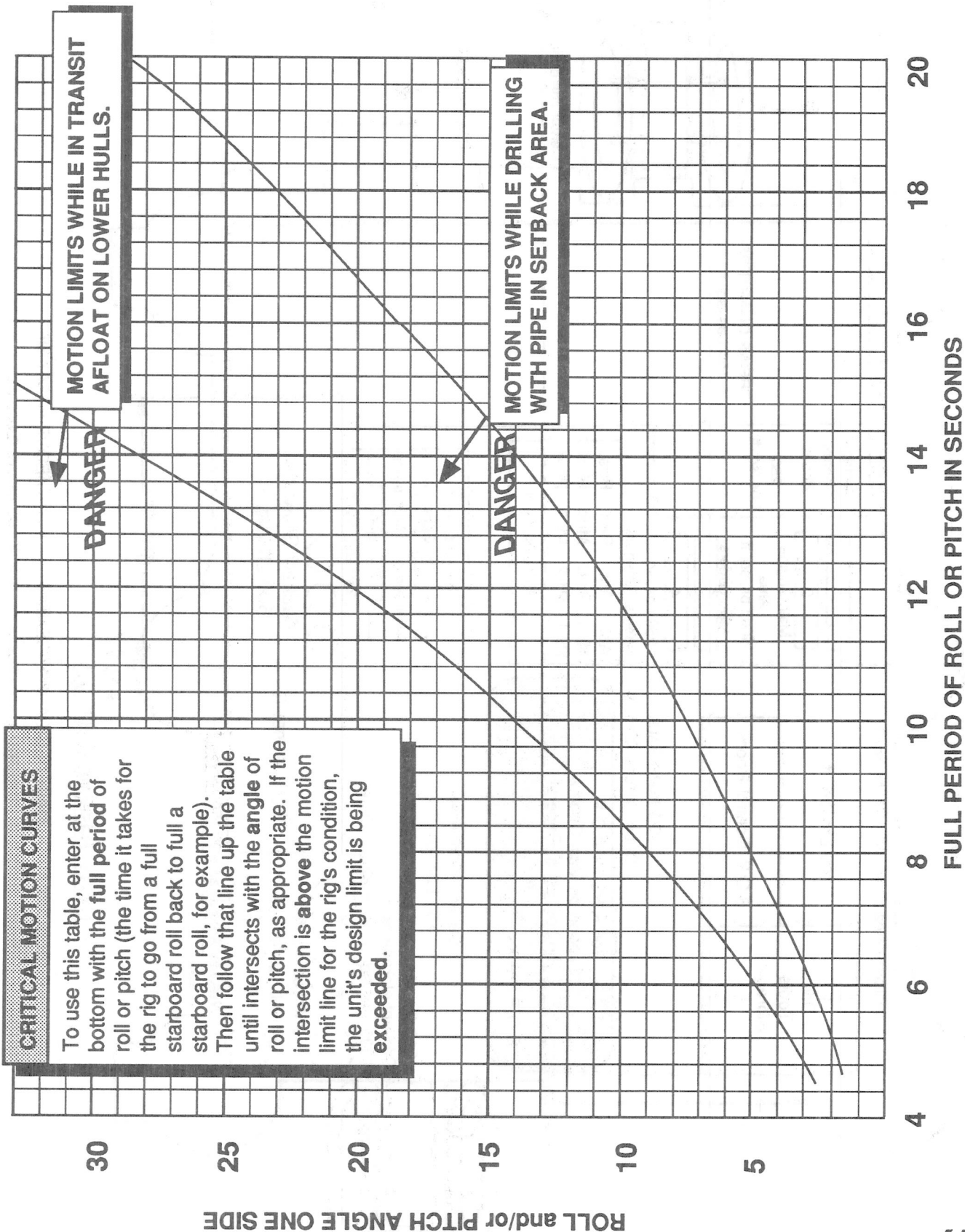
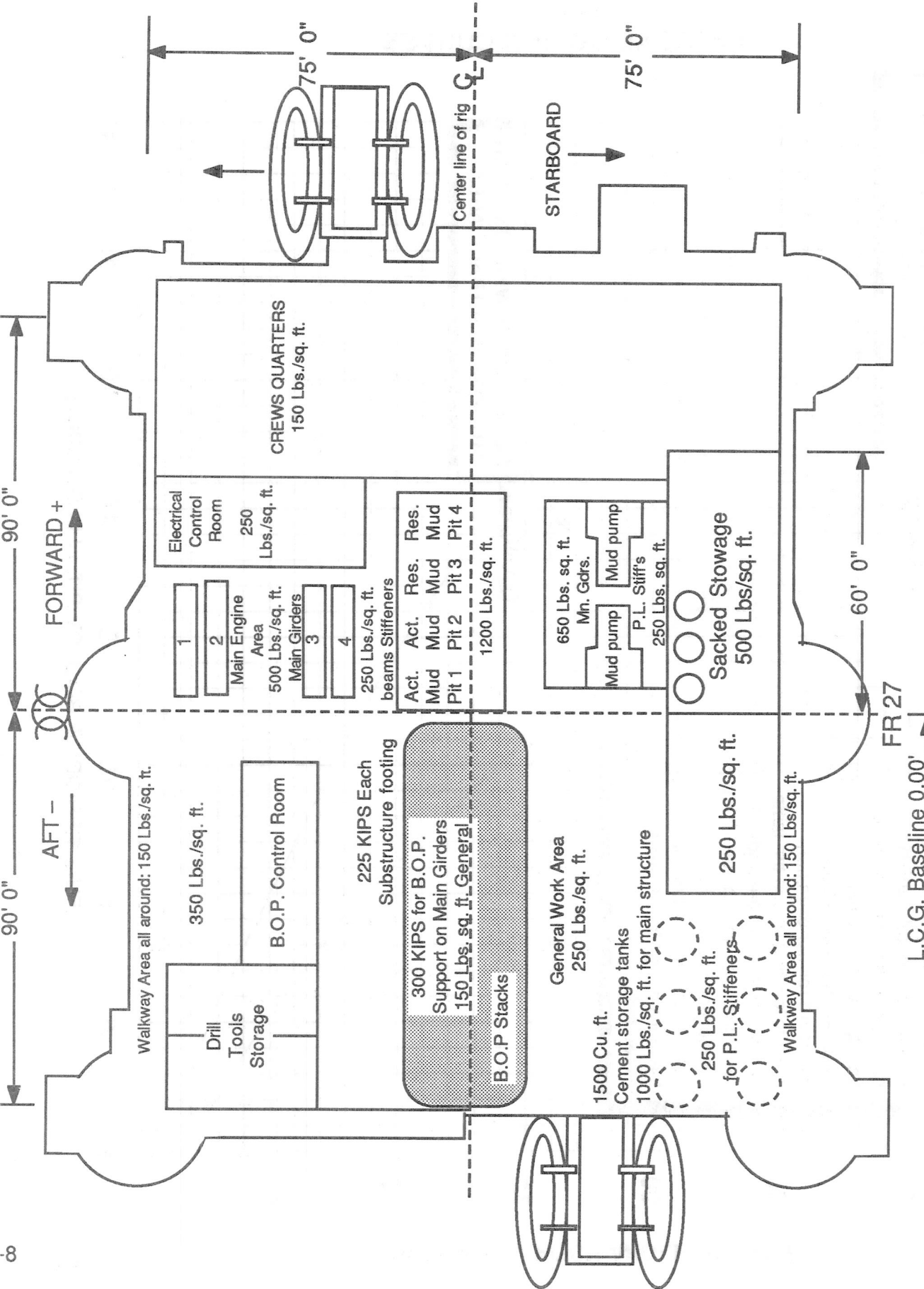

Figure 6
MAIN DECK ARRANGEMENTS



MAIN DECK ARRANGEMENT — 111' 0" ABOVE BASELINE

Spider deck shaded — 103' 3 1/2" above Baseline

Figure 7
UPPER DECK ARRANGEMENT +

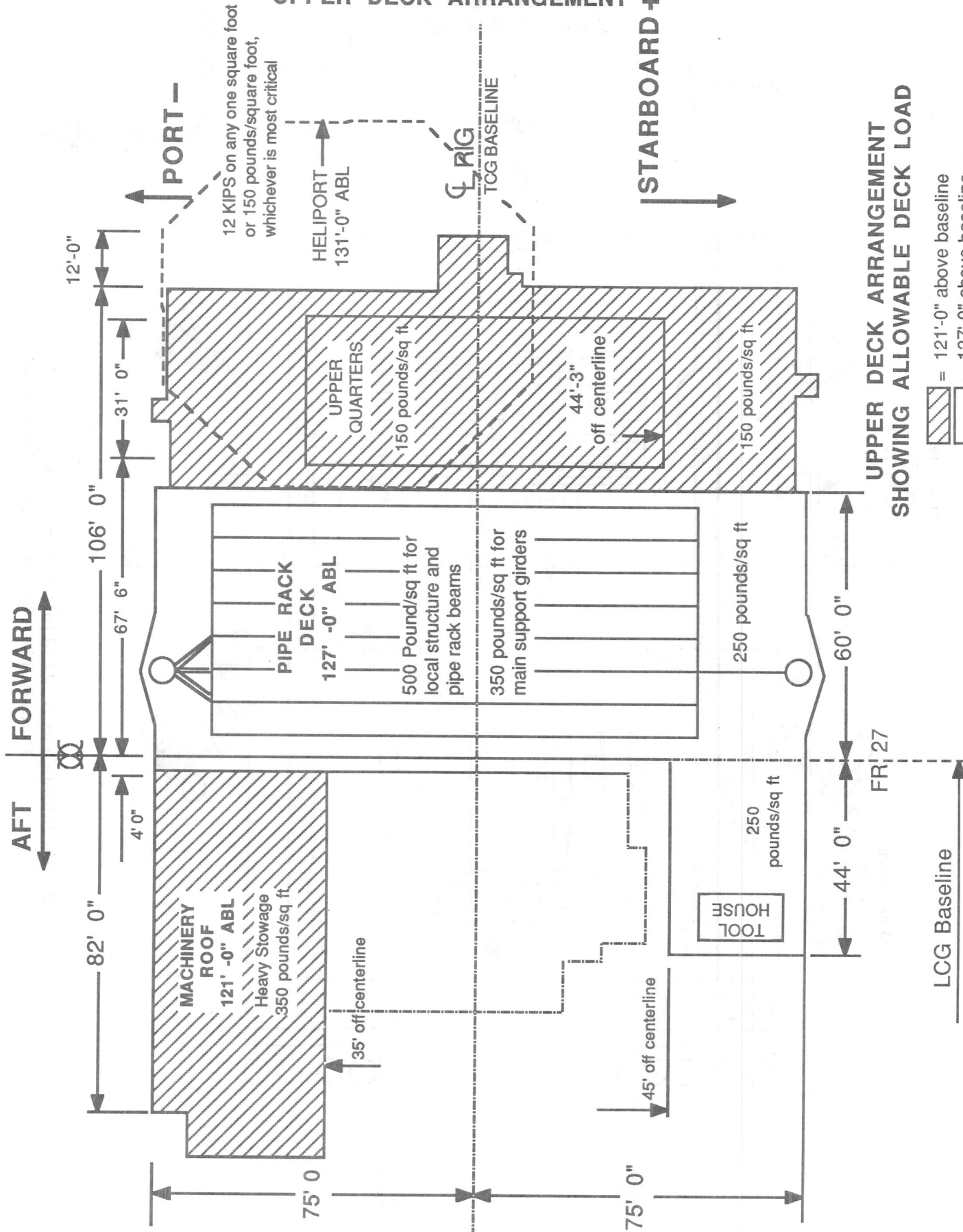

**Figure 8
DERRICK FLOOR
ARRANGEMENT**

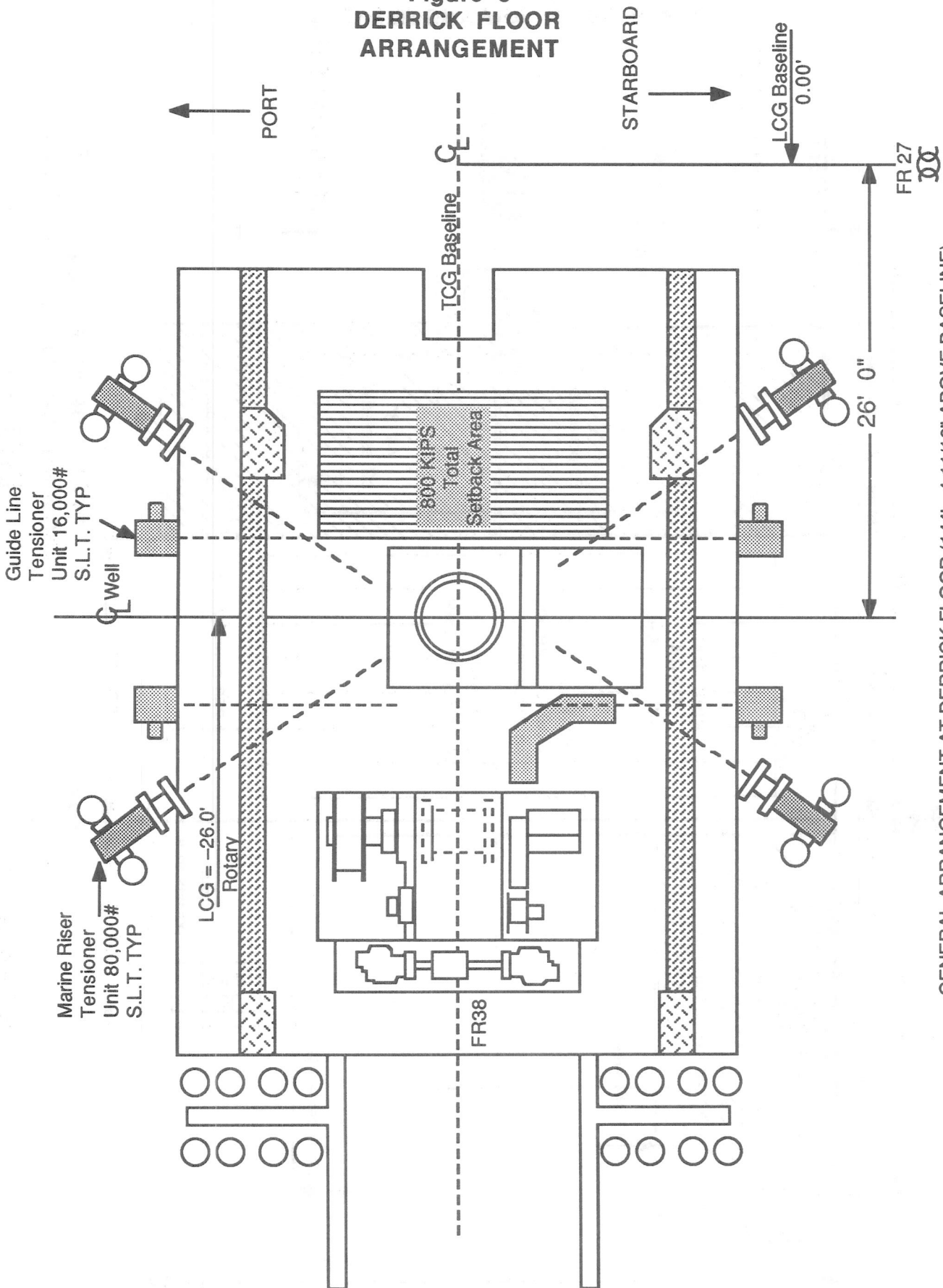

**GENERAL ARRANGEMENT AT DERRICK FLOOR (144' - 4 11/16" ABOVE BASELINE)
SHOWING ROTARY AND SETBACK TOTAL LOADING**

Figure 9
KG ALLOWABLE TABLE

The reference KG for using this table is the height of the center of gravity corrected for free surface effects (KGL or KGT), whichever is larger.

Draft Feet	70K Operating	100K Severe Storm	Draft Feet	70K Operating	100K Severe Storm
20.00	71.00	71.00	24.00	68.34	68.34
20.10	70.88	70.88	24.10	68.30	68.30
20.20	70.77	70.77	24.20	68.25	68.25
20.30	70.65	70.65	24.30	68.21	68.21
20.40	70.53	70.53	24.40	68.16	68.16
20.50	70.42	70.42	24.50	68.12	68.12
20.60	70.30	70.30	24.60	68.07	68.07
20.70	70.18	70.18	24.70	68.03	68.03
20.80	70.06	70.06	24.80	67.98	67.98
20.90	69.95	69.95	24.90	67.94	67.94
21.00	69.83	69.83	25.00	67.89	67.89
21.10	69.78	69.78	25.10	67.85	67.85
21.20	69.73	69.73	25.20	67.80	67.80
21.30	69.67	69.67	25.30	67.76	67.76
21.40	69.62	69.62	25.40	67.71	67.71
21.50	69.57	69.57	25.50	67.67	67.67
21.60	69.52	69.52	25.60	67.63	67.63
21.70	69.47	69.47	25.70	67.58	67.58
21.80	69.41	69.41	25.80	67.54	67.54
21.90	69.36	69.36	25.90	67.49	67.49
22.00	69.31	69.31	26.00	67.45	67.45
22.10	69.26	69.26	26.10	67.41	67.41
22.20	69.21	69.21	26.20	67.37	67.37
22.30	69.16	69.16	26.30	67.33	67.33
22.40	69.11	69.11	26.40	67.29	67.29
22.50	69.07	69.07	26.50	67.25	67.25
22.60	69.02	69.02	26.60	67.20	67.20
22.70	68.97	68.97	26.70	67.16	67.16
22.80	68.92	68.92	26.80	67.12	67.12
22.90	68.87	68.87	26.90	67.08	67.08
23.00	68.82	68.82	27.00	67.04	67.04
23.10	68.77	68.77	27.10	67.00	67.00
23.20	68.72	68.72	27.20	66.96	66.96
23.30	68.68	68.68	27.30	66.92	66.92
23.40	68.63	68.63	27.40	66.88	66.88
23.50	68.58	68.58	27.50	66.84	66.84
23.60	68.53	68.53	27.60	66.80	66.80
23.70	68.48	68.48	27.70	66.76	66.76
23.80	68.44	68.44	27.80	66.72	66.72
23.90	68.39	68.39	27.90	66.68	66.68

KG Table continued

Draft Feet	70K Operating	100K Severe Storm	Draft Feet	70K Operating	100K Severe Storm
28.00	66.64	66.64	32.00	65.22	65.22
28.10	66.60	66.60	32.10	65.19	65.19
28.20	66.56	66.56	32.20	65.16	65.16
28.30	66.53	66.53	32.30	65.13	65.13
28.40	66.49	66.49	32.40	65.10	65.10
28.50	66.45	66.45	32.50	65.07	65.07
28.60	66.41	66.41	32.60	65.03	65.03
28.70	66.37	66.37	32.70	65.00	65.00
28.80	66.34	66.34	32.80	64.97	64.97
28.90	66.30	66.30	32.90	64.94	64.94
29.00	66.26	66.26	33.00	64.91	64.91
29.10	66.22	66.22	33.10	64.88	64.88
29.20	66.19	66.19	33.20	64.85	64.85
29.30	66.15	66.15	33.30	64.82	64.82
29.40	66.12	66.12	33.40	64.79	64.79
29.50	66.08	66.08	33.50	64.76	64.76
29.60	66.04	66.04	33.60	64.73	64.73
29.70	66.01	66.01	33.70	64.70	64.70
29.80	65.97	65.97	33.80	64.67	64.67
29.90	65.94	65.94	33.90	64.64	64.64
30.00	65.90	65.90	34.00	64.61	64.61
30.10	65.87	65.87	34.10	64.58	64.58
30.20	65.83	65.83	34.20	64.55	64.55
30.30	65.80	65.80	34.30	64.53	64.53
30.40	65.76	65.76	34.40	64.50	64.50
30.50	65.73	65.73	34.50	64.47	64.47
30.60	65.69	65.69	34.60	64.44	64.44
30.70	65.66	65.66	34.70	64.41	64.41
30.80	65.62	65.62	34.80	64.39	64.39
30.90	65.59	65.59	34.90	64.36	64.36
31.00	65.55	65.55	35.00	64.33	64.33
31.10	65.52	65.52	35.10	64.30	64.30
31.20	65.48	65.48	35.20	64.28	64.28
31.30	65.45	65.45	35.30	64.25	64.25
31.40	65.42	65.42	35.40	64.22	64.22
31.50	65.39	65.39	35.50	64.20	64.20
31.60	65.35	65.35	35.60	64.17	64.17
31.70	65.32	65.32	35.70	64.14	64.14
31.80	65.29	65.29	35.80	64.11	64.11
31.90	65.25	65.25	35.90	64.09	64.09

KG Table continued

Draft Feet	70K Operating	100K Severe Storm	Draft Feet	70K Operating	100K Severe Storm
36.00	64.06	64.06	40.00	63.12	63.12
36.10	64.03	64.03	40.10	63.10	63.10
36.20	64.01	64.01	40.20	63.08	63.08
36.30	63.98	63.98	40.30	63.06	63.06
36.40	63.96	63.96	40.40	63.04	63.04
36.50	63.93	63.93	40.50	63.02	63.02
36.60	63.90	63.90	40.60	63.00	63.00
36.70	63.88	63.88	40.70	62.98	62.98
36.80	63.85	63.85	40.80	62.96	62.96
36.90	63.83	63.83	40.90	62.94	62.94
37.00	63.80	63.80	41.00	62.92	62.92
37.10	63.78	63.78	41.10	62.90	62.90
37.20	63.75	63.75	41.20	62.88	62.88
37.30	63.73	63.73	41.30	62.86	62.86
37.40	63.70	63.70	41.40	62.84	62.84
37.50	63.68	63.68	41.50	62.83	62.83
37.60	63.66	63.66	41.60	62.81	62.81
37.70	63.63	63.63	41.70	62.79	62.79
37.80	63.61	63.61	41.80	62.77	62.77
37.90	63.58	63.58	41.90	62.75	62.75
38.00	63.56	63.56	42.00	62.73	62.73
38.10	63.54	63.54	42.10	62.71	62.71
38.20	63.52	63.52	42.20	62.70	62.70
38.30	63.49	63.49	42.30	62.68	62.68
38.40	63.47	63.47	42.40	62.66	62.66
38.50	63.45	63.45	42.50	62.65	62.65
38.60	63.43	63.43	42.60	62.63	62.63
38.70	63.41	63.41	42.70	62.61	62.61
38.80	63.38	63.38	42.80	62.59	62.59
38.90	63.36	63.36	42.90	62.58	62.58
39.00	63.34	63.34	43.00	62.56	62.56
39.10	63.32	63.32	43.10	62.54	62.54
39.20	63.30	63.30	43.20	62.53	62.53
39.30	63.27	63.27	43.30	62.51	62.51
39.40	63.25	63.25	43.40	62.49	62.49
39.50	63.23	63.23	43.50	62.48	62.48
39.60	63.21	63.21	43.60	62.46	62.46
39.70	63.19	63.19	43.70	62.44	62.44
39.80	63.16	63.16	43.80	62.42	62.42
39.90	63.14	63.14	43.90	62.41	62.41

KG Table continued

Draft Feet	70K Operating	100K Severe Storm	Draft Feet	70K Operating	100K Severe Storm
44.00	62.39	62.39	48.00	61.84	60.32
44.10	62.38	62.38	48.10	61.83	60.23
44.20	62.36	62.36	48.20	61.82	60.13
44.30	62.35	62.35	48.30	61.81	60.04
44.40	62.33	62.33	48.40	61.80	59.94
44.50	62.32	62.32	48.50	61.79	59.85
44.60	62.30	62.30	48.60	61.77	59.76
44.70	62.29	62.29	48.70	61.76	59.66
44.80	62.27	62.27	48.80	61.75	59.57
44.90	62.26	62.26	48.90	61.74	59.47
45.00	62.24	62.09	49.00	61.73	59.38
45.10	62.23	62.05	49.10	61.72	59.30
45.20	62.21	62.02	49.20	61.71	59.23
45.30	62.20	61.98	49.30	61.70	59.15
45.40	62.18	61.95	49.40	61.69	59.08
45.50	62.17	61.91	49.50	61.68	59.00
45.60	62.16	61.87	49.60	61.67	58.92
45.70	62.14	61.84	49.70	61.66	58.85
45.80	62.13	61.80	49.80	61.65	58.77
45.90	62.11	61.77	49.90	61.64	58.70
46.00	62.10	61.73	50.00	61.63	58.62
46.10	62.09	61.66	50.10	61.62	58.54
46.20	62.07	61.59	50.20	61.61	58.45
46.30	62.06	61.52	50.30	61.60	58.37
46.40	62.04	61.45	50.40	61.59	58.29
46.50	62.03	61.39	50.50	61.59	58.21
46.60	62.02	61.32	50.60	61.58	58.12
46.70	62.00	61.25	50.70	61.57	58.04
46.80	61.99	61.18	50.80	61.56	57.96
46.90	61.97	61.11	50.90	61.55	57.87
47.00	61.96	61.04	51.00	61.54	57.79
47.10	61.95	60.97	51.10	61.53	57.71
47.20	61.94	60.90	51.20	61.52	57.63
47.30	61.92	60.82	51.30	61.52	57.56
47.40	61.91	60.75	51.40	61.51	57.48
47.50	61.90	60.68	51.50	61.50	57.40
47.60	61.89	60.61	51.60	61.49	57.32
47.70	61.88	60.54	51.70	61.48	57.24
47.80	61.86	60.46	51.80	61.48	57.17
47.90	61.85	60.39	51.90	61.47	57.09

KG Table continued

Draft Feet	70K Operating	100K Severe Storm	Draft Feet	70K Operating	100K Severe Storm
52.00	61.46	57.01	56.00	60.02	54.08
52.10	61.45	56.92	56.10	59.97	54.03
52.20	61.45	56.84	56.20	59.92	53.97
52.30	61.44	56.75	56.30	59.88	53.92
52.40	61.43	56.66	56.40	59.83	53.86
52.50	61.43	56.58	56.50	59.78	53.81
52.60	61.42	56.49	56.60	59.73	53.75
52.70	61.41	56.40	56.70	59.68	53.70
52.80	61.40	56.31	56.80	59.64	53.64
52.90	61.40	56.23	56.90	59.59	53.59
53.00	61.39	56.14	57.00	59.54	53.53
53.10	61.38	56.05	57.10	59.50	53.48
53.20	61.38	55.96	57.20	59.46	53.43
53.30	61.37	55.88	57.30	59.41	53.38
53.40	61.36	55.79	57.40	59.37	53.33
53.50	61.36	55.70	57.50	59.33	53.29
53.60	61.35	55.61	57.60	59.29	53.24
53.70	61.34	55.52	57.70	59.25	53.19
53.80	61.33	55.44	57.80	59.20	53.14
53.90	61.33	55.35	57.90	59.16	53.09
54.00	61.32	55.26	58.00	59.12	53.04
54.10	61.25	55.21	58.10	59.09	52.98
54.20	61.18	55.16	58.20	59.05	52.93
54.30	61.11	55.10	58.30	59.02	52.87
54.40	61.04	55.05	58.40	58.98	52.82
54.50	60.97	55.00	58.50	58.95	52.76
54.60	60.90	54.95	58.60	58.91	52.70
54.70	60.83	54.90	58.70	58.88	52.65
54.80	60.76	54.84	58.80	58.84	52.59
54.90	60.69	54.79	58.90	58.81	52.54
55.00	60.62	54.74	59.00	58.77	52.48
55.10	60.56	54.67	59.10	58.74	52.43
55.20	60.50	54.61	59.20	58.72	52.38
55.30	60.44	54.54	59.30	58.69	52.34
55.40	60.38	54.48	59.40	58.66	52.29
55.50	60.32	54.41	59.50	58.64	52.24
55.60	60.26	54.34	59.60	58.61	52.19
55.70	60.20	54.28	59.70	58.58	52.14
55.80	60.14	54.21	59.80	58.55	52.10
55.90	60.08	54.15	59.90	58.53	52.05
			60.00	58.50	52.00

Figure 10
APPROXIMATE DOWNFLOODING ANGLES

Downflooding

As a guide, Figure 10 shows the approximate combination of effective draft, list, and trim at which downflooding into the chain lockers may be expected to occur.

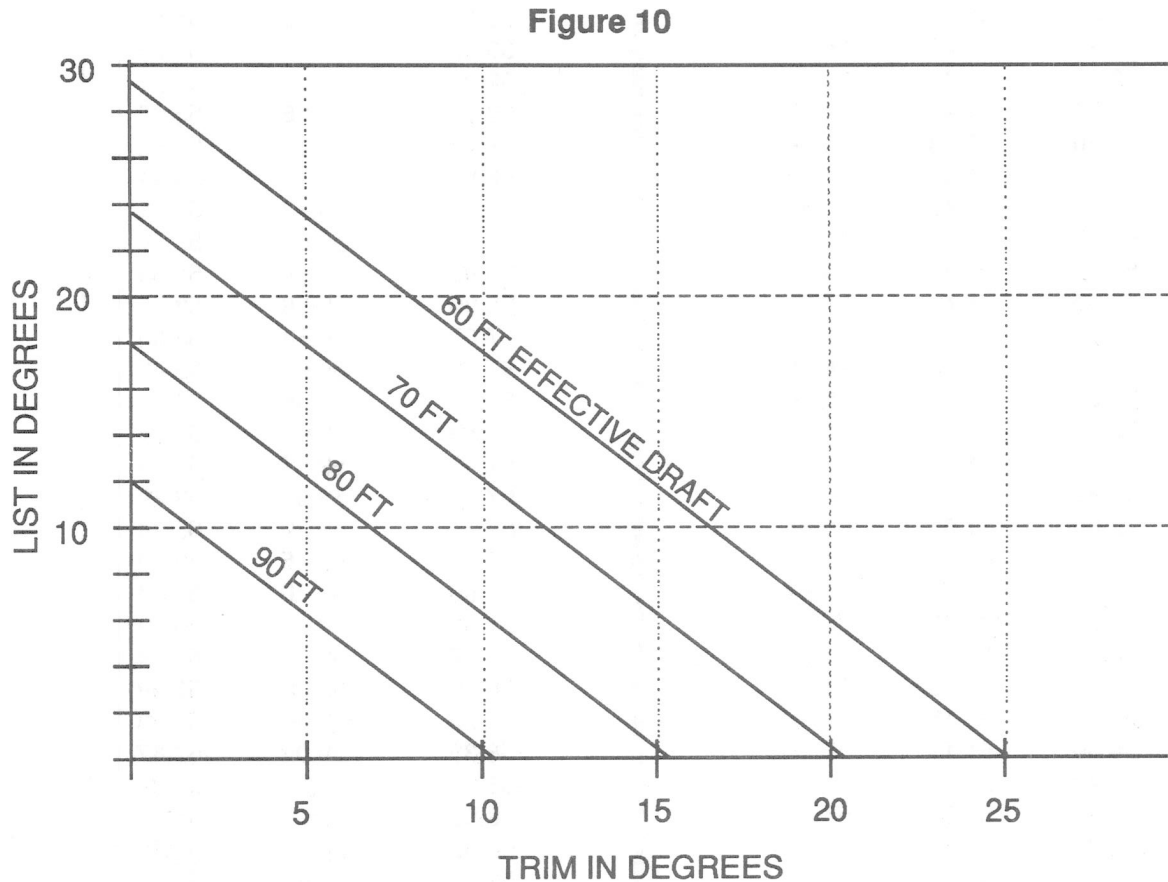

EFFECTIVE DRAFT = ACTUAL DRAFT + 1/2 WAVE HEIGHT

The drafts shown in the figure are “effective” drafts, which approximate the dynamic effects of heave, pitch, and roll. The effective draft used in the chart is defined as the actual draft plus one-half of the maximum wave height. Note that there are an infinite number of combinations of effective draft, list, and trim at which downflooding could occur.

For example, if the Deep Driller is operating at a draft of 60 feet, and the maximum wave heights are 20 feet, the effective draft is 70 feet. Under these conditions, a combination of list and trim at which downflooding could occur includes a list of 12° and a trim of 10°. Another combination is a list of 5° and a trim of approximately 17°.

This chart is intended to serve as a guide. In practice, caution should be exercised in the use of the chart since wave over-topping may occur before the predicted downflooding angles are reached.

Figure 11
HYDROSTATIC PROPERTIES
(Table on following page.)

The hydrostatic properties table on the next page considers:

1. Shell plating for hull, columns, and tubular braces.
2. No appendages, other than the tubular braces.
3. All brace volumes. However, the waterplane area of the horizontal braces at the 27' 6" elevation is neglected.
4. Keel plate thickness of 5/8 inch.

The table of hydrostatic properties shown on the next page is based on the following:

1. Draft is the vertical distance between the horizontal baseline, through the underside of the keel, and the waterplane. The draft is measured at the center of flotation.
2. Vertical measurements are in feet measured upward from the baseline.
3. Longitudinal measurements are in feet measured fore and aft of amidships. Positive values indicate distances forward of amidships, (Frame 27) and negative values indicate distances aft of amidships.
4. Transverse locations are relative to the centerline; positive being to starboard, and negative to port.
5. Displacement is measured in long tons and is the weight of sea water, assumed to weigh 64 pounds per cubic foot displaced by the immersed hull.
6. VCB is the vertical height of the center of buoyancy measured above the keel.
7. LCB is the longitudinal location of the center of buoyancy measured relative to amidships. For the Deep Driller it is always positive.
8. LCF is the longitudinal location of the center of flotation measured relative to amidships. LCF is located forward of amidships, and therefore has a positive value, for drafts less than 20.0 feet. For drafts greater than 20 feet, the LCF is located amidships, and thus has a value of zero.
9. KML and KMT are vertical distances measured in feet above the baseline to the metacenters in the longitudinal and transverse modes.
10. TPI is the weight in long tons that when added or discharged causes a change in draft of one inch.

Figure 11
TABLE OF HYDROSTATIC PROPERTIES (Salt Water)
Deep Driller

DRAFT Ft - in	Displacement LT	VCB Ft	LCB Ft	LCF Ft	KML Ft	KMT Ft	TPI LT/in
18 - 0	11139.69	9.49	2.99	4.62	351.98	386.69	60.03
18 - 3	11320.47	9.63	3.01	4.66	350.66	382.32	60.26
18 - 6	11501.25	9.77	3.04	4.71	349.34	377.96	60.50
18 - 9	11683.44	9.91	3.07	4.76	348.12	373.83	60.73
19 - 0	11865.64	10.04	3.09	4.81	346.91	369.70	60.97
19 - 3	12049.24	10.18	3.12	4.86	345.80	365.79	61.20
19 - 6	12232.84	10.32	3.15	4.90	344.68	361.87	61.44
19 - 9	12417.85	10.46	3.17	4.95	343.66	358.15	61.67
20 - 0	12602.86	10.60	3.20	5.00	342.64	354.43	61.90
20 - 3	12637.32	10.62	3.19	2.50	206.37	213.49	36.70
20 - 6	12671.79	10.65	3.18	0.00	70.10	72.55	11.49
20 - 9	12706.26	10.68	3.17	0.00	69.96	72.41	11.49
21 - 0	12740.73	10.70	3.16	0.00	69.83	72.27	11.49
21 - 3	12775.20	10.73	3.16	0.00	69.70	72.13	11.49
21 - 6	12809.66	10.76	3.15	0.00	69.57	71.99	11.49
21 - 9	12844.13	10.79	3.14	0.00	69.44	71.86	11.49
22 - 0	12878.60	10.82	3.13	0.00	69.31	71.72	11.49
22 - 3	12913.07	10.85	3.12	0.00	69.19	71.59	11.49
22 - 6	12947.53	10.88	3.11	0.00	69.07	71.46	11.49
22 - 9	12982.00	11.00	3.08	0.00	68.57	70.94	11.49
23 - 0	13016.47	10.94	3.10	0.00	68.82	71.20	11.49
23 - 3	13050.94	10.98	3.09	0.00	68.70	71.08	11.49
23 - 6	13085.41	11.01	3.08	0.00	68.58	70.95	11.49
23 - 9	13119.87	11.04	3.07	0.00	68.46	70.83	11.49
24 - 0	13154.34	11.07	3.07	0.00	68.34	70.70	11.49
24 - 3	13188.81	11.11	3.06	0.00	68.23	70.58	11.49
24 - 6	13223.28	11.14	3.05	0.00	68.12	70.46	11.49
24 - 9	13257.74	11.18	3.04	0.00	68.00	70.34	11.49
25 - 0	13292.21	11.21	3.03	0.00	67.89	70.22	11.49
25 - 3	13326.68	11.25	3.03	0.00	67.78	70.11	11.49
25 - 6	13361.15	11.29	3.02	0.00	67.67	69.99	11.49
25 - 9	13395.62	11.32	3.01	0.00	67.56	69.88	11.49
26 - 0	13430.08	11.36	3.00	0.00	67.45	69.76	11.49
26 - 3	13464.55	11.40	2.99	0.00	67.35	69.65	11.49
26 - 6	13499.02	11.44	2.99	0.00	67.24	69.54	11.49
26 - 9	13533.49	11.48	2.98	0.00	67.14	69.43	11.49
27 - 0	13567.95	11.51	2.97	0.00	67.04	69.32	11.49
27 - 3	13602.42	11.55	2.96	0.00	66.94	69.22	11.49
27 - 6	13636.89	11.59	2.96	0.00	66.84	69.11	11.49
27 - 9	13671.36	11.63	2.95	0.00	66.74	69.01	11.49
28 - 0	13705.83	11.67	2.94	0.00	66.64	68.90	11.49
28 - 3	13740.29	11.72	2.93	0.00	66.54	68.80	11.49
28 - 6	13774.76	11.76	2.93	0.00	66.45	68.70	11.49
28 - 9	13809.23	11.80	2.92	0.00	66.35	68.60	11.49
29 - 0	13843.70	11.84	2.91	0.00	66.26	68.50	11.49
29 - 3	13878.16	11.89	2.91	0.00	66.17	68.40	11.49
29 - 6	13912.63	11.93	2.90	0.00	66.08	68.31	11.49
29 - 9	13947.10	11.97	2.89	0.00	65.99	68.21	11.49

DRAFT Ft - in	Displacement LT	VCB Ft	LCB Ft	LCF Ft	KML Ft	KMT Ft	TPI LT/in
30 - 0	13981.57	12.02	2.88	0.00	65.90	68.12	11.49
30 - 3	14016.04	12.06	2.88	0.00	65.81	68.02	11.49
30 - 6	14050.50	12.11	2.87	0.00	65.72	67.93	11.49
30 - 9	14084.97	12.15	2.86	0.00	65.64	67.84	11.49
31 - 0	14119.44	12.20	2.86	0.00	65.55	67.75	11.49
31 - 3	14153.91	12.24	2.85	0.00	65.47	67.66	11.49
31 - 6	14188.37	12.29	2.84	0.00	65.39	67.57	11.49
31 - 9	14222.84	12.34	2.83	0.00	65.30	67.49	11.49
32 - 0	14257.31	12.38	2.83	0.00	65.22	67.40	11.49
32 - 3	14291.78	12.43	2.82	0.00	65.14	67.31	11.49
32 - 6	14326.25	12.48	2.81	0.00	65.07	67.23	11.49
32 - 9	14360.71	12.53	2.81	0.00	64.99	67.15	11.49
33 - 0	14395.18	12.58	2.80	0.00	64.91	67.06	11.49
33 - 3	14429.65	12.63	2.79	0.00	64.83	66.98	11.49
33 - 6	14464.12	12.68	2.79	0.00	64.76	66.90	11.49
33 - 9	14498.58	12.73	2.78	0.00	64.68	66.82	11.49
34 - 0	14533.05	12.77	2.77	0.00	64.61	66.74	11.49
34 - 3	14567.52	12.83	2.77	0.00	64.54	66.67	11.49
34 - 6	14601.99	12.88	2.76	0.00	64.47	66.59	11.49
34 - 9	14636.45	12.93	2.75	0.00	64.40	66.52	11.49
35 - 0	14670.92	12.98	2.75	0.00	64.33	66.44	11.49
35 - 3	14705.39	13.03	2.74	0.00	64.26	66.37	11.49
35 - 6	14739.86	13.08	2.74	0.00	64.19	66.30	11.49
35 - 9	14774.33	13.14	2.73	0.00	64.13	66.23	11.49
36 - 0	14808.79	13.19	2.72	0.00	64.06	66.15	11.49
36 - 3	14843.26	13.24	2.72	0.00	64.00	66.09	11.49
36 - 6	14877.73	13.30	2.71	0.00	63.93	66.02	11.49
36 - 9	14912.20	13.35	2.70	0.00	63.87	65.95	11.49
37 - 0	14946.66	13.40	2.70	0.00	63.80	65.88	11.49
37 - 3	14981.13	13.46	2.69	0.00	63.74	65.82	11.49
37 - 6	15015.60	13.51	2.69	0.00	63.68	65.75	11.49
37 - 9	15050.07	13.57	2.68	0.00	63.62	65.69	11.49
38 - 0	15084.54	13.62	2.67	0.00	63.56	65.62	11.49
38 - 3	15119.00	13.68	2.67	0.00	63.51	65.56	11.49
38 - 6	15153.47	13.74	2.66	0.00	63.45	65.50	11.49
38 - 9	15187.94	13.79	2.65	0.00	63.39	65.44	11.49
39 - 0	15222.41	13.85	2.65	0.00	63.34	65.38	11.49
39 - 3	15256.87	13.91	2.64	0.00	63.28	65.32	11.49
39 - 6	15291.34	13.96	2.64	0.00	63.23	65.26	11.49
39 - 9	15325.81	14.02	2.63	0.00	63.18	65.20	11.49
40 - 0	15360.28	14.08	2.62	0.00	63.12	65.14	11.49
40 - 3	15394.75	14.14	2.62	0.00	63.07	65.09	11.49
40 - 6	15429.21	14.20	2.61	0.00	63.02	65.03	11.49
40 - 9	15463.68	14.26	2.61	0.00	62.97	64.98	11.49
41 - 0	15498.15	14.31	2.60	0.00	62.92	64.92	11.49
41 - 3	15532.62	14.37	2.60	0.00	62.87	64.87	11.49
41 - 6	15532.62	14.37	2.60	0.00	62.87	64.87	11.49
41 - 9	15567.08	14.43	2.59	0.00	62.83	64.82	11.49
42 - 0	15636.02	14.55	2.58	0.00	62.73	64.72	11.49
42 - 3	15670.49	14.62	2.57	0.00	62.69	64.67	11.49
42 - 6	15704.96	14.68	2.57	0.00	62.64	64.62	11.49
42 - 9	15739.42	14.74	2.56	0.00	62.60	64.57	11.49

DRAFT	Displacement	VCB	LCB	LCF	KML	KMT	TPI
Ft - in	LT	Ft	Ft	Ft	Ft	Ft	LT/in
43 - 0	15773.89	14.80	2.56	0.00	62.56	64.52	11.49
43 - 3	15808.36	14.86	2.55	0.00	62.52	64.48	11.49
43 - 6	15842.83	14.92	2.54	0.00	62.47	64.43	11.49
43 - 9	15877.29	14.99	2.54	0.00	62.43	64.39	11.49
44 - 0	15911.76	15.05	2.53	0.00	62.39	64.34	11.49
44 - 3	15946.23	15.11	2.53	0.00	62.35	64.30	11.49
44 - 6	15980.70	15.17	2.52	0.00	62.31	64.26	11.49
44 - 9	16015.17	15.24	2.52	0.00	62.28	64.21	11.49
45 - 0	16049.63	15.30	2.51	0.00	62.24	64.17	11.49
45 - 3	16084.10	15.36	2.51	0.00	62.20	64.13	11.49
45 - 6	16118.57	15.43	2.50	0.00	62.17	64.09	11.49
45 - 9	16153.04	15.49	2.50	0.00	62.13	64.05	11.49
46 - 0	16187.50	15.56	2.49	0.00	62.10	64.01	11.49
46 - 3	16221.97	15.62	2.49	0.00	62.06	63.97	11.49
46 - 6	16256.44	15.69	2.48	0.00	62.03	63.94	11.49
46 - 9	16290.91	15.75	2.47	0.00	62.00	63.90	11.49
47 - 0	16325.38	15.82	2.47	0.00	61.96	63.86	11.49
47 - 3	16359.84	15.89	2.46	0.00	61.93	63.83	11.49
47 - 6	16394.31	15.95	2.46	0.00	61.90	63.79	11.49
47 - 9	16428.78	16.02	2.45	0.00	61.87	63.76	11.49
48 - 0	16463.25	16.08	2.45	0.00	61.84	63.73	11.49
48 - 3	16497.71	16.15	2.44	0.00	61.81	63.69	11.49
48 - 6	16532.18	16.22	2.44	0.00	61.79	63.66	11.49
48 - 9	16566.65	16.29	2.43	0.00	61.76	63.63	11.49
49 - 0	16601.12	16.35	2.43	0.00	61.73	63.60	11.49
49 - 3	16635.58	16.42	2.42	0.00	61.71	63.57	11.49
49 - 6	16670.05	16.49	2.42	0.00	61.68	63.54	11.49
49 - 9	16704.52	16.56	2.41	0.00	61.66	63.51	11.49
50 - 0	16738.99	16.63	2.41	0.00	61.63	63.48	11.49
50 - 3	16773.46	16.70	2.40	0.00	61.61	63.46	11.49
50 - 6	16807.92	16.76	2.40	0.00	61.59	63.43	11.49
50 - 9	16842.39	16.83	2.39	0.00	61.56	63.40	11.49
51 - 0	16876.86	16.90	2.39	0.00	61.54	63.38	11.49
51 - 3	16911.33	16.97	2.38	0.00	61.52	63.35	11.49
51 - 6	16945.79	17.04	2.38	0.00	61.50	63.33	11.49
51 - 9	16980.26	17.11	2.37	0.00	61.48	63.31	11.49
52 - 0	17014.73	17.18	2.37	0.00	61.46	63.28	11.49
52 - 3	17049.20	17.25	2.36	0.00	61.44	63.26	11.49
52 - 6	17083.67	17.33	2.36	0.00	61.42	63.24	11.49
52 - 9	17118.13	17.40	2.36	0.00	61.40	63.22	11.49
53 - 0	17152.60	17.47	2.35	0.00	61.39	63.19	11.49
53 - 3	17187.07	17.54	2.35	0.00	61.37	63.18	11.49
53 - 6	17221.54	17.61	2.34	0.00	61.35	63.16	11.49
53 - 9	17256.00	17.68	2.34	0.00	61.34	63.14	11.49
54 - 0	17290.47	17.75	2.33	0.00	61.32	63.12	11.49
54 - 3	17324.94	17.83	2.33	0.00	61.31	63.10	11.49
54 - 6	17359.41	17.90	2.32	0.00	61.30	63.08	11.49
54 - 9	17393.88	17.97	2.32	0.00	61.28	63.07	11.49

DRAFT Ft - in	Displacement LT	VCB Ft	LCB Ft	LCF Ft	KML Ft	KMT Ft	TPI LT/in
55 - 0	17428.34	18.05	2.31	0.00	61.27	63.05	11.49
55 - 3	17462.81	18.12	2.31	0.00	61.26	63.03	11.49
55 - 6	17497.28	18.19	2.30	0.00	61.25	63.02	11.49
55 - 9	17531.75	18.27	2.30	0.00	61.24	63.00	11.49
56 - 0	17566.21	18.34	2.30	0.00	61.22	62.99	11.49
56 - 3	17600.68	18.41	2.29	0.00	61.22	62.98	11.49
56 - 6	17635.15	18.49	2.29	0.00	61.21	62.96	11.49
56 - 9	17669.62	18.56	2.28	0.00	61.20	62.95	11.49
57 - 0	17704.09	18.64	2.28	0.00	61.19	62.94	11.49
57 - 3	17738.55	18.71	2.27	0.00	61.18	62.93	11.49
57 - 6	17773.02	18.79	2.27	0.00	61.17	62.92	11.49
57 - 9	17807.49	18.86	2.26	0.00	61.17	62.91	11.49
58 - 0	17841.96	18.94	2.26	0.00	61.16	62.90	11.49
58 - 3	17876.42	19.01	2.26	0.00	61.15	62.89	11.49
58 - 6	17910.89	19.09	2.25	0.00	61.15	62.88	11.49
58 - 9	17945.36	19.16	2.25	0.00	61.14	62.87	11.49
59 - 0	17979.83	19.24	2.24	0.00	61.14	62.86	11.49
59 - 3	18014.30	19.32	2.24	0.00	61.14	62.86	11.49
59 - 6	18048.76	19.39	2.23	0.00	61.13	62.85	11.49
59 - 9	18083.23	19.47	2.23	0.00	61.13	62.84	11.49
60 - 0	18117.70	19.55	2.23	0.00	61.13	62.84	11.49
60 - 3	18152.17	19.62	2.22	0.00	61.12	62.83	11.49
60 - 6	18186.63	19.70	2.22	0.00	61.12	62.83	11.49
60 - 9	18221.10	19.78	2.21	0.00	61.12	62.83	11.49
61 - 0	18255.57	19.86	2.21	0.00	61.12	62.82	11.49
61 - 3	18290.04	19.93	2.20	0.00	61.12	62.82	11.49
61 - 6	18324.51	20.01	2.20	0.00	61.12	62.82	11.49
61 - 9	18358.97	20.09	2.20	0.00	61.12	62.81	11.49
62 - 0	18393.44	20.17	2.19	0.00	61.12	62.81	11.49
62 - 3	18427.91	20.25	2.19	0.00	61.13	62.81	11.49
62 - 6	18462.38	20.33	2.18	0.00	61.13	62.81	11.49
62 - 9	18496.84	20.40	2.18	0.00	61.13	62.81	11.49
63 - 0	18531.31	20.48	2.18	0.00	61.13	62.81	11.49
63 - 3	18565.78	20.56	2.17	0.00	61.14	62.81	11.49
63 - 6	18600.25	20.64	2.17	0.00	61.14	62.81	11.49
63 - 9	18634.72	20.72	2.16	0.00	61.15	62.81	11.49
64 - 0	18669.18	20.80	2.16	0.00	61.15	62.81	11.49

Figure 12
LIGHTWEIGHT CORRECTION
FOR DEPLOYED CHAIN

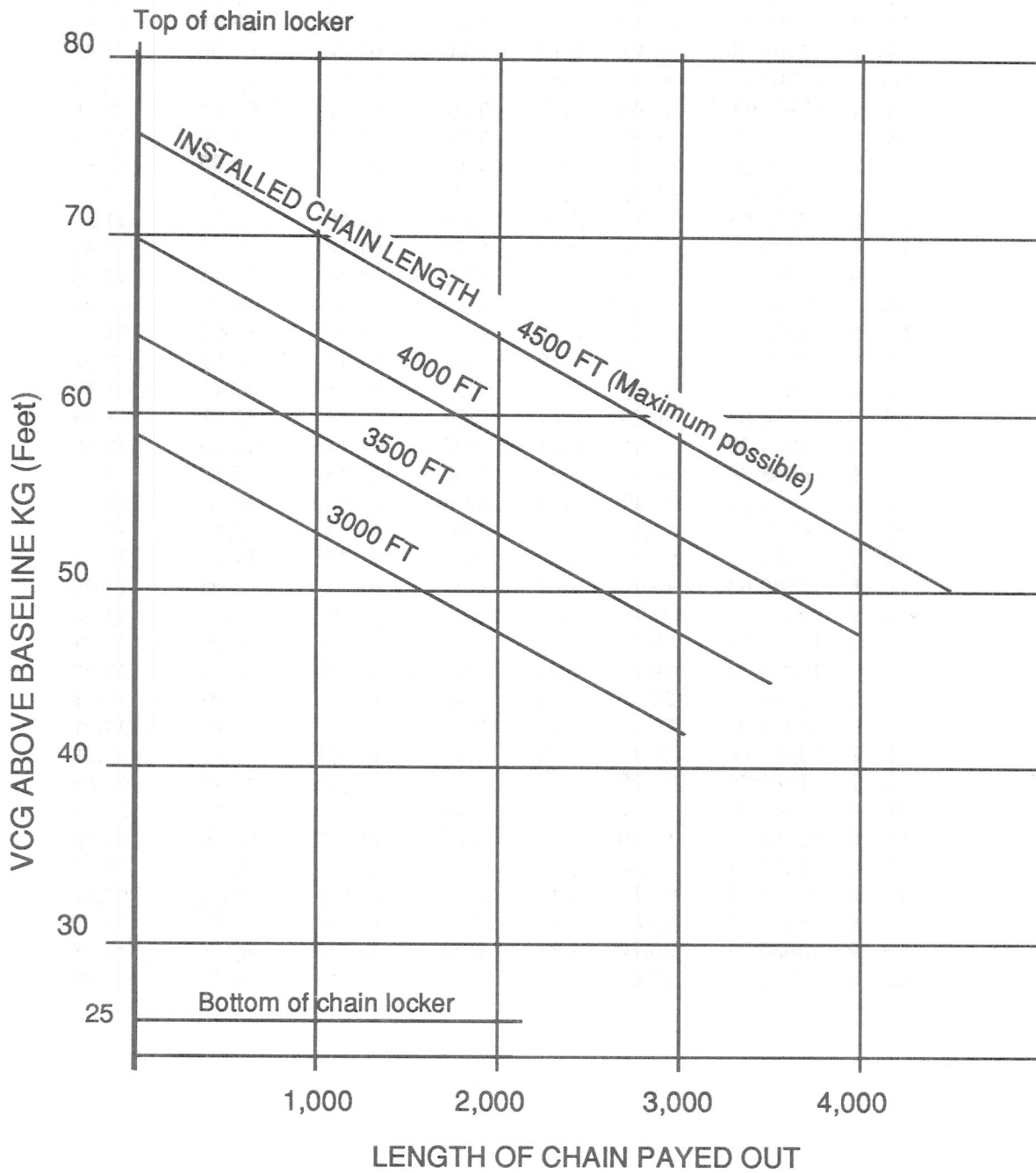

Figure 13
VERTICAL COMPONENT OF LINE TENSION
(long tons per mooring line)

Anchor Line Tension (kips)	WATER DEPTH IN FEET							
	200	300	400	500	600	700	800	900
50	15.8	18.7	20.5	21.7	22.2	•	•	•
60	17.6	20.9	23.3	24.9	26.0	26.6	•	•
70	19.2	23.0	25.8	27.8	29.3	30.4	31.0	•
80	20.7	24.9	28.0	30.4	32.3	33.7	34.7	35.4
90	22.1	26.6	30.1	32.8	35.0	36.8	38.1	39.1
100	23.4	28.3	32.0	35.1	37.6	39.6	41.2	42.5
110	24.6	29.8	33.9	37.2	39.9	42.2	44.1	45.6
120	25.8	31.3	35.6	39.2	42.2	44.7	46.8	48.6
130	26.9	32.7	37.3	41.1	44.3	47.0	49.3	51.3
140	28.0	34.0	38.9	42.9	46.3	49.2	51.8	53.9
150	29.0	35.3	40.4	44.6	48.2	51.4	54.1	56.4
160	30.0	36.6	41.9	46.3	50.1	53.4	56.3	58.8
170	31.0	37.8	43.3	47.9	51.9	55.4	58.4	61.1
180	31.9	39.0	44.7	49.5	53.6	57.3	60.5	63.4
190	32.8	40.1	46.0	51.0	55.3	59.1	62.5	65.5
200	33.7	41.2	47.3	52.5	56.9	60.9	64.4	67.6
210	34.6	42.3	48.6	53.9	58.5	62.6	66.3	69.6
220	35.4	43.3	49.8	55.3	60.1	64.3	68.1	71.6
230	36.2	44.4	51.0	56.6	61.6	66.0	69.9	73.5
240	37.0	45.4	52.2	58.0	63.0	67.6	71.6	75.3
250	37.8	46.4	53.3	59.3	64.5	69.1	73.3	77.1
260	38.6	47.3	54.4	60.5	65.9	70.7	75.0	78.9
270	39.4	48.3	55.5	61.8	67.3	72.2	76.6	80.6
280	40.1	49.2	56.6	63.0	68.6	73.6	78.2	82.3
290	40.8	50.1	57.7	64.2	69.9	75.1	79.7	84.0
300	41.5	51.0	58.7	65.4	71.2	76.5	81.2	85.6
310	42.2	51.9	59.7	66.5	72.5	77.9	82.7	87.2
320	42.9	52.7	60.7	67.6	73.7	79.2	84.2	88.8
330	43.6	53.6	61.7	68.8	75.0	80.6	85.7	90.3
340	44.3	54.4	62.7	69.9	76.2	81.9	87.1	91.8
350	44.9	55.2	63.7	70.9	77.4	83.2	88.5	93.3
360	45.6	56.0	64.6	72.0	78.6	84.5	89.8	94.8
370	46.2	56.8	65.5	73.1	79.7	85.7	91.2	96.2
380	46.9	57.6	66.5	74.1	80.9	87.0	92.5	97.7
390	47.5	58.4	67.4	75.1	82.0	88.2	93.9	99.1
400	48.1	59.1	68.2	76.1	83.1	89.4	95.1	100.5
410	48.7	59.9	69.1	77.1	84.2	90.6	96.4	101.8
420	49.3	60.7	70.0	78.1	85.3	91.8	97.7	103.2
430	49.9	61.4	70.9	79.1	86.3	92.9	98.9	104.5
440	50.5	62.1	71.7	80.0	87.4	94.1	100.2	105.8
450	51.1	62.8	72.5	81.0	88.4	95.2	101.4	107.1
460	51.7	63.5	73.4	81.9	89.5	96.3	102.6	108.4
470	52.2	64.3	74.2	82.8	90.5	97.4	103.8	109.7
480	52.8	65.0	75.0	83.7	91.5	98.5	105.0	110.9
490	53.3	65.6	75.8	84.6	92.5	99.6	106.1	112.1
500	53.9	66.3	76.6	85.5	93.5	100.7	107.3	113.4

Figure 14
ANCHOR CHAIN — CATENARY LENGTH IN FEET

Anchor Line Tension (kips)	WATER DEPTH IN FEET							
	200	300	400	500	600	700	800	900
50	456	537	591	624	640	•	•	•
60	507	602	670	718	749	766	•	•
70	553	661	741	801	844	874	892	•
80	595	715	806	876	930	970	1000	1018
90	635	766	866	945	1008	1058	1096	1125
100	672	813	922	1009	1080	1139	1185	1222
110	708	857	975	1070	1148	1214	1268	1312
120	741	900	1025	1127	1213	1285	1346	1397
130	774	940	1072	1182	1274	1352	1419	1476
140	804	979	1118	1234	1332	1416	1489	1552
150	834	1016	1162	1284	1387	1477	1556	1624
160	863	1052	1204	1332	1441	1536	1619	1693
170	891	1087	1245	1378	1493	1593	1681	1759
180	918	1121	1285	1423	1543	1647	1740	1823
190	944	1154	1323	1467	1591	1700	1798	1885
200	970	1186	1361	1509	1638	1752	1853	1944
210	994	1217	1397	1550	1684	1802	1907	2002
220	1019	1247	1432	1590	1728	1850	1960	2058
230	1042	1276	1467	1629	1771	1897	2011	2113
240	1065	1305	1501	1668	1814	1944	2061	2167
250	1088	1333	1534	1705	1855	1989	2109	2219
260	1110	1361	1566	1741	1895	2033	2157	2270
270	1132	1388	1598	1777	1935	2076	2203	2320
280	1153	1415	1629	1812	1974	2118	2249	2368
290	1174	1441	1659	1847	2012	2160	2294	2416
300	1195	1466	1689	1880	2049	2200	2337	2463
310	1215	1492	1719	1914	2086	2240	2380	2509
320	1235	1516	1747	1946	2122	2279	2423	2554
330	1255	1541	1776	1978	2157	2318	2464	2598
340	1274	1565	1804	2010	2192	2356	2505	2642
350	1293	1588	1831	2041	2226	2393	2545	2685
360	1312	1612	1859	2071	2260	2430	2585	2727
370	1330	1635	1885	2102	2293	2466	2624	2769
380	1349	1657	1912	2131	2326	2502	2662	2810
390	1366	1680	1938	2161	2358	2537	2700	2850
400	1384	1702	1963	2190	2390	2572	2737	2890
410	1402	1723	1989	2218	2422	2606	2774	2929
420	1419	1745	2014	2246	2453	2640	2810	2968
430	1436	1766	2039	2274	2484	2673	2846	3006
440	1453	1787	2063	2302	2514	2706	2882	3044
450	1470	1808	2087	2329	2544	2739	2917	3081
460	1486	1828	2111	2356	2574	2771	2951	3118
470	1503	1848	2135	2382	2603	2802	2986	3155
480	1519	1869	2158	2409	2632	2834	3019	3191
490	1535	1888	2181	2435	2660	2865	3053	3226
500	1551	1908	2204	2460	2689	2896	3086	3262

Figure 15
Significant wave height - bow

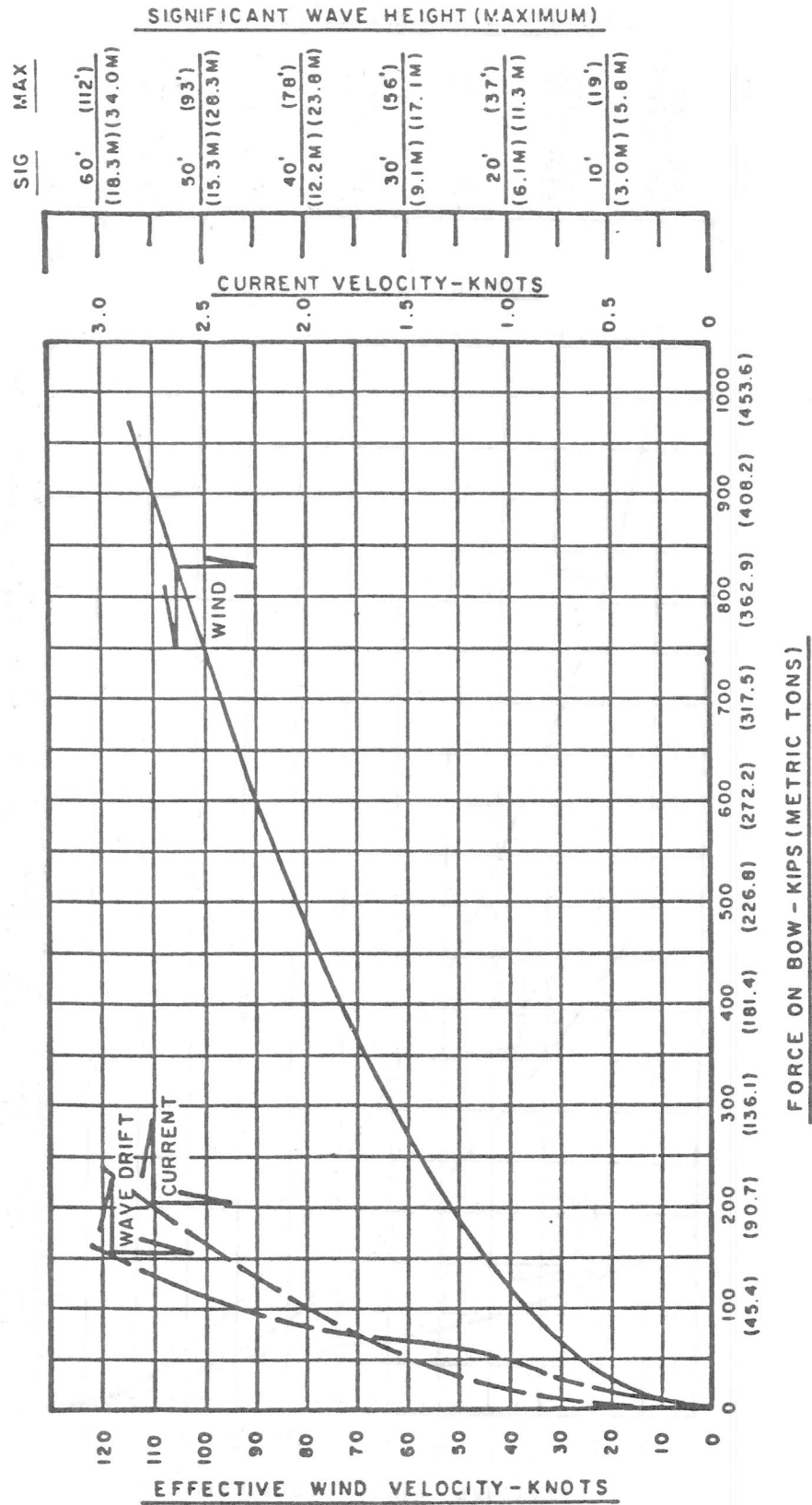

Figure 16
Significant wave height - beam

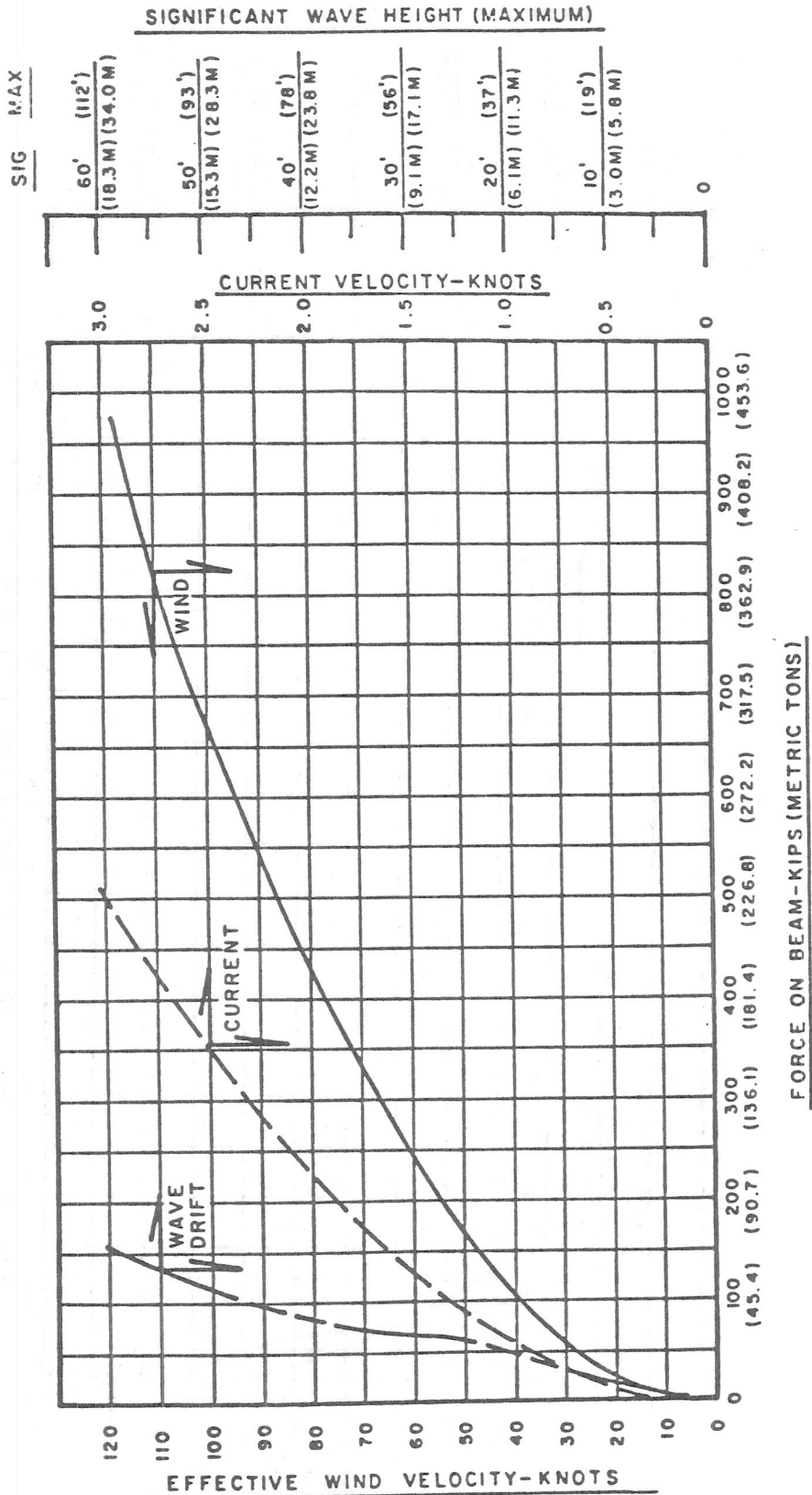
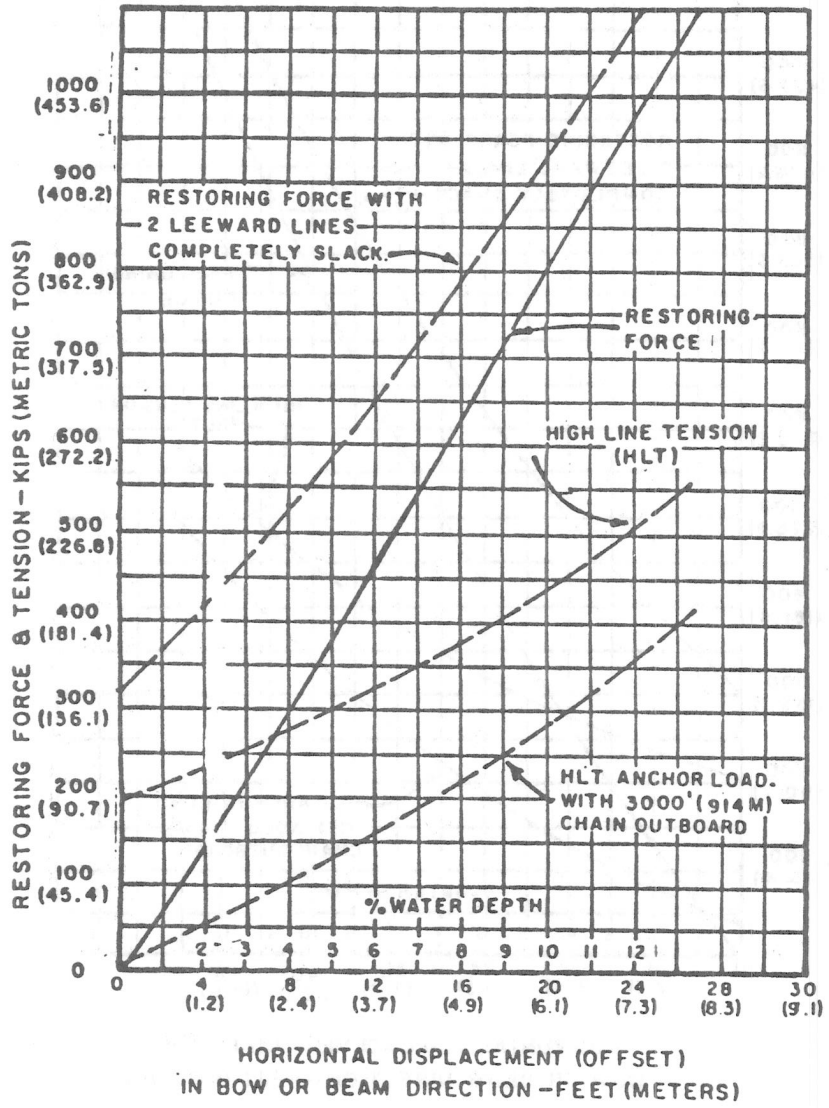
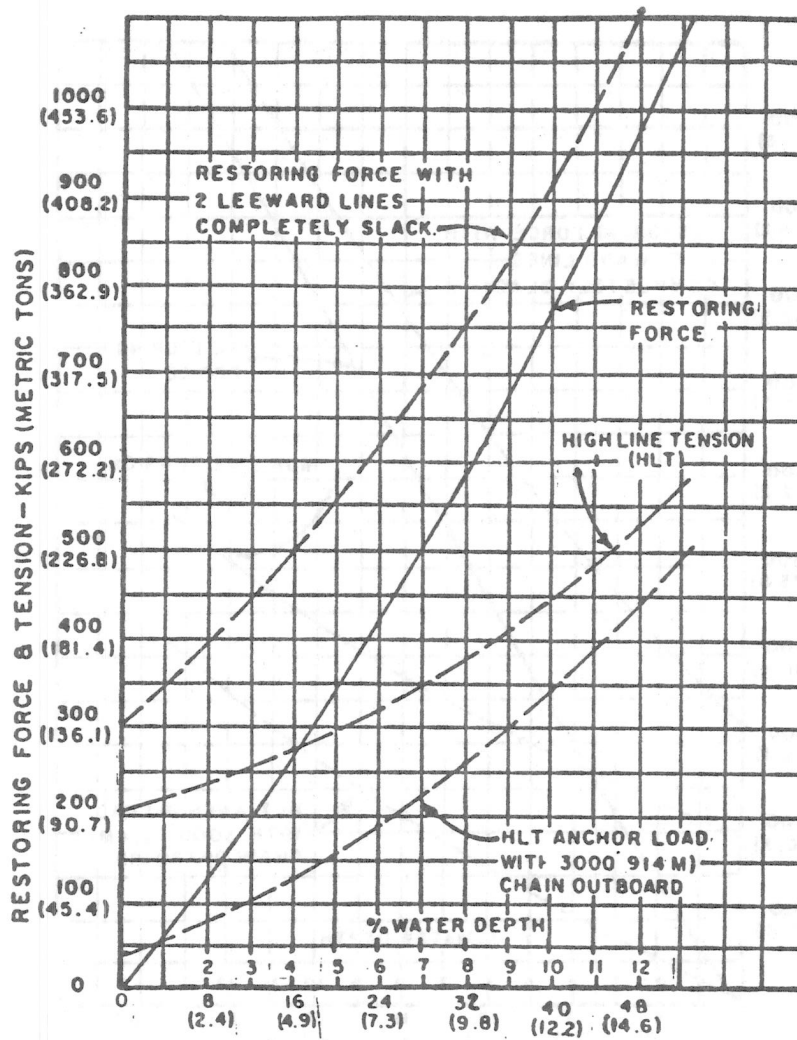

Figure 17
Mooring Analysis - 200 foot water depth



200 FT (61.0M) WATER DEPTH

Figure 18
Mooring Analysis - 400 foot water depth



HORIZONTAL DISPLACEMENT (OFFSET)
IN BOW OR BEAM DIRECTION - FEET (METERS)

400 FT. (121.9 M) WATER DEPTH

Figure 19
Mooring Analysis - 600 foot water depth

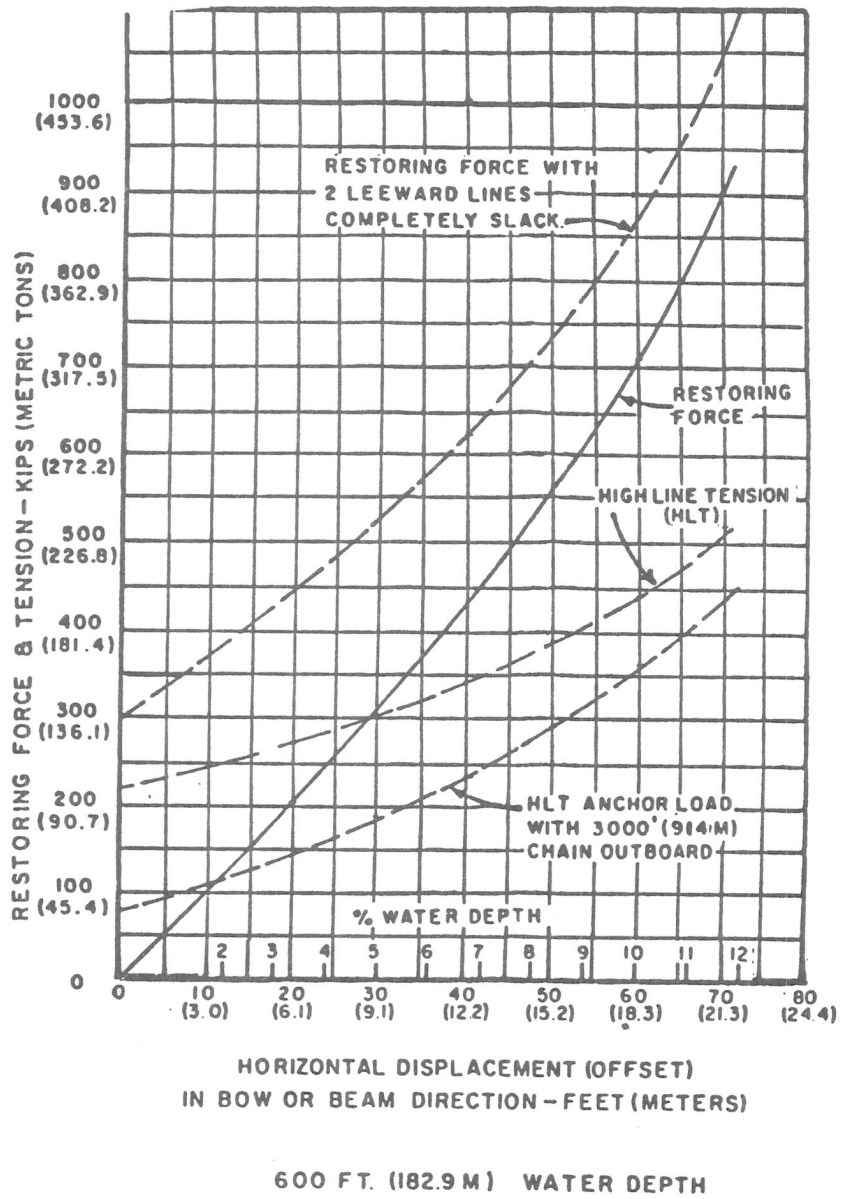

SECTION 6.0 TANK TABLES

REFERENCES:

VCG = Vertical Center of Gravity above Baseline

LCG = Longitudinal Center of Gravity in feet; forward being plus, or aft being minus, from midships (frame 27)

TCG = Transverse Center of Gravity in feet; starboard being plus, or port being minus; off centerline

L-tons = Long tons of 2240 pounds

ASSUMPTIONS:

- Rig is level without heel or trim
- Structural deduction for volume is 2%
- Densities are in accordance with the Table below:

Drill water	62.40 lbs/cuft
Potable water	62.40 lbs/cuft
Sea water	64.00 lbs/cuft
Fuel oil	54.00 lbs/cuft

**6.1
Ready Reference**

TANK SOUNDINGS

Tank	Service	Capacity Long tons	Weight/Sounding long tons/ft	FSML	FSMT
1	SW Ballast	689.85	34.4925	6707	1797
2	SW Ballast	688.42	34.4210	6666	1793
3	SW Ballast	688.28	34.4140	6666	1793
4	Fuel Oil	456.24	22.8120	2835	1189
5	Drill Water	537.73	26.8865	3328	1396
6	Fuel Oil	162.07	8.1035	199	270
7	Pot Water	191.02	9.5510	317	233
8	SW Ballast	744.12	37.2060	8418	1938
9	SW Ballast	551.74	27.5870	3423	1436
10	SW Ballast	375.92	37.5920	1733	4008
C1	SW Ballast	1185.50	19.7583	1139	1139
C2A	(Upper SW Ballast)	413.40	20.6800	1247	1247
C2B	(Lower SW Ballast)	826.80	20.6700	1247	1247
C3	SW Ballast	1140.85	19.0142	1055	1055

TANK COORDINATES

Tank	VCG	LCG	TCG
1	0.5 x Sounding	105.76	±75.00
2	0.5 x Sounding	65.00	±87.25
3	0.5 x Sounding	64.98	±62.75
4	0.5 x Sounding	20.00	±87.25
5	0.5 x Sounding	20.00	±62.75
6	0.5 x Sounding	-8.50	±87.50
7	0.5 x Sounding	-26.50	±87.50
8	0.5 x Sounding	-62.50	±62.80
9	0.5 x Sounding	-62.50	±87.20
10	0.5 x Sounding + 10.0	-106.00	±71.70
C1	0.5 x Sounding + 20.0	90.00	±75.00
C2A	0.5 x Sounding + 60.0	00.00	±75.00
C2B	0.5 x Sounding + 20.0	00.00	±75.00
C3	0.5 x Sounding + 20.0	-90.00	±75.00

NOTES:

- 1) Tanks are symmetrical port and starboard hulls.
- 2) TCG's are negative for port tanks, positive for starboard tanks.

SALT WATER BALLAST TANKS 1P AND 1S

SOUNDING ft	WEIGHT LT	VCG ft	SOUNDING ft	WEIGHT LT	VCG ft
0.25	8.62	0.13	10.25	353.55	5.13
0.50	17.25	0.25	10.50	362.18	5.25
0.75	25.87	0.38	10.75	370.80	5.38
1.00	34.49	0.50	11.00	379.42	5.50
1.25	43.12	0.63	11.25	388.05	5.63
1.50	51.74	0.75	11.50	396.67	5.75
1.75	60.36	0.88	11.75	405.29	5.88
2.00	68.99	1.00	12.00	413.92	6.00
2.25	77.61	1.13	12.25	422.54	6.13
2.50	86.23	1.25	12.50	431.16	6.25
2.75	94.86	1.38	12.75	439.79	6.38
3.00	103.48	1.50	13.00	448.41	6.50
3.25	112.10	1.63	13.25	457.03	6.63
3.50	120.73	1.75	13.50	465.66	6.75
3.75	129.35	1.88	13.75	474.28	6.88
4.00	137.97	2.00	14.00	482.90	7.00
4.25	146.60	2.13	14.25	491.53	7.13
4.50	155.22	2.25	14.50	500.15	7.25
4.75	163.84	2.38	14.75	508.77	7.38
5.00	172.47	2.50	15.00	517.40	7.50
5.25	181.09	2.63	15.25	526.02	7.63
5.50	189.71	2.75	15.50	534.64	7.75
5.75	198.33	2.88	15.75	543.26	7.88
6.00	206.96	3.00	16.00	551.89	8.00
6.25	215.58	3.13	16.25	560.51	8.13
6.50	224.20	3.25	16.50	569.13	8.25
6.75	232.83	3.38	16.75	577.76	8.38
7.00	241.45	3.50	17.00	586.38	8.50
7.25	250.07	3.63	17.25	595.00	8.63
7.50	258.70	3.75	17.50	603.63	8.75
7.75	267.32	3.88	17.75	612.25	8.88
8.00	275.94	4.00	18.00	620.87	9.00
8.25	284.57	4.13	18.25	629.50	9.13
8.50	293.19	4.25	18.50	638.12	9.25
8.75	301.81	4.38	18.75	646.74	9.38
9.00	310.44	4.50	19.00	655.37	9.50
9.25	319.06	4.63	19.25	663.99	9.63
9.50	327.68	4.75	19.50	672.61	9.75
9.75	336.31	4.88	19.75	681.24	9.88
10.00	344.93	5.00	20.00	689.86	10.00

LCG 105.76 ft
TCG +/- 75.00 ft

FSML 6707 ft-tons
FSMT 1797 ft-tons

SALT WATER BALLAST TANKS 2P AND 2S

SOUNDING ft	WEIGHT LT	VCG ft	SOUNDING ft	WEIGHT LT	VCG ft
0.25	8.61	0.13	10.25	352.82	5.13
0.50	17.21	0.25	10.50	361.42	5.25
0.75	25.82	0.38	10.75	370.03	5.38
1.00	34.42	0.50	11.00	378.63	5.50
1.25	43.03	0.63	11.25	387.24	5.63
1.50	51.63	0.75	11.50	395.84	5.75
1.75	60.24	0.88	11.75	404.45	5.88
2.00	68.84	1.00	12.00	413.05	6.00
2.25	77.45	1.13	12.25	421.66	6.13
2.50	86.05	1.25	12.50	430.26	6.25
2.75	94.66	1.38	12.75	438.87	6.38
3.00	103.26	1.50	13.00	447.47	6.50
3.25	111.87	1.63	13.25	456.08	6.63
3.50	120.47	1.75	13.50	464.68	6.75
3.75	129.08	1.88	13.75	473.29	6.88
4.00	137.68	2.00	14.00	481.89	7.00
4.25	146.29	2.13	14.25	490.50	7.13
4.50	154.89	2.25	14.50	499.10	7.25
4.75	163.50	2.38	14.75	507.71	7.38
5.00	172.11	2.50	15.00	516.31	7.50
5.25	180.71	2.63	15.25	524.92	7.63
5.50	189.32	2.75	15.50	533.53	7.75
5.75	197.92	2.88	15.75	542.13	7.88
6.00	206.53	3.00	16.00	550.74	8.00
6.25	215.13	3.13	16.25	559.34	8.13
6.50	223.74	3.25	16.50	567.95	8.25
6.75	232.34	3.38	16.75	576.55	8.38
7.00	240.95	3.50	17.00	585.16	8.50
7.25	249.55	3.63	17.25	593.76	8.63
7.50	258.16	3.75	17.50	602.37	8.75
7.75	266.76	3.88	17.75	610.97	8.88
8.00	275.37	4.00	18.00	619.58	9.00
8.25	283.97	4.13	18.25	628.18	9.13
8.50	292.58	4.25	18.50	636.79	9.25
8.75	301.18	4.38	18.75	645.39	9.38
9.00	309.79	4.50	19.00	654.00	9.50
9.25	318.39	4.63	19.25	662.60	9.63
9.50	327.00	4.75	19.50	671.21	9.75
9.75	335.60	4.88	19.75	679.81	9.88
10.00	344.21	5.00	20.00	688.42	10.00

LCG 65.00 ft
TCG +/- 87.25 ft

FSML 6666 ft-tons
FSMT 1793 ft-tons

SALT WATER BALLAST TANKS 3P AND 3S

SOUNDING ft	WEIGHT LT	VCG ft	SOUNDING ft	WEIGHT LT	VCG ft
0.25	8.60	0.13	10.25	352.74	5.13
0.50	17.21	0.25	10.50	361.35	5.25
0.75	25.81	0.38	10.75	369.95	5.38
1.00	34.41	0.50	11.00	378.55	5.50
1.25	43.02	0.63	11.25	387.16	5.63
1.50	51.62	0.75	11.50	395.76	5.75
1.75	60.22	0.88	11.75	404.36	5.88
2.00	68.83	1.00	12.00	412.97	6.00
2.25	77.43	1.13	12.25	421.57	6.13
2.50	86.04	1.25	12.50	430.18	6.25
2.75	94.64	1.38	12.75	438.78	6.38
3.00	103.24	1.50	13.00	447.38	6.50
3.25	111.85	1.63	13.25	455.99	6.63
3.50	120.45	1.75	13.50	464.59	6.75
3.75	129.05	1.88	13.75	473.19	6.88
4.00	137.66	2.00	14.00	481.80	7.00
4.25	146.26	2.13	14.25	490.40	7.13
4.50	154.86	2.25	14.50	499.00	7.25
4.75	163.47	2.38	14.75	507.61	7.38
5.00	172.07	2.50	15.00	516.21	7.50
5.25	180.67	2.63	15.25	524.81	7.63
5.50	189.28	2.75	15.50	533.42	7.75
5.75	197.88	2.88	15.75	542.02	7.88
6.00	206.48	3.00	16.00	550.62	8.00
6.25	215.09	3.13	16.25	559.23	8.13
6.50	223.69	3.25	16.50	567.83	8.25
6.75	232.29	3.38	16.75	576.43	8.38
7.00	240.90	3.50	17.00	585.04	8.50
7.25	249.50	3.63	17.25	593.64	8.63
7.50	258.11	3.75	17.50	602.25	8.75
7.75	266.71	3.88	17.75	610.85	8.88
8.00	275.31	4.00	18.00	619.45	9.00
8.25	283.92	4.13	18.25	628.06	9.13
8.50	292.52	4.25	18.50	636.66	9.25
8.75	301.12	4.38	18.75	645.26	9.38
9.00	309.73	4.50	19.00	653.87	9.50
9.25	318.33	4.63	19.25	662.47	9.63
9.50	326.93	4.75	19.50	671.07	9.75
9.75	335.54	4.88	19.75	679.68	9.88
10.00	344.14	5.00	20.00	688.28	10.00

LCG 64.98 ft
TCG +/- 62.75 ft

FSML 6666 ft-tons
FSMT 1793 ft-tons

FUEL OIL TANKS 4P AND 4S

SOUNDING ft	WEIGHT LT	VCG ft	SOUNDING ft	WEIGHT LT	VCG ft
0.25	5.70	0.13	10.25	233.82	5.13
0.50	11.41	0.25	10.50	239.53	5.25
0.75	17.11	0.38	10.75	245.23	5.38
1.00	22.81	0.50	11.00	250.93	5.50
1.25	28.52	0.63	11.25	256.64	5.63
1.50	34.22	0.75	11.50	262.34	5.75
1.75	39.92	0.88	11.75	268.04	5.88
2.00	45.62	1.00	12.00	273.74	6.00
2.25	51.33	1.13	12.25	279.45	6.13
2.50	57.03	1.25	12.50	285.15	6.25
2.75	62.73	1.38	12.75	290.85	6.38
3.00	68.44	1.50	13.00	296.56	6.50
3.25	74.14	1.63	13.25	302.26	6.63
3.50	79.84	1.75	13.50	307.96	6.75
3.75	85.55	1.88	13.75	313.67	6.88
4.00	91.25	2.00	14.00	319.37	7.00
4.25	96.95	2.13	14.25	325.07	7.13
4.50	102.65	2.25	14.50	330.77	7.25
4.75	108.36	2.38	14.75	336.48	7.38
5.00	114.06	2.50	15.00	342.18	7.50
5.25	119.76	2.63	15.25	347.88	7.63
5.50	125.47	2.75	15.50	353.59	7.75
5.75	131.17	2.88	15.75	359.29	7.88
6.00	136.87	3.00	16.00	364.99	8.00
6.25	142.58	3.13	16.25	370.70	8.13
6.50	148.28	3.25	16.50	376.40	8.25
6.75	153.98	3.38	16.75	382.10	8.38
7.00	159.68	3.50	17.00	387.80	8.50
7.25	165.39	3.63	17.25	393.51	8.63
7.50	171.09	3.75	17.50	399.21	8.75
7.75	176.79	3.88	17.75	404.91	8.88
8.00	182.50	4.00	18.00	410.62	9.00
8.25	188.20	4.13	18.25	416.32	9.13
8.50	193.90	4.25	18.50	422.02	9.25
8.75	199.61	4.38	18.75	427.73	9.38
9.00	205.31	4.50	19.00	433.43	9.50
9.25	211.01	4.63	19.25	439.13	9.63
9.50	216.71	4.75	19.50	444.83	9.75
9.75	222.42	4.88	19.75	450.54	9.88
10.00	228.12	5.00	20.00	456.24	10.00

LCG 20.00 ft
TCG +/- 87.25 ft

FSML 2835 ft-tons
FSMT 1189 ft-tons

DRILL WATER TANKS 5P AND 5S

SOUNDING ft	WEIGHT LT	VCG ft	SOUNDING ft	WEIGHT LT	VCG ft
0.25	6.72	0.13	10.25	275.59	5.13
0.50	13.44	0.25	10.50	282.31	5.25
0.75	20.17	0.38	10.75	289.04	5.38
1.00	26.89	0.50	11.00	295.76	5.50
1.25	33.61	0.63	11.25	302.48	5.63
1.50	40.33	0.75	11.50	309.20	5.75
1.75	47.05	0.88	11.75	315.92	5.88
2.00	53.77	1.00	12.00	322.64	6.00
2.25	60.50	1.13	12.25	329.37	6.13
2.50	67.22	1.25	12.50	336.09	6.25
2.75	73.94	1.38	12.75	342.81	6.38
3.00	80.66	1.50	13.00	349.53	6.50
3.25	87.38	1.63	13.25	356.25	6.63
3.50	94.10	1.75	13.50	362.97	6.75
3.75	100.83	1.88	13.75	369.70	6.88
4.00	107.55	2.00	14.00	376.42	7.00
4.25	114.27	2.13	14.25	383.14	7.13
4.50	120.99	2.25	14.50	389.86	7.25
4.75	127.71	2.38	14.75	396.58	7.38
5.00	134.44	2.50	15.00	403.31	7.50
5.25	141.16	2.63	15.25	410.03	7.63
5.50	147.88	2.75	15.50	416.75	7.75
5.75	154.60	2.88	15.75	423.47	7.88
6.00	161.32	3.00	16.00	430.19	8.00
6.25	168.04	3.13	16.25	436.91	8.13
6.50	174.77	3.25	16.50	443.64	8.25
6.75	181.49	3.38	16.75	450.36	8.38
7.00	188.21	3.50	17.00	457.08	8.50
7.25	194.93	3.63	17.25	463.80	8.63
7.50	201.65	3.75	17.50	470.52	8.75
7.75	208.37	3.88	17.75	477.24	8.88
8.00	215.10	4.00	18.00	483.97	9.00
8.25	221.82	4.13	18.25	490.69	9.13
8.50	228.54	4.25	18.50	497.41	9.25
8.75	235.26	4.38	18.75	504.13	9.38
9.00	241.98	4.50	19.00	510.85	9.50
9.25	248.70	4.63	19.25	517.57	9.63
9.50	255.43	4.75	19.50	524.30	9.75
9.75	262.15	4.88	19.75	531.02	9.88
10.00	268.87	5.00	20.00	537.74	10.00

LCG 20.00 ft
TCG +/- 62.75 ft

FSML 3328 ft-tons
FSMT 1396 ft-tons

FUEL OIL TANKS 6P AND 6S

SOUNDING ft	WEIGHT LT	VCG ft	SOUNDING ft	WEIGHT LT	VCG ft
0.25	2.03	0.13	10.25	83.07	5.13
0.50	4.05	0.25	10.50	85.09	5.25
0.75	6.08	0.38	10.75	87.12	5.38
1.00	8.10	0.50	11.00	89.14	5.50
1.25	10.13	0.63	11.25	91.17	5.63
1.50	12.16	0.75	11.50	93.20	5.75
1.75	14.18	0.88	11.75	95.22	5.88
2.00	16.21	1.00	12.00	97.25	6.00
2.25	18.23	1.13	12.25	99.27	6.13
2.50	20.26	1.25	12.50	101.30	6.25
2.75	22.29	1.38	12.75	103.33	6.38
3.00	24.31	1.50	13.00	105.35	6.50
3.25	26.34	1.63	13.25	107.38	6.63
3.50	28.36	1.75	13.50	109.40	6.75
3.75	30.39	1.88	13.75	111.43	6.88
4.00	32.42	2.00	14.00	113.46	7.00
4.25	34.44	2.13	14.25	115.48	7.13
4.50	36.47	2.25	14.50	117.51	7.25
4.75	38.49	2.38	14.75	119.53	7.38
5.00	40.52	2.50	15.00	121.56	7.50
5.25	42.55	2.63	15.25	123.59	7.63
5.50	44.57	2.75	15.50	125.61	7.75
5.75	46.60	2.88	15.75	127.64	7.88
6.00	48.62	3.00	16.00	129.66	8.00
6.25	50.65	3.13	16.25	131.69	8.13
6.50	52.68	3.25	16.50	133.72	8.25
6.75	54.70	3.38	16.75	135.74	8.38
7.00	56.73	3.50	17.00	137.77	8.50
7.25	58.75	3.63	17.25	139.79	8.63
7.50	60.78	3.75	17.50	141.82	8.75
7.75	62.81	3.88	17.75	143.85	8.88
8.00	64.83	4.00	18.00	145.87	9.00
8.25	66.86	4.13	18.25	147.90	9.13
8.50	68.88	4.25	18.50	149.92	9.25
8.75	70.91	4.38	18.75	151.95	9.38
9.00	72.94	4.50	19.00	153.98	9.50
9.25	74.96	4.63	19.25	156.00	9.63
9.50	76.99	4.75	19.50	158.03	9.75
9.75	79.01	4.88	19.75	160.05	9.88
10.00	81.04	5.00	20.00	162.08	10.00

LCG - 8.50 ft
TCG +/- 87.50 ft

FSML 199 ft-tons
FSMT 270 ft-tons

POTABLE WATER TANKS 7P AND 7S

SOUNDING ft	WEIGHT LT	VCG ft	SOUNDING ft	WEIGHT LT	VCG ft
0.25	2.39	0.13	10.25	97.90	5.13
0.50	4.78	0.25	10.50	100.29	5.25
0.75	7.16	0.38	10.75	102.67	5.38
1.00	9.55	0.50	11.00	105.06	5.50
1.25	11.94	0.63	11.25	107.45	5.63
1.50	14.33	0.75	11.50	109.84	5.75
1.75	16.71	0.88	11.75	112.22	5.88
2.00	19.10	1.00	12.00	114.61	6.00
2.25	21.49	1.13	12.25	117.00	6.13
2.50	23.88	1.25	12.50	119.39	6.25
2.75	26.27	1.38	12.75	121.78	6.38
3.00	28.65	1.50	13.00	124.16	6.50
3.25	31.04	1.63	13.25	126.55	6.63
3.50	33.43	1.75	13.50	128.94	6.75
3.75	35.82	1.88	13.75	131.33	6.88
4.00	38.20	2.00	14.00	133.71	7.00
4.25	40.59	2.13	14.25	136.10	7.13
4.50	42.98	2.25	14.50	138.49	7.25
4.75	45.37	2.38	14.75	140.88	7.38
5.00	47.76	2.50	15.00	143.27	7.50
5.25	50.14	2.63	15.25	145.65	7.63
5.50	52.53	2.75	15.50	148.04	7.75
5.75	54.92	2.88	15.75	150.43	7.88
6.00	57.31	3.00	16.00	152.82	8.00
6.25	59.69	3.13	16.25	155.20	8.13
6.50	62.08	3.25	16.50	157.59	8.25
6.75	64.47	3.38	16.75	159.98	8.38
7.00	66.86	3.50	17.00	162.37	8.50
7.25	69.24	3.63	17.25	164.75	8.63
7.50	71.63	3.75	17.50	167.14	8.75
7.75	74.02	3.88	17.75	169.53	8.88
8.00	76.41	4.00	18.00	171.92	9.00
8.25	78.80	4.13	18.25	174.31	9.13
8.50	81.18	4.25	18.50	176.69	9.25
8.75	83.57	4.38	18.75	179.08	9.38
9.00	85.96	4.50	19.00	181.47	9.50
9.25	88.35	4.63	19.25	183.86	9.63
9.50	90.73	4.75	19.50	186.24	9.75
9.75	93.12	4.88	19.75	188.63	9.88
10.00	95.51	5.00	20.00	191.02	10.00

LCG - 26.50 ft
TCG +/- 87.50 ft

FSML 317 ft-tons
FSMT 233 ft-tons

SALT WATER BALLAST TANKS 8P AND 8S

SOUNDING ft	WEIGHT LT	VCG ft	SOUNDING ft	WEIGHT LT	VCG ft
0.25	9.30	0.13	10.25	381.36	5.13
0.50	18.60	0.25	10.50	390.66	5.25
0.75	27.90	0.38	10.75	399.96	5.38
1.00	37.21	0.50	11.00	409.27	5.50
1.25	46.51	0.63	11.25	418.57	5.63
1.50	55.81	0.75	11.50	427.87	5.75
1.75	65.11	0.88	11.75	437.17	5.88
2.00	74.41	1.00	12.00	446.47	6.00
2.25	83.71	1.13	12.25	455.77	6.13
2.50	93.02	1.25	12.50	465.08	6.25
2.75	102.32	1.38	12.75	474.38	6.38
3.00	111.62	1.50	13.00	483.68	6.50
3.25	120.92	1.63	13.25	492.98	6.63
3.50	130.22	1.75	13.50	502.28	6.75
3.75	139.52	1.88	13.75	511.58	6.88
4.00	148.82	2.00	14.00	520.88	7.00
4.25	158.13	2.13	14.25	530.19	7.13
4.50	167.43	2.25	14.50	539.49	7.25
4.75	176.73	2.38	14.75	548.79	7.38
5.00	186.03	2.50	15.00	558.09	7.50
5.25	195.33	2.63	15.25	567.39	7.63
5.50	204.63	2.75	15.50	576.69	7.75
5.75	213.93	2.88	15.75	585.99	7.88
6.00	223.24	3.00	16.00	595.30	8.00
6.25	232.54	3.13	16.25	604.60	8.13
6.50	241.84	3.25	16.50	613.90	8.25
6.75	251.14	3.38	16.75	623.20	8.38
7.00	260.44	3.50	17.00	632.50	8.50
7.25	269.74	3.63	17.25	641.80	8.63
7.50	279.05	3.75	17.50	651.11	8.75
7.75	288.35	3.88	17.75	660.41	8.88
8.00	297.65	4.00	18.00	669.71	9.00
8.25	306.95	4.13	18.25	679.01	9.13
8.50	316.25	4.25	18.50	688.31	9.25
8.75	325.55	4.38	18.75	697.61	9.38
9.00	334.85	4.50	19.00	706.91	9.50
9.25	344.16	4.63	19.25	716.22	9.63
9.50	353.46	4.75	19.50	725.52	9.75
9.75	362.76	4.88	19.75	734.82	9.88
10.00	372.06	5.00	20.00	744.12	10.00

LCG - 62.50 ft
TCG +/- 62.80 ft

FSML 8418 ft-tons
FSMT 1938 ft-tons

SALT WATER BALLAST TANKS 9P AND 9S

SOUNDING ft	WEIGHT LT	VCG ft	SOUNDING ft	WEIGHT LT	VCG ft
0.25	6.90	0.13	10.25	282.77	5.13
0.50	13.79	0.25	10.50	289.66	5.25
0.75	20.69	0.38	10.75	296.56	5.38
1.00	27.59	0.50	11.00	303.46	5.50
1.25	34.48	0.63	11.25	310.35	5.63
1.50	41.38	0.75	11.50	317.25	5.75
1.75	48.28	0.88	11.75	324.15	5.88
2.00	55.17	1.00	12.00	331.04	6.00
2.25	62.07	1.13	12.25	337.94	6.13
2.50	68.97	1.25	12.50	344.84	6.25
2.75	75.86	1.38	12.75	351.73	6.38
3.00	82.76	1.50	13.00	358.63	6.50
3.25	89.66	1.63	13.25	365.53	6.63
3.50	96.55	1.75	13.50	372.42	6.75
3.75	103.45	1.88	13.75	379.32	6.88
4.00	110.35	2.00	14.00	386.22	7.00
4.25	117.24	2.13	14.25	393.11	7.13
4.50	124.14	2.25	14.50	400.01	7.25
4.75	131.04	2.38	14.75	406.91	7.38
5.00	137.94	2.50	15.00	413.81	7.50
5.25	144.83	2.63	15.25	420.70	7.63
5.50	151.73	2.75	15.50	427.60	7.75
5.75	158.63	2.88	15.75	434.50	7.88
6.00	165.52	3.00	16.00	441.39	8.00
6.25	172.42	3.13	16.25	448.29	8.13
6.50	179.32	3.25	16.50	455.19	8.25
6.75	186.21	3.38	16.75	462.08	8.38
7.00	193.11	3.50	17.00	468.98	8.50
7.25	200.01	3.63	17.25	475.88	8.63
7.50	206.90	3.75	17.50	482.77	8.75
7.75	213.80	3.88	17.75	489.67	8.88
8.00	220.70	4.00	18.00	496.57	9.00
8.25	227.59	4.13	18.25	503.46	9.13
8.50	234.49	4.25	18.50	510.36	9.25
8.75	241.39	4.38	18.75	517.26	9.38
9.00	248.28	4.50	19.00	524.15	9.50
9.25	255.18	4.63	19.25	531.05	9.63
9.50	262.08	4.75	19.50	537.95	9.75
9.75	268.97	4.88	19.75	544.84	9.88
10.00	275.87	5.00	20.00	551.74	10.00

LCG - 62.50 ft
TCG +/- 87.20 ft

FSML 3423 ft-tons
FSMT 1436 ft-tons

SALT WATER BALLAST TANKS 10P AND 10S

SOUNDING ft	WEIGHT LT	VCG ft
0.25	9.40	10.13
0.50	18.80	10.25
0.75	28.19	10.38
1.00	37.59	10.50
1.25	46.99	10.63
1.50	56.39	10.75
1.75	65.79	10.88
2.00	75.18	11.00
2.25	84.58	11.13
2.50	93.98	11.25
2.75	103.38	11.38
3.00	112.78	11.50
3.25	122.17	11.63
3.50	131.57	11.75
3.75	140.97	11.88
4.00	150.37	12.00
4.25	159.77	12.13
4.50	169.16	12.25
4.75	178.56	12.38
5.00	187.96	12.50
5.25	197.36	12.63
5.50	206.76	12.75
5.75	216.15	12.88
6.00	225.55	13.00
6.25	234.95	13.13
6.50	244.35	13.25
6.75	253.75	13.38
7.00	263.14	13.50
7.25	272.54	13.63
7.50	281.94	13.75
7.75	291.34	13.88
8.00	300.74	14.00
8.25	310.13	14.13
8.50	319.53	14.25
8.75	328.93	14.38
9.00	338.33	14.50
9.25	347.73	14.63
9.50	357.12	14.75
9.75	366.52	14.88
10.00	375.92	15.00

LCG - 106.00 ft
TCG +/- 71.70 ft

FSML 1733 ft-tons
FSMT 4008 ft-tons

SALT WATER BALLAST TANKS C1P AND C1S

SOUNDING ft	WEIGHT LT	VCG ft	SOUNDING ft	WEIGHT LT	VCG ft	SOUNDING ft	WEIGHT LT	VCG ft
0.50	9.88	20.25	20.50	405.04	30.25	40.50	800.20	40.25
1.00	19.76	20.50	21.00	414.92	30.50	41.00	810.08	40.50
1.50	29.64	20.75	21.50	424.80	30.75	41.50	819.96	40.75
2.00	39.52	21.00	22.00	434.68	31.00	42.00	829.84	41.00
2.50	49.39	21.25	22.50	444.56	31.25	42.50	839.71	41.25
3.00	59.27	21.50	23.00	454.43	31.50	43.00	849.59	41.50
3.50	69.15	21.75	23.50	464.31	31.75	43.50	859.47	41.75
4.00	79.03	22.00	24.00	474.19	32.00	44.00	869.35	42.00
4.50	88.91	22.25	24.50	484.07	32.25	44.50	879.23	42.25
5.00	98.79	22.50	25.00	493.95	32.50	45.00	889.11	42.50
5.50	108.67	22.75	25.50	503.83	32.75	45.50	898.99	42.75
6.00	118.55	23.00	26.00	513.71	33.00	46.00	908.87	43.00
6.50	128.43	23.25	26.50	523.59	33.25	46.50	918.75	43.25
7.00	138.31	23.50	27.00	533.47	33.50	47.00	928.63	43.50
7.50	148.19	23.75	27.50	543.35	33.75	47.50	938.51	43.75
8.00	158.06	24.00	28.00	553.22	34.00	48.00	948.38	44.00
8.50	167.94	24.25	28.50	563.10	34.25	48.50	958.26	44.25
9.00	177.82	24.50	29.00	572.98	34.50	49.00	968.14	44.50
9.50	187.70	24.75	29.50	582.86	34.75	49.50	978.02	44.75
10.00	197.58	25.00	30.00	592.74	35.00	50.00	987.90	45.00
10.50	207.46	25.25	30.50	602.62	35.25	50.50	997.78	45.25
11.00	217.34	25.50	31.00	612.50	35.50	51.00	1007.66	45.50
11.50	227.22	25.75	31.50	622.38	35.75	51.50	1017.54	45.75
12.00	237.10	26.00	32.00	632.26	36.00	52.00	1027.42	46.00
12.50	246.98	26.25	32.50	642.14	36.25	52.50	1037.29	46.25
13.00	256.85	26.50	33.00	652.01	36.50	53.00	1047.17	46.50
13.50	266.73	26.75	33.50	661.89	36.75	53.50	1057.05	46.75
14.00	276.61	27.00	34.00	671.77	37.00	54.00	1066.93	47.00
14.50	286.49	27.25	34.50	681.65	37.25	54.50	1076.81	47.25
15.00	296.37	27.50	35.00	691.53	37.50	55.00	1086.69	47.50
15.50	306.25	27.75	35.50	701.41	37.75	55.50	1096.57	47.75
16.00	316.13	28.00	36.00	711.29	38.00	56.00	1106.45	48.00
16.50	326.01	28.25	36.50	721.17	38.25	56.50	1116.33	48.25
17.00	335.89	28.50	37.00	731.05	38.50	57.00	1126.21	48.50
17.50	345.77	28.75	37.50	740.93	38.75	57.50	1136.09	48.75
18.00	355.64	29.00	38.00	750.80	39.00	58.00	1145.96	49.00
18.50	365.52	29.25	38.50	760.68	39.25	58.50	1155.84	49.25
19.00	375.40	29.50	39.00	770.56	39.50	59.00	1165.72	49.50
19.50	385.28	29.75	39.50	780.44	39.75	59.50	1175.60	49.75
20.00	395.16	30.00	40.00	790.32	40.00	60.00	1185.48	50.00

LCG 90.00 ft
TCG +/- 75.00 ft

FSML 1139 ft-tons
FSMT 1139 ft-tons

SALT WATER BALLAST TANKS CENTER COLUMN

C2BP & C2BS			C2BP & C2BS			C2AP & C2AS		
SOUNDING	WEIGHT	VCG	SOUNDING	WEIGHT	VCG	SOUNDING	WEIGHT	VCG
ft	LT	ft	ft	LT	ft	ft	LT	ft
0.50	10.34	20.25	20.50	423.74	30.25	0.50	10.34	60.25
1.00	20.67	20.50	21.00	434.07	30.50	1.00	20.67	60.50
1.50	31.01	20.75	21.50	444.41	30.75	1.50	31.01	60.75
2.00	41.34	21.00	22.00	454.74	31.00	2.00	41.34	61.00
2.50	51.68	21.25	22.50	465.08	31.25	2.50	51.68	61.25
3.00	62.01	21.50	23.00	475.41	31.50	3.00	62.01	61.50
3.50	72.35	21.75	23.50	485.75	31.75	3.50	72.35	61.75
4.00	82.68	22.00	24.00	496.08	32.00	4.00	82.68	62.00
4.50	93.02	22.25	24.50	506.42	32.25	4.50	93.02	62.25
5.00	103.35	22.50	25.00	516.75	32.50	5.00	103.35	62.50
5.50	113.69	22.75	25.50	527.09	32.75	5.50	113.69	62.75
6.00	124.02	23.00	26.00	537.42	33.00	6.00	124.02	63.00
6.50	134.36	23.25	26.50	547.76	33.25	6.50	134.36	63.25
7.00	144.69	23.50	27.00	558.09	33.50	7.00	144.69	63.50
7.50	155.03	23.75	27.50	568.43	33.75	7.50	155.03	63.75
8.00	165.36	24.00	28.00	578.76	34.00	8.00	165.36	64.00
8.50	175.70	24.25	28.50	589.10	34.25	8.50	175.70	64.25
9.00	186.03	24.50	29.00	599.43	34.50	9.00	186.03	64.50
9.50	196.37	24.75	29.50	609.77	34.75	9.50	196.37	64.75
10.00	206.70	25.00	30.00	620.10	35.00	10.00	206.70	65.00
10.50	217.04	25.25	30.50	630.44	35.25	10.50	217.04	65.25
11.00	227.37	25.50	31.00	640.77	35.50	11.00	227.37	65.50
11.50	237.71	25.75	31.50	651.11	35.75	11.50	237.71	65.75
12.00	248.04	26.00	32.00	661.44	36.00	12.00	248.04	66.00
12.50	258.38	26.25	32.50	671.78	36.25	12.50	258.38	66.25
13.00	268.71	26.50	33.00	682.11	36.50	13.00	268.71	66.50
13.50	279.05	26.75	33.50	692.45	36.75	13.50	279.05	66.75
14.00	289.38	27.00	34.00	702.78	37.00	14.00	289.38	67.00
14.50	299.72	27.25	34.50	713.12	37.25	14.50	299.72	67.25
15.00	310.05	27.50	35.00	723.45	37.50	15.00	310.05	67.50
15.50	320.39	27.75	35.50	733.79	37.75	15.50	320.39	67.75
16.00	330.72	28.00	36.00	744.12	38.00	16.00	330.72	68.00
16.50	341.06	28.25	36.50	754.46	38.25	16.50	341.06	68.25
17.00	351.39	28.50	37.00	764.79	38.50	17.00	351.39	68.50
17.50	361.73	28.75	37.50	775.13	38.75	17.50	361.73	68.75
18.00	372.06	29.00	38.00	785.46	39.00	18.00	372.06	69.00
18.50	382.40	29.25	38.50	795.80	39.25	18.50	382.40	69.25
19.00	392.73	29.50	39.00	806.13	39.50	19.00	392.73	69.50
19.50	403.07	29.75	39.50	816.47	39.75	19.50	403.07	69.75
20.00	413.40	30.00	40.00	826.80	40.00	20.00	413.40	70.00

LCG 00.00 ft
TCG +/- 75.00 ft

FSML 1247 ft-tons
FSMT 1247 ft-tons

SALT WATER BALLAST TANKS C3P AND C3S

SOUNDING ft	WEIGHT LT	VCG ft	SOUNDING ft	WEIGHT LT	VCG ft	SOUNDING ft	WEIGHT LT	VCG ft
0.50	9.51	20.25	20.50	389.79	30.25	40.50	770.07	40.25
1.00	19.01	20.50	21.00	399.29	30.50	41.00	779.57	40.50
1.50	28.52	20.75	21.50	408.80	30.75	41.50	789.08	40.75
2.00	38.03	21.00	22.00	418.31	31.00	42.00	798.59	41.00
2.50	47.54	21.25	22.50	427.82	31.25	42.50	808.10	41.25
3.00	57.04	21.50	23.00	437.32	31.50	43.00	817.60	41.50
3.50	66.55	21.75	23.50	446.83	31.75	43.50	827.11	41.75
4.00	76.06	22.00	24.00	456.34	32.00	44.00	836.62	42.00
4.50	85.56	22.25	24.50	465.84	32.25	44.50	846.12	42.25
5.00	95.07	22.50	25.00	475.35	32.50	45.00	855.63	42.50
5.50	104.58	22.75	25.50	484.86	32.75	45.50	865.14	42.75
6.00	114.08	23.00	26.00	494.36	33.00	46.00	874.64	43.00
6.50	123.59	23.25	26.50	503.87	33.25	46.50	884.15	43.25
7.00	133.10	23.50	27.00	513.38	33.50	47.00	893.66	43.50
7.50	142.61	23.75	27.50	522.89	33.75	47.50	903.17	43.75
8.00	152.11	24.00	28.00	532.39	34.00	48.00	912.67	44.00
8.50	161.62	24.25	28.50	541.90	34.25	48.50	922.18	44.25
9.00	171.13	24.50	29.00	551.41	34.50	49.00	931.69	44.50
9.50	180.63	24.75	29.50	560.91	34.75	49.50	941.19	44.75
10.00	190.14	25.00	30.00	570.42	35.00	50.00	950.70	45.00
10.50	199.65	25.25	30.50	579.93	35.25	50.50	960.21	45.25
11.00	209.15	25.50	31.00	589.43	35.50	51.00	969.71	45.50
11.50	218.66	25.75	31.50	598.94	35.75	51.50	979.22	45.75
12.00	228.17	26.00	32.00	608.45	36.00	52.00	988.73	46.00
12.50	237.67	26.25	32.50	617.95	36.25	52.50	998.24	46.25
13.00	247.18	26.50	33.00	627.46	36.50	53.00	1007.74	46.50
13.50	256.69	26.75	33.50	636.97	36.75	53.50	1017.25	46.75
14.00	266.20	27.00	34.00	646.48	37.00	54.00	1026.76	47.00
14.50	275.70	27.25	34.50	655.98	37.25	54.50	1036.26	47.25
15.00	285.21	27.50	35.00	665.49	37.50	55.00	1045.77	47.50
15.50	294.72	27.75	35.50	675.00	37.75	55.50	1055.28	47.75
16.00	304.22	28.00	36.00	684.50	38.00	56.00	1064.78	48.00
16.50	313.73	28.25	36.50	694.01	38.25	56.50	1074.29	48.25
17.00	323.24	28.50	37.00	703.52	38.50	57.00	1083.80	48.50
17.50	332.75	28.75	37.50	713.03	38.75	57.50	1093.31	48.75
18.00	342.25	29.00	38.00	722.53	39.00	58.00	1102.81	49.00
18.50	351.76	29.25	38.50	732.04	39.25	58.50	1112.32	49.25
19.00	361.27	29.50	39.00	741.55	39.50	59.00	1121.83	49.50
19.50	370.77	29.75	39.50	751.05	39.75	59.50	1131.33	49.75
20.00	380.28	30.00	40.00	760.56	40.00	60.00	1140.84	50.00

LCG - 90.00 ft
TCG +/- 75.00 ft

FSML 1055 ft-tons
FSMT 1055 ft-tons

P-TANK WEIGHTS AND CENTER OF GRAVITY LOCATIONS

Ullage Ft	VCG Ft	Cement Weight LT	Barite Weight LT	Bentonite Weight LT
19.4	113.19	0.00	0.00	0.00
19	113.39	1.36	1.95	0.80
18	113.90	4.75	6.84	2.81
17	114.41	8.14	11.73	4.82
16	114.92	11.53	16.61	6.83
15	115.43	14.92	21.50	8.84
14	115.94	18.31	26.38	10.84
13	116.45	21.70	31.27	12.85
12	116.96	25.09	36.16	14.86
11	117.47	28.48	41.04	16.87
10	117.97	31.87	45.93	18.88
9	118.48	35.26	50.81	20.88
8	118.99	38.65	55.70	22.89
7	119.50	42.04	60.59	24.90
6	120.01	45.43	65.47	26.91
5	120.52	48.82	70.36	28.92
4	121.03	52.21	75.24	30.92
3	121.54	55.60	80.13	32.93
2	122.05	58.99	85.02	34.94
1	122.55	62.38	89.90	36.95
0	123.06	65.77	94.79	38.96

NOTE: Interpolation may be necessary to determine weight and vertical center of gravity from the table above. Approximate values are available from graphs on the following two pages.

P-TANK NO.		LCG	TCG
1	Cement	- 53.40	52.60
2	Cement	- 66.90	52.60
3	Cement	- 80.40	52.60
4	Barite	- 53.40	68.60
5	Barite	- 66.90	68.60
6	Bentonite	- 80.40	68.60

P-TANKS WEIGHT VS. ULLAGE DEEP DRILLER

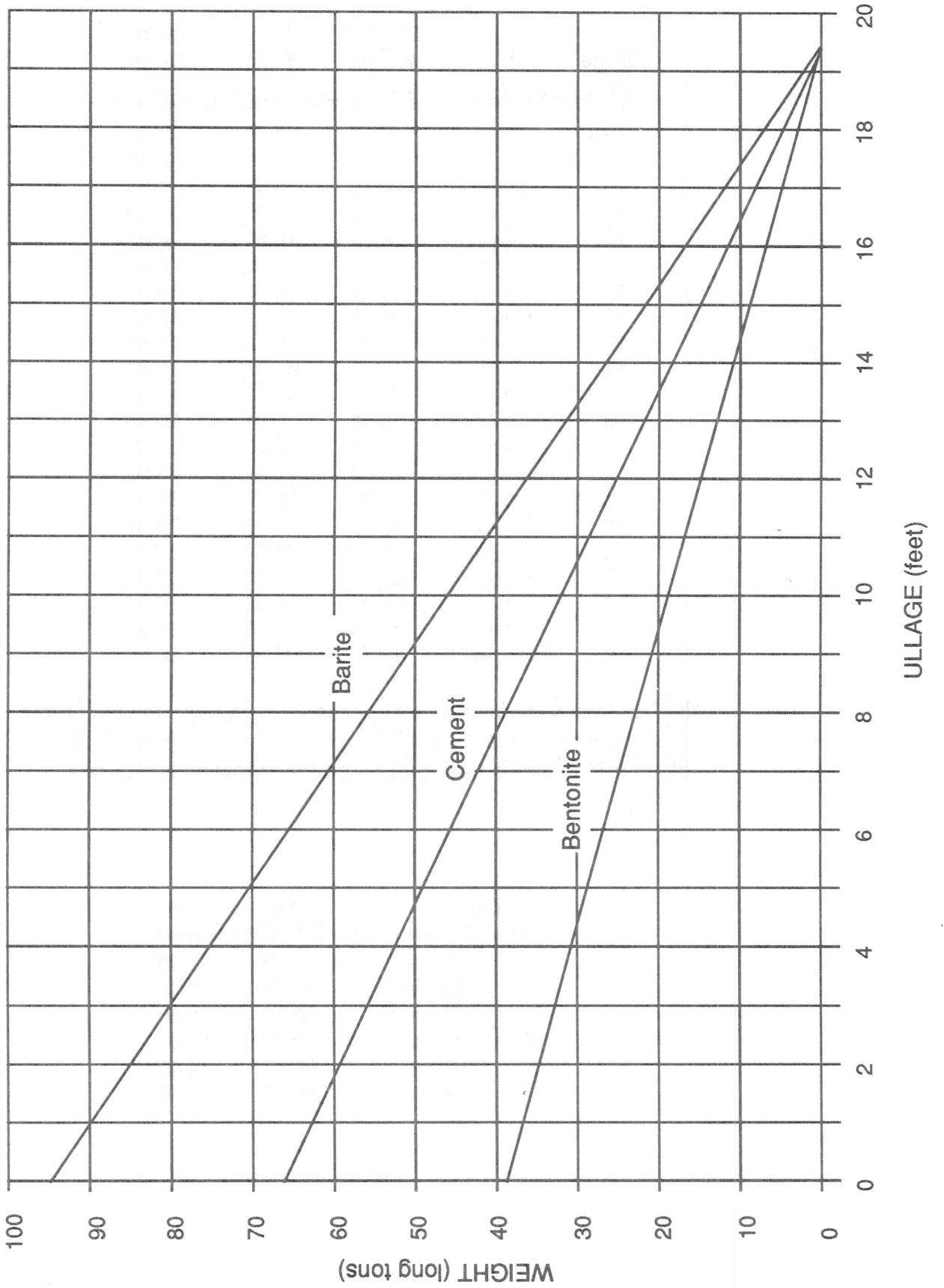

P-TANKS VCG VS. ULLAGE DEEP DRILLER

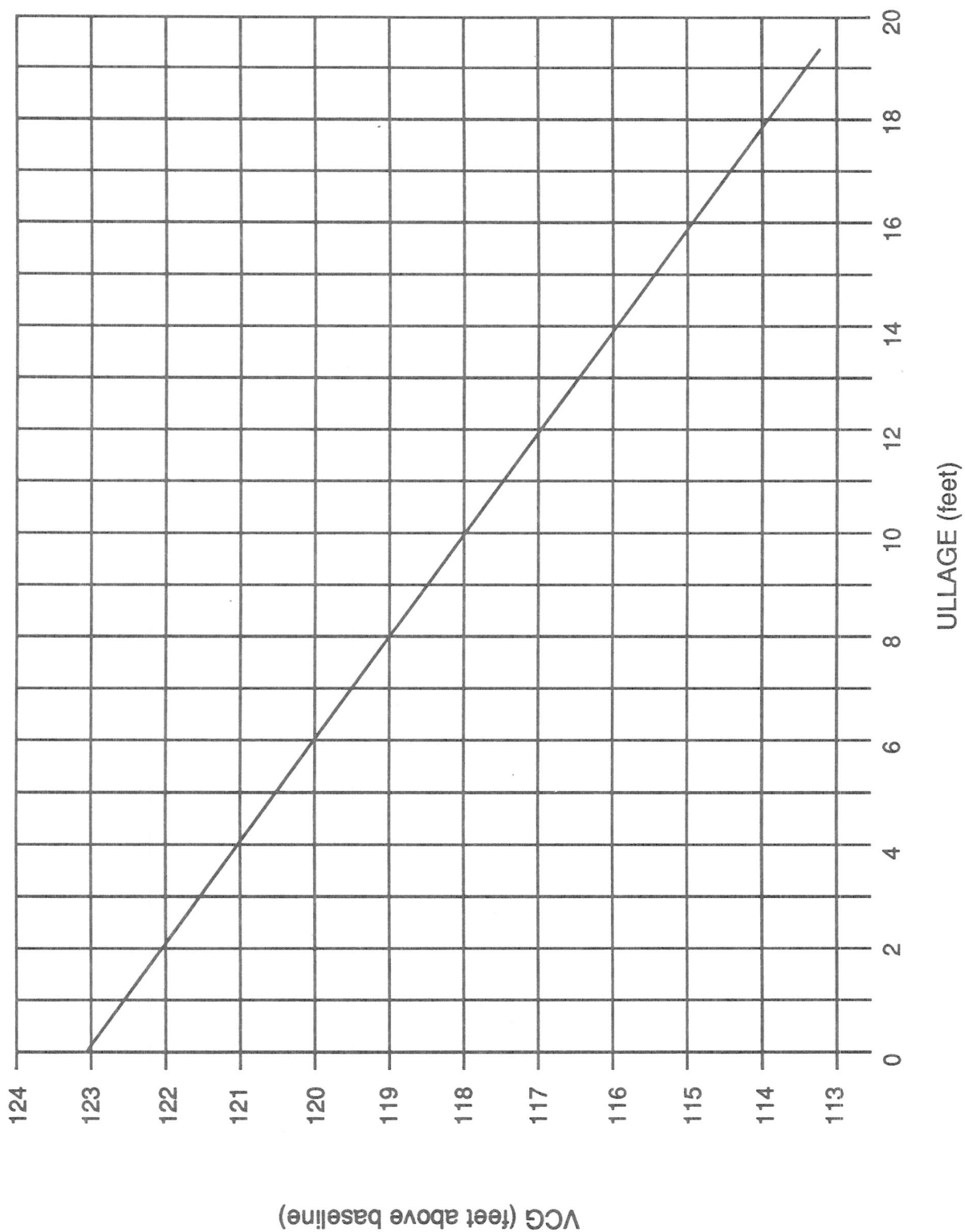

INDEX

A
Abandoning 4-9
Access 2-1
Allowable KG 3-12, 3-16, 3-19, 5-11
Anchor chain 2-8, 3-59
Anchor chain tension 3-60
Anchor pre-tensions 3-59
Anchoring 3-59
Anchors 2-8, 3-59

B
Ballast capacity 2-5
Ballast cross-over system 2-6
Ballasting 3-2
Ballast pump 2-6, 3-3
Ballast pump limitations 2-6, 3-3
Ballast system 2-6
Baseline 3-16, 3-17
Bilge dewatering 2-7
Blowout preventer 2-8
Breadth 3-16

C
Capacities 2-4
Center of buoyancy 3-13, 3-16
Center of gravity 2-3, 3-13, 3-15
Changes to lightweight 2-4
Chain catenary 3-19, 5-24
Chain tensions 3-18, 5-23
Classification 1-1
Corrected KG 3-19
Corrosion protection 2-1
Critical motion 3-10, 5-7
Cross-over system 2-6

D
Damage control 4-1
Deballasting 3-4
Deck Load Graph 5-6
Deck loads 2-4, 2-5, 3-5, 3-11, 5-6
Derrick floor arrangements 5-10
Dimensions 2-2
Disconnect 3-60
Displacement 2-2, 2-3, 3-15
Downflooding 3-12, 5-16
Draft 2-2, 2-3, 3-5, 3-11, 3-21
Draft - maximum 3-1, 3-5, 3-11
Drilling condition 3-60
Drilling equipment 2-8
Drilling operations 3-60
Drill water system 2-7

E
Emergency power 3-2
Emergency procedures 4-1
Environmental limits 3-10
Evacuation 4-9

F
Fire fighting 4-13
Free surface effects 3-2
Free surface corrections 3-19
Fuel oil system 2-7
Fuel oil tanks 2-7
FSML 3-16
FSMT 3-16

G
Generator 2-7
GM 3-13
GML 3-16
GMT 3-16
Gross tonnage 1-2

H
High line tension 3-61
Hydrostatic data 5-17

I
Ice and snow loads 3-5
Isolation valves 3-3

K
KGL 3-16, 3-19
KGmax 3-12, 3-16, 3-19, 5-11
KGT 3-16, 3-19

L
LCB 3-13
LCG 3-13, 3-15
Length, L 2-2, 3-16
Lightweight data 2-3
Limits of Service 3-10
List 3-20
Load form calculations 3-15
Load form samples 3-22
Ballast to Survival 3-29
De-ballast to Survival 3-47
Drilling 3-41
Preparing to Drill 3-35
Survival/ Ice and Snow 3-53
Transit 3-23

M
Main deck arrangement 5-8
Marine growth 3-2
Maximum wave height 3-10
Maximum wind velocity 3-10
Maximum allowable KG 3-12, 3-16, 3-19, 5-11
Metacenter 3-13
Metacentric height 3-14, 3-16, 3-20
Mooring chain (see Anchor Chain)
Mooring Equipment 2-8
Mooring System 3-59
Mooring tensions 3-60

N
Net tonnage 1-2

O
Offset 3-8, 3-60
Offshore Installation Manager 1-2
Operating draft 3-5
Owner 1-2

P
Piping system 2-5, 5-4
Potable water system 2-7
Power generation 2-7
Pumps 2-6, 3-3
P-Tanks 6-17

R
Radio Equipment 4-12
Reference planes 3-17
Restoring force 3-62
Rig move 3-7
Righting arm 3-13
Riser 3-9
Rounding 3-15

S
Saltwater service pump 2-6
Sample loading calculations
Ballast to Survival 3-29
De-ballast to Survival 3-47
Drilling 3-41
Preparing to Drill 3-35
Survival/ Ice and Snow 3-53
Transit 3-23

S (continued)

Severe storm 3-8, 3-9
Special steels 2-1
Stability 3-13
Stability calculations 3-13, 3-19
Standby operations 3-8, 3-60
Subsea equipment 2-8
Survival draft 3-8

T

Table entries 3-17
Tank coordinates 6-3
Tank tables 6-1
TCG 3-15, 3-16
Tons per inch (TPI) See
Hydrostatic Properties Table
Transit 3-7
Trim 3-20

U

Unit deck loads 3-11
Unexpected List/trim 4-3
Upper deck arrangement 5-9

V

VCG 3-15
Vertical moments 3-16
Vessel dimensions 2-2

W

Watertight integrity 3-2, 4-8