

STANDARD OPERATING PROCEDURES (SOP)

FOR

THE COAST GUARD'S TRAINING SYSTEM

Volume 9

PERFORMANCE QUALIFICATION GUIDE
(PQG), EOCT AND SWE



Office of Training, Workforce Performance & Development (CG-132)
Human Resources Directorate

Coast Guard Headquarters
Washington, D.C.
January 2007

January 2007
Version 2.0

Table of Contents

Section 1 - PQG Process	1-1
Section 2 - Analysis	2-1
Section 3 - Performance Objectives	3-1
Section 4 - Curriculum Outline	4-1
Section 5 - Test Item Writing	5-1
Section 6 - Test Item Development	6-1
Section 7 - Pamphlet Development	7-1
Section 8 - Pamphlet Testing Development	8-1
Section 9 - End-of-Course Test (EOCT)	9-1
Section 10 - Servicewide Examination (SWE)	10-1
Section 11 - Test Strategy and Statistics	11-1
Section 12 - Course Evaluation and Revision	12-1
Section 13 - Security and Compromise	13-1
Appendix A - PQG Certification Guide Pamphlet Format	A-1
Appendix B - Glossary of Terms	B-1

This page intentionally left blank

Section 1

PQG PROCESS

Overview

Purpose of this SOP

The purpose of this SOP is to provide standards, rules, and guidelines for the design and development of Coast Guard nonresident distance learning courses and guidance in the design and development of end-of-course tests (EOCTs) and servicewide examinations (SWEs). To ensure this multi-faceted professional development experience is performance-based, structured, and standardized, the Coast Guard has developed a nonresident distance learning program called a Performance Qualification Guide (PQG).

PQG Package

It is important to understand that the PQG design and development process involves developing PQGs and other materials. The whole PQG package consists of the following:

- Distance learning pamphlets which may include the following materials:
 - Lessons.
 - Job aids.
 - Topic reviews.
 - Glossaries of terms.
 - Self-quizzes.
 - Practice exercises.
 - Pamphlet review test.
- Certification guide pamphlet with sign-off sheets.
- Three separate EOCTs based on the EOs from the curriculum outline.

The ultimate goal of the PQG process is to increase the proficiency of assigned enlisted personnel in preparing for advancement or change in ratings.

Overview

EPQ and PQG Connection

Coast Guard enlisted members are classified as Apprentices (E-2 to E-4), Journeymen (E-5 and E-6), or Masters (E-7 to E-9). Most E-3s advance to E-4 by attending a rating-specific "A" school that allows them to learn and demonstrate mastery of the rating-specific E-4 enlisted performance qualifications (EPQs). Upon adequate demonstration of such mastery, students graduate as E-4s. For those students that do not attend an "A" school, an alternative process towards advancement is to complete their rating-specific PQG, thus demonstrating mastery of the rating-specific E-4 EPQs on-the-job.

The way Coast Guard enlisted members gain competency in their rating and advance to E-4, E-5, and E-6 is by enrolling in a PQG program of instruction, receiving mentoring and coaching from supervisors, and demonstrating on-the-job mastery of the rating-specific EPQs. The PQGs provide instruction, guidance, and structure to enlisted members striving to gain rating competency so they can advance to the next paygrade. PQGs also provide structure and guidelines for assigned professional development supervisors (PDSs). PDSs are members designated by the Commanding Officer/Officer-in-Charge as competent to sign-off enlisted performance qualifications. This is normally an E-6 or above who is capable of mentoring and coaching a member and signing off on demonstrated mastery of EPQs.

The certification pamphlet has sign-off sheets for the PDS to follow and record completion of performance tasks identified. These sign-off sheets correspond to the Terminal Performance Objectives (TPOs) and Enabling Objectives (EOs) of the EPQs for performance-required interventions.

Note: The PDS does not have to be the same rating as the student; the certification pamphlet and the distance learning pamphlets contain a specific job aid or task list to enable a PDS to measure and observe that the performance required was completed successfully.

Target Audience

The target audience for this SOP includes Coast Guard and contractor course designers and developers charged with developing PQGs and those charged with the design of End-of-course tests (EOCTs) and Servicewide Exams (SWEs).

PQG Process Overview

PQG Process

The PQG process is a performance-based, systematic approach to designing distance learning courses, based on the EPQs required for advancement. Upon receipt of the PQG course from the Coast Guard Institute (CGI), the student will read each pamphlet, complete applicable self-quizzes and pamphlet review quizzes. The student will perform each task that directly relates to the EPQ under the direction of their PDS and then have the PDS sign-off the performance observed in the PQG certification pamphlet and on the applicable EPQ.

Rules for PQG Development

This SOP establishes rules that govern PQG development:

1. DO NOT combine student distance learning pamphlets with student certification guide pamphlets unless pamphlet design and certifications worksheets combine to make a small, handy package. As a rule of thumb, avoid creating a large "phonebook" that members and supervisors must lug around.
 2. Use the templates in this SOP for locally reproducing the PQG materials.
 3. Remember to avoid inclusion of knowledge the member already possesses or that is not directly related to EPQ performance in student pamphlets.
 4. Job aids should make up the bulk of student pamphlet materials.
 5. Refer to your command's Style Manual as a tool for selecting standardized acronyms and words specifically used in Coast Guard-wide PQG and distance learning materials.
-

PQG Process Overview

Distance Learning Development Principles

The distance learning pamphlet must fulfill the role of classroom instruction. For this reason, the PQG must be well thought out and follow these rules of thumb:

- PQGs should incorporate job aids wherever appropriate.
- Since PQGs are delivered in a "distance format" (i.e., not via resident instruction), their instructional design needs to reflect a "self-contained" instructional strategy.
- PQGs focus only on performance outcomes that teach students how to perform their job, not about their job.
- PQGs require command-level participation to ensure that each EPQ task is learned and that all EPQs can be performed satisfactorily and safely.
- PQGs instructional course material provide job-specific procedure guides.
- PQGs provide a supervisor-observed performance check-off sheet for each EPQ, and requires student to pass an EOCT for key knowledge.
- Since PQGs are printed by the Coast Guard Institute (CGI) or delivered electronically via the CG Central Learning Tab, they must be compiled and produced in camera-ready format.

Job Aid for Developing PQG Certification Guide Pamphlet

Appendix A serves as a boilerplate for developing the PQG certification guide pamphlet. The job aid was created in Microsoft® Word using the structured writing template (SWT). The "master" document can be sent as an e-mail attachment and still maintains SWT keystrokes/buttons. The user simply has to type over the gray areas on the cover through page 8. Page 10 contains four PQG sheets followed by four Monthly Tracking Sheets (MTSs). If additional sheets are required, copy/paste as explained in the job aid.

Note: To obtain the job aid, go the TRACEN Yorktown web site <http://cgweb.tcyorktown.uscg.mil>, and click on the "Training" tab, then click on the "Performance System Branch" tab. Under resources tab, there is a downloadable SWT Format PQG Certification Pamphlet that allows you to fill in the blanks.

PQG Process Overview

Unit Level PQG Process

The PQG process strongly links student learning (distance learning pamphlets) with job performance (student certification pamphlet) and supervisor involvement through the certification pamphlets. The process for implementing PQGs at the unit level is contained in the job aid below.

Step	Action
1	Member and Education Services Officer (ESO) meet.
2	Member enrolls in distance learning course (PQG) program by ordering course material.
3	ESO requests the Commanding Officer (CO) assign a PDS (should be E-6 or above) to act as mentor and train member.
4	ESO issues Assignment Letter to PDS.
5	Member and PDS meet to review the PQGs certification pamphlet, distance learning pamphlets, and establish training timeline.
6	PDS sets up member's certification pamphlet Monthly Tracking Sheet (MTS).
7	Member and PDS begin apprentice or journeyman professional development program.
8	Member reads the certification pamphlet and lesson material; practices lesson objectives, completes practical exercises/job aids/lesson self-quiz; meets periodically with PDS and asks for help if he or she doesn't understand material. PDS provides coaching, mentoring, practice, and feedback opportunities.
9	Member and PDS work together toward completing performance of each EPQ task.

PQG Process Overview

Unit Level PQG Process (Continued)

Step	Action	
10	As member completes each task in the certification pamphlet, the PDS signs off the task on the MTS and initials and dates the appropriate column on the EPQ sheet. Note: All EPQs must be successfully completed before member can take the EOCT or SWE and advance to the next paygrade.	
11	Once all course materials are completed and all required performances signed off on the MTS, the member delivers the completed certification guide pamphlet, MTS, and EPQs to the unit XO, Training Officer, ESO, or other designated person for appropriate action.	
12	ESO orders EOCT or initiates online testing request. EOCT shall only be taken after all course material is completed.	
13	Member takes EOCT. Note: ESO must proctor EOCT and follow proper testing material security procedures to prevent compromise of test.	
14	ESO is notified by Coast Guard Institute of member's test results.	
15	Test Results	Passing Score: When member receives passing score, ESO forwards test results, MTS and any unit specific documentation to Commanding Officer.
		Failing score: If member fails to achieve passing score, ESO informs member that he/she must wait 21 days before taking next EOCT. Member should meet with PDS to receive additional instruction.
16	Member is eligible to participate in next SWE: <ul style="list-style-type: none"> • upon passing of EOCT, • completion of appropriate EPQ, • completion of minimum time in service and rate by terminal eligibility date, • and recommendation of command. 	

Section 2

ANALYSIS

How PQGs Link to Analysis

Introduction

The Analysis SOP has a critical relationship to the other Coast Guard Training System SOPs because it outlines the process for "starting off on the right foot." The Analysis SOP provides the same methodology to contractors, who are responsible for producing training-related materials or performance supports for the Coast Guard.

There are numerous types of analysis but this section attempts to identify the most common type that will be conducted in the design/development process of PQGs distance learning courses.

Occupational Analysis

The analysis type used for the creation of PQGs is called an Occupational Analysis (OA), which is a process that measures the job performance requirements of an occupation. An OA takes a "snapshot" of a ratings world of work at a particular point in time. As mandated by the Enlisted Performance Qualifications Manual (EPQM), COMDTINST M1414.8 (series), the Coast Guard follows a cycle for conducting OAs for each of its enlisted ratings.

The EPQM mandates an OA every:

3 years for technical ratings.	AMT, AST, AVT, EM, ET, GM and IT
4 years for its less-technical ratings and the non-rated workforce.	OS, BM, DC, MST, MK, SK, PS, FS, HS, YN, IV, PA, and E-2/E-3.

The slogan for Coast Guard OA work is "Real Data for Real Decisions." That slogan underscores the need to use a rigorous and systematic process to obtain Coast Guard occupational data. The Coast Guard must have absolute confidence in the integrity of OA data because this data determines:

- Entry level and subsequent paygrade performance qualifications.
 - Appropriate training.
 - Proper staffing.
-

How PQGs Link to Analysis

HPT Methodologies

Regardless of the type of analysis, the following Human Performance Technology (HPT) / Instructional System Design (ISD) methodologies are to be used:

- Systems approach to training.
- Analysis based on validated needs.
- All analysis is data-driven.
- All solutions are supported by findings.

OA Process Overview

Prime customers for OA data are the Coast Guard's rating force master chiefs (RFMCs). Enlisted Performance Qualifications Rating Review panels ("quals reviews") use OA outputs in determining the correct performance qualifications for each paygrade within that rating. COMDT (CG-132) training managers are also prime customers for OA outputs since they manage the Enlisted Performance Qualifications (EPQ) Program. COMDT (CG-132) validates the performance qualifications a Qualifications Review identifies. Once CG-132 publishes official EPQs, training managers, program managers, course designers/developers, and contractors use that information to determine content for and to develop Coast Guard training curricula.

The Coast Guard conducts OAs because it has a recurring need to evaluate the jobs its people are performing to ensure that training and qualifications reflect the true needs of the field. Refer to SOP Volume 2, Section 3.4 for a more detailed overview of the OA process.

How PQQs Link to Analysis

Link to Analysis The Enlisted Performance Qualification Manual, COMDTINST M1414.8 (series) describes how the EPQs are developed. Data collected from an Occupational Analysis is an input to a rating review and new or revised EPQs are an output of the rating review. Those EPQs at the E-4 level are the inputs to “A” school curriculum development and are the criteria a member who is striking a rating must meet. The E-4 EPQs for strikers and E-5 and E-6 EPQs are the inputs to the PQQ development process.

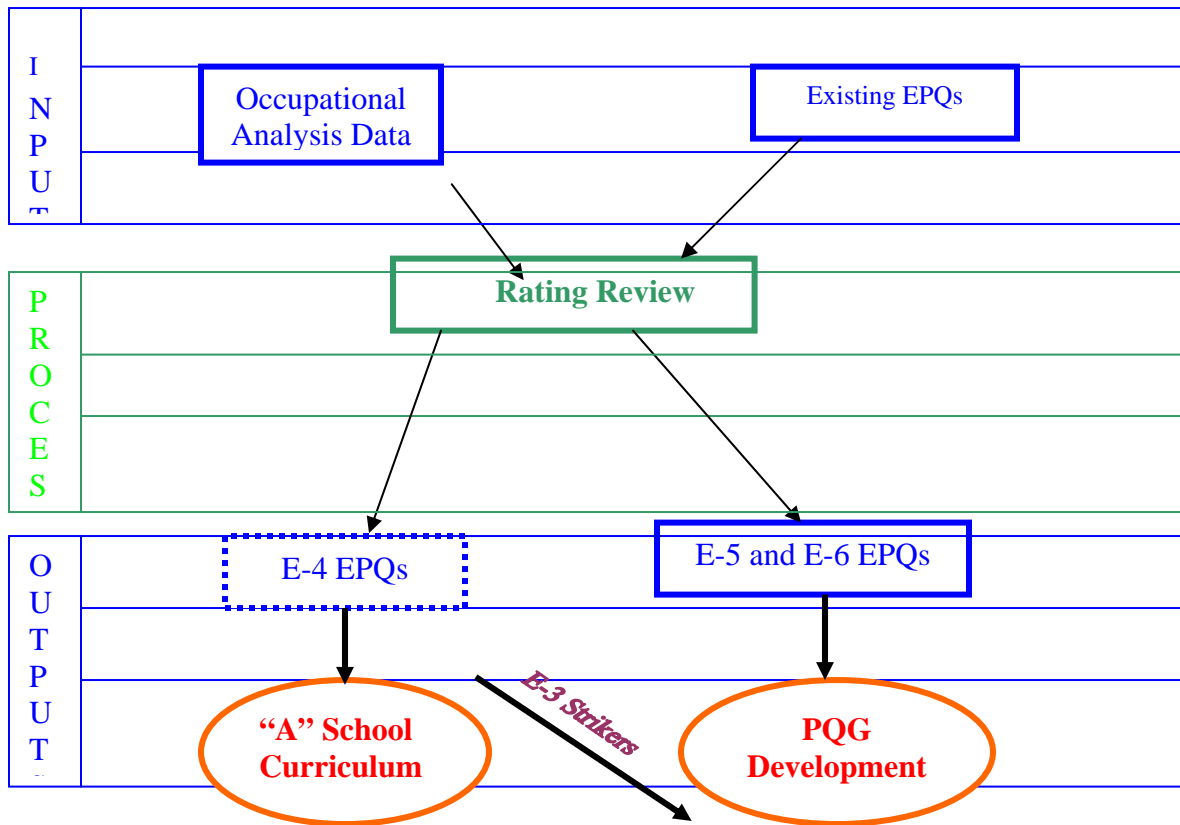

Note: As the chart indicates, EPQs are derived from Occupational Analysis and Rating Reviews. The EPQs become basis for the course's Terminal Performance Objectives (TPOs).

Task Analysis Process

Introduction

Before you can begin to develop a course for a particular job or set of EPQs, you should understand the process involved. In a task analysis, we look at each task selected for training and identify those steps necessary to complete the task. These tasks and steps become the basis for developing your learning objectives and test items.

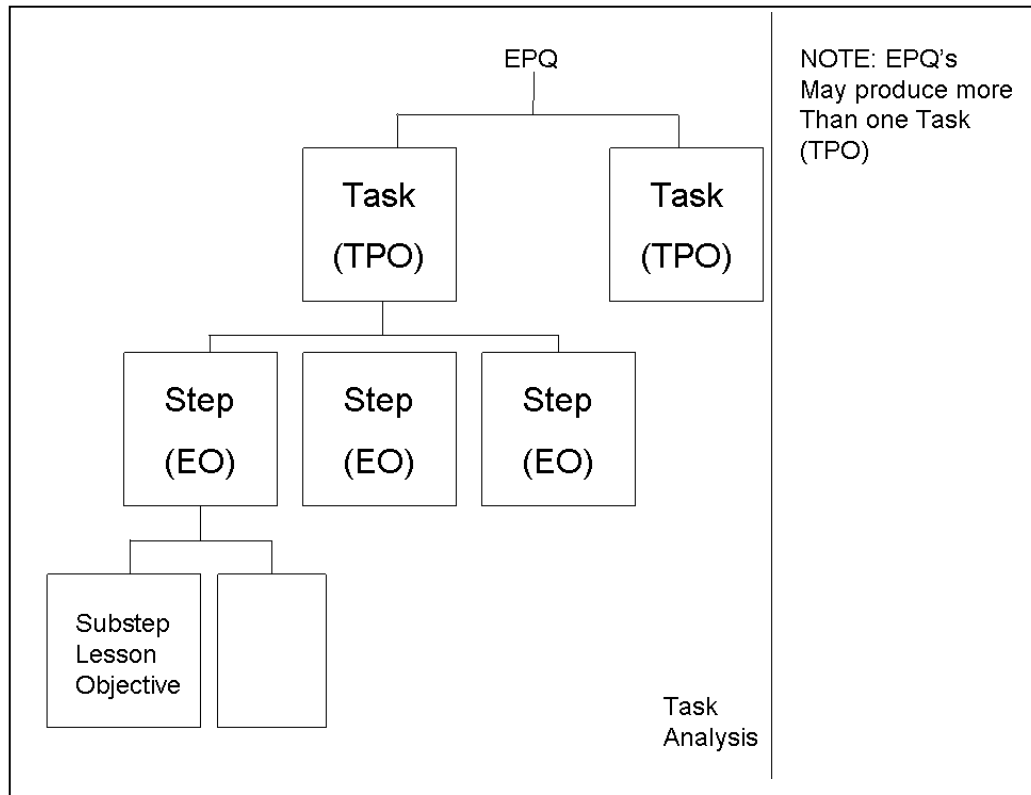

Task Characteristics

Remember that "task" means a single work assignment that is required of a person and is independent of other actions. Performance tasks are clearly prescribed actions performed by the job holder and have five specific characteristics. Each task:

1. Has a single, specific, action verb and an object.
 2. Has a definite beginning and end.
 3. Is observable or measurable on the job.
 4. Results in an accomplishment.
 5. Is independent of other actions.
-

Task Analysis Process

Task Characteristics (Continued)

Where job analysis is the process of identifying the tasks necessary to perform the job, a task analysis is the process of identifying the steps involved in performing the task.

A task analysis is the basic method (process) used to define the steps of a task listed in the order in which they are performed on the job, the skills and knowledge needed to perform each step of the task, and all other information pertaining to the on-the-job performance of the task.

Responsibility

A task analysis is typically performed by a subject matter specialist located at the appropriate training center.

Task Analysis Procedures

If a new task analysis is necessary, begin by listing all the tasks for that job, then list all the steps required to perform each task. It is important to place these steps in the order in which they are performed on the job. The analysis of a performance task consists of the following steps:

- Listing the procedures of the task.
- Generalizing the procedures into steps.
- Listing the prerequisite skills and knowledge.

These steps will be discussed in more detail in the following pages.

Target Population

The purpose of defining the target population is to establish the required entry-level skills and knowledge of the students who will receive training. This summary of required skills and knowledge helps define any prerequisites for course enrollment and provides a starting point in training design. By defining the target population, we ensure that:

- Students are not taught what they already know.
 - Training is designed to reduce the differences between what students know or do and what the Coast Guard needs them to know or do.
 - Criteria for students entering the course are set by determining any prerequisites necessary for course enrollment.
-

Task Analysis Process

Target Population (Continued)

There are several areas to be considered when identifying who the training is for, such as:

- Rating/rank.
- Work experience/position.
- Other courses attended.
- Types of on-the-job training (OJT).
- Reading/math levels.

Sources of this information include the program managers, service records, field units, and juries of experts.

Task Validation

Okay, let's assume you have compiled a complete list of performance tasks and you have grouped these tasks under appropriate headings. You have your tasks (TPOs) from the EPQs, what you do not have are the steps (EOs). The next step here is to validate the steps to complete the task. If the tasks are so broad you must break them down further into smaller TPOs. You can best accomplish task validation by polling a panel of Accomplished Performers (APs) who are removed from the training process. APs are considered "the best of the best," who are currently performing the job.

Task Analysis Process

Example

Let's look at a performance task for a gunner's mate.

Given a 25mm machine gun and a target, **ENGAGE** a target.

As you can see, this task has the five specific characteristics of a performance task:

- This task has a single specific action verb – **ENGAGE** – and an object – target.
- There is a definite beginning – the direct action to engage the target – and a definite end – the accomplishment of engaging that target.
- Is the performance task observable or measurable on the job? Can you observe a target being engaged? Can you measure the engagement of a target? If you can answer “YES” to both these questions, you have an observable or measurable performance task.
- Does the performance task result in an accomplishment? “Target engaged,” “target hit,” and “target destroyed” are all accomplished results of the performance task “engage target.”
- This performance task is independent of other actions.

Grouping Tasks

When you are analyzing a job, you will identify all the tasks involved in performing that job. Once you have a list of all the tasks you can think of, the next step is to organize the task list. To do this, you will group related tasks together. This grouping will have three results:

- Related tasks are grouped under one heading.
- Duplicate tasks are removed.
- Additional tasks may be developed to support the like area.

Note: When tasks have been grouped, it is easier to see duplicate tasks or to identify tasks that have been omitted.

Task Analysis Process

Task Analysis Work Sheet Record the task analysis data on the task analysis work sheet shown below.

TASK ANALYSIS WORK SHEET		
JOB		Damage Control Petty Officer
TASK		Weigh a 15-lb portable CO ₂ fire extinguisher
No.	Task Steps	Skills/Knowledge
1	Remove CO ₂ fire extinguisher from its station.	<ul style="list-style-type: none"> • Know safety precautions for pressurized cylinders. • Identify equipment/locations. • Lift minimum of 50 lb's.
2	Read bellyband to determine total weight of fire extinguisher. Note: If unreadable, use manual.	<ul style="list-style-type: none"> • Identify components of fire extinguisher. • Use manuals.
3	Attach fire extinguisher to the mounting eye.	
4	Lift scale to suspend bottle.	
5	Read scale.	
6	IF weight is . . . THEN . . .	<ul style="list-style-type: none"> • Know inspection tag procedures.
	1.5 lb < total weight	Follow ship's SOP to replace.
	Equal to total weight on belly band	<ul style="list-style-type: none"> • Complete inspection tag and • Replace fire extinguisher at station.
		REFERENCES: NEM M9000.6 (series) NSTM 555 NAVEDTRA DC 3&2 TM 2006

Note: In the table above, we identify the skills and knowledge and list the references in the appropriate sections as they relate to the task at hand. In the next sections, we will further discuss how to proceed at this stage to develop a successful PQG.

Section 3

PERFORMANCE OBJECTIVES

Overview

Introduction

The learning objective is the foundation of the training process. A learning objective translates real world job performance into training language. An objective is a description of a performance you want learners to be able to demonstrate before you consider them competent. The purpose of objectives is to tell the students what they will know or be able to do when they have finished your course. In this section, you will learn about objectives and about what is meant by test items that match your objectives.

Terminal Performance Objectives (TPOs)

The terminal performance objectives (TPOs) are derived from performance tasks and are the expected results or outcomes of a learning experience. The performance, conditions, and standards achieved in the TPO should transfer directly to the performance tasks of the job. Generally, in a PQG, the EPQ becomes one or more TPOs. However, if the EPQ does not contain a performance, conditions, and/or standards, you should write the TPO using the design principles of a good performance objective. The TPO must convey the intent of the EPQ; the EPQ may be broken down into several TPOs (if needed) to convey the performance required. Simply put, the TPOs are the desired results of training.

Enabling Objectives (EOs)

The enabling objectives (EOs) describe precisely the prerequisite skills, knowledge, and performance necessary to master the TPO. Each EO is a step required to complete the TPO. An EO also must contain a performance, condition, and standard unless it is the same as the TPOs. The course designer will need to determine the EPQ steps and substeps to properly identify the lesson's enabling objectives. The EOs from the curriculum outline become the task required to be signed off in the PQG certification pamphlet.

Note: The EOs may be broken down into smaller increments in the certification pamphlet to describe the performance required in greater detail.

Overview

Lesson Objectives (LOs)

You will write TPOs and EOs when you are developing your curriculum outline. When you begin to write your course, the EOs will be used to develop your lesson objectives (LOs), which are the EOs broken down into smaller steps. You will develop LOs for each step required to complete the EO.

PQG Development Process

Below is a quick snapshot of the PQG process from the EPQ to development of a PQG pamphlet.

The PQG Process

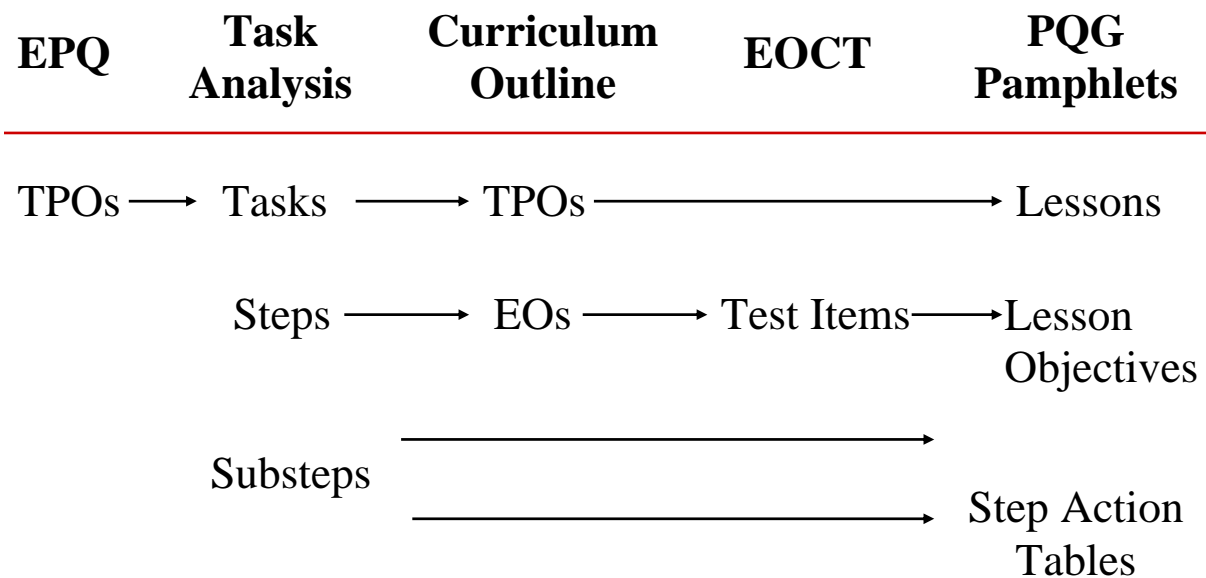

Learning Objectives

Introduction

Here you will determine what your students need to learn in order to perform a task. You will also develop test questions to match your objectives.

Purpose of Learning Objectives

The learning objective is the foundation of the training process. A learning objective translates real world job performance into training language. The purpose of objectives is to tell the students what they will know or be able to do when they have finished your course.

Benefits of Objectives

Before you can begin writing objectives, understand their benefits. Objectives benefit both the learner and the instructor by:

- Communicating clear-cut, intended outcomes of instruction.
 - Providing a firm basis for assessing what learners can or cannot do.
 - Establishing learning sequence and course structure.
 - Providing a basis for developing a course outline.
-

Writing Objectives for PQG Courses

The performance in your written objective should closely approximate the job performance. When writing a distance learning PQG course, there are many performances which can be accomplished and observed (and therefore written) the same as in a resident style course.

For example: A resident course objective may be **FIELD STRIP** an M-16 rifle which an instructor can observe, provide feedback, and critique based on a checklist. In a PQG, the objective may be observed by using the job aid in the lesson and the PDS observing the performance and checking it off on the PDS sign-off sheet.

Parts of an Objective

Clearly written enabling objectives for curriculum outlines contain three parts. These are the **performance**, what the student must be able to do; the **condition** under which the student must perform; and the **standard**, how well the student must perform to be considered acceptable.

We will now look at each of these more closely.

Learning Objectives

Performance

The performance or action statement of an objective is a specific description of what the student must be able to do after the instruction, not what the instructor will say or do. The tasks and steps from the task analysis will become the basis for the performance statement. The performance statement includes an action verb and the object of the action. The action verb reflects behaviors that are specific and measurable and are to be performed.

Example: FIELD STRIP an M-16 rifle to the basic components.

Action Verbs

When writing the performance part of your objectives, you will use action verbs such as those listed in the Curriculum Outline SOP. Because you will be writing a PQG course, your students will be taking an EOCT. All questions on the pamphlet review quiz and the EOCT shall be written in the four-response, multiple-choice format. Later in this section, and in this SOP, we will talk about matching test questions to objectives. By using the PQG, the PDS can observe performance objectives and indicate completion by signing off the PDS sign-off sheet in the PQG certification pamphlet.

Characteristics to Avoid

When choosing the action verb, keep in mind that the verb must reflect behaviors that are specific and measurable. Avoid writing an objective with the following characteristics:

- Unclear, vague, or abstract action verb, standards, or conditions.
- Too broad or too general.
- Several unrelated behaviors or action verbs.
- Unrealistic or untestable.
- Little or no consistency between action, conditions, or standards.
- No meaningful or realistic point of completion.

Therefore, you should avoid terms such as "be familiar with," "understand," "know," "appreciate," "ensure," and "supervise," among others. See the Curriculum Outline SOP for the lists of verbs that are suggested for use or suggested for avoidance.

Learning Objectives

Condition

The second element of an objective is the condition. The condition(s) statement of an objective describes relevant or important circumstances under which the student must perform. Simply stating the performance part of the objective may not be enough to prevent misunderstanding. We will need to clarify the instructional intent of the objective by stating the conditions that will affect student performance. Conditions normally describe important aspects of the performance environment and the equipment, special tools, and materials that may be given to (or denied to) the student. However, for distance learning course objectives, the conditions specify important information or training tools the student will use when demonstrating achievement of the objective. A condition will either identify the limits or restrictions placed on the desired behavior or will indicate assistance given for demonstrating the desired behavior.

Examples of conditions are:

- Given the diameter of a sphere and a list of . . .
- Given schematic symbols for common electronic components and a list of names . . .

Remember, conditions will either aid or limit the desired behavior.

Standard

The third and final element of an enabling objective for a curriculum outline is the standard. The standard is the minimum acceptable level of performance. Let's look at a behavior and standard applicable to a distance learning course.

For example, the performance is:

- Multiply two three-digit numbers. - As stated, you might reason that these are whole numbers and the solution would be expressed as a whole number. Now suppose we specify a minimum level of acceptable performance. The behavior and standard might be expressed as:

Multiply two three-digit numbers and round off the answer to the nearest tenth. - The standard clearly states the degree of acceptable performance.

Learning Objectives

Types of Standards

There are four types of standards which students may be required to meet.

Type of Standard	Example
Implied (no error)	(No standard is listed.) Given an illustration labeling the components of a gable roof and a list of terms, LOCATE each component and its corresponding location on a house.
Accuracy/completeness	Given a diagram of a human skeleton and a list of possible names of the bones, LABEL at least 80 percent of the bones correctly.
Standard operating procedure (published standard)	Given a list of procedures for restraining specified items of cargo on an HC-130 aircraft, PERFORM the appropriate procedures, in the correct sequence, in accordance with Technical Order 139.
Time and rate requirements	Given a standard Coast Guard workstation and a page of text, TYPE the text at a minimum rate of 40 words per minute.

Writing Objectives

Examples

Below are examples of the elements of objectives.

1. Given draft readings and required plans and tables, **COMPUTE** displacement for any class ship to within + or - 5 percent of the actual answer.

Performance	COMPUTE displacement for any class of ship
Condition	Given draft readings and required plans and tables
Standard	to within + or - 5 percent of the actual answer

2. Given schematic symbols for common electronic components and a list of names, **IDENTIFY** each symbol and its corresponding name.

Performance	IDENTIFY each symbol and its corresponding name.
Condition	Given schematic symbols for common electronic components and a list of names
Standard	Implied – No error

Sequencing Objectives

Grouping and Sequencing Objectives

This step involves grouping and sequencing objectives so they are tied together, make sense, and are easy to follow. Grouping and sequencing objectives should:

- Produce optimal learning in the most efficient manner.
- Help the student make the transition from one skill to another.
- Ensure material is presented in a building block sequence that paves the way for new and/or more difficult material.

Relationship

In order to sequence learning objectives, determine their relationship to each other. Learning objectives may be:

- Dependent
- Independent
- Supportive

The three types of relationships and how each affects the training sequence are explained below:

Relationship Among Learning Objectives		
Dependent	Independent	Supportive
One objective must be learned before another.	Objectives are totally unrelated to each other.	Learning one objective will help when learning another.
Example: In order to learn multiplication, one must first learn addition.	Example: For a yeoman, "typing letters" is independent of "maintaining files."	Example: "Disassemble weapon" has supportive relationship to "assemble weapon."
The learning objective must be sequenced based on what must be learned first.	In general, the learning objective can be arranged in any sequence without loss of learning.	The learning objectives should be placed close together to permit optimum transfer of learning.

Sequencing Objectives

Sequencing for Instruction

If a task is needed throughout the course, such as "use hand tools," then a decision needs to be made about where that objective needs to be placed.

There are two ways to place objectives:

- Grouping the objectives that occur more than once and teach them at the beginning of the course. This process is often referred to as "front loading." For example, teach all handtool enabling objectives as the first unit of instruction.
- Place the objective within the curriculum at the time it is first needed. In other words, teach the students what they need to know when they need to know it. That is, teach the handtool enabling objective the first time the student needs to know it.

Depending upon the difficulty of the task, either teach the enabling objectives at the beginning or teach at the time the information is first needed.

Sequencing Objectives

Objectives Evaluation Checklist

The learning objectives for a course serve as the basis for specifying test item requirements and performance outcomes in the PQG certification pamphlet. Before developing test items or performance outcomes, check the objectives to make sure they are clearly stated and appropriate for the intent of the course. If an objective does not communicate the desired student performance clearly, or if it is inappropriate for the course, then good test items or performance outcomes cannot be developed from it.

Ask the following questions when evaluating objectives:

TERMINAL PERFORMANCE AND ENABLING OBJECTIVES (TPO/EO) CHECKLIST	Yes	No
Do the action, condition, and standards of the objective match those of the performance required?		
Is the performance (Action) verb specific, measurable, and observable? (IAW CO SOP) *		
Are the conditions specified? (IAW CO SOP)		
Are the standards specified? (IAW CO SOP)		
Are the standards related to job performance?		
Are the standards realistic for nonresident training? (equipment, environmental, tools)		
Can the objective be evaluated by written test items?		

* (In accordance with Curriculum Outline SOP)

Matching Test Item Formats to Objectives

Introduction

Coast Guard distance learning courses use reinforcement (tests) at the end of each lesson and pamphlet, and a final examination (an EOCT) to measure the student's achievement of the course objectives. These tests are designed to show how well each student achieves the objectives. Designing test items is the key to successful distance instruction. Each test item must be consistent with the learning objective it supports and be adequately constructed. The way the distance learning courses measure performance objectives is by having the PDS observe the required performance against the job aid in the PQG lessons and then signing off the task in the PQG certification pamphlet.

Test Item Formats

The common types of test item formats used to measure objectives for distance learning PQG courses are:

- Matching (Lesson Quiz).
 - Multiple-choice (Lesson quiz and pamphlet review quiz).
 - Short-answer (Lesson Quiz).
 - Performance (Lesson Quiz).
-

Test Types

Each lesson within the course should have a self-quiz which fully tests each lesson objective. These assignment self-quiz items may use a variety of formats. At the end of each pamphlet, is a review quiz which tests selected objectives from the lessons within the pamphlet. The pamphlet review quiz and the EOCT are limited to the four-response, multiple-choice format.

This page intentionally left blank.

Section 4

CURRICULUM OUTLINES

Overview

Policy

Coast Guard Headquarters policy requires that curriculum outlines be submitted and approved for all distance learning PQG courses. The curriculum outline is the "blueprint" for course development, the justification for funding, and the instrument used to receive American Council of Education (ACE) credit for nontraditional learning. The curriculum outline must be approved before development of course materials begins.

Curriculum Outline

A standard format has been adopted to ensure uniformity throughout Coast Guard training. A well-written curriculum outline should meet the following criteria:

- Documents performance objectives for a course of instruction.
 - Documents training resource requirements for conducting resident and distance learning courses.
 - Identifies improvements or changes in training.
 - Maintains agreement between job performance requirements and validated training needs.
 - Facilitates the curriculum review and approval process and serves as an audit trail document.
-

Curriculum Outline Instructions

This section explains how to produce a curriculum outline. The information is taken directly from the Curriculum Outline SOP. Some sections/elements of a curriculum outline are self-explanatory and no further explanation is provided in this SOP. In those instances, only examples/samples are given. If you have additional questions or need assistance, consult your training center's instructional system specialist or CG-132.

Nonresident Curriculum Outline Cover Sheet

Format

The format of a Nonresident Curriculum Outline Cover Sheet is shown below.

Note: A Step/Action table explaining each numbered step follows the formatting information. A camera-ready example of the specific page is then shown.

Nonresident Curriculum Outline Cover Sheet

CURRICULUM OUTLINE

FOR

COURSE NAME **See Step 1**

COURSE ID **COURSECODE** **See Step 2**

RESERVE RETIREMENT POINTS **See Step 3**

CLASSIFICATION: **See Step 4**

DEVELOPED BY

SCHOOL NAME **See Step 5**

U.S. COAST GUARD TRAINING CENTER YORKTOWN **See Step 6**

YORKTOWN, VA

FREQUENCY OF REVIEW: **TRIENNIAL** **See Step 7**

REVIEWED AND APPROVED AT
U.S. COAST GUARD HEADQUARTERS
WASHINGTON, DC

SUBMITTED	<u>See Step 8</u>	_____
	DATE	CHIEF, SCHOOL BRANCH
FORWARDED	_____	_____
	DATE	TRAINING OFFICER
REVIEWED	_____	_____
	DATE	CG-132 TRAINING MANAGER
REVIEWED	_____	_____
	DATE	PROGRAM MANAGER
APPROVED	_____	_____
	DATE	CG-132

Next Review Date: 25 December 2008 **See Step 9**

Nonresident Curriculum Outline Cover Sheet (Continued)

Procedures

The procedures for completing the Curriculum Outline Cover Sheet are outlined in the following table.

STEP	ACTION
1	Insert the course name.
2	Insert the course ID and course code with edition number.
3	Insert total reserve retirement points. Use the directions provided later in this section. Reference: Reserve Policy Manual, COMDTINST M1001.28 (series)
4	Insert the proper classification. The classification deals with the content of the curriculum. If a portion of the curriculum is classified, please specify as well. Note: If this document is classified, follow proper procedures for handling of classified documents.
5	Insert the full name of the school where the course was developed.
6	Insert the full name of Training Center or Unit at which the course was developed.
7	Leave blank. Headquarters (CG-132) assigns the review date. Cycle is every three or four years depending on if the rating is considered highly technical or if data supports a shorter cycle. Reference: EPQ Manual, COMDTINST M1414.8 (series), Chapter 3
8	Insert the month, day, and year. Curriculum outlines at all training centers will be forwarded to the training officer prior to sending to Headquarters (CG-132).
9	Leave blank. Headquarters (CG-132) assigns the review date. This is based on when the curriculum is approved.

Nonresident Curriculum Outline Cover Sheet (Continued)

Example

Below is an example of a Nonresident Curriculum Outline Cover Sheet.

CURRICULUM OUTLINE
FOR
BOATSWAIN'S MATE, THIRD CLASS PQG
COURSE ID: **BM3** COURSE CODE: **0390-4**
34 RESERVE RETIREMENT POINTS
UNCLASSIFIED
DEVELOPED BY
BM SCHOOL
U.S. COAST GUARD TRAINING CENTER
YORKTOWN, VIRGINIA

FREQUENCY OF REVIEW: **TRIENNIAL**
REVIEWED AND APPROVED AT
U.S. COAST GUARD HEADQUARTERS
WASHINGTON, D.C.

SUBMITTED	_____	_____
	DATE	CHIEF, OPERATIONS BRANCH
FORWARDED	_____	_____
	DATE	TRAINING OFFICER
REVIEWED	_____	_____
	DATE	CG-132 TRAINING MANAGER
REVIEWED	_____	_____
	DATE	PROGRAM MANAGER
APPROVED	_____	_____
	DATE	CG-132

Next Review Date: _____

Curriculum Outline Table of Contents

Format The format of a Table of Contents is shown below.

TABLE OF CONTENTS

<u>SUBJECT</u>	<u>PAGE</u>
Course Data.....	3 See Step 1
Mission and Scope Statements.....	4
Units of Instruction, Terminal Performance Objectives (TPOs), and Enabling Objectives (EOs).....	5
Course Content Reference Table	See Step 2

EXHIBITS

- (1) Training Aids/Training Equipment
 - (2) References Listed in TPOs
 - (3) Training Center Pamphlets Issued to Student
 - (4) Reserve Retirement Points Work Sheet
-

Curriculum Outline Table of Contents (Continued)

Procedures The procedures for completing the Table of Contents are outlined in the following table.

STEP	ACTION								
1	<p>Note: It is easiest to insert the page numbers for Table of Contents when the entire document is complete.</p> <p>Insert the page numbers for the sections listed below.</p> <p>The following three pages of every curriculum outline will be numbered as follows:</p> <table data-bbox="511 787 1242 1123"> <thead> <tr> <th></th> <th style="text-align: right;"><u>PAGE</u></th> </tr> </thead> <tbody> <tr> <td>Course Data*</td> <td style="text-align: right;">3</td> </tr> <tr> <td>Mission and Scope Statements</td> <td style="text-align: right;">4</td> </tr> <tr> <td>Units of Instruction, Terminal Performance Objectives (TPOs), and Enabling Objectives (EOs)</td> <td style="text-align: right;">5</td> </tr> </tbody> </table>		<u>PAGE</u>	Course Data*	3	Mission and Scope Statements	4	Units of Instruction, Terminal Performance Objectives (TPOs), and Enabling Objectives (EOs)	5
	<u>PAGE</u>								
Course Data*	3								
Mission and Scope Statements	4								
Units of Instruction, Terminal Performance Objectives (TPOs), and Enabling Objectives (EOs)	5								
2	<p>After numbering the remaining TPO and EO pages, insert the page numbers of the following sections:</p> <p style="padding-left: 40px;">Course Content Reference Table</p> <p style="padding-left: 40px;">Exhibits</p>								

***Note:** *For a new course, this line will be “Course Data - New Curriculum.” For a revision, this line will be “Course Data - Course Revision.”

Course Data

Format The format for the Course Data page is shown below.

COURSE DATA	<u>See Step 1</u>
COURSE NAME, ID, CODE, AND EDITION:	<u>See Step 2</u>
<u>CURRICULUM/CHANGES PROPOSED</u> <u>See Step 3</u>	<u>DESCRIPTION</u>
ELIGIBILITY REQUIREMENTS:	
PREREQUISITES:	
CONTENT:	
LENGTH:	<u>See Step 4</u>
EQUIPMENT:	
FUNDING:	<u>See Step 5</u>
LIMITING FACTORS:	
COMPETENCY CODE AUTHORIZED:	
REASONS FOR PROPOSED CURRICULUM CHANGES:	<u>See Step 6</u>
RECOMMENDED IMPLEMENTATION DATE:	<u>See Step 7</u>

Course Data

Procedures The procedures for completing the Course Data page are outlined in the following table.

STEP	ACTION
1	<p>If this outline is for a new course, the title of this page is "COURSE DATA - NEW CURRICULUM."</p> <p>If this outline is for a revision, the title of this page is "COURSE DATA - COURSE REVISION."</p>
2	Insert the COURSE NAME, ID, CODE, and EDITION.
3	<p>If this outline is for a new course, this line should be "CURRICULUM PROPOSED." Write a short description for each of the 8 areas listed.</p> <p>If this outline is for a revision, this line should be "CHANGES PROPOSED." Write a short description for each of the 8 areas and any changes for each of the areas listed.</p>
4	Insert 36 months*. This is the maximum enrollment period for all nonresident courses. (*With the advent of the Performance Qualification Guide (PQG) to accompany nonresident courses, the suggested completion time is 6-12 months.)
5	Insert statement (see next page) on cost to develop PQGs which support the advancement system. Currently costs are approximately \$0.025 per camera-ready page in black and white and \$0.12 per camera-ready page in color. The cost for producing a CD-ROM is approximately \$1.00 per CD-ROM. This cost does not factor in salaries or the cost of reproduction. These costs are subject to change based on printing contract. Contact the CG Institute for the actual costs.
6	<p>If this outline is for a new course, this line should be "REASONS FOR PROPOSED CURRICULUM." Write a short statement to describe why this new course is being proposed.</p> <p>If this outline is for a revision, this line should be "REASONS FOR PROPOSED CHANGES." Write a short statement of the current situation or what is currently in place and compare this with the newly proposed needs or requirements.</p>
7	Insert the recommended implementation date.

Course Data (Continued)

Example

Below is an example of a Course Data page for a course that is new.

COURSE DATA – NEW CURRICULUM	
COURSE NAME, ID, CODE, AND EDITION:	<u>Boatswain's Mate Third Class PQG (BM3) 0312-1</u>
<u>CHANGES PROPOSED:</u>	<u>DESCRIPTION</u>
ELIGIBILITY REQUIREMENTS.....	NONE
PREREQUISITES	NONE
CONTENT	Subjects in this course include: Administration, Piloting and Navigation, Maintenance, and Honors and Ceremonies
LENGTH.....	36 months
EQUIPMENT	NONE
FUNDING	Costs to develop correspondence courses to support the advancement system are currently approximately \$0.025 cents per camera-ready page in black and white and \$0.12 per camera-ready page in color. The cost for producing a CD-ROM is approximately \$1.00 per CD-ROM. This cost does not factor in salaries or the cost of reproduction. These costs are subject to change based on printing contract.
LIMITING FACTORS	NONE
COMPETENCY CODE AUTHORIZED ...	NONE
REASONS FOR PROPOSED CURRICULUM....	Course developed in accordance with the Enlisted Qualifications Manual, COMDTINST M1414.8 (series). Based on new enlisted qualifications dated 2003.
RECOMMENDED IMPLEMENTATIONDATE:	April 2007

Course Data (Continued)

Example

Below is an example of a Course Data page for a course that is being revised.

COURSE DATA - COURSE REVISION	
COURSE NAME, ID, CODE, AND EDITION: <u>Electrician's Mate Third Class POG (EM3) 0319-1</u>	
<u>CHANGES PROPOSED</u>	<u>DESCRIPTION</u>
ELIGIBILITY REQUIREMENTS	NONE
PREREQUISITES	NONE
CONTENT	Subjects in this course include: Engineering Administration, Basic Electricity, Power Distribution, Motors and Controllers, Batteries, Standard Boat Electrical Systems, Auxiliary Control Systems, and National Electric Code (NEC).
LENGTH	36 months
EQUIPMENT	NONE
FUNDING	Costs to develop courses to support the advancement system are currently approximately \$0.025 cents per camera-ready page in black and white and \$0.12 per camera-ready page in color. The cost for producing a CD-ROM is approximately \$1.00 per CD-ROM. This cost does not factor in salaries or the cost of reproduction. These costs are subject to change based on printing contract.
LIMITING FACTORS	NONE
COMPETENCY CODE AUTHORIZATION	NONE
REASONS FOR PROPOSED CHANGES	Changes due to updating course to meet qualifications in accordance with the Enlisted Qualifications Manual, COMDTINST M1414.8 (series).
RECOMMENDED IMPLEMENTATION DATE:	9 March 2007

Mission and Scope Statements

Format

The format for the Mission and Scope Statements page is shown below.

MISSION AND SCOPE STATEMENTS

NAME OF COURSE: See Step 1 Procedures on next page

MISSION: See Step 2

This section shall include information on the purpose of the course, the type of billet toward which the training is directed, if appropriate, and reference to the Enlisted Performance Qualifications Manual.

SCOPE: See Step 3

This section shall include the following specific elements: (a) a description of the target population (the student's specialty area, rate, job assignment, etc.); (b) a brief overview of the tasks and content areas covered in the course; (c) a statement describing the performance criteria to be met in order for the student to successfully complete the course.

PREREQUISITES: See Step 4

COMPETENCY CODE ELIGIBILITY: See Step 5

STUDENT SECURITY CLASSIFICATION: See Step 6

Mission and Scope Statements (Continued)

Procedures

The procedures for completing the Mission and Scope Statements page are outlined in the following table.

STEP	ACTION
1	Insert the name of the course followed by the short title enclosed in parentheses.
2	Write a brief statement about the course to include: <ul style="list-style-type: none"> • Purpose of the course. • Type of billet for which the training is directed. • Reference to the Enlisted Performance Qualifications Manual, if applicable.
3	Write a short paragraph on the course which includes the following specific elements: <ul style="list-style-type: none"> • Description of the target student: <ul style="list-style-type: none"> ○ Specialty ○ Paygrade ○ Rating (if any) ○ Job assignment • Overview of the content areas covered in the course. • Statement describing the performance standards the student must meet to successfully complete the course. (The subject matter specialist (SMS) and rating force manager should determine the end-of-course test (EOCT) passing score and whether the EOCT may be an open book exam.)
4	Insert all prerequisites the student must have before taking this course. If there are none, insert NONE.
5	Insert the competency code(s) that students will be eligible for upon completion of the course. For information, see Competency Management System Manual, COMDTINST M5300.2 (series). For new courses, contact CG-1B. If there are none, insert NONE.
6	Insert security classification code which students must have before attending the course/school. For information, see Personnel Manual, COMDTINST M1000.6A (series), Chapter 5, and Military Personnel Security Program, COMDTINST M5520.12B (series), Chapters 1 and 2.

Mission and Scope Statement (Continued)

Example

Below is an example of a completed Mission and Scope Statements page.

MISSION AND SCOPE STATEMENTS

NAME OF COURSE: Boatswain's Mate Third Class PQG (BM3)

MISSION: The purpose of this course is to provide the knowledge's and skills necessary to perform at the Boatswain's Mate Third Class level as stated in the Enlisted Performance Qualifications Manual, COMDTINST M1414.8 (series).

SCOPE: This course consists of pamphlets and an end-of-course test (EOCT) provided in a distance learning, self-study format. Subject matter is specifically designed for seaman (E-3) as a required component for advancement to BM3. The course covers selected subjects in administration (maintenance of records and logs), seamanship and deck maintenance, piloting and navigation, and personnel supervision. The pamphlets include reading assignments with objectives to be mastered and appropriate review exercises specifically designed to test mastery of the objectives. The Professional Development Supervisor (PDS) will evaluate the student for 100 percent completion of the PQG sheets, and the student must achieve a minimum score of 80 percent on the EOCT to successfully complete the course.

PREREQUISITES: NONE

COMPETENCY CODE ELIGIBILITY: NONE

STUDENT SECURITY CLASSIFICATION: UNCLASSIFIED

Units of Instruction, TPOs, and EOs

Format

The format for the Units of Instruction, Terminal Performance Objectives (TPOs), and Enabling Objectives (EOs) page is shown below.

UNIT 1.0 **See Step 1 of Procedures on next page**

TERMINAL PERFORMANCE OBJECTIVE:

1.1 **See Step 2**

REFERENCES: (List all references used for this TPO to include sections or chapters)

The PDS will evaluate student competency for 100% completion during the PQG process. The EOCT will evaluate knowledge competency and an individual must achieve a minimum of 80% on the EOCT. (**Insert EPO Number Here**).

ENABLING OBJECTIVES: The standard(s) statement for each of the following enabling objectives is the same as written in the terminal performance objective, unless otherwise stated.

1.1.1 **See Steps 3 and 4**

1.1.2

Units of Instruction, TPOs, and EOs (Continued)

Procedures

The procedures for completing the Units of Instruction, Terminal Performance Objectives (TPOs), and Enabling Objectives (EOs) are outlined in the following table.

STEP	ACTION
1	<p>Insert the general title of the unit. Each subject area within the course will be referred to as a UNIT. Label the units in a sequential order, starting with 1.0, 2.0, 3.0, etc.</p> <p>Note: Each unit/TPO must begin on a separate page.</p>
2	<p>Insert the Terminal Performance Objective (TPO) following the unit number. Label each TPO starting with 1.1, the second 1.2, etc.</p> <p>Each TPO shall meet the following requirements:</p> <ul style="list-style-type: none"> • Specify what assistance, aids, or constraints (conditions) the students will be given. • Specify what the student will do (performance). • Capitalize and bold type the ACTION VERB. • Specify how well the student will perform (standard). • Focus on the qualifications or other job performance requirements (JPR) using the course reference table. <p>Note: When a qualification is used, its format must be adjusted to meet requirements.</p> <ul style="list-style-type: none"> ○ Begin a new page for each TPO in a given unit. • References: number the references and list the title, number, and section of each published reference. Be as specific as possible when citing the part of the reference used. • Write each TPO with performance (action), conditions, and standards using the job aid in Appendix A of the Curriculum Outline SOP.

Units of Instruction, TPOs, and EOs (Continued)

STEP	ACTION
3.	<p>Insert each Enabling Objective (EO) that supports the TPO. Each EO shall meet the following requirements:</p> <ul style="list-style-type: none"> • Be a step required to complete the TPO. • Number each EO sequentially and begin with the first two digits of the TPO. For TPO 1.1, number the first EO as 1.1.1, the second as 1.1.2, etc. • Specify what assistance, aids, or constraints (condition) the students will be given. • Specify what the student will do (performance). • Capitalize and bold type the ACTION VERB. • Specify how well the student will perform (standard) if different from the TPO (see Note below). • List the title and number of each reference. When more than one reference is listed in the TPO and each reference is used in all of the EOs, and the standard of performance is the same, use the following statement: <i>The standards and conditions statements for each of the following EOs are the same as written in the TPO unless otherwise stated.</i> <p>Note: Conditions and standards are not required for EOs when they are the same as the conditions and standards of the TPO being supported. However, if the EOs conditions and standards <u>are</u> different, then it will require its own set of conditions and standards.</p> <ul style="list-style-type: none"> • For all rating advancement courses that contain a PQG Certification Pamphlet, the following statement shall be added immediately below the list of references: <p>"The Professional Development Supervisor (PDS) will evaluate student competency for 100% completion during the PQG process. The end-of-course test (EOCT) will evaluate knowledge competency, and an individual must achieve a minimum of 80% (the RFMC determines score) on the EOCT. (<u>Insert EPQ Number Here</u>)."</p>

Units of Instruction, TPOs, and EOs (Continued)

STEP	ACTION
4	<p>Write TPOs and EOs to test four-response, multiple-choice, end-of-course test items.</p> <p>Note: Refer to the Standard Verb List in Appendix B of the Curriculum Outline SOP to select common action verbs.</p> <p>Example: Given deviation and compass heading, COMPUTE the magnetic heading with 100% accuracy.</p> <p>REFERENCES: Dutton's Piloting and Navigation, Section X.</p> <p>Corresponding EOCT test item: What is the magnetic heading if the deviation is 2°E and the compass heading is 180°?</p> <p>A. 182° B. 181° C. 180° D. 178°</p>

Units of Instruction, TPOs, and EOs (Continued)

Example

Below is an example of a Units of Instruction, TPOs, and EOs page.

UNIT 1.0 ADMINISTRATION

TERMINAL PERFORMANCE OBJECTIVE:

- 1.1 Given selected equipment and references, **ORDER** parts needed at your unit with 100% accuracy.

REFERENCES:

1. Supply and Policy Procedures Manual (SPPM), COMDTINST M4400.19A (series), (section or chapter number)
2. CMplus Users Manual, (section or chapter number)
3. FEDLOG User Manual and Tutorial
4. Material Information for Configuration and Allowances (MICA) Manual, (section or chapter number)

The Professional development supervisor (PDS) will evaluate student competency for 100% completion during the PQG process. The end-of-course test (EOCT) will evaluate knowledge competency and an individual must achieve a minimum of 80% on the EOCT. (EM EPQ A.5.01)

ENABLING OBJECTIVES: The standard(s) statement for each of the following enabling objectives is the same as written in the terminal performance objective, unless otherwise stated.

- 1.1.1 Given a copy of the Management Information for Configuration and Allowances (MICA) Manual, **IDENTIFY** the parts and sections of the Management Information for Configuration and Allowances (MICA) Manual and their contents.
- 1.1.2 Given a CG SWT-III and log-in information, **ENTER** content into the Federal Logistics Data Program (FEDLOG) Data Response Screens.
- 1.1.3 Given a specific part number, **ENTER** an inventory item in CMplus.
- 1.1.4 Given a specific piece of equipment, **ENTER** an OM&S item in CMplus.

Course Content Reference Table

Format The format of a Course Content Reference Table page is shown below.

COURSE CONTENT REFERENCE TABLE	
<u>TPOs</u>	<u>REQUIREMENT JUSTIFICATION</u>
1.1	See Step 1
	See Step 2
<p>Below is a chart to determine requirement justification.</p>	
IF the course is . . .	THEN . . .
A rating course	List all performance factors from the Enlisted Performance Qualifications Manual.
A specialty course (e.g., NAVRULES Course or SAR Fundamentals)	Use Job Task Analysis Panel, Field Survey, etc.
<p>Enlisted Qualifications NOT covered: See Step 3</p>	

Course Content Reference Table (Continued)

Procedures

The procedures for completing the Course Content Reference Table are outlined in the following table.

STEP	ACTION								
1	List all TPO numbers contained within the course.								
2	<p data-bbox="367 541 1284 611">Insert the proper justification for each TPO. The purpose of the Course Content Reference Table is to justify course content.</p> <p data-bbox="367 646 1325 758">Note: The purpose of the justification is to identify the source (authority) from which the TPO was derived, the analysis that determined the training requirement, and the applicable task.</p> <p data-bbox="367 793 1227 863">If manuals are listed, indicate chapters, sections, page #, applicable paygrades, or specific qualification number.</p> <table border="1" data-bbox="367 898 1325 1241"> <thead> <tr> <th data-bbox="367 898 846 940">IF</th> <th data-bbox="846 898 1325 940">THEN write as follows . . .</th> </tr> </thead> <tbody> <tr> <td data-bbox="367 940 846 1087">An enlisted qualification is used</td> <td data-bbox="846 940 1325 1087">Enlisted Personnel Qualifications Manual (EPQM), COMDINST M1414.8 (series) A.4.01</td> </tr> <tr> <td data-bbox="367 1087 846 1161">A job task analysis panel is used</td> <td data-bbox="846 1087 1325 1161">JTA Panel Report (include date of report)</td> </tr> <tr> <td data-bbox="367 1161 846 1241">A front end analysis is used</td> <td data-bbox="846 1161 1325 1241">Front End Analysis (FEA) dated (include date of report)</td> </tr> </tbody> </table>	IF	THEN write as follows . . .	An enlisted qualification is used	Enlisted Personnel Qualifications Manual (EPQM), COMDINST M1414.8 (series) A.4.01	A job task analysis panel is used	JTA Panel Report (include date of report)	A front end analysis is used	Front End Analysis (FEA) dated (include date of report)
IF	THEN write as follows . . .								
An enlisted qualification is used	Enlisted Personnel Qualifications Manual (EPQM), COMDINST M1414.8 (series) A.4.01								
A job task analysis panel is used	JTA Panel Report (include date of report)								
A front end analysis is used	Front End Analysis (FEA) dated (include date of report)								

Course Content Reference Table (Continued)

STEP	ACTION		
3	IF ...	AND ...	THEN ...
	The course is a rating course	<p>All enlisted quals are covered</p> <p>You have elected NOT to cover a qualification specific to the paygrade</p> <p>Note: If you have difficulty identifying sources of job information and cannot get help from the program manager, let CG-132 know.</p>	<p>Insert NONE.</p> <p>Get approval from CG-132 by:</p> <ul style="list-style-type: none"> • Listing the qualification not covered and • Identifying the rationale for not teaching the qualification. (Each situation will be evaluated on a case-by-case basis.) <p>Note: Do not omit a qualification because it is taught in an “A” or “C” school.</p>
		<p>You have covered lower level enlisted qualifications</p> <p>Note: Lower level qualifications may be covered in courses when the qualifications are supportive of and necessary for the understanding of the qualifications written for the paygrade of the course.</p>	<p>Do not list lower level qualifications in the curriculum outline and do not test on the lower level qualifications.</p>
The course is a specialty course	No qualifications are covered	<p>Enter the following statement:</p> <p>“This is a specialty course and is not required to cover specific qualifications.”</p>	

Course Content Reference Table (Continued)

Example

Below is an example of a Course Content Reference Table.

COURSE CONTENT REFERENCE TABLE	
<u>TPOs</u>	<u>REQUIREMENT JUSTIFICATION</u>
	Enlisted Performance Qualifications Manual (EPQM), COMDTINST M1414.8 (series)
1.1	EPQM: A.4.01
2.1	EPQM: B.4.02
3.1	EPQM: C.4.01
3.2	EPQM: C.4.01
3.3	EPQM: C.4.01
3.4	EPQM: C.4.01
3.5	EPQM: C.4.02
3.6	EPQM: C.4.03
3.7	EPQM: C.4.04
3.8	EPQM: C.4.05
3.9	EPQM: C.4.06
3.10	EPQM: C.4.06
3.11	EPQM: C.4.07
3.12	EPQM: C.4.08
4.1	EPQM: D.4.01
4.2	EPQM: D.4.03
4.3	EPQM: D.4.02
5.1	EPQM: G.4.01
Enlisted Qualifications NOT Covered:	
B.4.01	This performance qualification is covered during the boat crew qualification process outlined in COMDTINST 16114.9 (series). This process is an on-the-job study/application and validation process composed of practical small boat type-specific tasks and some nontype-specific tasks generic in nature to small boat operations. Completion of this process requires both demonstrated knowledge and observable application. The level of performance required cannot be achieved through a nonresident course of instruction.

Exhibits

Format

The format for exhibits 1-4 is shown below.

EXHIBITS:

(1) TRAINING AIDS/TRAINING EQUIPMENT:

See Step 1

(2) REFERENCES LISTED IN THE TPOs:

See Step 2a-2b

(3) TRAINING CENTER PAMPHLETS ISSUED TO THE STUDENT:

See Step 3

(4) RESERVE RETIREMENT POINTS WORKSHEET:

See Step 4

Exhibits (Continued)

Procedures

The procedures for completing exhibits 1-4 are outlined in the following table.

STEP	ACTION				
1	<p>List all of the items that are specific to the course. If there are none, insert "NONE." DO NOT list items that are generally used for all correspondence courses. Below is a sample list of acceptable and unacceptable items.</p> <table border="1" data-bbox="456 625 1144 869"> <thead> <tr> <th data-bbox="456 625 800 680">Acceptable</th> <th data-bbox="808 625 1144 680">Unacceptable</th> </tr> </thead> <tbody> <tr> <td data-bbox="456 690 800 869"> protractors triangles flash cards maneuvering board </td> <td data-bbox="808 690 1144 869"> pencils paper text study guide </td> </tr> </tbody> </table>	Acceptable	Unacceptable	protractors triangles flash cards maneuvering board	pencils paper text study guide
Acceptable	Unacceptable				
protractors triangles flash cards maneuvering board	pencils paper text study guide				
2a	<p>List all references found in the TPOs.</p> <p>Note: If you have a large number of references, you may need to use more than one page.</p>				
2b	<p>Arrange the reference titles in alphabetical order. Use the following format:</p> <p style="padding-left: 40px;">Title of reference/name of text, publication number, and chapter number if applicable</p> <p><u>Examples:</u> BASIC Oscilloscope AX-3725-1, Tektronic Inc. EIMB Installation Standards, NAVSHIP 0967-LP-00-0110</p>				
3	<p>List all Institute pamphlets issued to the student followed by the quantity provided for each. Use the following format:</p> <p style="padding-left: 40px;">Teletypewriters and Associated Equipment, CGI Pamphlet #W24504 Qty: 1 per student CD-ROM of entire course</p> <p>If pamphlets have not been developed, enter the following statement: "Pamphlets will be developed later."</p>				
4	<p>Complete the Reserve Retirement Points Worksheet in accordance with the directions on the following pages.</p>				

Exhibits (Continued)

Example Below is an example of exhibits 1-3.

EXHIBITS:

(1) TRAINING AIDS/TRAINING EQUIPMENT:

Nautical Charts

NavKit: Dividers, Compass, Parallel Rules, Weem's Plotter,

Nautical Slide Rule

(2) REFERENCES LISTED IN THE TPOs:

Boat Crew Qualification Guide, COMDTINST M16114.10 (series)

Boat Crew Seamanship Manual, COMDTINST M16114.5 (series)

Boat Crew Training Program, COMDTINST M16114.9 (series)

Boatswain's Mate 3 & 2 Manual, NAVEDTRA 10121-G1

Shipboard Helicopter Operational Procedures, COMDTINST M3710.2

(3) TRAINING CENTER PAMPHLETS ISSUED TO THE STUDENT:

Administration, Watch Standing, and Personnel Supervision Pamphlet, W24504

Qty: 1 per student

Deck Seamanship Pamphlet, Qty: 1 per student

Navigation and Piloting Pamphlet, Qty: 1 per student

Sampson Cordage Splicing Manual, Qty: 1 per student

Marlinespike Seamanship Pamphlet, Qty: 1 per student

Student CD-ROM of BM3 PQG, Qty, 1 Per Student

Reserve Retirement Points, Exhibit 4

Overview

It is the course writer's responsibility to determine the amount of Reserve Retirement Points (RRP) that can be earned in a particular course. To do this, TRACEN subject matter specialists (SMS) will determine the amount of time a member will need to complete each section of the PQG and EPME.

The time to complete these courses includes reading the material and completing quizzes and/or exercises. It does not include completing the performance tasks or taking of the end of course test (EOCT), as these activities are performed during drill time (on the job).

Since RRP's are correlated with drills, the total number of hours is divided by "4" (the number of hours in a drill) to arrive at the RRP's for that PQG/EPME.

Use the worksheet to record your work.

Format

The format for the Reserve Retirement Points Worksheet is shown below.

Course Completion Computation Work Sheet For Reserve Retirement Points					
Course Title:					
Terminal Performance Objective #	TPO/Lesson Length (words)	Reading (hrs)	Written Exercises and Quizzes (hrs)	CBT (if applicable)	Total TPO Hours

Reserve Retirement Points, Exhibit 4 (Continued)

Procedure The procedures for determining Reserve Retirement Points are outlined in the following table.

STEP	ACTION
1.	Determine word count of each pamphlet. Note: Use the word count feature in Microsoft Word® (Tools).
2.	Divide word count by the following: <ul style="list-style-type: none"> • A reading rate of 75 words per minute (WPM) will be used when determining the reading factor for each TPO in a rate or rate-related courses and specialty courses. • A reading rate of 150 WPM for non rate related courses to include EPME. Example Calculation: $6116 \text{ (section word count)} \div 75 \text{ (WPM for rate-related reading)} = 81.55 \text{ (minutes)}$ $81.55 \div 60 \text{ (minutes in an hour)} = 1.359 \text{ (hours)}$ Reading hours = 1.4 for the section counted (rounded to nearest tenth)
3.	After determining the WPM, the information will be documented on a sheet similar to the Instructor Contact Hours sheet, but will be modified to include: <ul style="list-style-type: none"> • Reading (estimated amount of time needed to complete a portion of the PQG using 75 WPM) • Written Exercises and Quizzes (reinforcement of the material contained within the PQG) • CBT (computer-based training) would be included only if it applied to the training course.
4.	Use the following formula to determine RRP: $((\textit{Reading hours} + \textit{WE/Quizzes} + \textit{CBT}) / 4)$
5.	Enter Course Reserve Retirement Points on Cover Page. Note: There is no maximum amount of reserve retirement points permitted to be awarded per course.
6.	Include the Reserve Retirement Points Worksheet as an enclosure in the Curriculum Outline.

Reserve Retirement Points, Exhibit 4 (Continued)

Example

Below is an example of a Reserve Retirement Points Work Sheet.

Exhibit 4					
Course Completion Computation Work Sheet For Reserve Retirement Points					
Course Title: BM3 PQG					
Terminal Performance Objective #	TPO/Lesson Length (words)	Reading (hrs)	Written Exercises and Quizzes (hrs)	CBT (if applicable)	Total TPO Hours
1.1 - 1.3	6116	1.4	.1	0	1.5
2.1 - 2.5	10755	2.4	.1	0	2.5
3.1 - 3.6	6856	1.5	0	0	1.5
4.1 - 4.5	9212	2.0	.4	.2	2.6
5.6 - 5.15	23725	5.2	.4	0	5.6
6.1	20833	4.6	.4	0	5.0
7.1	25357	5.6	.4	0	6.0
8.1 - 8.12	41472	9.2	.4	0	9.6
9.1 - 9.5	84572	18.8	.4	0	19.2
					53.5 Hours/4
					13 RRP

Note: The **13 RRP** is what is included on the cover page of the Curriculum Outline.

Nonresident Curriculum Outline Checklist

**PQG
Curriculum
Outline
Checklist**

Use this checklist to ensure that your curriculum outline has the required information.

Nonresident Curriculum Outline Checklist

No.	Section Description	X	Date Completed
1	Curriculum Outline Cover Page		
2	Table of Contents		
3	Course Data		
4	Mission and Scope Statements		
5	Units of Instruction (Terminal Performance Objectives)		
6	Course Content Reference Table		
7	Training Aids/Training Equipment, Exhibit 1		
8	References Listed in TPOs, Exhibit 2		
9	Training Center Pamphlets Issued to the Student, Exhibit 3		
10	Reserve Retirement Points Worksheet, Exhibit 4		
11	Total Reserve Retirement Points added to Cover Sheet?		
12	Objectives consistent with the PQG?		
13	References in the Outline Consistent with References in the PQG?		
14	Pamphlet Numbers listed in Curriculum Outline match PQG?		
15	COURSE NAME, ID, CODE, AND EDITION listed in Curriculum Outline?		

Writing Test Items

Stem Format

The format of the stem of a test item is developed using one of the following formats:

- Declarative Format. In the declarative stem, ask for only one piece of information. Use one blank to represent the missing information. Make the blank five underlines for multiple-choice questions. The blanks should be longer on self-quizzes for fill-in the blank test items. Place the blank as near the end of the sentence as possible to avoid confusion and necessitate excessive rereading of the stem.

Examples:

Poor: The _____ must be used when aligning _____ bearings.

Better: When aligning shaft bearings, you must use a _____.

Poor: The _____ mixes fuel and air in a gasoline engine.

Better: In a gasoline engine, the fuel and air are mixed by the _____.

- Interrogative Format. Ask only one question, and begin the main clause with an interrogative word (e.g., who, which, what, how, when, why).

Examples:

Poor: What is the primary color and rated capacity of a CO₂ cylinder?

Better: What is the primary color of a CO₂ cylinder?

Principles for Writing the Stem

The principles for writing the stem for a test item are provided below.

- Completeness. Write the stem so that its meaning is immediately clear without reading the responses. Include as much information as possible in the stem so that the alternatives are brief and nonrepetitive and lead to a single, correct answer listed in the response.
-

Writing Test Items

Principles for Writing the Stem (Continued)

Examples:

Poor: When lube oil leaves an engine sump, what does it do?

Better: When lube oil leaves an engine sump, it **FIRST** passes through a _____.

Poor: A blower or supercharger _____.

Better: A blower or supercharger is installed on some diesel engines to increase _____.

- Extraneous Information. Leave out all unnecessary information.

Examples:

Poor: Coast Guard Regulations provide that a leading petty officer must be detailed as master-at-arms. A senior petty officer is assigned this duty by the _____.

Better: Who assigns the master-at-arms duty to a senior petty officer?

- Exclusive Information. Include information in the stem which will set limits for the correct response (for example, first, maximum, minimum, least).

Examples:

Poor: The Mk 58 marine location marker will burn for _____ minutes.

Better: The Mk 58 marine location marker will burn for a **MAXIMUM** of _____ minutes.

Writing Test Items

Principles for Writing the Stem (Continued)

- Qualifying Information. Place qualifying information in the first part of the stem as a phrase, dependent clause, or a separate sentence. Eliminate qualifying information and modifiers that are vague or ambiguous.

Examples:

Poor: What should you do FIRST after you remove a potentially dangerous prisoner from a crowded building?

Better: After you remove a potentially dangerous prisoner from a crowded building, what should you do FIRST?

- Positive Items. Write positive test items, unless the negative form is more appropriate for safety, critical decision, or exception items.

Examples:

Poor: Which function is not a function of lube oil?

Better: The four MAIN functions of lube oil are to lubricate, clean, seal, and _____.

Safety: While using a welding torch, you should NEVER wear which material?

Critical Decision: When marking the parts of a gas turbine engine, you should NEVER use _____.

Exception: The copies of Direct Access documents are distributed as indicated on each copy EXCEPT when directed otherwise by _____.

- Comparisons. Do not omit words needed to complete comparisons.

Examples:

Poor: One advantage of channel-lock pliers is that they _____.

Better: One advantage of channel-lock pliers over waterpump pliers is that channel-lock pliers _____.

Writing Test Items

Principles for Writing the Response

The principles for writing the responses to test items are provided below:

- Plausibility. All distractors must be plausible (logical).

Examples:

Poor:

- A. Commandant
- B. District commander
- C. Commanding officer
- D. Mayor

Better:

- A. Commandant
- B. MLC commander
- C. District commander
- D. Commanding officer

- Distinct Choices. Provide clear and distinct choices.

Examples: The front of the ship is referred to as the _____.

Poor:

- A. bow
- B. bough
- C. brow
- D. beam

Better:

- A. bow
- B. stern
- C. port
- D. starboard

- Parallelism. All responses must be parallel in grammar, form, and intent.

Grammar Examples:

Poor: The MAIN purpose for including crewmembers in a search briefing is _____.

- A. to improve morale
- B. improving lookout performance
- C. to clarify duties
- D. clarify departure time

Better: The MAIN purpose for including crewmembers in a search briefing is to _____.

- A. improve morale
 - B. improve lookout performance
 - C. clarify objectives
 - D. clarify the departure time
-

Writing Test Items

Principles for Writing the Response (Continued)

Form (length) Examples:

Poor:

- A. In the chest
- B. In the kidney
- C. In the sella turcica of the sphenoid bone
- D. Under the arm

Better:

- A. In the chest
- B. In the kidney
- C. Near the brain
- D. Under the arm

Intent (primary point) Examples:

Poor: Which of the following statements concerning Servicemen's Group Life Insurance is correct?

- A. Married members who have never filed a beneficiary designation must do so to protect beneficiaries
- B. Reserve members on 2 weeks' active duty for training are automatically covered under SGLI unless they request otherwise
- C. Members canceling their coverage under SGLI must provide evidence of good health before being reinstated
- D. Claims for death benefits under SGLI will be paid by the Veterans' Administration

Better: To qualify for Servicemen's Group Life Insurance, Reservists must be on active duty for AT LEAST _____ days.

- A. 2
 - B. 14
 - C. 30
 - D. 60
-

Writing Test Items

Principles for Writing the Response (Continued)

- Extraneous Information. Leave out unnecessary information. Eliminate complex lists and sequence of steps.

Examples:

Poor: This refrigerant absorbs heat in the _____.

- A. evaporator in an R-12 system
- B. condenser in a boiler
- C. compressor in an R-12 system
- D. compressor in a turbine

Better: In an R-12 refrigeration system, the refrigerant absorbs heat in the _____.

- A. cooler
- B. condenser
- C. evaporator
- D. compressor

- Redundant Phrasing Responses. Omit all redundant phrasing.

Examples: Responsibility for a ship rests with the _____.

Poor:

- A. CO
- B. commanding officer
- C. "old man"
- D. senior officer

Better:

- A. commanding officer
- B. executive officer
- C. navigation officer
- D. engineer officer

- Overlapping Responses. Omit all overlapping ranges.

Examples:

Poor:

- A. 12 to 16
- B. 14 to 20
- C. 16 to 18
- D. 19 to 22

Better:

- A. 12 to 15
 - B. 16 to 19
 - C. 20 to 24
 - D. 25 to 29
-

Writing Test Items

Principles for Writing the Response (Continued)

The use of "None of the above" or "All of the above" is prohibited because the test item database program randomly orders distractors.

- Double Lists. Do not use double lists.

Examples:

Poor: The brake linings of a segmented rotor brake are attached to which of the following?

- | | |
|---------------------------|----------------|
| 1. Rotor segment | A. 1 and 5 |
| 2. Stator plate | B. 2 and 4 |
| 3. Backing plate | C. 1, 3, and 4 |
| 4. Pressure plate | D. 2, 3, and 5 |
| 5. Auxiliary stator plate | |

Better: The brake linings of a segmented rotor brake are attached to the _____ plate.

- A. keeper
 - B. pressure
 - C. stator
 - D. backing
-

Writing Test Items

Style and Punctuation

The principles for style and punctuation used in writing test items are provided below.

- Final Punctuation. Do not use a period after the last word in each response.

Example:

- A. Seal the compartment
- B. Secure the pump
- C. Add an eductor
- D. Add a second pump

- Quotation Marks. Use quotation marks to set off commands and examples of word use.

Examples:

1. To acknowledge the receipt of a message on a sound-powered telephone, you should say "_____."

- A. AFFIRMATIVE
- B. AYE, AYE
- C. ROGER
- D. ON THE LINES

2. What does the abbreviation "psi" represent?

- A. Positive Sensing Image
- B. Pounds Square Inch
- C. Per Square Internal
- D. Per Square Inch

- Abbreviations. Use only standard, widely accepted abbreviations. See Chapter 9 of the Government Printing Office Style Manual.

Examples:

CO, commanding officer
kW, kilowatt
lat., latitude
Loran, long-range navigation
NOAA, National Oceanic and Atmospheric Administration

Writing Test Items

Style and Punctuation (Continued)

- Capitalization in Responses. Capitalize the first letter of each response to a stem that asks a question.

Example: After crash landing, what should you do FIRST?

- A. Check the injuries
- B. Determine your position
- C. Set-up a temporary shelter
- D. Operate the emergency radio

Exception: Which symbol represents the engineering division at a district office?

- A. e
- B. ene
- C. E
- D. ENE

- Capitalization of Titles. Capitalize titles only if they are used as part of a person's name and immediately precede or follow that person's name. Exceptions in the Coast Guard chain of command are the Commandant, the Secretary of Homeland Security, and the President.

Example: On a Coast Guard vessel, the person responsible for the deck force is the _____.

- A. first lieutenant
- B. engineer officer
- C. operations officer
- D. communications officer

Other Correct Examples:

J. A. DOE, Captain, U.S. Coast Guard
Captain J. A. DOE was also . . .
called J. A. DOE, the captain of the vessel, . . .
when speaking with the Commandant . . .

Writing Test Items

Style and Punctuation (Continued)

- Data. Use "table form" to present four or more pieces of information in the stem.

Example: Using the following information, compute the total days' leave a member would use if hospitalized while on leave.

1639	29 June	Departed on leave
1700	3 July	Admitted to hospital (CO notified)
1000	11 July	Released to resume leave
0800	18 July	Readmitted to hospital for evaluation
1600	22 July	Released to resume leave
0900	4 Aug	Returned to unit

- Repetitive Phrasing. If the same word or phrase is used in all four responses, move it to the stem. However, do not separate numeric responses from symbols and abbreviations.

Examples:

Poor: When making an ordinary eye splice in fiber line, you should take a MINIMUM of _____.

- A. two rounds of tucks
- B. three rounds of tucks
- C. four rounds of tucks
- D. five rounds of tucks

Better: When making an ordinary eye splice in fiber line, you should take a MINIMUM of _____ rounds of tucks.

- A. two
- B. three
- C. four
- D. five

Exception:

- A. 500 psi
- B. 600 psi
- C. 700 psi
- D. 800 psi

Writing Test Items

Style and Punctuation (Continued)

- Units of Measure. Convert all responses to the same unit of measure unless the result is an abnormal use of the units.

Examples:

Poor:

- A. 1 day
- B. 15 days
- C. 1 month
- D. 3 months

Better:

- A. 1 day
- B. 15 days
- C. 30 days
- D. 90 days

Exceptions:

- A. 157.05 MHz
- B. 157.1 MHz
- C. 2181 kHz
- D. 2670 kHz

- A. 1 month
- B. 2 months
- C. 1 year
- D. 2 years

- Symbols. Use standard symbols with a number.

Examples:

Poor:

- A. 45 degrees
- B. 60 degrees
- C. 90 degrees
- D. 120 degrees

Better:

- A. 45°
- B. 60°
- C. 90°
- D. 120°

- Publications and Forms. When you use both the name and number of a publication or form, use the name first followed by the number.

Publications Examples.

Enlisted Performance Qualifications Manual, COMDTINST M1414.8 (series)
Directives System, COMDTINST M5215.6 (series)

Forms Examples.

Enlisted Service Record (CG-3300)
Statement of Understanding (CG-3301A)

Writing Test Items

Grammar

Grammar may be defined as a system of rules for the use of language, or as a study of what is preferred and what is to be avoided in effective speech and writing. To be effective, we must achieve clarity of expression. We need to know how to present ideas forcefully, without confusion or unnecessary words, by choosing language suited to our purpose. The principles for grammar are outlined below.

- Active Voice. Use active voice whenever the source of action can be identified. Your stem will have a subject or doer of the action, a verb (the action or task), and an object of that action.

Examples:

Poor: When a transmission is ending and no answer is expected, what proword should be used?

Better: When you are ending a transmission and expect no answer, what proword should you use?

- Passive Voice. Use passive voice if you have a good reason to avoid saying who or what has done the verb's action. This situation may occur when the doer is unknown, unimportant, obvious, or better left unsaid. Write passively also if the receiver of the action is more important than the source of the action.

Examples:

Poor: Aboard ship, everyone calls ammunition stowage spaces "_____."

Better: Aboard ship, ammunition stowage spaces are called _____.

Writing Test Items

Grammar (Continued)

- Agreement. Make each response grammatically consistent with the stem, i.e., use "a/an" if one or more distractors begins with a vowel.

Examples:

Poor: The commanding officer of a WMEC is normally a _____.

- A. chief petty officer
- B. ensign
- C. lieutenant (junior grade)
- D. commander

Better: The commanding officer of a WMEC is normally a/an _____.

- A. chief petty officer
- B. ensign
- C. lieutenant (junior grade)
- D. commander

- Dangling Modifiers. A dangling modifier is a phrase or clause that is attached either to no word in a sentence or to the wrong word. Avoid dangling modifiers (phrases or clauses).

Examples:

Poor: **Needing to be calibrated**, the watch stander should notify _____.

Better: When the pressure gage needs to be calibrated, the watch stander should notify the _____.

- Present Tense. In most cases, the use of the present tense for the main verb is more appropriate.

Examples:

Poor: What **caused** the plates of a battery to disintegrate more quickly than normal?

Better: What **causes** the plates of a battery to disintegrate more quickly than normal?

Writing Test Items

Word Use

Five principles on the use of certain words are listed below.

- Concise Wording. Use short, concise words whenever possible.

Examples:

Poor:

- A. investigate the condition of the pistons
- B. investigate the condition of the carburetor
- C. disencumber the intake valves
- D. disencumber the exhaust valve

Better:

- A. check the pistons
- B. check the carburetor
- C. clean the intake valves
- D. clean the exhaust valves

- Slang. Use proper terms rather than slang expressions.

Examples:

Poor: In an R-12 refrigeration system, what admits the R-12 into the **evap**?

Better: In an R-12 refrigeration system, what admits the R-12 into the **evaporator**?

- Should/Must/Would. Use "should" to express a preferred action; use "must" to express a required action; avoid the use of "would."

Examples:

Poor: Where **do** you record the proof-load test date on a Stokes litter?

Better: Where **should** you record the proof-load test date on a Stokes litter?

Poor: Which substance **would** you use to fight a class A fire?

Better: Which substance **should** you use to fight a class A fire?

Writing Test Items

Word Use (Continued)

- Explicit Words. Use explicit, precise words rather than vague, general, or ambiguous words.

Examples:

Poor: In which publication do you find correspondence information?

Better: What CG publication or directive contains detailed procedures for preparing a memo?

- Consistency. Be consistent in spelling.

Example:

harbor/harbour

Rule: Always check any style manual your command may have then the GPO Style Manual, and finally, check your dictionary.

Numbers

Five principles on use of numbers in the stem and responses are listed below.

- Spelling. Use figures for all numbers 10 or above. Spell the numbers zero through nine when they are not units of measure or time.

Examples:

- | | |
|----------|-----------|
| A. One | A. 1 ohm |
| B. Two | B. 2 ohms |
| C. Three | C. 3 ohms |
| D. Four | D. 4 ohms |

If numbers above and below 10 are mixed, use figures for all of them.

- A. 1
 - B. 10
 - C. 11
 - D. 30
-

Writing Test Items

Numbers (Continued)

- Fractions. Use figures to write fractions when used with units of measure. Use the following form: whole number, space, numerator, slant, denominator.

Example:

When securing an 8-inch towing hawser, you should use a MINIMUM of $3\frac{1}{2}$ turns around the _____.

- Dollar signs. In response sets, align dollar signs when they are used with numbers. Use the comma in a number containing four or more digits.

Examples:

- | | |
|----------|-------------|
| A. \$220 | A. \$ 50 |
| B. \$114 | B. \$ 150 |
| C. \$ 8 | C. \$ 1,000 |
| D. \$ 5 | D. \$ 2,000 |

- Alignment. In response sets, align numbers vertically by the decimal. Use the same number of decimal places in all responses unless common usage dictates otherwise, and precede all decimals with whole numbers. Align the units of measure following the numbers. Align fractions, sets, and ranges to the left.

Examples:

- | Poor: | Better: |
|-------------|-------------|
| A. 0.2 psi | A. 0.20 psi |
| B. 0.5 psi | B. 0.50 psi |
| C. 0.75 psi | C. 0.75 psi |
| D. 1 psi | D. 1.00 psi |

Other Correct Examples:

- | | | |
|---------|------------|-----------|
| A. 1 | A. 02-32-1 | A. 79/100 |
| B. 12 | B. 02-32-2 | B. 13/20 |
| C. 144 | C. 1-32-02 | C. 5/11 |
| D. 1728 | D. 2-32-02 | D. 1/2 |

Exception:

- A. 157.05 MHz
- B. 157.1 MHz
- C. 2182 kHz
- D. 2670 kHz

Writing Test Items

Numbers (Continued)

- Starting the Stem. Do not begin a stem with a figure. Spell out the number or rephrase the stem.

Examples:

Poor: 1 international nautical mile equals _____ meters.

Better: One international nautical mile equals _____ meters.

Writing Test Items

Illustrations

Illustrations should be used whenever an illustration is better than a written description.

- Quality. Use only line drawings or art designer graphics that have distinct black lines and are completely readable.

Examples:

Poor:

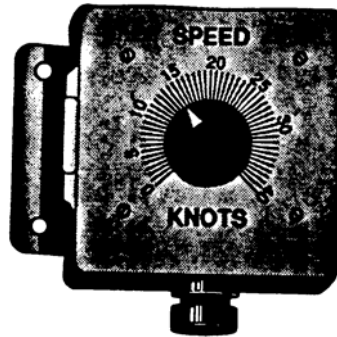

Better:

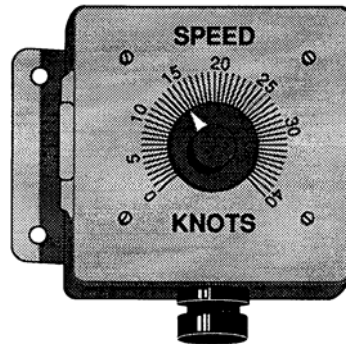

Writing Test Items

Illustrations (Continued)

- Single Illustration Lettering. Label parts of a single illustration clockwise starting from the upper left. Use the letters A, B, C, etc.

Example:

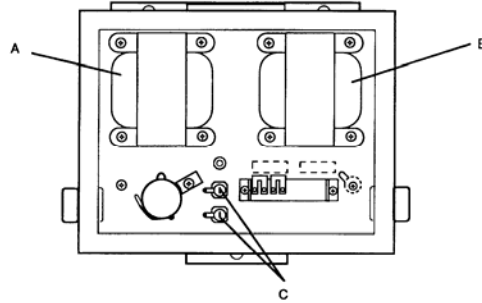

- Multiple Illustrations. When each response choice is a separate illustration, arrange and letter the choices left to right, or top to bottom.

Examples:

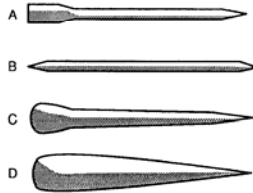
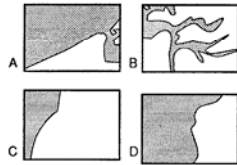
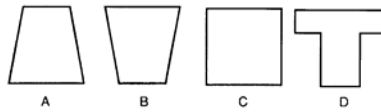

Writing Test Items

Illustrations (Continued)

- Location of Illustrations.

If the illustration is used with only one test item, place it between the stem and responses. It must be no wider than one column.

Example: _

This illustration shows a/an _____.



- A. anemometer
 - B. psychrometer
 - C. barometer
 - D. altimeter
- If the illustration is to be used with two or more test items, you must place it below the stem of each item. Illustration width (one or two columns) may vary, depending upon the complexity of the illustration. Provide instructions as in the following example:

Example: _

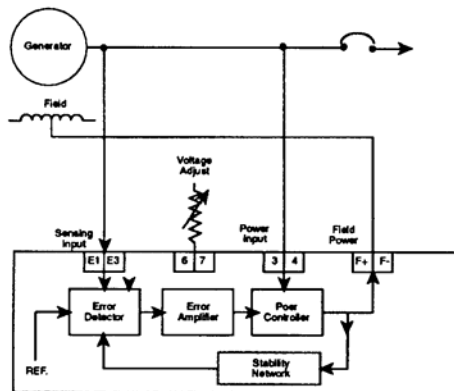

Writing Test Items

Illustrations (Continued)

- Extraneous Information. Omit all information and detail not necessary to understand the question and to choose the correct response.

Examples:

Poor: What section of the I-beam does the letter "Z" refer to?

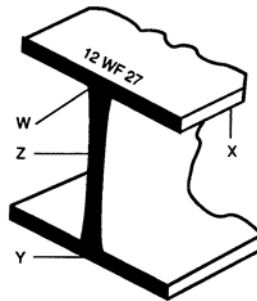

Better: What section of the I-beam does the letter "X" refer to?

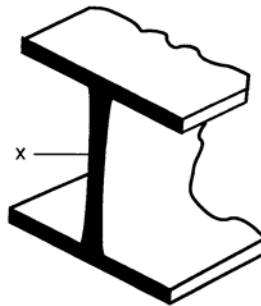

Section 6

TEST ITEM DEVELOPMENT

Test Item Development

Overview Performance-based, criterion-referenced testing requires students to demonstrate only the performance of objectives. Therefore, they are tested only on what they need to know to perform their job. Write test items so they relate directly to the performance objectives to ensure students display the same type of performance as in the objectives. Test items for servicewide examinations (SWEs) are developed from enlisted performance qualifications independent of course development.

Outline The three areas involved with the development of test items include:

- Matching Test Items to Objectives.
- Formatting Test Items.
- Writing Test Items.

Procedure Test items should be written and approved before they are used on an end-of-course test (EOCT) or SWE. The steps are listed below.

Step	Action	Responsibility
1	Review quals/objectives and references depending on the exam.	SMS or E-9 for SWE items.
2	Develop new items or revise old items and enter into the test item database (add illustrations if necessary).	SMS
3	For an EOCT item, have another SMS review item. If an SWE item, only the appropriate E-9 for the rating should have access to the item.	SMS
4	Review for educational content and for consistency with quals/objectives.	ISS
5	Make appropriate changes.	SMS
6	Conduct first edit.	Writer/Editor
7	Make appropriate changes.	SMS
8	Enter approval and/or revision date to new and revised items.	SMS

Note: Depending on training source and staff billets, the above responsibilities for the ISS, E-9, and/or W/E could be performed by other staff members.

Test Item Development

Breakdown of Responsibilities

The responsibility for developing test items for self-quizzes/topic reviews, pamphlet review quizzes, and EOCTs is shared among the subject matter specialist, the instructional systems specialist, and the writer/editor. For SWE questions, the responsibility is shared among the appropriate E-9 for the rating, the instructional systems specialist, and the writer/editor. A breakdown of the responsibilities during the review phase of test item development is outlined below.

Subject Matter Specialist (SMS) or appropriate E-9 for the rating:

- Reviews each test item for content, currency, accuracy, validity, and single correct response.

Instructional Systems Specialist (ISS):

- Test Items - Reviews each new test item for consistency with quals and objectives and for educational content; reviews items with answers for clarity, relevance, ambiguity, cueing, appropriateness of illustrations, and order and validity of distractors.

Writer/Editor (W/E):

- Corrects spelling, punctuation, capitalization, grammatical structure, sexist language, clarity, active voice, and positive statement.
- EOCT and SWE Review – Reviews each test for cueing, question sequencing, and item repetition or similarity.

Note: Depending on training source and staff billets, the above responsibilities for the ISS and/or W/E could be performed by other staff members.

Test Item Database

Test items for EOCT and SWE are developed and stored in a test item database. Each item must be reviewed and approved by the SMS or E-9 for the rating, the ISS, and the W/E before using on a test.

Writing Test Items

The test items for a EOCT shall be written based on the TPOs and EOs for the course. There SHALL be sufficient questions (a minimum of five per TPO/EO) for the test items database to randomly select enough questions to create three separate tests.

The test items for a SWE shall be written based on the EPQ's and required competencies listed in the EPQ's. There SHALL be sufficient questions (a minimum of five) for the test items database to randomly select enough questions to create two separate tests for each paygrade.

Matching Test Items to Objectives

Introduction

As discussed previously, the tests you will develop for your course are performance-based, criterion-referenced tests. What this means is the test items must match your performance objectives. The decision table below will help you identify (by test) which objectives to base your items on.

IF you are developing the . . .	THEN your test item must match the . . .
self-quiz/topic review	lesson objective.
pamphlet review quiz	lesson objective.
EOCT	performance objective (TPOs and EOs).
SWE*	Enlisted Performance Qualifications.

* The SWE is not a criterion-referenced test; it is a norm-referenced test. The development of test items for the SWE is based on the Enlisted Performance Qualifications outlined for each rate in the Enlisted Qualifications Manual, COMDTINST M1414.8 (series).

Norm-Referenced Test

A norm-referenced test (NRT) is one that compares a member's performance to national or regional averages rather than to a standard. If, Coast Guard-wide, the average score on a particular SWE is 60% and a student scores 70%, the member's performance is above average, even if the 60% represents a very low level of performance. In a test that is not norm-referenced (or "curved"), members' performances are measured against a standard, such as the criterion-referenced EOCT: if 76% is a passing grade and the student receives a 60% (even though Coast Guard-wide most students received a 60%), he or she still fails.

A score on a norm-referenced test cannot be compared to a score on a standards-based test because they are each being compared to something different, the norm-referenced score to a curve and the standards-referenced score to a standard.

The main purpose of NRTs is to rank and sort students, not to determine whether students have learned the material they have been taught. They do not measure anywhere near enough of what students should learn.

Matching Test Items to Objectives

Development Process

A performance objective identifies the job performance you want your student to achieve at the end of a lesson, a pamphlet, or a course. How you measure that achievement depends on the design of your test items. The following chart shows the process of developing test items from performance objectives, starting with the enlisted performance qualification and ending with the pamphlet review quiz test item. When you develop test items, remember to write the performance objective first. Then write test item(s) to match that objective. This process is completed BEFORE you develop the test or write the course.

SWE items are based on the performance qualifications and are written independent of course development. The SWE items cover tasks, skills, and knowledge needed to perform the enlisted performance qualifications.

COMPONENT	EXAMPLE
Enlisted Performance Qualification (EPQ)	BM EPQ D4.01 MAINTAIN cutter and/or small boat surfaces to include hull, underwater body, decks, and all related fittings and equipment (interior/exterior) IAW Coatings and Color Manual, COMDTINST M10360.3 (series) and Boat Operators Handbook.
Performance Objectives	<p>Terminal Performance Objective (TPO): Generally the EPQ becomes the TPO. However, if the EPQ does not contain a performance, conditions, and/or standards, you should write the TPO using the design principles of a good performance objective.</p> <p>Note: Not all EPQs are written with condition statements (as in the EPQ above).</p> <p><u>Example</u> Given instructional material and job aids, MAINTAIN cutter and/or small boat surfaces to include hull, underwater body, decks, and all related fittings and equipment (interior/exterior) IAW Coatings and Color Manual, COMDTINST M10360.3 (series) and Boat Operators Handbook.</p> <p>[The Performance Development Supervisor (PDS) will evaluate student competency for 100% completion during the PQG process <u>and</u> for 80% accuracy by the end-of-course test (EOCT). (D.4.01)]</p>

Matching Test Items to Objectives

Development Process (Continued)

COMPONENT	EXAMPLE
Performance Objectives, continued	<p>Enabling Objective (EO): EOs are task steps (or groups of task steps) that support the TPO. EOs are identified during the task analysis.</p> <p><u>Example:</u></p> <p>Given instructional material and job aids, LIST the correctly ordered steps, material, and procedures for different types of surface preparation IAW the Color and Coatings Manual COMDTINST M10360.3 (series).</p>
SWE or EOCT Item	<p><u>Example #1</u></p> <p>You are burning paint off a wooden surface. After blistering the paint, you should start scraping _____.</p> <p>A. after the blisters break B. while the paint is hot and soft C. after cracks appear in the cooled paint D. when the paint cools and becomes brittle</p> <p><u>Example #2</u></p> <p>When painting an exterior surface, which paint should you select to produce a nonporous, hard, durable chemical-resistant surface?</p> <p>A. Mare Island Epoxy B. Silicone Alkyd Enamel C. Interior Enamel Undercoat D. Exterior Gloss Resin Enamel</p> <p><u>Example #3</u></p> <p>What power tool should you use to remove rust from a large metallic area?</p> <p>A. Sander B. Grinder C. Wire brush D. Rotary or needle scaler</p>

Matching Test Items to Objectives

Development Process (Continued)

COMPONENT	EXAMPLE
Lesson Objective(s)	<p>Lesson objectives guide you through the text and help you answer the self-quiz at the end of each lesson.</p> <p><u>Example #1</u> IDENTIFY the type of blast cleaning used to prepare the surface for coatings that must withstand exposure to very corrosive atmospheres.</p> <p><u>Example #2</u> IDENTIFY the power tool used to remove rust, mill scale, and oil paint from large metallic and masonry areas.</p>
Self-quiz Item(s)/Topic Review Item(s)	<p><u>Example #1</u> Which type of blast cleaning should you use to prepare the surface for coatings that must withstand exposure to very corrosive atmospheres?</p> <p><u>Example #2</u> The power tool used to remove rust, mill, scale, and oil paint from large metallic and masonry areas is _____.</p>
Pamphlet Review Quiz	<p>Also based on the lesson objectives, the only difference here is that it is written in multiple choice format.</p> <p><u>Example</u> The paint used as a primer/sealer or finish coat on exterior concrete and masonry is _____.</p> <p>A. Mare Island Epoxy B. Exterior Acrylic Emulsion C. Chlorinated Alkyd Resin Enamel D. Interior/Exterior Gloss Alkyd Resin Enamel</p> <p>Note: When designing your review quiz, you are sampling your lesson objectives. You can develop your review quiz items by converting your self-quiz items to multiple-choice format.</p>

Test Item Format

Introduction

In distance learning courses, test items are developed for self-quizzes, pamphlet review quizzes, EOCT, and SWE. The test items in the self-quizzes are formatted to directly correspond to the lesson objectives. Test items for the other three types of tests are written in the four-response, multiple-choice format.

Test Item Types

The four basic types of test items you will use are:

- Short-answer
- Matching
- Multiple-choice (one correct answer with three distractors)
- Performance

True/false test items and items requiring the student to circle information are not to be used.

Test Item Selection Table

The following table identifies which test item format you may use on the tests you develop.

Test	Test Item Format
Self-Quiz/Topic Review	Short answer Matching Multiple choice Performance
Pamphlet Review Quiz	Multiple choice
EOCT	Multiple choice
SWE	Multiple choice

Test Item Format

Characteristics The characteristics for each type of test item are shown below.

Test Item Type	Characteristics
Short-Answer	<ul style="list-style-type: none">• Requires brief response.• Used to test simple recall.• Requires student to supply answer.
Matching	<ul style="list-style-type: none">• Requires student to select a response.• Tests student's ability to identify or recognize objects, words, or ideas.
Multiple-Choice	<ul style="list-style-type: none">• Requires student to select a response.• Tests student's ability to identify or recognize objects, words, or ideas.• Tests student's ability to apply concepts, principles, procedures, or processes.
Performance	<ul style="list-style-type: none">• May be written as short answer, multiple choice, or performance.• Requires student to apply rules or procedures in writing or by performing.• Tests student's ability to problem solve a situation/product using several rules.

Test Item Format

Short-Answer Construction

Short-answer items include completion, list, and explanation. Use short-answer items when you want the student to recall facts, basic ideas, or principles, or to make simple applications. Short-answer items are constructed based on the following guidelines:

- Completion Items. Completion items can be used for who, what, when, where, and why types of verbal association. They eliminate guesswork and save time. Some guidelines for writing completion items are:
 - Give the student all of the required information that will lead to the correct response before the blank.
 - Make sure there is only one correct answer.
 - Place the blank at or near the end of the statement.

Example:

In an internal combustion engine, the straight-line motion of the pistons is converted into the circular motion of the drive shaft by the _____.

- List Items. List items require the student to write out the answers. Answers for list items should:
 - Be brief responses (a few words or phrases).
 - Require no more than eight items to be listed.

Example:

List the three equations derived from Ohm's Law.

- 1.
- 2.
- 3.

Note: You may use a., b., c., etc., in place of numbers.

Test Item Format

Short-Answer Construction (Continued)

- Explanation Items. Explanation items relate very closely to completion items. The length of the required response is the obvious difference, but explanation items can be made more demanding. The student is required to furnish a response and to spell it out. Good explanation items demand the student's best thinking. Some guidelines for writing explanation items are:
 - Make sure the student understands what kind of discussion you want.
 - Limit answers to only a few phrases or sentences.

Example:

What is the primary purpose of each of the following blocks in the transmitter?

Modulator _____

Microphone _____

Antenna _____

Oscillator _____

- Short-Answer Item Using Illustrations. Graphic items can present the "given" element in a figure and require a graphic or essay response, or a combination of both, or they can present the "given" element verbally and require a graphic response. Many technical courses combine the graphic and problem items effectively. With some minor changes, these simple quiz items can become more complex multiple-choice items for use on the EOCT.

Test Item Format

Short-Answer Construction (Continued)

The next two examples show short-answer items using graphics.

Example #1:

Study the diagram below and write your answer to each question in the appropriate blank.

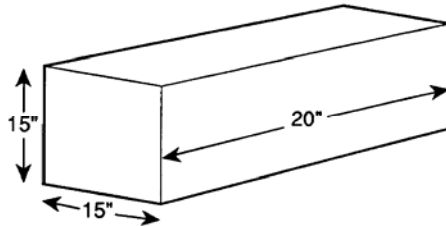

_____ 1. What is the horizontal distance?

_____ 2. What is the volume?

Example #2:

Using the diagram below of a simple electrical circuit, label each component shown.

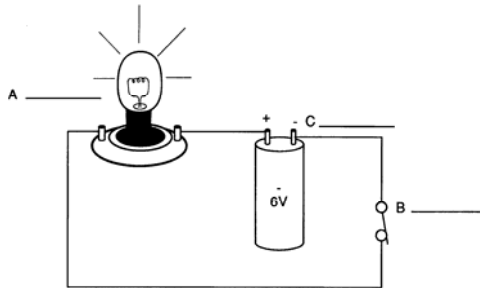

Test Item Format

Short-Answer Construction (Continued)

- Short-Answer Item Requiring Application of Knowledge.

Example:

The S. G. governor was just put on the engine. The governor drain has always worked properly in the past but now the governor is overflowing.

What is the MOST probable cause of the problem?

What corrective action should you take?

Matching Construction

Properly constructed matching items can make the student reflect, discriminate, interpret, organize, and classify. You should also build your matching items around a related body of facts or ideas. Construct matching items based on the following guidelines:

- Write directions to include:
 - Content of each column.
 - How many times the answer entries may be used.
 - List nothing in either column that is not relevant to the subject; do not include out-of-place entries.
 - Include more entries in the answer column than in the question column.
 - Place the column containing the longer entries on the right side of the page.
 - Arrange entries in logical order (e.g., alphabetically, chronologically).
-

Test Item Format

Matching Construction (Continued)









Example #1:

Match the electrical symbols in column B with the appropriate name of the symbol listed in column A. Use each symbol only once.

Column A

- _____ 1. Antenna
- _____ 2. Battery
- _____ 3. Fuse
- _____ 4. Inductance
- _____ 5. Resistance
- _____ 6. S P Switch

Column B

- a. 
- b. 
- c. 
- d. 
- e. 
- f. 
- g. 
- h. 

(Question Column)

(Answer Column)

Example #2:

Match each transmitter component listed in column A with its purpose from column B. Use each letter only once.

Column A

- _____ 1. Modulator
- _____ 2. Microphone
- _____ 3. Antenna

Column B

- a. Assigns RF carrier wave.
- b. Impresses intelligence on RF carrier wave.
- c. Amplifies RF signal.
- d. Radiates energy into space.
- e. Converts sound to electrical energy.

Test Item Format

Matching Construction (Continued)

Example #3:

Using the diagram of the block shown in column B, match each of the components listed in column A to its appropriate location on the diagram. Each letter may be used only once.

Column A

- _____ 1. Becket
- _____ 2. Breech
- _____ 3. Check
- _____ 4. Face
- _____ 5. Hook
- _____ 6. Pin
- _____ 7. Sheave
- _____ 8. Shell
- _____ 9. Swallow
- _____ 10. Thimble

Column B

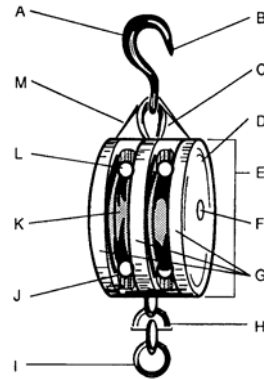

Multiple-Choice Construction

Multiple-choice test items must comply with the section on test item-writing principles in this manual. Construct multiple-choice items based on the following guidelines:

- Provide one correct answer and three distractors.
 - Use distractors that are plausible.
 - Place blank at or near the end of the question.
 - Make the blank **five underlines** (i.e., _____).
 - Make the alternatives as nearly equal in length as possible.
 - Ensure there is only ONE correct answer.
 - Ensure the stem is free of irrelevant material.
-

Test Item Format

Multiple-Choice Construction (Continued)

When you are constructing multiple-choice test items, DO NOT USE the following:

- Wording that serves as clues (i.e., "a" or "an" before the blank). The use of "a/an" is, however, acceptable when indicated by distractor and answer.
- Changes in parts of speech.
- Mix of singular and plural nouns and verb tenses.
- "None of the above" or "all of the above."
- Repetition in wording of responses.

If you encounter these problems in a test item, reword the question another way.

The multiple-choice test item format can be constructed using a single type or a combination of the following types:

- Recognition Item. Use a direct question or incomplete statement to determine the student's ability to recognize facts, concepts, procedures, processes, and principles.

Example #1:

Which is the correct formula for Ohm's law?

- A. $R = I/E$
- B. $I = ER$
- C. $E = R/I$
- D. $I = E/R$

Example #2:

The formula for Ohm's law is _____.

- A. $R = I/E$
 - B. $I = ER$
 - C. $E = R/I$
 - D. $I = E/R$
-

Test Item Format

Multiple-Choice Construction (Continued)

- Situation Item. Present the information on which the test item is based in the form of an actual or hypothetical set of circumstances. Items of this type can be simple or complex and can be used for one or more problems. Situation items are extremely useful in testing the student's ability to apply information from the text.

Example:

After working outside in subzero temperatures, your hands are beginning to feel stiff and numb. You notice that the skin on your hands is very white. How should you treat your hands?

- A. Warm your hands with a heat lamp
 - B. Immerse your hands in warm water
 - C. Place your hands over a hot stove or fire
 - D. Rub your hands together until the feeling returns
- Item Using an Illustration. An illustration is the "given" element used with any of the previous types of multiple-choice test items.

Example:

The signal shown below indicates _____.

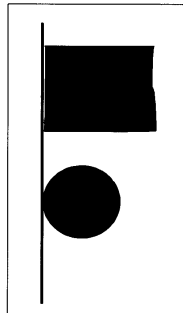

- A. diving operations
 - B. survey operations
 - C. a vessel in distress
 - D. an unknown medical emergency
-

Test Item Format

Performance Construction

Performance items are functional. To solve them, the student must understand principles and be able to apply them. Math problems, in particular, force the student to perform operations accurately and in a definite sequence. Most math problems, other than those limited to simple arithmetic, fall into the category of formula and equation problems. You need to specify what operations the student must perform, give the necessary data to work the problem, and ask the student to solve for the unknown value(s). The formula sets up the broad outline of the problem.

Construct performance test items based on the following rules:

- Use the rules for the test item format that you choose. Provide clear, complete directions.
- Identify criteria for test items requiring response within given parameters.
- Make sure the explanation portion of each test item contains only a few short phrases or sentences to minimize confusion.

Example #1:

Using the formula for solving time, speed, and distance problems, solve for the unknown values.

TIME	SPEED	DISTANCE
a. _____	14 kts	147 NM
b. 12 min	_____	.6 NM
c. 73.5 hrs	16 kts	_____

Example #2:

Your ship is on course 320°T, speed 15 knots. Your radar operator is tracking contact "K" on course 080°T, speed 8 knots. At time 1412, the contact bears 300°T, 18,000 yards from your unit. You are ordered to alter course in 6 minutes that will bring contact "K" no closer than 3 miles. What is the avoidance course?

- A. 355°T
- B. 350°T
- C. 180°T
- D. 175°T

Test Item Format

**Performance
Construction
(Continued)**

Example #3:

During lite-offs, the ECU does not respond to normal power and indicates the alternate source of power. After troubleshooting, you find the trouble to be in the power converter. The connection from fuse F1 to TB1 is loose due to vibration. You should _____.

- A. replace fuse F1
- B. replace the power converter
- C. retighten shock mounts
- D. retighten loose connection

Example #4:

Upon completion of the operational check of the VHF-FM, the following indicators were observed:

1. VHF-FM has proper transmit and receive capability in all modes.
2. VHF-FM will properly tune to selected frequencies.
3. When activating CCO toggle switch to control squelch, no change in operation is noted.

Does a malfunction exist?

If no, stop.

If yes, answer 1 and 2.

1. What indication leads to this conclusion?

2. List all probable causes.

Section 7

PAMPHLET DEVELOPMENT

Overview

Source Materials

Before you begin to organize your course, you must gather facts and ideas from various sources. You are a specialist assigned to write in an area because you know the subject matter. Thus, your primary sources are your own knowledge and the resources of the Coast Guard. Other sources include:

- Existing Correspondence Courses. No doubt you have a professional library of your own, and existing correspondence courses may contain supplementary information. You can adapt such material to your purposes if it is appropriate. Many ratings have common topics; e.g., administration, CSMP, and supply; don't reinvent the wheel, network with other subject matter specialist (SMSs) and share common information.
- Outside Sources. Even experts profit from consulting "outside" sources to keep themselves up-to-date and to get new ideas on how to present their subject matter. You may find useful library resources where you work, as well as in the libraries of colleges, universities, and technical schools in your vicinity.
- Other Services Correspondence Courses. You can also get copies of Army, Navy, Air Force, and Marine Corps correspondence courses for reference material.

U.S. Army	Army Institute for Professional Development USA Training Support Center Newport News, VA 23628-9989	(804) 878-4001
U.S. Air Force	Air Force Institute for Advanced Distributed Learning 50 South Turner Blvd. Maxwell AFB, Gunter Annex, AL 36118-5643	(334) 416-3159 www.maxwell.af.mil/au/afiadl/
U.S. Navy	NETPDTC (N3) 6490 Saufley Field Road Pensacola, FL 32509-5237	(850) 452-8095 https://wwwa.nko.navy.mil/portal/splash/index1.jsp
U.S. Marine Corps	Marine Corps Institute Washington Navy Yard 912 Charles Poor Street SE Washington, DC 20391-5680	(202) 685-7515 http://www.mci.usmc.mil

Pamphlet Format

Introduction

This section establishes how a Coast Guard distance learning course standard pamphlet is formatted. The certification pamphlet is described in Appendix A of this SOP. The purpose of an established format is to standardize the product and to ease the preparation procedures. A second section (beginning on page 7-25) includes information how to write text, use illustrations, edit text, and submit camera-ready copy.

Overview

The following table presents an overview of pamphlet format.

Pamphlet Format Overview		
Component	Characteristics	See Page No.
Text	Times New Roman 12 pt.	7-13 7-14
Labels	Arial Bold 12 pt.	7-13 7-14
Titles	Arial Bold 14 pt.	7-13 7-14
Page Numbers	Times New Roman 9 pt.	7-13
Cover/ Pamphlet No.	No page number. (Obtain pamphlet numbers from CGI.)	7-5
Title Page	Title page	7-6
Record of Changes	Record of Changes (Used by the student to make updates to course material after receipt from CGI).	7-7
Table of Contents	Always page i.	7-8
Acknowledgments/ Reference Page	Back of TOC page. Page number ii. If reference list is long, it becomes an appendix.	7-10
Notice to Students	Page number iii - iv.	7-11/7-12
Lesson	Always begins on right-hand page. Numbered 1-1, 1-2, etc.	7-14
Lesson Title	Centered at top of page.	7-14
Figures	Label identifies figures. See alternative labeling on page 7-16	7-16

Pamphlet Format

Overview (Continued)

Pamphlet Format Overview (Continued)		
Component	Characteristics	See Page No.
Table	Label identifies the table.	7-16
Self-Quiz	May use a variety of test item formats.	7-18
Answers to Self-Quiz	Follows the self-quiz. Add a blank page if necessary so that the student cannot see the answers while completing the test.	7-19
Appendixes	Number pages A-1, A-2, etc. B-1, B-2, etc.	7-20
Pamphlet Review Quiz	Must be multiple-choice, four-response format. Add as an appendix (usually Appendix A).	7-20
Pamphlet Review Quiz Answer Key	Add as an appendix (usually Appendix B).	7-21
Glossary	May add as an appendix (usually Appendix C).	7-22
Request for Feedback	Add at the end of your pamphlet.	7-23
List of Materials Furnished From CGI	Place on the back page of each pamphlet	7-24

Pamphlet Templates

Templates are available to help you in formatting your course materials. The templates include all of the formatting elements described in this section. The templates, as well as instructions for using them, are located in Microsoft® Word. Go from “Start” to “New Office Document” to the tab entitled “More,” then click on the folder “Pamphlet Templates.” Ask your training specialist for help when using these templates for the first time. You will find these templates to be extremely efficient in assembling your lessons and quizzes. Print the latest step-by-step instructions for the pamphlet templates and keep them as handy references. The templates are located on the TRACEN Yorktown web site under Training in the Performance Systems Branch downloads section.

Pamphlet Format

Format

The format of the pamphlet can be defined as the make-up or arrangement of the publication, and includes the following:

- Page layout.
 - Heading subordination.
 - Page numbering.
 - Required pages (Table of Contents, Notice to Student, etc.).
 - Text components (objectives, self-quizzes).
-

Pamphlet Organization

All correspondence course pamphlets must be organized in the following manner:

- Cover. The standard cover format, shown on page 7-5, is mandatory. You need to provide:
 - Pamphlet title.
 - Pamphlet number (SMS requests pamphlet numbers from Coast Guard Institute).
 - Date produced or revised.
 - Title Page. The title page, shown on page 7-6, must contain the following information:
 - Pamphlet title.
 - Creation date of the pamphlet.
 - Revision date, if applicable.
 - Training source address/responsible (originating) office.
 - Training source telephone number.
 - Standard statement of responsibility.
-

Pamphlet Format

Sample Cover Page

U.S. Department of
Homeland Security

United States
Coast Guard



**MK3
PERFORMANCE QUALIFICATION GUIDE
HYDRAULICS**

Arial Bold
All Caps 24 pt.

Arial Bold
All Caps 14 pt.

**U.S. Coast Guard
Pamphlet No. Y33206
(March 2005)**



The letter in the pamphlet number is
training center where created.

Pamphlet Format

Sample Title Page

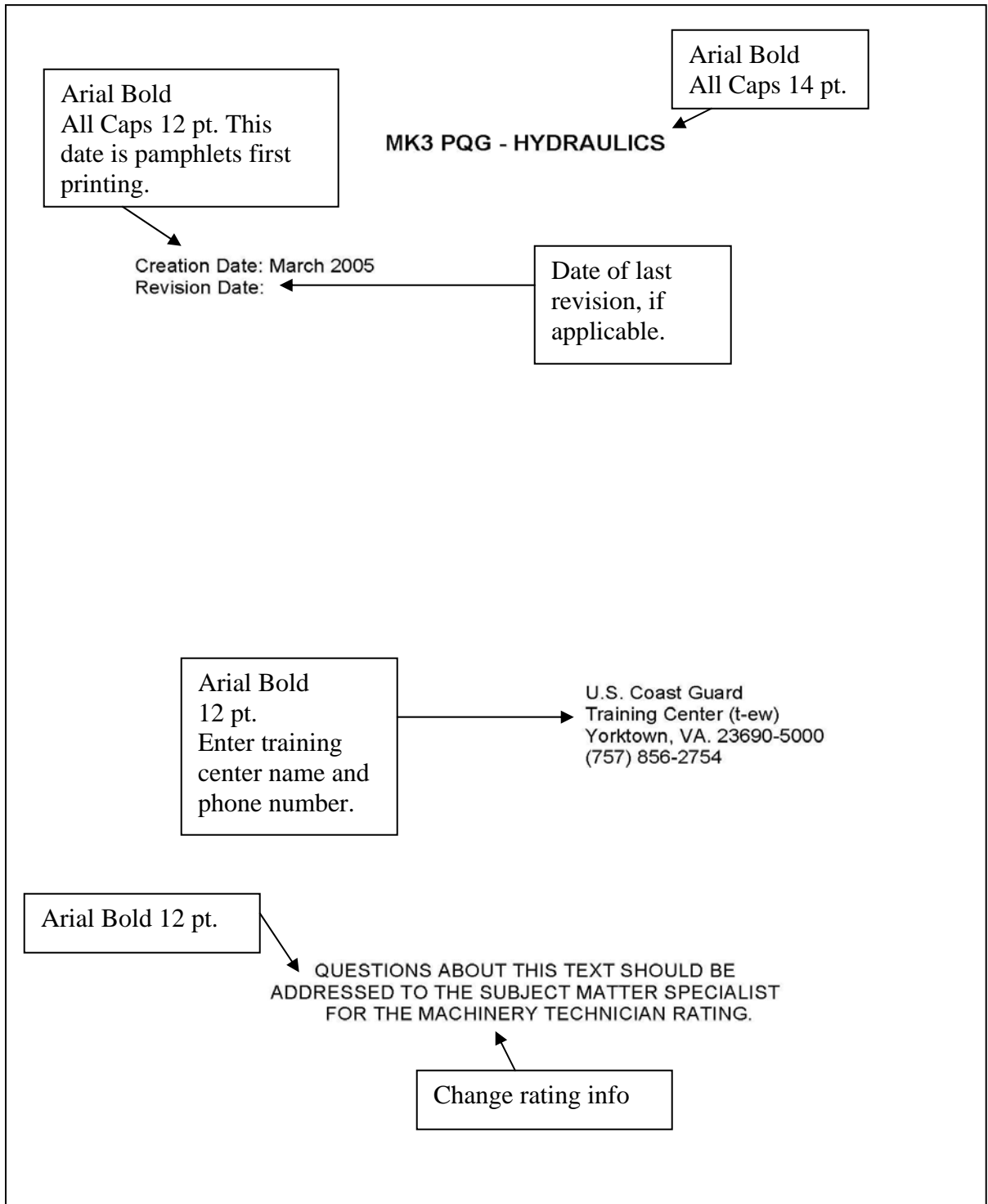

Pamphlet Format

Sample Table of Contents Page

TABLE OF CONTENTS	
TITLE	PAGE
Acknowledgments and References	ii
Notice to Students	iii
Lessons	
#1 Conducting Briefings	1-1
#2 Briefing Legal Authorities	2-1
#3 Maximum Punishments and Statutes of Limitations	3-1
#4 Miranda/Tempia Warnings	4-1
#5 Cleansing Waiver of Rights Form	5-1
#6 Consent Search	6-1
#7 Search Authorization	7-1
#8 Evidence Entry Log	8-1
#9 Storage and Transfer of Evidence	9-1
#10 Court Testimony	10-1
Appendixes	
A Pamphlet Review Quiz	A-1
B Pamphlet Review Quiz Answers	B-1
C Glossary	C-1
	i

Pamphlet Format

Pamphlet Organization (Continued)

- Record of Changes. The record of changes page is used by the student and CGI to indicate changes made to an existing course material after printing.
- Table of Contents. The table of contents, shown on page 7-8, is always page i. If necessary, it may be continued on the reverse (page ia, ib, ic).
- Acknowledgments. When used, the acknowledgment page ii, shown on page 7-10, will always be on the back of the table of contents page. Before you can use copyrighted material, you must obtain written permission from the copyright owner. A copy of this permission must be on file in the course originator's file. When this information is printed, credit **MUST** be given to the source. The acknowledgment page follows the sample or the statement furnished by the publisher or author. Procedures for obtaining a copyright release are discussed in the section "Writing the Text" in this manual.
- References. If the reference list is short, it may be included on the acknowledgment page shown on page 7-10. Otherwise, it should be on a separate page as an appendix. It should contain both materials from which excerpted material has been taken and materials which were used for research.
- Notice to Student. The Notice to Student, shown on pages 7-11 and 7-12, should **ALWAYS** begin on page iii.
 - The **FIRST** paragraph may be taken from the mission and scope of the curriculum outline. It should be a concise description of the contents of the pamphlet and should provide the student with any information that will be helpful in completing the course.
 - The **SECOND** paragraph is the Important Note. This paragraph must be **EXACTLY** as stated in the sample.
 - The next paragraphs may describe the course or pamphlet construction or content. Any specific suggestions about studying the course/pamphlet can be included here.
 - The last paragraphs are the learning objectives, Quizzes, and SWE Study Suggestions. These paragraphs must be **EXACTLY** as stated in the sample. In addition, if your course has a lot of acronyms, add a glossary and add the following paragraph:

"Throughout this course, you will see terms/acronyms along with their meanings. Many of these acronyms will be used on your end-of-course test; therefore, a glossary of terms/acronyms to be used as a study guide has been included at the end of this pamphlet."

Pamphlet Format

Sample Acknowledgment/Reference Page

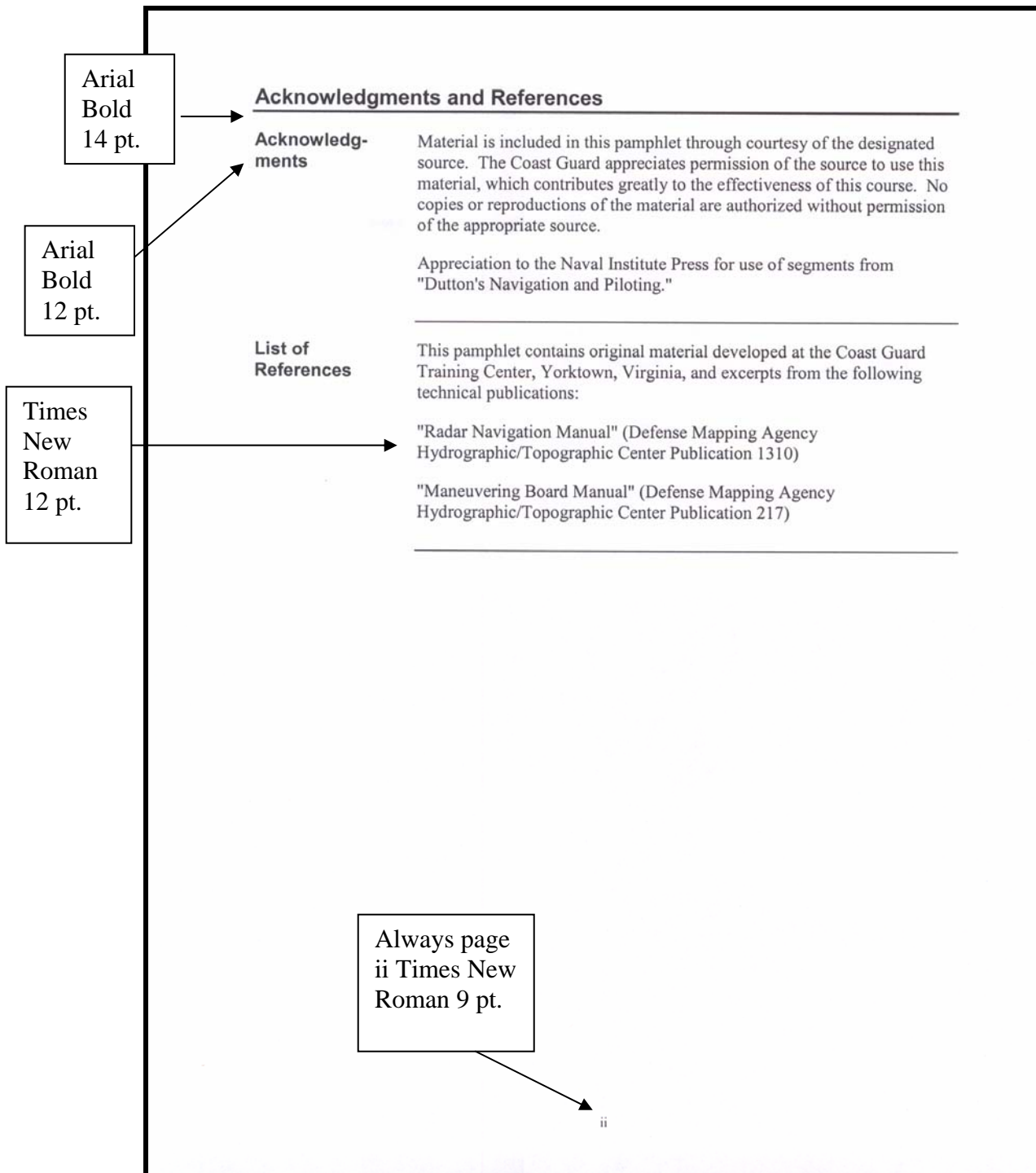

Pamphlet Format

Sample Notice to Student Page

Arial Bold 14 pt. → **Notice to Students**

Arial Bold 12 pt. → **Purpose**

This pamphlet serves as a training aid to provide you with a basic overview of Coast Guard preventive maintenance system (PMS), CMplus 5.0 maintenance and supply module, and equipment tag-out procedures. **Prior to reading the course pamphlets listed below, you must review the MK3 PQG certification pamphlet (Y33201).**

This block must be verbatim. → **Important Note**

This text has been compiled for TRAINING ONLY. It should NOT be used in place of official directives or publications. The test information is current according to the references listed. You should, however, remember that it is YOUR responsibility to keep up with the latest professional information available for your rating. Current information is available from the Enlisted Performance Qualifications Manual, COMDTINST M1414.8 (series).

Change for your course. → **MK3 Course Content**

This course content is based on the requirements stated in the Enlisted Performance Qualifications Manual, COMDTINST M1414.8 (series). The MK3 PQG course consists of the following pamphlets:

Pamphlet No. Y33201	MK3 Performance Qualification Guide
Pamphlet No. Y33202	Administration
Pamphlet No. Y33203	Electrical and Electronic
Pamphlet No. Y33204	Auxiliary Equipment I
Pamphlet No. Y33205	Auxiliary Equipment II
Pamphlet No. Y33206	Hydraulics
Pamphlet No. Y33207	Outboard Engines
Pamphlet No. Y33208	Internal Combustion Engines

Record of Changes

From time to time courses, after they are printed, have minor editorial changes made to them by the Subject Matter Specialist that do not require a new course. The student is responsible for any changes made to the course after printing and receipt from the Coast Guard Institute. The Coast Guard Institute will post on their web site a listing of current changes based on the course code and edition that should be downloaded in a **.pdf** format and entered in the current course material. The Coast Guard Institute will send an errata sheet out with each ordered course that list the required changes.

Always starts on page iii Times New Roman 9 pt. → **iii**

Pamphlet Format

Sample Notice to Student Page (Continued)

Notice to Students	
Pamphlet Content	This pamphlet (Administration) contains four lessons: Lesson 1 Introduction to Preventive Maintenance System Lesson 2 Introduction to CMplus and Maintenance Module Lesson 3 CMplus Supply Module Lesson 4 Tag Out
Learning Objectives	Read the learning objectives before you begin reading the text. The objectives will guide you through the text and help you answer the questions in the self-quiz at the end of each lesson.
Quizzes	Each lesson has a self-quiz and each pamphlet has a pamphlet review quiz. You will find the answers to each quiz on the pages following the quiz. Included are the reference pages for the answers. These self-quizzes are meant to check your comprehension of the material you covered. If you are having problems understanding a section, go through it again or <u>ask someone for help</u> . The pamphlet review quiz questions are samples of the type of questions you will find on the end-of-course-test (EOCT).
SWE Study Suggestion	Servicewide exam questions for your rate and pay grade are based on the Professional and Military Requirements sections of the Enlisted Performance Qualifications Manual, COMDTINST M1414.8 (series). If you use the references from this text and consult the Enlisted Performance Qualifications Manual, you should have good information for review when you prepare for your servicewide exam (SWE).
Glossary of Terms	A glossary of terms is included at the end of this pamphlet as Appendix C.

These blocks must be verbatim.

Use if you add a glossary of acronyms.

iv

Pamphlet Format

Text Breakdown

PQG certification pamphlets are developed as accompanying pamphlets to distance learning courses. The PQG serves as a performance-based, systematic approach to direct the student in completing tasks directly related to their enlisted performance qualifications. A professional development supervisor (PDS) is appointed to mentor/train the student as he/she successfully demonstrates the tasks identified in the certification pamphlet. Courses are broken down into pamphlets; pamphlets into either units or lessons; units into lessons; and lessons into boldface divisions (map titles and block labels). These lesson headings (map titles) and subheadings (block labels) are standardized by the templates to achieve a professional appearance.

Text Format

When developing your course, you should use the presentation that best helps you teach the text. You may use any one of the following formats:

- Structured writing format. (Sample on pages 7-14.) A Structured Writing Practice Guide is available at Training Center Yorktown or Training Center Petaluma. Also available is a structured writing template (SWT), a tool containing the formatting keystrokes and buttons to ensure uniform style of course material. For more information, read the Job Aid for Structured Writing Template (SWT) located at the TRACEN Yorktown web site under the Training Link under Performance System Branch resources tab.
- Workbooks or study guides presented in the structured writing format.
- Optional formats, such as audio-visual programs and computer-assisted instruction.

In special cases, a text other than one developed at the training source may be selected as appropriate for nonresident distance learning. If you use a commercial textbook, you must develop a workbook or study guide to accompany the text. The workbook/study guide should be organized by reading lessons. If the text does not contain adequate objectives and self-quizz items, you must supply them in the workbook. You also must write clear directions in any study guide which accompanies the commercial textbook.

Lesson Title

The lesson title is centered at the top of the page in the structured writing format.

Lesson Number

In the structured writing format, lesson numbering is required.

Pamphlet Format

Sample Structured Writing Format

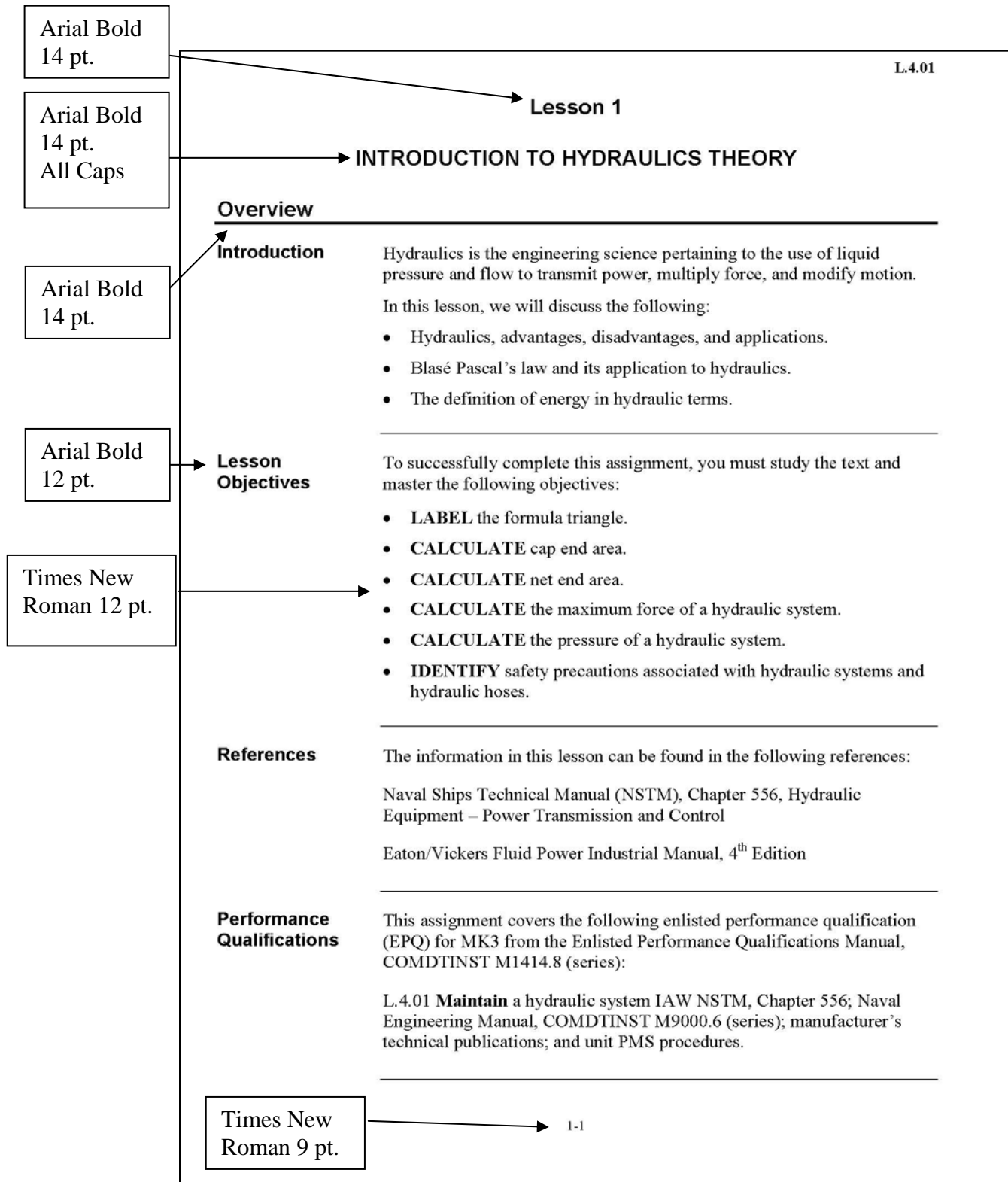

Pamphlet Format

Sample Structured Writing Format (Continued)

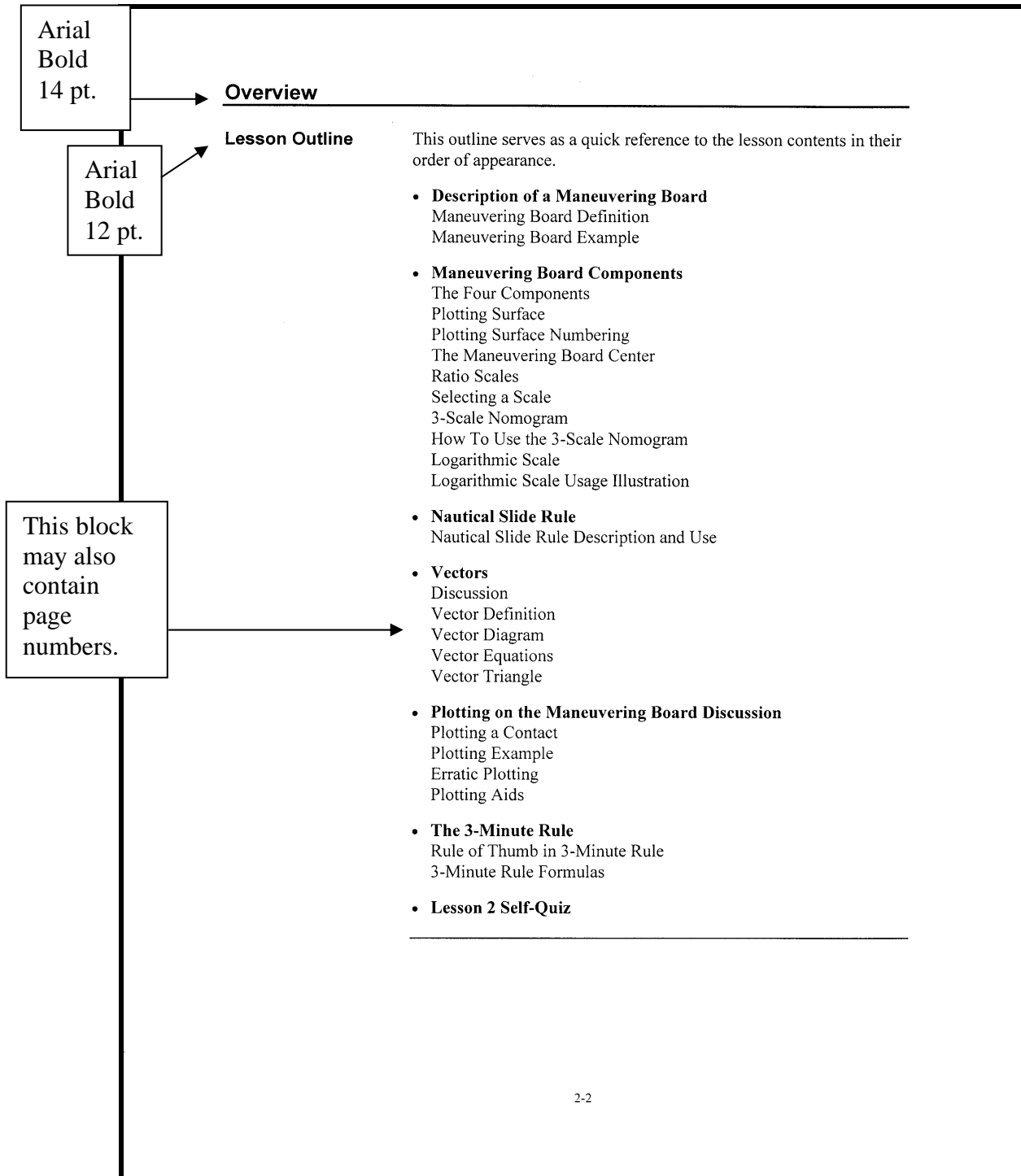

Pamphlet Format

Objectives

List the performance objectives as shown in the sample formats.

Figures

When using the structured writing format, use block labels to identify figures. As an alternative to using a block label, you may identify with a description below the illustration, shown below:



Figure 1-1. A line of cars in a motorcade.

(Suggested style is 10 pt./bold figure and its number/period/two spaces/
uppercase first letter and lowercase remaining title or description/period.)

Tables

When using the structured writing format, use block labels to identify tables, or describe the table in a paragraph text preceding the table. Tables should not be labeled as figures.

Page Numbers

The first page of each lesson must always begin on the right-hand page. The pages within the lessons will be numbered 1-1, 1-2, 1-3, etc.

Self-Quiz

A self-quiz, shown on page 7-18, is required for each lesson and is typically located at the end of each lesson. You may, however, include more than one self-quiz (within lesson itself) depending on the lesson length. Placement of this answer key may be immediately following the extra self-quiz or it may be placed at the end of the lesson.

Answers to Self-Quiz

For every self-quiz, you must include answers with page references to aid the student in locating the material in the text. The "Answers to Self-Quiz" page, shown on page 7-19, typically follows the self-quiz at the end of the lesson. If necessary, add a blank page after the self-quiz so the student cannot see the answers while completing the test. Refer to the "Self-Quiz" section in this SOP for more detailed instructions.

Pamphlet Format

Pamphlet Review Quiz

The pamphlet review quiz, shown on page 7-20, is a required component designed to sample lesson objectives and to serve as practice for the end-of-course test. Label the pamphlet review quiz as Appendix A. Number the pages according to its appendix alphabetic designation. For example, Appendix A is numbered A-1, A-2, and so forth.

Pamphlet Review Quiz Answer Key

The pamphlet review quiz answer key with the page references, shown on page 7-21, should be Appendix B immediately following the pamphlet review quiz. The answer key should not be visible to the student when taking the pamphlet review quiz. A blank page may be necessary.

Glossary

If you choose to add a glossary of terms and/or acronyms, shown on page 7-22, include it as Appendix C. Also, when you add a glossary of acronyms, add a paragraph to the Notice to Students as follows:

"Throughout this course, you will see terms/acronyms along with their meanings. Many of these terms/acronyms will be used on your end-of-course test; therefore, a glossary of terms/acronyms to be used as a study guide has been included at the end of this pamphlet."

Request for Feedback

A request for feedback, shown on page 7-23, should be included at the end of each pamphlet in the course. These suggestions and comments will help you when revising your course.

List of Materials Furnished

The back cover of the pamphlet, shown on page 7-24 will have a list of materials furnished with the course (e.g., dividers, compass, charts). It should list all pamphlets and other issue items. **DO NOT** include the CD-ROM furnished as the ESO must order these separately.

Pamphlet Format

Sample Self-Quiz

Arial Bold 14 pt.	Lesson 1 Self-Quiz <hr/>												
Arial Bold 12 pt.	Questions												
Times New Roman 12 pt.	<p>1. List the three purposes for organizing a paint job.</p> <p>1) _____</p> <p>2) _____</p> <p>3) _____</p> <p>2. Recording the progress of a paint job is the responsibility of the ____.</p> <p>A. first lieutenant B. paint locker foreman C. supervisor D. deck worker</p> <p>3. Match the paint in column A with its characteristics in column B. A paint may have more than one characteristic.</p> <table border="0"><thead><tr><th><u>Column A</u></th><th><u>Column B</u></th></tr></thead><tbody><tr><td>____ 1. Mare Island Epoxy</td><td>a. Fire retardant paint used on interior bulkheads overheads, and on machinery.</td></tr><tr><td>____ 2. Chlorinated Alkyd Resin</td><td>b. Paint containing a two-part kit. The two parts are mixed 1:1.</td></tr><tr><td>____ 3. Interior Gloss Alkyd</td><td>c. Paint is especially desirable on surfaces exposed to frequent scrubbing.</td></tr><tr><td>____ 4. Silicone Alkyd Enamel</td><td>d. Used on underwater bodies constructed of steel, wood, and fiberglass.</td></tr><tr><td></td><td>e. Highly weather resistant.</td></tr></tbody></table> <hr/>	<u>Column A</u>	<u>Column B</u>	____ 1. Mare Island Epoxy	a. Fire retardant paint used on interior bulkheads overheads, and on machinery.	____ 2. Chlorinated Alkyd Resin	b. Paint containing a two-part kit. The two parts are mixed 1:1.	____ 3. Interior Gloss Alkyd	c. Paint is especially desirable on surfaces exposed to frequent scrubbing.	____ 4. Silicone Alkyd Enamel	d. Used on underwater bodies constructed of steel, wood, and fiberglass.		e. Highly weather resistant.
<u>Column A</u>	<u>Column B</u>												
____ 1. Mare Island Epoxy	a. Fire retardant paint used on interior bulkheads overheads, and on machinery.												
____ 2. Chlorinated Alkyd Resin	b. Paint containing a two-part kit. The two parts are mixed 1:1.												
____ 3. Interior Gloss Alkyd	c. Paint is especially desirable on surfaces exposed to frequent scrubbing.												
____ 4. Silicone Alkyd Enamel	d. Used on underwater bodies constructed of steel, wood, and fiberglass.												
	e. Highly weather resistant.												

Pamphlet Format

Sample Answers to Self-Quiz

Arial Bold 14 pt.	Answers to Self-Quiz		
Arial Bold 12 pt.	Question	Answer	Reference
	1	1) Promotes safety 2) Saves time and material 3) Workers know what is expected	1-1
	2	C	1-2
Times New Roman 12 pt.	3	1. b 2. a 3. c 4. e	1-3

2-11

Pamphlet Format

Sample Pamphlet Review Quiz

Arial
Bold
14 pt.

Appendix A

Arial
Bold
12 pt.

PAMPHLET REVIEW QUIZ

Times New
Roman 12 pt.

1. Movement can be measured in terms of _____.
 - A. direction and distance
 - B. distance and speed
 - C. direction and speed
 - D. speed and time
2. The movement that takes place when an object changes positions in relation to a fixed reference point is known as ____ movement.
 - A. ground
 - B. relative
 - C. directional
 - D. true or actual
3. The movement that takes place between two ships when one or both are moving is known as ____ movement.
 - A. relative
 - B. directional
 - C. geographical
 - D. true or actual
4. Which of the following is an example of relative motion?
 - A. A train traveling from Key West, FL to Bangor, ME
 - B. A speeding automobile passing a motorcycle
 - C. A ship sailing around the world
 - D. A person walking 5 miles
5. What is an imaginary line of direction across the water or land to an object such as a ship?
 - A. Line of position
 - B. Line of sight
 - C. Bearing
 - D. Angle
6. Relative bearings are measured clockwise from _____.
 - A. ship's true direction
 - B. ship's head
 - C. imaginary north
 - D. true north
7. What is the relative bearing of a contact that is broad on the starboard quarter of own ship?
 - A. 225°R
 - B. 190°R
 - C. 135°R
 - D. 090°R
8. Own ship's heading is 260°T. Your radar picks up a contact bearing 100°T. What is the relative bearing of the contact?
 - A. 360°R
 - B. 240°R
 - C. 200°R
 - D. 185°R

A-1

Pamphlet Format

Sample Pamphlet Review Quiz Answer Key

Arial Bold 14 pt. → Appendix B

Arial Bold 12 pt. → PAMPHLET REVIEW QUIZ - ANSWER KEY

Arial Bold All Caps 12 pt. →

Times New Roman 12 pt. →

QUESTION	ANSWER	REFERENCE	QUESTION	ANSWER	REFERENCE
1	D	1-3	20	A	2-8
2	D	1-4	21	C	2-8
2	B	1-4	22	C	2-8
4	B	1-4	23	C	2-12
5	C	1-8	24	B	2-14
6	B	1-8	25	D	2-14
7	C	1-10	26	C	2-15
8	C	1-11	27	A	3-3
9	D	1-11	28	C	3-5
10	A	1-13	29	A	3-8
11	D	1-13	30	C	3-14
12	A	1-14	31	C	4-3
13	A	1-15	32	B	4-3
14	D	1-16	33	C	4-3
15	C	1-16	34	C	4-7
16	A	1-16	35	A	4-12
17	B	2-3	36	A	4-17
18	D	2-7	37	D	5-3
19	B	2-7	38	A	5-3

B-1

Pamphlet Format

Sample Glossary

Arial Bold 14 pt.	→ Appendix C																										
Arial Bold All Caps 14 pt.	→ GLOSSARY																										
	<table><tr><td>Aerodynamics</td><td>The science of the motion of air and other gases.</td></tr><tr><td>Aeromagnetic</td><td>Pertaining to the magnetic field of the Earth as surveyed from the air.</td></tr><tr><td>Balanced</td><td>Electrically alike and symmetrical with respect to the ground.</td></tr><tr><td>Bass</td><td>Sounds in the low audio-frequency range.</td></tr><tr><td>Common pool</td><td>A dedicated area of memory used as storage and shared by various processes.</td></tr><tr><td>Decoding</td><td>The process of obtaining intelligence from a signal code.</td></tr><tr><td>Electrical field intensity</td><td>A measure of the force exerted at a point by a unit charge at that point.</td></tr><tr><td>Electric tachometer</td><td>A tachometer that uses voltage or electrical impulses.</td></tr><tr><td>Functional intensity</td><td>A diagram that shows the functional relationship among parts of a system.</td></tr><tr><td>Gyro</td><td>Abbreviation for gyroscope.</td></tr><tr><td>Half tap</td><td>A bridge that can be placed across conductors without disturbing their continuity.</td></tr><tr><td>Half wave</td><td>A wave with an electrical length of half a wavelength.</td></tr><tr><td>Half-wave rectifier</td><td>A rectifier utilizing only one-half of each cycle to change alternating current into pulsating direct current.</td></tr></table>	Aerodynamics	The science of the motion of air and other gases.	Aeromagnetic	Pertaining to the magnetic field of the Earth as surveyed from the air.	Balanced	Electrically alike and symmetrical with respect to the ground.	Bass	Sounds in the low audio-frequency range.	Common pool	A dedicated area of memory used as storage and shared by various processes.	Decoding	The process of obtaining intelligence from a signal code.	Electrical field intensity	A measure of the force exerted at a point by a unit charge at that point.	Electric tachometer	A tachometer that uses voltage or electrical impulses.	Functional intensity	A diagram that shows the functional relationship among parts of a system.	Gyro	Abbreviation for gyroscope.	Half tap	A bridge that can be placed across conductors without disturbing their continuity.	Half wave	A wave with an electrical length of half a wavelength.	Half-wave rectifier	A rectifier utilizing only one-half of each cycle to change alternating current into pulsating direct current.
Aerodynamics	The science of the motion of air and other gases.																										
Aeromagnetic	Pertaining to the magnetic field of the Earth as surveyed from the air.																										
Balanced	Electrically alike and symmetrical with respect to the ground.																										
Bass	Sounds in the low audio-frequency range.																										
Common pool	A dedicated area of memory used as storage and shared by various processes.																										
Decoding	The process of obtaining intelligence from a signal code.																										
Electrical field intensity	A measure of the force exerted at a point by a unit charge at that point.																										
Electric tachometer	A tachometer that uses voltage or electrical impulses.																										
Functional intensity	A diagram that shows the functional relationship among parts of a system.																										
Gyro	Abbreviation for gyroscope.																										
Half tap	A bridge that can be placed across conductors without disturbing their continuity.																										
Half wave	A wave with an electrical length of half a wavelength.																										
Half-wave rectifier	A rectifier utilizing only one-half of each cycle to change alternating current into pulsating direct current.																										
	C-1																										

Pamphlet Format

Sample Request for Feedback

Arial Bold 14 pt. → **Request for Feedback - IV2 ADMINISTRATION**

Suggestions and Corrections Please note your suggestions, corrections, and comments below.

Page	Location on Page	What Correction is Needed

Arial Bold 12 pt. → **Your Comments** If you were writing this pamphlet, what improvements would you make? What was good about it? What did you not like about it? Please be specific in your comments/suggestions.

Times New Roman 12 pt. →

To Contact You Please provide the following so that we can contact you if needed.

Name	Unit	Phone
		()

Mail, Fax, or Call Please mail, fax, or call your information to:
Commanding Officer (CGIS-DET) PHONE: (757) 898-2471
U.S. Coast Guard
Training Center Yorktown
Yorktown VA 23690-5000
ATTN: IV Subject Matter Specialist

Pamphlet Format

Sample List of Materials Furnished Page



LIST OF MATERIALS FURNISHED

COURSE TITLE: **BM1** COURSE CODE: **0112** EDITION: **1**

1. The materials for the course you requested are listed below. If any item listed is not enclosed in this package, report that fact to your Educational Service Officer (ESO).
2. If you enrolled in this course for credit, you have **36 months** to complete the course. If you requested course materials only, you will not receive an End-of-Course Test (EOCT) and will not receive credit for the course.

<u>COMPONENT</u>	<u>NUMBER</u>	<u>QTY</u>
Administration	Y11201	01
Piloting and Navigation	Y11202	01
Maintenance	Y11203	01
Training	Y11204	01
Honors	Y11205	01
PQG	Y11206	01

Note: If you send a CD-ROM with the course, DO NOT add a Student CD to the bottom of components given to student list above as the ESO must order the CD-ROM separately.

Pamphlet Development

Overview

Pamphlet development involves several interrelated tasks. Those tasks include writing and illustrating the text, reviewing for technical accuracy, formatting tests, and conducting the formal review. A pamphlet may be comprised of one or more related units of instruction. Each unit is divided into lessons. Lessons are structured from the sequencing of both the terminal performance and enabling objectives.

Outline

This section includes the following:

- Writing the text.
 - Illustrations.
 - Editing the text.
 - Submitting camera-ready copy for publication.
-

Procedure

The steps to follow to develop a course pamphlet are listed below.

Step	Action	Responsibility
1	Plan course strategy.	Subject Matter Specialist (SMS), Instructional Systems Specialist (ISS)
2	Group/sequence curriculum outline objectives.	SMS, ISS
3	Develop EOCT items. See test item bank development procedures.	SMS
4	Develop lesson objectives.	SMS
5	Review lesson objectives for consistency with curriculum outline objectives.	ISS
6	Research subject matter for each lesson objective.	SMS
7	Develop lesson self-quiz. See self-quiz development procedures.	SMS

Pamphlet Development

Procedure (Continued)

Step	Action	Responsibility
8	Develop lesson text in desired format.	SMS
9	Identify and add illustrations to text.	SMS
10	Review lesson text and illustrations for educational content and consistency with lesson objectives.	ISS
11	Make appropriate changes.	SMS
12	Conduct first edit.	Writer/Editor (W/E)
13	Make appropriate changes.	SMS
14	Conduct second edit.	W/E
15	Review content and make appropriate changes.	SMS
16	Repeat steps 4-15 for each subsequent lesson.	
17	Develop and add pamphlet review quiz and answer key. See pamphlet review quiz development procedures.	SMS
18	Prepare EOCT. See EOCT development procedures.	SMS
19	Add pamphlet cover, title page, etc.	SMS
20	Compile table of contents.	SMS
21	Determine reserve retirement points and add to curriculum outline cover page.	SMS
22	Conduct camera-ready copy edit.	W/E
23	Print the final copy, complete sub-missions forms, and mail to CGI.	SMS

Note: Depending on training source and staffing billets, the responsibilities for the ISS and/or W/E could be performed by other staffmembers.

Writing the Text

Introduction

Plunging into the writing of an instructional pamphlet without some careful planning may be a good approach for a genius, but it won't work for most of us. Goals have to be set, limitations imposed, and the nature of the basic content determined.

Factors Affecting Learning

There are many factors that affect learning. Six factors are discussed here.

- Motivation is considered the key to all learning. The student must want to learn if there is to be any learning of consequence.
 - Organization is the structured sequence of terms, facts, concepts, principles, procedures, and operations. Each element must be organized and presented in some structured sequence or pattern if it is to be learned easily.
 - Participation is a situation in which students learn by their own activity (e.g., mental and physical). You can increase the amount of participation by inserting questions throughout the text.
 - Confirmation (feedback) is the procedure by which students are told of their progress from time to time. Frequent self-quizzes, if correctly used, can help to sustain motivation. Normally, students become quite selective in learning. Students tend to avoid unsuccessful actions and shift their activity to other roads hoping the alternate method will lead to success which will lead to success. Selective feedback is most effective when students know why they are right or wrong. Feedback should be as immediate as possible. Delaying confirmation only interferes with the learning process.
 - Application is where students must be able to apply what they know to new situations. They must develop the ability to generalize and transfer new learning in order to retain it. The most important knowledge and skills are those that can be applied. The students must be able to transfer that knowledge to new tasks in new contexts.
 - Repetition reinforces confirmed actions and responses. It is very important for long-term retention of learning.
-

Writing the Text

Teaching Through the Text

How do you create a course that will highly motivate and involve your students? Learning should be a success experience for the student, not a frustrating experience. To ensure success, get a good match between the objectives of the course and the text materials that support the objectives. Practice comparing instructional materials with objectives and with your students' needs to determine where the materials are inadequate in accomplishing the objective.

The concept of writing course objectives and then creating the pamphlet to achieve these objectives is not new. Most big courses simply attempt to cover as much material as possible and hope to include all student needs. Sometimes the result is that the students know the subject well but they still cannot accomplish the original intent of the course.

The best way to develop an effective and efficient course is to present the students with only the subject matter that is needed to attain the course objectives.

Writing the Text

Text Organization

Once you have selected text format, you then need to choose how to best present the material. The easiest way to organize the body of your material is to do it in stages. The following guidelines will help.

- Organize material using lesson objectives and distinguish between relevant and irrelevant supporting material.
- Determine the points you want to make. Words, ideas, or facts that are not essential to the understanding or acceptance of a specific objective can obscure and weaken it. To organize material, you should define, sift, and discard until only a clear objective and the ideas necessary to support it remain.
- Distinguish between the main and subordinate or supporting ideas. The main ideas are the basic explanations or arguments of the lesson objective. They are of equal importance to the objective and leaving one out unbalances the rest. The subordinate ideas are the facts, figures, or examples that support the main ideas. For example, the main ideas in describing an automobile might be the engine, transmission, chassis, and the body. Parts such as pistons or seats would be subordinate ideas.
- Group all related subordinate ideas together under the appropriate main ideas.

The next step is to arrange your main ideas in an order that leads the students systematically and logically to your conclusion. You want to select the method(s) that will present your subjects clearly and help the students satisfy the requirements of the lesson objectives. You can use one or more of the methods discussed below.

Go from the simple to the complex. Use this method when you have a series of topics that can be arranged in order of complexity (from the student's point of view).

Go from the known to the unknown. With this method of organizing your material, start with what your students know and build your lessons on that base. You can achieve this by relating job situations students may have experienced to the new material in the lesson.

Topical. This is probably the most common method used to organize course material. Use it to treat closely related subjects separately. With this method, you should use parallel structure in your headings to show the relationship between subjects.

Writing the Text

Text Organization (Continued)

Order of Performance. Another method of organizing your material is introducing the steps in a process or procedure in the same order as they are performed. Backward chaining is a variation of this method in which the last step in the procedure is introduced first, then the next to last step along with the last step and so on, back to the beginning. Each step is always learned in its correct sequence relative to those it precedes and follows. If you use this approach, you need to ensure that the steps ultimately are linked in their correct sequence.

Cause and Effect. Use this method to point out why an event took place, the effect of one event on another, or the relationships within a chain of events.

Contrast/Comparisons. Use this method to distinguish between two similar items or events. You can use it to point out how things that seem alike are different and how things that seem different are alike.

Definition. If you want your students to define a term, give them the definition first and then provide them with examples and non-examples, as appropriate.

Student- Centered Approach

The "Guide for Authors" Standards for Course Development from the Air Force Institute for Advanced Distributed Learning (AFIADL) describes some general techniques for preparing your course. This guide is located on the TRACEN Yorktown web site (under the Training Tab) under Performance System Branch resources tab. These techniques are applicable to your course development method. As you write, you should:

- Include essential text only.
- Provide details and examples.
- Relate teaching material to job situations.
- Use graphics.
- Emphasize key information.
- Use reasonable text length.
- Use short, clear titles.
- Spell out titles of official publications.
- Create an interesting first assignment.
- Write for both men and women.
- Observe copyright laws and procedures.

Writing the Text

Essential Text Only

Give your students all of the information they need to fulfill the objectives and complete the quizzes. This is the only information that the text should contain. Anything that does not contribute to the student's ability to achieve the objective does not belong in the text. You must take special care to avoid "nice-to-know" information.

Details & Examples

Whether you are teaching through a self-paced text or in a classroom, you must give your students the details and examples they need to understand the subject and apply the knowledge they gain. Before you begin to put together your text, gather the facts.

When writing a distance learning course, you should:

- Be brief and to the point.
- Give current information.
- Keep it simple, accurate, and relevant.
- Use examples to support your text and to represent or amplify facts. Good examples are appropriate, brief, and interesting.

Giving examples without showing how to apply them can leave students in the dark. Always consider your audience; are they trainees, experts, or a combination of both?

Trainees. Suppose you are writing a course for trainees in oil geophysics (an imaginary rating). You write this:

Place the shot below the weathering so that ground roll will not affect recording of the reflection.

A student reads the sentence and has two questions: (1) What is weathering? (2) What is the relation of weathering to the recording? Perhaps a better way to write this would be:

Weathering roughly corresponds to the layer of earth between the surface and the ground-water table. Below this table, the rocks (depending on their permeability) are saturated with water. The slow earth waves that move horizontally through the weathering interfere with, and often obliterate, the faster waves that we are trying to record.

Writing the Text

Details & Examples (Continued)

Here, you defined a term that a beginner would not know and anticipated a question about the relation between weathering and recording that an alert student might be likely to think up. You eliminated a term "ground roll" that you did not need and that might be confusing.

Experts. If, on the other hand, your course is directed toward more experienced oil geophysicists, you could use the first version. These audience members would probably know the terms and the problem you are describing. They would understand that you are reminding them of something important.

If you were writing a volume aimed at experts in oil geophysics, you could leave out any example. This judgment would be up to you. You would not want to insult students by telling them the obvious.

Combination of Both. Sometimes you write a course directed at students who are on several levels of knowledge and competence. Coast Guard specialty courses, for example, are aimed at a varied audience. Here, it is best to aim your writing at a student with a reasonable level of knowledge and competence. If you do so, you will hit the inexperienced people most of the time, particularly if you are careful to define terms that might confuse them.

Another thing you can do is to stop now and then and explain to your experienced students that the next section is written to define and introduce your subject to beginners. If the old pros know this material already, then they can skip over it. The first part of an assignment is a good place to do this.

Understanding What You Read

As course developers, we all share one goal: to produce texts that teach. Each sentence we write has one aim: to help students learn. We must adapt our personal writing style to make sure that the students understand what we write. You may need to translate complex regulations into easy-to-understand text segments that contain only the information essential to the student.

- Officialese. Almost everyone who works for the Government is exposed daily to "officialese." Directives, regulations, and daily bulletins are usually written in this strange language. Officialese is easy to recognize. It is written in the passive voice, uses the future tense, and issues orders.

Writing the Text

Understanding What You Read (Continued)

- Example: "It has been observed that accidents increase during holiday periods. Therefore, personnel traveling during such periods will exercise the necessary caution required in order to prevent such accidents."

Nobody in particular has done the observing; everybody in general is ordered to be cautious. If you are used to officialese, you have already translated this example into something like:

"If you're driving anywhere over the holidays, be especially careful."

But why should you have to translate at all? A text is for teaching. Don't slow your reader down by using a formal, technical, impersonal style. Your text should speak simply and directly and avoid needless jargon.

- Word Usage. Use words your students can understand. Write simply. Short, familiar words will improve the quality of your writing. Avoid the following overused words and phrases:

Instead of this:

Accomplish
Accordingly
Advantageous
Disseminate
Due to the fact that
During the periods when
Ensure that
Finalize
In lieu thereof
In regard to
In the event of
In view of
Majority
Not later than
Subsequent
Transpire
Ultimate

Try:

Complete, do
So, therefore
Helpful
Issue, get out, circulate
Because, since, hence
When
Make sure, see that
Complete, finish, include
Instead
About, concerning
If
Since
Most
By
Later, after, next
Occur
Final

- Sentence and Paragraph Structure. As you translate regulations, remember that the only true measure of readability is clarity. Sentence length, as well as word length, affects the students' ability to understand. Short paragraphs help the general appearance of the page and give the students a breather.

Writing the Text

Understanding What You Read (Continued)

- **Transitions.** To help your students associate material presented previously with upcoming material, use transitions. They help your students follow your line of thought. The following example illustrates how you can use a transitional paragraph to tie in previous material and to point forward to what is coming.
 - **Example:** As we have just explained, the echo you hear when you shout at a cliff face is caused by a velocity differential. The cliff rock may have a velocity of 15,000 feet per second, while the air's velocity is about 1,100 feet per second. The application to earth seismology may seem obvious. However, before we go on to discuss this application, let us first list the various kinds of shock waves that can be propagated in rocks.

Use the following list as a guide to transitional words and phrases.

To add ideas	To contrast ideas	To show time
again also another besides first, second next, last finally in addition moreover furthermore now, however what's more	but yet nevertheless however still conversely on the one hand instead of neither of these to the contrary on the contrary rather than much less than in contrast otherwise nor	immediately presently meantime afterward next as of today this year a little later then last year now finally
To compare ideas		To show results
like just as in the same way similarly likewise		therefore as a result thus for this reason on that account so consequently hence

Writing the Text

Understanding What You Read (Continued)

Using a nonexample might also be helpful in illustrating the use of transitions. Pointing verbally to what you have said and then to what you intend to say next does not make a transition. Once in a while you get text that is littered with one-sentence transitions of this type.

- Nonexample: Now that we have discussed the adjustment of the range computer, let's discuss the adjustment of the range servo.

Such transitional efforts are called the "now-let's" plague. The use of "now" and "let's" in the nonexample illustrates "tags" rather than "transitions." Neither the "now" nor the "let's" element contains enough substance to show the students the relationship between the parts of a discussion. These words do not provide a "thought bridge," only a short rope that leaves the student hanging in a crevasse. Fill out the nonexample so that the students are reminded of what they have learned and will be guided in a new direction.

- Example: The adjustment of the range computer establishes only the accuracy of the range information furnished to the range servo by the radar set. To complete the range calibration procedure, we must make the range-zero and slope adjustment of the range-servo unit. This adjustment determines the accuracy of the range information furnished the A-4 sight by the range-servo unit.

Relating Teaching Material to Job Situations

Set up a realistic teaching situation by addressing the students directly when you discuss tasks that they must do. Most people find procedures stated with active verbs easier to remember than those that use passive verbs.

One trouble with passive construction is that it hides the doer of the action. At best, it makes for indirect and wordy writing; and at worst, it can be completely ambiguous.

- Example: The fuel level **should be checked** each morning at the motor pool by the driver.

If the student is the driver, state simply:

Check the fuel level each morning at the motor pool.

Writing the Text

Relating Teaching Material to Job Situations (Continued)

This direct address to the reader is simple, short, and clear. What more can you ask? In any event, identify the doer.

The **driver checks** the fuel level each morning at the motor pool.

Here is another example of procedural instructions that, as presently written, may or may not apply to the students.

- Example: Once the popping pressure **is adjusted** and the relief valve **is closed**, the adjusting screw **is locked** in place with the safety nut, as shown in figure 3-2.

If your students must do the adjusting, say so.

Once **you have adjusted** the popping pressure and closed the relief valve, lock the adjusting screw in place with the safety nut, as shown in figure 3-2.

When the students must be able to do the task, make them the center of the action. When the students' role is secondary, specify their responsibilities. When the material you are giving the students is merely background information, tell them so.

Even when you are presenting general information, explaining principles, or discussing theories, remember that you are writing for individuals. Address your students and make them feel that you are talking to them. Also, when you write in this direct manner, you probably will write shorter, clearer sentences. But don't feel compelled to get a "you" in every sentence. Address the student when it is natural.

Using Graphics

Part of your job as a course developer is to learn what you should illustrate graphically and how it should be illustrated. You can probably think of a hundred ways in which you can use illustrations to improve your teaching. Instructions for illustrating your text are provided in the section titled "Illustrations." Some examples you can use include:

- Schematics. You may use schematics to explain complicated, electrical circuits.
-

Writing the Text

Using Graphics (Continued)

- Forms. Many courses have various forms, either completed as samples or to be completed by students in exercises.
 - Tables and Charts. You may summarize long segments of text or even replace text segments by using tables and charts.
 - Line Drawings. You may use a foldout or line drawing of a piece of equipment and then have an exploded view or cutaway drawing of its sub-elements.
-

Using Analogies

By now, you know that some ways of presenting your course materials are more effective than others in terms of desired learning results. An analogy can sometimes help students comprehend an otherwise difficult-to-understand concept. An analogy is an extended comparison.

- Example #1: What happens when a seismic shock wave is recorded is extremely complicated. Roughly, it is similar to the reflection of a sound wave from a cliff face. When you shout at a cliff, the sound comes back to you because the rock's shock-wave velocity is greater than that of the air. This suggests that, in the earth, seismic waves reflect from an interface, say, of a shale and a limestone, where the limestone's velocity is higher than the shale's.
 - Example #2: Imagine a bathtub filled with irregular piles of sand. Now, run water into the tub slowly. Notice how the water level rises, filling the depressions and moving up the "valleys." Turn off the water. If you were to "draw" a continuous line at the water level, you would have a contour line that could be shown graphically on a contour map. Now, if you were to run in another inch of water and "draw" another line, you would have a second contour on the map. Your contour interval would be 1 inch. Contour maps are meant to show you the form and shape of the Earth's surface.
-

Writing the Text

Key Information

To emphasize key information, you should:

- Use boldface headings for emphasis.
 - Use bullets to flag a few short statements or to announce topics you plan to discuss in a lesson. Use a different bullet to display subordinate text elements.
 - Talk about one point at a time. Present the essential information clearly; then, go on to the next point. Do not overwhelm the students with printed text for a few key points.
 - Break up a long passage of solid text by making a list of the main ideas. A list gives some white space on the page and also helps the students to pick out the important ideas more easily. Do not overdo listing. Most lists should have no more than seven elements, and seldom should two lists be on the same page.
-

Text Length

One of the purposes of lesson objectives is to tighten text development. If properly defined, the objectives as well as specifying the nature of the exercises control both the content and length of the text that supports them. A well developed lesson should not exceed 7 to 10 manuscript pages. Conversely, don't make your segments choppy. Develop ideas fully without unnecessary division of material.

- Each pamphlet should be complete in itself, the length (within limitations) to be determined by its subject. From the student's point of view, the ideal length of a correspondence course pamphlet is 75 to 100 pages in the printed form. Try for the ideal limit and consider anything over 150 pages as too long.
 - Special emphasis should be placed on shortening courses of more than 6 pamphlets or over 600 pages. The best performance results have been reported for the short, one-to-three volume courses.
 - If a pamphlet is so long that it cannot be adequately covered in 75 to 150 printed pages, consider breaking it down into two or more pamphlets, with additional pamphlet numbers assigned as required by the split.
-

Writing the Text

Short, Clear Titles

A title for a lesson assignment should clearly state what is in the lesson. If possible, it should also be interesting; a short title is better than a long, involved one. The title for this section, "Writing the Text," is typographically attractive and hopefully more interesting to you than "Important Considerations in Developing Materials for Distance Learning Courses."

Spell Out Titles

The first time you mention a publication or form, give the complete title and the identifying number as it appears in current indexes. You may give a title more than once if you need to. Also, spell out acronyms the first time you use them in the text.

Example #1: Directives, Publications, and Reports Index, COMDTNOTE 5600

Example #2: Search and Rescue (SAR)

First Lesson

The first lesson is always critical since it is the first material the students see. It typically introduces the course and sets the tone for future study. The techniques for creating a highly interesting and motivational first lesson can be applied to the entire course. Here are some questions to ask yourself concerning your first lesson.

- Is the text under 20 pages? (A length of 7 to 10 pages is ideal.)
 - Is it properly illustrated?
 - Is there a brief restatement of the benefits of the course?
 - Is it generally non-technical and inspiring?
 - Does it contain a deliberately easy self-quiz or review exercise? (Student gains confidence.)
 - Is there a clear transition leading to the next lesson?
-

Writing the Text

Avoiding Sex Bias

Until recently, most writing used the masculine pronouns "he," "him," and "his" generically to denote both women and men. There was also a tendency to stereotype jobs--all electricians were men and all nurses women. In the past few years, this has changed considerably. The technician who comes to change your fluorescent tubes may be a woman. The nurse who takes your pulse at the clinic may be a man. Most ratings today include both males and females.

For that reason, we should address our instruction to both sexes. The Coast Guard Directives System, COMDTINST M5215.6 (series), requires that we use sex-neutral language when possible. It offers several good tips on how to do so. The following guidelines are taken from that instruction and apply to the preparation of all new courses and to revisions of existing courses:

- Do not typecast. Ability to fill a job and competency in that job are not a matter of gender. Men and women should be even-handedly portrayed as lawyers, secretaries, committee members, executives, homemakers, etc.

Avoid

businessman
mailman
policeman

Use

business executive
mail carrier, letter carrier
police officer

- Avoid implications that any position or role is more "fitting" for either men or women.
- Do not make assumptions. Never assume the sex of an unknown person.
- Never use "he" or "she" to lump men and women together. Avoid the use of the pronouns (he/she, him/her, his/hers) when referring to an unknown or hypothetical person or humanity in general. Avoid gender specific words when there is an alternative term in common use or when rewording will remove the gender aspect.

Avoid

Mankind

Use

People, persons, human kind,
humanity, human beings

Writing the Text

Avoiding Sex Bias (Continued)

Avoid

best man for the job
man-made
manpower

man-hours
manning charts
bachelors

The average American can no longer fill out his tax return.

- Replace occupational terms ending in “man” with terms, in common use, that include members of either sex.

Avoid

congressman
serviceman
crewman

- Similarly, use gender-specific words associated solely with women.

Avoid

police matron
coed
authoress
stewardess

Use

best person (candidate) for the job
artificial, synthetic
workers, workforce, labor force,
human resources

staff hours
staffing charts
single members, single persons,
singles

Most Americans can no longer fill out their own tax returns.

Or

The average American can no longer fill out a tax return.

Use

member of congress or
representative
service member
crewmember

Use

police officer
student
author
flight attendant

Writing the Text

Avoiding Sex Bias (Continued)

- Avoid the implication that there are nontraditional roles for men or women or that people filling certain roles are exceptions.

Avoid

lady economist
lady boss
woman lawyer
male nurse
male secretary

Use

economist
boss, supervisor
lawyer
nurse
secretary

- Similarly, do not link gender specific pronouns with certain work or occupations with the implication that the worker is always or usually female or male.

Avoid:

The average worker with a wife and two children has lost 13 percent of his income to inflation.

Use:

The average family of four . . .
or

The average worker with three dependents . . .

Avoid:

When the consumer goes to the grocery store, she will find . . .

Use:

When consumers go to the grocery store, they will find . . .

- Where no gender-free term has yet achieved widespread acceptance, use terms that accurately identify the sex of the person referred to.

Examples:

chairman	chairwoman
spokesman	spokeswoman

- Where neither a gender-free term nor any term accurately designating gender is yet in common use, continue to use gender specific terms, even where not literally accurate.

Examples:

Yeoman Third Class Mary Smith
Seaman Apprentice Jane Smith

Writing the Text

Avoiding Sex Bias (Continued)

If you use photos and illustrations, show a variety of occupations and dress for men and women. An occupation or hobby should not be shown as either "masculine" or "feminine" and should not reflect on anyone's masculinity or femininity.

Copyright Laws

You must get permission in writing from the owner of the copyright, author, or publisher when you:

- Use parts of copyrighted publications, whether text or illustrations.
- Quote any passage of more than one or two sentences from copyrighted materials.
- Rely on copyrighted publications as your main source, even though you paraphrase.

Exception: Books, which are published by the U.S. Government, are in the public domain and may not be copyrighted. However, if the publication from which you borrow contains copyrighted material, you are the "second borrower" and must get permission from the copyright owner.

When you request permission to use copyrighted material, inform the owner that the material will be published by the Coast Guard for use by Coast Guard personnel. Request permission to use copyrighted material about specific subject matter in a training course for Coast Guard personnel. A sample letter requesting copyright releases is provided on the following page.

When permission is granted, the copyright release will be placed in the permanent files of the training source. Copies of the letter will be kept in the training source subject matter specialist's files and with the camera-ready copy (CRC) of the pamphlet in which the material will be used.

If you quote from copyrighted sources, prepare an acknowledgment page to be placed in the front of the pamphlet. If the copyright owner specifies the form of the acknowledgment or credit lines, set up your credits as requested.

Writing the Text

Copyright Form Letter

U.S. Department of
Homeland Security

United States
Coast Guard



Commanding Officer
U.S. Coast Guard
Training Center Yorktown
End of State Route 238
Yorktown, VA 23690

Staff Symbol: T-Tew
Phone: 757-856-2000
Fax:
Email:

5870
November 1, 2005

Permissions Department
ABC Corporation
555 Main Street
Any town, USA 12345

Dear Sir or Madam:

Subj: REQUEST FOR PERMISSION TO DUPLICATE COPYWRIGHTED MATERIAL

The U.S. Coast Guard ABC School would like permission to duplicate pages _____ through _____ of your _____ technical manual. The pages describe the inner workings of your diesel engine number _____. Copies of these pages will be incorporated into a training correspondence course used to train Coast Guard Machinery Technicians on the maintenance and repair of your _____ diesel engines.

It is anticipated that _____ copies will be made to incorporate into distance learning course material. The courses are not for sale and are used only by active reserve, and auxiliary Coast Guard personnel.

A pre-addressed return envelope and a copy of this letter for your files are enclosed for your convenience.

Please let us know what conditions, if any, apply to this use.

Thank you for your cooperation.

Sincerely,

M. HANNA
Captain
U.S. Coast Guard

Enclosures: (1) Copy of Letter
(2) Pre-Addressed Envelope

Permission Granted: _____
(Signature and Title) (Date)

Conditions, if any: _____

Writing the Text

Text Readability

The best-designed course will be wasted if the student is unable to read it easily. If your students are able to read easily, they will be more likely to finish the course and pass the end-of-course test. To write a manuscript that can be easily read, you must know what affects readability.

Reading ease depends on the writer's style and the design of the printed page. The main factors to consider are the style of the typeface, the ratio of space between words and space between lines, and column width (length of each line in print).

A writer's style is more difficult to control, but is far more important than the printing style. It is essential that all writers know the principles of clear writing and that they use them.

Readability Statistics

It is always a good idea to check the readability level of your text. In Microsoft Word®, readability statistics are displayed after you run a grammar check.

A manual readability formula that is easy to use is the Fog Index. This formula is reliable and may be used to determine the reading level of your text materials. See the procedure and example on the following pages to apply the Fog Index.

Writing the Text

Fog Index Procedure

The steps for determining the Fog Index of a narrative text are listed below:

Step	Action						
1	Select a sample passage of approximately 100 words.						
2	Assign a value of 1 to all one- and two-syllable words.						
3	Assign a value of 3 to all remaining words.						
4	Determine Fog Index by adding the values.						
5	Divide the Fog Index by the number of sentences						
6	<table border="1"><thead><tr><th>IF the average Fog Index is . . .</th><th>THEN to obtain the grade level, you should . . .</th></tr></thead><tbody><tr><td>over 20</td><td>divide by 2.</td></tr><tr><td>under 20</td><td>subtract 2, then divide by 2.</td></tr></tbody></table>	IF the average Fog Index is . . .	THEN to obtain the grade level, you should . . .	over 20	divide by 2.	under 20	subtract 2, then divide by 2.
IF the average Fog Index is . . .	THEN to obtain the grade level, you should . . .						
over 20	divide by 2.						
under 20	subtract 2, then divide by 2.						

The example on the next page shows each of the steps.

Writing the Text

Example of Applying the Fog Index

Applying the Fog Index

1. Select a sample passage of approximately 100 words:

3

To avoid what he called the “swindles and perversions” of language, George Orwell
3
recommended six rules for writing right:

1. *Never use a metaphor, simile, or other figure of speech which you are used to seeing
3 3
in print.*
2. *Never use a long word where a short one will do.*
3
3. *If it is possible to cut a word out, cut it out.*
3
4. *Never use a foreign phrase, a scientific word, or a jargon word if you can think of an
3 3
everyday equivalent.*
3

3

Break any of these rules sooner than say anything outright barbarous. (101)

2. Assign a value of 1 to all one- and two-syllable words. 92
3. Assign a value of 3 to all remaining words. 27
4. Determine Fog Index by adding the values. 119
5. Divide the Fog Index (119) by the number of sentences (7). 17
6. Since the average Fog Index is under 20, subtract 2 then divide by 2 to obtain grade level. (If the average Fog Index is over 20, divide by 2 to obtain grade level.) 7.5

Writing the Text

Increasing Course Completion Rates

What can you do to achieve high graduation rates?

Keep it short. There is nothing less motivating to students than realizing there are 15 books to read in the course. Anything that you do to reduce their study time, while not compromising quality or learning effectiveness, will help to get them started faster and finished sooner. By eliminating unnecessary assignments and keeping the remaining assignments short and to the point, you not only will get more students to finish sooner, but also will reduce costs.

Nonresident distance learning is, after all, independent study. Remember do not give the students more than they need to know to achieve the stated course objectives.

Illustrations

Illustrating Your Course

Illustrations greatly enhance the learning experience of the student by providing a visual presentation of text material. Good illustrations make difficult concepts easier to understand and, in many cases, allow the student to grasp in a single glance what would take pages of written material to explain.

The creation of an illustration is a very important aspect of course development. The SMS must determine the objective of each illustration. The SMS may want to portray a situation that is difficult to describe in words or may want to clarify the relationship between items. Whatever the objective, the SMS must decide the type of illustration to use, the points to emphasize, the amount of detail required, and the size of the illustration.

Sources for Illustrations

After the SMS decides what the illustration should show and before creating a new illustration, the SMS should check other sources where the illustration may be available. Possible sources are:

- Other SMSs.
- CD-ROMs containing clip art and photographs.
- Clip art.
- Computer graphic library.
- Internet.
- Naval or other publications.
- Technical manuals.

The original source may have a camera-ready illustration that the source will supply on request or for a slight fee. With computer technology, poor illustrations can be scanned and cleaned up. Remember, any lack of clarity in an original illustration will become worse when it is printed.

Copyright

Illustrations in print are protected by copyright just as any other printed materials. The SMS should check to determine whether the material is protected and obtain copyright permission. Refer back to the information on copyright laws in this section for procedures to follow in obtaining permission to use copyrighted material.

Illustrations

Line Drawings

A line drawing is any illustration made through the skills of an artist or by computer. Line drawings must:

- Be sharp and clear.
- Contain crisp black lines on a clean, white surface.

Example:

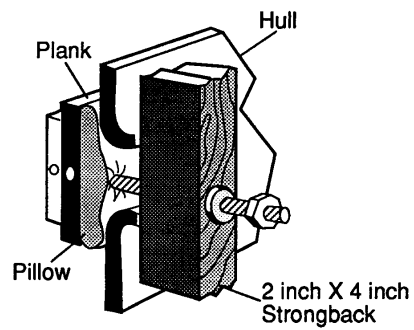

Illustrations

Illustration Captions

Block labels may identify illustrations in the structured writing format. Instead of a block label, you may use a figure number and descriptive title below the illustration.

Text Reference to Illustrations

Illustrations become part of the text in a structured writing format. If referencing an illustration on another page, identify the location of the illustration by its block label or figure number.

When illustrating instructional text, remember these guidelines:

- Use clear, concise illustrations that concentrate on only the essential parts.
- Ensure consistency in technique.
- Show the correct relationship of tools to hands (or other portions of the body) and parts.
- Make sure the perspective or point of emphasis you choose is the clearest one possible to show movement, and remove any detail that is not essential to the instructional meaning. Use blow-ups or inserts to show important details from larger parts or systems.
- Label only the parts that you want to draw the learner's attention to, but include enough information on the location of particular parts. Mention each illustration in the text before it appears in its illustrated format.
- Place the illustration directly below or next to the textual description of the illustration.

If you use copyrighted material, be sure to get written permission of the copyright holder.

Editing the Text

Introduction

Perfect manuscripts do not just happen; they are the result of many hours of editing. Error-free manuscripts assure students that time, effort, and care have gone into the preparation of the course. Students are likely to spend more time and devote more concentration on a course that has few typographical errors. The writer/editor conducts three separate edits.

- First edit.
 - Second edit.
 - Camera-ready edit.
-

First Edit

The first edit is a thorough edit conducted on each lesson as the lesson is developed. The writer/editor conducts the edit using the editing symbols listed on the following page and discusses the revisions with the SMS. The writer/editor completes the first half of the first/second edit checklist.

Second Edit

In the second edit, the writer/editor rereads the entire lesson, paying particular attention to changes made by the SMS, and marks any additional editing changes. When necessary, the writer/editor again discusses the revisions with the SMS. The writer/editor completes the second half of the first/second edit checklist.

Camera-Ready Edit

The writer/editor conducts the camera-ready edit after the SMS has completed the entire pamphlet. The SMS should ensure that all of the required pages are inserted as well as the pamphlet review quiz, for this should be the last review before submission to Coast Guard Institute for printing. The writer/editor edits all material in addition to the lessons (i.e., cover page, table of contents, appendixes, title page, notice to students, acknowledgments, and references) and completes the camera-ready edit checklist.

Editing the Text

Editing Symbols

Writer/editors use the following editing symbols to edit lessons. Everyone involved in the course development process should become familiar with these symbols, as you will see them often.

⊙	Insert period	≡	Caps--used in text
↗	Insert comma	<i>l.c.</i>	Lowercase--used in margin
:	Insert colon	//	Align vertically
;	Insert semicolon	<i>g</i>	Delete
?	Insert question mark	<i>g</i>	Delete and close up
!	Insert exclamation mark	<i>w.f.</i>	Wrong font
=/	Insert hyphen	⊂	Close up
∨	Insert apostrophe]	Move right
“ ”	Insert quotation marks	[Move left
#	Insert space	↖	Move up
∨	Superior	↙	Move down
∧	Inferior	...	Let it stand--used in text
()	Parentheses	<i>stat.</i>	Let it stand--used in margin
[]	Brackets	<i>run over</i>	Carry over to next line
¶	Paragraph	<i>run back</i>	Carry back to preceding line
<i>no</i> ¶	No paragraph	~~~~~	Boldface--used in text
<i>~</i>	Transpose--used in text	<i>b.f.</i>	Boldface--used in margin
<i>sp</i>	Spell out	<i>—</i>	Italic--used in text
/	Lowercase a letter (make it a small letter)	^	Caret--Used to mark position of error where material needs to be added

Editing the Text

Roles and Responsibilities

The roles and responsibilities of the SMS and the writer/editor are identified below.

SMS Responsibilities

The SMS responsibilities are to:

- Obtain copyright permission.
 - Spell check the lesson.
 - Number all of the pages.
 - Include and identify all illustrations within the text.
 - Ask another SMS or someone in the resident school to read the completed lesson. An expert in the field who has not developed the material may be able to point out errors the SMS missed.
 - Provide the writer/editor with a hard copy of a complete lesson that contains the following:
 - Lesson objectives
 - Text
 - Self-quiz
 - Answer key
 - Make corrections to the lesson after each edit, checking every correction to ensure that it was made properly and that making the correction did not cause a new error.
 - Submit the lesson, as well as the edited (marked-up) copy, to the writer/editor for the second edit.
 - Provide a hard copy of the entire pamphlet to the writer/editor for camera-ready review.
-

Editing the Text

Writer/Editor Responsibilities

The writer/editor responsibilities are to:

- Conduct the first edit of each lesson using the editing symbols.
 - Rewrite and reorganize the lesson as necessary.
 - Discuss the changes with the SMS.
 - Review the changes made by the SMS.
 - Conduct the second edit.
 - Complete the first/second edit checklist.
 - Conduct the camera-ready edit.
 - Complete the camera-ready edit checklist.
-

Editing the Text

First/Second Edit Checklist

The first/second edit checklist includes the following:

EDIT CHECKLIST		1st	2nd
TEXT	Spacing is consistent between titles, subtitles, bullets, etc.		
	Format agrees with standardized guidelines.		
	Organization, abbreviations, and punctuation are correct and consistent.		
	Sexist language is removed.		
	Lesson is grammatically correct.		
	Pages are numbered consecutively by lesson.		
ILLUSTRATIONS	Quality of illustrations is acceptable.		
	Placement of illustrations is acceptable.		
SELF-QUIZ	The lesson has a self-quiz.		
	Questions are in the same order as text material.		
	Items are consecutively numbered.		
	End of stem punctuation is correct.		
	Multiple-choice items have ABCD.		
	Multiple-choice blanks are five underlines.		
	Reference page numbering is checked.		
	All answers are provided, but are not visible while reading questions.		

Editing the Text

Camera-Ready Copy Checklist

The camera-ready copy checklist includes the following:

CAMERA-READY COPY CHECKLIST		
REQUIRED PAGES (In the correct order)	Cover page	
	Title page	
	Table of Contents	
	Record of Changes	
	Acknowledgments (if needed)	
	Notice to Students	
	References	
	Blank pages	
	Request for Feedback	
SELF-QUIZZES	Reference page numbering is rechecked.	
PAMPHLET REVIEW QUIZ	Question numbering is checked.	
	Multiple-choice items have ABCD.	
	End of stem punctuation is correct.	
	Reference page numbering is checked.	
TEXT	Page numbering is correct.	
	Blank pages are added if necessary.	
APPENDIXES	Page numbering is correct.	
	Required pages are listed.	
	Content titles are consistent with text.	

Camera-Ready Copy Submission

Camera-Ready Copies

The final step in producing courses is printing the pamphlets. To ensure the best quality printing, the Coast Guard Institute must provide the printing source the best quality pages. These pages, called camera-ready copy (CRC), are produced by the SMSs. All camera-ready copy pamphlet material must be printed on a laser quality printer in either color or black and white. The laser quality printer is equipped to give the darkest impression possible.

Note: The pamphlets shall also be converted into a **.pdf** file, with each pamphlet being sent on a SEPARATE CD-ROM to the Coast Guard Institute. This allows the Coast Guard Institute to send each pamphlet out to a different print source for cost savings. The complete course will also be sent out on a single CD-ROM with a printed label for issue with the paper-based course.

Memo to the Institute

The SMS submits camera-ready copy of new or revised pamphlets or courses by memo to CGI. The memo will contain at least the following information:

- Name of each pamphlet (component) clearly identified by pamphlet, course, and course code.
- A list for each pamphlet that requires color printing due to photos and illustrations that require color.
- How the course is to be printed (e.g., with tabs or individual pamphlets, or as one book).
- Any factors that would affect the reorder quantity, such as expected new qualifications or massive reenrollments. (See sample memo on following page.)
- If tabs are desired they should be sent as a single file so they can be printed at a single print source. Each tab label and tab color must be specified by the SMS prior to sending to the CGI.

Note: All course material will be delivered with three holes punched and will be loose leaf shrink wrapped from the institute to the student.

Camera-Ready Copy Submission

Enclosures to Memo

In addition, the memo will contain the following enclosures:

- Course and Inventory Control Sheet - Create/Modify Course (CGI-2834) or Course and Inventory Control Sheet - Delete Course (CGI-2834a). See samples with instructions on the following pages.
- Camera-ready copy of each pamphlet. The entire pamphlet CRC is not required to be sent when individual CRC pages are submitted to replace pages existing in current pamphlets.
- If you are submitting a pamphlet revision, provide a copy of the old pamphlet (with the pages to be revised X'd out) to Coast Guard Institute. This X'd out pamphlet is to be sent by the SMS with the CRC of the revised pages.

Print Quantity

Initial print and reprint levels will be determined by Coast Guard Institute after consultation with the training source and Rating Force Master Chief, as necessary.

Sample Memo to CGI

U.S. Department of
Homeland Security

United States
Coast Guard



Commanding Officer
United States Coast Guard
Training Center Yorktown
End of Route 238
Yorktown, Va. 23690-5000

Staff Symbol: tew
Phone: (757) 856-2257
Email:

1514
9 November 2005

MEMORANDUM

From: I.A. Meter, EMCM, Electrician Rating Training Master Chief
To: Commanding Officer, Coast Guard Institute
Subj: ELECTRICIAN'S MATE SECOND CLASS PQG COURSE 0219

1. The Electrician's Mate Second Class Performance Qualification Guide (PQG), course code 0219, edition 3 has been completely revised. The new course consists of seven pamphlets numbered Y21901, Y21902, Y21903, Y21904, Y021905, Y21906 and Y21907.
2. Please shrink wrap each pamphlet, loose leaf style.
3. Tabbed dividers in each pamphlet for Table of Contents, each Lesson, Glossary and Pamphlet review quiz (with answers to review quiz included). Insert tab pages & label titles as indicated in 12 font Times New Roman as indicated.
4. Please make each pamphlets front and back cover out of a durable material.
5. Please make 3/8-inch three ring binder holes in each pamphlet.
6. The photos and illustrations in the course should be printed in color.
7. We have provided two copies of the entire course on CD. One copy is for a print contractor; the other is for the Institutes use. We request that it be reproduced and issued with the course for the student. A copy of the label is provided in this package on a 3 1/2" disc.
8. Three new EOCT have been developed and will follow shortly.
9. There are no factors that would affect the reorder quantity.
10. All required forms are enclosed.
11. If there is any other information we can provide, please contact the Subject Matter Specialist for the EM rating, EMCM Meter at (757) 856-5000

Encl: (1) Course and Inventory Control Sheet (CGI-2834).
(2) Course and Inventory Control Sheet (CGI-2834a).
(3) Electrician's Mate Second Class Course CD.
(4) Electrician's Mate Second Class Course CD graphic on a 3.5" disc.
(5) Electrician's Mate Second Class Course camera-ready copy on CD in pdf format.
(6) Electrician's Mate Second Class Course camera-ready

#

Camera-Ready Copy Submission

Course and Inventory Control Sheet - Create/Modify Course (Instructions)

INSTRUCTIONS FOR THE PREPARATION AND USE OF THE COURSE AND INVENTORY CONTROL SHEET - CREATE/MODIFY COURSE (CGI-2834)

The training source should complete all appropriate bold face blocks on CGI-2834 as needed for processing. CGI should complete all appropriate non-bold face blocks on CGI-2834 as needed for processing.

1. **Course Code.** Enter the 4-digit course code for this new course/edition. If it is a new course code, check with pro-1 for code numbers.
2. **Course Edition.** Enter the edition for this new course/edition (from pro-1) (Max 2 digits)..
3. **Ace Identifier.** Enter the ACE Identifier number (Max 10 characters).
4. **Short Title.** Enter the short title for this new course/edition, e.g., YN7, MRN-E5 (Max 6 characters).
5. **Long Title.** Enter the long title of the new course/edition being created (Max. 69 characters).
6. **Description.** Enter a description of the course/edition (Max 350 characters).
7. **Edition Date.** Enter the intended date the new course/edition begins.
8. **Passing Score.** Enter the passing score for the new course/edition (Max 3 digits).
9. **Reserve Points.** Enter the number of points a Reserve may earn by completing this course. Refer to the Course Development Manual for instructions to compute reserve retirement points (from curriculum outline) (Max 9 digits).
10. **Course Duration.** Enter the maximum time in months the student will have to complete this new course/edition (Max 6 characters).
11. **Security Class.** Enter "U" if this new course/edition is unclassified, "C" if it is confidential, and "S" if it is secret.
12. **Status Code.** If this is a new course, enter "N". If this course is going obsolete, enter "O". If this course is active, enter "A".
13. **Billet Code.** Enter the responsible rate for this course/edition (Max. 6 characters).
14. **Branch.** Enter the branch responsible for this course/edition (1 character).
15. **Course Limiter.** If everyone can enroll in this new course/edition, leave blank. If you would like to allow only Auxiliaries to enroll, enter "XONLY". If you would like to limit Auxiliaries from enrolling, enter "XNO". All classified courses should be marked "XNO".
16. **Component Code.** Enter the 6-character component number that will be part of this new course/edition. Contact the CG Institute(pro-1) for assignment of a component number.
17. **PS(Print Source).** Enter 2-character print source.
18. **DS(Document Size).** Enter 2-character document size.
19. **CW(Component Weight).** Enter 2-digit component weight.
20. **Component Name.** Enter the component name, a maximum of 39 characters.
21. **Price.** Enter price to produce 1 component (Max 7 digits).
22. **NSN(National Stock Number).** Enter National Stock Number (Max 15 characters).
23. **Publish Date.** Enter the date the component was first published.
24. **QTYS(Quantity Stocked).** Enter total quantity stocked at Institute (Max 5 digits).
25. **QOH(Quantity On Hand).** Enter current quantity on hand (Max 5 digits).
26. **Low Limit.** Enter low limit. If inventory drops below this amount pro will be warned on an error report (Max 5 digits).
27. **RE/L(Re-order level).** Enter amount of components to be ordered with each re-order (Max 5 digits).
28. **BCN(Billet Control Number).** Enter the responsible rate (Max 6 characters).
29. **TC(Type Code).** Enter component type code. "CH" = Chart "CP" = Commercial Publication "DD" = Department of Defense Pub. "DV" = Dividers "FS" = Frequency Scale "HB" = Handbook "MB" = Maneuvering Board "MP" = Manual Publication "N" = Notice to Students "PG" = Pocket Guide "PH" = Pamphlet "PS" = Plotting Sheets "TA" = Triangle "TB" = Test Booklet and "VT" = Video Tape.
30. **SC (Security Class).** Enter "U" if the component is unclassified, "C" if it is confidential and "S" if it is secret..
31. **Order Date.** Enter last order date.
32. **E (Expendable Materials).** Enter X the component is expendable, enter "N" if the component is non-expendable.
33. **QPC (Quantity Per Course).** Enter the number of components (for that component code) that will be issued with this course. This can be from 01 to 99.

Camera-Ready Copy Submission

Course and Inventory Control Sheet - Delete Course (Instructions)

**INSTRUCTIONS FOR THE PREPARATION AND USE OF THE
COURSE AND INVENTORY CONTROL SHEET - DELETE COURSE (CGI-2834a)**

The training source should complete all appropriate bold face blocks on CGI-2834 as needed for processing. CGI should complete all appropriate non-bold face blocks on CGI-2834 as needed for processing.

1. **Course Code.** Enter the 4-digit course code for this new course/edition. If it is a new course code, check with pro-1 for code numbers.
2. **Course Edition.** Enter the edition for this new course/edition (from pro-1) (Max 2 digits).
3. **Obsolete Date.** Enter the obsolete date. No course materials or tests will be sent after this date. All completed EOCTs will be rejected and NOT graded by CGI if administered after this date.
4. **Replacement Edition.** Enter the replacement edition for this new course/edition (from pro-1) (Max 2 digits).
5. **Component Code.** Enter the 6-character component number that will be deleted from this course/edition.
6. **Delete From Course.** Enter "Y" to delete this component from this course edition.
7. **Delete From Inventory.** Enter "Y" to delete this component from inventory. This will COMPLETELY remove this component from the system at CGI.
8. **Remarks.** Use as needed.

Section 8

PAMPHLET TESTING DEVELOPMENT

Overview

Introduction

The purpose of testing is to find out how well the instructional material and learning process is working. Performance-based criterion referenced tests require students to demonstrate performance only on the objectives. Therefore, the students are being tested only on what they need to know to perform their job.

The principles underlying testing in the course development process are based on the achievement of objectives. Tests are given to determine whether an individual student has reached the criterion specified in an objective.

The test development process is designed to provide the necessary review and feedback within the course to ensure that the students will be able to achieve the objectives. Therefore, the course must provide relevant practice in the text material to prepare the student to answer the self-quiz/topic review and pamphlet review quiz questions. The pamphlet review quiz prepares the student to take the end-of-course test (EOCT). The successful completion of the EOCT is one step toward qualifying to take the servicewide exam (SWE).

Lesson self-quizzes/topic reviews, pamphlet review quizzes, and EOCTs are all criterion-referenced. The SWE, on the other hand, is a norm-referenced test that is based on the Enlisted Performance Qualifications (EPQs) and is developed to identify those candidates best qualified for advancement on the basis of rate-related/required knowledge and performance.

Outline

When developing a course, you will be creating three types of tests. A fourth type, the SWE, is based on the EPQs and is linked with the Coast Guard promotion system. Two types of tests are discussed in this section, followed by sections on the EOCT, SWE, and test strategy and statistics:

- Self-quiz.
 - Pamphlet review quiz.
-

Self-Quiz/Topic Review

Introduction

A self-quiz/topic review follows each lesson in the text to reinforce the lesson objectives and the reading material. The self-quiz/topic review should be carefully designed as a working review of each objective. The test items you develop on your self-quiz/topic review are limited to paper-and-pencil exercises that will help determine the student's ability to recognize and recall facts and apply principles, processes, procedures, and concepts specified in the lesson objectives.

Requirements

To help the student get actively involved with the course material, a lesson self-quiz/topic review should:

- Cover all the lesson objectives thoroughly.
 - Follow the same sequence as the reading material.
 - Be clearly supported by the text and referenced by a page number.
 - Develop the review by small steps to provide for recall, develop understanding, and solve problems.
 - Contain a correct answer for each test item.
-

Answer Key

After answering an item on a self-quiz/topic review, the student checks the answer on the answer key that follows. To develop a functional answer key, include the following:

- Make sure the answers satisfy the requirements of the test items.
 - Do not introduce new factors not found in the item.
 - Place the answers in sequential order.
 - Make the answers clear and comprehensive.
 - Do not make the answers visible when the student is completing the quiz.
 - Include reference page numbers where the information can be found in the text.
-

Self-Quiz/Topic Review

Procedure

The development of a self-quiz/topic review involves teamwork. The procedure is listed below.

Step	Action	Responsibility
1	List lesson objectives.	Subject Matter Specialist (SMS)
2	Research subject matter.	SMS
3	Develop quiz items (with illustrations as necessary).	SMS
4	Develop answer key.	SMS
5	Review quiz for consistency with lesson objectives.	Instructional Systems Specialist (ISS)
6	Conduct edit of quiz and answer key.	Writer/Editor (W/E)
7	Make appropriate changes.	SMS
8	Print camera-ready copy and add to end of lesson text.	SMS

Note: Depending on the training source and staffing billets, the above responsibilities of the ISS and/or W/E could be performed by other staff members, (i.e., Training Specialist).

Self-Quiz/Topic Review

Sample Self-Quiz

May also be called Topic Review or Practical

N.4.01, I.4.03

Lesson 5 Self-Quiz

Questions

1. Which function describes the accurate measuring of fuel delivered to each cylinder of the engine for each power stroke?
A. Injecting
B. Metering
C. Delivering
D. Distributing

2. Match the items in column A with their descriptions in column B. Use each description only once.

Column A

Column B

- | | |
|------------------------------|--|
| _____ 1. Fuel Tank | a. Moves fuel from the fuel tank to the high-pressure fuel pumps. |
| _____ 2. Fuel Strainer | b. Injects the fuel in atomized form into the combustion chamber of each cylinder. |
| _____ 3. Fuel Transfer Pump | c. Removes fine particles of contamination from the fuel. |
| _____ 4. Fuel Filter | d. Tests the fuel for contaminants. |
| _____ 5. High-Pressure Pump | e. Holds the fuel and keeps it free from contaminants. |
| _____ 6. Spray Nozzle or Tip | f. Times and meters the correct amount of fuel injected into the cylinders. |
| | g. Removes coarse particles and impurities from the fuel oil. |
| | h. Supplies fuel to the fuel tank. |

3. What do you do with clothing that becomes soaked in fuel?

Self-Quiz/Topic Review

Sample Self-Quiz Answer Key

May also be called Answers
to Topic Review or Practical

N.4.01, I.4.03

Answers to Self-Quiz

Question	Answer	Reference
1.	B	5-7
2.	1. e	5-9
	2. g	5-10
	3. a	5-10
	4. c	5-11
	5. f	5-11
	6. b	5-12
3.	Any clothing that becomes soaked in fuel shall be: <ul style="list-style-type: none">• Washed as soon as possible separately from other clothing.• Stored in a flammable storage container if not able to wash immediately.	5-16
4.	a. Contaminants. b. Chemical instability. c. Microbiological contamination. d. Incompatibility between fuel loads.	5-18

5-24

Pamphlet Review Quiz

Introduction

The pamphlet review quiz should be designed to continue the same instructional process as the lesson self-quiz/topic review. However, the pamphlet review quiz has another function, which is to prepare the student for taking the EOCT. For this reason, the format of the pamphlet review quiz is limited to multiple-choice items.

Requirements

Some basic requirements of the pamphlet review quiz are:

- Items should sample only the lesson objectives listed.
 - Information not covered by an objective should not be introduced in the item.
 - Items should be clearly supported by the text and referenced by page number.
 - Items must be criterion-referenced in a four-response, multiple-choice format.
 - Correct answers must be located on a different page from the quiz.
 - Items should be based on the same standards used on EOCT items.
-

Answer Key

The requirements for developing the answer key for the pamphlet review quiz include the same requirements listed for self-quiz. In addition, the answer key should be presented in double column unless the pamphlet review quiz is short.

Pamphlet Review Quiz

Test Items

The self-quiz/topic review covers all lesson objectives thoroughly, whereas the pamphlet review quiz only samples those objectives. To develop items for the review quiz, you can convert the self-quiz/topic review items to the multiple-choice format.

Example:

Lesson Objective: **CONVERT** ZT to GMT.

Self-quiz item: Your ship is in longitude $125^{\circ} 35' W$ and ZT is 08h 25m. What is GMT?_____

Pamphlet review
quiz item: Your ship is in longitude $125^{\circ} 35' W$ and ZT
is 08h 25m. What is GMT?

- A. 00h 35m
 - B. 08h 25m
 - C. 16h 25m
 - D. 20h 35m
-

Pamphlet Review Quiz

Procedure

The pamphlet review quiz is developed to sample the lesson objectives and to serve as a practice for the EOCT. The procedure is listed below.

Step	Action	Responsibility
1	Plan pamphlet review quiz strategy.	Subject Matter Specialist (SMS)
2	List lesson objectives.	SMS
3	Research subject matter.	SMS
4	Develop pamphlet review quiz (with illustrations as necessary).	SMS
5	Develop answer key.	SMS
6	Review pamphlet review quiz for consistency with lesson objectives.	Instructional Systems Specialist (ISS)
7	Make appropriate changes.	SMS
8	Conduct edit of pamphlet review quiz and answer key.	Writer/Editor (WE)
9	Make appropriate changes.	SMS
10	Print camera-ready copy and add to end of pamphlet.	SMS

Note: Depending on the training source and staffing billets, the above responsibilities of the ISS and/or W/E could be performed by other staff members, (i.e., Training Specialist).

Pamphlet Review Quiz

Sample Pamphlet Review Quiz

Appendix A

PAMPHLET REVIEW QUIZ

1. Movement can be measured in terms of _____.
 - A. direction and distance
 - B. distance and speed
 - C. direction and speed
 - D. speed and time
2. The movement that takes place when an object changes positions in relation to a fixed reference point is known as ____ movement.
 - A. ground
 - B. relative
 - C. directional
 - D. true or actual
3. The movement that takes place between two ships when one or both are moving is known as ____ movement.
 - A. relative
 - B. directional
 - C. geographical
 - D. true or actual
4. Which of the following is an example of relative motion?
 - A. A train traveling from Key West, FL to Bangor, ME
 - B. A speeding automobile passing a motorcycle
 - C. A ship sailing around the world
 - D. A person walking 5 miles
5. What is an imaginary line of direction across the water or land to an object such as a ship?
 - A. Line of position
 - B. Line of sight
 - C. Bearing
 - D. Angle
6. Relative bearings are measured clockwise from _____.
 - A. ship's true direction
 - B. ship's head
 - C. imaginary north
 - D. true north
7. What is the relative bearing of a contact that is broad on the starboard quarter of own ship?
 - A. 225°R
 - B. 190°R
 - C. 135°R
 - D. 090°R
8. Own ship's heading is 260°T. Your radar picks up a contact bearing 100°T. What is the relative bearing of the contact?
 - A. 360°R
 - B. 240°R
 - C. 200°R
 - D. 185°R

Pamphlet Review Quiz

Sample Pamphlet Review Quiz Answer Key

Appendix B

PAMPHLET REVIEW QUIZ - ANSWER KEY

QUESTION	ANSWER	REFERENCE	QUESTION	ANSWER	REFERENCE
1	D	1-3	20	A	2-8
2	D	1-4	21	C	2-8
2	B	1-4	22	C	2-8
4	B	1-4	23	C	2-12
5	C	1-8	24	B	2-14
6	B	1-8	25	D	2-14
7	C	1-10	26	C	2-15
8	C	1-11	27	A	3-3
9	D	1-11	28	C	3-5
10	A	1-13	29	A	3-8
11	D	1-13	30	C	3-14
12	A	1-14	31	C	4-3
13	A	1-15	32	B	4-3
14	D	1-16	33	C	4-3
15	C	1-16	34	C	4-7
16	A	1-16	35	A	4-12
17	B	2-3	36	A	4-17
18	D	2-7	37	D	5-3
19	B	2-7	38	A	5-3

B-1

Section 9

END-OF-COURSE TEST (EOCT)

Overview

Introduction

Besides the reinforcement "tests" used in the pamphlets, the Coast Guard uses a final examination, an "end-of-course test (EOCT)," to measure the student's achievement of the performance/knowledge objectives. The EOCT is a proctored examination completed at one sitting with no time limit. The test is scored at the Coast Guard Institute (CGI). The students may now find their test scores through the CGI's web site. Unit Education Services Officer (ESOs) can provide specific instructions on obtaining scores through this web site.

If students pass, they receive letters of completion and their scores are recorded in Direct Access. If they fail, they receive a profile letter showing their scores on individual sections of the test. Another test is sent or authorized after an appropriate waiting period, and the student must be reexamined and receive the established passing score on the EOCT to be eligible for the servicewide examination (SWE).

Requirements

The basic requirements for writing the EOCT are:

- Each item should be written and entered into the EOCT test item database.
 - Each item must measure a performance/knowledge objective.
 - The information tested must be covered in the text and the location of that information is noted in the item bank.
 - All items must be written in the four-response, multiple-choice format.
 - Each test should be divided into sections based on the curriculum outline and pamphlet titles. Minimum number of questions per section is four test items. The number of section titles in an EOCT is based on the pamphlet titles. (Student profile letters will be developed from this information.)
-

Overview

Requirements (Continued)

- Three completely separate but parallel tests will be prepared with the same number of questions and sections. (Each section should strive to have the same amount of questions as the other two versions of the test.)
- Test length will vary, depending on course size. Normal ranges are 25 to 100 items. (At least one questions per enabling objective (EO) should be tested.) **The maximum number of questions is 120 due to limitations of the answer key.**
- Each test must end on an even-numbered page. The statement "**THIS PAGE INTENTIONALLY LEFT BLANK**" should be placed in the center of the last page if last test item ends on an odd-numbered page.

Note: The test item database will include these words “**STOP. END OF TEST.**” automatically in the footer on page with last question.

End-of-Course Test

Procedures

The EOCT is developed to sample the terminal performance objectives (TPOs) and EOs, which are based on the EPQs. The procedure is listed below.

Step	Action	Responsibility
1	List TPOs and EOs.	Subject Matter Specialist (SMS)
2	Research subject matter.	SMS
3	Select test items from the EOCT test item database for selected performance objectives.	SMS
4	Develop three separate versions of the EOCT (with illustrations as necessary).	SMS
5	Conduct first edit.	Writer/Editor (W/E)
6	Make appropriate changes.	SMS
7	Review versions 1, 2, and 3 for each curriculum outline objective.	Instructional Systems Specialist (ISS)
8	Make appropriate changes.	SMS
9	Print camera-ready copy for versions 1, 2, and 3.	SMS
10	Conduct camera-ready review.	W/E
11	Make appropriate changes.	SMS
12	Complete answer sheet and hand-scoring template.	SMS

End-of-Course Test

Procedures (Continued)

Step	Action	Responsibility
13	Complete score key change/profile sheet.	SMS
14	Complete course/inventory control sheet.	SMS
15	Send all versions, answer sheets, etc., to CGI via registered/applicable express carrier.	SMS
16.	CGI mails 100% test back to training source for verification of test answer sheets.	CGI
17	SMS has 3 days to complete 100% test and send them back to the CGI.	SMS
18	Mail answers for 100% test to CGI.	SMS

Note: Depending on the training source and staffing billets, the above responsibilities of the ISS and/or W/E could be performed by other staff members.

Design Principles

The principles of designing the tests include the following:

- Related to the Job. The test must be highly related to what students will do on the job. It must sample the same knowledge and performance the students will be required to use on the job.
 - Sample the Student's Ability to Perform. Remember that when you write the test items, you are sampling the ability of the student to perform paper and pencil-versions of actual tasks. The test items should require the students to make the same types of decisions they will make on the job. If the job is to fill in forms, the test item should require the student to identify a proper entry on the form or to convert general information into coded information on the form.
 - Predictor of Success on the Job. The EOCT is only a sample of what the student has learned. Because of the limitations of the multiple-choice, paper-and-pencil test, the test will not show the total knowledge and performance the student has gained from the course. This will be evaluated by the PQG certification pamphlet. Although the number of items on the test will vary, a well-designed test will be a fairly accurate predictor for most students, as the four-response format will reduce the possibility of the student guessing successfully. The test will predict success on the job, but it will not guarantee success.
-

End-of-Course Test

EOCT Numbering

Each EOCT series contains three separate tests. The procedures for numbering EOCT are discussed below.

IF the EOCT is . . .	THEN . . .
the first edition	begin with tests numbered 51, 52, and 53.
being credited at least 10 percent	<ul style="list-style-type: none">• develop a new series of exams and• begin with tests numbered 54, 55, and 56 <p>Note: The next series will be numbered 57, 58, and 59, followed by series numbered 60, 61, and 62 with a final series number of 99. Then restart with 51.</p>
a confirmed compromise	print out three new tests and continue with the next three series numbers.
a new edition series of exams	renumber starting again with 51, 52, and 53.

End-of-Course Test

EOCT Construction

To make up the three forms or series of the test (versions 51, 52, and 53), follow the procedures outlined below.

- Write test items. The test items shall be written based on the TPOs and EOs for the course. There should be sufficient questions (a minimum of five per TPO/EO) for the test items database to randomly select enough questions to create three separate tests.
 - Select items that have been adequately reviewed. The items selected from your item database for the EOCT may be reviewed at the lesson self-quiz/topic review level and may be reviewed again at the pamphlet review quiz level. The questions shall be written differently than what has already been written on the pamphlet review quiz and self-quiz.
-

EOCT Package

After the test development process is completed, mail the following completed items by registered/express mail carrier to the CGI. Sample items required in the EOCT package are shown on pages 9-9 through 9-15 of this SOP.

- Properly formatted, camera-ready copy of the EOCT. Format will depend on whether the test is unclassified or classified. See samples for variations. All EOCTs must end on an even-numbered page; therefore, the test may require a blank page.
- Correspondence Course Answer Sheet (CGI-2800). You must complete an answer sheet for each test form (51, 52, 53) for use as a computer grading key. Enter the course writer's name and rank/rate on the first two lines. Enter the short title and edition of the course on the course title line. Enter the following information in the blocks and darken the appropriate circles:

Social Security Number Enter 000 00 0005.

Course Code

Edition

Test No. Enter 51, 52, or 53 as appropriate.

End-of-Course Test

Packaging and Mailing Instructions

All testing material, whether sensitive or classified, shall be mailed/shipped double-wrapped with the inside envelope containing the following instructions on both sides in at least 1/4 - inch letters:

SENSITIVE MATERIALS TO BE OPENED BY A TESTING MATERIAL OFFICER ONLY

The office and person designated to receive testing material shall be identified on the inner envelope only.

When sensitive testing material is mailed between the training source (TS) and the Coast Guard Institute (CGI), it must be accounted for by signature using registered mail or authorized shipping agent via overnight delivery. Classified testing material **MUST** be mailed via registered mail. **DO NOT** use certified mail. A mail logbook shall be used to track testing material that is mailed.

End-of-Course Test

EOCT Package (Continued)

To fill in the responses, darken the circle that corresponds to the correct response for each item.

- Hand-Scoring Template (CGI-2800A). One hand-scoring template (CGI-2800A) is prepared for each test. Use the one-hole punch to remove #1 and #120 so that you can align the template over the answer sheet. Punch out the correct response for each item.

1	2	3	4	5	6	7	8	9	10	11	12	13	14	15	16	17	18	19	20	21	22	23	24	25	26	27	28	29	30	31	32	33	34	35	36	37	38	39	40	41	42	43	44	45	46	47	48	49	50	51	52	53	54	55	56	57	58	59	60	61	62	63	64	65	66	67	68	69	70	71	72	73	74	75	76	77	78	79	80	81	82	83	84	85	86	87	88	89	90	91	92	93	94	95	96	97	98	99	100	101	102	103	104	105	106	107	108	109	110	111	112	113	114	115	116	117	118	119	120
---	---	---	---	---	---	---	---	---	----	----	----	----	----	----	----	----	----	----	----	----	----	----	----	----	----	----	----	----	----	----	----	----	----	----	----	----	----	----	----	----	----	----	----	----	----	----	----	----	----	----	----	----	----	----	----	----	----	----	----	----	----	----	----	----	----	----	----	----	----	----	----	----	----	----	----	----	----	----	----	----	----	----	----	----	----	----	----	----	----	----	----	----	----	----	----	----	----	----	-----	-----	-----	-----	-----	-----	-----	-----	-----	-----	-----	-----	-----	-----	-----	-----	-----	-----	-----	-----	-----

CGI-2800A (1-77)

- EOCT Score Key Change/Profile Sheet (CGI-2801). This form is available from the CGI website. This form is used to:
 - Issue a new EOCT.
 - Keep an inventory of the number of EOCTs.
 - Identify the section titles (Maximum section titles for an EOCT is 9) and indicate the total number of questions in each section. (Total number of questions in each section shall be the same for all 3 tests).
 - Make changes to EOCT items (i.e., deleting items or changing the answers of individual items).
 - Recap EOCT credited items.
 - Make computer grading key changes.
- Course and Inventory Control Sheet - Create Modify Course (CGI-2834). This sheet is submitted if your course is a new course or new edition of an old course. This form is available from the CGI website.

The EOCT answer sheet, template, and profile sheet are not complex; however, they must be completed correctly to enter the information on the computer.

End-of-Course Test

Sample EOCT

FOR OFFICIAL USE ONLY
QM3 (3rd) 0337-51

COMMUNICATIONS

1. In the Northern Hemisphere, the semipermanent subtropical highs move southward during the ____ months.

- A. winter
- B. autumn
- C. summer
- D. spring

2. When you use the thermal wind between the 1,000- and 700-mb levels to indicate the speed of a surface low, the low's speed is approximately ____ of the thermal wind's speed.

- A. 90%
- B. 75%
- C. 50%
- D. 30%

3. To objectively predict the 24-hour movement and change in intensity of maritime low pressure systems, you should use height and temperature measurements from the ____ level.

- A. 1,000-mb
- B. 850-mb
- C. 500-mb
- D. 350-mb

4. In the upper atmosphere over a developing low, the isopycnic level is generally considered to be at the ____ level.

- A. 200-mb
- B. 350-mb
- C. 450-mb
- D. 600-mb

5. To acknowledge the receipt of a message on a sound-powered telephone, you should say "____."

- A. AFFIRMATIVE
- B. AYE, AYE
- C. ROGER
- D. ON THE LINES

6. The Geostrophic Wind Method uses the surface and 700-mb levels to forecast the movement of ____.

- A. isobars
- B. highs
- C. fronts
- D. isotherms

7. What is the most intensive and effective cooling process?

- A. Frontal lifting
- B. Orographic lifting
- C. Horizontal divergence
- D. Vertical stretching

8. The most important factor in short-range terminal forecasting is the accuracy of ____.

- A. area
- B. time
- C. distance
- D. direction

9. In the Northern Hemisphere, the most extensive and dense cirrus clouds occur on the high pressure side or ____ of the jet stream axis.

- A. west
- B. east
- C. south
- D. north

GO ON TO THE NEXT PAGE
FOR OFFICIAL USE ONLY

1

Times New Roman Bold 12 pt.

Times New Roman 12 pt.

Double Space

Times New Roman Bold 12 pt.

End-of-Course Test

Sample Confidential EOCT

Times New Roman Bold 12 pt.

CONFIDENTIAL
FT2 (2nd Ed.) 0337-51

Times New Roman Bold 10 pt.

COMMUNICATIONS

1. (U) In the Northern Hemisphere, the semipermanent subtropical highs move southward during the ____ months.

A. winter
B. autumn
C. summer
D. spring

2. (U) When you use the thermal wind between the 1,000- and 700-mb levels to indicate the speed of a surface low, the low's speed is approximately ____ of the thermal wind's speed.

A. 90%
B. 75%
C. 50%
D. 30%

3. (U) To objectively predict the 24-hour movement and change in intensity of maritime low pressure systems, you should use height and temperature measurements from the ____ level.

A. 1,000-mb
B. 850-mb
C. 500-mb
D. 350-mb

4. (U) In the upper atmosphere over a developing low, the isopycnic level is generally considered to be at the ____ level.

A. 200-mb
B. 350-mb
C. 450-mb
D. 600-mb

5. (U) To acknowledge the receipt of a message on a sound-powered telephone, you should say "____."

A. AFFIRMATIVE
B. AYE, AYE
C. ROGER
D. ON THE LINES

6. (U) The Geostrophic Wind Method uses the surface and 700-mb levels to forecast the movement of ____.

A. isobars
B. highs
C. fronts
D. isotherms

7. (U) What is the most intensive and effective cooling process?

A. Frontal lifting
B. Orographic lifting
C. Horizontal divergence
D. Vertical stretching

8. (U) The most important factor in short-range terminal forecasting is the accuracy of ____.

A. area
B. time
C. distance
D. direction

9. (U) In the Northern Hemisphere, the most extensive and dense cirrus clouds occur on the high pressure side or ____ of the jet stream axis.

A. west
B. east
C. south
D. north

Times New Roman 12 pt.

Double Space

Times New Roman Bold 12 pt.

1

GO ON TO THE NEXT PAGE
CONFIDENTIAL

Times New Roman Bold 10 pt.

End-of-Course Test

Sample EOCT Blank Page

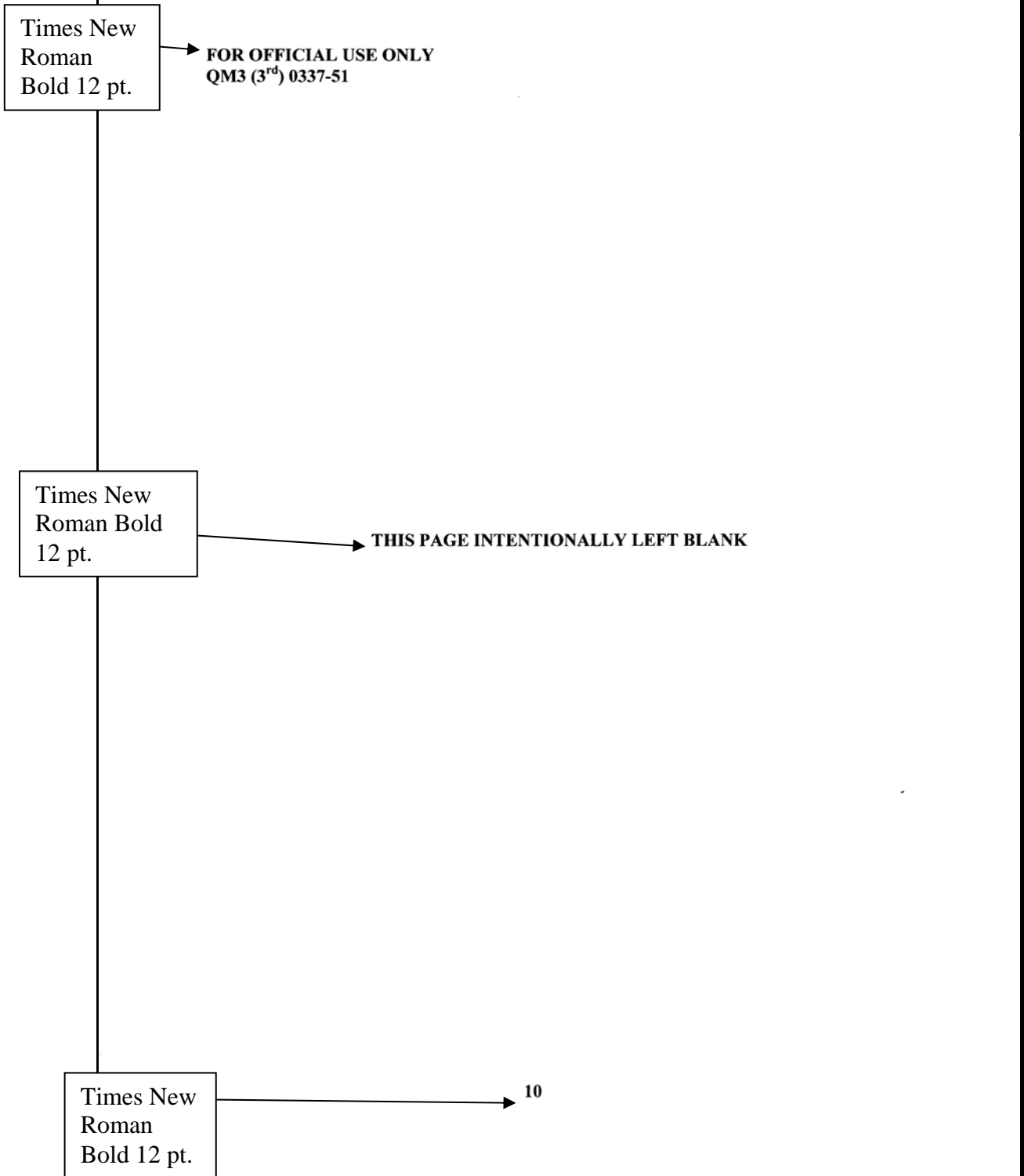

End-of-Course Test

Correspondence Course Answer Sheet (CGI-2800)

<p style="text-align: center;">HOMELAND SECURITY UNITED STATES COAST GUARD FORM CGI - 2800 (1-99)</p>	<p>UNITED STATES COAST GUARD INSTITUTE CORRESPONDENCE COURSE ANSWER SHEET</p>																																																																																																																																																																																																																																																																																																																																																																																																																
<p>STUDENTS:</p> <p>Fill in blanks completely. Make your marks with a No.2 black lead pencil. Enter in the designated blocks your social security number, course code number, edition of course book, lesson or test number, and OPFAC number. Next carefully fill in the numbers opposite the blocks you have just marked.</p> <p>Answer spaces are arranged in vertical sequence. Make only one mark to answer one question. To avoid erasures, at first mark your selection lightly or with a small dot. Then, after you are satisfied no changes will be made, darken circles carefully.</p>	<p>EXAMPLE:</p> <p>WRONG 1 (A) <input type="radio"/> <input type="radio"/> <input type="radio"/> <input type="radio"/></p> <p>WRONG 2 (A) <input checked="" type="radio"/> <input type="radio"/> <input type="radio"/> <input type="radio"/></p> <p>WRONG 3 (A) <input type="radio"/> <input type="radio"/> <input type="radio"/> <input type="radio"/></p> <p>RIGHT 4 (A) <input type="radio"/> <input type="radio"/> <input checked="" type="radio"/> <input type="radio"/></p>	<p>Name _____ (last) _____ (first) _____ (middle)</p> <p>Rank/Rate _____</p> <p>Course title _____</p> <p>Present unit address: _____</p> <p>_____ Zip Code _____</p>																																																																																																																																																																																																																																																																																																																																																																																																															
<p>PRIVACY ACT OF 1974</p> <p>A. AUTHORITY FOR USE AND WHETHER MANDATORY OR VOLUNTARY - 14 U.S.C. Sec 633. Voluntary.</p> <p>B. PRINCIPAL PURPOSE - Identify student record. Score test answers.</p> <p>C. ROUTINE USES - Establish score on test. Enter score on student record.</p> <p>D. EFFECT ON YOU IF YOU DO NOT PROVIDE INFORMATION REQUESTED - Your answer sheet will not be scored. You will not achieve course completion.</p>																																																																																																																																																																																																																																																																																																																																																																																																																	
<table border="1" style="width: 100%; border-collapse: collapse;"> <tr><th colspan="10">SOCIAL SECURITY NUMBER</th></tr> <tr><td> </td><td> </td><td> </td><td> </td><td> </td><td> </td><td> </td><td> </td><td> </td><td> </td></tr> <tr><td>0</td><td>0</td><td>0</td><td>0</td><td>0</td><td>0</td><td>0</td><td>0</td><td>0</td><td>0</td></tr> <tr><td>1</td><td>1</td><td>1</td><td>1</td><td>1</td><td>1</td><td>1</td><td>1</td><td>1</td><td>1</td></tr> <tr><td>2</td><td>2</td><td>2</td><td>2</td><td>2</td><td>2</td><td>2</td><td>2</td><td>2</td><td>2</td></tr> <tr><td>3</td><td>3</td><td>3</td><td>3</td><td>3</td><td>3</td><td>3</td><td>3</td><td>3</td><td>3</td></tr> <tr><td>4</td><td>4</td><td>4</td><td>4</td><td>4</td><td>4</td><td>4</td><td>4</td><td>4</td><td>4</td></tr> <tr><td>5</td><td>5</td><td>5</td><td>5</td><td>5</td><td>5</td><td>5</td><td>5</td><td>5</td><td>5</td></tr> <tr><td>6</td><td>6</td><td>6</td><td>6</td><td>6</td><td>6</td><td>6</td><td>6</td><td>6</td><td>6</td></tr> <tr><td>7</td><td>7</td><td>7</td><td>7</td><td>7</td><td>7</td><td>7</td><td>7</td><td>7</td><td>7</td></tr> <tr><td>8</td><td>8</td><td>8</td><td>8</td><td>8</td><td>8</td><td>8</td><td>8</td><td>8</td><td>8</td></tr> <tr><td>9</td><td>9</td><td>9</td><td>9</td><td>9</td><td>9</td><td>9</td><td>9</td><td>9</td><td>9</td></tr> </table>	SOCIAL SECURITY NUMBER																				0	0	0	0	0	0	0	0	0	0	1	1	1	1	1	1	1	1	1	1	2	2	2	2	2	2	2	2	2	2	3	3	3	3	3	3	3	3	3	3	4	4	4	4	4	4	4	4	4	4	5	5	5	5	5	5	5	5	5	5	6	6	6	6	6	6	6	6	6	6	7	7	7	7	7	7	7	7	7	7	8	8	8	8	8	8	8	8	8	8	9	9	9	9	9	9	9	9	9	9	<table border="1" style="width: 100%; border-collapse: collapse;"> <tr><th colspan="10">OPFAC NUMBER</th></tr> <tr><td> </td><td> </td><td> </td><td> </td><td> </td><td> </td><td> </td><td> </td><td> </td><td> </td></tr> <tr><td>0</td><td>0</td><td>0</td><td>0</td><td>0</td><td>0</td><td>0</td><td>0</td><td>0</td><td>0</td></tr> <tr><td>1</td><td>1</td><td>1</td><td>1</td><td>1</td><td>1</td><td>1</td><td>1</td><td>1</td><td>1</td></tr> <tr><td>2</td><td>2</td><td>2</td><td>2</td><td>2</td><td>2</td><td>2</td><td>2</td><td>2</td><td>2</td></tr> <tr><td>3</td><td>3</td><td>3</td><td>3</td><td>3</td><td>3</td><td>3</td><td>3</td><td>3</td><td>3</td></tr> <tr><td>4</td><td>4</td><td>4</td><td>4</td><td>4</td><td>4</td><td>4</td><td>4</td><td>4</td><td>4</td></tr> <tr><td>5</td><td>5</td><td>5</td><td>5</td><td>5</td><td>5</td><td>5</td><td>5</td><td>5</td><td>5</td></tr> <tr><td>6</td><td>6</td><td>6</td><td>6</td><td>6</td><td>6</td><td>6</td><td>6</td><td>6</td><td>6</td></tr> <tr><td>7</td><td>7</td><td>7</td><td>7</td><td>7</td><td>7</td><td>7</td><td>7</td><td>7</td><td>7</td></tr> <tr><td>8</td><td>8</td><td>8</td><td>8</td><td>8</td><td>8</td><td>8</td><td>8</td><td>8</td><td>8</td></tr> <tr><td>9</td><td>9</td><td>9</td><td>9</td><td>9</td><td>9</td><td>9</td><td>9</td><td>9</td><td>9</td></tr> </table>	OPFAC NUMBER																				0	0	0	0	0	0	0	0	0	0	1	1	1	1	1	1	1	1	1	1	2	2	2	2	2	2	2	2	2	2	3	3	3	3	3	3	3	3	3	3	4	4	4	4	4	4	4	4	4	4	5	5	5	5	5	5	5	5	5	5	6	6	6	6	6	6	6	6	6	6	7	7	7	7	7	7	7	7	7	7	8	8	8	8	8	8	8	8	8	8	9	9	9	9	9	9	9	9	9	9	<p>IF OPFAC NUMBER IS A CHANGE DARKEN CIRCLE</p> <p style="text-align: center;"><input type="radio"/></p>	<table border="1" style="width: 100%; border-collapse: collapse;"> <tr><th colspan="4">COURSE CODE</th></tr> <tr><td> </td><td> </td><td> </td><td> </td></tr> <tr><td>0</td><td>0</td><td>0</td><td>0</td></tr> <tr><td>1</td><td>1</td><td>1</td><td>1</td></tr> <tr><td>2</td><td>2</td><td>2</td><td>2</td></tr> <tr><td>3</td><td>3</td><td>3</td><td>3</td></tr> <tr><td>4</td><td>4</td><td>4</td><td>4</td></tr> <tr><td>5</td><td>5</td><td>5</td><td>5</td></tr> <tr><td>6</td><td>6</td><td>6</td><td>6</td></tr> <tr><td>7</td><td>7</td><td>7</td><td>7</td></tr> <tr><td>8</td><td>8</td><td>8</td><td>8</td></tr> <tr><td>9</td><td>9</td><td>9</td><td>9</td></tr> </table>	COURSE CODE								0	0	0	0	1	1	1	1	2	2	2	2	3	3	3	3	4	4	4	4	5	5	5	5	6	6	6	6	7	7	7	7	8	8	8	8	9	9	9	9	<table border="1" style="width: 100%; border-collapse: collapse;"> <tr><th>EDITION</th></tr> <tr><td> </td></tr> <tr><td>0</td></tr> <tr><td>1</td></tr> <tr><td>2</td></tr> <tr><td>3</td></tr> <tr><td>4</td></tr> <tr><td>5</td></tr> <tr><td>6</td></tr> <tr><td>7</td></tr> <tr><td>8</td></tr> <tr><td>9</td></tr> </table>	EDITION		0	1	2	3	4	5	6	7	8	9	<table border="1" style="width: 100%; border-collapse: collapse;"> <tr><th>TEST NO.</th></tr> <tr><td> </td></tr> <tr><td>0</td></tr> <tr><td>1</td></tr> <tr><td>2</td></tr> <tr><td>3</td></tr> <tr><td>4</td></tr> <tr><td>5</td></tr> <tr><td>6</td></tr> <tr><td>7</td></tr> <tr><td>8</td></tr> <tr><td>9</td></tr> </table>	TEST NO.		0	1	2	3	4	5	6	7	8	9	<table border="1" style="width: 100%; border-collapse: collapse;"> <tr><th colspan="3">DATE TEST ADMINISTERED</th></tr> <tr><th>MONTH</th><th>DAY</th><th>YEAR</th></tr> <tr><td>Jan</td><td>1</td><td> </td></tr> <tr><td>Feb</td><td>2</td><td> </td></tr> <tr><td>Mar</td><td>3</td><td> </td></tr> <tr><td>Apr</td><td>4</td><td> </td></tr> <tr><td>May</td><td>5</td><td> </td></tr> <tr><td>June</td><td>6</td><td> </td></tr> <tr><td>July</td><td>7</td><td> </td></tr> <tr><td>Aug</td><td>8</td><td> </td></tr> <tr><td>Sept</td><td>9</td><td> </td></tr> <tr><td>Oct</td><td>10</td><td> </td></tr> <tr><td>Nov</td><td>11</td><td> </td></tr> <tr><td>Dec</td><td>12</td><td> </td></tr> </table>	DATE TEST ADMINISTERED			MONTH	DAY	YEAR	Jan	1		Feb	2		Mar	3		Apr	4		May	5		June	6		July	7		Aug	8		Sept	9		Oct	10		Nov	11		Dec	12		<p>DO NOT WRITE IN THIS BLOCK. FOR USE OF U.S. COAST GUARD INSTITUTE</p> <table border="1" style="width: 100%; border-collapse: collapse;"> <tr><td>A</td><td>0</td><td>0</td><td>0</td></tr> <tr><td>B</td><td>1</td><td>1</td><td>1</td></tr> <tr><td>C</td><td>2</td><td>2</td><td>2</td></tr> <tr><td>D</td><td>3</td><td>3</td><td>3</td></tr> <tr><td>E</td><td>4</td><td>4</td><td>4</td></tr> <tr><td>F</td><td>5</td><td>5</td><td>5</td></tr> <tr><td>G</td><td>6</td><td>6</td><td>6</td></tr> <tr><td>H</td><td>7</td><td>7</td><td>7</td></tr> <tr><td>I</td><td>8</td><td>8</td><td>8</td></tr> <tr><td>J</td><td>9</td><td>9</td><td>9</td></tr> </table>	A	0	0	0	B	1	1	1	C	2	2	2	D	3	3	3	E	4	4	4	F	5	5	5	G	6	6	6	H	7	7	7	I	8	8	8	J	9	9	9
SOCIAL SECURITY NUMBER																																																																																																																																																																																																																																																																																																																																																																																																																	
0	0	0	0	0	0	0	0	0	0																																																																																																																																																																																																																																																																																																																																																																																																								
1	1	1	1	1	1	1	1	1	1																																																																																																																																																																																																																																																																																																																																																																																																								
2	2	2	2	2	2	2	2	2	2																																																																																																																																																																																																																																																																																																																																																																																																								
3	3	3	3	3	3	3	3	3	3																																																																																																																																																																																																																																																																																																																																																																																																								
4	4	4	4	4	4	4	4	4	4																																																																																																																																																																																																																																																																																																																																																																																																								
5	5	5	5	5	5	5	5	5	5																																																																																																																																																																																																																																																																																																																																																																																																								
6	6	6	6	6	6	6	6	6	6																																																																																																																																																																																																																																																																																																																																																																																																								
7	7	7	7	7	7	7	7	7	7																																																																																																																																																																																																																																																																																																																																																																																																								
8	8	8	8	8	8	8	8	8	8																																																																																																																																																																																																																																																																																																																																																																																																								
9	9	9	9	9	9	9	9	9	9																																																																																																																																																																																																																																																																																																																																																																																																								
OPFAC NUMBER																																																																																																																																																																																																																																																																																																																																																																																																																	
0	0	0	0	0	0	0	0	0	0																																																																																																																																																																																																																																																																																																																																																																																																								
1	1	1	1	1	1	1	1	1	1																																																																																																																																																																																																																																																																																																																																																																																																								
2	2	2	2	2	2	2	2	2	2																																																																																																																																																																																																																																																																																																																																																																																																								
3	3	3	3	3	3	3	3	3	3																																																																																																																																																																																																																																																																																																																																																																																																								
4	4	4	4	4	4	4	4	4	4																																																																																																																																																																																																																																																																																																																																																																																																								
5	5	5	5	5	5	5	5	5	5																																																																																																																																																																																																																																																																																																																																																																																																								
6	6	6	6	6	6	6	6	6	6																																																																																																																																																																																																																																																																																																																																																																																																								
7	7	7	7	7	7	7	7	7	7																																																																																																																																																																																																																																																																																																																																																																																																								
8	8	8	8	8	8	8	8	8	8																																																																																																																																																																																																																																																																																																																																																																																																								
9	9	9	9	9	9	9	9	9	9																																																																																																																																																																																																																																																																																																																																																																																																								
COURSE CODE																																																																																																																																																																																																																																																																																																																																																																																																																	
0	0	0	0																																																																																																																																																																																																																																																																																																																																																																																																														
1	1	1	1																																																																																																																																																																																																																																																																																																																																																																																																														
2	2	2	2																																																																																																																																																																																																																																																																																																																																																																																																														
3	3	3	3																																																																																																																																																																																																																																																																																																																																																																																																														
4	4	4	4																																																																																																																																																																																																																																																																																																																																																																																																														
5	5	5	5																																																																																																																																																																																																																																																																																																																																																																																																														
6	6	6	6																																																																																																																																																																																																																																																																																																																																																																																																														
7	7	7	7																																																																																																																																																																																																																																																																																																																																																																																																														
8	8	8	8																																																																																																																																																																																																																																																																																																																																																																																																														
9	9	9	9																																																																																																																																																																																																																																																																																																																																																																																																														
EDITION																																																																																																																																																																																																																																																																																																																																																																																																																	
0																																																																																																																																																																																																																																																																																																																																																																																																																	
1																																																																																																																																																																																																																																																																																																																																																																																																																	
2																																																																																																																																																																																																																																																																																																																																																																																																																	
3																																																																																																																																																																																																																																																																																																																																																																																																																	
4																																																																																																																																																																																																																																																																																																																																																																																																																	
5																																																																																																																																																																																																																																																																																																																																																																																																																	
6																																																																																																																																																																																																																																																																																																																																																																																																																	
7																																																																																																																																																																																																																																																																																																																																																																																																																	
8																																																																																																																																																																																																																																																																																																																																																																																																																	
9																																																																																																																																																																																																																																																																																																																																																																																																																	
TEST NO.																																																																																																																																																																																																																																																																																																																																																																																																																	
0																																																																																																																																																																																																																																																																																																																																																																																																																	
1																																																																																																																																																																																																																																																																																																																																																																																																																	
2																																																																																																																																																																																																																																																																																																																																																																																																																	
3																																																																																																																																																																																																																																																																																																																																																																																																																	
4																																																																																																																																																																																																																																																																																																																																																																																																																	
5																																																																																																																																																																																																																																																																																																																																																																																																																	
6																																																																																																																																																																																																																																																																																																																																																																																																																	
7																																																																																																																																																																																																																																																																																																																																																																																																																	
8																																																																																																																																																																																																																																																																																																																																																																																																																	
9																																																																																																																																																																																																																																																																																																																																																																																																																	
DATE TEST ADMINISTERED																																																																																																																																																																																																																																																																																																																																																																																																																	
MONTH	DAY	YEAR																																																																																																																																																																																																																																																																																																																																																																																																															
Jan	1																																																																																																																																																																																																																																																																																																																																																																																																																
Feb	2																																																																																																																																																																																																																																																																																																																																																																																																																
Mar	3																																																																																																																																																																																																																																																																																																																																																																																																																
Apr	4																																																																																																																																																																																																																																																																																																																																																																																																																
May	5																																																																																																																																																																																																																																																																																																																																																																																																																
June	6																																																																																																																																																																																																																																																																																																																																																																																																																
July	7																																																																																																																																																																																																																																																																																																																																																																																																																
Aug	8																																																																																																																																																																																																																																																																																																																																																																																																																
Sept	9																																																																																																																																																																																																																																																																																																																																																																																																																
Oct	10																																																																																																																																																																																																																																																																																																																																																																																																																
Nov	11																																																																																																																																																																																																																																																																																																																																																																																																																
Dec	12																																																																																																																																																																																																																																																																																																																																																																																																																
A	0	0	0																																																																																																																																																																																																																																																																																																																																																																																																														
B	1	1	1																																																																																																																																																																																																																																																																																																																																																																																																														
C	2	2	2																																																																																																																																																																																																																																																																																																																																																																																																														
D	3	3	3																																																																																																																																																																																																																																																																																																																																																																																																														
E	4	4	4																																																																																																																																																																																																																																																																																																																																																																																																														
F	5	5	5																																																																																																																																																																																																																																																																																																																																																																																																														
G	6	6	6																																																																																																																																																																																																																																																																																																																																																																																																														
H	7	7	7																																																																																																																																																																																																																																																																																																																																																																																																														
I	8	8	8																																																																																																																																																																																																																																																																																																																																																																																																														
J	9	9	9																																																																																																																																																																																																																																																																																																																																																																																																														
<p>NOTE THE RESPONSES ARE IN VERTICAL SEQUENCE</p>																																																																																																																																																																																																																																																																																																																																																																																																																	
1	(A) (B) (C) (D)	16	(A) (B) (C) (D)	31	(A) (B) (C) (D)	46	(A) (B) (C) (D)	61	(A) (B) (C) (D)	76	(A) (B) (C) (D)	91	(A) (B) (C) (D)	106	(A) (B) (C) (D)																																																																																																																																																																																																																																																																																																																																																																																																		
2	(A) (B) (C) (D)	17	(A) (B) (C) (D)	32	(A) (B) (C) (D)	47	(A) (B) (C) (D)	62	(A) (B) (C) (D)	77	(A) (B) (C) (D)	92	(A) (B) (C) (D)	107	(A) (B) (C) (D)																																																																																																																																																																																																																																																																																																																																																																																																		
3	(A) (B) (C) (D)	18	(A) (B) (C) (D)	33	(A) (B) (C) (D)	48	(A) (B) (C) (D)	63	(A) (B) (C) (D)	78	(A) (B) (C) (D)	93	(A) (B) (C) (D)	108	(A) (B) (C) (D)																																																																																																																																																																																																																																																																																																																																																																																																		
4	(A) (B) (C) (D)	19	(A) (B) (C) (D)	34	(A) (B) (C) (D)	49	(A) (B) (C) (D)	64	(A) (B) (C) (D)	79	(A) (B) (C) (D)	94	(A) (B) (C) (D)	109	(A) (B) (C) (D)																																																																																																																																																																																																																																																																																																																																																																																																		
5	(A) (B) (C) (D)	20	(A) (B) (C) (D)	35	(A) (B) (C) (D)	50	(A) (B) (C) (D)	65	(A) (B) (C) (D)	80	(A) (B) (C) (D)	95	(A) (B) (C) (D)	110	(A) (B) (C) (D)																																																																																																																																																																																																																																																																																																																																																																																																		
6	(A) (B) (C) (D)	21	(A) (B) (C) (D)	36	(A) (B) (C) (D)	51	(A) (B) (C) (D)	66	(A) (B) (C) (D)	81	(A) (B) (C) (D)	96	(A) (B) (C) (D)	111	(A) (B) (C) (D)																																																																																																																																																																																																																																																																																																																																																																																																		
7	(A) (B) (C) (D)	22	(A) (B) (C) (D)	37	(A) (B) (C) (D)	52	(A) (B) (C) (D)	67	(A) (B) (C) (D)	82	(A) (B) (C) (D)	97	(A) (B) (C) (D)	112	(A) (B) (C) (D)																																																																																																																																																																																																																																																																																																																																																																																																		
8	(A) (B) (C) (D)	23	(A) (B) (C) (D)	38	(A) (B) (C) (D)	53	(A) (B) (C) (D)	68	(A) (B) (C) (D)	83	(A) (B) (C) (D)	98	(A) (B) (C) (D)	113	(A) (B) (C) (D)																																																																																																																																																																																																																																																																																																																																																																																																		
9	(A) (B) (C) (D)	24	(A) (B) (C) (D)	39	(A) (B) (C) (D)	54	(A) (B) (C) (D)	69	(A) (B) (C) (D)	84	(A) (B) (C) (D)	99	(A) (B) (C) (D)	114	(A) (B) (C) (D)																																																																																																																																																																																																																																																																																																																																																																																																		
10	(A) (B) (C) (D)	25	(A) (B) (C) (D)	40	(A) (B) (C) (D)	55	(A) (B) (C) (D)	70	(A) (B) (C) (D)	85	(A) (B) (C) (D)	100	(A) (B) (C) (D)	115	(A) (B) (C) (D)																																																																																																																																																																																																																																																																																																																																																																																																		
11	(A) (B) (C) (D)	26	(A) (B) (C) (D)	41	(A) (B) (C) (D)	56	(A) (B) (C) (D)	71	(A) (B) (C) (D)	86	(A) (B) (C) (D)	101	(A) (B) (C) (D)	116	(A) (B) (C) (D)																																																																																																																																																																																																																																																																																																																																																																																																		
12	(A) (B) (C) (D)	27	(A) (B) (C) (D)	42	(A) (B) (C) (D)	57	(A) (B) (C) (D)	72	(A) (B) (C) (D)	87	(A) (B) (C) (D)	102	(A) (B) (C) (D)	117	(A) (B) (C) (D)																																																																																																																																																																																																																																																																																																																																																																																																		
13	(A) (B) (C) (D)	28	(A) (B) (C) (D)	43	(A) (B) (C) (D)	58	(A) (B) (C) (D)	73	(A) (B) (C) (D)	88	(A) (B) (C) (D)	103	(A) (B) (C) (D)	118	(A) (B) (C) (D)																																																																																																																																																																																																																																																																																																																																																																																																		
14	(A) (B) (C) (D)	29	(A) (B) (C) (D)	44	(A) (B) (C) (D)	59	(A) (B) (C) (D)	74	(A) (B) (C) (D)	89	(A) (B) (C) (D)	104	(A) (B) (C) (D)	119	(A) (B) (C) (D)																																																																																																																																																																																																																																																																																																																																																																																																		
15	(A) (B) (C) (D)	30	(A) (B) (C) (D)	45	(A) (B) (C) (D)	60	(A) (B) (C) (D)	75	(A) (B) (C) (D)	90	(A) (B) (C) (D)	105	(A) (B) (C) (D)	120	(A) (B) (C) (D)																																																																																																																																																																																																																																																																																																																																																																																																		

End-of-Course Test

EOCT Score Keys and Profiles (CGI-2801) (Back page)

Reverse of CGI-2801 (Rev. 11-92)

(Submit Original & 1)

Date: _____

From:

To: Commanding Officer, Coast Guard Institute (nrt)

Via: Commanding Officer, Coast Guard Institute (rss)

SHORT TITLE: _____ COURSE CODE: _____ EDITION: _____

EOCT NUMBER	ITEM NUMBER	DELETE ITEM	CHANGE ANSWER FROM	TO	REASON
_____	_____	()	()	()	_____
_____	_____	()	()	()	_____
_____	_____	()	()	()	_____
_____	_____	()	()	()	_____
_____	_____	()	()	()	_____
_____	_____	()	()	()	_____
_____	_____	()	()	()	_____
_____	_____	()	()	()	_____

EOCT RECAP					
Form	Total Items	Previously Deleted	Deleted This Time	Total Deleted	Total Verified
_____	_____	_____	_____	_____	_____
_____	_____	_____	_____	_____	_____
_____	_____	_____	_____	_____	_____

(Subject Matter Specialist)

(TS Supervisor)

Date: _____

From: Commanding Officer, Coast Guard Institute (nrt)

To:

Action completed as requested, EOCT RECAP above verified/corrected.

Other: _____

(Central Core)

PREVIOUS EDITIONS OBSOLETE

End-of-Course Test

100 Percent Test

After the printed instructor's copy of the EOCT is returned to the training source by the CGI, the SMS must take the EOCT and receive a score of 100 percent.

The SMS should take the "100 percent test" using ONLY the CGI's printed copy of the EOCT without the aid of a previously prepared answer key or other keyed copy of the EOCT. Meticulous attention to this important step will guarantee that a completely accurate answer key is used to score student EOCTs. The SMS should use the review copy of the EOCT to verify the answer key is correct. The SMS will take the 100 percent tests of all three versions of current series of EOCT.

Note: Enter "100 percent test" in the name block and leave the social security number blank. The new EOCT series cannot be placed on-line until each "100 percent test" has been graded by the CGI.

Statistical Analysis

A statistical analysis should be requested from the CGI using form CGI-1960 after a new series of EOCTs has been in use long enough to get a reasonable sample (approximately 6 months). The statistical analysis will identify the following information:

- Miskeyed items.
 - Items with two correct answers or an answer that is partially correct.
 - Areas that were not covered adequately in the text.
 - Questions that are poor discriminators.
 - Questions that are too easy/difficult.
 - Unwanted cues in the stem.
 - Unwanted cues in the answers.
-

Crediting Items

Any credited item means that the student receives a correct response regardless of the answer choice.

When an item is credited, nothing happens to the test booklet. The student does not know the item will not be graded. **If more than 10 percent of the items need to be credited, you must write a new series of exams.**

End-of-Course Test

Crediting Items (Continued)

To credit an item, complete a computer key change on the EOCT Score Key Change Profile Sheet (CGI-2801). Once the action has been completed by CGI, an endorsed copy will be returned to the training source. File this copy along with the master copy of the test. You will need this form when revising the test.

Some EOCT items may need to be credited before the test is revised. This could be due to poor performance when analyzed, changing obsolete material in a pamphlet, or any of the reasons covered earlier.

Challenges from Students

Challenges from students are usually received by CGI with the administered EOCT. The student's inquiry will then be forwarded to the training source. The SMS responds to the challenge by mail or e-mail. No test answers are given to the student, but the SMS can reference where the student may find the answer (i.e., see lesson # in pamphlet # __).

Note: Copies of replies to students should be filed in the course file maintained by the SMS.

Pass/Fail

Pass/fail scores on course completion/failure letters will reflect the actual pass/fail percentage (%) score established by the subject matter specialist (SMS) and rating force master chief (RFMC) responsible for the course. SMSs have set the pass/fail score on the majority of EOCTs at 76% or 80% (i.e., 76 or 80 correct out of 100 questions). However, EOCT pass/fail percentage scores can range from 66% - 98%.

Actual Score

Students passing an EOCT will receive the actual score achieved on the test regardless of the number of times they take the EOCT.

Auxiliary EOCT

Commandant (G-OCX) is the program/training manager for all auxiliary correspondence courses and EOCTs. CGI will continue to score EOCTs that are available to Coast Guard Auxiliarist through their local Director of Auxiliary. The score keys for these EOCTs will continue to be supplied by Commandant (G-OCX) to CGI. EOCTs and auxiliary correspondence course pamphlets will not be stocked by the CGI.

This page intentionally left blank.

Section 10

SERVICEWIDE EXAMINATION (SWE)

Overview

Introduction

The Enlisted Performance Qualifications Manual, COMDTINST M1414.8 (series), serves as the basis for the development of the servicewide examination (SWE). The manual prescribes the minimum occupational and military standards, expressed in enlisted performance qualifications, for advancement in rate. The SWE is the final phase of the advancement competition. The main goal of the SWE is to identify those candidates best qualified for advancement on the basis of rate-related/required knowledge and performance and to rank order those already qualified. The SWE is a norm-referenced examination. The candidate's name appears on the advancement list in order of the final multiple score, which is a combination of time-in-service, time-in-grade, sea duty points, surf duty points, medals and awards, marks, and SWE score.

Components

Each SWE is divided into the following two basic parts:

- Part I - Professional. Knowledge and performance relevant to the total field of the rate. Many different section topics particular to the rate may be addressed.
 - Part II - Enlisted Professional Military Education (E-PME). Requirements common to all ratings in each paygrade.
-

SWE Construction

To make up the TWO series of the SWE for each paygrade, follow the procedures outlined below.

- The test items for a SWE shall be written based on the EPQ's and required competencies listed in the EPQ's. There SHALL be sufficient questions (a minimum of five) for the test items database to randomly select enough questions to create two separate tests for each paygrade.
 - Select items that have been adequately reviewed. The items selected from your test item database for the SWE may also have been of the same type questions written for the EOCT's, the lesson self-quiz/topic review level and may have been used again at the pamphlet review quiz level. The questions for the SWE shall be written differently than what has already been written on the pamphlet review quiz and self-quiz.
-

Overview

Requirements

The following requirements are specified for writing SWE items:

- All SWEs will be created by appropriate rating E-9s/test writers.
- Under no circumstances will individuals have access to any examination component for examinations in which they could participate.
- Each SWE consists of 150 items (questions).
- All items must be written in the four-response, multiple-choice format.
- All newly created SWE test items must be approved by the ISS and W/E prior to being used on a SWE. (Depending on the training source and staffing billets, other staff could perform this responsibility.)
- Every SWE item in the Professional and E-PME parts must test a performance-based qualification required by COMDTINST M1414.8 (series) of the target rate or any lower rate.
- Two parallel but different exams for each pay grade (E-4, E-5, etc.) must be developed for each exam cycle. Section emphasis must be identical for each exam for that pay grade.
- Series numbers for each exam cycle are given out by PSC (adv) and should be labeled as per samples on pages 10-8 thru 10-10.
- Every item must have a written reference, which confirms the correctness of the item. Each reference must be either:
 - An official directive applicable throughout the Coast Guard.

Examples: Coast Guard publications, Commandant Instructions, or other documents listed in COMDTNOTE 5600.

or

- A generally accepted source of information.

Examples: Dutton's "Navigation and Piloting," "Gray's Anatomy," or a manufacturer's instruction book, which should be available to all and **is a required EPQ reference**.

Overview

Part Size Requirements

The size of each part of an examination is depicted below. Part size for Professional and E-PME parts will vary depending on paygrade.

Part	Part Size (No. of Items)	Action and Responsibility
Professional	E-5 - 120 E-6/E-7 - 125 E-8/E-9 - 80	Written by E-9. Reviewed by writer/editor (W/E) (or training specialist) and Instructional System Specialist (ISS) (or E-9's supervisor).
Enlisted Professional Military Education Requirement	E-5 - 30 E-6/E-7 - 25 E-8/E-9 - 70	Written by E-PME section, CGTRACEN Petaluma. Reviewed and approved by subject matter experts (SME's) supervisor.

Servicewide Examination

Section Requirements

Items in each part of the examination should be arranged in specific topic areas called sections. Sections within each part must meet the following requirements:

- Must be homogeneous, (i.e., all items in a section must refer to a common topic corresponding to the EPQ section titles.).

Procedure

The SWE is developed to sample the Enlisted Performance Qualifications (EPQs). The procedure is listed below:

Step	Action	Responsibility
1	Validate database test items, EPQs, and references.	E-9/ISS
2	Prepare exam strategy and develop test section emphasis for next SWE cycle.	E-9/Rating Force Master Chief (RFMC)
3	Determine if test items to be retained, rejected, or revised. See Section 11 - Test Strategy and Statistics - Item Revision.	E-9
4	Print/format exams.	E-9
5	Spell-check and proofread the exams.	E-9

Servicewide Examination

Procedure (Continued)

Step	Action	Responsibility
6	Conduct first edit. Note: The ISS and W/E must approve all test items before they are used on an SWE.	W/E and/or ISS
7	Review and make appropriate changes.	E-9
8	Print camera-ready copy (CRC).	E-9
9	Conduct camera-ready edit.	W/E
10	If revision needed, go to step 9.	E-9
11	Complete section title sheets. (PPC-1400)	E-9
12	Prepare answer sheets. (PSC-4801)	E-9
13	Dual proof answer keys with another SME or W/E.	E-9
14	Conduct final review.	ISS
15	Send servicewide exams to Personnel Support Command (PSC) (adv).	E-9

Note: Depending on training source and staffing billets, responsibilities of the ISS and/or W/E could be performed by other staffmembers.

Servicewide Examination

Deadline Dates Deadline dates for deliverable items required during the SWE cycles are listed in the below table.

MONTH	MAY SWE	OCT RSWE	NOV SWE
JAN	15JAN: CGPC (epm) releases SWE Announcement MSG. 15JAN: PSC (adv) builds electronic SWE sections and answer keys using CRC		15JAN: PSC (adv) sends Item Analysis (final run) to Test Writers
FEB	05FEB: PSC (adv) sends CRC to printer for mass printing		
MAR	15MAR: PSC (adv) begins “early mail” of SWE’s to underway units		
APR	10APR: PSC (adv) mails SWE’s to Exam Boards		15APR: Message from COMDT announcing SWE competition
MAY	First Tuesday and Thursday of May, SWE administered	15MAY: Camera Ready Copy delivered to PSC (adv)	
JUN	01JUN: PSC (adv) scans and scores SWE majority of SWE answer sheets. 05JUN: PSC (adv) sends Item Analysis (dirty run) and Challenge Questions to Test Writers 5 working days after receipt: Test Writers provide Challenge Question decisions to PSC (adv) 15JUN: PSC (adv) modifies answer keys based on SME challenge decisions and rescores all exams for final raw score	15JUN: CGPC (rpm) releases SWE Announcement MSG. 15JUN PSC (adv) builds electronic SWE sections and answer keys using CRC	15JUN: Camera Ready Copy delivered to PSC (adv)
JUL	15JUL: PSC (adv) sends Item Analysis (final run) to Test Writers	05JUL: PSC (adv) sends CRC to printer for mass printing	15JUL: CGPC (epm) releases SWE Announcement MSG. 15JUL: PSC (adv) builds electronic SWE sections and answer keys using CRC

Servicewide Examination

MONTH	MAY SWE	OCT RSWE	NOV SWE
AUG		15AUG: PSC (adv) begins “early mail” of SWE’s to underway units	05AUG: PSC (adv) sends CRC to printer for mass printing
SEP		10SEP: PSC (adv) mails SWE’s to Exam Boards	15SEP: PSC (adv) begins “early mail” of SWE’s to underway units
OCT		Third Saturday in October, SWE administered	10OCT: PSC (adv) mails SWE’S to Exam Boards
NOV		<p>01NOV: PSC (adv) scans and scores SWE majority of SWE answer sheets.</p> <p>05NOV: PSC (adv) sends Item Analysis (dirty run) and Challenge Questions to Test Writers</p> <p>5 working days after receipt: Test Writers provide Challenge Question decisions to PSC (adv)</p> <p>15NOV: PSC (adv) modifies answer keys based on SME challenge decisions and rescores all exams for final raw score</p>	First Tuesday and Thursday of November, SWE administered
DEC	15DEC: Camera Ready Copy delivered to PSC (adv)	15DEC: PSC (adv) sends Item Analysis (final run) to Test Writers	<p>01DEC: PSC (adv) scans and scores SWE majority of SWE answer sheets.</p> <p>05DEC: PSC (adv) sends Item Analysis (dirty run) and Challenge Questions to Test Writers</p> <p>5 working days after receipt: Test Writers provide Challenge Question decisions to PSC (adv)</p> <p>15DEC: PSC (adv) modifies answer keys based on SME challenge decisions and rescores all exams for final raw score</p>

Servicewide Examination

Administration Schedules

The schedules for administering the SWE are outlined in the table below. The administration of the SWE is limited to 3½ hours.

SWE Schedule by Rating		
Regular	E-5 through E-6	November
	E-5 through E-9	May
Reserve	E-5 through E-9	October

SWE Package

After the test development process is completed, mail the following completed items by Registered mail or authorized shipping agent to PSC (adv). Sample items required in the SWE package are included on the following pages.

- Properly formatted, camera-ready copy of the SWE. Format will depend on whether the test is unclassified or classified.
 - The professional section of the SWE must end on an even-numbered page; therefore, the test may require a blank page.
 - SWE Section Title Sheet (PPC-1400).
 - SWE Answer Sheet (PSC-4801). The examination answer key is prepared on this form.
 - A transmittal memorandum that indicates the above underscored items as enclosures.
-

Packaging and Mailing Instructions

All testing material, whether sensitive or classified, shall be mailed/shipped double-wrapped with the inside envelope containing the following instructions on both sides in at least 1/4-inch letters:

SENSITIVE MATERIALS TO BE OPENED BY A TESTING MATERIAL OFFICER ONLY

The office and person designated to receive testing material shall be identified on the inner envelope only. When sensitive testing material is mailed between the training source (TS) and the Coast Guard Institute (CGI) or PSC (adv), it must be accounted for by signature using registered mail or authorized shipping agent via overnight delivery. Classified testing material **MUST** be mailed via registered mail. **DO NOT** use certified mail. A mail logbook shall be used to track testing material.

Servicewide Examination

Sample SWE

Times New Roman Bold 12 pt.	FOR OFFICIAL USE ONLY U.S. COAST GUARD SERVICESIDE EXAM COMMUNICATIONS	MST3 Series 35
Double Space.	1. In the Northern Hemisphere, the semipermanent subtropical highs move southward during the ____ months. A. winter B. autumn C. summer D. spring	5. To acknowledge the receipt of a message on a sound-powered telephone, you should say "____." A. AFFIRMATIVE B. AYE, AYE C. ROGER D. ON THE LINES
Times New Roman 12 pt.	2. When you use the thermal wind between the 1,000- and 700-mb levels to indicate the speed of a surface low, the low's speed is approximately ____ of the thermal wind's speed. A. 90% B. 75% C. 50% D. 30%	6. The Geostrophic Wind Method uses the surface and 700-mb levels to forecast the movement of ____. A. isobars B. highs C. fronts D. isotherms
Times New Roman 12 pt.	3. To objectively predict the 24-hour movement and change in intensity of maritime low pressure systems, you should use height and temperature measurements from the ____ level. A. 1,000-mb B. 850-mb C. 500-mb D. 350-mb	7. What is the most intensive and effective cooling process? A. Frontal lifting B. Orographic lifting C. Horizontal divergence D. Vertical stretching
Times New Roman 12 pt.	4. In the upper atmosphere over a developing low, the isopycnic level is generally considered to be at the ____ level. A. 200-mb B. 350-mb C. 450-mb D. 600-mb	8. The most important factor in short-range terminal forecasting is the accuracy of ____. A. area B. time C. distance D. direction
Times New Roman Bold 12 pt.	1	GO ON TO THE NEXT PAGE FOR OFFICIAL USE ONLY

Servicewide Examination

Sample Confidential SWE

Times New Roman Bold 12 pt.

CONFIDENTIAL
U.S. COAST GUARD SERVICEWIDE EXAM

FT2 Series 35

COMMUNICATIONS

1. (U) In the Northern Hemisphere, the semipermanent subtropical highs move southward during the ____ months.

- A. winter
- B. autumn
- C. summer
- D. spring

2. (U) When you use the thermal wind between the 1,000- and 700-mb levels to indicate the speed of a surface low, the low's speed is approximately ____ of the thermal wind's speed.

- A. 90%
- B. 75%
- C. 50%
- D. 30%

3. (U) To objectively predict the 24-hour movement and change in intensity of maritime low pressure systems, you should use height and temperature measurements from the ____ level.

- A. 1,000
- B. 850
- C. 500
- D. 350

4. (U) In the upper atmosphere over a developing low, the isopycnic level is generally considered to be at the ____ level.

- A. 200
- B. 350
- C. 450
- D. 600

5. (U) To acknowledge the receipt of a message on a sound-powered telephone, you should say "____."

- A. AFFIRMATIVE
- B. AYE, AYE
- C. ROGER
- D. ON THE LINES

6. (U) The Geostrophic Wind Method uses the surface and 700-mb levels to forecast the movement of ____.

- A. isobars
- B. highs
- C. fronts
- D. isotherms

7. (U) What is the most intensive and effective cooling process?

- A. Frontal lifting
- B. Orographic lifting
- C. Horizontal divergence
- D. Vertical stretching

8. (U) The most important factor in short-range terminal forecasting is the accuracy of ____.

- A. area
- B. time
- C. distance
- D. direction

9. (U) In the Northern Hemisphere, the most extensive and dense cirrus clouds occur on the high pressure side or ____ of the jet stream axis.

- A. west
- B. east
- C. south
- D. north

Times New Roman Bold 10 pt.

Double Space

Times New Roman Bold 12 pt.

1

GO ON TO THE NEXT PAGE
CONFIDENTIAL

Servicewide Examination

Sample SWE Blank Page

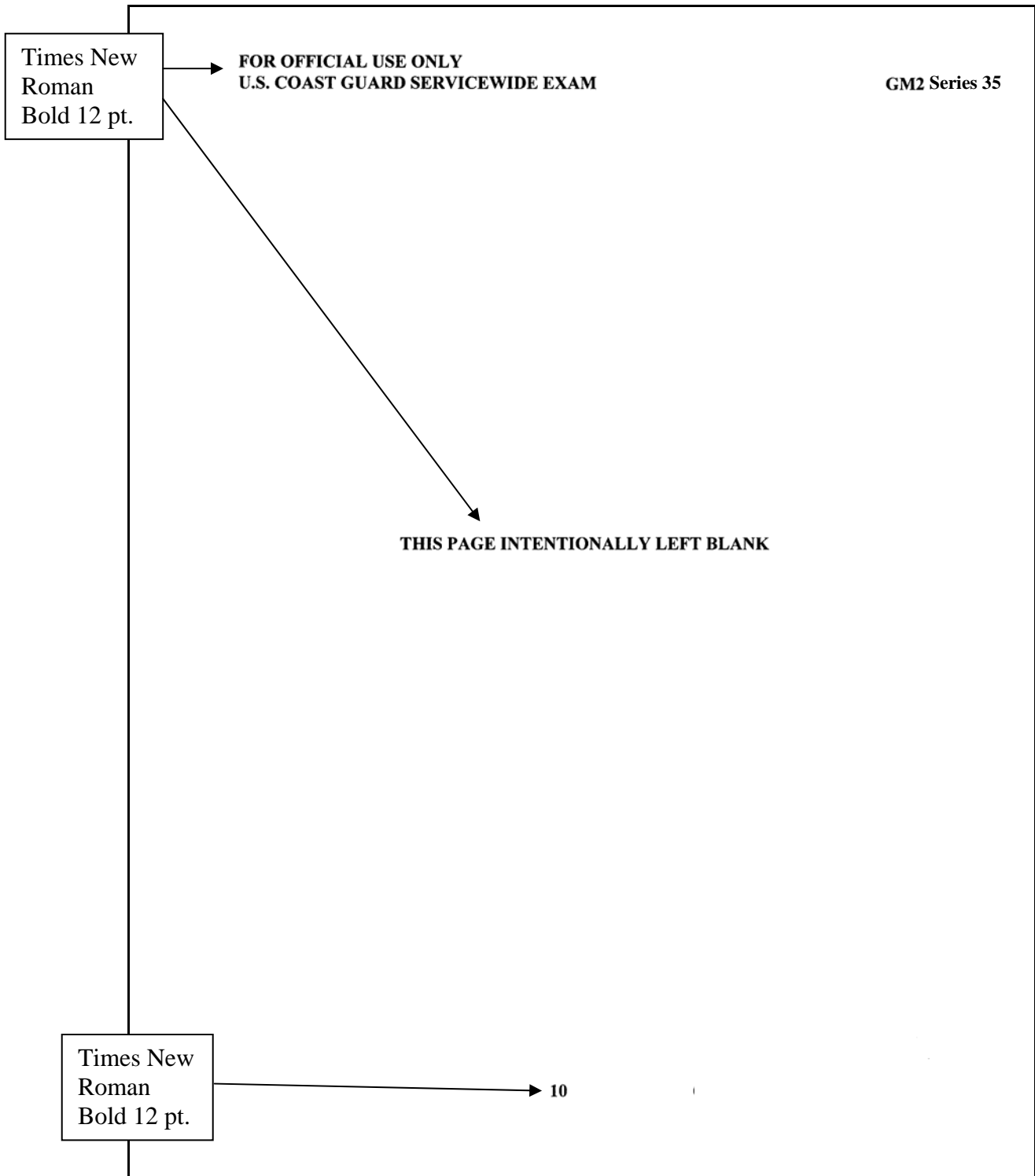

Servicewide Examination

SWE Section Title Sheet

Each SWE is divided into sections. Each section title should describe the topic of the section. The Section Title Sheet (PPC-1400) is used to record section titles, as shown below, and is prepared by the E-9/test writer after completion of the dual-column examination. The following applies:

- Limit each section title to a maximum of 30 characters including spaces between words.
- Maximum section titles including the E-PME sections for a SWE are not limited, they should be based on the EPQ section titles.
- Include Enlisted Professional Military Education line with appropriate number of questions per paygrade.
- Ensure that the "No. of Items" column sums to 150.
- Submit the completed Section Title Sheet with the camera-ready copy of the examination.

SWE SECTION TITLE WORKSHEET																																				
RATE:	BMCM																																			
SERIES:	29																						FOR ADVANCEMENTS													
PAY GRADE:	E9																						USE ONLY													
																														QUESTIONS	SYSTEM					
																														PER	SECTION	SECURITY				
																														SECTION	NUMBER	CODE				
///	1	2	3	4	5	6	7	8	9	10	11	12	13	14	15	16	17	18	19	20	21	22	23	24	25	26	27	28	29	30						
01	A	D	M	I	N	I	S	T	R	A	T	I	O	N																				15		
02	O	P	E	R	A	T	I	O	N	S																								13		
03	P	I	L	O	T	I	N	G																									26			
04	M	A	I	N	T	E	N	A	N	C	E																							12		
05	H	O	N	O	R	S																											6			
06	O	R	D	N	A	N	C	E																										6		
07	T	R	A	I	N	I	N	G																										2		
08	E	-	P	M	E																												70			
09																																				
10																																				
11																																				
12																																				
																														TOTAL:	150					
* PLEASE PRINT TITLES ONE LETTER PER BLOCK AND LEAVE A SPACE BETWEEN WORDS.																																				
* PROFILE LETTERS CANNOT ACCEPT MORE THAN 30 CHARACTERS FOR A SECTION TITLE. PLEASE ABBREVIATE, WHEN NECESSARY, TO ENSURE ONLY 30 CHARACTERS PER SECTION TITLE.																																				
DOT-U S Coast Guard															BMCM I. M. SAILOR															12-Dec-03						
PPC 1400 3/1/96															EXAM WRITER															DATE						
(Replaces CGI 2836 11/76)																																				

Servicewide Examination

SWE Answer Key

The SME prepares an answer key for the professional portions of each examination on the USCG Examination Answer Sheet (PSC-4801). The steps are listed below:

- Use a #2 soft lead black pencil.
- Fill in name of person who prepared the key, the short title, and exam series number.
- Leave this area for the Social Security Number **blank**. PSC will enter appropriate data.
- Complete the Exam Identification Number using the appropriate examination rate code and series number.
 - Examination rate codes are listed on the following page.
 - Exam series are numbered in a continuous series.

Below is an example of the USCG Examination Answer Sheet. Ensure ovals are darkened completely and dark enough that the letter in the oval cannot be read. Also, use clean erasures leaving no smudges if possible.

leave blank. PSC will assign # exam rate code series # 999 designates this as the answer key

DEPARTMENT OF TRANSPORTATION UNITED STATES COAST GUARD HRSIC-4801 05/2002		USCG EXAMINATION ANSWER SHEET																	
Name <u>Doe</u> <u>JD</u> <small>(last) (initials)</small>		SOCIAL SECURITY NUMBER								EXAM IDENTIFICATION NO.									
Rate/Grade <u>E-5</u> Exam title <u>short title</u> <small>i.e. BM2</small>		[Blank]								2 1 2 2 9 0 9 9 9									
Exam Board OPFAC _____		[Grid of 0-9 ovals]								[Grid of 0-9 ovals]									
Answer spaces are arranged in vertical sequence. Make only one mark to answer one question. To avoid erasures, at first mark your selection lightly or with a small dot. Then, after you are satisfied no changes will be made, darken circles carefully.		[Grid of 0-9 ovals]								[Grid of 0-9 ovals]									
EXAMPLE: 1 (A) <input checked="" type="radio"/> (B) <input type="radio"/> (C) <input type="radio"/> (D) <input type="radio"/> 3 (A) <input type="radio"/> (B) <input type="radio"/> (C) <input type="radio"/> (D) <input type="radio"/>		[Grid of 0-9 ovals]								[Grid of 0-9 ovals]									
2 (A) <input type="radio"/> (B) <input checked="" type="radio"/> (C) <input type="radio"/> (D) <input type="radio"/> 4 (A) <input type="radio"/> (B) <input type="radio"/> (C) <input type="radio"/> (D) <input checked="" type="radio"/>		[Grid of 0-9 ovals]								[Grid of 0-9 ovals]									
PRIVACY ACT OF 1974																			
A. AUTHORITY FOR USE AND WHETHER MANDATORY OR VOLUNTARY – 14 U.S.C. Sec 633. Voluntary. B. PRINCIPAL PURPOSE – Identify student record. Score test answers. C. ROUTINE USES – Establish score on exam. Enter score into final multiple for advancement. D. EFFECT ON YOU IF YOU DO NOT PROVIDE THE INFORMATION REQUESTED – Your answer sheet will not be scored. You will be dropped from advancement competition.																			

Note: This form is acceptable for use, although some blocks contain out-of-date information (e.g., Department of Transportation).

Servicewide Examination

SWE Rate Codes

The examination “rate code” is the first three digits of the exam identification number on the answer sheet. These can change so please contact PSC prior to using. Examination rate codes are listed below:

SERVICEWIDE EXAMINATION RATE CODES

Rate	Code	Rate	Code	Rate	Code	Rate	Code
AMT2	206	EM2	219	IT2	280	PS2	267
AMT1	106	EM1	119	IT1	180	PS1	167
AMTC	006	EMC	019	ITC	080	PSC	067
AMTCS	806	EMCS	819	ITCS	880	PSCS	867
AMTCM	906	EMCM	919	ITCM	980	PSCM	967
AET2	202	ET2	222	IV2	266	PA2	236
AET1	102	ET1	122	IV1	166	PA1	136
AETC	002	ETC	022	IVC	066	PAC	036
AETCS	802	ETCS	822	IVCS	866	PACS	836
AETCM	902	ETCM	922	IVCM	966	PACM	936
AST2	210	FS2	251	MK2	232	SK2	250
AST1	110	FS1	151	MK1	132	SK1	150
ASTC	010	FSC	051	MKC	032	SKC	050
ASTCS	810	FSCS	851	MKCS	832	SKCS	850
ASTCM	910	FSCM	951	MKCM	932	SKCM	950
BM2	212	GM2	229	MST2	234		
BM1	112	GM1	129	MST1	134		
BMC	012	GMC	029	MSTC	034		
BMCS	812	GMCS	829	MSTCS	834		
BMCM	912	GMCM	929	MSTCM	934		
DC2	215	HS2	230	OS2	238		
DC1	115	HS1	130	OS1	138		
DCC	015	HSC	030	OSC	038		
DCCS	815	HSCS	830	OSCS	838		
DCCM	915	HSCM	930	OSCM	938		

SERVICEWIDE EXAMINATION RATE CODES

Aviation Maintenance Technician (AMT)	Information Systems Technician (IT)
Avionics Electrical Technician (AET)	Investigator (IV)
Aviation Survival Technician (AST)	Machinery Technician (MK)
Boatswain’s Mate (BM)	Marine Science Technician (MST)
Damage Controlman (DC)	Operations Specialist (OS)
Electrician’s Mate (EM)	Port Security Specialist (PS)
Electronics Technician (ET)	Public Affairs Specialist (PA)
Food Service Specialist (FS)	Storekeeper (SK)
Gunner’s Mate (GM)	Yeoman (YN)
Health Services Technician (HS)	

Servicewide Examination

Challenge of SWE

After administration of the SWE, some examinees will write to PSC (adv) to challenge SWE items. The challenges for the SWE will be sent via the ESO to PSC who will then forward them on to the training source. For any challenge, the SWE item must be checked. Challenges are generally of two types:

- Content. Content challenges are usually received when the SWE answer sheets are returned to PSC (adv). Challenged items dealing with content will be credited during the "dirty run" stage at the discretion of the training source (TS).
- Computation. Computation (scoring) challenges are received after the SWEs have been scored and profile letters are sent to examinees. Any computation problems are corrected upon receipt of the challenges by PSC (adv).

Acknowledging Challenges

Although most correspondence challenging the content of SWE items will be received by PSC (adv), some challenges may be received directly by the TS. The subject matter expert (E-9) at the TS will review challenges during the prescoring audit or "dirty run" stage. Crediting of exam items will be done at this stage as appropriate. The E-9 will acknowledge each challenge received. The acknowledgment reply should be similar to the Examination Question Inquiry on the following page.

Servicewide Examination

Sample Examination Question Inquiry

U.S. Department of
Homeland Security

United States
Coast Guard



Commanding Officer
U.S. Coast Guard
Training Center Yorktown

Yorktown, VA 23690-5000
Staff Symbol: t-bfc
Phone: (757) 555-2000

5600
28 Aug 2002

MEMORANDUM

From: BMCM I. M. Sailor
CG TRACEN Yorktown

Reply to t-bfc
Attn of: (757) 555-2000

To: Commanding Officer (ESO of Unit for Person who challenged question)

Subj: SWE INQUIRY

Ref: (a) Your SWE Challenge dtd 15 May 2004

1. Your correspondence, ref. (a), concerning item(s) **49** on the **BMC** servicewide exam for **BM1 Green** has been received and reviewed against the BM qualification factors and is not being credited.
2. Each challenged item is checked for accuracy and currency. If an examination question is determined to be invalid, that questions is credited for all exam participants.
3. Your effort to ensure a fair and accurate examination is appreciated. To prevent compromises, the subject matter expert does not provide answers or references for examination questions. However, if any other information would be helpful, please contact the subject matter expert, BMCM Sailor, at the address or phone above.

I. M. SAILOR, BMCM
By direction

#

Servicewide Examination

Prescoring Audit

The E-9/test writer must audit the entire examination. Every item must be verified to be current and applicable based on the status of the item reference on examination day. Challenges from students must be considered during the audit of the examinations. This audit is conducted in two phases. Phase one is done prior to the receipt of the item analysis ("dirty run"). Phase two is performed after receipt of the "dirty run."

During phase one, the E-9/test writer will:

- Review all items based on references that have been changed between the time the examination was prepared and the time it was administered.
- Complete as much item verification and research as possible prior to receipt of the "dirty run" because of the quick turnaround time required.
- Credit the score key for any item which was not correct on examination day.

Upon receipt of the "dirty run," the E-9/test writer has **3 working days** to audit the examination and express mail the results back to PSC (adv).

During phase two, the E-9/test writer will:

- Review every item that has a "pSel" value that is higher than the "pSel" value for the correct response and every item that has a "pSel" value of 1.000.
- Check score key and take the following action:

IF ...	THEN ...
score key was miskeyed	correct the score.
score key is correct	check item wording.
item is unclear or irrelevant	credit the item.
item is clear and relevant	take no action.

Note: Following the Reserve CG examinations, the prescoring audit is conducted for CG examinations that were waived for the May SWE and administered for the first time in October for reserve and the PS and IV ratings.

Servicewide Examination

SWE Audit Results

The E-9 will use one of the following change forms received with the "dirty run" from PSC (adv) to record the SWE audit results. Samples of each change form are shown on the following pages.

- Credits and/or Score Key Changes Form. Indicate the items to be credited or that have score key changes. A separate form is required for each examination that has key changes or credits.
- No Credit/Score Key Change Form. Indicate no changes to answer key. The same form may be used for all examinations with no key changes.

Upon completion of the prescoring audit, the E-9/test writer will submit to PSC (adv) the appropriate change form that denotes items which are to be credited and which have a score key correction. The examination name, item number, and action required must be entered. Change forms shall be sent by registered mail or authorized express package service only, but must be double-wrapped and stamped with 1/4" letters stating:

**“SENSITIVE MATERIALS TO BE OPENED BY TESTING
MATERIAL OFFICER ONLY.”**

A credited item will be marked with an asterisk on the PSC (adv) item analysis printout for the next examination series revision. All four responses of the item will be set apart by parentheses.

Note: This "dirty run" analysis is not to be used for exam revision. A new run will be provided before a new series revision.

Student Profile Form

To provide the candidate with SWE results and the points used to compute the final multiple, PSC (adv) mails a student a profile form and publishes it online in Direct Access. The candidate profile form includes:

- List of examination section titles.
 - Percent of correct answers per section.
 - Candidate's ranking on exam compared to others in same rating
 - SWE Standard Score; Performance Score; TIS Points; TIR Points; Awards Points; Sea Points; Surf Points
 - Candidate's final multiple used to determine placement on the eligibility list.
-

Servicewide Examination

Sample Credits/or Score Key Changes Form

U.S. Department of
Homeland Security

United States
Coast Guard



Commanding Officer
U.S. Coast Guard
Training Center Yorktown

Yorktown, VA 23690-5000
Staff Symbol: t-bfc
Phone: (757) 555-2593

5600
28 Aug 2002

MEMORANDUM

From: BMCM I. M. Sailor
CG TRACEN Yorktown

Reply to t-bfc
Attn of: (757) 555-2593

To: Commanding Officer, Coast Guard Personnel Service Center (adv)

Subj: CREDIT/OR SCORE KEY CHANGES

1. Change score key for the May 2004 **BM1** servicewide examination series 29.

CHANGE SCORE KEY

ITEM #	CREDIT/CHANGE	FROM	TO
23	CREDIT		

I. M. SAILOR, BMCM
By direction

#

Servicewide Examination

Sample No Credit/Score Key Change Form

U.S. Department of
Homeland Security

United States
Coast Guard



Commanding Officer
U.S. Coast Guard
Training Center Yorktown

Yorktown, VA 23690-5000
Staff Symbol: t-bfc
Phone: (757) 555-2593

5600
28 Aug 2002

MEMORANDUM

From: BMCM I. M. Sailor
CG TRACEN Yorktown

Reply to t-bfc
Attn of: (757) 555-2593

To: Commanding Officer, Coast Guard Personnel Service Center (adv)

Subj: CREDIT/OR SCORE KEY CHANGES

1. There will be NO CREDITS OR SCORE KEY CHANGES for the following rates
Regular/Reserve SWE series _____:

(NO.)

EXAMINATION RATES	
BMCM	
BMCS	
BMC	
BM1	
BM2	

I. M. SAILOR, BMCM
By direction

#

Section 11

TEST STRATEGY AND STATISTICS

Overview

Introduction

The servicewide examination (SWE) is what is known as a "norm-referenced test," as opposed to the end-of-course test (EOCT), which is a "criterion referenced test." A norm-referenced test determines a member's placement on a normal distribution curve. Members compete against each other on this type of assessment. This is what is being referred to with the phrase, "grading on a curve." There is specific strategy to be used in the development of SWE based on the following conditions:

- Test items are updated to reflect current enlisted performance qualifications (EPQs), verified for content and currency, and revised as needed.
- Level of emphasis of rating qualifications has been determined by sections based on statistics produced by administration of the EOCT.
- Test items for qualifications are classified by weight levels for each paygrade.
- Statistics of previous examinations and individual test items are reviewed and analyzed.

Item Revision

The E-9/test writer must check each item in the test item database prior to developing the examination to determine whether to retain, revise, or reject a test item. A retained item must meet the following qualifications:

- Fall within the strategy for the examination.
- Be related to a qualification, have a valid reference, and have acceptable parameter values.
- Conform to item writing principles.

If an item does not meet these qualifications, it should be revised. If an item does not meet these qualifications, even after revision, it should be rejected.

Overview

Item Revision Plan

An item revision plan provides a record of revision/deletion actions to be taken. The purpose of the plan is to:

- Identify items that need to be revised or deleted.
 - Determine appropriate action to be taken.
 - Provide specific reason or justification for item revision or deletion.
-

Level of Emphasis

The level of emphasis is a design tool to assist the E-9/test writer in developing an examination. This procedure assists in determining the most important qualifications for each paygrade. The responsibility of determining the level of emphasis belongs to the subject matter experts who review and revise the qualifications (at a rating qualification review). The specific rating senior person should be a member of the review panel.

When determining the level of emphasis, divide the specific rating qualifications into sections (e.g., Imagery, Public Affairs, Edit and Layout, Writing, etc.) and paygrade. Use common sections for all paygrades E-4 through E-9. This ensures consistency in the format of examinations between each paygrade.

Example: An E-7 will need more emphasis placed on imagery and writing rather than on public affairs, edit and layout, web-based skills, or administrative. The breakdown by section is shown below, the below example is from the Gemini test item database for the "PA" rating.

For each pay grade, enter the percentage of questions you want to be selected from each subject. Totals for each pay grade must equal either 0 or 100%.

Subject	E4	E5	E6	E7	E8	E9
IMAGERY				29		
PUBLIC AFFAIRS						
EDIT AND LAYOUT						
WRITING						
WEB-BASED SKILL						
ADMINISTRATIVE						
TOTAL	0	0	0	29	0	0

OK Cancel

Test Strategy and Statistics

Weight Level

A weight level is assigned to each test item based on the description and decisions outlined in the following table.

Weight Level	Description	Decisions
A	Must know to perform.	<ul style="list-style-type: none">• Minimum of one question per qualification.• How many more questions depends on level of emphasis.
B	Good to know but not required to be able to perform.	<ul style="list-style-type: none">• Depends on level of emphasis whether these questions are needed to reinforce knowledge of A-level questions.
C (Lower Paygrade)	Nice to know but covered at lower paygrade.	<ul style="list-style-type: none">• Used at a higher paygrades as a discriminator to identify who knows most about the rating, not the paygrade.

The same test item may also be used at different paygrades; however, the weight level assigned to the test item will change. The test should have different degrees of difficulty with some difficult questions and some easy questions.

Example #1:

At the E-4 paygrade, you may have a test item for "perform CPR" which is assigned a weight level of A. At the E-5 paygrade, an individual may be a trainer or supervisor. That E-4 test item then becomes supporting knowledge for "describe CPR," which is assigned a weight level of B at the E-5 paygrade.

Example #2:

At the E-6 paygrade, you may have a test item for "analyze o-scope traces" which is assigned a weight level of A. At the E-5 paygrade, that same test item is assigned a weight level of B for "read o-scope traces."

Test Strategy and Statistics

Test Strategy

The E-9/test writer uses the level of emphasis and the weight levels of test items to plan the test strategy. In the example illustrating the level of emphasis breakdown, the level of emphasis for the imagery section is 29 percent (or 36 questions) for the E-7 examination. If the specific rating has 14 qualifications in the imagery section, the E-9/test writer must write at least one question per qualification with a weight level of A. To determine what test items to use for the remaining 22 test items, the E-9/test writer should use historical trends, knowledge of the rating, and professional judgment as guides in answering the following questions:

- How many additional questions should be used at the A-level?
- Should B-level test items be used? If so, how many?
- Should C-level test items (those tested at lower grades) be used as discriminators? If so, how many?

In addition, the E-9/test writer uses test and test item analysis statistics to plan the strategy for developing both SWEs and EOCTs.

Test and Item Statistics

Detailed statistical analysis of the SWE is provided by PSC (adv). Statistics are tools that help to ensure a quality examination. They provide very important feedback to persons in the examination development process. Statistics can be used to answer the following questions:

- Is the test both reliable and valid?
 - Is the test item as difficult or easy as desired?
 - Do the items portray an accurate measure of an individual's knowledge and ability to perform a qualification?
 - Are there mistakes in the answer keys or in the items themselves?
-

Test Strategy and Statistics

Statistical Terms

Before using statistical reports to develop an examination, review the following terms. (See sample item analysis printout (fig. 11-1) and section analysis (fig. 11-2) report for examples.)

Reliability - A perfectly reliable test will produce exactly the same results (test score) if administered to the same candidates again and again. True reliability can be statistically estimated by a number ranging from .000 to +1.000. Reliability estimates close to .000 are bad; those close to +1.000 are good. The minimum acceptable reliability estimate for populations of 20 or more is .80. Replacing items that all or almost all candidates answer correctly and items that all or almost all candidates answer incorrectly can raise low reliability estimates.

Example of a good reliability estimate: **REL .830**

The problem here may be that the test question is reliable, in that it is consistently answered the same way but it may not be valid. An example would be having a list of all wrong responses but one of them is close so it is almost always answered that way, making it statistically "reliable":

1. What is the sum of 20 + 18?
A. 39 B. 28 C. 52 D. 46

The response consistently selected is "A" because it is the closest to being correct. That makes the question reliable but not valid.

Validity - The ability of the test to accurately identify the knowledge possessed by the candidates. Validity draws an inference from test scores to a large domain of items similar to those on the test. Content validity is concerned with sample-population representativeness (i.e., the knowledge and skills covered by the test items should be representative to the larger domain of knowledge and skills). Content validity is usually established by content experts. It is extremely important that the E-9/test writer check each question for validity otherwise, absent of any challenges, a "bad" question could be repeated over and over because it is statistically "reliable".

Variability - The ability of the test to spread candidates along the raw score range of the test (0-150 for the SWE). Low or no variability indicates that a test is incapable of distinguishing those candidates with the most knowledge from those with the least.

Test Strategy and Statistics

Statistical Terms (Continued)

The variability of a test is estimated by the standard deviation (STD DEV). The ideal standard deviation is 15.00. The acceptable range of the standard deviation is 12.00 - 18.00. If the standard deviation is too low, too many candidates are getting scores too close to each other. To increase the standard deviation, revise or replace items to:

- Increase the range of item difficulty on the test.
- Spread the item difficulties (p-values) more evenly throughout the range.

Example of an acceptable standard deviation: **STD DEV 12.64**

Difficulty - The difficulty of a test is indicated by the following two statistics:

- Average score (mean).
- Average p-value (average item difficulty).

The mean and the average p-value are mathematically identical, but expressed in different scales. The average p-value is the mean expressed as a proportion of the total number of items. Examples are located on the Section Analysis Report (fig.11-2).

Mean. The mean is a measure of central tendency sometimes referred to as the "arithmetic average." It is found by summing all of the values and dividing by the number of cases. The larger the sample size, the more reliable its mean. The larger the variation of data values, the less reliable the mean. The larger the sample size, the more reliable its mean. The larger the variation of data values, the less reliable the mean.

Statistical Significance (p-value). The statistical significance of a result is an estimated measure of the degree to which it is "true" (in the sense of "representative of the population"). Simply put - The proportion of individuals responding correctly on an item; a measure of item difficulty.

Test Strategy and Statistics

Statistical Terms (Continued)

More technically, the value of the *p-value* represents a decreasing index of the reliability of a result. The higher the *p-value*, the less we can believe that the observed relation between variables in the sample is a reliable indicator of the relation between the respective variables in the population. Specifically, the p-level represents the probability of error that is involved in accepting our observed result as valid, that is, as "representative of the population." For example, the *p-value* of .05 (i.e., 1/20) indicates that there is a 5 percent probability that the relation between the variables found in our sample is a "fluke." In other words, assuming that in the population there was no relation between those variables whatsoever, and we were repeating experiments like ours one after another, we could expect that approximately in every 20 replications of the experiment, there would be one in which the relation between the variables in question would be equal or stronger than in ours. In many areas of research, the *p-level* of .05 is customarily treated as a "border-line acceptable" error level.

Example of an average score: MEAN 90.64

Example of an average p-value: AVG P .605

Statistical Revision Guidelines

The guidelines for revising or replacing items on an examination are discussed below.

Population 20 and Greater. Review, revise, or replace the following items:

- Those that have a Percent Selected (PSel) value that is higher for an incorrect response than for the correct response on the Item Analysis Printout.
- Those outside the desired examination average Discrim (d-value) range. These replaced items may be used later in another examination when a different average p-value range is desired.
- Credited items.

Population Less Than 20. Revise or replace items that have been CREDITED.

Note: Subject matter specialists should use historical trends, knowledge of the rating, and professional judgment as guides to determine if any other items should be revised or replaced.

Test Strategy and Statistics

Item Analysis Report

The Item Analysis Report shows how every item on a particular examination performed statistically. The statistics on each test item are used to determine whether a particular test item should be retained, revised, or rejected. PSEL and Discrim (d-values) are listed for every item. These item statistics are discussed later in this section. The correct response for an item is indicated by an underline. The PSEL value shows the percentage of test takers that responded to a particular distracter. The PSEL value should normally be highest for the correct response. If it is highest for an incorrect distracter, the question and distracters should be evaluated. Parentheses around all responses for an item indicate that the item has been credited.

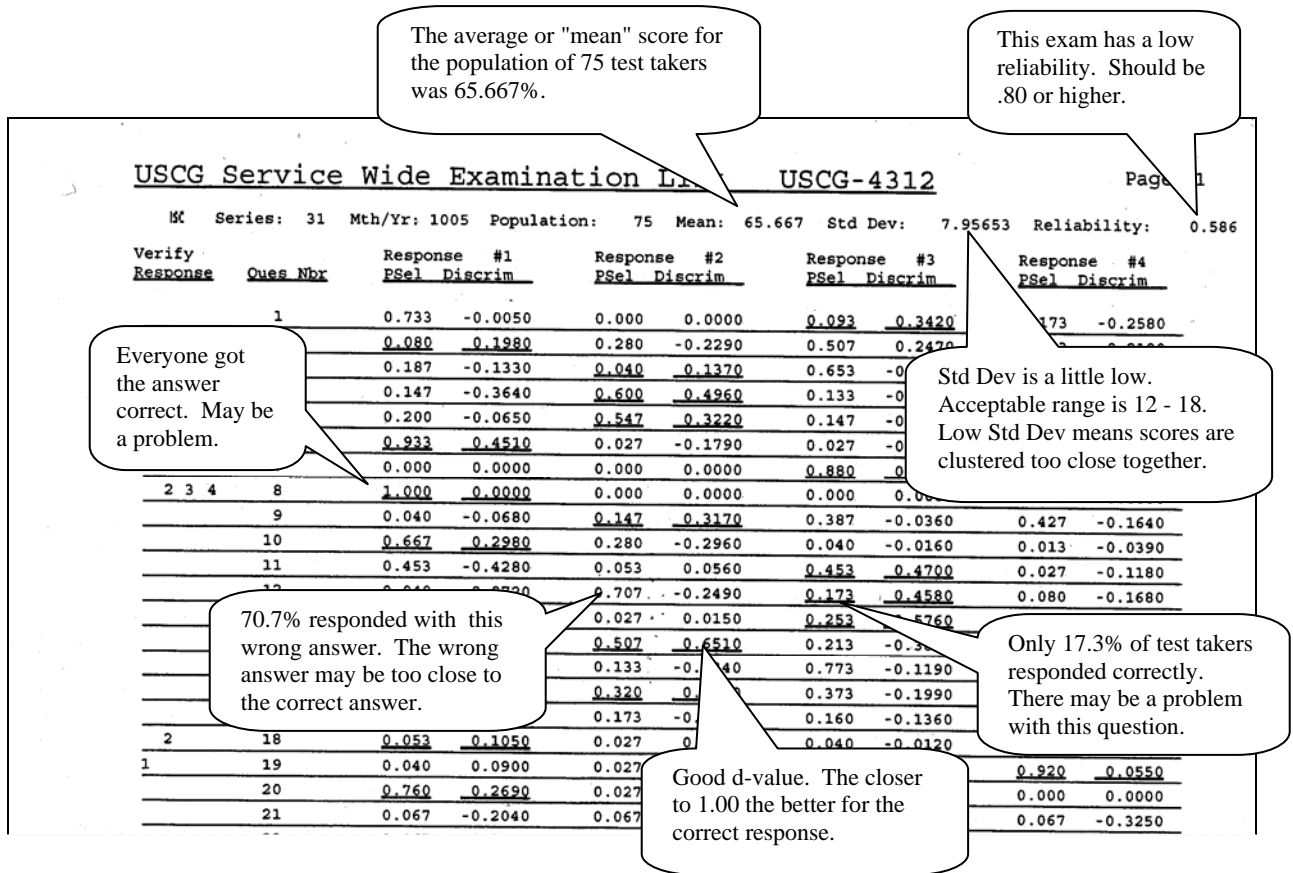

Item Analysis Report

Figure 11-1

Test Strategy and Statistics

Section Analysis Report

The Section Analysis Report provides test analysis statistics to determine the difficulty of an examination. This report is beneficial when the SMS is revising an EOCT because it shows the trend analysis over time rather than just a "snapshot" for the SWE. A new SWE is used every exam cycle, whereas an EOCT is valid for a longer period of time. The example below is for a SWE and is used for illustration.

Coast Guard Service-Wide Examination Section Analysis Report Us 4372 11/30/2005 Page

E Rate	Series	Month	Population	Skewness	Kurtosis	Mean	Std Dev	Reliability	Avg P
ISC	31	1005	75	0.446	3.432	65.667	7.95653	0.586	0.438

A negative number generally indicates the exam was easy whereas a positive number indicates a harder exam. This has more significance on an EOCT than on a SWE.

The average score for this test was 65.667%. For a SWE, this is not a true measure of knowledge retained because it is a norm-referenced test.

The Avg. P should be between .75 and .85 - This exam is statistically "too hard" and should be scrutinized.

P - Value Distribution						Section Analysis							
Sec	.00-.19	.20-.42	.43-.51	.52-.61	.62-.70	.71-.85	.86-1.00	Sec	Items	Mean	Std Dev	Adj Rel	Relia
1	4					3		1	11	5.440	1.328	0.770	0
2	1	1						2	3	0.933	0.759	-2.940	-0
3	2	3				3	1	3	11	5.413	1.326	-2.292	-0
4	8	14				1	2	42	17.467	3.746	0.711	0.4	
5	1	8				1	2	5			0.850	0.405	0.513
6	1	4	1	1				6			0.548	0.054	0.335
7	8	13	3	2		1	6	7	3		0.783	0.443	0.411
8	5	9	2	3	2	1	3	8	2		0.706	0.285	0.451
Total	30	52	15	21	8	7	17	Total	150			1.723	3.423
Normal	0	10	35	60	35	10	0						

A low value for a SWE is OK. The value should be high for an EOCT.

Only these questions had an "acceptable" p-value.

A perfectly reliable test would have a value of 1.000.

Intercorrelation Matrix								
Section	1	2	3	4	5	6	7	8
1	1.000	-0.024	0.126	0.162	0.054	0.122	0.331	0.123
2		1.000	-0.053	0.106	0.107	0.113	0.244	-0.101
3			1.000	-0.077	-0.052	-0.090	0.134	0.049
4				1.000	0.329	-0.003	0.278	-0.003
5					1.000	-0.028	0.036	0.077
6						1.000	0.033	-0.004
7							1.000	0.100
8								1.000

The numbers show that the test sections do not relate to each other

Adjusted Reliability is calculated by using a certain value for the competency level of the data and applying it to the calculated reliability. In small datasets, the reliability is an insignificant measure for the most part.

Section Analysis Report
Figure 11-2

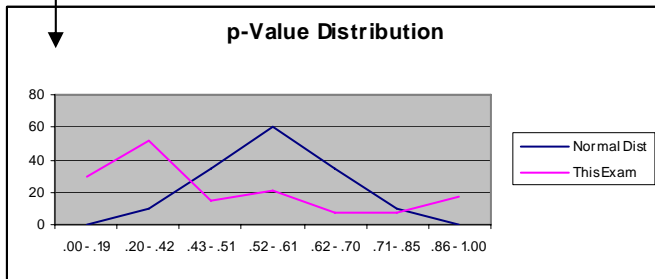

This is a graphical representation of the p-value distribution of this exam compared to a "normal" bell curve distribution.

Test Strategy and Statistics

Terminology	The following is a list of terms found on the Section Analysis Report (fig. 11-2). Please refer to the illustration for comparison and examples.
E-Rate	E-Rate indicates the enlisted rating and paygrade for the exam given.
Series	Series indicates the SWE or EOCT examination series number.
Month	Month indicates the month and year of the examination.
Population	Population indicates the number of people who participated in the examination.
Skewness	The skewness for a normal distribution is 0, and any symmetric data should have a skewness near 0. Negative values for the skewness indicate data that are skewed left and positive values for the skewness indicate data that are skewed right. By skewed left, we mean that the left tail is heavier than the right tail. Similarly, skewed right means that the right tail is heavier than the left tail. Some measurements have a lower bound and are skewed right. To put it simply, easy examinations usually yield negatively-skewed distributions and difficult examinations are positively skewed.
Kurtosis	Kurtosis measures the "peakedness" of a distribution. If the kurtosis is clearly different than 0, then the distribution is either flatter or more peaked than normal; the kurtosis of the normal distribution is 0. Kurtosis is a measure of whether the data are peaked or flat relative to a normal distribution. That is, data sets with high kurtosis tend to have a distinct peak near the mean, decline rather rapidly, and have heavy tails. Data sets with low kurtosis tend to have a flat top near the mean rather than a sharp peak. A uniform distribution would be the extreme case.
Mean	The mean is a measure of central tendency sometimes referred to as the "arithmetic average." It is found by summing all of the values and dividing by the number of cases. The larger the sample size, the more reliable its mean. The larger the variation of data values, the less reliable the mean.

Test Strategy and Statistics

Standard Deviation (Std. Dev.)

The standard deviation is a commonly-used measure of variation or dispersion of scores around the mean. The standard deviation is kind of the "mean of the mean," and often can help you find the story behind the data. The standard deviation is a statistic that tells you how tightly all the various examples are clustered around the mean in a set of data. When the examples are pretty tightly bunched together and the bell-shaped curve is steep, the standard deviation is small. When the examples are spread apart and the bell curve is relatively flat, that tells you that you have a relatively large standard deviation. The standard deviation can also help you evaluate the worth of all those so-called "studies" that seem to be released to the press every day. A large standard deviation in a study that claims to show a relationship between eating Twinkies and killing politicians, for example, might tip you off that the study's claims aren't all that trustworthy.

Reliability

Reliability is the ratio of true variance divided by obtained variance. When the ratio is 1.0, there is no error variance, and the reliability is perfect.

Number of items and reliability. This conclusion describes a basic principle of test design. Namely, the more items there are in a scale designed to measure a particular concept, the more reliable will the measurement (sum scale) be. Perhaps a somewhat more practical example will further clarify this point. Suppose you want to measure the height of 10 persons, using only a crude stick as the measurement device. Note that we are not interested in this example in the absolute correctness of measurement (i.e., in inches or centimeters), but rather in the ability to distinguish reliably between the 10 individuals in terms of their height. If you measure each person only once in terms of multiples of lengths of your crude measurement stick, the resultant measurement may not be very reliable. However, if you measure each person 100 times, and then take the average of those 100 measurements as the summary of the respective person's height, then you will be able to make very precise and reliable distinctions between people (based solely on the crude measurement stick).

Intercorrelation Matrix

A basic assumption of an intercorrelation matrix is that variables that significantly correlate with each other do so because they are measuring the same "thing." The problem arises in defining what is the "thing" that the correlated variables are measuring in common?

Test Strategy and Statistics

Avg P

Statistical Significance (p-level). The probability of making an error is often called the "p-value" in research reports. The statistical significance of a result is an estimated measure of the degree to which it is "true" (in the sense of "representative of the population"). Simply put, the proportion of individuals responding correctly on an item is a measure of item difficulty. More technically, the value of the *p-level* represents a decreasing index of the reliability of a result. The higher the *p-level*, the less we can believe that the observed relation between variables in the sample is a reliable indicator of the relation between the respective variables in the population. Specifically, the p-level represents the probability of error that is involved in accepting our observed result as valid, that is, as "representative of the population." For example, the *p-level* of .05 (i.e., 1/20) indicates that there is a 5% probability that the relation between the variables found in our sample is a "fluke." In other words, assuming that in the population there was no relation between those variables whatsoever, and we were repeating experiments like ours, one after another, we could expect that approximately in every 20 replications of the experiment there would be one in which the relation between the variables in question would be equal or stronger than in ours. In many areas of research, the *p-level* of .05 is customarily treated as a "borderline acceptable" error level.

In the case of the SWE, the population taking a particular exam is small, so the statistical significance of the p-value is minimal. The p-value which results from an EOCT given to many people over a longer period of time becomes more statistically significant.

Sec.

Sec. indicates which section of the examination the questions were in. Example: Section 1 of the Exam may have been "Administration" and contained 17 questions as indicated by the *Total* row.

Verify Response

"Verify Response" indicates that statistically, there may or may not be a problem with the question and answers provided. The question and all responses should be reviewed to determine whether they are valid. This includes checking to see whether the question is a "gimmie"-type question that is either so easy that most everyone answers it correctly 100% of the time, or so confusing that it can be interpreted several different ways. When verify response is indicated it does not necessarily indicate there is something wrong with the question; just take a look at it and verify its design.

Test Strategy and Statistics

PSel

Percent Selected (PSel) indicates the percentage of exam takers that selected a particular response. Example: a PSel value of 0.576 indicates that 57.6% of the exam takers selected that response. Normally, the PSel value should be highest for the correct response. If the PSel value for a distracter is higher than for the correct response, there may be a problem with the distracter, in that it is too close to the correct answer for the test taker to make a correct discrimination. If the PSel value for the correct answer is 1.000, that means everyone responded to the question correctly, which may mean the question is too easy.

Discrim

Discrimination index is a measure of the extent to which an item is capable of separating the most from the least knowledgeable students using either external or internal criteria. The discrimination index, D , is obtained by subtracting the proportion of students responding correctly on an item in upper and lower criterion groups. The maximum positive value of D is 1.0, and the minimum, 0. Negative discrimination indices usually suggest some deficiency of an item.

Interpreting Item Data and Parameters

The three critical measurements for interpreting item data and parameters are addressed below.

- P-value. P-value is the percentage of examinees who chose a particular response. The p-value of each distracter is calculated by dividing the number of examinees choosing that answer by the total number of examinees. The p-value of the correct answer is the item's p-value, or difficulty.

A good item will have a correct answer p-value between .25 and .90. Items with p-values very close to either 0.000 or 1.000 are poor items because:

- Low p-value means the item is too difficult; few examinees chose the correct response.
- High p-value means the item is too easy; many examinees chose the correct response.

Incorrect answer p-values that are 0.000 or very close to it indicate poor distractors that need revision or replacement.

Test Strategy and Statistics

Interpreting Item Data and Parameters (continued)

- Discrim (d-value) is the discrimination index. The d-value measures the item's ability to identify those examinees with the most knowledge of the subject. It is a comparison of an item in relation to other items in the SAME section. The d-value for each response results from comparing the section average score for those examinees who chose each response against the average score of the section of all examinees.

The d-value range is from -1.000 to +1.000.

- A good item will have a correct answer d-value between +.250 and +.750. The closer the correct answer d-value is to +1.000, the better the item is at identifying those examinees with more knowledge. The closer the correct answer d-value is to 0.000, the less power the item has to discriminate.
 - A good item will have an incorrect answer d-value between -.250 through -.750. An incorrect answer d-value that is positive indicates that those examinees with the most knowledge are choosing the incorrect answer to that item.
-

Test Strategy and Statistics

Desired Average P-Value Range

The following procedure and example are provided to assist the SMS in determining the desired average p-value range. Accuracy is best with populations of 20 or greater.

Step	Action						
1	Estimate the percent of candidates who, in your professional judgment, are at least minimally competent. Consult with program force and training managers to make an informed decision. Note: That percentage of candidates should score 70 percent correct or above on the examination.						
2	Find the average p-value range for the percent that you judge to be at least minimally competent using the chart on the following page.						
3	Find the average p-value of the previous examination, either: <ul style="list-style-type: none"> • From the Section Analysis Report. • By dividing the mean on the item analysis by the number of questions on the test. 						
4	Adjust the difficulty of the test so that the percent of minimally competent will score 70 percent correct or above.						
5	Revise items if the average p-value is outside the p-value range so that the average p-value of the test will be within the desired range. <table border="1" data-bbox="704 1413 1336 1661" style="margin-left: auto; margin-right: auto;"> <thead> <tr> <th data-bbox="704 1413 1049 1545">IF the average p-value of the previous exam is . . .</th> <th data-bbox="1049 1413 1336 1545">THEN the exam items are . . .</th> </tr> </thead> <tbody> <tr> <td data-bbox="704 1545 1049 1602">below range</td> <td data-bbox="1049 1545 1336 1602">too difficult.</td> </tr> <tr> <td data-bbox="704 1602 1049 1661">above the range</td> <td data-bbox="1049 1602 1336 1661">too easy.</td> </tr> </tbody> </table>	IF the average p-value of the previous exam is . . .	THEN the exam items are . . .	below range	too difficult.	above the range	too easy.
IF the average p-value of the previous exam is . . .	THEN the exam items are . . .						
below range	too difficult.						
above the range	too easy.						

Test Strategy and Statistics

Desired Average P-Value Range (Continued)

Example

1. In rating (X), the SMS, after consulting with program, force, and training managers, judges that 85 percent of the candidates are at least minimally competent and that 15 percent are incompetent.
2. From the chart below, the average p-value range for 85 percent is .75-.80.
3. The average p-value on the source exam was .71, which is below the desired range, and means that the previous exam (without revision) would be too hard for 85 percent of the candidates to score 70 percent correct or above.
4. In this example, adjust the difficulty of the test by revising items with p-values less than .75 so that the average p-value of the new exam falls within the range (i.e., .75 to .80).

DESIRED AVERAGE P-VALUE RANGES

Percent of Candidates Who Are At Least Minimally Competent	Desired Examination Average P-value Range*
0	.45-.59
5	.51-.60
10	.54-.62
15	.57-.63
20	.57-.65
25	.61-.66
30	.62-.67
35	.63-.67
40	.64-.69
45	.65-.70
50	.66-.71
55	.67-.72
60	.68-.73
65	.69-.74
70	.70-.75
75	.71-.77
80	.73-.78
85	.75-.80
90	.76-.83
95	.79-.87
100	.84-1.00

* The term "average p-value range" refers to the overall examination, not individual item p-values.

Test Strategy and Statistics

Examination Strategy Worksheet

The Examination Strategy Worksheet, used primarily with SWEs, describes this basic plan, outlines section size and content guidelines, and records necessary changes to the examination. You may modify the basic format to meet your needs. Prepare a worksheet for each examination to develop the examination strategy as outlined below:

- Introduction. Enter the following statistical data in this section:
 - Percent judged to be at least minimally competent.
 - Average p-value range.
 - Average p-value for previous examination.
- Inputs to Revision. This section gives a general description of the examination revision planned by the SMS for this cycle. You should note important qualifications, references, job emphasis, and statistical changes used as a basis for revision.
- Examination Section Outline. Design this outline so the examination will sample those performance-based qualification areas you determine necessary for this cycle.
 - Generally, obtain the section titles and number of items per section by modifying or duplicating the previous examination. However, major changes in the "qualifications" or the "job" could create the need for a major change in the examination section outline.
 - In this outline, the E-9/test writer determines the number of items in each section that can be retained from the previous examination. Comparison of this information with the total number of items needed for each section gives a good forecast of how many items need to be added, deleted, or revised.

After completion of the examination development process, the Examination Strategy Worksheet becomes the historical record of actions taken on the examination.

Test Strategy and Statistics

Sample Examination Strategy Worksheet

EXAMINATION STRATEGY WORKSHEET

SERIES 5

SMS _____

RATE BM

REVIEWER _____

Percent judged to be at least minimally competent: 85%

Average p-value range: .75-.80

Average p-value for previous exam: .71

INPUT TO REVISION:

- A. QUAL (TPOs):** Maintenance qualifications lowered in pay grade.
- B. REFERENCES:** Check revision of the Coast Guard Safety and Occupational Health Manual (COMDTINST M5100.29).
- C. STATISTICS:** Six items need to be revised. Five items have p-values below desired average p-value range. One item was coded with a double asterisk on the item analysis printout.
- D. OTHER:** More emphasis needed on administration and less on maintenance due to lowering of maintenance performance qualifications.

EXAM SECTION OUTLINE:

Section	Title	Level of Emphasis	# of Items
1	Administration	30%	36
2	Publications	10%	12
3	Security	10%	12
4	Safety	15%	18
5	Maintenance	15%	18
6	Operations	20%	24
Totals		100%	120

Test Strategy and Statistics

Summary of Examination Revision

When the Examination Strategy Worksheet has been completed, the E-9/test writer begins the actual development of the examination by revising or replacing items identified as faulty for either statistical or content reasons and by writing new items as required to fill out the Examination Section Outline.

When you have identified, prepared, and approved all retained, revised, and new items, you may prepare the new exam in double-column format. The writer/editor (W/E) then proofreads the exam for grammatical accuracy, cueing, question sequencing, item repetition or similarity, and appropriateness to sections. Finally, the E-9/test writer corrects the edited copy and reprints the camera-ready copy, answer key, and review copy.

When you have prepared the camera-ready copy, the ISS conducts the final review. The E-9/test writer completes the Section Title Sheet (PPC-2836) and prepares the answer key.

The camera-ready copy of the examination, the Section Title Sheet, and the HRSIC 4801 answer key are then sent via registered mail/commercial express mail carrier to PSC (adv). (Also include one cover transmittal memorandum with SWEs.) Retain the Examination Strategy Worksheet at the training source.

Note: Depending on the training source and staffing billets, the responsibilities of the ISS and/or W/E could be performed by other staffmembers.

This page intentionally left blank.

Section 12

COURSE EVALUATION AND REVISION

Course Revisions

Course Documentation File

The subject matter specialists (SMSs) maintain master copies (instructor's copy) of their courses and end-of-course tests (EOCTs). Errors in pamphlets and tests can be changed in the master copies and the changed page numbers posted on the cover. This amounts to a running revision "on file" for the reprinting of the pamphlet. The course documentation file contains inquiries, comments, criticisms, challenges, and other source material (or appropriate references to such material) relating to pamphlet/test content. The file can be a valuable tool in reviewing and revising pamphlet and test materials, but only if properly maintained and if action is taken on its content. The course documentation file can also be used as a tool to identify training system weaknesses (low p-values) that can justify changes in both resident and nonresident course emphases.

Procedure

The table below summarizes the procedures to follow for maintaining a course documentation file.

IF you are . . .	THEN . . .	AND . . .
reviewing a pamphlet	establish files when pamphlet is first issued	point out errors in composition, presentation, and logic that have gone undetected in the review process.
evaluating a course/examination	as a minimum, keep information on which you test, and on critical points to the operation taught (e.g., safety items and protection of equipment) whether covered by test or not	provide criticism for use in revising pamphlets.

Course Revisions

Procedure (Continued)

IF you are. . .	THEN. . .	AND. . .
handling inquiries from the field	review and update information as often as necessary to ensure file remains current and useful	keep track of official changes in equipment and procedures covered by the pamphlet.
crediting EOCT items (pending revision of items)	keep a copy (or draft) of pamphlet and applicable test items in the file for annotation of content to be reviewed (rough notes may be discarded if not needed for record)	keep new information in a handy reference place and also in the file.
preparing notices to the field and/or errata material	following pamphlet revision, decide whether you need to establish a file or keep the old, updated file	document significant conversations and ideas that may otherwise be forgotten.

Document Security

To prevent a possible compromise, maintain the course documentation file that contains test materials or classified information in a safe in accordance with the Physical Security and Force Protection Program Manual, COMDTINST M5530.1 (series).

Course Revision

The useful life of a course depends on many variables. Some courses become obsolete almost as soon as they are issued; others stay current for many years. Who determines when a course is obsolete and needs revision? The responsibility for maintaining a course, in consultation with the program and training managers, basically rests on the subject matter specialist.

Course Revisions

Course Revision (Continued)

After conducting a thorough evaluation of the course and checking the documentation file, the subject matter specialist may recommend either a “major” or “minor” revision of the course.

- Major Revision. A course revision is usually termed “major” if the revision requires a new course edition. The most common reasons for issuing a new course edition are:
 - An existing course will not meet requirements due to changes in quals or new or obsolete equipment/procedures.
 - Enough course matter must be revised to require a new or revised EOCT. (More than 10% of the EOCT must be credited.)
 - Revisions affect the mission, scope, or terminal performance objectives of the curriculum outline.
 - One or more pamphlets must be added, removed, or replaced.
 - A new curriculum outline is required.
- Minor Revision. Some text presentation will always need revision. A “minor” revision can include changes in the wording of objectives, corrections to ambiguous phrases or paragraphs, or corrections for typographical errors. A minor revision does not usually affect the EOCT.
 - A minor revision can be sent out to the Coast Guard Institute by using an errata sheet or an individual change sheet.

Record of Changes for Course Material

To allow the students to track changes to their course material after receipt of a course, a record of changes to course material will be published on the Coast Guard Institute website.

Course Revisions

Resources

To determine the need for revising a course, review the following resources:

- Enlisted Performance Qualifications Manual
 - Job requirements
 - Technical publications
 - Course curriculum outline and pamphlets
 - EOCT analysis
 - Student questionnaires
 - EOCT challenges
 - Course documentation file
 - Commandant message files
-

Section 13

SECURITY AND COMPROMISE

Security and Compromise

Introduction Everyone involved in the development of end-of-course tests (EOCTs) and servicewide exams (SWEs) has the responsibility to safeguard material in order to prevent compromise. Revision of a compromised test is expensive and time-consuming. A compromise could delay promotions, creating a great impact on the enlisted personnel of the Coast Guard. Therefore, general guidelines have been included here to prevent compromise. Detailed instructions can be found in Physical Security and Force Protection Program, COMDTINST M5530.1 (series); Classified Information Management Program Manual, COMDTINST M5510.23 (series); Coast Guard Freedom of Information and Privacy Acts Manual, COMDTINST M5260.3 (series); and Information Assurance Manual, COMDTINST M5500.13 (series).

Testing Material All unclassified testing material is considered sensitive and afforded protection as such. All classified material will be afforded the protections of its classification. Testing material includes camera-ready copies, work sheets and notes, statistical data, and any hard copies of test questions. All elements of computer technology that contain the above listed sensitive material must also be safeguarded.

Definitions The terms dealing with security and compromise of sensitive or classified information are listed in the table below:

Term	Definition
Access	The ability and opportunity to obtain knowledge or possession of classified information. An individual does not have access to classified information merely by being in a place where such information is kept, provided the security measures which are in effect prevent the individual from gaining knowledge or possession of such classified information.
Classified material	Any matter, document, product, or substance on or in which classified information is recorded.
Compromise	The disclosure of sensitive or classified information to persons not authorized access.

Security and Compromise

Definitions (Continued)

Term	Definition
Confidential	The designation which shall be applied to information or material the unauthorized disclosure of which could reasonably be expected to cause damage to the national security.
Controlled area	The least secure type of restricted area. It contains a security interest which if lost, stolen, compromised, or sabotaged would cause identifiable damage to the unit mission or national security. It may also serve as a buffer zone for exclusion and limited areas, thus providing administrative control, safety, and protection against sabotage, disruption, or potentially threatening acts. Uncontrolled movement may or may not permit access to a security interest or asset.
Password	A protected word or string of characters that identifies or authenticates a user for access to a specific resource such as a data set (file) or record.
Physical security	Internal security concerned with the physical measures designed to prevent unauthorized access to equipment, facilities, material, and documents and to safeguard them against espionage, sabotage, damage, theft, or other acts which would in some degree lessen the ability of the command to perform its mission or would affect overall national security interests.
Restricted area	Any area to which access is subject to special restrictions or controls for reasons of security or safeguarding of property or material. This term is a legal designation. Specific administrative terms are used to designate various security areas/levels.
Sensitive material	Material which requires a high degree of protection and control due to regulatory requirements.

Security and Compromise

Personnel Designation

All personnel working with testing material or holding testing material shall be designated in writing by the unit's commanding officer.

Work Site Designation

In order to reduce the risk of compromise, each nonresident work site where testing material and classified course material are produced shall be designated a Restricted Area, in writing, in accordance with Physical Security and Force Protection Manual, COMDTINST M5530.1 (series).

Key and Lock Control System

A key and lock control system shall be established for all restricted areas. A key and lock control system supplements other security measures used to control access and is essential for the safeguarding of testing material.

All restricted areas shall be equipped with cipher locks. Under no circumstances shall a key to or the combination to any cipher lock be in possession of personnel who do not work in the specified area.

If entrance is required after normal working hours, a staff member must be recalled to open the space. The officer of the day (OOD) shall have letters designating staff for recall for entry in each restricted area.

Specific guidelines to establish the system are outlined in chapter 2 of the Physical Security and Force Protection Program, COMDTINST M5530.1 (series).

Visitor Control

Visitors to restricted areas should be kept to a minimum. If, at any time, personnel visit workspaces where testing material is being processed, the testing material should immediately be put out of sight and the visit terminated until a more opportune time. A Visitor Control Log should be maintained at all nonresident training restricted areas.

GSA Approved Container

Testing material must be kept in an authorized GSA-approved security container when the office is vacant or the materials are not being used. Safe combinations and Security Container Check Sheet (SF-702) shall be maintained in accordance with Classified Information Management Program, COMDTINST M5510.23 (series). Access to testing material must be limited to authorized persons (those with the proper clearance and with a need to know). This includes testing material for all ratings.

Security and Compromise

Combinations

Combinations to security containers used to store testing material shall only be changed by the custodian. Combinations shall be changed under any of the following circumstances:

- Upon receipt of the container.
- Whenever the custodian is transferred, discharged, or reassigned.
- When the combination or record of the combination has been compromised, or when the security container has been discovered unlocked and unattended.
- At least annually (this applies to classified material containers only).

Recording Combinations

A Security Container Information Form (SF-700) shall be maintained for each security container used for storing testing material. When selecting combination numbers, DO NOT use:

- Multiples of five or simple ascending or descending arithmetical series.
- Personal data such as birth date or SSN.

The combination shall be recorded on the SF-700. The SF-700 shall be entered into the Classified Material Control System and maintained by the Classified Material Control Officer or centralized control point designated by the command.

Note: Combinations will not be carried in wallets or otherwise on the person or hidden within an office.

Security and Compromise

Container Precautions

The following special precautions shall be followed to ensure that adequate security is being provided for testing material:

- Security containers shall be kept locked when not under the direct observation of the custodian or other authorized persons.
- Reversible "Closed/Open" signs shall be used as additional reminders on security containers.
- For safe containing classified material, a Security Container Check Sheet (SF-702) shall be affixed to each container for the purpose of checking each time the container is opened or closed.
- Only testing material shall be stored in the container. This includes paper and magnetic media copies.
- Testing material not being immediately processed shall be properly stored.

Note: Additional information can be found in chapter 12 of the Classified Information Management Program, COMDTINST M5510.23 (series).

Test Material at the Unit

When testing material is being moved within workspaces or around the unit, the material must be strictly controlled. Each individual must ensure that access is limited to authorized personnel only. The following steps must be taken to safeguard the material:

- A cover sheet must be used when handling testing material within workspaces. For SWEs and EOCTs, each training source may design its own. For classified material, the appropriate cover sheet or label shall be affixed to the inner folder. For movement of testing material outside a building, insert the testing material (along with the cover sheet/folder) into another container (a sealed envelope or a briefcase).
 - Turnover of testing material must be from hand to hand. At no time shall testing material be left in an office when persons authorized to receive it are not present.
 - Testing material shall not be viewed, studied, displayed, or worked on except in authorized spaces.
 - Each SME/SMS shall maintain a Testing Material Control Log for accountability. (See example at the end of this section.) A locally developed equivalent log may also be used.
-

Security and Compromise

Test Material When Traveling

Hand-carrying test material when you are in a travel status should be kept to an absolute minimum. However, if the situation arises where it cannot be avoided, the following safeguards must be in place:

- Testing material must be kept in the physical possession of the individual at all times unless proper storage at a U.S. Government activity is available.
- Testing material shall not be viewed, studied, displayed, or worked on while in public conveyances or places.
- Individuals responsible for hand-carrying classified testing material in a travel status must be authorized in writing by the commanding officer. A clearance verification letter or message may serve as written authorization. However, one-time authorization letters (courier letters) shall be used for individuals hand-carrying classified testing material in a travel status. These individuals must also be briefed on their duties and responsibilities in accordance with the Classified Information Management Program, COMDTINST M5510.23 (series).

Note: Additional requirements for a courier letter can be found in the Classified Information Management Program, COMDTINST M5510.23 (series).

Packaging

All testing material, whether sensitive or classified, shall be mailed/shipped double-wrapped with the inside envelope containing the following instructions on both sides in at least 1/4-inch letters:

**SENSITIVE MATERIALS TO BE OPENED BY A TESTING
MATERIAL OFFICER ONLY**

The office and person designated to receive testing material shall be identified on the inner envelope only.

Mailing Procedures

When sensitive testing material is mailed between the training source (TS) and CGI or PSC (adv), it must be accounted for by signature using registered mail or authorized overnight delivery service. Classified testing material **MUST** be mailed via registered mail. **DO NOT** use certified mail. A mail logbook shall be used to track testing material that is mailed.

Note: Encrypted transmission of sensitive testing material may soon be an alternative to registered mail or authorized overnight delivery service.

Security and Compromise

Receipt of Testing Material

The testing material officer shall be designated, in writing, by the training source (TS). This person must be a commissioned officer, master chief petty officer, or civilian who shall open all testing material packages received by the TS. CGI and PSC (adv) shall also designate a testing material officer who shall open and distribute registered mail and express delivery packages containing testing material from the TS. In cases of classified materials, the registered mail package MUST transit the Command Security Control Point (SCP) prior to being received for by the testing material officer.

Classified testing material shall be handled, mailed/shipped, and disposed of in accordance with the Classified Information Management Program, COMDTINST M5510.23 (series) and Physical Security and Force Protection Program, COMDTINST M5530.1 (series).

Telephone Security

The discussion of sensitive testing material over the telephone shall be avoided. The discussion of classified matters on the telephone is STRICTLY forbidden.

Disposal of Test Development Materials

All work materials, (i.e., notes, research papers, drafts, etc.,) used for development of test items (EOCTs and SWEs) must be disposed of by authorized individuals through shredding or burning in accordance with the Freedom of Information Privacy Acts Manual, COMDTINST M5260.3 (series) and the Classified Information Management Program, COMDTINST M5510.23 (series).

Note: From development to the time of destruction, EOCTs and SWEs must be maintained for a period of 3 years in accordance with the Information and Life Cycle Management Manual, COMDTINST M5212.12 (series).

Reproduction of Testing Material

Testing material shall not be reproduced unless approved by either the senior SME for the rating or higher authority. Once reproduced, the new copy shall be accounted for in the Test Material Control Log for the appropriate rating. Personnel reproducing test material shall exercise care to prevent the testing material from being compromised. They shall be aware of and alert to the specific security hazards listed in chapter 7 of Classified Information Management Program, COMDTINST M5510.23 (series).

Security and Compromise

Labeling of Removable Media

All removable media, (i.e., diskettes, Jazz/Zip disks, thumb drives, etc.) shall be labeled in accordance with the sensitivity or classification of the data stored on them. The following standard forms are to be used:

- Sensitive SF-710
- Confidential SF-708
- Secret SF-707

Note: Standard forms can be ordered through the Coast Guard acquisition system.

Maintaining SWE/EOCT Hard Copies and Removable Media Versions for Record Purposes

SWE/EOCT hard copies should be maintained at the unit for a minimum period of 3 years in accordance with the Information and Life Cycle Management Manual, COMDTINST M5212.12 (series). Upon this expiration, those hard copies should be properly disposed of in accordance with the above paragraph. In addition, the removable media version of the SWEs and EOCTs should be maintained for a minimum of 3 years. Upon expiration of the 3 years, the removable media versions can be deleted or archived.

Compromise or Suspected Compromise During Development

Required Actions for a Compromise or Suspected Compromise During the Development Stage. If there is reason to suspect that compromise of testing material has occurred during the development stage, the following actions apply:

1. Send a routine precedence message. A routine precedence message shall be sent as soon as possible after discovery to Commandant (CG-86), with the CGI as an info addressee for EOCT compromises and PSC as an info addressee for SWE compromises. Commandant (CG-132) shall be an info addressee for all suspected compromises of testing material. The message shall identify:
 - The exact testing instrument involved.
 - A brief summary of the circumstances known.
 - A preliminary evaluation as to the probability of compromise (Low, Medium, or High).
-

Security and Compromise

Compromise or Suspected Compromise During Development (Continued)

Note: This notification is necessary to allow sufficient time for planning test replacement strategy and assessing the impact on advancements. If an actual compromise is found to have occurred, the standard for replacement of an EOCT is 30 days from the notification of a confirmed compromise. Depending on the timing of a compromise of an SWE, the replacement time could be as little as 14 days.

2. Investigate the incident. The commanding officer of the unit discovering the compromise or suspected compromise shall investigate the incident. If deemed necessary, an informal board of investigation may be convened in accordance with the Military Justice Manual, COMDTINST M5810.1 (series).
 - Intentional compromise of testing instruments may be punishable under non-judicial punishment (NJP) under the Uniform Code of Military Justice (UCMJ) provisions as appropriate.
 - Unintentional compromise or procedures that contributed to compromise should be identified and corrective action recommended or taken.
3. Send a routine precedence message of compromise. After a determination has been made as to whether a confirmed compromise did occur, a routine precedence message must be sent to all concerned clearly identifying which testing instruments were actually compromised. Also include any recommendations which would prevent future compromises.

Note: SMSs should maintain file copies of messages and investigative reports together with the compromised tests.

Security and Compromise

Compromise or Suspected Compromise at a Unit Other than a TS

Required Actions for a Compromise or Suspected Compromise at a Unit Other than the TS. If there is probable cause to believe that an actual or suspected compromise of any testing instrument has occurred, the following actions apply:

1. Send a routine precedence message. A routine precedence message shall be sent as soon as possible after discovery to Commandant (CG-86), with the CGI as an info addressee to EOCT and PSC as an info addressee for SWE compromises. The TS responsible for development of the testing instrument in question shall also be an info addressee in all cases. Commandant (CG-132) shall be an info addressee for all suspected compromises of testing material. The message shall identify:
 - The exact testing instrument involved.
 - A brief summary of the circumstances known.
 - A preliminary evaluation as to the probability of compromise (Low, Medium, or High).

Note: This notification is necessary to allow sufficient time for planning test replacement strategy and assessing the impact on advancements. If an actual compromise is found to have occurred, the standard of replacement for an EOCT is 30 days from the notification of a confirmed compromise. Depending on the timing of a compromise of an SWE, the replacement time could be as little as 14 days.

2. Investigate the incident. The commanding officer of the unit discovering the compromise or suspected compromise shall investigate the incident. If deemed necessary, an informal board of investigation may be convened in accordance with the Military Justice Manual, COMDTINST M5810.1 (series).
 - Intentional compromise of testing instruments may be punishable under NJP/UCMJ provisions as appropriate.
 - Unintentional compromise or procedures that contributed to compromise should be identified and corrective action recommended or taken.
3. Send a routine precedence message of compromise. After a determination has been made as to whether a confirmed compromise did occur, a routine precedence message must be sent to all concerned clearly identifying which testing instruments were actually compromised. Also include any recommendations which would prevent future compromises.

Note: SMSs should maintain file copies of messages and investigative reports together with the compromised tests.

Security and Compromise

Compromises Involving Classified Material

Compromises involving classified material shall be handled in accordance with the Classified Information Management Program, COMDTINST M5510.23 (series).

Communicating with Field Personnel

When talking to field personnel via telephone, in person, e-mail, or letter, test writers must be constantly aware of what they are saying and what kind of information they are passing. The following shall NOT be discussed:

- Specific questions on EOCTs or SWEs.
 - Specific information on where to find the correct answer.
 - Areas/topics of concentration on SWEs.
 - Specific study areas. Instead, guide them to the performance qualifications and appropriate reference material.
 - Discussion of classified material is **STRICTLY FORBIDDEN**.
-

Inappropriate Activities

There are some activities that test writers cannot participate in, because in so doing it might cause a perception of favoritism, unfairness, or personal gain. These activities include:

- Organizing, holding, or participating in study sessions for SWEs.
 - Working for commercial sources that publish and sell study guides for Coast Guard personnel.
 - Participating in any activity which would give an individual or individuals an unfair or perceived unfair advantage in the participation of EOCTs or SWEs.
-

Upon Transfer

When transferred out of the job or to a new unit, test writers may NOT take any testing material with them and may not participate in any of the activities listed above for the first 2 years following transfer.

Computer Security

Introduction

Regardless of the physical security of workspaces, if computer security is lenient, a compromise of testing material can occur. Providing adequate and effective protection of all computer system resources, including computer equipment and peripherals, is the responsibility of each test writer and should be a constant concern when generating testing material.

Classification

Because testing material is to be handled as sensitive material, most computer systems used by test writers shall be designated as Level II, Standard Works Stations with the Microsoft operating system. Some rates include classified material and shall have computer systems designated as Level I, with MSNT-OS as a standalone or in offline mode. Level I (Classified) is classified information including Confidential, Secret, Top Secret, and higher. Accreditation is required for this level. Review the Information Assurance Manual, COMDTINST M5510.13 (series) for information on accreditation.

Computer Configuration

Computer systems used to generate testing material must meet the criteria of one of the following:

- Networked system capable of booting offline. Networked computers used to generate testing material must be capable of booting offline. The system must be configured so that the test writer has the capabilities of selecting ON-LINE or OFFLINE. **When offline, the computer shall NOT be capable of accessing any network function.** While working offline, save all information strictly to removable media. There must be a printer connected to the computer and a removable media system installed in the computer. An offline system shall consist only of a keyboard, display, CPU, output device (printer), hard drive, and a removable storage media system (Thumb Drive, CD-ROM, DVD, Floppy Drive).
- A stand-alone system shall consist only of a laptop or desktop computer, printer, and a removable storage media system.

Note: All computers used to generate testing material must be equipped with removable storage media (Thumb Drive, CD-ROM, DVD, Floppy Drive).

Computer Security

Security Requirements

Any computer used to generate testing material must be password-protected. While being used to work on testing material, the computer must not be connected to the unit network (offline or stand-alone). Printing must be done to a local printer that is not accessible to anyone other than test developers.

Note: Testing material that is not being immediately processed shall be stored on removable media (Thumb Drive, CD-ROM, DVD, Floppy Drive) and safeguarded in a security container.

Appendix A

SAMPLE PQG CERTIFICATION GUIDE PAMPHLET

This page intentionally left blank.

U.S. Department of
Homeland Security

United States
Coast Guard



INSERT TITLE (Short Title)
performance qualification GUIDE (PQG) CERTIFICATION Pamphlet

U.S. Coast Guard
Pamphlet No. Insert pamphlet number
(Insert month/year)



INSERT TITLE
PERFORMANCE QUALIFICATION CERTIFICATION GUIDE (PQG)

Creation Date: Insert month/year
Revision Date:

U.S. Coast Guard
Training Center (Insert branch code)
Yorktown, VA. 23690-5000
(757) 856-insert extension

QUESTIONS ABOUT THIS TEXT SHOULD BE
ADDRESSED TO THE SUBJECT MATTER SPECIALIST
FOR THE insert name of rating RATING.

January 2007
Version 2.0

This page intentionally left blank.

TABLE OF CONTENTS

TITLE	PAGE
Overview	1
Guidelines for PQG	3
Example of Nonresident Assignment Memorandum	6
Professional Development Supervisor (PDS) Instructions	7
Example of PDS Designation Memorandum	9
Performance Qualification Certification Sheets	10
Monthly Tracking Sheet	insert page #

This page intentionally left blank.

HOW TO USE THE PERFORMANCE QUALIFICATION CERTIFICATION GUIDE (PQG)

Overview

Introduction

The Performance Qualification Certification Guide (PQG) is a performance-based, systematic approach to completing the enlisted performance qualifications (EPQs) for advancement. This PQG is a new training aid that is included as part of your INSERT course title nonresident correspondence course. Under the direction of your assigned professional development supervisor (PDS), you will complete all tasks identified in this PQG.

PQG Job Aid

This job aid will guide you and your chain-of-command through the overall process leading up to your being able to compete in the INSERT rating and 3, 2, or 1 servicewide exam (SWE).

Step	Action	Responsibility
1	Order INSERT course title nonresident course. (The PQG will be a separate pamphlet enclosed with your course material.)	Member and ESO
2	Assign member (student) to nonresident program and assign a professional development supervisor (PDS) to coach/train student. (See examples of assignment memorandums on pages 6 and 9.)	CO and/or ESO
3	Review PQG and establish training timeline to complete all tasks.	Member and PDS
4	Prepare the PQG Monthly Tracking Sheet (MTS).	PDS
5	Read course material; complete all practical exercises, job aids, and quizzes; and demonstrate proficiency on all tasks, TPOs, and EPQs to PDS.	Member
6	Provide feedback to member on performance. Initial/sign off on successfully completed job aids, tasks, TPOs, and EPQs.	PDS
7	Track member's progress on MTS and ensure all actions have been initialed or signed off as completed.	Member and PDS
8	Submit MTS to department head for periodic review and approval.	Member, PDS
9	Sign MTS* to acknowledge member has successfully completed all requirements of PQG nonresident program. (*Retain MTS in member's Training Record.)	CO or XO
10	Ensure end-of-course test (EOCT) is ordered for member and arrange test time.	ESO
11	Take and pass EOCT.	Member
12	Recommend member for advancement.	CO

Overview

Assignment Letters

Letters assigning the student to the nonresident program and designating the PDS are recommended. Examples of these letters are provided on pages 6 and 9.

Monthly Tracking Sheet

The PDS and the student will complete a Monthly Tracking Sheet (MTS). Periodically this sheet will be evaluated and signed by the student's department head. After the student has successfully completed all PQG sheets and passed the end-of-course test (EOCT), the CO/XO will sign the final completion block on the MTS and the tracking sheet will become a permanent part of the student's Training Record.

Completion of Nonresident Program

The student will remain in the nonresident program until every EPQ has been successfully completed and signed off by the PDS. Normal time frame for completion of training is 6 to 12 months.

Guidelines for PQG

Purpose The purpose of this PQG is to provide a comprehensive, systematic approach to performance-based training. By successfully performing the tasks identified in this PQG, you will be able to complete your enlisted performance qualifications (EPQs), which are part of the preparation for eligibility to compete in the servicewide exam (SWE).

You and Your Supervisor It is YOUR responsibility to make sure that the person designated as your PDS reads the “Professional Development Supervisor (PDS) Instructions” in this course.

Your PDS will use this PQG as a tool to document your successful completion of the EPQs as a part of your advancement process. All EPQs for E-INSERT 4, 5, or 6 are covered in this PQG.

Performance Objectives This PQG contains terminal performance objectives (TPOs) and enabling objectives (EOs), which are explained in the table below.

Type of Objective	Outcomes
Terminal Performance Objective	These objectives reflect the EPQs you are striving to complete.
Enabling Objectives (Tasks)	These objectives are the performances you will complete that will lead you to successful completion of the TPOs.

PQG Sheets The PQG sheets identify the TPOs and tasks you need to master to be proficient in completing your enlisted performance qualifications (EPQs). The number appearing on the right top corner of the PQG sheet corresponds to the qual number on the Record of Performance Qualifications (CG-3303C-1) for the rating.

As you complete each task listed on the PQG sheets, your professional development supervisor will sign next to each task, indicating you have satisfactorily completed that task. After you have completed all tasks under the TPO, you will be ready to accomplish the TPO that directly relates to the EPQ you are working on.

Guidelines for PQG

PQG Sheets (Continued)

Once you demonstrate proficiency in the performance of the TPO(s), your PDS will initial and date the appropriate column on the Record of Performance Qualifications (CG 3303C-1), indicating your completion of that EPQ.

PQG Completion Steps

Follow these steps to guide you toward final completion of your PQG.

Step	Action
1	Read the PQG sheet and lesson material.
2	Practice the lesson objectives; complete the practical exercises/job aids/lesson self-quizzes. Ask for help if you do not understand the material.
3	Take the job aid(s) to your PDS.
4	Perform the steps/actions in the job aid(s) for your PDS.
5	Receive feedback from your PDS. Perform steps/actions again, if necessary.
6	Have PDS initial the box next to each job aid when successfully performed. (OPTIONAL step – This initial box may not be in every rating PQG.)
7	Take the PQG sheet and the job aid(s) to your PDS.
8	Using the job aid(s), perform all TPO tasks listed on the PQG sheet for your PDS.
9	Have PDS sign and date each task on the PQG sheet to verify that you have successfully performed each task.
10	Have PDS initial and date the appropriate EPQ on your Record of Performance Qualification (CG-3303C-1).
11	Repeat steps 1-10 for each PQG sheet.
12	Take the completed PQG, Monthly Tracking Sheet, and the CG-3303C-1 to your unit XO, training officer, ESO or other designated recipient for appropriate action.

Guidelines for PQG

End-of-Course Test (EOCT)

The end-of-course test (EOCT) measures your knowledge that supports each performance objective contained in your nonresident course. Be sure to complete the self-quiz for each lesson, along with the pamphlet review quiz. Remember, these pamphlet review questions are examples of the types of questions you will find on the EOCT.

Passing your EOCT is part of the advancement process. Take the exam seriously and study all of the course pamphlets. Ask others for help, prior to taking the exam, if you do not understand the material.

Example of Nonresident Assignment Memorandum

U.S. Department of
Homeland Security

United States
Coast Guard



Commanding Officer
U.S. Coast Guard
Cutter Steadfast

St. Petersburg, FL 33703-5001
Staff Symbol: XO
Phone: (727) 335-6192
Fax: (727) 335-6192
Email:

1500
25 Oct 2003

MEMORANDUM

From: B. A. MOORE, CAPT, USCG
USCGC STEADFAST

Reply to XO
Attn of: (757) 856-2131

To: Insert appropriate rating and class Jeff Robertson, 0372, USCG

Subj: ASSIGNMENT TO THE NONRESIDENT E-insert 4, 5, or 6 PROGRAM

(b) Station Instruction 1500.2B

1. You are hereby assigned to the Nonresident E-insert 4, 5, or 6 Program.
2. This assignment is based on your desires to become a insert Third, Second, or First Class Petty Officer. It will be your responsibility to acquire the skills, knowledge, and abilities in the Insert full rating name rating, as well as the completion of the Enlisted Performance Qualifications (EPQs) to be eligible for advancement to E-insert 4, 5, or 6.
3. The following guidelines have been established to ensure the standardization of the training process for the Nonresident E-insert 4, 5, or 6 Program.
 - The Performance Qualification Certification Guide (PQG) will be your tool to track your progress towards completion of the EPQs.
 - You should be able to demonstrate proficiency in each of the performance objectives listed in the PQG. There is an initial block next to each task where your professional development supervisor (PDS) must indicate that he/she has observed your successful completion of that task in accordance with the steps and criteria contained in the lesson job aid.
 - Normal time frame for completion of the Nonresident Program is 6 to 12 months. You will be evaluated each month by your PDS on your progression. You will be given feedback on your performance, and the evaluation will be sent to your immediate supervisor.
4. Once you have completed all of the performance objectives in the PQG, you will be ready to demonstrate your proficiency of the E-insert 4, 5, or 6 quals to your PDS, who will initial and date the appropriate column in the Record of Performance Qualifications (CG 3303C-1). All EPQs at this level must be successfully completed for advancement.
5. I commend you on this assignment, and look forward to your successful completion.

#

January 2007
Version 2.0

Professional Development Supervisor (PDS) Instructions

Purpose The purpose of this PQG is to provide a comprehensive, systematic approach to performance-based training. The student, along with your assistance and mentorship, will be striving towards completion of the EPQs in order to be eligible for advancement to INSERT rating and 3, 2, or 1.

Your Role As PDS You have been selected as a PDS based on your paygrade and professional competence. It will be your responsibility to assist, guide, and mentor the student in his/her efforts towards professional development and advancement in the INSERT name of rating rating.

Note: An example of a PDS designation memorandum is provided on page 9.

PDS Competencies

The following guidelines have been established to ensure the standardization of the training process.

- The PQG will be your tool to track the student's progress towards completion of the EPQs.
 - Within the lesson material are job aids that the student will demonstrate to you. (Some ratings have included an initial box next to each job aid in the course material.)
 - The student should be able to demonstrate proficiency in all terminal performance objectives listed on the PQG sheets. There is a signature block next to each task in a table below the TPO where you must indicate the student's completion of that task.
 - Once all tasks have been completed, the student will demonstrate each TPO to you. It will be your job to assess the student's ability to satisfy the accomplishment of that TPO and its EPQ. Basically, the EPQs are the PQG's TPOs.
 - Use your good judgment in determining your student's performance. The Coast Guard is putting its trust in you to help your fellow shipmate become a competent INSERT name of rating and Third, Second, or First Class.
-

Professional Development Supervisor (PDS) Instructions

Monthly Tracking Sheet

Included at the end of this handbook is a Monthly Tracking Sheet (MTS). You and the student must develop a reasonable timeline for completion of this PQG handbook. Periodically, this tracking sheet should be evaluated and signed by your department head. If used correctly, the MTS will motivate the student and you to systematically develop his/her skills to perform all the tasks required for performance of INSERT rating and 3, 2, or 1 enlisted performance qualifications.

EPQ Sign-Off

When the student has demonstrated proficiency in the performance of the EPQ, you will initial and date the appropriate column in the Record of Performance Qualifications (CG 3303C-1). This official record, along with the completed PQG, will document the student's eligibility for advancement to INSERT rating and 3, 2, or 1.

For More Information

For more detailed information regarding the completion of the Record of Performance Qualifications, refer to the Coast Guard Enlisted Qualifications Manual, COMDTINST M1414.8 (series).

Example of PDS Assignment Memorandum

U.S. Department of
Homeland Security

United States
Coast Guard



Commanding Officer
U.S. Coast Guard
Cutter Steadfast

St. Petersburg, FL 33703-5001
Staff Symbol: XO
Phone: (727) 335-6192
Fax: (727) 335-6192
Email:

1500
25 October 2003

MEMORANDUM

From: B. A. MOORE, CAPT, USCG
USCGC STEADFAST

Reply to XO
Attn of: (757) 856-2131

To: BM2 Horace Greely, 1492, USCG

Subj: ASSIGNMENT AS PROFESSIONAL DEVELOPMENT SUPERVISOR (PDS)

Ref: (a) Station Instruction 1500.2B

1. You are hereby designated as a professional development supervisor (PDS) for (enter member's name and rate).
2. This assignment is based on your paygrade and professional competence. It will be your responsibility to assist, guide, and mentor the member in his/her efforts to improve his/her skills, knowledge, and abilities in the INSERT name of rating rating.
3. The following guidelines have been established to ensure the standardization of this performance-based training process:
 - The Performance Qualification Certification Guide (PQG) will be your tool to track the member's progress towards completion of the EPQs.
 - The member should be able to demonstrate proficiency in each of the terminal performance objectives listed in the PQG. There is signature block next to each task where you must indicate that you have observed the member's successful completion of that task in accordance with the steps and criteria contained in the lesson/job aid.
4. Once the member has completed all of the terminal performance objectives, it will be your responsibility to determine if he/she has successfully demonstrated proficiency in all currently published E-insert 4, 5, or 6 enlisted performance qualifications in the INSERT name of rating rating. Use your good judgment in determining successful performance. I am placing my trust in your ability to assist your fellow shipmate in becoming a highly competent, professional member of the U.S. Coast Guard.

#

This page intentionally left blank.

**Terminal
Performance
Objective**

INSERT TPO.

Notes to PDS

INSERT info for PDS.

Item	Task	Job Aid Location	PDS Signature and Date
1	INSERT task.	INSERT pamphlet title, lesson title.	
2	INSERT task.	INSERT pamphlet title, lesson title.	

Professional Development Supervisor's Comments and Notes

**Terminal
Performance
Objective**

INSERT TPO.

Notes to PDS

INSERT info for PDS.

Item	Task	Job Aid Location	PDS Signature and Date
1	INSERT task.	INSERT pamphlet title, lesson title.	
2	INSERT task.	INSERT pamphlet title, lesson title.	

Professional Development Supervisor's Comments and Notes

**Terminal
Performance
Objective**

INSERT TPO.

Notes to PDS

INSERT info for PDS.

Item	Task	Job Aid Location	PDS Signature and Date
1	INSERT task.	INSERT pamphlet title, lesson title.	
2	INSERT task.	INSERT pamphlet title, lesson title.	

Professional Development Supervisor's Comments and Notes

Terminal Performance Objective INSERT TPO.

Notes to PDS INSERT info for PDS.

Item	Task	Job Aid Location	PDS Signature and Date
1	INSERT task.	INSERT pamphlet title, lesson title.	
2	INSERT task.	INSERT pamphlet title, lesson title.	

Professional Development Supervisor’s Comments and Notes

MONTHLY TRACKING SHEET FOR INSERT RATING AND 3, 2, OR 1 PERFORMANCE QUALIFICATION GUIDE

Name: _____

Name of PDS	EPQ	Start Date	Due Date	Progress			Date Completed	PDS Signature
				25%	50%	75%		
INSERT qual section heading								
INSERT lesson title	qual code							
INSERT lesson title	qual code							
INSERT lesson title	qual code							
INSERT lesson title	qual code							
PDS comments and/or department head periodic review and signature/date:								
INSERT qual section heading								
INSERT lesson title	qual code							
INSERT lesson title	qual code							
INSERT lesson title	qual code							
INSERT lesson title	qual code							
PDS comments and/or department head periodic review and signature/date:								

MONTHLY TRACKING SHEET FOR INSERT RATING AND 3, 2, OR 1 PERFORMANCE QUALIFICATION GUIDE

Name:

Name of PDS	EPQ	Start Date	Due Date	Progress			Date Completed	PDS Signature
				25%	50%	75%		
INSERT qual section heading								
INSERT lesson title	qual code							
INSERT lesson title	qual code							
INSERT lesson title	qual code							
INSERT lesson title	qual code							
PDS comments and/or department head periodic review and signature/date:								
INSERT qual section heading								
INSERT lesson title	qual code							
INSERT lesson title	qual code							
INSERT lesson title	qual code							
INSERT lesson title	qual code							
PDS comments and/or department head periodic review and signature/date:								

MONTHLY TRACKING SHEET FOR INSERT RATING AND 3, 2, OR 1 PERFORMANCE QUALIFICATION GUIDE

Name: _____

Name of PDS	EPQ	Start Date	Due Date	Progress			Date Completed	PDS Signature
				25%	50%	75%		
INSERT qual section heading								
INSERT lesson title	qual code							
INSERT lesson title	qual code							
INSERT lesson title	qual code							
INSERT lesson title	qual code							
PDS comments and/or department head periodic review and signature/date:								
INSERT qual section heading								
INSERT lesson title	qual code							
INSERT lesson title	qual code							
INSERT lesson title	qual code							
INSERT lesson title	qual code							
PDS comments and/or department head periodic review and signature/date:								

MONTHLY TRACKING SHEET FOR INSERT RATING AND 3, 2, OR 1 PERFORMANCE QUALIFICATION GUIDE

Name: _____

Name of PDS	EPQ	Start Date	Due Date	Progress			Date Completed	PDS Signature
				25%	50%	75%		
INSERT qual section heading								
INSERT lesson title	qual code							
INSERT lesson title	qual code							
INSERT lesson title	qual code							
INSERT lesson title	qual code							
PDS comments and/or department head periodic review and signature/date:								
INSERT qual section heading								
INSERT lesson title	qual code							
INSERT lesson title	qual code							
INSERT lesson title	qual code							
INSERT lesson title	qual code							
PDS comments and/or department head periodic review and signature/date:								

This page intentionally left blank.

Appendix B

GLOSSARY OF TERMS

Glossary

Access The ability and opportunity to obtain knowledge or possession of classified information. An individual does not have access to classified information merely by being in a place where such information is kept, provided the security measures which are in effect prevent the individual from gaining knowledge or possession of such classified information.

Classified Material Any matter, document, product, or substance on or in which classified information is recorded.

Compromise The disclosure of sensitive or classified information to persons not authorized access.

Confidential The designation which shall be applied to information or material the unauthorized disclosure of which could reasonably be expected to cause damage to the national security.

Controlled Area The least secure type of restricted area. It contains a security interest which if lost, stolen, compromised, or sabotaged would cause identifiable damage to the unit mission or national security. It may also serve as a buffer zone for exclusion and limited areas, thus providing administrative control, safety, and protection against sabotage, disruption, or potentially threatening acts. Uncontrolled movement may or may not permit access to a security interest or asset.

Correspondence Course A course of instruction in which the instructor and the student are not at the same location. The student requires no live feedback from the instructor. Correspondence courses allow the students to work at their own pace and to decide when and where the learning will take place.

Glossary

Course A series of units of instruction designed to fulfill a specified purpose, such as qualification to enter a rating or specialized field, or to enhance job qualifications.

Course Review A formal or informal content and/or process review of a course which includes mission and scope, terminal performance objectives (TPOs), lesson plans, training aids, student and instructor critiques, and results of external evaluations. A course review may occur prior to submitting a curriculum outline or during evaluations of the course. A course review can occur whenever deemed necessary by the training manager or program manager to review the consistency between the curriculum outline, lesson plans, tests, and job analysis data.

Criteria The standards by which the performance of an instruction objective is judged; the principles for evaluating the quality of the performance.

Criterion-Referenced Test A test constructed solely from terminal performance objectives and enabling objectives. Its purpose is to determine how well the student's performance at the end of instruction coincides with the performance called for in the objectives.

Curriculum The instructional materials of a course which include: (a) curriculum outline, (b) lesson plans, and (c) supporting materials.

Curriculum Outline A document containing the scope, objectives, and resource requirements of a particular course. The outline is developed by the training source and must be approved by the appropriate training manager and program manager prior to implementation of a course.

Delivery System A method of instruction such as a job aid, self-paced instruction, programmed instruction, correspondence study, resident training, or computer-assisted instruction.

Glossary

D-Value	It is a comparison of an examination item in relation to other items in the same section. This provides a measure of the test item's ability to identify those students with the most knowledge of the subject.
Enabling Objective (EO)	An objective developed from a skill or knowledge that describes in measurable and observable terms a necessary step to accomplish the related TPO. It contains a stated and measurable standard of performance.
End-of-Course Test (EOCT)	A multiple-choice examination that measures the student's achievement of the course objectives. Successful completion of the EOCT for a course taken for advancement is necessary for becoming eligible for the SWE.
Evaluation	A systematic process to obtain measurable information (feedback) about the strengths and weaknesses of a course of examination.
Examination Strategy Worksheet	Describes the basic plan for the exam, outlines section size and content guidelines, and records necessary change to the exam.
External Evaluation	An analysis of course components to determine if the training is relevant to the job; if the training is adequate for the job; whether the training helped the student on the job; whether the training affected the student's advancement; and what measures, if any, should be taken to improve the course.
Feedback	Information to the student about the adequacy of performance. Also, information to the course developer about the adequacy of the instruction.
Flowchart	A graphic representation of the steps of a task or process.

Glossary

Force Manager	The individual within a program manager's organization responsible for the oversight of an enlisted rating. This oversight includes structural concerns for the rating's size and grade distribution, location of billets, the setting of performance standards, and the content of performance qualifications.
Internal Evaluation	An analysis of course components to determine if the objectives are based on the quals; if the objectives adequately cover the quals; whether the objectives are effectively taught; whether the students master the objectives; and what measures, if any, should be taken to improve the course.
Item Analysis Printout	Shows how every item on a particular exam performed statistically.
Job Analysis	A systematic procedure for identifying exactly what people do on their jobs, the order in which they do it, and the level of skill needed for the jobs. Job analysis is conducted by: (1) observations of incumbents doing the job; (2) interviews of job incumbents about what they do on their job; (3) occupational survey methods; (4) a panel of experts; and/or (5) equipment analysis.
Job Performance Requirement	The essential tasks an individual must perform in a job/rating in order to qualify for advancement and assignment to specific billets.
Lesson Objective	A task statement that identifies a skill or knowledge outcome of a lesson. A lesson provides instruction on one or more related objectives.
Major Course Revision	A revision that increases or decreases course length; requires additional staff or funding; or changes the course mission, scope, job performance requirements, TPOs, or authorized qual codes. Major revisions are based on the results of a course review and need approval from the appropriate program and training managers prior to course implementation.

Glossary

Minor Course Revision Any revision that is not covered by the definition of a major revision, such as a change in the wording of a TPO or enabling objective. Minor revisions do not require training manager or program manager approval prior to implementation.

Mission and Scope Statement A required element of the curriculum outline that states the purpose of the course and the type of billet the training is directed toward. This section includes a description of the target student by paygrade, rating, and job assignment; an overview of the course content; and the standard for successful completion of the course.

Nonresident Training Training that is not conducted at a training facility. Examples include on-the-job training, exportable training, and correspondence courses.

Norm-Referenced Test A test designed to measure an individual's level of achievement relative to a population's performance.

Occupational Analysis The system of examining the way work is organized in order to make informed decisions about workforce structures, selection, classification, assignment, evaluation, advancement, and the way jobs are designed.

Password A protected word or string of characters that identifies or authenticates a user for access to a specific resource such as a data set (file) or record.

PDS The professional development supervisor is appointed to mentor/train the student as he/she successfully demonstrates the tasks identified in the certification pamphlet.

Glossary

Physical Security Internal security concerned with the physical measures designed to prevent unauthorized access to equipment, facilities, material, and documents and to safeguard them against espionage, sabotage, damage, theft, or other acts which would in some degree lessen the ability of the command to perform its mission or would affect overall national security interests.

PQG The performance-based systematic approach to completing the enlisted performance qualification for advancement. It consists of a nonresident distance learning course and a certification pamphlet.

Program Manager (PM) The staff officer at Headquarters designated by and responsible to the program director for the detailed management of a Coast Guard program (e.g., search and rescue or maritime law enforcement).

P-Value The percentage of examinees who chose a particular response. It is printed as a decimal ratio rather than as a percentage.

Restricted Area Any area to which access is subject to special restrictions or controls for reasons of security or safeguarding of property or material. This term is a legal designation. Specific administrative terms are used to designate various security areas/levels.

Sampling Predicting the quality of the whole by examining only a part of the whole.

Self-Paced Training and Education Instruction in which students work at their own pace and at a location and time of their own choosing. Examples include correspondence courses.

Sensitive Material Material which requires a high degree of protection and control due to regulatory requirements.

Subject Matter Specialist The person assigned to develop the specific rate distance learning courses.

Glossary

Subject Matter Expert	The E-9 assigned as the distance learning course SWE test writer.
Task Analysis	Procedures for identifying the various elements that are essential to the accomplishment of a task.
Terminal Performance Objective (TPO)	A description of what the student will be required to do upon completion of the instruction. It is a statement of task performance that has three parts: the conditions statement (tools, reference materials, environmental situations, etc.) under which the task will be performed in real life; the statement of actual performance which should take the form of an action verb, object, and qualified; and a standards statement which tells how well the task must be performed to meet minimal acceptance of entry level work on-the-job.
Training	Formal or informal activity designed to provide an individual with essential job performance skills.
Training Managers	Commandant (CG-132), Director of Reserve and Training, who is responsible for all active duty resident and nonresident training and education programs. Commandant (CG-131), Office of Reserve Affairs, who is responsible for the development and validation of Reserve ADT courses and certain nonresident training and education programs.
Training Needs	A job performance problem that indicates training as the solution. It is the gap between the existing performance level and the desired performance level of someone doing the job.
Training Source (TS)	U.S. Coast Guard training centers and other government or commercial agencies that provide training or produce instruction materials.