

Heavy Flavor Hadrons at CDF

Kai Yi

Johns Hopkins University

BNL, October 30, 2003

Outline

- The Tevatron
- Tevatron Heavy Flavor Physics
- The CDF Detectors
- Triggers for Heavy Flavor Hadrons
- Hadron Spectroscopy– $X(3872)$ Mystery
 - CDF Hadron Spectroscopy Intro.
 - Introduction to $X(3872)$
 - CDF Observation of $X(3872)$
 - Prospects
- Precision Measurement $-\Lambda_b$ Lifetime
 - A puzzle–Theory vs Experiment
 - lifetime at CDF
 - $\Lambda_b \rightarrow \ell \Lambda_c \nu, \Lambda_c \rightarrow p K \pi$ reconstruction
 - Lifetime measurement method
 - Discussion
- Summary and Outlook

The Tevatron

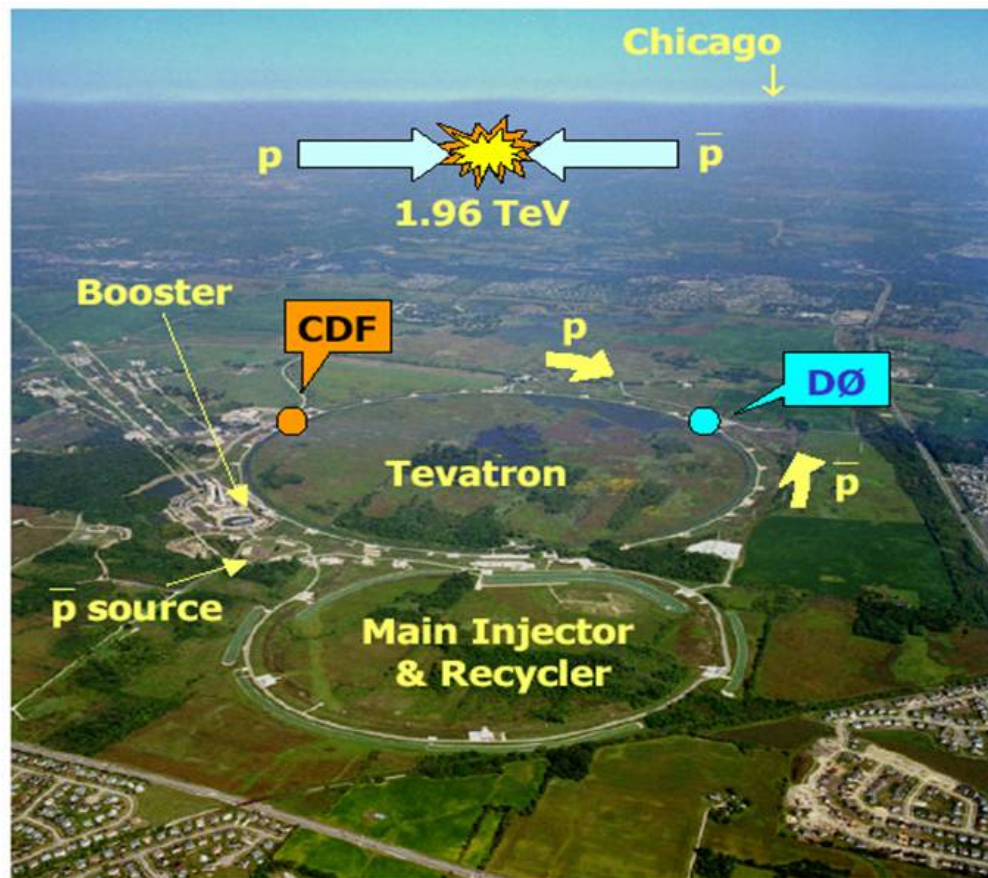

- C.M.E.: 1.96 TeV
- 2.5M Hz Collision
- Peak Lum. ($10^{32} cm^{-2} s^{-1}$):
 - Run I Avg: 0.16
 - Run II Record: 0.52
 - Until 2005: 0.8
 - Before LHC: 2-4
- Int. Luminosity:
 - Run I: $\sim 110 pb^{-1}$ (92-95)
 - Run II: 220 pb^{-1} to tape
 - $\sim 2 fb^{-1}$ by 2005 (Run II)
 - $\sim 6 fb^{-1}$ before LHC (Run II)

The Tevatron–Luminosity

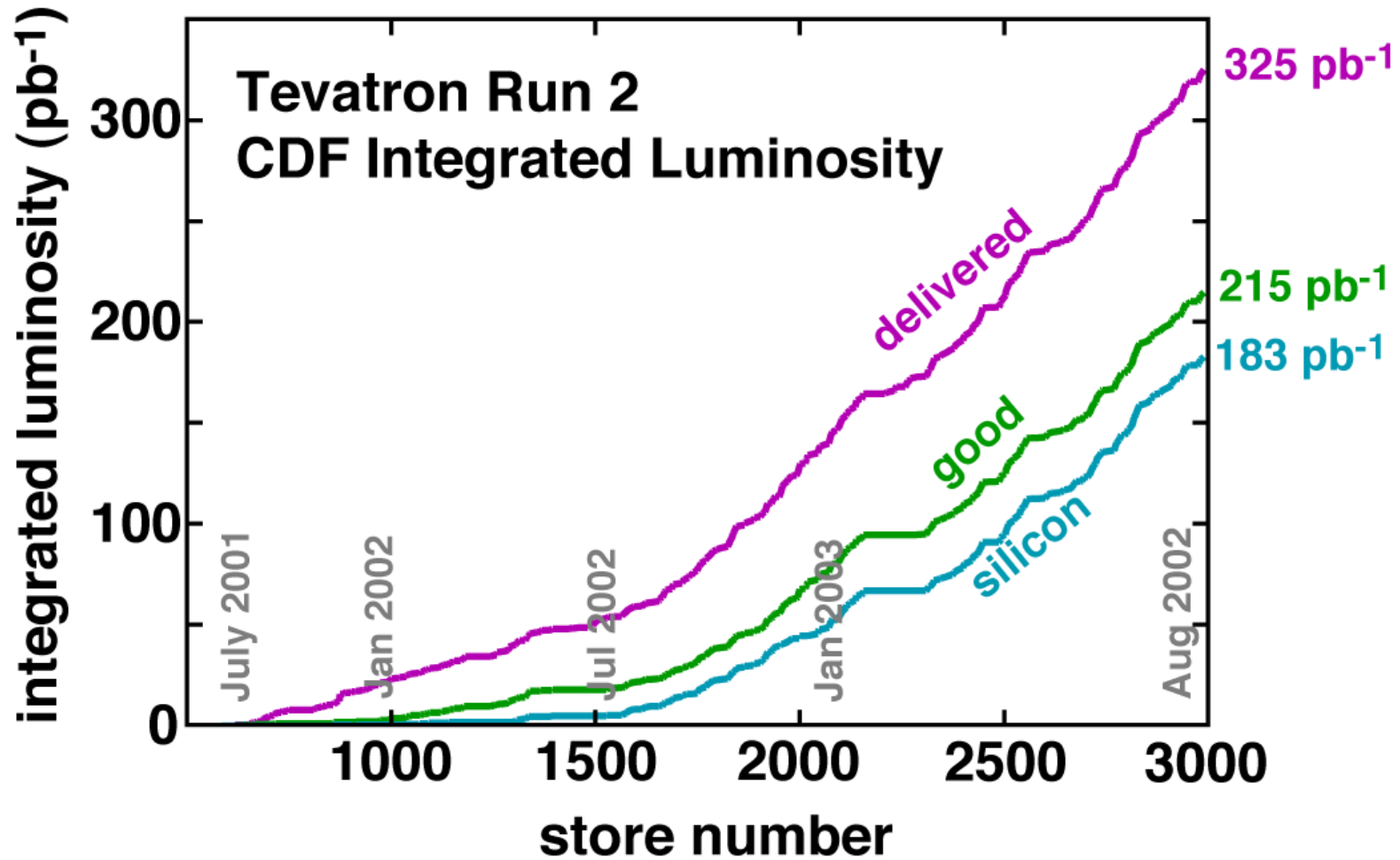

Tevatron Heavy Flavor Physics

- CDF I(110 pb⁻¹) successful!
b hadron mass, lifetime, mixing...
 $\sin 2\beta$
- Run II goals
- b Hadron spectroscopy
 - $B_s, B_c, B^{**}, B_{sJ}^*$
 - $\Lambda_b, \Xi_b, \Omega_b? \dots$
- Other **competitive** hadron spectroscopy
 - **X(3872)**
 - ...
- Precision measurements
 - B_s mixing,
No. 1 B measurement!
 - $B_s, \Lambda_b, B_c \dots$ **lifetime.**
 - Branching ratio, polarization
 - ...
- Rare decays
 - $B_s \rightarrow \mu^+ \mu^-, B_s \rightarrow K^{*0} \gamma,$
 - $\Lambda_b \rightarrow \Lambda \gamma$
 - ...

The CDF Detectors

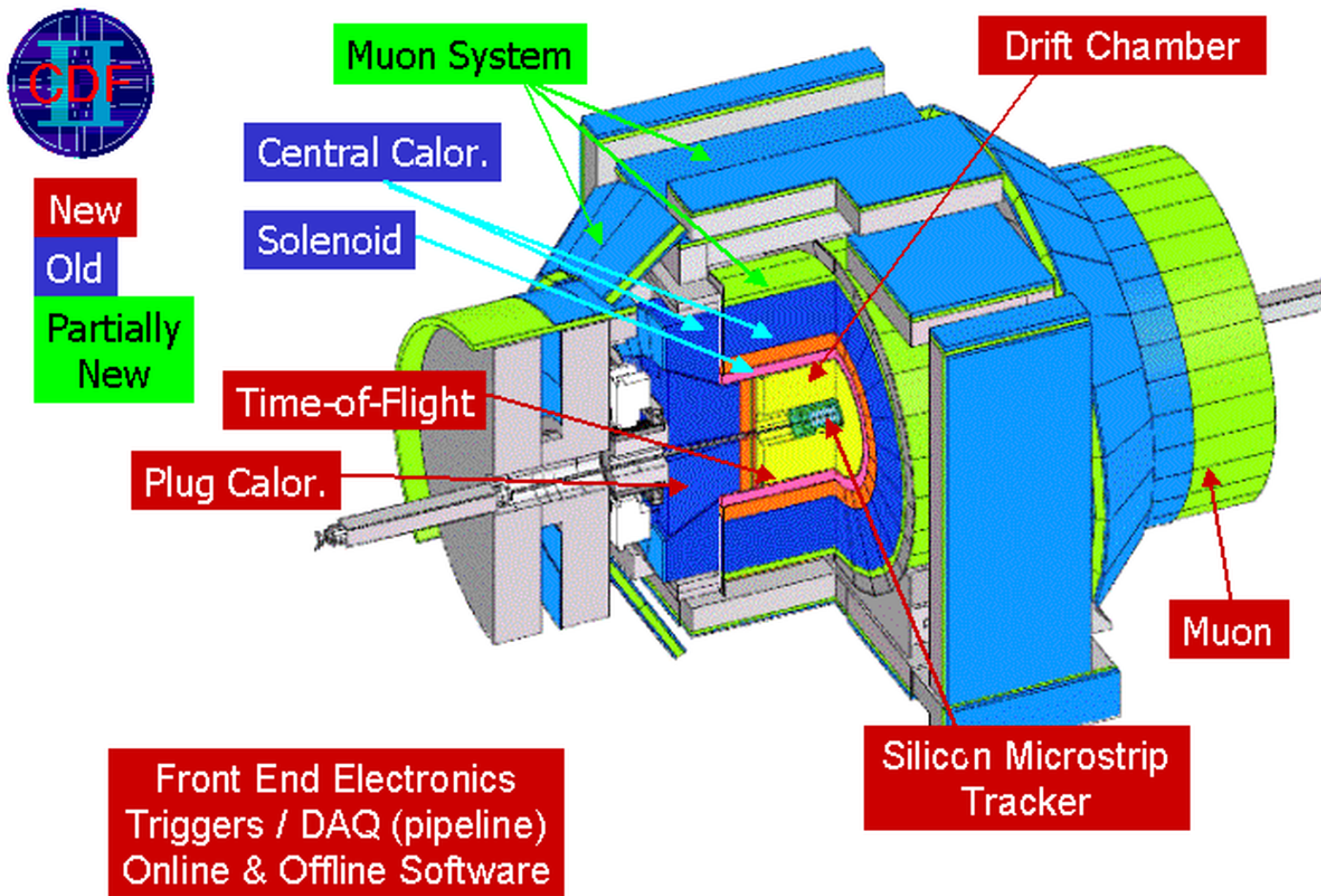

The CDF Detectors

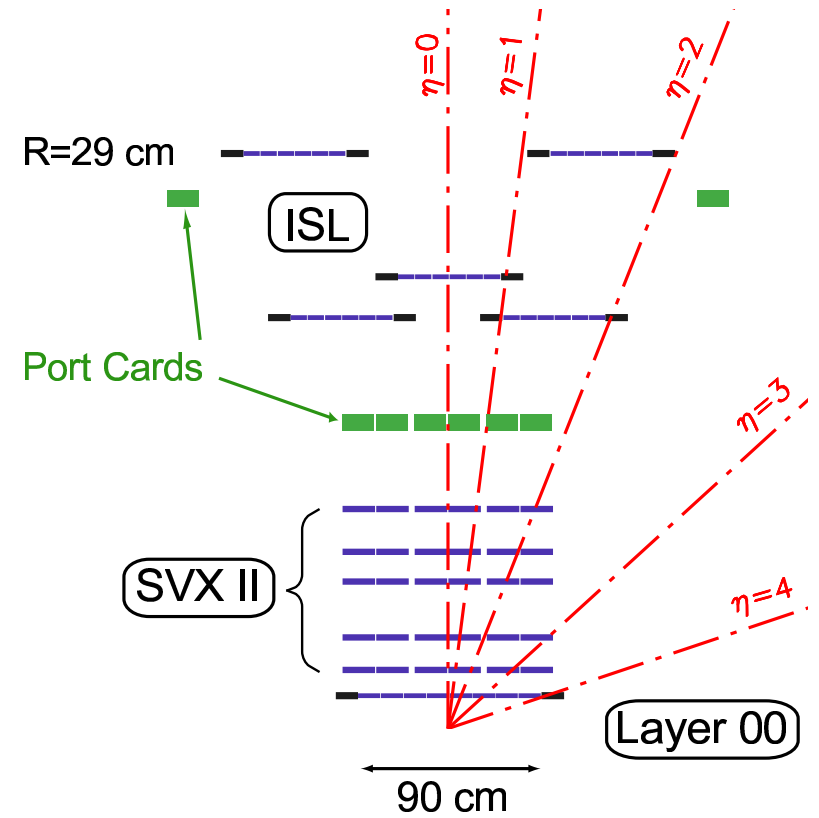
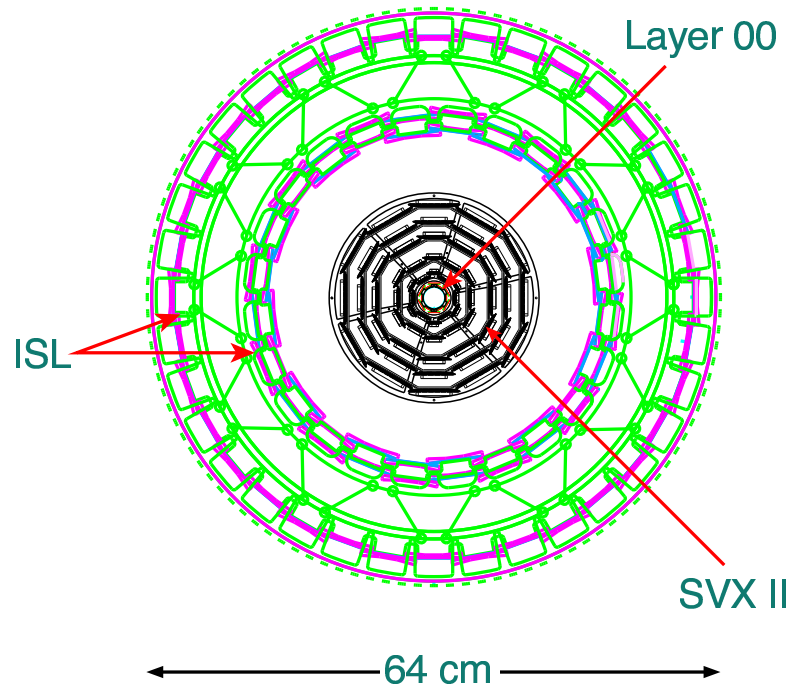

Triggers: Revolutionary Silicon Vertex Tracker(SVT)

- Collision rate: 2.5M Hz
- Bandwidth: L1/L2/L3: 20k/350/75 Hz
- **Never had** hadronic B trigger at Hadron collider

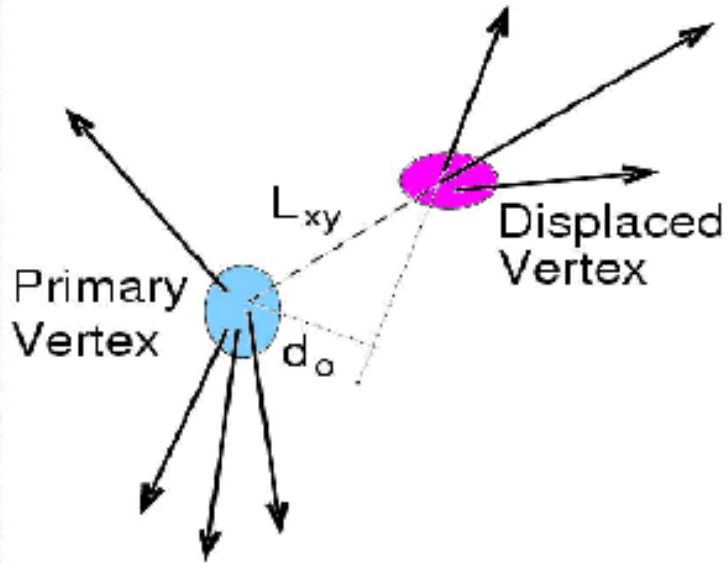

- Significantly **reduce** L2 trigger **rate**

- Increase physics sensitivity
 - CDF as “Charm Factory”
 - **Hadronic** B trigger. $B \rightarrow hh, B_s \rightarrow D_s\pi$
 - Increased **yield** for semileptonic decays
 - **new** particles decaying into b/c quarks

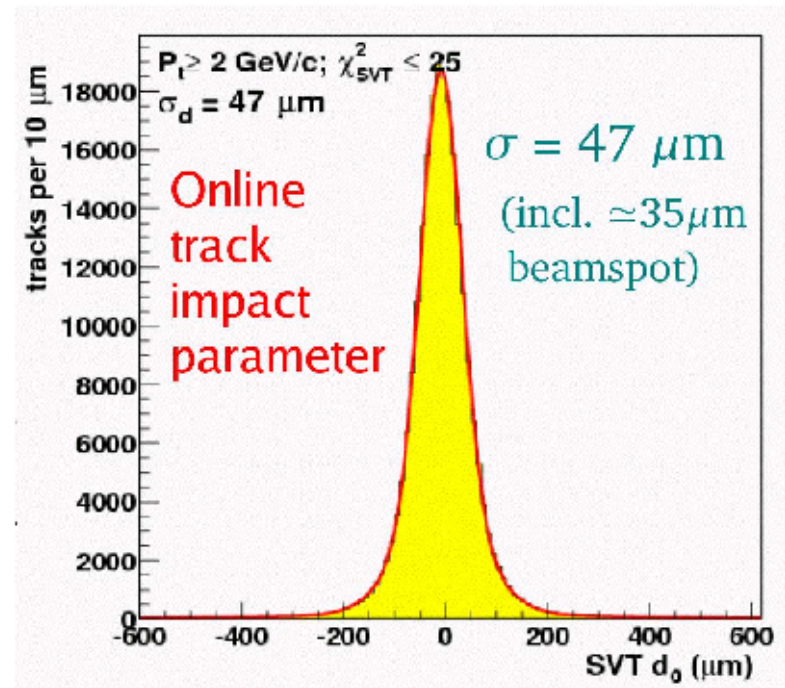

Triggers for B/Charm Physics

- CDF Di-muon-Trigger

- $J/\psi \rightarrow \mu\mu$
- Two central μ ($|\eta| < 1.0$)
- $p_T > 1.5$ GeV

- Lepton+Track-Trigger(ℓ +SVT)

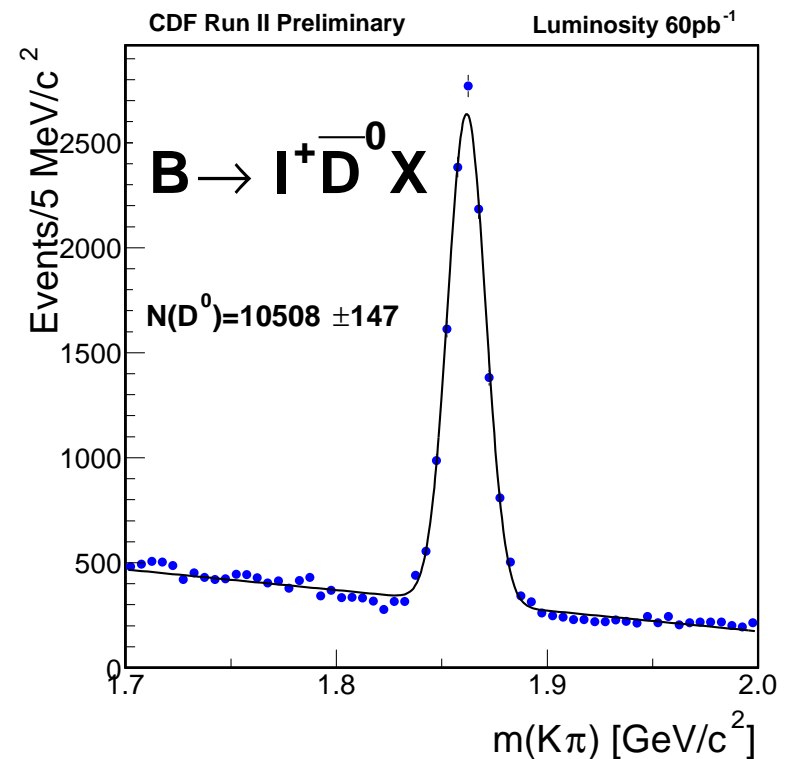
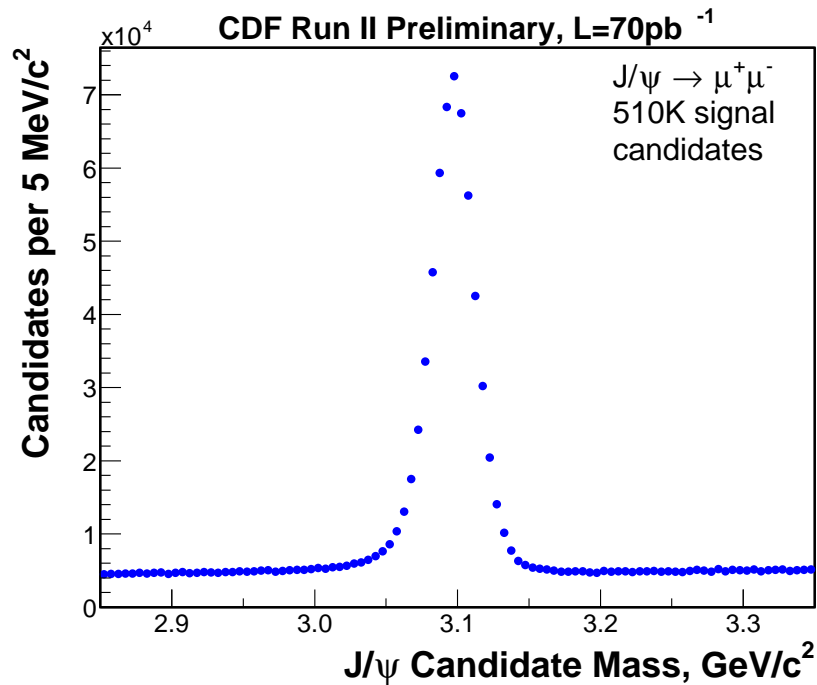
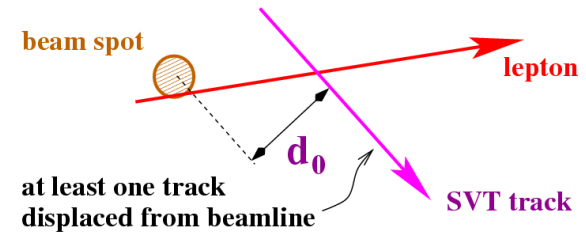

Hadron Spectroscopy

- B_s :

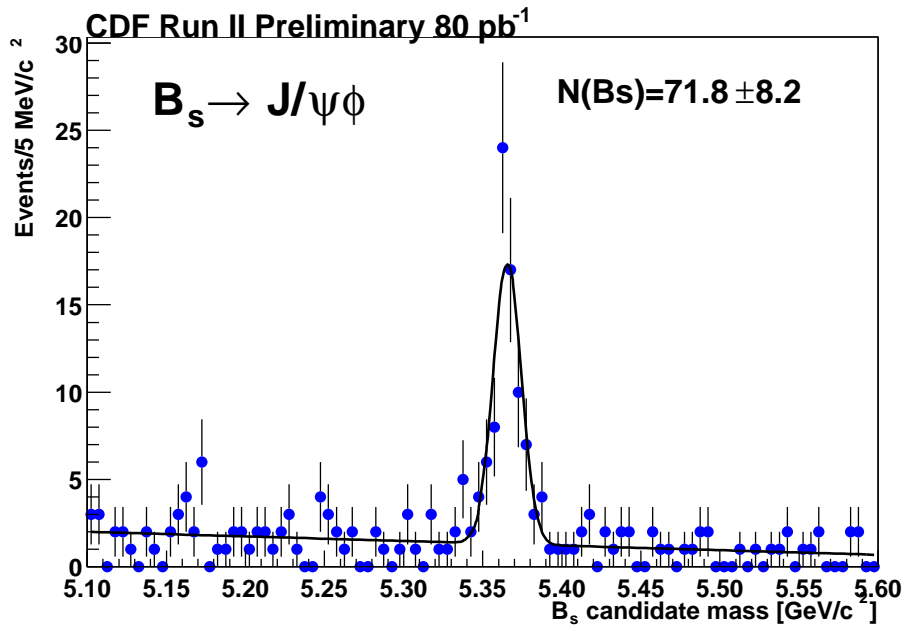

- Λ_b :

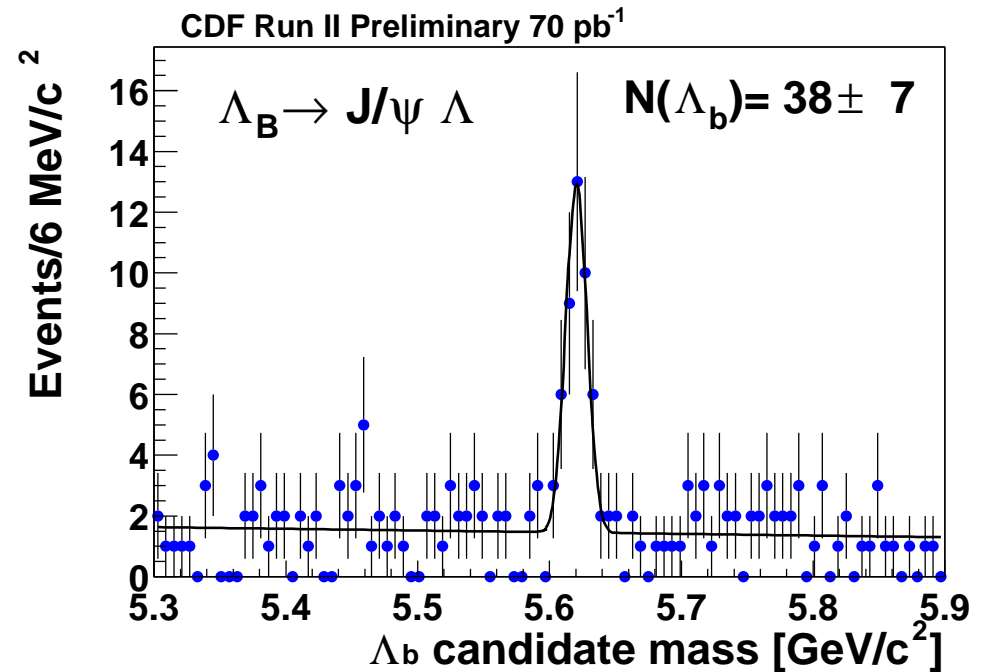

- $m(B_s^0)$ from $B_s^0 \rightarrow J/\psi \phi$:
 $5365.50 \pm 1.29(stat) \pm 0.94(sys) \text{ MeV}/c^2$
 $5369.6 \pm 2.4 \text{ MeV}/c^2$ (2002 PDG)

- $m(\Lambda_b)$ from $\Lambda_b \rightarrow J/\psi \Lambda$:
 $5620.4 \pm 1.6(stat) \pm 1.2(sys) \text{ MeV}/c^2$
 $5624 \pm 9 \text{ MeV}/c^2$ (2002 PDG)

Hadron Spectroscopy (Other decay channels–SVT!!)

- $B_s \rightarrow D_s^+ \pi^-$:

CDF Run II Preliminary, L = 119 pb⁻¹

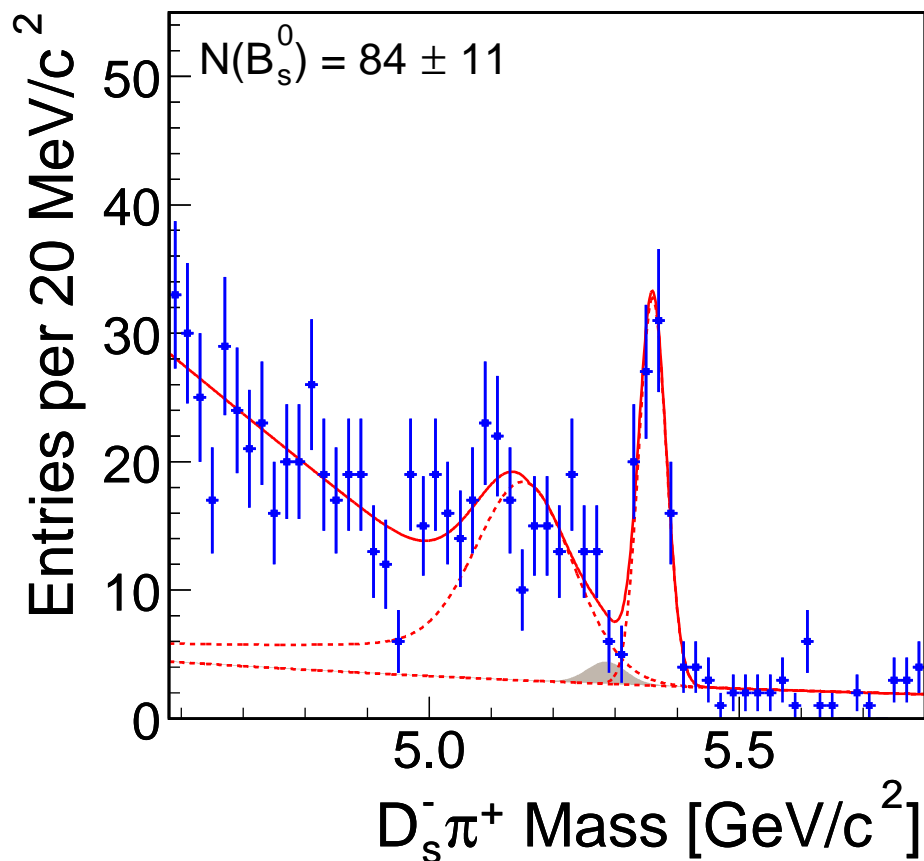

- Will be used for B_s mixing

- $\Lambda_b \rightarrow \Lambda_c^+ \pi^-$:

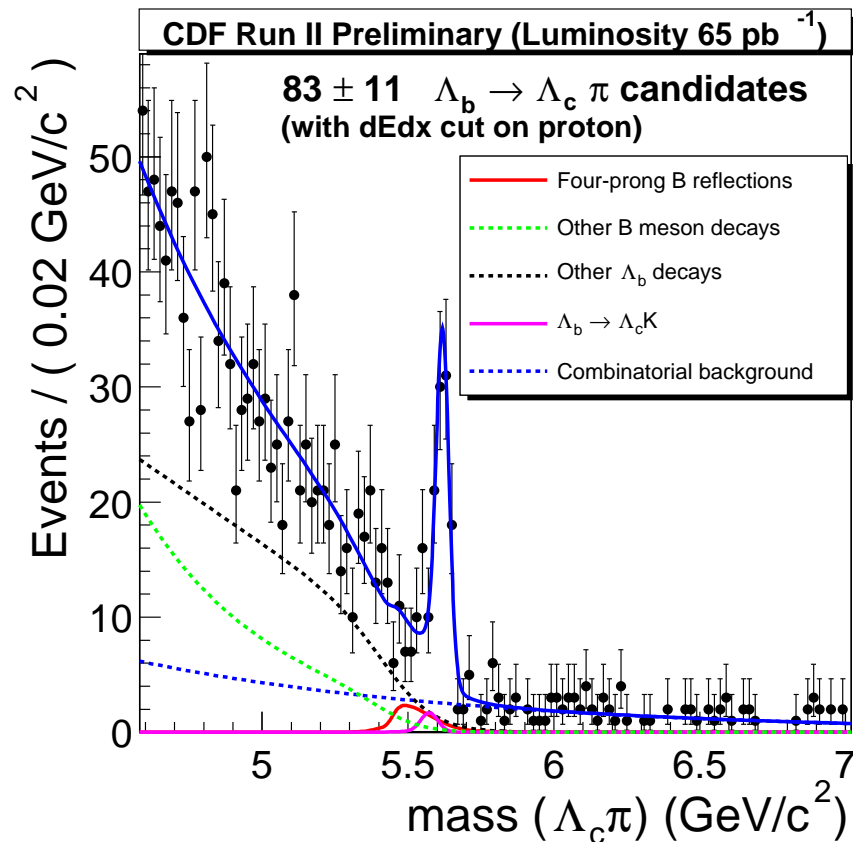

- Largest fully reconstructed Λ_b sample in existence!

X(3872) \rightarrow $J/\psi\pi\pi$ Mystery – Introduction

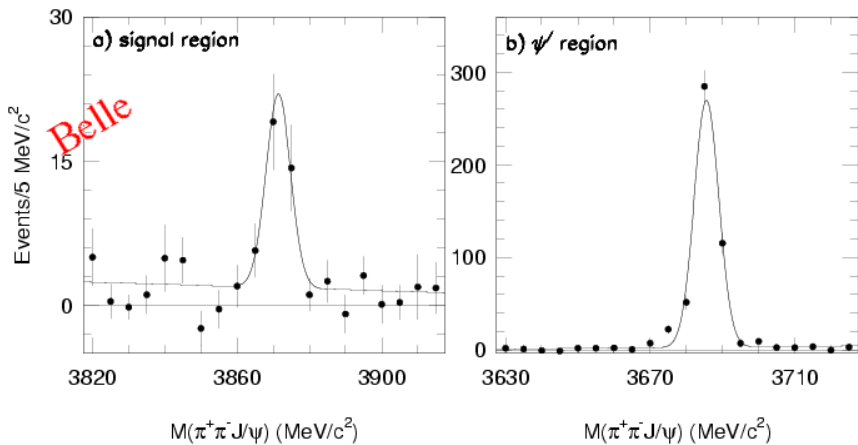

- New narrow state – Belle (Aug. 10)
 $J/\psi\pi^+\pi^-$

- Using exclusive $B^+ \rightarrow J/\psi\pi^+\pi^-K^+$

- 35.7 ± 6.8 signal events (10.3σ)

- Mass = $3872.0 \pm 0.6 \pm 0.5$ MeV

- $\Gamma < 2.3$ MeV, 90% CL

- A new Charmonium? or something else?

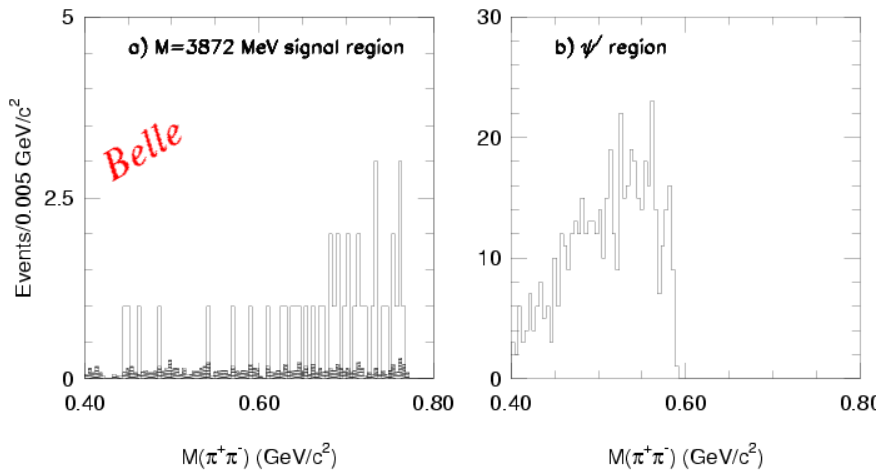

X(3872) Mystery – Introduction

PDG Quark Model:

$N^{2S+1}L_J$	J^{PC}	$u\bar{d}, u\bar{u}, d\bar{d}$ $I = 1$	$uu, \bar{d}\bar{d}, s\bar{s}$ $I = 0$	cc $I = 0$	bb $I = 0$	$su, \bar{s}d$ $I = 1/2$	$cu, c\bar{d}$ $I = 1/2$	cs $I = 0$	$bu, \bar{b}d$ $I = 1/2$	bs $I = 0$	bc $I = 0$
1^1S_0	0^{-+}	π	η, η'	$\eta_c(1S)$	$\eta_b(1S)$	K	D	D_s	B	B_s	B_c
1^3S_1	1^{--}	ρ	ω, ϕ	$J/\psi(1S)$	$\Upsilon(1S)$	$K^*(892)$	$D^*(2010)$	D_s^*	B^*	B_s^*	
1^1P_1	1^{+-}	$b_1(1235)$	$h_1(1170), h_1(1380)$	$h_c(1P)$		K_{1B}^\dagger	$D_1(2420)$	$D_{s1}(2536)$			
1^3P_0	0^{++}	$a_0(1450)^*$	$f_0(1370)^*, f_0(1710)^*$	$\chi_{c0}(1P)$	$\chi_{b0}(1P)$	$K_0^*(1430)$					
1^3P_1	1^{++}	$a_1(1260)$	$f_1(1260), f_1(1420)$	$\chi_{c1}(1P)$	$\chi_{b1}(1P)$	K_{1A}^\dagger					
1^3P_2	2^{++}	$a_2(1320)$	$f_2(1270), f_2'(1525)$	$\chi_{c2}(1P)$	$\chi_{b2}(1P)$	$K_2^*(1430)$	$D_2^*(2460)$				
1^1D_2	2^{-+}	$\pi_2(1670)$	$\eta_2(1645), \eta_2(1870)$			$K_2(1770)$					
1^3D_1	1^{--}	$\rho(1700)$	$\omega(1650)$	$\psi(3770)$		$K^*(1680)^\ddagger$					
1^3D_2	2^{--}			??		$K_2(1820)$					
1^3D_3	3^{--}	$\rho_3(1690)$	$\omega_3(1670), \phi_3(1850)$			$K_3^*(1780)$					
1^3F_4	4^{-+}	$a_4(2040)$	$f_4(2050), f_4(2220)$			$K_4(2045)$					
2^1S_0	0^{-+}	$\pi(1300)$	$\eta(1295), \eta(1440)$	$\eta_c(2S)$		$K(1460)$					
2^3S_1	1^{--}	$\rho(1700)$	$\omega(1420), \phi(1680)$	$\psi(2S)$	$\Upsilon(2S)$	$K^*(1410)^\ddagger$					
2^3P_2	2^{++}	$\rho(1700)$	$f_2(1950), f_2(2010)$		$\chi_{b2}(2P)$	$K_2^*(1980)$					
3^1S_0	0^{-+}	$\pi(1800)$	$\eta(1760)$			$K(1830)$					

L = 2

J/ψ π⁺π⁻

X(3872) Mystery –Introduction

- Choice 1: 3D_2
 - 3D_2 expected around 3820 MeV
 - 3872 MeV too heavy!
 - No observation $\chi_{c1}\gamma$ at Belle!
 $\Gamma(\chi_{c1}\gamma)/\Gamma(J/\psi\pi\pi) < 0.89$
- Choice 2: DD^* molecule
 - Mass(3872 MeV) $\sim DD^*$
- Choice 3: P wave, F wave states?
- Choice x: $c\bar{c}g^*$ Hybrids ?
- Whatever, interesting!
- hep-ph/0309294,...
- First Confirmation of Belle's result
- Complementary Information?
- The Tevatron Comparison:
 - The Good:
 - * Various production mechanisms
→ Open to all states
 - * Large production cross sections
 - The Bad:
 - * Even larger total cross section
 - * Selective triggers needed! ℓ , SVT
 - The Ugly:
 - * Large Combinatorial background!

X(3872) Mystery – Introduction

- Example: Production Mechanism:
 J/ψ Prompt & B Production

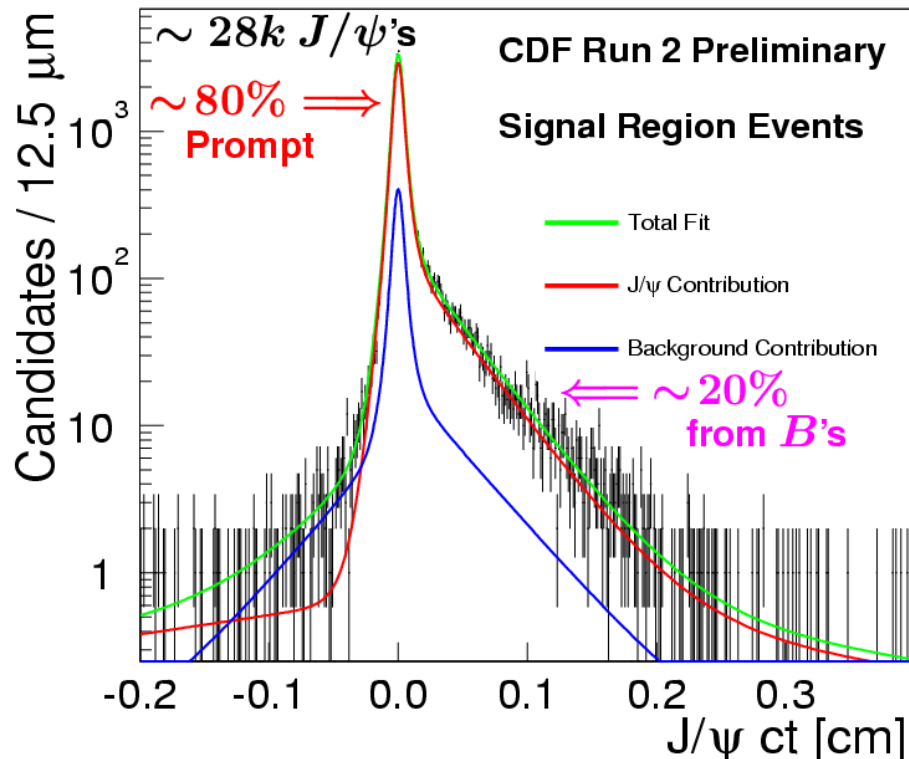

- B fraction depends on
 - kinematics

- CDF Search:
 - $\sim 2\text{M}$ J/ψ (220 pb^{-1}) at CDF
 - Use inclusive $J/\psi\pi^+\pi^-X$
- Background suppression strategies:
 - minimum p_T 's
 - good silicon tracks
 - only tracks in fixed cone
- optimize $\psi(2s) \rightarrow J/\psi\pi^+\pi^-$
Scale to X signal

X(3872) Mystery –CDF Observation of X(3872)

- ~ 600 candidates around 3872 MeV
- $\sim 6k$ $\psi(2s)$ candidates

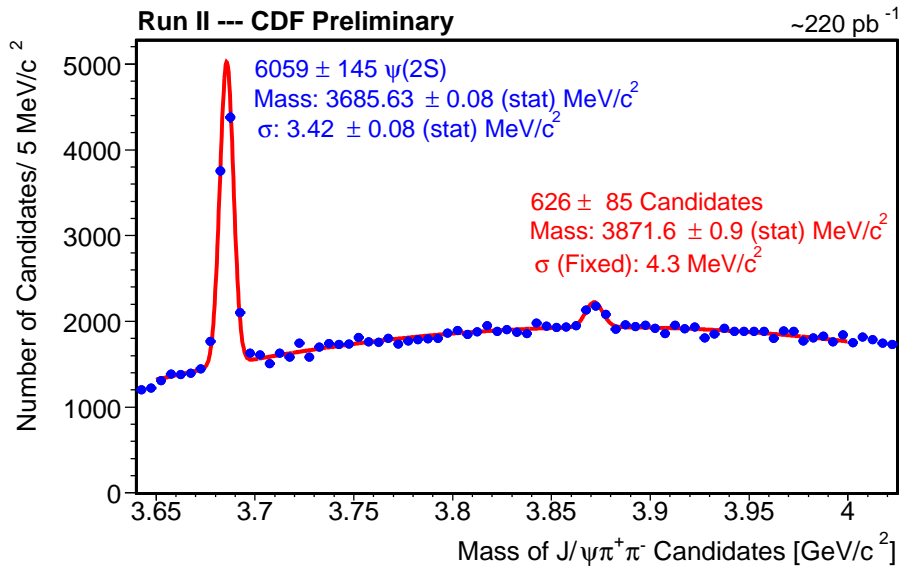

- Width **fixed** from $\psi(2S)$ extrapolation
 - help stabilize yield
 - no effect on mass

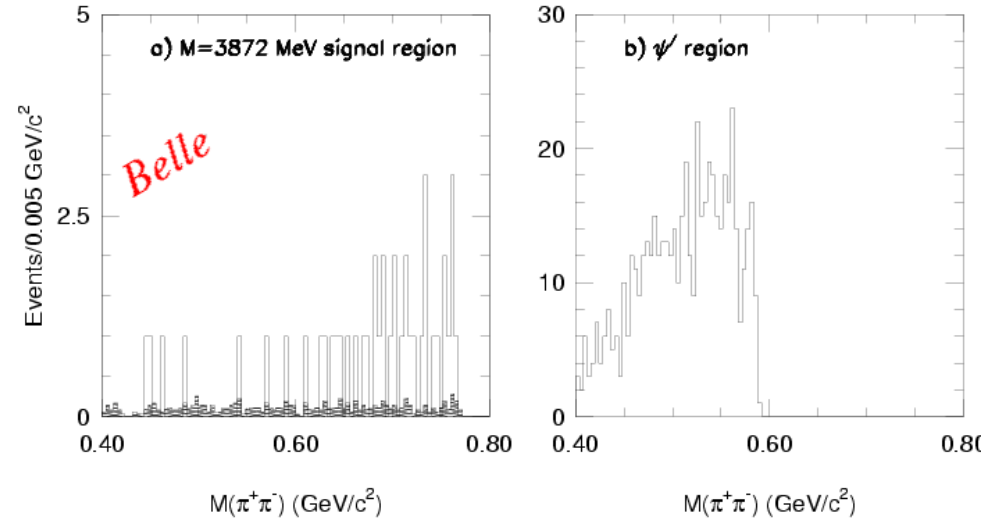

- Belle's signal favor **high** $m(\pi\pi)$
- **What happens** if apply $m(\pi\pi) > 500$ MeV/c?

X(3872) Mystery – CDF Observation of X(3872)

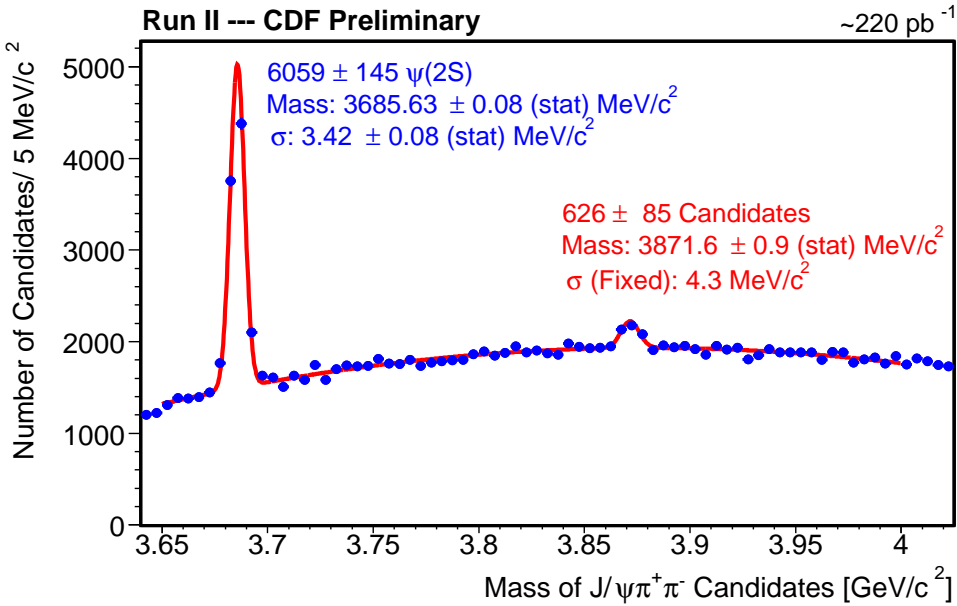

Significantly improve signal!

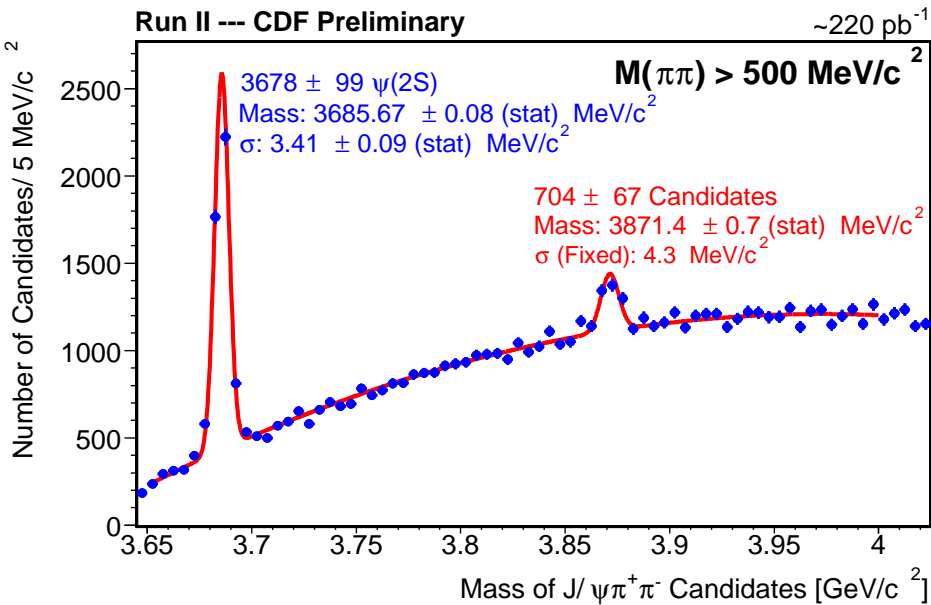

X(3872) Mystery –CDF Observation of X(3872)

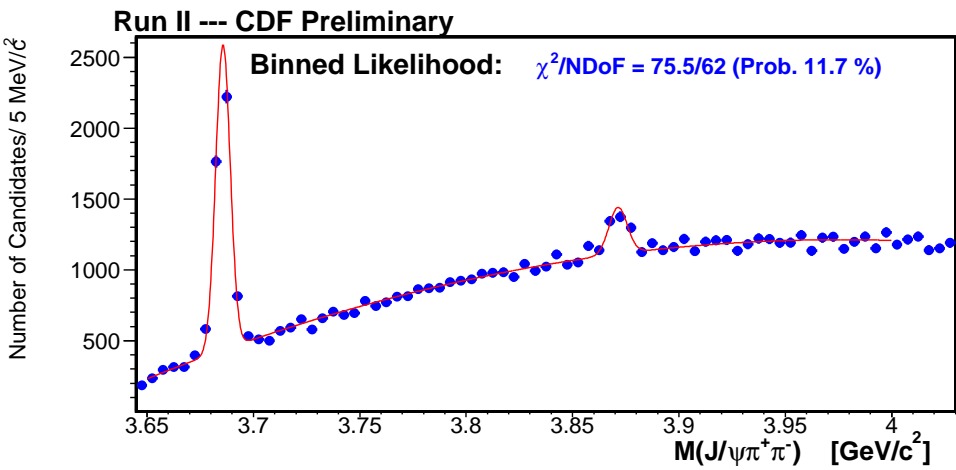

$$\text{Significance} = \sqrt{-2\ln(\mathcal{L})_0/\mathcal{L})_{max}}$$
$$= 10.9 \sigma$$

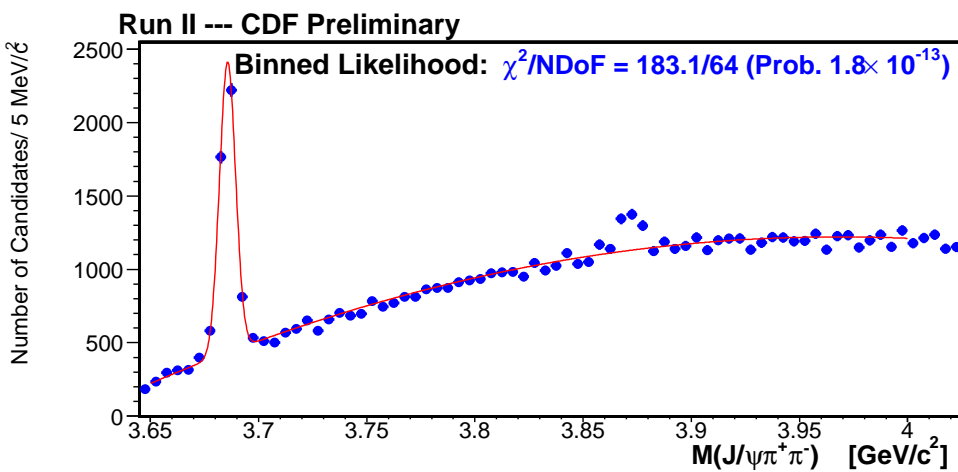

X(3872) Mystery –Prospects

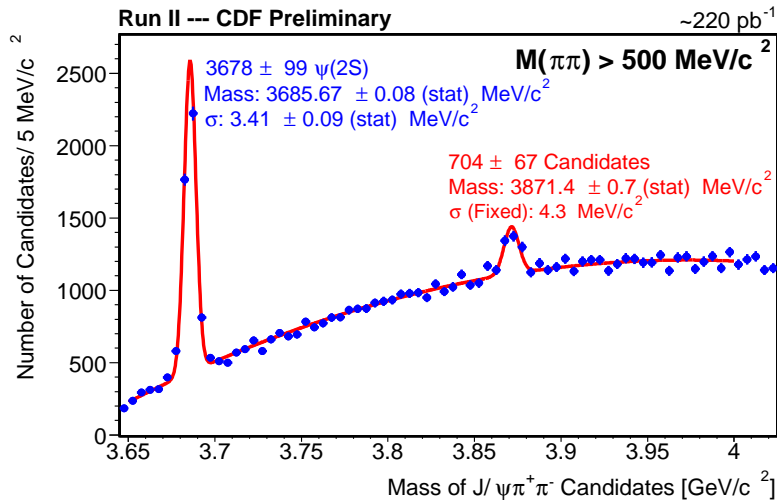

- $M = 3871.4 \pm 0.7 \pm 0.4$ MeV
 Belle: $3872.0 \pm 0.6 \pm 0.5$ MeV
- first error–stat, second–sys

- Good agreement, CDF \longleftrightarrow Belle
- $M(\psi') = 3685.67 \pm 0.08(stat)$ MeV
 PDG 02: 3685.96 ± 0.09 MeV
- Use $\psi(2s)$ to estimate sys: 0.4 MeV
- Belle: < 2.3 MeV. 90% C.L.
 Width: $<$ CDF detector Resolution.
- Yield: 704 ± 67 inclusive
 Belle: 35.7 ± 6.8 exclusive

X(3872) Mystery –Prospects

- What is **THIS**??
- Hints:
 - Charmonium **does not** decay to $J/\psi\rho$
 - $J/\psi\pi^0\pi^0$, $J/\psi\pi^+\pi^0$
 - Measure **Spin**–Angular distribution analysis
 - **Production** mechanism
 - ...
- CDF working on:
 - $m(\pi\pi)$ – Is it a ρ , probably not conclusive!
 - Trying **angular** distribution? Difficult!?
 - **Prompt vs Long lived** production mechanism? lifetime fit.
- Note: $X/\psi(2s)$ rate is **large!** like D-state?

Λ_b Lifetime—the Puzzle

- Heavy Quark Expansion:

- $\Gamma = \Gamma_0 + \frac{\Lambda^2}{m_b^2}\Gamma_2 + \frac{\Lambda^3}{m_b^3}\Gamma_3 + \dots$

- $\frac{\Lambda}{m_b} \simeq \frac{M_B - m_b}{m_b} \simeq 0.1$

- Γ_0 : *spectator model*

All b-hadrons have same lifetime!

- No $1/m_b$ corrections

- Γ_2 (due to isospin): *Fermi Motion* and *chromomagnetic interaction*

- Γ_3 : *Weak annihilation* and *Pauli interference*

- Theoretical prediction for b-hadrons until the end of 2001

$$\tau_{\Lambda_b}/\tau_{B_d} = 0.90\dots 1.00 \text{ ps}$$

- Experimental results for b-hadrons, Heavy Flavor Averaging Group, 2003

$$\tau_{\Lambda_b}/\tau_{B_d} = 0.789 \pm 0.034 \text{ ps}$$

- A **puzzle** – Λ_b lifetime

Current Λ_b Lifetime Measurements (before CDF II)

Experiment	DataSet	#event	Channel	$\tau_{\Lambda_b} (ps)$
ALEPH	91-95	$705 \pm 32 \pm 62$	$\Lambda \ell$	$1.20 \pm 0.08 \pm 0.06$
	$4 \times 10^6 Z$	137 ± 2	$\Lambda_c \ell$ $\Lambda_c \rightarrow pK\pi$ $\Lambda_c \rightarrow pK_s^0$ $\Lambda_c \rightarrow \Lambda\pi$ $\Lambda_c \rightarrow \Lambda\pi\pi\pi$	$1.18^{+0.13}_{-0.12} \pm 0.03$
DELPHI	91-94	82 ± 9	$\Lambda_c \ell$ $\Lambda_c \rightarrow pK\pi$ $\Lambda_c \rightarrow pK_s^0$ $\Lambda_c \rightarrow pK_s^0\pi\pi$	$1.11^{+0.19}_{-0.18} \pm 0.05$
	$3.6 \times 10^6 Z$	235 ± 25	$p\ell$	$1.19 \pm 0.14 \pm 0.07$
OPAL	90-94	490	$\Lambda \ell$ I.P.	$1.21^{+0.15}_{-0.13} \pm 0.10$
	$3.6 \times 10^6 Z$	356	$\Lambda \ell$ vtx	$1.15 \pm 0.12 \pm 0.06$
	90-95	129 ± 25	$\Lambda_c \ell$ $\Lambda_c \rightarrow pK\pi$	$1.29^{+0.24}_{-0.22} \pm 0.06$
	$4.4 \times 10^6 Z$			
CDF I	92-95	197 ± 25	$\Lambda_c \ell$ $\Lambda_c \rightarrow pK\pi$	$1.32 \pm 0.15 \pm 0.06$
	110 pb^{-1}			

- Dominated by **statistical** error!

Λ_b Lifetime-at CDF

- CDF Situation

- Exclusive decays: $\Lambda_b \rightarrow J/\psi \Lambda$

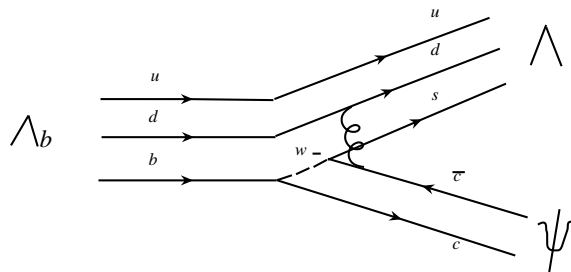

- Semileptonic decays: $\Lambda_b \rightarrow \ell \bar{\nu}_\ell \Lambda_c$

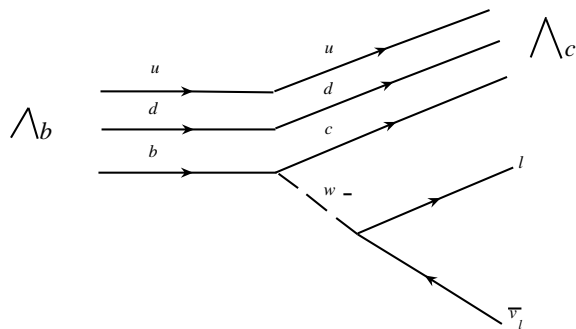

- Lifetime measurement: proper time

$$c\tau = \frac{L}{\beta\gamma} = L_{xy} \cdot \frac{m_{\Lambda_b}}{p_T(\Lambda_b)}$$

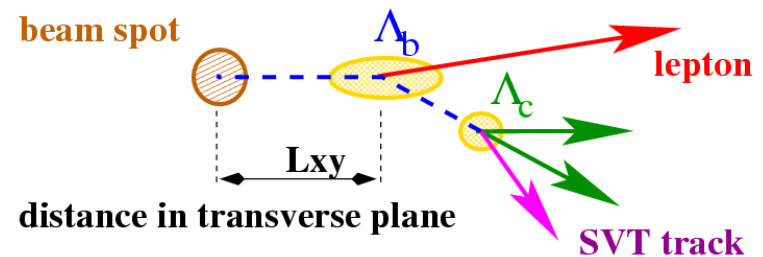

- **Exclusive:** $m_{\Lambda_b}, p_T(\Lambda_b)$ reconstructed
- **Inclusive:** $m_{\Lambda_b}, p_T(\Lambda_b)$ missing due to ν
- Exclusive \rightarrow low **systematic** uncertainty
- Inclusive \rightarrow low **statistic** uncertainty
- **Complementary!**

Λ_b Lifetime—at CDF

- Preliminary result from $\Lambda_b \rightarrow J/\psi \Lambda$

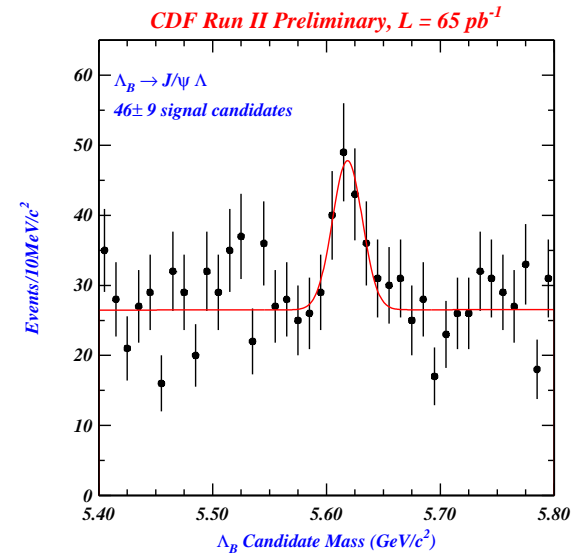
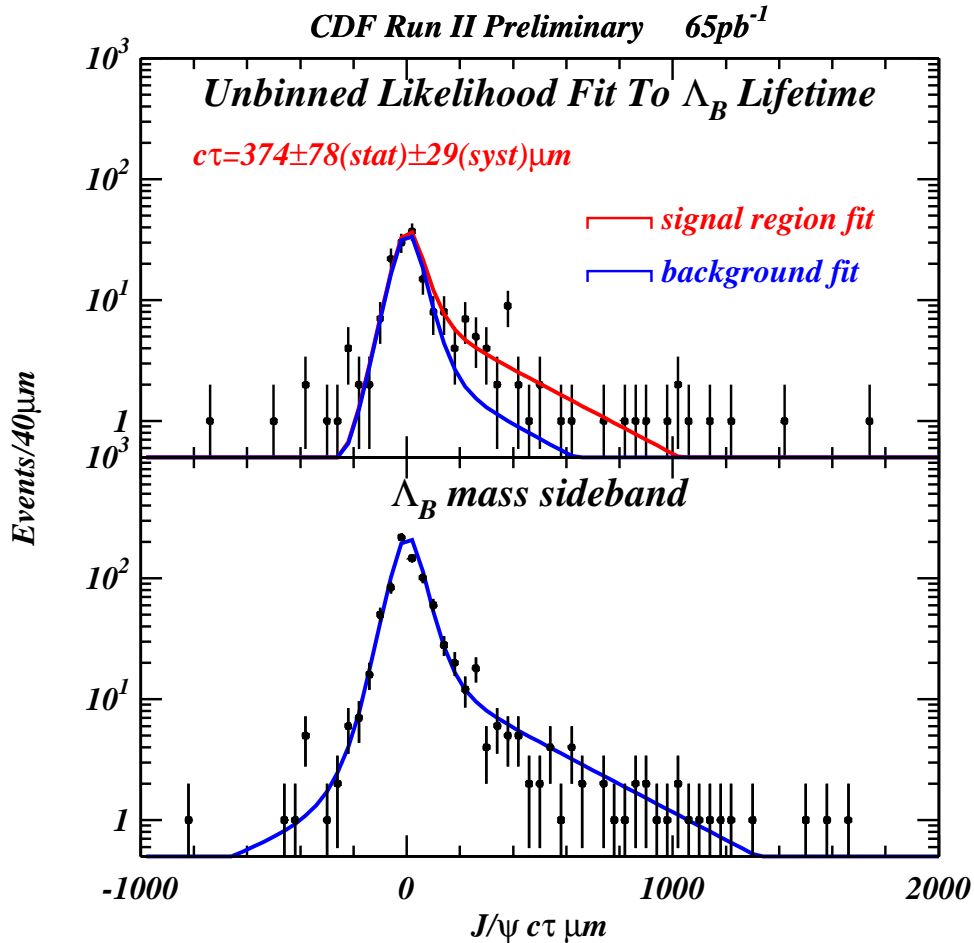

- $c\tau(\Lambda) = 374 \pm 78 \pm 29 \mu\text{m}$
 $1.25 \pm 0.26 \pm 0.10 \text{ ps}$
 $369 \pm 24 \mu\text{m}$ PDG 2002
 $1.229 \pm 0.08 \text{ ps}$
- Sys. uncertainty \rightarrow current V0 tracking
- **Statistics too low!**
- $\Lambda_c \pi$ channel, unknown \leftarrow trigger bias

Λ_b Lifetime— $\Lambda_b \rightarrow \ell \bar{\nu}_\ell \Lambda_c, \Lambda_c \rightarrow p K \pi$ Reconstruction

- **Trigger** confirmation:
 $p_T(\ell) > 4 \text{ GeV}$ + **SVT** track with
 $p_T > 2 \text{ GeV}, d_0 > 120 \mu m$
- Good **silicon** tracks
- Fixed **cone size** around lepton $\leftarrow \Lambda_c$
- Λ_b vertex \leftarrow **intersection** of ℓ and Λ_c

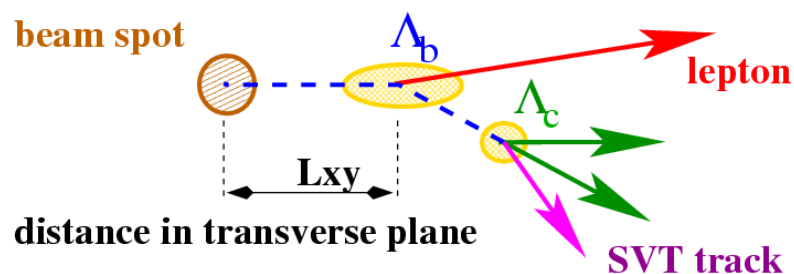

- Large background:
 - **Combinatorial** background! Always
 - $X \ell^- D^+(K \pi \pi), X \ell^- D_s^+(K K \pi) \leftarrow B$
 - Identify **proton**/pion is the solution!
- Small background:
 - $\Lambda_b \rightarrow \Lambda_c^{+*} \ell \nu, \Lambda_c^{+*} \rightarrow \Lambda_c \pi^+ \pi^-$
 - $\bar{B} \rightarrow \Lambda_c^+ D_s^- \bar{N} X, D_s^- \rightarrow \ell^- X$
 - $\Lambda_b \rightarrow \Lambda_c^+ D_s^- X, D_s^- \rightarrow \ell^- X$
 - $3.5 < m_{\ell + \Lambda_c} < 5.6 \text{ GeV}/c^2$
 $p_T(\Lambda_c) > 5 \text{ GeV}$
- Other background:
 - Monitor $\ell^+ \Lambda_c^+$ and $\ell^- \Lambda_c^-$

Λ_b Lifetime— $\Lambda_b \rightarrow \ell \bar{\nu}_\ell \Lambda_c, \Lambda_c \rightarrow p K \pi$ Reconstruction

- Particle ID(PID) on proton

- New Time-of-Flight(ToF)
- Excellent resolution, $d \sim 60\%$ Efficiency

CDF Time-of-Flight : Tevatron store 860 - 12/23/2001

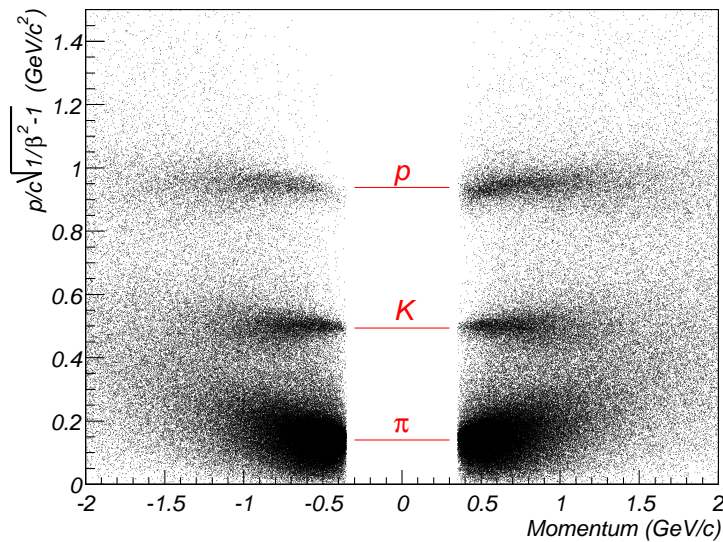

- dE/dx , $\sim 100\%$ Efficiency
- Need recalibration
- Combined χ^2 prob. of ToF and dE/dx
- First analysis used ToF for PID at CDF

- PID control sample: $\Lambda \rightarrow p\pi$

- $\Lambda \rightarrow p\pi^-$, good sample to test $p\pi$ ID
- $K_s \rightarrow \pi^+\pi^-$ reflection

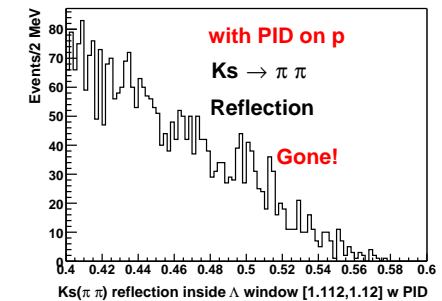
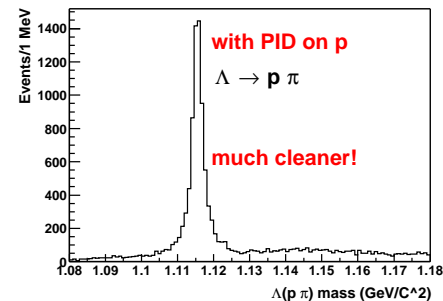
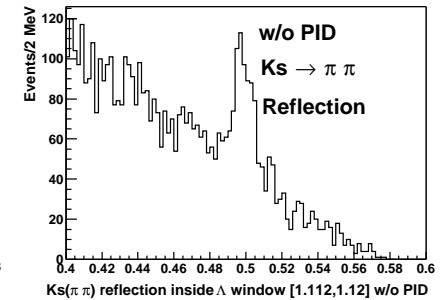
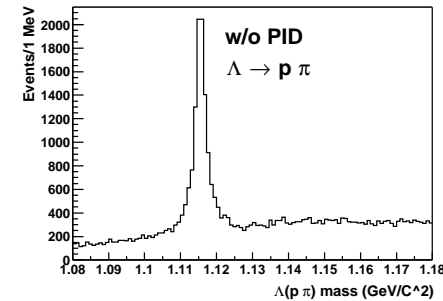

Λ_b Lifetime— $\Lambda_b \rightarrow \ell \bar{\nu}_\ell \Lambda_c, \Lambda_c \rightarrow pK\pi$ Reconstruction

- 586 events in $e/\mu + SVT$ sample, Largest Λ_b sample

- $\ell^+ \Lambda_c^-$ compare with wrong charge combinations $\ell^+ \Lambda_c^+, \ell^- \Lambda_c^-$

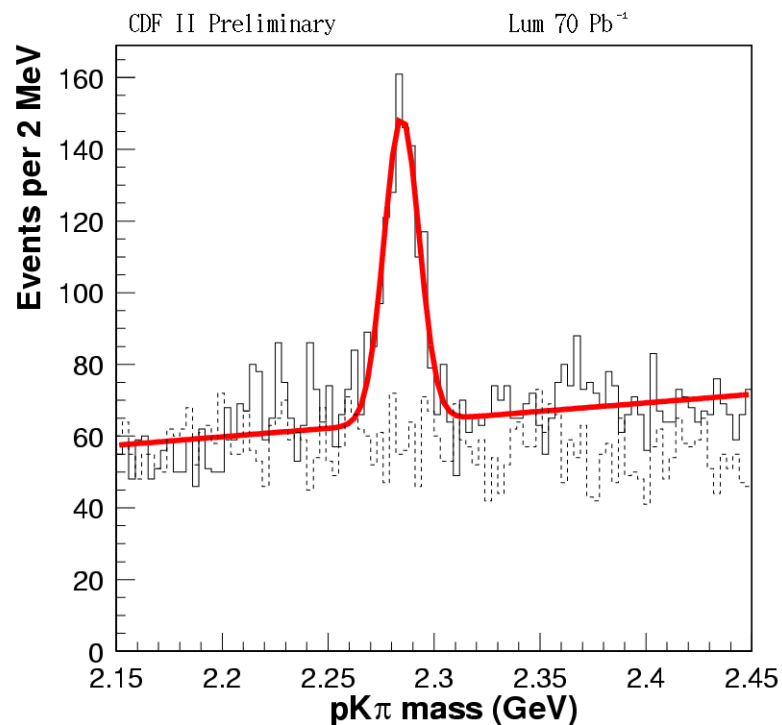
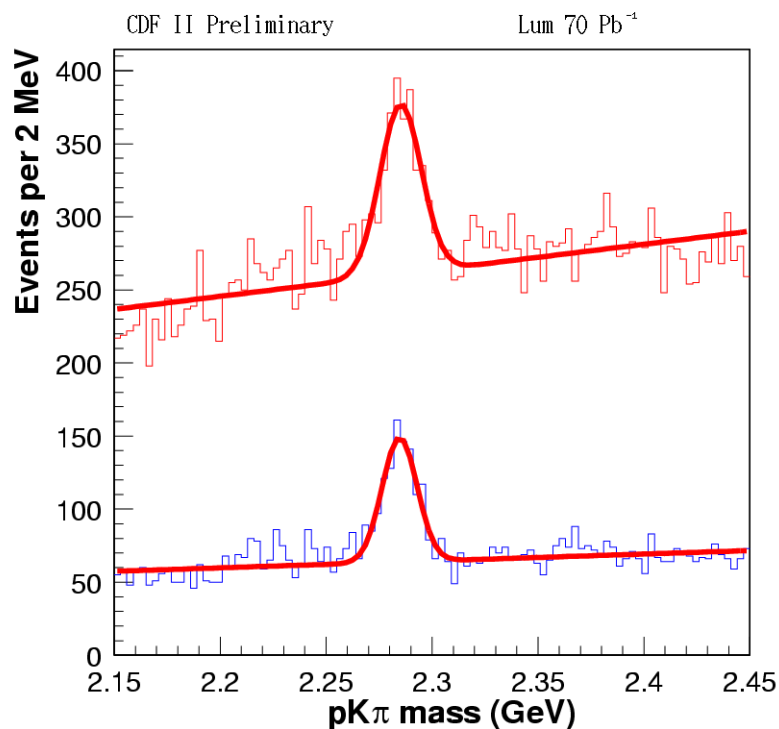

- Upper—no PID, lower—PID on proton
- Reduce bkg $\div 4$, keep $\sim 60\%$ signal

- Solid line—right charge combinations
- Dash line—wrong charge combinations

Λ_b Lifetime— $\Lambda_b \rightarrow \ell \bar{\nu}_\ell \Lambda_c$ Reconstruction

- Currently for lifetime only fit 345 evts
 μ +SVT sample
 e +SVT coming soon

- **Two** proton PID scenarios:
proton track has dE/dx only
proton track has both dE/dx and ToF

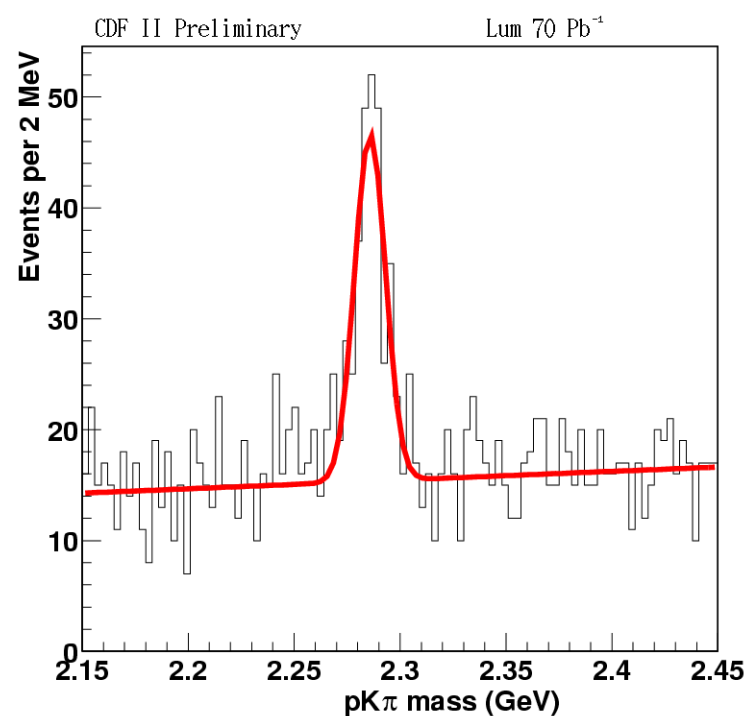
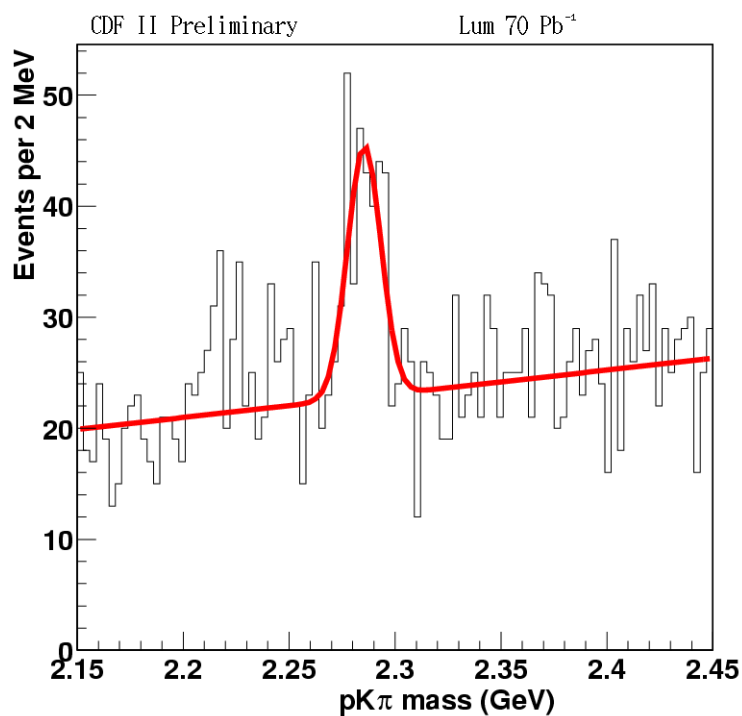

- Proton track has **dE/dx** only

- Proton track has both **dE/dx** and **ToF**

Λ_b Lifetime–Lifetime Measurement Method

- Lifetime ← proper time distribution
- Proper decay length:

- m_{Λ_b} from PDG
- Define:

$$c\tau = \frac{L}{\beta\gamma} = L_{xy} \cdot \frac{m_{\Lambda_b}}{p_T(\Lambda_b)}$$

$$K = \frac{p_T(\Lambda_{c\ell})}{p_T(\Lambda_b)}$$

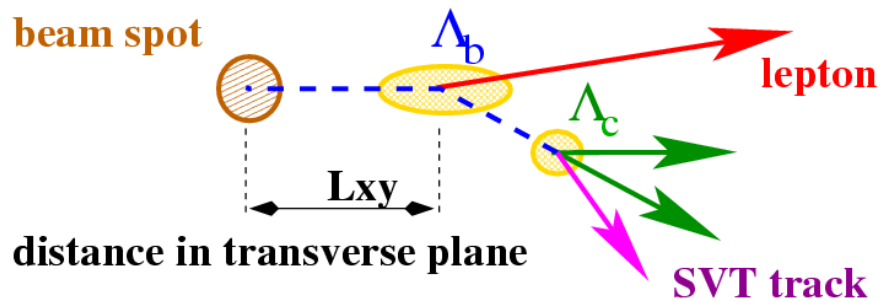

$$\implies c\tau = L_{xy} \cdot \frac{m_{\Lambda_b}}{p_T(\Lambda_{c\ell})} \cdot K = XK$$

- $m_{\Lambda_b}?, p_T(\Lambda_b)? \leftarrow$ missing ν

- X–pseudo proper time
- K from Monte Carlo
Large uncertainty source

Λ_b Lifetime–Lifetime Measurement Method

- Momentum correction due to missed ν

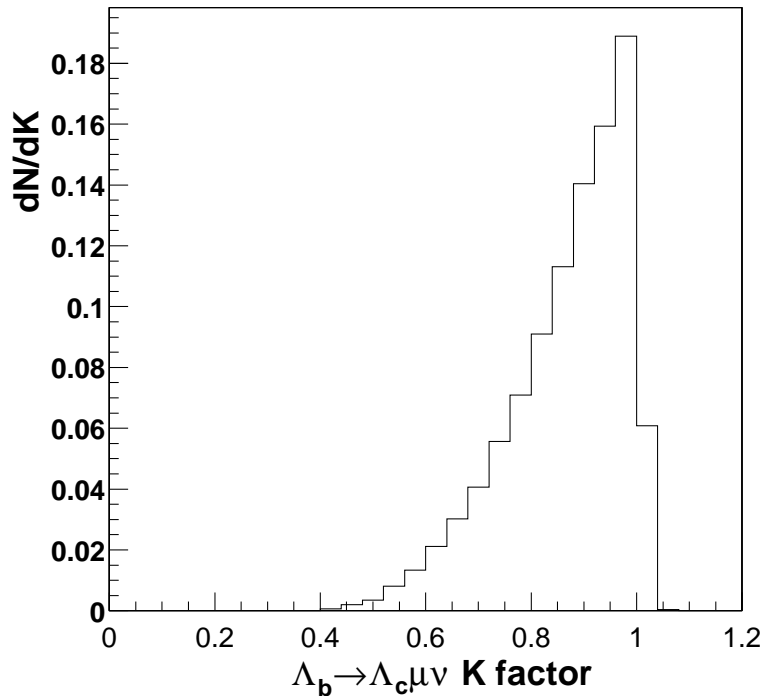

- K factor shape used in convolution of likelihood fit

- Λ_b SVT efficiency vs true proper time

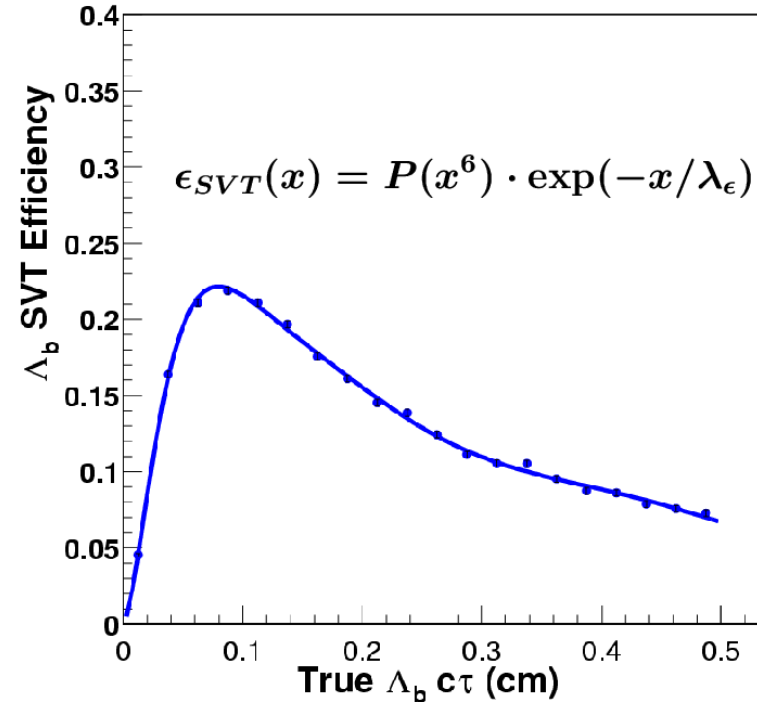

- Parametric MC for SVT, $p_T > 2\text{GeV}$
 $d_0 > 120\mu\text{m}$
- Validate MC on high stat. ℓD sample

Λ_b Lifetime–Lifetime Measurement Method

- Unbinned likelihood fit
Event by Event

- Total likelihood

$$\ln \mathcal{L} = \sum_{i=1}^{N_s} \ln \mathcal{F} + \sum_{i=1}^{N_b} \ln \mathcal{F}_b$$

$$\mathcal{F} = (1 - f_b) \mathcal{F}_s + f_b \mathcal{F}_b$$

- Sig. Prob. Density Function(P.D.F)

$$\mathcal{F}_s = [\epsilon_{SVT}(KX') e^{-\frac{KX'}{c\tau\Lambda_b}}] \otimes G(X' - X, s\sigma) \otimes H(K)$$

- Background P.D.F: parametric

- ϵ_{SVT} –the correction due to SVT track
- $G(x-x',s\sigma)$ –Gaussian resolution function
- σ –the measurement error
- s –scale factor due to our imperfect modeling of the measurement error in reconstruction.
- s –determined from an independent control data sample(has no SVT bias) inclusive lepton sample

Λ_b Lifetime–Lifetime Measurement Method

- **Simultaneous** fit:
signal+background(**both float**)

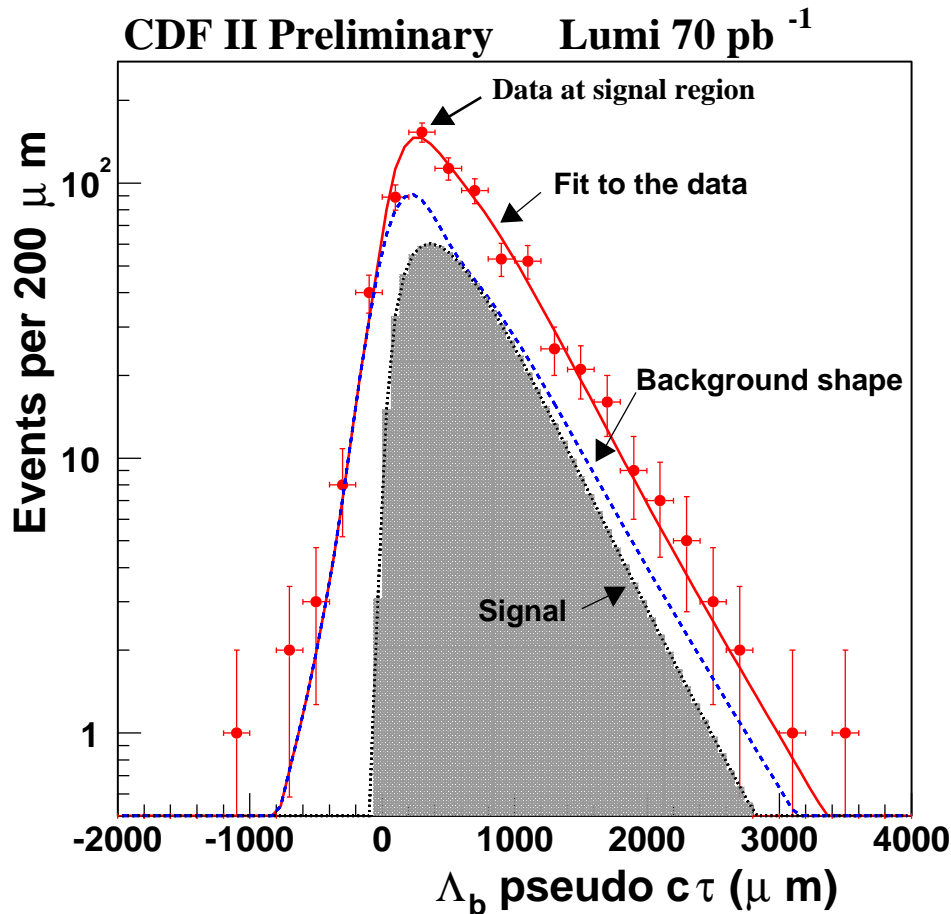

- Fitting result in 70 pb⁻¹ μ +SVT sample:

$$\sigma_{c(\tau_{\Lambda_b})} (\text{stat}) : \quad \sim 40\mu\text{m}(0.13\text{ps})$$

$$\sigma_{c(\tau_{\Lambda_b})} (\text{stat, CDF II})$$

$$(\Lambda_b \rightarrow J/\psi\Lambda) : \quad \sim 78\mu\text{m}(0.26\text{ps})$$

$$\sigma_{c(\tau_{\Lambda_b})} (\text{PDG, 2002}) : \quad \sim 24\mu\text{m}(0.08\text{ps})$$

- Adding e +SVT sample, $\times 2$
Using 220 pb⁻¹, $\times 3$
Potential $\sigma_{c(\tau_{\Lambda_b})}(\text{stat})$ in this channel :
 $40(0.13)/\sqrt{6} \sim 16\mu\text{m}(0.05\text{ps})$
- Central value pending completion of
 $B^+ \rightarrow \ell^+ \nu D^0$ control sample studies
 - New trigger to be understood
 - $B^0 \rightarrow \ell^+ D^{*-}$ cross talk
 - In progress

Λ_b Lifetime–Discussion

- Systematic uncertainties:

source	value
SVT bias	15 μm
Λ_c^* (30% contribution)	11 μm
event selection bias	9 μm
PID bias	3 μm
background normalization	3 μm
fitting procedure	2 μm
$L_{xy}(\Lambda_b)$ error scale factor	2 μm
total	21 μm

- Leading errors: SVT bias, Λ_c^*

- Reduce **stat** error:

- more **data**
- more **channels**

- Reduce **sys** error:

- **SVT**, more studies from high stat sample: $B \rightarrow \ell\nu D^0$ studies, $\sim 5\mu\text{m}$?
- Λ_c^* uncertainty, possible ways:
 - increase $p_T(\Lambda_c)$, lose stat.
 - increase $m(\ell\Lambda_c)$, lose stat.
- spectroscopy** studies

- **Combine** exclusive and inclusive channels

Summary and Outlook

- **Many** results in heavy hadron spectroscopy: B_s , Λ_b masses, ...
- **First** result for heavy baryon lifetime from $\Lambda_b \rightarrow J/\psi\Lambda$ exclusive channel:
 $c\tau = 374 \pm 78(\text{sta}) \pm 29(\text{sys}) \mu\text{m}$
- Confirmed **X(3872)** discovered by Belle, measured its mass at CDF as:
 $M = 3871.4 \pm 0.7(\text{stat}) \pm 0.4(\text{sys}) \text{ MeV}$
New studies in progress
- More **data** coming soon
- Prepare for **mixing**:
 B^0 as test case, have seen $B_s \rightarrow D_s\pi$
preparing **B_s mixing**
- More **excitement** in the future!

Tevatron B/Charm Physics

- Heavy Flavor(c, b, t) Production

- Interactions of **partons** from p and \bar{p}
- **Fragmentation** thereafter, **separately**
- **LO**: $q\bar{q}$ annihilation (a)+ gluon fusion(b,c,d)
- $q\bar{q}$ dominate, $2M_q/\sqrt{s} \geq 0.1$, t quark
- Others dominate, $2M_q/\sqrt{s} \ll 1$, b, c

- **Leading order** production

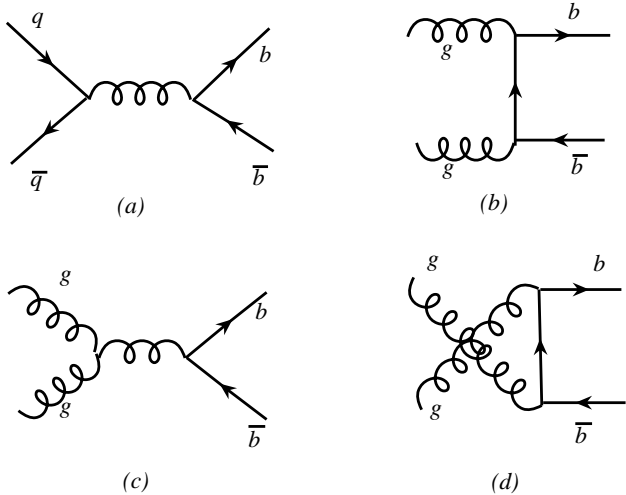

- Schematic of **fragmentation** process

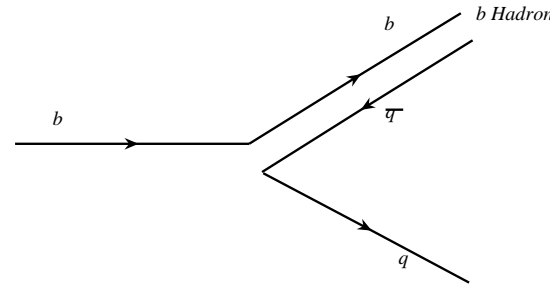

- **Higher order** $b(c,t)$ production

