

II. FACILITY DESIGN STANDARDS



BIKEWAY & WALKWAY STANDARDS

QUICK REFERENCE TABLE & METRIC CONVERSION

BIKEWAYS

	"ENGLISH"		METRIC	
Bike lane	6	feet	1.8	meters
Shoulder bikeway	6	feet	1.8	meters
Wide lane	14-15	feet	4.2-4.5	meters
Multi-use path	10	feet	3	meters
(high use)	12	feet	3.6	meters
Bike lane stripe	8	inches	200	millimeters
Shoulder stripe	4	inches	100	millimeters
Vertical clearance	10	feet	3	meters

WALKWAYS

	"ENGLISH"		METRIC	
Sidewalk*	6	feet	1.8	meters
(on bridge)	7	feet	2.1	meters
(high use)	8	feet	2.4	meters
Shy distance	2	feet	0.6	meters
Sign height	7	feet	2.1	meters

* *Clear dimensions, exclusive of curb and obstructions*

II.1. ON-ROAD BIKEWAYS

A. TYPES OF BIKEWAYS

Bicycles are legally classified as vehicles and are ridden on most public roads in Oregon, which are open to bicycle traffic with a few exceptions (mostly the freeways in the metropolitan area of Portland). Roadways must be designed to allow bicyclists to ride in a manner consistent with the vehicle code.

A **bikeway** is created when a road has the appropriate design treatment to accommodate bicyclists, based on motor vehicle traffic volumes and speed. The basic design treatments used to accommodate bicycle travel on the road are: shared roadway, shoulder bikeway, or bike lane. Another type of facility is separated from the roadway: multi-use path.

SHARED ROADWAY – On a shared roadway, bicyclists and motorists share the same travel lanes. A motorist will usually have to cross over into the adjacent travel lane to pass a bicyclist. Shared roadways are common on neighborhood streets and on rural roads and highways. There are two treatments that enhance shared roadways for cyclists:

- **WIDE OUTSIDE LANE** – Where shoulder bikeways or bike lanes are warranted but cannot be provided due to severe physical constraints, a wide outside lane may be provided to accommodate bicycle travel. A wide lane usually allows an average size motor vehicle to pass a bicyclist without crossing over into the adjacent lane.
- **BICYCLE BOULEVARDS** – A modification of the operation of a local street to function as a through street for bicycles while maintaining local access for automobiles. Traffic calming devices control traffic speeds and discourage through trips by automobiles. Traffic controls limit conflicts between automobiles and bicycles and give priority to through bicycle movement.

SHOULDER BIKEWAY – Paved roadway shoulders on rural roadways provide a suitable area for bicycling, with few conflicts with faster moving motor vehicle traffic. Most rural bicycle

travel on the state highway system is accommodated on shoulder bikeways.

BIKE LANE – A portion of the roadway designated for preferential use by bicyclists. Bike lanes are appropriate on urban arterials and major collectors. They may be appropriate in rural areas where bicycle travel and demand is substantial. Bike lanes must always be well marked to call attention to their preferential use by bicyclists.

MULTI-USE PATH (previously called “Bike Path”) – A facility separated from motor vehicle traffic by an open space or barrier, either within the roadway right-of-way or within an independent right-of-way. These are typically used by pedestrians, joggers, skaters and bicyclists as two-way facilities. Multi-use paths are appropriate in corridors not well served by the street system (if there are few intersecting roadways), to create short cuts that link destination and origin points, and as elements of a community trail plan. See chapter 3 for design standards.

Note: bikeways are listed in increasing order of complexity, with no implied order of preference.



This bridge was restriped to include wider shoulders

B. DESIGN STANDARDS

B.1. SHARED ROADWAYS

There are no specific bicycle standards for most shared roadways; they are simply the roads as constructed. Shared roadways function well on local streets and minor collectors, and on low-volume rural roads and highways. Mile per mile, shared roadways are the most common bikeway type.

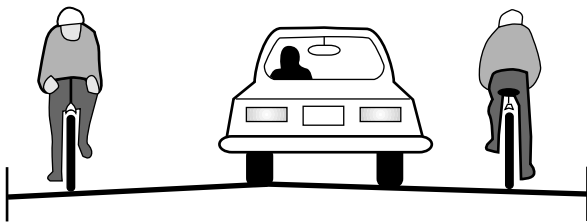

Figure 10: Shared roadway

Shared roadways are suitable in urban areas on streets with low speeds - 40 km/h (25 MPH) or less - or low traffic volumes (3,000 ADT or less, depending on speed and land use).

In rural areas, the suitability of a shared roadway decreases as traffic speeds and volumes increase, especially on roads with poor sight distance. Where bicycle use or demand is potentially high, roads should be widened to include shoulder bikeways where the travel speeds and volumes are high.



Residential street with young cyclist

Many urban local streets carry excessive traffic volumes at speeds higher than they were designed to carry. These can function as shared roadways if traffic speeds and volumes are

reduced. There are many “traffic calming” techniques that can make these streets more amenable to bicycling on the road (see page 159 for more discussion of traffic calming and its effect on bicycling and walking).

B.1.a. Wide Curb Lanes

A wide curb lane may be provided where there is inadequate width to provide the required bike lanes or shoulder bikeways. This may occur on retrofit projects where there are severe physical constraints, and all other options have been pursued, such as removing parking or narrowing travel lanes. Wide curb lanes are not particularly attractive to most cyclists, they simply allow a motor vehicle to pass cyclists within a travel lane.

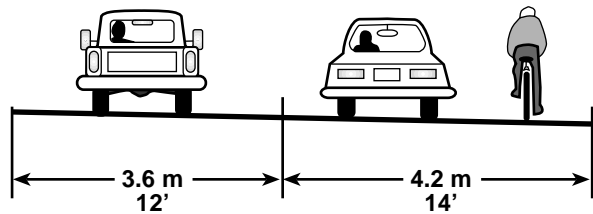

Figure 11: Wide curb lane

To be effective, a wide lane must be at least 4.2 m (14 ft) wide, but less than 4.8 m (16 ft). Usable width is normally measured from curb face to the center of the lane stripe, but adjustments need to be made for drainage grates, parking and the ridge between the pavement and gutter. Widths greater than 4.8 m (16 ft) encourage the undesirable operation of two motor vehicles in one lane. In this situation, a bike lane or shoulder bikeway should be striped.



Wide curb lane

	ADT under 250	ADT 250-400	ADT 400-DHV* 100	DHV 100-200	DHV 200-400	DHV over 400
Rural Arterials	1.2 m (4 ft)	1.2 m (4 ft)	1.8 m (6 ft)	1.8 m (6 ft)	2.4 m (8 ft)	2.4 m (8 ft)
Rural Collectors	0.6 m (2 ft)	0.6 m (2 ft)	1.2 m (4 ft)	1.8 m (6 ft)	2.4 m (8 ft)	2.4 m (8 ft)
Rural Local Route	0.6 m (2 ft)	0.6 m (2 ft)	1.2 m (4 ft)	1.8 m (6 ft)	1.8 m (6 ft)	2.4 m (8 ft)

**DHV (Design Hour Volume) is the expected traffic volume in the peak design hour (usually at commuter times); usually about 10% of ADT in urban areas, higher on rural highways with high recreational use (beach access, ski resorts, etc.)*

Table 7: Standard rural highway shoulder widths

B.2. SHOULDER BIKEWAYS

Paved shoulders are provided on rural highways for a variety of safety, operational and maintenance reasons:

- Space is provided for motorists to stop out of traffic in case of mechanical difficulty, a flat tire or other emergency;
- Space is provided to escape potential crashes;
- Sight distance is improved in cut sections;
- Highway capacity is improved;
- Space is provided for maintenance operations such as snow removal and storage;
- Lateral clearance is provided for signs and guardrail;
- Storm water can be discharged farther from the pavement; and
- Structural support is given to the pavement.

B.2.a. Width Standards

In general, the shoulder widths recommended for rural highways in the ODOT Highway Design Manual serve bicyclists well. The above table should be used when determining roadway shoulder widths.

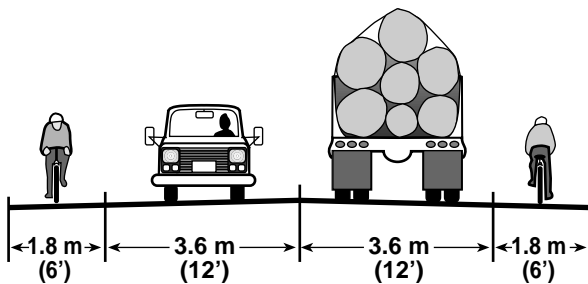

Min: 1.5 m (5') against curb, parking or guardrail, 1.2 m (4') open shoulder

Figure 12 : Shoulder bikeway

When providing shoulders for bicycle use, a width of 1.8 m (6 ft) is recommended. This allows a cyclist to ride far enough from the edge of pavement to avoid debris, yet far enough from passing vehicles to avoid conflicts. If there are physical width limitations, a minimum 1.2 m (4-ft) shoulder may be used. Shoulders against a curb face, guardrail or other roadside barriers must have a 1.5 m (5-ft) minimum width or 1.2 m (4 ft) from the longitudinal joint between a monolithic curb and gutter and the edge of travel lane.



Shoulder bikeway

On steep grades, it is desirable to maintain a 1.8 m (6-ft), (min. 1.5 m [5-ft]) shoulder, as cyclists need more space for maneuvering.

Note: many rural roads are 8.4 m (28 ft) wide, with fog lines striped at 3.3 m (11 ft) from centerline. The remaining 0.9 m (3 ft) should not be considered a shoulder bikeway (min. width 1.2 m {4 ft}); these are still considered shared roadways, as most cyclists will ride on or near the fog line.



Cyclist on shoulder bikeway

B.2.b. Pavement Design

Many existing gravel shoulders have sufficient width and base to support shoulder bikeways. Minor excavation and the addition of 75-100 mm (3-4") of asphaltic concrete is often enough to provide shoulder bikeways. It is best to widen shoulders in conjunction with pavement overlays for several reasons:

- The top lift of asphalt adds structural strength;
- The final lift provides a smooth, seamless joint;
- The cost is less, as greater quantities of materials will be purchased; and
- Traffic is disrupted only once for both operations.

When shoulders are provided as part of new road construction, the pavement structural design should be the same as that of the roadway.

On shoulder widening projects, there may be some opportunities to reduce costs by building to a lesser thickness. 50-100 mm (2-4") of asphalt and 50-75 mm (2-3") of aggregate over

existing roadway shoulders may be adequate if the following conditions are met:

- There are no planned widening projects for the road section in the foreseeable future;
- The existing shoulder area and roadbed are stable and there is adequate drainage or adequate drainage can be provided without major excavation and grading work;
- The existing travel lanes have adequate width and are in stable condition;
- The horizontal curvature is not excessive, so that the wheels of large vehicles do not track onto the shoulder area (on roads that have generally good horizontal alignment, it may be feasible to build only the inside of curves to full depth); and
- The existing and projected ADT and heavy truck traffic is not considered excessive (e.g. under 10%).

The thickness of pavement and base material will depend upon local conditions, and engineering judgment should be used. If there are short sections where the travel lanes must be reconstructed or widened, these areas should be constructed to normal full-depth standards.

B.2.c. The Joint between the Shoulders and the Existing Roadway

The following techniques should be used to add paved shoulders to roadways where no overlay project is scheduled:

1. **Saw Cut:** A saw-cut 0.3 m (1 ft.) inside the existing edge of pavement provides the opportunity to construct a good tight joint. This eliminates a ragged joint at the edge of the existing pavement.

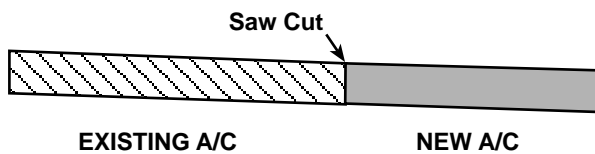

Figure 13 : Saw-cut joint

2. **Feathering:** “Feathering” the new asphalt onto the existing pavement can work if a fine mix is used and the feather does not extend across the area traveled by bicyclists.

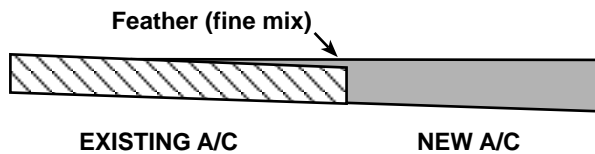

Figure 14: Asphalt feathering

3. **Grinder:** Where there is already some shoulder width and thickness available, a pavement grinder can be used to make a clean cut at the edge of travel lane, grade the existing asphalt to the right depth and cast aside the grindings in one operation, with these advantages:

- Less of the existing pavement is wasted;
- The existing asphalt acts as a base;
- There will not be a full-depth joint between the travel lane and the shoulder; and
- The grindings can be recycled as base for the widened portion.

New asphalt can then be laid across the entire width of the shoulder bikeway with no seams.

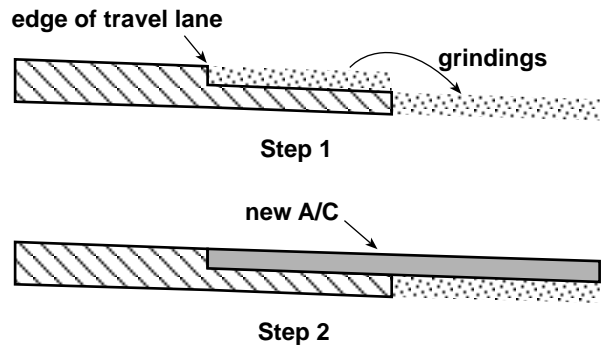

Figure 15 : Grinding out existing A/C

B.2.d. Gravel Driveways and Approaches

Wherever a highway is constructed, widened or overlaid, all gravel driveways and approaches should be paved back 4.5 m (15 ft) to prevent loose gravel from spilling onto the shoulders.

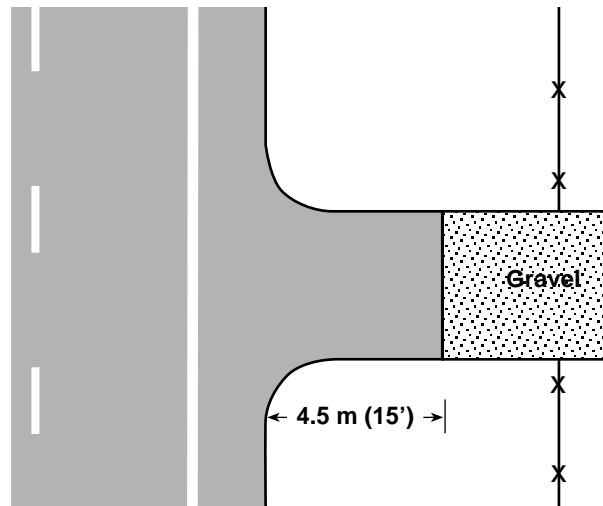

Figure 16: Paved driveway apron



Gravel driveway with paved apron

B.3. BIKE LANES

Bike lanes are provided on urban arterial and major collector streets. Bike lanes may also be provided on rural roadways near urban areas, where there is high potential bicycle use.

Bike lanes are generally not recommended on rural highways with posted speeds of 90 km/h (55 MPH): at channelized intersections, the speeds are too high to place a through bike lane to the left of right-turning vehicles (see chapter 4, Intersection Design). Shoulder bikeways, striped with a 100 mm (4") fog line, are the appropriate facility for these roads.

Bike lanes are one-way facilities that carry bicycle traffic in the same direction as adjacent motor-vehicle traffic; bike lanes should always be provided on both sides of a two-way street.

Well-designed urban arterials should have paved shoulders. Bike lanes are created by using a 200 mm (8") stripe and stencils. Motorists are prohibited from using bike lanes for driving and parking, but may use them for emergency avoidance maneuvers or breakdowns.

B.3.a. Width Standards

The standard width of a bike lane is 1.8 m (6 ft), as measured from the center of stripe to the curb or edge of pavement. This width enables cyclists to ride far enough from the curb to avoid debris and drainage grates, yet far enough from passing vehicles to avoid conflicts. By riding away from the curb, cyclists are more visible to motorists than when hugging the curb.

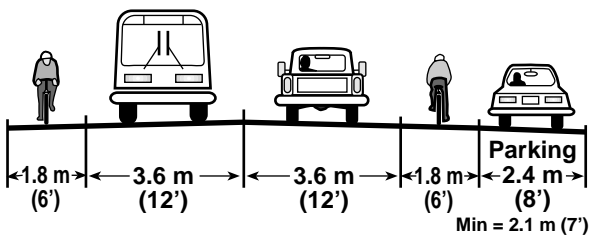

Min: 1.5 m (5') against curb, parking or guardrail; 1.2 m (4') open shoulder

Figure 17 : Bike lane standards

The minimum bike lane width is 1.2 m (4 ft) on open shoulders and 1.5 m (5 ft) from the face of a curb, guardrail or parked cars. A clear riding zone of 1.2 m (4 ft) is desirable if there is a

longitudinal joint between asphalt pavement and the gutter section. On roadways with flat grades, it may be preferable to integrate the bike lane and gutter to avoid a longitudinal joint in the bike lane.

Bike lanes wider than 1.8 m (6 ft) may be desirable in areas of very high use, on high-speed facilities where wider shoulders are warranted, or where they are shared with pedestrians. Care must be taken so they are not mistaken for a motor vehicle lane or parking area, with adequate marking or signing.

A bike lane must always be marked with pavement stencils and a 200 mm (8") wide stripe. This width increases the visual separation of a motor vehicle lane and a bike lane. It is a legal requirement in Oregon (OAR 734-20-055). Refer to page 145 for bike lane marking standards.

If parking is permitted, the bike lane must be placed between parking and the travel lane, and have a minimum width of 1.5 m (5 ft).



Bike lane next to parking

B.3.b. Bike Lanes on One-way Streets

Bike lanes on one-way streets should be on the right side of the roadway, except where a bike lane on the left decreases the number of conflicts (e.g., those caused by heavy bus traffic or dual right-turn lanes), if cyclists can safely and conveniently return to the right.

See page 146 for detailed information on bike lane configuration at intersections.

C. PRACTICES TO BE AVOIDED

The Oregon Department of Transportation has over 20 years of experience designing bikeways, and has also learned from local city and county experiences; some practices have proven to be poor ones.

C.1. SIDEWALK BIKEWAYS

Some early bikeways used sidewalks for both pedestrians and bicyclists. While in rare instances this type of facility may be necessary, or desirable for use by small children, in most cases it should be avoided.

Sidewalks are not suited for cycling for several reasons:

- Cyclists face conflicts with pedestrians;
- There may be conflicts with utility poles, sign posts, benches, etc.;
- Bicyclists face conflicts at driveways, alleys and intersections: a cyclist on a sidewalk is generally not visible to motorists and emerges unexpectedly. This is especially true of cyclists who ride opposing adjacent motor vehicle traffic: drivers do not expect a vehicle coming from this direction; and
- Bicyclists are put into awkward situations at intersections where they cannot safely act like a vehicle but are not in the pedestrian flow either, which creates confusion for other road users.

Cyclists are safer when they are allowed to function as roadway vehicle operators, rather than as pedestrians.

Where constraints do not allow full-width walkways and bikeways, solutions should be sought to accommodate both modes (e.g. narrowing travel lanes or reducing on-street parking). In some urban situations, preference may be given to accommodating pedestrians. Sidewalks should not be signed for bicycle use - the choice should be left to the users.

C.2. EXTRUDED CURBS

These create an undesirable condition when used to separate motor vehicles from cyclists: either one may hit the curb and lose control, with the motor vehicle crossing onto the bikeway or the cyclist falling onto the roadway.

At night, the curbs cast shadows on the lane, reducing the bicyclist's visibility of the surface. Extruded curbs make bikeways difficult to maintain and tend to collect debris. They are often hit by motor vehicles, causing them to break up and scatter loose pieces onto the surface.



Curb presents obstacle to cyclist

C.3. REFLECTORS & RAISED PAVEMENT MARKERS

These can deflect a bicycle wheel, causing the cyclist to lose control. If pavement markers are needed for motorists, they should be installed on the motorist's side of the stripe, and have a beveled front edge.



Raised reflectors force cyclists into travel lane

C.4. TWO-WAY BIKE LANE

This creates a dangerous condition for bicyclists. It encourages illegal riding against traffic, causing several problems:

- At intersections and driveways, wrong-way riders approach from a direction where they are not visible to motorists;
- Bicyclists closest to the motor vehicle lane have opposing motor traffic on one side and opposing bicycle traffic on the other; and
- Bicyclists are put into awkward positions when transitioning back to standard bike-ways.

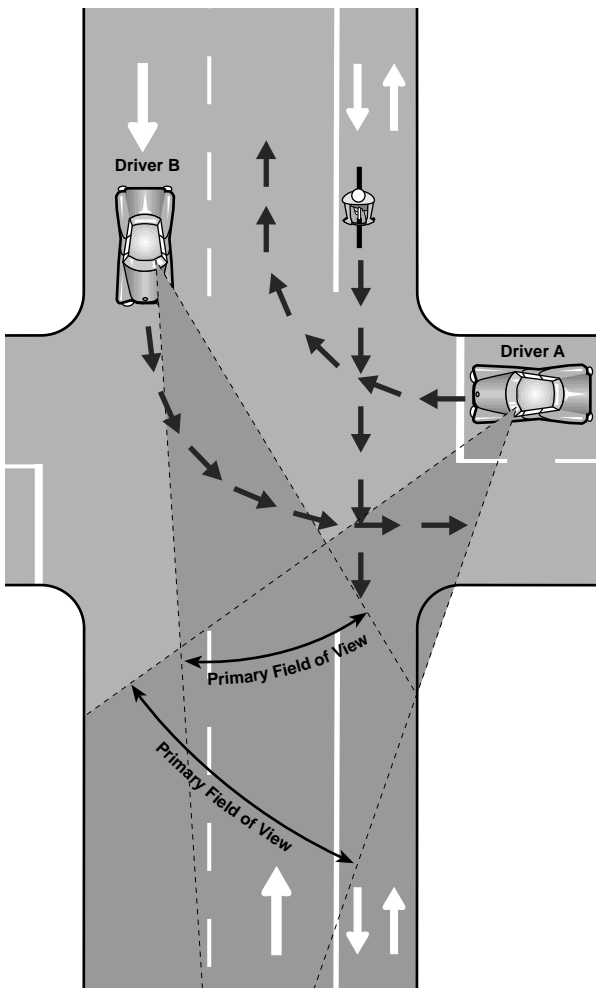

Right-turning driver A is looking for traffic on the left; Left-turning driver B is looking for traffic ahead; In both cases, a wrong-way bicyclist is not in the driver's main field of vision.

Figure 18: Problems with two-way bike lane

If constraints allow widening on only one side of the road, the centerline stripe may be shifted to allow for adequate travel lanes and bike lanes:

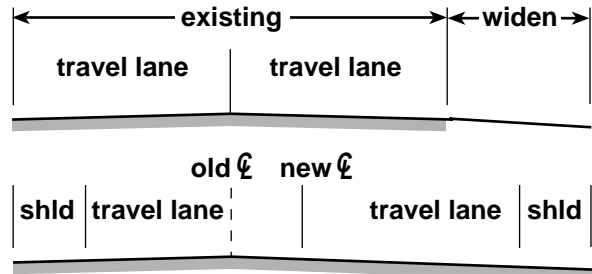

Figure 19: Shoulder widening on one side

C.5. CONTINUOUS RIGHT-TURN LANES

This configuration is difficult for cyclists: riding on the right puts them in conflict with right-turning cars, but riding on the left puts them in conflict with cars merging into and out of the right-turn lane. The best solution is to eliminate the continuous right-turn lane, consolidate accesses and create well-defined intersections.

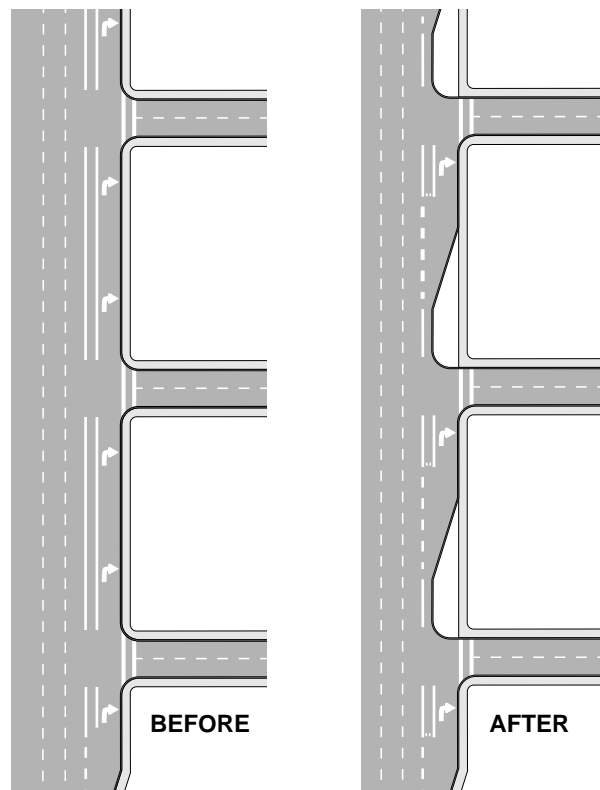

Figure 20: Continuous right-turn lane reconfigured to standard approaches

D. OTHER DESIGN CONSIDERATIONS

D.1. DRAINAGE GRATES

Care must be taken to ensure that drainage grates are bicycle-safe, as required by ORS 810.150. If not, a bicycle wheel may fall into the slots of the grate causing the cyclist to fall. Replacing existing grates (A, B, preferred methods) or welding thin metal straps across the grate perpendicular to the direction of travel (C, alternate method) is required. These should be checked periodically to ensure that the straps remain in place.

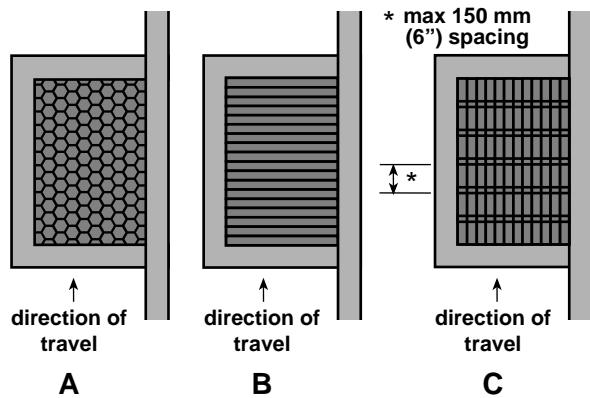

Figure 21: Bicycle safe grates

Note: grates with bars perpendicular to the roadway must not be placed at curb cuts, as wheelchairs could get caught in the slot.

The most effective way to avoid drainage-grate problems is to eliminate them entirely with the use of inlets in the curb face (type CG-3).

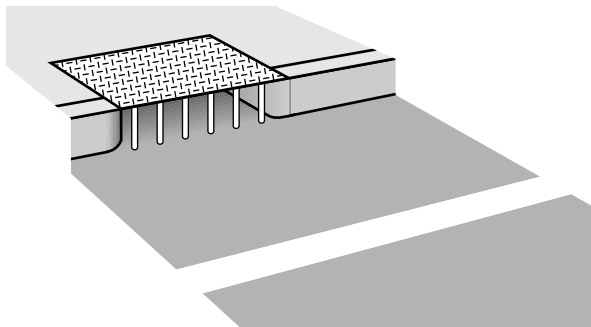

Figure 22: Inlet flush in the curb face

If a street-surface grate is required for drainage (types G-2 and CG-2), care must be taken to ensure that the grate is flush with the road surface. Types G-1 and CG-1 drainage grates that have bars parallel to the roadway should not be used in areas where bikes may be present.



Well placed drainage grate

Inlets should be raised after a pavement overlay to within 6 mm (1/4") of the new surface. If this is not possible or practical, the pavement must taper into drainage inlets so they do not cause an abrupt edge at the inlet.



Inlet in the curb face

D.2. RAILROAD CROSSINGS

Special care must be taken wherever a bikeway intersects railroad tracks. The most important improvements for bicyclists are smoothness, angle of crossing and flange opening.

D.2.a. Smoothness

Concrete performs best under wet conditions and, when laid with precision, provides a smooth ride. Rubberized crossings provide a durable, smooth crossing, though they tend to become slippery when wet. If asphalt pavement is used, it must be maintained in order to prevent a ridge buildup next to the rails. Timber crossings wear down rapidly and are slippery when wet.

D.2.b. Angle of crossing

The risk is kept to a minimum where the bikeway crosses the tracks at a 90° angle. If the skew angle is less than 45°, special attention should be given to the bikeway alignment to improve the angle of approach, preferably to 60° or greater, so cyclists can avoid catching their wheels in the flange and losing their balance.

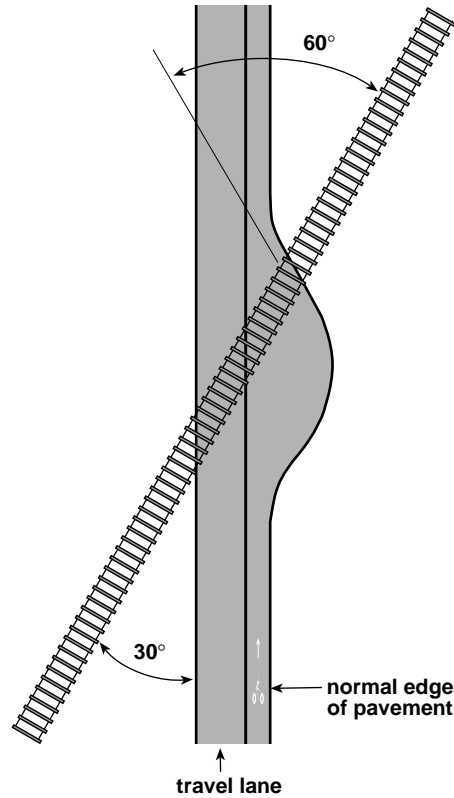

Figure 23: Bike lane or shoulder crossing railroad tracks

*Note: The **combination** of smoothness, angle and flange opening create conditions that affect cyclists. By improving smoothness and flange opening, the angle becomes less critical.*



This rubberized crossing is smooth, with a narrow flange opening

D.2.c. Flange Opening

The open flange area between the rail and the roadway surface can cause problems for cyclists, since it can catch a bicycle wheel, causing the rider to fall. Flange width must be kept to a minimum.



Extremely undesirable condition

D.3. SIDEWALK RAMPS ON BRIDGES

These can help cyclists if the bridge sidewalks are wide enough for bicycle use (minimum 1.2 m [4 ft]). They should be provided where motor vehicle traffic volumes and speeds are high, the bridge is fairly long and the outside traffic lanes or shoulders on the bridge are narrow.

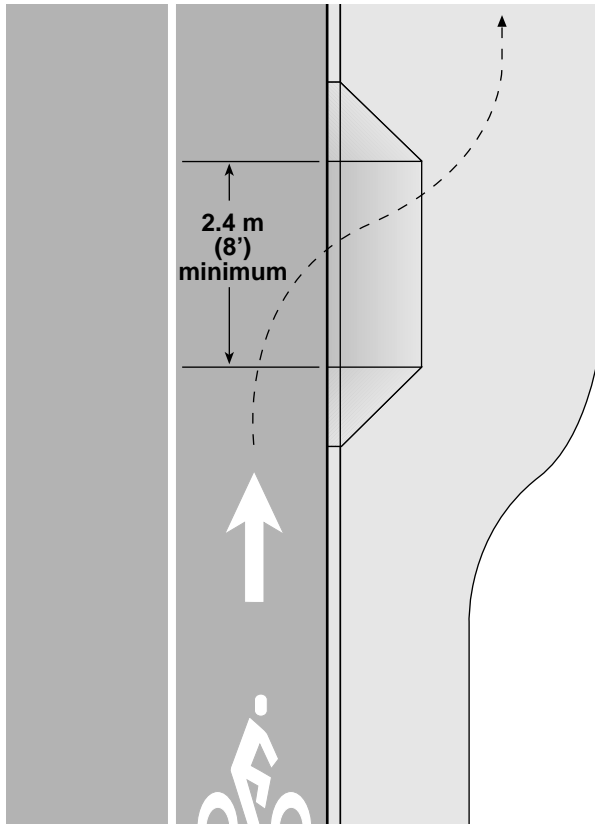

Figure 24: Ramp provides access to sidewalk



This ramp allows bicyclists to ride straight onto bridge sidewalk

D.4. RUMBLE STRIPS

Rumble strips are provided to alert motorists that they are wandering off the travel lanes onto the shoulder. They are most common on long sections of straight freeways in rural settings, but are also used on sections of two-lane undivided highways. Early designs placed bumps across the entire width of the shoulder, which is very uncomfortable for cyclists.

A newer rumble strip design is more bicycle-friendly: 400 mm (16") grooves are cut into the shoulder, 150 mm (6") from the fog line. On a 2.4 m (8 ft) shoulder, this leaves 1.8 m (6 ft) of usable shoulder for bicyclists.

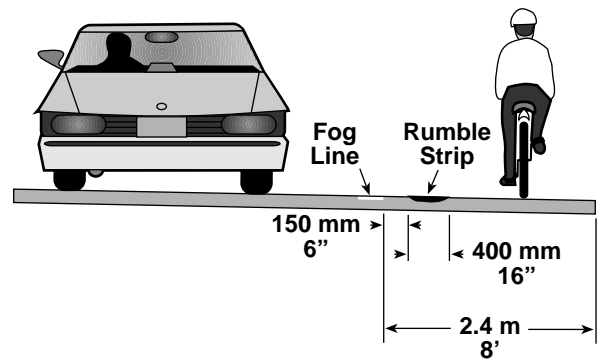

Cross-sectional view

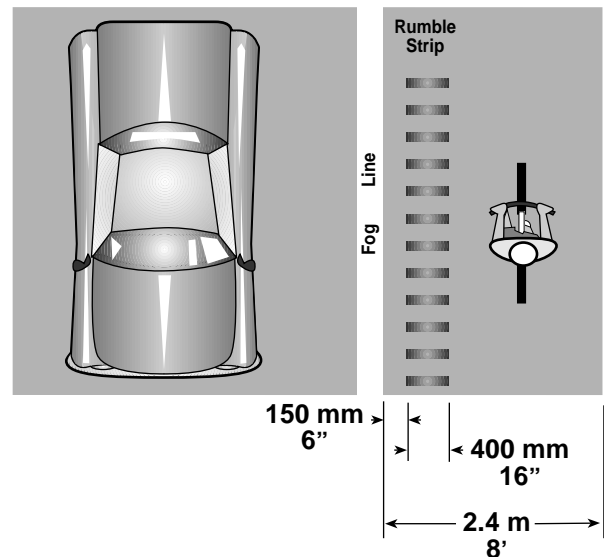

Plan view

Figure 25: Bicycle-friendly rumble strip

E. OTHER INNOVATIVE DESIGNS

These concepts are presented as information, to help ODOT, cities and counties to come up with new solutions to common problems.

E.1. BICYCLE BOULEVARDS

The bicycle boulevard is a refinement of the shared roadway concept: the operation of a local street is modified to function as a through street for bicycles while maintaining local access for automobiles. Traffic calming devices reduce traffic speeds and through trips. Traffic controls limit conflicts between motorists and bicyclists and give priority to through bicycle movement.

Advantages of Bicycle Boulevards

- Opportunity - traditional street grids offer many miles of local streets that can be converted to bicycle boulevards;
- Low cost - major costs are for traffic control and traffic calming devices;
- Traffic calming techniques are increasingly favored by residents who want slower traffic on neighborhood streets;
- Bicycle travel on local streets is usually compatible with local land uses;
- Bicycle boulevards may attract new or inexperienced cyclists who do not feel comfortable on arterials and prefer to ride on lower traffic streets; and
- Bicycle boulevards can improve conditions for pedestrians, with reduced traffic and improved crossings.

Disadvantages of Bicycle Boulevards

- They are often located on streets that do not provide direct access to commercial land uses and other destinations; some cyclists may have to negotiate a hostile street environment to complete a portion of their trip;
- If improperly implemented, they can cause traffic diversion onto other streets;
- Failure to provide arterial crossings can result in unsafe conditions for bicyclists; and
- Traffic signals may be expensive or unacceptable for the traffic conditions.

Successful bicycle boulevard implementation requires careful planning with residents and businesses to avoid unacceptable impacts.

Elements of a Bicycle Boulevard

- Selecting a direct and continuous street, rather than a circuitous route that winds through neighborhoods. Bike boulevards work best on a street grid system;
- Turning stop signs towards intersecting streets, so bicyclists can ride with few interruptions;
- Placing motor vehicle traffic diverters at key intersections to reduce traffic volumes (the diverters must be designed to allow through bicycle movement);
- Placing traffic-calming devices on streets to lower traffic speeds;
- Placing directional signs to route cyclists to key destinations, to guide cyclists through difficult situations, and to alert motorists of the presence of bicyclists; and
- Providing protection where the boulevard crosses high-volume arterials with:
 1. Signals, where a traffic study has shown that a signal will be safe and effective; to ensure that bicyclists can activate the signal, signal loops should be installed where bicyclists ride, supplemented with a push button that won't require dismounting; or
 2. Median refuges, with gaps wide enough to allow bicyclists to pass through (min. 2.4 m [8 ft]); the median should be wide enough to provide a refuge (min. 3 m [10 ft]). The design should allow bicyclists to see the travel lanes they must cross.



Bike boulevard allows through bicycle movement

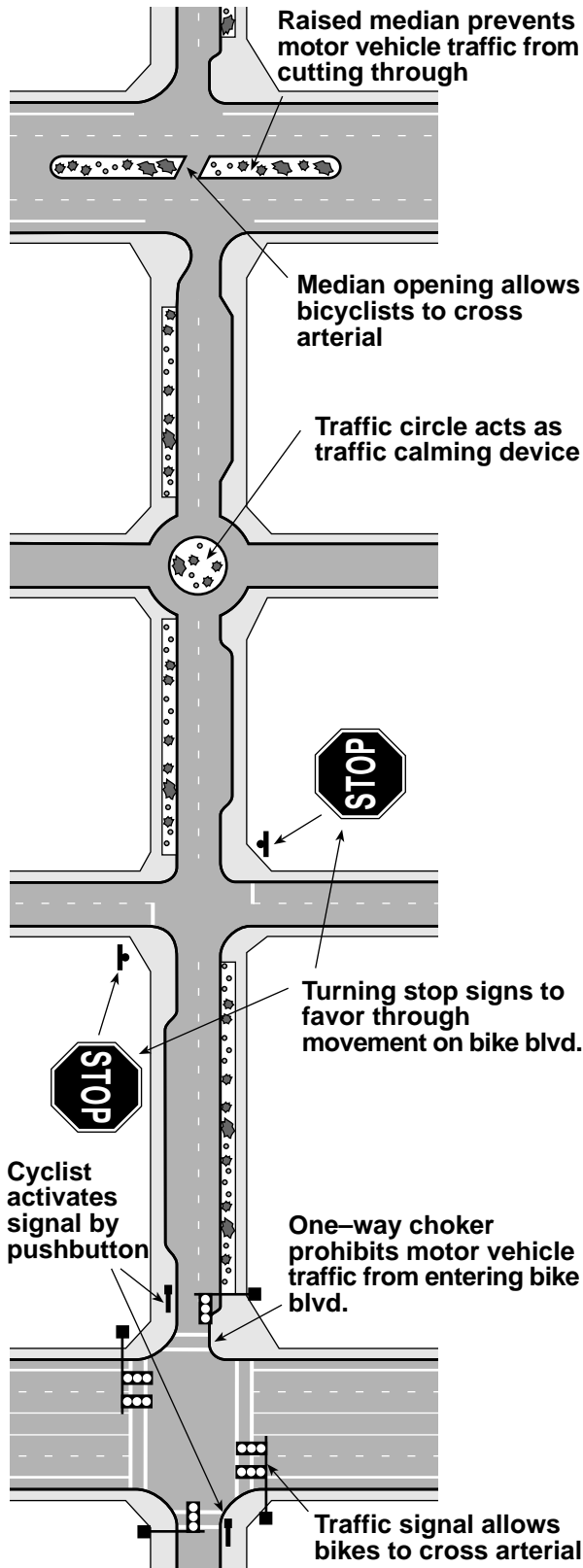

Figure 26: Elements of a bike boulevard, including street crossings

E.2. RAISED BIKE LANES

Normally, bike lanes are an integral portion of the roadway surface and are delineated from motor vehicle lanes with painted stripes. Though most bicyclists ride on these facilities with comfort, others prefer more positive separation, but separated paths are not practical in most urban settings.

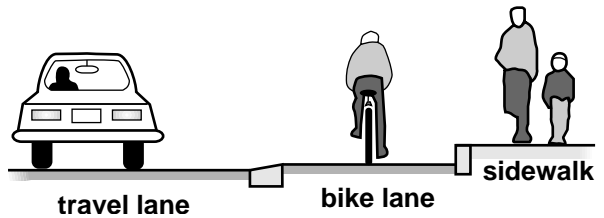

Figure 27: Raised bike lane

Raised bike lanes incorporate the convenience of riding on the street with the psychological separation of a barrier, with these advantages:

- A mountable curb allows cyclists to enter or leave the lane as needed for turning or overtaking;
- Motorists know they are straying from the travel lanes when they feel the slight bump created by the mountable curb; and
- Novice bicyclists are more likely to ride in the bike lane, leaving the sidewalk for pedestrians.



Raised bike lane

An effective design provides a gentle slope, with no lip, so a bicycle tire is not caught during crossing maneuvers. Using concrete curbs in an asphalt roadway increases the visibility of the bike lane stripe. The raised bike lane is dropped prior to intersections, where the roadway surfacing is uniform.

The disadvantage of raised bike lanes is the greater costs of construction: the travel lanes and bike lanes must be paved separately and a narrow paving machine is required for paving the bike lane.

The additional costs are mitigated by reduced long-term maintenance costs:

- The bike lane portion receives less wear and tear than the travel lanes;
- The bike lane accumulates less debris, requiring less frequent sweeping; and
- The bike lane stripe doesn't need frequent repainting.

Note: on roads with parking, the bike lane should be placed between the travel lanes and parked cars, elevating the parking lane.

E.3. CONTRA-FLOW BIKE LANES

Contra-flow bike lanes on a one-way street are not usually recommended. They may encourage cyclists to ride against traffic, which is contrary to the rules of the road and a leading cause of bicycle/motor vehicle crashes.

There are, however, special circumstances when this design may be advantageous:

- A contra-flow bike lane provides a substantial savings in out-of-direction travel;
- The contra-flow bike lane provides direct access to high-use destinations;
- Improved safety because of reduced conflicts on the longer route;
- There are few intersecting driveways, alleys or streets on the side of the contra-flow lane;
- Bicyclists can safely and conveniently reenter the traffic stream at either end of the section;
- A substantial number of cyclists are already using the street; and
- There is sufficient street width to accommodate a bike lane.



One-way street with bike lane and contra-flow bike lane

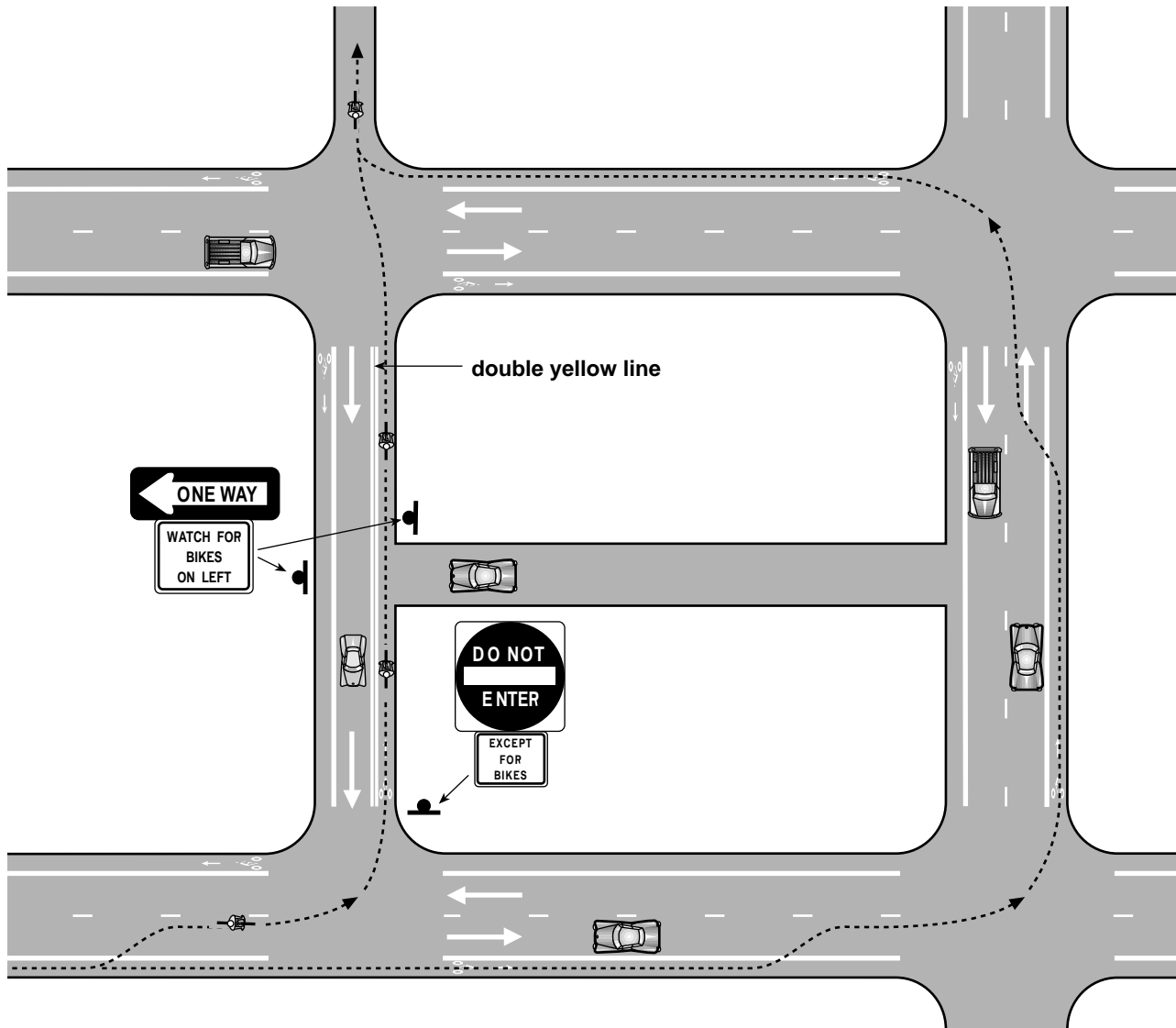

Figure 28: Contra-flow bike lane (Arrows indicate out-of-direction travel saved with contra-flow bike lane)

A contra-flow bike lane may also be appropriate on a one-way residential street recently converted from a two-way street (especially where this change was made to calm traffic).

For a contra-flow bike lane to function well, these special features should be incorporated into the design:

- The contra-flow bike lane must be placed on the right side of the street (to motorists' left) and must be separated from on-coming traffic by a double yellow line. This indicates that the bicyclists are riding on the street legally, in a dedicated travel lane.

- Any intersecting alleys, major driveways and streets must have signs indicating to motorists that they should expect two-way bicycle traffic.
- Existing traffic signals should be fitted with special signals for bicyclists; this can be achieved with either loop detectors or push-buttons (these should be easily reached by bicyclists without having to dismount).

NOTE: Under no circumstances should a contra-flow bike lane be installed on a two-way street, even where the travel lanes are separated with a raised median.

E.4. DIAGONAL PARKING

Diagonal parking causes conflicts with bicycle travel: drivers backing out have poor visibility of oncoming cyclists and parked vehicles obscure other vehicles backing out. These factors require cyclists to ride close to the center of a travel lane, which is intimidating to inexperienced riders.

Where possible on one-way streets, diagonal parking should be limited to the left side, even if the street has no bike lane; on one-way streets with bike lanes, the bike lane should be placed adjacent to parallel parking (preferably on the right).

Bike lanes are not usually placed next to diagonal parking. However, should diagonal parking be required on a street planned for bike lanes, the following recommendations can help decrease potential conflicts:

- The parking bays must be long enough to accommodate most vehicles;
- A 200 mm (8") stripe should separate the parking area from the bike lane; and
- Enforcement may be needed to cite or remove vehicles encroaching on the bike lane.

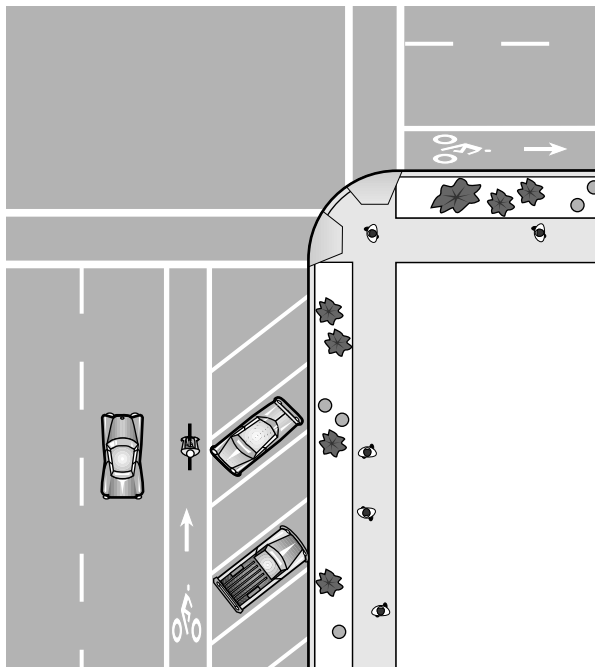

Figure 29: Bike lane next to diagonal parking

E.5. BIKE LANES & BUS LANES

In most instances, bicycles and buses can share the available road space. On routes heavily traveled by both bicyclists and buses, separation can reduce conflicts (stopped buses hinder bicycle movement and slower moving bicycles hinder moving buses).

Separate bus lanes and bike lanes should be considered, with the bus lane at the curb side, to reduce conflicts between passengers and bicyclists. Buses will be passing bicyclists on the right, but the fewer merging and turning movements reduce overall conflicts.

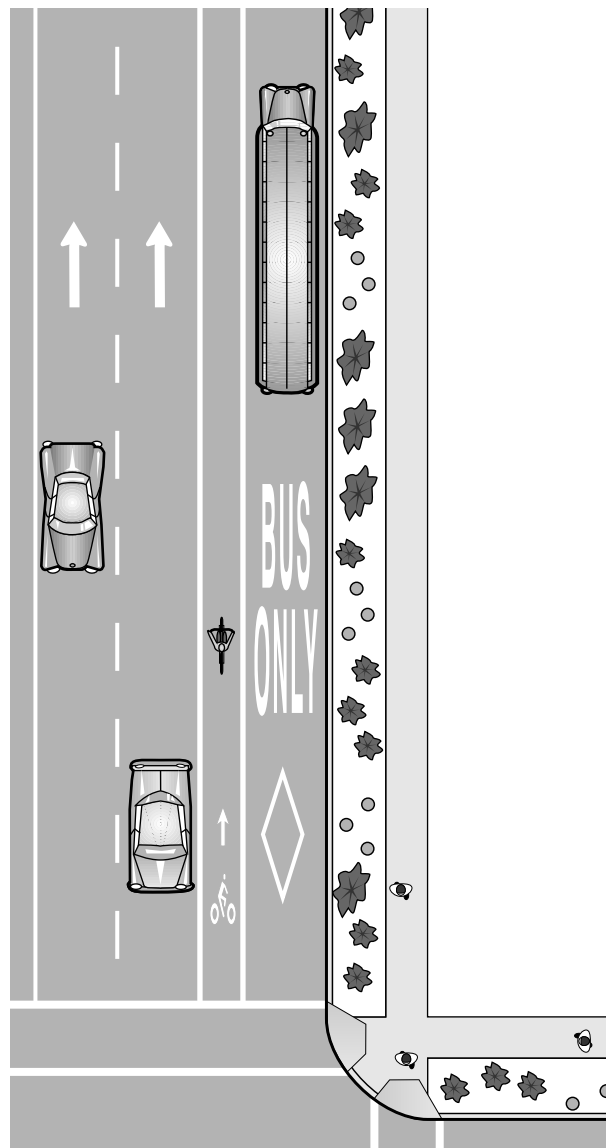

Figure 30: Bike lane adjacent to bus lane

II.2. RESTRIPING EXISTING ROADS WITH BIKE LANES

INTRODUCTION

To accommodate bicyclists on busy roadways in urban areas, bike lanes generally serve bicyclists and motorists best. Many roadways in urban areas were originally built without bike lanes. These roadways often act as deterrents to bicycle travel and may cause conflicts between bicyclists and motorists.

The needs of cyclists can be accommodated by retrofitting bike lanes onto many existing urban roadways using the following methods:

1. Marking and signing existing shoulders as bike lanes;
2. Physically widening the roadway to add bike lanes; or
3. Restriping the existing roadway to add bike lanes.

Method #1 is simple, and bike lane marking standards are outlined on page 145. Method #2

involves reconstruction, and standards are outlined on page 70. In many instances, existing curb-to-curb width allows only method #3 to be considered.

Where existing width doesn't allow full standards to be used, it may be possible to modify portions of the roadway to accommodate bike lanes. Current urban standards are: 4.2 m (14 ft) center turn lanes, 3.6 m (12 ft) travel lanes, 1.8 m (6 ft) bike lanes and 2.4 m (8 ft) parking lanes.

These guidelines should be used to determine how the roadway can be modified to accommodate bike lanes, without significantly affecting the safety or operation of the roadway. Reduced travel lane widths are within AASHTO minimums.

It is important to use good judgement, and each project should be reviewed by a traffic engineer.



Bike lanes were striped on this arterial by narrowing travel lanes

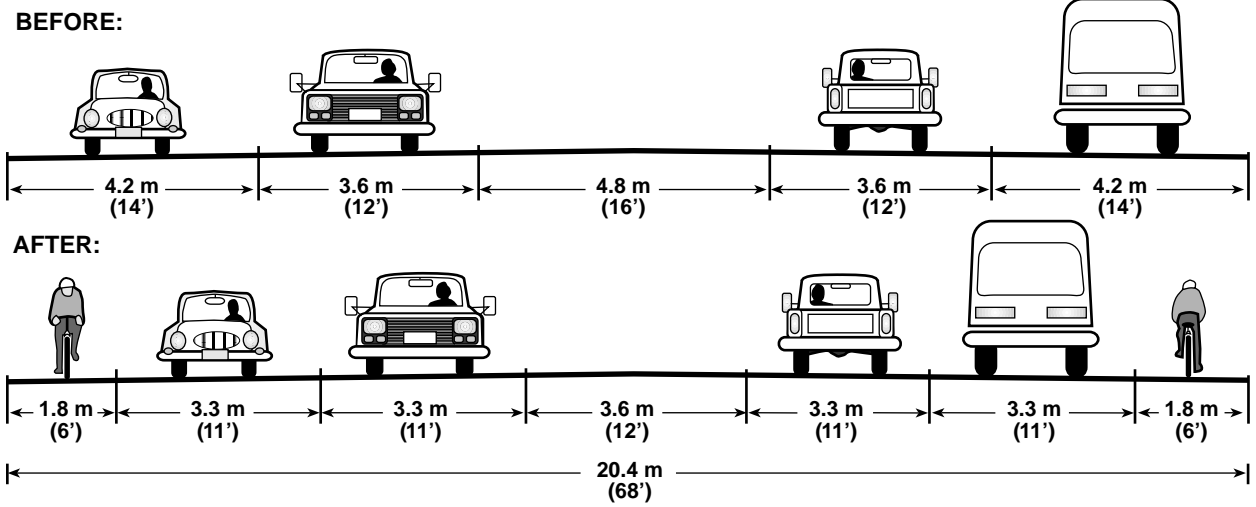

Figure 31: Reduced travel lane widths

A. REDUCE TRAVEL LANE WIDTHS

The need for full-width travel lanes decreases with speed:

- Up to 40 km/h (25 MPH): travel lanes may be reduced to 3 or 3.2 m (10 or 10.5 ft).
- 50 to 65 km/h (30 to 40 MPH): 3.3 m (11 ft) travel lanes and 3.6 m (12 ft) center turn lanes may be acceptable.
- 70 km/h (45 MPH) or greater: try to maintain a 3.6 m (12 ft) outside travel lane and a 4.2 m (14 ft) center turn lane if there are high truck volumes.



Bike lane created by narrowing travel lanes

B. REDUCE NUMBER OF TRAVEL LANES

Many one-way couplets were originally two-way streets. This can result in an excessive number of travel lanes in one direction. A study will determine if traffic can be handled with one less lane.

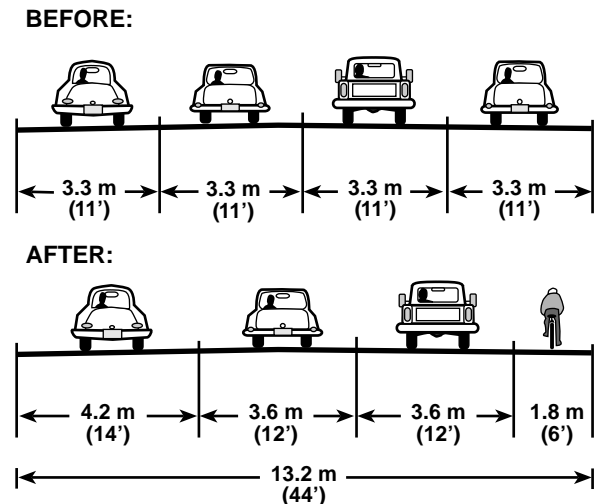
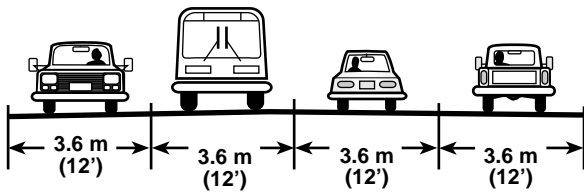

Figure 32: Travel lanes reduced from 4 to 3 on a one-way street

On two-way streets with four travel lanes and a significant number of left-turn movements, restriping for a center turn lane, two travel lanes, and two bike lanes can often improve traffic flow.

BEFORE:



AFTER:

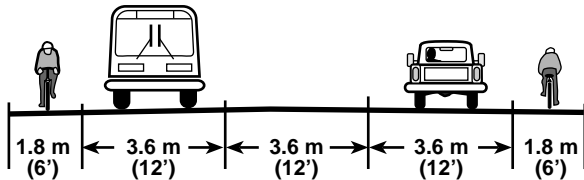

Figure 33: Travel lanes reduced from 4 to 2, with center turn lane

C. RECONSIDER THE NEED FOR PARKING

A roadway’s primary function is to move people and goods, rather than to store stationary vehicles. When parking is removed, safety and capacity are generally improved. Removal of parking will require negotiations with the local governing body (such as city council), affected business owners and residents.

To stave off potential conflicts, careful research is needed before making a proposal, including:

- Counting the number of businesses/residences and the availability of both on-street and off-street parking.
- Selecting which side would be less affected by removal (usually the side with fewer residences or businesses, or the side with residences rather than businesses in a mixed-use neighborhood).
- Proposing alternatives such as:
 1. allowing parking for church or school activities on adjacent lots during services or special events,
 2. shared use by businesses, or
 3. constructing special parking spaces for residents or businesses with no other options.

Rather than removal of all on-street parking, several other options can be pursued:

C.1. NARROW PARKING LANE

Parking can be narrowed to 2.1 m (7 feet), particularly in areas with low truck parking volumes, as today’s cars are smaller.

BEFORE:

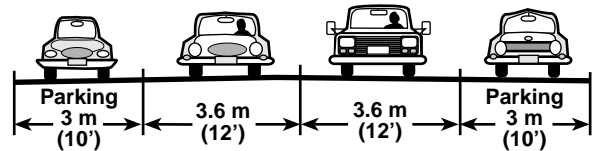

AFTER:

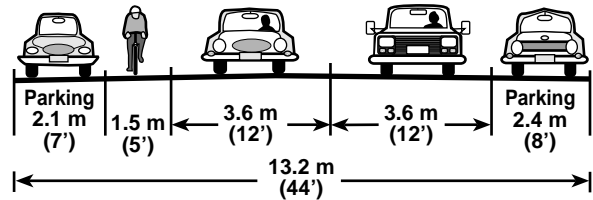
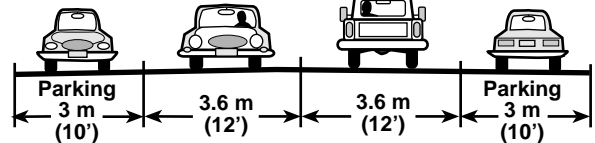

Figure 34: Narrowing parking on a one-way street

C.2. REMOVE PARKING ON ONE SIDE

In some cases, parking may be needed on only one side to accommodate residences and/or businesses. *Note: It is not always necessary to retain parking on the same side of the road through an entire corridor.*

BEFORE:



AFTER:

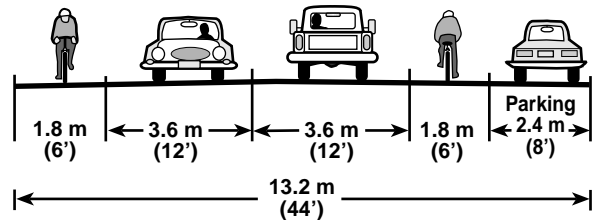

Figure 35: Parking removed on one side of a two-way street



Parking was removed from one side to provide bike lanes

C.3. CHANGE FROM DIAGONAL TO PARALLEL PARKING

Diagonal parking takes up an inordinate amount of roadway width relative to the number of parking spaces provided. It can also be hazardous, as drivers backing out cannot see oncoming traffic. Changing to parallel parking reduces availability by less than one-half.

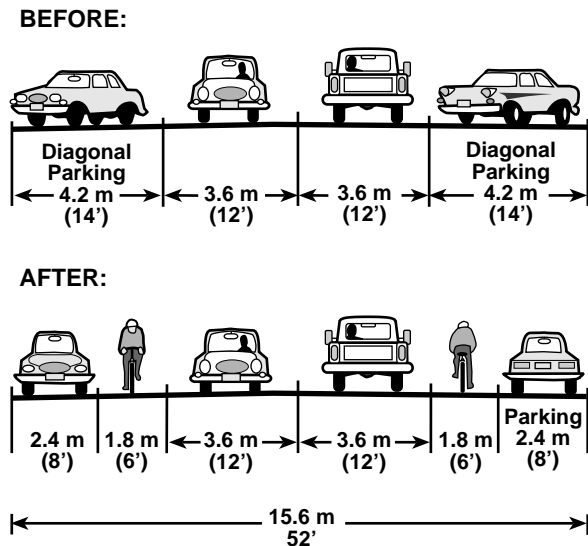

Figure 36: Changing from diagonal to parallel parking on two-way street

Special note: on one-way streets, changing to parallel parking on one side only is sufficient; this reduces parking by less than one-fourth.

C.4. PROHIBIT PARKING BY EMPLOYEES

Most business owners cite the fear of losing potential customers as the main reason to retain on-street parking. Many cities have had success with ordinances prohibiting employees from parking on the street. This could help increase the number of available parking for customers, even if the total number of parking spaces is reduced.

Special note: One parking place occupied by an employee for eight hours is the equivalent of 16 customers parking for half an hour, or 32 customers parking for 15 minutes.

C.5. REPLACING LOST PARKING

Where all of the above possibilities of replacing parking with bike lanes have been pursued, and residential or business parking losses cannot be sustained, innovative ideas should be considered to provide parking, such as with off-street parking.

Other uses of the right-of-way should also be considered, such as using a portion of a planting strip, where available:

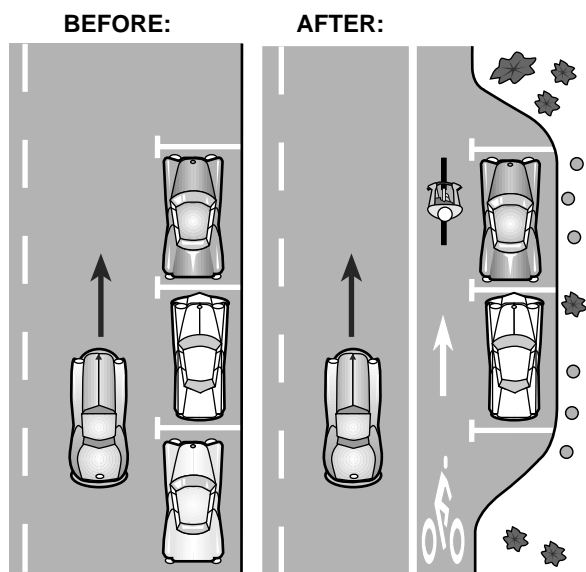

Figure 37: Providing parking when there are no reasonable alternatives

D. OTHER CONSIDERATIONS

Not all existing roadway conditions will be as simple to retrofit as those listed above. In many instances unique and creative solutions will have to be found.

Width restrictions may only allow for a wide curb lane (4.2-4.8 m/14-16 ft) to accommodate bicycles and motor vehicles.

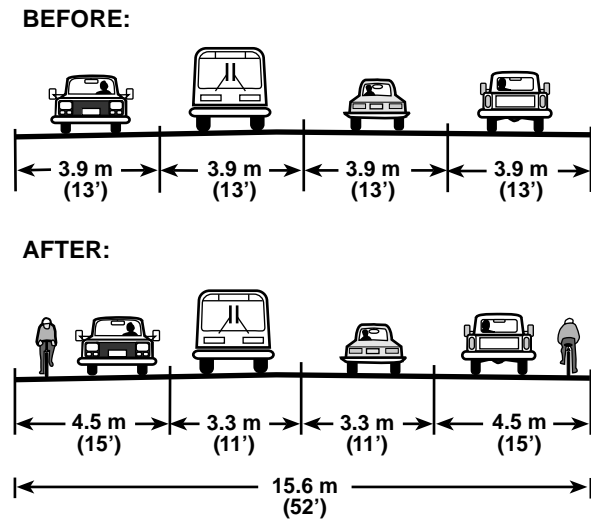

Figure 38: Restriping for wide curb lane

Bike lanes must resume where the restriction ends. It is important that every effort be made to ensure bike lane continuity. Practices such as directing bicyclists onto sidewalks or other streets for short distances should be avoided, as they may introduce unsafe conditions (See Figure 7, page 50).

Other minor improvements at the outer edge of the roadway should be made in conjunction with bike lane restriping, including:

- Existing drainage grates, manhole and utility covers should be raised flush to the pavement prior to striping a bike lane.
- Minor widening may be required to obtain adequate width; and
- Removal or relocation of obstructions away from the edge of roadway may gain some useable width. Obstructions can include guardrail, utility poles and sign posts.

E. ADDITIONAL BENEFITS

E.1. SAFETY BENEFITS

Safety is enhanced as travel lanes are offset from curbs, lanes are better defined, and parking is removed or reduced. Adding bike lanes can often improve sight distance and increase turning radii at intersections and driveways.

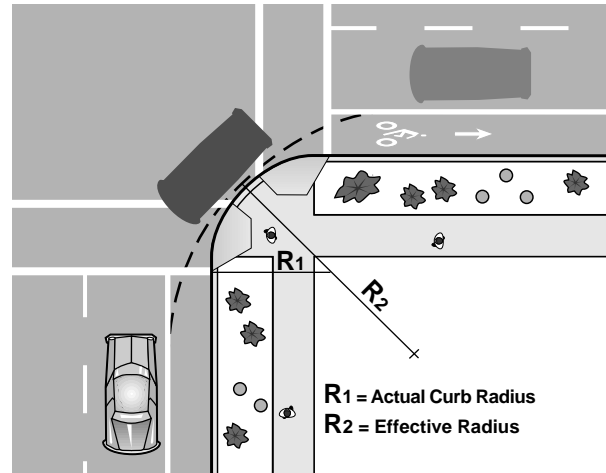

Figure 39: Effective radius at intersections is increased with bike lanes

E.2. PAVEMENT BENEFITS

Restriping travel lanes moves motor vehicle traffic over, which can help extend the pavement life, as traffic is no longer driving in the same well-worn ruts.

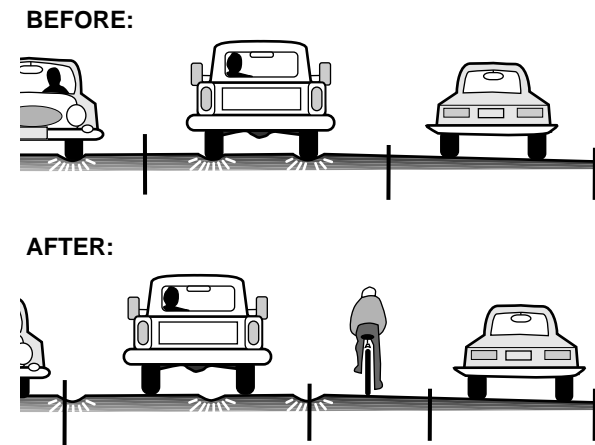

Figure 40: Motor vehicles no longer drive in wheel ruts after restriping



This street had four travel lanes before being reconfigured to three lanes and bike lanes

F. BIKE LANE WIDTHS

While it is important to maintain standards for bicycle facilities, there may be circumstances where restrictions don't allow full standards. The standard width for a bike lane is 1.8 m (6 ft).

Minimum widths are:

- 1.5m (5 ft) against a curb or adjacent to a parking lane, and
- 1.2 m (4 ft) on uncurbed shoulders. A 1.2 m (4-ft) curbed bike lane may be allowable where there are very severe physical constraints.

II.3. BICYCLE PARKING

INTRODUCTION

For a bikeway network to be used to its full potential, secure bicycle parking should be provided at likely destination points. Bicycle thefts are common and lack of secure parking is often cited as a reason people hesitate to ride a bicycle to certain destinations. The same consideration should be given to bicyclists as to motorists, who expect convenient and secure parking at all destinations.

Bicycle racks must be designed so that they:

- Do not bend wheels or damage other bicycle parts;
- Accommodate the high security U-shaped bike locks;
- Accommodate locks securing the frame and both wheels;
- Do not trip pedestrians;
- Are covered where users will leave their bikes for a long time; and
- Are easily accessed from the street and protected from motor vehicles.

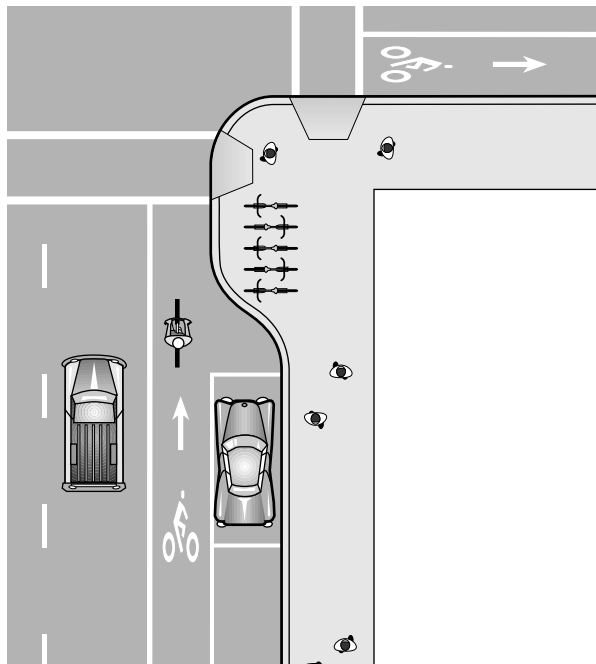

Figure 41: Bicycle parking provided away from main sidewalk area



Short-term parking by sidewalk cafe on downtown street

To provide real security for the bicycle (with its easily removed components) and accessories (lights, pump, tools and bags), either bicycle enclosures, lockers or a check-in service is required.

Bicycle parking facilities are generally grouped into 2 classes:

Long Term - Provides complete security and protection from weather; it is intended for situations where the bicycle is left unattended for long periods of time: apartments and condominium complexes, schools, places of employment and transit stops. These are usually lockers, cages or rooms in buildings.

Short Term - Provides a means of locking bicycle frame and both wheels, but does not provide accessory and component security or weather protection unless covered; it is for decentralized parking where the bicycle is left for a short period of time and is visible and convenient to the building entrance.

The following recommendations are presented to help cities and counties develop local bicycle parking ordinances.

A. RECOMMENDED STANDARDS

(The recommendations are in italics, followed by explanatory text)

A.1. DIMENSIONS

- *Bicycle parking spaces should be at least 1.8 m (6 ft) long and 0.6 m (2 ft) wide, and overhead clearance in covered spaces should be at least 2.1 m (7 ft).*
- *A 1.5 m (5 ft) aisle for bicycle maneuvering should be provided and maintained beside or between each row of bicycle parking.*
- *Bicycle racks or lockers should be securely anchored to the surface or a structure.*

These dimensions ensure that bicycles can be securely locked without undue inconvenience and will be reasonably safeguarded from theft as well as intentional or accidental damage.

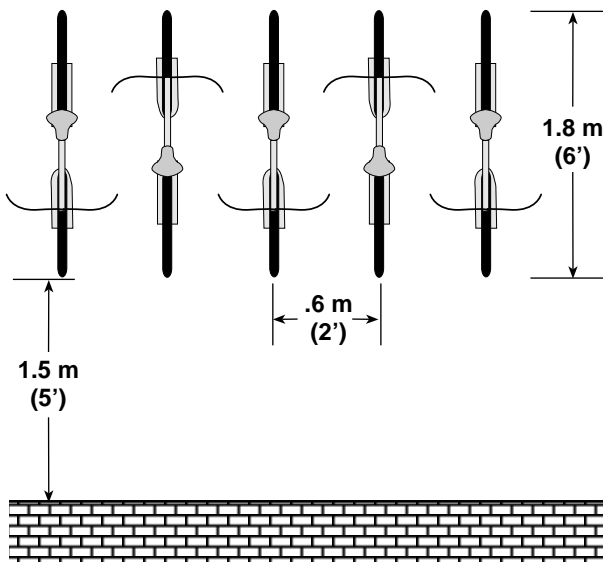

Figure 42: Bicycle parking dimensions

A.2. COVERED PARKING

- *Bicycle parking for residential, school and industrial uses should be covered.*
- *50% of bicycle parking for commercial uses should be covered.*
- *Where motor vehicle parking is covered, bicycle parking should also be covered.*
- *Where there are 10 or more bicycle parking spaces, at least 50% of the bicycle parking spaces should be covered.*

Pacific Northwest winters have mild temperatures and periods of intermittent rain. Many short trips can be made by bicycle without getting wet; however, if the bicycle must be left unattended for a long time, a rider might hesitate to leave it exposed to the weather.

Covered parking is necessary for long-term parking (mostly residential and employee uses). For customers, visitors and other occasional users, covered parking is also beneficial.

Covered spaces can be building or roof overhangs, awnings, lockers or bicycle storage spaces within buildings.

Covered parking needs to be visible for security, unless supplied as storage within a building. Covering should extend 0.6 m (2 ft) beyond the parking area, to prevent crosswinds from blowing rain onto bicycles.

A.3. LOCATION

- *Bicycle parking should be located in well lit, secure locations within 15 m (50 ft) of the main entrance to a building, but not further from the entrance than the closest automobile parking space, but in no case further than 15 m (50 ft) from an entrance where several entrances are involved.*

The effectiveness of bicycle parking is often determined by location. To reduce theft, a highly visible location with much pedestrian traffic is preferable to obscure and dark corners. Because of its smaller size, the bicycle can be parked closer to the rider's destination than a car.

Racks near entrances should be located so that there are no conflicts with pedestrians. Curb cuts at the rack location discourage users from riding the sidewalk to access the racks.

Many sites need two types of bicycle parking: short-term for customers, which should be up front; and long-term (covered) for employees, which may be placed farther away.

Separating bicycle from car parking by a physical barrier or sufficient distance protects parked bicycles from damage by cars.



Bicycle parking placed close to entrance of large retail store

- *Bicycle parking may also be provided inside a building in secure and accessible locations.*

This provides a high degree of security and protection, at the expense of some convenience. Dedicated rooms with card locks are very effective. Locating a room close to changing and showering facilities enhances its attractiveness.

- *Bicycle parking provided in the public right-of-way should allow sufficient passage for pedestrians: 1.8 m (6 ft)*

Bicycle parking may be provided within the public right-of-way in areas without building setbacks, subject to approval of local officials and provided it meets the other requirements for bicycle parking.

A.4. NUMBER OF SPACES

- *See Table 8 on page 90 for recommendations.*

The recommendations are based on specific and easily measurable criteria; e.g. size of buildings, number of residential units, number of classrooms, etc.

Combined parking could be allowed in areas of concentrated small businesses, such as downtowns and business parks. Publicly provided bicycle parking could also be used.

For park-and-ride lots, requirements need to relate the number of bicycle parking spaces to

the probable service area; e.g. the number of residents within a five kilometer radius of a facility.

The amount, location and usage of bicycle parking should be monitored and adjusted to ensure that there is an adequate supply. If bicycle use increases, the need for bicycle parking may increase above that specified when facilities are constructed. Local jurisdictions may have to require additional bicycle parking to meet the demand.

Employment and retail centers should voluntarily provide additional parking to satisfy the demands of customers and employees.

B. SIGNING

- *Directional signs are needed where bicycle parking locations are not visible from building entrances or transit stops.*
- *Instructional signs may be needed if the design of bicycle racks isn't readily recognized as such.*
- *For security reasons, it may be desirable not to sign long-term employee parking within a building, to avoid bringing bicycles to the attention of potential thieves.*

C. OTHER RECOMMENDATIONS

Long-term bicycle parking spaces should be provided at no cost, or with only a nominal charge for key deposits, etc. This does not preclude the operation of private for-profit bicycle parking businesses. Residential parking spaces should be available to residents as part of rental or ownership contracts.

Short-term bicycle parking should be available near the building entrances of all land uses, and should be free.

LAND USE CATEGORY	MINIMUM REQUIRED BICYCLE PARKING SPACES	MINIMUM COVERED AMOUNT
Residential		
Multi-family residential, general	1 space per unit	100%
Multi-family residential, seniors or with physical disabilities	4, or 1 space per 5 units, whichever is greater	100%
Institutional		
Schools – Elementary	4 spaces per classroom	100%
Schools – Jr. Hi or Middle School	4 spaces per classroom	100%
Schools – Sr. High	8 spaces per classroom	100%
College	1 space per 4 students <i>(plus 1 space per student housing room/unit)</i>	100%
Transit Centers/Park & Ride Lots	5% of auto spaces <i>(or 100% of demand, depending on accessibility to bicyclists)</i>	100%
Religious Institutions	1 space per 40 seat capacity	25%
Hospitals	1 space per 5 beds	75%
Doctor, Dentist Offices	2, or 1 space per 1000 ft ² , whichever is greater	25%
Libraries, Museums, etc.	2, or 1 space per 1000 ft ² , whichever is greater	25%
Commercial		
Retail Sales	0.33 space per 1000 ft ²	50%
Auto-oriented Services	2 or 0.33 space per 1000 ft ² , whichever is greater	10%
Groceries/Supermarkets	0.33 space per 1000 ft ²	10%
Office	2, or 1 space per 1000 ft ² , whichever is greater	10%
Restaurant	1 space per 1000 ft ²	25%
Drive-in Restaurant	1 space per 1000 ft ²	25%
Shopping Center	0.33 space per 1000 ft ²	50%
Financial Institutions	2, or 0.33 space per 1000 ft ² , whichever is greater	10%
Theaters, Auditoriums, etc.	1 space per 30 seats	10%
Industrial		
Industrial Park	2, or 0.1 space per 1000 ft ² , whichever is greater	100%
Warehouse	2, or 0.1 space per 1000 ft ² , whichever is greater	100%
Manufacturing, etc.	2, or 0.15 space per 1000 ft ² , whichever is greater	100%
<i>Notes:</i>		
<i>Each individual use needs to be evaluated for bicycle parking - e.g. a commercial accessory use in an industrial district may have different requirements than the industrial uses around it. Similarly, in mixed-use developments, the amount of each use and required bicycle parking needs evaluation. Finally, within each use category one needs to consider the different user categories - residents, employees, customers, etc. - and parking requirements for each.</i>		
<i>Jurisdictions may wish to develop provisions to allow requirement of additional bicycle parking exceeding these minimums where it is appropriate.</i>		

Table 8: Recommended bicycle parking spaces

II.4. WALKWAYS

A. TYPES OF WALKWAYS

Pedestrian Facilities include walkways, traffic signals, crosswalks and other amenities such as illumination and benches.

A **Walkway** is a transportation facility built for use by pedestrians and persons in wheelchairs. Walkways include:

SIDEWALKS, which are located along roadways, separated with a curb and/or planting strip, and have a hard, smooth surface. Sidewalks in residential areas are sometimes used by bicyclists, but cities may ban bicycle riding on sidewalks.

PATHS, which are typically used by pedestrians, cyclists, skaters and joggers (Multi-Use Paths). It is not realistic to plan and design a path for the exclusive use by pedestrians, as other users will be attracted to the facility. Paths may be unpaved, constructed with packed gravel or asphalt grindings, if they are smooth and firm enough to meet ADA requirements.

SHOULDERS, which can serve pedestrians in many rural areas. The shoulder widths recommended by AASHTO are usually adequate to accommodate pedestrians. In rural areas with a residential character, but with low population densities, shoulders should be wide enough to accommodate both pedestrian and bicycle traffic.



**Wide planter strip
increases pedestrian comfort**

B. STANDARDS

B.1. SIDEWALKS

B.1.a. Width

The standard sidewalk width is 1.8 m (6 ft), exclusive of curb and obstructions. This width allows two pedestrians (including wheelchair users) to walk side by side, or to pass each other comfortably. It also allows two pedestrians to pass a third pedestrian without leaving the sidewalk. Where it can be justified and deemed appropriate, the minimum width may be 1.5 m (5 ft); on local streets, circumstances may include a combination of width constraints or low potential usage.

The minimum width for sidewalks directly adjacent to a motor vehicle lane is 1.8 m (6 ft). A level area outside the sidewalk should be provided on fills. Greater sidewalk widths are needed in high pedestrian use areas, such as central business districts.

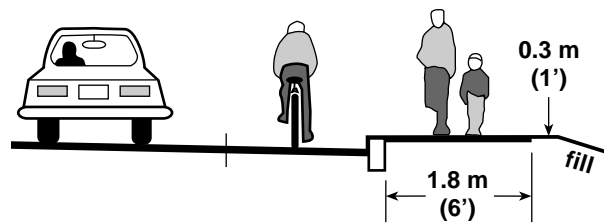

Figure 43: Standard sidewalk width

B.1.b. Obstructions

The standard sidewalk width is clear of obstructions such as sign posts, utility and signal poles, mailboxes, parking meters, fire hydrants, trees and other street furniture. Obstructions should be placed between the sidewalk and the roadway, to create a “buffer” for increased pedestrian comfort. Movable obstructions such as sign boards, tables and chairs must allow for a 1.8 m (6 ft) clear passage. Obstructions should not be placed in such a manner that they impair visibility by motorists.

Clearance to vertical obstructions (signs, trees, etc.) must be at least 2.1 m (7 ft):

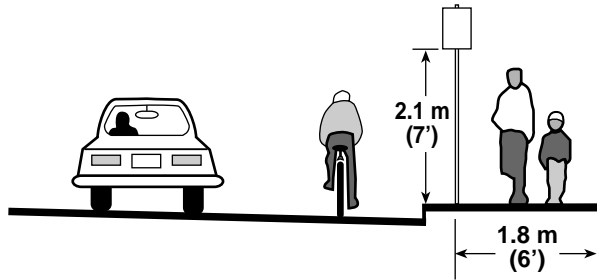

Figure 44: Sidewalk clearances

Cars parked perpendicular or diagonally to sidewalks can be obstructions if there is excessive overhang. Blocks can be used to prevent narrowing the usable sidewalk width:

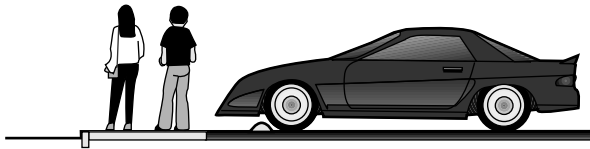

Figure 45: Reducing overhang from parked cars

B.1.c. Shy distance

An additional 0.6 m (2 ft) shy distance is needed from shoulder-high vertical barriers such as buildings, sound walls, retaining walls and fences:

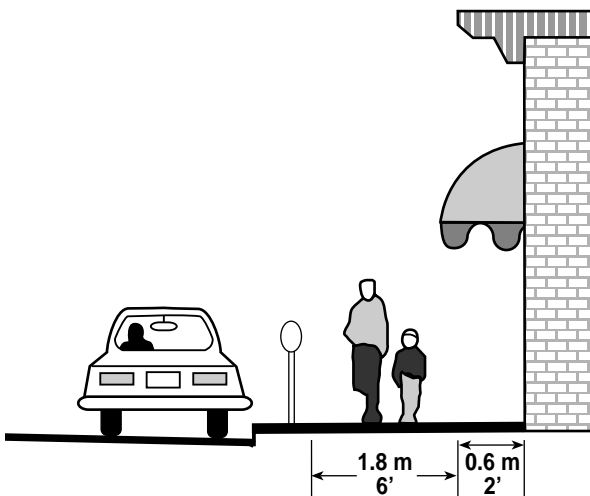

Figure 46 : Sidewalk against wall

Note: ADA requires that “objects protruding from walls (e.g. signs, fixtures, telephones, canopies) with their leading edge between 27” and 80” (685 and 2030 mm) above the finished sidewalk shall protrude no more than 4” (100 mm) into any portion of the public sidewalk.” (ADAAG 14.2.2)

B.1.d. Planting Strips

Well-designed streets include planting strips. A planting strip should be 1.5 m (5 ft) wide or greater (min. 0.9 m [3 ft]), and landscaped with low-maintenance plantings.

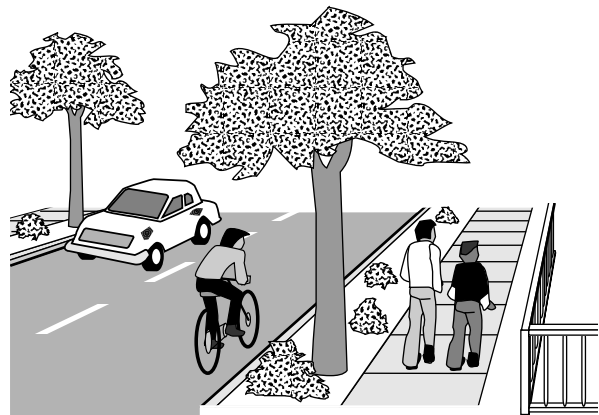

Figure 47 : Street with planting strip

The extra separation from motor vehicle traffic decreases road noise, prevents water in puddles from splashing onto sidewalk users and generally increases a walker’s sense of security. Planting strips offer many other benefits to pedestrians:

- Room for street trees;
- Room for sign posts, utility and signal poles, mailboxes, parking meters, fire hydrants, etc.:

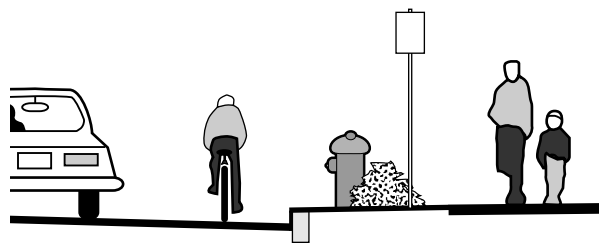

Figure 48: Sidewalk with planting strip

- When wide enough, a place for a motor vehicle to wait out of the stream of traffic while yielding to a pedestrian in a driveway:

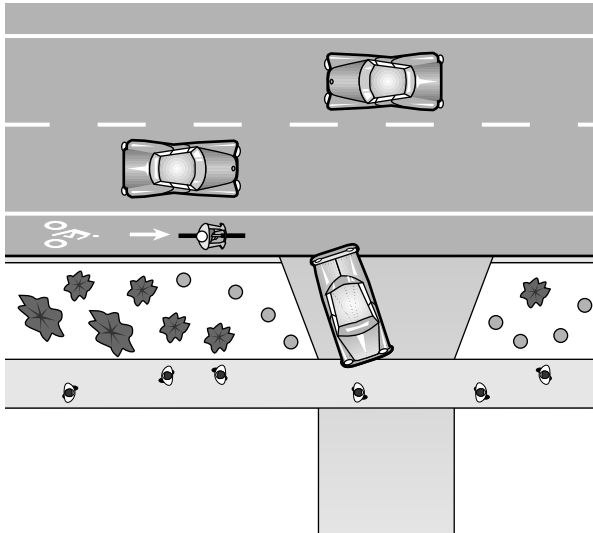

Figure 49: Wide planting strip adds room for turn movements

- The opportunity to line up sidewalks, curb cuts and crosswalks at intersections:

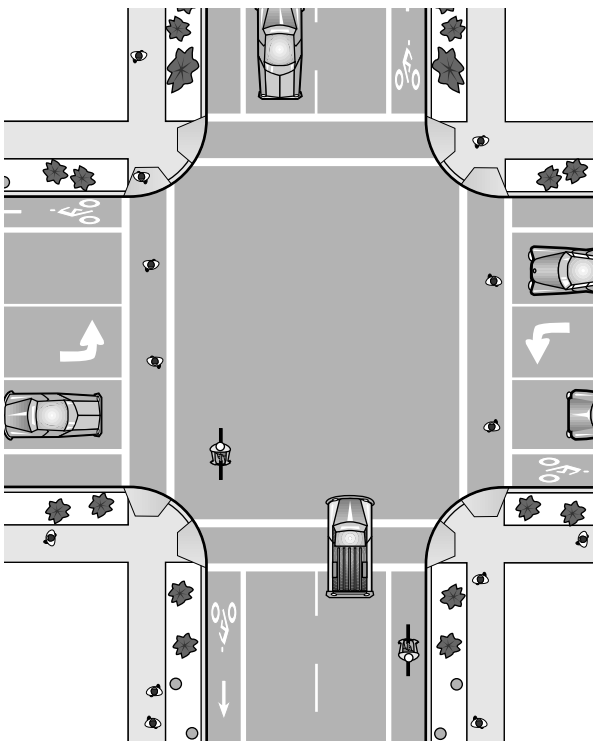

Figure 50: Sidewalks, curb cuts and crosswalks lined up

- An enhanced environment for wheelchair users, as the sidewalk can be kept at a constant side slope, with the slope for driveways built into the planting strip section:



Figure 51: Planting strip at driveway (and effect on cross-slope)

- An opportunity for aesthetic enhancements such as landscaping (plants should be selected that require little maintenance and watering, and whose roots will not buckle sidewalks);
- Less runoff water, decreasing overall drainage requirements.
- A place to store snow during the winter.
- Easier identification of driveways by motorists.

Where constraints preclude the use of the same width throughout a project, the planting strip can be interrupted and resume where the constraint ends:

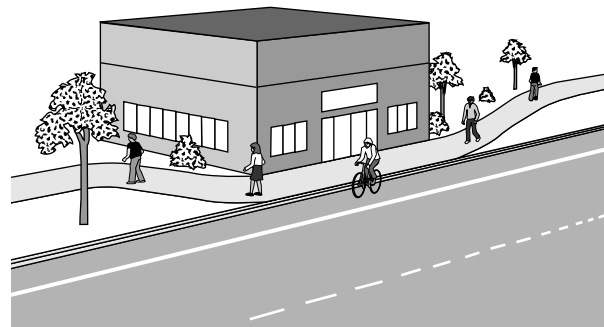

Figure 52: Planting strip constraints

Trees, street furniture and other objects should not obscure pedestrians, bicyclists and signs.

B.1.e. High-Speed Corridors

Sidewalks must not be placed directly adjacent to a high-speed travel lane (design speed 70 km/h [45 MPH] and above). Acceptable buffers include a planting strip, a shoulder barrier, a parking lane or a bike lane. Buffers are also beneficial on lower speed facilities.



Wide sidewalk on bridge with parking meters

B.1.f. Bridges

The standard width for sidewalks on bridges is 2.1 m (7 ft) (min. 1.8 m [6 ft]), to account for a shy distance from the bridge rail - some pedestrians feel uncomfortable walking close to a high vertical drop. The bridge sidewalk must not be narrower than the approach sidewalk; in instances where the approach sidewalks are of differing widths, the lesser of the two widths may be used on the bridge. Sidewalks on bridges with design speeds greater than 65 km/h (40 MPH) require a vehicle barrier at

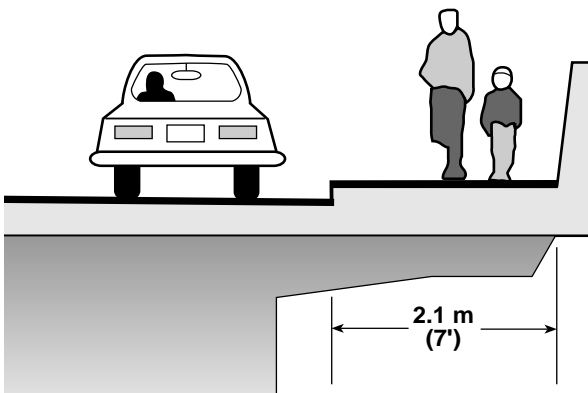

Figure 53: Sidewalk on bridge

curb line. Bridge pedestrian rails should be the standard 1.1 m (42") height.

B.1.g. Surfacing

The preferred material for sidewalks is Portland Cement Concrete (PCC), which provides a smooth, durable finish that is easy to grade and repair.

Asphaltic Concrete (A/C) may be used if it can be finished to the same surface smoothness as PCC. A/C is susceptible to break up by vegetation, requires more frequent maintenance and generally has a shorter life expectancy (15-20 years versus 40 years or more for PCC).

Brick pavers can provide an aesthetically pleasing effect if the following concerns are addressed:

- They should be laid to a great degree of smoothness;
- The surface must be slip-resistant when wet; and
- Long-term maintenance costs should be considered.

C. PATHS

C.1. UNPAVED PATHS

In general, the standard width of an unpaved path is the same as for sidewalks. An unpaved path should not be constructed where a sidewalk is more appropriate.

The surface material should be packed hard enough to be usable by wheelchairs and children on bicycles (the roadway should be designed to accommodate more experienced bicyclists).

Recycled pavement grindings provide a suitable material: they are usually inexpensive and easy to grade (this should be done in the summer, when the heat helps pack and bind the grindings).

C.2. PAVED PATHS

See page 117 for standards for multi-use paths.

D. SHOULDER STANDARDS

Refer to Table 7 on page 67. Where shoulders are expected to be used by bicyclists and pedestrians, shoulders should be 1.8 m (6 ft) or wider. High pedestrian use indicates that sidewalks are necessary.

E. TRANSIT STOPS

E.1. SIDEWALKS

At transit stops, sidewalks should be constructed to the nearest intersection or to the nearest section of existing sidewalk. It may be necessary to wrap a sidewalk around a corner to join an existing sidewalk on a side street. If a transit route does not have complete sidewalks, it is still important to provide a suitable area for waiting pedestrians.

ADA requires a 2.4 m (8 ft) by 1.5 m (5 ft) landing pad at bus entrances and exits. To avoid the choppy effect this creates at permanent bus stop locations, it may be preferable to construct a continuous 2.4 m (8 ft) wide sidewalk the length of the bus stop, or at least to the front and rear bus doors.

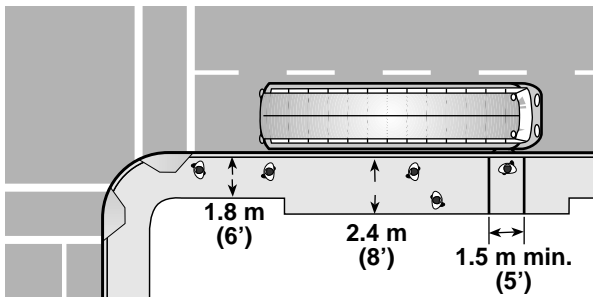

Figure 54: Bus stop pad

At stops in uncurbed areas, the shoulder should be 2.4 m (8 ft) wide to provide a landing pad.

E.2. BUS SHELTERS

A standard-size bus shelter requires a 1.8 x 3 m (6 x 10 ft) pad, with the shelter placed no closer than 0.6 m (2 ft) from the curb. The adjacent sidewalk must still have a 1.8 m (6 ft) clear-zone. Orientation of the shelter should take into

account prevailing winter winds. Bike racks should be considered at bus stops in urban fringe areas.

Each transit agency may have its own standards for bus shelter pads; walkway construction should be coordinated with local transit agencies to ensure compatibility.

E.3. BUS PULLOUTS

Where traffic conditions warrant a bus pullout at an intersection, a far-side location is preferred. The needs of passengers boarding or exiting a bus should not conflict with the needs of pedestrians and bicyclists moving through the area. A curb extension helps pedestrian crossing movements, prevents motorists from entering the bus pullout area and reduces conflicts with through bicyclists. Each pullout should be designed to meet roadway conditions and bus characteristics.

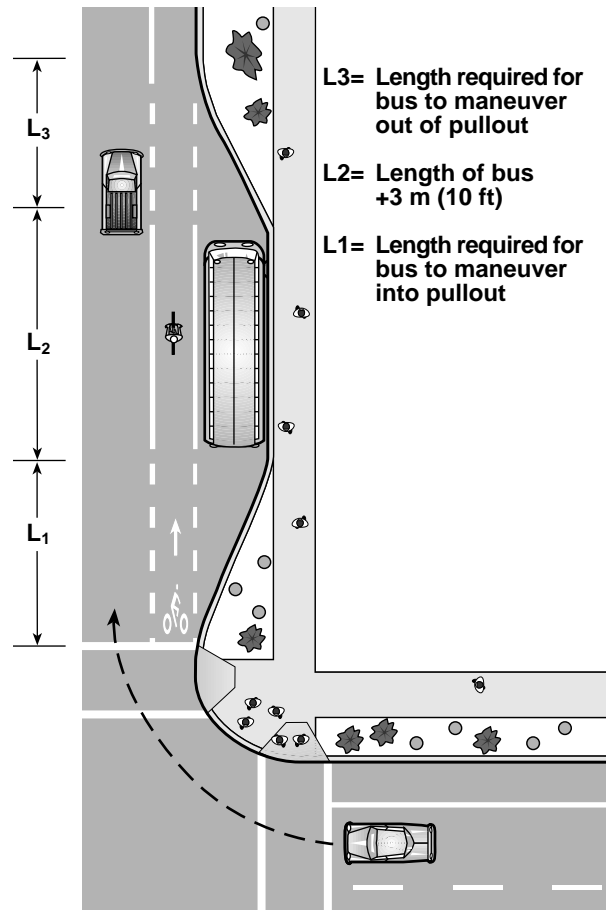

Figure 55: Far side bus pullout at intersection

On streets with parking, near-side bus stops also benefit from curb extensions, so passengers can board or dismount the bus directly without stepping onto the street. This also makes it easier to meet ADA requirements (the bus pulls up right next to the curb), and requires less removal of on-street parking (curb-side bus stops require up to 80' of no-parking zone).

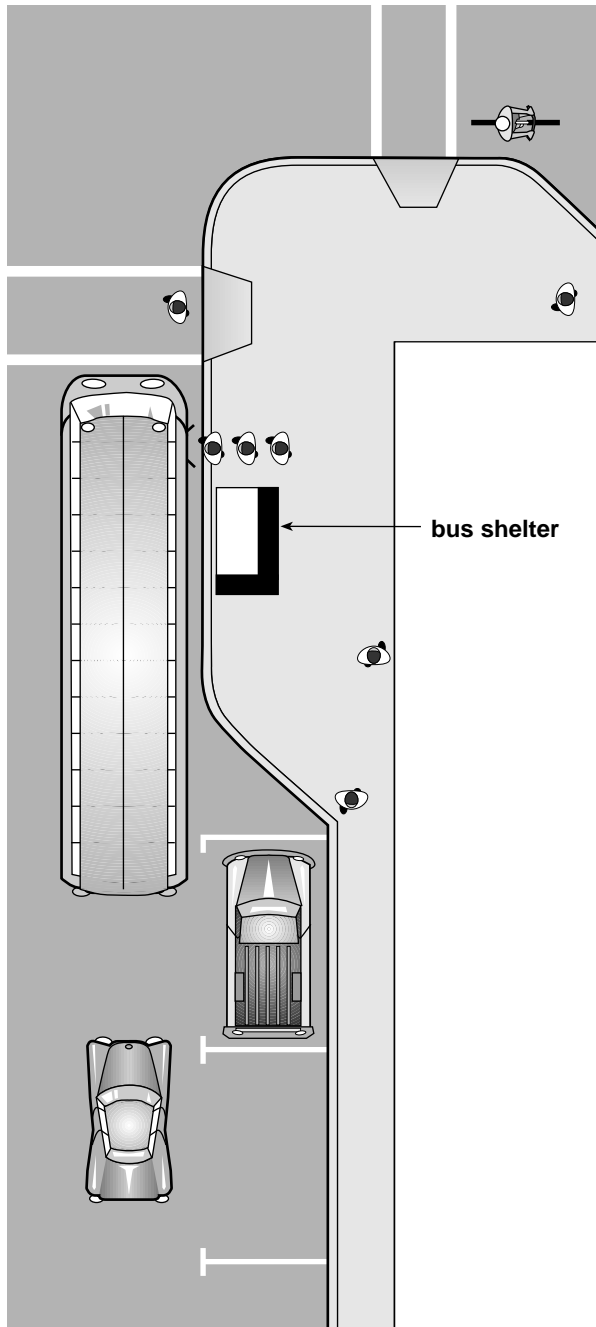

Figure 56: Near-side curb extension at intersection



Bus stop with curb extension



Bus pullout near shopping center



Transit stop at shopping mall entrance reduces walking distance

F. ACCOMMODATING THE DISABLED

The Americans with Disabilities Act (ADA) requires that transportation facilities accommodate the disabled. For most practical purposes, mobility- and vision-impaired pedestrians need special attention.

ODOT walkway standards meet or exceed minimum ADA requirements. Some minor improvements can greatly improve accessibility. The following general requirements are not discussed in detail; the ADAAG (Americans with Disabilities Act Accessibility Guidelines) and ODOT Standard Drawings should be used to construct curb cuts and driveways.

F.1. WIDTH

ADA requires a minimum passage of 1 m (3 ft). The standard sidewalk width of 1.8 m (6 ft) exceeds this requirement. If a 1 m (3 ft) walk is used, 1.5 m X 1.5 m (5 ft X 5 ft) passing areas are required at 60 m (200 ft) intervals (max.).

F.2. GRADES

The following standards pertain mostly to the grade of separated paths on independent alignments (sidewalk curb cuts have their own requirements). Where sidewalks are directly adjacent to a roadway, they may follow the natural grade of the land.

The maximum grade of ramps and separated pathways is 5%. A maximum grade of 12:1 (8.33%) is acceptable for a rise of no more than 0.75 m (2.5 ft) if a level landing at least 1.5 m (5 ft) long is provided at each end.

While this may be suitable for short distances, such as a ramp to the entrance of a building, a 12:1 slope followed by a level landing over a long distance creates a choppy effect that is hard to

construct. The overall grade achieved by this design is 7.1%. It may be preferable to extend the ramp length to achieve a constant 5% grade.

A 1.5 m (5 ft) landing should also be provided wherever the grade changes abruptly, such as between closely-spaced driveways.

F.3. CROSS-SLOPE

The maximum allowable cross-slope for a walkway is 2%. At driveways, curb cuts and road approaches (in crosswalks, marked or unmarked), a 1 m (3 ft) minimum wide area must be maintained at 2%:

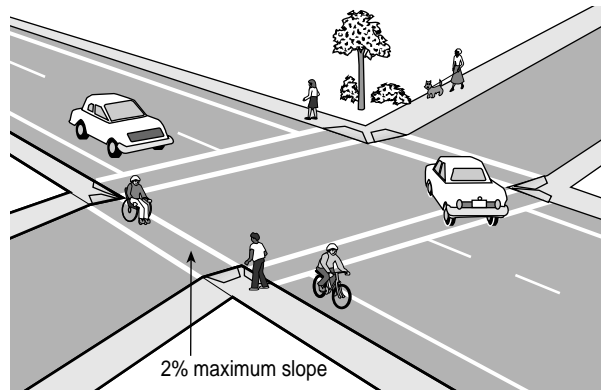

Figure 58: 2% Cross-slope maintained through crosswalk



Level area maintained in crosswalk

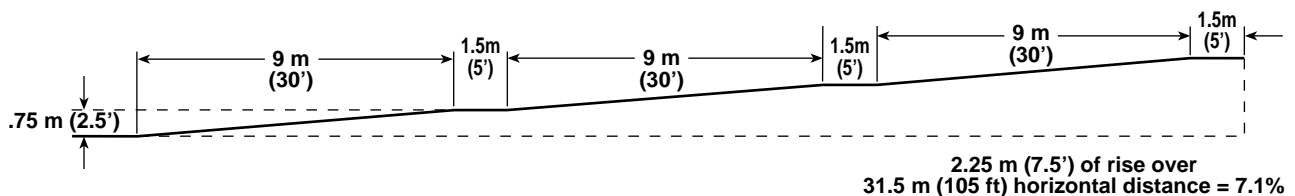

Figure 57: Maximum allowable grades

To facilitate wheelchair movement at driveways, the following techniques prevent an exaggerated warp and cross-slope:

- Reducing the number of accesses reduces the need for special provisions; this strategy should be pursued first;
- Constructing wide sidewalks avoids excessively steep driveway slopes; the overall width must be sufficient to avoid an abrupt driveway slope:

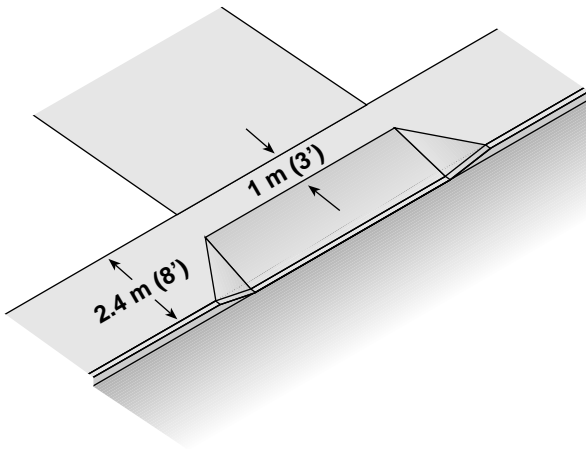

Figure 59: Wide sidewalk at driveway

- Planting strips allow sidewalks to remain level, with the driveway grade change occurring in the planting strip:

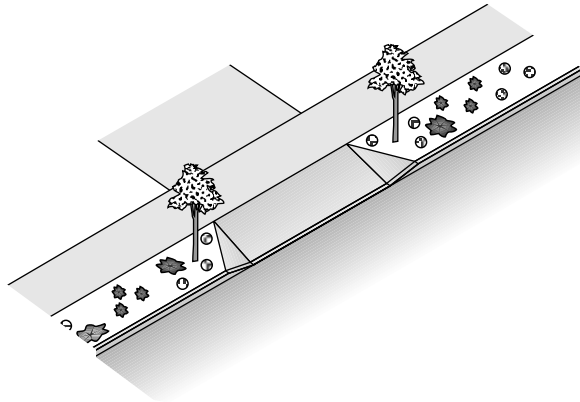

Figure 60: Driveway with planting strip

- Where constraints don't allow a planting strip, wrapping the sidewalk around driveway entrances has a similar effect (this

method may have disadvantages for the vision-impaired who follow the curb line for guidance):

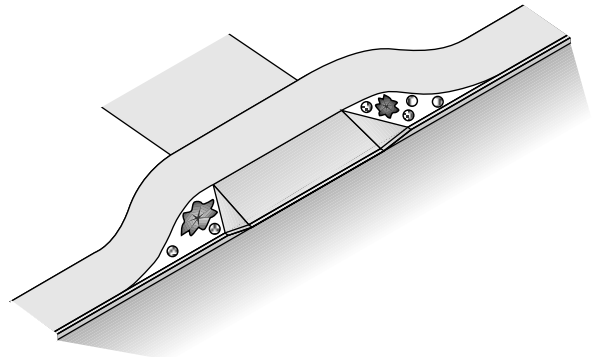

Figure 61: Sidewalk wrapped around driveway

- When constraints allow for only minimal sidewalks behind the curb, dipping the entire sidewalk at approaches keeps the cross-slope at a constant grade. This may be uncomfortable for pedestrians and may create drainage problems behind the sidewalk.

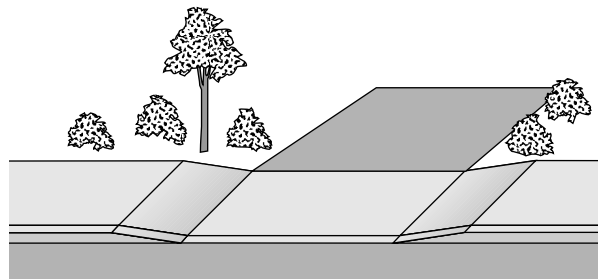

Figure 62: Entire sidewalk dips at driveway



Sloping driveway creates difficulties for wheelchair users

F.4. CURB-CUTS

ADA requires two curb-cuts per corner at intersections for new construction (one oblique cut may direct users into the travelway). A 1 m (3 ft) wide passage with a cross slope of 2% must be maintained behind curb cuts.

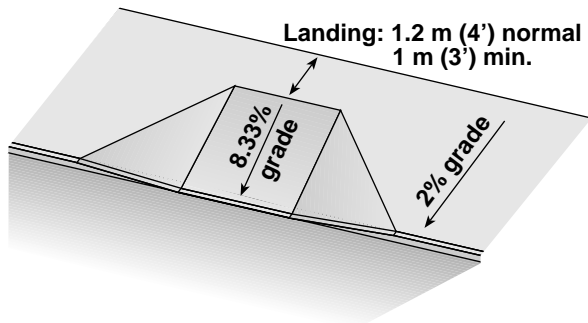

Figure 63: 1 m (3 ft) wide area at 2% cross-slope on sidewalks

F.5. FACILITIES FOR THE VISION-IMPAIRED

Pedestrian facilities should be designed so people with impaired vision can track their way across approaches and through intersections.

Most recommended practices for sidewalk construction satisfy these requirements.

The most critical areas for the vision impaired are locations where the crossing points may not be readily apparent to motorists, for example at a corner with a large radius. There are several techniques that enhance the environment for the vision-impaired:

- Placing crosswalks in areas where they are expected (in line with curb cuts and sidewalks);
- Providing audible pedestrian signals at busy intersections; and
- Using special surface texture at curb-cuts to identify the placement of the crosswalk.

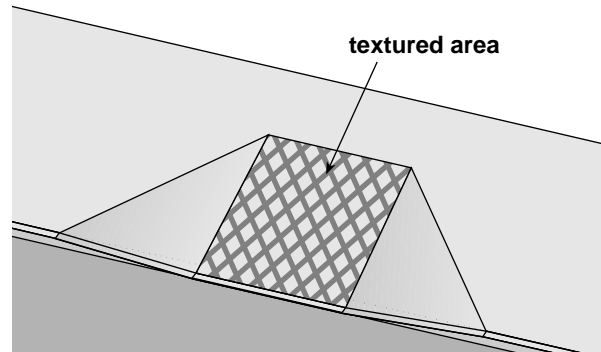

Figure 64: Textured ramp



Curb-cut retrofit projects improve accessibility

G. ADDITIONAL PEDESTRIAN FACILITIES

Since pedestrians are exposed to the weather and use their own energy to move, several low-cost improvements can be made to provide a better environment.

G.1. BENCHES

People walking want to sit down and rest occasionally. In an urban setting, wide sidewalks and curb extensions provide opportunities for placing benches outside of the pedestrian traffic stream.

G.2. SHELTERS

At bus stops, transfer stations and other locations where pedestrians must wait, a shelter makes the wait more comfortable. People are more likely to ride a bus if they don't have to wait in the rain.

G.3. AWNINGS

Where buildings are close to the sidewalk, awnings protect pedestrians from the weather and can be a visual enhancement to the shopping district.

G.4. LANDSCAPING

The outer edge of a roadway is often neglected and unpleasant; yet this is where pedestrians are expected to travel. Landscaping can greatly

enhance the aesthetic experience, making the walk less stressful or tiring. Landscaping can increase the effectiveness of a planting strip as a buffer between travel lanes and sidewalks, as well as mask features such as soundwalls.

Choosing appropriate plants and ground preparation is important. The following guidelines should be considered:

- Plants should be adapted to the local climate and fit the character of the surrounding area - they should survive without protection or intensive irrigation, and should require minimal maintenance, to reduce long-term costs.
- Plants must have growth patterns that do not obscure pedestrians from motor vehicles, especially at crossing locations, nor must they obscure signs.
- Plants should not have roots that could buckle and break sidewalks (root barriers should be placed to prevent such buckling).
- Planting strips should be wide enough to accommodate plants grown to mature size.
- The soil should be loosened and treated (with mulching materials) deep enough so plants can spread their roots downward, rather than sideways into the walk area.

G.5. WATER FOUNTAINS & PUBLIC REST ROOMS

Strategically placed water fountains make it easier for pedestrians to be outdoors for a long time and to walk long distances.

Well-placed public rest rooms make it easier for pedestrians to stay outdoors without worrying about where to find a business that will accommodate their needs.

G.6. MAPS

Local walking maps make it easier for pedestrians to find their way to points of interest in a new urban environment. They are especially useful when combined with transit maps. So far, no standards have been developed.



Statues add interest to the streetscape

H. OTHER CONSIDERATIONS

H.1. ALLEYS

Alleys in urban areas can present problems for pedestrians if sight distance is limited and if the alley is surrounded by buildings adjacent to the sidewalk: pedestrians are often not noticed by drivers exiting an alley. Several measures can be taken to improve pedestrian visibility:

- Continuing the surface design (texture and color) of the sidewalk through the alley crossing, so motorists know they are entering a pedestrian zone;
- Placing stop signs;
- Placing a speed hump before the front of a vehicle protrudes onto the sidewalk;
- Placing mirrors so drivers can see approaching pedestrians.

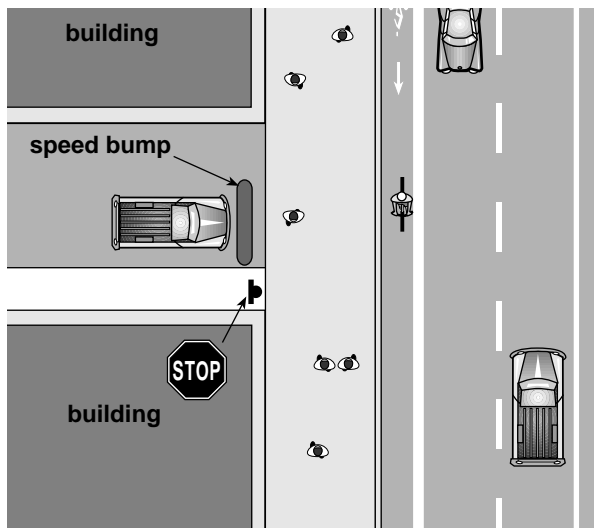

Figure 65: Alley approaching sidewalk

H.2. DRIVEWAYS

Accesses onto private property can be built as conventional driveways, or with designs that resemble street intersections. For pedestrian safety and comfort, the conventional driveway type is preferred, for the following reasons:

- Motorists must slow down more when turning into the driveway; and
- The right of way is clearly established, as motorists cross a sidewalk.

Intersection-type driveways have the following disadvantages for pedestrians:

- Motorists can negotiate the turn at faster speeds; and
- The right of way is not as clearly established, as the roadway appears to wrap around the curb line.

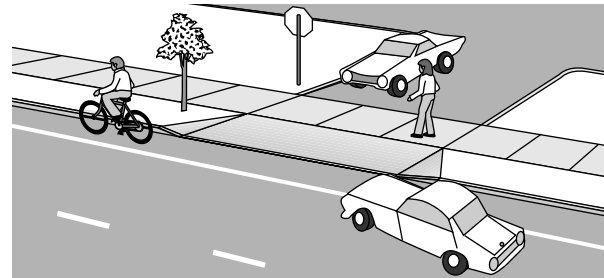

Conventional driveway slows turning vehicles

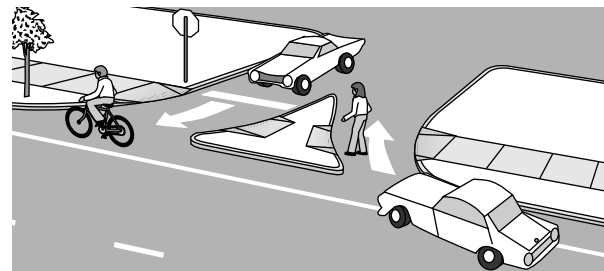

This style of driveway may encourage high-speed turns

Figure 66: Driveway configurations and their effect on pedestrians

Where an intersection-style driveway is used (such as to implement a “right-in, right-out” policy), the following techniques can be used to alleviate the above concerns:

- The street surface material should not carry across the driveway - rather, the sidewalk should carry across the driveway, preferably at sidewalk height, so motorists know they are entering a pedestrian area;
- The radius of the curb should be kept as small as possible;
- Driveway widths should be the minimum needed for entering and exiting vehicles; and
- Where the volume of turning vehicles is high, right-turn channelization should be considered, to remove slower turning vehicles from the traffic flow, allowing them to stop for pedestrians; or a traffic signal should be considered where the turning movements are very high.

I. PRACTICES TO BE AVOIDED

I.1. OBSTRUCTIONS IN SIDEWALK

The full sidewalk pavement width should be maintained to the extent possible. Permanent fixtures such as mailboxes, poles and sign posts should be placed outside of the sidewalk, or the sidewalk should be enlarged or wrapped around to avoid these obstructions.



Poles in sidewalk



Sidewalk wraps around poles



Signs in sidewalk

I.2. NARROW SIDEWALKS

Though ADA does specify a 1 m (3') minimum clear passage, this is inadequate for pedestrian use. The 1.5 m (5') ODOT minimum standard should be applied wherever possible.



This sidewalk, along a busy street, is too narrow for comfort

I.3. DISCONTINUOUS SIDEWALKS

Sidewalks must link up to each other, or to a defined origin or destination point.



Wheelchair user is forced into street where sidewalk is missing

I.4. STEEP CROSS-SLOPE

Severe cross-slopes hinder movements of wheelchair users. Where the ADA 2% maximum cannot be achieved, attempts should be made to reduce cross-slope as much as possible.



Steep cross-slope tilts wheelchair

I.5. BROKEN PAVEMENT

Sidewalks in poor repair are difficult for wheelchair users to negotiate. Even able-bodied pedestrians have difficulty walking through badly broken pavement.



Sidewalk in disrepair



Wheelchair can't proceed here

I.6. ENCROACHING VEGETATION

Bushes, shrubs and trees can reduce sidewalk width and obscure visibility. Maintenance should be scheduled to ensure that plants are trimmed on a regular basis.



Overgrown shrub obscures visibility of pedestrians

I.7. INACCESSIBLE CROSSWALKS

Any open leg of an intersection should lead to a sidewalk.



Crosswalk is inaccessible because of guardrail

J. OTHER INNOVATIVE DESIGNS

These concepts are presented as information, to help ODOT, cities and counties to come up with new solutions to common problems.

J.1. SIDEWALKS WITHOUT CURB & GUTTER

Most sidewalks are separated from the roadway with a curb. The main functions of a curb are for drainage and as a positive separation for motor vehicles. Curb and gutter add substantially to the cost of sidewalks in areas where no storm drain system is in place.

In situations where sidewalks are needed, but the high cost of curb and drainage cannot be justified, or where curbs don't fit the character of the street, two designs enable sidewalks to be constructed without curb and drainage: sidewalks behind the ditch and soft sidewalks.

J.1.a. Sidewalks Behind the Ditch

On roads with a rural character, where drainage is provided with an open ditch, and where there is sufficient right-of-way, sidewalks may be placed behind the ditch.

The sidewalk should be built to the same standard as curbed sidewalks: 1.8 m (6 ft) wide (1.5 m [5 ft] min.). If the traffic on the road is high, bicyclists should be accommodated with on-road bike lanes or shoulders. Gravel drive-ways should be paved back 5 m (15 ft) to avoid debris accumulation on the sidewalks.

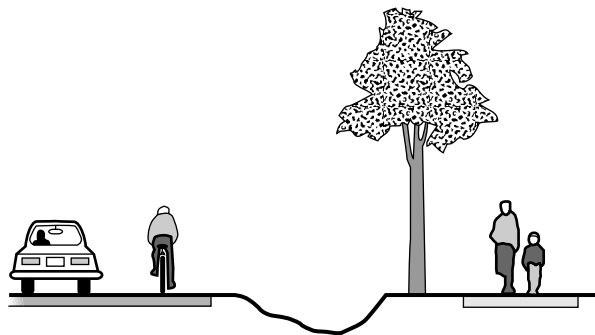

Figure 67: Sidewalk behind the ditch

J.1.b. “Soft Sidewalks”

A “soft sidewalk” has no curb separating the roadway from the walkway. This treatment may be appropriate in areas of moderate precipitation and low traffic volumes and speeds. Sidewalks are separated by a brick paver strip, gravel or other permeable material, so runoff water can percolate. A change in surface texture is needed for vision-impaired pedestrians to detect the edge of walkway with a cane.

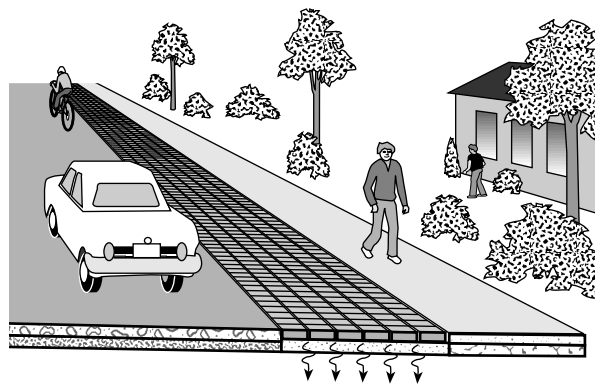

Figure 68: Soft sidewalk



Awning and trees provide shade

II.5. STREET CROSSINGS

INTRODUCTION

Walkways along a road provide mobility in one direction, but a successful pedestrian network also requires safe and convenient crossing opportunities. Wide roads carrying large traffic volumes can be obstacles to pedestrians, making facilities on the other side difficult to access.

Safe street crossings also benefit motorists: an automobile driver parking on one side of the road may desire access to points across the street. A pedestrian system with sidewalks and crossing opportunities allows a driver to park once and walk to several destinations.

Most pedestrian crashes occur when a pedestrian crosses a road, often at locations other than intersections. Mid-block crossings are a fact that planners and designers need to consider: people will take the shortest route to their destination. Prohibiting such movements is counter-productive if pedestrians dash across the road with no protection. It is better to design roadways that enable pedestrians to cross safely.

A. CROSSWALKS DEFINED

Oregon law defines a crosswalk as the prolongation of a curb, sidewalk or shoulder across an intersection, whether it is marked or not. Outside an intersection, a crosswalk is created

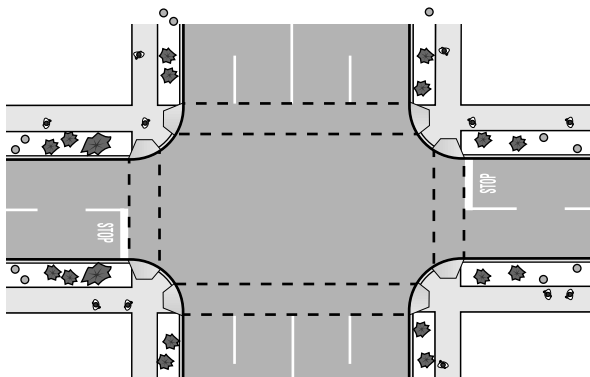

Figure 69: Unmarked crosswalks

with markings on the road. If a pedestrian is in a crosswalk, all drivers on that half of the street are required to yield the right of way to the pedestrians. See ORS 801.220 in Appendix I for the complete legal definition of a crosswalk.

B. LEGAL CROSSING MOVEMENTS

“Jay-walking” does not necessarily mean crossing a street outside of a crosswalk, marked or unmarked. The Oregon Vehicle Code states that it is illegal for pedestrians to:

- Cross a street against a traffic signal;
- Cross the street outside of a crosswalk without yielding to automobile traffic;
- Cross the street outside of a crosswalk at an intersection; and
- Proceed in a crosswalk in a manner that causes an immediate hazard to an approaching motor vehicle.

The right of way laws are:

- At crosswalks, marked or unmarked, the pedestrian has the right of way (ORS 811.010, 015 & 020).
- At other locations, crossing is allowed, but the pedestrian must yield to motor vehicles (ORS 814.040). Some local jurisdictions have passed ordinances prohibiting crossings outside of crosswalks in the Central Business District between signalized intersections.



Curb extension and refuge island

C. IMPROVING CROSSING OPPORTUNITIES

To increase pedestrian crossing opportunities and safety, two approaches can be considered:

1. Designing roads that allow crossings to occur safely by incorporating design features such as raised medians or signal timing that creates gaps in traffic; or
2. Constructing actual pedestrian crossings with pedestrian activated signals, mid-block curb extensions, marked crosswalks, etc.

C.1. ISSUES

Safe and convenient pedestrian crossings must be considered when planning and designing urban roadways. The following issues should be addressed when seeking solutions to specific problems:

C.1.a. Level of Service (LOS) & Design Standards

Appropriate design standards take into account the needs of all users. Pedestrian access and mobility should be considered when determining the desirable LOS for a roadway. In some areas, pedestrian needs should be elevated above the needs of motorized traffic (e.g. downtown, near schools or parks). Pedestrians are less visible and less protected than motorists; well-designed roads take this into account.

In general, there is an inverse relationship between traffic volumes or speeds and the ease of pedestrian crossing, which can lead to conflicting goals when determining priorities for a roadway:

- Some motor vehicle designs may reduce pedestrian crossing safety (e.g. a high number of wide travel lanes increases the distance a pedestrian must cross);
- Some designs that facilitate pedestrian crossings may reduce capacity (e.g. pedestrian signals);
- Other design features benefit all users (e.g. improved sight distance at intersections and raised medians).

In some cases, actual travel speeds may be higher than is appropriate for the adjacent

land use, and improvements that facilitate crossing may be useful in reducing traffic speeds to desirable and legal limits. Minor collectors and residential streets often carry more fast-moving traffic than the street is designed to carry. The design of a road should not encourage excessive speeds; even a major arterial can be treated for pedestrian safety without degrading capacity.



Textured crosswalk

C.1.b. Land Use

As the number and density of pedestrian-accessible origin and destination points increase, so does the demand for pedestrian crossings. On corridors with scattered development and residences, it is difficult to predict where crossings may occur. On corridors with concentrated nodes of activity, special crossing treatments are easier to justify at locations where crossings will likely occur (apartment complexes, senior citizen centers, schools, parks, shopping areas, libraries, hospitals and other public or institutional uses).

Planners and transportation officials must work together to ensure that land use is compatible with the roadway design, and vice versa.

C.1.c. Transit Stops

Most transit users will have to cross the road to access a transit stop on one leg of their trip. Cooperation between public transit agencies and transportation designers is essential to

ensure safe pedestrian crossings. By coordinating land use, roadway design and transit stops, passengers will be more secure when boarding or leaving a bus, and walking to or from their destination at either end of the transit trip.

C.1.d. Signal Spacing

Signalized intersections may be the preferred pedestrian crossing points at peak traffic hours; other crossing opportunities close to signalized intersections benefit from a “platooning” effect, as traffic signals create gaps in traffic. The effect decreases:

- As the distance from the signalized intersections increases;
- As traffic volumes increase at peak hours; or
- If poor access management allows vehicles to continually enter the roadway.

C.1.e. Access Management

Many uncontrolled accesses to a busy road decrease pedestrian crossing opportunities: when a gap is created in the traffic stream, motorists entering the road fill the gap. Pedestrians seeking refuge in a center turn lane are unprotected. One access management tool benefits pedestrian crossing: well-designed raised center medians provide a refuge for

pedestrians, so they can cross one direction of traffic at a time.

However, eliminating road connections and signals also eliminates potential pedestrian crossing opportunities. Creating an urban freeway can increase traffic speeds and volumes. Concrete barriers placed down the middle of the road (rather than a raised median) effectively prohibit pedestrian crossings. See Figure 5, page 44.

C.1.f. Perception of Safety at Crosswalks

Some studies have indicated that pedestrians may develop a “false sense of security” when crossing a road in marked crosswalks. Other studies have indicated that motorists are more likely to stop for pedestrians in marked crosswalks, especially where the right-of-way laws are enforced. Proper design makes it clear who has the right-of-way.

C.1.g. Grade-Separation & Out-of-Direction Travel

Though grade-separation may seem to offer greater safety, excessive added travel distance will discourage pedestrians who want to take a more direct route. Grade-separation must offer obvious advantages over an at-grade crossing. A structure that is unused because of inconvenience creates a situation whereby pedestrians are at risk when they attempt to cross the road with no protection.

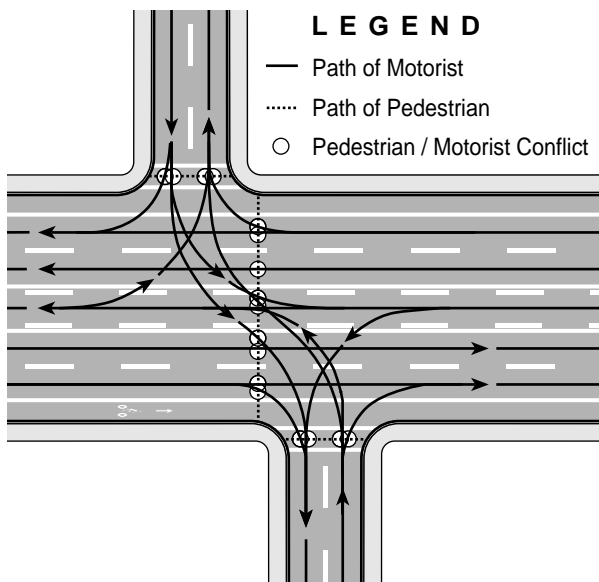

Figure 70: Accesses create additional conflicts for crossing pedestrians



Pedestrians will cross where it's most convenient

C.1.h. Maintenance

The effectiveness of a design will be lost if maintenance is excessively difficult or expensive. Forethought must be given to the practicality of future maintenance. Facilities will be effective over time only if they are in good condition. Examples of design features to be avoided include:

- Blind corners that can accumulate debris;
- Restricted areas that cannot accommodate sweepers or other power equipment; and
- Remote areas requiring hand maintenance, such as sweeping.

C.2. SOLUTIONS

No one solution is applicable in all situations as the issues will usually overlap on any given section of road. In most cases, a combination of measures will be needed to improve pedestrian crossing opportunities and safety.

C.2.a. Raised Medians

These benefit pedestrians on two-way, multi-lane streets, as they allow pedestrians to cross only one direction of traffic at a time: it takes much longer to cross four lanes of traffic than two. Where raised medians are used for access management, they should be constructed so they provide a pedestrian refuge.

Where it is not possible to provide a continuous raised median, island refuges can be created between intersections and other accesses.



Curb extensions

These should be located across from high pedestrian generators such as schools, park entrances, libraries, parking lots, etc.

In most instances, the width of the raised median is the width of the center turn-lane, minus the necessary shy distance on each side. Ideally, raised medians should be constructed with a smooth, traversable surface, such as brick pavers. If a median is landscaped, the plants should be low enough so they do not obstruct visibility, and spaced far enough apart to allow passage by pedestrians.

C.2.b. Curb Extensions

Also known as “bulbs, neckdowns, flares or chokers,” curb extensions reduce the pedestrian crossing distance and improve the visibility of pedestrians by motorists. Curb extensions should be considered at all intersections where on-street parking is allowed. The crossing distance savings are greatest when used on streets with diagonal parking. On arterials and collectors, space should be provided for existing or planned bike lanes.

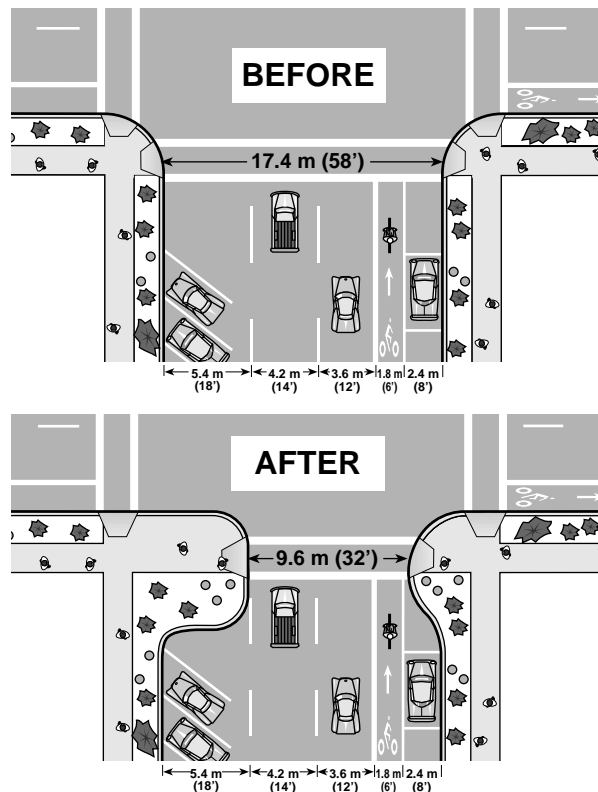

Figure 71: Curb extensions reduce crossing distance



Zebra crosswalks are highly visible

Mid-block crossing curb extensions may be considered where there are pedestrian generators on both sides of the road. However, entrances to buildings should be placed close to intersections, existing signals or crosswalks, where possible. Mid-block crossings are established by the appropriate road authority.

C.2.c. Illumination

Many crossing sites are not well lit. Providing illumination or improving existing lighting can increase nighttime safety at many locations, especially at mid-block crossings, which are often not expected by motorists.

Reducing pedestrian crossing distance improves signal timing if the pedestrian phase controls the signal. The speed normally used for calculating pedestrian crossing time is 1.2 m (4 ft)/sec., or less where many older pedestrians are expected. The time saved is substantial when two corners can be treated with curb extensions.

Non-signalized intersections also benefit from curb extensions: reducing the time pedestrians are in a crosswalk improves pedestrian safety and vehicle movement.

C.2.d. Crosswalks

Marked crosswalks are generally located at all open legs of signalized intersections. They may also be considered at other locations. Combined with curb extensions, illumination and signage, marked crosswalks can improve the visibility of pedestrian crossings. Crosswalks send the message to motorists that they are encroaching on a pedestrian area, rather than the reverse, which is often the common assumption.

There is considerable debate concerning the usefulness and safety of crosswalks (see section C.1.f). If a crosswalk is not working, some possible problems include:

- Enforcement – more rigorous enforcement of traffic laws is needed for motorists to understand that it is their duty to yield to pedestrians in a crosswalk, marked or unmarked;
- Location – marked crosswalks must be placed in locations where they are visible and where obstructions such as parked cars and signs do not affect sight lines;
- Traffic movement – many turning vehicles at nearby intersections or driveways can compromise the crosswalk;
- Users – Some people need extra help crossing a street and crosswalks alone may not be sufficient; for example, young children lack judgement and may need the positive control given by signals.

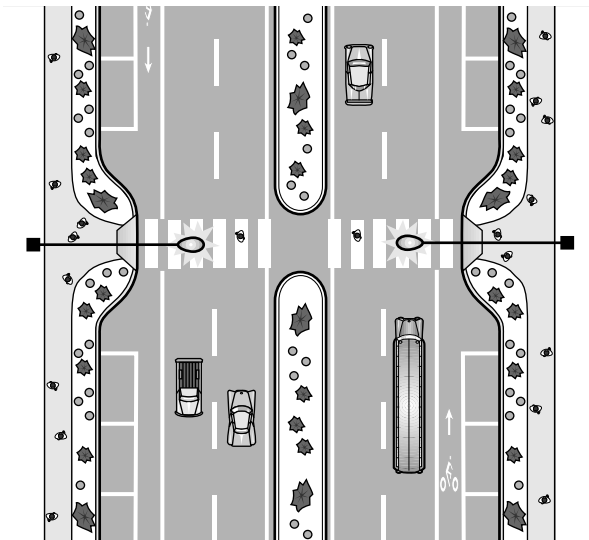

Figure 72: Mid-block curb extension with median and illumination

A traffic study will determine if a marked crosswalk will enhance pedestrian safety. This is usually in locations that are likely to receive high use, based on adjacent land use.

Crosswalks should be 3 m (10 ft) wide, or the width of the approaching sidewalk if it is greater. Two techniques to increase the visibility and effectiveness of crosswalks are:

- Striped (or “zebra”) markings, which are more visible than double lines;
- Textured crossings, using non-slip bricks or pavers, which raise a driver’s awareness through increased noise and vibration.

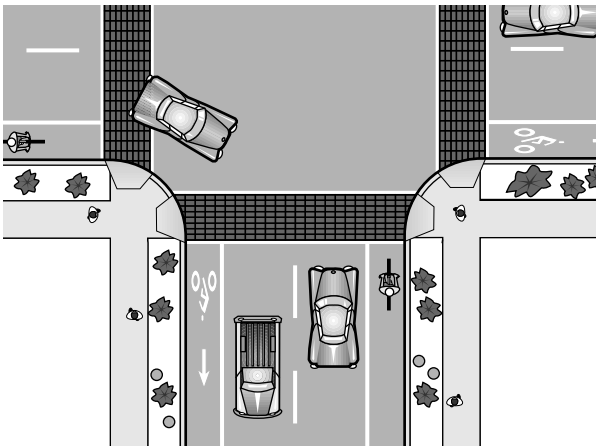

Figure 73: Colored & textured crosswalk

Colored pavers increase the visibility of the crosswalk.

C.2.e. Islands & Refuges

At wide intersections, there is often a triangular area between a through lane and a turn lane unused by motor vehicle traffic. Placing a raised island in this area benefits pedestrians by:

- Allowing pedestrians to cross fewer lanes at a time, and to judge conflicts separately;
- Providing a refuge so that slower pedestrians can wait for a break in the traffic stream;
- Reducing the total crossing distance (which provides signal timing benefits); and
- Providing an opportunity to place easily accessible pedestrian push-buttons.

An island can also be provided in the middle of an intersection. An island must be a minimum of 1.2 m (4 ft) wide, preferably 2.4 m (8 ft) or more.

Islands must be large enough to provide refuge for several pedestrians waiting at once. For wheelchair accessibility, it is preferable to provide at-grade cuts rather than ramps. Poles must be mounted away from curb cuts and out of the pedestrian path.



Median allows pedestrian to cross one direction of traffic at a time

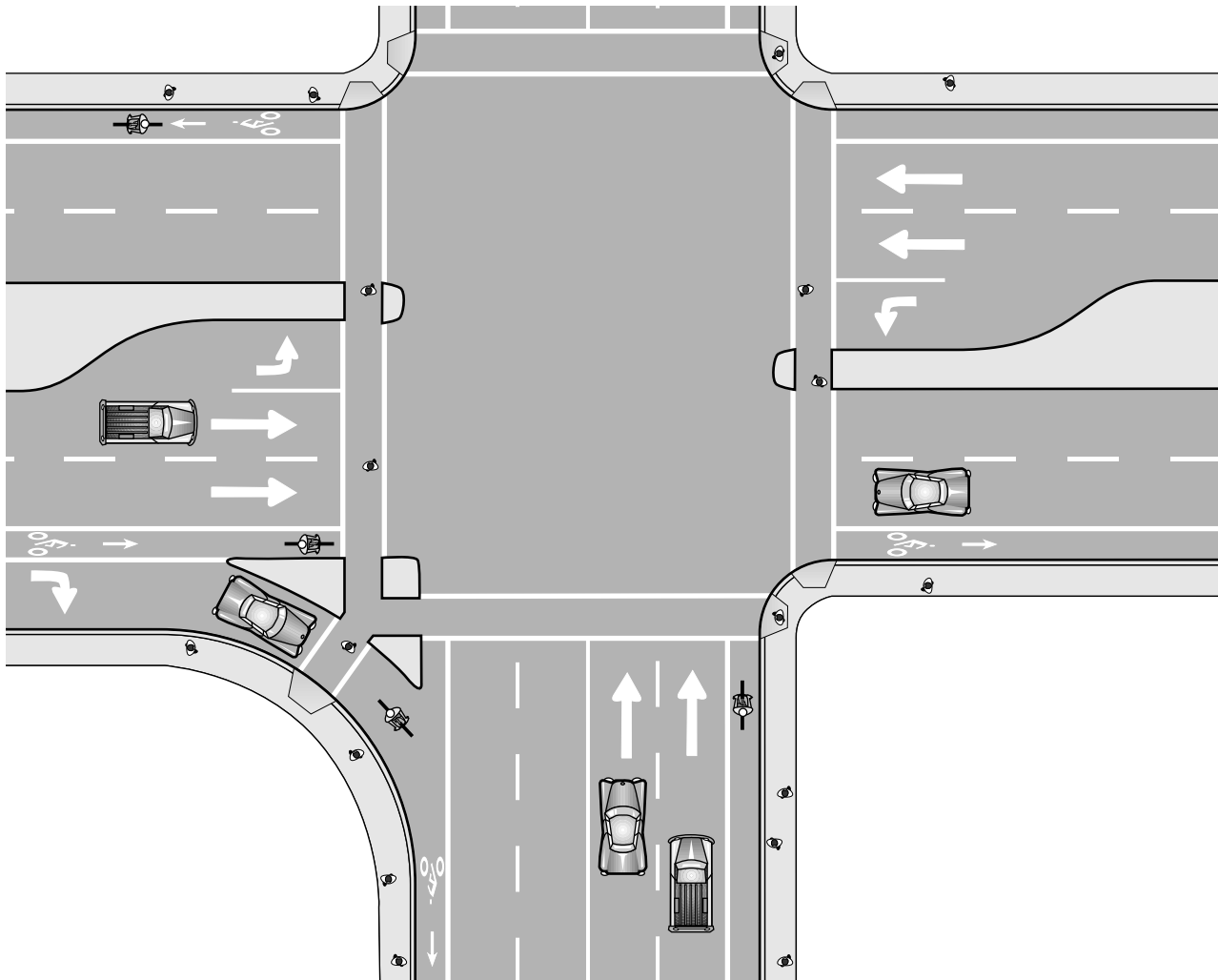

Figure 74: Raised islands at intersections

C.2.f. Pedestrian Signals

A pedestrian activated signal may be warranted where the expected number of people needing to cross a roadway at a particular location is significant. Anticipated use must be high enough for motorists to get used to stopping frequently for a red light (a light that is rarely activated may be ignored when in use). Refer to the MUTCD for pedestrian signal warrants.

Sight-distance must be adequate to ensure that motorists will see the light in time to stop. Warning signs should be installed on the approaching roadway.

Pedestrian signals may be combined with curb extensions, raised medians and refuges.



Pedestrian island provides refuge

C.2.g. Signing

Recommended signs include both advance warning signs and pedestrian crossing signs at the crossing itself, and regulatory signs at intersections to reinforce the message that motorists must yield to pedestrians. These signs should only be placed at warranted locations, because excessive signage leads to signs being missed or ignored.



Pedestrian crossing signs

D. OTHER INNOVATIVE DESIGNS

These concepts are presented as information, to help ODOT cities and counties to come up with new solutions to street-crossing problems.

D.1. RAISED CROSSWALKS

Raised crosswalks, especially if textured and colored, are more visible. They also act as speed humps and may be used in areas where excessive speeds are a problem. See page 160 for a discussion on the design and applicability of speed humps.

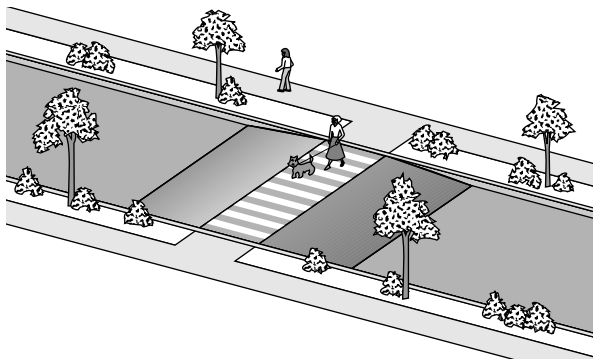

Figure 75: Raised crosswalk acts as speed hump on local street

D.2. RAISED INTERSECTIONS

Raised intersections take this concept further: motorists see that the area is not designed for rapid through movement - it is an area where pedestrians are to be expected. The driver must be cautious in approaching the intersection and be ready to yield the right-of-way to pedestrians.

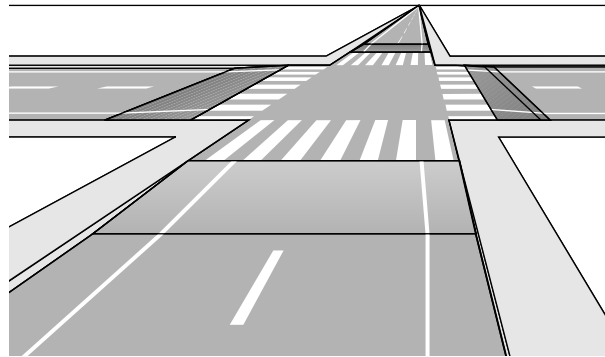

Figure 76: Raised intersection

Raised crosswalks and intersections have additional advantages:

- It is easier to meet certain ADA requirements, as the crosswalk is a natural extension of the sidewalk, with no change in grade, but they require special treatment to be detected by the visually-impaired;
- Raised intersections can simplify drainage inlet placement, as all surface water will drain away from the intersection.

Note: these treatments are more appropriate on roads other than high-speed thoroughfares.



Raised crosswalk

II.6. MULTI-USE PATHS

INTRODUCTION

Though originally conceived to provide a facility for bicyclists separated from motor-vehicle traffic, paths often see greater use by pedestrians, joggers and skaters, sometimes even equestrians. The planning and design of multi-use paths must therefore take into account the various skills, experience and characteristics of these different users.

A. WHERE PATHS ARE APPROPRIATE

Well-planned and designed multi-use paths can provide good pedestrian and bicycle mobility. They can have their own alignment along streams and greenways, or may be components of a community trail system.

Paths can serve both commuter and recreational cyclists. Many inexperienced cyclists fear motor vehicle traffic and will not ride on streets until they gain experience and confidence. A separated path provides a learning ground for potential bicycle commuters and can attract experienced cyclists who prefer an aesthetic ride.

The key components to successful paths include:

- **Continuous separation from traffic**, by locating paths along a river or a greenbelt such as a rail-to-trail conversion, with few street or driveway crossings (paths directly adjacent to roadways are not recommended, as they tend to have many conflict points);
- **Scenic qualities**, offering an aesthetic experience that attracts cyclists and pedestrians;

- **Connection to land-uses**, such as shopping malls, downtown, schools and other community destinations;
- **Well-designed street crossings**, with measures such as bike and pedestrian activated signals, median refuges and warning signs for both motor vehicles and path users;
- **Shorter trip lengths** than the road network, with connections between dead-end streets or cul-de-sacs, or as short-cuts through open spaces;
- **Visibility**: proximity to housing and businesses increases safety. Despite fears of some property owners, paths have not attracted crime into adjacent neighborhoods;
- **Good design**, by providing adequate width and sight distance, and avoiding problems such as poor drainage, blind corners and steep slopes; and
- **Proper maintenance**, with regular sweeping and repairs. The separation from motor vehicle traffic can reduce some maintenance requirements, such as sweeping the debris that accumulates on roads.



Path set in pleasant surroundings

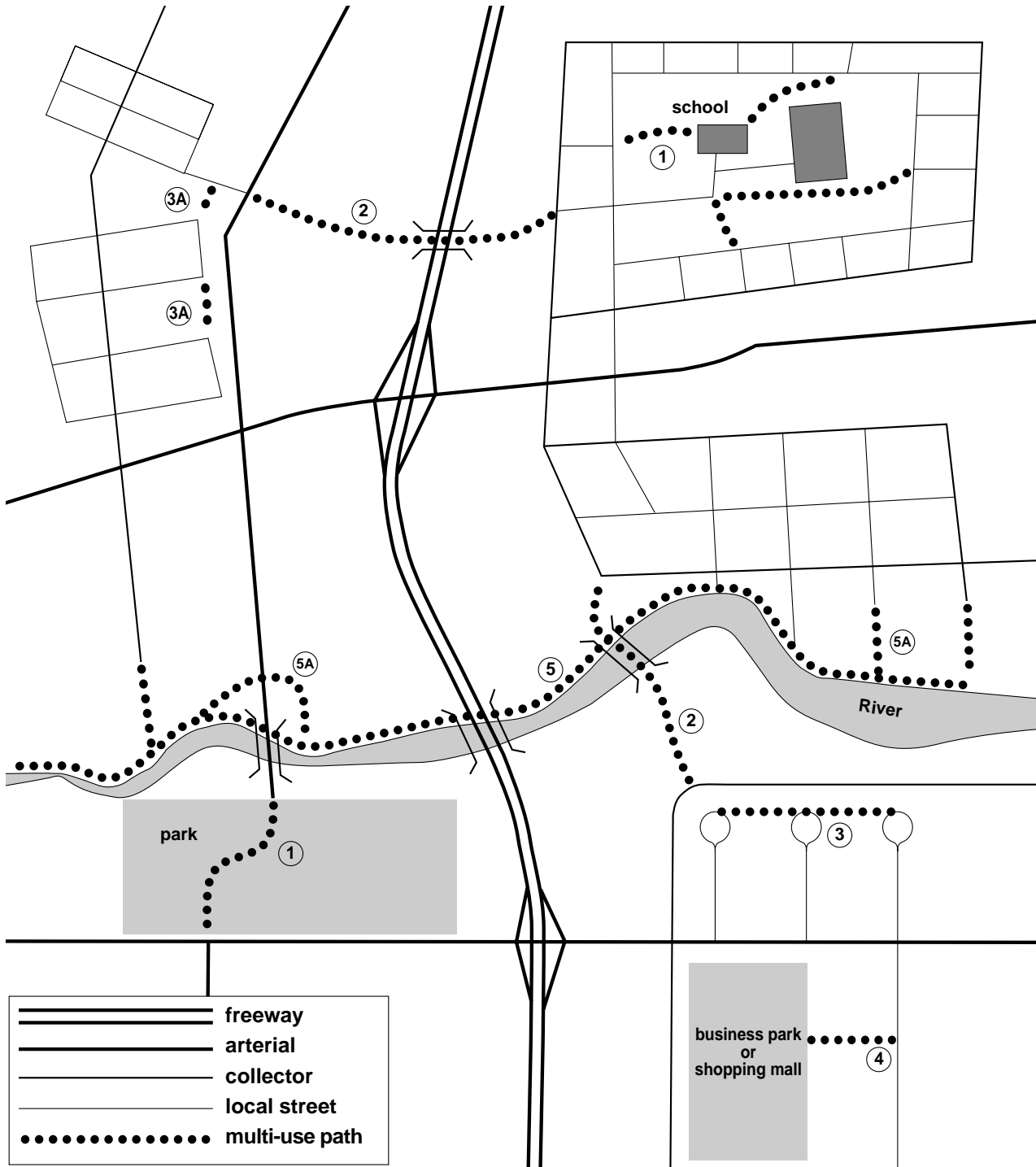

- (1) As a short cut through public land, such as a park, or as a direct access to a school, etc.
- (2) To bridge obstacles such as freeways, rivers etc.
- (3) To connect up cul-de-sacs and dead-end streets, or as shortcuts (3A).
- (4) To connect up residential areas to business areas.
- (5) Along a river or other natural corridor, with links to street system (5A).

Figure 77: Examples of multi-use paths in urban setting

B. IMPORTANT CONSIDERATIONS

B.1. CROSSINGS

The number of at-grade crossings with streets or driveways should be limited. Poorly designed crossings put pedestrians and cyclists in a position where motor vehicle drivers do not expect them at street crossings.

B.2. ACCESS

Limiting crossings must be balanced with providing access. If a path is to serve bicyclists and pedestrians well, there should be frequent and convenient access to the local road network. Access points that are spaced too far apart will require users to travel out of direction to enter or exit the path. The path should terminate where it is easily accessible to and from the street system, e.g. at a controlled intersection or at the end of a dead-end street. Directional signs direct users to and from the path.

B.3. SECURITY

Multi-use paths in secluded areas should be designed with personal security in mind. Illumination and clear sight distances improve visibility. Location markers, mileage posts and

directional signing help users know where they are. Frequent accesses improve response time by emergency vehicles.

B.4. MAINTENANCE

Multi-use paths require special trips for inspection, sweeping and repairs. They must be built to a standard high enough that allows heavy maintenance equipment to use the path without deterioration.

B.5. ON-STREET FACILITIES

As bicyclists gain experience and realize some of the advantages of riding on the road, many stop riding on paths placed adjacent to roadways. This can be confusing to motorists, who may expect bicyclists to use the path. The presence of a nearby path should not be used as a reason to not provide adequate shoulders, bike lanes or sidewalks on the roadway.

B.6. STANDARDS

Paths intended for multiple use by commuters and recreationists should be built to a standard that accommodates the various users with minimal conflicts. Designing to a low standard to save money can lead to problems if the path is popular. If usage is expected to be low, the need for a path should be reconsidered.



Lack of conflicts with motor vehicles attracts cyclists to this path

C. PATHS NEXT TO ROADWAYS

C.1. CONCERNS

Multi-use paths should not be placed next to roadways; half of the bicycle traffic will ride against the normal flow of motor vehicle traffic, which is contrary to the rules of the road, with the following consequences for bicyclists:

- When the path ends, bicyclists riding against traffic tend to continue to travel on the wrong side of the street, as do bicyclists getting to a path. Wrong-way travel by bicyclists is a major cause of bicycle/automobile crashes and should be discouraged.
- At intersections, motorists crossing the path often do not notice bicyclists coming from certain directions, especially where sight distances are poor.
- Bicyclists on the path are required to stop or yield at cross-streets and driveways.
- Stopped motor vehicle traffic on a cross-street or driveway may block the path.
- Because of the closeness of motor vehicle traffic to opposing bicycle traffic, barriers are often necessary to separate motor vehicles and bicyclists. These barriers are obstructions, complicate maintenance of the facility and waste available right-of-way.

C.2. GUIDELINES

Separated paths along roadways should be evaluated using the following guidelines:

- Bicycle and pedestrian use is anticipated to be high;
- The adjacent roadway is a heavily-traveled, high-speed thoroughfare where on-road bikeways and sidewalks may be unsafe;
- The path will generally be separated from motor vehicle traffic, with few roadway or driveway crossings.
- There are no reasonable alternatives for bikeways and sidewalks on nearby parallel streets;

- There is a commitment to provide path continuity throughout the corridor;
- The path can be terminated at each end onto streets with good bicycle and pedestrian facilities, or onto another safe, well-designed path;
- There is adequate access to local cross-streets and other facilities along the route.
- Any needed grade-separation structures do not add substantial out-of-direction travel; and
- The total cost of providing the proposed path is proportionate to the need. This evaluation should consider the costs of:
 1. Grading, paving, drainage, fences, retaining walls, sound walls, signs and other necessary design features;
 2. Structures needed to eliminate at-grade crossings; and
 3. Additional maintenance, including the need for specialized maintenance equipment.

Notes: In many cases, the best choice is to improve the roadway system to accommodate cyclists and pedestrians, which may require connecting up local streets or improving nearby, parallel streets.



Path adjacent to roadway creates conflicts at intersections

D. STANDARDS

D.1. WIDTH & CLEARANCES

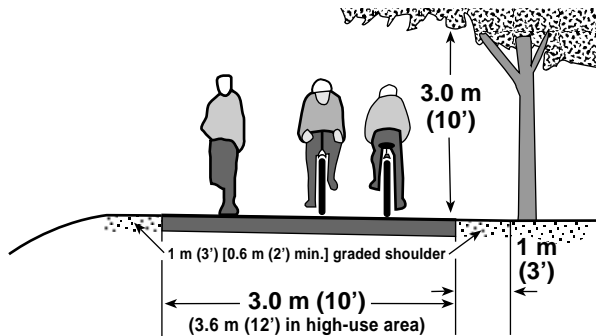

Figure 78: Multi-use path standards

D.1.a. Width

3 m (10 ft) is the standard width for a two-way multi-use path; they should be 3.6 m (12 ft) wide in areas with high mixed-use. Faster-moving bicyclists require greater width than pedestrians; optimum width should be based on the relative use by these two modes. High use by skaters may also require greater width.

The minimum width is 2.4 m (8 ft). However, 2.4 m wide multi-use paths are not recommended in most situations because they may become over-crowded. They should only be constructed as short connectors, or where long-term usage is expected to be low, and with proper horizontal and vertical alignment to assure good sight distances.

Although one-way paths may be intended for one direction of bicycle travel, they will often be used as two-way facilities, especially by pedestrians. Caution must be used in selecting this type of facility. If needed, they should be 1.8 m (6 ft) wide (min. 1.5 m [5 ft]) and designed and signed to assure one-way operation by bicyclists.

D.1.b. Lateral Clearance

A 1 m (3 ft) or greater (min. 0.6 m [2 ft]) “shy” or clear distance on both sides of a multi-use path is necessary for safe operation. If there is a railing, soundwall, retaining wall or other vertical face adjacent to the path, this area should be paved to the face of the vertical barrier. Where there is a fill- or cut-slope, this area should be unpaved and graded to the same slope as the path to allow recovery by errant bicyclists.

D.1.c. Overhead Clearance

The standard clearance to overhead obstructions is 3 m (10 ft), min. 2.4 m (8 ft).

D.1.d. Separation from roadway

Where a path is parallel and adjacent to a roadway, there should be a 1.5 m (5 ft) or greater width separating the path from the edge of roadway, or a physical barrier of sufficient height should be installed (see D.6, Railings, Fences and Barriers).

D.2. TYPICAL PAVEMENT SECTIONS

The use of concrete surfacing for paths is best for long-term use. Concrete provides a smooth ride when placed with a slip-form paver. The surface must be cross-broomed. The crack-control joints should be saw-cut, not troweled. Concrete paths cost more to build than asphalt paths, but long-term maintenance costs are lower, since they do not become as brittle, cracked and rough with age, or deformed by roots and weeds as does asphalt.

Multi-use paths should be designed with sufficient surfacing structural depth for the subgrade soil type to support maintenance and emergency vehicles. If the path must be constructed over a very poor subgrade (wet and/or poor material), treatment of the subgrade with lime, cement or geotextile fabric should be considered.

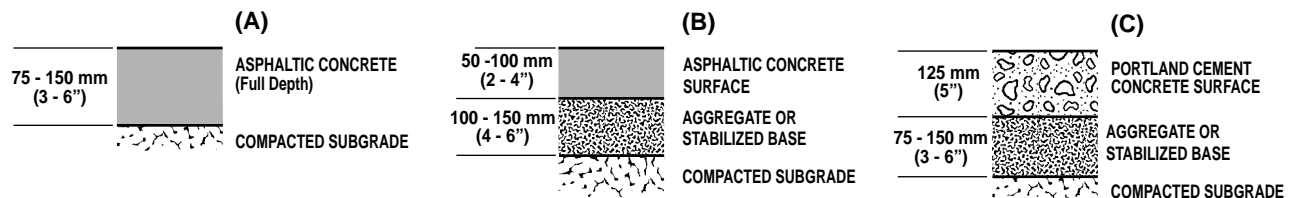

Figure 79: Multi-use path pavement structure

D.3. GRADES & CROSS-SLOPE

AASHTO recommends a maximum grade of 5% for bicycle use, with steeper grades allowable for up to 150 m (500 ft.), provided there is good horizontal alignment and sight distance. Extra width is also recommended. Engineering judgment and analysis of the controlling factors should be used to determine what distance is acceptable for steep grades.

If use by pedestrians is expected, ADA requirements must be met: the grade of separated pathways should not exceed 5%, to accommodate wheelchair users. See page 97 for an explanation of the ADA grade requirements.

Based on AASHTO recommendations and ADA requirements, 5% should be considered the maximum grade allowable for multi-use paths.

The standard cross-slope grade is 2%, to meet ADA requirements and to provide drainage. Curves should be banked with the low side on the inside of the curve to help bicyclists maintain their balance.

D.4. AT-GRADE CROSSINGS OF THOROUGHFARES

At-grade crossings introduce conflict points, and grade separation should be sought, as most path users expect continued separation from traffic. The greatest conflicts occur where

paths cross freeway entrance and exit ramps. Motorists using these ramps are seeking opportunities to merge with fast moving traffic; they are not expecting bicyclists and pedestrians at these locations.

When grade separation structures cannot be justified, signalization or other measures should be considered to reduce conflicts. Good sight distance must be provided so vehicle drivers can see approaching path users. One method is to provide a median island on multi-lane roadways as a refuge:

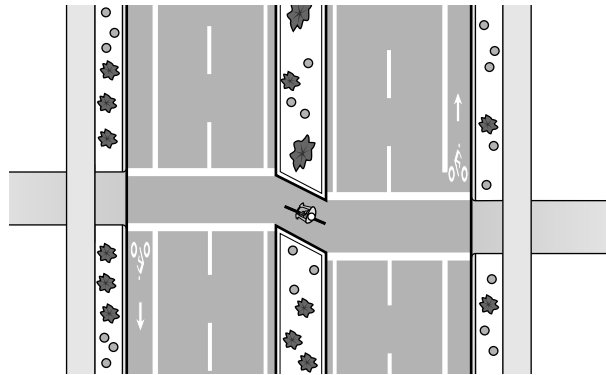

Figure 80: At-grade crossing of a thoroughfare with median island

Where a path must cross a roadway at an intersection, improvements to the alignment should be made to increase the visibility of approaching path users. One method is to



Urban path intersection with cross-street

curve the path slightly, so that it is not parallel to the adjacent roadway:

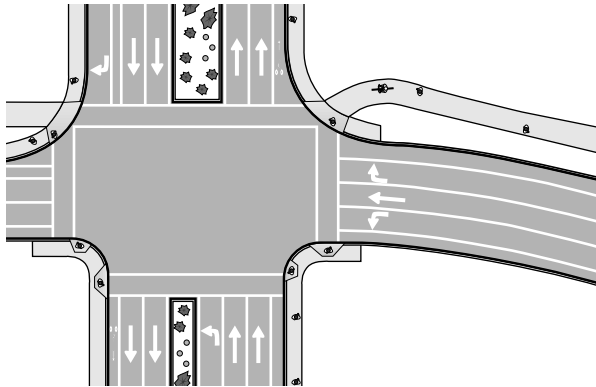

Figure 81: Path curves to improve visibility at signalized intersection

D.5. STRUCTURES

The width of multi-use path structures is the same as the approach paved path, plus a 0.6 m (2 ft) shy distance on both sides. For example, a 3 m (10 ft) wide path requires a 4.2 m (14 ft) wide structure.

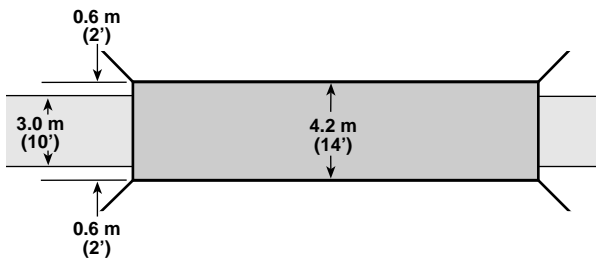

Figure 82: Multi-use path bridge

The standard overhead clearance of undercrossings is 3 m (10 ft); a 2.4 m (8 ft) min. may be allowable with good horizontal and vertical clearance, so users approaching the structure can see through to the other end. Undercrossings should be visually open for the personal security of users. Illumination is needed in areas of poor visibility.

There are advantages and disadvantages to both overcrossings and undercrossings:

D.5.a. Under-crossings

ADVANTAGES: They provide an opportunity to reduce approach grades, as the required 3 m

(10 ft) clearance is less than the clearance required for crossing over a roadway. If the roadway is elevated, an undercrossing can be constructed with little or no grade. They are often less expensive to build.

DISADVANTAGES: They may present security problems, due to reduced visibility. An open, well-lighted structure may end up costing as much as an over-crossing. They may require drainage if the sag point is lower than the surrounding terrain.

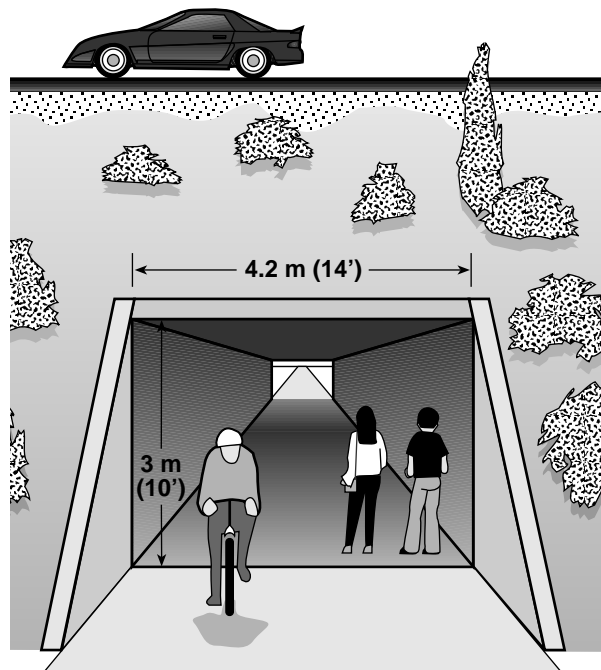

Figure 83: Undercrossing dimensions

D.5.b. Over-crossings

ADVANTAGES: They are more open and present fewer security problems.

DISADVANTAGES: They require longer approaches to achieve the standard 5 m (17 ft) of clearance over most roadways. With an additional structural depth of 1 m (3 ft), the total rise will be 6 m (20 ft). At 5%, this requires a 120 m (400 ft) approach ramp at each end, for a total of 240 m (800 ft). This can be lessened if the road is built in a cut section.

Note: 7m (23 ft) clearance is required over railroad tracks.

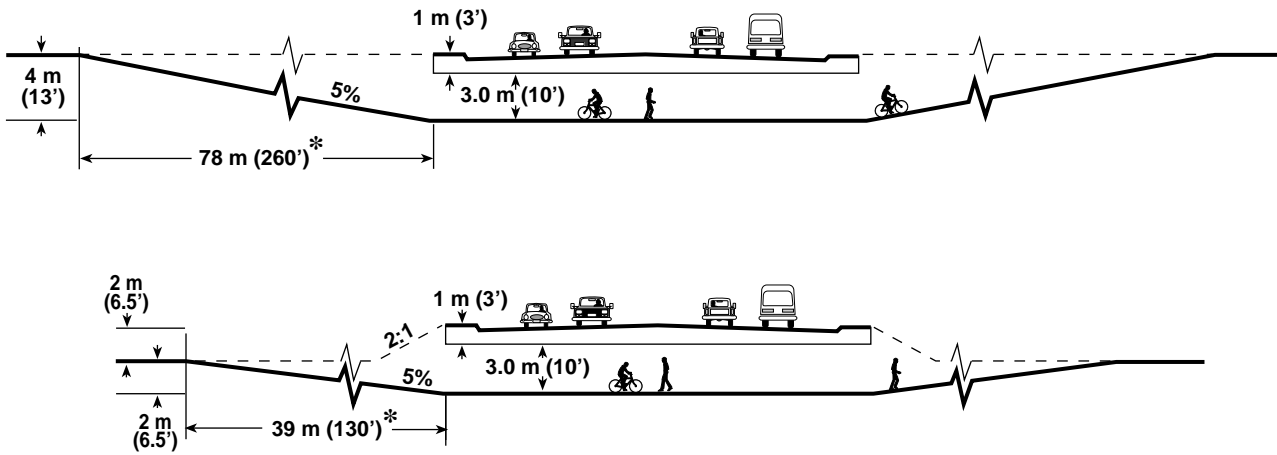

* not to scale

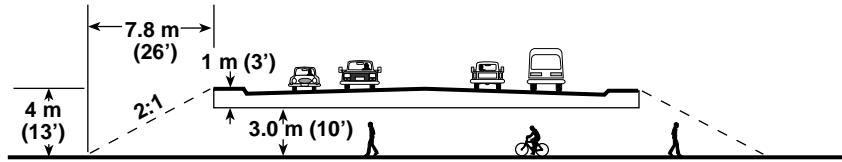
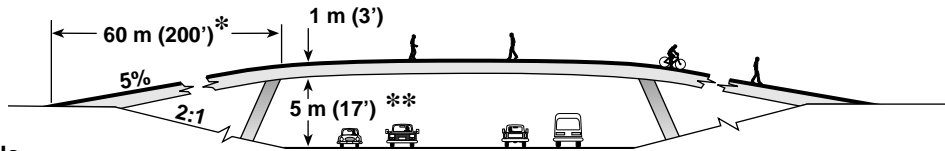
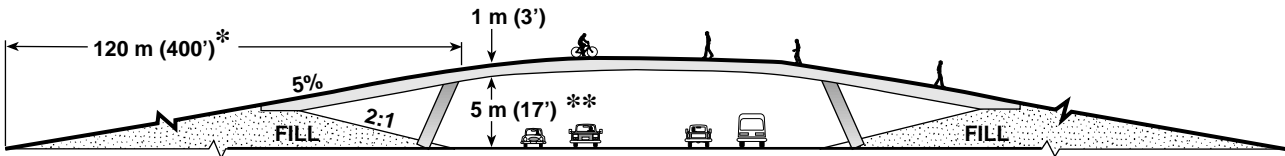
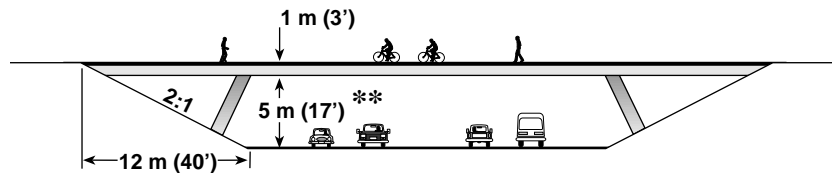

Figure 84: Undercrossing configurations



* not to scale



** 7 m (23') req'd over RR tracks

Figure 85: Overcrossing configurations



Structure with railing and illumination

The fence should be high enough to prevent a cyclist from toppling over – AASHTO recommends 1.4m (54”). Openings in the railing must not exceed 150 mm (6”) in width.

Where a cyclist’s handlebar may come into contact with a fence or barrier, a smooth, wide rub-rail may be installed at a height of 1 m (3 ft).

Where concrete barriers are used, adding tube railing or chain link fencing may be necessary to achieve the required height.

D.6. RAILINGS, FENCES & BARRIERS

Fences or railings along paths may be needed to prevent access to high-speed highways, or to provide protection along steep side slopes and waterways. **Fences, railings or barriers can become obstructions and should only be used where they are needed for safety reasons; for example, in an area where a pedestrian or a bicyclist could fall into a river, a high-speed roadway or a canyon.** They should be placed as far away from the path as possible. Duplication of fences should be avoided, such as fences on the right-of-way and fences to keep pedestrians off freeways.

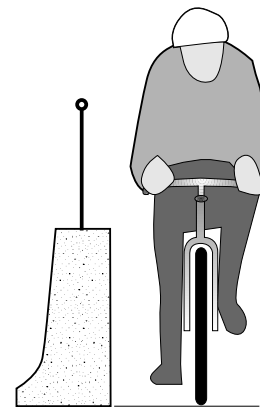

Figure 87: Adding railing to a barrier

Care must be taken to avoid a “cattle chute” effect by placing a high chain-link fence on each side of a path.

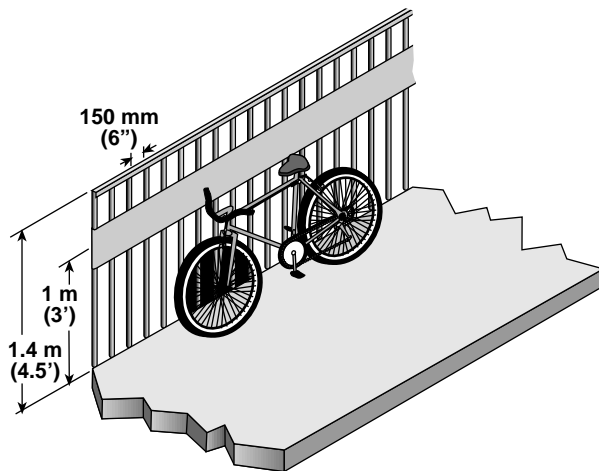

Figure 86: Railing with “rub-rail”

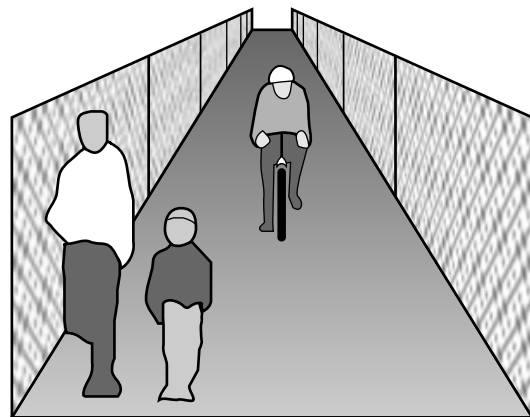

Figure 88 : “Cattle-chute” effect

D.7. PREVENTING MOTOR-VEHICLE ACCESS

D.7.a. Geometric Design

One method branches the path into two narrower one-way paths just before it reaches the roadway, making it difficult for a motor vehicle to gain access to the path:

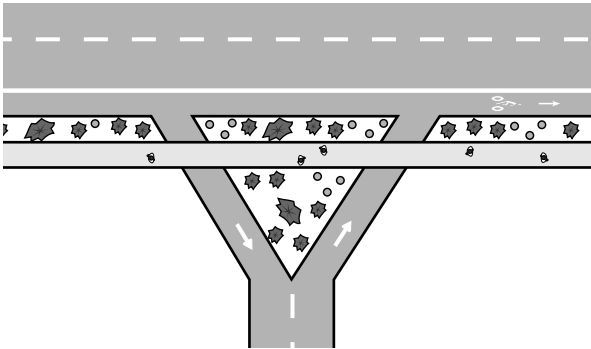

Figure 89: Split path discourages motor-vehicle access

D.7.b. Short Curb Radii

Short curb radii (1.5 m [5 ft]) make it difficult for motorists to enter a path from the roadway.

D.7.c. Bollards

Barrier posts (“bollards”) may be used to limit vehicle traffic on paths. However, they are often hard to see and cyclists may not expect them. When used, they must be spaced wide enough (min. 1.5 m [5 ft]) for easy passage by

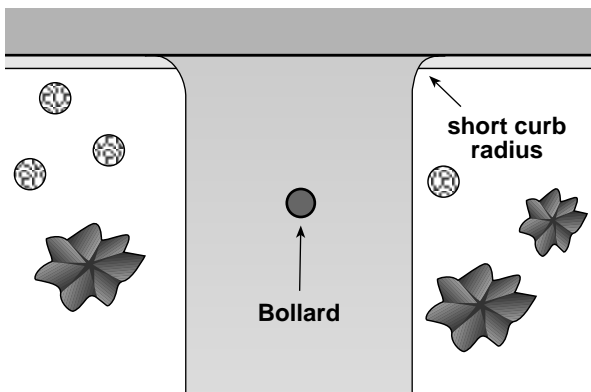

Figure 90: Short curb radius and bollard at the entrance to a path

cyclists and bicycle trailers as well as wheelchair users. A single bollard is preferred, as two may channelize bicyclists to the middle opening, creating conflicts. They should not be placed right at the intersection. They should be painted with bright, light colors for visibility.

D.7.d. Signing

Standard signing is often sufficient to inform motorists. Refer to page 153 for signing recommendations.

D.8. CURB CUTS

Curb cuts for bicycle access to multi-use paths should be built so they match the road grade without a lip. The width of the curb cut is the full width of the path when the approaching path is perpendicular to the curb and a minimum of 2.4 m (8 ft) wide when the approaching path is parallel and adjacent to the curb. Greater widths may be needed on downhill grades.

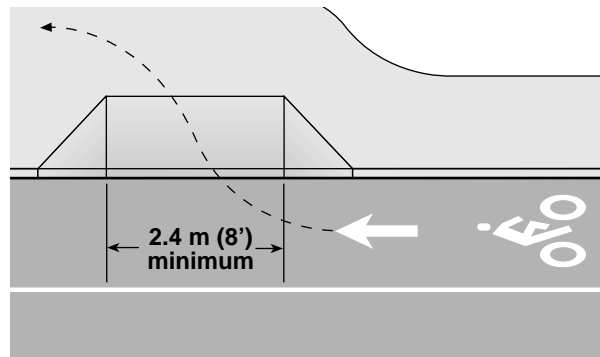

Figure 91: Curb cuts for paths



Wide pedestrian and bicycle bridge



Encroaching vegetation and poor sight distance create an undesirable situation

D.9. DRAINAGE

Multi-use paths must be constructed with adequate drainage to avoid washouts and flooding, and to prevent silt from intruding onto the path.

D.10. VEGETATION

All vegetation, including roots, must be removed in the preparation of the subgrade. Special care is needed to control new growth, such as the use of soil sterilant or lime treatment of the subgrade. Plants that can cause other problems should be controlled, such as plants with thorns that can puncture bicycle tires.

Paths built in wooded areas present special problems. The roots of shrubs and trees can pierce through the surface and cause it to bubble up and break apart. Preventive methods include removal of vegetation, realignment of the path away from trees, and placement of root barriers along the edge of the path. An effective barrier is created with a 300 mm (12”) deep metal shield; greater depth is required for some trees such as cottonwoods.

D.11. PATHS WITH HEAVY USE

If a path must handle a high number of users, it should be wider than standard (3.6 m or more). A separate soft-surface jogger or equestrian path may be constructed with bark mulch alongside the paved path.

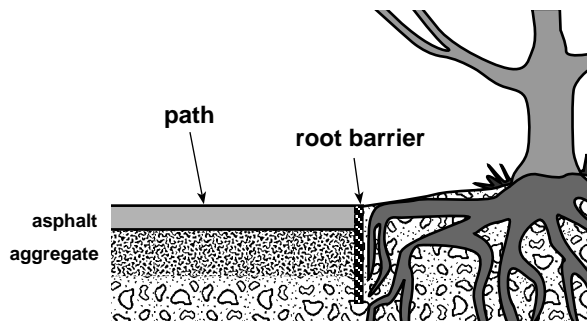

Figure 92: Path adjacent to trees

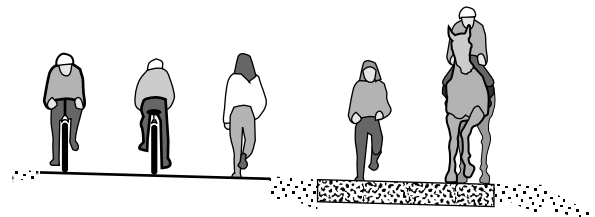

Figure 93: Multi-use path with additional jogger/equestrian way

D.12. STAIRWAYS

Where a connection is needed to a destination or another path at a different elevation, a stairway can be used where the terrain is too steep for a path. A grooved concrete trough should be provided so bicyclists can easily push their bicycles up or down.

Note: Stairways are usually provided as a shortcut and do not meet ADA requirements; the destination should also be accessible along a flatter route, even if this route is longer and more circuitous.

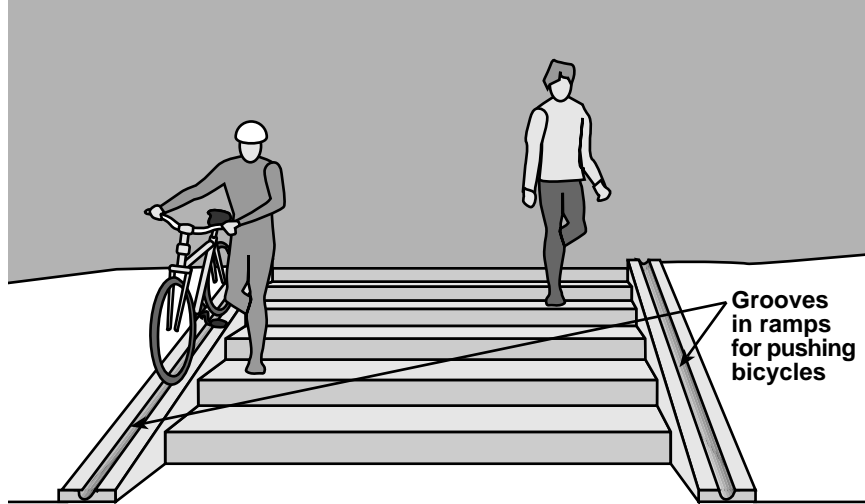

Figure 94: Stairway provides easy access for bicycles and pedestrians



Groove in stairway provides bicycle access to underground passage



Stairway provides access from arterial to local street

II.7. INTERSECTIONS

INTRODUCTION

Most conflicts between roadway users occur at intersections, where one group of travelers crosses the path of others. Good intersection design indicates to those approaching the intersection what path they must follow and who has the right-of-way, including pedestrians and bicyclists, whose movements are complicated by their lesser speed and visibility.

A. BASIC PRINCIPLES

A.1. FOR BOTH BICYCLISTS & PEDESTRIANS

- Unusual conflicts should be avoided.
- Access management practices should be used to remove additional conflict points.
- Signals should be timed so they do not impede bicycle or foot traffic with excessively long waits or insufficient crossing times.
- Good intersection designs are compact and avoid free-flowing movements.
- Simple right angle intersections are usually the simplest to treat for bicycle and pedestrian movement. The problems are more complex at skewed and multiple intersections.

A.2. FOR BICYCLISTS

- Good design creates a path for bicyclists that is direct, logical and close to the path of motor vehicle traffic; only in rare cases should they proceed through intersections as pedestrians.

- Bicyclists should be visible and their movements should be predictable.
- Bike lanes should be striped to a marked crosswalk or a point where turning vehicles would normally cross them. The lanes should resume at the other side of the intersection.

A.3. FOR PEDESTRIANS

- All legs of an intersection should be open to pedestrians.
- The pedestrian's path of travel should be direct with minimal out-of-direction travel.
- Pedestrians should not have to travel over an excessive expanse of uninterrupted pavement.
- At signalized intersections, pedestrian signal heads should be clearly visible - this requires that they not be placed too far from the nearest safe refuge.
- Additional pedestrian refuges should be used to decrease crossing distances.



Large island offers protection for pedestrians at this intersection

B. PEDESTRIAN CROSSINGS

Marked or unmarked, crosswalks are the continuation of the sidewalk. They should be kept as short as possible. This can be achieved by:

- Making the radius of a corner as short as needed to accommodate design vehicles. The effective radius takes into account parking and bike lanes:

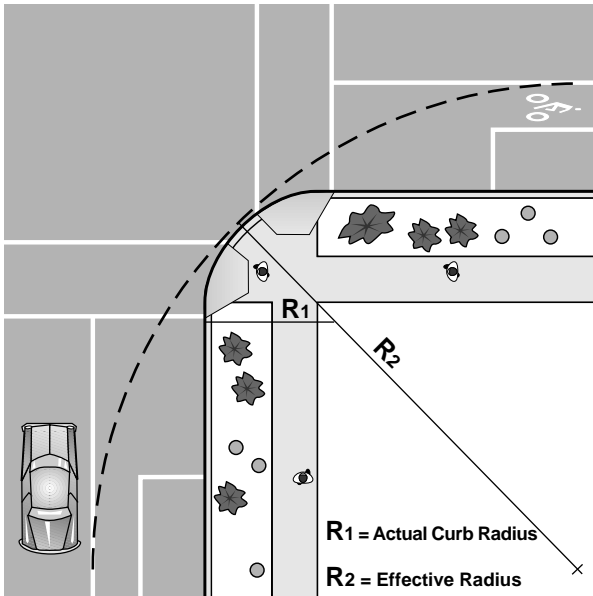

Figure 95 : Effective radius with bike lanes and parking



Even very large intersections can be treated for pedestrian crossings

- Using a short radius (1.5 m [5 ft]) on one-way streets, where no turn movements are allowed at a corner, the radius can be very short:

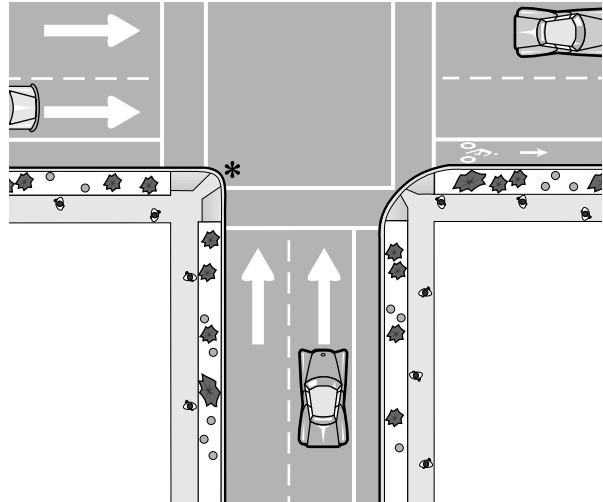

Figure 96: *Corner with no possible turn movements on a one-way street

- Using curb extensions, as they make pedestrians more visible to motorists. At signalized intersections, they improve signal timing by reducing the time needed for the pedestrian phase. See Figure 71, page 108, for an illustration of curb extensions.
- Using islands to interrupt extremely long crosswalks. See Figure 74, page 111 for an illustration of islands; and
- Lining up curb cuts with the crosswalk.



Closing crosswalk doesn't prevent pedestrians from crossing

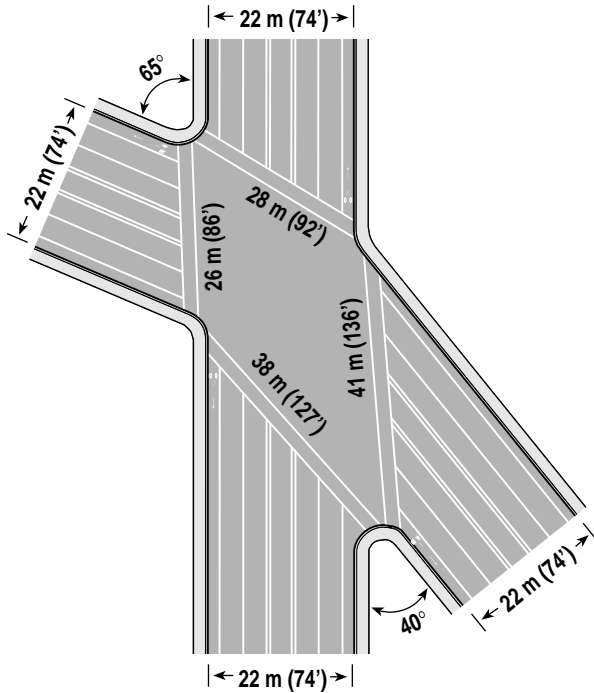

Figure 97: Skewed intersection increases crosswalk distances

- Sight distance should be improved by removal of obstacles;
- Pedestrian refuges should be provided if the crossing distance is excessive; and
- Bike lanes may be striped with dashes, or colored, if needed to guide bicyclists through a long undefined area.

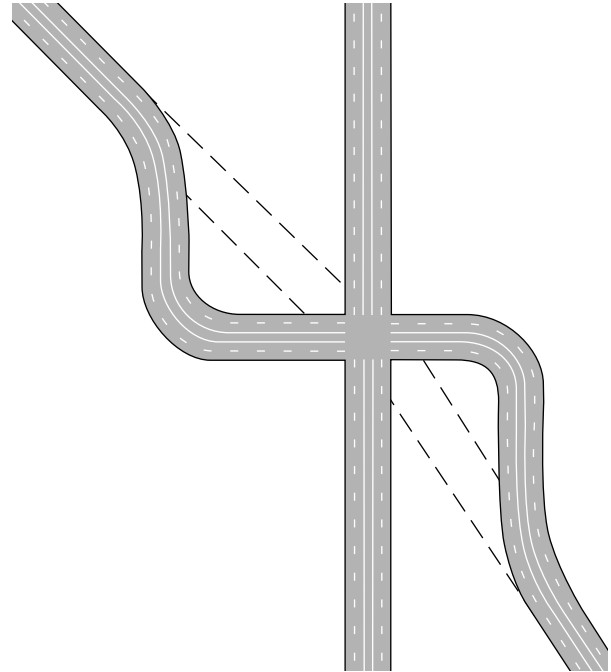

Figure 98: Skewed intersection reconfigured to a right angle

C. SKEWED INTERSECTIONS

Skewed intersections are generally undesirable for all roadway users and introduce these complications for bicyclists and pedestrians:

- Bicyclists and pedestrians approaching from an acute angle on the right are not very visible to motorists;
- The crossing distance for pedestrians is increased, which lengthens the pedestrian phase at a signalized intersection; and
- The path a bicyclist must follow may not be evident.

To alleviate these concerns, several options should be considered:

- Every reasonable effort should be made to design the intersection closer to a right angle;



Right-angle intersection with median island is easiest for pedestrians to cross

D. MULTIPLE INTERSECTIONS

Multiple intersections are generally undesirable for all roadway users and introduce these complications for bicyclists and pedestrians:

- Multiple conflict points are created as motor vehicles arrive from several directions;
- The visibility of cyclists and pedestrians is poor as they are not seen due to many approaching vehicles;
- The unpredictability of motorists, cyclists and pedestrians is increased;
- Pedestrians and bicyclists must cross more lanes of traffic;
- The total crossing distance is great; and
- At least one leg will be skewed.

To alleviate these concerns, several options should be considered:

- Every reasonable effort should be made to design the intersection so that only two roads cross at a given point. This is accomplished by removing one or more legs from the major intersection and creating a minor intersection further downstream;
- One or more of the approach roads can be closed to motor vehicle traffic;
- Pedestrian refuges should be created if the crossing distance is excessive;

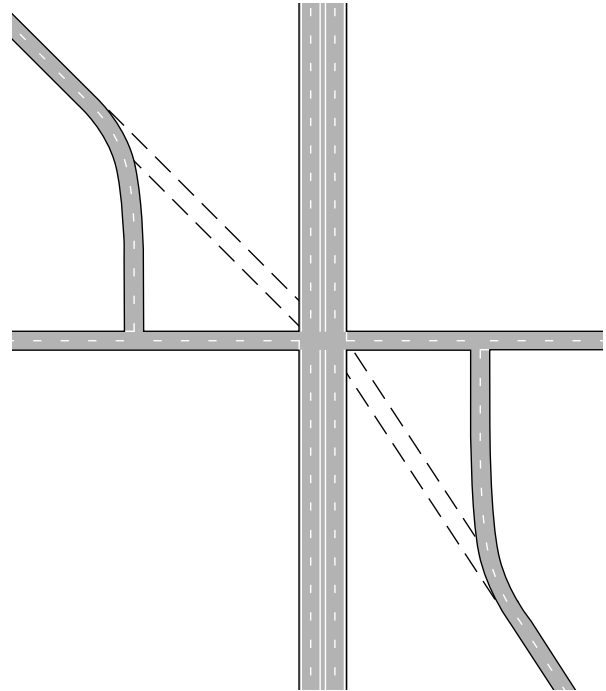

Figure 99: Multiple intersection reconfigured to right angles

- Bike lanes may be striped with dashes, or colored, if needed to guide bicyclists through a long undefined area; and
- Innovative designs such as roundabouts should be considered at complex intersections.



At this complex intersection in Switzerland, islands are provided for pedestrians

E. RIGHT-TURN LANES

E.1. STANDARD CONFIGURATION

Right-turn lanes should be used only where warranted by a traffic study, as they present these problems for cyclists and pedestrians:

- Right-turning cars and through bicyclists must cross paths;
- The additional lane width adds to the pedestrian crossing distance; and
- Right-turn moves are made easier for motorists, which may cause inattentive drivers to not notice pedestrians on the right.

The design shown below makes through bicyclists and right-turning motor vehicles cross prior to the intersection, with these advantages:

- This conflict occurs away from the intersection and other conflicts;

- The difference in travel speeds enables a motor vehicle driver to pass a bicyclist rather than ride side-by-side; and
- Bicyclists are encouraged to follow the rules of the road: through vehicles (including bicyclists) proceed to the left of right-turning vehicles.

For pedestrian safety and convenience, the following concerns must be addressed:

- The angle of approach of right-turning cars must be such that the crossing pedestrian is clearly visible; and
- Where possible, pedestrian refuges should be provided to reduce the total crossing distance.

Where it is not possible to add a full-right turn lane, the bike lane should still be placed to the left of right-turning motor-vehicles. See figures 121 and 122, page 148 for examples of through bike lanes provided through striping only.

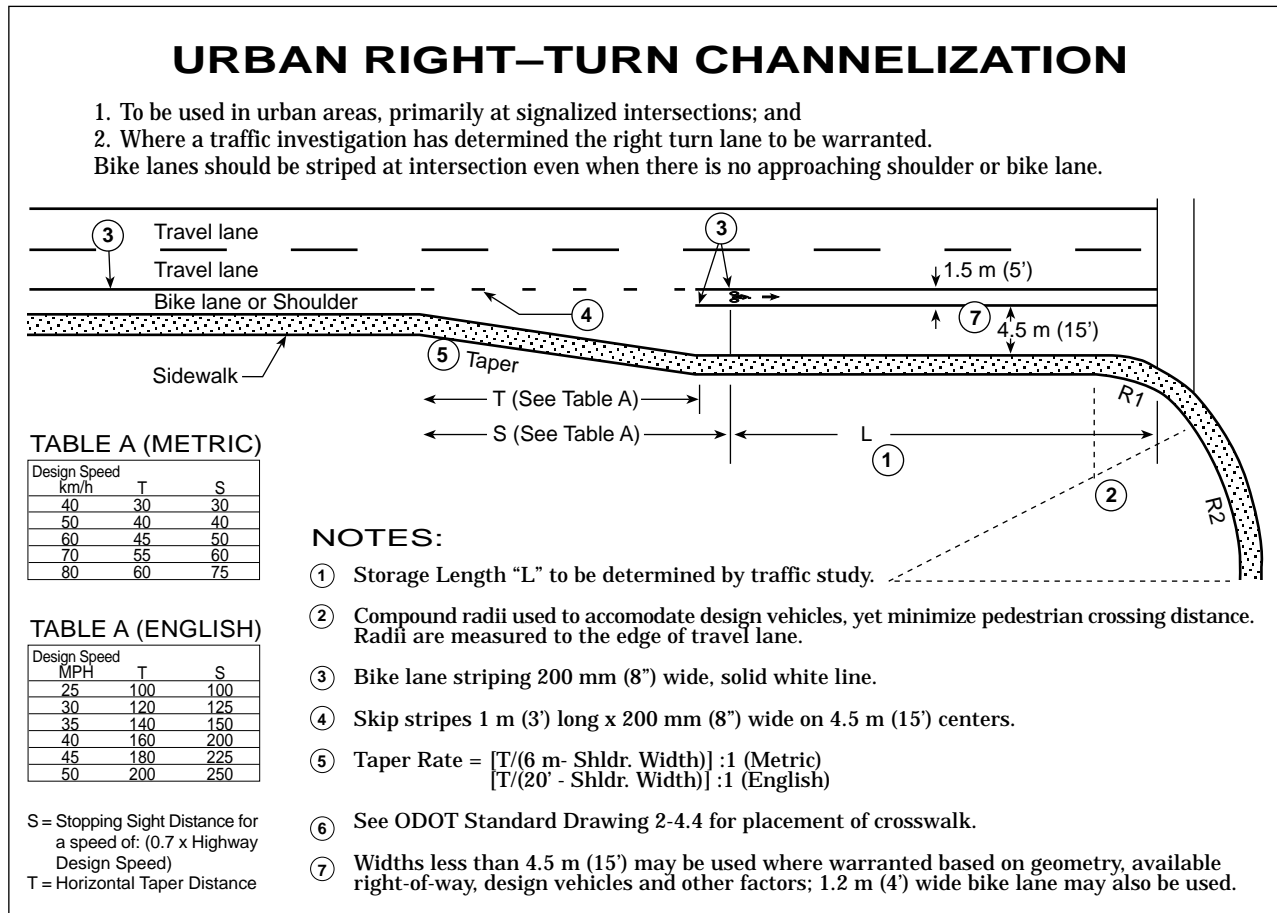

Figure 100: Standard right-turn lane configuration

E.2. EXCEPTIONS

E.2.a. Heavy Right Turns

If the major traffic movement at an intersection is to the right, and the straight through move leads to a minor side street, then the bike lane may be placed on the right and wrapped around the curve, assuming that the majority of cyclists will desire to turn right too. This often occurs where a highway is routed over local streets and the route is indirect.

E.2.b. Tee Intersections

At a Tee intersection, where the traffic split is approximately 50% turning right and 50% turning left, the bike lane should be dropped prior to the lane split to allow cyclists to position themselves in the correct lane; where traffic volumes are very high, a left- and right-turn bike lane should be considered.

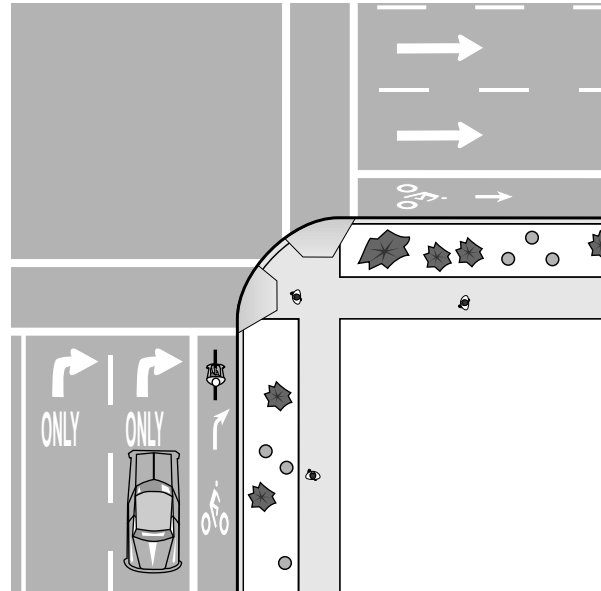
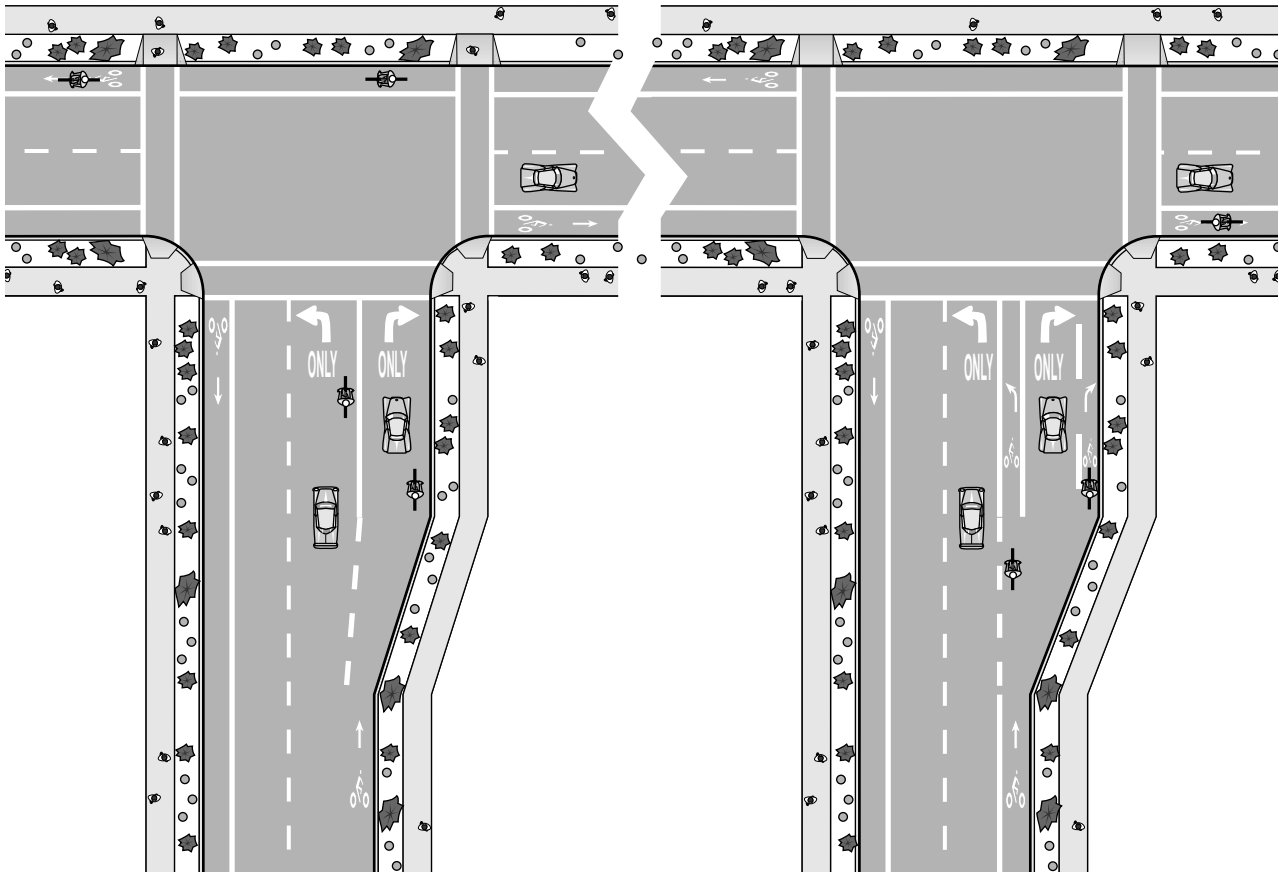

Figure 101: Bike lane follows major traffic flow to the right



Option A: Bike lane drops prior to T intersection

Option B: Left and right bike lanes provided

Figure 102: Bike lanes at T intersection

F. SIGNALS

Traffic signals are timed to accommodate smooth motor vehicle flows at a desired operational speed. In urban areas, this ranges from 25 to 70 km/h (15 to 45 MPH). These speeds are higher than typical bicycling and walking speeds (15 to 30 km/h [10 to 20 MPH] and 3 to 5 km/h [2 to 3 MPH] respectively).

Signal timing can create difficulties for bicyclists trying to maintain a constant speed to take advantage of their momentum. They may be able to get through two or three lights, then have to stop and wait, to start over again. This can tempt bicyclists to get a jump on a light or to run red lights out of frustration.

The situation is more frustrating to pedestrians, who often can only walk one or two blocks at a time, stopping at nearly every light.

Very little research has been done in this area. Where bicycle and pedestrian use is high,

signal timing should take into account the convenience of bicyclists and pedestrians. For example, the traffic signals in downtown Portland are timed for speeds of 20-25 km/h (12-16 MPH), allowing bicyclists to ride with traffic.

On signals that function “on-call” (with loop detectors), there are several improvements that can be made to benefit cyclists:

1. Placing loop detectors in bike lanes on side street to trip the signal;
2. Placing loop detectors in bike lanes to prolong green phase when a bicyclist is passing through (the upcoming yellow phase may not allow enough time for a cyclist to cross a wide intersection);
3. Increasing the sensitivity of existing loop detectors in bike lanes, and painting stencils to indicate to cyclists the most sensitive area of the loop;
4. Placing push-buttons close to the roadway where a bicyclist can reach them without dismounting.

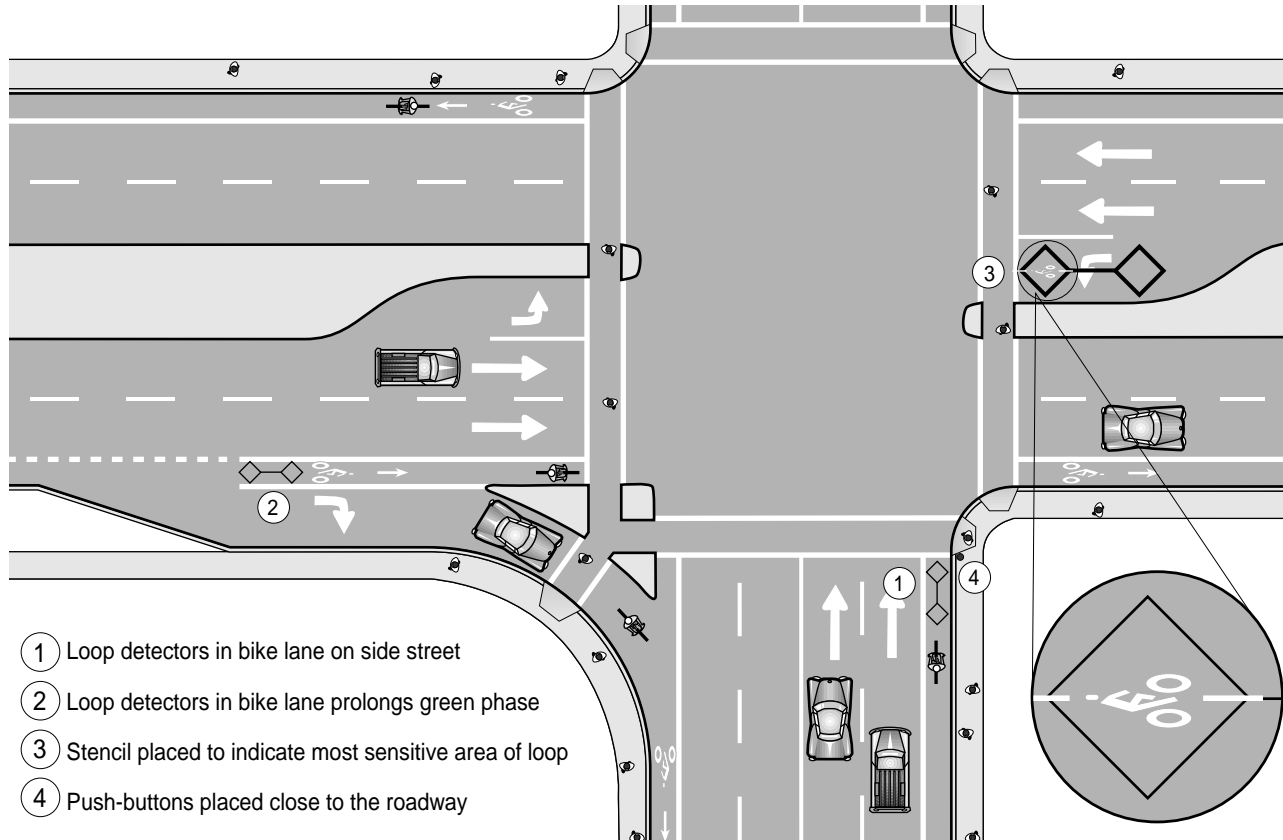

Figure 103: Signalized intersection sensitive to bicycles

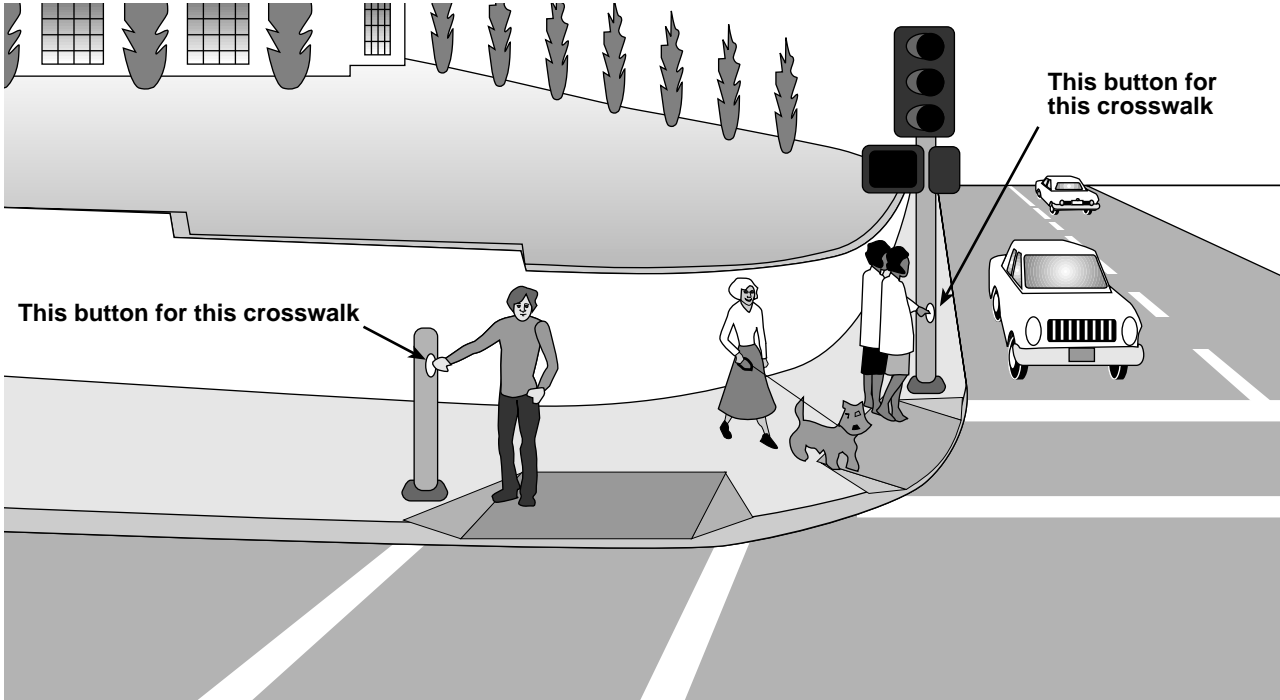

Figure 104: Conveniently-placed push-buttons



Push-buttons on poles and pedestal

Improvements for pedestrians include:

- Adjusting the signal timing to accommodate average walking speeds, or to limit the time a pedestrian has to wait.
- Incorporating a pedestrian phase in the signal sequence, rather than on-demand, in locations with high pedestrian use;
- Placing pedestrian push-buttons in locations that are easy to reach, facing the sidewalk and clearly in-line with the direction of travel (this will improve operations, as many pedestrians push all buttons to ensure that they hit the right one);
- Placing additional actuators prior to the intersection, to decrease pedestrian waiting time; and

Motion detectors (both infrared and video) are being experimented with; these automatically change the signal phase when a pedestrian approaches.



Signalized pedestrian crossing

G. INTERCHANGES

INTRODUCTION

Freeways in urban areas often present barriers to pedestrian and bicycle circulation. Though interchanges function as freeway crossings, they can be obstacles to walking and bicycling if they are poorly designed. Pedestrians and bicyclists should be accommodated on the intersecting and parallel local roads and streets in urban areas.

In rural areas, traffic volumes are usually lower, little pedestrian use is expected, and recreational and touring bicyclists are usually experienced enough to make their way through an interchange. Shoulder widths through interchanges should be wide enough for bicycle use.

However, in urban and suburban areas, pedestrians and bicyclists of all skill levels travel on

the intersecting cross-streets. Well-designed interchanges provide safe and convenient passage for non-motorized traffic.

To alleviate conflicts, more non-interchange crossings of freeways should be provided, with these advantages for bicyclists and pedestrians:

- Bicyclists and pedestrians can cross the freeway at locations with fewer conflicts with vehicles entering and exiting freeway ramps; and
- The additional crossings will relieve some cross traffic from the interchanges, making it easier for bicyclists and pedestrians who must cross at these locations.

G.1. BASIC PRINCIPLES

Designs that encourage free-flowing motor vehicle traffic movements are the most difficult for pedestrians and bicyclists to negotiate safely and comfortably. Conversely, designs that provide safe and convenient pedestrian and bicycle passage may require some slowing or stopping of motor vehicle traffic.

It is important to consider both convenience and safety when providing for pedestrian and bicycle travel near interchanges. If facilities are not used because of perceived inconvenience, the issue of safety becomes moot. The expected path of pedestrians and bicyclists must be obvious and logical, with minimal out-of-direction travel and grade changes.

In most urban and suburban settings, the appropriate pedestrian facilities are sidewalks and the appropriate bicycle facilities are bike lanes. Sidewalks should be wide enough to facilitate two-way pedestrian travel; bike lanes must be placed on both sides of the roadway to allow bicyclists to ride with traffic.



Signals and right-angle intersection make this freeway entrance crossable by pedestrians

G.2. STANDARDS

Refer to chapters II and III for bikeway and walkway standards. Higher standards should be considered under these special circumstances:

- When sidewalks are placed on only one side of the road, they should be 2.4 m (8 ft) wide (this occurs where sidewalks are not provided on the other side due to conflicts).
- If sidewalks are intended for joint use by pedestrians and bicyclists, they should be at least 3 m (10 ft) wide (this situation should be avoided wherever possible).

G.3. GUIDELINES

G.3.a. At-Grade Crossings

Interchanges with access ramps connecting to local streets at a right angle are easiest for pedestrians and bicyclists to negotiate; the intersection of the ramp and the street should follow established urban intersection design. The main advantages are:

- The distance that pedestrians and bicyclists must cross at the ramps is minimized;
- Signalized intersections stop traffic; and
- Visibility is enhanced.

Where large truck turning movements must be accommodated, compound curves reduce the distance for pedestrians at crosswalks.

The use of traffic islands can help create pedestrian refuges. Pedestrians won't have to cross too many lanes of traffic at once, which helps improve signal timing. Illumination ensures good nighttime visibility.

Interchanges that use a rural design create more difficult crossing movements for pedestrians and bicyclists, as motor vehicle speeds are higher and movements are less restricted. Configurations with free-flowing right turns and dual left- or right-turns are difficult for pedestrians and bicyclists to negotiate safely. They are

particularly vulnerable where a high-speed ramp merges with a roadway.

If these configurations are unavoidable, mitigation measures should be sought. Special designs should be considered that allow pedestrians and bicyclists to cross ramps in locations with good visibility and where speeds are low.

G.3.b. Grade-Separated Crossings

Where it is not possible to accommodate pedestrians and bicyclists with at-grade crossings, grade separation should be considered. Grade-separated facilities are expensive; they add out-of-direction travel and will not be used if the added distance is too great. This can create a potentially hazardous situation if pedestrians and bicyclists ignore the facility and try to negotiate the interchange at grade with no sidewalks, bike lanes or crosswalks.

In some instances, a separated path can be provided on only one side of the interchange, which leads to awkward crossing movements:

- Pedestrians must cross prior to the interchange (signs should be used to direct them at the nearest signalized crossing); and
- Some bicyclists will be riding on a path facing traffic, creating difficulties when they must cross back to a bike lane or shoulder (clear and easy to follow directions must be given to guide bicyclists' movements that are inconsistent with standard bicycle operation).



Pedestrian crossing exit ramp

To ensure proper use by pedestrians and bicyclists, structures must be open, with good visibility - especially undercrossings.

G.3.c. Other Considerations

Special care must be given to accommodate all potential pedestrian and bicycle movements. Closing of a crosswalk should only be considered as a last resort.

Continuity of sidewalks and bike lanes must be provided to ensure linkage with existing facilities beyond the intersection.

If a path is used to carry bicycle and pedestrian traffic, opportunities to provide direct links to destination points should be sought, if they offer less travel distance than following the roadway alignment. This might be accomplished by providing paths with direct access to destinations.

Good visibility of pedestrians at ramp terminals on structures should be provided, by flaring guard rails at corners.

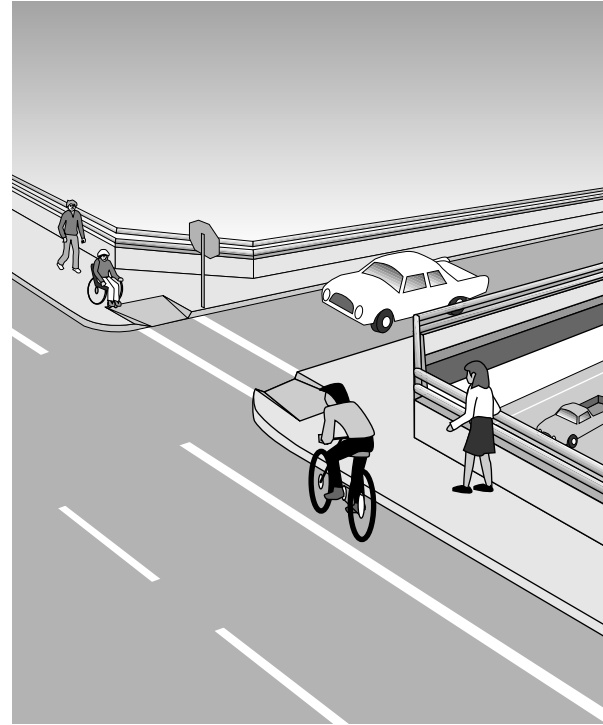

Figure 105: Ramp terminal with good pedestrian sight distance

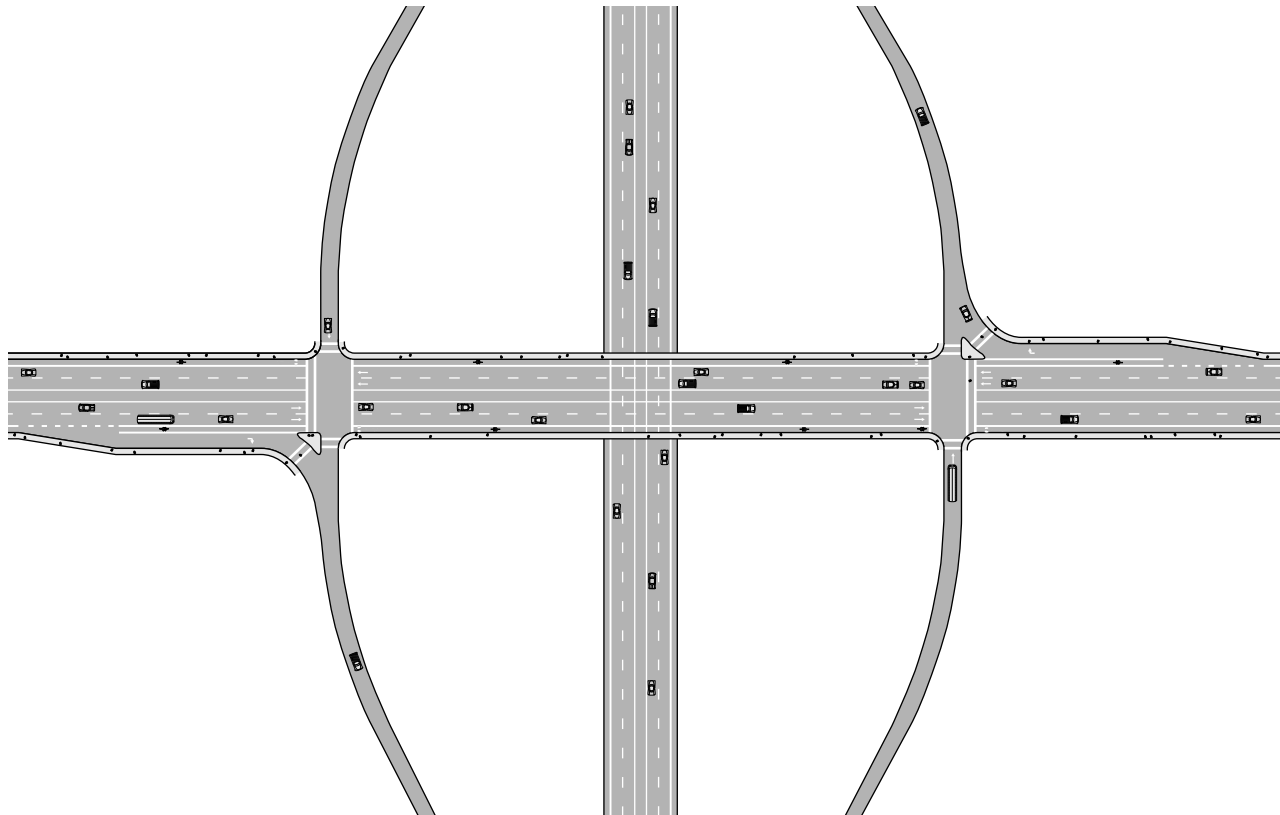

Figure 106: Urban-style right-angle intersections at interchange

H. OTHER INNOVATIVE DESIGNS

These concepts are presented as information, to help ODOT, cities and counties to come up with new solutions to common intersection problems.

H.1. MERGING & EXIT LANES

While bike lanes and sidewalks are not appropriate on limited access freeways, they are common on urban parkways. These parkways often have freeway-style designs such as merging lanes and exit ramps rather than simple intersections.

Traffic entering or exiting a roadway at high speeds creates difficulties for slower-moving bicyclists and pedestrians. The following designs help alleviate these difficulties:

H.1.a. Right-Lane Merge

It is difficult for cyclists and pedestrians to traverse the undefined area created by right-lane merge movements, because:

- The acute angle of approach creates visibility problems;
- Motor vehicles are often accelerating to merge into traffic; and
- The speed differential between cyclists and motorists is high.

The following design guides cyclists and pedestrians in a manner that provides:



Bike lane striped across gore area

- A short distance across the ramp at close to a right angle;
- Improved sight distance in an area where traffic speeds are slower than further downstream; and
- A crossing in an area where drivers' attention is not entirely focused on merging with traffic.

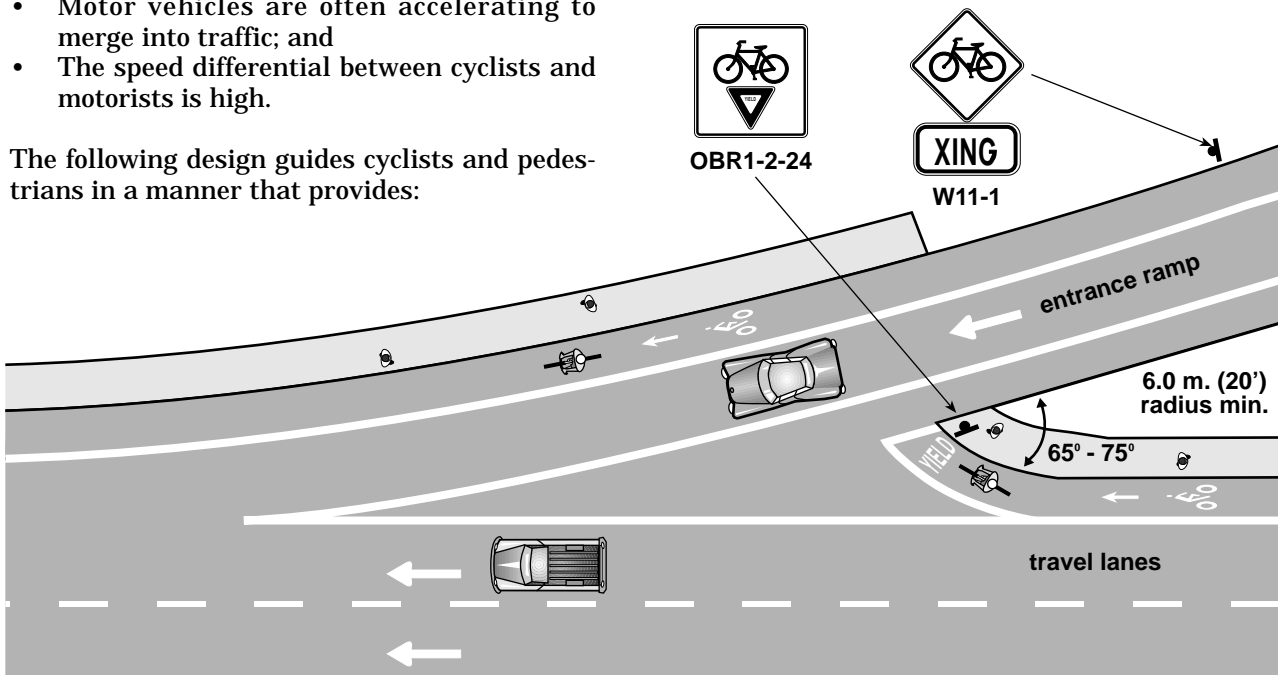

Figure 107: Right-lane merge - bike lane and sidewalk configuration (Urban design - not for use on limited access freeways)

H.1.b. Exit Ramps

Exit ramps present difficulties for bicyclists and pedestrians because:

- Motor vehicles exit at fairly high speeds;
- The acute angle creates visibility problems; and
- Exiting drivers often do not use their right-turn signal, confusing pedestrians and bicyclists seeking a gap in traffic.

The following design guides cyclists and pedestrians in a manner that provides:

- A short distance across the ramp, at close to a right angle;
- Improved sight distance in an area where traffic speeds are slower than further upstream;
- A crossing in an area where the driver's attention is not distracted by other motor vehicles.

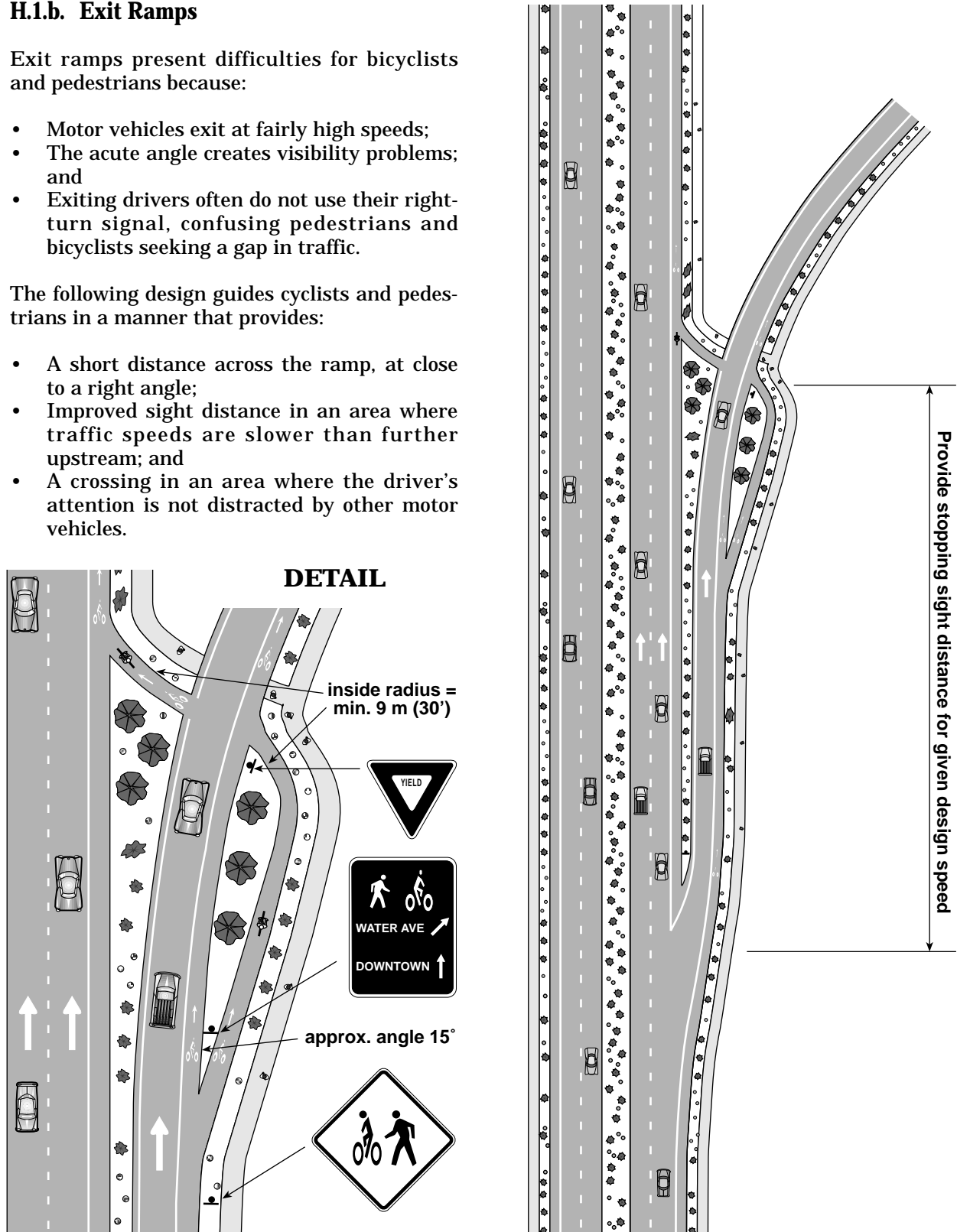

Figure 108: Exit ramp configuration for bike lanes and sidewalks (Urban design - not for use on limited access freeways)

H.2. DUAL RIGHT-TURN LANES

This situation is particularly difficult for bicyclists and pedestrians. Warrants for dual turn lanes should be used to ensure that they are provided only if absolutely necessary.

The design for single right-turn lanes allows bicyclists and motorists to cross paths in a predictable manner, but the addition of a lane from which cars may also turn adds complexity: Some drivers make a last minute decision to turn right from the center lane without signaling, catching bicyclists and pedestrians unaware.

Bicyclists and motorists should be guided to

areas where movements are more predictable, so bicyclists and motorists can tackle one conflict at a time, in a predictable manner. A curb cut provides bicyclists with an access to the sidewalk, for those who prefer to proceed as pedestrians.

- Design A encourages cyclists to share the optional through/right-turn lane with motorists.
- Design B guides cyclists up to the intersection in a dedicated bike lane.
- Design C allows cyclists to choose a path themselves (this design is the AASHTO recommendation - simply dropping the bike lane prior to the intersection).

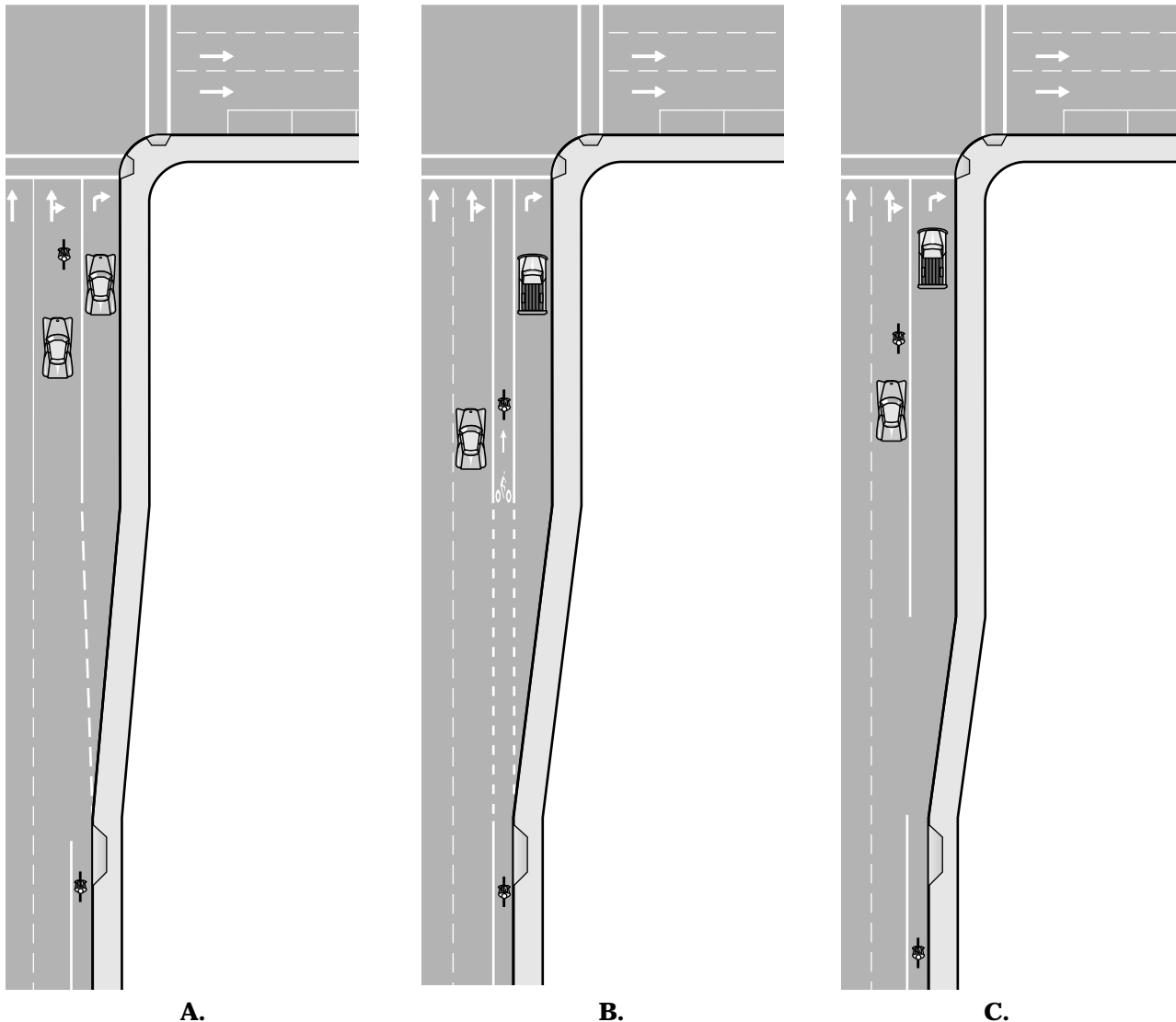

Figure 109: Bike lane through dual right-turn lanes

A fourth design places an island between the right-turn lane and the optional through/right turn lane. This creates a more conventional intersection, separating the conflicts. This design is also better for pedestrians, as the island provides a refuge.

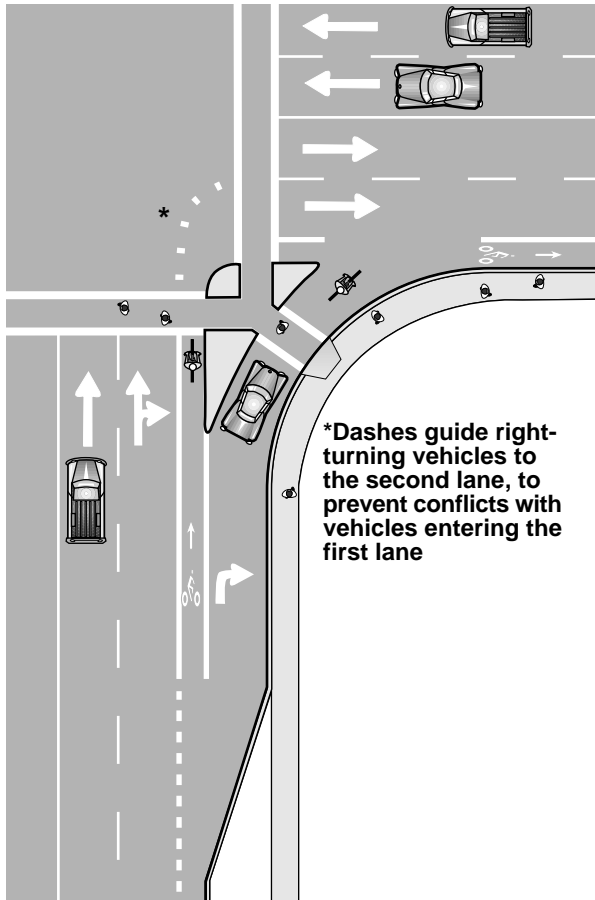

Figure 110: Bike lane through dual right-turn lanes with island

Engineering judgment should be used to determine which design is most appropriate for the situation.

H.3. RIGHT-TURN LANE WITHOUT ROOM FOR A BIKE LANE

On bike lane retrofit projects, where there is insufficient room to mark a minimum 1.2 m (4 ft) bike lane to the left of the right-turn lane, a right-turn lane may be marked and signed as a shared-use lane, to encourage through cyclists to occupy the left portion of the turn lane. This is most successful on slow-speed streets.

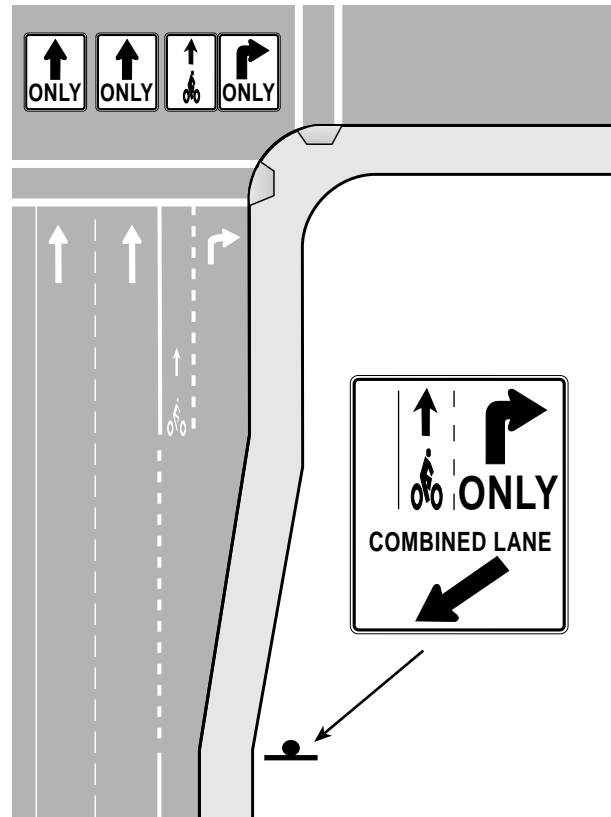

Figure 111: Joint use of a right-turn lane for through bicyclists.



Combined right-turn lane and through bike lane



Modern roundabout (Switzerland)

H.4. MODERN ROUNDABOUTS

A roundabout is a method of handling traffic at intersections commonly used in Europe, Australia and Japan. Roundabouts are now gaining acceptance in this country. Early attempts at roundabouts were often not successful for several reasons, mainly:

- The radius was too small (creating difficulties for trucks);
- The radius was too large (encouraging high speeds);
- The right of way was not clearly defined (causing confusion and collisions); or
- Pedestrians were allowed access to the middle of the roundabout.

Modern roundabout design has several distinctive features:

- A radius large enough to allow movement by trucks, but small enough to slow traffic speeds;
- A visual obstruction, through landscaping, that obscures the driver's view of the road ahead, to discourage users from entering the roundabout and proceeding at high speeds;
- The right of way clearly established: drivers entering the roundabout yield to drivers already in the roundabout; and
- No bicycle or pedestrian access to the center of the roundabout, which should not contain attractions such as fountains or statues.

One of the major advantages of roundabouts is the reduced need for travel lanes, as traffic is constantly moving (signals create stop-and-go conditions for motor vehicles - extra travel lanes are needed to handle capacity at intersections).

Other advantages include:

- Reduced crash rates;
- Reduced severity of injuries (due to slower speeds);
- Reduced costs (compared to traffic signals, which require electrical power); and
- Reduced liability by transportation agencies (there are no signals to fail).



Crosswalk at roundabout approach

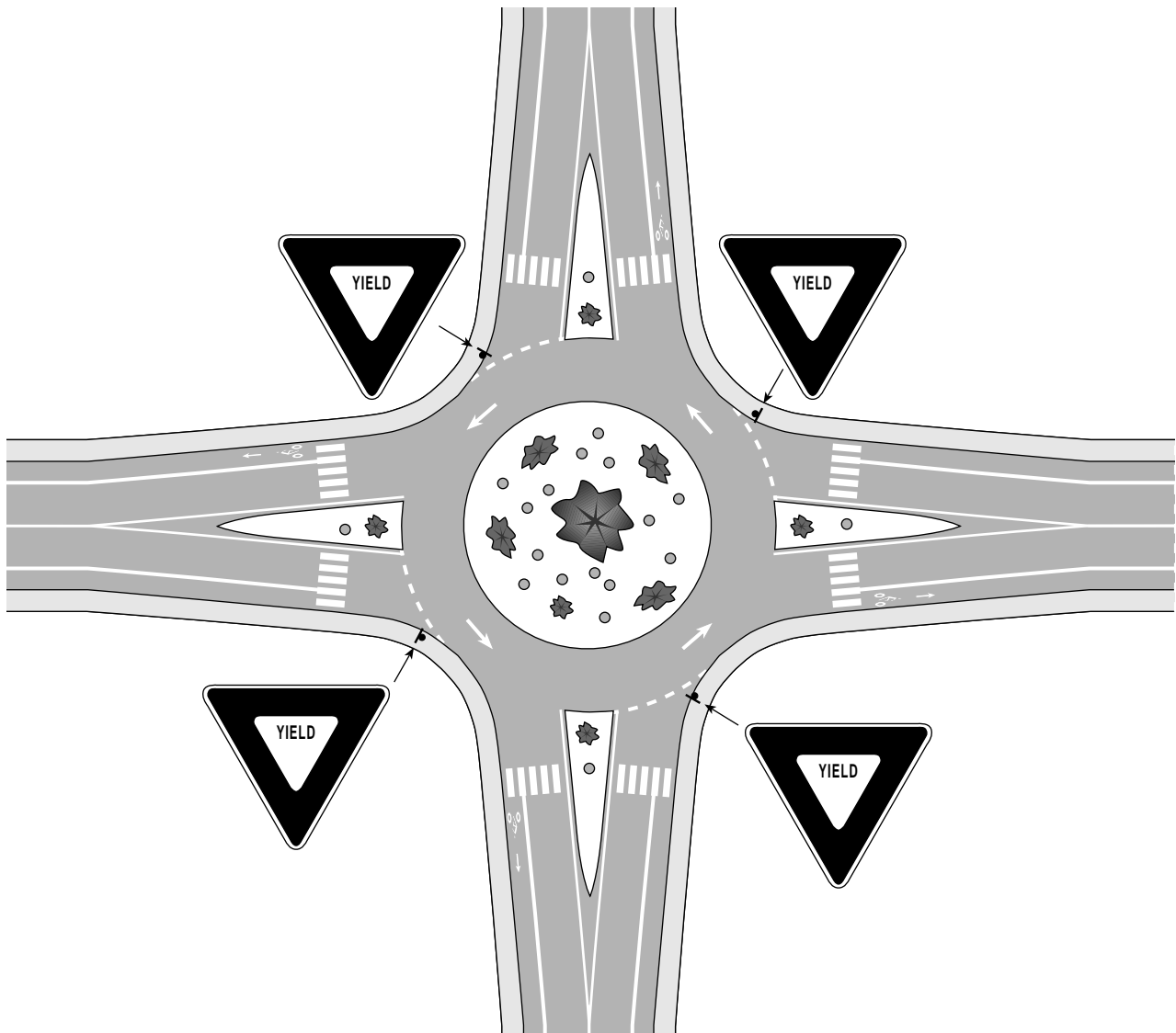

Figure 112: Modern urban roundabout

Most of the advantages and disadvantages of roundabouts affect motor vehicle flow, but there are advantages and disadvantages for bicyclists and pedestrians:

Advantages for pedestrians and bicyclists

- The reduced cost frees funds for other purposes, including bicycle and pedestrian facilities;
- The reduced need for travel lanes frees right-of-way for other purposes, including bicycle and pedestrian facilities;
- Traffic flows at a more even pace, making it easier for bicyclists and pedestrians to judge crossing movements;
- Pedestrians have to cross only one or two lanes of travel at a time, in clearly marked crosswalks;
- Bicyclists negotiate intersections at speeds closer to that of motor vehicles; and
- Mid-block crossing opportunities may be

improved if the number of travel lanes can be reduced.

Disadvantages for pedestrians and bicyclists

- Traffic flowing more evenly may reduce pedestrian crossing opportunities as fewer gaps are created;
- Pedestrians are responsible for judging their crossing opportunities; there is no signal protection provided, though pedestrian signals can be added at special sites; and
- Bicyclists must share the road and occupy a travel lane; by riding too far to the right, they risk being cut off by vehicles leaving the roundabout in front of them.

For more design details not discussed here, please consult other publications such as Guide to Traffic Engineering Practices, Part 6: Roundabouts, published by Austroads.



A loop detector in the bike lane should supplement push-button



Stencil in left-turn lane marks "hot spot" of loop detector

II.8. SIGNING & MARKING

INTRODUCTION

Signing and marking of bikeways and walkways must be uniform and consistent for them to command the respect of the public and provide safety to users. Signing and marking must be warranted by use and need. All signing and markings of bikeways and walkways on the state highway system shall be in conformance with the recommendations of this section. To provide uniformity and continuity, cities and counties are encouraged to adopt these standards.

Well-designed roads make it clear to users how to proceed, and require very little signing. Conversely, an over-abundance of warning and regulatory signs may indicate a failure to have addressed problems. The attention of drivers, bicyclists and pedestrians should be on the road and other users, not on signs on the side of the road. Oversigning degrades the usefulness of signs, causes distractions, creates a cluttered effect, is ineffective and wastes resources.

Language Barriers: Many people don't read English. The message conveyed by signs should be easily understandable by all roadway users: symbols are preferable to text.

Sign Placement: Signs placed adjacent to roadways must conform to adopted standards for clearance and breakaway posts.



Directional signs on multi-use path



An abundance of commercial signs distracts from traffic signs

A. ON-ROAD BIKEWAYS

A.1. SHARED ROADWAYS & SHOULDER BIKEWAYS

A.1.a. Signing

In general, no signs are required for these two types of bikeways. Bicyclists should be expected on all urban local streets, which are mostly shared roadways. Bicyclists riding on shoulder bikeways are well-served with adequate width and a smooth pavement.

On narrow rural roads heavily used by cyclists, it may be helpful to install bike warning signs (W11-1) with the rider ON ROADWAY or ON BRIDGE ROADWAY, where there is insufficient shoulder width for a significant distance. This signing should be in advance of the roadway condition. If the roadway condition is continuous, an additional rider “NEXT XX MILES” may be used.



Figure 113: Sign W11-1 with riders

Directional signs are useful where it is recommended that bicyclists follow a routing that differs from the routing recommended for motorists. This may be for reasons of safety, convenience, or because bicyclists are banned from a section of roadway (the routing must have obvious advantages over other routes).

ODOT recommends **against** the use of BIKE ROUTE signs and arrows along city streets with no indication to cyclists as to where they are being directed. Cyclists will usually



Figure 114: Sign OBD11-1; Destination sign

ignore these signs if they send them out of direction.

A.1.b. Marking

A normal 100 mm (4”) wide fog line stripe is used on shoulder bikeways.



Warning sign on narrow roadway



Rural shoulder bikeway stripe

A.2. BIKE LANES

A.2.a. Bike Lane Designation

Bike lanes are officially designated to create an exclusive or preferential travel lane for bicyclists with the following markings:

- A 200 mm (8") white stripe; and
- Bicycle symbol and directional arrow stencils on pavement.

Optional NO PARKING signs (R7-9 and R7-9a) may be installed if problems with parked cars occur; painting curbs yellow also indicates that parking is prohibited.

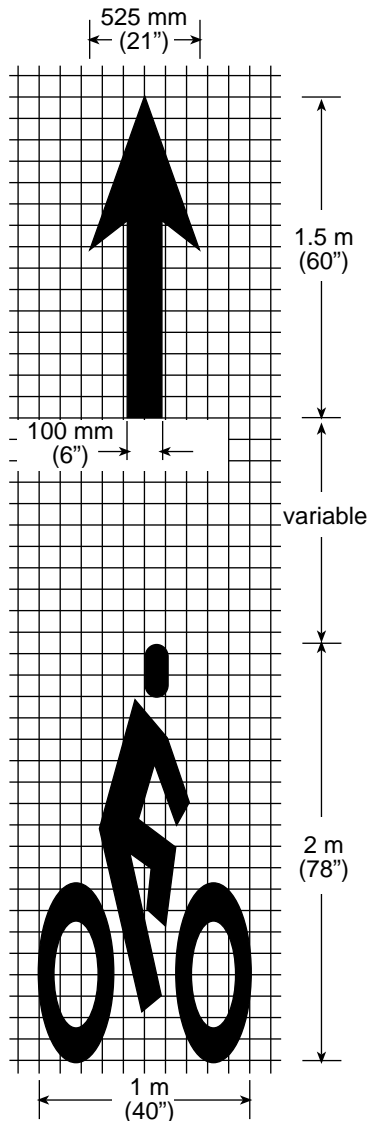

Figure 115: Bike lane stencil dimensions



Figure 116: Signs R7-9 and R7-9a

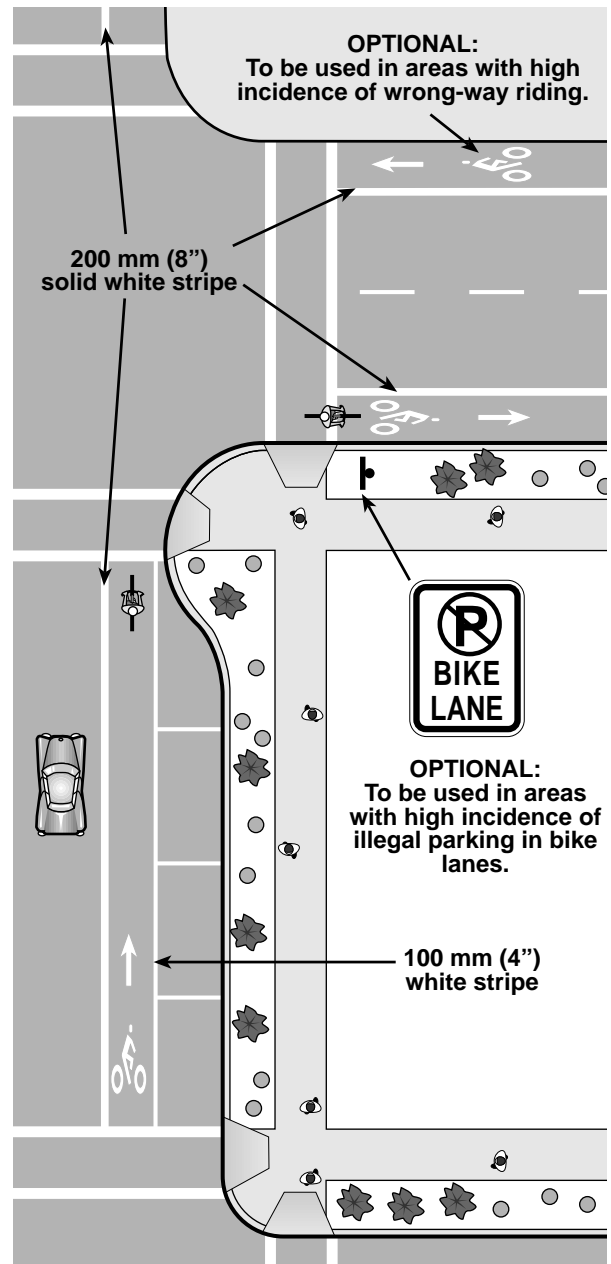

Figure 117: Bike lane designation

A.2.b. Stencil Placement

Stencils should be placed after most intersections; this alerts drivers and bicyclists entering the roadway of the exclusive nature of the bike lanes. Stencils should be placed after every intersection where a parking lane is placed between the bike lane and the curb.

Supplementary stencils may also be placed at the end of a block, to warn cyclists not to enter a bike lane on the wrong side of the road.

Additional stencils may be placed on long sections of roadway with no intersections. A rule of thumb for appropriate spacing is: multiply designated travel speed (in MPH) by 40. For example, in a 35 MPH speed zone, stencils may be placed approximately every 1400 feet. Metric formula: speed times 7; e.g., appropriate spacing in a 60 km/h zone is approximately 400 m.

Care must be taken to avoid placing stencils in an area where motor vehicles are expected to cross a bike lane - usually driveways and the area immediately after an intersection.

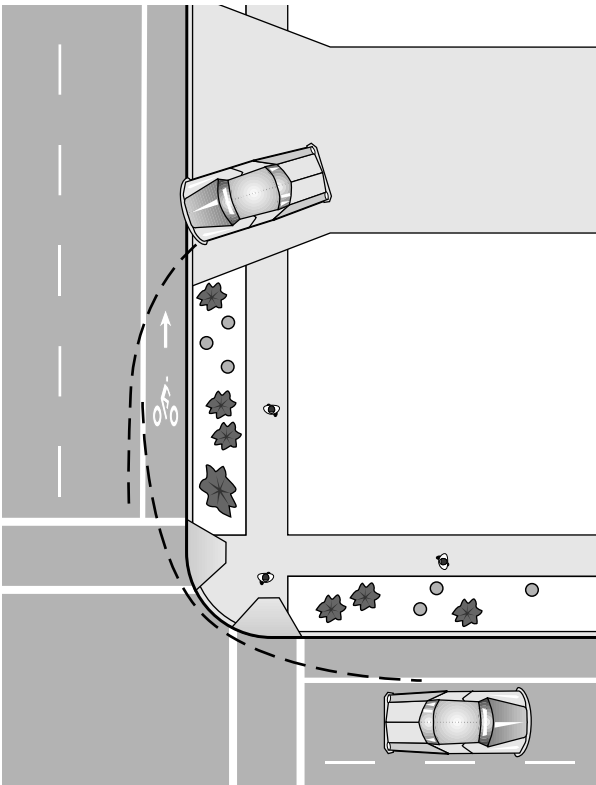

Figure 118: Bike lane stencil placed out of swept path of turning vehicles

A.2.c. Intersections

Bike lanes should be striped to a marked crosswalk or a point where turning vehicles would normally cross them. The lanes should resume at the other side of the intersection. Bike lanes are not normally striped through intersections; however, it may be appropriate to do so where extra guidance is needed; in this case, they may be striped with dashes, or colored, to guide bicyclists through a long undefined area.

Local jurisdictions may stripe bike lanes through all intersections.

A.2.d. Right Turn Lanes at Intersections

The through bike lane to the left of a right-turn lane must be striped with two 200 mm (8") stripes and connected to the preceding bike lane with at least one dashed line on the left. This allows turning motorists to cross the bike lane. A stencil must be placed at the beginning of the through bike lane.

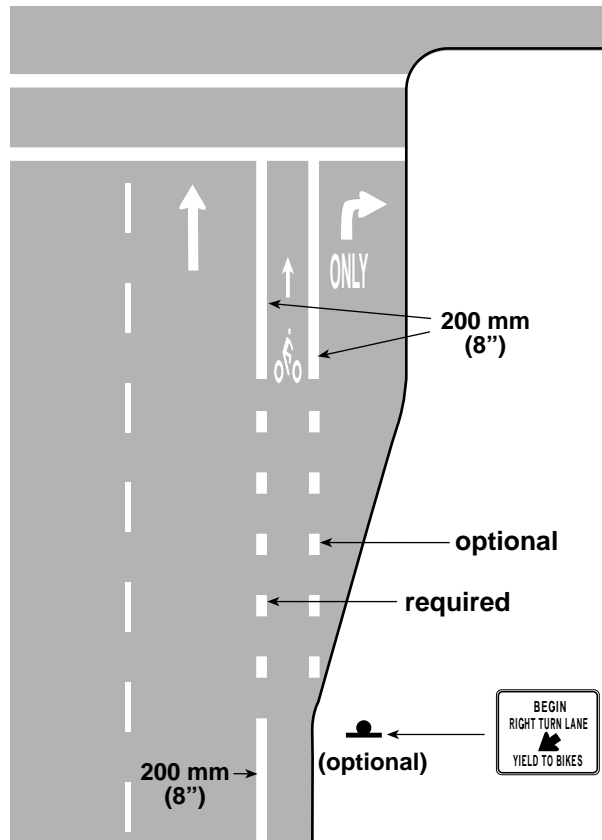

Figure 119: Bike lane marking at right-turn lane

Sign R4-4, BEGIN RIGHT TURN LANE, YIELD TO BIKES, may be placed at the beginning of the taper in areas where a through bike lane may not be expected (on high-speed urban roadways with a rural character, or on sections of roadway where bike lanes have been added where there weren't any previously).



Figure 120: Sign R4-4



Bike lane stencil



Multiple bike lanes (Holland)



Through bike lane striped to left of right-turn lane

Not all intersections can be widened to provide a right-turn lane. A bike lane to the left of right turning cars should still be provided.

One common configuration occurs where a right-turn lane is developed by dropping parking:

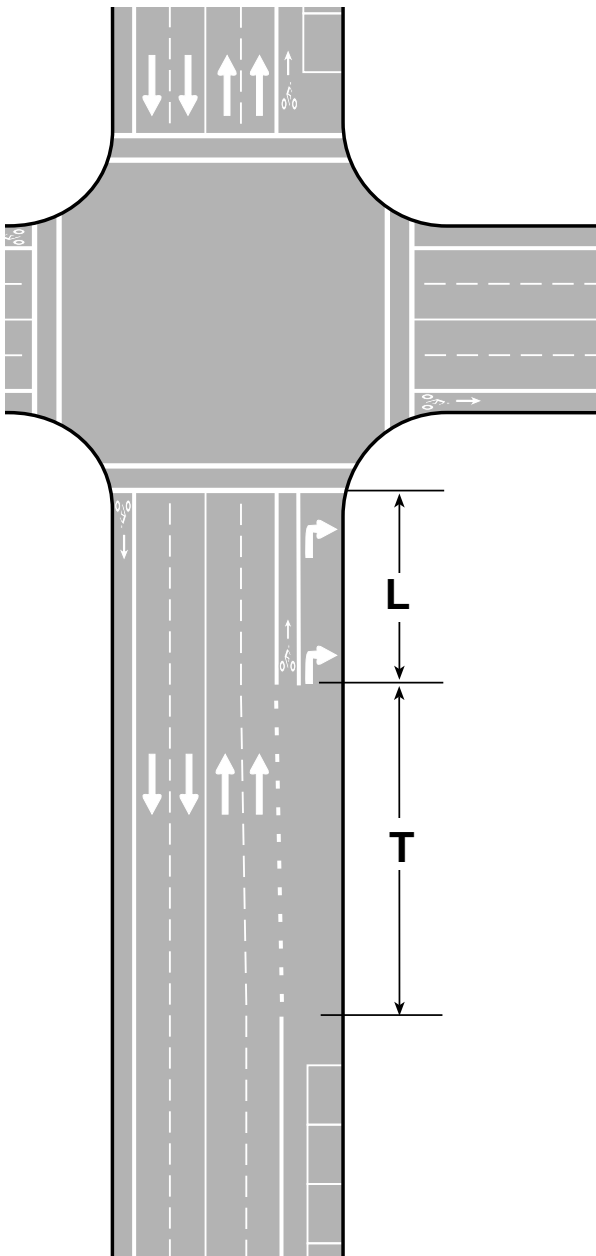

L = Storage length required for right turns
 T = Taper length needed for motorists to merge right (to be calculated based on standard right-turn configuration)

Figure 121: Bike lane left of right-turn lane developed by dropping parking

Another configuration occurs where a lane drops and turns into a right-turn lane.

Note: This is a difficult movement for bicyclists as they must merge left and find a gap in the traffic stream:

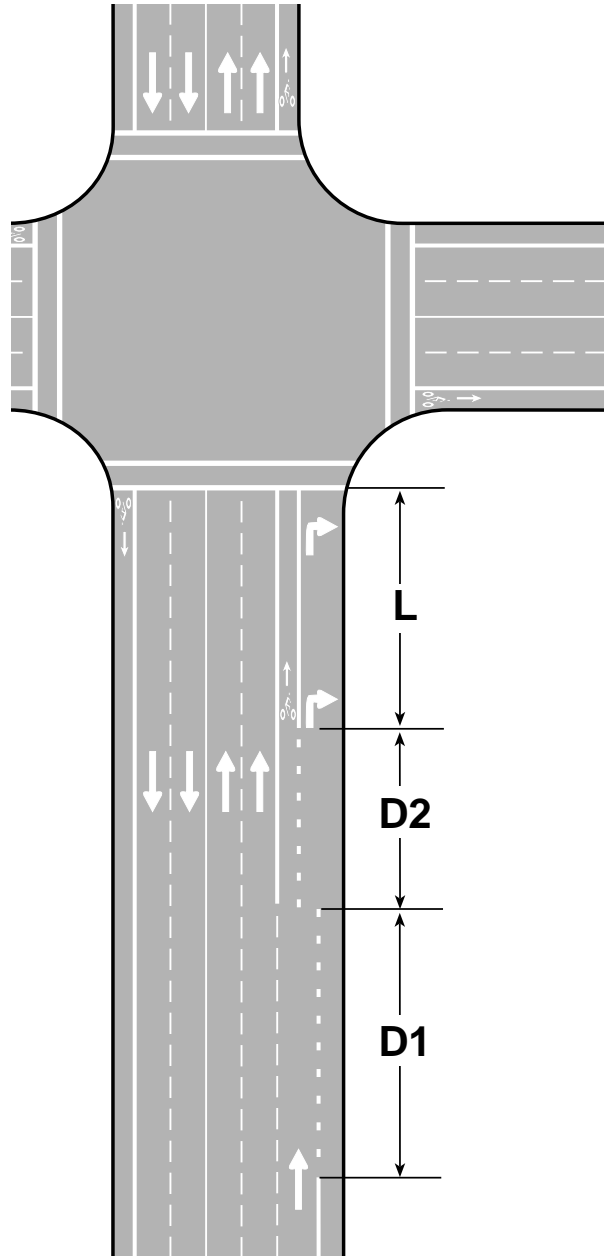

L = Storage length required for right turns
 D1, D2 = Distance needed for bicyclists to merge left (to be field-determined for each case)

Figure 122: Bike lane left of right-turn lane developed by dropping a travel lane



Bike lane to left of right-turn lane (parking dropped)

A.2.e. Outer Edge of Bike Lane

Where parking is allowed next to a bike lane, the parking area should be defined by parking space markings or a solid 100 mm (4") stripe.



Tick marks may be used to separate bike lane from parking

Reflectors and raised markings in bike lanes can deflect a bicycle wheel, causing the cyclist to lose control. If pavement markers are needed for motorists, they should be installed on the motorist's side of the stripe, and have a beveled front edge.

A.2.f. Bike Lane Ends

The bike lane ends symbol sign may be used where a bicycle lane is abruptly terminated and the rider must merge with the through lane of traffic. It may or may not have the BIKE LANE ENDS (OBW 1-10) rider placed under this sign. The BIKE LANE ENDS sign may be used as a rider under the bike lane ends symbol Sign No. OBW 1-9.



Figure 122b: Signs OBW1-9 and OBW1-10

A.3. SPECIAL USE SIGNS

A.3.a. Railroad Crossing

Where a shared roadway, shoulder bikeway, bike lane or multi-use path crosses a railway at an unfavorable crossing angle, or if the crossing surface is rough, warning sign OBW8-20 may be used:



Figure 123: Sign OBW8-20

A.3.b. Sidewalk Users

Where bicyclists are allowed to use sidewalks, and the sidewalks are too narrow for safe riding (usually on a bridge), sign OBR10-13 may be used to encourage cyclists to walk:



Figure 124: Sign OBR10-13

A.3.c. Bicycle Use of Push-Buttons

Where it is recommended that bicyclists use a push-button to cross an intersection (usually where a multi-use path crosses a roadway at a signalized intersection), the following signs should be used:

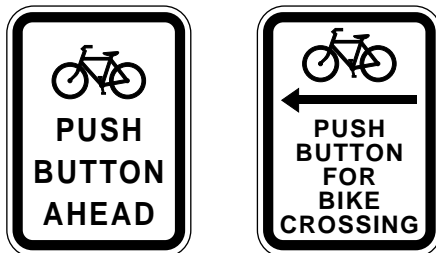

Figure 125: Signs OBR10-15 and OBR10-12

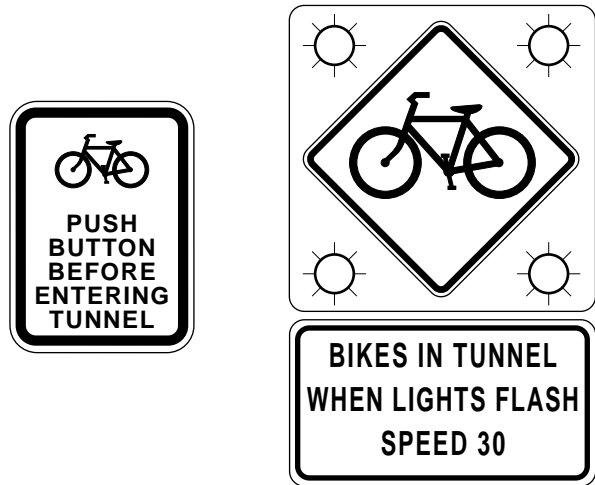

Figure 126: Signs OBR10-10 and OBW1-8

A.3.d. Tunnels

Where substantial bicycle traffic is expected in a narrow tunnel, the signs OBR10-10 and OBW1-8 may be used.

The push-button sign should be placed at a location that allows cyclists to proceed at a normal speed and enter the tunnel as lights begin to flash. The timing of the flashing lights should be based on normal bicycle travel speed, plus an extra margin for safety (though leaving the flashing lights on for too long may render them ineffective if motorists enter the tunnel and cyclists are no longer present).



“BIKES IN TUNNEL” sign on the Oregon Coast Highway

A.3.e. Touring Routes

Special signs may be created to guide cyclists along touring routes, such as the Oregon Coast Bike Route:



Figure 127: OBD11-3

These signs should be used sparingly, mainly at intersections to guide cyclists along the route.



Oregon Coast Bike Route signs guide touring cyclists down the coast



Bicycle races usually occupy an entire travel lane

A.3.f. Bicycle Races

A special sign to be used on the roadway for bicycle races in Oregon is OBW16-2:



Figure 128: OBW16-2

Sign OBW17-1 should be mounted on escort vehicles:



Figure 129: OBW17-1

For a complete description of measures to be taken for bicycle racing, please consult the "Guidelines for Administration of Bicycle Racing on Oregon Roads."

B. MULTI-USE PATHS

Paths should be signed with appropriate regulatory, warning and destination signs.

B.1. REGULATORY SIGNS

Regulatory signs inform users of traffic laws or regulations. They are erected at the point where the regulations apply. Common regulatory signs for bicyclists are:

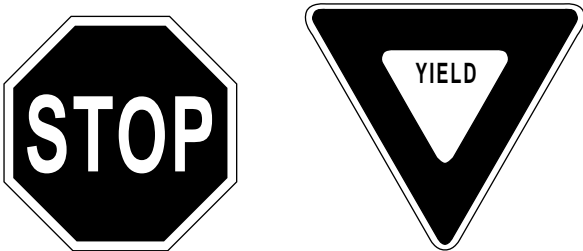

Figure 130: Signs R1-1 and R1-2

Note: signs R1-1 and R1-2 are reduced versions of standard motor vehicle signs, to be used where they are visible only to bicyclists (where a path crosses another path or where a path intersects a roadway at right angles):

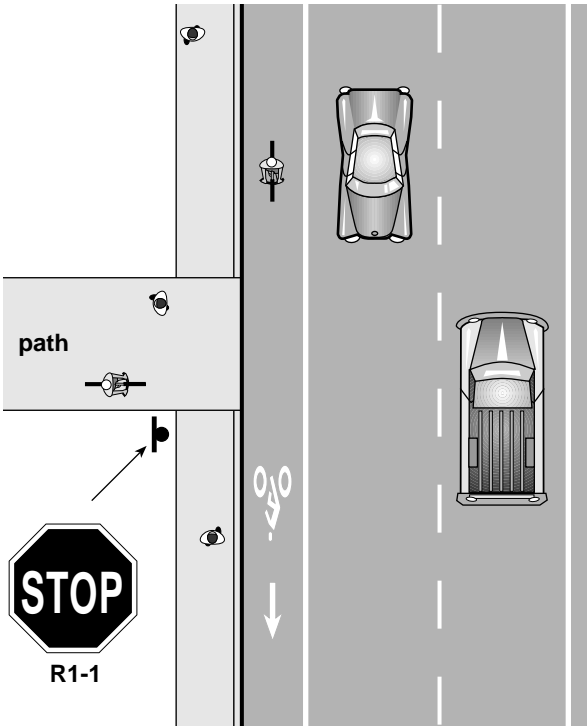

Figure 131: Appropriate use of sign R1-1

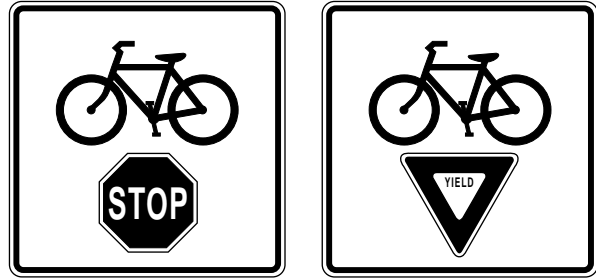

Figure 132: Signs OBR1-1 and OBR1-2

Signs OBR1-1 and OBR1-2 should be used where the signs are visible to motor vehicle traffic (where a path is parallel and close to a roadway):

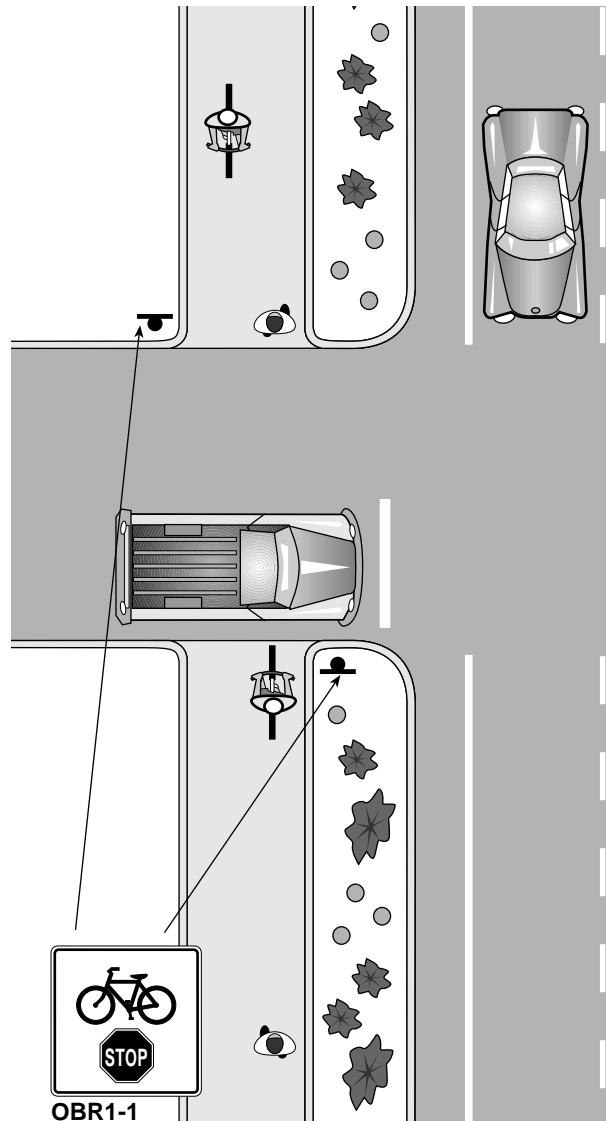

Figure 133: Appropriate use of sign OBR1-1

Sign OBR1-3 should be used at the beginning of multi-use paths and at important access points to warn cyclists of the presence of other users:



Figure 134: Sign OBR1-3

Signs R5-3 and OBR10-14 may be used at the beginning of a multi-use path if there are problems with motor vehicles using the path:



Figure 135: Signs R5-3 and OBR10-14

Where bicyclists using the path must cross a road at a signalized intersection (in a cross-walk) and proceed as pedestrians, sign OBR10-11 may be used:



Figure 136: Sign OBR10-11

B.2. WARNING SIGNS

Warning signs are used to inform path users of potentially hazardous conditions. They should be used in advance of the condition. Most are reduced versions (450 mm X 450 mm [18" X 18"]) of standard highway warning signs:

B.2.a. Curves

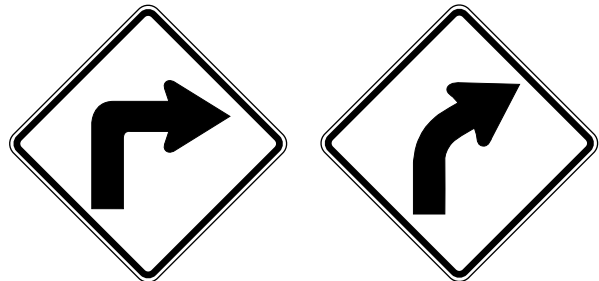

Figure 137: Signs W1-1 and W1-2

B.2.b. Intersections

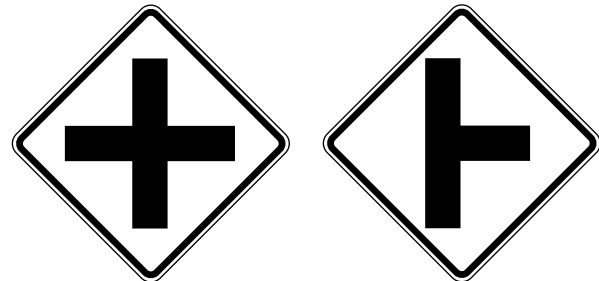

Figure 138: Signs W2-1 and W2-2

B.2.c. Hill



Figure 139: Sign W7-5

B.2.d. Height and Width Constraints

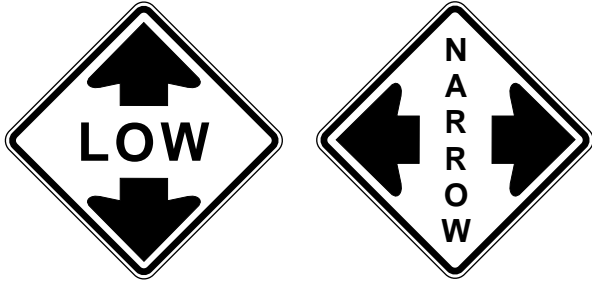

Figure 140: Signs OBW12-2 and OBW12-3

B.2.e. Railroad, STOP Ahead, etc.



Figure 141: Signs W10-1 and W3-1

B.2.f. Path Crossing Roadway

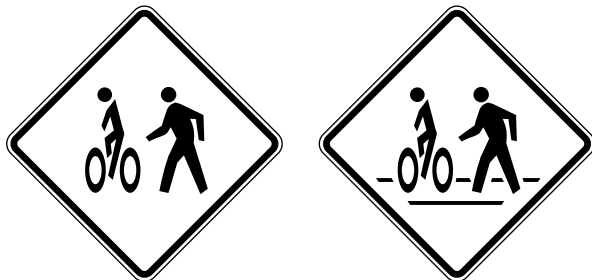

Figure 142: Signs OBW 8-22 and OBW 8-23

Signs OBW 8-22 and OBW 8-23 should be used where a multi-use path crosses a roadway in an unexpected location. This sign is not for use where bike lanes and shoulder bikeways cross streets at controlled intersections.

B.3. DIRECTIONAL, DESTINATION & STREET SIGNS

Where a path crosses a roadway or branches off into another path, directional and destination signs should be provided. It is also helpful to have street name signs at street crossings and access points. Signs directing users to the path are also helpful. These signs are more useful to users than “BIKE ROUTE” signs.



Figure 143: Directional and street signs

B.4. END OF PATH

Where a path ends, and bicyclists continue riding on the roadway, the following sign should be used to direct cyclists to the right side of the road to minimize wrong-way riding:



Figure 144: End of path signs

B.5. PLACEMENT OF SIGNS

Signs should have 1 m (3 ft) lateral clearance from the edge of the path (min 0.6 m [2 ft]). Because of cyclists' and pedestrians' lower line of sight, the bottom of signs should be about 1.5 m (5 ft) above the path. If a secondary sign is mounted below another sign, it should be a minimum of 1.2 m (4 ft) above the path. Signs placed over a path should have a minimum vertical clearance of 2.4 m (8 ft).

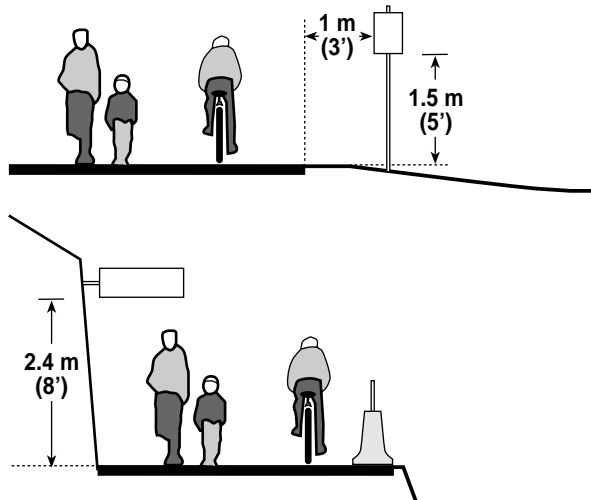

Figure 145: Sign clearances

B.7. STRIPING

On paths with high use, a broken yellow centerline stripe may be used to separate travel into two directions. Spacing may be either 1 m (3 ft) segments and 2.7 m (9 ft) gaps or 3 m (10 ft) segments and 9 m (30 ft) gaps. A solid centerline stripe should be used through curves and areas of poor sight distance.

Note: Attempts to separate pedestrians from cyclists with an additional painted lane have not proven successful and are not recommended.

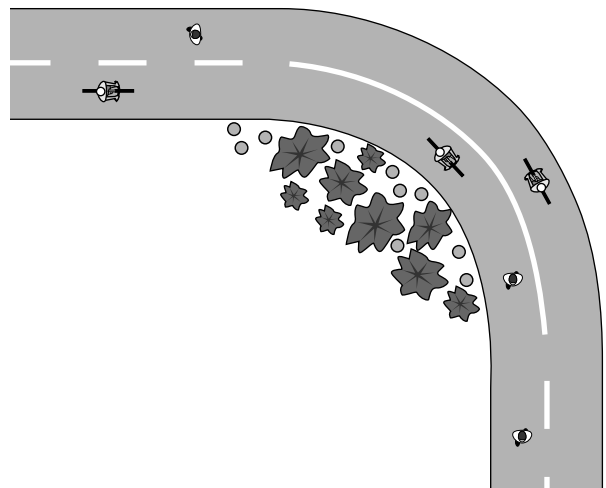

Figure 147: Path striping

B.6. RAILROAD CROSSINGS

Stencils and a sign should be placed prior to railroad crossings:

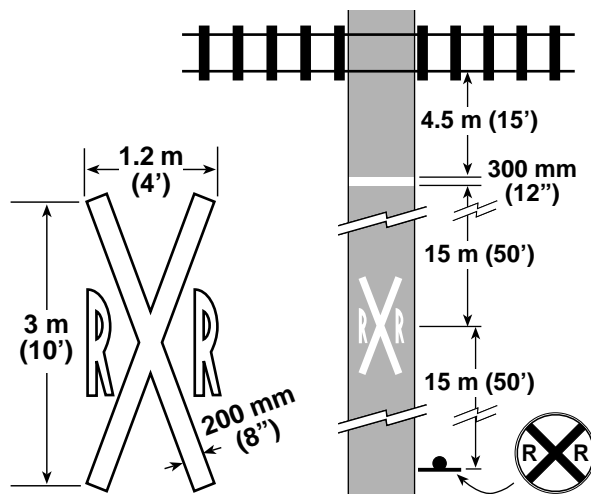

Figure 146: Railroad crossing stencils



Striping and arrows in blind curve

C. REVIEW OF EXISTING BIKEWAY SIGNING

Many bikeways are signed and marked in a manner that is not consistent with current standards and practices. ODOT recommends periodic review of existing signs, to upgrade and standardize bikeway signing.

All existing signs and markings should be inventoried and recommendations made to the appropriate office. **In most cases, this results in a net decrease in the total number of signs.**

See Figure 148 for examples of signs and markings that ODOT recommends for removal.

Other signs that are not appropriate for the situation, as well as bike lane stencils on rural shoulder bikeways, should be removed.



These signs are confusing

BIKE LANE signs should be replaced with bike lane stencils, with optional NO PARKING signs where needed.

BIKE ROUTE signs, especially with BEGIN and END riders, should be removed, or replaced with direction signs (OBD11-1) for directional assistance.

BEGIN
END

BIKE XING signs are not needed for bike lanes or shoulder bikeways where they approach controlled intersections.

BIKE WARNING sign with ON SHOULDER rider is not needed where shoulder width is adequate for bicycling.

This warning sign is not needed as bicyclists can judge for themselves the width of a lane.

Figure 148: Obsolete signs

D. WALKWAYS

Walkways generally require little signing. Most regulatory and warning signs are directed at motor vehicle traffic when they approach a crossing. Very little has been done for directional signs for pedestrians.

D.1. REGULATORY SIGNS

The most important signs to increase pedestrians' safety in crosswalks at controlled intersections are STOP and YIELD signs.



Stop sign increases security of pedestrians at crosswalk

At signalized intersections with right-turn or left-turn lanes, signs OR17-5 or OR17-6 may be installed where conflicts with crossing pedestrians could occur:

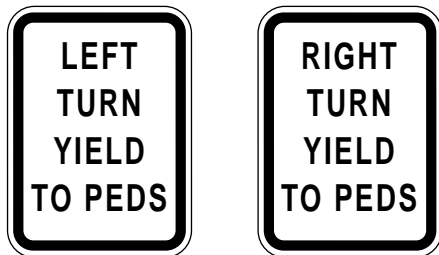

Figure 149: Signs OR17-5 and OR17-6

R10-2a is used to direct pedestrian traffic at intersections where it would be unsafe for

pedestrians to cross at a location other than a marked crosswalk:



Figure 150: Sign R10-2a

R9-2a and R9-3 direct pedestrians to cross on green only or to use a push-button:



Figure 151: R9-2a and R9-3

D.2. WARNING SIGNS

Pedestrian Crossing signs (W11A-2 and W11-2) should be used at locations where a crossing is not normally encountered. This is usually at mid-block locations, where the adjacent land use is likely to generate a fairly high number of crossings.

Sign W11A-2, should be used in advance of crossings or areas of high pedestrian use. Sign W11-2 should only be used at a crosswalk.

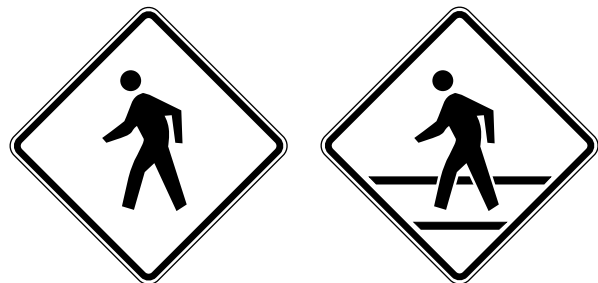

Figure 152: W11A-2 and W11-2



Pedestrian crossing sign

D.3. DIRECTIONAL SIGNS

Most directional signs are installed for the benefit of motorists. They are large, mounted fairly high, indicating destinations relatively far away, and may not adequately serve pedestrians. Most walking trips are short, and the pedestrian's line of sight is fairly low.

No standards have been developed yet for pedestrian directional signs. Signs should be developed for urban areas to assist pedestrians new to the area, or for residents who may not realize that the best route on foot is shorter than what they are used to driving.

To avoid adding clutter to the existing street signs, it may be preferable to cluster signs together on one post, placed in strategic locations. Distances should be given in blocks,



Overhead pedestrian crossing sign at mid-block crosswalk

average walking time, or other measurements meaningful to pedestrians.

Examples of key destinations to include are: libraries, schools, museums, entertainment centers, shopping districts, etc.

Signs should be unobtrusive, easy to read and aesthetic. This example is based on a model used in Switzerland:

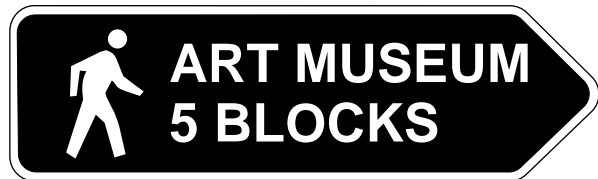

Figure 153: Pedestrian directional sign



Directional signs placed high are not visible to pedestrians

D.4. STREET SIGNS

Most street signs adequately serve pedestrians. However, there are situations where pedestrians cannot read signs mounted for automobile drivers:

- On one-way streets, signs should face both ways, as foot traffic will be approaching from both directions.
- Signs that are mounted high on mast arms over the roadway should be supplemented with conventional, smaller signs on the street corners.

II.9. TRAFFIC CALMING

INTRODUCTION

Citizens are often concerned about excessive traffic volumes and speeds on residential streets. Local streets are intended to serve the adjacent land use at slow speeds, yet they are often designed so that high speed travel is accommodated. Well-designed traffic calming devices effectively reduce traffic speeds and volumes while maintaining local access to neighborhoods.

Motorists often choose short-cuts through residential areas when the arterial or collector street system isn't functioning properly. Traffic calming should be viewed as an area-wide treatment, rather than a solution for only one or two problem streets, so that through traffic is not diverted onto other residential streets; this may require improving the arterial street system.

Public involvement is needed for residents, businesses, planners and engineers to understand the issues and agree with the proposed changes.

The benefits of traffic calming for bicycling and walking are:

- Reduced traffic speeds and volumes allow bicyclists to share the road with vehicles;
- Quieter streets and increased ease of crossing enhance the pedestrian environment;
- Lower traffic speeds increase safety (high speeds are responsible for many pedestrian fatalities); and
- Parents will be more likely to let their children walk or ride a bike in the neighborhood if the streets are made safer.

Some earlier attempts at traffic calming in this country have not proven effective for several reasons:

- The technique slowed cars down excessively, encouraging drivers to accelerate to higher speeds to make up for lost time, which increases noise and air pollution. For example, speed bumps are uncomfortable to cross at even very low speeds, and are unpopular with bicyclists.

- The technique was a misuse of traffic controls, breeding disrespect for their legitimate use; e.g. four-way stop signs are often ignored where there is no perceived danger.
- No further efforts were made beyond placing speed limit signs. Most drivers travel at a speed they feel comfortable with, which is usually a product of roadway design.

Effective traffic calming techniques rely on these general principles:

- The street design allows drivers to drive at, but no more than, the desired speed;
- The street design allows local access, while discouraging through traffic; and
- Traffic calming works best when roads are properly designed in the first place.



Traffic circles slow motor vehicles

Traffic calming can be viewed as a method to help reestablish the proper hierarchy for streets:

- Local streets should carry local traffic at slow-speeds, with bicyclists sharing the road and pedestrians crossing freely.
- Collector streets should carry traffic to and from local streets and arterials, at moderate speeds. Bicyclists should be able to share the road or ride on bike lanes. Pedestrians should be provided with buffered sidewalks and frequent crossing opportunities.
- Arterial streets should carry mostly through traffic. Bicyclists should be accommodated with bike lanes. Pedestrians should have buffered sidewalks and be offered reasonably-spaced crossing opportunities.

A. REDUCING TRAFFIC SPEEDS

Reducing traffic speeds can be accomplished through physical constraints on the roadway or by creating an “illusion of less space.” Motorists typically drive at a speed they perceive as safe; this is usually related to the road design, especially available width.

A.1. PHYSICAL CONSTRAINTS

A.1.a. Narrow Streets or Travel Lanes

Narrow cross-sections can effectively reduce speeds, as most drivers adjust their speed to the available lane width. Narrow streets also reduce construction and maintenance costs.

A.1.b. Speed Humps (not speed bumps)

Well-designed speed humps allow vehicles to proceed over the hump at the intended speed with minimal discomfort, but will rock vehicles when driven at higher speeds. One common hump design has a reversing curve at each end, and a level area in the middle long enough to accommodate most wheelbases. Others are parabolic.

Speed humps are preferable to bumps for several reasons:

- They allow vehicles to travel at a constant speed, as opposed to the braking and accelerating associated with bumps; and
- They are easier for bicyclists to ride over.

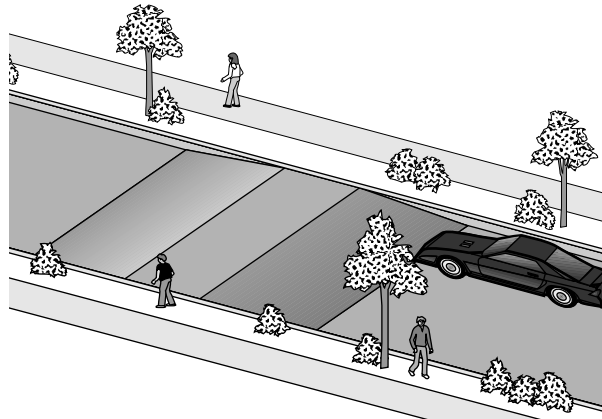

Figure 154: Speed hump

A.1.c. Chokers (curb extensions)

Chokers constrict the street width and reduce the pedestrian crossing distance (see Figure 71, page 108).



Street space rededicated to pedestrians (Holland)



Colored bike lanes

A.2. ILLUSION OF LESS SPACE

A.2.a. Creating Vertical Lines

By bringing buildings closer to the roadway edge, or by adding tall trees, the roadway appears narrower than it is.

A.2.b. Coloring or Texturing Bike Lanes

Drivers see only the travel lanes as available road space, so the roadway appears narrower than it is. Painting the road surface is expensive; lower-cost methods include:

1. Slurry-sealing or chip-sealing the roadway and not the bike lanes;
2. Incorporating dyes into concrete or asphalt.

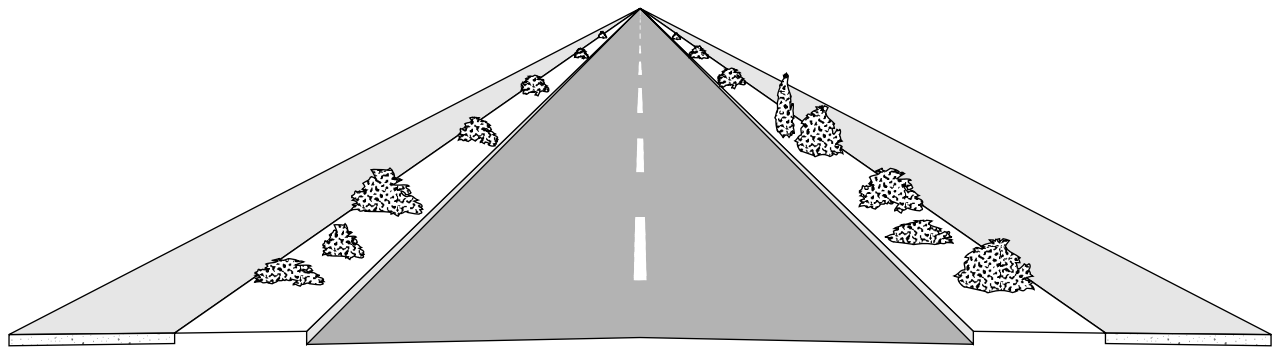

WITHOUT TREATMENTS

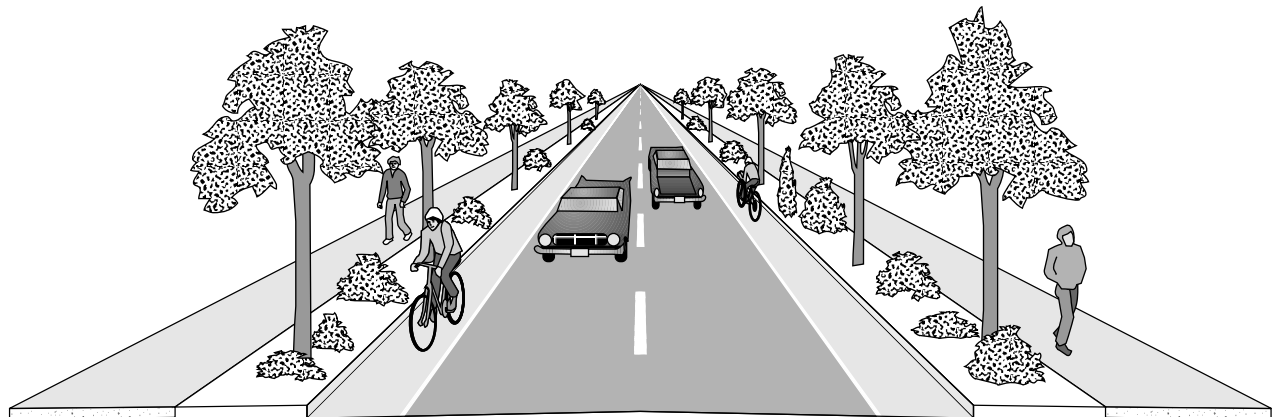

WITH TREATMENTS

Figure 155: Trees and colored bike lanes make a roadway appear narrower

Creating vertical lines and colored bike lanes can be used on higher speed arterials, as there is no change in the roadway width available to motor vehicles.

A.2.c. Chicanes

By alternating on-street parking, landscaping or other physical features from one side of the road to the other, the driver does not see an uninterrupted stretch of road. The roadway width remains adequate for two cars to pass.

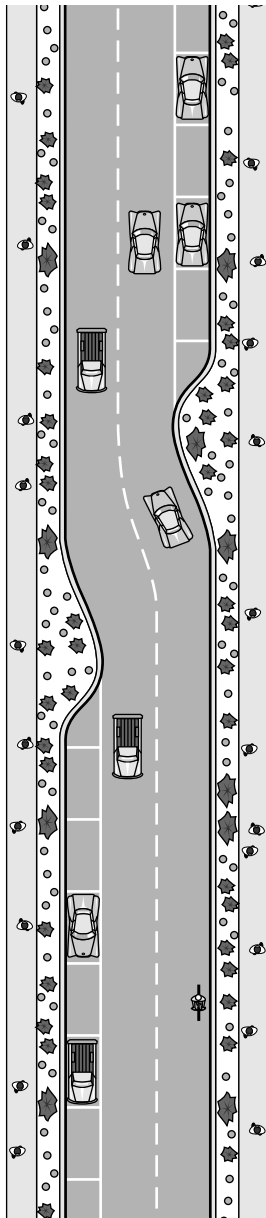

Figure 156: Chicane created through alternate parking

B. DISCOURAGING THROUGH TRAFFIC ON LOCAL STREETS

These techniques physically limit access to local streets for through traffic. This may require some out-of-direction travel for some trips. Techniques include:

B.1. ONE-WAY CHOKERS

Autos are allowed out of a street, but entrance occurs at side streets. Bicyclists and pedestrians are allowed to travel in both directions.

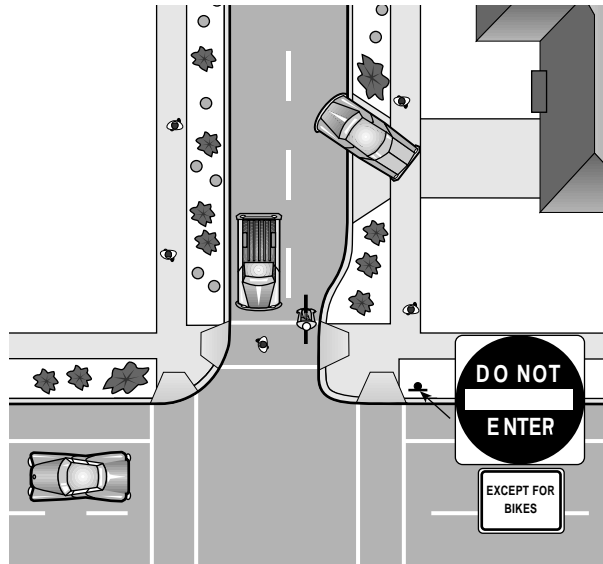

Figure 157: Choker at entrance of two-way local street



Choker on one-way street allows access for bicyclists

B.2. DIVERTERS AND CUL-DE-SACS

These prohibit all movements into a certain section of street.

Caution should be used when physically restricting access: this may contradict other transportation goals, such as an open grid system. Cul-de-sacs should allow through bicycle and pedestrian access. Refer to Figure 6, page 44, for an example of an open design that provides bicyclists and pedestrians easy access to and from cul-de-sacs.

**C. LIVING STREETS
(DUTCH “WONERF”)**

This idea originated in Holland, and takes traffic calming to its ultimate realization: streets are designed primarily for foot traffic, bicyclists and children playing - automobiles are treated as guests. This requires a legislative change, as this is a modification of existing right of way laws. The burden of responsibility for safety is on motorists: they are assumed to be at fault if they hit a pedestrian.

The street is designed with physical constraints that allow only local motor vehicle

access (residents and visitors) at low speeds (under 15 km/h). Streets are designed with physical constraints that do not allow high speed. Signs are posted warning entering motorists of the street characteristics - the signs depict children playing and pedestrians.

A new treatment such as this requires public involvement, support from the residents, and a street system that functions well enough so that through traffic has access to a reasonable alternative route. As with all traffic calming measures, emergency vehicles must be able to access residences.

One major advantage is cost: streets are very narrow, which reduces the total paved surface area, and there is no need for curb and sidewalks.

A similar concept is already in use in Boulder Colorado - they are called “access lanes.”

Other traffic-calming techniques and design details not discussed here may be found in other publications such as FHWA-PD-93-028, Case Study No. 19: “Traffic Calming, Auto-Restricted Zones and Other Traffic Management Techniques - Their Effects on Bicycling and Walking.”



This street is reserved for pedestrians, bicyclists and transit

EFFECTS OF ON-STREET PARKING		
	BICYCLISTS	PEDESTRIANS
FUNCTIONAL		
Additional buffer width	—	P
Aesthetics (glare, noise, heat)	N	N
Interferes with street furniture	—	N
Interferes with bike racks	N	N
Increases shy distance.....	N	P
Increases access to destinations	—	P
Incentive to orient businesses towards street.....	P	P
SAFETY/OPERATIONAL		
Interferes with bicycle traffic (esp. diagonal).....	N	—
Traffic calming effect (slower speeds).....	P	P
Obscures sight distance (both at intersections and mid-block crossing)	N	N
Complicates street maintenance.....	N	—
Encourages car use	N	N
Interferes with transit operation	N	N
Reduces need for driveways to access off-street parking	P	P
Provides good access to sidewalks for drivers/passengers	—	P
ECONOMIC/LIVABILITY		
Increases activity on street	P	P
Keeps CBD commercially viable	P	P
Reduces need for off-street parking.....	P	P
Additional demand on right-of-way	N	N
Political problems with removal	N	N
<p>P = <i>Positive impact</i> N = <i>Negative impact</i> — = <i>No impact one way or the other</i></p>		

Table 9: Effects of on-street parking

D. ON-STREET PARKING

While the primary purpose of a public right-of-way is to transport people and goods, on-street parking is often cited as an advantage for pedestrians, primarily as a buffer. Yet on-street parking also uses space that could be used for wider sidewalks or bike lanes. Table 9 lists some of the advantages and disadvantages for both pedestrians and bicyclists of on-street parking, to help guide planners, designers and elected officials in the difficult decision to remove or retain parking.



Bollards used to prevent parking on narrow Dutch street

II.10. BICYCLE MAPS

INTRODUCTION

Consistency in bicycle maps enables users to readily identify standard symbols and colors when they visit a new area. A system of unified codes and symbols is also useful to planners, designers and engineers.

There are four basic types of bicycle maps:

- Urban bicycle facility maps;
- County, state or regional bicycling guides;
- Bicycling tour guides; and
- City or county planning maps.

The first three types are used mainly by bicycle riders; the fourth is used by a wide variety of interested parties.

A. URBAN BICYCLE MAP

Used primarily by local utilitarian bicyclists, newcomers and visitors, this type of map is intended to help cyclists choose routes they feel comfortable cycling on, and to encourage first-time riders to try making certain trips by bicycle.

All streets should be shown. A simple color code indicates the presence and type of bicycle facilities. It also warns bicyclists of roads they should use with caution. The accompanying text should provide information on good riding skills, traffic laws and safety tips.

Other useful information includes enlargements of difficult intersections, steep hills, weather data, parking facilities, bike shops, important destinations and landmarks, etc. But too much detail creates a cluttered effect; simplicity makes it easier to find needed information.

CODE:

- Blue.....Bike Lanes
- PurpleMulti-Use Paths
- Red.....Caution Areas
- Black.....Local streets (shared roadways)

B. BICYCLING GUIDE

The intended audience is recreational and touring riders interested in medium to long-distance trips. The major concerns when choosing a route are traffic volumes and roadway conditions. Color coding indicates traffic volume levels; a solid line indicates the presence of shoulders wide enough for bicycle travel.

The map should include state highways and county roads. The level of detail is less than on an urban map. Other information to include are distances, grades, weather data (especially prevailing wind directions), bike shops, markets and camping facilities. Text should be used for information on local history, landmarks, viewpoints, etc.

Description of loop tours is useful to riders planning day trips. Local cyclists should ride the loops in order to assess conditions. A written description of the route listing landmarks and turns is helpful.

Since bicycle trips often cross jurisdictional boundaries, counties are encouraged to coordinate regional maps, covering a natural geographical area within easy reach of several population centers.

CODE:

Traffic Volumes:

- Green.....Low(<1000 ADT)
- YellowModerate ... (1000-3000 ADT)
- Orange ...High(>3000 ADT)
- RedCaution areas, due to narrow roads, poor visibility or high truck volumes

Shoulders:

Black lines indicate shoulders 1.2 m (4 ft) or wider on both sides of the roadway

Grades:

- 1 Chevron2-4% grade
- 2 Chevrons.....4-6% grade
- 3 Chevrons.....Over 6% grade

C. BICYCLING TOUR GUIDE

The intended audience is bicyclists on an extended tour. The format can be fold-out maps, strip maps or brochures. Various agencies can cooperate to produce maps for long-distance bicycle tours that traverse several jurisdictions.

If a loop or one-way tour is best when cycled in one direction only, this should be emphasized in the text (for example, it is best to ride the Oregon Coast Bike Route from north to south, to take advantage of prevailing winds).

Points of interest are important, as are distances, grades, campgrounds, availability of water and details of difficult areas. A written description of the route listing landmarks and turns is useful, as well as an elevation profile.

D. CITY & COUNTY BICYCLE & PEDESTRIAN PLAN MAP

The intended audience are planners, advisory committees, designers, engineers, elected officials and interested citizens. The maps document planned and existing facilities. They should be readily available to the public.

The following coding is convenient: open squares and circles and dashed lines can be filled in when projects are completed. The use

of black and white makes these maps easy to photocopy, enlarge and FAX.

CODE:

- Bike LanesSquares
 - plannedopen
 - existingfilled
- PathsCircles
 - plannedopen
 - existingfilled
- SidewalksDiamonds
 - plannedopen
 - existingfilled
- ShouldersLines
 - planneddash
 - existingsolid

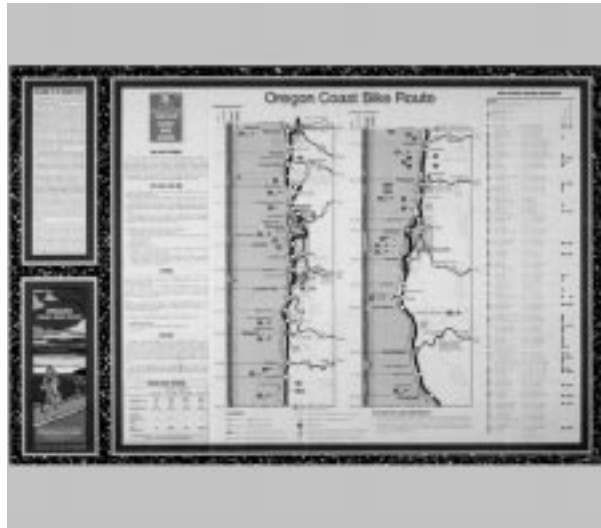

The Oregon Coast Bike Route Map



Bicyclists in Oregon have several statewide and local maps available



The Corvallis Area Bikeways Map

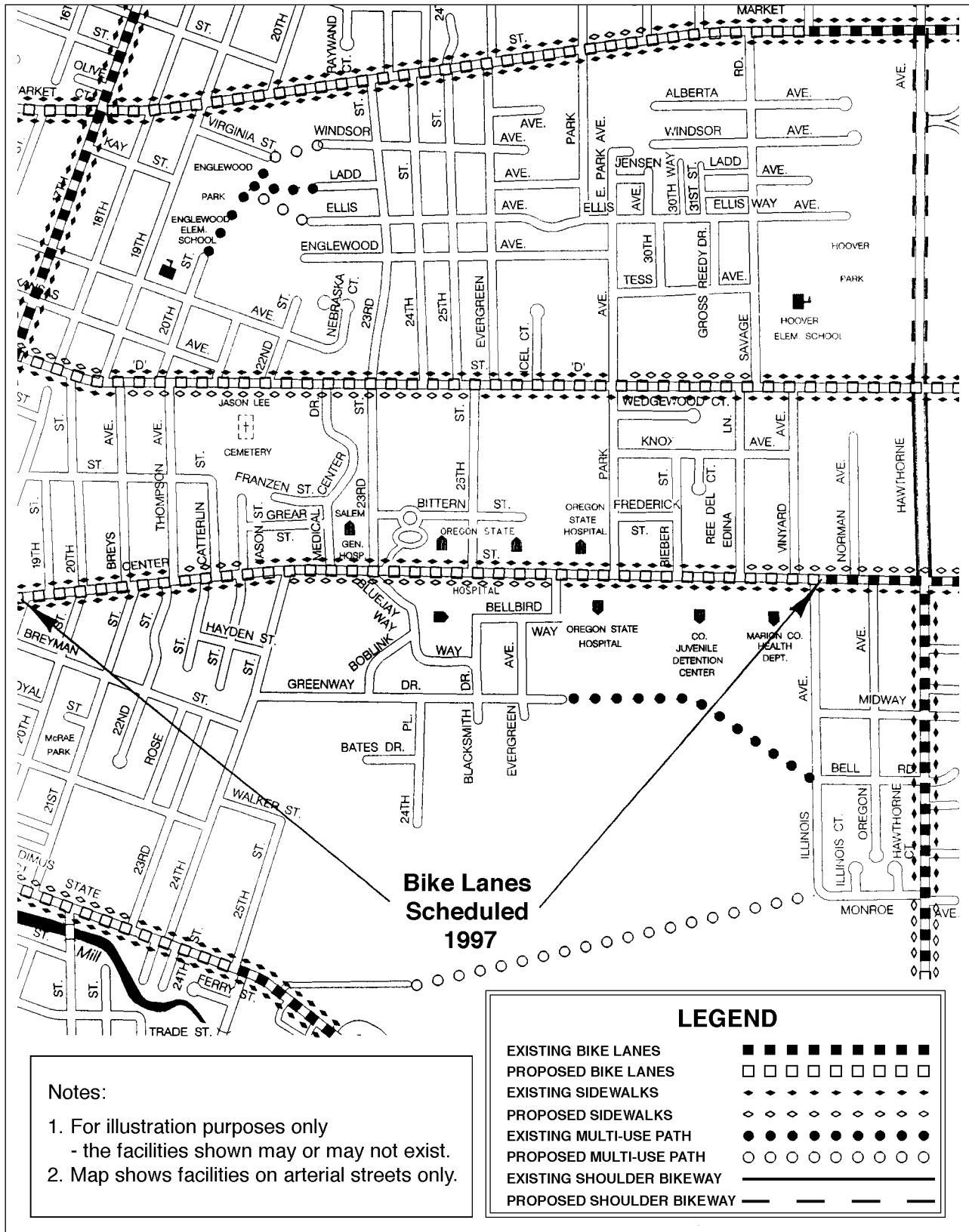

Figure 158: Bicycle and pedestrian facility planning map