

PRICE LIST

Traditional Office Wood Veneer Products

Baritone

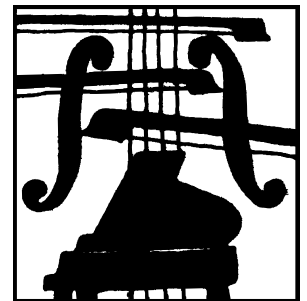

Prices Effective August 2007

UNICOR



TABLE OF CONTENTS

ITEM	PAGE
MATERIALS AND FABRICATION METHODS	ii
SUGGESTED WORKSTATIONS	1-8
INDIVIDUAL ITEMS AND ACCESSORIES	
DESKS	9 - 10
L-UNIT EXTENSIONS AND BRIDGES.....	11
CONFERENCE ENDS	11
CREDENZA BASE UNITS	12 - 13
BOOKCASES	14
CREDENZA UPPER STORAGE UNITS.....	16
TRANSACTION COUNTERS	16
FILES.....	17
WARDROBES.....	17
BOOKCASES	18
TABLES.....	19
COMPUTER STANDS	21
ACCESSORIES AND PAPER MANAGEMENT	21
HOW TO ORDER	23
ORDER FORM	24
TERMS AND CONDITIONS	25 - 26

Baritone is a comprehensive line of traditional office furniture scaled to work within the wide range of Federal office environments and administrative spaces.

Credenza bases, desks and credenza upper storage units can be configured to meet specific office requirements. Double pedestal desks and secretarial desks with return tops allow for L and U-shape configurations. Storage options include filing cabinets, wardrobes, and bookcases. Computer support furniture and conference tables round out the Baritone line to meet the varying needs of today's workplace.

BARITONE PRICE LIST

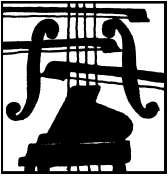

MATERIALS AND FABRICATION METHODS

MATERIALS

Veneer	The 1/40" veneer is grade "A" Cherry, plain-sliced, book-matched without knots or objectionable grain distortion.
Hardwood	All molding and edges are solid cherry hardwood.
Finishes	A multi-step finish using environmentally friendly water based materials, which include stains and multiple coats of sealer and lacquer, gives the furniture a medium gloss finish. All drawer boxes have a clear UV finish on birch. All furniture pieces have a full, finished backs.

DESIGN FEATURES

Desk Pad	An executive desk pad is included with all Baritone desks to help protect the finish from possible damage by pens and sharp objects, ensuring a lasting finish for years to come.
Pencil Tray	Desk center drawers feature maple hardwood pencil trays.
Drawer Slides	Slides are 100-pound rated, ball bearing slides with full extension.
Lighting	Accent down lights are standard with upper bridges and task lights are standard on hutches.
Filing	File drawers feature adaptable rails for letter and legal filing. Desk and credenza file drawers provide 20" file depths. Lateral file drawers allow front-to-back vertical filing and side-to-side lateral filing.
Wire Management	Wire management grommets are located on the sides of desks and desk returns as well as on the sides and worksurfaces of the corner transition units. Credenza kneehole areas feature a removable modesty panel to access wall receptacle and route wires.
Locks	All file drawers have locking mechanisms.

SPECIFICATIONS

Testing	Assembled furniture products meet or exceed ANSI/BIFMA standards X5.5 and X5.6.
Surface	Exterior surface finishes meet or exceed the durability standards of Federal specification AA-2850 for water base coatings.

BARITONE PRICE LIST

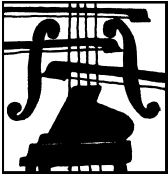

TO ORDER:

Select the product number and add finish color.

For example: BT6830DKCH
Product # BT6830DK Finish Color - CH = Cherry Finish

Finish Color:

CH = Cherry Finish
 MH = Mahogany Finish
 WN = Walnut Finish

Baritone product numbers are comprised of alpha and numeric characters. This number indicates product line, size, product options and finish color.

ITEM	DESCRIPTION	WIDTH	DEPTH	HEIGHT	PRODUCT NUMBER	SHIP WEIGHT	FOB ORIG	FOB DEST
------	-------------	-------	-------	--------	----------------	-------------	----------	----------

SUGGESTED OFFICE PLANS

The workstations presented below are suggestions to show the versatility of the groupings. Each grouping is accompanied by a list of the furniture represented in the drawing. You can make your own plans by using different items listed in this catalog.

L-Unit 68" - Right Hand Return

ORDER PRODUCTS LISTED BELOW

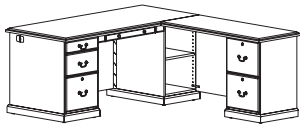

Footprint: 68" w x 79" d x 30" h

Desk Extension, Right Hand Return,
 Pedestal with Two File Drawers on Right
 Desk - Single Pedestal with Pencil, Box,
 File Drawer on Left Side Open Shelves on Right
 with Center Pencil Drawer

49"	20 3/4"	30"	BT4921EXRH_ _	232 lbs	\$640	\$745
68"	30"	30"	BT6830DKLH_ _	385 lbs	\$1,190	\$1,365
TOTAL				617 LBS	\$1,830	\$2,110

L-Unit 68" - Left Hand Return

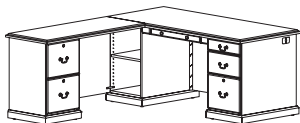

Footprint: 68" w x 79" d x 30" h

Desk Extension, Left Hand Return,
 Pedestal with Two File Drawers on Left
 Desk - Single Pedestal with Pencil, Box, File
 Drawer on Right Side Open Shelves on Left
 with Center Pencil Drawer

49"	20 3/4"	30"	BT4921EXLH_ _	232 lbs	\$640	\$745
68"	30"	30"	BT6830DKRH_ _	385 lbs	\$1,190	\$1,365
TOTAL				617 LBS	\$1,830	\$2,110

L-Desk with Transaction Counter - Right Hand Return

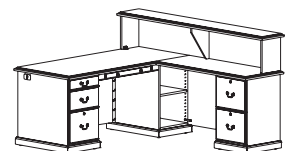

Footprint: 68" w x 79" d x 45" h

Transaction Counter
 Desk Extension, Right Return,
 Pedestal with Two File Drawers on Right
 Desk - Single Pedestal with Pencil, Box, File
 Drawer on Left Side Open Shelves on Right
 with Center Pencil Drawer

78 3/4"	12"	14 1/2"	BT7912TC_ _	203 lbs	\$395	\$485
49"	20 3/4"	30"	BT4921EXRH_ _	232 lbs	\$640	\$745
68"	30"	30"	BT6830DKLH_ _	385 lbs	\$1,190	\$1,365
TOTAL				820 lbs	\$2,225	\$2,595

L-Desk with Transaction Counter - Left Hand Return

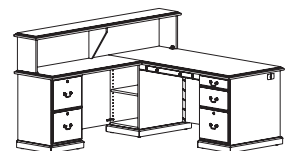

Footprint: 68" w x 79" d x 45" h

Transaction Counter
 Desk Extension, Left Return,
 Pedestal with Two File Drawers on Left
 Desk - Single Pedestal with Pencil, Box, File
 Drawer on Right Side Open Shelves on Left
 with Center Pencil Drawer

78 3/4"	12"	14 1/2"	BT7912TC_ _	203 lbs	\$395	\$485
49"	20 3/4"	30"	BT4921EXLH_ _	232 lbs	\$640	\$745
68"	30"	30"	BT6830DKRH_ _	385 lbs	\$1,190	\$1,365
TOTAL				820 lbs	\$2,225	\$2,595

* All file drawers have locks and adaptable rails for letter and legal filing.

BARITONE PRICE LIST

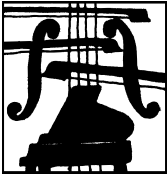

TO ORDER:

Select the product number and add finish color.

For example: BT6830DKCH
Product # BT6830DK Finish Color - CH = Cherry Finish

Finish Color:

CH = Cherry Finish
 MH = Mahogany Finish
 WN = Walnut Finish

Baritone product numbers are comprised of alpha and numeric characters. This number indicates product line, size, product options and finish color.

ITEM	DESCRIPTION	WIDTH	DEPTH	HEIGHT	PRODUCT NUMBER	SHIP WEIGHT	FOB ORIG	FOB DEST
------	-------------	-------	-------	--------	----------------	-------------	----------	----------

SUGGESTED OFFICE PLANS

L-Unit - Right Hand Return

ORDER PRODUCTS LISTED BELOW

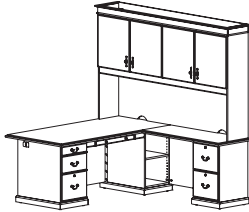

Upper Hutch, Four Solid Doors with 33" Task Light	85"	14 1/2"	54"	BT8515HTUS__	375 lbs	\$960	\$1,130
Desk Extension, Right Return, Pedestal with Two File Drawers on Right	49"	20 3/4"	30"	BT4921EXRH__	232 lbs	\$640	\$745
Desk - Single Pedestal with Pencil, Box, File Drawer on Left Side Open Shelves on Right with Center Pencil Drawer	72"	36"	30"	BT7236DKLH__	417 lbs	\$1,240	\$1,430
Total					1024 lbs	\$2,840	\$3,305

Footprint: 72" w x 85" d x 84" h

L-Unit - Left Hand Return

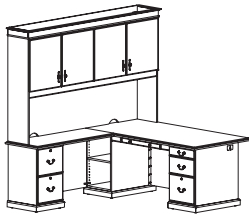

Upper Hutch, Four Solid Doors with 33" Task Light	85"	14 1/2"	54"	BT8515HTUS__	375 lbs	\$960	\$1,130
Desk Extension, Left Return, Pedestal with Two File Drawers Left	49"	20 3/4"	30"	BT4921EXLH__	232 lbs	\$640	\$745
Desk - Single Pedestal with Pencil, Box, File Drawer on Right Side Open Shelves on Left with Center Pencil Drawer	72"	36"	30"	BT7236DKRH__	417 lbs	\$1,240	\$1,430
Total					1024 lbs	\$2,840	\$3,305

Footprint: 72" w x 85" d x 84" h

U-Unit - 68" - Left Hand

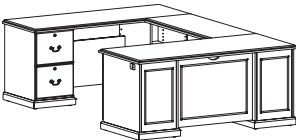

Credenza - Pedestal with Two File Drawers on Left Side Open Shelves on Right Side	68"	24"	30"	BT6824CR2FKHOC__	205 lbs	\$950	\$1,040
Extension Bridge	42"	20 3/4"	30"	BT4221BR__	118 lbs	\$300	\$355
Desk - Single Pedestal with Pencil, Box, File Drawer on Right Side Open Shelves on Left with Center Pencil Drawer	68"	30"	30"	BT6830DKRH__	385 lbs	\$1,190	\$1,365
Total					708 lbs	\$2,440	\$2,760

Footprint: 68" w x 96" d x 30" h

U-Unit - 68" - Right Hand

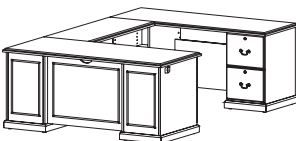

Credenza Credenza - Pedestal with Two File Drawers on Right Side Open Shelves on Left Side	68"	24"	30"	BT6824CROCKH2F__	205 lbs	\$950	\$1,040
Extension Bridge	42"	20 3/4"	30"	BT4221BR__	118 lbs	\$300	\$355
Desk - Single Pedestal with Pencil, Box, File Drawer on Left Side Open Shelves on Right	68"	30"	30"	BT6830DKLH__	385 lbs	\$1,190	\$1,365
Total					708 lbs	\$2,440	\$2,760

Footprint: 68" w x 96" d x 30" h

* All file drawers have locks and adaptable rails for letter and legal filing.

BARITONE PRICE LIST

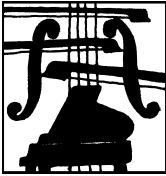

TO ORDER:

Select the product number and add finish color.

For example: BT6830DKCH
Product # BT6830DK Finish Color - CH = Cherry Finish

Finish Color:

CH = Cherry Finish
 MH = Mahogany Finish
 WN = Walnut Finish

Baritone product numbers are comprised of alpha and numeric characters. This number indicates product line, size, product options and finish color.

ITEM	DESCRIPTION	WIDTH	DEPTH	HEIGHT	PRODUCT NUMBER	SHIP WEIGHT	FOB ORIG	FOB DEST
------	-------------	-------	-------	--------	----------------	-------------	----------	----------

SUGGESTED OFFICE PLANS

68" - Workstation with Four Door Hutch - Right Hand Return

ORDER PRODUCTS LISTED BELOW

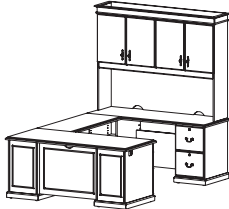

Footprint: 68" w x 96" d x 84" h

Upper Hutch, Four Solid Doors with Task Light	68"	15"	54"	BT6815HTUS__	298 lbs	\$830	\$965
Credenza - Pedestal with Two File Drawers on Right Side Open Shelved on Left Side	68"	24"	30"	BT6824CROCKH2F__	205 lbs	\$950	\$1,040
Extension Bridge	42"	20 3/4"	30"	BT4221BR__	118 lbs	\$300	\$355
Desk - Single Pedestal with Pencil, Box, File Drawer on Left Side Open Shelves on Right with Center Pencil Drawer	68"	30"	30"	BT6830DKLH__	385 lbs	\$1,190	\$1,365
Total					1006 lbs	\$3,270	\$3,725

68" - Workstation with Four Door Hutch - Left Hand Return

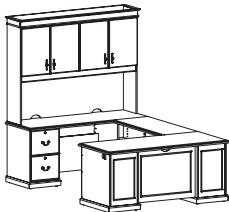

Footprint: 68" w x 96" d x 84" h

Upper Hutch, Four Solid Doors with Task Light	68"	15"	54"	BT6815HTUS__	298 lbs	\$830	\$965
Credenza - Pedestal with Two File Drawers on Left Side Open Shelves on Right Side	68"	24"	30"	BT6824CR2FKHOC__	205 lbs	\$950	\$1,040
Extension Bridge	42"	20 3/4"	30"	BT4221BR__	118 lbs	\$300	\$355
Desk - Single Pedestal with Pencil, Box, File Drawer on Right Side Open Shelves Left with Center Pencil Drawer	68"	30"	30"	BT6830DKRH__	385 lbs	\$1,190	\$1,365
Total					1006 lbs	\$3,270	\$3,725

68" - Workstation with Glass Door Upper Bookcase w/Light Bridge - Right Hand Return

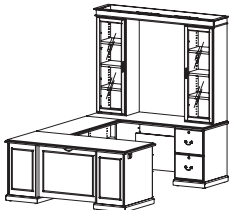

Footprint: 68" w x 96" d x 84" h

Upper Bookcase with Glass Doors and 33" Light Bridge	68"	14 1/2"	54"	BT6815BCUGLGB__	360 lbs	\$895	\$1,055
Credenza - Pedestal with Two File Drawers on Right Side Open Shelved on Left Side	68"	24"	30"	BT6824CROCKH2F__	205 lbs	\$950	\$1,040
Extension Bridge	42"	20 3/4"	30"	BT4221BR__	118 lbs	\$300	\$355
Desk - Single Pedestal with Pencil, Box, File Drawer on Left Side Open Shelves on Right with Center Pencil Drawer	68"	30"	30"	BT6830DKLH__	385 lbs	\$1,190	\$1,365
Total					1068 lbs	\$3,335	\$3,815

68" - Workstation with Glass Door Upper Bookcase w/Light Bridge - Left Hand Return

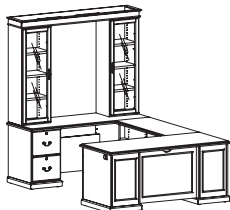

Footprint: 68" w x 96" d x 84" h

Upper Bookcase with Glass Doors and 33" Light Bridge	68"	14 1/2"	54"	BT6815BCUGLGB__	360 lbs	\$895	\$1,055
Credenza - Pedestal with Two File Drawers on Left Side Open Shelves on Right Side	68"	24"	30"	BT6824CR2FKHOC__	205 lbs	\$950	\$1,040
Extension Bridge	42"	20 3/4"	30"	BT4221BR__	118 lbs	\$300	\$355
Desk - Single Pedestal with Pencil, Box, File Drawer on Right Side Open Shelves on Left with Center Pencil Drawer	68"	30"	30"	BT6830DKRH__	385 lbs	\$1,190	\$1,365
Total					1068 lbs	\$3,335	\$3,815

* All file drawers have locks and adaptable rails for letter and legal filing.

BARITONE PRICE LIST

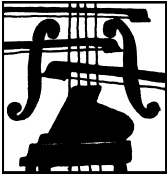

TO ORDER:

Select the product number and add finish color.

For example: BT6830DKCH
Product # BT6830DK Finish Color - CH = Cherry Finish

Finish Color:
 CH = Cherry Finish
 MH = Mahogany Finish
 WN = Walnut Finish

Baritone product numbers are comprised of alpha and numeric characters. This number indicates product line, size, product options and finish color.

ITEM	DESCRIPTION	WIDTH	DEPTH	HEIGHT	PRODUCT NUMBER	SHIP WEIGHT	FOB ORIG	FOB DEST
------	-------------	-------	-------	--------	----------------	-------------	----------	----------

SUGGESTED OFFICE PLANS

U-Unit - 72" Desk - Left Hand

ORDER PRODUCTS LISTED BELOW

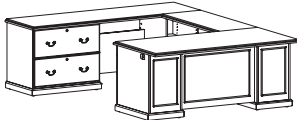

Footprint: 85" w x 102" d x 30" h

Credenza - 2-Drawer Lateral File on Left Side Open Shelves Right Side	85"	24"	30"	BT8524CR2LKHOC__	255 lbs	\$1,120	\$1,235
Extension Bridge	42"	20 3/4"	30"	BT4221BR__	118 lbs	\$300	\$355
Desk - Single Pedestal with Pencil, Box, File Drawer on Right Side Open Shelves on Left with Center Pencil Drawer	72"	36"	30"	BT7236DKRH__	417 lbs	\$1,240	\$1,430
Total					790 lbs	\$2,660	\$3,020

U-Unit - 72" Desk - Right Hand

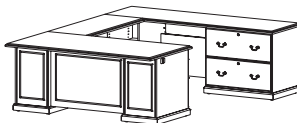

Footprint: 85" w x 102" d x 30" h

Credenza - 2-Drawer Lateral File on Right Side Open Shelves Left Side	85"	24"	30"	BT8524CROCKH2L__	255 lbs	\$1,120	\$1,235
Extension Bridge	42"	20 3/4"	30"	BT4221BR__	118 lbs	\$300	\$355
Desk - Single Pedestal with Pencil, Box, File Drawer on Left Side Open Shelves on Right with Center Pencil Drawer	72"	36"	30"	BT7236DKLH__	417 lbs	\$1,240	\$1,430
Total					790 lbs	\$2,660	\$3,020

72" - Workstation with Four Doors - Right Hand Return

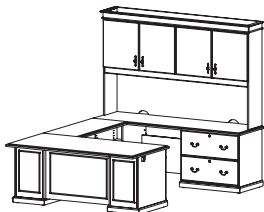

Footprint: 85" w x 102" d x 30" h

Upper Hutch, Four Solid Doors with Task Light	85"	14 1/2"	54"	BT8515HTUS__	375 lbs	\$960	\$1,130
Credenza - 2-Drawer Lateral File on Right Side Open Shelves on Left Side	85"	24"	30"	BT8524CROCKH2L__	255 lbs	\$1,120	\$1,235
Extension Bridge	42"	20 3/4"	30"	BT4221BR__	118 lbs	\$300	\$355
Desk - Single Pedestal with Pencil, Box, File Drawer on Left Side, Open Shelves on Right with Center Pencil Drawer	72"	36"	30"	BT7236DKLH__	417 lbs	\$1,240	\$1,430
Total					1165 lbs	\$3,620	\$4,150

NOTE: 49" Extension Bridge BT4921BR__ (p. 11) Can be substituted to allow more room between the desk and credenza.

72" - Workstation with Four Doors - Left Hand Return

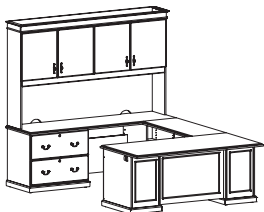

Footprint: 85" w x 102" d x 30" h

Upper Hutch, Four Solid Doors with Task Light	85"	14 1/2"	54"	BT8515HTUS__	375 lbs	\$960	\$1,130
Credenza - 2-Drawer Lateral File on Left Side Open Shelves Right Side	85"	24"	30"	BT8524CR2LKHOC__	255 lbs	\$1,120	\$1,235
Extension Bridge	42"	20 3/4"	30"	BT4221BR__	118 lbs	\$300	\$355
Desk - Single Pedestal with Pencil, Box, File Drawer on Right Side Open Shelves on Left with Center Pencil Drawer	72"	36"	30"	BT7236DKRH__	417 lbs	\$1,240	\$1,430
Total					1165 lbs	\$3,620	\$4,150

NOTE: 49" Extension Bridge BT4921BR__ (p. 11) Can be substituted to allow more room between the desk and credenza.

* All file drawers have locks and adaptable rails for letter and legal filing.

BARITONE PRICE LIST

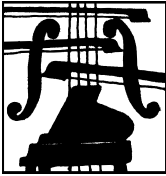

TO ORDER:

Select the product number and add finish color.

For example: **BT6830DKCH**
Product # BT6830DK **Finish Color - CH = Cherry Finish**

Finish Color:

CH = Cherry Finish
 MH = Mahogany Finish
 WN = Walnut Finish

Baritone product numbers are comprised of alpha and numeric characters. This number indicates product line, size, product options and finish color.

ITEM	DESCRIPTION	WIDTH	DEPTH	HEIGHT	PRODUCT NUMBER	SHIP WEIGHT	FOB ORIG	FOB DEST
------	-------------	-------	-------	--------	----------------	-------------	----------	----------

SUGGESTED OFFICE PLANS

72" - Workstation with Upper Bookcase Open Shelves - Right Hand Return

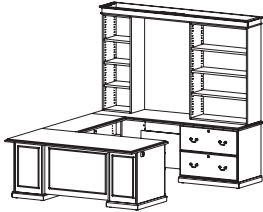

Footprint: 85" w x 102" d x 84" h

Upper Bookcase, Double Open Shelves Right, Single Shelves Left with 33" Light Bridge
 Credenza - 2-Drawer Lateral File on Right Side Open Shelves Left Side
 Extension Bridge
 Desk - Single Pedestal with Pencil, Box, File Drawer on Left Side Open Shelves on Right with Center Pencil Drawer

ORDER PRODUCTS LISTED BELOW								
85"	14 1/2"	54"	BT8515BCU10LB20__	275 lbs	\$895	\$1,020		
85"	24"	30"	BT8524CROCKH2L__	255 lbs	\$1,120	\$1,235		
42"	20 3/4"	30"	BT4221BR__	118 lbs	\$300	\$355		
72"	36"	30"	BT7236DKLH__	417 lbs	\$1,240	\$1,430		
Total				1065 lbs	\$3,555	\$4,040		

72" - Workstation with Upper Bookcase Open Shelves - Left Hand Return

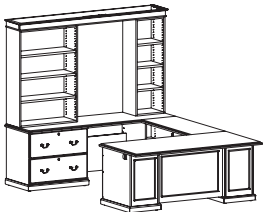

Footprint: 85" w x 102" d x 84" h

Upper Bookcase, Double Open Shelves Left, Single Shelves Right, with 33" Light Bridge
 Credenza - 2-Drawer Lateral File on Left Side Open Shelves Right Side
 Extension Bridge
 Desk - Single Pedestal with Pencil, Box, File Drawer on Right Side Open Shelves on Left with Center Pencil Drawer

85"	14 1/2"	54"	BT8515BCU20LB10__	275 lbs	\$895	\$1,020		
85"	24"	30"	BT8524CR2LKHOC__	255 lbs	\$1,120	\$1,235		
42"	20 3/4"	30"	BT4221BR__	118 lbs	\$300	\$355		
72"	36"	30"	BT7236DKRH__	417 lbs	\$1,240	\$1,430		
Total				1065 lbs	\$3,555	\$4,040		

72" - Workstation with Glass Doors - Right Hand Return

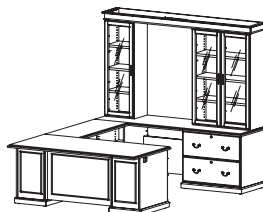

Footprint: 85" w x 102" d x 84" h

Upper Bookcase, Double Glass Doors Right, Single Left, with 33" Light Bridge
 Credenza - 2-Drawer Lateral File on Right Side Open Shelves Left Side
 Extension Bridge
 Desk - Single Pedestal with Pencil, Box, File Drawer on Left Side Open Shelves on Right with Center Pencil Drawer

85"	14 1/2"	54"	BT8515BCU1GLB2G__	390 lbs	\$1,195	\$1,370		
85"	24"	30"	BT8524CROCKH2L__	255 lbs	\$1,120	\$1,235		
42"	20 3/4"	30"	BT4221BR__	118 lbs	\$300	\$355		
72"	36"	30"	BT7236DKLH__	417 lbs	\$1,240	\$1,430		
Total				1180 lbs	\$3,855	\$4,390		

NOTE: 49" Extension Bridge BT4921BR__ (p. 11) Can be substituted to allow more room between the desk and credenza.

72" - Workstation with Glass Doors - Left Hand Return

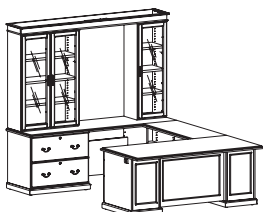

Footprint: 85" w x 102" d x 84" h

Upper Bookcase, Double Glass Doors Left, Single Right, with 33" Light Bridge
 Credenza - 2-Drawer Lateral File on Left Side Open Shelves Right Side
 Extension Bridge
 Desk - Single Pedestal with Pencil, Box, File Drawer on Right Side Open Shelves on Left with Center Pencil Drawer

85"	14 1/2"	54"	BT8515BCU2GLB1G__	390	\$1,195	\$1,370		
85"	24"	30"	BT8524CR2LKHOC__	255	\$1,120	\$1,235		
42"	20 3/4"	30"	BT4221BR__	118	\$300	\$355		
72"	36"	30"	BT7236DKRH__	417	\$1,240	\$1,430		
Total				1180 lbs	\$3,855	\$4,390		

NOTE: 49" Extension Bridge BT4921BR__ (p. 11) Can be substituted to allow more room between the desk and credenza.

* All file drawers have locks and adaptable rails for letter and legal filing.

BARITONE PRICE LIST

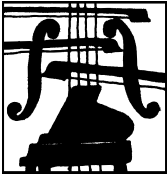

TO ORDER:

Select the product number and add finish color.

For example: BT6830DKCH
Product # BT6830DK Finish Color - CH = Cherry Finish

Baritone product numbers are comprised of alpha and numeric characters. This number indicates product line, size, product options and finish color.

Finish Color:

CH = Cherry Finish
 MH = Mahogany Finish
 WN = Walnut Finish

ITEM	DESCRIPTION	WIDTH	DEPTH	HEIGHT	PRODUCT NUMBER	SHIP WEIGHT	FOB ORIG	FOB DEST
------	-------------	-------	-------	--------	----------------	-------------	----------	----------

SUGGESTED OFFICE PLANS

U-Unit - 84" Desk - Left Hand with Corner Extension

ORDER PRODUCTS LISTED BELOW



Footprint: 85" w x 114" d x 30" h

Desk, Single Pedestal Right Hand with Pencil, Box, File Drawer - Open Shelves Left Side with Center Pencil Drawer
 Extension Bridge
 Corner Unit
 Extension Left Hand Return with Pedestal with Two File Drawers

84"	42"	30"	BT8442DKRH__	513 lbs	\$1,395	\$1,625
36"	20 3/4"	30"	BT3621BR__	103 lbs	\$260	\$305
36"	36"	30"	BT3636CU__	252 lbs	\$470	\$585
49"	20 3/4"	30"	BT4921EXLH__	232 lbs	\$640	\$745

Total 1100 lbs \$2,765 \$3,260

U-Unit - 84" Desk- Right Hand with Corner Extension



Footprint: 85" w x 114" d x 30" h

Desk, Single Pedestal Left Hand with Pencil, Box, File Drawer - Open Shelves Right Side with Center Pencil Drawer
 Extension Bridge
 Corner Unit
 Extension Right Hand Return with Pedestal with Two File Drawers

84"	42"	30"	BT8442DKLH__	513 lbs	\$1,395	\$1,625
36"	20 3/4"	30"	BT3621BR__	103 lbs	\$260	\$305
36"	36"	30"	BT3636CU__	252 lbs	\$470	\$585
49"	20 3/4"	30"	BT4921EXRH__	232 lbs	\$640	\$745

Total 1100 lbs \$2,765 \$3,260

84" - U-Shape Desk with Corner Unit Extension and Hutch

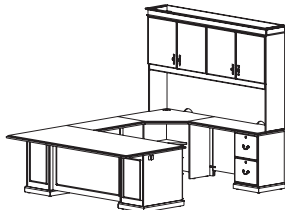

Footprint: 85" w x 114" d x 30" h

Upper Hutch, Four Solid Doors with 33" Task Light
 Desk, Single Left Hand Pedestal with Pencil, Box, File Drawer - Right Hand Open Shelves with Center Pencil Drawer
 Extension Bridge
 Corner Unit
 Extension Right Hand Return with Pedestal with Two File Drawers

85"	14 1/2"	54"	BT8515HTUS__	375 lbs	\$960	\$1,130
84"	42"	30"	BT8442DKLH__	513 lbs	\$1,395	\$1,625
36"	20 3/4"	30"	BT3621BR__	103 lbs	\$260	\$305
36"	36"	30"	BT3636CU__	252 lbs	\$470	\$585
49"	20 3/4"	30"	BT4921EXRH__	232 lbs	\$640	\$745

Total 1475 lbs \$3,725 \$4,390

84" - U-Shape Desk with Corner Unit Extension and Hutch

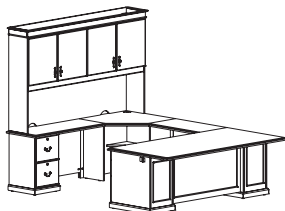

Footprint: 85" w x 114" d x 30" h

Upper Hutch, Four Solid Doors with 33" Task Light
 Desk, Single Right Hand Pedestal with Pencil, Box, File Drawer-Left Hand Open Shelves with Center Pencil Drawer
 Extension Bridge
 Corner Unit
 Extension Left Hand Return with Pedestal with Two File Drawers

85"	14 1/2"	54"	BT8515HTUS__	375 lbs	\$960	\$1,130
84"	42"	30"	BT8442DKRH__	513 lbs	\$1,395	\$1,625
36"	20 3/4"	30"	BT3621BR__	103 lbs	\$260	\$305
36"	36"	30"	BT3636CU__	252 lbs	\$470	\$585
49"	20 3/4"	30"	BT4921EXLH__	232 lbs	\$640	\$745

Total 1475 lbs \$3,725 \$4,390

* All file drawers have locks and adaptable rails for letter and legal filing.

BARITONE PRICE LIST

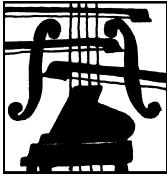

TO ORDER:

Select the product number and add finish color.

For example: BT6830DKCH
Product # BT6830DK Finish Color - CH = Cherry Finish

Finish Color:
 CH = Cherry Finish
 MH = Mahogany Finish
 WN = Walnut Finish

Baritone product numbers are comprised of alpha and numeric characters. This number indicates product line, size, product options and finish color.

ITEM	DESCRIPTION	WIDTH	DEPTH	HEIGHT	PRODUCT NUMBER	SHIP WEIGHT	FOB ORIG	FOB DEST
------	-------------	-------	-------	--------	----------------	-------------	----------	----------

SUGGESTED OFFICE PLANS

L-Unit - Left Hand Return with Tooled Wood Leg

ORDER PRODUCTS LISTED BELOW

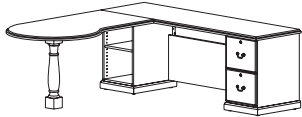

Footprint: 85" W x 84" D x 30" H

Credenza - Pedestal with Two File Drawers on Right Side Open Shelved on Left Side
 P-Shape Peninsula Conference End Left Hand

85"	24"	30"	BT8524CROC3KH2F__	195 lbs	\$1,000	\$1,090
60"	36"	30"	BT6136PCXLH__	190 lbs	\$595	\$680
Total				385 lbs	\$1,595	\$1,770

L-Unit - Right Hand Return with Tooled Wood Leg

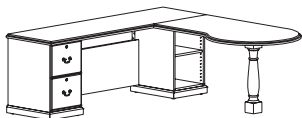

Footprint: 85" W x 84" D x 30" H

Credenza - Pedestal with Two File Drawers on Left Side, Open Shelves Right Side
 P-Shape Peninsula Conference End Right Hand

85"	24"	30"	BT8524CR2F3KHOC__	195 lbs	\$1,000	\$1,090
60"	36"	30"	BT6136PCXRH__	190 lbs	\$595	\$680
Total				385 lbs	\$1,595	\$1,770

L-Unit Workstation with Tooled Wood Leg and Four Door Hutch - Left Hand Return

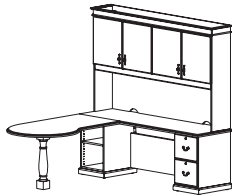

Footprint: 85" W x 84" D x 84" H

Upper Hutch, Four Solid Doors with 33" Task Light
 Credenza - Pedestal with Two File Drawers on Right Side Open Shelves on Left Side
 P-Shape Peninsula Conference End Left Hand

85"	14 1/2"	54"	BT8515HTUS__	375 lbs	\$960	\$1,130
85"	24"	30"	BT8524CROC3KH2F__	195 lbs	\$1,000	\$1,090
60"	36"	30"	BT6136PCXLH__	190 lbs	\$595	\$680
Total				760 lbs	\$2,555	\$2,900

L-Unit Workstation with Tooled Wood Leg and Four Door Hutch - Right Hand Return

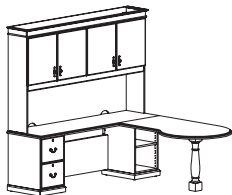

Footprint: 85" W x 84" D x 84" H

Upper Hutch, Four Solid Doors with 33" Task Light
 Credenza - Pedestal with Two File Drawers on Left Side Open Shelves on Right Side
 P-Shape Peninsula Conference End Right Hand

85"	14 1/2"	54"	BT8515HTUS__	375 lbs	\$960	\$1,130
85"	24"	30"	BT8524CR2F3KHOC__	195 lbs	\$1,000	\$1,090
60"	36"	30"	BT6136PCXRH__	190 lbs	\$595	\$680
Total				760 lbs	\$2,555	\$2,900

* All file drawers have locks and adaptable rails for letter and legal filing.

BARITONE PRICE LIST

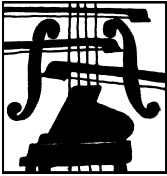

TO ORDER:

Select the product number and add finish color.

For example: **BT6830DKCH**
Product # BT6830DK Finish Color - CH = Cherry Finish

Baritone product numbers are comprised of alpha and numeric characters. This number indicates product line, size, product options and finish color.

Finish Color:

CH = Cherry Finish
 MH = Mahogany Finish
 WN = Walnut Finish

ITEM	DESCRIPTION	WIDTH	DEPTH	HEIGHT	PRODUCT NUMBER	SHIP WEIGHT	FOB ORIG	FOB DEST
------	-------------	-------	-------	--------	----------------	-------------	----------	----------

SUGGESTED OFFICE PLANS

L-Unit Workstation with Tooled Wood Leg and Open Shelf Hutch - Left Hand Return

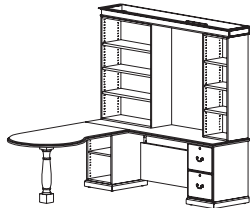

Footprint: 85" w x 84" d x 84" h

Upper Bookcase Open Shelves Right Side, 33" Light Bridge, Open Shelves Left Side

Credenza - Pedestal with Two File Drawers on Right Side Open Shelved on Left Side

P-Shape Peninsula Conference End Left Hand

85"	14 1/2"	54"	BT8515BCU20LB10__	275 lbs	\$895	\$1,020
85"	24"	30"	BT8524CROC3KH2F__	195 lbs	\$1,000	\$1,090
60"	36"	30"	BT6136PCXLH__	190 lbs	\$595	\$680

Total 660 lbs \$2,490 \$2,790

ORDER PRODUCTS LISTED BELOW

L-Unit Workstation with Tooled Wood Leg and Open Shelf Hutch - Right Hand Return

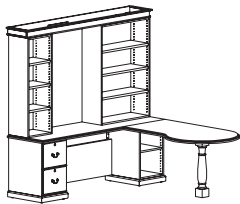

Footprint: 85" w x 84" d x 84" h

Upper Bookcase Open Shelves Left Side, 33" Light Bridge, Open Shelves Right Side

Credenza - Pedestal with Two File Drawers on Left Side, Open Shelves Right Side

P-Shape Peninsula Conference End Right Hand

85"	14 1/2"	54"	BT8515BCU10LB20__	275 lbs	\$895	\$1,020
85"	24"	30"	BT8524CR2F3KHOC__	195 lbs	\$1,000	\$1,090
60"	36"	30"	BT6136PCXRH__	190 lbs	\$595	\$680

Total 660 lbs \$2,490 \$2,790

"L" Unit Workstation with Tooled Wood Leg and Glass Door Hutch - Left Hand Return

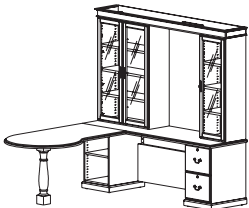

Footprint: 85" w x 84" d x 84" h

Upper Bookcase, Double Glass Doors Left Side, Single Glass Door Right Side, with 33" Light Bridge

Credenza - Pedestal with Two File Drawers on Right Side Open Shelved on Left Side

P-Shape Peninsula Conference End Left Hand

85"	14 1/2"	54"	BT8515BCU2GLB1G__	390 lbs	\$1,195	\$1,370
85"	24"	30"	BT8524CROC3KH2F__	195 lbs	\$1,000	\$1,090
60"	36"	30"	BT6136PCXLH__	190 lbs	\$595	\$680

Total 775 lbs \$2,790 \$3,140

"L" Unit Workstation with Tooled Wood Leg and Glass Door Hutch - Right Hand Return

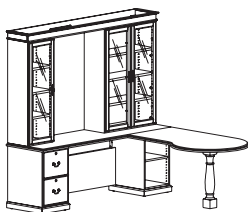

Footprint: 85" w x 84" d x 84" h

Upper Bookcase, Double Glass Doors Right Side, Single Glass Door Left Side, with 33" Light Bridge

Credenza - Pedestal with Two File Drawers on Left Side Open Shelves on Right Side

P-Shape Peninsula Conference End Right Hand

85"	14 1/2"	54"	BT8515BCU1GLB2G__	390 lbs	\$1,195	\$1,370
85"	24"	30"	BT8524CR2F3KHOC__	195 lbs	\$1,000	\$1,090
60"	36"	30"	BT6136PCXRH__	190 lbs	\$595	\$680

Total 775 lbs \$2,790 \$3,140

* All file drawers have locks and adaptable rails for letter and legal filing.

BARITONE PRICE LIST

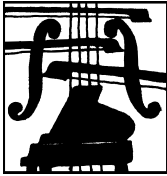

TO ORDER:

Select the product number and add finish color.

For example: BT6830DKCH
Product # BT6830DK Finish Color - CH = Cherry Finish

Finish Color:

CH = Cherry Finish
 MH = Mahogany Finish
 WN = Walnut Finish

Baritone product numbers are comprised of alpha and numeric characters. This number indicates product line, size, product options and finish color.

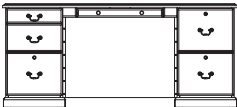
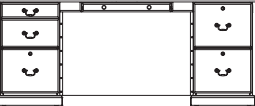
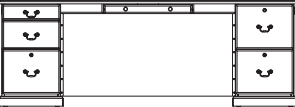
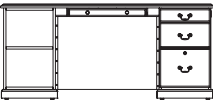
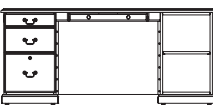
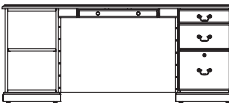
ITEM	DESCRIPTION	WIDTH	DEPTH	HEIGHT	PRODUCT NUMBER	SHIP WEIGHT	FOB ORIG	FOB DEST
Desk - Double Pedestal								
	Pencil, Box, File Drawers Left Pedestal, Center Pencil Drawer, Two File Drawer Right Pedestal w/ locks with Center Pencil Drawer	68"	30"	30"	BT6830DK_ _	409 lbs	\$1,300	\$1,485
	Pencil, Box, File Drawers Left Pedestal, Center Pencil Drawer, Two File Drawer Right Pedestal w/ locks with Center Pencil Drawer	72"	36"	30"	BT7236DK_ _	442 lbs	\$1,350	\$1,550
	With optional seal & approved artwork	72"	36"	30"	BT7236DKSEAL_ _	442 lbs	\$1,600	\$1,800
	Pencil, Box, File Drawers Left Pedestal, Center Pencil Drawer, Two File Drawer Right Pedestal w/ locks with Center Pencil Drawer	84"	42"	30"	BT8442DK_ _	538 lbs	\$1,495	\$1,735
	With optional seal & approved artwork	84"	42"	30"	BT8442DKSEAL_ _	442 lbs	\$1,725	\$1,965
Desk - Single Pedestal								
	Pencil, Box, File Drawer Right Pedestal, Open Shelves Left with Center Pencil Drawer	68"	30"	30"	BT6830DKRH_ _	385 lbs	\$1,190	\$1,365
	Pencil, Box, File Drawer Left Pedestal, Open Shelves Right with Center Pencil Drawer	68"	30"	30"	BT6830DKLH_ _	385 lbs	\$1,190	\$1,365
	Pencil, Box, File Drawer Right Pedestal, Open Shelves Left with Center Pencil Drawer	72"	36"	30"	BT7236DKRH_ _	417 lbs	\$1,240	\$1,430
	With optional seal & approved artwork	72"	36"	30"	BT7236DKRHSEAL_ _	417 lbs	\$1,490	\$1,680

* All file drawers have locks and adaptable rails for letter and legal filing.

BARITONE PRICE LIST

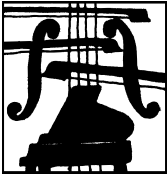

TO ORDER:

Select the product number and add finish color.

For example: BT6830DKCH
Product # BT6830DK Finish Color - CH = Cherry Finish

Baritone product numbers are comprised of alpha and numeric characters. This number indicates product line, size, product options and finish color.

Finish Color:

CH = Cherry Finish
 MH = Mahogany Finish
 WN = Walnut Finish

ITEM	DESCRIPTION	WIDTH	DEPTH	HEIGHT	PRODUCT NUMBER	SHIP WEIGHT	FOB ORIG	FOB DEST
------	-------------	-------	-------	--------	----------------	-------------	----------	----------

Desk - Single Pedestal Continued

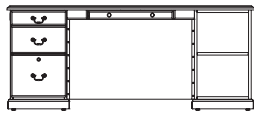

Pencil, Box, File Drawer Left Pedestal,
 Open Shelves Right
 with Keyboard Tray

72" 36" 30" BT7236DKLH__ 417 lbs \$1,240 \$1,430

With optional seal & approved artwork

72" 36" 30" BT7236DKLHSEAL__ 417 lbs \$1,490 \$1,680

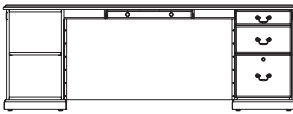

Pencil, Box, File Drawer Right Pedestal,
 Open Shelves Left

84" 42" 30" BT8442DKRH__ 513 lbs \$1,395 \$1,571

With optional seal & approved artwork

84" 42" 30" BT8442DKRHSEAL__ 513 lbs \$1,635 \$1,865

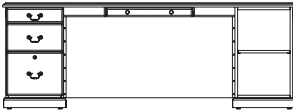

Pencil, Box, File Drawer Left Pedestal,
 Open Shelves Right

84" 42" 30" BT8442DKLH__ 513 lbs \$1,395 \$1,571

With optional seal & approved artwork

84" 42" 30" BT8442DKLHSEAL__ 513 lbs \$1,635 \$1,865

Desk - Table



Four Legs, with Center Drawer

72" 36" 30" BT7236TBDK__ 154 lbs \$730 \$800

Desk - Corner

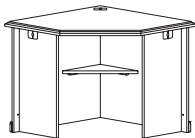

Corner Unit Desk

36" 36" 30" BT3636CU__ 252 lbs \$470 \$585

Note: can be mated to L-Extensions and U-Bridge Extensions (p. 11)

*** All file drawers have locks and adaptable rails for letter and legal filing.**

BARITONE PRICE LIST

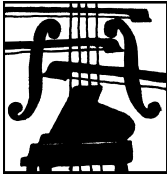

TO ORDER:

Select the product number and add finish color.

For example: **BT6830DKCH**
Product # BT6830DK **Finish Color - CH = Cherry Finish**

Finish Color:

CH = Cherry Finish
 MH = Mahogany Finish
 WN = Walnut Finish

Baritone product numbers are comprised of alpha and numeric characters. This number indicates product line, size, product options and finish color.

ITEM	DESCRIPTION	WIDTH	DEPTH	HEIGHT	PRODUCT NUMBER	SHIP WEIGHT	FOB ORIG	FOB DEST
------	-------------	-------	-------	--------	----------------	-------------	----------	----------

Desk - Extensions

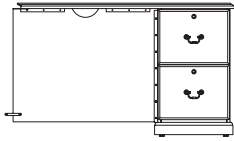

L-Extension, Right Return, Pedestal with two file drawers

49" 20 3/4" 30" BT4921EXRH_ _ 232 lbs \$640 \$745

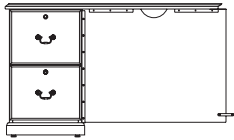

L-Extension, Left Return, Pedestal with two file drawers

49" 20 3/4" 30" BT4921EXLH_ _ 232 lbs \$640 \$745

Desk - Extension Bridge



U-Extension, Bridge Return

36" 20 3/4" 30" BT3621BR_ _ 103 lbs \$260 \$305

Note: can only be used with a corner desk (p. 10) in a U-Shape configuration.



U-Extension, Bridge Return

42" 20 3/4" 30" BT4221BR_ _ 118 lbs \$300 \$355



U-Extension, Bridge Return

49" 20 3/4" 30" BT4921BR_ _ 138 lbs \$340 \$400

Desk - Conference Ends

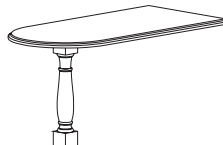

Bullet-Shape Peninsula Conference End

60" 30" 30" BT6030BCX_ _ 185 lbs \$425 \$510

Note: can fit 84" single pedestal desks and 5-position Credenzas with open corners.

*** All file drawers have locks and adaptable rails for letter and legal filing.**

BARITONE PRICE LIST

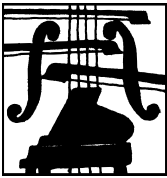

TO ORDER:

Select the product number and add finish color.

For example: BT6830DKCH
Product # BT6830DK Finish Color - CH = Cherry Finish

Finish Color:
 CH = Cherry Finish
 MH = Mahogany Finish
 WN = Walnut Finish

Baritone product numbers are comprised of alpha and numeric characters. This number indicates product line, size, product options and finish color.

ITEM	DESCRIPTION	WIDTH	DEPTH	HEIGHT	PRODUCT NUMBER	SHIP WEIGHT	FOB ORIG	FOB DEST
------	-------------	-------	-------	--------	----------------	-------------	----------	----------

Desk - Conference Ends Continued

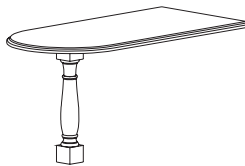

Bullet-Shape Peninsula Conference End 84" 36" 30" BT8436BCX_ _ 310 lbs \$530 \$670

Note: can fit Credenzas with open corners.

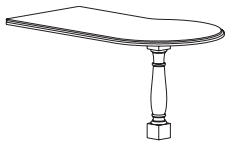

P-Shape Peninsula Conference End (Right Hand) 60" 36" 30" BT6136PCXLH_ _ 190 lbs \$595 \$680

Note: can fit 84" single pedestal desks and Credenzas with open corners.



P-Shape Peninsula Conference End (Left Hand) 60" 36" 30" BT6136PCXRH_ _ 190 lbs \$595 \$680

Note: can fit 84" single pedestal desks and Credenzas with open corners.



Bullet-Shape Peninsula Conference End, freestanding 72" 30" 30" BT7230CEDK_ _ 240 lbs \$595 \$705

Credenzas

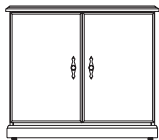

Credenza - two doors one adjustable shelf 35" 24" 30" BT3524CR2DR_ _ 179 lbs \$530 \$610

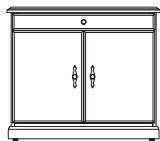

Credenza - CPU with slide out printer shelf, two doors, executive keyboard tray, keyboard size 30 1/2" w, 18" d, 3" h CPU area 8" w, 21" d, 19 3/4" h pull-out print shelf 15 1/4" w, 17 1/4" d, 17" h 35" 24" 30" BT3524CRCPU_ _ 187 lbs \$790 \$875

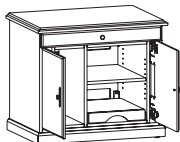

Inside view

BARITONE PRICE LIST

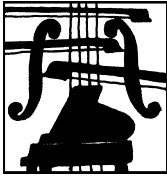

TO ORDER:

Select the product number and add finish color.

For example: BT6830DKCH
Product # BT6830DK Finish Color - CH = Cherry Finish

Finish Color:

CH = Cherry Finish
 MH = Mahogany Finish
 WN = Walnut Finish

Baritone product numbers are comprised of alpha and numeric characters. This number indicates product line, size, product options and finish color.

ITEM	DESCRIPTION	WIDTH	DEPTH	HEIGHT	PRODUCT NUMBER	SHIP WEIGHT	FOB ORIG	FOB DEST
------	-------------	-------	-------	--------	----------------	-------------	----------	----------

Credenzas Continued

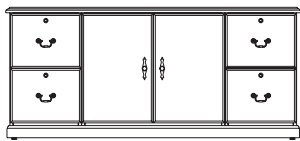

Credenza - Two doors and four file drawers 68" 24" 30" BT6824CR2F2D2F__ 293 lbs \$1,320 \$1,450

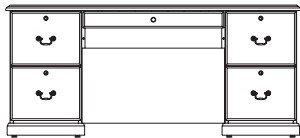

Credenza, four file drawers, individual locks, hanging file rods with wire access panel, center keyboard tray. 68" 24" 30" BT6824CR2FKH2F__ 229 lbs \$1,130 \$1,235

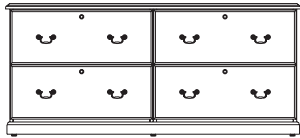

Credenza - Four lateral file drawers, individual locks with wire access panel 68" 24" 30" BT6824CR2L2L__ 293 lbs \$1,189 \$1,320

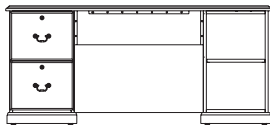

Credenza - Two file drawers on left hand side, open shelves right hand side with wire access panel 68" 24" 30" BT6824CR2FKHOC__ 205 lbs \$950 \$1,040

Note: can be used only with desk extensions (p. 11).

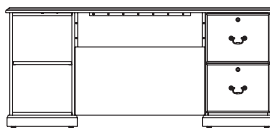

Credenza - Two file drawers on right hand side, open shelves left hand side with wire access panel 68" 24" 30" BT6824CROCKH2F__ 205 lbs \$950 \$1,040

Note: can be used only with desk extensions (p. 11).

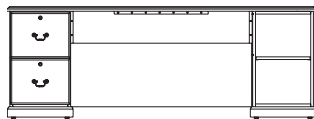

Credenza - Two file drawers, left hand side, Open right hand side with wire access panel 85" 23 1/2" 30" BT8524CR2F3KHOC__ 195 lbs \$1,000 \$1,090

Note: can be used only with desk extensions (p. 11-12).
*** All file drawers have locks and adaptable rails for letter and legal filing.**

BARITONE PRICE LIST

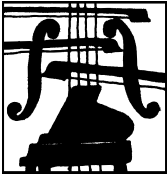

TO ORDER:

Select the product number and add finish color.

For example: BT6830DKCH
Product # BT6830DK Finish Color - CH = Cherry Finish

Finish Color:
 CH = Cherry Finish
 MH = Mahogany Finish
 WN = Walnut Finish

Baritone product numbers are comprised of alpha and numeric characters. This number indicates product line, size, product options and finish color.

ITEM	DESCRIPTION	WIDTH	DEPTH	HEIGHT	PRODUCT NUMBER	SHIP WEIGHT	FOB ORIG	FOB DEST
------	-------------	-------	-------	--------	----------------	-------------	----------	----------

Credenzas Continued



Credenza - two files, Right,
 Open Left Side
 with wire access panel

85" 24" 30" BT8524CROC3KH2F__ 195 lbs \$1,000 \$1,090

Note: can be used only with desk extensions and conference ends (p. 11-12).

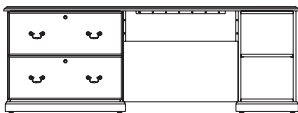

Credenza - 2-drawer lateral files on left side,
 open shelves right side
 with wire access panel

85" 24" 30" BT8524CR2LKHOC__ 255 lbs \$1,120 \$1,235

Note: can be used only with desk extensions (p. 11).

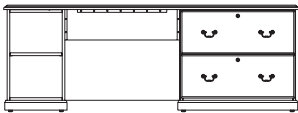

Credenza - 2-drawer lateral file on right side,
 open shelves left side
 with wire access panel

85" 24" 30" BT8524CROCKH2L__ 255 lbs \$1,120 \$1,235

Note: can be used only with desk extensions (p. 11).

Upper Bookcases

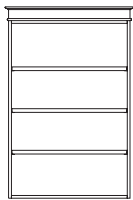

Upper Bookcase - four open shelves,
 three are adjustable

35" 14 1/2" 54" BT3515BCUO__ 164 lbs \$395 \$470

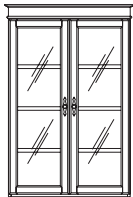

Upper Bookcase - two glass doors,
 four shelves, three are adjustable

35" 14 1/2" 54" BT3515BCUG__ 240 lbs \$795 \$905



Upper Bookcase - two doors "solid pocket",
 upper TV-AV Cabinet, TV swivel pull-out shelf,
 three additional shelves for TV-AV equipment,
 (TV opening 25"h x 26"w x 22"d)

35" 23 1/2" 52" BT3322TVAV__ 292 lbs \$995 \$1,125

*** All file drawers have locks and adaptable rails for letter and legal filing.**

BARITONE PRICE LIST

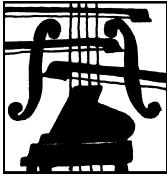

TO ORDER:

Select the product number and add finish color.

For example: BT6830DKCH
Product # BT6830DK Finish Color - CH = Cherry Finish

Finish Color:

CH = Cherry Finish
 MH = Mahogany Finish
 WN = Walnut Finish

Baritone product numbers are comprised of alpha and numeric characters. This number indicates product line, size, product options and finish color.

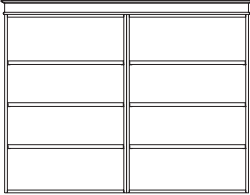
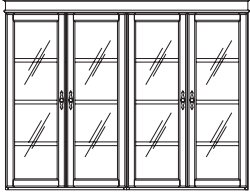
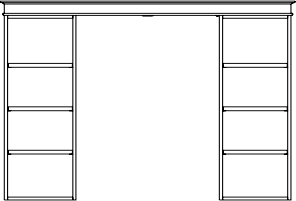
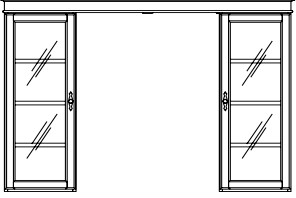
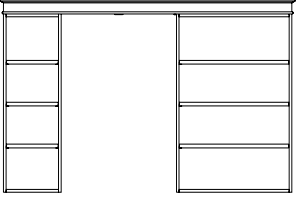
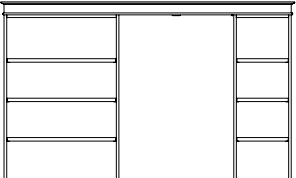
ITEM	DESCRIPTION	WIDTH	DEPTH	HEIGHT	PRODUCT NUMBER	SHIP WEIGHT	FOB ORIG	FOB DEST	
Upper Bookcases Continued									
	Upper Bookcase "Double" - Eight open shelves, six are adjustable	68"	14 1/2"	54"	BT6815BCUO_ _	320 lbs	\$720	\$865	
	Upper Bookcase "Double Glass Doors" - eight shelves, six are adjustable	68"	14 1/2"	54"	BT6815BCUG_ _	472 lbs	\$1,195	\$1,405	
	Upper Bookcase Open Center - two each 16 1/2" open shelves, 3 adjustable shelves each side with 33" Bridge, with 10-watt halogen down light	68"	14 1/2"	54"	BT6815BCUOLBO_ _	260 lbs	\$695	\$810	
	Upper Bookcase Open Center - two each 16 1/2" glass doors, three adjustable shelves each side with 33" Bridge, with 10-watt halogen down light	68"	14 1/2"	54"	BT6815BCUGLBG_ _	360 lbs	\$895	\$1,055	
	Upper Bookcase Open Center - 16 1/2" wide, adjustable open shelves left side, 33" Bridge, with 10-watt halogen down light 33" wide adjustable open shelves right side	85"	14 1/2"	54"	BT8515BCU10LB20_ _	275 lbs	\$895	\$1,020	
	Upper Bookcase Open Center - 16 1/2" wide open shelves right side, 33" Bridge, with 10-watt halogen down light 33" wide adjustable open shelves left side	85"	14 1/2"	54"	BT8515BCU20LB10_ _	275 lbs	\$895	\$1,020	

BARITONE PRICE LIST

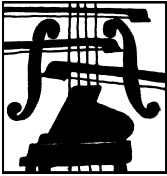

TO ORDER:

Select the product number and add finish color.

For example: BT6830DKCH
Product # BT6830DK Finish Color - CH = Cherry Finish

Finish Color:
 CH = Cherry Finish
 MH = Mahogany Finish
 WN = Walnut Finish

Baritone product numbers are comprised of alpha and numeric characters. This number indicates product line, size, product options and finish color.

ITEM	DESCRIPTION	WIDTH	DEPTH	HEIGHT	PRODUCT NUMBER	SHIP WEIGHT	FOB ORIG	FOB DEST
------	-------------	-------	-------	--------	----------------	-------------	----------	----------

Upper Bookcases Continued

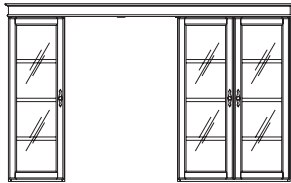

Upper Bookcase, One Single 16 1/2" glass door left side, with 33" Bridge, with 10-watt halogen down light, double open glass doors right side (six adjustable shelves)

85" 14 1/2" 54" BT8515BCU1GLB2G__ 390 lbs \$1,195 \$1,370

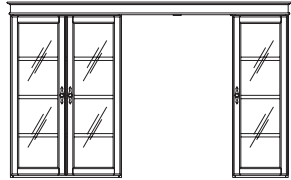

Upper Bookcase, One Single 16 1/2" glass door right side, with 33" Bridge, with 10-watt halogen down light, double open glass doors left side (six adjustable shelves)

85" 14 1/2" 54" BT8515BCU2GLB1G__ 390 lbs \$1,195 \$1,370

Upper Hutches

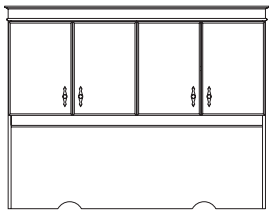

Upper Hutch, Four Solid Doors, with two adjustable shelves and Task Light (optional tack board available)

68" 15" 54" BT6815HTUS__ 298 lbs \$830 \$965

Tack Board
 Fabric cover: FAB #3161

BT68TKBD3161 15 lbs \$89 \$104

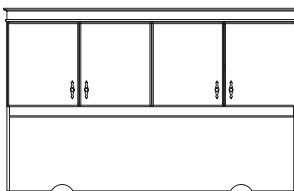

Upper Hutch, Four Solid Doors, with two adjustable shelves and Task Light (optional tack board available)

85" 14 1/2" 52" BT8515HTUS__ 375 lbs \$960 \$1,130

Tack Board
 Fabric cover: FAB #3161

BT85TKBD3161 15 lbs \$99 \$114

Transaction Counters

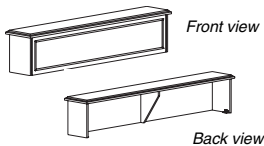

Transaction Counter -
Note: fits any 68" credenza or desk

68" 12" 14 1/2" BT6812TC__ 175 lbs \$360 \$440

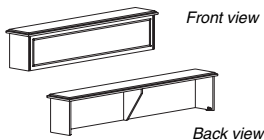

Transaction Counter -
Note: Fits on a 49" desk extension (p. 11) with a 68" pedestal desk (p. 9)

78 3/4" 12" 14 1/2" BT7912TC__ 203 lbs \$395 \$485

BARITONE PRICE LIST

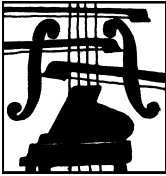

TO ORDER:

Select the product number and add finish color.

For example: **BT6830DKCH**
Product # BT6830DK **Finish Color - CH = Cherry Finish**

Finish Color:

CH = Cherry Finish
 MH = Mahogany Finish
 WN = Walnut Finish

Baritone product numbers are comprised of alpha and numeric characters. This number indicates product line, size, product options and finish color.

ITEM	DESCRIPTION	WIDTH	DEPTH	HEIGHT	PRODUCT NUMBER	SHIP WEIGHT	FOB ORIG	FOB DEST
------	-------------	-------	-------	--------	----------------	-------------	----------	----------

Lateral Files

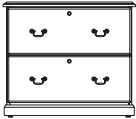

2-drawer lateral file, hanging file system, individual drawer locks

35"

19 3/4"

30 1/2"

BT3520LF2L__

205 lbs

\$630

\$720

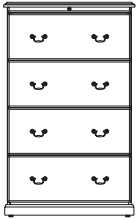

4-drawer lateral file, hanging file system, central locking (anti-tip system)

35"

19 3/4"

56 1/2"

BT3520LF4L__

343 lbs

\$990

\$1,145

Vertical Files



4-drawer Vertical File, hanging file system, central locking (anti-tip system)

18 1/2"

24"

56 3/4"

BT1924VF4F__

260 lbs

\$730

\$845



2-drawer Vertical File, hanging file system, individual drawer locks

18 1/2"

24"

30"

BT1924VF2F__

130 lbs

\$495

\$555

* All file drawers have locks and adaptable rails for letter and legal filing

Storage Cabinets



Wardrobe Cabinet - four adjustable shelves, with clothes rod and mirror, full front to back hanging with protective rubber mat on inside bottom cabinet

18 1/2"

24"

82 1/2"

BT1924WD__

227 lbs

\$650

\$750

BARITONE PRICE LIST

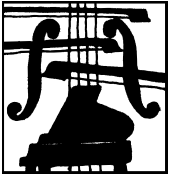

TO ORDER:

Select the product number and add finish color.

For example: BT6830DKCH
Product # BT6830DK Finish Color - CH = Cherry Finish

Finish Color:
 CH = Cherry Finish
 MH = Mahogany Finish
 WN = Walnut Finish

Baritone product numbers are comprised of alpha and numeric characters. This number indicates product line, size, product options and finish color.

ITEM	DESCRIPTION	WIDTH	DEPTH	HEIGHT	PRODUCT NUMBER	SHIP WEIGHT	FOB ORIG	FOB DEST
------	-------------	-------	-------	--------	----------------	-------------	----------	----------

Storage Cabinets Continued



Wardrobe Cabinet - double doors, four adjustable shelves with clothes rod, mirror and protective rubber mat on inside bottom cabinet

35" 24" 82 1/2" BT3524WD__ 430 lbs \$920 \$1,115

Bookcases

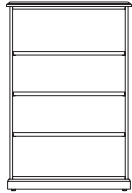

Bookcase - four shelves, three adjustable shelves

35" 14" 52 1/2" BT3515BC4SHO__ 251 lbs \$495 \$610

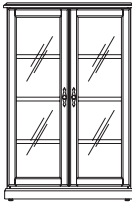

Bookcase - four shelves, three adjustable shelves with two glass doors

35" 14" 52 1/2" BT3515BC4SHG__ 327 lbs \$640 \$785



Bookcase - six shelves, four adjustable shelves

35" 14" 82 1/2" BT3515BC6SHO__ 329 lbs \$595 \$745



Bookcase - six shelves, four adjustable shelves with four glass doors

35" 14" 82 1/2" BT3515BC6SHG__ 443 lbs \$840 \$1,040

BARITONE PRICE LIST

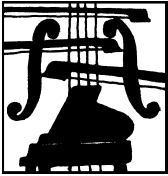

TO ORDER:

Select the product number and add finish color.

For example: BT6830DKCH
Product # BT6830DK Finish Color - CH = Cherry Finish

Finish Color:

CH = Cherry Finish
 MH = Mahogany Finish
 WN = Walnut Finish

Baritone product numbers are comprised of alpha and numeric characters. This number indicates product line, size, product options and finish color.

ITEM	DESCRIPTION	WIDTH	DEPTH	HEIGHT	PRODUCT NUMBER	SHIP WEIGHT	FOB ORIG	FOB DEST
------	-------------	-------	-------	--------	----------------	-------------	----------	----------

Tables



Corner Table

22 1/4"

22 1/4"

17 3/4"

BT23230TB_ _

40 lbs

\$295

\$315



Lamp Table

24"

18"

22 1/2"

BT24180TB_ _

32 lbs

\$295

\$310



Magazine Table

40 1/4"

19 1/4"

17 3/4"

BT41200TB_ _

52 lbs

\$395

\$420



Sofa Table

66"

20"

29 1/2"

BT66200TB_ _

85 lbs

\$495

\$535

Conference Tables



Conference Table with four legs

96"

42"

30"

BT9642RTCTB_ _

320 lbs

\$795

\$940

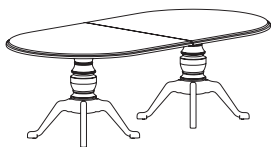

Conference Table - Racetrack-Shape
 (made of two sections, hasp locking)
 with Queen Anne Base

96"

48"

30"

BT9642XCTB_ _

360 lbs

\$1,540

\$1,700

BARITONE PRICE LIST

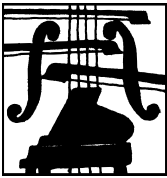

TO ORDER:

Select the product number and add finish color.

For example: BT6830DKCH
Product # BT6830DK Finish Color - CH = Cherry Finish

Finish Color:
 CH = Cherry Finish
 MH = Mahogany Finish
 WN = Walnut Finish

Baritone product numbers are comprised of alpha and numeric characters. This number indicates product line, size, product options and finish color.

ITEM	DESCRIPTION	WIDTH	DEPTH	HEIGHT	PRODUCT NUMBER	SHIP WEIGHT	FOB ORIG	FOB DEST
------	-------------	-------	-------	--------	----------------	-------------	----------	----------

Conference Tables Continued

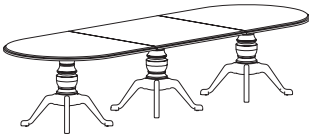

Conference Table - Racetrack-Shape, (made of three sections) with Queen Anne Base

144" 48" 30" BT14442XCTB__ 540 lbs \$2,070 \$2,315



Conference Table - Racetrack-Shape, half-round end section, with Queen Anne Base

48" 48" 30" BT4848XCTBES__ 180 lbs \$770 \$850

Note: Not a stand-alone table. Two half round tables can be ganged together or ganged to both ends of our 4 foot wide square tables (BT4848XCTBMS __, see below). Use as many of the square tables to obtain your desired width.



Conference Table - Racetrack-Shape, square mid-section, with Queen Anne Base

48" 48" 30" BT4848XCTBMS__ 180 lbs \$640 \$720

Note: Not a stand-alone table. Must be ganged with at least 2 half round tables (BT4848XCTES __, see above). Use as many of these 4 foot wide sections to obtain your desired width.



Table, 36" Round diameter, with Queen Anne Base

36" 30" 30" BT36RDTB__ 122 lbs \$595 \$650



Table, 42" Round diameter, with Queen Anne Base

42" 30" 30" BT42RDTB__ 141 lbs \$625 \$690



Table, 48" Round diameter, with Queen Anne Base

48" 48" 30" BT48RDTB__ 160 lbs \$700 \$770

BARITONE PRICE LIST

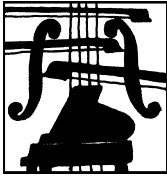

TO ORDER:

Select the product number and add finish color.

For example: BT6830DKCH
Product # BT6830DK Finish Color - CH = Cherry Finish

Finish Color:

CH = Cherry Finish
 MH = Mahogany Finish
 WN = Walnut Finish

Baritone product numbers are comprised of alpha and numeric characters. This number indicates product line, size, product options and finish color.

ITEM	DESCRIPTION	WIDTH	DEPTH	HEIGHT	PRODUCT NUMBER	SHIP WEIGHT	FOB ORIG	FOB DEST
------	-------------	-------	-------	--------	----------------	-------------	----------	----------

Computer workstation - Mobile

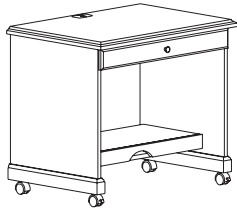

Mobile computer Workstation with keyboard drawer, shelf and casters

35"	24"	30"	BT3524MCW__	160 lbs	\$495	\$555
-----	-----	-----	-------------	---------	-------	-------

Lecturns

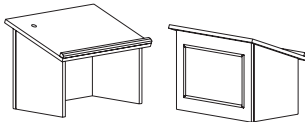

Lectern - table top
 with agency seal & approved artwork

24 1/2"	16 1/4"	17 7/8"	BT2517LCTB__	32 lbs	\$170	\$195
24 1/2"	16 1/4"	17 7/8"	BT2517LCTSEALB__	32 lbs	\$395	\$420

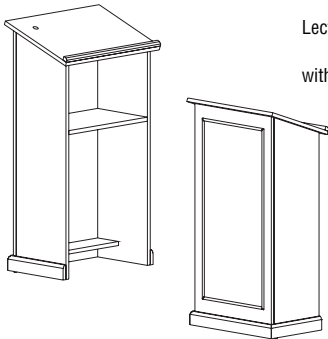

Lectern - freestanding
 with agency seal & approved artwork

24 1/2"	16 1/4"	47 1/4"	BT2517LC__	88 lbs	\$260	\$325
24 1/2"	16 1/4"	47 1/4"	BT2517LCSEAL__	88 lbs	\$485	\$550

ACCESSORIES

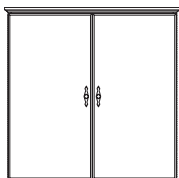

Visual Wall Cabinet, two doors, with white board and tack board on doors

44"	5 1/2"	43 1/4"	BT4406VC__	178 lbs	\$495	\$585
-----	--------	---------	------------	---------	-------	-------

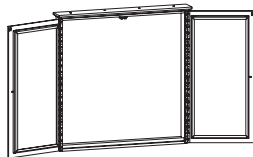

Open view

BARITONE PRICE LIST

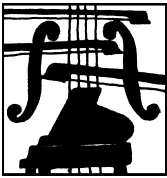









TO ORDER:

Select the product number and add finish color.

For example: BT6830DKCH
Product # BT6830DK **Finish Color - CH = Cherry Finish**

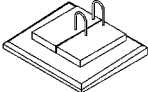
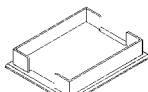
Finish Color:
 CH = Cherry Finish
 MH = Mahogany Finish
 WN = Walnut Finish

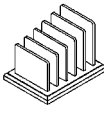
Baritone product numbers are comprised of alpha and numeric characters. This number indicates product line, size, product options and finish color.

ITEM	DESCRIPTION	WIDTH	DEPTH	HEIGHT	PRODUCT NUMBER	SHIP WEIGHT	FOB ORIG	FOB DEST
	Planter/Waste Container	13 7/8"	13 7/8"	16 1/4"	BT1212WC__	29 lbs	\$95	\$105
	Glass Desk Top Protector	33 3/4"	20 3/4"	1/2"	S2034DPG__	10 lbs	\$85	\$91
	Composition Desk Top Protector	33 3/4"	20 3/4"	1/2"	S2034DPC__	5 lbs	\$40	\$44
	Wall Calendar (calendar inserts included)	14"	3/4"	34 3/4"	S1435WCL__	8 lbs	\$91	\$94
	Desk Calendar (calendar inserts included)	8 3/4"	7 1/4"	1"	S0907DCL__	3 lbs	\$21	\$24
	Desk Tray	11"	14 1/4"	3"	S1114DTR__	3 lbs	\$34	\$37
	Wall Clock (batteries included)	9 1/2"	3/4"	12 3/4"	S1013WCK__	2 lbs	\$38	\$42
	Desk Clock (batteries included)	6"	3 1/2"	6 3/4"	S0607DCK__	3 lbs	\$34	\$38
	Letter Organizer	6 1/4"	8"	6 1/4"	S0608LOR__	3 lbs	\$73	\$78
	Book Ends	6 1/4"	3 1/4"	8 1/2"	S0609BKE__	4 lbs	\$78	\$82

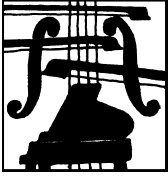

HOW TO ORDER BARITONE FURNITURE

BY INTERNET

We're on the World Wide Web, ready to take your electronic order. See us at:

www.unicor.gov

BY PHONE

Use your government credit card and call UNICOR toll free at:

(800) 827-3168

BY FAX

Fax your purchase order 24 hours a day to:

(859) 254-9390 Standard Orders

(859) 254-9048 Credit Cards

BY MAIL

Send your purchase order to:

UNICOR
Customer Service Center
P.O. Box 13640
Lexington, KY 40577-1670

Customer Service

For information about products, prices or to request catalogs, call UNICOR Customer Service at (800) 827-3168 from 7:30 a.m. to 6:00 p.m. EST or leave a message at other times.

Product Warranty

UNICOR guarantees that all items furnished under this order will be free from defects in material and workmanship.

"Escape Proof Guarantee"

We take great pride in teaching inmates a good work ethic and marketable job skills in order to produce high quality goods and services for our customers. We are committed to your complete and continual satisfaction. If at any time an item we have provided does not entirely meet your expectations, we will cheerfully and promptly repair or replace it, entirely at our expense.

Specifications

UNICOR reserves the right to make changes in design, and/or construction on non-spec catalog items without advance notice.

BARITONE PRICE LIST

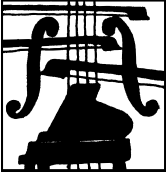

CREDIT CARD ORDER FORM

FAX orders to (859) 254-9048 or call (800) 827-3168. Online orders <http://www.unicor.gov>

SHIPPING ADDRESS (NO POST OFFICE BOXES PLEASE)

NAME _____

TITLE _____

AGENCY _____

STREET _____

CITY _____ STATE _____ ZIP _____

TELEPHONE () _____ FAX NUMBER () _____

FAX NUMBER MUST BE INCLUDED.

E-MAIL _____ CUSTOMER NO. _____

CREDIT CARD # _____ EXPIRATION DATE _____

SIGNATURE _____ DATE _____

Please be sure that all information is complete to avoid delaying your order.

PRODUCT NUMBER	DESCRIPTION	FINISH COLOR	QUANTITY	UNIT PRICE	TOTAL
<p>Note: For shipments outside the contiguous U.S., freight will be based upon rates at the time of delivery. <i>Thank you for your order.</i></p>				Subtotal	
				Overseas Shipping	
				TOTAL	

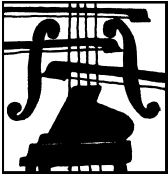

TERMS AND CONDITIONS

The Customer Service Center

Contact the UNICOR Customer Service Center for any questions or assistance regarding the information in this price list. Our business hours are 7:30 AM to 6:00 PM (EST), Monday through Friday (excluding Federal holidays). Our phone number is (800) 827-3168.

Order Acknowledgment

UNICOR acknowledges every order. Orders are accepted, filled, and invoiced based on the information in this written order-confirmation. UNICOR contracts with a third party for services and installation in support of its product(s) on the customer's behalf. Services and installation represent a separate portion of the customer's agreement. Payment for furniture is due and payable upon delivery of product. Payment for services and installation is due and payable upon completion of the support services. Should you note any discrepancy, please advise immediately.

Your order acknowledgment indicates a due date when your products will arrive. In the event your products are manufactured earlier than scheduled, we will ship them upon completion, providing that your purchase order states "Early Shipments Authorized."

Order Modifications

Modification to your purchase order will be accepted up to 4 weeks prior to the due date indicated on your order acknowledgment. However, if the revision results in a change in product availability, a new due date may be set by UNICOR. Such due date adjustment may be for your full purchase order, whether or not the specifications of all line-items on it are modified. All purchase order

modifications are acknowledged in writing, including the annotation of any adjusted due date(s).

Changes requested after we obtain materials for your order may be subject to an upcharge.

Confirmation of your order modification will note any such additional charge(s).

Standard Lead Time

Typical lead time for Baritone product delivery is 45 days after receipt of your order.

Product Delivery and Pricing

We take both FOB Origin and FOB Destination orders. All products are shipped via surface transportation.

On FOB Origin orders, title/product-responsibility passes to the customer at the time of shipment.

You may arrange your own transportation on FOB Origin orders, coordinating with FPI accordingly.

Otherwise, your order will be shipped by common carrier at your expense.

On FOB Destination orders, title/product-responsibility passes to the customer upon delivery to the dock of the designated point-of-delivery. Freight charges are included in the product prices listed in the FOB Destination column of this price list.

Contact the Customer Service Center for destination prices where none are given. Such destination pricing for delivery outside the continental U.S. must be negotiated based on the freight rates at the time of shipment.

Services, such as space-planning/design, storage, inside-delivery and installation are not in this price list.

Contact the Customer Service Center for such service-fee quotations.

Special Packaging

Standard packaging varies per individual product. UNICOR will accommodate your special packaging requests, however, an upcharge may apply. Contact the Customer Service Center for more information.

Shipment Claims

UNICOR products are packed to comply with carrier requirements. All shipments should be inspected by the consignee before acceptance.

The delivering carrier should be requested to record any damage or shortage of items shipped. If any shortages are discovered, please also notify UNICOR Customer Service Center immediately.

Shipping damage and shortage claims must be filed with the carrier within 15 days of delivery. This applies to both FOB Destination and FOB Origin shipments. Carrier liability ends after 15 days for shipping damages or shortages.

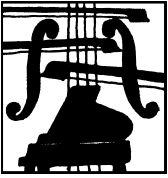

TERMS AND CONDITIONS

Concealed Damage Claims

Claims for concealed damages must be filed with the carrier within 15 days after the delivery of goods. This applies to both FOB Destination and FOB Origin shipments. Carrier liability ends after 15 days for concealed damages.

Neither UNICOR nor the carrier will be responsible for concealed damages if shipments are left unopened and/or claims are not filed within 15 days.

Customer-Delayed Deliveries

Please notify the Customer Service Center at least 2 weeks prior to the confirmed due date when you cannot receive delivery of goods by that scheduled date. We will delay the delivery at your request. However, after 30 days of such delay, you will be invoiced for the subject products whether or not delivery is extended beyond this first 30 days.

UNICOR may allow up to 2 weeks for shipping. Therefore, if you do not request delayed delivery at least 2 weeks prior to the confirmed due date for arrival of your shipment, we may incur additional handling costs.

UNICOR will bill you for such handling costs if you refuse receipt of the goods, or request delayed shipment in less than 2 weeks prior to the due date on your order acknowledgment.

Product Returns

All product returns must be coordinated in advance with the Customer Service Center. Additionally, all freight or express service charges must be prepaid on return shipments.

Product returns may be subject to your being invoiced for additional handling/restocking fees. UNICOR will determine and notify you of such charges upon receipt and inspection of the returned goods.

Order Status

Call the Customer Service Center to obtain status of your order during order processing or the production and shipment/delivery of goods. We will give you the status based on your purchase order number and/or the UNICOR work order number on your order acknowledgment.

You may also access your order status by clicking on the customer service icon on our website at www.unicor.gov

Invoice Payment

Payments from government agencies should be addressed to:

UNICOR - FPI
P.O. Box 371736
Pittsburgh, PA 15252-7736

Payments from private sector parties should be addressed to:

UNICOR - LEX
Accounts Receivable
P.O. Box 11670
Lexington, KY 40583-3640

All general billing or specific invoice questions should be directed to the UNICOR Customer Service Center.

Product Warranty

UNICOR guarantees all furniture products will be free from defects in materials and workmanship. If at any time an item we have provided does not meet your expectations, we will repair or replace it at our expense.

Product Finishes

Examples of the finishes may be seen in the Baritone catalog. We have taken great care to accurately reproduce these finishes. However, there may be variations between the photographic and actual finishes.

Also, finished products may vary slightly. We cannot assure an exact piece-to-piece match due to certain variations in raw materials such as wood. Actual wood finish samples are available through the UNICOR Customer Service Center.

About Baritone

The European 32mm fabrication system gives a consistently high degree of assembly precision. Additional holes are drilled for field adjustment of shelf locations and inter-change of drawer and door components.

BARITONE PRICE LIST



U.S. Department of Justice

UNICOR

Federal Prison Industries, Inc.

**For more information about UNICOR products
or services contact Customer Service Center
(800) 827-3168**

CATAP502



Printed on Recycled Paper