

**UNITED STATES  
DEPARTMENT OF AGRICULTURE**

**RURAL UTILITIES SERVICE**

**RUS 2004 ELECTRIC  
ENGINEERING SEMINAR**

**FEBRUARY 10-11, 2004**

**NEW ORLEANS, LA**

The U.S. Department of Agriculture (USDA) prohibits discrimination in all its programs and activities on the basis of race, color, national origin, sex, religion, age, disability, political beliefs, sexual orientation, and marital or family status. (Not all prohibited bases apply to all programs.) Persons with disabilities who require alternative means for communication of program information (Braille, large print, audiotape, etc..) should contact USDA's TARGET Center at (202) 720-2600 (voice and TDD).

To file a complaint of discrimination, write USDA, Director, Office of Civil Rights, Room 326-W, Whitten Building, 14th and Independence Avenue, SW, Washington, D.C. 20250-9410 or call (202) 720-5964 (voice or TDD). USDA is an equal opportunity provider and employer.

# **RUS 2004 ELECTRIC ENGINEERING SEMINAR**

## **TABLE OF CONTENTS**

### **RUS Update**

*Blaine Stockton, Assistant Administrator - Electric, RUS*

### **Revision of the National Electrical Safety Code**

*Bob Lash, Chief, Transmission Branch, RUS, and NESC Subcommittee Members*

### **Safety Accreditation**

*Ken Brubaker, Manager, Safety Programs, NRECA*

### **Critical Infrastructure Protection – RUS Security Requirements**

*John Pavek, Chief, Distribution Branch, and RUS Homeland Security Representative*

### **Avian Protection Working Group - The New Mexico Experience**

*Dennis Rankin, Environmental Protection Specialist, Engineering and Environmental Staff, RUS*

### **Joint Use Contracts and Attachment Procedures**

*Ty Diamond, Vice President of Engineering and Operations, Flint Energy*

### **RUS Technical Publications**

*Fred Gatchell, Deputy Director, Electric Staff Division, RUS*

### **New RUS Narrow Profile Construction Assemblies**

*Jim Bohlk, Electrical Engineer, Distribution Branch, and  
Jim Higginbotham, General Field Representative, RUS*

### **NRECA's Transmission & Distribution Engineering Committee**

*Mike Pehosh and Bob Saint, Principals, T&D Engineering, NRECA*

**Spill Prevention Control and Countermeasures Rules - Electric Utility & Electrical Equipment-Specific Issues**

*James Roewer, Executive Director, Utility Solid Waste Activities Group*

**Developing a Landfill Methane Generation Project**

*Ralph Tyree, Program Manager, Non-Traditional Power Production Projects, East Kentucky Power Cooperative*

**DOE – RUS Partnership to Expand Acceptance of Photovoltaic Systems for Rural Community Needs**

*Larry Moore, Senior Member of Technical Staff, Sandia National Laboratories*

**NRECA/DOE Wind Power Workshop**

**Co-op Opportunities in Wind Energy**

*Randy Manion, Non-Hydro Renewable Program Manager, Western Power Administration*

**Building a Business Case for Wind Energy**

*Chris Tuttle, Load Forecast Officer, RUS*

**Co-op Wind Development in the Dakotas**

*Ron Rebenitsch, Manager of Member Marketing, Basin Electric Power Cooperative*

**Wind Development - Fact or Fiction**

*Jim Edwards, Assistant General Manager of Operations, East River Electric Power Cooperative, Inc.*

**Distributed Wind Power Interconnection**

*Thomas A. Wind, PE, Wind Utility Consulting*

**Contacts**

**RUS 2004 ELECTRIC  
ENGINEERING SEMINAR**

**FEBRUARY 10-11, 2004**

**NEW ORLEANS, LA**

**RUS Update**

**Blaine Stockton**

**Assistant Administrator-Electric, RUS**

*BIOGRAPHICAL SKETCH*

**BLAINE STOCKTON**

Blaine D. Stockton was selected as the Assistant Administrator for the Electric Program of the Rural Utilities Service (RUS) on December 5, 1994. RUS is the successor agency to the Rural Electrification Administration (REA). Mr. Stockton is responsible for directing and coordinating the activities pertaining to the rural electric loan program of RUS.

Prior to this selection, Mr. Stockton served as the Assistant Administrator for the Economic Development and Technical Services Program of REA from November 1991. In that capacity he was responsible for directing and coordinating the rural economic development and technical services program of the Agency. Mr. Stockton served as the principal director of the Rural Economic Development Loan and Grant Program since it was established by Congress in 1987. He was instrumental in establishing the Distance Learning and Telemedicine Grant Program in REA.

From October 1982 until November 1991, Mr. Stockton had served as the Assistant Administrator for Management in REA. He was responsible for the administrative management function, providing direction and guidance to the Offices of Budget, Personnel Management Division, Administrative Services Division, Financial Operations Division and the Automated Information Systems Division of the Agency.

Mr. Stockton holds a Bachelor of Science degree in Personnel Management from Pennsylvania State University and a Master of Science degree in Governmental Administration from George Washington University.

A resident of Manassas, Virginia, Mr. Stockton and his family are consumer members of a local electric distribution cooperative. His parents were active in the cooperative movement, managing rural electric systems in New York and North Carolina.

# RUS UPDATE



*2004 ELECTRIC ENGINEERING SEMINAR  
FEBRUARY 10-11, 2004*



## TOPICS

### LOAN PROGRAM SUMMARY

- ELECTRIC
- TELECOMMUNICATIONS
- WATER & ENVIRONMENTAL

### RENEWABLES



## TOPICS

# ELECTRIC LOAN PROGRAM SUMMARY

## *Summary of Loan Program*

### *Electric Program Budget*

(Dollars in Million)

<u>Loan Program:</u>	<u>2003</u>	<u>2004</u>
Direct 5%	\$ 120	\$ 240
Municipal Rate	\$ 99	\$ 1,000
Direct Treasury Rate	\$ 1,150	\$ 750
FFB Guaranteed	\$ 2,500	\$ 1,900
Non-FFB Guaranteed	\$ 99	\$ 99
<b>Total Electric Loans</b>	<b>\$ 3,968</b>	<b>\$ 3,989</b>



## Electric Program Loans Approved FY 2003 (In Millions)

<b>LOAN TYPE</b>	<b>NUMBER</b>	<b>AMOUNT</b>
<b>Direct</b>	<b>19</b>	<b>\$ 120.3</b>
<b>Municipal</b>	<b>18</b>	<b>\$ 101.3</b>
<b>Treasury</b>	<b>65</b>	<b>\$1,150.0</b>
<b>Guaranteed (FFB/Other)</b>	<b>95</b>	<b>\$2,600.0</b>
<b>TOTALS</b>	<b>197</b>	<b>\$3,971.6</b>

## Dollars and Loans Processed

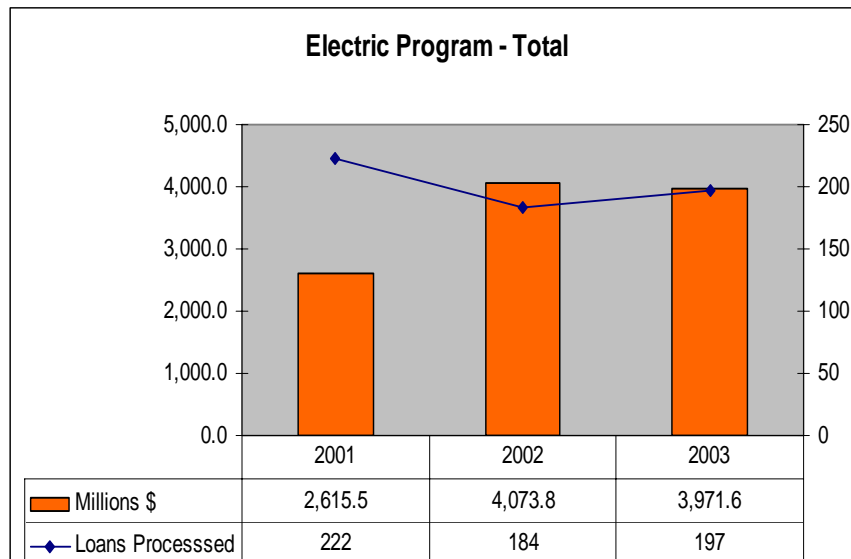

## Box Scores

- As of February 4, 2004, there were:
  - 28 G&T loans pending for a total request of \$1,805,557,000
  - 100 Distribution loans pending for a total request of \$1,248,415,000.



**TOPICS**



**TELECOMMUNICATIONS  
LOAN PROGRAM  
SUMMARY**

## **Summary of Loan Program**

### **Telecommunications Program Budget**

(Dollars in Million)

<u>Loan Program:</u>	<u>2003</u>	<u>2004</u>
<b>INFRASTRUCTURE</b>		
Hardship	\$ 74.5	\$145.0
Cost of Money	\$291.1	\$248.5
RTB	\$173.5	\$173.5
FFB	<u>\$120.0</u>	<u>\$120.0</u>
<b>TOTAL INFRASTRUCTURE</b>	<b>\$659.1</b>	<b>\$687.0</b>

## **Summary of Loan Program**

### **Telecommunications Program Budget**

(Dollars in Million)

<u>Loan Program:</u>	<u>2003</u>	<u>2004</u>
<b>DISTANCE LEARNING AND TELEMEDICINE</b>		
Loans	\$300.0	\$300.0
Grants	<u>\$ 46.0</u>	<u>\$ 24.9</u>
<b>TOTAL DISTANCE LEARNING AND TELEMEDICINE</b>	<b>\$346.0</b>	<b>\$324.9</b>

# Summary of Loan Program

## Telecommunications Program Budget

(Dollars in Million)

<u>Loan Program:</u>	<u>2003</u>	<u>2004</u>
<b>BROADBAND</b>		
4 Percent	\$ 80.0	\$ 0.0
Treasury Rate	\$1,295.0	\$598.1
Guaranteed	\$ 80.0	\$ 0.0
Grants	<u>\$ 10.0</u>	<u>\$ 8.9</u>
<b>TOTAL BROADBAND</b>	<b>\$1465.0</b>	<b>\$607.0</b>



## TOPICS

WATER AND  
ENVIRONMENTAL  
LOAN PROGRAM  
SUMMARY

## **Summary of Loan Program**

### **Water & Environmental Program Budget**

(Dollars in Million)

<u>Loan Program:</u>	<u>2003</u>	<u>2004</u>
Direct	\$ 780.0	\$1,044.4
Grant	\$ 642.0	\$ 566.7
Guaranteed	<u>\$ 75.0</u>	<u>\$ 75.0</u>
<b>TOTAL WATER &amp; ENVIRONMENTAL</b>	<b>\$ 1,497.0</b>	<b>\$1,686.1</b>



## TOPICS

RENEWABLES

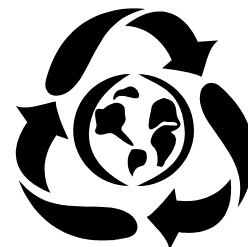

# **Expanding Rural Renewable Energy Systems**



## **The Farm Security and Rural Investment Act of 2002 (FARM BILL)**

### **Section 9006 –Renewable Energy Systems and Energy Efficiency Improvements**

**Establishes a grant, loan, and loan guarantee program to assist eligible farmers, ranchers, and rural small businesses in purchasing renewable energy systems and for making energy efficiency improvements**

# **FISCAL YEAR 2003 GRANTS APPROVED**

- **113 APPLICATIONS**
- **24 STATES**
- **\$21,207,233**

## **RENEWABLES**

### **SPECIFIC FUNDING**

**\$200 MILLION OF MUNICIPAL RATE FUNDS**

**PRIORITY PROCESSING - NO QUEUE**

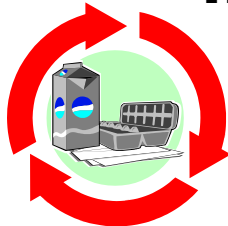

**2 LOANS IN HOUSE FOR  
APPROXIMATELY \$17 MILLION**

# INFORMATION

## USDA Website

- RUS (<http://www.usda.gov/rus/>)
  - Staff and phone numbers
  - Regulations
  - Bulletins
  - Forms
  - Items of Interest

*Connecting Rural America*  
Rural Utilities Service

**RUS - COOPERATIVES**  
**68 YEARS OF PUBLIC - PRIVATE PARTNERSHIP**  
**MAY 11, 2003**





**RUS 2004 ELECTRIC  
ENGINEERING SEMINAR**

**FEBRUARY 10-11, 2004**

**NEW ORLEANS, LA**

**Revision of the National  
Electrical Safety Code**

**Bob Lash**

**Chief, Transmission Branch, RUS, and**

**NESC Subcommittee Members**

## ***BIOGRAPHICAL SKETCHES***

**Bob Lash:** Bob Lash is presently Chief of the Transmission Branch, Electric Staff Division. In this position he supervises the review of transmission line designs, substation designs, contract and policy review and revision, and other technical areas of support for the area offices. Bob is a member of IEEE, and American Wood Preservers' Association and sits on several ANSI subcommittees. Prior to joining RUS in 1983, Bob was employed by Burns & McDonnell Consultants and Joslyn Manufacturing. He graduated from Kent State University in 1980 with a MBA and SUNY College of Environmental Science and Forestry in 1974 with a BS in Wood Products Engineering.

**Harvey Bowles:** Mr. Bowles received his BS in Electrical Engineering from Virginia Tech in 1973. He joined the Rural Electrification Administration in 1976 as an engineer in the Distribution Branch of what is now the Electric Staff Division. From November 1991 to May 1997, he served as Chairman of Technical Standards Committee "A" (Electric). In November 1995, he returned to the Distribution Branch as the Branch Chief. He was reassigned to the position of Senior Electrical Engineer in September 1999 and his duties include those of Chairman of Technical Standards Committee "A" (Electric) and Electric Program webmaster. Mr. Bowles has served on a number of industry committees, including the IEEE Switchgear Committee, the IEEE Insulated Conductors Committee, and the Rural Electric Power Committee. In addition he has served as the RUS liaison to various subcommittees of the NRECA T&D Engineering Committee. He is also a registered Professional Engineer in the Commonwealth of Virginia.

**Jim Bohlk:** Jim grew up in northwestern lower Michigan. He was graduated from Michigan State University in 1969 with a BSEE degree. After college, Jim worked for 10 years at Ohio Edison Company in Akron. For the first 3 years he engineered distribution lines and facilities. Next he worked as an Industrial Sales Engineer. His last 4 years he performed short-range and long-range plans in the Planning Division. Jim then accepted the position of System Engineer at Cherryland Electric Cooperative in Michigan. For 7 years he supervised the Engineering Department and performed all of the system's planning and special studies. He was then promoted to Operations Manager where he supervised both the Engineering and Line Departments. Since coming to work at RUS in the Distribution Branch of the Electric Staff Division in 1990, Jim had updated the Construction Work Plan bulletin, the Long-Range System Planning bulletin, and the Specifications and Drawings for 24.9/14.4 kV overhead construction. He has made several presentations, including workshops, on various topics regarding distribution line design and planning. He serves on various NESC and NRECA committees.

**Donald Heald:** Donald Heald is a structural engineer employed in the Electric Staff Division of the Rural Utilities Service. For the past 20 years, he has been working in the Transmission Branch of the Electric Staff Division in developing agency recommendations, guidelines, and standards for use by RUS engineers, borrowers, and its consulting engineers. He is active in transmission related committees and working groups in IEEE and represents RUS on the Strengths and Loadings Subcommittee of the NESC. Mr. Heald graduated from Virginia Polytechnic Institute and State University in 1972 in Civil Engineering where he later received his masters.

**Trung Hiu:** Mr. Trung Hiu is an electrical engineer and serves as the Underground Distribution Engineer in the Electric Staff Division at RUS. Mr. Hiu graduated from Virginia Tech in 1992. He has been with RUS for over ten years. His primary responsibilities include revising and updating the RUS Bulletin D-806, "Specifications and Drawings for Underground Electric Distribution" and the U-1, "Specification for 15 kV and 25 kV Primary Underground Power Cable." His area of specialty is URD Cables. He represents RUS at the ICC (Insulated Conductors Committee) Meetings, the ANSI Z535 Committee for safety signs, and the Subcommittee 7, Underground Lines, of the NESC (National Electrical Safety Code.)

# Revision of the NESC

## Subcommittee 2, Section 9 Grounding Methods

Harvey Bowles, Senior Electrical Engineer  
Electric Staff Division-Committee "A", Chair

**CP -2731, 2732, and 2790:** These three change proposals requested the addition of a specific reference to NEMA GR-1 in rule 094B2a. If adopted, these proposals would require that all ground rods meet the requirements contained in NEMA GR-1. Subcommittee 2 rejected the proposals. RUS was asked to be on the ANSI canvas list when NEMA asked for ANSI recognition of the standard. Although RUS cast a negative ballot because of several problems in the standard, GR-1 was adopted by ANSI. (There will be more concerning GR-1 in the discussion of Distribution Branch projects later in the program.)

**CP - 2715:** This change proposal requested recognition of embedded steel poles as a grounding electrode by adding new rule 094B7. This proposal was adopted as modified by the Subcommittee.

### 7. *Directly Embedded Metal Poles*

*Directly embedded steel poles shall constitute an acceptable electrode, if all of the following requirements are met:*

- a. backfill around the pole is native earth, concrete, or conductive grout (not gravel),*
- b. the embedment depth is not less than 1.5 m (5.0 ft),*
- c. the pole diameter is not less than 125 mm (5 in),*
- d. the metal thickness is not less than 6 mm (1/4 in), and*
- e. any protective coating over the metal shall be conductive.*

*Note 1: Directly embedded steel poles having a nonconductive covering below ground are not considered as an acceptable electrode. Aluminum installed below ground is not considered as an acceptable electrode. Weathering steel may not be an acceptable material for this application.*

*Note 2: There are structural and corrosion concerns that should be investigated prior to using metal poles as grounding electrodes. See Sections 25 and 26.*

**CP - 2538:** This change proposal requested a change in rule 092D. The proposal was adopted as modified by the Subcommittee.

*D. Current in Grounding Conductor*

*Ground connection points shall be so arranged that under normal circumstances there will be no objectionable flow of current over the grounding conductor. If an objectionable flow of current occurs over a grounding conductor due to the use of multi-grounds, one or more of the following may be used:*

- 1. Determine the source of the objectionable ground conductor current and take action necessary to reduce the current to an acceptable level at its source.*
- 2. Abandon one or more grounds.*
- 3. Change location of grounds.*
- 4. Interrupt the continuity of the grounding conductor between ground connections.*
- 5. Subject to the approval of the administrative authority, take other effective means to limit the current.*

*The system ground of the source transformer shall not be removed.*

*Under normal system conditions a grounding conductor current will be considered objectionable if the electrical or communication system's owner/operator deems such current to be objectionable, or if the presence and/or electrical characteristics of the grounding conductor current is in violation of the rules and regulations governing the electrical system, as set forth by the authority having jurisdiction to promulgate such rules.*

*The temporary currents set up under abnormal conditions while the grounding conductors are performing their intended protective functions are not considered objectionable. The conductor shall have the capability of conducting anticipated fault current without thermal overloading or excessive voltage buildup. Refer to Rule 093C.*

*NOTE: Some amount of current will always be present on the grounding conductors of an operating AC electrical system.*

**IR 532 (CP - 2831):** This change proposal, generated by the Subcommittee in response to the interpretation request clarified rule 096C (otherwise known as the four grounds per mile rule) by adding note 2:

*NOTE 2: The intent is to ensure that grounds are distributed at approximately 400 meters (1/4 mile) or smaller intervals, although some intervals may exceed 400 meters (1/4 mile).*

# Proposed NESC Changes

Section 9 - Grounding Methods  
(Subcommittee 2)

## Proposed Changes to the 2002 NESC for the 2007 NESC

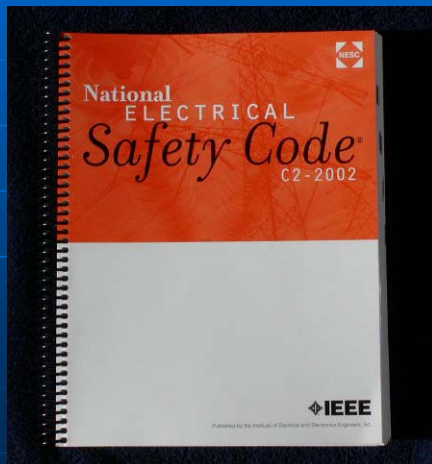

- *Change Proposals and vote by SC's printed for comment Sept , 2004*
- *Comments from the public to be received by May, 2005 (8 mos.)*
- *Final Vote by SC's Oct, 2005*

## Rule 094B2a (Grounding Electrodes –Driven Rods)

- CP - 2731, 2732, 2790 – Rejected
  - Acceptance of these proposals would have added a specific reference to NEMA GR-1 within the NESC

## Rule 094B7 (New)

- CP - 2715 – Accept as modified
  - Allows the use of steel poles as grounding electrodes under specified conditions.
  - Cautionary note:
    - "There are structural and corrosion concerns that should be investigated prior to using metal poles as grounding electrodes. See Sections 25 and 26."

## Rule 092D (Current in Grounding Conductor)

- CP - 2538 – Revised Rule 092D by adding paragraph and footnote
  - “Under normal system conditions a grounding conductor current will be considered objectionable if the electrical or communication system’s owner/operator deems such current to be objectionable, or if the presence and/or electrical characteristics of the grounding conductor current is in violation of the rules and regulations governing the electrical system, as set forth by the authority having jurisdiction to promulgate such rules.”

## Rule 092D (Current in Grounding Conductor)

- “NOTE: Some amount of current will always be present on the grounding conductors of an operating AC electrical system.”

## Rule 096C

### Ground Resistance Requirements

- CP - 2831 – In response to IR 532, Subcommittee 2 generated a proposal that adds a note to Rule 096C (otherwise known as the four grounds per mile rule).
  - "The intent is to ensure that grounds are distributed at approximately 400 meters (1/4 mile) or smaller intervals, although some intervals may exceed 400 meters (1/4 mile)."



## **Subcommittee 4, Sections 20, 21, 22 and 23 Overhead Lines - Clearances**

James Bohlk, Electrical Engineer  
Electric Staff Division-Distribution Branch

Nineteen voting members of Subcommittee 4 (Clearances) met during October, 2003 to act on the *change proposals* (CP's), submitted by various individuals, relative to clearances in the NESC. The purpose of a change proposal is to make corrections or to modify the current edition (2002) of the NESC for inclusion in the next (2007) edition of the NESC.

The subcommittee considered and voted on 138 change proposals. Eleven CP's were withdrawn at the meeting and 13 CP's were rejected. Fifty-three CP's were accepted with no changes. A total of 15 CP's were accepted in part or in principal and combined with the remaining 46 CP's that were accepted as modified. Modifications to CP's consist of additional wording or a change in wording (but not meaning) to the submitter's CP.

**The subcommittee did not accept nor modify any CP's that would significantly change the clearances between conductors in the existing edition of the NESC.** Nearly all of the CP's accepted or modified by the subcommittee merely corrected errors or improved existing language to clarify the meanings in the current edition of the NESC.

Of interest to most users of the NESC is the subcommittee's acceptance of a CP, submitted by Working Group 4.8, to change the terminology of the present "Loading Districts" to "Loading Zones." Also, the Subcommittee accepted a CP that would modify Rule 215C2 and add new Rules 215C3 through 215C6. All of these rules pertain to anchor guys or span guys. In essence this change would move and combine existing Rule 279 (which also pertains to guys) to Rule 215 such that those rules governing guys are together and easier to cross-reference. The rules themselves would not be significantly changed, but the new wording would emphasize that all guys supporting conductors of over 300 volts must be grounded. The exception that grounds may be insulated (for the purpose of mitigating cathodic corrosion) would still remain intact. (RUS requires that all guys be grounded unless written permission is given on a case-by-case basis. RUS recommends that galvanized or stainless steel ground rods, or else sacrificial anodes be installed to mitigate cathodic corrosion.)

The subcommittee accepted a (modified) CP that would require a 4-inch mid-span clearance between secondary cables and neutrals when they are both attached to a same insulator at each end of a span. The subcommittee also accepted a few change proposals that clarify the types of conductors that are allowed in the (40-inch) "communications space" and the clearances required for these conductors.

**Subcommittee 5, Sections 24, 25, 26, and 27**  
**Overhead Lines - Strength and Loading**

Donald Heald, Structural Engineer  
Electric Staff Division-Transmission Branch

Subcommittee 5 is responsible for Sections 24, 25, 26 and 27 of the NESC. These sections deal with Strengths and Loadings for Overhead Lines. Proposed changes to these sections of the 2002 NESC produced much debate. Some of the proposed changes and what is proposed to be adopted for the 2007 edition of the NESC are summarized below:

**A Complete Rewrite of Sections 25, 26, and 27 (Change Proposal 2737)**

A complete rewrite of the strength and loading sections (Sections 25–27) passed as an alternate to the existing code. Light, Medium and Heavy Loading Districts are not part of the alternate method. The need for these change proposals is explained by the NESC working group 5.2 and follows.

It is the intention of NESC Subcommittee 5 that the strength and loading requirements for overhead lines be revised to be consistent with the latest trends in ANSI recognized standards, including the American Society of Civil Engineers ANSI/ASCE 7 and other related documents. These changes include new combined ice and wind loading maps and associated requirements, and recognition of loadings that may not have been previously explicitly accounted for in the NESC. This new method will impact the structures, conductors, and insulators, as would be specified in revised Sections 25, 26 and 27, and may also impact the sags and clearances of Section 23.

In order to allow the industry a reasonable transition period (5 years) to adjust to and the new procedures and modify their internal procedures and standards, etc., the proposed “new” method would be included in the 2007 NESC with an “N” prefixed to all of the rules, section and table numbers. The present “old” or previous method would remain in the 2007 NESC with a “P” prefixed to all of the rules, section and table numbers. These “N” and “P” sections are to be grouped together (i.e., not intermingled) and would contain a preface to each grouping stating:

Users of the 2007 NESC may use either the New “N” rules or Previous “P” rules and methods for the design of new facilities. Except as may be related to conductor sag and clearance issues, under no circumstances may the two methods be combined or intermingled in the design of a structure.

It is intended that Working Group 5.2 of NESC SC5 will submit a Change Proposal for the 2012 NESC to eliminate the “P” rules from that edition.

## **ANSI O5.1, Wood Poles – Specification and Dimensions and calculating moments at the groundline (Change Proposals 2780 and 2781):**

The 2002 edition of the NESC references ANSI O5.1-1992 as the standard to use to obtain the designated fiber stress of a wood pole. In that edition of the standard, an equation for decreasing fiber stress with height is in the appendix and as such, is not a part of the standard. The 2002 ANSI O5.1 moved this information from the appendix to the body of the standard. The NESC voted to accept reference to the 2002 edition of ANSI O5.1-2002 for the 2007 NESC.

The committee also voted to remove 'EXCEPTION 1' to Rule 261A.2.a. This rule states "When installed, naturally grown wood poles acting as single-based structures or unbraced multiple-pole structures, shall meet the requirements of Rule 261A2a without exceeding the permitted stress level at the ground line for unguyed poles or at the points of attachment for guyed poles."

If the public accepts these two change proposal and the final vote of Subcommittee 5 reflects the wishes of the public, the 2007 edition of the NESC will require all wood pole designs to consider the maximum stress point above ground while at the same time decreasing fiber stress with height.

## **60-Foot Exclusion (Change Proposal 2766)**

Subcommittee 5, Strengths and Loadings, established a task force to revisit the 60-foot height limit for extreme winds in the 2002 NESC. Rule 250C, Extreme Wind Loading, states:

*If no portion of a structure or its supported facilities exceeds 18 m (60 ft) above ground or water level, the provisions of this rule (Extreme Wind Loading) are not required, except as specified in Rule 261A1c or Rule 261A2f.*

The original change proposal to the 1997 edition of the NESC was to remove the 60-foot exclusion from Rule 250C. Comments from the public and from members of the committee seem to indicate that removal of the 60-foot exemption would not necessarily increase safety and reliability. During extreme wind events, debris is blown into overhead line facilities (especially those under 60 feet), which has a more dramatic affect on the line than does extreme wind. Removal of this exemption ignores this problem while imposing a possible costly solution. However, the subcommittee recognizes that wind blows below 60 feet and has asked this working group to develop a position that would accommodate both opinions for the 2007 edition of the NESC.

The committee voted to accept the change proposal (to remove the 60 foot exclusion) from the task force and establish an upper limit on the extreme wind loads for structures 60 feet and below. For Grade C this limit is 15 psf and for Grade B this upper limit is 22 psf. The committee also decided to alter Table 253-1. For Rule 250C loads (extreme wind loads) show overload factors of 1.00 for Grade B construction and .87 for Grade C construction. This change proposal is to distinguish Grade B and Grade C construction for the extreme wind loads.

**Table 253-1  
Overload Factors for Structures,<sup>1</sup> Crossarms,**

<b>Support Hardware, Guys, foundations, and Anchors to Be Used with the Strength Factors of Table 261-1A Overload Factors</b>		
	<b>Grade B</b>	<b>Grade C</b>
<b>Rule 250B Loads</b>		
<i>Vertical Loads<sup>3</sup></i>	1.50	1.90 <sup>6</sup>
<i>Transverse Loads</i>		
<i>Wind</i>	2.50	2.20 <sup>4</sup>
<i>Wire Tension</i>	1.65 <sup>2</sup>	1.30 <sup>5</sup>
<i>Longitudinal Loads</i>		
<i>At Crossings</i>		
<i>In general</i>	1.10	no requirement
<i>At deadends</i>	1.65 <sup>2</sup>	1.30 <sup>5</sup>
<i>Elsewhere</i>		
<i>In general</i>	1.00	no requirement
<i>At deadends</i>	1.65 <sup>2</sup>	1.30 <sup>5</sup>
<b>Rule 250C Loads</b>	1.00 <sup>9</sup>	0.87 <sup>7,8</sup>

(Footnotes 1-6 the same)

<sup>7</sup> For wind velocities above 100 mph (except Alaska) a factor of 0.75 may be used.

<sup>8</sup> For wire attachments points that are 18 m (60 ft) or less above ground or water level and for structure height (h) under 60 ft., the wind pressures defined by  $0.00256 V^2 k_z G_{RF}$  need not exceed 15 psf

<sup>9</sup> For wire attachments points that are 18 m (60 ft) or less above ground or water level and for structure height (h) under 60 ft., the wind pressures defined by  $0.00256 V^2 k_z G_{RF}$  need not exceed 30 psf

### **Incorporation of a New 50 Yr. Combined Ice/Wind Map (Change Proposal 2802)**

The extreme ice with concurrent wind loads is currently in the SEI/ASCE 7-02 standard, Minimum Design Loads for Buildings and Other Structures (Revision of ASCE 7-98). The radial ice indicated on this map may be greater than that presently specified by the Loading Districts currently in the NESC. In some areas of the country the radial ice may be less. Change Proposal 2802 was accepted and the new loading criteria will be added to the Light, Medium, and Heavy Loading District Loads and to the extreme wind loads. The proposed wording follows:

#### *D. Extreme Ice with Concurrent Wind Loading*

*If no portion of a structure or its supported facilities exceeds 18 m (60 ft) above ground or water level, the provisions of this rule are not required, except as specified*

in Rule 261A1c or Rule 261A2f. Where a structure or its supported facilities exceeds 18 m (60 ft) above ground or water level the structure and its supported facilities shall be designed to withstand the ice and wind load associated with the Uniform Ice Thickness and Concurrent Wind Speed, as specified by Figure 250-3. The wind pressures for the concurrent wind speed shall be calculated using the formulas presented in Rule 250C. The wind pressures calculated shall be applied to the entire structure and supported facilities without ice and to the iced wire diameter determined in accordance with Rule 251.

1. For Grade B, the radial thickness of ice from Figure 250-3 shall be multiplied by a factor of 1.00.
2. For Grade C, the radial thickness of ice from Figure 250-3 shall be multiplied by a factor of 0.80.

**Table 250-1**  
**Ice, Wind, and Temperature**

	<b>Loading districts (For use with Rule 250B)</b>			<b>Extreme wind loading (For use with Rule 250C)</b>	<b><u>Extreme ice loading with concurrent wind (For use with Rule 250D)</u></b>
	<b>Heavy</b>	<b>Medium</b>	<b>Light</b>		
<i>Radial thickness of ice (mm)</i>	12.5	6.5	0	0	<u>See fig 250-3</u>
<i>(in)</i>	0.50	0.25	0	0	<u>See fig 250-3</u>
<i>Horizontal wind pressure (Pa)</i>	190	190	430	See fig 250-2	<u>See fig 250-3</u>
<i>(lb/ft<sup>2</sup>)</i>	4	4	9	See fig 250-2	<u>See fig 250-3</u>
<i>Temperature (°C)</i>	-20	-10	-1	+15	<u>-10</u>
<i>(°F)</i>	0	+15	+30	+60	<u>+15</u>

**Table 251-1**  
**Temperatures and Constants**

	<i>Loading districts (For use with Rule 250B)</i>			<i>Extreme wind loading (For use with Rule 250C)</i>	<u><i>Extreme ice loading with concurrent wind (For use with Rule 250D)</i></u>
	<i>Heavy</i>	<i>Medium</i>	<i>Light</i>		
<i>Temperature (°C)</i>	-20	-10	-1	+15	-10
<i>(°F)</i>	0	+15	+30	+60	+15
<i>Constant to be added to the resultant(all conductors) in N/m</i>	4.4	2.9	0.73	0.0	0.0
<i>in lb/ft</i>	0.30	0.20	0.05	0.0	0.0

Rule 250B today contains a modified version of the district load map first introduced to the code in the second edition published in 1916. Subsequent editions of the code published in 1926, 1941 and 1977 modified the district map boundaries along political subdivisions based upon weather data and experiences and State choices. It must also be pointed out that the committee published discussion in 1928 stating that “the chosen values do not represent the most severe cases recorded, but do represent conditions that occur more or less frequently.” From 1977 to the present, the map remained unchanged through seven code editions. Consequently, it must be appreciated that the district loading idea has served the industry for an extended period of time and been the basis not only of loading criteria but also a part of the clearance requirements. At this time, the elimination of the district map has been accepted by NESC Subcommittee 5; however, the code committee feels that the district map was based on limited data and that icing events have proved increasingly destructive as power systems have grown.

Since the early 1980’s, much work has been done by utilities and government to study icing, resulting in the ice maps now available to us in ASCE 7-02. These maps are 50-year mean recurrence interval maps giving uniform ice thicknesses due to freezing rain with concurrent 3-second gust wind speeds. This change proposal recommends that the ASCE-7 ice maps be included as a new Rule 250D while maintaining the existing Rule 250B. Rule 250B would still be utilized as one of the code loading criteria and as the basis of the code clearance requirements.

Figure 10-2. 50-year mean recurrence interval uniform ice thicknesses due to freezing rain with concurrent 3-second gust wind speeds: contiguous 48 states.

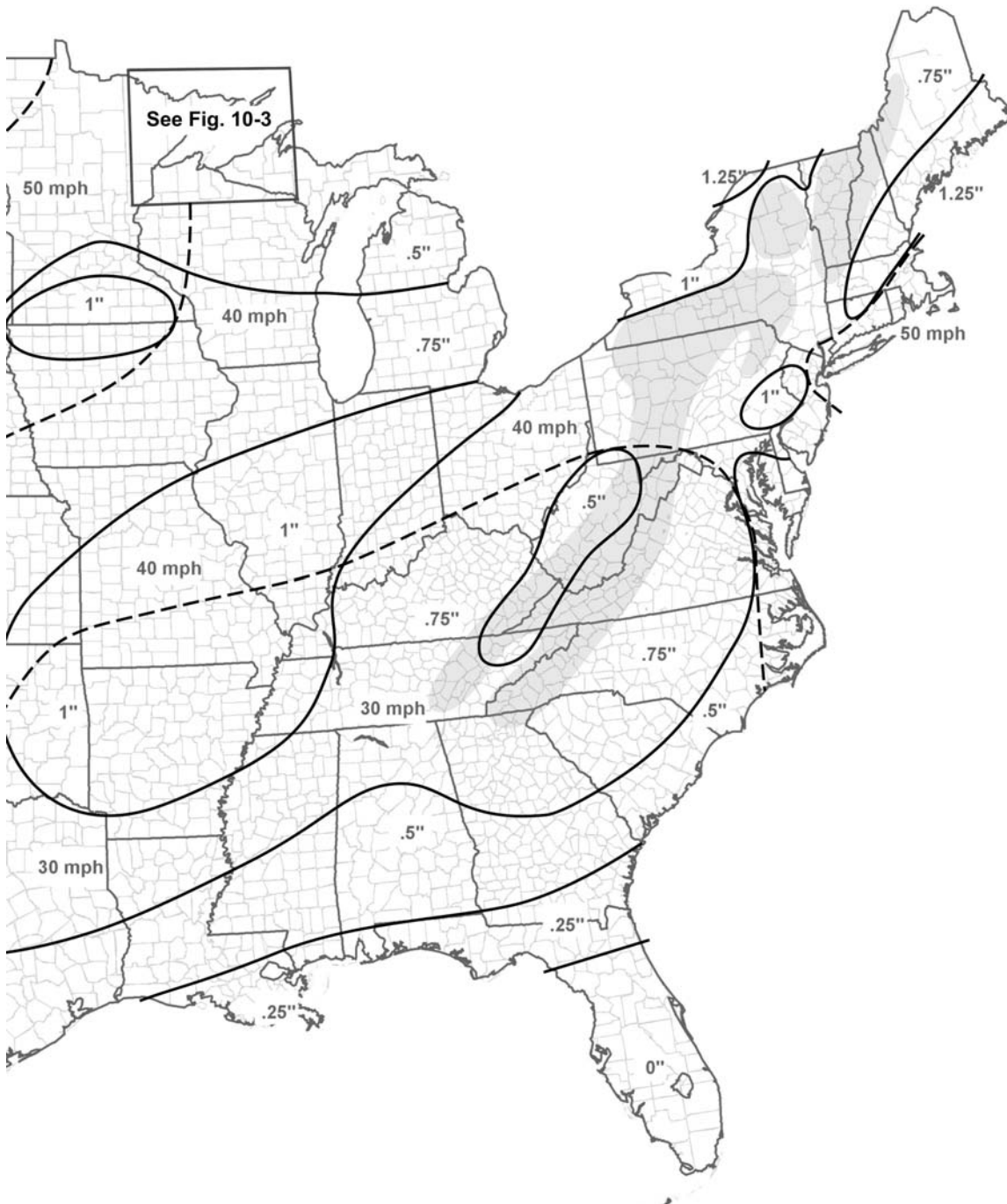

Reproduced from standard SEI/ASCE 07-2002, Minimum Design Loads for Buildings and Other Structures, Copyright 2003 with permission from ASCE



Reproduced from standard SEI/ASCE 07-2002, Minimum Design Loads for Buildings and Other Structures, Copyright 2003 with permission from ASCE



**Other Change Proposals of Interest include:**

- Removal of the K factor from Table 251-1 used to determine sags and tensions
- Removal of the words urban and rural in section 24
- Changing the wording of overload factor to load factor throughout sections 25 and 26
- Added an EXEPTION to Rule 261.D.4.b which states: “*Crossarm braces used to sustain unbalanced vertical loads need only be designed for these unbalanced loads.*”
- Notes 2 and 3 to Table 261-1A will be changed to indicate “*If a structure or structure component is replaced, it shall meet the strength required by Table 261-1A*”.
- An appendix is added with examples demonstrating calculations for extreme wind.
- Table 253-1 (load factors) is reformatted to the heading:

Grade B	Grade C
<u>All locations</u>	<u>At crossings</u> <u>Elsewhere</u>

- A new section (261.N) covering climbing and working steps and attachments has been added.
- A new section to Rule 250 which addresses the issue of worker loads and installation loads has been added

## Sections 24,25,26 & 27

### Subcommittee 5 Overhead Lines—Strengths and Loadings

## Proposed Changes to the 2002 NESC for the 2007 NESC

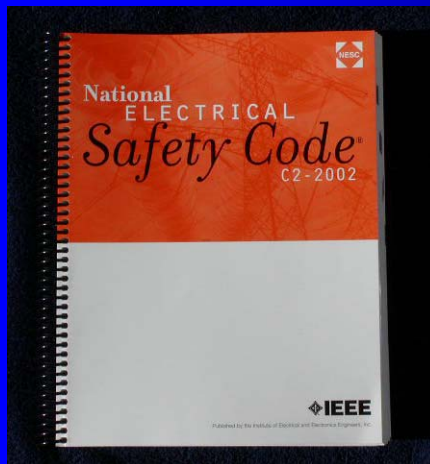

- *Change Proposals and vote by SC's printed for comment*  
**Sept, 2004**
- *Comments from the public to be received*  
**by May, 2005**  
(8 mos.)
- *Final Vote by SC's*  
**Oct, 2005**

## Complete Rewrite of Sections 25 and 26

- **PROPOSED** –

*Rewrite eliminates L,M,and H Loading Districts and replaces these with construction, extreme wind, and extreme wind and ice loads.*

- **OUTCOME** –

*– Accepted as an alternate method for the 2007 NESC*

## New Combined Ice/Wind Map

- **PROPOSED** –

*– New combined ice and wind map; retain current requirements of Light, Medium, and Heavy Loading Zones.*

- **OUTCOME** –

*– Accepted*

## New Combined Ice/Wind Map

- For Grade B, the radial thickness of ice from Figure 250-3 shall be multiplied by a factor of 1.00.
- For Grade C, the radial thickness of ice from Figure 250-3 shall be multiplied by a factor of 0.80.
- Structures and wires under 60 foot are excluded.

Figure 10-2. 50-year mean recurrence interval uniform ice thicknesses due to freezing rain with concurrent 3-second gust wind speeds: contiguous 48 states.

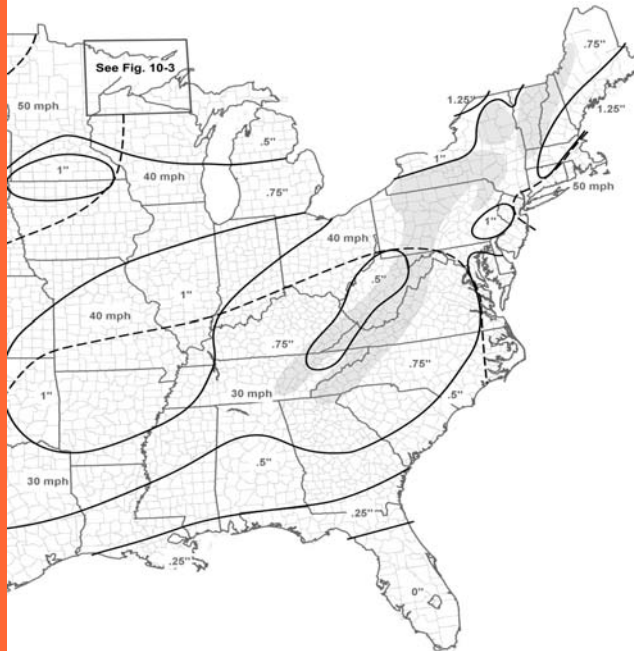

Reproduced from  
SEI/ASCE 7-02  
standard, Minimum  
Design Loads for  
Buildings and Other  
Structures (Revision of  
ASCE 7-98).

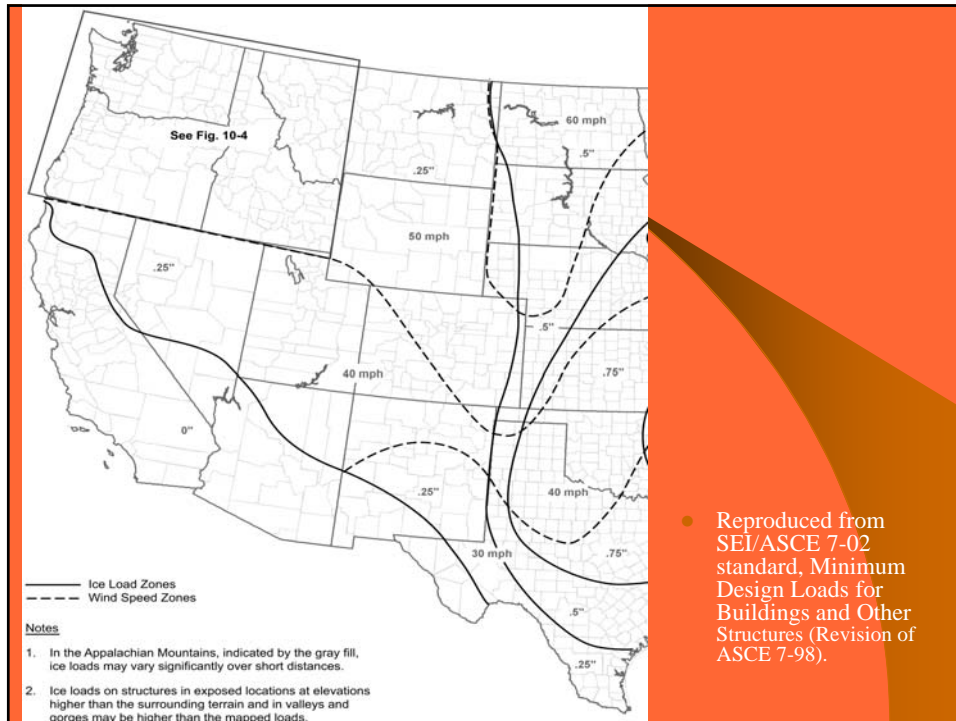

## Reference to ANSI O5.1-2002

- **PROPOSED** –

*Update reference of ANSI O5.1 to ANSI O5.1-2002*

- **OUTCOME** –

*Accepted*

## Reference to ANSI O5.1-2002

- *The suggested equation for decreasing stress with height is moved from the appendix to the body of the standard.*
- *NESC will require decreasing fiber stress with height*

## Ground line moments

- **PROPOSED** –  
*To remove Exception 1 to Rule 261A2a*
- **OUTCOME** –  
*– Accepted*

## Ground line moments

*Rule 26A2a states:*

*“When installed, naturally grown wood poles acting as single based structures or unbraced multiple pole structures, shall meet the requirements of Rule 261A2a without exceeding the permitted stress level at the ground line for unguyed poles or at the points of attachment for guyed poles.”*

## *Life is beautiful!!*

*The 2007 edition of the NESC for wood poles:*

- *Design based on decreasing fiber stress with height*
- *Design based on the maximum stress point above ground*

## 60 foot exclusion (250C)

- **PROPOSED** –
  - *Remove 60 ft Exclusion Limit*
- **OUTCOME** –
  - *Accepted*







## 60 foot exclusion (250C)

*For wires under 60 feet the wind pressure need not exceed :*

*For Grade B.....22 psf*

*For Grade C.....15 psf*

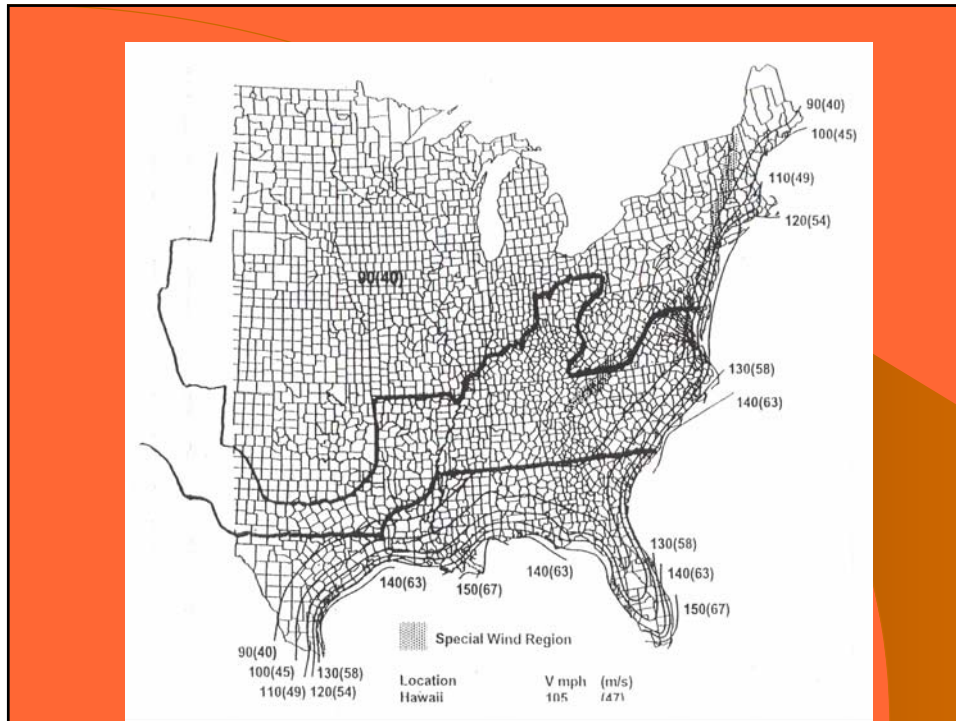

## High Wind Loads

- *Grade B* Load Factor = 1.0
- *Grade C* Load Factor = 0.87

## Other Changes

- *Removal of the 'K' factor from Table 251-1 used to determine sags and tensions*
- *Removal of the words urban and rural in section 24*
- *Changing the wording of overload factor to load factor throughout sections 25 and 26*

## Other Changes (continued)

- *Added an EXCEPTION to Rule 261.D.4.b which states: "Crossarm braces used to sustain unbalanced vertical loads need only be designed for these unbalanced loads."*
- *Note 2 and 3 to Table 261-1A will be changed to indicate "...If a structure or structure component is replaced, it shall meet the strength required by Table 261-1A.*

## Other Changes (continued)

- *An appendix is added with examples demonstrating calculations for extreme wind.*
- *Table 253-1 (load factors) is reformatted to the heading:*

*Grade B*  
*All locations*

*Grade C*  
*At crossings Elsewhere*

## Sections 24,25,26 & 27

- *Many proposed significant changes for the 2007 edition of the NESC*

## *On the Road of Life.....*

*Never be afraid to try something new.*

*Remember, amateurs built the ark.  
Professionals built the Titanic.*

## Subcommittee 7, Sections 30-39 Underground Lines

Trung Hiu, Electrical Engineer  
Electric Staff Division-Distribution Branch

We discussed and voted on 26 change proposals and interpretation requests. The major developments to the safety rules for underground lines were:

- **Add new Rule 311C:** This rule covers the laying of supply and communication cables on grade during emergency installations. This is in Part 2, Overhead Lines. Some field users use this overhead rule to apply to underground, but most would not think to look in the overhead rules for an underground application. This rule will be added to Part 3, Underground Lines where users would be more likely to look.
- **Delete the term “readily” from Rule 312:** Rule 312 uses the term “readily accessible.” The similar rule in Part 2, Rule 213, uses the term “accessible”. Underground manholes may be accessed with portable ladders; therefore, “accessible” is more appropriate than “readily accessible”
- **Revise Rule 320B2:** The “not less than” wording which is common throughout the Code has been added to this rule. The present wording requires a fixed distance.
- **Revise Rule 342:** The “exposed to personnel contact” wording has been added. The intent of this rule is to require insulation shielding to be effectively grounded if the joint is exposed to personnel contact.
- **Move Rule 350F to Rule 384C:** Rule 350F is located in Section 35 which only applies to direct buried cable. The grounding requirement of Rule 350F is not unique to direct buried cables; it should also apply to conduit systems. Moving Rule 350F to 384C puts the rule in Section 38, Equipment, which would require the rule to apply to both direct buried cable systems and conduit systems.
- Add “Bonding” to the title of Rule 384 to reflect the newly added Rule 384C.
- **Revise Rule 351C1:** The “storage tank foundations” wording has been replaced with “other structures” to be consistent with the heading.
- **Add new Rules 352E and 352F:** Rule 350H was added in the 2002 edition to require that direct buried cable installed in a duct comply with the direct buried rules in Section 35. Adding these rules, which were taken from Section 34, Rule 341A6 and 341A7, will re-emphasize that supply and communication direct buried cables in Section 35 cannot be installed in the same duct unless owned and maintained by the same utility.

- **Revise language in Rule 354A2:** Remove the term “fuel”. Flammable material includes “other fuels” as well as flammable materials used in numerous industrial processes, but not as fuels. They are often piped underground within industrial complexes. To assure safety, it is important to keep buried lines that transport all flammable material, not only fuel, from contacting electrical cables and steam lines.

**RUS 2004 ELECTRIC  
ENGINEERING SEMINAR**

**FEBRUARY 10-11, 2004**

**NEW ORLEANS, LA**

**Safety Accreditation**

**Ken Brubaker**

**Manager, Safety Programs, NRECA**



*BIOGRAPHICAL SKETCH*

**KEN BRUBAKER**

Kenneth J. Brubaker is currently Manager Safety Programs with the National Rural Electric Cooperative Assn. Brubaker holds a degree in Business Management and Safety from the Columbus State Community College.

Brubaker's Cooperative career began in May of 1972 in Northwest Ohio at Tricounty REC. Brubaker's father, Joe, still serves as one of the Board Directors of his family's home electric distribution system.

From 1985 to 1994, Brubaker served as a Safety Instructor with the Ohio Rural Electric Cooperatives. During this time, he provided safety training and loss control services for the management of Ohio's Electric Distribution systems.

As the Compliance and Safety Coordinator with Butler Rural Electric Cooperative until October 2000, Brubaker developed the safety and loss control program for this dynamic organization. On Butler's management team, Brubaker worked as a key part of Human Resources Department.

Brubaker and his spouse, Carol, currently live in the northern Virginia area. They are very proud of their grown family; son, Jeremy; a daughter Kimberly; son-in-law Jeff, and new grand daughter, Marissa Lynn. Pictures are available.

Kenneth J. Brubaker, NRECA  
Manager Safety Programs  
703-907-6414  
ken.brubaker@nreca.org.

2004 Rural Utilities Service  
Electric Engineering Seminar



1

## The Future

- “Where a calculator on the ENIAC is equipped with 18,000 vacuum tubes and weighs 30 tons, computers of the future may have only 1000 vacuum tubes and weigh 1.5 tons.”  
Popular Mechanics,  
March 1949



2

## Accreditation future...

- “The best way to predict the future is to invent it.” Alan Kay
- An Electronic Accreditation application is ready to use

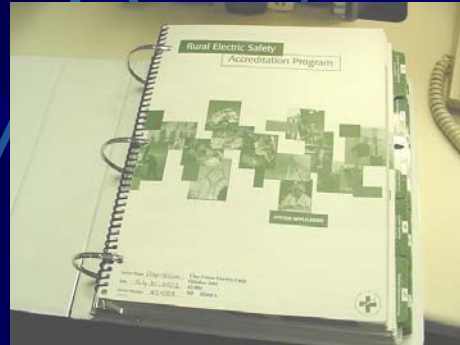

3

## Comparing is difficult...

### Electronic vs. Binder Application

- Same sections
  - Same guidelines
  - Same Accreditation possible
- 
- Users like Electronic
    - Less time for application
    - More objective scoring
    - Score is higher

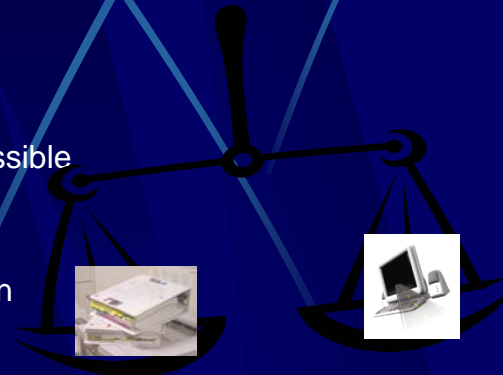

4

# Electronic Application... last phase of 3 year RESAP

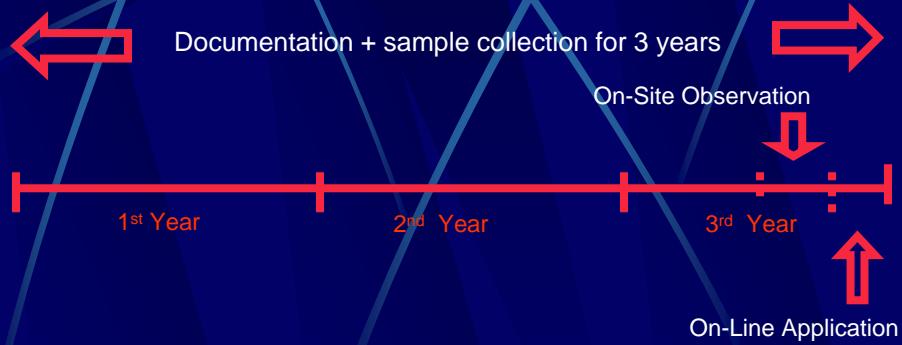

5

# Electronic Process Ideal Timeline

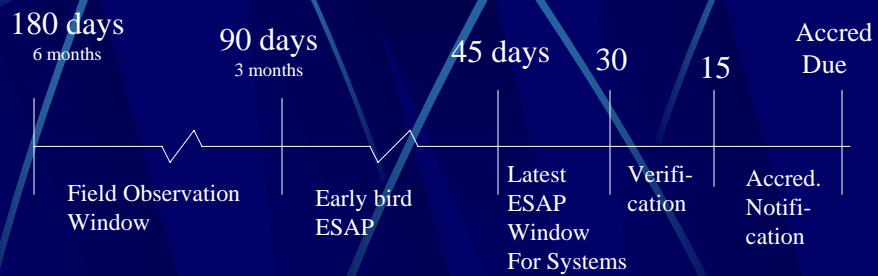

6

# Electronic Safety Accreditation... as perfect as any plan



- Accomplishing a task is often less perfect than the plan
- Electronic programs depend on:
  - Hardware
  - Software
  - Physical Connections
  - Browsers
  - Internet Access
  - Security Measures
  - Proper Instructions
  - Users
  - etc.

7

# Electronic Application Process

- Electronic questionnaire
  - 5 points each question

- Random 6 documents to verify electronic answers

Application overall score

■ 60% of application score

+

■ 40% of application score

=

100%



+



=

RESAP Application

8

Cooperative.com - Microsoft Internet Explorer

Address: <http://www.cooperative.com>

Home | Help | People Finder | Co-op Directory | Calendar | Jobs | Site Map | Profile

COOPERATIVE.COM Happy Thanksgiving!

registered users, please log in to Cooperative.com

username password (case sensitive)

**Log In For:**

Professional Communities where co-op staff can get up-to-date information and documents, and share in the knowledge of peers nationwide.

Our people finder tool or member directory, to help you locate that friend from Regionals or a fellow member co-op.

Complete information about products and services offered by NRECA, NRTC, CFC, and Federated... all in one place!

Policy and Legislative Updates: Check out our Government Affairs section to learn about current issues, read policy reports and updates, and find out how you can take action.

By the end of the year, if you have benefits with NRECA, you will be able to access both Cooperative.com and your NRECA Employee Benefits online (formerly AdvantageNet) using the same username and password.

When you log into Cooperative.com, you will be able to access your NRECA Employee Benefits

Industry News

Get daily updates on news about electric co-ops and the electric industry.

Homeland Security

Stay informed. Check out the latest news, information & links on this important subject...

AP Top Headlines

Keep up with top stories affecting your life and business.

Today's stories include:

Check in daily for...

Plus! Check out these cool tools:

Your Co-op Community Calendar

Your Local Weather

**http://www.cooperative.com**

**Password**

**Username**

Rural Electric Safety Accreditation Program - Microsoft Internet Explorer

Address: <http://www.cooperative.com/Programs/RESAP/RESAP.html>

Home | Help | People Finder | Co-op Directory | Calendar | Jobs | Site Map | Profile

COOPERATIVE.COM Happy Thanksgiving!

Search: For:

Advanced Search | Search Tips

Communities | Government Affairs | Resource Center | Conferences & Training | Products & Services | **Programs**

Programs > RESAP

**RESAP**

**Rural Electric Safety Accreditation**

Who We Are . . .

The Rural Electric Cooperative Safety Accreditation Program, a service of the National Rural Electric Cooperative Association (NRECA), strives to promote the highest standards of safety among electric co-ops and concerned utilities nationwide.

RESAP's Vision

Zero injury, zero loss . . . nothing less.

Our Mission

RESAP dedicates itself to promoting safety and loss control as a high-priority goal for electric utility management. We encourage utility management to set for its goal "zero injury, zero loss." To help utilities advance toward this goal, RESAP offers a comprehensive and demanding safety accreditation program. Components of the program include

Related Links and Resources

Safety Accreditation Application

Safety Sentinel

Safety Comments

FREIE Safety Articles

Information and educational resources

Consulting services

A rigorous peer-review audit program.

**Click, Click, click...**

**Programs**

**RESAP**

**Go to Safety Accreditation Application**

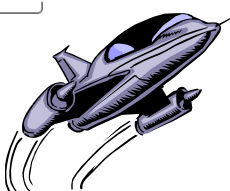

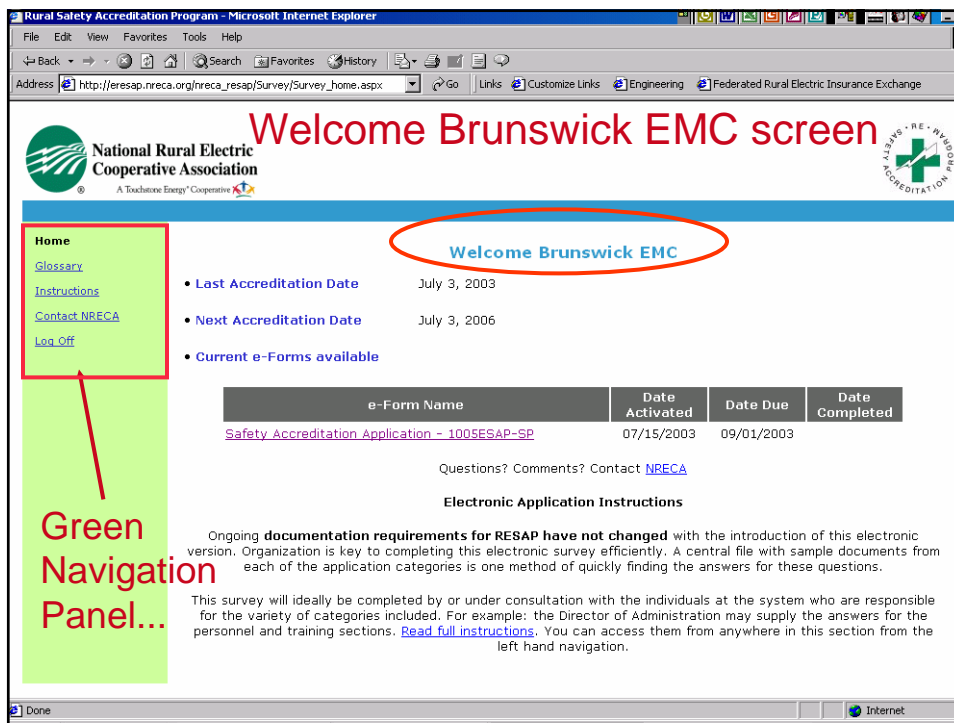
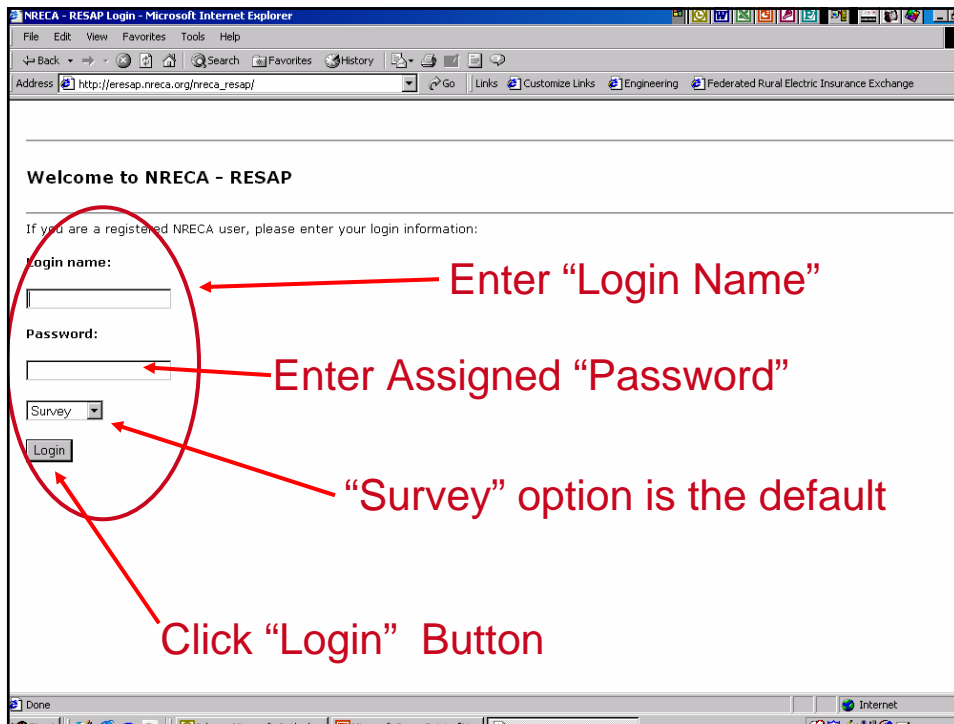

Rural Safety Accreditation Program - Microsoft Internet Explorer

Address: http://nreca-dev.workgroup.infoconcepts.com/nreca\_dev/Survey/Sur...

**Use Print entire e-Form options**

**All Pages "Blank"**

**Or as "Completed"**

Submit Eform -- Web Page Dialog

Would you like to print a blank survey or the completed survey?

Blank Completed Cancel

Home

- Glossary
- Instructions
- Print e-Form**
- Contact NRECA
- Log Off

• Last Accreditation Date

• Next Accreditation Date

• Current e-Forms available

Utility

Date Completed

Ongoing documentation requirements for RESAP have not changed with the introduction of this electronic version. Organization is key to completing this electronic survey efficiently. A central file with sample documents from each of the application categories is one method of quickly finding the answers to these questions.

This survey will ideally be completed by or under consultation with the individuals at the system who are responsible for the variety of categories included. For example: the Director of Administration may supply the answers for the personnel and training sections. [Read full instructions](#). You can access them from anywhere in this section from the left hand navigation.

Rural Safety Accreditation Program - Microsoft Internet Explorer

Address: http://eresap.nreca.org/nreca\_resap/Survey/Survey\_home.aspx

**System accesses application... by clicking hyperlink**

Welcome Brunswick EMC

- Last Accreditation Date July 3, 2003
- Next Accreditation Date July 3, 2006
- Current e-Forms available

e-Form Name	Date Activated	Date Due	Date Completed
<a href="#">Safety Accreditation Application - 1005ESAP-SP</a>	07/15/2003	09/01/2003	

Questions? Comments? Contact [NRECA](#)

**Electronic Application Instructions**

Ongoing documentation requirements for RESAP have not changed with the introduction of this electronic version. Organization is key to completing this electronic survey efficiently. A central file with sample documents from each of the application categories is one method of quickly finding the answers to these questions.

This survey will ideally be completed by or under consultation with the individuals at the system who are responsible for the variety of categories included. For example: the Director of Administration may supply the answers for the personnel and training sections. [Read full instructions](#). You can access them from anywhere in this section from the left hand navigation.



**“Progress Report”... updates automatically**

**Marked for Review?**

**Status? Review?**

**Not started**

**In Progress**

**Completed**

**Yes**

**No**

**Sections**

**Accreditation Progress Report**

**Accreditation Time** You have 22 days to complete your e-Form. Click [here](#) to get started. Click the Start button below.

Section	Status	Marked for Review
Demographics	Completed	No
1. Safety and Loss Control Policy	Completed	No
2. Accident Investigation Procedures	Completed	No
3. Sample Accident Investigation	Completed	No
4. Reporting Employee Accidents	Completed	No
5. Employee Safety Education and Training	Completed	No
6. Personnel Procedures	Completed	No
7. Job Planning and Supervision	Completed	No
8. Hazard Recognition	Completed	No
9. Consumer Safety Education	Completed	No
10. Regulatory Compliance	Completed	No
11. Substations	Completed	No
12. Overhead Lines and Structures	Completed	No
13. Underground Electrical Lines and Equipment	Completed	No
14. Head Protection	Completed	No

**“Demographics” section opens first**

**These key fields preloaded... review is recommended**

**Demographics**

A. System Contact Information

- 1) Name of System
- 2) System ID Number
- 3) Name of Board President
- 4) Name of General Manager or Chief Executive Officer
- 5) Email address of General Manager
- 6) System Mailing Address
- 7) City
- 8) State
- 9) Zip
- 10) Phone
- 11) Fax
- 12) Name of local Safety Accreditation Coordinator
- 13) Email address of Safety Accreditation Coordinator
- 14) Name of Area/Statewide Administrator for Safety Accreditation Program
- 15) Email address of Area/Statewide Administrator

Moheve Electric Co-op  
AZ022  
Box 1045  
Bullhead City  
AZ  
86430-1045  
928 763 9112  
928 763 9120

Rural Safety Accreditation Program - Microsoft Internet Explorer

Address: http://eresap.nreca.org/nreca\_resap/Survey/Survey\_Summary.aspx

**Proceed to any Application Section**

Home  
Glossary  
Instructions  
Print e-Form  
Contact NRECA  
Log Off  
Survey Home

**1. Safety and Loss Control Policy**  
2. Accident Investigation Procedures  
3. Sample Accident Investigation  
4. Reporting Employee Accidents  
5. Employee Safety Education and Training  
6. Personnel Procedures  
7. Job Planning and Supervision  
8. Hazard Recognition  
9. Consumer Safety Education

**Welcome to the Electronic Accreditation Application Questions**

Please answer all the questions in each of the following numbered sections. Questions about terminology may be answered by clicking the Glossary link in the navigation bar to the left.

**System user selects section to open...**

**1. Safety and Loss Control Policy**  
**2. Accident Investigation Procedures**  
**3. Sample Accident Investigation**

**...by clicking on link**

Start | Inb... - Microsoft Outlook | Microsoft PowerPoint - (N... | Rural Safety Accredita... | 11:21 AM

Rural Safety Accreditation Program - Microsoft Internet Explorer

Address: http://eresap.nreca.org/nreca\_resap/Survey/Survey\_Section.aspx

**Yes/No answer type = 5 – 0 points**

Home  
Glossary  
Instructions  
Print e-Form  
Contact NRECA  
Log Off  
Survey Home

**1. Safety and Loss Control Policy**

Print

A. A written Safety/Loss Control Policy is in place?  Yes  No

B. In this policy, responsibility for safety is assigned to System Manager/CEO?  Yes  No

1) Give the name of the person (ie. Board President) who signs the Safety and Loss Control Policy? Hubert Britten

2) Give the date (mm/dd/yyyy) of the most recent Safety Policy reviewed by the Board of Directors. Form Description 07/25/2002 N/A

C. Safety and Loss Control Activities are reported to the board in the following manner:

1) Monthly Safety/Loss Control reports are compiled?  Yes  No

2) These Safety/Loss Control report are discussed with the Board of Directors?  Yes  No

3) These reports are distributed to each Board Member?  Yes  No

D. Select the range of verifiable, monthly, Safety/Loss Control

**"Yes" not always the 5 points answer**

Start | Inb... - Microsoft Outlook | Microsoft PowerPoint - (N... | Rural Safety Accredita... | 11:27 AM

Rural Safety Accreditation Program - Microsoft Internet Explorer

Address: http://eresap.nreca.org/nreca\_resap/Survey/Survey\_Section.aspx

**Text and dates usually for verification...**

**1. Safety and Loss Control Policy**

Print

A. A written Safety/Loss Control Policy is in place?  Yes  No

B. In this policy, responsibility for safety is assigned to System Manager/CEO?  Yes  No

1) Give the name of the person (i.e. Board President) who signs the Safety and Loss Control Policy?

2) Give the date (mm/dd/yyyy) of the most recent Safety Policy reviewed by the Board of Directors.   N/A

C. Safety and Loss Control Activities are reported to the board in the following manner:

1) Monthly Safety/Loss Control reports are compiled?  Yes  No

2) These Safety/Loss Control report are discussed with the Board of Directors?  Yes  No

3) These reports are distributed to each Board Member?  Yes  No

D. Select the range of verifiable, monthly, Safety/Loss Control

**Numerical answers may build scored formulas**

Rural Safety Accreditation Program - Microsoft Internet Explorer

Address: http://eresap.nreca.org/nreca\_resap/Survey/Survey\_Section.aspx

reports compiled for the board of directors in this accreditation cycle:

1) First Year: (All reports from this year may be requested for verification) [Form Description](#)  9-12 Reports  5-8 Reports  1-4 Reports

2) Second Year: (All reports from this year may be requested for verification) [Form Description](#)  9-12 Reports  5-8 Reports  1-4 Reports

3) Third Year: (All reports from this year may be requested for verification) [Form Description](#)  9-12 Reports  5-8 Reports  1-4 Reports

**Multiple choice answer types**

**3 choices = 5, 3, or 1 point(s)**

**5 choices = 5, 4, 3, 2, or 1 point(s)**

E. Select the range of verifiable monthly board minute excerpts that reflect the Board of Director discussions about Safety/Loss Control activities in this accreditation cycle:

1) First Year: (All safety excerpts from this year's minutes may be requested for verification) [Form Description](#)  9 - 12 Minutes  5 - 8 Minutes  1 - 4 Minutes

2) Second Year: (All safety excerpts from this year's minutes may be requested for verification) [Form Description](#)  9 - 12 Minutes  5 - 8 Minutes  1 - 4 Minutes

3) Third Year: (All safety excerpts from this year's minutes may be requested for verification) [Form Description](#)  9 - 12 Minutes  5 - 8 Minutes  1 - 4 Minutes

Comments:

**zero point answers added for no activity**



# CYCA

- People
- Members
- System
- Facilities
- Equipment
- Tools
- Documentation
- Margins



23

# BYOB

- Guideline
- Outline
- Timeline
- Deadline
- Headline
- Baseline
- In Line



## Engineering/Operations... on site responsibilities



### ● On Site Areas

- Warehouse/Storage
- Maintenance Facility
- Pole Yard/Outside
- Administration Bldg.
- Vehicles
- Equipment/Tools
- PPE
- Substations
- Lines and Structures
- Crew work practices

25

## Engineering/Operations... documentation responsibilities

- Safety Policy
- Accid Investigation Procedures
- Sample Investigation
- Accident Reporting
- Employee Ed and Training
- Personnel Procedures
- Job Planning and Supervision
- Hazard Recognition Training
- Consumer Safety Education
- Environmental Reg Compliance
- Substations
- Lines/structures
- Underground
- Head Protection
- Eye and Face Protection
- Hearing Protection
- Respiratory Protection
- Rubber Gloves/Sleeves
- Body Belt/Straps/Climbers
- Digger/Bucket Maint + Test
- Safety Rules for Operating Equip
- Truck Tools + Equip

26

## ESAP is a different process; but...

- Federal, State, and Local Documentation requirements have not changed!
- RESAP guidelines have not changed!
- System documentation sampling should not change!



27

## ESAP Info or Questions?

- Call or email
  - Area Administrator in your state
  - NRECA's L. Daniels
    - 703-907-6440
    - [lrđ@nreca.coop](mailto:lrđ@nreca.coop)
  - NRECA's K. Brubaker
    - 703-907-6414
    - [ken.brubaker@nreca.coop](mailto:ken.brubaker@nreca.coop)

28

“The only way to discover the limits of the possible  
is to go beyond them  
into the impossible” Arthur C. Clark (1917 - )

Accredited Systems are the leaders who do this!





**RUS 2004 ELECTRIC  
ENGINEERING SEMINAR**

**FEBRUARY 10-11, 2004**

**NEW ORLEANS, LA**

**Critical Infrastructure Protection  
RUS Security Requirements**

**John Pavek**

**Chief, Distribution Branch**

**RUS Homeland Security  
Representative.**

*BIOGRAPHICAL SKETCH*

**JOHN PAVEK**

John Pavek is the Distribution Branch Chief of the Electric Staff Division. John is also the RUS Homeland Security Representative, a member of the Rural Development Homeland Security Task Force, the North American Electric Reliability Councils Critical Infrastructure Protection Advisory Group and has represented the USDA on a number of the Homeland Security Councils Policy Coordination Committees. John has a Master of Arts degree in National Security and Strategic Studies and a diploma from the College of Command and Staff from the United States Naval War College in Newport, Rhode Island. John obtained his undergraduate degree from the State University of New York Maritime College in Marine/Mechanical Engineering with a minor in Nuclear Engineering. John was an Officer in the United States Navy Reserve from 1985 till 1994. John has worked in the electric utility industry since 1988 as a lineman; line supervisor and a system operator for Investor owned utilities in New York State and joined RUS in 1998. Prior to working in the electric utility industry, John sailed as First and Chief Engineer on various Tugboats and Tankers out of New York.

# **Critical Infrastructure Protection –RUS Security Requirements**

The September 11 attacks highlighted terrorists are capable of causing enormous damage by attacking our critical infrastructure. The August 14, 2003, Northeast Power Outage further identified the electric grid as a target and some of its weaknesses.

## **Critical Infrastructures Defined**

Physical and virtual systems and assets that are so essential to the minimum operations of government and the economy that the incapacity of such systems and assets would have a debilitating impact on national security; economic security; public health or safety; or any combination of these.

## **Critical Infrastructure**

Critical infrastructures have been identified as energy sources to include: electrical, nuclear, gas, oil, and dams, information and telecommunications networks, water, food, agriculture, health and emergency services, transportation to include: air, road, rail, ports and waterways, banking and finance systems, and postal systems.

## **Basic Principles of Protecting Critical Infrastructure**

Some of the basic principle that assists in the protection of America's critical infrastructure include: surveillance, two-way communications and the understanding that it is a shared responsibility of the Federal Government, State Government, Local Government and the private sector.

Electric utilities need to develop and maintain Plans and Procedures, Orders of Succession, Delegations of Authority, Alternate Facilities, Interoperable Communications, Vital files, Records & Databases, Exercises, training & testing and define Essential Functions.

## **Plans and Procedures**

A utility should develop a plan that: delineates essential functions and activities; outlines a decision process for determining appropriate actions and implementing plans & procedures; and establishes a roster of emergency personnel with authority to perform essential functions. The plan should also include procedures for employee advisories, alerts and emergency restoration plan activation.

## **Orders of Succession**

Orders of succession need to be established for the organization head and for other key headquarters leadership positions. These orders should identify limitations of authority and establish rules and procedures addressing: condition of succession, method notification and time, geographical, and organization limitations.

### **Delegation of Authority**

- Identify programs & administrative authorities needed
- Identify which authorities can/should be delegated
- Identify circumstances in which specific authorities becomes effective

### **Alternate Facilities**

- Capable of supporting operations in threat free environment
- Interoperable communications
- Reliable logistical support services & infrastructure systems
- Appropriate physical security & access controls
- Health, safety & emotional well being of personnel

### **Vital Files, Records & Data Bases**

A utility must protect and back up vital files, records and databases (VFRDB) to ensure the ability to continue business operations with the loss of access to its headquarters. Some examples of VFRDB are: business, legal & financial records, personnel, payroll, insurance, contracts, customers, emergency operating records, plans & directives, orders of succession, and delegation of authority and staffing assignments

### **Exercises, Training & Testing**

In order to properly assess the viability of an emergency restoration plan, particularly under emergency or stressful conditions, a utility must exercise and test the plan. Such testing will create a familiarity with the plan and its procedures. A utility should incorporate exercises for individual & team (G&T with Distribution members) personnel. Internal exercising of emergency plans and procedures, testing of alert and notification systems, joint utility exercising of emergency plans and procedures (Mutual Aid) and refresher orientation should be performed annually.

### **REA/RUS Previous Requirements**

- REA BULLETIN 60-7 (1960)
- RUS BULLETIN 1730-1 (1998)

### **RUS Security Requirements**

A borrower will need to perform a vulnerability and risk assessment of its own system for both the physical and cyber elements of all plant. The assessment should consider who the system serves, identify specific critical components unique to the system and determine if components are crucial to the utility and possibly national security.

The utility has the option to perform a self assessment or hire a contractor which can be a G&T (energy provider). Borrowers can obtain vulnerability and risk assessment information from DHS - Protective Security Division, DOE, NRECA (which maintains a contractors list) or pick a contractor on their own. The vulnerability and risk assessment will be self-certified.

### **Emergency Restoration Plan**

RUS is not planning on dictating a specific, unilateral Emergency Restoration Plan (ERP) as all utilities are not the same and one size does not fit all. RUS does expect borrowers' ERPs to incorporate consideration of unnatural disasters to include terrorism both domestic & foreign.

RUS expects borrowers' ERP's to exist in written form, be certified and signed by top management (CEO, Manager, etc.,) and that copies must be readily available to key personnel. RUS also expects the ERP's to be exercised annually, at a minimum, to ensure operability and employee competency while also serving to identify and correct deficiencies that manifest themselves during testing. Borrowers will indicate the existence and their annual testing of the ERP by appropriately recording information on Part II, "Operations and Maintenance" of RUS Form 300, "Review Rating Summary.". A borrower's ERP must also include a business continuity section, identify Key Utility Management Personnel, incorporate a chain of command and delegation authority, include a spare parts emergency supply agreement on critical items with Equipment Suppliers or other utilities, and serve to develop and maintain Mutual Aid Agreements. The ERP must have key emergency contact telephone (land and cell) numbers such as: Local, State & Federal Law Enforcement (FBI), Federal Emergency Management Agency (FEMA), chemical, biological, radiological, and health incident response teams.

### **Federal Guidance**

- The National Strategy for The Physical Protection of Critical Infrastructures and Key Assets: [www.whitehouse.gov/pcipb/physical.html](http://www.whitehouse.gov/pcipb/physical.html)
- National Strategy for Homeland Security: [www.whitehouse.gov/homeland/book](http://www.whitehouse.gov/homeland/book)
- The National Strategy to Secure Cyberspace: [www.whitehouse.gov/pcipb](http://www.whitehouse.gov/pcipb)

### **Private Sector Guidance**

- North American Electric Reliability Council's Critical Infrastructure Protection Advisory Group
- Guidelines for Physical and Cyber Security: [www.nerc.com](http://www.nerc.com)

### **Presidential Decision Directives**

- PDD – 63 May 22, 1998 Critical Infrastructure Protection
- Executive Order 13228 October 8, 2001 Establishing Office of Homeland Security

- Executive Order 13231 October 16, 2001 Critical Infrastructure Protection in the Information Age
- HSPD-1 October 29, 2001 Organization & Operation of the Homeland Security Council
- HSPD-5 February 28, 2003 Management of Domestic Incidents
- HSPD-7 December 17 2003 Critical Infrastructure Identification, Prioritization, and Protection

# RUS 2004 Electric Engineering Seminar

John B. Pavek  
Branch Chief  
Electric Staff Division  
RUS Homeland Security

February 10, 2004

Rural Utilities Service  
Homeland Security

1

## Critical Infrastructure Protection

- September 11 attacks highlighted terrorists are capable of causing enormous damage by attacking our critical infrastructure
- August 14, 2003, Northeast Power Outage further identified the electric grid as a target

Rural Utilities Service  
Homeland Security

2

## August 14, 2003 Blackout

- 21 power plants shut down in 3 minutes (10 nuclear)
- Impacted area covering 50 million people
- 9,300 sq. miles without power
- 62,000 MW of power lost
- Worst blackout in US history
- **Cascading effects across all critical infrastructures**



Courtesy of DOE OEA

3

## Critical Infrastructures Defined

- **USA Patriot ACT of 2001**
  - systems and assets, whether physical or virtual, so vital to the United States that the incapacity or destruction of such systems and assets would have a debilitating impact on:
    - Security
    - National economic security
    - National public health or safety
    - Any combination of those matters

Rural Utilities Service  
Homeland Security

4



## Interdependency on Electricity

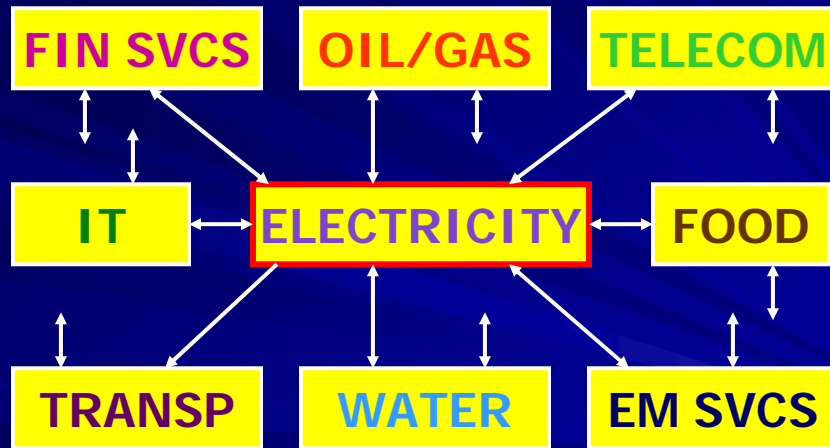

Rural Utilities Service  
Homeland Security

5

## Critical Infrastructure

- **Energy sources**
  - Electrical
  - Nuclear
  - Gas
  - Oil
  - Dams
- **Information and telecommunications networks**
- **Water**
- **Food**

Rural Utilities Service  
Homeland Security

6

## Critical Infrastructure

- Agriculture
- Health and Emergency Services
- Transportation
  - Air
  - Road
  - Rail
  - Ports
  - Waterways
- Banking and Finance Systems
- Postal Systems

Rural Utilities Service  
Homeland Security

7

## Protecting America's Critical Infrastructure

- Surveillance
- Communications
- Shared responsibility
  - Federal Government
  - State Government
  - Local Government
- Active partnership
  - Private sector - 85 % Critical Infrastructure

Rural Utilities Service  
Homeland Security

8

# VIABLE CAPABILITY

- Plans and Procedures
- Essential Functions
- Orders of Succession
- Delegations of Authority
- Alternate Facilities
- Interoperable Communications
- Vital files, Records & Databases
- Exercises, training & testing

## Plans and Procedures

- PREPARE CLEAR, UNCOMPLICATED PLANS AND CLEAR, CONCISE ORDERS TO ENSURE THOROUGH UNDERSTANDING
  - Broad strategies and guidance, rather than detailed instructions, encourage flexibility
  - Direct, simple plans reduce misunderstanding and confusion
  - Simple plans executed promptly are preferred over complex plans executed later

## Plans and Procedures

- Develop a plan that:
  - Delineates essential functions and activities
  - Outlines a decision process for determining appropriate actions, implementing plans & procedures
  - Establishes a roster of emergency personnel with authority to perform essential functions
  - Includes procedures for employee advisories, alerts and emergency restoration plan activation

## Plans and Procedures

“Make your plans to fit the circumstances.”

"A good plan executed today is better than a perfect plan executed at some indefinite point in the future."

General George S. Patton, Jr.

## Orders of Succession

- Establish for Organization Head
- Establish for other key headquarters leadership position
- Identify Limitations of Authority
- Establish rules and procedures addressing:
  - Condition of succession
  - Method Notification
  - Time, geographical, organization limitations

## Delegation of Authority

- Identify programs & administrative authorities needed
- Identify which authorities can/should be delegated
- Identify circumstances in which becomes effective

## Alternate Facilities

- Capable of supporting operations in threat free environment
- Interoperable communications
- Reliable logistical support services & infrastructure systems
- Appropriate physical security & access controls
- Health, safety & emotional well being of personnel

## Vital Files, Records & Data Bases

- Business, Legal & Financial Records
  - Personnel
  - Payroll
  - Insurance
  - Contracts
  - Customers
- Emergency Operating Records
  - Plans & directives
  - Orders of succession
  - Delegation of authority
  - Staffing assignments

## Exercises, Training & Tests

- Individual & team (G&T with Dist. Members)
- Internal exercising of emergency plans and procedures
- Testing of alert and notification system
- Refresher orientation
- Joint utility exercising of emergency plans and procedures (Mutual Aid)

## REA/RUS PREVIOUS REQUIREMENTS

### ➤ REA BULLETIN 60-7 (1960)

*“Every system should have an **emergency plan** which outlines a course of action in the event of source or substation transformer failure, excessive storm damage, etc. The plan should provide for **obtaining outside help** from neighboring systems and contractors when needed. The coordination of outside help with system personnel requires **planning ahead** of the disaster. Such details as **availability** of system maps, staking sheets and other **records, communication facilities**, housing and food for extra personnel should be considered. The plan must be **tested periodically** to see that it is operational.”*

# REA/RUS PREVIOUS REQUIREMENTS

➤ RUS BULLETIN 1730-1 (1998)

*“Each borrower should have a **written plan** detailing how to restore its system in the event of a system wide outage resulting from a major natural disaster or other causes. This plan should include how to **contact emergency agencies, borrower management and other key personnel**, contractors and **equipment suppliers, other utilities**, and any others that might need to be reached in an emergency. It should also include recovery from loss of power to the headquarters, key offices, and/or operation center facilities. It should be **readily accessible at all times** under any and all circumstances.”*

## Homeland Security

- RUS will be amending 7 CFR Part 1730 to establish policy to include Homeland Security measures. It will require that borrowers of RUS funds perform a vulnerability and risk assessment (physical and cyber) on their systems and establish and exercise an emergency restoration plan. Publication of the proposed rule is expected early 2004.

**NO ERP = NO \$\$\$**



## RUS Emergency Restoration Plan Time Line

Initiating Events

Determination whether Rule is Needed

Preparation of Proposed Rule

Internal Review of Proposed Rule

Publication of Proposed Rule

30 day Comment Period

Review & Evaluate Comments

Preparation of Final Rule

Publication of Final Rule

Electric System Emergency Restoration Bulletin

## RUS Security Requirements

### ■ VULNERABILITY / RISK ASSESSMENT

CO-OP's will need to perform a vulnerability and risk assessment of its own system

### ■ Physical and Cyber

- Consider who the system serves
- Identify specific critical components unique to the system
- Determine if components are crucial to the utility and possibly national security

# RUS Security Requirements

vulnerability assessment cont.

## Who Performs Assessment ??

Self Assessment  
G&T  
Contractor

## Where to get vulnerability assessment information ??

DHS  
Protective Security Division  
DOE  
Office of Energy Assurance  
NRECA  
Contractor list  
NERC

✓ **SELF CERTIFIED**

Rural Utilities Service  
Homeland Security

23

# RUS Security Requirements

## EMERGENCY RESTORATION PLAN

- Incorporate unnatural disasters to include terrorism (domestic & foreign)
- RUS not planning on dictating a specific, unilateral Emergency Restoration Plan (ERP)
- All utilities are not the same and one size does not fit all

Rural Utilities Service  
Homeland Security

24

## RUS Security Requirements

### EMERGENCY RESTORATION PLAN

- Exist in written form, be certified and signed by the borrower's CEO and Manager and approved by the Board of Directors
- Copies must be readily available to key personnel
- Include a business continuity section

## RUS Security Requirements

### Emergency Restoration Plan

- It must be exercised annually, at a minimum, to ensure operability and employee competency
- Serve to identify and correct deficiencies that manifest themselves during testing
- Recorded on RUS Form 300, Part II. Operations and Maintenance verifying compliance



# RUS Security Requirements

## EMERGENCY RESTORATION PLAN

- Develop and maintain a Mutual Aid Agreements and flowcharts
  
- It must have key emergency contact numbers
  - Local, State & Federal Law Enforcement (FBI)
  - Federal Emergency Management Agency (FEMA)
  - Chemical, Biological Radiological & Health Incident Response Teams

## EMERGENCY RESPONSE TELEPHONE NUMBERS

- **Chemical Incident**  
National Response Center  
[www.nrc.uscg.mil/](http://www.nrc.uscg.mil/) 1-888-424-8802  
202-267-2675
  
- **Biological Incident**  
Medical Research Institute of Infectious Diseases  
[www.usamrid.army.mil/](http://www.usamrid.army.mil/) 1-888-872-7443
  
- **Radiation Incident**  
Armed Forces Radiobiology Research Institute  
[www.affri.usuhs.mil/](http://www.affri.usuhs.mil/)  
AFRRI/MRAT (301) 295-0530  
1-800-SKY-PAGE Pin 801-0338  
  
Radiation Emergency Assistance Center  
[www.orau.gov/reacts/](http://www.orau.gov/reacts/)  
8:00 a.m.-4:30 p.m. (CST) (865) 576-3131  
After 4:30 p.m. (CST) (865) 576-1005

# EMERGENCY RESPONSE TELEPHONE NUMBERS

- **Health Incident**
  - Health and Human Services [www.hhs.gov](http://www.hhs.gov)  
[www.dhhs.gov](http://www.dhhs.gov)
  - Center for Disease Control [www.cdc.gov](http://www.cdc.gov)  
[www.bt.cdc.gov](http://www.bt.cdc.gov)
  - Public Inquiries (404) 639-3534  
(800) 311-3435
  - Centers for Disease Control and Prevention (24/7)  
(404) 639-3311  
Hot Line 888-246-2675
- **Criminal or Terrorist Incident**
  - Federal Bureau of Investigation  
[www.fbi.gov/contact/fo/territory.htm](http://www.fbi.gov/contact/fo/territory.htm)
  - National Infrastructure Protection Center  
[www.nipc.gov](http://www.nipc.gov) (202) 323-3205  
Toll free: 888-585-9078

Rural Utilities Service  
Homeland Security

31

## Construction Changes for Security

What specific physical security changes is RUS looking at ????

“Never tell people how to do things. Tell them what to do and they will surprise you with their ingenuity.”

General George S. Patton, Jr.

Rural Utilities Service  
Homeland Security

32

## Federal Guidance

The National Strategy for **The Physical Protection of Critical Infrastructures and Key Assets**

[www.whitehouse.gov/pcipb/physical.html](http://www.whitehouse.gov/pcipb/physical.html)

National Strategy for **Homeland Security**

[www.whitehouse.gov/homeland/book](http://www.whitehouse.gov/homeland/book)

The National Strategy to **Secure Cyberspace**

[www.whitehouse.gov/pcipb](http://www.whitehouse.gov/pcipb)

## Private Sector Guidance

North American Electric Reliability Council's  
Critical Infrastructure Protection Advisory Group  
Guidelines for Physical and Cyber Security

[www.nerc.com](http://www.nerc.com)

## Presidential Decision Directives

- PDD – 63
  - May 22, 1998 Critical Infrastructure Protection
- Executive Order 13228
  - October 8, 2001 Establishing Office of Homeland Security
- Executive Order 13231
  - October 16, 2001 Critical Infrastructure Protection in the Information Age
- HSPD -1
  - October 29, 2001 Organization & Operation of the Homeland Security Council
- HSPD -5
  - February 28, 2003 Management of Domestic Incidents
- HSPD – 7
  - December 17, 2003 Critical Infrastructure Identification, Prioritization, and Protection

## FINAL THOUGHTS

"After we have thought out everything carefully in advance and have sought and found without prejudice the most plausible plan, we must not be ready to abandon it at the slightest provocation. Should this certainty be lacking, we must tell ourselves that nothing is accomplished in warfare without daring; that the nature of war certainly does not let us see at all times where we are going; that what is probable will always be probable though at the moment it may not seem so; and finally, that we cannot be readily ruined by a single error, if we have made reasonable preparations."

**Karl von Clausewitz**



**RUS 2004 ELECTRIC  
ENGINEERING SEMINAR**

**FEBRUARY 10-11, 2004**

**NEW ORLEANS, LA**

**Avian Protection Working Group  
The New Mexico Experience**

**Dennis Rankin**

**Environmental Protection Specialist  
Engineering and Environmental Staff  
RUS**

*BIOGRAPHICAL SKETCH*

**DENNIS RANKIN**

Mr. Rankin received a Bachelor of Arts Degree in Biology and a Master of Science Degree in Biology from West Virginia University.

He was employed by West Virginia University/Water Resource Research Institute as a research assistant from 1971 to 1973 working on the effects of acid mine drainage and thermal pollution. From 1973 to 1977 he was employed by Ecometrics, Inc., as a project analyst and manager. In 1977 and 1979 he worked as a project manager for the Ohio River Basin Energy Study and as a private consultant.

Employed by the Rural Electrification Administration since 1979, he has held the position of Environmental Protection Specialist dealing mainly with electric and telephone projects in the Western and Southwest areas of the United States. Mr. Rankin currently holds the position of Environmental Protection Specialist within the Engineering and Environmental Staff of the Water and Environmental Programs at the Rural Utilities Service.

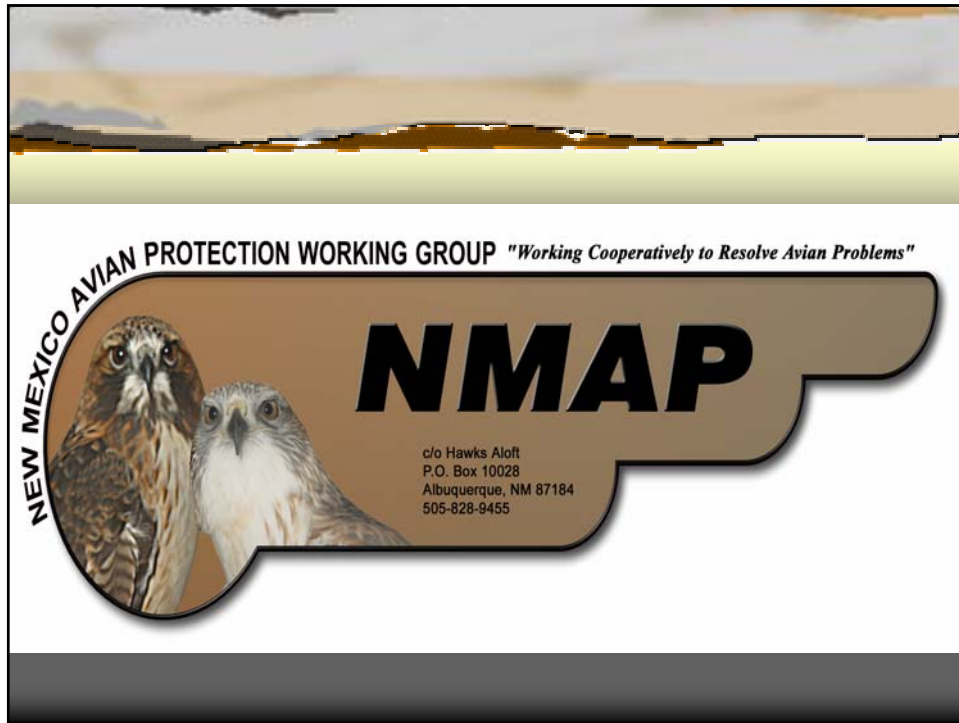

## BACKGROUND

Electrocution / Collision Problem

⇒ USFWS Concern – 1970

⇒ Moon Lake Electric Association – 1999

## BACKGROUND

- ⇒ Raptor Electrocution Prevention Workshops
  - Colorado - 2000
  - Alaska - 2000
  - North Dakota - 2001
  - Montana - 2001
  - Kansas - 2002
  - Florida - 2003
  - Georgia - 2003
  - South Dakota - 2003

## Purpose and Objectives

- ⇒ Formed in February 2002 to address avian mortalities and injuries due to electrocution and collision with power lines in New Mexico.
- ⇒ To work with the cooperatives and other utilities to heighten awareness of avian issues and to develop an affordable framework for a statewide avian protection plan.
- ⇒ To include the USFWS as a working member as an alternative to Moon Lake.

## New Mexico Avian Protection Working Group

Founding Members:

- ⇒ Hawks Aloft, Inc.
- ⇒ New Mexico Dept of Game & Fish
- ⇒ New Mexico Falconer's Association
- ⇒ Public Service Company of New Mexico
- ⇒ Rural Utilities Service
- ⇒ US Fish & Wildlife Service

## Establish a good team

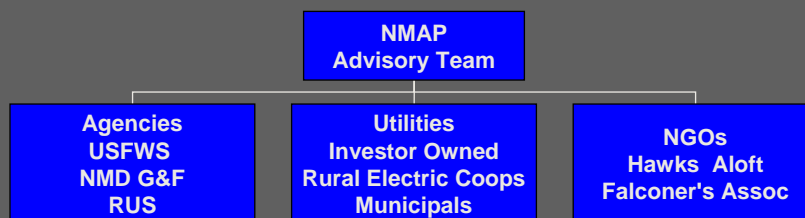

## **New Mexico Avian Protection Working Group /Other Participants**

- ⇒ Excel Energy (TX)
- ⇒ Hurd Museum (TX)
- ⇒ Forest Service
- ⇒ Bureau of Land Management
- ⇒ Bureau of Indian Affairs
- ⇒ Florida Power & Light

## **Support**

- ⇒ APLIC Speakers and Materials
- ⇒ PNM Foundation
- ⇒ Equipment Providers
- ⇒ EPRI speakers
- ⇒ Consultant Speakers
- ⇒ Agency Speakers/Materials

## Workshops

1<sup>st</sup> Workshop August 2002

Free 1 ½ day workshop

Invitations to attend

Purpose: 1) Increase Awareness of NM problems

2) Provide State of the Art knowledge

3) Further collaboration between Agencies and industry

## 1<sup>st</sup> Workshop Results

- ⇒ 103 Attendees representing:
  - ⇒ 5 Federal Agencies
  - ⇒ 3 State agencies
  - ⇒ 5 investor Owned Utilities
  - ⇒ 16 NM Electric Cooperatives
  - ⇒ 5 Arizona Electric Cooperatives
  - ⇒ Engineering Consultants
  - ⇒ Non Governmental Organizations
- ⇒ Talked about:
  - ⇒ NM Raptors
  - ⇒ Live Bird Demos
  - ⇒ Factors influencing electrocution
  - ⇒ Justification/ Benefits of Raptor Protection Plans
  - ⇒ Laws/ Permits Spoke about positive experiences by Coops
  - ⇒ Avian Protection Plans
  - ⇒ What we could do to help NM utilities

## 2<sup>nd</sup> Workshop Feb 2003

Full 2 days

98 attendees with the same mix of representation

Fee charged to offset costs

Notebook provided for full fee attendees

1 Day APLIC Training included

- ⇒ Design Standards
- ⇒ EPRI avian interaction with wind turbines and collision issues
- ⇒ PacifiCorp's Raptor Electrocutation Reduction Program
- ⇒ PG&E's Avian Protection Plan Presentation









## Workshop Products

- Bird Identification Guide (Raptors)
- Feather Identification Guide (Raptors)
- New Mexico Avian Concentration Map
- List of New Mexico Wildlife Rehabilitators
- Guide For What To Do If You Find An Injured Bird

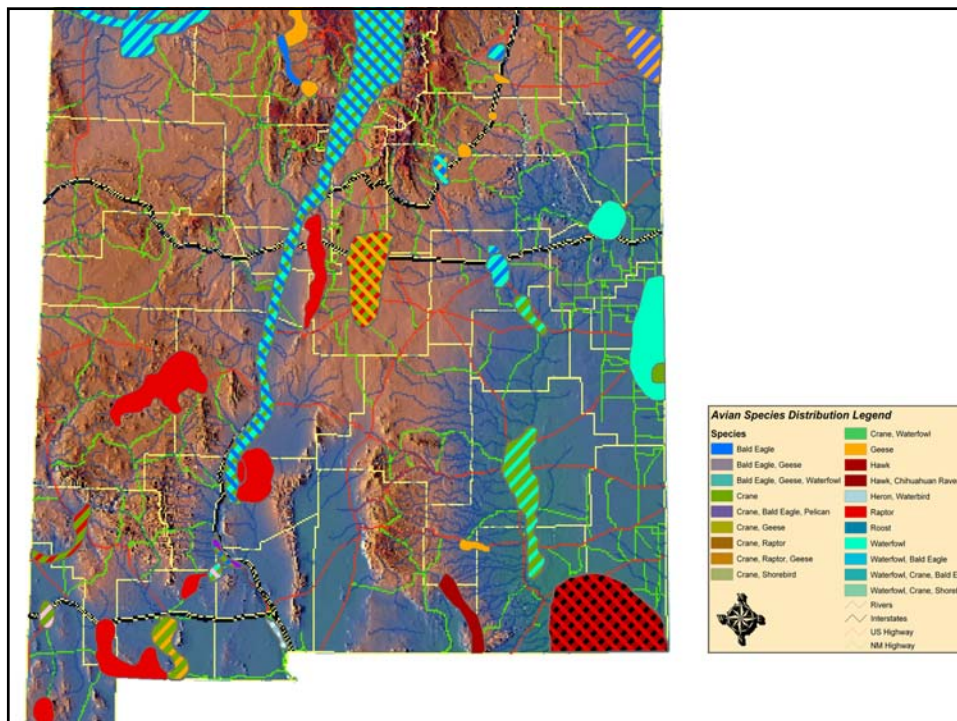

## **Third Workshop Agenda**

- Avian Protection Plans
- New Mexico Avian Protection Areas
- Problem Structures/Retrofits
- Federal/State Agency Requirements
- Wind Generation
- Oil Field Discussion
- Field Trip/Pole Yard/Retrofits

## **Proposed Workshop Products**

- Nest Identification Guide (Raptors)
- Egg Identification Guide (Raptors)
- Detailed New Mexico Avian Concentration Map and Discussion

## Conclusions

- NMAP is doing some rather non-traditional things to resolve concerns in New Mexico
- We are working on the basic parts of APPs for our members which will reduce costs and stimulate results
- We are using collective thinking with the USFWS to solve common problems in the spirit of cooperation and collaboration.
- Other states showing an interest in establishing a similar kind of arrangement.

**RUS 2004 ELECTRIC  
ENGINEERING SEMINAR**

**FEBRUARY 10-11, 2004**

**NEW ORLEANS, LA**

**Joint Use Contracts and  
Attachment Procedures**

**Ty Diamond**

**Vice President  
Engineering and Operations  
Flint Energy**

## *BIOGRAPHICAL SKETCH*

### **TY DIAMOND**

After graduating from the University of Florida in 1983 with a degree in Electrical Engineering, Mr. Diamond was employed by Sumter Electric Cooperative as an Electrical Engineer. While in this position, he performed sectionalizing studies on numerous substations, designed and built several 69kV/25kV substations, revised the Distribution Specification Manual, and was the project manager for the installation of a 69kV transmission line. In 1985, Mr. Diamond received the position of Director of Operations. His duties included supervising the Engineering and Operations Department of the cooperative, consisting of 55 employees. The department performed the following work: two year and long range work plans, SCADA and load management systems, staking, metering and communications, transformer shop, line crews, right-of-way program, etc. He was the Project Manager for a 230/69kV substation.

In 1987, Mr. Diamond joined Flint Electric Membership Corporation as the Section Manager of Engineering. His duties included performing the technical engineering such as completing two year work plans and long range studies, sectionalizing studies, building substations, implementing a scada and load management program, and building a looped analog microwave system. Around 1990, Mr. Diamond received his professional engineering license from the State of Georgia. His supervisory responsibilities included the Staking Department, Metering and Communications, Transformer Shop and Drafting. He was promoted to the Manager of Engineering in October of 1990. The Procurement section, which included Warehousing, Purchasing, Building Maintenance and Vehicle Maintenance was added to his previous responsibilities. He negotiated a contract with PCS providers and built a new digital 6 GHz Microwave System for the cooperative at no cost.

Mr. Diamond became the Vice President of Engineering and Operations in June of 1999. Here he picked up the operations side of the cooperative in addition to his previous duties. Operations includes line crew operations and right-of-way. Presently, Mr. Diamond supervises a department of approximately 100 cooperative employees and 60 contract personnel. He further advanced his education obtaining a Masters in Business Administration in May of 2003 from Georgia College and State University.

## **Joint Use Contracts and Attachment Procedures**

Joint use contracts and attachments pose one of the greatest challenges to engineering and operations personnel of electric cooperatives today. Many factors play into the proper management of a joint use program to ensure safety to workers and proper operation of the electric and communication systems involved. This paper will explore many of the considerations involved in a joint use contract and how they should be implemented. The joint use agreement establishes the relationship between the electric utility and the communication provider. The agreement should address all engineering, operational, and economic issues between the two companies.

Let's start with the technical issues of the agreement. First, the agreement must specify that both parties must abide by the National Electrical Safety Code (NESC), latest edition, standards of any government agency that apply (federal, state, local, etc.) or standards specified in the contract. The standard which is more stringent should apply. Clearances between electric and communication facilities are very important for safety to workers and the public. Rules 235 and 238 of the NESC specify vertical clearances between electrical and communication facilities. Rule 232 specifies vertical clearances above ground and other surfaces. The rules should be applied accordingly. Drawings illustrating these guidelines should be made part of the contract. There needs to be an agreement between the cooperative and communications company as to what clearance standards apply and include drawings to clarify these.<sup>1</sup>

Cooperatives should design their distribution systems to allow attachment of communication company facilities when installing poles. Clearance drawings in the joint use agreement should specify seven or eight feet between the bottom of the neutral bracket and the top of the communication cable bracket where no electrical equipment exists on a pole.



Clearance above ground must exist for this to take place. This allows electrical equipment to be added at a later time. Even though the NESC allows 40 inches between the bottom of a neutral bracket and the top of the communication cable bracket, many code violations are created by transformers being installed on poles after communication cables are already present. Installing communication facilities at this separation requirement would eliminate many future code violations. Of course, if seven or eight feet is not available, the 40 inch rule as stated in the NESC would apply. While 30 inches of clearance between a neutral (as defined in Rule 230E1 of the NESC) conductor and a communication conductor is allowed by footnote 5 of Table 235-5 of the NESC, it is not recommended as a standard due to misapplication by field personnel. Other common clearance issues involve keeping 30 inches between the bottom of grounded transformer tanks and the top of CATV or phone attachment hardware or cable. Also, 40 inches is required from the lowest point of secondary wire (attachment hardware or conductor) to the top of the communication attachment bracket or cable. It is important to measure from the closest surface areas when evaluating these clearances.<sup>2</sup>

The NESC also requires midspan vertical clearances between electrical facilities and communication facilities to be 75% of the clearances stated in Table 235-5. The temperature and loading requirements, when taking the measurements, is defined in 235C2C of the NESC. Many times, the clearances of the supports at the poles will have to be greater than the 40 inches normally required between secondary conductors and communication cables to meet midspan clearance requirements. This is due to long span lengths, loading, wire size, sag, etc.<sup>3</sup>

Pole size and loading is often critical in evaluating whether existing poles are acceptable for joint use. Sag and tension parameters of both the cooperative and communication company conductor must be known to make the pole loading calculations that are required. Sections 24,

25, and 26 of the NSEC define loading criteria on which poles should be evaluated for joint use consideration. Care should be taken to study the NSEC to make sure all appropriate overload factors are applied correctly in determining pole strength requirements. Many times, communication cables place more loading stress on poles than electric facilities. The sag and tension charts used by the cooperative and the communication company should be shared with one another so design parameters will be known when evaluating pole strength. From past experience, it is often difficult to determine what sag and tension parameters communication companies use. It is critical this information be obtained to evaluate permit requests from attachment companies. It is in the best interest of the cooperative to install poles to accommodate joint use attachments when a line is built in areas where communication companies are anticipated in the future. Failure to plan ahead leads to problems. The time for installation of 35 foot poles distribution is past for many areas of the country. A 40 foot pole should be the minimum installed and circumstances should be evaluated to determine if 40 foot poles are tall enough. Pole classes should be based on strength requirements.

Guy and anchor considerations should be carefully evaluated in joint use. CATV and phone companies should not use cooperative's anchors unless permission has been obtained to do so. Many times, there is not enough room for installation of additional anchors and the cooperative and communication companies should work together for the benefit of the public. Poor guying and anchoring practices lead to inadequate pole loading, sag and clearance problems, etc.

Next, the operational parameters needed in a joint use agreement are discussed to protect the cooperative from an operational point of view. The operational process for a communication

company to place attachments on a pole is listed below and should be part of the joint use agreement.

1. Permit Submission – The communication company should submit a permit application requesting joint use. The permit should contain all the engineering data to insure the NESC is met along with other requirements specified in the joint use agreement. Pole sizes (height and class) should be provided along with the existing clearances of all facilities from the distribution neutral hardware bracket down to the ground. The attachment company should state at what height its new cable will be attached on the pole. The clearances at the pole should be evaluated to ensure they are correct based on standards applied for electric facilities and communication cables. Existing and proposed midspan clearance should be stated for compliance with standards relating to above ground clearances and clearance between facilities. A map showing span lengths, cable size and type, guys, anchors, poles size, location, number of poles, etc., should be included with the permit. Enough information must be provided to develop a profile of the line. Sag and tension data should be provided for the communication cable if this information has not been provided to the cooperative prior to the time of the permit. Also, it is important that the cooperative provide design criteria for its sag and tension to the communication company. Without this information, the communication company can not structurally evaluate the line in question. All make ready work that needs to be completed for attachments to be made should be identified on the permit. This includes pole change outs, rearrangements of secondary cable, other pre-existing joint use cables, etc. It should be clearly stated in the joint use agreement that all responsibility and liability for attachment to cooperative poles is born by the communication company.

With this said, experience has shown that without proper evaluation of the process by the cooperative, standards will not be met that are required in the joint use agreement. Some cooperatives require a P.E. sign the permit for the communication company; most do not.

2. Pre-Construction Meeting – After the permit request has been made, a meeting should be scheduled between the field engineers of the cooperative, the communication company requesting attachments, and any pre-existing attachment company on the pole. All parties should evaluate the line on site and agree on all make ready work which must be completed before any attachments are made. If make ready work is required, the cooperative should state the cost to the CATV or phone company for approval. If the communication company approves the costs in writing, collect payment for make ready work in advance of performing construction and then perform the work. The attachment company should pay the cooperative for this pre-construction meeting preferably by a flat hourly fee. Both make ready and pre-construction cost should be stated as the responsibility of the communication company in the agreement. It should also be stated that the company making attachments must pay for make ready costs of any other joint use companies with facilities already on the pole. Remember to tell the attachment company where they should be on the pole. If seven or eight feet of clearance exists below the neutral, make them attach at that height if proper ground clearance can be obtained. This allows addition of cooperative equipment in the future.
3. Post Construction Inspection – the field engineers of the cooperative and attachment company should perform an inspection of the line after attachments have been made. Cost of this inspection should be born by the communication company. Any violations of standards should be identified with clean up to occur within 30 days. Should

cooperative or other pre-existing attachment companies have to perform work to resolve violation of construction standards, these costs should be paid by the company making attachments. Should the attachment company fail to correct such violations, the cooperative should make the corrections and bill the attachment company for all costs, terminate the agreement, or carry out both options. This should complete the installation process of new attachments.

4. Transfers – The joint use agreement should allow the cooperative to transfer the communication company’s attachments when changing out poles. Attachments should only be transferred that the cooperative is qualified to perform. A flat transfer fee should be stated in the agreement that would be paid to the cooperative. All other attachments should be transferred by the communication company within 60 days after receipt of transfer request from the cooperative. This arrangements lowers costs to all parties as the cooperative does not have to send employees back to pull poles and the attachment company does not have to send employees out to perform work. Some union contracts of attachment companies prevent this arrangement. Any attachments that cannot be transferred by the cooperative must be monitored to see they are completed. Any transfers not completed within 60 days should trigger a penalty to be billed to the communication company on a per attachment basis. The cooperative should always maintain the right by contract to have the transfers made by the cooperative or a third party and bill the attachment company. Termination of the agreement should also be an option but exercised last and with advice of legal counsel.
5. System Inspection – At a time chosen by the cooperative but no longer than five years, a representative of the cooperative and attachment companies should perform an inspection

of the system and determine the number of attachments present for billing and the existence of any NESC code violations. All code violations should be identified and corrected within 60 days by the responsible party. Failure to comply with this requirement should cause termination of the agreement, correction of the problem by the cooperative with cost born by the company in violation and/or both consequences. Problems involving attachment companies constitute a great deal of code violations present on electric utility systems today. Sometimes it is difficult to determine which party in the agreement caused the violation. Who built what when? In such cases, it may be best to share the cost to resolve the problem.

6. Easements – The joint use agreement should require that all attachment companies obtain their own easements.
7. Overlashing – Overlashing should require submission of a permit for evaluation by the cooperative for compliance with technical standards. There is much debate as to whether or not this is a new attachment and should be billed.
8. Attachments – All attachments should be placed on the same side of the pole to allow climbing.
9. Identification of Cable and Contact Information – The agreement should specify the attachment company identify their cable a minimum of every third pole with a metallic tag carrying the name of the company and a specific color. This designation makes it easy to determine which companies are present on poles. The contact information for contract issues and operational issues should be stated in the agreement. Many times, these contacts are different employee positions and there may be more than one if

different operating districts are involved. After hours contact information is also very important.

10. Unauthorized Attachments – Unauthorized attachments should be considered as a serious offense and should be stated as such in the agreement. The options listed in a joint use agreement to be exercised by the cooperative should be any or all of the following:
  - A. Penalty fee for unauthorized attachment.
  - B. Submission of a permit request for the attachments in question with the associated costs normally required in the agreement. Permit required must be submitted in seven days.
  - C. Considered a breach of contract and calls for termination of the agreement.
11. Space Reallocation – A statement should be in the agreement allowing the cooperative to take back the space granted to the attachment company should it ever be needed. Many joint use contracts have this present in them, but it leads to much debate. The attachment company would have to pay for the additional space to be constructed if they choose to stay on the pole.

Another highly debated topic is the cost companies pay for making attachments. While a majority of cooperatives are not regulated in determination of attachment rates, the FCC does provide a formula for determination of attachment fees. RUS has also had formulas to determine such rates. Based on experience, most contract discussions start out with some form of rate methodology and end by negotiation. A basis for increase of the attachment rates should be established such as CPI. This stipulation saves a great deal of time in negotiation when established rates in a contract expire. It is not uncommon to see phone attachment costs based on allocation of space and CATV cost on

a per attachment basis. Whichever path is chosen for phone or cable agreements should be standard throughout the cooperative's attachment agreements.

Many legal considerations need to be addressed by the cooperative's counsel in regard to these agreements. Some of these include proper insurance requirements, continuing terms of the agreement, hold harmless and liability clauses, and actions resulting in termination of the agreement, etc. Always ensure the cooperative's engineering personnel and corporate counsel work together to establish the joint use contract.

All of the above criteria discussed should be part of a joint use agreement. One of the most important items in any contractual relationship of this type is communication between parties. Cooperatives, phone and CATV companies should be sharing system plans and upgrades with each other. Problems in engineering and construction practices should be discussed and resolved. Education of each party's employees as to the requirements of the agreement should be carried out. This includes construction personnel who deal with each other on a daily basis. Joint use is certainly beneficial to the public and the cooperative should seek to recover all costs associated in this endeavor.



## References

---

<sup>1</sup> Institute of Electrical and Electronics Engineers, Inc. National Electrical Safety Code, 2001, pp 71-148.

<sup>2</sup> Ibid.

<sup>3</sup> Ibid.

**JOINT USE CONTRACTS  
AND ATTACHMENT PROCEDURES**

**Ty Diamond**  
VP of Engineering and Operations



**NRECA WILL SOON  
HAVE AVAILABLE A  
GUIDE FOR  
CONTRACTS WITH  
COMMUNICATION  
COMPANIES**

## What Should Be In A Joint Use Contract?

- A. Engineering
- B. Operational
- C. Economic
- D. Legal

## ENGINEERING

- A. NESC, NEC, federal, state, local, cooperative standards, etc.
- B. Rules 235 and 238 of the NESC specify vertical clearances between electrical and communication facilities on the pole.
- C. Rule 232 of the NESC specifies vertical clearances above ground.

**D. Measurements between electrical facilities and communication facilities are surface to surface.**

**E. If space is available on the pole and above ground, have CATV and phone attached at 7 to 8 feet below the neutral. This prevents future code violations when the cooperative hangs a transformer on the pole.**

**F. Design space and strength into distribution lines when they are built in an area expecting joint use.**

**G. On distribution lines, the NESC normally allows 40 inches between lower surface of the neutral bracket and upper surface of the nearest communication facilities.**

- H. Midspan clearances between distribution electrical facilities and communication facilities are required to be 75% of the clearances stated in Table 235-5 of the NESC. Due to span lengths, wire size, sag, etc., clearances may have to be increased over those stated in NESC Table 235-5 at the pole to achieve this standard.
- I. Sections 24, 25, and 26 of the NESC define loading criteria for poles and poles should be evaluated under these criteria to allow joint use. Often, communication cables cause more loading on poles than electrical lines.

## Operational Issues

- A. Joint use company submits a permit – NRECA Guide.
  - 1. All Engineering data needs to be included – pole size and class, existing and proposed clearances (at pole and midspan), sag and tension data, conductor size, needed make-ready work, etc.

## **B. Pre-Construction Meeting**

- 1. Review line in question and permit request with joint use company.**
- 2. Charge a flat hourly fee for employee's time and state in the contract.**
- 3. Agree with attachment company on make-ready work and then send them a bill for make-ready work up front. NRECA guide states send an estimate and then bill for actual work.**
- 4. No attachments are made until all make-ready work is completed.**

## **C. Post-Construction Inspection – Not in NRECA Guide**

- 1. Inspect attachments after construction is performed at a flat hourly rate.**
- 2. Any needed change completed within 30 days or corrections will be made by cooperative or third party at the joint user's expense.**

#### **D. Transfers**

- 1. Try to get language in the contract to allow cooperative to make transfers at a specified fee. Only those transfers cooperative employees are qualified to do.**
- 2. Any transfers that can't be made by cooperative should be made by the attachment company within 60 days. Failure to do so should trigger a penalty to be billed on a per attachment per month basis. NRECA guide suggests cooperative perform transfers and bill joint user or the pole becomes property of joint user with all liability.**

**E. System Inspection – Perform inspection on system for attachment count and NESC violations. Code violations should be cleaned up within 60 days or cooperative perform work and bill, terminate agreement, access penalty or any or all of the above. NRECA Guide.**

**F. Attachment companies obtain their own easements. NRECA Guide.**

**G. Overlapping – Joint user submits a permit for. NRECA Guide**

**H. All attachments on the same side of pole.**

**I. Identification of attachment with metallic color-coded tag and contact information – NRECA Guide.**

**J. Unauthorized attachments are serious offense with consequences.**

**1. Penalty Fee - \$100 per attachment.**

**2. Permit request for attachment in question within 7 days with associated costs.**

**3. Termination of Contract.**

**4. Any and all of the above.**

**5. NRECA Guide covers this subject.**



**K. Space reallocation – Have a clause in the agreement stating cooperative can take back space if needed for use, and joint use company can pay to change out pole if needed.**

**L. All attachment companies must maintain facilities in accordance with the NESC, NEC, and applicable standards.**

## **Economic Issues**

**(NRECA Guide does a good job here.)**

**A. FCC Formula**

**B. RUS Formula**

**C. Negotiation**

**D. Discussion on rates normally start off with a rate methodology and end with negotiation, especially phone company joint use contracts.**

**E. If not getting \$20-\$27 per pole for two feet of space allocation, or \$10-\$15 per attachment, review your contracts.**

**F. Increase rates based on CPI.**

**G. Is a security deposit or performance bond needed for non-payment or bankruptcy?**

## **Legal**

**(NRECA Guide - Consult your cooperative's Counsel.)**

**A. Insurance requirements and worker's compensation.**

**B. Termination clauses and notice.**

**C. Liability and hold harmless clauses.**

**D. Many others.**

## Conclusion

- A. Engineering and legal counsel should work together to establish good joint use agreements.
- B. Educate cooperative employees on attachment process and contractual requirements in joint use agreements – field engineering and line personnel.

- C. Establish good communications with joint users and make sure all parties know what to expect and responsibilities.
- D. Plan ahead and build lines for joint use when expected.
- E. Have tight contracts with joint users and take the time to perform contracts correctly.

**RUS 2004 ELECTRIC  
ENGINEERING SEMINAR**

**FEBRUARY 10-11, 2004**

**NEW ORLEANS, LA**

**RUS Technical Publications**

**Fred Gatchell**

**Deputy Director  
Electric Staff Division, RUS**

*BIOGRAPHICAL SKETCH*

**FRED GATCHELL**

Mr. Gatchell is the Deputy Director of the Electric Staff Division, responsible for, among other duties, coordinating the updating and issuing of many of RUS' technical publications. In his 28 years with RUS/REA, he has also been with the Power Engineering Branches of the Northwest and the Northeast Areas and with the Power Plants Branch.

Before joining RUS/REA, Mr. Gatchell worked at the Norfolk Naval Shipyard and at Bechtel Power Corporation. He received a B.S. in Mechanical Engineering from the University of Maryland, and is a registered professional engineer in Virginia.

## RUS Technical Publications

RUS has issued a number of technical publications recently. These publications include:

### RULES:

- **7 CFR 1710, Subpart H, “Demand Side Management and Renewable Energy Systems.”** This final rule, dated November 21, 2002, eliminated Subpart H in its entirety. The old Subpart H detailed separate policies and requirements for loans for renewable energy systems and demand side management. Many of these requirements overlapped provisions found elsewhere in part 1710. Others did not seem well suited for the smaller scale projects of the type that are becoming increasingly common in the industry. RUS decided that it is more appropriate to consider such small scale projects in this rapidly developing segment of the energy industry by proceeding on a case-by-case basis.

For more information, please contact Georg Shultz of ESD at 202-720-1920 or at [Georg.Shultz@usda.gov](mailto:Georg.Shultz@usda.gov).

- **7 CFR 1726, Revision of Electric Program Standard Contract Forms.** This proposed rule, dated July 2, 2002, would update, consolidate, and streamline our standard forms of contracts. This would include the elimination of unneeded forms, making forms suitable for “subject to” or “not subject to” RUS approval, making construction contract forms suitable for “labor only” or “labor and material,” standardizing tables and information pages and incorporate them as separate attachments, maximizing consistency among forms, and updating and clarifying contract provisions as necessary. These changes are being made to improve the usefulness of the standard forms of contract.

For more information, please contact Fred Gatchell of ESD at 202-720-1398 or at [Fred.Gatchell@usda.gov](mailto:Fred.Gatchell@usda.gov).

- **7 CFR 1794, Environmental Policies and Procedures.** This final rule, dated August 1, 2003, revised RUS’ existing environmental regulations. The amended final rule contains a variety of changes from the provisions of the previous rule. Most of these revisions are minor or merely intended to clarify existing RUS policy and procedure and to ensure that procedures are consistent among the three RUS programs. Other revisions expand upon the existing types of actions that are subject to environmental review or reclassify actions within categories.

For more information, please contact Larry Wolfe, Senior Environmental Protection Specialist, Engineering and Environmental Staff, at 202-720-5093 or at [Larry.Wolfe@usda.gov](mailto:Larry.Wolfe@usda.gov).

## GUIDANCE DOCUMENTS:

The following five bulletins replace REA Bulletin 160-2, "Mechanical Design Manual for Overhead Distribution Lines." This series of bulletins is the result of considerable effort of the Overhead Lines Subcommittee of the NRECA T&D Engineering Committee. RUS would like to thank the subcommittee members who helped make this series of bulletins possible.

- **Bulletin 1724E-150, "Unguyed Distribution Poles – Strength Requirements,"** dated July 31, 2003. This presents equations, data, and other information needed to determine:
  - \* The loads applied to unguyed wood distribution poles,
  - \* A pole's strength requirements to sustain applied loads, and
  - \* Maximum horizontal spans based on pole strengths.Sample solved problems are included in this bulletin to help the reader understand and apply the presented equations. A table of calculated ground line moments caused by wind on wood poles and a table of calculated permitted moments at the ground line of commonly used wood poles are included at the end of this bulletin.
- **Bulletin 1724E-151 "Mechanical Loading on Distribution Crossarms,"** dated November 21, 2002. This bulletin presents equations, data, and other information needed to determine the permitted mechanical loading on wood distribution crossarms. Sample solved problems and tables of permitted crossarm loading are presented to help the reader understand and apply the information in this bulletin.
- **Bulletin 1724E-152, "The Mechanics of Overhead Distribution Line Conductors,"** dated July 31, 2003. This bulletin will present and explain:
  - \* The equations needed to calculate ruling spans and conductor sags and tensions,
  - \* Guidelines for preparing or selecting sag-tension tables,
  - \* The characteristics, behavior, and installation of distribution line conductors, and,
  - \* Information regarding aeolian vibration.
- **Bulletin 1724E-153, "Electric Distribution Line Guys & Anchors,"** dated April 25, 2001. This guide bulletin provides information needed to properly design guying for conductors attached to wood distribution poles. To this end, the bulletin contains data, equations, and sample calculations. The bulletin also contains information regarding standard RUS anchor and guying assemblies and their component parts to assist the user in the proper selection and installation of these assemblies.

- **Bulletin 1724E-154, “Distribution Conductor Clearances and Span Limitations,”** dated July 31, 2003. The conductor clearance requirements of Rule 235 of the National Electrical Safety Code (NESC) may limit overhead distribution span lengths. This bulletin presents information and the equations needed to determine the maximum span lengths that will meet NESC mid-span and supporting structure clearance requirements between conductors. Only bare electric supply conductors supported by the Rural Utilities Service (RUS) standard distribution primary, pole-top assemblies are analyzed in this bulletin. However, the equations presented in this bulletin can be applied to other types of conductors and support assemblies. Diagrams and example solved problems are included in this bulletin to clarify the presentation.

For more information, please contact Jim Bohlk of ESD at 202-720-1967 or at Jim.Bohlok@usda.gov.

- **IP 202-1, “List of Materials Acceptable for Use on Systems of RUS Electrification Borrowers,”** published in July, 2003, and its quarterly supplements. This document provides a convenient listing of the materials and equipment that have been accepted by RUS.

For more information, please contact Harvey Bowles of ESD at 202-720-0980 or at Harvey.Bowles@usda.gov.

- **“Summary of Items of Engineering Interest,”** published in August, 2003, continues the practice of furnishing annually, on an informal basis, engineering information and developments related to the rural electrification program.

For more information, please contact Fred Gatchell of ESD at 202-720-1398 or Fred.Gatchell@usda.gov.

If you need any of these publications, please contact RUS' Program Development and Regulatory Analysis staff at 202-720-8674. Many RUS publications are also available via the Internet at:

*For Rules:* <http://www.usda.gov/rus/electric/regs/index.htm>

*For Bulletins:* <http://www.usda.gov/rus/electric/bulletins.htm>

#### PUBLICATIONS IN PROGRESS:

**Timber Specifications:** RUS is in the process of revising the following three bulletins that cover pressure treating of poles and crossarms, and their respective quality control:

- **Bulletin 1728F-700, “RUS Specification for Wood Poles, Stubs and Anchor Logs,”**
- **Bulletin 1728H-701, “RUS Specification for Wood Crossarms (Solid and Laminated) Transmission Timbers and Pole Keys” (7 CFR 1728.201), and**



- **Bulletin 1728H-702, “RUS Specification for Quality Control and Inspection of Timber Products”** (7 CFR 1728.202).

Topics currently being considered for revision include:

- \* Elimination of the requirement for borrowers to notify RUS of their timber product purchases during the previous year,
- \* Reinstatement of the acceptance and listing of inspection agencies in the RUS List of Materials,
- \* Requirement for a heat sterilization during kiln drying or steam conditioning of poles,
- \* Requirement for inspection agencies to have their company designation branded or tagged on the pole face,
- \* Requirement for all independent inspectors and plant quality control personnel to be trained and certified by x-ray fluorescence instrument manufacturer,
- \* Requirement for treating plants and inspection agencies to maintain certain levels of liability insurance and errors and omission insurance, and
- \* Include butt treating of cedar poles as an acceptable method of treatment for poles.

RUS is soliciting input from electric borrowers and others as to necessary changes to these bulletins. Comments or suggestions should be sent to H. Robert Lash, Chief, Transmission Branch, RUS, Stop 1569, 1400 Independence Ave SW, Washington, DC 20250-1569, e-mail: Bob.Lash@usda.gov. All comments are welcome.

RUS is also working on the following publications:

- **Bulletin 1724D-114, “Voltage Regulator Application on Rural Distribution Systems.”** This bulletin will examine the application of voltage regulators on rural distribution systems and serve as a general guide for voltage regulator applications to RUS borrowers and others.

For more information, please contact John Pavek of ESD at 202-720-5082 or at John.Pavek@usda.gov.

- **Bulletin 1724E-200, “Design Manual for High Voltage Transmission Lines.”** This publication is an excellent reference of fundamental engineering guidelines and basic recommendations. The subject area includes structural and electrical aspects of transmission line design as well as explanations and illustrations. Numerous cross-references and examples, along with the latest in design philosophy, should be of great benefit to engineers performing design work for RUS borrower transmission lines. It should be particularly helpful to relatively inexperienced engineers beginning careers in transmission line design. RUS, with the help of the NRECA Transmission Line Subcommittee, is currently updating and expanding this bulletin to meet the 2002 NESC,

to include information and references to steel and concrete pole construction, to add information on polymer insulators, and to update the manual concerning the use of computer aided design programs. The bulletin is going through final editing and should be available in the spring of 2004.

For more information, please contact Don Heald of ESD at 202-720-9102 or at Don.Heald@usda.gov.

- **Bulletin 1724E-220, “Procurement and Application Guide for Non-Ceramic Insulators, Voltage Class 34.5 kV and Above.”** This guide is being proposed to simplify the procedure in selecting and procuring non-ceramic insulators. While most, if not all, utilities are experts on the use of ceramic insulators, utilities are in a learning mode when it comes to use of non-ceramic insulators. Over the years, non-ceramic insulator use has steadily increased. In the same time frame, changes made in the manufacturing processes to produce non-ceramic insulators have been continual. There have been vast improvements from the first generation non-ceramic insulators to those on the market today.

RUS, with the help of the NRECA Transmission Line Subcommittee, is working on a guide to aid in the process of specifying and procuring non-ceramic insulators with development of this proposed bulletin. This guide is being proposed to simplify the procedure in selecting and procuring non-ceramic insulators. Some of the topics that currently are proposed to be addressed in the guide include:

- \* Advantages and disadvantages of non-ceramic insulators,
- \* Materials,
- \* Electrical and mechanical considerations,
- \* Interchangeability with ceramic insulators and replacement,
- \* Environmental and quality assurance,
- \* Testing, and
- \* Handling

The majority of the information in the guide will be directed towards transmission suspension insulators but post and station post insulators will also be discussed. Also included in the proposed guide will be a sample specification for non-ceramic insulators.

This guide is the result of considerable effort of the Transmission Subcommittee of the NRECA T&D Engineering Committee. RUS would like to thank the subcommittee members who helped make this bulletin possible.

For more information, please contact Don Heald of ESD at 202-720-9102 or at Don.Heald@usda.gov, or Norris Nicholson of ESD at 202-720-1924 or at Norris.Nicholson@usda.gov.

- **Bulletin 1726A-125, “Joint Use Agreements with CATV Companies.”** This bulletin is currently being updated as a “tool kit” by NRECA with input from RUS and the NRECA Overhead Lines Subcommittee. The “tool kit” contains “pick and choose” elements that can be used to create a joint use agreement with telecommunication companies. It also has some rental rate formulas to choose from. Once completed, NRECA will post this bulletin on their website. Afterwards, RUS will update 1726A-125 as an abbreviated guide bulletin and reference the NRECA tool kit. We expect this project will be completed in late 2004.

For more information, please contact Jim Bohlk of ESD at 202-720-1967 or at Jim.Bohlik@usda.gov.

- **Bulletin 1728F-U-1, “RUS Specifications for 15 kV, 25 kV, and 35 kV Primary Underground Power Cable”** (incorporated by reference.) RUS is in the process of revising RUS Bulletin 50-70 (U-1), “RUS Specification for 15 kV and 25 kV Primary Underground Power Cable.” The revised bulletin will be renumbered RUS Bulletin 1728F-U-1 and be renamed, “RUS Specifications for 15 kV, 25 kV, and 35 kV Primary Underground Power Cable.” The bulletin is being revised to keep abreast of current primary insulated cable technology. The U-1 Bulletin will provide RUS specifications on 15 kV, 25 kV and 35 kV primary underground cables.

Highlights of the changes that will be proposed include:

- \* A water blocking sealant would be required in all stranded conductor cables.
- \* Plain cross-linked polyethylene (XLP) would be removed and be replaced by cross-linked polyethylene with tree-retardant (XLP-TR) as an acceptable insulation material.
- \* Nominal insulation thickness on 25 kV cable would be reduced from 345 mils to 260 mils.
- \* A 35 kV rated cable would be included as an RUS acceptable operating voltage for underground residential distribution cable and the specifications for this voltage rating would be included in the revised bulletin.
- \* A semi conducting jacket will be specified in the proposed bulletin and it is intended to be used on cables to be installed in areas with soil resistivities greater than 2500 ohm-centimeters in lieu of insulating jacket.

For more information, please contact Trung Hiu, Electrical Engineer, Distribution Branch, at 202-720-1877 or at Trung.Hiu@usda.gov.

- **Bulletin 1728F-803, “Specifications and Drawings for 24.9/14.4 kV Line Construction.”** This bulletin was issued by RUS in December 1998 and became effective in July 2001. RUS is updating this bulletin to include a complete set of narrow profile assemblies, clarify borrowers’ options to use either the new or the old assembly

numbers, and correct several errors and omissions. The updating of this bulletin is well underway, and should be completed in late 2004 or 2005.

For more information, please contact Jim Bohlk of ESD at 202-720-1967 or at Jim.Bohlok@usda.gov.

- **Bulletin 1728F-804, “Specifications and Drawings for 12.47/7.2 kV Line Construction”** (incorporated by reference.) This will be an update of an existing Bulletin 50-3 with the same title.

This bulletin will update the specifications and drawings that are to be used by borrowers in the construction of 12.47/7.2 kV overhead electric distribution lines and associated equipment and construction assembly units. It is one of the RUS standards that help borrowers build safe, reliable, and economical electric facilities in rural America. Listed below are some of the significant changes and additions which are being considered in connection with the update of this bulletin:

The bulletin will be reformatted into 19 separate sections or categories. Most of the sections contain construction specifications, an index of drawings, and construction drawings of assemblies designed to perform a similar function.

- \* New tables will be added to define maximum line angles, permitted unbalanced conductor tensions, and soil classification data. Appendix 1 at the end of the bulletin will document the formula and data used to determine the line angles in the tables. Appendix 2, also at the end of the bulletin, will document the formula and data used to determine permitted unbalanced conductor tensions.
- \* All of the drawing numbers will be changed to a uniform format in which each character in the number has a functional meaning. However, most of the drawings and assemblies, brought forth from previous Bulletin 50-3, will also show the same numbers previously used in Bulletin 50-3. Borrowers may use at their discretion either the old numbers or the new numbers for these assemblies.
- \* Each drawing has been given a new, shorter, and more uniform title or name.
- \* "Design parameters", which define and usually limit maximum line angles or mechanical loading (tension), will be added to most of the drawings.
- \* Several new construction "guide" drawings will be added which will show the configuration and spacing of more than one assembly on a structure, or will show the installation details of full or partial assembly units. These drawings will not list the material used.
- \* A set or coordinated, three-phase “narrow profile” assemblies and drawings will be incorporated into this bulletin. (For more information, please see the paper entitled “New RUS Narrow Profile Construction Assemblies” included in this Engineering Seminar.)

- \* New conditions and specifications for the use of stirrups will be added.

For more information, please contact Jim Bohlk of ESD at 202-720-1967 or at Jim.Bohlik@usda.gov.

- **7 CFR 1730, “Electric System Emergency Restoration Plan.”** RUS is planning to amend its regulations to require electric borrowers to have an Emergency Restoration Plan. This plan is to detail how the utility will restore its system in the event of a system wide outage resulting from a major natural or man-made disaster or other causes. The Emergency Restoration Plan is to include preventative measures and emergency recovery from physical and cyber attacks to electric systems and core businesses and is to include Homeland Security concerns. There is no intent to dictate a specific, unilateral plan to all borrowers; as all electric utilities are not the same and one size does not fit all. RUS will, however, require that an acceptable Electric Emergency Restoration Plan be in place, that it be exercised annually, and that the plan be specific to the borrower’s system and its particular system needs.

RUS is also drafting a companion guide, **Bulletin 1730-2, “Electric System Emergency Restoration Plan,”** that will identify key provisions that should be incorporated into a borrower’s emergency restoration plan and will provide references to assist utilities in identifying specific critical components unique to its system and possibly national security. This bulletin will also contain general methodologies, practices, and planning related to procedures which support the protection of electric systems and support homeland security in the protection of the electric infrastructure. This bulletin will also outline RUS suggested practices with respect to instituting security measures.

For more information, please see the paper entitled “Critical Infrastructure Protection - RUS Security Requirements” included in this Engineering Seminar or contact John Pavek ESD at 202-720-5082 or at John.Pavek@usda.gov.

- **Bulletin 1730A-119, “Interruption Reporting & Service Continuity Standards for Distribution Systems.”** This will be an update of an existing Bulletin 161-1 with the same title. This bulletin was last issued in March, 1972. The revised edition will reflect changes in industry standards and practices as well as changes in RUS policies and regulations. This revision is being made with the assistance of the NRECA Power Quality Subcommittee.

For more information, please contact Timothy Roscoe ESD at 202-720-1792 or at Timothy.Roscoe@usda.gov.

If you would like more information or have any questions, please contact Fred Gatchell, Deputy Director, Electric Staff Division, at 202-720-1398 or at Fred.Gatchell@usda.gov.

# **RUS 2004 ELECTRIC ENGINEERING SEMINAR**

---

## **RUS TECHNICAL PUBLICATIONS**

**Fred Gatchell  
Deputy Director  
Electric Staff Division**

## **RUS TECHNICAL PUBLICATIONS - RULES**

---

### **7 CFR 1710, SUBPART H**

#### **DEMAND SIDE MANAGEMENT AND RENEWABLE ENERGY SYSTEMS**

**x Eliminated Special Requirements for These Projects**

**RUS TECHNICAL  
PUBLICATIONS - RULES**

---

**7 CFR 1726**

**REVISION OF ELECTRIC  
PROGRAM STANDARD  
CONTRACT FORMS**

× Update, Consolidate & Streamline

**RUS TECHNICAL  
PUBLICATIONS - RULES**

---

**7 CFR 1794**

**ENVIRONMENTAL POLICIES  
AND PROCEDURES**

× Updated & Clarified Requirements

# **RUS TECHNICAL PUBLICATIONS - GUIDES**

---

## **REA BULLETIN 160-2 MECHANICAL DESIGN MANUAL**

**Replaced by 5 Bulletins:**

- x 1724E-150 – Pole Strength**
- x 1724E-151 – Crossarm Loading**
- x 1724E-152 – Conductors**
- x 1724E-153 – Guys & Anchors**
- x 1724E-154 – Clearances & Span Limitations**

# **RUS TECHNICAL PUBLICATIONS - GUIDES**

---

- x LIST OF MATERIALS ACCEPTABLE  
FOR USE ON SYSTEMS OF RUS  
ELECTRIFICATION BORROWERS**
- x SUMMARY OF ITEMS OF ENGINEERING  
INTEREST**



## **RUS TECHNICAL PUBLICATIONS - COMING**

---

### **TIMBER SPECIFICATIONS**

- x POLES - 1728F-700**
- x CROSSARMS - 1728H-701**
- x QUALITY CONTROL - 1728H-702**

## **RUS TECHNICAL PUBLICATIONS - COMING**

---

- x VOLTAGE REGULATORS - 1724D-114**
- x TRANSMISSION LINE DESIGN MANUAL  
1724E-200**
- x NON-CERAMIC INSULATORS - 1724E-220**
- x JOINT USE AGREEMENTS – 1726A-125**
- x SPECIFICATION FOR UNDERGROUND  
CABLE - 1728F-U1**

## **RUS TECHNICAL PUBLICATIONS - COMING**

---

- x 25kV SPECIFICATIONS – 1728F-803**
- x 15kV SPECIFICATIONS – 1728F-804**
- x EMERGENCY RESTORATION PLAN  
RULE AND BULLETIN – 1730**
- x SERVICE CONTINUITY – 1730A-119**

**RUS 2004 ELECTRIC  
ENGINEERING SEMINAR**

**FEBRUARY 10-11, 2004**

**NEW ORLEANS, LA**

**New RUS Narrow Profile  
Construction Assemblies**

**Jim Bohlk  
Electrical Engineer  
Distribution Branch, and**

**Jim Higginbotham  
General Field Representative, RUS**

## *BIOGRAPHICAL SKETCHES*

### **JIM BOHLK**

Jim grew up in northwestern lower Michigan. He was graduated from Michigan State University in 1969 with a BSEE degree.

After college, Jim worked for 10 years at Ohio Edison Company in Akron. For the first 3 years he engineered distribution lines and facilities. Next he worked as an Industrial Sales Engineer. His last 4 years he performed short-range and long-range plans in the Planning Division.

Jim then accepted the position of System Engineer at Cherryland Electric Cooperative in Michigan. For 7 years he supervised the Engineering Department and performed all of the system's planning and special studies. He was then promoted to Operations Manager where he supervised both the Engineering and Line Departments.

Since coming to work at RUS in the Distribution Branch of the Electric Staff Division in 1990, Jim had updated the Construction Work Plan bulletin, the Long-Range System Planning bulletin, and the Specifications and Drawings for 24.9/14.4 kV overhead construction. He has made several presentations, including workshops, on various topics regarding distribution line design and planning. He serves on various NESC and NRECA committees.

### **JIM HIGGINBOTHAM**

Jim Higginbotham was born and raised in Alabama, received a BS in Management degree from Jacksonville State University (AL), a BS-Engineering degree from University of Alabama in Birmingham, and an MBA degree from University of Tampa (FL).

He worked for Tampa Electric Company (TECO) (an I.O.U.) as a power plant design engineer, a SCADA/EMS engineer, and a distribution operations engineer for 8 years. His co-op experience includes Chief Engineer for Joe Wheeler EMC, Trinity, AL (1 year), Manager of Engineering for Cullman EC, Cullman, AL (2 years), General Manager of Glades EC, Moore Haven, FL (5 years), and General Manager of Mountain EC, Mountain City, TN (1 year).

He is currently the General Field Representative (GFR) for RUS-SRD (3 years), serving borrowers in Alabama and parts of Florida and Tennessee.

## **New RUS Narrow Profile Construction Assemblies**

The Rural Utilities Service (RUS) has developed complete sets of 12.47/7.2 kV and 14.4/24.9 kV *proposed*<sup>1</sup> narrow profile assemblies for use by borrowers. Narrow profile construction can simply be defined as primary line construction without crossarms. The new RUS narrow profile designs offer the following features:

- The vertical and horizontal conductor spacing combined with the staggered configuration allows relatively long spans, comparable to crossarm construction, and thus is economically favorable. This feature is particularly advantageous in the transition from tangent to vertical assemblies,
- The 2-foot vertical spacing between the staggered conductor support brackets eliminates the need and cost of taller poles for narrow profile construction,
- The proposed designs can be used to convert existing RUS standard single-phase lines to three-phase narrow profile construction without changing out existing poles and materials,
- The proposed designs incorporate the RUS recommendation to have at least 12 inches of wood separation between conductor attachments and grounded or other conductor attachments,
- The proposed assemblies incorporate the RUS recommendation to have a 300 kV minimum Basic Insulation Impulse Level (BIL) for all pole top assemblies,
- All of the new proposed designs are relatively raptor friendly,
- Each proposed new assembly complies with the clearance requirements of the National Electrical Safety Code (NESC),
- Proposed assemblies are included for both NESC Grade C and Grade B construction,
- Each proposed new assembly can be constructed with materials presently listed in RUS Informational Publication 202-1, List of Materials Acceptable for Use on Systems or RUS Electric Borrowers (“List of Materials”), and,
- All line angles can be built without the use of crossarms by using the proposed new narrow profile assemblies in conjunction with other existing and proposed new RUS standard distribution assemblies.

---

<sup>1</sup> These narrow profile assemblies and designs are considered “proposed” until after they have been published as a final RUS rule in the *Federal Register*.

Each set of 92 new assemblies (depicted on 60 drawings) incorporates three different basic designs of pole-top assembly configurations:

1. The first design consists of a pole-top pin with the other primary support brackets mounted below in a staggered configuration. The spacing between the brackets is 21 inches. This proposed design and spacing utilizes the existing RUS distribution standard pole drilling and allows multi phasing of existing RUS standard single-phase lines without replacing the existing pole or materials.
2. The second proposed staggered design has 24 inch spacing between the primary conductor support brackets and can be used for new construction without pole-top pins. This design is applicable for transmission line underbuilds and double circuit distribution lines.
3. The third proposed design consists of installing all of the primary support brackets above one another on the same side of the pole. The spacing between the primary support brackets (and the neutral attachment) is 48 inches. This design can be used in narrow rights-of-ways and for additional clearances from trees or buildings. This design is needed to provide adequate clearance when multiple down guys are needed for medium and large line angle narrow profile assemblies.

Each new drawing has design parameters that define the maximum line angle for the assembly or else references a specific maximum line angle table. The drawings have new, uniform, standard title blocks and assembly descriptions. Since each proposed assembly is new, it has a new number that conforms to the recently updated RUS standard format and numbering scheme.

The proposed new designs include a complete set of post-type insulators assemblies. In addition to the assembly drawings are 5 new “guide drawings” that show narrow profile mounting arrangements for arresters, cutouts and single-phase primary taps.

RUS did not develop nor does RUS recommend a compact, triangular pole top design because such a design is not raptor friendly, does not lend itself to long span construction, and does not comply with the RUS BIL or wood spacing recommendations. The triangular design requires the same pole height as the proposed new RUS staggered design. Furthermore, the replacement of existing wood crossarms with fiberglass narrow profile brackets is relatively expensive and would not meet most of RUS’ design criteria.

Any metal or fiberglass narrow profile bracket (item “eq” or “fm”) that conforms to the proposed new design and is included in the RUS List of Materials may be used to construct the proposed new narrow profile assemblies. RUS has reviewed certified test results of each listed bracket and determined that each listed bracket can vertically support large conductors with adjacent spans over 400 feet. Engineers are advised to determine the required strength of narrow profile brackets for distribution line designs with extra large conductors or particularly long spans.

RUS assumes that fiberglass brackets have no electrical insulation (flashover) value and advises users to make the same assumption. Even though manufacturers may electrically test new fiberglass brackets, most manufacturers do not publish the brackets’ electrical flashover test results and certainly do not warranty the products to retain any insulation or flashover values

once the products have been installed and subjected to ultra-violet rays and other adverse environmental factors.

Presently RUS considers narrow profile to be non-standard distribution construction because narrow profile assemblies are not published in any of RUS' distribution construction drawings and specifications. RUS may approve narrow profile construction (similar to other non-standard construction), on a case-by-case, site-specific basis, if:

- (1) The borrower's General Field Representative (GFR) has reviewed the need or other sufficient reasons for narrow profile construction and approved its use, and,
- (2) The non-standard assemblies (and non-listed material if applicable) have been reviewed by the Regional Engineering Office in Washington and provided written approval.

RUS proposes to incorporate the proposed new narrow profile assemblies in the proposed new updated and revised Bulletin 803, "Specifications and Drawings for 12.5/7.2 kV Line Construction." This revised bulletin will be renumbered as RUS Bulletin 1728F-804. This proposed updated bulletin is presently in the review and approval process prior to its publication in the *Federal Register* as a proposed rule for comments. If still included in the document after publication in the *Federal Register* as a final rule (and there is no reason to expect they will not be included), the proposed new narrow profile assemblies will become standard construction assemblies and can be routinely used by borrowers without the need of further review and approval by RUS.

RUS recognizes borrowers' present needs and desires to use narrow profile construction. The following steps will allow borrowers to immediately begin using the proposed new RUS narrow profile assemblies prior to their standardization:

- (1) As presently established, each GFR may approve the use, if justified, of narrow profile construction on a case-by-case, site-specific project basis,
- (2) Upon request, the GFR will furnish the borrower with copies of the proposed new RUS narrow profile assembly drawings for use on the GFR approved projects,
- (3) RUS considers the proposed new narrow profile assemblies and resulting construction to be "experimental to gain experience." As such, RUS requests that borrowers provide comments and suggested improvements regarding the proposed assemblies and designs, and,
- (4) The GFR will inform the appropriate Regional Engineering Office in Washington in writing (to be placed in the borrower's file) information regarding each approved narrow profile construction project.

# **NEW RUS NARROW PROFILE CONSTRUCTION ASSEMBLIES**

**Jim Bohlk - Design**

**Jim Higginbotham - Availability**

**RUS 2004 ELECTRIC ENGINEERING SEMINAR**

New Orleans, Louisiana

February 11, 2004

## **New RUS Narrow Profile Construction Assemblies**

### **PART 1: TECHNICAL ASPECTS**



**Rural Utilities Service**

**Jim Bohlk**

Distribution Branch  
Electric Staff Division  
Washington, DC

**(202) 720-1967**

**Jim.Bohlik@usda.gov**





## Design Features – Save Money

Conductor spacing and staggered brackets allow long spans  
*(even tangent to vertical assemblies)*

No need for taller poles

Can convert to 3-phase using existing pole & 1-phase assembly



## New Designs Incorporate RUS Recommendations

Each assembly has a minimum of 12 inches of wood spacing between conductor supports

Each assembly has a minimum 300 kV BIL

Each assembly is relatively raptor friendly

## Additional Design Features

Each assembly meets NESC clearance requirements

Assemblies available for NESC Grade C and Grade B construction.

Each assembly can be constructed with material from “List of Materials”

Assemblies available for all line angles

## New Narrow Profile “Standards”

Complete sets available for both 12.47 and 24.9 kV construction

Each set has 92 assemblies plus guides for taps, cutouts and arresters

Each set includes post-type insulators

Each set has 3 fully developed designs with different bracket configurations



# 1. Staggered Bracket Design

(21 inch spacing utilizes standard pole drilling)  
 Application: Convert existing 1-phase to 3-phase

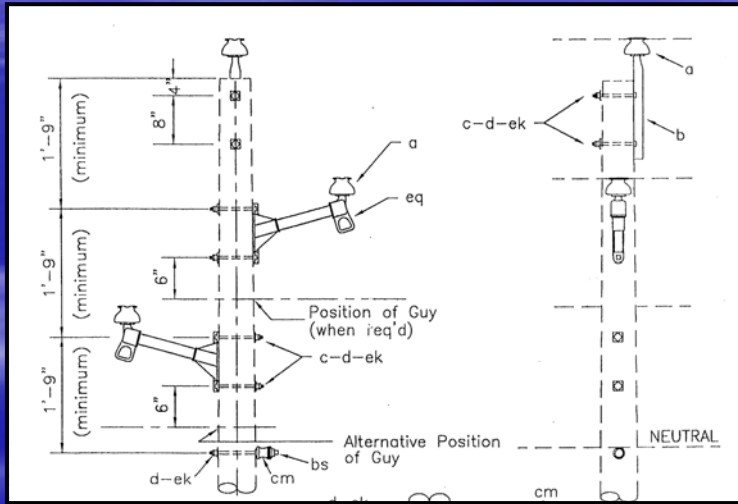

# 2. Staggered Bracket Design

(24 inch spacing for new construction)  
 Applications: Underbuilds & double circuits

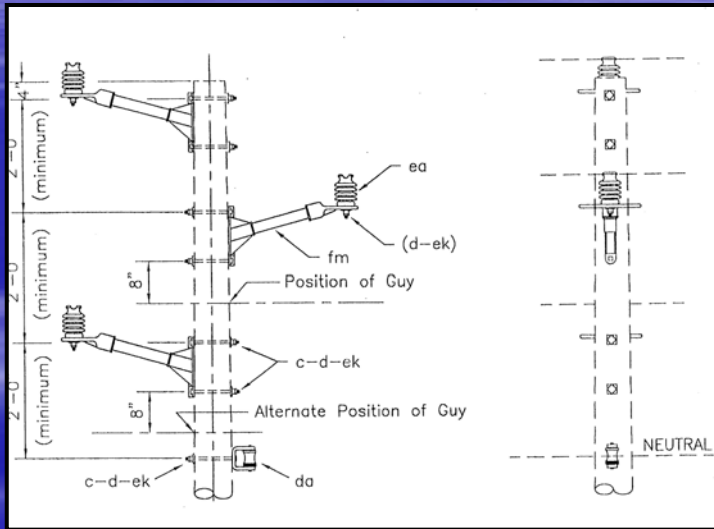

### 3. Vertical Design

(48 inch spacing for down guy clearances)

Applications: Narrow ROWs and tree clearances

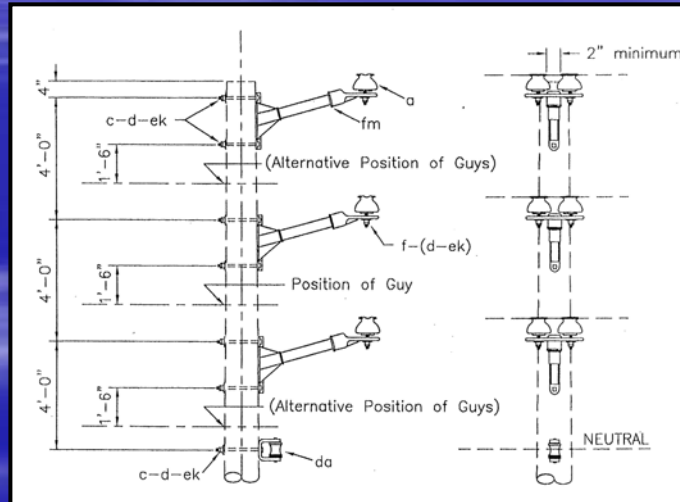

### New AutoCad Drawings

Post Type Insulators Added

Materials imply "Assembly"

New "Design Parameters"

Standard, Uniform Title Block and Drawing Titles

New Numbers !

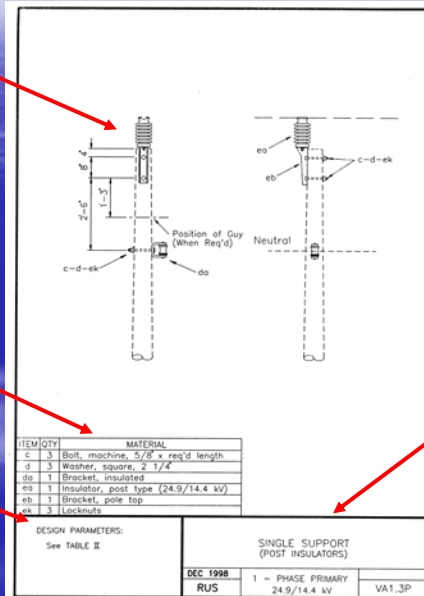

## Maximum Line Angles Referenced in “Design Parameters” on Assemblies

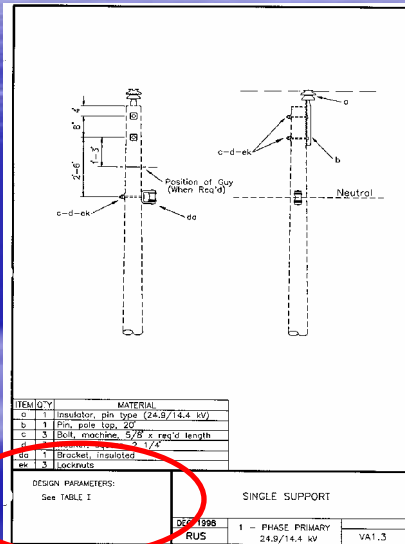

MAXIMUM LINE ANGLES:  
5° - Small Conductors  
2° - Larger than #1/0

Based on neutral  
conductor slipping  
off from insulator

Note: Line Angle Tables  
and formula derivation  
furnished with drawings

## “Triangular” design not recommended by RUS because:



Not raptor friendly

Limits span lengths

Less than 12 inches of wood  
separation

Less than 300 kV BIL

Needs same pole height



## **Narrow Profile Brackets, RUS “List of Materials”**

**Any bracket from “List of Materials”,  
(IP 202-1) may be used in new designs**

**“eq” = NP brackets & special arm assemblies**

**“fm” = Extension bracket for mounting apparatus**

**May use fiberglass or steel**

**RUS has ascertained vertical strength,  
(for spans well over 400 feet)**

**Engineers should check for long spans**



## **Narrow Profile Fiberglass Brackets**

**RUS assumes no electrical (flashover)  
insulation values for fiberglass  
brackets**

**Manufacturers test but do not publish  
or warranty insulation values after  
installation**

**RUS recommends that borrowers  
assume no insulation (flashover)  
values**

**New RUS Narrow Profile  
Construction Assemblies**

**PART 2: Availability**

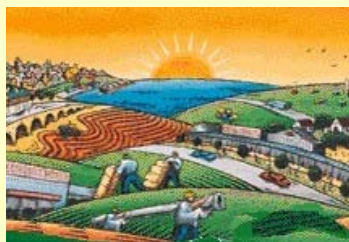

**Rural Utilities Service**

**Jim Higginbotham**

General Field Representative  
Southern Regional Division  
Anniston, Alabama

**(256) 240-2599**

**[Jim.Higginbotham@usda.gov](mailto:Jim.Higginbotham@usda.gov)**

## New Features of Bulletin 1728F-804 (Similar to 25 kV Bulletin 1728F-803)

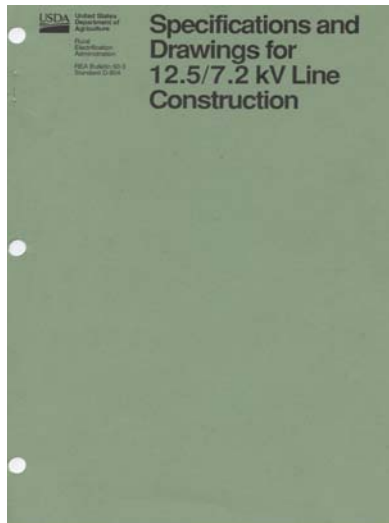

- New format – 19 Sections**
- New narrow profile, other assemblies & guide drawings**
- New “Design Parameters”**
- New and “dual” numbers (re-used assembly numbers may be used)**
- New appendix exhibits**
  - Disposition of old assemblies
  - Maximum line angle tables
  - Permitted crossarm load tensions

## Derivation of New Bulletin 1728F-804

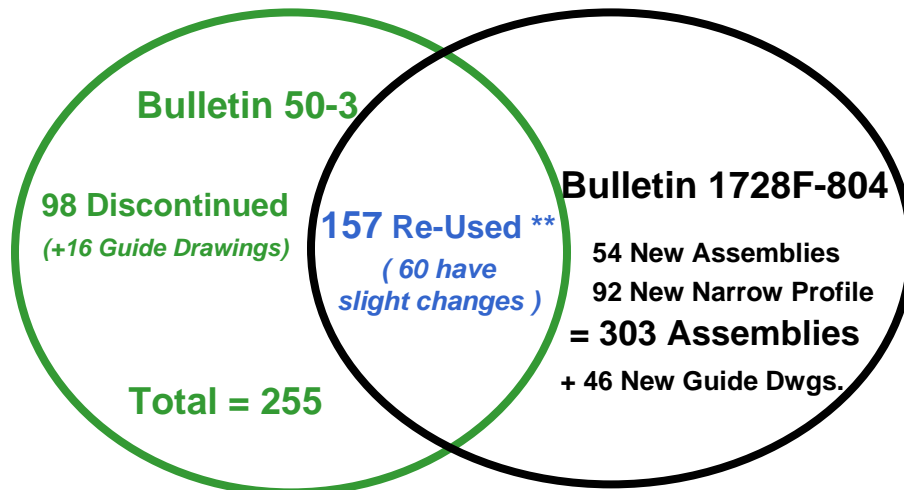

**\*\* 157 Old numbers (dual numbers) may be used**



# New Bulletin 1728F-804

**Specifications and Drawings for 12.5/7.2 kV Line Construction**

**BULLETIN 1728F-804: INDEX**

**MAXIMUM LINE ANGLES ON PIN INSULATOR ASSEMBLIES**

**APPENDIX 1: DERIVATION OF MAXIMUM PERMISSIBLE LINE ANGLES**

**TABLE II: MAXIMUM LINE ANGLES ON PIN INSULATOR ASSEMBLIES**

CONDUCTOR SIZE (AWG)	MAX. LINE ANGLE (DEG)
100	10
110	11
120	12
130	13
140	14
150	15
160	16
170	17
180	18
190	19
200	20
210	21
220	22
230	23
240	24
250	25
260	26
270	27
280	28
290	29
300	30

**Appendix 19 "Category" Sections**

**Assembly Drawings**

**Applicable Tables**

**Section Specifications**

**Section Index**

**Overall Index & Specifications**

# New AutoCad Drawings

**Post Type Insulators Added**

**Materials imply "Assembly"**

**New "Design Parameters"**

**Standard, Uniform Title Block and Drawing Titles**

**New Numbers !**

ITEM	QTY	MATERIAL
c	3	Bolt, machine, 5/8 x req'd length
d	3	Washer, square, 2 1/4"
do	1	Bracket, insulated
eo	1	Insulator, post type (24.9/14.4 kV)
eb	1	Bracket, pole top
el	3	Locknuts

**DESIGN PARAMETERS:** See TABLE II

**SINGLE SUPPORT (POST INSULATORS)**

DEC 1998 1 - PHASE PRIMARY  
RUS 24.9/14.4 kV VA1\_3P

# New Guide Drawings

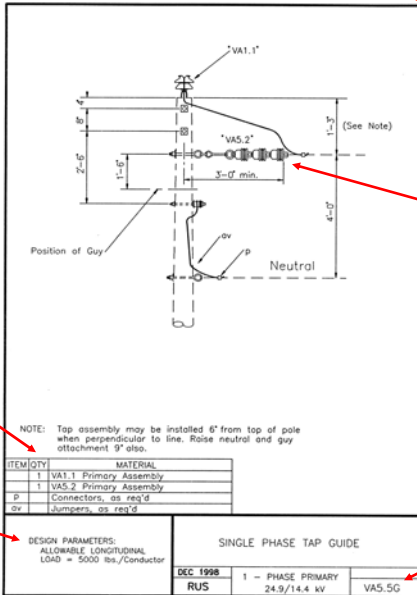

No Materials Imply Guide Drawing (List of Assemblies)

Note Design Parameters

New. 4-1/4 inch Insulators Shown

May use:  
three 6-inch  
two 9-inch  
one polymer deadend  
(Change material quantity as required)

Number Suffix "G" implies Guide Drawing

# New Guy Assembly Guide Drawings

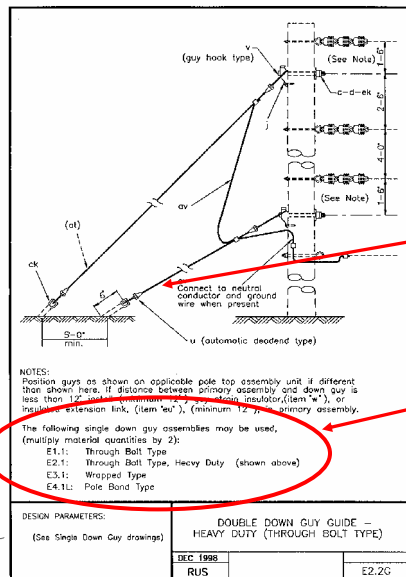

Fewer assemblies

New "Maximum Working Loads"

Guy Marker "at" (old "E3-10") now part of assembly

Multiple down guys are the sum of single down guy assemblies

## New Transformer/Meter Connection Guides

Better connection details without cluttering assembly drawings

Connection guide drawings show additive polarity.  
(Transformers larger than 200 kVA have subtractive polarity.)

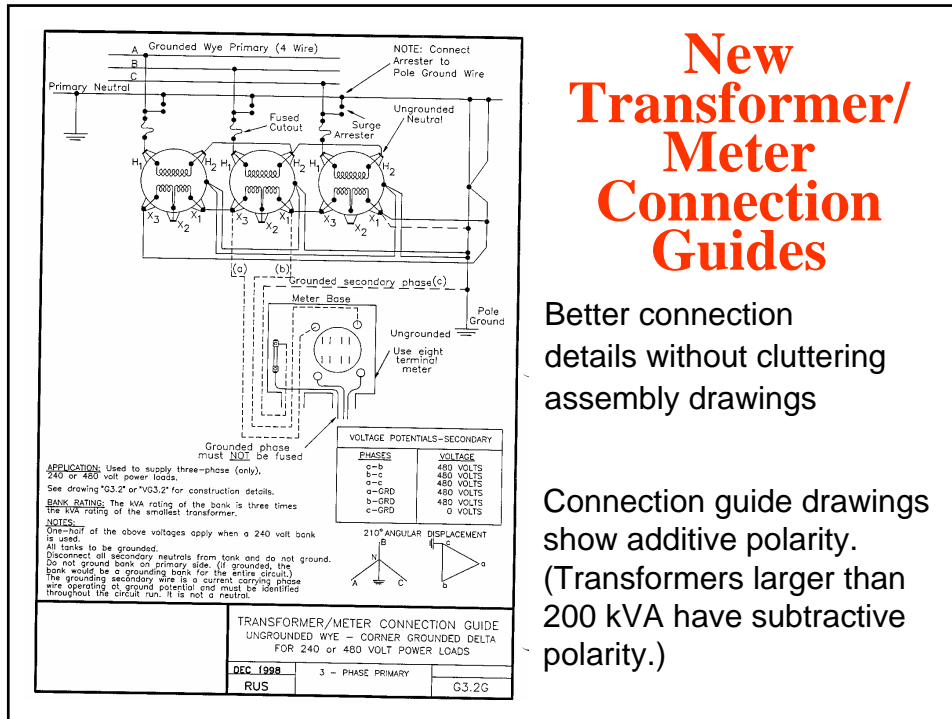

## Specifications: Changes & Additions

- Allows stirrups - conditions specified
- Provides for use of extra large conductors
- Neutral may be lowered 2 feet for clearance requirements; additional 6 feet for bucket truck installation and maintenance.
- 3 inch square curved washer abutting pole.
- Washer under shoulder of crossarm pins.

## Why New Numbers & Format ?

- New bulletin has 146 new assemblies + 38 new guide drawings = 184 new numbers
- RUS internal “rules”
  - No provisions to modify existing numbers
  - Numbers cannot be re-used
- Too many “M” assemblies
- Old numbering system not documented and gone awry

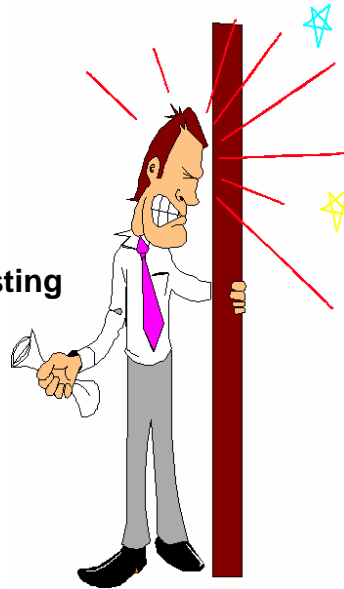

## Standard RUS Numbering Format

$L_1N_1-N_2$  = Historical Format

A1

C2-1

$L_1N_1.N_2$  = New Standard Format

A1.1

C2.52

$L_1$  = **Category** of Assemblies

$N_1$  = **Subcategory** or Assemblies

$N_2$  = Assembly **Identification Number**

## Borrower Generated Assemblies & Numbers

- Only unmodified RUS assemblies are official
- Minor changes are OK
  - (Add inventory numbers)
  - (Specify bolt lengths, etc.)
  - Need not inform RUS
  - Modify number
- “Significant” changes or additions:
  - Inform RUS for approval on “case-by-case” basis



## Maximum Line Angles Referenced in “Design Parameters” on Assembly Drawings

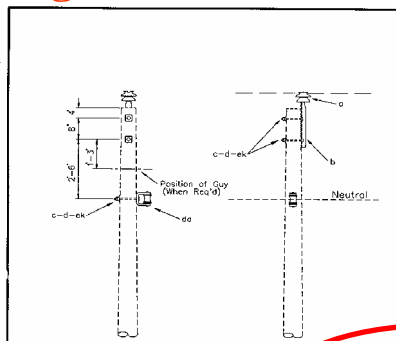

MAXIMUM LINE ANGLES:  
5° – Small Conductors  
2° – Larger than #1/0

Based on neutral  
conductor slipping  
off insulator

DESIGN PARAMETERS:

See TABLE I

ITEM/Qty	MATERIAL
c	1 Insulator, pin type (24.9/14.4 kV)
b	1 Pin, pole top, 20'
c	3 Bolt, machine, 5/8" x req'd length
d	3 Washer, square, 2 1/4"
da	3 Bracket, insulated
ek	3 Locknuts

DESIGN PARAMETERS:  
See TABLE I

SINGLE SUPPORT		
DEC 1996	1 - PHASE PRIMARY	VA1.3
RUS	24.9/14.4 kV	

# Maximum Line Angle Tables

**TABLE II**  
**MAXIMUM LINE ANGLES (Degrees) ON PIN INSULATOR ASSEMBLIES**  
 NESC Grade C Construction

Designated Maximum Transverse Load = 750 Lbs./Conductor

Note: Decrease line angle by 1 degree for poles adjacent to a crossing span.

WIND SPAN (feet)	150	200	250	300	350	400
<b>LIGHT LOADING DISTRICT</b>						
4 ACSR (7/1)	22	21	21	20	20	19
2 ACSR (6/1)	18	17	17	16	16	15
2 ACSR (7/1)	14	13	13	13	12	12
1/0 ACSR (6/1)	11	11	10	10	10	9
123.3 AAAC (7)	11	11	10	10	9	9
2/0 ACSR (6/1)	11	11	10	10	9	9
3/0 ACSR (6/1)	9	8	8	7	7	6
4/0 ACSR (6/1)	8	8	7	7	6	6
246.9 AAAC (7)	8	8	7	7	6	6
336.4 ACSR (18/1)	8	7	7	6	6	5
336.4 ACSR (26/7)	5	5	5	4	4	3
<b>MEDIUM LOADING DISTRICT</b>						
4 ACSR (7/1)	21	21	20	19	19	18
2 ACSR (6/1)	18	17	16	16	15	14
2 ACSR (7/1)	14	13	13	12	12	11
1/0 ACSR (6/1)	11	11	10	10	10	9
123.3 AAAC (7)	11	11	10	10	9	9
2/0 ACSR (6/1)	11	11	10	10	9	9
3/0 ACSR (6/1)	9	8	8	8	7	7
4/0 ACSR (6/1)	9	8	8	7	7	7
246.9 AAAC (7)	8	8	8	7	7	6
336.4 ACSR (18/1)	8	8	7	7	6	6
336.4 ACSR (26/7)	6	5	5	5	4	4
<b>HEAVY LOADING DISTRICT</b>						
4 ACSR (7/1)	20	19	18	17	15	14
2 ACSR (6/1)	16	15	14	13	12	11
2 ACSR (7/1)	13	12	11	10	10	9
1/0 ACSR (6/1)	11	10	9	8	8	7
123.3 AAAC (7)	10	10	9	8	8	7
2/0 ACSR (6/1)	10	10	9	8	8	7
3/0 ACSR (6/1)	8	8	7	6	6	5
4/0 ACSR (6/1)	8	7	7	6	6	5
246.9 AAAC (7)	8	7	7	6	6	5
336.4 ACSR (18/1)	8	7	6	6	5	5
336.4 ACSR (26/7)	5	5	4	4	4	3

Re-calculate for Grade B

RUS designation based crushing of wood fibers

Decrease because of values in NESC Table 261-1A

Tables and formula in Exhibit 1 at end of bulletin

## Conductor Loading Limitations are given in the "Design Parameters" on Assembly Drawings

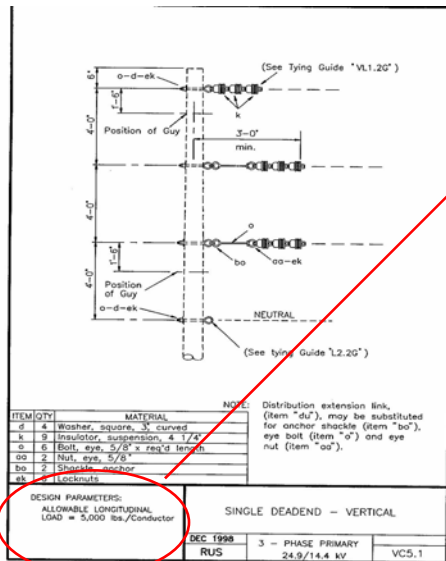

DESIGN PARAMETERS:  
 ALLOWABLE LONGITUDINAL LOAD = 5,000 lbs./Conductor

- Equals 50% of the M&E rating of 4 - 1/4 inch suspension insulator.
- Assumes 3 inch square, curved washer resisting the tension.
  - For 2 - 1/4 inch square washers, decrease to 3,600 lbs
- Multiply all applied loads by the appropriate overload factors of NESC Table 253-1.

## Permitted Unbalanced Conductor Tension (Longitudinal Loading on Crossarm Assemblies)

**TABLE 2**  
**PERMITTED UNBALANCED CONDUCTOR TENSION (Lbs / Phase)\***  
**DOUBLE DEADEND ASSEMBLIES - 2 PHASES EACH SIDE OF POLE - NESC Grade C**

CONDUCTOR SIZE	Vertical Loading (lbs/ft)	2 CROSSARMS			3 CROSSARMS		
		WEIGHT SPANS** (feet)			WEIGHT SPANS** (feet)		
		200	300	400	200	300	400
<b>NESC LIGHT LOADING DISTRICT (0.00" ice, 9 ft Wind)</b>							
4 ACSR (7/1)	0.0670	950	950	900	1,450	1,480	1,480
2 ACSR (6/1)	0.0913	950	950	940	1,450	1,420	1,470
123.3 AAAC (7)	0.1157	950	940	930	1,480	1,470	1,460
1/0 ACSR (6/1)	0.1452	940	930	920	1,470	1,450	1,450
2/0 ACSR (6/1)	0.1831	940	920	900	1,470	1,450	1,430
3/0 ACSR (6/1)	0.2329	930	910	880	1,460	1,440	1,410
246.9 AAAC (7)	0.2318	930	900	890	1,460	1,430	1,410
4/0 ACSR (6/1)	0.2911	920	890	860	1,450	1,420	1,390
312.8 AAAC (19)	0.2935	920	890	860	1,450	1,420	1,390
336.4 ACSR (18/1)	0.3630	900	870	830	1,430	1,400	1,360
<b>NESC MEDIUM LOADING DISTRICT (0.20" ice, 4 ft Wind)</b>							
4 ACSR (7/1)	0.2247	930	910	890	1,460	1,440	1,420
2 ACSR (6/1)	0.2673	920	890	870	1,450	1,420	1,400
123.3 AAAC (7)	0.3172	910	880	850	1,440	1,410	1,380
1/0 ACSR (6/1)	0.3457	900	870	840	1,430	1,400	1,370
2/0 ACSR (6/1)	0.3998	890	860	820	1,420	1,390	1,350
3/0 ACSR (6/1)	0.4647	880	840	790	1,410	1,370	1,320
246.9 AAAC (7)	0.4848	880	830	780	1,410	1,360	1,310
4/0 ACSR (6/1)	0.5439	870	810	760	1,400	1,340	1,290
312.8 AAAC (19)	0.5700	860	810	750	1,390	1,340	1,280
336.4 ACSR (18/1)	0.6957	850	780	720	1,380	1,310	1,250
<b>NESC HEAVY LOADING DISTRICT (0.50" ice, 4 ft Wind)</b>							
4 ACSR (7/1)	0.5379	870	820	760	1,400	1,350	1,290
2 ACSR (6/1)	0.5969	860	800	740	1,390	1,330	1,270
123.3 AAAC (7)	0.6741	840	780	710	1,370	1,310	1,240
1/0 ACSR (6/1)	0.7036	840	770	700	1,370	1,300	1,230
2/0 ACSR (6/1)	0.7719	820	750	670	1,350	1,280	1,200
3/0 ACSR (6/1)	0.8539	810	720	640	1,340	1,250	1,170
246.9 AAAC (7)	0.8927	800	710	630	1,330	1,240	1,160
4/0 ACSR (6/1)	0.9520	790	700	600	1,320	1,230	1,130
312.8 AAAC (19)	1.0037	780	680	580	1,310	1,210	1,110
336.4 ACSR (18/1)	1.1016	760	650	550	1,290	1,180	1,080

NOTES: Reduce unbalanced tensions by 40% for NESC Grade B construction.  
\*Lbs/Phase means tension difference at each point on crossarms where conductors are attached.  
\*\*Weight span equals 1/2 span length into assembly plus 1/2 span length out from assembly.  
Calculations assume all conductors same size and type as largest conductor and level spans.  
Assemblies have been multiplied by strength factor of 0.85 (2002 NESC Table 241-1A).  
Applied loads have been multiplied by overload factors (2002 NESC Table 233-1).

RUS has performed calculations for standard crossarm assemblies and tabulated results.

Formula and tables in Exhibit 2 at end of Bulletin

**RUS 2004 ELECTRIC  
ENGINEERING SEMINAR**

**FEBRUARY 10-11, 2004**

**NEW ORLEANS, LA**

**NRECA's Transmission &  
Distribution Engineering Committee**

**Mike Pehosh**

**Bob Saint**

**Principals  
T&D Engineering, NRECA**



## *BIOGRAPHICAL SKETCHES*

### **MIKE PEHOSH**

Mike is a principal engineer for the NRECA T&D Engineering section of Technical Services in Arlington, VA.

In that function, he works with the Materials Subcommittee, the Underground Line Subcommittee, Overhead Lines Subcommittee, Avian Power Line Interaction Committee (APLIC), IEEE Rural Electric Power Committee, and the Utility Purchasing Managers Group (UPMG) executive committee. He works with some CRN Projects including Managing the NEETRAC project. He also is the NRECA liaison to the Supply Chain Management Community for electric cooperatives. He has been with NRECA for past three and half years.

He is a registered professional engineer, a certified engineering manager and a master electrician.

Prior to NRECA:

He worked seventeen years for Ozarks Electric Cooperative Corporation in Fayetteville, Arkansas as the manager of engineering department.

He worked four years as a distribution engineer for First Electric Cooperative in Jacksonville, AR.

He worked five years in electrical distribution sales.

He worked five years as a field service engineer for Westinghouse Electric Corporation.

He has been married for the past 38 years and has two children and three grandchildren.

### **BOB SAINT**

Bob graduated from Wichita State University in Wichita, Kansas, with a BS degree in Electrical Engineering. Since graduating from college, he has worked for electric utilities in Texas (2 1/2 years) and Colorado (22 years). He worked for Tri-State G & T for over 5 years doing primarily substation design and 17 years with distribution co-op's in Colorado.

He is a Professional Engineer in Texas and Virginia and a senior member of IEEE.

At NRECA, his primary role is technical advisor for the T&D Engineering Committee. The subcommittees he works with are: Power Quality, Substations, System Planning and Transmission Lines. He is also the liaison for the E&O Community on Cooperative.com.



## NRECA's

# Transmission & Distribution Engineering Committee



## Who is the T&D Engineering Committee?

A voluntary and collaborative community of more than 80 experienced cooperative engineering and supply chain professionals who work with the Rural Utility Service's (RUS) Electric Staff Division to update technical bulletins, standards and guides for co-op systems.



## HISTORY

- Created by NRECA Board of Directors in 1991
- Chair appointed by NRECA Board President
- Chairman (1991 to 1996) Jim Baker, CEO, Middle Tennessee Electric Co-op Corp
- Chairman (1997 to 2002), Overt Carroll, CEO, Clark Energy, Kentucky
- Chairman (2003), Max Davis, Gen. Mgr., South Alabama Electric Co-op Corp



## Mission of T&DEC

The Mission of NRECA's Transmission & Distribution Engineering Committee is to develop and promote the implementation of the most appropriate engineering practices and materials that support rural utility challenges.

## Goals



- Represent rural cooperative utility and community interests
- Assist RUS in the timely development and dissemination of standards, specifications, guide bulletins, and other technical information
- Provide modern, cost effective, safe, and environmentally conscious engineering solutions utilizing appropriate techniques

## Recent Project Examples



- Underground Cable Failure report on Cooperative.com
- List of Materials on RUS Web site with Link on Cooperative.com
- Revising the U-1 Specification for underground primary cable
- Updating bulletin 160-2 "Overhead line mechanical design manual"

## Projects Continued



- DG Interconnection Tool kit
- Revising bulletin 161-1 “Interruption Reporting and Service Continuity Standards for Electric Distribution Systems”
- Developing a “New Procurement and Application Guide for Non-Ceramic Composite Transmission Insulators”

## Stakeholders



### Cooperatives:

Engineering and Operations Community, General Managers, Cooperative Supply Chain Managers, Other interested Co-op Employees

### Expectations..

- Dissemination of experience, information, knowledge, and expertise
- Advice and counsel on modern and future engineering / materials opportunities
- Recognition of practical engineering as debates occur within the Leg. and Reg. arena

## Stakeholders



Rural Utilities Service (RUS):

The Electric Staff Divisions, General Field Representatives and RUS Management

Expectations..

- Provide document review, editorial advice, production assistance as well as Engineering, Operations, and Materials experience and expertise in support of RUS.

## Stakeholders



Member/Owners:

The consumers on co-op lines

Expectations

- Promoting individual member interests in production of standards, specs, and bulletins
- Promoting the provision of Quality Power
- Promoting the provision of Low Cost Power
- Promoting Community Safety
- Promoting Environmental Stewardship

## Stakeholders



Manufacturers / Suppliers:



Equipment and materials providers with potential to supply Cooperatives.



Expectations:



- Promote and maintain fair and equitable standards and specs that enable access to rural markets
- Performance assessments and problem resolution assistance
- The adoption of new technology in addressing engineering opportunities

## T&DEC Executive Committee



Chairman: Max Davis, South Alabama EC



RUS Liaison – George Bagnall, Electric Staff Division



Seven Subcommittee Chairs



NRECA Liaisons – Steve Lindenberg  
Mike Pehosh  
Bob Saint

## T&DEC Subcommittees



- Materials: John Mitchell, Rappahannock Electric Co-op  
Overhead Dist.: Terry Rosenthal, Laclede Electric Co-op  
Substation: Bil Kahaneck, Lower Colorado River Authority  
Syst. Planning: Robin Blanton, Piedmont EMC, N.C.  
Power Quality: Ed Bevers, Rural Electric Coop, OK  
Transmission: John Burch, Florida Keys Electric Co-op  
Underground: Steve Gwinn, Middle Tenn. Elect. Coop.

## T&DEC Strategic Plan



### Six Step Process

1. T&DEC Project Definition and Description
2. Project Prioritization Model Creation
3. Executive Committee Review
4. Project Evaluation and Prioritization
5. Executive Committee and RUS Workshop
6. Plan Development and Implementation



## Project Description Example



**Subcommittee:** Substation



**Principal:** Robert Saint

**Project / Publication:** Power Transformer Witness Testing Guide



**Explanation:** Guide designed to advise cooperative engineers on protocols and requirements for witnessing power transformer tests. By design, the guide details tests that should be included in the purchase specification. The overall intent in updating this publication is assisting in ensuring reliability, mitigating potential liability, and updating a needed industry standard.



**Deliverable:** Updated Guide

**Expected Completion:** October 2004 (draft)

## Prioritization Model Criteria



Cooperative Need – Reliability, Liability, Applicability, and Affordability



Legislation, Regulation, and Policy – time sensitive policy changes occurring at the state or federal level



Safety – General Public, Cooperative Employees, and Natural Resources



Industry Technical Standards – responding to changes in IEEE, NESC, ANSI, etc.

## Prioritized List of Projects



RUS Interruption Reporting Bulletin



IEEE 1366 Reliability Indices Standards

RUS Operations Manual



Cooperative.com E&O Community

URD Research & Education



FERC Small Generator Interconnection

RUS Joint Use Agreement Bulletin

RUS Transmission Line Design Manual

RUS Transmission Line Specs and Drawings

RUS Voltage Levels Bulletin

## Prioritized List of Projects



RUS Sectionalizing Bulletin



RUS Long Range Planning Guide

IEEE ICC Membership



IEEE 1547 Working Group Membership

NEETRAC Project Advisors



IEEE Standards Activities

Cable Specification Trends

Cable Failure Report

NESC Committee and Subcommittee

RUS Oil Spill Prevention and Mitigation Bulletin

## Get Involved!!

We need your help.....



- Sign up to contribute expertise to T&DEC
- Fill out application in your T&DEC brochure
- Stop by the T&DEC Booth at TechAdvantage
- Sign up on Cooperative.com
  - go to “E&O Community” and click on “T&D Engineering Committee” and go to “How to Become a Member” tab
  - sign up for the E&O listserv and participate
  - participate in the bulletin board discussions for the respective subcommittees.



# QUESTIONS??

# **RUS 2004 ELECTRIC ENGINEERING SEMINAR**

**FEBRUARY 10-11, 2004**

**NEW ORLEANS, LA**

**Spill Prevention Control and  
Countermeasures Rules -  
Electric Utility & Electrical  
Equipment-Specific Issues**

**James Roewer**

**Executive Director, Utility Solid Waste  
Activities Group**

*BIOGRAPHICAL SKETCH*

**JAMES ROEWER**

Jim is the Executive Director of the Utility Solid Waste Activities Group (USWAG), where he is responsible for overall program management, including the addressing of solid and hazardous waste, and toxic substance issues on behalf of the utility industry.

Jim serves as the Chairman of ASTM Subcommittee E50.03 on Environmental Risk Management/Sustainable Development/Pollution Prevention, and as a member of the Steering Committee of the Combustion Byproducts Research Consortium.

Jim has served as Senior Environmental Manager in the Energy Policy Department of the National Rural Electric Cooperative Association (NRECA); Environmental Scientist in the Natural Resources Section of the Edison Electric Institute; Manager, State and Local Government Relations with the American Society of Mechanical Engineers; and Research Assistant with the Science Unit of the Illinois Legislative Research Service.

Jim holds a Masters of Science in Environmental Science from the School of Public and Environmental Affairs at Indiana University, and a B.A. in Biology from Wittenberg University.

# Spill Prevention Control & Countermeasures Regulations

Jim Roewer  
Executive Director, USWAG  
RUS Electric Engineering  
Seminar  
February 11, 2004

## SPCC Rule Revisions

- ◆ Published July 17, 2002 Federal Register (67 Fed. Reg. 47042)
- ◆ Original Proposal October 22, 1991; Amendments Proposed February 17, 1993 & December 2, 1997)
- ◆ Effective Date August 16, 2002

USWAG

## Compliance Timeframes

- ◆ Revisions to plans must be made by February 17, 2003, and implemented by August 18, 2003
- ◆ New facilities must have plan before commencing operations
- ◆ Acquired facilities considered already operational and must have plans in place

USWAG

## Compliance Timeframes

- ◆ January 9, 2003 *Federal Register* Notice
- ◆ Deadline Extension April 17, 2003 (68 Fed. Reg. 18890)
  - August 17, 2004 -- Upgrade plans consistent with SPCC Amendments
  - February 18, 2005 – Implementation of upgraded plans

USWAG

## SPCC Litigation Issues

- ◆ Secondary Containment Cost Impracticability
- ◆ Loading Racks
- ◆ Navigable Waters
- ◆ Produced Waters
- ◆ "Should" to "Shall/Must" (SBREFA Issues)

USWAG

## SPCC Litigation Issues – EPA Technical Workgroup

- ◆ Secondary Containment Cost Impracticability
- ◆ Loading Racks
- ◆ Produced Waters

USWAG



## SPCC Issues "On the Table"

- ◆ Motive Power
- ◆ Oil-filled Operational Equipment
- ◆ Secondary Containment v General Containment
- ◆ Piping
- ◆ Mobile Storage Containers
- ◆ Wastewater Exemption/Oil-Water Separators
- ◆ Electrical Equipment

USWAG

## What's Coming Up

- ◆ Internal EPA Deadline of February 2004:
  - Resolve some issues through Interpretative Guidance
  - Identify issues the Agency intends to address in Rulemaking
  - Describe expectations r.e. issues that will not be resolved before August 17, 2004

USWAG

## SPCC Threshold Determination

- ◆ Facilities that can “reasonably be expected to discharge oil” subject to SPCC Rule
  - Manmade features cannot be considered
  - >1320 Gallons of Oil at Facility Equipment
  - <55 Gallons exempt
  - Underground tanks exempt

USWAG

## Electrical Equipment

- ◆ Oil-filled electrical equipment is subject to EPA’s SPCC jurisdiction
- ◆ EPA amended § 112.1(b), which describes activities triggering SPCC regulation, by inserting “using” before phrase “oil and oil products.” (67 Fed. Reg. at 47054, 47060, 47140)

USWAG

## Electrical Equipment

- ◆ Electric Equipment excluded from “bulk storage container” definition. 67 Fed. Reg. at 47072, 47141
- ◆ Equipment therefore not subject to §112.8(c) bulk storage requirements:
  - bulk storage secondary containment
  - corrosion protection
  - periodic integrity testing
  - inspection requirements

USWAG

## Electrical Equipment & Secondary Containment

- ◆ Secondary containment is a requirement for facilities that use oil-filled electrical equipment “whenever practicable” (67 Fed. Reg. at 47116)
- ◆ EPA acknowledges some or perhaps all types of secondary containment for electrical equipment may be contrary to safety factors or other good engineering practice considerations

USWAG

## Electrical Equipment & General Containment

- ◆ Facilities with Electric Equipment subject to general containment requirements of § 112.7(c)
  - Containment and/or diversionary structures or equipment to prevent a discharge:
    - ◆ dikes, berms, retaining walls;
    - ◆ curbing;
    - ◆ culverting, gutters, drainage systems;
    - ◆ weirs, booms, other barriers;
    - ◆ spill diversion ponds;
    - ◆ retention ponds;
    - ◆ sorbent materials

USWAG

## Plan Certification

- ◆ All SPCC plans must be certified and reviewed by a P.E.
- ◆ Certification that the facility's equipment, design, construction, and maintenance procedures used to implement the Plan are in accordance with good engineering practices
- ◆ Certification must be completed in accordance with the law of the State in which the P.E. is working

USWAG

## Plan Certification

- ◆ All sites must be visited prior to P.E. certification, but P.E. is not personally required to do the visit -- an agent of the P.E. may visit a site
- ◆ The P.E. substitutes for the regulatory official in making the initial decision on what constitutes good engineering practice and how to exercise discretion where the rules contemplate exercise of discretion

USWAG

## Plan Formatting

- ◆ Multi-facility plan is specifically mentioned as an option "for electrical utility transmission systems, electrical cable systems, and similar facilities which might aggregate equipment located in diverse areas into one plan."  
67 Fed. Reg. 47080

USWAG

## Plan Formatting

- ◆ Multi-facility/system-wide plans provide broad discretion in meeting SPCC requirement
- ◆ A system-wide plan (e.g., generic spill and contingency plan) with site-specific information drawn from existing databases, supplemented with topographical information might meet the SPCC plan requirements

USWAG

## Plan Formatting

- ◆ The initial decision for designing the SPCC plan and using flexible alternatives is made by the P.E.
- ◆ No requirement to submit departures from basic rule requirements to EPA Regions before implementation 67 Fed. Reg. 47143

USWAG

## Location of Plan

- ◆ SPCC Plan must be maintained at each facility if manned > 4 hours each day (old rule: 8 hours/day) 67 Fed. Reg. 47143
- ◆ For facilities not attended 4 hours/day, Plan must be kept at “nearest field office” (nearest office with operational responsibility for facility or nearest emergency response center for facility) 67 Fed. Reg. 47086

USWAG

## Plan Review/Amendment

- ◆ SPCC plans must be reviewed and certified every five years (old rule = 3 year) 67 Fed. Reg. 47145
- ◆ Amendments required when a material change is made affecting facility's potential to discharge oil (e.g., after facility change results in decrease in volume of oil stored). 67 Fed. Reg. 47091

USWAG

## Compliance with SPCC Regulation

- ◆ EPA's final rule offers exemptions, improvements, clarifications, and amendments to the old SPCC regulations, many of which reduce regulatory burdens.

USWAG

## Compliance Burden Reduction

- Increased regulatory threshold to > 1,320 gallons; exemption for all containers < 55 gallons
- Open definition of "facility"
- Impracticability determination for secondary containment at substations due to operational and design factors
- Manmade structures may be considered part of secondary containment

USWAG



## Compliance Burden Reduction

- SPCC plan review frequency extended from three to five years
- SPCC plans may be certified by a company-employed P.E.
- Certifying P.E. need not personally visit each "facility" if his/her agent has visited the facility

USWAG

## SPCC Compliance: Applying Creativity

- P.E. may exercise broad discretion and rely on best engineering judgment and/or industry standards throughout SPCC process (including industry models, such as EPRI's MOSES model)
- P.E. may certify alternatives to requirements in SPCC rules (other than training and recordkeeping requirements) that achieve equivalent environmental protection

USWAG

## SPCC Compliance: Applying Creativity

- Multiple facilities may be covered by single written SPCC plan if plan contains site-specific information (which may be maintained in separate location if readily available);
- P.E. has discretion to define what constitutes a "facility" and therefore whether the "facility" requires an SPCC plan (factors to consider include ownership of the site, nature of the operations, degree of integration, and extent of function differentiation)

USWAG

## Electrical Equipment – A Need to Tailor the Regs

- ◆ Basis for Tailoring Regulations for Electrical Equipment
  - Electrical Equipment Fundamentally Different from Oil Tanks
  - Response = Containment
  - Excellent Spill History (<1%)

USWAG

## Tailored SPCC Program for Electrical Equipment

### ◆ USWAG Proposal

- No aggregation of electrical equipment/raising of volume threshold (55 Gal ⇒ 1320 Gal)
- Contingency Plans for “Small Equipment” that is monitored & has no history of spills
- Full SPCC Plans for “non-qualified” equipment (large pieces/those with spills)

USWAG

## Next Steps ...

### ◆ EPA to Communicate Plans by Mid-February 2004

- Guidelines
- Policy Statements
- Rulemaking

USWAG

## For More Information:

[jim.roewer@uswag.org](mailto:jim.roewer@uswag.org)

202/508-5645

[www.uswag.org](http://www.uswag.org)

USWAG

**RUS 2004 ELECTRIC  
ENGINEERING SEMINAR**

**FEBRUARY 10-11, 2004**

**NEW ORLEANS, LA**

**Developing a Landfill Methane  
Generation Project**

**Ralph Tyree**

**Program Manager, Non-Traditional  
Power Production Projects,  
East Kentucky Power Cooperative**

*BIOGRAPHICAL SKETCH*

**RALPH TYREE**

Ralph has been employed by East Kentucky Power Cooperative, Inc. (“EKPC”) for the past 25 years with the majority of his career in construction management activities. His experience consists with projects ranging in cost from a few hundred thousand dollars to over one hundred million dollars. Ralph has extensive knowledge and experience in power plant operations, permitting, planning, construction management, and project development for both commercial and power generation projects, including gas combustion turbines, hydro pump storage, low impact hydro and coal fired generation.

After serving a couple of years in EKPC’s Resource Planning department, Ralph was chosen to lead a newly formed process titled, Non-Traditional Power Production Projects two years ago. His new responsibilities include the development of new electrical resources and technologies including low-impact hydro, wind, coal bed methane, landfill gas and other sources of biomass. Ralph also heads up EKPC’s Green Power program called *EnviroWatts...Earth Friendly Energy Alternatives*, which supplies the option of renewable energy to EKPC’s Member Systems and their 456,000 homes and businesses.

# Landfill Gas to Electric Generation

## Developing a Landfill Methane Project - Why?

*Ralph Tyree*

Program Manager, Non-Traditional Power Production Projects  
East Kentucky Power Cooperative, Inc.



# East Kentucky Power Cooperative



## *Who We Are*

Wholesale Energy, Transmission and Services to  
16 Customer-Owned Distribution Co-ops  
*Serving 468,000 loads across 89 counties*



# East Kentucky Power Cooperative



## Who We Are

Not-for-Profit Generation & Transmission Co-op  
*Headquartered in Winchester, KY*

- \* >2700 miles of transmission lines
- \* > 350 substations
- \* Winter Peak 2568 MW's
- \* Summer Peak 2120 MW's



A Touchstone Energy  
Cooperative 

# Distribution Cooperatives



## Member Systems are

- Locally owned
- Locally operated
- Governed by the people

Collectively, EKPC and Distribution Co-ops  
known as Kentucky's Touchstone Energy  
Cooperatives



A Touchstone Energy  
Cooperative 



# EKPC Portfolio

Resource Mix  
(MWh's 2002)

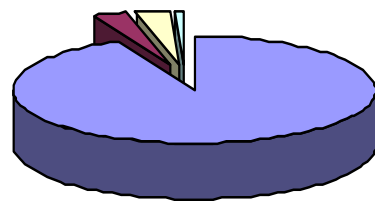

Coal	94%
CTs	3%
SEPA	2%
LFG	<1%

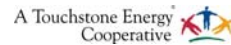

# EKPC Portfolio

Coal	1387 MW
Combustion Turbines	448 MW (summer) 646 MW (winter)
SEPA (Hydro)	170 MW
Landfill Gas	10 MW (9/30/03)

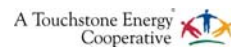

## Why Landfill Gas?

- Environmental Stewards
- Environmental Education/Biodiesel
- Customer Survey Results
- Toyota / EnviroWatts
- Competitive Pricing
- Encourages New Technology Development

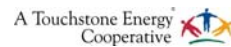

## Landfills in Kentucky



# How does it work?

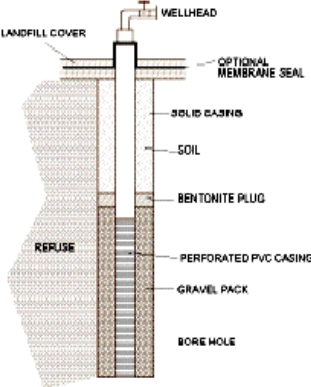

## Typical Vertical Extraction Well

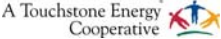

# Landfill Gas Projects

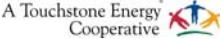

## The EKPC Development Concept

- Stability of your local Coop & RUS
- Secure a long term, low cost, reliable fuel
- Provide a revenue for the landfill Owner
- Develop a cost competitive project w/other options
- Develop a renewable energy resource
- Improve the lives of our members

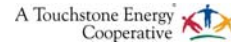

## Landfill Gas Projects Under Construction



### **Bavarian Landfill**

*Boone County*

### **Green Valley Landfill**

*Greenup County*

### **Laurel Ridge Landfill**

*Laurel County*



# Foundations

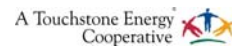

# Masonry Construction

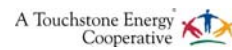

# Cat 3516 LE Engine/Gensets

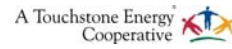

# Fuel Gas Compressor

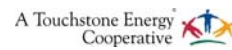

# Motor Control Center

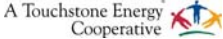

# EKPC Landfill Gas Projects

## **Bavarian Landfill**

*Boone County*

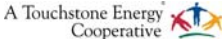

# EKPC Landfill Gas Projects

## Green Valley Landfill

*Greenup County*

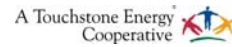

# EKPC Landfill Gas Projects

## Laurel Ridge Landfill

*Laurel County*





## Bavarian Ribbon Cutting Ceremony

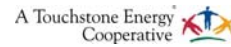

## First Landfill Tour



*Owen Electric Scholarship Recipients*



# EKPC Landfill Gas Projects

*In summary,*

**Cost Competitive**

**Reliable**

**Renewable**

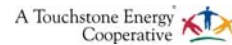

# EKPC Landfill Gas Projects

“We are making a product from  
a renewable that is not only  
good for the environment but  
makes good business

Sense”.....Roy M. Palk

*President & CEO EKPC*



# EKPC Landfill Gas Projects

## Questions

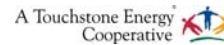

# Thank you for your time

## Landfill Gas – Electric Generation

Ralph Tyree, Program Manager  
Non-Traditional Production Projects  
East Kentucky Power Cooperative, Inc.  
email: [ralph@ekpc.com](mailto:ralph@ekpc.com)



**RUS 2004 ELECTRIC  
ENGINEERING SEMINAR**

**FEBRUARY 10-11, 2004**

**NEW ORLEANS, LA**

**DOE – RUS Partnership to Expand  
Acceptance of Photovoltaic Systems  
for Rural Community Needs**

**Larry Moore**

**Senior Member of Technical Staff,  
Sandia National Laboratories**

*BIOGRAPHICAL SKETCH*

**LARRY MOORE**

Larry Moore is a senior project manager at Sandia National Laboratories for the rural utility photovoltaics program. He holds an undergraduate degree in mathematics and a graduate degree in physics from North Texas State University. Early in his career, Larry conducted chemical fuel and oxidizer analyses at Cape Canaveral Air Force Station. He also has experience as an agricultural meteorologist for the National Weather Service. For the past 21 years, he has been at Sandia specializing in critical infrastructure issues associated with weapons, explosives and energy supply. His last 5 years have been spent in photovoltaic systems. His work in developing a reliability database for installed systems has been instrumental within the DOE program to establish lifecycle costs for viable applications. He has provided numerous workshops and presentations on photovoltaics to the rural electric community and is actively engaged in partnerships with several coops. He currently is the program manager for the DOE/RUS interagency agreement to expand the use of renewable energy systems to the nation's rural communities. His outside interests include a general class radio amateur license and an active member of a rural fire department in northern New Mexico.

## **DOE – RUS PARTNERSHIP TO EXPAND ACCEPTANCE OF PHOTOVOLTAIC SYSTEMS FOR RURAL COMMUNITY NEEDS**

Larry Moore  
Hal Post  
Sandia National Laboratories  
Albuquerque, NM

Jim Dunlop  
Kevin Lynn  
Florida Solar Energy Center  
Cocoa, FL

### Presentation Summary

The U.S. Department of Energy (DOE) and U.S. Department of Agriculture Rural Utilities Service (RUS) share a common goal of expanding the use of renewable energy systems to provide an additional customer service option for the nation's rural electric utilities. To formalize this partnership, both agencies signed a September 2003 agreement to address this mutual goal. A key objective is to simplify rural utility access to accepted photovoltaic (PV) systems via the RUS List of Materials. This interagency agreement enables Sandia National Laboratories to provide technical support to the RUS by helping to develop a process, acceptance criteria, and review procedure to get complete PV systems listed. To accomplish this objective, Sandia is utilizing its 25-years of experience with PV systems and our unique long-term collaboration with the Florida Solar Energy Center (FSEC) that resulted in the development of the Florida PV Buildings Program. Many of the processes developed through the Florida Program are being utilized in the current effort with the RUS.

A number of potentially viable rural applications including water pumping, both on-grid and off-grid power for residential and small facility use, lighting, fence charging and gate openers have been identified and installed across the country. However, the opportunities to expand this use have been hampered by lack of familiarity with the technology as well as concerns regarding PV reliability, cost and performance. To address these issues, the DOE and Sandia are providing educational materials, workshops and direct project assistance to both the customer and supplier communities. Additionally, a program is in place to analyze field experience regarding reliability and operation and maintenance costs with installed PV systems. This information has allowed Sandia and their installed system partners to examine lifecycle costs for a variety of applications. The success of this work is illustrated by two case studies, one regarding water pumping and the other, off-grid residential systems. The Northwest Rural Public Power District in Nebraska has installed over 30 PV water pumpers since 1990. These systems have provided a significant database of component reliability, O&M costs, and lifecycle costs for this application. Use of these data have resulted in utility lease pricing plans for PV water pumpers as well as breakeven cost comparisons with conventional line extension service options. Similarly, over 60 off-grid residential PV systems installed by the Arizona Public Service over the past 6 years provide O&M records and lifecycle costs for this application. These data provide important breakeven cost comparisons with conventional line extension and help the utility better understand the business opportunity of supplying PV systems to their customers.

The approach developed for listing PV systems on the List of Materials follows the existing RUS process for other hardware. The first PV systems will focus on water pumping and on-grid residential applications. The acceptance criteria for these systems have been developed and the

technical review process that will provide advice to the TSC in the system acceptance evaluation is in place. The system technical review will examine safety/code compliance, performance, system viability, installation procedures, documentation, electrical and mechanical design, and component details utilizing comprehensive checklists. The review effort is centered around the successful implementation processes developed by Sandia and FSEC for the Florida PV Buildings Program. These processes are backed by the American Association for Laboratory Accreditation (A2LA) and the PowerMark certification of design reviews for grid-tied and stand-alone PV systems. Currently, 9 PV systems from 4 different suppliers are pending acceptance.

# DOE-RUS Partnership to Expand Acceptance of Photovoltaic Systems for Rural Community Applications

**Larry Moore  
Hal Post  
Sandia National Laboratories  
Albuquerque, NM**

**Jim Dunlop  
Kevin Lynn  
Florida Solar Energy Center  
Cocoa, FL**



Sandia is a multi-program laboratory operated by Sandia Corporation, a Lockheed Martin Company, for the United States Department of Energy under Contract DE-AC04-94AL85000.





# What's to be Done?

- RUS & DOE interagency agreement – Sep03
  - Sandia National Laboratories in partnership with Florida Solar Energy Center will provide technical support
    - Develop process, acceptance criteria, technical review of photovoltaic systems
    - Design review as basis for including PV systems on equivalent “List of Materials”

# What are Viable PV Options for Rural Applications?

## Off-Grid Residential



## Livestock Water Pumping

# There are Market Barriers for Expanded PV Use!

- Lack of familiarity
- Concern with reliability/performance/cost
- History of fielded solar systems – lack of distinction between solar thermal and solar electric systems

# What is DOE/Sandia Doing to Address These Issues?

- Educational
  - Technical Guides
  - Workshops
  - Direct farmer/rancher/coop assistance
- Analyzing data from fielded systems – Performance, Reliability, O&M – to assess commercial readiness and lifecycle costs

# PV Water Pumping for Livestock

## *A Business Opportunity for Coops*



- 1000+ windmills
- Existing power lines
  - 50-70 years old
  - Replacing 30-40 miles @ \$12,000/mile ~ \$500K long term value
  - Yearly maintenance - \$200 per mile
- PV viable alternative-Yes

## Annual Maintenance Cost (Parts+Labor+Travel) as Per Cent of Initial System Cost

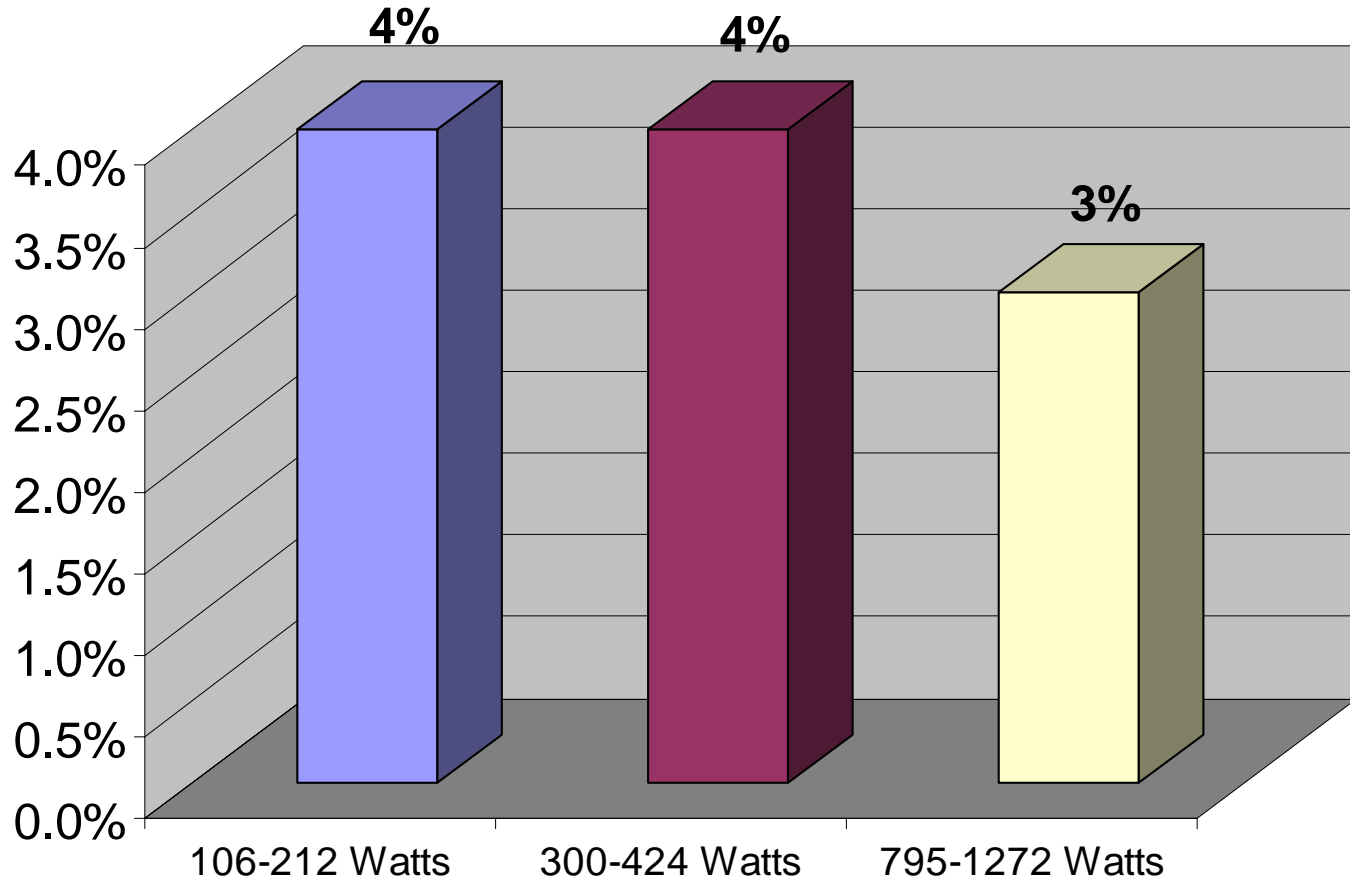

Rolland Skinner  
rskinner@gpcom.net  
308-638-4491

Source: 28 installed systems (CY1990-2000), 74 reported failures  
Northwest Rural Public Power District, Hay Springs, NE

Larry Moore  
lmoore@sandia.gov  
505-845-9191



# Northwest Rural Public Power District (Data from Fielded Systems): Lifecycle Cost Comparison of Distribution Lines And Photovoltaic System for Livestock Water Pumping

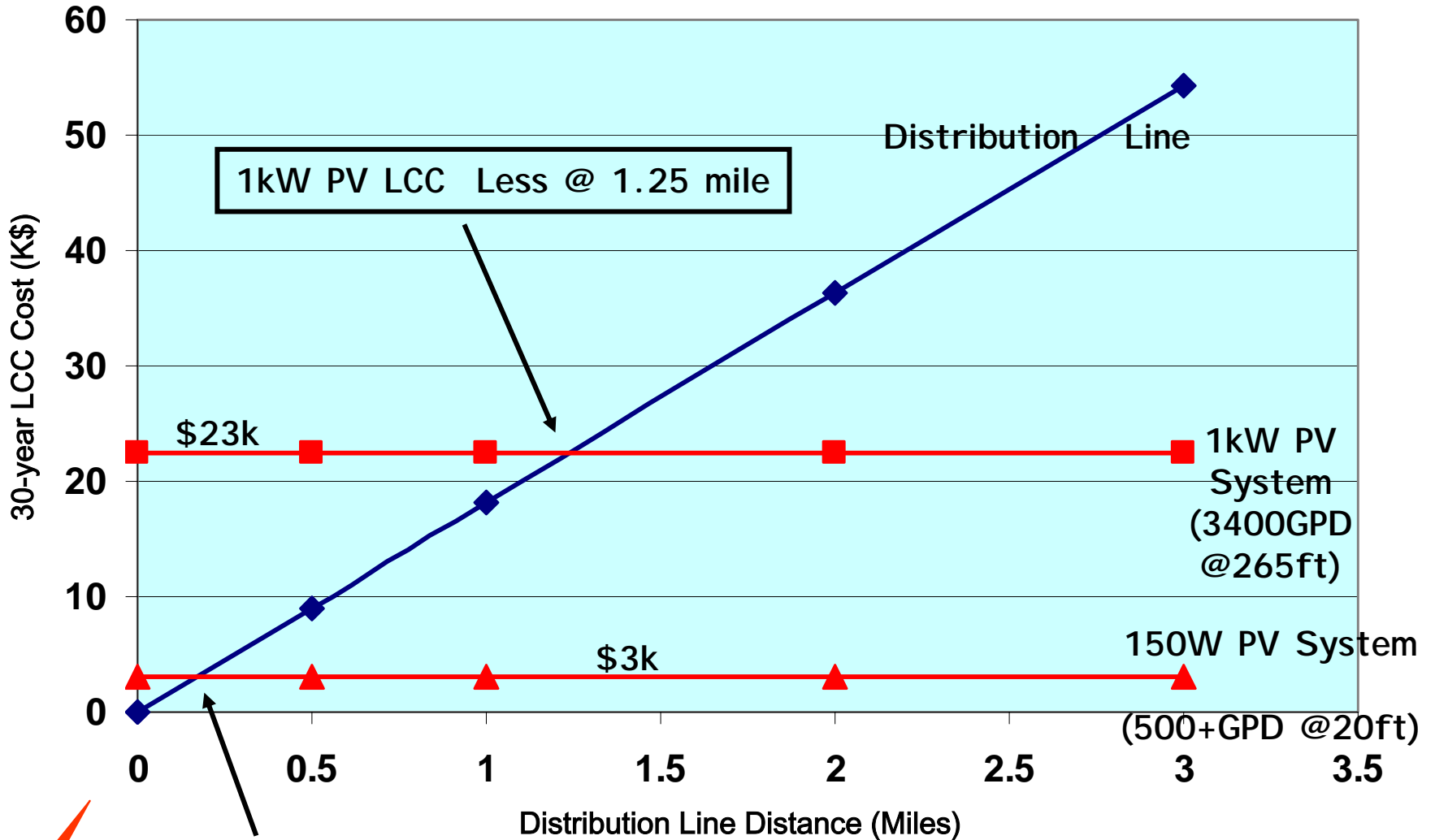

1kW PV LCC Less @ 1.25 mile

150W PV LCC Less @ .25 mile



# PV for Off-Grid Residential

## *A Business Opportunity for Coops*

- Arizona Public Service -- service via leased systems
- 62 systems installed 1996-2002
- Sized to provide 2.5-10 kWh per day in four configurations
- Includes propane generator & battery storage
- Viable for Specific Business Model





# Total O&M (Schd + Unschd) as % Quarterly Capital Cost and Running Avg on Total O&M

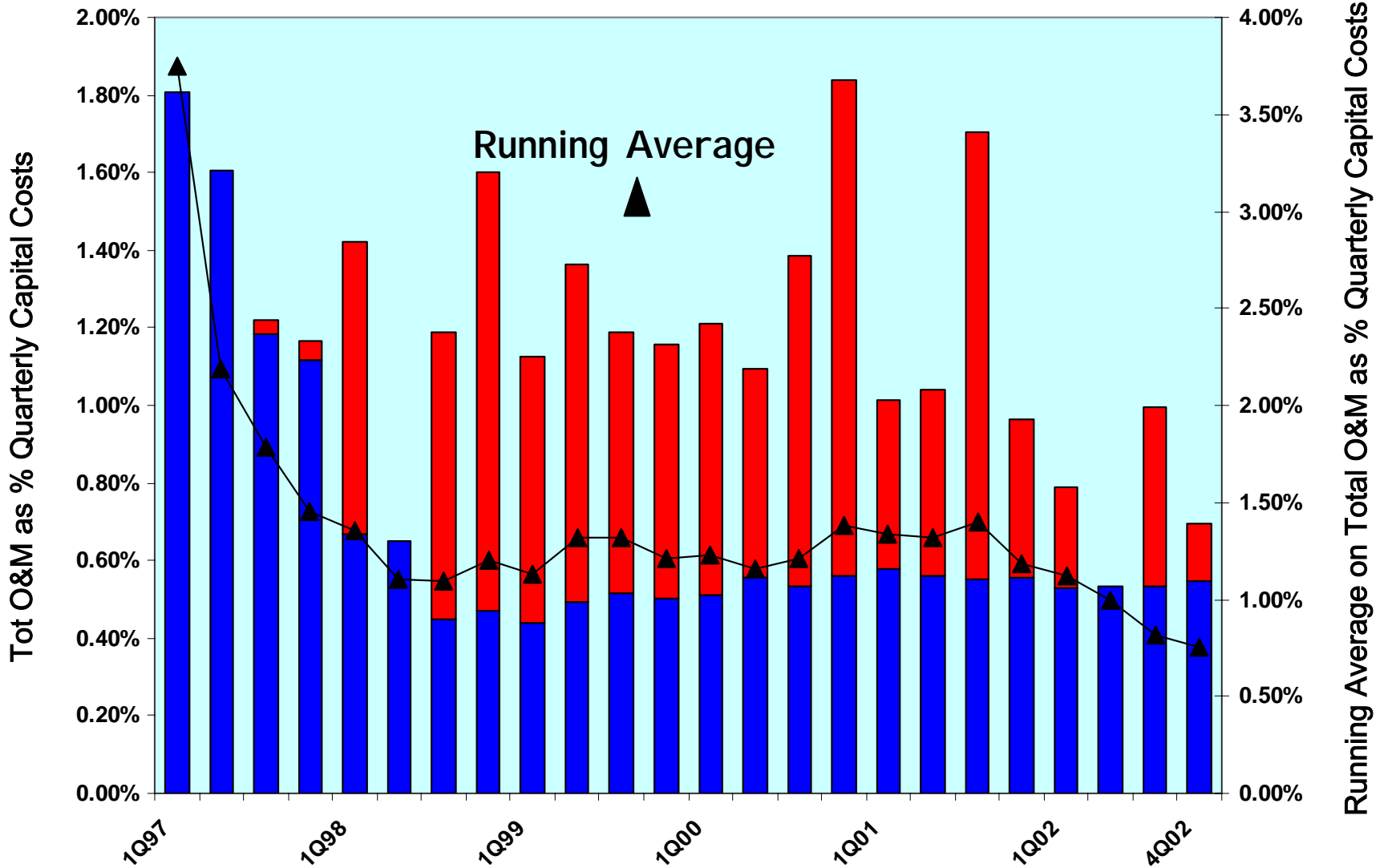

# APS/Pinnacle West (data from fielded systems): Lifecycle Cost Comparison of Distribution Lines And Photovoltaic Off-Grid Residential System

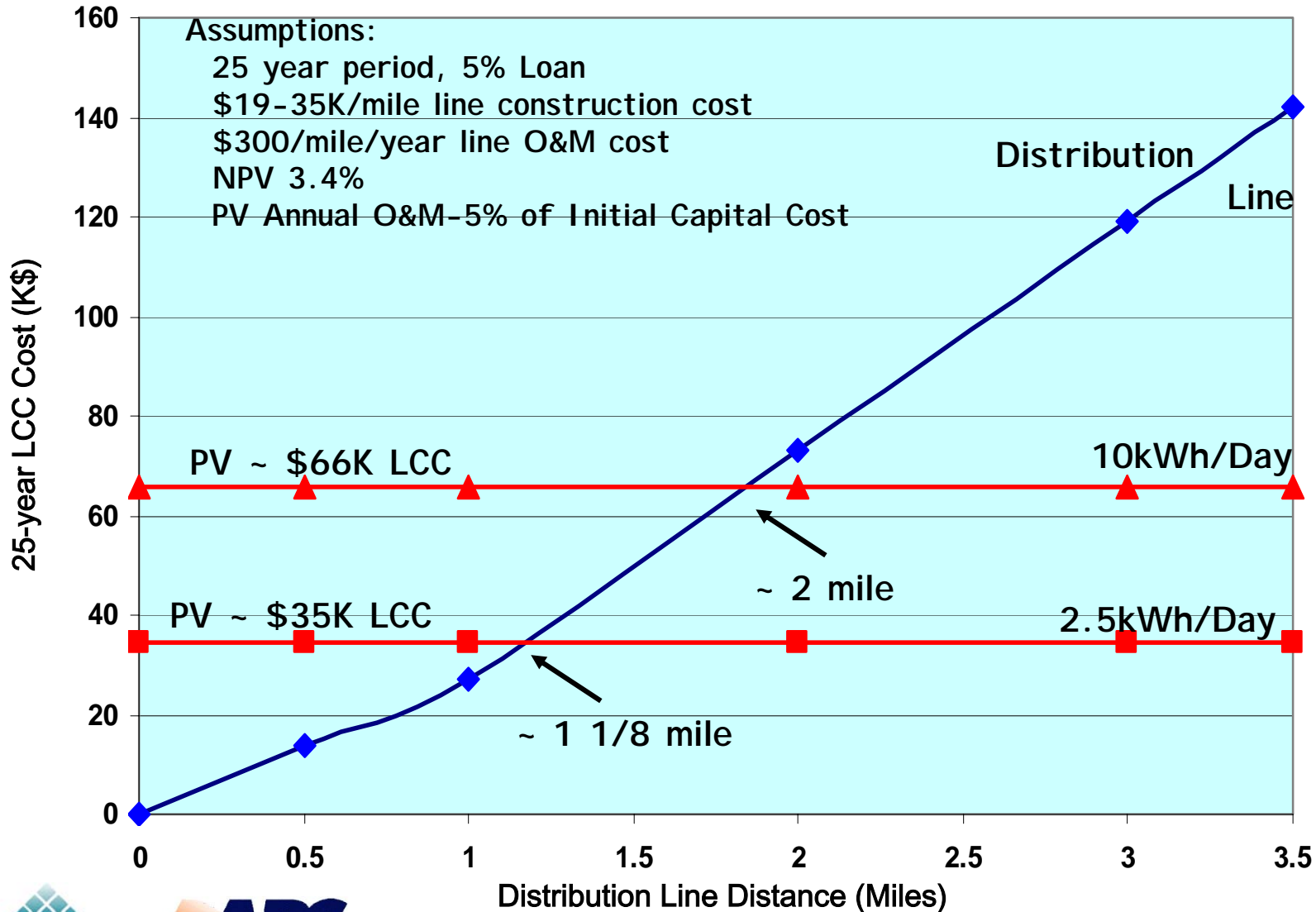

# What's the Approach to PV System Acceptance?

- Follow the existing RUS Review Process
- Initial listings for Water Pumping and Grid Tied Residential
- Technical Acceptance Criteria
  - Builds on experience of Florida PV Building Program
  - Sandia/FSEC technical team provides advice on system acceptance to RUS

# What's Included in the PV System Acceptance Review?

- System Documentation
- Component Documentation
- Safety/Code Compliance
- Performance
- Electrical Design
- Mechanical Design
- Installation Procedures
- Long-term system viability

# Validity of Review Process

- American Association for Laboratory Accreditation (AALA)
  - Provides laboratory accreditation/related training
  - Based on ISO/IEC 17025
- PowerMark Certification
  - Established 1996 to promote manufacture of quality PV products
  - Sole U.S. agent for Global Approval Program
  - Only U.S. PV tests/certification program meets requirements for international reciprocity

# Current Status

- Technical acceptance criteria for water pumping and grid tied applications developed
- Design review process established/review committee in place
- RUS sponsored workshops planned as outreach for acceptance process
- 9 grid-tied PV system applications pending TSC review for ‘List of Materials’

# Summary

- Interagency agreement in place for DOE/RUS
- Workshops planning stages to address familiarity/reliability/cost/performance
- Review process established/committee in place
  - Complements RUS traditional approach
  - Follows Florida PV Building Program historical approach
- Initial systems pending acceptance process

**The End**



**RUS 2004 ELECTRIC  
ENGINEERING SEMINAR**

**FEBRUARY 10-11, 2004**

**NEW ORLEANS, LA**

**NRECA/DOE**

**WIND POWER  
WORKSHOP**

**RUS 2004 ELECTRIC  
ENGINEERING SEMINAR**

**FEBRUARY 10-11, 2004**

**NEW ORLEANS, LA**

**Co-op Opportunities in Wind Energy**

**Randy Manion**

**Non-Hydro Renewable  
Program Manager**

**Western Power Administration**

*BIOGRAPHICAL SKETCH*

**RANDY MANION**

Randy Manion began his career in the energy industry in 1979, implementing Portland General Electric Company's aggressive conservation and renewable energy program. From 1983 to 1985 Mr. Manion managed energy auditing for the Hood River Conservation Project. From 1985 to 1991, Mr. Manion managed conservation and renewable energy programs for Imperial Irrigation District in addition to serving three years as Power Superintendent for the El Centro Power Division. From September of 1991 through December of 1993, Randy Manion held the position of Energy Services Manager for Western Area Power Administration's Desert Southwest Regional Office. In January of 1994, Randy Manion was promoted to Division Director of Power Marketing and Contracts for the Desert Southwest Regional Office, and held that position through June of 1996. On January 19, 1997, Randy Manion was offered and accepted the position of Non-Hydro Renewable Program Manager reporting to Western's Corporate Service Office out of Golden, Colorado.

In his position, Mr. Manion is responsible for facilitating the development of a Western wide program which advances renewable energy technologies across a 15 state service territory to more than 600 electric cooperatives and other public power utilities. Through a collaborative effort with each Regional Office in Western, Mr. Manion assists in the identification of renewable resource advancement opportunities and works towards tangible and measurable benefits to Western's firm power customers and other stake holders in power industry.

In total, Mr. Manion brings 25 years experience in conservation and renewable resources to Western. Mr. Manion has a B.A. in Public Administration, is a Certified Energy Manager (CEM) with the Association of Energy Engineers; Certified Institutional Energy Auditor with the California Energy Commission and has actively held positions on several boards, executive committees, advisory committees, including the Sustainable Building Industry Council in Washington, DC; Arizona Alliance for the Advancement of Math, Science and Technology in Phoenix, Arizona; EPRI Green Power Target; Manion also serves on the advisory team to the U.S. , Dept. of Energy Wind Powering America, and GeoPowering the West Programs. Other accomplishments include founder of the Southwest Public Power and Water Symposium, the Arizona Chapter Association of Professional Energy Managers, the Colorado River Chapter of the Association of Professional Energy Managers, Western's IRP Training Series and most recently the Public Renewable Partnership.

Co-op Opportunities in Wind Power  
Randy Manion, Western Area Power Administration  
February 11, 2004  
NRECA / DOE Wind Workshop

Slide 1:

Good afternoon, it's great to be here with you. I bring you greetings from Phil Dougherty, the National Wind Powering America Program Manager; and Larry Flowers, the National Wind Powering America Program Technical Lead. I'm here today on behalf of the U.S. DOE Wind Powering America Program to talk to you about "Co-op Opportunities in Wind Power." In this presentation I'm going to provide a high-level overview of Wind Power America partnership activities benefiting electric cooperatives; and a comprehensive overview of wind power today.

The creation of the U.S. DOE Wind Powering American Program was first announced at the American Wind Energy Association Windpower Conference 1999. The program is a state-based based effort to increase the nation's domestic energy supply by promoting the use of wind energy technologies, such as low wind speed technology, to increase rural economic development, balance the national generation portfolio, protect the environment, and enhance the nation's energy security. At its announcement, the program challenged the nation to meet 5% of our electricity needs with wind power by the year 2020, triple the number of states with significant wind power capacity, and support the Department of Energy's corporate effort to increase the federal government's use of renewable electricity to 5% by 2010.

Wind Powering America's primary goal today is to provide state-based technical support and outreach to 16 targeted states with the goal of expanding the use of wind power to more than 100 MW by 2010. To achieve this goal, Wind Powering America provides technical support as well as educational and outreach materials about utility-scale development and small wind electric systems to utilities, rural cooperatives, federal property managers, rural landowners, Native Americans, and the general public.

Slide 2:

Much of what we accomplish in the Wind Powering America Program is accomplished through partnership activities. A few of our partnership-based activities include:

Slide 3:

Since its inception in fiscal year 2000, Wind Powering America has supported the development of the Public Renewables Partnership, an effort among public utilities, electric cooperatives, Federal Power Marketing Administrations, EPA, BLM, USDA, American Public Power Association and the National Rural Electric Cooperative Association, among many others, to advance the use of wind power and other renewable resources in public power. A few of PRP's activities include a \$7 million grant from the California Energy Commission to do 13 research and development projects. Three projects of interest to this audience include investigating how to interconnect wind and other renewable energy sources into the Pacific Northwest – Southwest High Voltage DC Intertie Line which goes from the Columbia River in Oregon to Los Angeles, California; AC transmission studies investigating how to get wind and other renewable energy sources from Oregon, Idaho, and Nevada into California over the Sierra's; wind resource assessments – we've already identified more than 5 Giga-Watts of developable wind power that could be brought into California; and energy storage, looking aspects of energy storage to make wind more valuable.

Another important PRP project currently in the development process is a consumer owned utility certified Tradable Renewable Energy Credit. We are working closely with NRECA, APPA, BPA, APA, CRC, Basin Electric Coop, Tri-State and many other co-ops and consumer owned utilities to develop a program that would give special branding and certification to those co-ops and consumer-owned utilities desiring to wholesale renewable energy credits. Only co-ops and consumer owned utilities will qualify for for participation in this program. You can learn more about PRP and our activities by going to the PRP web site at [www.repartners.org](http://www.repartners.org).

Slide 4:

Wind Powering America has financially supported the development of Western Area Power Administration's Federal Green Tags Program. Federal agencies across the nation can now take advantage of the benefits of wind power and other renewable energy sources through a program geared to their needs offered by Western Area Power Administration, in cooperation with the U.S. DOE Federal Energy Management Program. The program offers three renewable energy products for Federal agencies. Under the first product, Western can buy and physically deliver wind power and other renewable energy sources for Federal agencies located within its 15 state service territory; With the second product, Western use wind power and other renewable resources to supplement its customers firm hydropower deliveries; with the third product, Western will buy wind power and other renewable energy sources and sell the energy's environmental attributes to a Federal agency. For more information on this program, go to <http://www.wapa.gov/powerm/pmtags.htm> .

Slide 5:

The American Public Power Association and the National Rural Electric Cooperative Association have been working closely with the Wind Powering America Program for the last several years. These two publications, Wind Power For America: Rural Electric Utilities Harvest a New Crop; and Wind Power for Municipal Utilities, are icons for what has been accomplished with the assistance of the Wind Powering America Program.

With the National Rural Electric Cooperative Association – Cooperative Research Network, Wind Powering America formed a partnership to promote wind energy where it makes sense for electric cooperatives. Over 40% of electric cooperatives are in states with the majority of the harvestable wind potential. Through working with the Cooperative Research Network Wind Powering America seeks to help these co-ops take advantage of their wind resources. So far, wind energy workshops have been conducted in Texas, Montana, Kansas, Tennessee, Colorado and the Dakota's. They have been well attended and attracted a regional cross-section of co-op representatives. Some meetings also included elected officials and other consumer-owned utilities. In addition, technical assistance has been provide by the National Rural Electric Cooperative Association's technical consultant, AWS Scientific, to a number of co-ops

seeking to start the process of developing a wind project, as well as others who were further along but needed the advise and expertise of independent expert. Wind Powering America looks forward to working with the Cooperative Research Network over the next 12 to 24 months, conducting more regional co-op wind workshops, such as this one, providing information dissemination through articles on wind technologies, wind forecasting, and answering questions about wind energy applications, among other activities.

Slide 6:

For the past several years, funding has been provided to Western Area Power Administration's Upper Great Plains Region to conduct transmission studies throughout that region. The studies aim to identify where and how much wind power can be developed today; as well as what upgrades and technical barriers exist which inhibit further expansion of the transmission system so more wind power can be developed. These transmission study reports are available on our Upper Great Plains web site. The Wind Program and Hydro Program at the Department of Energy's Office of Energy Efficiency and Renewable Energy (EERE) have merged. Because of this consolidation, Peter Goldman, the Director of the DOE Wind – Hydro Program, is seeking opportunities for conducting wind-hydro integration studies. Wind Powering America has taken the lead in identifying where those opportunities are and is pursuing the necessary business relationships to move more wind-hydro integration studies forward. Currently, studies are being put together and will soon be underway with the Arizona Power Authority, a significant customer of Western Area Power Administration; and with the Bonneville Power Administration. Contact Brian Parsons at NREL, 303-384-6958, for more information on these activities.

Slide 7:

Wind Powering American has been supporting regional wind mapping efforts. We have been working with coops and muni's overlaying wind resource maps with their power distribution system to assist with the identification of good wind resource areas with their electrical distribution system. Go to the [www.windpoweringamerica.gov](http://www.windpoweringamerica.gov) web site to see a complete list of wind resource maps on line.

Slide 8:

WAPA partners with NREL to loan out wind anemometers to Co-ops, consumer-owned utilities and Native American Tribes throughout WAPA's 15 state service territory. At this time, WAPA has 81 anemometers in its Equipment Loan Program – and all of them are in the field. In addition, Wind Powering America has established other anemometer loan programs through universities and state energy offices throughout the United States.

Slide 9:

In 2003, Basin Electric was the recipient of the Wind Powering America “Wind” Co-op of the Year Award. This year's winner has not been selected yet, stay tuned.

Slide 10:

If you go to the Wind Powering America web site at [www.windpoweringamerica.gov](http://www.windpoweringamerica.gov), you will find on the left hand side of the web site a Wind Project Financial Calculator. With this program, you can create a new wind project or modify an existing one, by entering values for numerous assumptions, step-by-step, until enough information has been entered to calculate a projects cost of electricity. This is a great tool for any electric co-op system desiring estimated wind project cost information.

We have many, many more partnership activities underway, including:

- State Working Groups
- Deliberative Polling
- Wind – Hydro Integration Studies
- Native American Outreach
- Utility Wind Interest Group
- National Wind Coordinating Committee
- American Public Power Association
- Wind in a Box Outreach Kits
- Among many others



#### Slide 11:

Let's take a look at wind power today. Wind power today is based on about 2000 years of experience, even further back, since the dawn of civilization, people have relied on the wind for propelling sailing vessels and to power grain grinding mills, saw mills, water pumps, and other devices.

#### Slide 12:

Wind is generated by small regional differences in atmospheric pressure caused by solar heating of the Earth's surface, radiation cooling at night, passage of air over warm or cold ocean water, passage of fronts and storms, and other complex meteorological phenomena. Wind resource quality can vary significantly from site to site. Obviously some locations are windier than others, but even within a known wind resource area, the wind can vary with local terrain. This is further complicated by the fact that for a given site, the wind will generally have seasonal, diurnal, and in some cases hourly variations. Accurately assessing the quality of the wind resource at a proposed project site is a critical first step to the success of a potential wind project.

#### Slide 13:

This is a wind resource map of the United States. It shows class 2 to class 7 wind resource areas. Many areas of the United States contain excellent wind resources that are potentially suitable for utility scale developments.

#### Slide 14:

This slide shows where the co-ops are located and where there are good wind resource areas. As you can see, about 50% of all co-ops are in good wind resource areas. The list on the right shows a few of the co-ops that have invested in wind. Electric cooperatives have been leaders wind power development. There are about 19 electric cooperatives and generation and transmission organizations in the United States that use wind or offer it to their customers as part of a green pricing program.

#### Slide 15:

This map shows 2003 year-end installed wind power capacity. Ironically, some of the best wind resources in the world are located in the Dakotas and only 130 MW have been installed – primarily because of transmission constraints. Next to the expiration of the Production Tax Credit, the single biggest barrier to more development of utility scale wind is available transmission capacity.

#### Slide 16:

Wind power technologies can be categorized into three classifications: Utility scale wind farms; distributed clusters connected to a distribution grid; and distributed clusters serving remote loads. These three classifications are otherwise known as large, intermediate and small wind.

- Small wind typically serves homes, farms and remote applications. Systems are generally less than 10 KW.
- Intermediate wind systems are generally 10 to 250 KW. They're often used in rural areas as distributed generation systems. Sometimes as hybrid systems with another generation source such as diesel or solar.
- Large wind systems, typically known as Utility Scale Generation, are central station wind farms, usually numbering 3 or more per cluster. Sometimes they are used as a distributed power system; however, when using wind turbines reaching 2.5 MW in size, it's not very cost effective to install just one of these huge machines. If you're going to pay thousands of dollars for special equipment to install one, you might as well install several at the same embedded cost.

#### Slide 17:

Small wind turbines are different than large wind turbines. For example, large wind turbines in projects of at least 10 MW in size typically cost around \$1,000 per kW and require at least 13 mph wind speeds. Small wind turbines on the other hand are typically more expensive and cost \$2,000 to \$6,000 per kW; and only require wind speeds around 9 mph.

Slide 18:

There was a great quote awhile back by Steve Zwolinski, President and CEO of GE Wind, he said: “wind is not a science project anymore.” As you can see on this chart, in the 1980’s wind power systems were typically 50 to 100 kW, three-blade, upwind, yaw-driven, constant speed systems on a lattice structure. Costs were around 40 Cents a kWh.

In the 1990’s, wind generators had several technological improvements, including a variable speed drive, special airfoils, stall regulation and pitch control, planetary transmission, induction generator, and significant increase in size from 300 to 500 kW. Of these improvements, the two most significant were: the increase in size. This enable economies of scale, one turbine could now generate 200 to 500% more energy than those in the 1980’s. The second was performance. Wind systems could now operate at 95% reliability.

Slide 19:

Over the last 25 years the technology has significantly matured. Today’s utility-scale wind machines are commonly 1.2 to 2.5 MW in size. The larger the turbine and the larger the wind farm, the lower the overall project cost. Availabilities are reported at 98 to 99%; certification to international standards helps avoid show stoppers; performance and cost have dramatically improved; and new hardware is being developed on multiple fronts including:

- Advanced blade materials
- Improvements in manufacturing
- Low-speed direct drive generators
- Custom power electronics
- Feedback control of drive train and rotor loads
- More structural flexibility
- Operation and Maintenance reduction features
- Taylor designs for high capacity factor, low wind speed and extreme weather conditions
- Larger size units – up to 5 MW and climbing

## Slide 20:

This chart is somewhat difficult to read, but the basic message is this: Wind power is the fastest growing power generation technology in the world for the past decade, about 25% per year. As of January 2003, North America had a total of 5,018 MW of installed and operational wind power generation. Across the pond, close to 30 million Europeans use wind-generated power with Germany being the largest producer. In Denmark, wind turbines generate close to 20% of that country's electrical power. As of January 2003, Europe had 21,319 MW of installed and operational wind power generation.

## Slide 21:

Drivers for wind power include:

- Declining wind costs. Over the last 20 years wind has gone from 40 cents a kWh to less than 2.5 cents today.
- Fuel costs have never been so unstable. Wind has no fuel cost, so it offers stability to a utility's resource portfolio. In Colorado, where I live, the Colorado Public Service Commission recently determined that wind was cheaper than gas when Xcel accepted bids at \$3.50 a million BTU.
- Federal and state policies are drivers, such as a Renewable Portfolio Standards or Net Metering Laws.
- Economic development is a big driver in rural areas. Landowners can receive from \$2500 to \$4000 per turbine when their land is used for development of wind. The American Wind Industry Association estimates that over the next 20 years, \$50 billion in capital investment will occur because of wind power generation; \$500 million in new income to states and rural landowners; and 40,000 permanent jobs.
- Green pricing programs are another important driver. This is where customer demand for renewable resources is met with wind and other renewable energy sources offered by the serving utility.
- And last but not least, energy security, less dependence on foreign oil; a more diverse power generation portfolio and a more reliable power grid.

Slide 22:

In 2003, the average wholesale cost of electricity from wind ranged from 2.5 cents a kWh in high wind speed areas; and 4.5 cents a kWh in lower wind speed sites. These prices include the Production Tax Credit. If you sell the green tag associated with wind power, these prices can drop by another half a cent to one cent a kWh.

Slide 23:

As we can see on this chart, the price for wind energy continues to drop and it is now competitive with other sources of bulk power supplies. Having said this, you still need to do a comprehensive and thorough analysis to determine the actual benefits and costs from each unique wind project.

Slide 24:

This chart displays the average natural gas prices over the last 10 years. You can see the volatility in marketplace over the last 3 years. It's forecasted that this volatility will continue.

Slide 25:

One usually needs incentives to make small wind systems more economical. Incentives include:

- Monthly net metering
- Annual net metering
- Buy down incentives

These types of incentives can ensure a payback between 10 and 15 years, at a retail electricity rate of 7 – 9 cents/kWh, for a small wind system.

Slide 26:

The map displays the states with Renewable Energy Policies. Policies such as:

- System Benefit Charges

- Renewable Portfolio Standards
- Wind related tax incentives

Slide 27:

This map shows which states have Net Metering, whom is offering it, and the maximum allowable size of generation allowed.

Slide 28:

This map shows which states offer residential small wind incentives and the types and combinations of incentives offered, such as:

- Buy-downs
- Net Metering
- Loans
- Productivity Incentives

Slide 29:

There are many determining factors to wind economics, including: How good is the wind resource? A one-half mile an hour increase in wind speed can equate to a one cent per kWh decrease in wind cost. Financing and ownership makes a huge difference in the bottom line. I have a chart that will depict this in a moment.

Plant size is critical. The larger the wind project, the more economies of scale can be had with regard to leasing of a crane to put the turbines up, legal fees, installation and O&M. Size is everything when driving the cost of wind generation lower. The larger the turbine, the greater the MW's per unit. Other determining factors include is it a green field or a site expansion, meaning, is it a new site requiring environmental assessment, substation and transmission additions, roads and other infrastructure improvements; or is it an expansion of an existing site where additional infrastructure costs are kept to a minimum.

Slide 30:

This slide demonstrates the benefits of coop and consumer-owned utility financing. A for profit company, such as an investor owned utility or independent power project (IPP), will need to install a 50 MW wind project to secure the same project benefits as 10 MW wind project financed through a cooperative or consumer-owned utility. As you will hear about shortly, RUS has set funds to finance renewable energy projects.

Slide 31:

Green pricing is a mechanism to provide renewable generation to electric cooperative customers wishing to support renewable resources. These types of voluntary programs can be very effective and can provide a variety of benefits, including increasing customer loyalty and decreasing price volatility. The electric cooperative, or its G&T, such as Basin, can build renewable power generation or purchase it on the market; or can purchase it in the form of “Renewable Energy Credits.” Renewable Energy Credits are a way to purchase the environmentally positive portions of energy generation, without necessarily purchasing the energy itself.

Buying Renewable Energy Credits from someone else is the quickest, easiest way to develop a green pricing program, but may be confusing to explain to customers and may not meet local economic development and community goals. Developing an effective green pricing program requires substantial thought to be given to the type of power purchased or built, pricing of the generation, operational development issues, and marketing/customer education. Time spent developing the program infrastructure before rollout can increase effectiveness and decrease pitfalls for an organization. Willingness to constantly reevaluate the program and change it if necessary is important in the long-term. Partnership with other groups in the Cooperative, community, and industry are also vital to developing and maintaining an effective green pricing program.

As you can see by this slide, almost every state has at least one utility or cooperative that offers a green pricing program.

Slide 32:

Best Practices in Marketing Green Pricing Programs: A resource guide for renewable energy marketers. Was a PRP facilitated project through the American Public Power Association's DEED Program. This comprehensive report is available to all CRN members on the PRP Web site.

Slide 33:

Wind power generation offers significant economic development opportunities. A few of the benefits include:

- Land lease payments, typical 2-3% of gross revenue, can range from \$2500-4000/MW/year for a landowner.
- Local property tax revenue for each 100 MW of wind power can bring in \$1 million annually.
- 1-2 jobs for each MW of wind during construction.
- 2-5 permanent Operation and maintenance jobs for each 50-100 MW of wind.
- Local construction and service industry benefit, such as concrete and towers which are usually done locally.
- Investment as equity owners, production tax credit, and accelerated depreciation are all economic development drivers.
- Nationally, manufacturing and assembly plants are expanding across the U.S., such as the Micon facility in Illinois and the LM Glassfiber facility in North Dakota.

Slide 34:

We've documented some actual economic development figures from recent wind projects, there impressive. A 240 MW wind project in Iowa provided:

- \$640,000/yr in lease payments to farmers (\$2,000/turbine/yr)
- \$2 million/yr in property taxes
- \$5.5 mil/yr in O&M income
- 40 long-term O&M jobs
- 200 short-term construction jobs
- Doesn't include multiplier effect



A 107 MW wind project in Minnesota provided:

- \$500,000/yr in lease payments to farmers
- \$611,000 in property taxes in 2000 = 13% of total county taxes
- 31 long-term local jobs and \$909,000 in income from O&M (includes multiplier effect)

Slide 35:

Native Americans are becoming a bigger driver of wind. Some of the Nation's best wind resources are on Native American lands. Here's a quote from Ronald Neiss, Rosebud Utility Commission President, Rosebud Sioux Reservation, South Dakota:

Slide 36:

“In evaluating the potential of wind energy generation, Native Americans realize that wind power is not only consistent with our cultural values and spiritual beliefs, but can also be a means of achieving Native sustainable homeland economies.” So we expect to see continued aggressive pursuit of wind power by Native Americans.

Slide 37:

The three biggest issues for wind today are the Production Tax Credit (PTC), which expired on December 31<sup>st</sup>. According to the American Wind Energy Association, the PTC is “being held hostage” by the Energy Bill. Apparently, there is no chance of the PTC being passed under separate legislation. Unless the Energy Bill passes, the PTC will remain expired.

Another significant issue is transmission access. Unless more transmission is constructed, some of the best wind areas will remain undeveloped.

And the third significant issue is tradable tax credits for consumer owned utilities. Currently, consumer-owned utilities do not qualify for the PTC and tradable tax credits would level the playing field and increase coop and consumer-owned utility investment in wind and other renewable resources.

Lesser issues but still impacting are siting and permitting; avian issues had decreased significantly due to better siting practices and use of tubular

towers. However, bat kills in certain areas can be significant. Surprisingly, the bats are flying into the blades, not the stationary towers. Permitting on Federal lands is still a big issue and is being addressed as we speak by BLM. I'm not sure any progress has been made with regard to siting on Federal forest lands.

Operational impacts are also issue. Wind is an intermittent resource. The California Independent System Operator has determined that wind resources in California have a zero capacity benefit. I personally believe we need to spend more time investigating how to match wind resources up with load and using load control devices to help firm up wind.

Slide 38:

This flowchart shows development process for a wind project. When you speak with a developer they'll always point out the most important step on this flowchart is the Purchase Power Agreement. Developers will end-up investing hundreds of thousands of dollars; even millions of dollars doing the first seven steps of a wind project with the risk of never securing a Purchase Power Agreement. At which point, everything shuts down.

That concludes my presentation. If you have time later today, read some of testimonials that I've included at the end my PowerPoint presentation. The testimonials were provided by your peers who have invested in wind power.



## Co-op Opportunities in Wind Energy



Randy Manion

11 February 2004

New Orleans, LA





## Partnership Activities



- PMA Green Tags
- PRP Web Site
- Transmission Analysis
- Coop Outreach
- Green Pricing Support
- Publications
- Wind-Hydro Analysis
- Wind Mapping
- Anemometer Loans
- WPA Awards

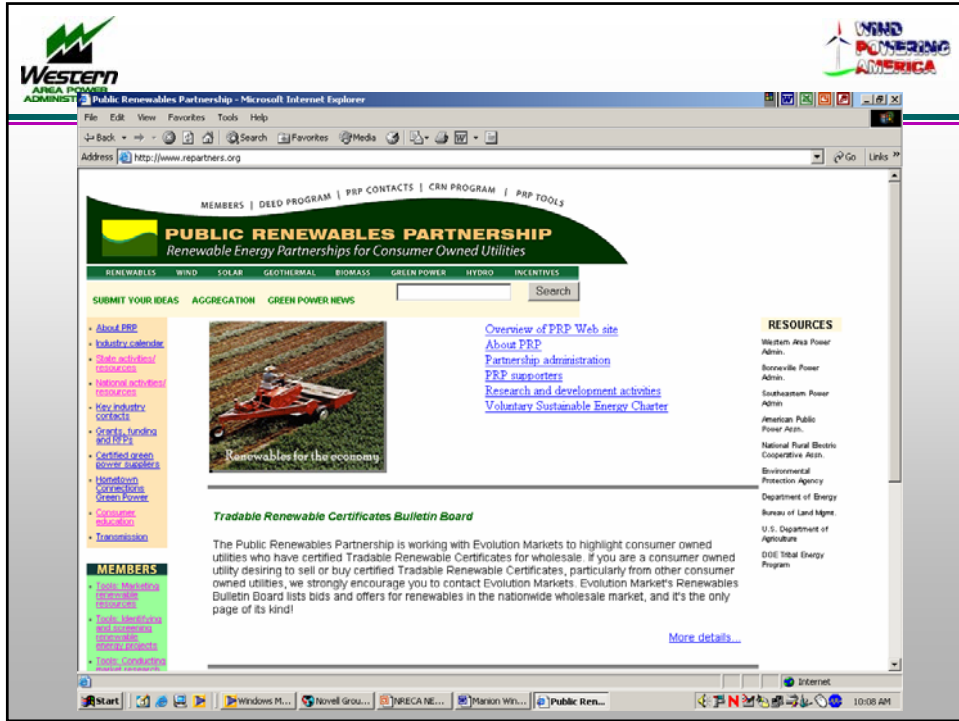





# WAPA Federal Green Tags



The renewable electricity is physically delivered to Western's transmission system and the Green Tag is delivered to the purchasing Federal agency regardless of location. Federal facilities continue to pay for the power needed to meet load from their current supplier without charge. The price for the Green Tag is the difference between the renewable resource price and Western's avoided cost. Transmission costs to deliver the energy to the site are not required, although transmission is needed to deliver the renewable energy to Western's transmission system. The total cost (including transmission costs) will be negotiated. A fixed price with a periodic adjustment would assure that the full benefits/costs of this service are passed through to the Federal agency. Existing Western customers could combine payments for Green Tags with payments for Western's hydroelectric power.

Current Green Tag costs from a variety of suppliers are shown in [http://www.wapa.gov/greenpower/centr\\_summ.shtml](http://www.wapa.gov/greenpower/centr_summ.shtml)

**PRODUCT BENEFITS**

- No transmission costs for the Green Tag.
- No impact on your existing power supplier.

**Sample Purchases**

- Western recently entered into a renewable power purchase with American Electric Power on behalf of Edwards Air Force Base in California. The contract term is five years and the price is \$78.50/MWh.
- In 2002, Western purchased Green Tags from Basin Electric Power Cooperative on behalf of Ellsworth South Dakota and Warren (Wyoming) Air Force bases. The cost was \$25/MWh for five years.
- Although future prices may vary, Western is a non-profit agency and provides renewable resource services based on our cost.

**How do I sign up?**

- Federal agencies interested in renewable power will sign commitment letters with Western detailing:
  - the type of product desired
  - the quantity to be purchased and
  - the desired price range
- After sufficient commitment letters have been signed, Western will issue a Renewable Request for Proposal.
- Resulting bids will be reviewed, and if deemed acceptable, Western will sign a contract with the renewable provider (and with each of the federal agency sites).

Benefits of Western's renewable resource services will be retained by Federal customers. Details of renewable resource products provided by Western listed below:

**For more information**

**Bob Fullerton**  
Western Area Power Administration  
bfullerton@wapa.gov  
720/960-7079

**Chandra Shah**  
National Renewable Energy Laboratory  
chandra\_shah@nrel.gov  
303/254-7557

**David McAndrew**  
Federal Energy Management Program  
David.McAndrew@fedea.gov  
202/586-7122



Western, in cooperation with the Department of Energy's Federal Energy Management Program (FEMP), is working to increase the renewable power options available to Federal agencies.

4/28/03

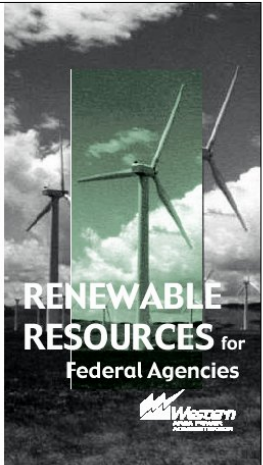

©2003

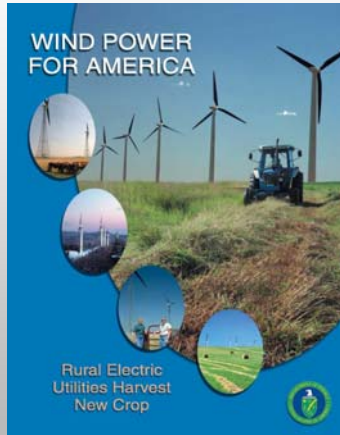

## Transmission Study

Upper Great Plains Region

[UGPR's Home Page](#)  
[Press Release](#)  
[Study Results](#)  
[Study Scope](#)



Montana/Dakotas Regional Transmission Study Scope

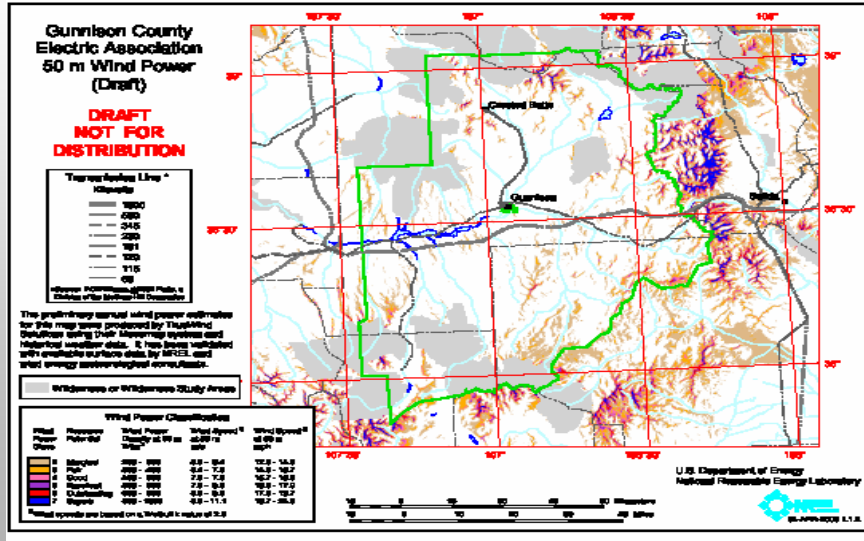



# 2003 Wind Co-op Award



# Wind Energy Calculator



File Edit View Favorites Tools Help Address http://analysis.nrel.gov/windfinance/default.asp

**WIND ENERGY FINANCE** Logout

Help Print <<Start <Back Next> Finish>>

**PROJECT SELECTION** Jump To... [v]

A wind energy power project is an electricity generation investment that produces electricity at an average cost of electricity that is based on technology, location and financial assumptions.

In this application you create new (or modify an existing) project by entering values for numerous assumptions step-by-step, until enough information has been entered to calculate the project's cost of electricity.

The projects that you add or modify will be stored for your convenience and will be available to you the next time you login. An asterisk at the end of a project name means that the project is visible to all users and cannot be modified by a single user.

Select a Project [Default\* v]

Add a New Project

Help Print <<Start <Back Next> Finish>>

analysis Wind Energy Finance Webmaster

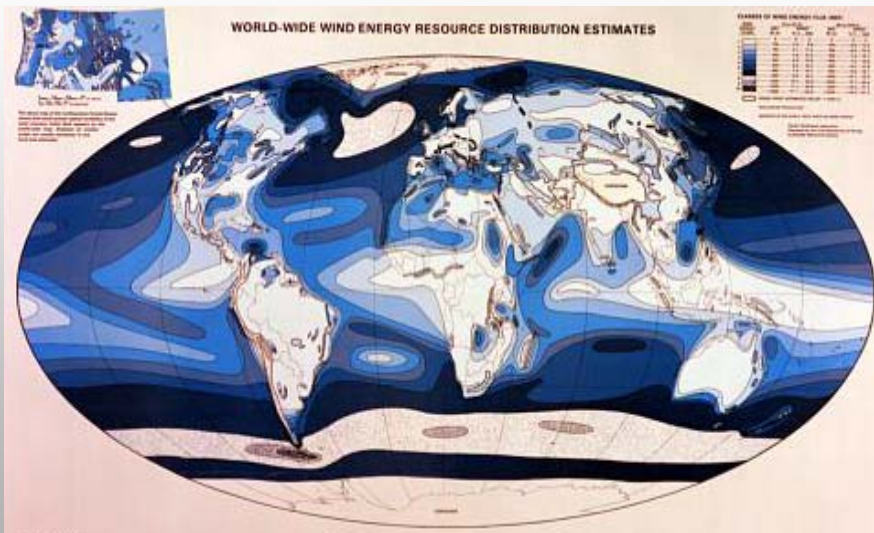



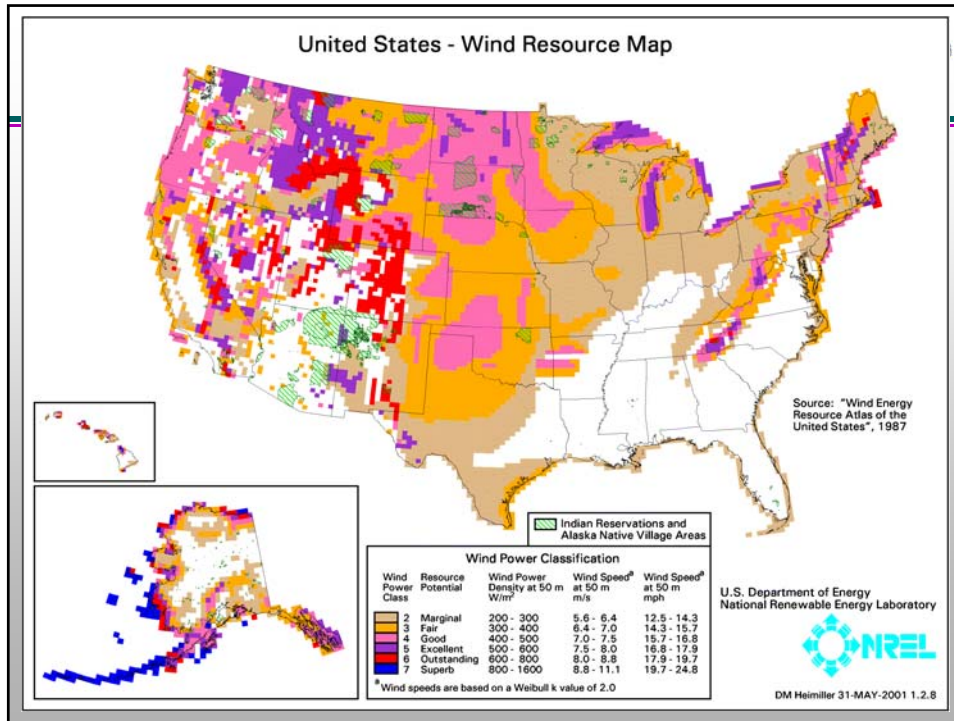

## Wind in Co-op Territory

Electric Co-op Service Areas

Source: NRECA

Wind Resource

- ❖ **G&T's can own, purchase, or wheel wind generation**
  - Tri-State, Colorado
  - Basin Electric, North Dakota
  - East River Electric, South Dakota
  - Great River Energy, Minnesota
  - Corn Belt, Iowa
  - Sunflower, Kansas
  - Nebraska Electric, Nebraska
  - Upper Missouri, Montana

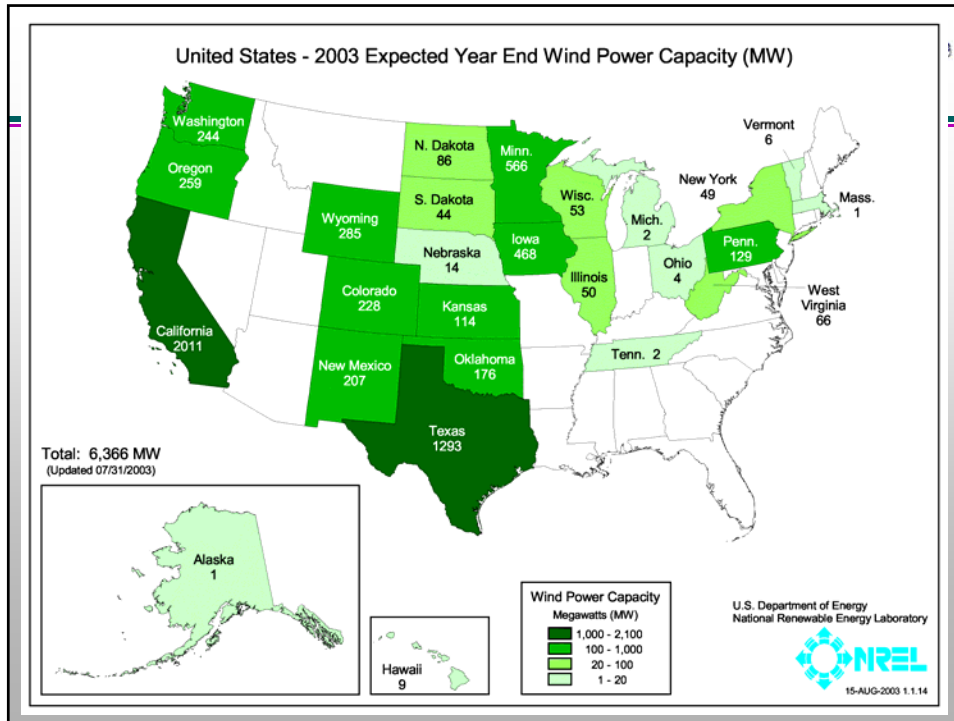



## Sizes and Applications





### Small ( $\leq 10$ kW)

- Homes
- Farms
- Remote Applications

(e.g. water pumping, telecom sites, icemaking)



### Intermediate (10-250 kW)

- Village Power
- Hybrid Systems
- Distributed Power



### Large (660 kW – 5 MW)

- Central Station Wind Farms
- Distributed Power

## Small Wind Turbines are Different

- Large Turbines (600-1800 kW)
  - Installed in Windfarms, 10 - 100 MW
  - Provide Low Cost Power to the Grid
  - < \$1,000/kW
  - Require 6 m/s (13 mph) Average Wind Speeds
- Small Turbines (0.3-50 kW)
  - Installed Off-Grid or at On-Grid Facilities
  - \$2,000-6,000/kW
  - Designed for Reliability / Low Maintenance
  - Require 4 m/s (9 mph) Average

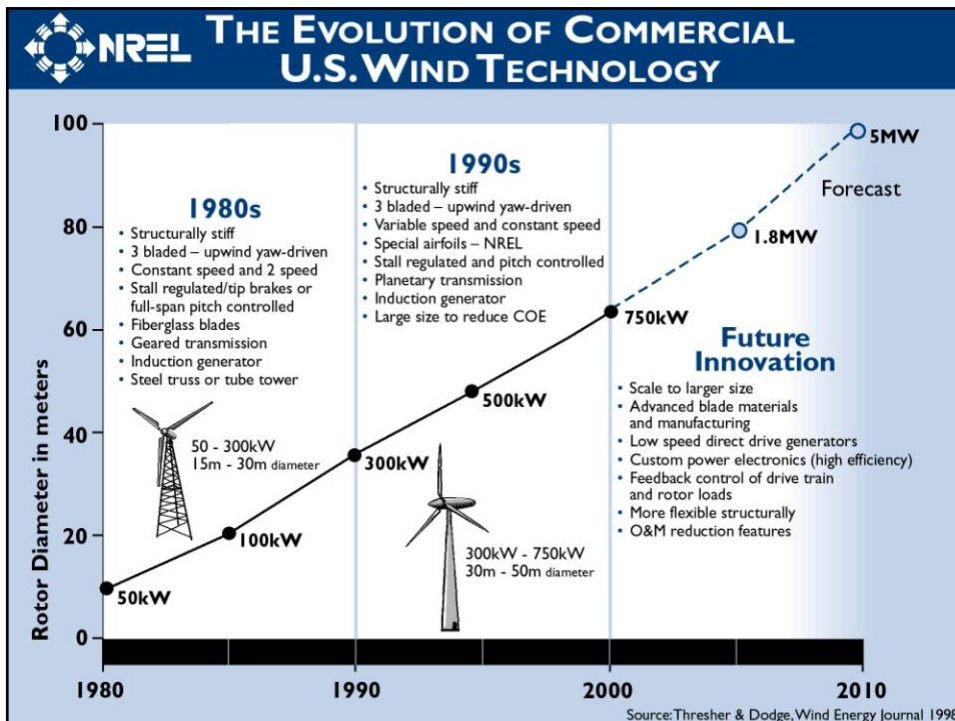
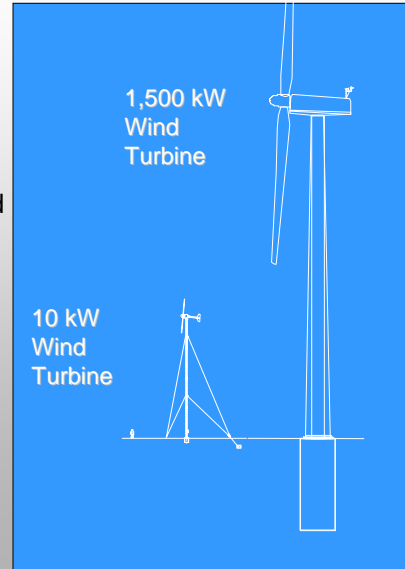



- Technology has matured over 25 years of learning experiences
- Availabilities reported of 98-99%
- Certification to international standards helps to avoid “show stoppers”
- Performance and cost have dramatically improved
- New hardware is being developed on multiple fronts:
  - higher productivity and lower costs
  - larger sized for both land and off-shore installations
  - tailored designs for high capacity factor, low wind speed and extreme weather conditions

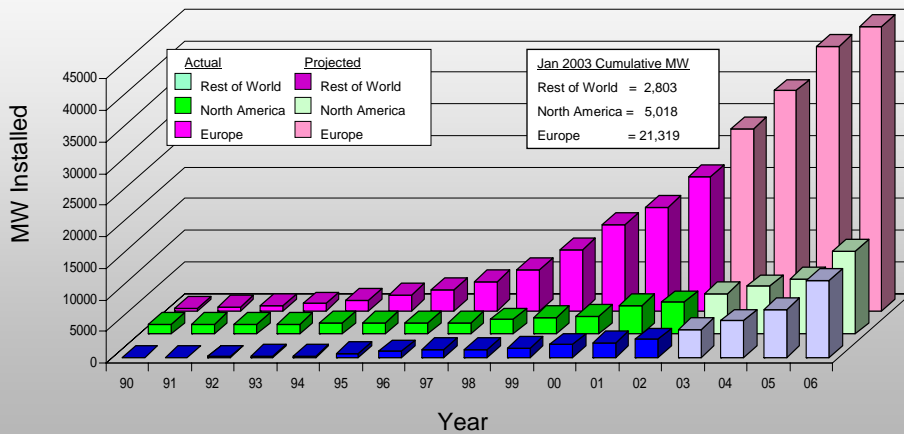

Sources: BTM Consult Aps, March 2001  
Windpower Monthly, January 2003

- Declining Wind Costs
- Fuel Price Uncertainty
- Federal and State Policies
- Economic Development
- Green Power
- Energy Security
- Native American Interest

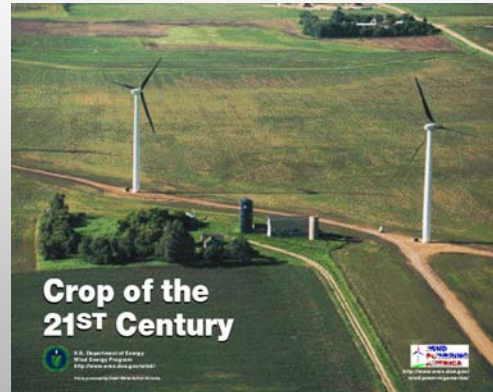

**1979: 40 cents/kWh**

**2000:  
4 - 6 cents/kWh**



NSP 107 MW Lake Benton wind farm  
4 cents/kWh (unsubsidized)

- Increased Turbine Size
- R&D Advances
- Manufacturing Improvements

**2004:  
2.5 – 4.5 cents/kWh**

## Wind Cost of Energy

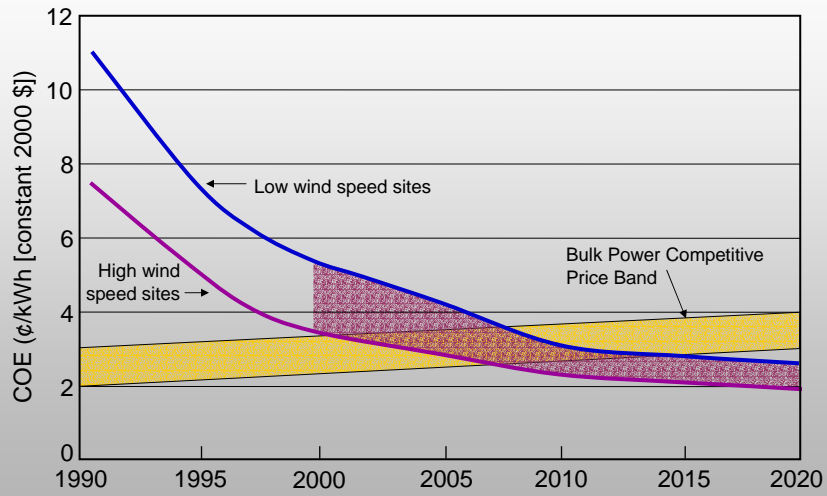

## U.S. Average Natural Gas Prices

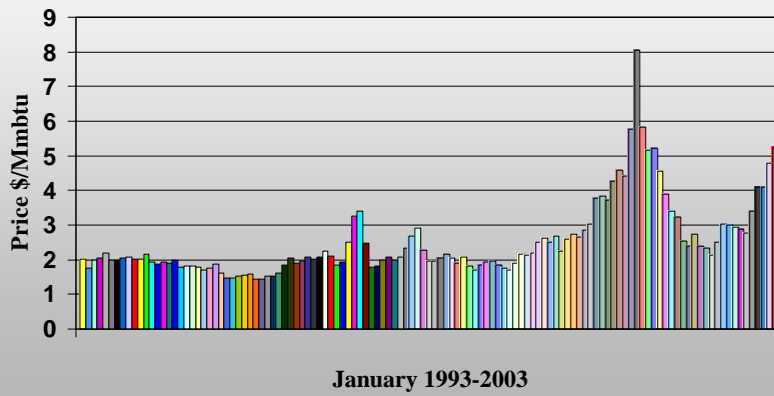

## More Economical

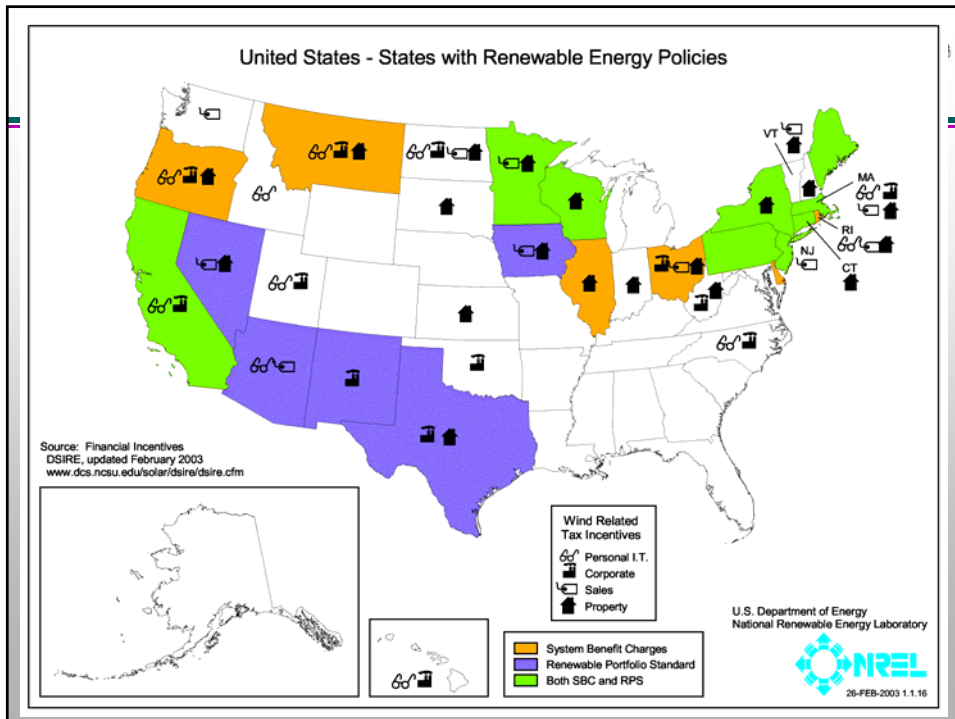
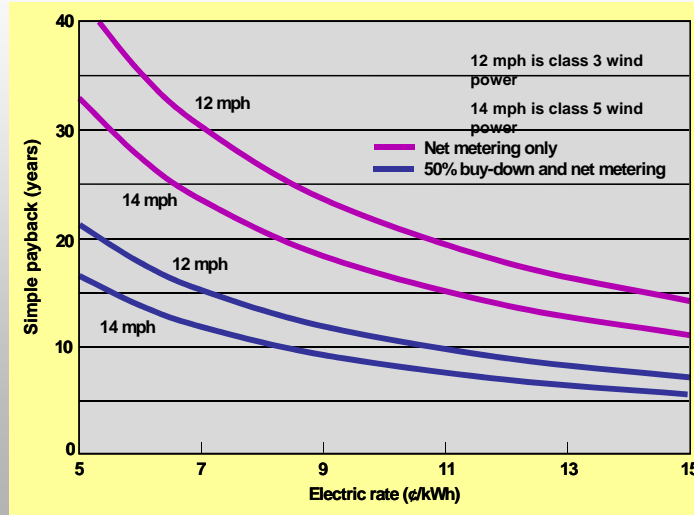

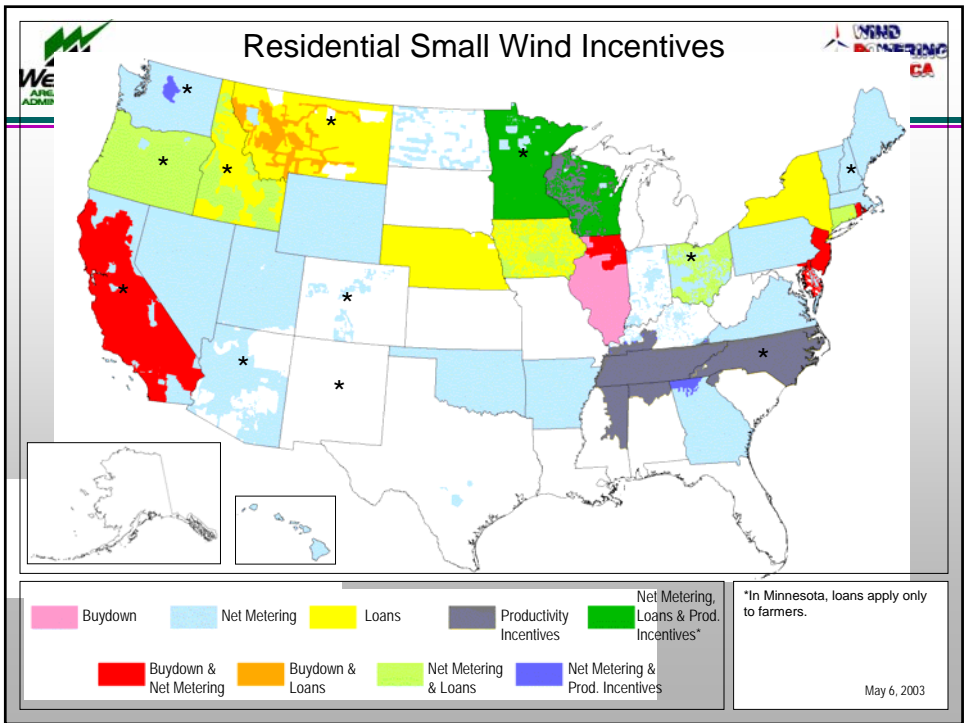
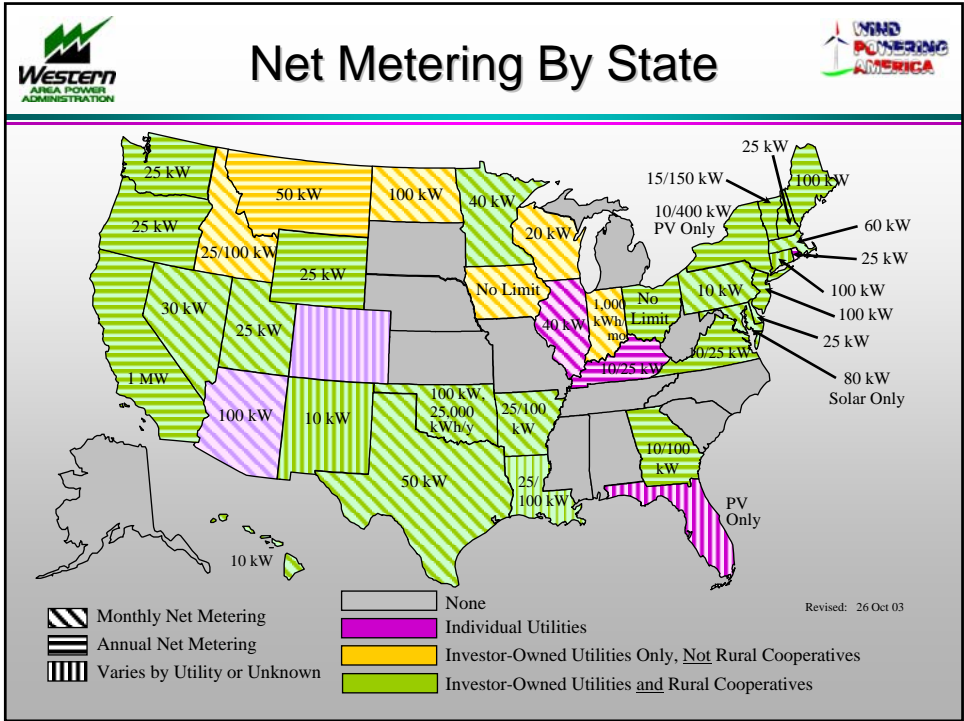



## Wind Economics - Determining Factors

- Wind Resource
- Financing and Ownership Structure
- Taxes and Policy Incentives
- Plant Size: equipment, installation and O&M economies of scale
- Turbine size, model, and tower height
- Green field or site expansion
- What is included: land, transmission, ancillary services



## Co-op vs. IPP Financing

- Larger plants are significantly less expensive per kWh
- Co-ops can own/install smaller plants at comparable cost to large IPP projects
- Aggregation of demand reduces costs

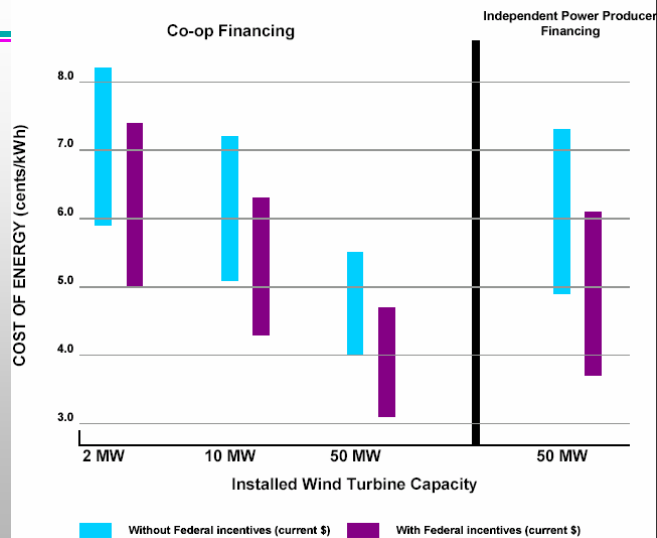

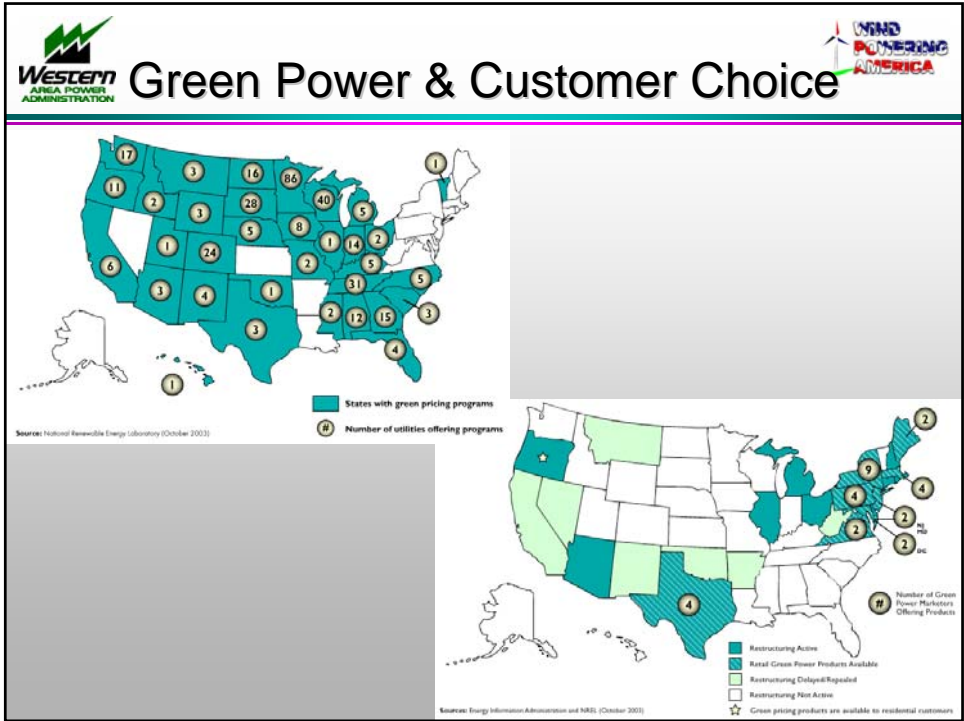

**Western AREA POWER ADMINISTRATION** **WIND POWERING AMERICA**

Best Practices in Marketing Green Pricing Programs - Microsoft Internet Explorer

Address: <http://www.cr2.net/gp/handbook/>

**Best Practices in Marketing Green Pricing Programs**

A Resource Guide for Renewable Energy Marketers

Keri Bolding  
 Center for Resource Solutions  
 November 2003



Windows M... Novell Grou... NRECA NE... Manion Win... Public Rene... Best Pract... Internet 10:11 AM

- Land Lease Payments: 2-3% of gross revenue \$2500-4000/MW/year
- Local property tax revenue: 100 MW brings in on the order of \$1 million/yr
- 1-2 jobs/MW during construction
- 2-5 permanent O&M jobs per 50-100 MW,
- Local construction and service industry: concrete, towers usually done locally
- Investment as Equity Owners: production tax credit, accelerated depreciation
- Manufacturing and Assembly plants expanding in U.S. (Micon in IL, LM Glasfiber in ND)



- 240 MW of wind in Iowa
  - \$640,000/yr in lease payments to farmers (\$2,000/turbine/yr)
  - \$2 million/yr in property taxes
  - \$5.5 mil/yr in O&M income
  - 40 long-term O&M jobs
  - 200 short-term construction jobs
  - Doesn't include multiplier effect
- 107 MW wind project in MN
  - \$500,000/yr in lease payments to farmers
  - \$611,000 in property taxes in 2000 = 13% of total county taxes
  - 31 long-term local jobs and \$909,000 in income from O&M (includes multiplier effect)



**WIND  
POWER  
for NATIVE  
AMERICANS**

**INDIGENOUS  
ENVIRONMENTAL  
ECONOMIC  
NOW AND FOREVER**

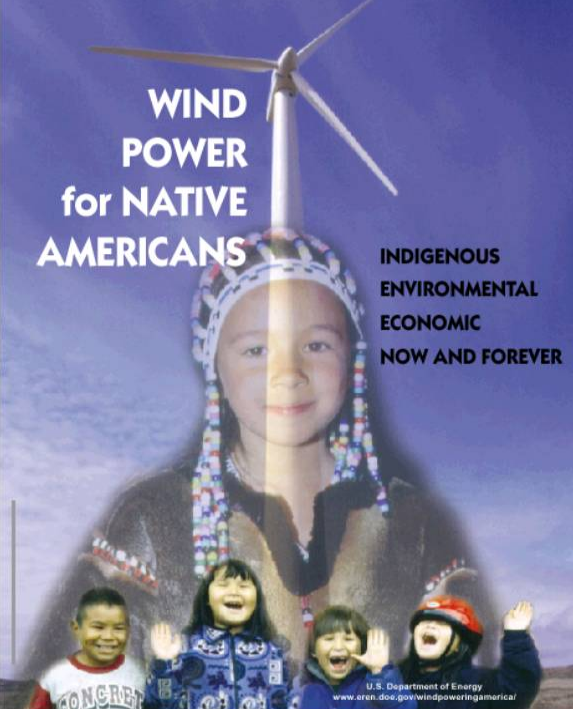

U.S. Department of Energy  
www.eren.doe.gov/windpoweringamerica/







**"In evaluating the potential of wind energy generation, Native Americans realize that wind power is not only consistent with our cultural values and spiritual beliefs, but can also be a means of achieving Native sustainable homeland economies."**

*Ronald Neiss, Rosebud Utility Commission President, Rosebud Sioux Reservation, South Dakota*

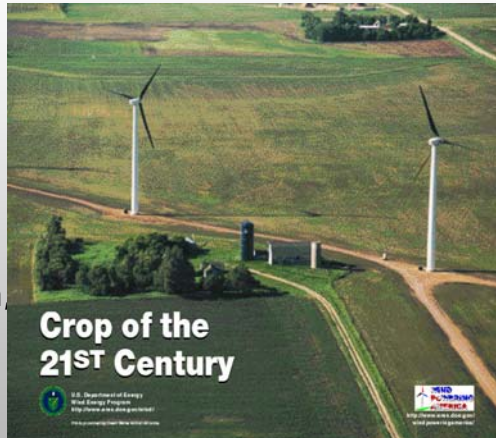
- Production Tax Credit
- Transmission: access, RTO formation and rules, new lines
- Operational impacts: intermittency, ancillary services, allocation of costs
- Siting and Permitting: avian, noise, visual, federal land
- Tradable Tax Credits



"Rural Electric Cooperative utilities take care of their members, the communities they serve, and the land that sustains them all. Cooperatives and their members were stewards of the earth long before it was popular. Here at Holy Cross, wind energy serves our members and the environment. We are proud of our wind program, and enjoy watching it grow."



*Bob Gardner, General Manager-  
Support Services, Holy Cross  
Energy*

"Our Prairie Winds initiative is the first step in capturing the enormous wind potential in the Dakotas. This wind farm demonstrates the exciting opportunity wind offers for our energy future."



*Jeff Nelson, General Manager,  
East River Electric*

“Our Cooperative members have high expectations of their electric utility, including environmental stewardship and providing a reliable, innovative power supply. Our Wellspring Renewable Energy Program allows us to develop wind energy resources to meet our members expectations.”



*Mark Rathbun, Key Account Representative, Demand-Side Management/Member Services, Great River Energy*



“It seems only natural for rural utilities to do everything they can to advance both farm-based renewable energy development and rural economic development in a cost-effective way. In my opinion, wind energy is the next great chapter in the rural electrification story.”

*Aaron Jones, Washington Rural Electric Cooperative Association; Olympia, WA*



"Wind energy adds diversity to our generation fleet and provides a hedge against fossil fuel price increases. In addition, the development of renewable energy resources is widely supported by the public and our customers."

*Rick Walker, director, Renewable Energy Business Development, AEP Energy Services, Inc., Dallas, TX*



"Our customers wanted this wind program and it was our job to deliver it. It has turned out to be a huge source of community pride. The turbines are a visible landmark showing the Moorhead Community's commitment to a better world for our children."

*Christopher Reed, Moorhead Public Service, Moorhead, Minnesota*



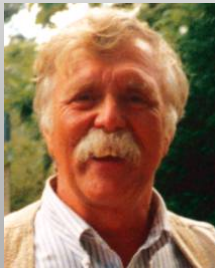

"Wind is a homegrown energy that we can harvest right along side our corn or soybeans or other crops. We can use the energy in our local communities or we can export it to other markets. We need to look carefully at wind energy as a source of economic growth for our region"

*David Benson, Farmer and County Commissioner, Nobles County, Minnesota*



*Carpe Ventem*

[www.windpoweringamerica.gov](http://www.windpoweringamerica.gov)

**RUS 2004 ELECTRIC  
ENGINEERING SEMINAR**

**FEBRUARY 10-11, 2004**

**NEW ORLEANS, LA**

**Building a Business Case  
for Wind Energy**

**Chris Tuttle**

**Load Forecast Officer, RUS**

*BIOGRAPHICAL SKETCH*

**CHRIS TUTTLE**

Chris Tuttle has worked as an Economist with the Electric Staff Division at RUS for 11 years. For the past four years, he has been involved in RUS policy development and outreach efforts as they pertain to renewable energy development. He is the headquarters lead regarding wind energy projects and regularly advises program staff on these issues. He currently is assisting in the development of regulations pertaining to RUS renewable energy issues, and on guidance for small wind loans. Chris has a BA in economics from the University of MD, and an MA in economics from The George Washington University.

## **Building a Business Case for Wind Energy**

Good afternoon and thank you for joining us for our sessions on renewable energy. I'd like to accomplish two things today: 1) provide an overview and update on policy and programmatic issues at the USDA and specifically RUS where wind energy is concerned, and 2) offer a framework for documenting a business case for wind energy project funding consideration.

First let's discuss what's been going on at RUS. Over the past several years, RUS has lent or guaranteed over \$80 million for renewable or zero emission generation projects totaling 60 MW of nameplate capacity. These projects have included not only wind energy, but on- and off-grid photovoltaic (PV), biomass (landfill gas), and a zero emission heat recovery project. Borrowers for these projects have included 3 G&Ts, a distribution cooperative, and two tribal utilities.

As some of you may already know, our Administrator has announced a \$200 million dollar loan priority for renewables this fiscal year. What this means is that renewable projects will have their own queue until this priority is exhausted.

On October 22, 2003, Ann Veneman of USDA and Glenn English of NRECA signed a Memorandum of Understanding (MOU) between our two organizations. Under this MOU, the USDA and NRECA will identify and advance cost effective, voluntary opportunities for cooperatives to partner with farmers and ranchers to reduce emissions.

We continue to work on regulatory changes that will make renewable energy projects more attractive and the application process more clear. We have published a 7 CFR 1721 entitled "Extensions of Payments of Principal and Interest." This regulation allows for deferment of principal to finance distributed generation including renewable energy systems for up to 7 years. The regulation also allows borrowers to defer principal for the purpose of providing its consumers with loans to install all or part of a customer-owned renewable energy system up to 5 kW.

We are also in the beginning stages of working on a distributed generation (under 10 MW) regulation and a new renewable energy regulation. Some of you may recall that we rescinded 7 CFR 1710, Subpart H, our previous renewable/DSM regulation, because we felt the requirements were too complicated for the scale of many smaller projects now being investigated by our borrowers. We are also in the process of working on a guidance bulletin to help clarify the necessary documentation to support a small wind energy project.

My next slide provides a quick update on the Rural Business-Cooperative Service's (RBS) program to support renewable energy and energy efficiency. This program, authorized by the 2002 Farm Bill, targets farmers, ranchers, and rural small business for grants, loans, and loan guarantees. In FY03, the first year of the program, 113 grants totaling over \$21 million were awarded.

Six of these grants, totaling \$1.6 million, went to five electric cooperatives. All five received grants for wind energy projects; one cooperative also received an energy efficiency grant for \$29,000. Two cooperatives received the maximum grant award of \$500,000.

More generally, of the 113 grants awarded, 87 were for renewable energy projects totaling \$19.4 million. Thirty-five wind energy grant applicants received \$7.4 million.

Regulations for administration of the RBS grant/loan/loan guarantee program for FY04 and beyond are currently in progress. A proposed rule is currently expected to be published in the second quarter of 2004.

Let's turn our attention now to the main topic of my presentation and discuss the necessary documentation for developing a wind energy loan application. This discussion assumes that the borrower has determined that a wind energy project is the right thing at a strategic level.

The following business plan or documentation framework is intended to provide RUS with most of the information needed to make eligibility and loan feasibility determinations regarding a proposed project. Many of you will recognize that not every form, certification, or resolution required for loan approval is specifically identified in what follows. Those requirements are still relevant, however, not at the level of detail we're discussing today.

Put simply, loan feasibility is demonstrated by financial viability and the mitigation of project risk. In the context of a wind energy loan application, project risks are typically associated with wind resource assessment, technological issues, and project management. If these three areas are adequately considered and the proposed revenue or offset is sufficient to cover cost, then a feasibility finding should be made.

I have decided to break the business plan framework in to four pieces: 1) The Project Overview, 2) Resource Assessment and Engineering, 3) Legal and Environmental, and 4) Financial Feasibility. This particular organization is secondary to the inclusion of all the individual pieces in developing a loan package, it does however provide for one way to compartmentalize the many aspects of wind energy development.

The Project Overview: The overview is by no means an insignificant piece of the project presentation. First, the identification of ownership and intended customers will normally provide enough information to make an eligibility determination. This typically will not be an issue for a current RUS borrower. It is however an ever present issue where renewable energy projects are concerned. Many non-traditional participants are getting involved in renewable energy projects. This is evidenced by the 81 non-cooperative grant awardees for renewable energy through the first year RBS program.

More importantly for this audience, the project overview provides a first impression regarding the risk factors previously discussed. The project team is perhaps the most critical element of this slide. Site selection and turbine technology are critical to project success; however these issues will be given more attention throughout the plan. In plain English, this is where the applicant must demonstrate that they have assembled a team with the necessary capabilities to construct, operate, and maintain the project.

Again, we would like to see a discussion of the selected site and a summary of its suitability for wind energy development. The applicant should also provide a description of the project in terms of total capacity and unit size. A discussion of the installation and operational history of the proposed unit should also be provided.

In addition, we would like to have a proposed timeline for development. This will help us enable the applicant to meet their development milestones and contractual commitments.

Resource Assessment and Engineering: Wind resource assessment has been identified as an area of project risk that must be adequately studied. The reality of a wind project can change be seriously impacted by an overly ambitious capacity factor assumption in pro forma analysis; this is especially true beyond year 10, the current period for most wind incentives. The benchmark by which applications will be judged is one year of site specific data, at an appropriate height. Will we approve of projects that don't meet this standard? We probably will, however, factors affecting this decision will include the location and topography of the site, the quality of alternative data, project size, the strength of the pro forma, the strength of the borrower, and the reason for not collecting the site specific data.

Construction work plan or engineering items should begin with a discussion of the project delivery method (turn-key or other) and competitive bidding procedures used to select contractors and equipment vendors. The applicant should specify who will be responsible for each phase or action of development process, including obtaining necessary zoning, electrical, and building permits.

The work plan should contain detailed technical specifications for all wind turbine and other system components including third party equipment certifications. A detailed project cost breakdown should also be provided. Specifications for, and any studies required to support, system interconnection and transmission availability should be identified. Interconnection should be consistent with IEEE 1547, Standard for Interconnecting Distributed Resources with Electric Power Systems.

Engineering documentation should also address plant operations and outline a maintenance schedule for the project. Planned turbine availability should be addressed in relation to the project pro forma and maintenance contract if applicable.

Finally, the issue of spare parts availability and inventory will need to be addressed. We will also want to know what plans are in place to deal with the failure of a major turbine component, such as a blade, generator, or gearbox.

Legal/Environmental: Some of the necessary agreements and permits related to project development have been specifically mentioned or alluded to in the context of project engineering. These include equipment purchase and construction contracts, electrical, and building permits. In many instances a formal interconnection and/or transmission agreement is also necessary.

A land use or property entitlement agreement must be executed prior to financing and equipment purchase. This agreement must be in place minimally for the life of financing. We will need a description of the terms of this agreement and any issues or restrictions related to site access.

Turbine warranties and performance guarantees appear to come in many shapes and sizes. The benchmark by which these agreements will be judged is a 3 year parts and labor warranty. However, as noted previously, we will also be asking for detail as to how any major component failure beyond the standard warranty period will be handled. Turbine performance relative to the rated power curve is an issue which will be addressed on a case by case basis. RUS realizes that this analysis is not without cost and simply may not be justified for very small projects.

Insurance requirements for RUS borrowers are outlined in 7 CFR 1788, and in 7 CFR 1726 as these requirements relate to contractor's bonds. Generally speaking, insurance must be maintained in accordance with prudent utility practice. Please discuss the necessary requirements for insurance coverage and associated cost to be included in the project pro forma.

We would also like a brief discussion of property tax rates and any local tax incentives as they will appear in the pro forma cash flow.

A discussion of relevant environmental concerns should be included, with special emphasis on visual, noise, avian impacts, and air traffic. Any special environmental considerations which would impact construction and installation should also be identified.

New RUS environmental regulations (7 CFR 1794) were published in the Federal Register on August 1, 2003. This regulation outlines what will be required for smaller distributed projects, such as a wind energy project. The following is a summary of these requirements specific to wind energy.

1. Small turbines (under 100 kW) at a customer or remote location are considered categorically excluded, not requiring any additional documentation.
2. Projects of 10 MW or less at an existing utility, industrial, commercial, or educational facility are considered categorically excluded but require the preparation of an Environmental Report.
3. Projects of 20 MW or less at a new site will normally require an Environmental Assessment (EA).
4. Projects of more than 20 MW but not more than 50 MW will normally require an EA with scoping.
5. Projects of more than 50 MW will require an Environmental Impact Statement.

Financial Feasibility: In examining the demand-side of a wind energy project, we will need a discussion of the intended market for the power. If this market is the cooperatives native load, please provide an indication of the memberships demand for green power.

Please also provide a detailed discussion of all revenue sources for the project, including a power purchase agreement, an offset agreement, green tag sales, plus any expected benefits to be gained from local and/or federal production incentives for renewable energy.

A detailed pro forma cash flow for the project should be provided as evidence of financial viability. In addition, the results of this pro forma should be included in a system level financial forecast as is normally developed in support of a loan application.

The project pro forma should cover the life of the proposed project. Loan terms previously offered for utility scale wind energy projects have been 20 years. This is intended to be consistent with the design life of most turbines built today.

In summary, Rural Development Mission Area stands ready to offer assistance to electric borrowers interested in developing wind and other renewable energy projects through both the Rural Business-Cooperative Service and the Rural Utilities Service. In addition to the \$200 million loan guarantee priority, the RUS has offered its principal deferment capability to assist in funding both borrower and customer owned renewable energy projects.

We also hope to publish two new regulations related to distributed resource interconnection and renewable energy application development, and continue to work on developing a guidance document to assist in wind energy application development.



## Building a Business Case for Wind Financing



Rural Utilities Service  
2004 Electric Engineering  
Seminar  
New Orleans, LA  
February 10-11, 2004

Chris Tuttle  
Rural Utilities Service  
[chris.tuttle@usda.gov](mailto:chris.tuttle@usda.gov)

## Renewable Policy and Lending at RUS

- RUS Renewable Loans Approved
- FY04 Priority Loan Processing \$200 Million
- MOU Between USDA and NRECA
- Regulatory Changes
  - Principal Deferment Regulation
    - To finance DG and renewable energy projects
    - Consumer loans for systems up to 5kW
    - Extensions up to 7 years
  - New Renewables Regulation
  - Distributed Generation Regulation
  - Guidance Document for Wind Projects



## The Farm Bill and RUS Borrowers

- RBS FY03 Grants Announced
- 113 Grants Totaling \$21,202,233
- 5 Cooperatives Awarded Grants
  - \$1.6 million total
  - All but \$29,000 for wind projects
- 87 Renewable Energy Grants
  - Renewable energy grants totaling \$19.4 million
  - 35 wind energy grants totaling \$7.4 million
- FY04 Proposed Regulation



## Wind Project Business Plan Framework

- Project Overview
- Technical Feasibility
- Legal / Environmental
- Financial Feasibility

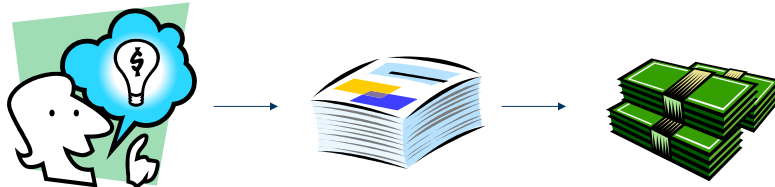

## Wind Project Business Plan

- Project Overview
  - Project Team
    - Owner, Developer, Engineer, Meteorologist, Manufacturer, O&M Provider, Interconnection Provider, Transmission Provider, Marketer, Customers
  - Site Location
  - Unit Size and Total Capacity
    - Operational history of model chosen
  - Development Timeline



## Wind Project Business Plan

- Resource Assessment and Engineering
  - Resource Assessment
  - Engineering – Construction Work Plan
    - Project Delivery Method
    - Bidding / Vendor – Contractor Selection
    - Component Specs and Project Cost
    - Interconnection / Transmission Availability
    - Operations & Maintenance Schedule
    - Turbine Availability
    - Parts Inventory / Major Component Replacement



## Wind Project Business Plan

- Legal / Environmental
  - Property Entitlements / Access Restrictions
  - Warranty / Turbine Performance
  - Insurance and Taxes
    - 7 CFR Part 1788
  - Environmental Requirements
    - 7 CFR Part 1794 Amended 8/1/03
    - Breakdowns by Project Size and Location



## Wind Project Business Plan

- Financial Feasibility
  - Market Survey
  - Power Purchase Agreement / WPC
  - Federal / State Incentives
  - Green Tags
  - Pro Forma Cash Flow / System Financial Forecast
  - Loan Term – Design Life

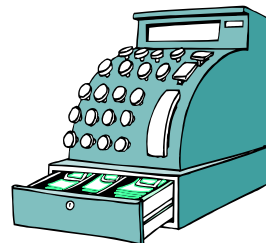

## Conclusions

- RUS Loan Processing Priority
- RBS Grant / Loan Availability
- Principal Deferment Program
- New Regulations
- Wind Project Business Plan Development



**RUS 2004 ELECTRIC  
ENGINEERING SEMINAR**

**FEBRUARY 10-11, 2004**

**NEW ORLEANS, LA**

**Co-op Wind Development  
in the Dakotas**

**Ron Rebenitsch**

**Manager of Member Marketing  
Basin Electric Power Cooperative**

*BIOGRAPHICAL SKETCH*

**RON REBENITSCH**

Ron is Manager of Member Marketing at Basin Electric and manages Basin Electric's wind generation resources and "green pricing" programs, along with other distributed generation.

He has a civil engineering degree from ND State University and an MBA from the University of North Dakota. He is licensed as a Professional Engineer in the states of ND, CO and WY.

Ron has been employed with Basin Electric for 27 years, working on large projects as a construction management engineer, design engineer and civil engineering manager before assuming his current position 7 years ago.



**BASIN ELECTRIC  
POWER COOPERATIVE**

Your Touchstone Energy® Partner 

***RUS Electric  
Engineering Seminar  
February 11, 2004***

*Ron Rebenitsch, PE*



**124 Member Co-ops:  
Serving 1.7 Million  
Consumers**

Basin Electric Power Cooperative  
**MEMBERSHIP AREA**



# Powering yesterday, today and tomorrow

- Serving rural America ... border to border

~ 3000 MW Resources  
(Own 2500 MW)

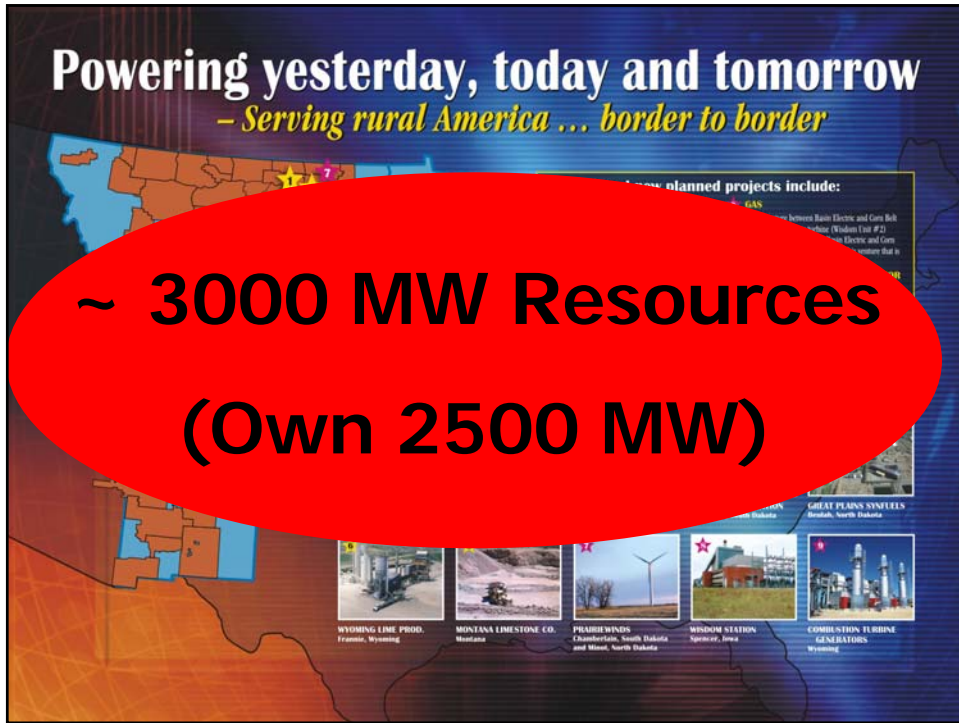

## Includes 87 MW of Wind

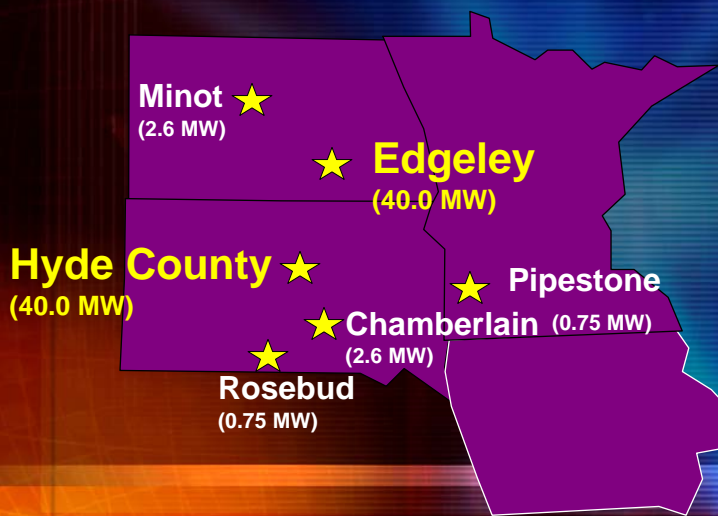

## Why Wind???

9 of the top 12 wind states are in member's service territory!

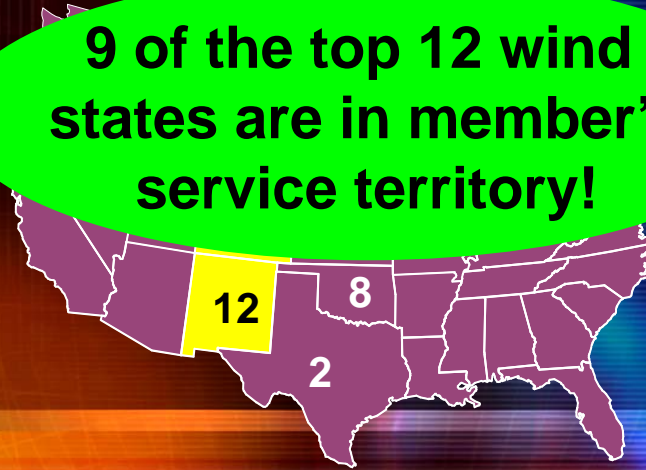

## Members see wind as opportunity...

Jobs



Economic Development



Clean Industry



Tax Base

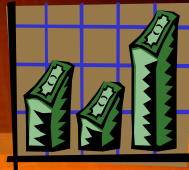

Landowner Revenue

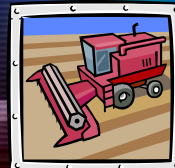

Natural Gas Pricing is also a consideration, with...  
...projected growth at 1.8%/yr

Source: EIA

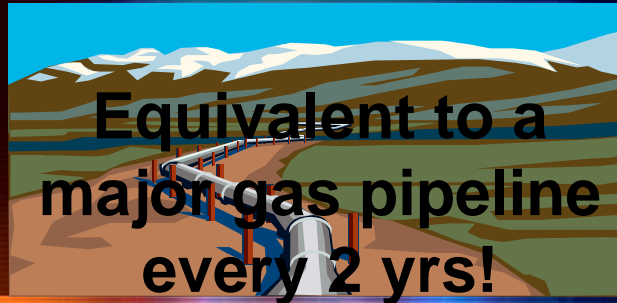
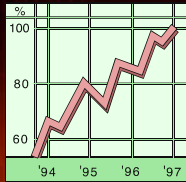

## Wind is Hedge Against Gas Volatility

*(Energy Only)*

Wind Costs are Fixed



1st Things 1st...

Electricity is a commodity...

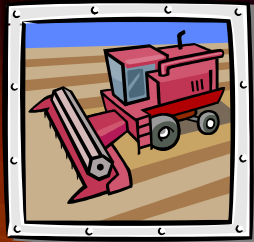

An electron is an electron!

To be viable...

*Wind needs to meet market pricing...*





## Wholesale Spot Market North Central Region - MAPP (2001 and 2002 Weekly Average)

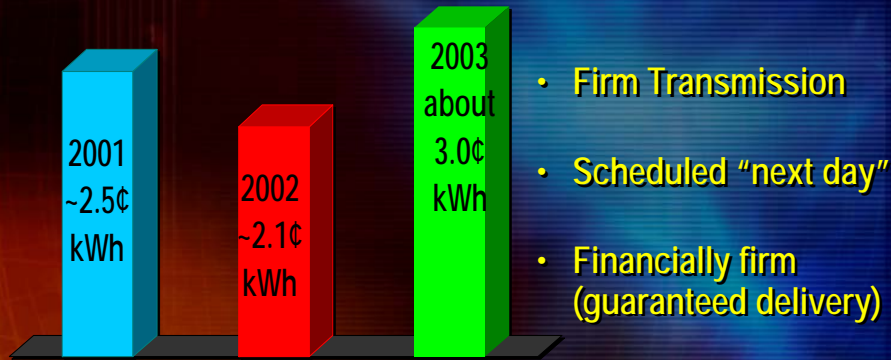

## Typical Power Supply Cost Chain

Fuel/O&M (1.1¢) + Local Losses (0.2¢) = 1.3¢ /kWh

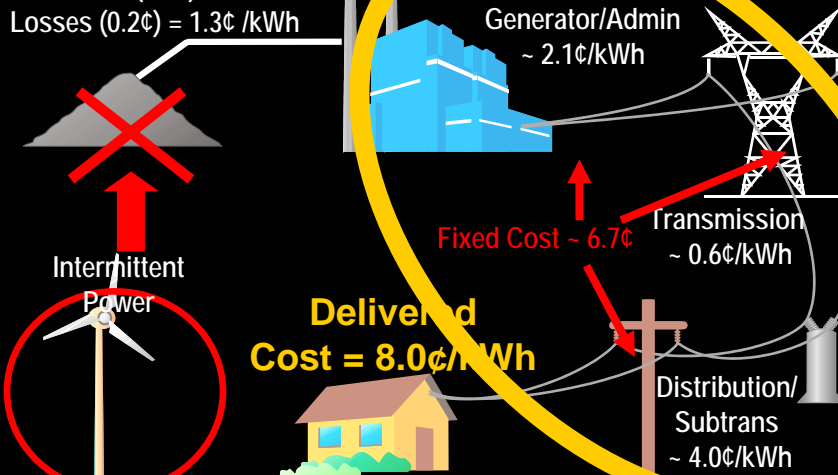

## Key Points...

2/3 to 3/4 of the cost of power supply is fixed

Fixed costs DON'T change with self-generation

Over 1/2 the cost of power supply is "wires" ...  
Not electricity

## Since Wind Generation Is Intermittent...

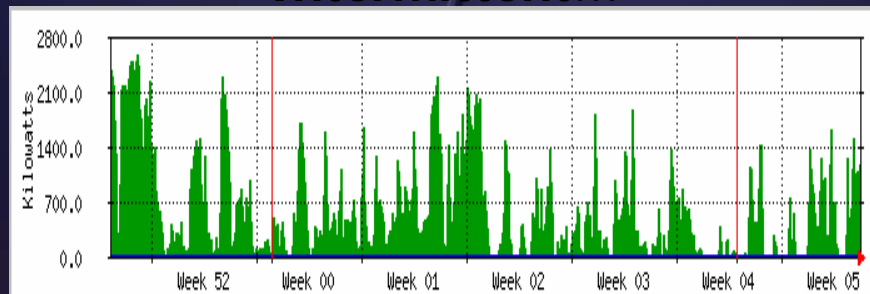

Chamberlain Generation

*...Backup generation is still needed somewhere*

## Since Wind Generation Is Intermittent...

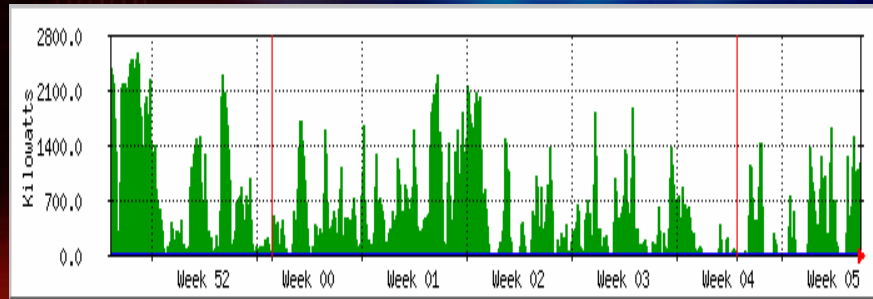

Chamberlain Generation  
*...Backup generation is still  
needed somewhere*

## Capacity Value of Wind is Minimal...

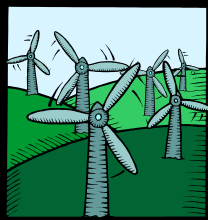

*...because it can't be  
scheduled for peak loads*



**Roughly \$1/MWH**



Also -- Some value in  
"Green Tags"



**Green Tags...**

Defined as "...*bundle of rights related to the non-energy attributes of a MWH of electricity, generated from an environmentally-preferred source...*"

Source: Bonneville  
Environmental Foundation

## Concept of Green Tags: *Separate renewable feature from the power...*



## Basin Electric's Green Tag Program...



\$10 per Green Tag  
(Equivalent to 1 MWH)

**Taxes are main driver for Wind**  
*Over 1/2 of a Wind Project's  
cash flow is tax-related*

**Prod Tax Credit  
\$50,000/MW**

**Accelerated Depr  
over \$300,000/MW**

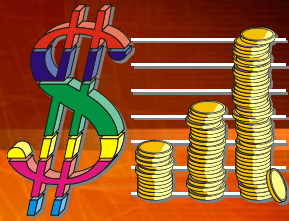

**Most cooperatives don't  
have the "tax appetite"**

**To Get  
Economy  
of Scale ...**

*You have  
to go  
**Big!***





Developers are projecting prices near 2.0¢/kWh for large projects in ND/SD

**(After Tax Credits)**

## Basin Electric Agreements with FPL Energy...

**Two  
40 MW  
Projects...**

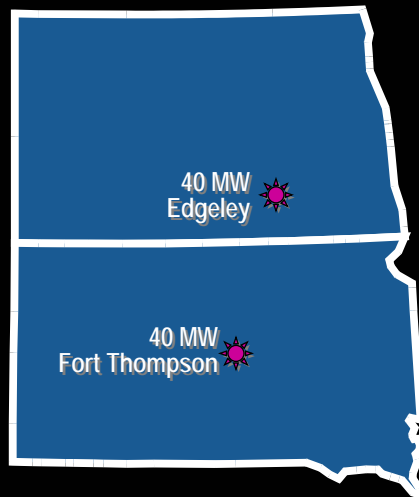

## PPA Terms are *Confidential*, but...

### Allowable Public Information:

- Life of contract is 25 years
- Avg. cost over life is "mid-2 cent" range
- Basin Electric gets the "Green Tags"



## Hyde County Project (SD)

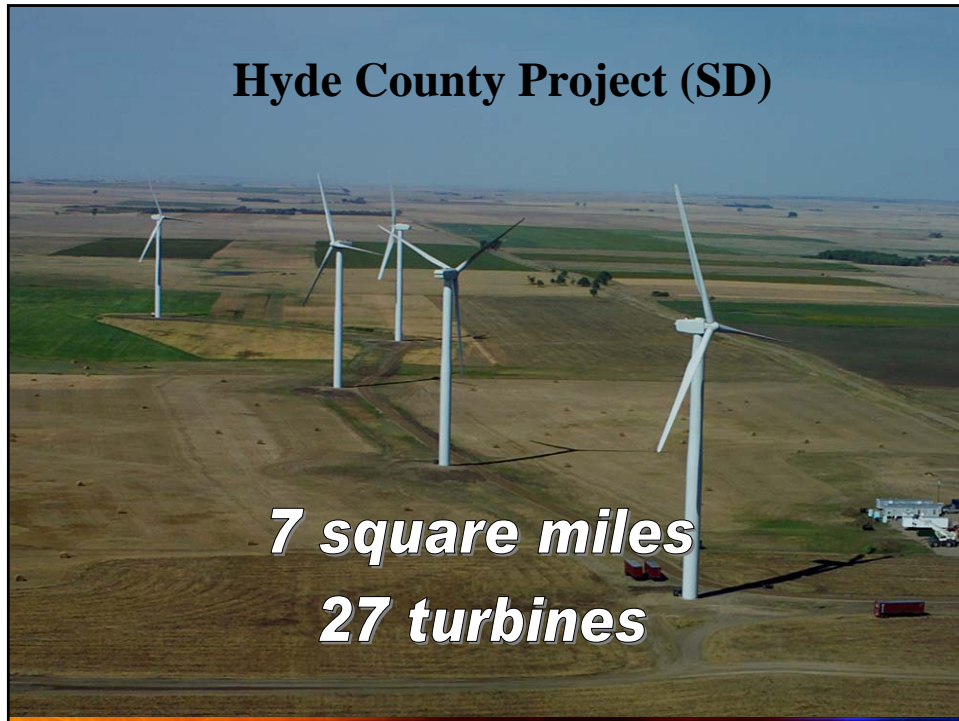

**Each 1.5 MW Turbine produces the  
annual equivalent needs of  
350-400 homes**



**87 MW of Wind produces the**

**Green Tags from these projects  
will be sold to members & others  
wanting Green Power**



**Large projects set price benchmark**

**Rate for small consumer-owned  
projects...**

**Renewable Purchase Rate:**

- 2.0¢/kWh
- Includes Green Tags

**Self-Generation:**

- Pay: "PURPA" Rate
- Standby Rate (if requested)
  - Capacity at "Market"
  - Energy at "Market"

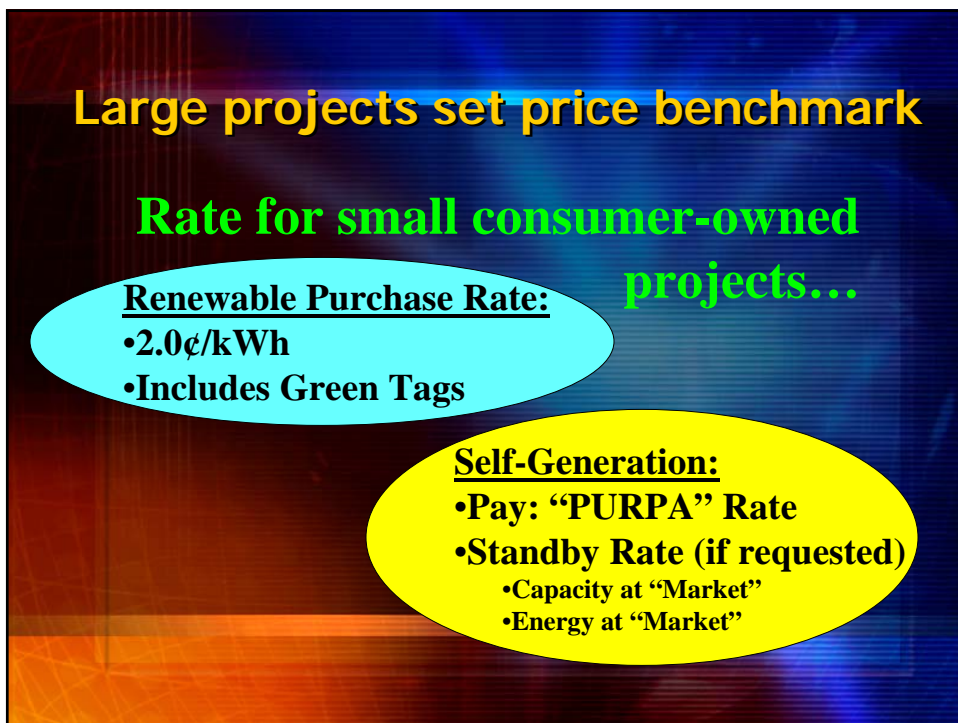

## Current Small Wind Producers: *150 kW or Less*

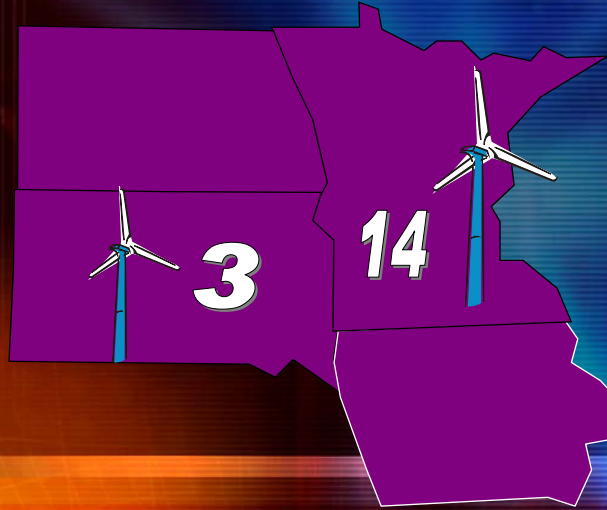

One problem with light rural distribution systems...

voltage flicker problem...



## Chamberlain/Minot Voltage Flicker Problem...

Chamberlain: 6-8%



Minot: 9-11%



Duration: 1/2 second

DVAR w/Transformer...



## Voltage flicker when wind turbine starts...

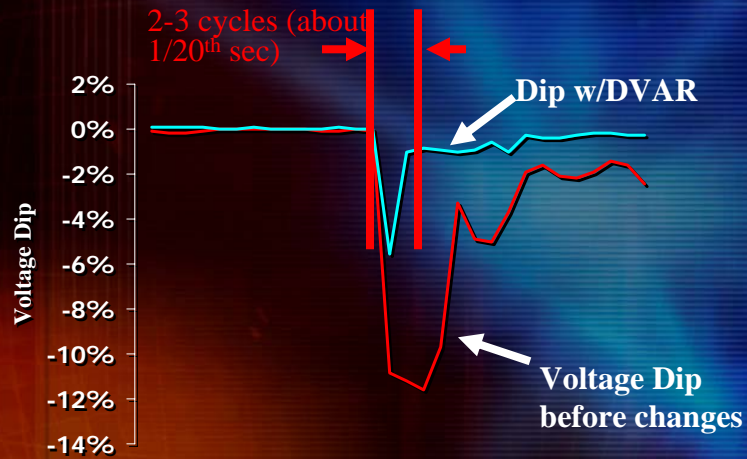

## Challenges...

- Transmission
- System Integration
- Predictability
- Availability

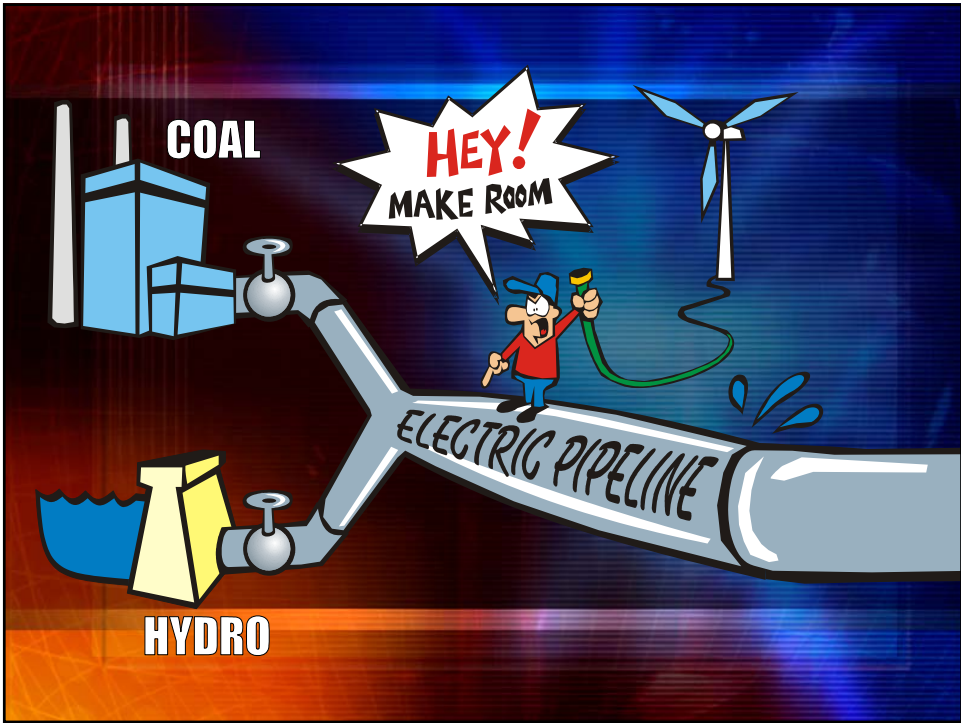

## Problem:

The wind is where  
the transmission  
isn't....!

## NASA Night Satellite View of US

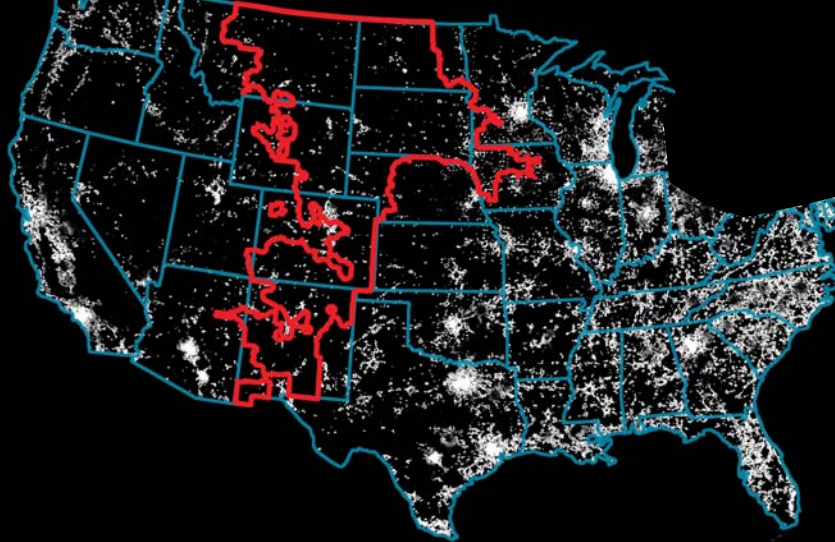

## System Integration...

Imbalance Costs  
&  
Regulation

Need Accurate "Next Day"  
Generation Forecasts

## Generation vs Wind Speed

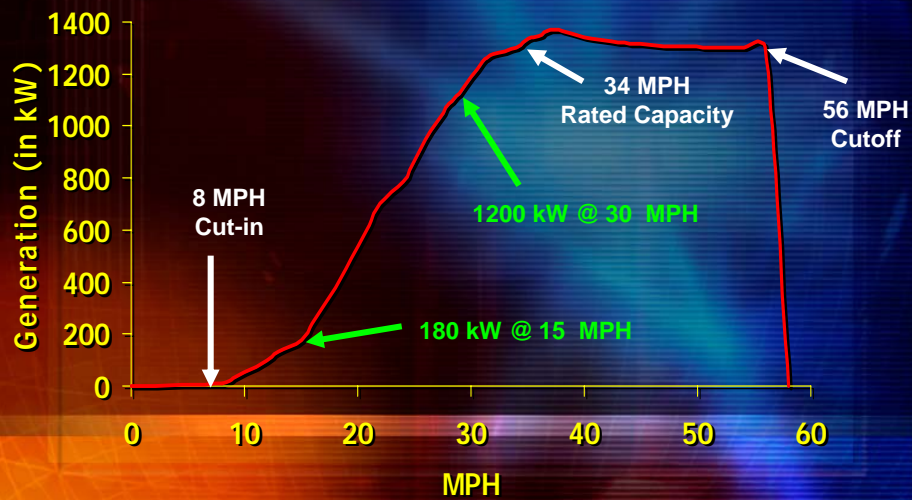

## We're also looking at wind diversity...

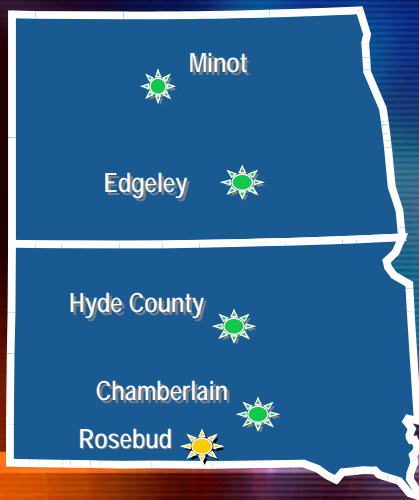

## October 2003 Total Wind Generation

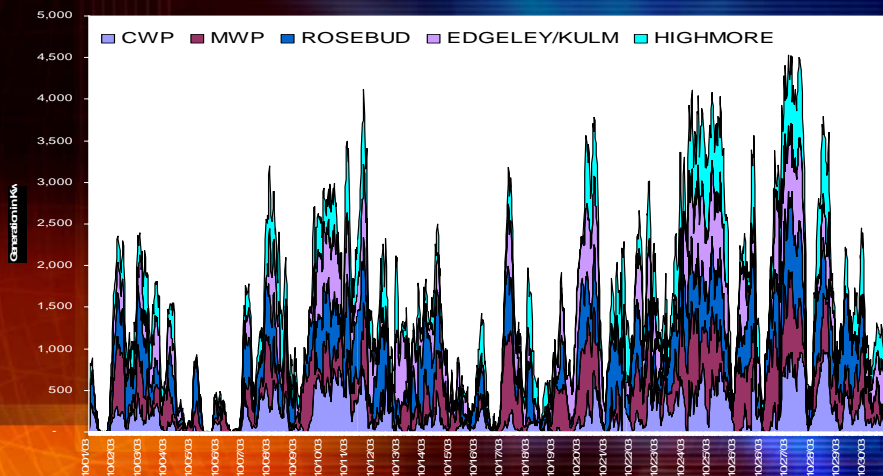

**For New Generation...**  
*Is Wind cheaper than fossil fuels??*

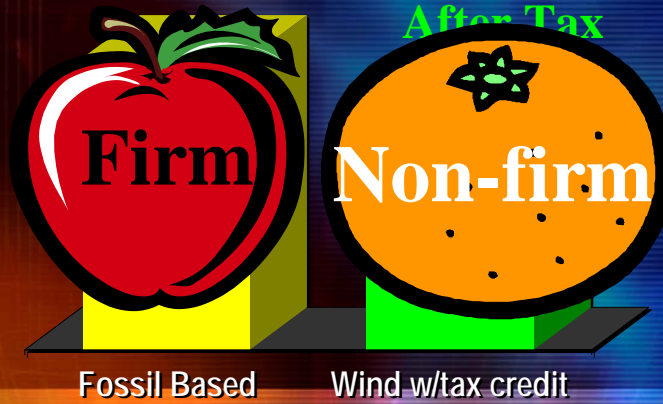

**The products are different –  
and so are the prices!**

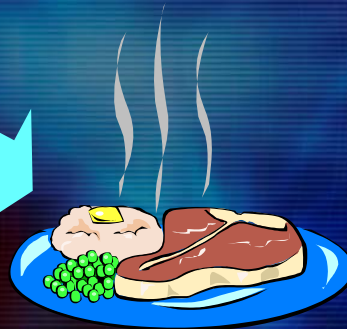

The good news is...

Costs are going down!

Turbines are being built!

Technology is moving!

Basin is very proud of...

DOE/NRECA  
Wind  
Powering  
America  
Award





**RUS 2004 ELECTRIC  
ENGINEERING SEMINAR**

**FEBRUARY 10-11, 2004**

**NEW ORLEANS, LA**

**Wind Development - Fact or Fiction**

**Jim Edwards**

**Assistant General Manager of Operations**

**East River Electric Power Cooperative**

*BIOGRAPHICAL SKETCH*

**JIM EDWARDS**

Jim Edwards is Assistant General Manager of Operations for East River Electric Power Cooperative located in Madison, South Dakota. East River is a rural electric transmission and power supply cooperative that serves 21 rural electric distribution cooperatives and 1 municipal utility in eastern South Dakota and western Minnesota. East River has over 200 substations and 2600 miles of transmission line that supplies power to the electric distribution systems of its 22 members who serve approximately 84,000 consumers.

East River was instrumental in the development of the 2.6 MW PrairieWinds wind project near Chamberlain, South Dakota, which was the first commercial sized wind project in South Dakota. East River also worked with Basin Electric and FPL Energy on the development of FPL Energy's 40 MW Hyde County Wind Farm near Highmore, South Dakota.

Jim has twenty years of utility experience working for electric utilities in South Dakota, Oregon, Texas, and Maryland. He has a Bachelor's degree in Electrical Engineering from South Dakota State University and a Master's degree in Engineering from the University of Colorado. Jim is a registered Professional Engineer in five states.

# Wind Development *Fact or Fiction*

## *RUS 2004 ELECTRIC ENGINEERING SEMINAR*



February 10-11, 2004  
New Orleans, LA

*Is Wind Development . . .*

- . . . Good or Bad?*
- . . . Economical?*
- . . . Wanted?*
- . . . Feasible?*

***It Depends!***

*A perspective from . . .*



# East River Electric



# South Dakota's Past . . .

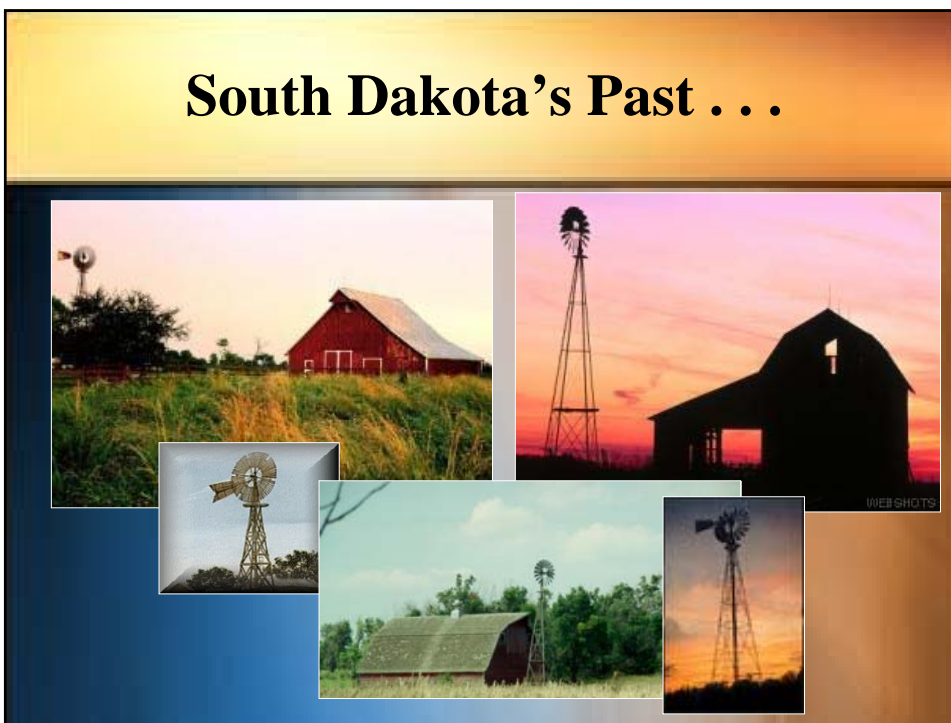

# South Dakota's Future . . .



# South Dakota Cooperative Wind Projects

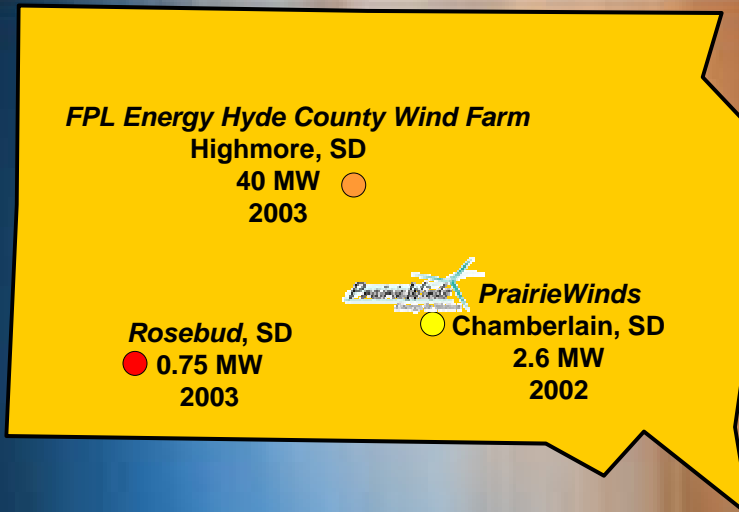

# Is South Dakota Ready for Wind Development?

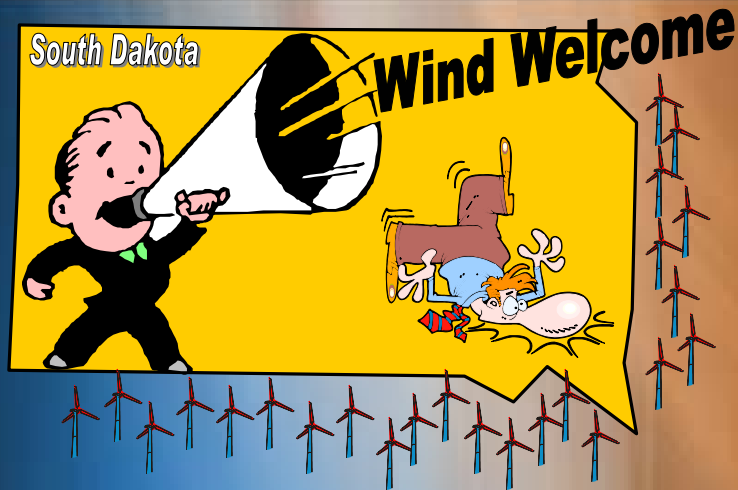

Or More Importantly . . .

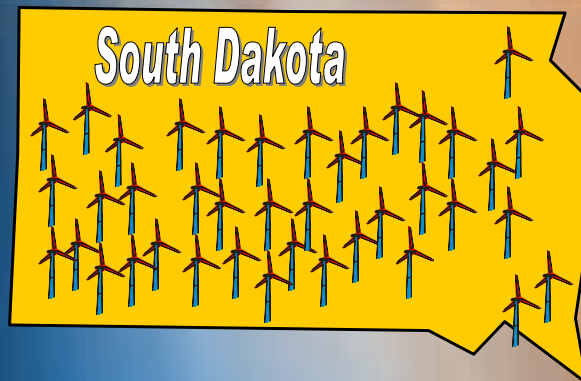

How Much Are We Ready For?

# Fact or Fiction . . . Does South Dakota have a Good Wind Resource?

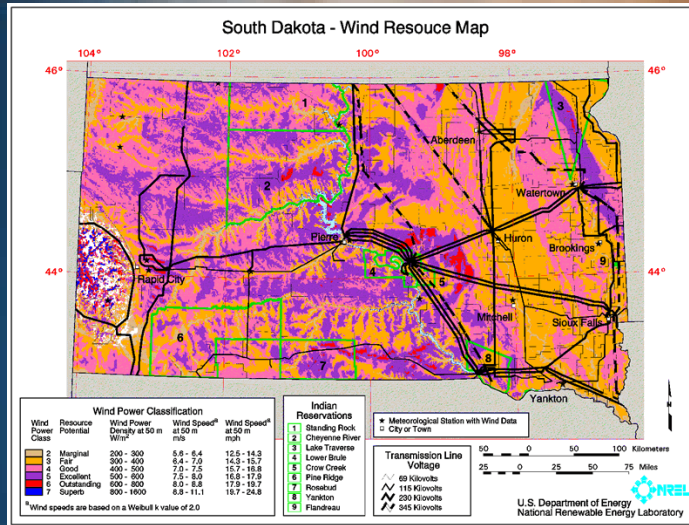

# What Can A Good Resource Mean?

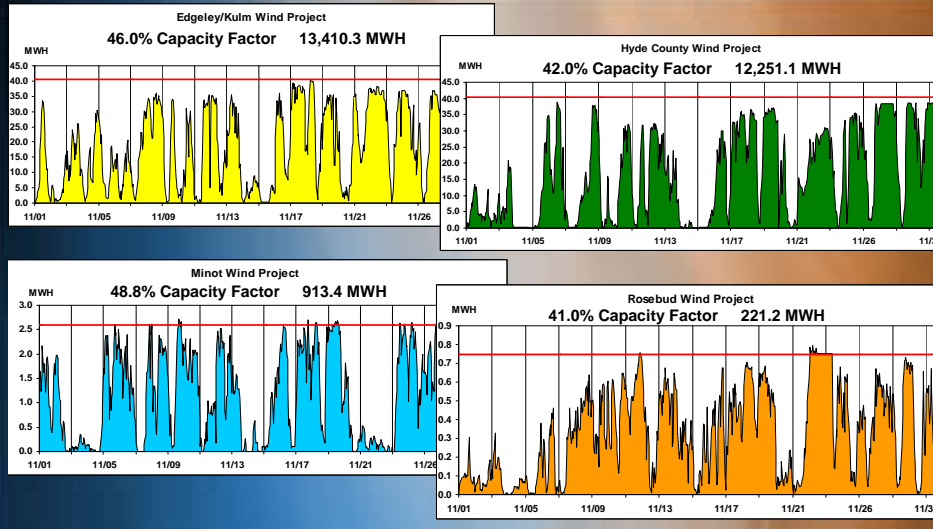



# What Can A Poor Wind Resource Mean?

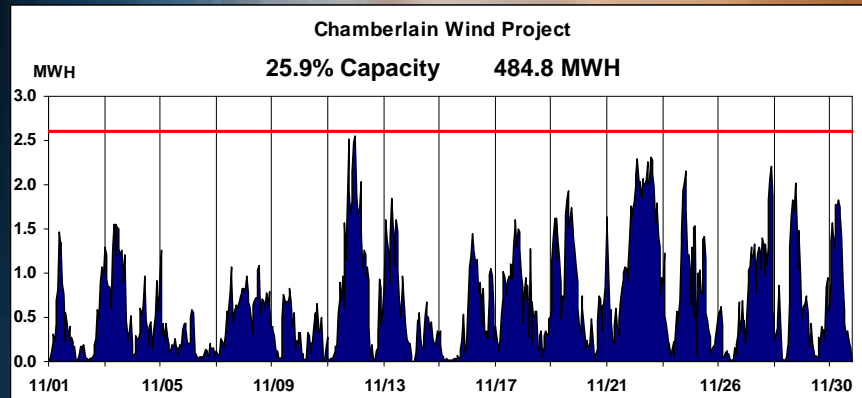

# What Can An Unreliable Wind Turbine Mean?

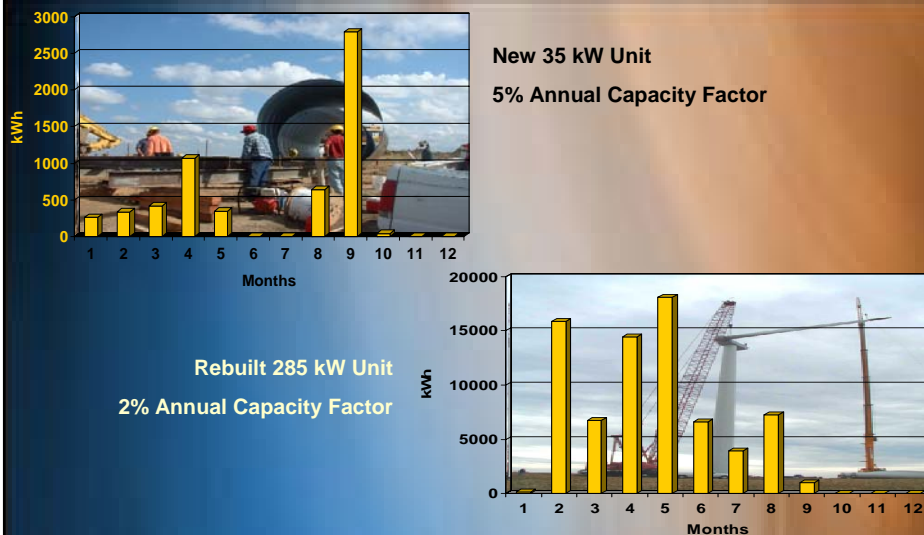

## Fact or Fiction . . . Is Wind Development Good for South Dakota?

**Jobs**



**Economic Development**



**Clean Industry**



**Tax Base**

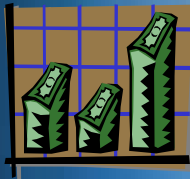

**Landowner Revenue**

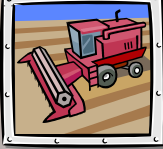

## Fact or Fiction . . . Is Wind Development Good for South Dakota?

**Hyde County Wind Farm**

861 Square Miles      1.9 People/Square Mile      Population: 1,600

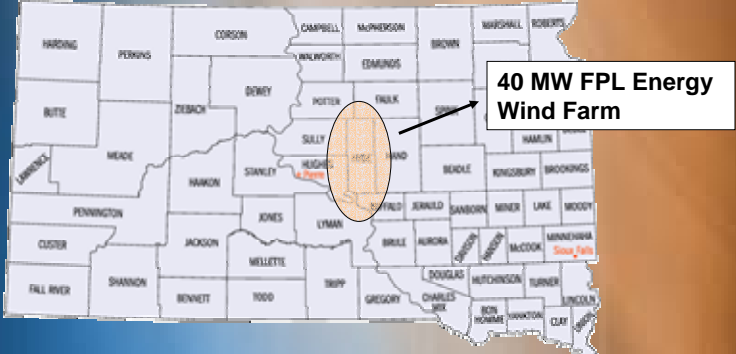

Largest Town:  
Highmore

→ Population: 835

→ Average Family Income:  
\$31,000

## Fact or Fiction . . . Does Everyone Want Wind Development?

- > Interest in wind generation is rapidly growing
- > Not sure how much, when, where and who
- > Almost everyone is talking about wind energy
  - *Landowners*
  - *Public/Utility Customers*
  - *Wind Developers*
  - *Turbine Manufacturers*
  - *State/Federal*
  - *Utilities*
  - *Environmental Groups*

## Fact or Fiction . . . Are People Willing to Pay More?

### East River 1999 Wind Survey Results:

- > 75% surveyed interested in wind energy
- > 40% of those interested willing to pay more
  - 46% - \$5 or less per month
  - 40% - \$5-\$10 per month
  - 14% - \$10 or more per month
- > East River 2003 PrairieWinds energy sales
  - 1,250 / 100 kWh blocks @ \$2.50 per block
  - Less than 1.5% of end consumers

## Fact or Fiction . . . Is Wind Generation the Same as Other Generation?

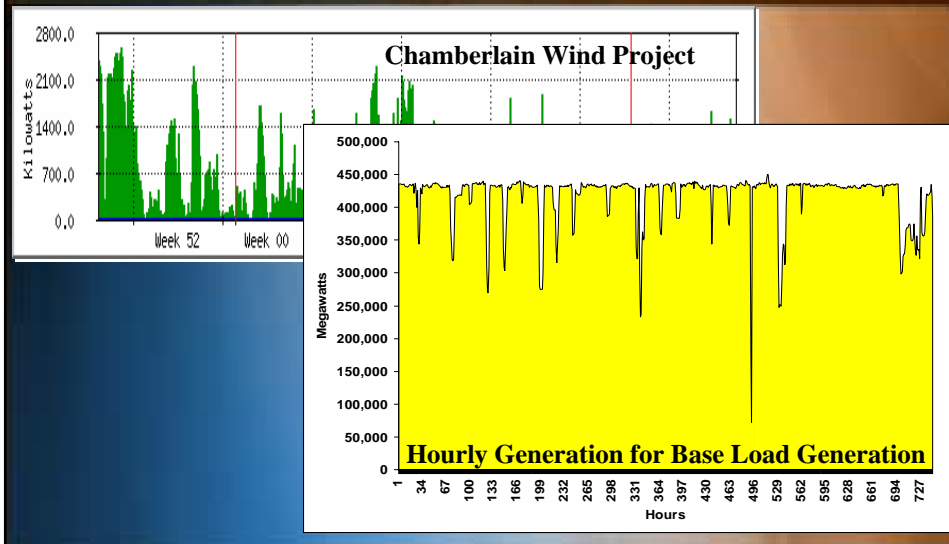

## Fact or Fiction . . . Does Wind Generation Have Power Quality Issues?

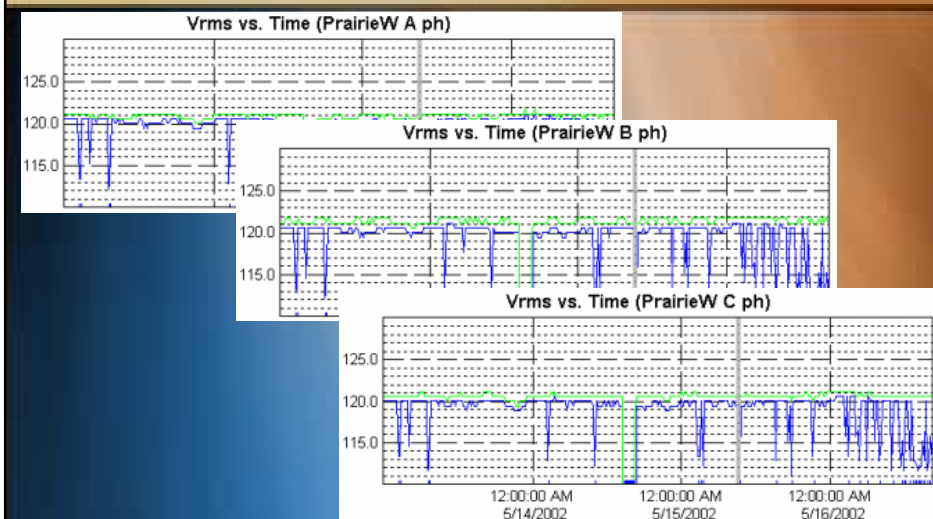

## Fact or Fiction . . . Is There Transmission Capacity to Accommodate Wind Generation?

Depends on how much and where!

Transmission systems are mainly built to serve the local load

Reliability is a key concern

## Fact or Fiction . . . Is There Transmission Capacity to Accommodate Wind Generation?

- > **East River Transmission System**
- > **Good Part - extensive system**
  - 200 substations
  - 2,500 miles of 69 kV transmission connected to 40,000 miles of member distribution lines
  - Covers 36,000 square miles
  - Connected to WAPA's high voltage transmission system
- > **Bad Part - built to serve the local customers**
  - 84,000 end consumers
    - 400 consumers per substation
    - 2 consumers per distribution mile/34 consumers per transmission mile
    - 350 MWs of peak load
    - Average of 1.75 MWs per substation

## Fact or Fiction . . . Can You Build a Successful Wind Project?

- › Need the wind resources
- › Need the transmission
- › Need reliable proven wind turbines
- › Need the economics
- › Need tax credits
- › Need federal/state support
- › Need renewable markets
- › and . . .



## Need the Support of Everyone Involved

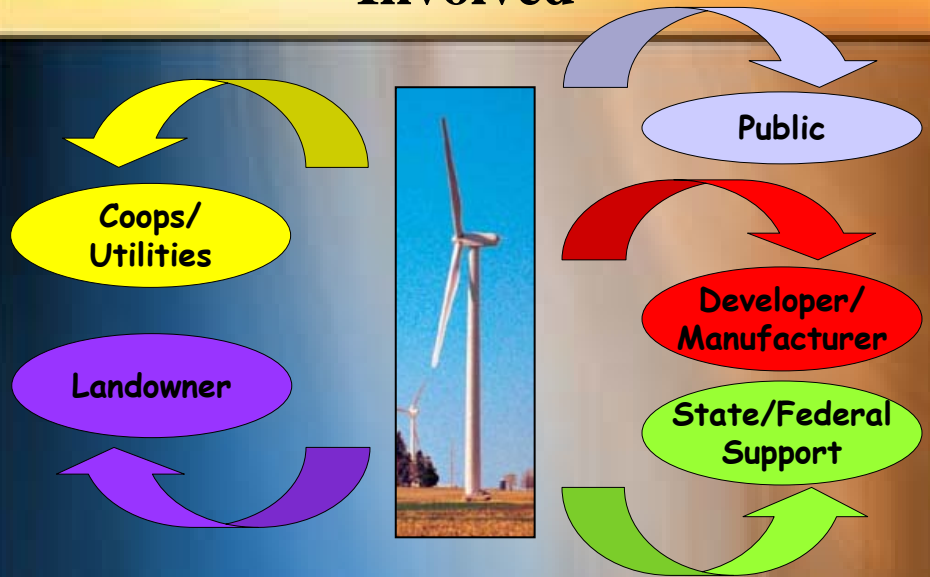

## So Fact or Fiction . . . Can You Build a Successful Wind Project?



## Questions That Are Being Asked (Repeatedly)



## Questions Asked by Members/Public/Landowners

- › How do I get wind turbines on my property?
- › What is the annual lease payment per turbine?
- › Should I sign an option and lease agreement?
- › Have you heard of this wind developer and are they really building this project?
- › Is it better for me to own the turbines, invest in a wind project, or just lease the land, and what is my risk?

## Questions Asked by Members/Public/Landowners

- › How do I connect a wind turbine to your electrical system?
- › How much does a wind turbine cost and where can I buy one?
- › Who can I sell my wind power to and for how much?
- › What is the deal with the tax credits?
- › And lastly . . .
  - *How can I get in on this and how can I make money?*



## Questions Asked by Developers

- › How much will you pay for wind energy?
- › Why don't you pay more?
- › What is your tariff and do I have to pay for it?
- › Can I wheel wind energy across your system and how much will it cost me?
- › Why won't you work with us instead of them?
- › How much capacity does your system have?
- › And lastly . . .
  - *What needs to be done to get a wind project built?*

## Questions Asked by Cooperatives

- › Is the wind energy more expensive than our existing generation resources?
- › What size of project, if any, should we be involved in?
- › Should we own the wind turbines or purchase the output?
- › How can we utilize the tax credits?
- › How does this affect our all-requirements contract?
- › How do we handle this intermittent resource?

## Questions Asked by Cooperatives

- › Do we have the transmission capacity?
- › How much will transmission upgrades cost and who will pay for them?
- › Will wind turbines cause power quality or other problems?
- › Should we be proactive versus reactive with respect to wind development?
- › And lastly,
  - *Is this good for cooperative members as a whole?*

### ***Jim Edwards***

Assistant General Manager-Operations  
East River Electric Power Cooperative, Inc.  
PO Box 227  
Madison, South Dakota 57042  
Telephone: 605-256-8002  
Email: jedwards@eastriver.coop



**RUS 2004 ELECTRIC  
ENGINEERING SEMINAR**

**FEBRUARY 10-11, 2004**

**NEW ORLEANS, LA**

**Distributed Wind Power  
Interconnection**

**Tom Wind**

**Wind Utility Consulting**



# Distributed Wind Power Interconnection

RUS 2004 Electric Engineering Seminar  
February 10-11, 2004  
New Orleans, Louisiana

Thomas A. Wind, PE  
Wind Utility Consulting  
Jefferson, Iowa

© Layne Kennedy



## Topics I Will Cover



- Examples of distributed wind generation projects
- How wind turbines are interconnected to the distribution system
- How do wind turbines affect the distribution system
- What are the primary interconnection issues
- What are the power quality impacts

Single 900 kW Wind Turbine  
Connected to Distribution Line  
For Waverly Power & Light

2

### Examples of Distributed Wind Generation

- Small wind turbines in Wisconsin
  - One serving a farm
  - One simply interconnected to rural distribution feeder

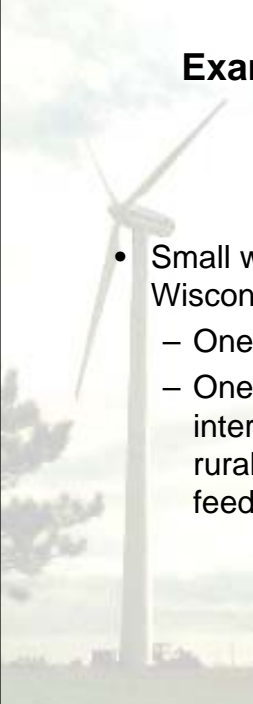

3

### Three 35 kW Wind Turbines Near Lynd, Minnesota



4

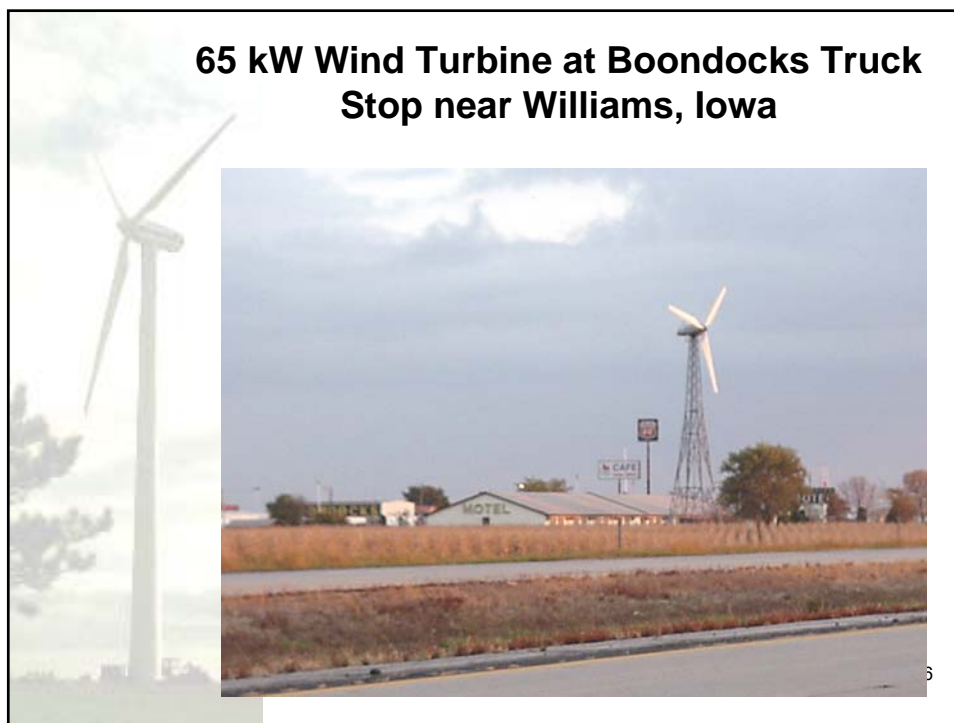
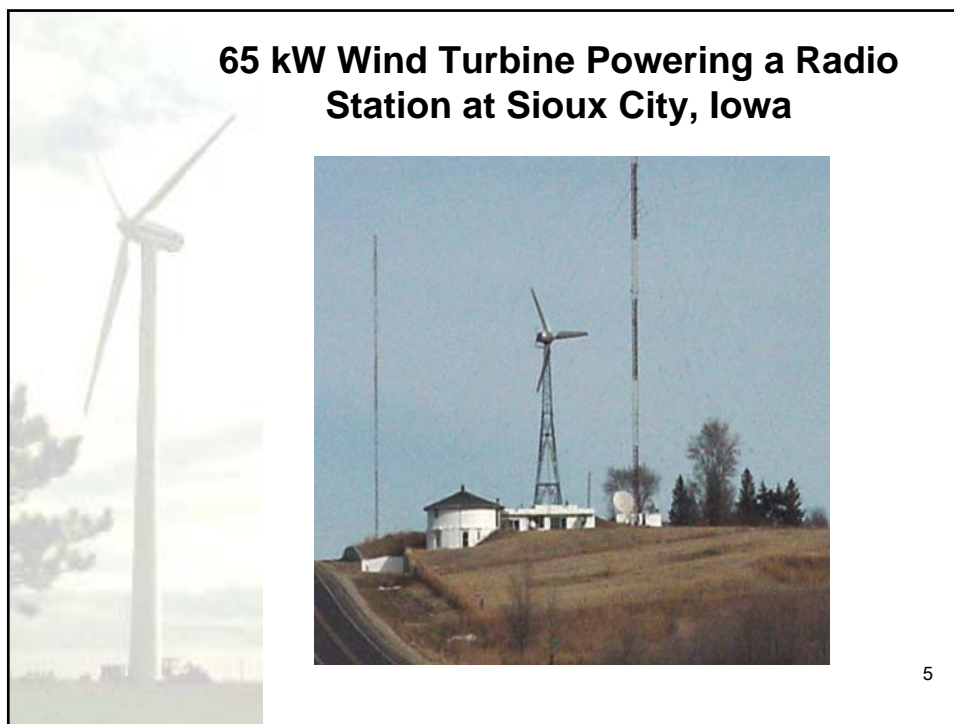

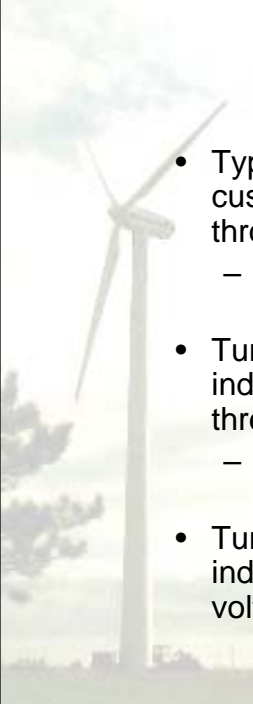

### How Are Small Wind Turbines Interconnected?

- Typically, turbines up to 10 kW are connected to customer's 120/240 volt service entrance panel through an inverter.
  - Inverter needed because small wind turbines aren't constant speed
- Turbines from 20 kW to 40 kW are usually induction generators, which may be single or three phase for net billing applications
  - One or two speed, essentially synchronized to 240 or 480 volt service
- Turbines larger than 40 kW are three-phase induction generators, usually tied directly to 480 volt. New Bergey 50 kW unit will use an inverter.

7

### 65 kW Wind Turbine Near Livingston, Montana



3 x 25 kVA

### Three 65 kW Wind Turbines at Britt, Iowa



### 65 kW Wind Turbine for Sentral Schools at Fenton, Iowa





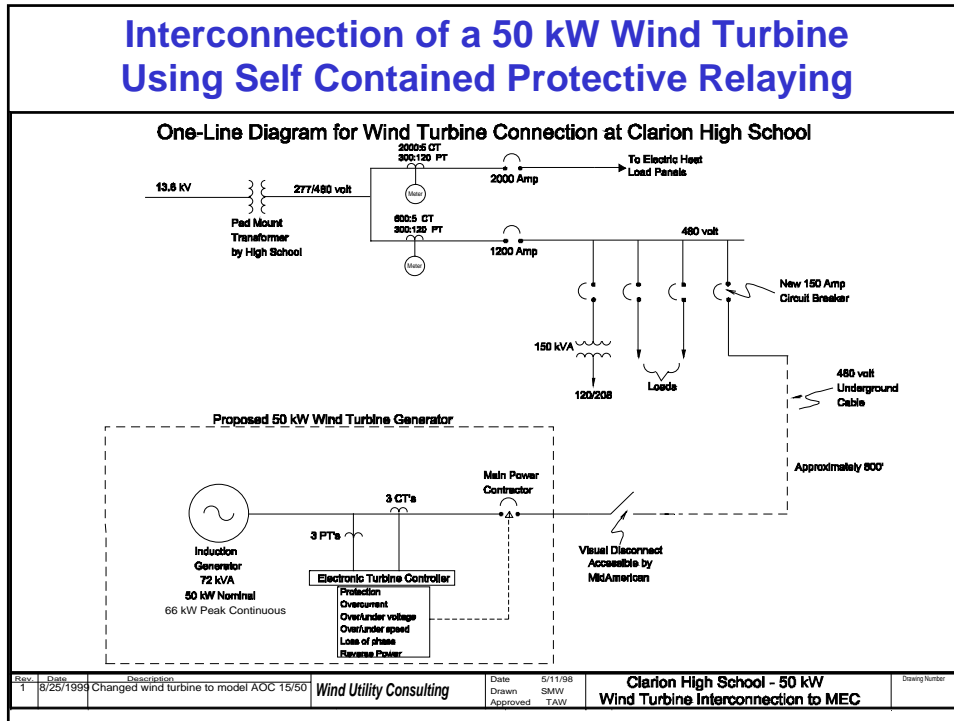

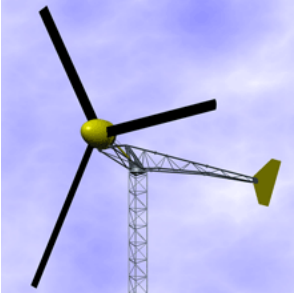

### New Bergey 50 kW Wind Turbine

- Latest technology
- Designed to be less expensive per kW
- 22' long blades
- More efficient in low wind speeds
- Very simple design – three moving parts
- Uses slightly modified ABB variable speed motor controller as inverter interface to 480 v. electric service

12

**Midsized Wind Turbines (100-250 kW)**



**225 kW at Lac Qui Parle School in Minnesota**

13

**225 kW Wind Turbine Powering Waste Water Treatment Plant at Nevada, Iowa**



14

### How Are Midsize Wind Turbines Interconnected?

- If the turbine is close to a customer's load center, then the turbine can be connected to customer's 240/480 volt main service panel
  - This allows easy netting of load and generation
- Turbine may have a step up transformer at the base of the wind turbine to connect directly to distribution grid
  - More difficult to connect wind turbine "behind the meter" for netting unless the customer has primary metering
- Midsize Turbines usually have sophisticated protective relaying system built into turbine controller, which should preclude the need for separate relays and breaker

15

### 250 kW Wind Turbine on Rural 13.8 kV Line

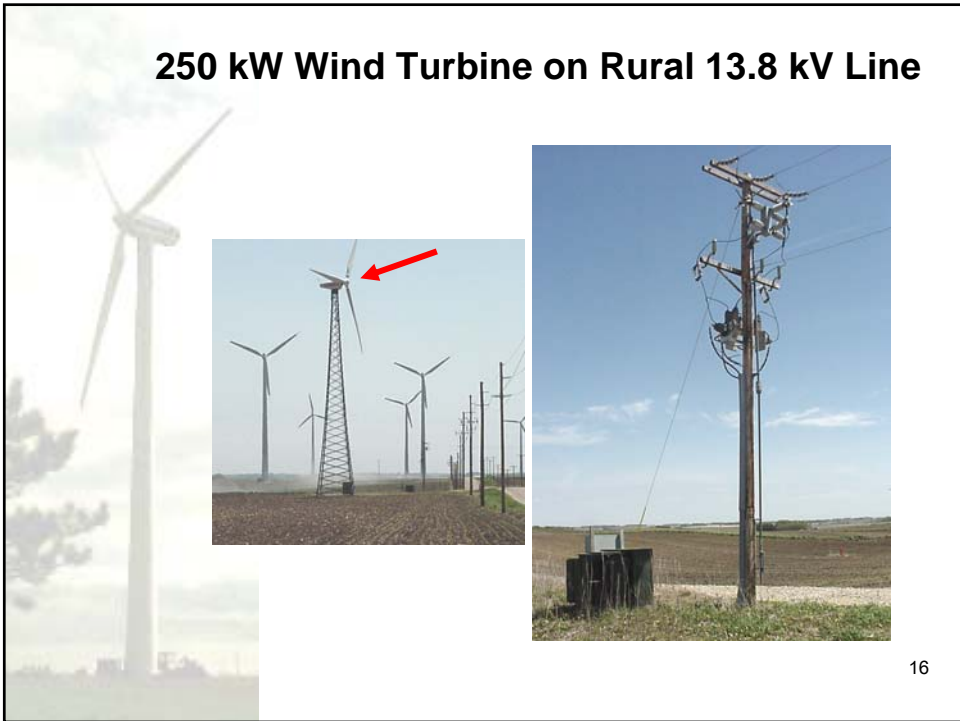

16

### Large Wind Turbines (250-2,000 kW)

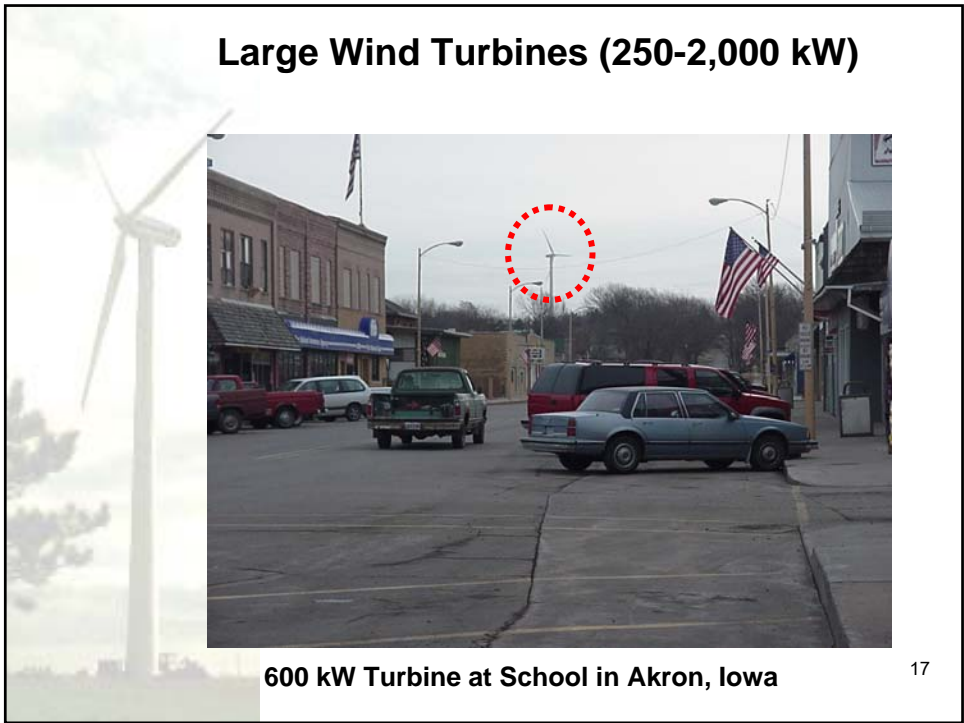

### 600 kW Turbine at School in Forest City, Iowa

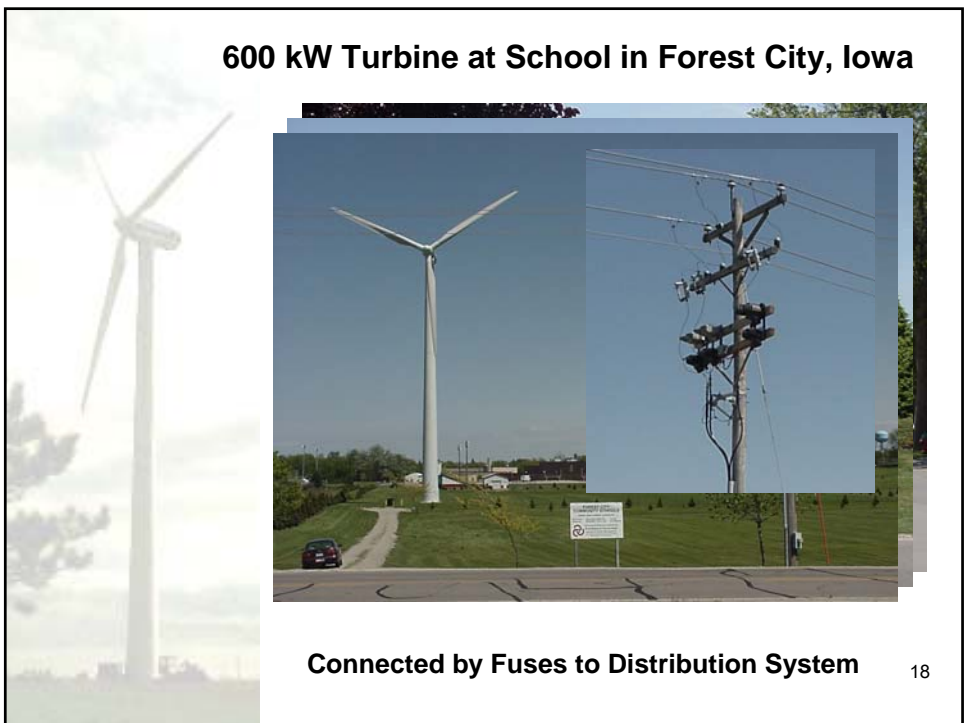

### How Are Larger Wind Turbines Interconnected?

- Larger wind turbines have step-up transformer at base of the wind turbine to boost voltage to distribution level, then interconnection is made to the primary. This could be either before or after a customer's meter or directly to the distribution feeder.

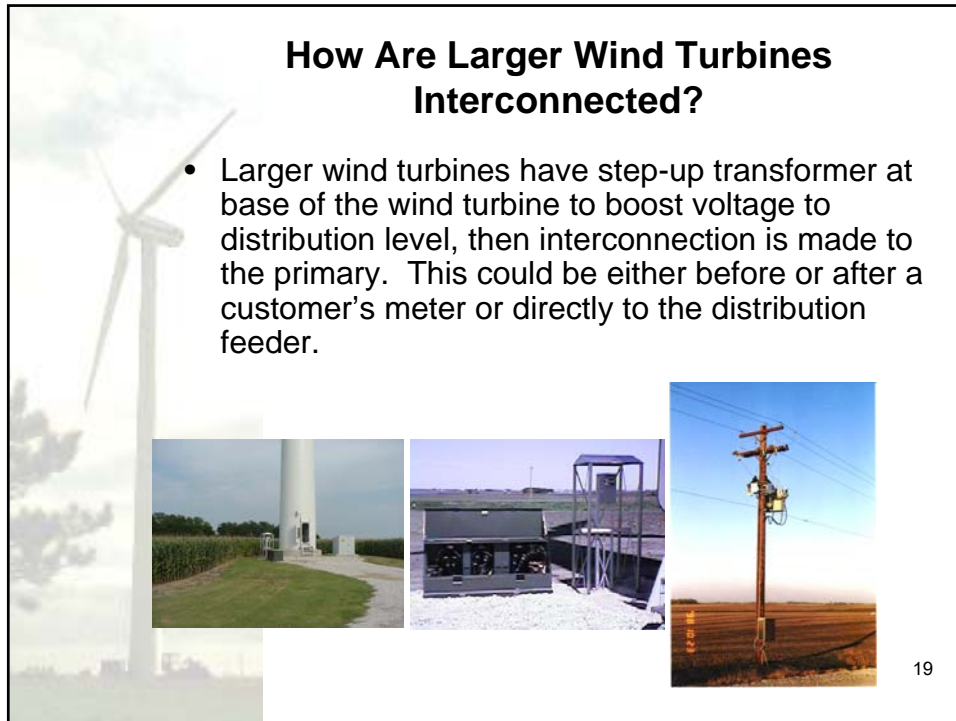

19

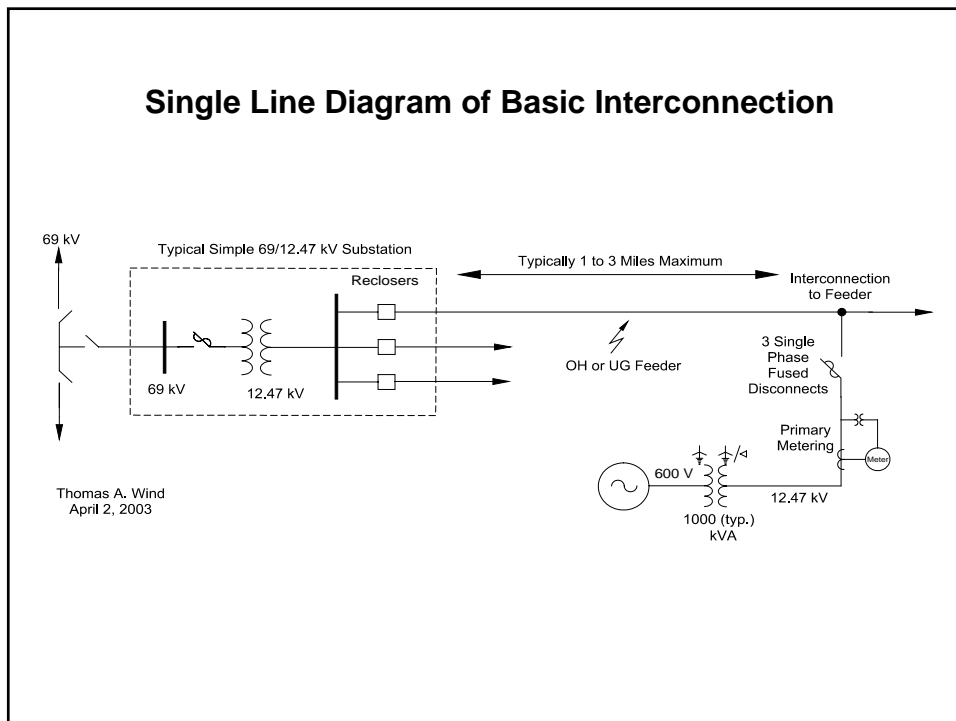

### What Type of Interconnection Equipment is Used for Larger Wind Turbines?

- The type of equipment will vary depending upon what the utility requires
  - This depends upon the need for control and information
    - Can be very simple
    - Can be more complex and costly
- Based on my experience, if utility owns wind turbines, then installation is typically simpler and less costly

21

### A 750 kW & 250 kW Wind Turbine at Spirit Lake Schools



22

**Two 750 kW Wind Turbines  
for the City of Moorhead, Minnesota**

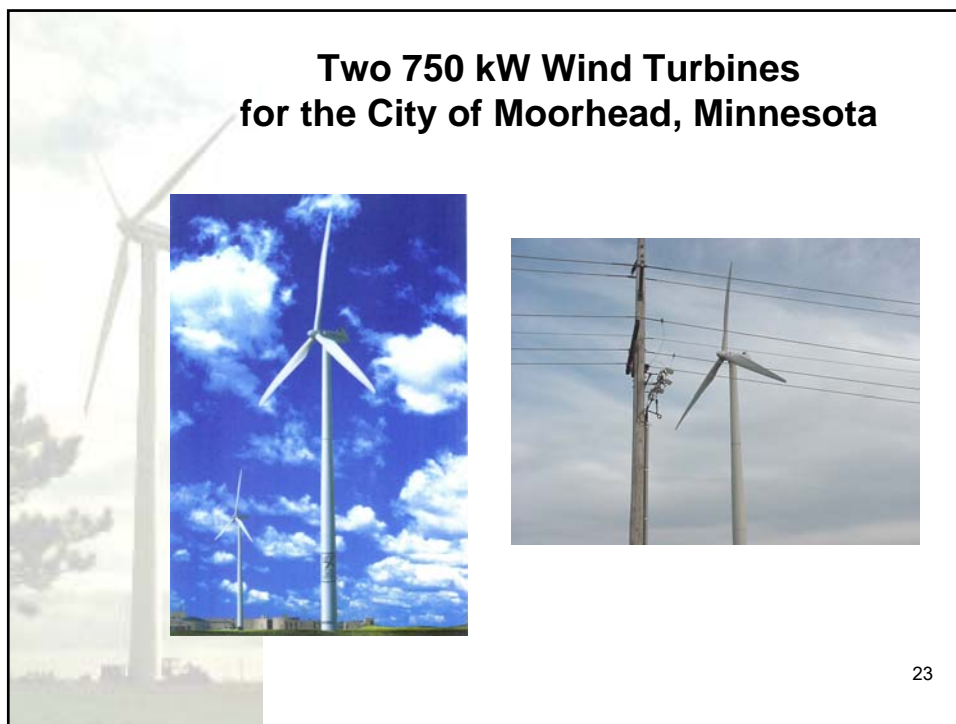

23

**Two 750 kW Turbines Owned by the Kas  
Brothers at Woodstock, Minnesota**



24

**MinWind 1 & 2 Wind Farms  
Four 950 kW Turbines at LuVerne, Minnesota**



Two Farmer-Owned  
Cooperatives, each owns  
Two 950 kW wind turbines  
Tom Arends, Mark Willers  
are the two presidents



25

**Two 900 kW Farmer-Owned  
Wind Turbines Near Woodstock, Minnesota**



26



### What is the Electrical Impact of a Large Wind Turbine on a Distribution Feeder

- Will reduce the power flow from the substation
  - May cause back-feed into substation
  - Need to make sure substation voltage regulator will work for reverse power
- May increase or decrease distribution line losses over the course of a year, depending upon the relative level and location of the wind generation and load
- Will reduce transmission system losses
- Will usually increase the voltage level out on the feeder during normal operation.

27



### Coordination of Feeder Protection

- Must ensure that the addition of a wind turbine won't significantly impact feeder reliability
- Wind turbine should readily trip off on its own for any disturbance, such as faults and for over or under voltages
- Wind turbines also trip for phase unbalance, and over/under frequency
- Don't want extra unnecessary substation or line recloser operations because of wind turbine



28

### Two 950 kW Wind Turbines for the City of Fairmont, Minnesota



**Reclosers Moved  
Downstream from  
Turbines**

**Interconnected with Fuses**

29

### Transient Electrical Impacts

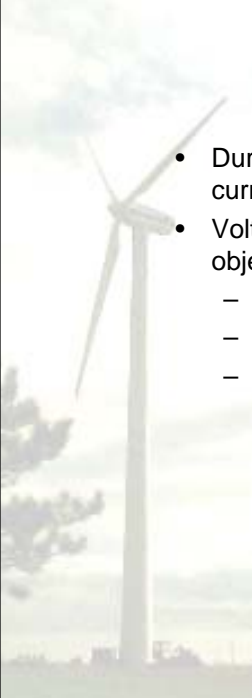

- During startup and generator switching, there will be inrush currents which will cause the voltage to dip or flicker
- Voltage flicker may or may not be noticeable or objectionable
  - Depends upon magnitude and how often it occurs
  - See IEEE Flicker Curve
  - Magnitude of flicker depends upon the stiffness of the line
    - Voltage level (4.16 kV, 12.5 kV, etc.)
    - Distance from substation
    - Size of substation transformer
    - Wind turbine electrical design.

30

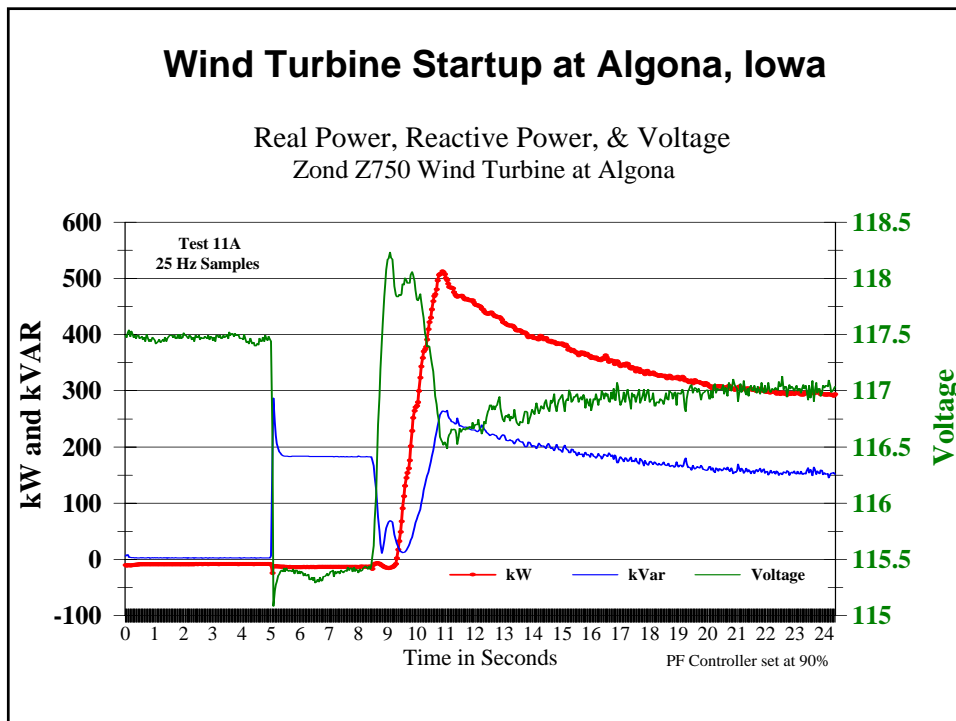
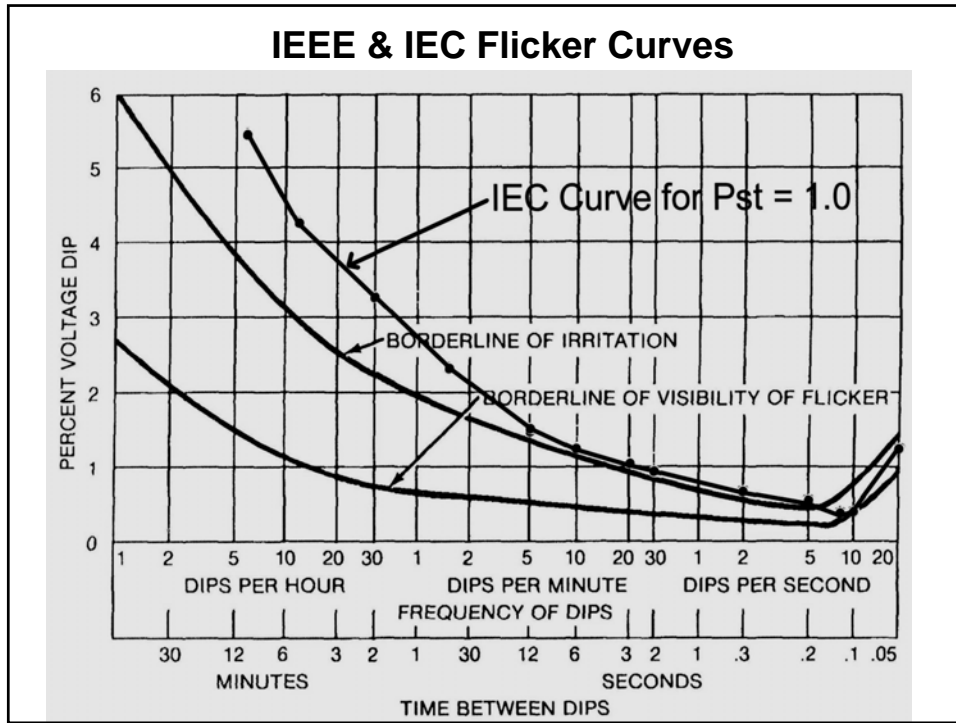

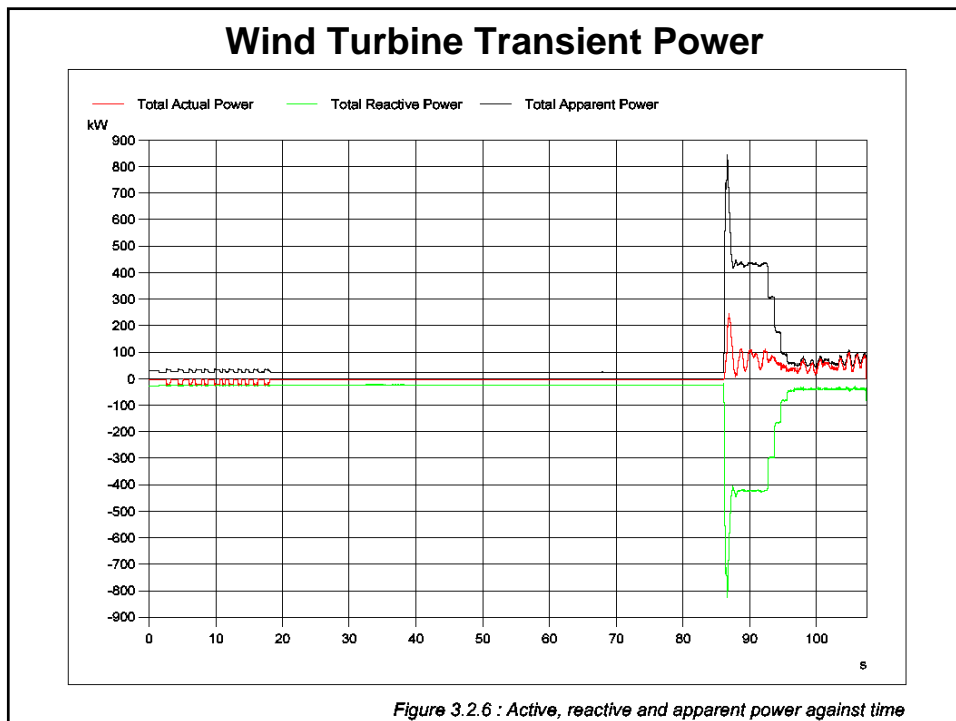
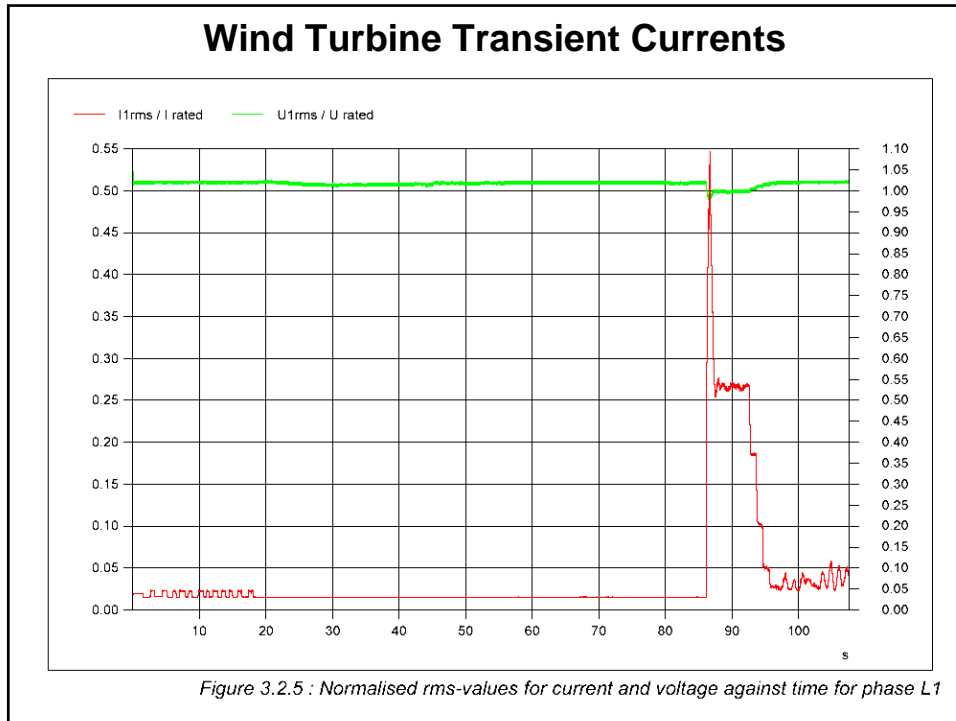

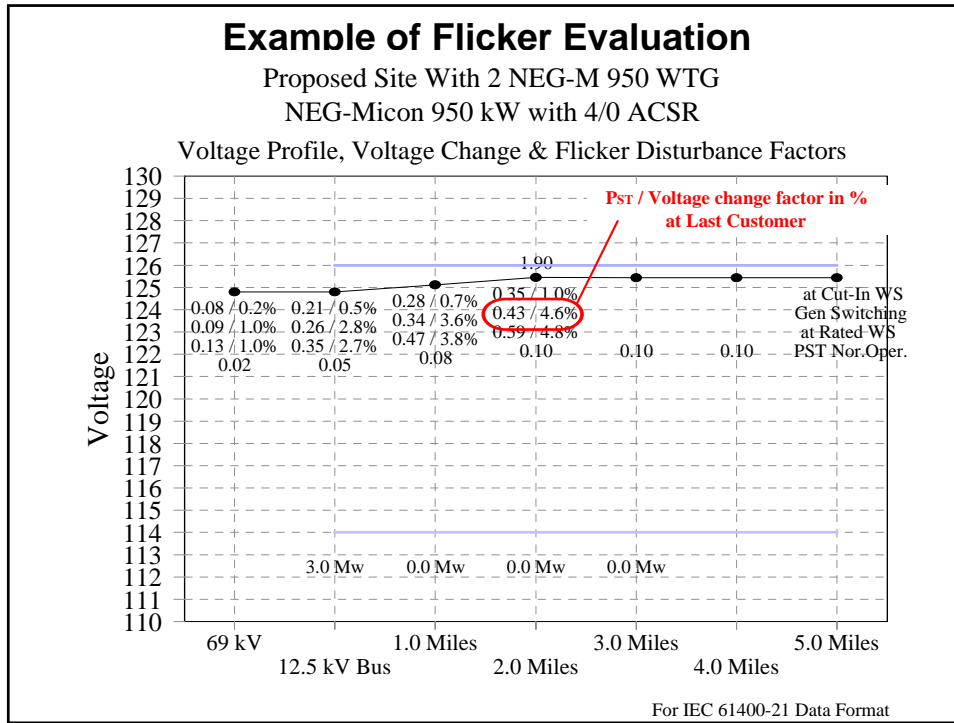

### Electrical Impacts (continued)

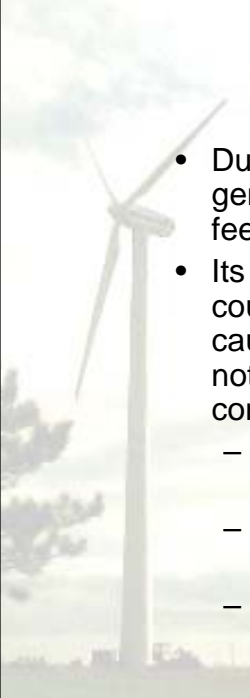

- During normal operation, changes in kW generation will change the voltage level on the feeder
- Its possible, but very unlikely, that gusty wind could change the kW output enough that it would cause the voltage level to change enough to be noticeable. To be noticeable, the following conditions would be needed:
  - Very weak grid, such as a 2.4 kV system, or a long distance from the substation
  - A combination of wire size and distance from substation
  - A wind turbine with a high flicker characteristic

36

### Three 750 kW Wind Turbines Designed to Regulate Power Factor Connected to 13.8 kV 1/0 ACSR Rural Feeder at Algona

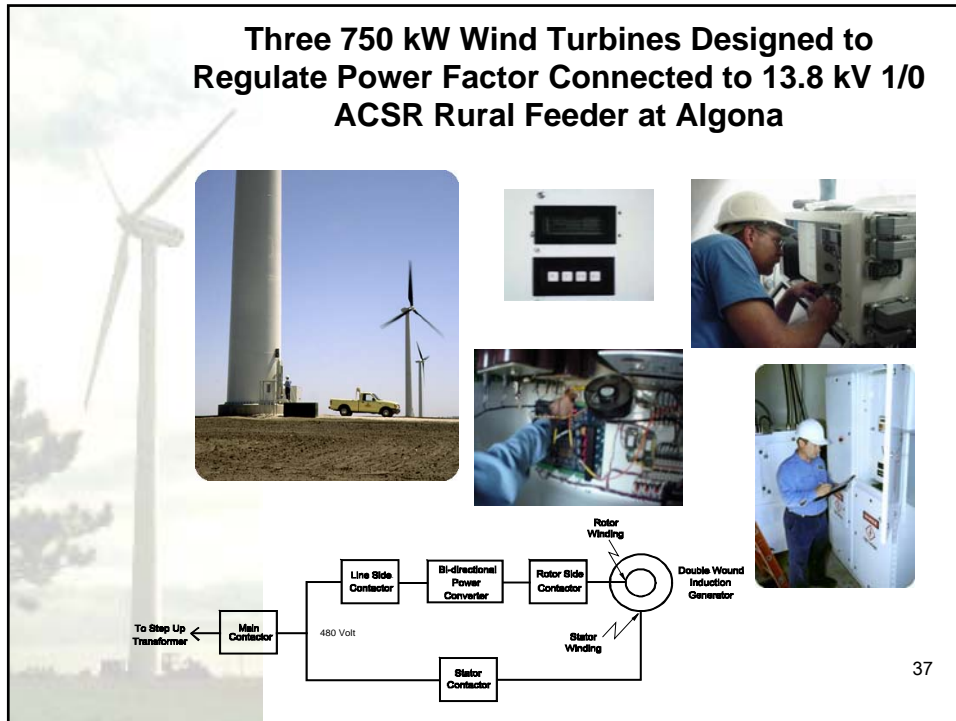

The collage includes: a large wind turbine in the background; a smaller turbine with a yellow truck nearby; a close-up of an electrical control panel; a technician in a hard hat working on a piece of equipment; a close-up of a hand adjusting a dial on a control panel; and another technician in a hard hat working on a large electrical cabinet.

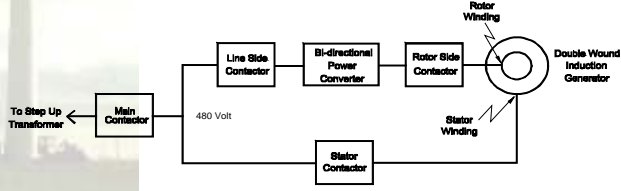

The schematic diagram shows the following components and connections:

- To Step Up Transformer** connected to a **Main Contactor**.
- The **Main Contactor** is connected to a **480 Volt** line.
- The 480 Volt line branches into two paths:
  - One path goes through a **Line Slide Contactor** to a **Bi-directional Power Converter**.
  - The other path goes through a **Stator Contactor** to the **Stator Winding** of a **Double Wound Induction Generator**.
- The **Bi-directional Power Converter** is connected to a **Rotor Side Contactor**, which in turn connects to the **Rotor Winding** of the **Double Wound Induction Generator**.

37

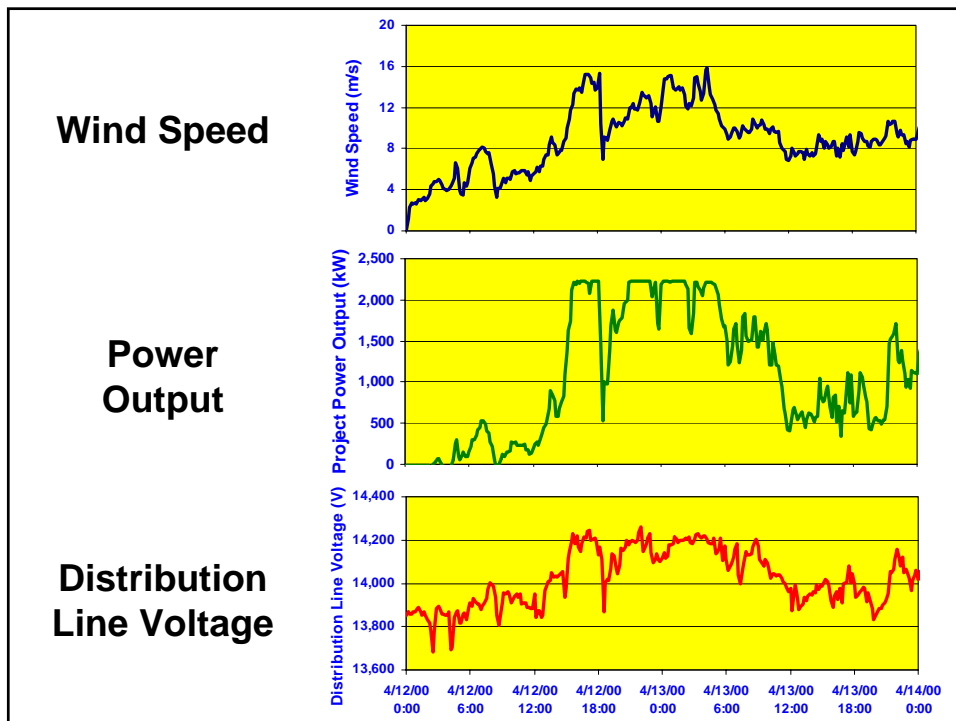

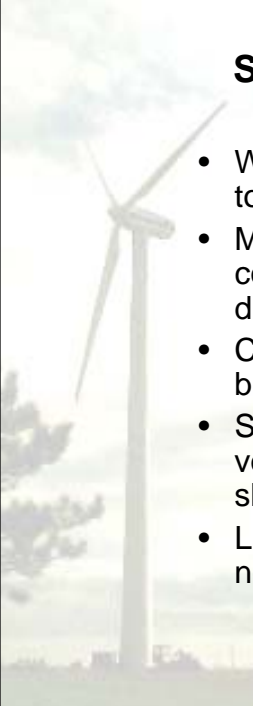

### Summary of Interconnection Issues

- Wind turbines are relatively easy to interconnect to the distribution system
- Modern large wind turbines have very sensitive controls that trip the wind turbine off line for any disturbances
- Coordination of relay settings and fuses should be checked when a large wind turbine is added
- Since large wind turbines can cause noticeable voltage flicker in some cases, an evaluation should be made for each installation
- Large wind turbines can potentially cause above normal voltage levels on feeders

39



### Case Study in Iowa

- Distributed Wind Power Assessment
- Sponsored by the National Wind Coordinating Committee
  - Princeton Energy Resources International
  - Wind Utility Consulting
- Case study in Iowa to determine how many wind turbines could be connected to the existing distribution system in an area
- 750 square mile area in Iowa

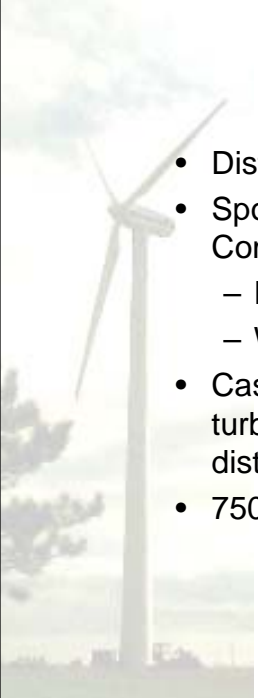

41

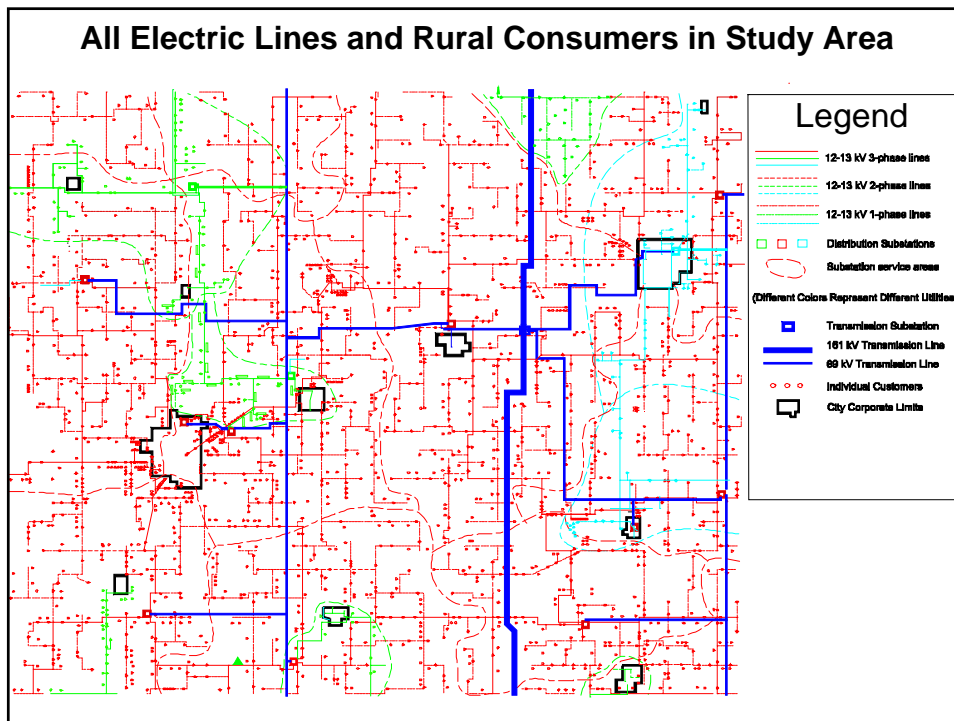



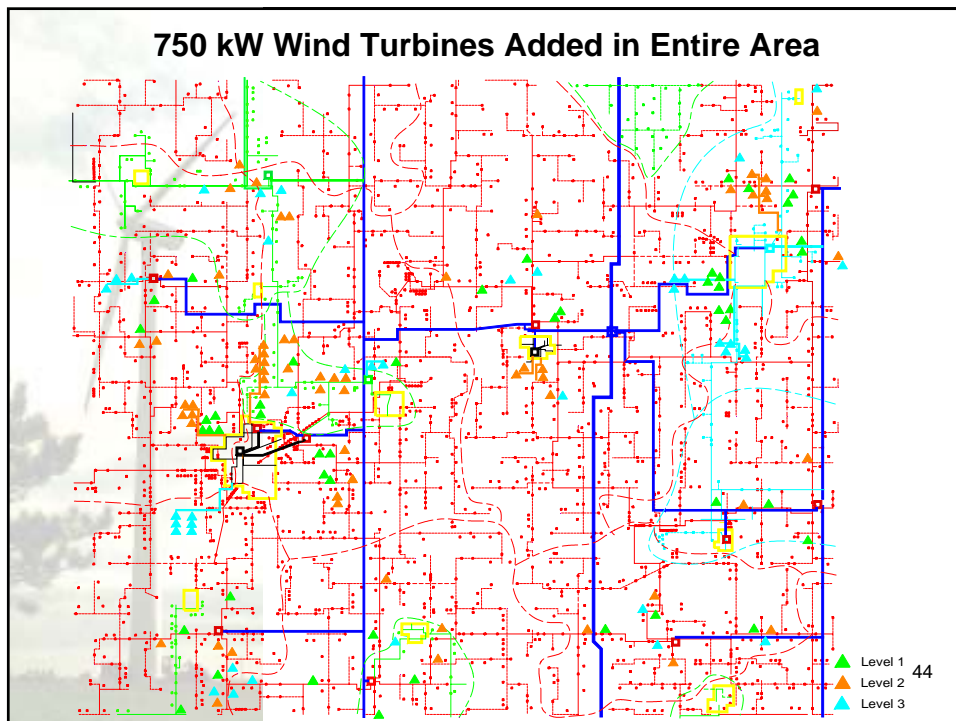
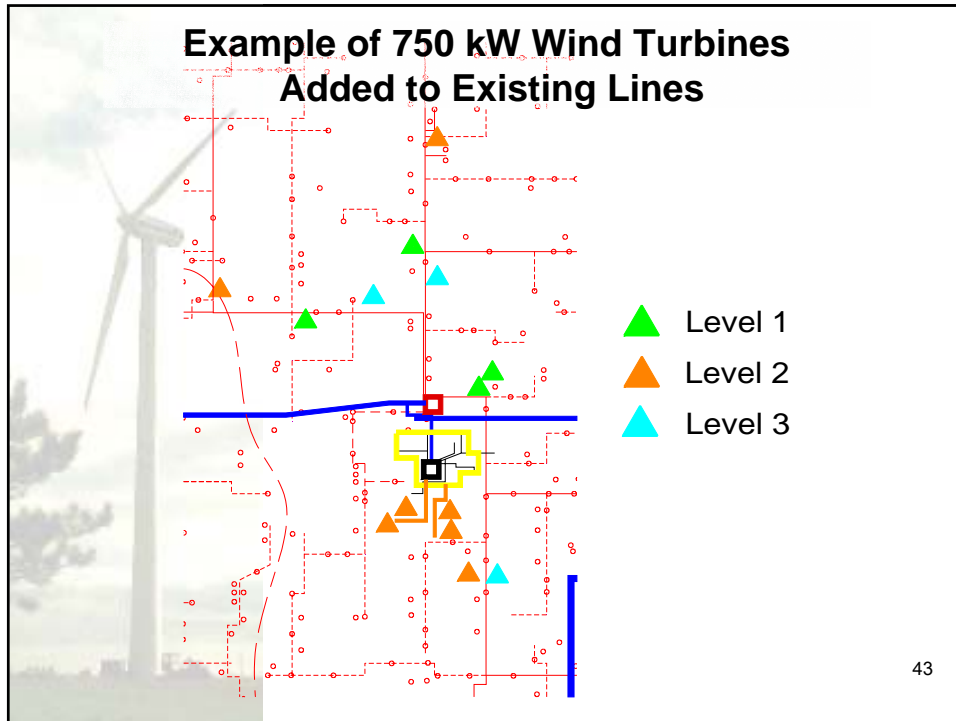

### Summary of Number of Wind Turbines Added and the Cost of Interconnection

Cost of Distribution System Reinforcements for Added Wind Generation						
Penetration Level	750 kW Turbines Added		Range of Reinforcement Costs in \$/kW			Cumulative Average Cost
	Number	MW	Minimum	Maximum	Average	
Level I	48	36.00	\$2	\$20	\$5	\$5
Level II	62	46.50	\$27	\$105	\$61	\$36
Level III	41	30.75	\$38	\$178	\$115	\$58
Totals	151	113.25				

**This amount of wind generation will produce on average twice as much electricity as the study area uses over the year**

### Potential 50 MW Wind Farm Using 33 1,500 kW Wind Turbines

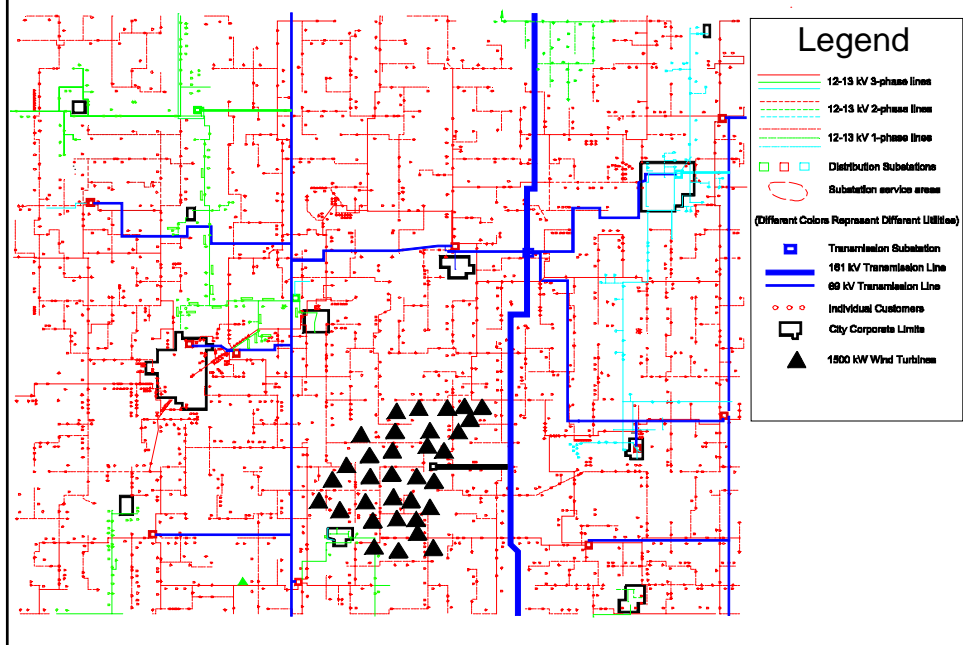

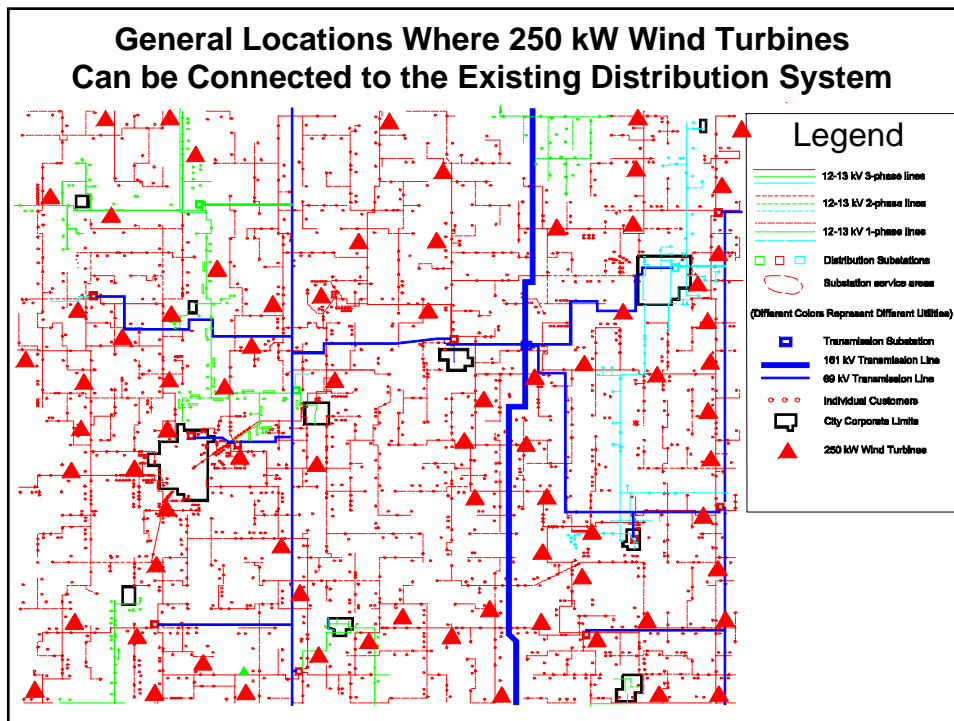
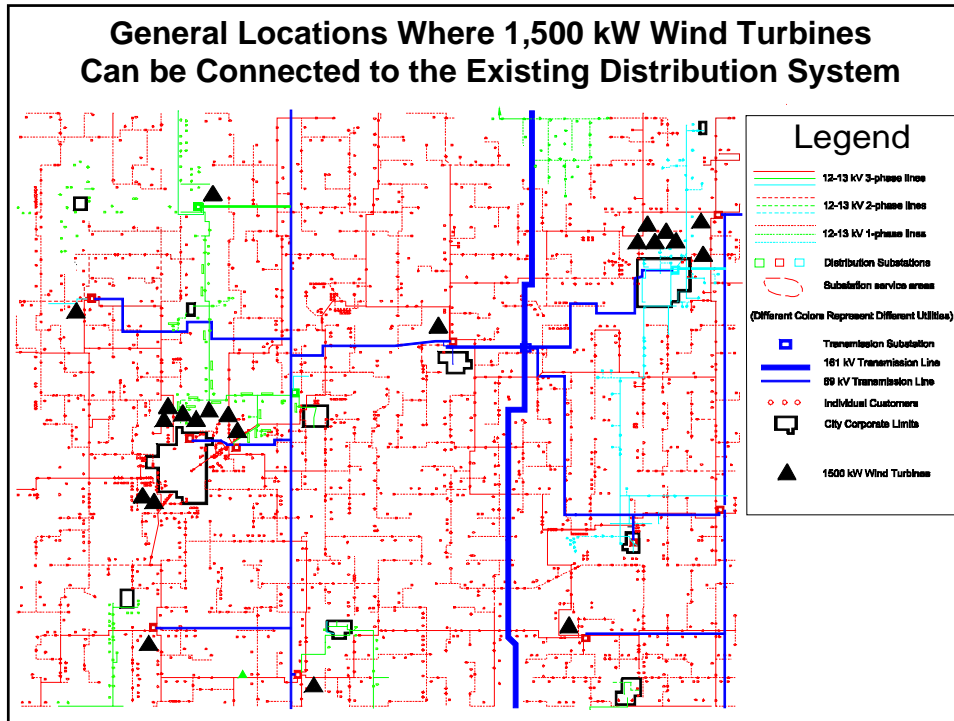

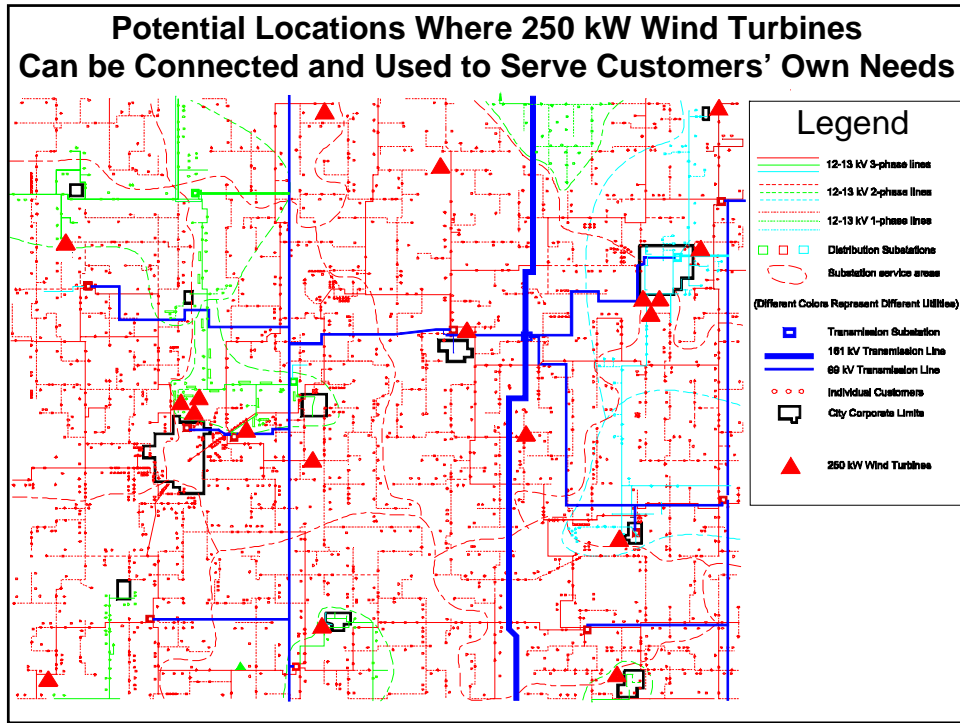

**RUS 2004 ELECTRIC  
ENGINEERING SEMINAR**

**FEBRUARY 10-11, 2004**

**NEW ORLEANS, LA**

**Contacts**

# RURAL UTILITIES SERVICE ELECTRIC PROGRAM

## Office of the Administrator

**Hilda G. Legg** Administrator  
(202) 720-9540 Hilda.Legg@usda.gov

**Curtis M. Anderson** Deputy Administrator  
(202) 720-9542 Curtis.Anderson@usda.gov

FAX - (202) 720-1725  
Room 5135-S Stop 1510

## Office of the Assistant Administrator-Electric

**Blaine D. Stockton** Assistant  
Administrator - Electric  
(202) 720-9545 Blaine.Stockton@usda.gov

**Alfred Rodgers** Deputy Assistant  
Administrator - Electric  
(202) 720-9547 Al.Rodgers@usda.gov

FAX - (202) 690-0717  
Room 5165-S Stop 1560

## Northern Regional Division

**VACANT** Director  
(202) 720-1420

**James F. Elliott** Deputy Director  
(202) 720-1421 Jim.Elliott@usda.gov

**Brian Jenkins** Chief, Operations Branch  
(202) 720-1422 Brian.Jenkins@usda.gov

**Charles M. Philpott** Chief, Northern  
Engineering Branch  
(202) 720-1432 Charles.Philpott@usda.gov

FAX - (202) 720-0498  
Room 0243-S Stop 1566

## Southern Regional Division

**Robert O. Ellinger** Director  
(202) 720-0848 Robert.Ellinger@usda.gov

**Annie J. Holloway-Jones** Deputy Director  
(202) 720-0848 Annie.Jones@usda.gov

**Nivin Elgohary** Chief, Operations Branch  
(202) 720-1932 Nivin.Elgoary@usda.gov

**Louis E. Riggs** Chief, Southern  
Engineering Branch  
(202) 720-8437 Lou.Riggs@usda.gov

FAX - (202) 720-0097  
Room 0221-S Stop 1567

## Power Supply Division

**Victor T. Vu** Director  
(202) 720-6436 Victor.Vu@usda.gov

**VACANT** Deputy Director  
(202) 720-6436

**William Railey** Chief, Financial  
Analysis, Security & Compliance Branch  
(202) 720-1383 William.Railey@usda.gov

**Steven M. Slovikosky** Chief, Power  
Delivery & Transmission  
Assessment Branch  
(202) 720-1396 Steven.Slovikosky@usda.gov

**Wei M. Moy** Chief, Power  
Resources & Planning Branch  
(202) 720-1438 Wei.Moy@usda.gov

FAX - (202) 720-1401  
Room 0270-S Stop 1568

*For accounting matters, please call the*

## **Electric Staff Division**

**George J. Bagnall** Director  
(202) 720-1900 George.Bagnall@usda.gov

**Fred J. Gatchell** Deputy Director  
(202) 720-1398 Fred.Gatchell@usda.gov

**John Pavek** Chief, Distribution Branch  
(202) 720-5082 John.Pavek@usda.gov

**H. Robert Lash** Chief,  
Transmission Branch  
(202) 720-0486 Bob.Lash@usda.gov

**Georg A. Shultz** Chief, Energy  
Forecasting Branch  
(202) 720-1920 Georg.Shultz@usda.gov

**Harvey L. Bowles** Chair, Technical  
Standards Committee "A"  
(202) 720-0980 Harvey.Bowles@usda.gov

FAX - (202) 720-7491  
Room 1246-S Stop 1569

## **Program Accounting Services Division**

**Kenneth Ackerman**  
Assistant Administrator, Program  
Accounting & Regulatory Analysis  
(202) 720-9450

Kenneth.Ackerman@usda.gov

**James Murray** Director  
Program Accounting Services Division  
(202) 720-5227 James.Murray@usda.gov

**Diana C. Alger** Branch Chief, Technical  
Accounting & Auditing Staff  
(202) 720-5227 Diana.Alger@usda.gov

FAX - (202) 720-8265  
Room 2221-S Stop 1530

### **Mailing Address**

Rural Utilities Service  
Room \_\_\_\_ [for express/direct delivery]

**\*\*OR\*\***

Stop \_\_\_\_ [for regular mail]  
1400 Independence Avenue SW  
Washington DC 20250-\_\_\_\_ [Stop]

We also encourage you to visit the Rural Utilities Service's Home Page at:

**<http://www.usda.gov/rus/>**

*As of January, 2004. For updated information, see: <http://www.usda.gov/rus/index2/contacts.htm>*

# RURAL UTILITIES SERVICE ELECTRIC STAFF DIVISION

## Office of the Director

**George J. Bagnall** Director  
202-720-1900 George.Bagnall@usda.gov

**Deborah Watkins** Secretary  
202-720-1900  
Deborah.Watkins@usda.gov

**Fred J. Gatchell** Deputy Director  
202-720-1398 Fred.Gatchell@usda.gov

**Harvey L. Bowles** Chair, Technical  
Standards Committee "A"  
202-720-0980 Harvey.Bowles@usda.gov

**Gail Underwood** Technical Committee  
Assistant  
202-720-0980 Gail.Underwood@usda.gov

**Marshall D. Duvall** Staff Engineer  
202-720-0096 Marshall.Duvall@usda.gov

**Robin L. Meigel** Finance Specialist  
202-720-9452 Robin.Meigel@usda.gov

## Energy Forecasting Branch

**Georg A. Shultz** Chief  
202-720-1920 Georg.Shultz@usda.gov

**Carolyn Bliss** Secretary  
202-720-1920 Carolyn.Bliss@usda.gov

**Sharon E. Ashurst** Public Utility Specialist  
202-720-1925 Sharon.Ashurst@usda.gov

**Christopher L. Tuttle** Economist  
202-205-3655 Chris.Tuttle@usda.gov

## Distribution Branch

**John Pavek** Chief  
202-720-5082 John.Pavek@usda.gov

**Stephanie Brown** Secretary  
202-720-5082  
StephanieN.Brown@usda.gov

**James L. Bohlk** Electrical Engineer  
202-720-1967 Jim.Bohlok@usda.gov

**Trung V. Hiu** Electrical Engineer  
202-720-1877 Trung.Hiu@usda.gov

**George L. Keel** Equipment Specialist  
202-690-0551 George.Keel@usda.gov

**Timothy Roscoe** Electrical Engineer  
202-720-1792 Timothy.Roscoe@usda.gov

## Transmission Branch

**H. Robert Lash** Chief  
202-720-0486 Bob.Lash@usda.gov

**VACANT** Secretary  
202-720-0486

**Mike Eskandary** Electrical Engineer  
202-720-9098  
Mike.Eskandary@usda.gov

**Donald G. Heald** Structural Engineer  
202-720-9102 Don.Heald@usda.gov

**Ted V. Pejman** Electrical Engineer  
202-720-0999 Ted.Pejman@usda.gov

**Norris Nicholson** Electrical Engineer  
202-720-1924 Norris.Nicholson@usda.gov