

CONTRACT NO. GS23-F-0011L

Cargo Tank Roll Stability Study

Final Report

Prepared for:

U.S. Department of Transportation
Federal Motor Carrier Safety Administration
400 Seventh Street, SW
Washington, D.C. 20590

Prepared by:

Battelle

The Business of Innovation

Douglas B. Pape, Kate Harback, Nancy McMillan,
Art Greenberg, Heather Mayfield, and J. Caleb Chitwood

U.S. Department of Transportation
Federal Motor Carrier Safety Administration
400 Seventh Street, SW
Washington, D.C. 20590

Prepared by:

Douglas B. Pape, Kate Harback, Nancy McMillan,
Art Greenberg, Heather Mayfield, and J. Caleb Chitwood

Michelle Barnes, Christopher B. Winkler,
Daniel Blower, and Timothy Gordon,
(University of Michigan Transportation Research Institute)

John Brock
(General Dynamics Information Technology)

April 30, 2007

This report is a work prepared for the United States Government by Battelle.

In no event shall either the United States Government or Battelle have any responsibility or liability for any consequences of any use, misuse, inability to use, or reliance on the information contained herein, nor does either warrant or otherwise represent in any way the accuracy, adequacy, efficacy, or applicability of the contents hereof.

Table of Contents

| | Page |
|---|-------------|
| Executive Summary | xii |
| Crash Statistics | xii |
| Driver Training | xv |
| Electronic Stability Aids..... | xv |
| Cargo Tank Design..... | xvi |
| Highway Design | xvii |
| Benefit-cost Analysis..... | xvii |
| Performing Organizations | xviii |
| Acknowledgments..... | xix |
| 1.0 Introduction..... | 1 |
| 2.0 Crash Statistics..... | 5 |
| 2.1 Introduction..... | 5 |
| 2.1.1 Databases | 5 |
| 2.1.1.1 MCMIS Database: The Hazardous Materials Serious Crash Analysis Database | 6 |
| 2.1.1.2 Large Truck Crash Causation Study (LTCCS) Database..... | 8 |
| 2.1.1.3 TIFA..... | 9 |
| 2.1.1.4 GES..... | 9 |
| 2.1.2 Presentation..... | 11 |
| 2.1.3 Approach..... | 12 |
| 2.2 Crosscutting Factors..... | 13 |
| 2.2.1 Primary Reason or Critical Event | 13 |
| 2.2.2 Pre-crash Maneuver | 18 |
| 2.3 Vehicle Factors | 20 |
| 2.3.1 Vehicle Configuration and Body Type | 20 |
| 2.3.2 Cargo Tank Type and Specification..... | 22 |
| 2.3.3 Presence of Hazardous Materials | 24 |
| 2.3.4 Quantity of Loading | 24 |
| 2.3.5 Mechanical Defect | 25 |
| 2.4 Roadway and Environment Factors | 27 |
| 2.4.1 Road Type..... | 27 |
| 2.4.2 Population Area | 29 |
| 2.4.3 Roadway Surface Condition | 30 |
| 2.4.4 Roadway Curvature..... | 31 |
| 2.4.5 Location Relative to Interchange | 31 |
| 2.5 Driver Factors | 32 |
| 2.5.1 Age..... | 32 |
| 2.5.2 Speed..... | 33 |
| 2.5.3 Driver Errors and Distractions | 34 |
| 2.6 Conclusions Concerning Crash Statistics..... | 36 |
| 3.0 Driver Training | 38 |
| 3.1 Introduction..... | 38 |
| 3.2 Task Analysis..... | 38 |

| | | |
|-------|--|-----|
| 3.3 | Training Gap Analysis | 40 |
| 3.4 | Technologies for Monitoring Drivers | 45 |
| 3.4.1 | Devices to Detect Patterns Risky Behavior Over Time | 46 |
| 3.5 | Review of Modern Training Technologies | 47 |
| 3.5.1 | Computer-based Instruction | 47 |
| 3.5.2 | Simulation Technology | 49 |
| 3.6 | Benefits to Advanced Training Approaches | 52 |
| 3.7 | Effect of Operations on Rollover Experience | 54 |
| 3.8 | Conclusions | 57 |
| 4.0 | Electronic Stability Aids | 60 |
| 4.1 | Introduction | 60 |
| 4.2 | Review of Automatic Stability Systems | 60 |
| 4.3 | Review of Systems that Inform the Driver | 62 |
| 4.4 | Estimate of Benefits | 63 |
| 4.4.1 | Approach | 64 |
| 4.4.2 | Simulation Example | 65 |
| 4.4.3 | Probability Calculation | 68 |
| 4.4.4 | Benefits Formula | 69 |
| 4.5 | Conclusion | 70 |
| 5.0 | Vehicle Design | 71 |
| 5.1 | Introduction | 71 |
| 5.2 | Interviews and Results Summary | 76 |
| 5.3 | Tank and Trailer Design Change Analysis | 77 |
| 5.4 | Estimate of Benefits | 80 |
| 5.4.1 | Approach | 80 |
| 5.4.2 | Vehicle Model and Simulation Methodology | 81 |
| 5.4.3 | Estimate of Reduction in Rollovers | 84 |
| 5.5 | Conclusion | 85 |
| 6.0 | Highway Design | 88 |
| 6.1 | Introduction | 88 |
| 6.2 | Site Selection | 88 |
| 6.3 | Site Cases | 91 |
| 6.3.1 | College Drive North Section | 92 |
| 6.3.2 | Telephone Canyon Section | 94 |
| 6.3.3 | Rawlins-Walcott Junction Section | 98 |
| 6.4 | Lessons Learned | 99 |
| 7.0 | Benefit-Cost Analysis | 102 |
| 7.1 | General Methodology | 102 |
| 7.1.1 | Common Assumptions | 102 |
| 7.1.2 | Common Time Period for Analysis and Timing Assumptions | 103 |
| 7.2 | Benefits | 105 |
| 7.2.1 | Estimating the Pool of Relevant Crashes | 105 |
| 7.2.2 | Estimating the Reduction in Crashes | 108 |
| 7.2.3 | Valuing the Reduction in Crashes | 108 |
| 7.3 | Costs | 114 |
| 7.3.1 | Driver Training | 114 |
| 7.3.2 | Electronic Stability Aids | 117 |
| 7.3.3 | Vehicle Design | 119 |
| 7.4 | Conclusions | 121 |
| 8.0 | Conclusions | 126 |
| 8.1 | Driver Training | 126 |

| | | |
|-------|---|-----|
| 8.2 | Electronic Stability Aids | 127 |
| 8.3 | Vehicle Design | 127 |
| 8.4 | Highway Design..... | 128 |
| | References..... | 130 |
| | Appendix A Detailed Tables Of Crash Statistics | 136 |
| A-1 | Crosscutting Factors | 139 |
| A-1.1 | Primary Reason or Critical Event..... | 139 |
| A-1.2 | Accident Type | 146 |
| A-2 | Vehicle Factors | 150 |
| A-2.1 | Vehicle Configuration..... | 150 |
| A-2.2 | Vehicle Loading | 153 |
| A-2.3 | Cargo Tank Specification..... | 156 |
| A-2.4 | Mechanical Problems | 156 |
| A-3 | Environment and Roadway..... | 161 |
| A-3.1 | Location of Accident with Respect to Junctions | 161 |
| A-3.2 | Population Area | 162 |
| A-3.3 | Road Designation or Access Control | 163 |
| A-3.4 | Traffic Control Devices: GES | 168 |
| A-3.5 | Lighting Conditions | 168 |
| A-3.6 | Road Surface Conditions | 170 |
| A-3.7 | Roadway Curvature (Horizontal and Vertical) | 172 |
| A-4 | Driver Factors | 176 |
| A-4.1 | Driver Experience | 176 |
| A-4.2 | Driver Age | 177 |
| A-4.3 | Effect of Speed on Rollovers | 179 |
| A-4.4 | Training and Rollover | 183 |
| A-4.5 | Other Driver Factors | 183 |
| | Appendix B Additional TIFA Data Analyses | 191 |
| | Appendix C Model Of The TIFA Data..... | 201 |
| | Appendix D Vehicle Inventory And Use Survey..... | 207 |
| | Appendix E Survey Of Tank Truck Carrier Training Practices..... | 211 |
| | Appendix F Assumptions For The Benefit-Cost Analysis..... | 217 |
| | Appendix G Population Of Petroleum-Hauling Semitrailers..... | 227 |
| | Appendix H Historical Profiles For Tractor And Trailer Fleets | 231 |
| | Appendix J Number of Drivers for Hazmat-Carrying Cargo Tanks..... | 237 |
| | Appendix K Wyoming Highway Plan | 240 |

List of Tables

| | Page |
|--|-------------|
| Table ES - 1 Most of the Cargo Tank Vehicles that Roll Over are Tractor-semitrailer Combinations | xiii |
| Table ES - 2 Most Rollovers Occur on Undivided Highways | xiv |
| Table ES - 3 Rollovers Occur on their Own or Along with Another Kind of Crash | xiv |
| Table ES - 4 Characteristics of the Nominal and Three Improved Semitrailer Designs..... | xvii |
| Table ES - 5 Comparison of Benefits and Costs..... | xviii |
| | |
| Table 1 - 1 The Discussion in this Report Focused on Cargo Tank Vehicles Carrying a Hazardous Material. This Table Shows the Scope of the Quantitative Analysis..... | 2 |
| | |
| Table 2 - 1 Summary Information on Four Crash Databases..... | 6 |
| Table 2 - 2 Weighting Factors Used to Remove the Sampling Bias from the MCMIS Analysis | 8 |
| Table 2 - 3 Selection Criteria to Identify Cargo Tanker Rollover Crashes in GES | 10 |
| Table 2 - 4 Percent and Number of Rollover Crashes by Body Type and Year | 11 |
| Table 2 - 5 Rollover Crash Primary Reason Category Relative Frequency (MCMIS)..... | 14 |
| Table 2 - 6 Rollover Crash Primary Reason Category Relative Frequency (LTCCS)..... | 14 |
| Table 2 - 7 Rollover Crash Primary Reason Category Relative Frequency (GES) | 15 |
| Table 2 - 8 Average Annual Number of Cargo Tank Rollovers, by Crash Type and Preceding Conflict (GES) | 17 |
| Table 2 - 9 Rollover Crash Pre-crash Maneuver Category Relative Frequency (LTCCS) | 19 |
| Table 2 - 10 Rollover Crash Pre-crash Maneuver Category Relative Frequency (TIFA) | 19 |
| Table 2 - 11 Rollover Crash Pre-crash Maneuver Category Relative Frequency (GES)..... | 20 |
| Table 2 - 12 Rollover Crash Configuration Category Relative Frequency (MCMIS)..... | 21 |
| Table 2 - 13 Rollover Crash Body Type and Configuration Category Relative Frequency (TIFA)..... | 21 |
| Table 2 - 14 Rollover Crash Configuration Relative Frequency (GES) | 21 |
| Table 2 - 15 Rollover Crash Cargo Tank Specification Category Relative Frequency (MCMIS) | 22 |
| Table 2 - 16 Tank Type, All Crashes Whether Roll or Not (TIFA)..... | 22 |
| Table 2 - 17 Tank Type of Tanks with Loads, All Crashes, Whether Roll or Not (TIFA)..... | 23 |
| Table 2 - 18 Rollover by Tank Type, Loaded Only (TIFA) | 23 |
| Table 2 - 19 Rollover by Tank Type, Empty or Loaded, (TIFA) | 23 |
| Table 2 - 20 Rollover Crash Hazmat Category Relative Frequency (TIFA) | 24 |
| Table 2 - 21 Rollover Crash Load Category Relative Frequency (MCMIS)..... | 25 |
| Table 2 - 22 Rollover Crash Load Category Relative Frequency (LTCCS – Cargo Tanks Only) | 25 |
| Table 2 - 23 Rollover Crash Load Category Relative Frequency (TIFA) | 25 |
| Table 2 - 24 Rollover Crash Brake Condition Category Relative Frequency (LTCCS – Cargo Tanks Only) | 26 |
| Table 2 - 25 Rollover Crash Tire Condition Category Relative Frequency (LTCCS – Cargo Tanks Only) | 26 |
| Table 2 - 26 Rollover Crash Mechanical Problem Category Relative Frequency (GES)..... | 27 |
| Table 2 - 27 Rollover Crash Road Type Category Relative Frequency (MCMIS)..... | 28 |
| Table 2 - 28 Rollover Crash Road Type Category Relative Frequency (LTCCS – Cargo Tank Only)..... | 28 |
| Table 2 - 29 Rollover Crash Road Type Category Relative Frequency (TIFA) | 28 |
| Table 2 - 30 Rollover Crash Road Type Category | 29 |
| Table 2 - 31 Rollover Crash Population Area Category Relative Frequency (MCMIS) | 29 |
| Table 2 - 32 Rollover Crash Population Area Category Relative Frequency (TIFA)..... | 29 |
| Table 2 - 33 Rollover Crash Roadway Surface Condition Category Relative Frequency (LTCCS – Cargo Tank Only)..... | 30 |

| | |
|--|-----|
| Table 2 - 34 Rollover Crash Roadway Surface Condition Category Relative Frequency (TIFA) | 30 |
| Table 2 - 35 Rollover Crash Roadway Surface Condition Category Relative Frequency (GES)..... | 30 |
| Table 2 - 36 Rollover Crash Roadway Curvature Category Relative Frequency (TIFA)..... | 31 |
| Table 2 - 37 Rollover Crash Roadway Curvature Category Relative Frequency (GES)..... | 31 |
| Table 2 - 38 Rollover Crash Location Relative to Interchange Category Relative Frequency (MCMIS) . | 32 |
| Table 2 - 39 Rollover Crash Location Relative to Interchange Category Relative Frequency (GES)..... | 32 |
| Table 2 - 40 Rollover Crash Age Category Relative Frequency | 33 |
| Table 2 - 41 Rollover Crash Speed Category Relative Frequency (LTCCS) | 33 |
| Table 2 - 42 Rollover Crash Speed Category Relative Frequency (GES) | 33 |
| Table 2 - 43 Rollover Crash Driver Errors and Distractions Category Relative Frequency (TIFA) | 34 |
| Table 2 - 44 Rollover Crash Driver Errors and Distractions Category Relative Frequency (GES) Physical Impairment..... | 35 |
| | |
| Table 3 - 1 Course Topics for LCV Drivers | 41 |
| Table 3 - 2 Carrier Frequency of Use: Training Methods (N=23)..... | 43 |
| Table 3 - 3 Ratings of Driver Training Materials | 44 |
| Table 3 - 4 Minimum Qualities for Computer Based Instruction Commercial Vehicle Operators | 48 |
| Table 3 - 5 Levels of Transit Bus Operator Simulators (From Brock, Jacobs, and Buchter, 2001) | 51 |
| | |
| Figure 4 - 1 Path of an Actual Truck in Revenue Service | 65 |
| Figure 4 - 2 Speed through the Path of Figure 4-1, as in the FOT and Increased Nearly to the Point of Rollover | 66 |
| Figure 4 - 3 Simulation of the Electronic Stability Aid to Reduce Speed and Avoid a Rollover | 67 |
| Figure 4 - 4 The Electronic Stability Aid Limits the Lateral Acceleration of the Trailer..... | 67 |
| Figure 4 - 5 The Electronic Stability Aid Limits the Roll Angle of the Trailer..... | 67 |
| | |
| Figure 5 - 1(a) Standard Case (406 oval tank, CG height 77 inches) | 73 |
| Figure 5 - 2(a) Standard Case (412 circular tank, CG height 77 inches) | 75 |
| Figure 5 - 3 A Constant-radius, Increasing Speed Maneuver was Simulated to Estimate the Rollover Threshold of the Nominal Trailer Design and Three Proposed Improvements | 82 |
| Figure 5 - 4 Time History of Trailer's Path in the Simulated Maneuver | 83 |
| Figure 5 - 5 Expected Rollover Rates for the Four Tank Designs, as Predicted from Estimates of Historical Crash Rates..... | 84 |
| | |
| Table 6 - 1 Vehicle and Crash Severity Threshold for MCMIS Crash File..... | 89 |
| Table 6 - 2 The Counties with the Highest Heavy Vehicle Rollover Rates..... | 90 |
| Table 6 - 3 Summary of the Three Sites in Wyoming that were Selected for Study | 92 |
| Table 6 - 4 Crashes in the College Drive North Section..... | 93 |
| Table 6 - 5 Crashes in the Telephone Canyon Section | 95 |
| Table 6 - 6 Crashes in the Rawlins-Walcott Junction Section | 98 |
| | |
| Table 7 - 1 Disproportionate Crashes by Age..... | 106 |
| Table 7 - 2 Rollover Crash Frequency by Cargo Type and Vehicle Configuration (MCMIS)..... | 107 |
| Table 7 - 3 Rollovers Addressed by the Three of the Four Approaches | 107 |
| Table 7 - 4 Efficacy Rates by Approach | 108 |
| Table 7 - 5 Estimated Crash Reductions | 109 |
| Table 7 - 6 Social Cost of Crashes by Severity (2000 dollars) | 110 |
| Table 7 - 7 Totals for all Cargo Tank Incidents (Weighted)..... | 110 |
| Table 7 - 8 Totals for all Cargo Tank Spill Incidents | 111 |
| Table 7 - 9 Spill Percentage by Category | 111 |
| Table 7 - 10 Costs of HAZMAT Spills (2007 dollars) | 111 |

| | |
|---|-----|
| Table 7 - 11 Total Benefits, in millions | 112 |
| Table 7 - 12 Total Discounted Benefits, in millions | 113 |
| Table 7 - 13 Training Requirements | 115 |
| Table 7 - 14 Undiscounted Training Costs, in Millions..... | 116 |
| Table 7 - 15 Discounted Training Costs, in Millions..... | 117 |
| Table 7 - 16 Undiscounted Costs for Electronic Stability Aids, in Millions | 118 |
| Table 7 - 17 Discounted Costs for Electronic Stability Aids, in Millions | 119 |
| Table 7 - 18 Incremental Purchase Cost for New Vehicle Designs in 2007 Dollars | 120 |
| Table 7 - 19 Undiscounted Purchase Costs for New Vehicle Designs, in Millions..... | 120 |
| Table 7 - 20 Discounted Vehicle Costs, in Millions | 121 |
| Table 7 - 21 Comparison of Benefits and Costs | 122 |
| Table 7 - 22 Comparison of Costs and Benefits with Alternate Discount Rate (4%)..... | 124 |
| | |
| Table A - 1 Primary Reasons Assigned to Single Vehicle Accidents (MCMIS)..... | 139 |
| Table A - 2 Primary Reasons Assigned to Multiple Vehicle Accidents (MCMIS) | 140 |
| Table A - 3 Primary Reason for Rollover: All Trucks (LTCCS)..... | 142 |
| Table A - 4 Primary Reason for Rollover: Cargo Tanks Only (LTCCS) | 142 |
| Table A - 5 Percent of Rollover Crashes by Critical Event (GES)..... | 143 |
| Table A - 6 Pre-crash Event for Rollovers: All Trucks (LTCCS) | 145 |
| Table A - 7 Pre-crash Event for Rollovers: Cargo Tank Trucks Only (LTCCS)..... | 145 |
| Table A - 8 Accident Type for Straight Truck Tanks (TIFA)..... | 146 |
| Table A - 9 Accident Type for Tractor-semitrailer Tanks (TIFA)..... | 147 |
| Table A - 10 Pre-crash Maneuver for Straight Truck Tanks (TIFA)..... | 147 |
| Table A - 11 Pre-crash Maneuver for Tractor-semitrailer Tanks (TIFA) | 148 |
| Table A - 12 Single and Multiple Vehicle Accident Rollover Percentages (MCMIS)..... | 148 |
| Table A - 13 First Event when The Rollover was a Subsequent Event (MCMIS) | 149 |
| Table A - 14 Percent and Number of Rollover Crashes by Manner of Collision (GES)..... | 149 |
| Table A - 15 Rollover Percentages as a Function of the Vehicle Configuration (MCMIS) | 150 |
| Table A - 16 Percentage of Rollovers Occurring on Highways for each Vehicle Configuration (MCMIS) | 150 |
| Table A - 17 Vehicle Type Rollover Rate: All Vehicles (LTCCS) | 151 |
| Table A - 18 Vehicle Type Rollover Rate: Cargo Tanks Only (LTCCS)..... | 151 |
| Table A - 19 Vehicle Configuration (TIFA) | 152 |
| Table A - 20 Body Type (TIFA)..... | 152 |
| Table A - 21 Presence of Hazmat (TIFA)..... | 152 |
| Table A - 22 Percent of Rollover Crashes by Trailing Units and Body Type (GES) | 153 |
| Table A - 23 Percent of Rollover Crashes by Trailing Units and Body Type (MCMIS) | 154 |
| Table A - 24 Rollover Related to Load: All Trucks (LTCCS) | 154 |
| Table A - 25 Rollover Related to Load: Cargo Tanks (LTCCS) | 154 |
| Table A - 26 Load Status (TIFA)..... | 155 |
| Table A - 27 Cargo Percent of GCW (TIFA) | 155 |
| Table A - 28 Rollover Probabilities by Cargo Tank Specification Number (MCMIS) | 156 |
| Table A - 29 Brake System Deficiency and Rollover: All Trucks (LTCCS) | 158 |
| Table A - 30 Brake System Deficiency and Rollover: Cargo Tanks (LTCCS) | 159 |
| Table A - 31 Tire Failure or Defect Related to Rollover: All Trucks (LTCCS)..... | 160 |
| Table A - 32 Tire Failure or Defect Related to Rollover: Cargo Tanks Only (LTCCS)..... | 160 |
| Table A - 33 Tire Failure or Defect Related to Rollover: Cargo Tanks Only (GES) | 160 |
| Table A - 34 Effect of Location on Rollover Probability given an Accident (MCMIS) | 161 |
| Table A - 35 Percent of Rollover Crashes by Relation to Junction (GES) | 162 |
| Table A - 36 Effect of Populated Area on Rollover Probability given an Accident (MCMIS)..... | 162 |

| | |
|---|-----|
| Table A - 37 Effect of Populated Area on Single Vehicle Cargo Tank Rollover Probabilities (MCMIS) | 162 |
| | 162 |
| Table A - 38 Rural vs. Urban (TIFA) | 163 |
| Table A - 39 Cargo Tank Rollover and Highway Type (MCMIS) | 163 |
| Table A - 40 Functional Roadway Group and Rollovers: All Trucks (LTCCS) | 164 |
| Table A - 41 Functional Roadway Group and Rollovers: Cargo Tank (LTCCS) | 164 |
| Table A - 42 Road Category “Signage”: Rollover for All Trucks (LTCCS) | 164 |
| Table A - 43 Road Category “Signage”: Rollover for Cargo Tanks (LTCCS) | 165 |
| Table A - 44 Road Type (TIFA) | 165 |
| Table A - 45 Type of Trafficway Flow (GES) | 166 |
| Table A - 46 Percent of Rollover Crashes by Number of Travel Lanes and Trafficway Flow (GES) | 167 |
| Table A - 47 Highway Access Control: Rollover for All Trucks (LTCCS) | 167 |
| Table A - 48 Highway Access Control: Rollover for Cargo Tank Trucks (LTCCS) | 167 |
| Table A - 49 Percent of Rollover Crashes by Traffic Control Device (GES) | 168 |
| Table A - 50 Daylight and Rollover: All Trucks (LTCCS) | 168 |
| Table A - 51 Daylight and Rollover: Cargo Tank Trucks Only (LTCCS) | 168 |
| Table A - 52 Light Condition (TIFA) | 169 |
| Table A - 53 Percent of Rollover Crashes by Light Condition (GES) | 169 |
| Table A - 54 Road Conditions and Rollover: All Trucks (LTCCS) | 170 |
| Table A - 55 Road Conditions and Rollover: Cargo Tank Trucks Only (LTCCS) | 170 |
| Table A - 56 Roadway Surface Conditions (TIFA) | 171 |
| Table A - 57 Percent and Number of Rollover Crashes by Weather (GES) | 171 |
| Table A - 58 Percent and Number of Rollover Crashes by Roadway Surface Condition (GES) | 172 |
| Table A - 59 Roadway Curvature (TIFA) | 172 |
| Table A - 60 Percent and Number of Rollover Crashes by Road Alignment (GES) | 173 |
| Table A - 61 Percent of Rollover Crashes by Movement Prior to Critical Event (GES) | 173 |
| Table A - 62 Roadway Profile (TIFA) | 175 |
| Table A - 63 Percent and Number of Rollover Crashes by Roadway Profile (TIFA) | 175 |
| Table A - 64 Driver Experience (Cargo Tank Drivers) (MCMIS) | 176 |
| Table A - 65 Driver Experience (non-Cargo Tank Drivers) (MCMIS) | 176 |
| Table A - 66 Driver Experience and Rollovers: All Trucks (TIFA) | 177 |
| Table A - 67 Driver Experience and Rollovers: Cargo Tanks Only (TIFA) | 177 |
| Table A - 68 Age of Driver Involved in Cargo Tank Accidents by Event Sequence (MCMIS) | 178 |
| Table A - 69 Age of Driver Involved in Single Vehicle Cargo Tank Accidents by | 178 |
| Table A - 70 Driver Age (TIFA) | 178 |
| Table A - 71 Percent of Rollover Crashes by | 179 |
| Table A - 72 Speed Driver Traveling Before Crash: All Trucks (LTCCS) | 180 |
| Table A - 73 Speed Driver Traveling Before Crash: Cargo Tanks Only (LTCCS) | 180 |
| Table A - 74 Percent and Number of Rollover Crashes by Speed Related (GES) | 181 |
| Table A - 75 Percent and Number of Rollover Crashes by | 181 |
| Table A - 76 Percent of Rollover Crashes by Number of Speed Limit and Travel Speed (GES) | 182 |
| Table A - 77 Training and Rollover: All Trucks (LTCCS) | 183 |
| Table A - 78 Training and Rollover: Cargo Tank Trucks Only (LTCCS) | 184 |
| Table A - 79 Miscellaneous Driver Factors for Straight Tank Trucks (TIFA) | 185 |
| Table A - 80 Miscellaneous Driver Factors for Tractor-semitrailers (TIFA) | 186 |
| Table A - 81 Percentage of Drivers with a Physical Impairment (GES) | 187 |
| Table A - 82 Percent of Rollover Crashes by Driver Vision Obscured (GES) | 188 |
| Table A - 83 Percent of Rollover Crashes by Driver Distraction (GES) | 188 |
| Table A - 84 Percent of Rollover Crashes by Driver Drinking in Vehicle (GES) | 189 |
| Table A - 85 Percent of Rollover Crashes by Police-reported Drug Involvement (GES) | 189 |

| | |
|--|-----|
| Table B - 1 Miscellaneous Driver Factors for Straight Tank Trucks..... | 193 |
| Table B - 2 Miscellaneous Driver Factors for Tractor-semitrailer Tank Trucks | 195 |
| Table B - 3 Accident Type for Straight Tank Trucks | 197 |
| Table B - 4 Accident Type for Tractor-semitrailer Tanks | 198 |
| Table B - 5 Pre-crash Maneuver for Straight Tank Trucks..... | 199 |
| Table B - 6 Pre-crash Maneuver for Tractor-semitrailer Tanks..... | 200 |
| Table C - 1 Model Variables..... | 204 |
| Table C - 2 Model..... | 205 |
| Table C - 3 Example Cases from Model..... | 206 |
| Table D - 1 Estimates of Vehicles and Miles For Tank Trucks, 2002 Vehicle Inventory and Use Survey | 209 |

List of Figures

| | Page |
|--|-------------|
| Figure 1 - 1 Roll Plane Forces Acting on a Tank Trailer..... | 3 |
| Figure 3 - 1 Data Recorded During a Previous Field Operational Test Indicates that..... | 47 |
| Figure 4 - 1 Path of an Actual Truck in Revenue Service | 65 |
| Figure 4 - 2 Speed through the Path of Figure 4-1, as in the FOT and Increased Nearly to the Point of Rollover | 66 |
| Figure 4 - 3 Simulation of the Electronic Stability Aid to Reduce Speed and Avoid a Rollover | 67 |
| Figure 4 - 4 The Electronic Stability Aid Limits the Lateral Acceleration of the Trailer..... | 67 |
| Figure 4 - 5 The Electronic Stability Aid Limits the Roll Angle of the Trailer..... | 67 |
| Figure 5 - 1(a) Standard Case (406 oval tank, CG height 77 inches) | 73 |
| Figure 5 - 2(a) Standard Case (412 circular tank, CG height 77 inches) | 75 |
| Figure 5 - 3 A Constant-radius, Increasing Speed Maneuver was Simulated to Estimate the Rollover Threshold of the Nominal Trailer Design and Three Proposed Improvements | 82 |
| Figure 5 - 4 Time History of Trailer's Path in the Simulated Maneuver..... | 83 |
| Figure 5 - 5 Expected Rollover Rates for the Four Tank Designs, as Predicted from Estimates of Historical Crash Rates..... | 84 |
| Figure 6 - 1 Map Showing the Three Sites in Wyoming that were Selected for Detailed Study..... | 92 |
| Figure 6 - 2 I-25 at College Drive North Section..... | 94 |
| Figure 6 - 3 Telephone Canyon Section..... | 97 |
| Figure 6 - 4 I-80 Near Union Avenue, Rawlins-Walcott Junction – Carbon County | 100 |
| Figure A - 1 Percent of Rollover Crashes by Critical Event (GES)..... | 144 |
| Figure A - 2 Percent of Rollover Crashes by Type of Trafficway Flow (GES) | 166 |
| Figure A - 3 Percent of Rollover Crashes by Movement Prior to Critical Event (GES) | 174 |
| Figure A - 4 Percent of Rollover Crashes by Driver Age..... | 179 |
| Figure A - 5 Percent and Number of Rollover Crashes by Travel Speed (GES)..... | 182 |
| Figure A - 6 Miscellaneous Driver Factors for Straight Tank Trucks (TIFA)..... | 184 |
| Figure A - 7 Miscellaneous Driver Factors for Tractor-semitrailer Tanks (TIFA)..... | 187 |

| | |
|--|-----|
| Figure A - 8 Percent of Rollover Crashes by Driver Distraction (GES)..... | 188 |
| Figure H - 1 Percent of Trucks by Age..... | 233 |
| Figure H - 2 Percent of Trucks by Age, Fitted and Actual | 234 |
| Figure H - 3 Percent of Tractors Pulling Tankers HAZMAT by Age | 235 |
| Figure H - 4 Percent of Tractors Pulling Tankers HAZMAT by Age, Fitted and Actual..... | 235 |
| Figure J - 1 Drivers per Power Unit..... | 239 |

Executive Summary

Rollovers are among the most serious crashes of cargo tank motor vehicles carrying hazardous materials. They are more likely to be fatal to the driver of the vehicle than other crashes, and they can cause spills and necessitate highway closures. The Federal Motor Carrier Safety Administration (FMCSA) has identified the need to study cargo tanks, from design through operation, to improve their roll stability.

The objective of this program was to evaluate four complementary approaches to reducing the incidence of cargo tank truck rollovers: improving the training of drivers, deploying electronic stability aids, implementing new vehicle designs, and learning lessons from highway designs. The benefits, in terms of reduced numbers of rollover crashes, that could accrue from each approach, have been estimated, along with the costs of achieving those benefits. All four approaches are expected to be cost beneficial.

Ultimate responsibility for the safety of the vehicle rests with the driver. The driver must be aware of the situations that can lead to rollover and have the skills and vigilance to prevent those situations from developing. Drowsiness and inattention together contribute to 1 in 5 cargo tank rollovers, so adherence to viable and legal schedules of work and rest is essential. Modern, motion-base simulators can help new drivers acquire skills more quickly and without consuming fuel, so simulators can pay for themselves through reduced training costs alone, for those carriers large enough to afford them. Electronic stability aids automatically slow a vehicle when it starts to round a corner too fast. Excessive cornering speed accounts for about 1 in 5 cargo tank rollovers, and these devices can be quite effective in what they do while adding only marginally to the cost of a tractor or trailer. Vehicles with more stable designs are available on the market today. Lowering the trailer's center of gravity by only three inches can reduce rollover incidence by more than 10 percent. However, these trailers have been slow to gain market share because they have a cost premium and their benefit is not widely appreciated. Improvements in highway geometry, surface, or signage, of course, have to be considered at individual sites.

Crash Statistics

Statisticians examined four crash databases to identify the conditions and circumstances that are present when cargo tank motor vehicles roll over. The databases were

- Motor Carrier Management Information System (MCMIS),
- Large Truck Crash Causation Study (LTCCS),
- Trucks Involved in Fatal Accidents (TIFA), and
- General Estimates System (GES).

The data from MCMIS was a subset of hazardous materials that was enhanced with additional information during a previous study for the FMCSA. The final LTCCS data set was not available at the time of this task, so a draft data set was used. TIFA, of course, is limited to fatal accidents, and rollovers were well represented in the data. GES was the only one of the four databases not specifically limited to large trucks. Agreement between the databases was quite

good for the most part. Exact agreement between the databases was not expected because they are distinct databases with their own reporting procedures.

The focus of the search was crashes of a cargo tank truck transporting a hazardous material where there was a rollover. In some cases, rollover crashes were analyzed alongside all crashes so that the characteristics of the two could be compared. Both single-unit trucks and combination-unit trucks were studied in the statistical analysis, though the remainder of the project focused on trailers or combination vehicles. The study included crashes where an untripped rollover was the primary event as well as crashes where a rollover was a secondary event following another event. The queries of TIFA and LTCCS sorted the cargo tank body type, but they were not limited to hazardous materials.

Table ES-1 indicates the configurations of cargo tank vehicles in rollover crashes in the three large databases. Approximately 60 percent of the rollovers were tractor-semitrailer combinations. Combinations were a slightly higher fraction of the fatal crashes (i.e. in the TIFA database). Table ES-1 is a combination of Tables 2-12, 2-13, and 2-14 of the main text.

Table ES - 1 Most of the Cargo Tank Vehicles that Roll Over are Tractor-semitrailer Combinations

| Vehicle Configuration | MCMIS | | GES | TIFA | |
|-----------------------------|-----------------|----------------------|----------------------|-----------------|----------------------|
| | Total Rollovers | Percent of Rollovers | Percent of Rollovers | Total Rollovers | Percent of Rollovers |
| Tractor, One Trailer | 174 | 59.8% | 55.6% | 371 | 77% |
| Tractor, Two Trailers | 7 | 2.4% | 3.9% | | |
| Straight Truck, No Trailer | 90 | 30.9% | 39.7% | 111 | 23% |
| Straight Truck, One Trailer | 15 | 5.2% | 0.2% | | |
| Other or Unknown | 5 | 1.7% | 0.7% | 0 | 0% |
| Total | 291 | 100.0% | 100.0% | 482 | 100% |

(The MCMIS and GES numbers are for one-year periods. The TIFA totals are for six years.)

The data confirmed many expectations, but a few of the factors were not as strong as might have been expected. The portion of rollovers that occur on freeways (approximately 15 to 20 percent), though substantial, is not the largest share. Only about 7 percent of cargo tank rollovers occur on entrance or exit ramps. A driver error of one kind or another (e.g., decision or performance error) figures in about 3/4 of cargo tank rollovers. Inattention and distraction account for about 15 percent. Evasive maneuvers were a factor in 5 to 10 percent of rollovers. Pavement is dry in 85 to 90 percent of rollovers.

Tables ES-2 and ES-3 summarize the most important information about where rollovers occur and the circumstances surrounding them. Table ES-1 indicates the locations of cargo tank rollovers. The numbers come from the MCMIS database, summarizing the data in Tables 2-38 and A-34.

Table ES - 2 Most Rollovers Occur on Undivided Highways

| Location of Accident | Total Rollovers | Percent of All Rollovers |
|--------------------------------|------------------------|---------------------------------|
| Close to Interchange | 11 | 4.6% |
| Not at Interchange | 45 | 19.0% |
| On or Off Ramp | 17 | 7.2% |
| Total Divided Highway | 74 | 31.2% |
| Close to Intersection | 82 | 34.6% |
| Not at Intersection | 81 | 34.2% |
| Not on Roadway | 0 | 0% |
| Railroad Grade Crossing | 0 | 0% |
| Total Undivided Highway | 163 | 68.8% |
| Total | 237 | 100.0% |

Table ES-3 is a summary of Table 2-8 in the main text. It is taken from GES. Roadway departures accompany more than half of all cargo tank rollovers. Separate studies on roadway departures have implicated drowsiness, inattention, and speed as causes for roadway departures of heavy vehicles.

The annual number of cargo tank rollovers nationwide, averaged from the GES data over the years studied, is 1,265. The report itself and the appendixes contain complete tables and more fully nuanced interpretation.

Table ES - 3 Rollovers Occur on their Own or Along with Another Kind of Crash

| Kind of Crash | Total Rollovers | Percent of Rollovers |
|------------------------------|------------------------|-----------------------------|
| Untripped rollover | 65 | 5.1% |
| SVRD with untripped rollover | 113 | 8.9% |
| SVRD with tripped rollover | 599 | 47.4% |
| Lane Change Merge | 5 | 0.4% |
| Rear End | 12 | 0.9% |
| Other | 471 | 37.2% |
| Total | 1265 | 100% |

SVRD means “Single Vehicle Roadway Departure.”

This kind of crash is also called “run off road.”

An “untripped” rollover results from rounding a corner too fast.

Driver Training

Modern motion-base simulators can deliver better training for some tasks than actual driving because of their ability to simulate dangerous situations without actually posing a danger. The disadvantage of simulators is that they are quite expensive, and there is no demonstrated business model for incorporating them in training for drivers of smaller carriers.

The tasks required to safely operate a tanker are essentially the same as those to operate another heavy vehicle, but they must be mastered to a greater proficiency. Several medium and large carriers, who are early adopters, are currently using fixed-base and motion-base simulators to train new drivers the skills, including rollover prevention skills, for driving tractors hauling dry freight. Their experience has been that training that includes simulator time is both faster and more thorough than conventional training. An initial step to improving the training for cargo tank drivers would be to provide simulator training for tank drivers. Existing simulators can vary the properties of the trailer, so the next step would be to tailor the dynamics of the simulators to model various cargo tanks. This should include at least the center of gravity height and roll inertia of tanks, but input from experienced tank trainers would be needed to ensure that enough effects were captured to produce proper fidelity.

Because the crash statistics disproved some common assumptions about the causes of rollovers, it is important to tell drivers what the true causes are. Certainly drivers of top-heavy cargo tank vehicles need to appreciate the consequences of taking a freeway ramp too fast, but they need to realize that running off the road due to inattention is a leading cause of serious crashes as well. Dispatchers and drivers alike need to understand the benefits of good communication, proper route selection, and practical scheduling.

Electronic Stability Aids

Technologies to help the driver maintain stable control of the vehicle have been on the North American market for about five years. They have gained such wide acceptance that they are now standard on some models. Conceptually, these technologies slow the vehicle when the vehicle is in danger of rolling over due to excess speed. Roll stability aids are incorporated into the existing braking equipment on heavy vehicles, so their costs are low. They add several hundred to a thousand dollars to the price of a tractor or trailer and require only minimal additional training of drivers or mechanics.

These systems can be quite effective, but marketing literature is correct when it points out that the devices cannot prevent all rollovers. Both computer simulations and test track maneuvers have shown that some situations develop so suddenly that even the automatic braking cannot prevent a rollover. More importantly, crash statistics are clear that excessive speed is a factor in only about half of all rollovers. When a rollover results from a vehicle drifting off the road, these aids are not useful. Electronic stability aids are certainly an important part of an overall rollover prevention program, but they are only a part.

Stability aids can track the time and location of events when they are activated. This information can be useful for the continuing education of drivers, alerting them to instances where they

approached a rollover condition but did not roll over. Some carriers are already incorporating the information in a formal feedback program.

Roll stability aids that are mounted on tractors can be combined with additional features that provide yaw (steering) stability as well. The most important benefit of these fuller stability systems is that they can prevent a tractor from oversteering, which is a jackknife. The yaw stability aids can be effective in any conditions, but their greatest benefit is when the road surface is slippery, due to water or snow. On the other hand, the kinds of rollover where the electronic stability aids are effective, i.e., driving too fast in a curve, are most likely to occur when pavement is dry and friction is good. Because the topic of this study was rollovers, it concentrated on the function and benefits of only the roll stability aids and not the yaw stability function.

Cargo Tank Design

The three other approaches evaluated in this program can be quite effective in eliminating rollovers in a variety of situations, but the only way to address rollovers from all scenarios is through improvements in the stability of the vehicle itself. Some cargo tank trailer manufacturers already offer products with a slightly lowered center of gravity for a small premium in cost. The economic analysis in this study has shown that such improvements are cost beneficial.

Substantial reductions in the height of a tank have been studied by some manufacturers. One carrier of cryogenic liquids has decided to adopt a new trailer design that is more stable than its previous trailers. In another case, a manufacturer began a project to substantially lower the tanks in its DOT 406 trailers. Not only was the height of existing load racks an impediment to the lowered fittings, but the amount that drivers would have to bend over to make the connections was another practical obstacle that would not be easily overcome. This example illustrates perhaps the largest reason that improved vehicle designs have not to date appeared to improve roll stability: the tremendous segmentation of the cargo tank vehicle market. DOT 406 trailers represent a large, somewhat uniform market, but the diversity of other cargoes and the requisite vehicle configurations means that each vehicle model is its own design problem with an associated capital cost.

The legal restriction posing the greatest impediment to improved vehicle stability is the requirement that trailers be at most 96 inches wide off arterials. New van trailers are almost exclusively 102 inches wide, and some cargo tank trailers are wider as well. To be sure, carriers who deliver to service stations in tight urban areas cannot use wider trailers, but many can, and permitting others to do so would increase vehicle stability at very little cost in capital expense or weight.

Table ES-4 summarizes the analysis of the proposed improvements to cargo tank vehicle design. It lists a “nominal” case, which is a typical modern DOT 406 trailer. Three proposed improvements, a modest and an aggressive lowering of the center of gravity and a widening of the axles, are listed below the nominal case. The first two columns list the features that identify the design modifications. The next column is the expected reduction in the number of rollovers,

which was estimated through computer simulation and comparison to historical crash statistics as outlined in Section 5.4 of the main text. The final column is the estimated cost premium for each improvement, which was provided by manufacturers.

Table ES - 4 Characteristics of the Nominal and Three Improved Semitrailer Designs

| Case | Height of the Loaded Trailer's Center of Gravity, in. | Track Width, in. | Reduction in Annual Rollovers, Compared to the Nominal Case | Cost Premium (from Manufacturer Interviews) |
|------------------------|---|--------------------------|---|---|
| Nominal | 78.9 | 96 | -- | -- |
| Lower CG | 75.9 (nominal - 3) | 96 | 12% | \$1500 to \$4000 |
| Wider Track | 78.9 | 102 (nominal + 6) | 17% | \$150 to \$800 |
| Aggressive Improvement | 70.9 (nominal - 8) | 96 | 30% | About \$12,000 |

Highway Design

The analysis of rollover improvements through infrastructure was limited to a few locations where a relatively high incidence of rollover was observed and geometric information could be obtained. A high incidence of rollovers in Wyoming was observed at locations that are subject to high winds or where mountainous terrain made steep grades and sharp curves unavoidable. The Wyoming Department of Transportation is addressing the rollovers by providing information to truckers through various means, including new Intelligent Transportation System (ITS) technologies. The treatments are expected to be cost beneficial. The benefit-cost analysis cannot be compared to the others from this project because the mitigation efforts are specific to individual locations and the benefits are spread across all heavy vehicles, not just cargo tanks.

Benefit-cost Analysis

The benefit-cost analysis was performed from the societal viewpoint. Separate analyses were conducted for potential reductions in cargo tank rollovers arising from improved driver training, electronic stability aids, and vehicle design. Highway design, with each location being a separate situation, was not analyzed. The analyses were conducted in a parallel fashion and, to the extent possible, under a common set of assumptions. Net discounted costs and benefits were computed over a 20-year time frame. Under the assumptions in the analysis, all of the proposed approaches to reducing rollovers, except one, were cost beneficial. The substantial reduction in the height of a semitrailer, though expected to prevent a number of rollovers, fell short of being economical, due to its high cost. The modest reduction in the height of semitrailers was economical.

Table ES-5 lists the estimated net benefits and the benefit-cost ratio for the electronic stability aids and the three improvements in vehicle design. The net benefits are the total estimated costs over the 20-year time frame, minus the total estimated costs. Even though widening the track has a higher benefit-cost ratio than the electronic stability aids, it has lower net benefits. This is because the analysis applied electronic stability aids to all cargo tank semitrailers carrying a

hazardous material but the vehicle design improvements were applied only to some DOT 406 semitrailers. An advantage of the electronic stability aids is that they can be applied with only modest engineering effort to any vehicle, whereas the vehicle design improvements require a separate engineering analysis for every different trailer. Driver training and highway design are not listed in this table because they were treated differently. Table ES-5 is a summary of Table 7-21 of the main text.

Table ES - 5 Comparison of Benefits and Costs

| Approach | Semitrailer Population | Net Benefits (millions) | Benefit Cost Ratio |
|---------------------------|-------------------------------|--------------------------------|---------------------------|
| Electronic Stability Aids | Cargo tank HM | \$51 | 2.2 |
| Tanker Design | | | |
| Lower CG | DOT 406 | \$21 | 1.7 |
| Wider Track | DOT 406 | \$35 | 18.9 |
| Aggressive Improvement | DOT 406 | -\$56 | 0.71 |

Performing Organizations

The prime contractor for this work was Battelle. Subcontractors were The University of Michigan Transportation Research Institute (UMTRI) and General Dynamics Information Technology.

Battelle had primary responsibility for the project, including integrating the work of the subcontractors. Battelle was responsible for the benefit-cost analysis, the assessment of electronic stability aids, and the majority of the work on crash statistics. Battelle contributed to the driver safety work and the benefits assessment of the vehicle designs. UMTRI had primary responsibility for the vehicle design and highway design portions of the project, and made substantial contributions to the crash statistics work. General Dynamics Information Technology had primary responsibility for the driver training review.

Acknowledgments

The authors are indebted to a number of people working in highway safety who have given their time and provided information and insights concerning rollovers and the circumstances surrounding them. The sources included cargo tank manufacturers, carriers, other manufacturers and suppliers, drivers, and state highway officials.

A few individuals warrant special mention. John Conley, president of National Tank Truck Carriers, Inc., made many introductions, provided opportunities, and supplied information himself. Tony Laird, Tom Carpenter, and Ben Saunders of the Wyoming Department of Transportation were always willing to discuss the sites and provide road plans and crash data.

Danny Shelton, now retired from the Federal Motor Carrier Safety Administration, was instrumental in starting the project, and he provided valuable guidance as work progressed.

This Page Intentionally Left Blank

1.0 Introduction

In investigating ways to improve the rollover stability of cargo tanks, the Federal Motor Carrier Safety Administration (FMCSA) identified the need to study cargo tanks from their design through their operation.

Rollovers occur in more than two-thirds of the serious single-vehicle crashes of cargo tank motor vehicles. Cargo tank trucks account for only 15 percent of all fatal crashes involving heavy trucks, yet cargo tank rollovers account for 31 percent of the heavy vehicle rollover fatal crashes. Improving the rollover performance of cargo tank motor vehicles offers significant benefits to society in terms of lives saved, environmental damage avoided, and improved traffic flow.

The purpose of this research was to identify and evaluate four broad approaches to decreasing the number of cargo tank rollovers. They are

- Driver training. Some carriers have experienced significant improvement in the safety of new drivers through improved training, including simulators. The potential benefits in rollover prevention are discussed.
- Electronic stability aids. Devices that automatically apply the truck's brakes when a rollover is imminent can prevent rollovers that occur due to certain kinds of driver errors.
- Improvements in design of the vehicle itself. By improving the basic stability of the vehicle, rollovers arising from potentially any cause can be avoided.
- Improvements in highway design. The experience of a state department of transportation in handling locations known to have high rollover incidence is discussed.

This report presents the results of a research program that has identified specific improvements to be made within each of the four broad areas and evaluated their potential economic benefits to society. The four approaches are discussed separately, and their economic benefits are evaluated side by side.

FMCSA anticipates that solutions may come from regulations, outreach, operational changes, and deployment of technology. The study has identified some of the obstacles to implementing solutions, but actually developing plans or business cases is beyond the scope of this project.

To the extent possible, the scope for the discussion in this report was cargo tank motor vehicles carrying a hazardous material. In the cases of driver training and electronic stability aids, the economic benefits calculation included only cargo tank combination vehicles carrying a hazardous material, to be parallel with the other analyses, but this was done with the realization that the principles apply to other trucks as well. The vehicle design discussion generally applies to all cargo tanks, but the economic analysis concentrated on petroleum semitrailers (DOT 406), which is the largest uniform segment of the market. Any improvements to the infrastructure benefit all vehicles. Table 1-1 summarizes the scope for each analysis.

Table 1 - 1 The Discussion in this Report Focused on Cargo Tank Vehicles Carrying a Hazardous Material. This Table Shows the Scope of the Quantitative Analysis.

| Section | Vehicles Included in the Analysis |
|-----------------------------|---|
| 2 Crash Statistics | Primarily cargo tanks. See Table 2-1. |
| 3 Driver Training | Cargo tank semitrailers carrying a hazardous material (specifically, the excess of crashes experienced by drivers under age 35) |
| 4 Electronic Stability Aids | Cargo tank semitrailers carrying a hazardous material (further limited to rollovers due to cornering at an excessive speed) |
| 5 Vehicle Design | DOT 406 semitrailers |
| 6 Highway Design | All heavy vehicles |

A heavy truck rolls over when the sideways forces are too great. The vertical forces on the tires tend to resist the rolling over. The lateral (sideways) force on the center can come from a high-speed curve or from gravity if one side of the truck has dropped off the pavement. The lateral forces on the tires can come from cornering at to high a speed. If a truck rolls over for this reason, the crash is called an “untripped” rollover. Or, the lateral forces on the tire can come from striking a curb or another fixed object. Rollovers that result from striking a fixed object or uneven ground are said to be “tripped.” The arrows in Figure 1-1 illustrate the force pulling on the center of gravity and the tire forces. The propensity of a vehicle to roll over depends on the height of its center of gravity, its track width (the left-to-right distance between the tires), and the lateral force on the tractor, which ordinarily comes from cornering. In its simplest form, the rollover threshold is the ratio of the half track width to the height of the center of gravity. The actual threshold is lower than this theoretical maximum because of a number of other factors, many of which are related to the suspension. Notably, when the trailer begins to lean, the tires on the lower side compress, allowing the trailer to lean even more. This process is revisited in Section 5.1 of this report. The roll stability of heavy vehicles is discussed quite thoroughly in Chapters 2, 3, and 4 of Winkler et al. [2000].

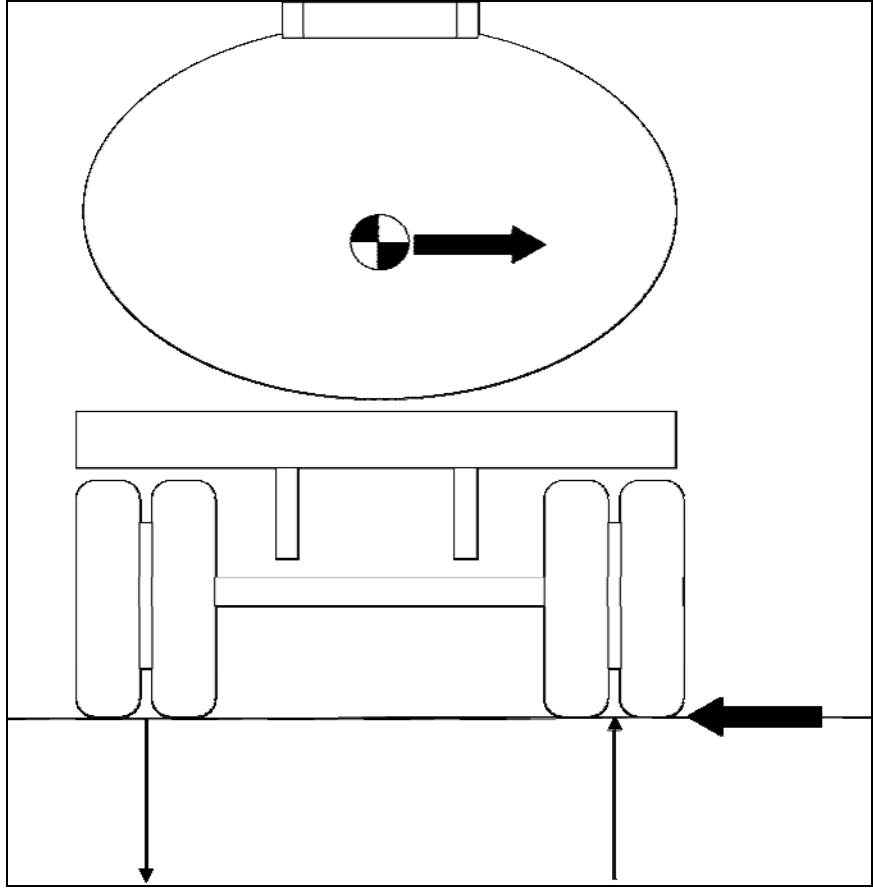

Figure 1 - 1 Roll Plane Forces Acting on a Tank Trailer

This Page Intentionally Left Blank

2.0 Crash Statistics

2.1 Introduction

By identifying the conditions and circumstances most commonly present when a heavy vehicle rolls over, crash statistics provide guidance on what kinds of treatments are likely to be beneficial. The statistics in this section form part of the basis of the benefit-cost analysis in Section 7.

This section contains tables with the most prominent findings and accompanying discussion. The appendices have many more tables, with more numerical details.

2.1.1 Databases

Four crash databases were searched for this analysis:

- Motor Carrier Management Information System (MCMIS),
- Large Truck Crash Causation Study (LTCCS),
- Trucks Involved in Fatal Accidents (TIFA) and the
- General Estimates System (GES).

The MCMIS data analyzed consist of data that were sampled, enhanced, and analyzed for the second phase of FMCSA's Hazardous Materials Serious Crash Analysis (HMSCA) project [Battelle, 2005]. The MCMIS data referenced in this report represent a further analysis of the data from that study.

The national traffic safety databases all contain descriptive data primarily collected from police accident reports. FMCSA's MCMIS includes a limited amount of descriptive data on all trucks and buses involved in serious accidents and are submitted to FMCSA by the States. The LTCCS was a two-year study involving field investigations promptly after crashes occurred. It supplements the ongoing safety databases but includes more emphasis on pre-crash factors. NHTSA's Fatality Analysis Reporting System (FARS), which was not used directly in this study, includes descriptive data on vehicles, drivers, roadways, and environmental conditions. The TIFA database from UMTRI supplements FARS data with additional data from interviews with involved parties. The National Highway Traffic Safety Administration (NHTSA) GES is a nationally representative sample of all police-reported fatal, injury, and property-damage-only crashes.

Summary information about how the four databases were queried for this project is provided in Table 2-1. The number of records of data describing individual crashes available in each of the databases is provided in the second column. These are important numbers to consider when contemplating the uncertainty associated with percentages calculated based on these data. Two sets of data from LTCCS were analyzed in this study. The first set consisted of all rollovers of all cargo body type trucks; the second, of tank cargo body type only. The analysis of all cargo

body type rollover factors was performed because the number of tank cargo body type rollovers was so small (89).

Table 2 - 1 Summary Information on Four Crash Databases

| Database | Number of Records | Time Period | Database Crash Type | Subsetting for this Analysis |
|-------------------------|--|---------------|--------------------------------|---|
| MCMIS | 1,261 | 2002 | Serious Crashes | The serious incident study [Battelle, 2005] was limited to crashes with hazardous materials. Data reported below are further limited to cargo tank crashes. Rollovers are reported separately in most tables. |
| LTCCS: All | 1,241 Trucks in 1,070 Crashes | 2001- 2002 | Fatality or Injury | (Rollovers are reported separately in most tables.) |
| LTCCS: Cargo Tank | 89 | | | Cargo Tank body type (rollovers are reported separately in most tables.) |
| TIFA | 1,837 | 1999- 2003 | Fatal Crashes | Cargo tanks (vans are reported in some tables; rollovers are reported separately in most tables.) |
| GES | 197 | 2000- 2004 | Police- Reported Crashes | Cargo tanks that rolled over. (Tables show percentages for all cargo tank rollovers, whether hazmat or not. Hazmats are discussed specifically following Table 2-8.) |

A motor vehicle rollover can be “tripped” or “untripped.” In a tripped rollover, a fixed object helped start the roll by imparting a roll moment to the vehicle. The vehicle may have struck a curb or rolled down an embankment. An untripped rollover occurs when a vehicle rolls over on reasonably smooth pavement without striking an object. The reason for untripped rollovers is often, but not always, taking a curve too fast. The focus of this project is all cargo tank rollovers, both tripped or untripped. The goal is to reduce the number of rollovers that occur for any reason. Some countermeasures, notably those that automatically apply the brakes as a truck enters a curve too fast, are expected to have a greater influence on the untripped variety. Approximately 10 to 15 percent of cargo tank rollovers are untripped (Tables 2-8, A-8, and A-9).

2.1.1.1 MCMIS Database: The Hazardous Materials Serious Crash Analysis Database

This database uses 2002 data from the MCMIS that was sampled, enhanced and analyzed for the second phase of FMCSA’s Hazardous Materials Serious Crash Analysis, project [Battelle, 2005]. (All MCMIS data analyzed for this report were first sorted for that project. All references to MCMIS data in this report pertain to data that were queried and weighted for that project, according to the process described below.) MCMIS includes only serious crashes, defined as those that result in: a fatality, an injury requiring transport to a facility for immediate medical attention, or at least one vehicle towed from the scene as a result of vehicle-disabling crash damages.

- Of the approximately 105,000 serious crashes reported in MCMIS for 2002, identified approximately 2,100 MCMIS crash records involving hazardous materials and initially sampled 1,000 crashes for analysis and supplemental data collection to add to a HAZMAT Accident Database.
- Added an additional 260 crashes to the sample to compensate for the non-HM crashes discovered among the 1,000 originally selected. This brought the number of HM vehicles to be analyzed back up to nearly 1,000 cases. For the 1,260 selected crashes, the fields unique to the HAZMAT Accidents Database were populated for all the vehicles that were carrying hazmat. Data were entered for 966 hazmat crashes that involved 970 hazmat vehicles. Since some of these vehicles carried multiple types of hazardous material, over 1,000 hazardous material records were associated with these 970 vehicles.
- Identified approximately 100 crashes that were also reported to the Hazardous Materials Information System (HMIS) database maintained by the Pipeline and Hazardous Materials Safety Administration (PHMSA) and electronically transferred the data into the HAZMAT Accidents Database.
- Validated and supplemented the data for the 966 crashes by using information on Police Accident Reports and by corresponding with the involved carriers using telephone calls, faxes, and e-mails.

Bias was introduced to the sample by intentional oversampling, and it was removed by weighting factors. The most frequent hazardous material crashes involved Classes 2, 3, 8, and 9. While the goal was to develop more detail for 1,000 crashes, there was also a desire to obtain as much information as possible for crashes involving shipments of the less-commonly shipped materials in Classes 1, 4, 5, 6, and 7. Therefore, all the crashes in 2002 associated with these rarer classes were included in the sample. The decision was also made to include all crashes for which complementary records could be identified in the HMIS database. The distribution of crashes by hazard class will over-represent the rare classes and under-represent the more-commonly shipped classes. To remove this bias, weighting factors were used for each class of hazardous material based on the initial assignment of classes from the MCMIS crash file. The weighting factors that were developed are shown in Table 2-2.

To estimate the number of serious crashes involving cargo tanks for this report, the HAZMAT Accident Database was queried to identify all crashes involving cargo tanks. These crashes were then weighted using the factors shown in Table 2-2. This resulted in an estimate of 1,261 annual serious cargo tank crashes. Of these crashes, 291 or about 23 percent resulted in rollovers.

Table 2 - 2 Weighting Factors Used to Remove the Sampling Bias from the MCMIS Analysis

| HM Class | Vehicle Weighting Factors |
|----------|---------------------------|
| 1 | 1.021 |
| 2 | 1.773 |
| 2.1 | 1.813 |
| 2.2 | 2.000 |
| 2.3 | 1.000 |
| 3 | 1.771 |
| 4 | 1.000 |
| 5 | 1.000 |
| 6 | 1.000 |
| 7 | 1.000 |
| 8 | 2.175 |
| 9 | 1.738 |
| Unknown | 1.776 |
| HMIS | 1.039 |

For this analysis, the Battelle team examined a number of factors related to rollover in order to identify insights into the causes of crashes where a rollover occurs. The tank truck categories carrying hazmat examined in the analysis include straight trucks and semitrailers.

2.1.1.2 Large Truck Crash Causation Study (LTCCS) Database

The FMCSA and NHTSA established a team to study a set of large truck crashes immediately after they occurred. The LTCCS identifies factors that contributed to truck crashes. Large amounts of data were collected by a special team from post-crash field inspections of crash vehicles and interviews with drivers. Data were also developed from interviews with key participants and investigations by police. The LTCCS collected data on crashes that occurred within 24 pre-defined areas in 17 States.

A representative sample of large-truck crashes was investigated during 2001 to 2003. Each crash involved at least one fatality or injury. The sample included 967 crashes, which included 1,127 large trucks and 959 non-truck motor vehicles. For this Rollover Project, the team used an early draft database because the final database was not available for general research use in May 2006. The draft includes 1,241 large trucks (All Trucks) and of these, 89 are cargo tank vehicles (Cargo Tank Only).

2.1.1.3 TIFA

The TIFA crash data file is produced by the Center for National Truck and Bus Statistics at UMTRI. The TIFA file is a survey of all medium and heavy trucks (gross vehicle weight rating, or GVWR > 10,000 lbs) involved in a fatal crash in the United States. Candidate truck cases are extracted from the NHTSA FARS file, which is a census of all traffic accidents involving a fatality in the United States. To collect data for the TIFA survey, police accident reports are acquired for each crash, and UMTRI researchers contact drivers, owners, operators, and other knowledgeable parties about each truck. The TIFA survey collects a detailed description of each truck involved, as well as data on the truck operator and a variable on the truck's role in the crash. Survey data include the physical configuration of the truck, such as the GVWR, weights and lengths of each unit, cargo body style, type of cargo (including hazardous materials), and cargo spillage. Motor carrier data include carrier type (private or for-hire) and area of operation (interstate or intrastate). The analysis file constructed from this data includes all variables from the FARS file, which captures the crash environment and all other vehicles and persons involved in the crash.

The TIFA survey project has operated continuously since 1980. The most recent year completed is 2003. TIFA is a sample file (approximately a 60 percent sample) for the years 1987-1992 and 1994-1998. For all other years, the file provides a census of trucks involved in a fatal crash. This analysis uses five years of TIFA data from 1999-2003. For this period there are records for 25,704 trucks of all configurations in the file. These data were filtered to include all trucks that had a tank cargo body and one of following configurations: (1) straight truck with no trailer (referred to as "straight truck" in this analysis), or (2) tractor-semitrailer. There were 1,837 (Cargo Tanks) trucks that met these criteria.

For comparison, a different filter was also applied to find trucks with a cargo van body and with the same two configurations described above. This yielded 10,396 straight or tractor-semitrailers with a van cargo body (Van).

The data from the TIFA database are presented alongside the tables from the other databases in the main text and in Appendix A. Appendix B contains additional data from TIFA, and Appendix C presents a model based on the TIFA data.

2.1.1.4 GES

The National Automotive Sampling System (NASS) General Estimates System (GES) obtains its data from a nationally representative probability sample of police-reported crashes. Police accident reports include crashes resulting in fatalities, injuries, or major property damage, but may exclude some crashes in which no significant personal injury and only minor property damage occurred. Neighbor [2001] contains a detailed description of the GES data, including sampling design, relevant variable information, and database acquisition.

The two other national databases, MCMIS and TIFA, are intended to be a census, that is, they include every appropriate crash that occurred. GES, on the other hand, is a sample, with a small but representative number of crashes included. Because GES is a sample and not a census, a

more sophisticated statistical analysis is required to estimate the numbers of crashes. Specifically GES is a clustered, multi-stage probability sample, so both sample weights and sample design must be considered to construct population estimates and understand the uncertainty associated with these estimates. SUDAAN [RTI, 2001] was used to construct the estimates and associated confidence limits. SUDAAN is commercially available software for the statistical analysis of sample survey data from stratified, multi-stage cluster samples. It uses a Taylor series linearization approximation to account for the inherent clustering or relationships present in data collected through a complex survey. For functions of linear statistics including means, proportions, etc. that can be estimated from the sample, variances of sample estimate are derived by creating a linearized variable that is defined by the Taylor series expansion of the function (typically only first-order terms are used), and then this variable is substituted into the appropriate variance formula for the specified design. Variance estimates for nonlinear statistics are estimated using first-order Taylor series approximations of the deviations of estimates from their expected values.

GES data from the years 1999 to 2004 were initially considered for this analysis. Prior to 1999 GES used different coding schemes for many of the variables that describe the circumstances of the crash. GES often updates the data for the most recent year; therefore, the 2004 data may not be complete and final [USDOT, 2004]. The data selected for this analysis include all large (> 10,000 lbs GVW) tank trucks involved in crashes in which the truck rolls over. Table 2-3 shows the criteria used to select the data from GES. Each column indicates a GES variable used to select the rollover crashes for analysis; the entries in the table reflect the levels selected into the data set.

Table 2 - 3 Selection Criteria to Identify Cargo Tanker Rollover Crashes in GES

| Body Type | Cargo Body Type | Rollover |
|---|-----------------|---|
| Step Van Single Unit Straight Truck Truck-Tractor Unknown Medium/Heavy Truck | Cargo Tank | 10 – Untripped Rollover 20 – Tripped rollover – by curb 21 – Tripped rollover – by guardrail 22 – Tripped rollover – by ditch 23 – Tripped rollover – by soft soil 28 – Tripped rollover – other 29 – Tripped rollover – unknown 99 – Rollover, unknown whether untripped or tripped |

Table 2-4 illustrates the percentage and number of rollover crashes by body type and year, along with associated confidence intervals for the percentages and standard errors for the number. These summary statistics indicate a steady decline in the number of rollover crashes per year from 2000 to 2004. Discerning the reason for the decline is beyond the scope of this study, but it is attributable in part to the replacement of older vehicles with newer, more stable vehicles. Electronic stability aids are gaining market share, but there are not yet enough of them in service to affect national crash statistics. The table also shows that the 1999 data are different from the data for 2000-2004 in terms of the distribution of rollover crashes across body types. In 1999, an inordinately large percentage of the rollover crashes were among truck tractor vehicles.

Table 2 - 4 Percent and Number of Rollover Crashes by Body Type and Year

| Year | Body Type | Number of Records | Percent | 95% Confidence Interval | Estimated Number of Rollovers | Standard Error (Number) |
|------|----------------------------|-------------------|---------|-------------------------|-------------------------------|-------------------------|
| 1999 | Single-unit Straight Truck | 6 | 7.59 | (2.77,19.15) | 129.34 | 70.56 |
| 2000 | | 10 | 45.60 | (16.90, 77.55) | 880.62 | 517.03 |
| 2001 | | 14 | 33.66 | (22.31, 47.27) | 428.84 | 148.33 |
| 2002 | | 12 | 32.54 | (20.07, 48.09) | 429.87 | 185.97 |
| 2003 | | 12 | 47.14 | (17.96, 78.41) | 543.58 | 269.57 |
| 2004 | | 12 | 37.38 | (14.91, 67.04) | 241.2 | 134.23 |
| 1999 | Truck Tractor | 34 | 85.60 | (71.72, 93.30) | 1458.18 | 366.75 |
| 2000 | | 36 | 54.40 | (22.45, 83.10) | 1050.63 | 336.93 |
| 2001 | | 28 | 66.34 | (52.73, 77.69) | 845.12 | 391.73 |
| 2002 | | 26 | 67.46 | (51.91, 79.93) | 891.26 | 294.01 |
| 2003 | | 25 | 52.86 | (21.59, 82.04) | 609.55 | 258.53 |
| 2004 | | 20 | 56.45 | (29.73, 79.88) | 364.26 | 115.15 |
| 1999 | Unknown Medium Heavy Truck | 5 | 6.81 | (2.22, 19.00) | 115.93 | 56.16 |
| 2000 | | 0 | 0 | | 0 | 0 |
| 2001 | | 0 | 0 | | 0 | 0 |
| 2002 | | 0 | 0 | | 0 | 0 |
| 2003 | | 0 | 0 | | 0 | 0 |
| 2004 | | 2 | 6.18 | (1.16, 27.01) | 39.85 | 31.41 |
| 1999 | Total | 45 | 100 | | 1703.45 | 385.52 |
| 2000 | | 46 | 100 | | 1931.25 | 575.47 |
| 2001 | | 42 | 100 | | 1273.96 | 517.07 |
| 2002 | | 38 | 100 | | 1321.13 | 440.07 |
| 2003 | | 37 | 100 | | 1153.13 | 342.46 |
| 2004 | | 34 | 100 | | 645.31 | 184.14 |

Note that only years 2000-2004 were used in later analysis in this report.

In the interest of determining whether the rollover crash data can be pooled across years, a further look into the GES data by year was performed using the accident type variable. Based on these analyses, the years 2000-2004 can be pooled for analysis. Subsequent investigation into the circumstances surrounding rollovers will be made on the basis of the pooled 2000-2004 data.

2.1.2 Presentation

Results from the four databases are presented somewhat differently. For MCMIS, number of records in the database by condition factor is presented as well as the percentage of the rollover crashes where that condition occurred. The percentage of rollovers with a particular condition is not the number of rollovers with that condition divided by the total number of rollovers, because as the sample weights discussed in Table 2-2 must be considered in the analysis. The total

number of records in a category does, however, provide some insight into the variability associated with the results presented in this report. For the LTCCS and TIFA, numbers of records in the databases corresponding to each level of each factor are also presented. For this study, sample weights were not used for either of these studies, and thus, percentages are proportional to number of records alone; TIFA is a census of fatal truck crashes, so sample weights are not necessary for this database.

The tables for the GES analyses do not include the numbers of records assigned to each level of a factor. Instead, 95 percent confidence intervals are constructed for each percentage estimate. These confidence intervals account for uncertainty from both the sample design used to select the police accident reports included in the database and the number of rollover crashes observed from 2000 to 2004.

2.1.3 Approach

The purpose of this statistical analysis is to answer the question, “What conditions cause the most cargo tank rollovers?” That is a different question than “What conditions are most likely to lead to a rollover?” The focus of this report is to address what circumstances need to be ameliorated to reduce the greatest number of future rollovers. Some of those events, such as driving on straight road on a sunny day, may actually be quite safe, leading to a rollover only on exceedingly rare occasions. But if these events occur frequently, they will contribute to a significant number of rollovers, and methods should be explored to make them yet safer. Other conditions may be more dangerous in that they are relatively more likely to lead to a rollover when they occur. However, if these conditions occur much less frequently, they contribute to only a small number of rollovers. Although the number of rollovers reduced might be relatively small, if these conditions may be easily addressed by cost-effective measures, the return on an investment in preventive measures might be worthwhile. Mathematically, the question being answered in this report is, “Given that there was a rollover, what is the probability that a certain set of circumstances was present?”

There are four areas for potential interventions to reduce the incidence of rollover—redesign of cargo tank vehicles, redesign of highways, vehicle control technology, and driver training. Accordingly, the databases used for this analysis were searched for associations between vehicle, environmental, and driver factors and rollover. Vehicle control technologies are gaining a presence in the market, but they have not been in use long enough that their presence is detectable in national crash databases. Their benefits will be assessed by noting the crash factors they are expected to address. The following is an outline of the data presented in the report, noting the databases that provided the information. Statistics on the percentage of rollover crashes associated with each level of a factor are presented, organized by topic. Where available, data from each of the four databases used for the analysis are included. Subsections 2-2 through 2-5 of Section 2 in the main report are organized according to this structure, as is Appendix A.

Crosscutting Factors:

- Primary Reason or Critical Event (MCMIS, LTCCS, GES)
- Pre-crash Event or Maneuver (TIFA, LTCCS, GES)

Vehicle Factors:

- Body type (MCMIS, TIFA, GES)
- Hazardous material involvement (TIFA)
- Load (MCMIS, TIFA, LTCCS)
- Mechanical problems (LTCCS, GES)
- Cargo Tank Specification (MCMIS)

Roadway and Environment Factors:

- Road type (MCMIS, LTCCS, TIFA, GES)
- Population area (MCMIS, TIFA)
- Roadway surface condition (LTCCS, TIFA, GES)
- Roadway curvature (TIFA, GES)
- Location relative to interchange (MCMIS, GES)

Driver Factors

- Driver age (MCMIS, TIFA, GES)
- Speed (LTCCS, GES)
- Driver errors or distractions (TIFA, GES)

2.2 Crosscutting Factors

Crosscutting factors are those that include more than one category of vehicle, environment, and driver. The analysis of the associations between cross-cutting factors and rollover focused on the primary reason or critical event for the rollover and the pre-crash maneuver of the truck. An additional variable, accident type, was considered, and tables on this variable are provided in Appendix A.

2.2.1 Primary Reason or Critical Event

The primary reason for the rollover is that event that is thought to have the greatest influence on the crash occurring. Three of the four databases (MCMIS, LTCCS, and GES) provide the primary reason. Tables 2-5, 2-6, and 2-7 provide the primary reason category relative frequency for MCMIS, LTCCS, and GES, respectively. The primary reasons of interest were ones that correspond to one of the four areas for potential interventions.

Table 2 - 5 Rollover Crash Primary Reason Category Relative Frequency (MCMIS)

| Primary Reasons | Single Vehicle | | Multiple Vehicles | |
|----------------------------|-----------------|--------------------------|-------------------|--------------------------|
| | Total Rollovers | Percent of All Rollovers | Total Rollovers | Percent of All Rollovers |
| Driver Decision Error | 92 | 41.6% | 7 | 16.3% |
| Driver Non-Performance | 17 | 7.7% | 0 | 0.0% |
| Driver Performance Error | 23 | 10.2% | 0 | 0.0% |
| Driver Recognition Error | 58 | 26.3% | 4 | 9.3% |
| Total Driver Errors | 189 | 85.8% | 11 | 25.6% |
| Vehicle Related | 9 | 3.9% | | 0.0% |
| Highway Related | 8 | 3.7% | 0 | 0.0% |
| Weather Related | 0 | 0.0% | 1 | 2.3% |
| Other Vehicle Induced | 12 | 5.3% | 31 | 72.1% |
| Unknown | 3 | 1.3% | 0 | 0.0% |
| Total | 220 | 100% | 43 | 100% |

Table 2 - 6 Rollover Crash Primary Reason Category Relative Frequency (LTCCS)

| Primary Reason Category | All Trucks | | Cargo Tanks Only | |
|--|------------|--------------------------|------------------|--------------------------|
| | Rollover | Percent of All Rollovers | Rollover | Percent of All Rollovers |
| No Driver, Vehicle or Environmental Factor | 38 | 15.1% | 5 | 17.9% |
| Driver Physical Factor | 29 | 11.5% | 3 | 10.7% |
| Driver Decision Factor | 92 | 36.5% | 14 | 50.0% |
| Driver Performance Factor | 29 | 11.5% | 2 | 7.1% |
| Driver Recognition Factor | 30 | 11.9% | 1 | 3.6% |
| Total Driver Factors | 180 | 71.4% | 20 | 71.4% |
| Environment – Highway | 2 | 0.8% | 0 | 0.0% |
| Environment – Weather | 0 | 0.0% | 0 | 0.0% |
| Unknown Reason | 2 | 0.8% | 1 | 3.6% |
| Vehicle Related Factor | 30 | 11.9% | 2 | 7.1% |
| Overall | 252 | 100.0% | 28 | 100.0% |

Table 2 - 7 Rollover Crash Primary Reason Category Relative Frequency (GES)

| Category | Percent of All Rollovers | |
|-----------------------------------|--------------------------|-------------------------|
| | Estimate | 95% Confidence Interval |
| Blow Out or Flat Tire | 1.05% | (0.3, 3.8) |
| Disabling Vehicle Failure | 0.07% | (0.0, 0.6) |
| Non-disabling Vehicle Failure | 0.05% | (0.0, 0.4) |
| Other Vehicle Stopped | 4.54% | (1.9, 10.6) |
| Total Vehicle | 5.71% | (2.5, 12.4) |
| Poor Road Conditions | 0.94% | (0.4, 2.5) |
| Total Road | 0.94% | (0.4, 2.5) |
| Traveling too Fast for Conditions | 28.4% | (16.1, 45.1) |
| Other Cause of Control Loss | 4.44% | (2.3, 8.4) |
| Unknown Cause of Control Loss | 0.53% | (0.1, 2.0) |
| Over Lane Line Left | 3.79% | (1.4, 9.9) |
| Over Lane Line Right | 0.67% | (0.1, 3.2) |
| Off Edge Road Left | 12.04% | (6.1, 22.3) |
| Off Edge Road Right | 23.75% | (16.6, 32.8) |
| Total Driver | 73.62% | (58.9, 84.4) |
| Turning Left @ Intersection | 0.61% | (0.1, 2.6) |
| Turning Right at Intersection | 0.07% | (0.0, 0.6) |
| Crossing Intersection | 3.73% | (1.6, 8.4) |
| Encroaching Vehicle Left | 13.36% | (6.4, 25.8) |
| Animal in Roadway | 1.02% | (0.2, 5.1) |
| Other Critical Event/No Collision | 0.93% | (0.3, 2.8) |
| Total Other | 19.73% | (10.9, 33.1) |

In all three databases, driver errors influence a large portion of rollovers. In all, 85.8 percent of the single vehicle rollovers and 25.6 percent of the multiple vehicle rollovers in MCMIS, 71.4 percent of the rollovers in LTCCS, and 74.1 percent of the rollovers in GES had driver error as the primary reason. Vehicle related primary reasons account for 3.9 percent of the single vehicle rollovers and none of the multiple vehicle rollovers in MCMIS, 11.9 percent of the truck rollovers and 7.1 percent of the cargo tank rollovers in LTCCS, and 5.71 percent of the rollovers in GES. Roadway and environment related primary reasons account for 3.9 percent of the single vehicle rollovers and 2.3 percent of the multiple vehicle rollovers in MCMIS, 0.8 percent of the truck rollovers and none of the cargo tank rollovers in LTCCS, and 0.9 percent of the rollovers in GES.

Table 2-8 illustrates the number of cargo tank rollover crashes by crash type and preceding conflict. Records were selected according to the criteria presented in Table 2-3 to produce the numbers in the column “All Rollovers.” The “Untripped Rollover” column in Table 2-8

enumerates the crashes where the GES Rollover variable had a value of 10, as shown in Table 2-3. The “Accident Type” variable in GES is separate from the “Rollover” variable. The “Crash Type” in Table 2-8 was determined from the “Accident Type” variable in GES. Crashes in GES where the rollover variable was set to “untripped rollover” but without a Crash Type designation are identified in Table 2-8 as an “Untripped Rollover” crash type. The “Driving Conflict” was determined from a combination of the Critical Event and Movement Prior to Critical Event variables in GES. Thus, the procedure to determine the frequencies included the following five steps:

1. Subset to relevant data (the criteria listed in Table 2-3)
2. Parse data by crash type (i.e., the first column in Table 2-8)
3. Identify the predominant critical events that led to the truck’s involvement in the crash for the crash type of interest
4. Identify the movements prior to those critical events
5. Use the combination of the critical events and the movements prior to define the driving conflicts.

The annual average number of all cargo tank rollovers is 1,265, as indicated in Table 2-8. According to the GES database, only 640 of those were specifically recorded as carrying a hazardous material, with the presence of a hazardous material unknown in 75 rollovers. If the 75 unknown cases are allocated in proportion to the known cases, the total annual number of hazmat cargo tank rollovers is 680. (Note that this represents all vehicle configurations. See Table 2-14 below.) For benefits estimates, though, we will apply an equal proportion (53.8 percent) to all crash counts where we want to deal with hazardous cargo in a cargo tank. (Table 2-20, from TIFA, shows a 50/50 split of HM and not for tank rolls, so the databases are consistent.)

“Driving Conflicts” are the unsafe events that occur prior to a crash and lead to the crash. They are recorded in the GES database. Crash avoidance strategies aim to prevent these conflicts from occurring or to keep the conflicts from resulting in a crash. Some crash avoidance approaches are intended to address certain conflicts, so is important to know what fraction of the rollovers result from the various conflicts. In particular, note that conflicts 1.1 and 1.4 for single-vehicle roadway departures are parallel to 4.1 and 4.4 for untripped rollovers. There are similarities between the untripped rollovers and rollovers accompanying roadway departures (and, as well, roadway departures without a rollover, which are not shown in the table).

Roadway departures accompany more than half of all cargo tank rollovers. Separate studies have addressed roadway departures more thoroughly. Drowsiness, inattention, and speed are commonly implicated [Pape, et al., 1999]. Section 3.4.1 briefly reviews in-vehicle countermeasures for roadway departure crashes. Infrastructure-based countermeasures (i.e. roadside rumble strips) have been used as well.

Table 2 - 8 Average Annual Number of Cargo Tank Rollovers, by Crash Type and Preceding Conflict (GES)

| Crash Type: Rollover and. . . | Driving Conflict | All Rollovers | Untripped Rollovers |
|--|--|--------------------------|--------------------------------|
| Single Vehicle Roadway Departure (SVRD) | 1.1 Truck is traveling at constant speed and travels over the edge of the road | 138 | 16 |
| | 1.2 Truck is turning or negotiating a curve and travels over the edge of the road | 195 | 17 |
| | 1.3 Truck is traveling at constant, excessive speed and loses control | 23 | |
| | 1.4 Truck is turning or negotiating a curve at excessive speed and loses control. | 185 | 72 |
| | 1.5 Truck loses control due to vehicle related failure | 41 | |
| | 1.9 Other | 129 | 8 |
| | Subtotal | 712 | 113 |
| Rear-Ends | 2.4 Truck encounters a stopped vehicle in lane. | 11 | |
| | 2.9 Other | 1 | |
| | Subtotal | 12 | |
| Lane Change and Merge | 3.2 Both vehicles are traveling in the same direction and the other vehicle encroaches into the truck's lane while truck is traveling at constant speed. | 4 | |
| | 3.4 Truck is traveling at a constant speed and another vehicle encroaches into its lane from a yield. | 1 | |
| | 3.9 Other | 1 | |
| | Subtotal | 5 | |
| Untripped Rollovers | 4.1 Truck is traveling at constant speed and travels over the edge of the road | 5 | 5 |
| | 4.4 Truck is turning or negotiating a curve at excessive speed and loses control. | 55 | 55 |
| | 4.9 Other | 5 | 5 |
| | Subtotal | 65 | 65 |
| Other | 5.9 Other | 471 | |
| | Subtotal | 471 | |
| Total | | 1,265 | 178 |

2.2.2 Pre-crash Maneuver

The pre-crash maneuver for the rollover is the final normal action prior to the crash sequence. Tables 2-9, 2-10, and 2-11 provide the relative frequencies of pre-crash maneuvers from LTCCS, TIFA, and GES, respectively. A large number of rollovers occurred either after straight travel or after the truck negotiated a curve. The tables show the following fractions of vehicles were traveling straight prior to the rollover:

- 41.7 percent of all trucks (35.7 percent of the cargo tanks) in LTCCS,
- 59.5 percent of the straight tank trucks (53.6 percent of the tractor-semitrailer tanks) in TIFA,
- 41.5 percent of all trucks in GES,

and the following fractions were negotiating a curve prior to the rollover:

- 40.1 percent of all trucks (57.1 percent of the cargo tanks) in LTCCS,
- 27.9 percent of the straight tank trucks (36.1 percent of the tractor-semitrailer tanks) in TIFA,
- 31.8 percent of the rollovers in GES.

GES indicates that an additional 22.2 percent (11.7 + 10.5) of rollovers are preceded by turning left or right; this percentage is estimated to be much smaller (4.4 percent) based on LTCCS.

The layout of the highway is related to the maneuver in that it determines whether the vehicle should be going straight or curving. Section 2.4.4 will have tables showing that roughly equal numbers of rollovers occur on straight and on curved sections of road.

Table 2 - 9 Rollover Crash Pre-crash Maneuver Category Relative Frequency (LTCCS)

| PreEvent Movement | All Trucks | | Cargo Tanks Only | |
|--|------------|--------------------------|------------------|--------------------------|
| | Rollover | Percent of All Rollovers | Rollover | Percent of All Rollovers |
| Going Straight | 105 | 41.7% | 10 | 35.7% |
| Negotiating a curve | 101 | 40.1% | 16 | 57.1% |
| Successful avoidance maneuver to a previous critical event | 13 | 5.2% | 2 | 7.1% |
| Turning right | 7 | 2.8% | | |
| Decelerating in traffic lane | 6 | 2.4% | | |
| Changing lanes | 5 | 2.0% | | |
| Passing or overtaking another vehicle | 4 | 1.6% | | |
| Turning left | 4 | 1.6% | | |
| Accelerating in traffic lane | 2 | 0.8% | | |
| Merging | 2 | 0.8% | | |
| No driver present | 1 | 0.4% | | |
| Other (specify) | 1 | 0.4% | | |
| Starting in traffic lane | 1 | 0.4% | | |
| Backing up (other than for parking position) | | 0% | | |
| Disabled or parked in travel lane | | 0% | | |
| Making a U-turn | | 0% | | |
| Stopped in traffic lane | | 0% | | |
| Unknown | | 0% | | |
| Overall | 252 | 100.0% | 28 | 100.0% |

Table 2 - 10 Rollover Crash Pre-crash Maneuver Category Relative Frequency (TIFA)

| Pre-crash Maneuver | Straight Truck Tanks | | Tractor-semitrailer Tanks | |
|--------------------|----------------------|--------------------------|---------------------------|--------------------------|
| | Roll | Percent of All Rollovers | Roll | Percent of All Rollovers |
| Going Straight | 66 | 59.5% | 199 | 53.6% |
| Negotiate Curve | 31 | 27.9% | 134 | 36.1% |
| Other | 14 | 12.6% | 38 | 10.2% |
| Total | 111 | 100.0% | 371 | 100.0% |

**Table 2 - 11 Rollover Crash Pre-crash Maneuver Category
Relative Frequency (GES)**

| Category | Percent of All Rollovers | |
|---------------------------------------|--------------------------|-------------------------|
| | Estimate | 95% Confidence Interval |
| Going Straight | 41.46% | (28.0, 56.3) |
| Decelerating in traffic lane | 1.86% | (0.5, 7.3) |
| Passing or overtaking another vehicle | 1.48% | (0.3, 6.1) |
| Turning right | 11.69% | (4.7, 26.3) |
| Turning left | 10.46% | (4.5, 22.6) |
| Negotiating a curve | 31.77% | (18.6, 48.6) |
| Changing lane | 0.9% | (0.2, 5.2) |
| Merging | 0.07% | (0.0, 0.6) |
| Other | 0.31% | (0.0, 2.2) |

2.3 Vehicle Factors

The analysis of the associations between vehicle factors and rollover focused on body type, cargo tank type, whether the truck was carrying hazardous material, the load the truck was carrying, and any mechanical problems that existed during the time of the rollover.

2.3.1 Vehicle Configuration and Body Type

Tables 2-12, 2-13, and 2-14 provide the body type of the truck which rolls over for MCMIS, TIFA, and GES, respectively. There were more semitrailer rollovers than straight truck rollovers. In all, 59.8 percent of the rollovers in MCMIS and 79.9 percent of the van rollovers and 77.0 percent of the tank rollovers in TIFA occurred among semitrailers. Conversely, 36.1 percent of the rollovers in MCMIS and 20.1 percent of the van rollovers and 23.0 percent of the tank rollovers in TIFA occurred among straight trucks. In GES, most of the straight truck rollovers occurred among trucks with no trailing units and most of the semitrailer rollovers occurred among trucks with one trailing unit. This is not surprising as these are the normal configurations for these body types.

The tables in Appendix D, from the Vehicle Inventory and Use Survey (VIUS), are the best available estimate of the number of miles driven by various kinds of tanks, which is their exposure to possible rollovers. The definitions of vehicles differ from those in the crash databases, so direct comparison is not possible.

**Table 2 - 12 Rollover Crash Configuration Category
Relative Frequency (MCMIS)**

| Vehicle Configuration | Total Rollovers | Percent of All Rollovers |
|-----------------------------|-----------------|--------------------------|
| Tractor/Semitrailer | 174 | 59.8% |
| Tractor, Two Trailers | 7 | 2.4% |
| Straight Truck, No Trailer | 90 | 30.9% |
| Straight Truck, One Trailer | 15 | 5.2% |
| Other / Unknown | 5 | 1.7% |
| Overall | 291 | 100.0% |

**Table 2 - 13 Rollover Crash Body Type and Configuration Category
Relative Frequency (TIFA)**

| Configuration | Total Rollovers | Percent of All Rollovers |
|----------------|-----------------|--------------------------|
| Van | | |
| Straight Truck | 215 | 20.1% |
| Tractor-Semi | 856 | 79.9% |
| Total | 1,071 | 100.0% |
| Tank | | |
| Straight Truck | 111 | 23.0% |
| Tractor-Semi | 371 | 77.0% |
| Total | 482 | 100.0% |

Table 2 - 14 Rollover Crash Configuration Relative Frequency (GES)

| Configuration | Number of Trailing Units | Percent of All Rollovers | |
|----------------------------|--------------------------|--------------------------|-------------------------|
| | | Estimate | 95% Confidence Interval |
| Single-Unit Straight Truck | None | 39.76% | (25.36, 56.18) |
| | 1 | 0.15% | (0.02, 1.15) |
| | 2 | 0% | -- |
| Truck Tractor | None | 0% | -- |
| | 1 | 55.58% | (43.32, 67.2) |
| | 2 | 3.88% | (0.81, 16.6) |
| Medium Heavy Truck | None | 0.16% | (0.02, 1.27) |
| | 1 | 0.47% | (0.06, 3.61) |
| | 2 | 0% | -- |

2.3.2 Cargo Tank Type and Specification

Table 2-15 provides the relative frequency of the cargo tank specification for MCMIS. The DOT-series tanks are the more modern tanks. The lion's share of rollovers of specification tanks occur in fuel (306 and 406) vehicles.

**Table 2 - 15 Rollover Crash Cargo Tank Specification Category
Relative Frequency (MCMIS)**

| DOT Specification Number | Total Rollovers | Total Crashes | Percent Rollover Crashes | Percent of All Rollovers |
|--------------------------|-----------------|---------------|--------------------------|--------------------------|
| MC306 | 61 | 283 | 21.5% | 53.0% |
| DOT406 | 23 | 130 | 17.3% | 20.0% |
| MC307 | 24 | 47 | 51.0% | 20.9% |
| DOT407 | 7 | 30 | 23.5% | 6.1% |
| Total | 115 | 490 | 23.4% | 100.0% |

Table 2-16 shows the population of tank trucks involved in fatal accidents. The proportion of straight trucks that are dry bulk is much lower than in VIUS. (This is likely a difference in classification, as mentioned above, with a large number of feed bodies and similar configurations called dry bulk tankers. TIFA defines a dry bulk tank as pneumatically discharged, and bodies that unload using an auger as classified as "other.") Note that in VIUS, tractor combinations have a higher proportion of dry bulk than the crash population. In the VIUS, 26 percent of tractor-semitrailer and double tankers are dry bulk, and dry bulk accounts for 25 percent of the travel of tractor combination tankers. But in the crash population, only 18.4 percent are dry bulk. Although the uncertainty in these estimates has not been assessed to determine if the observed differences are real (and there are coding differences between VIUS and TIFA) this implies that dry bulk trailers have a lower probability of crash involvement.

Table 2 - 16 Tank Type, All Crashes Whether Roll or Not (TIFA)

| Tank Type | TS & Double | | Straights | | Total | |
|------------|-------------|-------|-----------|-------|--------|-------|
| | Number | % | Number | % | Number | % |
| Dry bulk | 281 | 18.4 | 9 | 2.2 | 290 | 15.0 |
| Liquid/gas | 1,247 | 81.6 | 398 | 97.8 | 1,645 | 85.0 |
| Total | 1,528 | 100.0 | 407 | 100.0 | 1,935 | 100.0 |

Table 2-17 shows the additional split between gas and liquid tankers that can be determined in TIFA, but only for tanks with loads. If gas and liquid tanks are expected to have similar crash probabilities, then the split between gas and liquid tankers here could be applied to the population estimates from VIUS. (This assumes that loading increases crash probability for a gas tanker about as much as it does for a liquid tanker, or that loading does not bias the distribution of tank type.) Note that the sum of liquid and gas percentages in Table 2-17 (86.1 percent) is about the same as the 85 percent from Table 2-16.

Table 2 - 17 Tank Type of Tanks with Loads, All Crashes, Whether Roll or Not (TIFA)

| Tank Type | TS & Double | | Straights | | Total | |
|-----------|-------------|-------|-----------|-------|--------|-------|
| | Number | % | Number | % | Number | % |
| Dry bulk | 178 | 17.8 | 5 | 1.6 | 183 | 13.9 |
| Gas | 63 | 6.3 | 47 | 15.0 | 110 | 8.4 |
| Liquid | 757 | 75.9 | 262 | 83.4 | 1,019 | 77.7 |
| Total | 998 | 100.0 | 314 | 100.0 | 1,312 | 100.0 |

Table 2-18 adds some additional detail, showing rollovers by three different types of tank, as identified in TIFA. All the tanks were carrying some cargo, since tanks for gases cannot be distinguished from tanks with liquids except by looking at the type of load. That is, tank cargo bodies are either liquid/gas or dry bulk, while cargoes distinguish gases in bulk, solids in bulk, and liquids in bulk. About 27 percent of loaded dry bulk tanks rolled over when involved in a fatal crash, compared with 39.1 percent of loaded gas tankers and 37.6 percent of loaded liquid tankers. It looks like dry bulk tanks roll over at a lower rate, compared with liquid and gas tanks. This analysis does not include all factors, however. Dry bulk tank design may result in lower centers of gravity, possibly less slosh, etc. However, both straight trucks and tractor-semi/ tractor-double are represented here, and there are very few straight dry bulk tanks. One would expect none, but in fact there are four in the five years of data.

Table 2 - 18 Rollover by Tank Type, Loaded Only (TIFA)

| Tank Type | No Roll | | Roll | | Total | |
|-----------|---------|------|--------|------|--------|-------|
| | Number | % | Number | % | Number | % |
| Gases | 67 | 60.9 | 43 | 39.1 | 110 | 100.0 |
| Solids | 134 | 73.2 | 49 | 26.8 | 183 | 100.0 |
| Liquids | 636 | 62.4 | 383 | 37.6 | 1,019 | 100.0 |
| Total | 837 | 63.8 | 475 | 36.2 | 1,312 | 100.0 |

Table 2-19 shows a similar distribution for all load conditions. That is, all tanks, regardless of whether the tank had a load at the time of the fatal crash, are included. Again, dry bulk tanks tend to roll over at a lower rate than liquid and gas tanks.

Table 2 - 19 Rollover by Tank Type, Empty or Loaded, (TIFA)

| Tank Type | No Roll | | Roll | | Total | |
|------------|---------|------|--------|------|--------|-------|
| | Number | % | Number | % | Number | % |
| Dry Bulk | 233 | 80.3 | 57 | 19.7 | 290 | 100.0 |
| Liquid/Gas | 1,189 | 72.3 | 456 | 27.7 | 1,645 | 100.0 |
| Total | 1,422 | 73.5 | 513 | 26.5 | 1,935 | 100.0 |

2.3.3 Presence of Hazardous Materials

Table 2-20 provides the relative frequency of Hazardous Material (HM) presence for van and tanker rollovers for TIFA. Most (97.9 percent) of the van rollovers occurred among vans which were not carrying HM. About half of the tanker rollovers occurred among tankers which were carrying HM cargo. These statistics are representative of the relative frequency with which tankers carry HM as compared to vans.

Table 2 - 20 Rollover Crash Hazmat Category Relative Frequency (TIFA)

| Hazmat Cargo | Total Rollovers | Percent of All Rollovers |
|--------------|-----------------|--------------------------|
| Van | | |
| Hazmat | 22 | 2.1% |
| No Hazmat | 1,049 | 97.9% |
| Total | 1,071 | 100.0% |
| Tank | | |
| Hazmat | 244 | 50.6% |
| No Hazmat | 238 | 49.4% |
| Total | 482 | 100.0% |

2.3.4 Quantity of Loading

Tables 2-21, 2-22, and 2-23 provide the load category of the truck at the time of the rollover for MCMIS, LTCCS, and TIFA, respectively. Trucks were classified as empty if they had cargo from 0 to 20 percent capacity. Trucks were classified as partial if they had cargo from 20 to 75 percent capacity. Trucks were classified as full if they had cargo greater than 75 percent capacity. As expected, the majority of the rollovers occurred among trucks that had partial to full loads. In all, 94.1 percent of the rollovers in MCMIS, more than 71.3 percent of the rollovers in TIFA, and 77.1 percent of the cargo tank rollovers in LTCCS occurred among trucks with at least partial loads. Note that the TIFA load variable was constructed based on gross weight accounted for by the cargo. Specifically, gross cargo weight was constructed as the ratio of cargo weight to gross weight and used to assign the rollover to a load level.

**Table 2 - 21 Rollover Crash Load Category
Relative Frequency (MCMIS)**

| Loading | Total Rollovers | Percent of All Rollovers |
|----------------|------------------------|---------------------------------|
| Empty | 1 | 2.0% |
| Partial | 10 | 19.6% |
| Full | 38 | 74.5% |
| Unknown | 2 | 3.9% |
| Overall | 51 | 100.0% |

**Table 2 - 22 Rollover Crash Load Category Relative Frequency
(LTCCS – Cargo Tanks Only)**

| Loading | Rollover | Percent of All Rollovers |
|----------------|-----------------|---------------------------------|
| Empty | 0 | 0.0% |
| Partial | 7 | 20.0% |
| Full | 20 | 57.1% |
| Partial & Full | 27 | 77.1% |
| Overall | 35 | 100.0% |

**Table 2 - 23 Rollover Crash Load Category
Relative Frequency (TIFA)**

| Cargo Percent of GCW | Total Rollovers | Percent of All Rollovers |
|-----------------------------|------------------------|---------------------------------|
| 0 to 10% | 32 | 8.1% |
| 11 to 50% | 81 | 20.6% |
| > 50% | 281 | 71.3% |
| Total | 394 | 100.0% |

2.3.5 Mechanical Defect

Tables 2-24, 2-25, and 2-26 provide the brake condition for LTCCS, the tire condition for LTCCS, and the mechanical condition for GES of the truck at the time of the rollover, respectively. While 53.6 percent of the cargo tank rollovers in LTCCS had brake defects and 3.6 percent of the cargo tank rollovers in LTCCS had tire defects in LTCCS, it is unknown how many of these defects really affected the rollover. Among the rollovers in GES, tire defects were implicated in only 2.5 percent and brake defects in 1.2 percent. GES lacks data on the detailed brake inspections found in LTCCS. Consequently, it is difficult to compare the results in the two databases. One can assume many GES crashes likely included trucks with brake defects that were never detected.

Tables 2-24 through 2-26, along with 2-5 through 2-7 and A-3 through A-5, implicate a vehicle-related failure as the primary cause of less than 10 percent of cargo tank rollovers. It is interesting to note that the Large Truck Crash Causation Study found that 32 percent of cargo tank vehicles in the crashes studied and 54 percent of vehicles in rollovers had a brake defect of some sort (Table A-30). This is consistent with studies by the Commercial Vehicle Safety Alliance (CVSA), which have found that 20 percent of randomly stopped heavy vehicles had a brake defect severe enough to put the vehicle out of service [Keppler, 2004]. The present study focused on the benefits of improvements to be made in ideal situations, and it did not examine the effect of defects in the vehicle. However, it is worth mentioning that, if brakes are defective, neither the driver nor an electronic stability aid can properly slow a vehicle to prevent an imminent rollover.

Table 2 - 24 Rollover Crash Brake Condition Category Relative Frequency (LTCCS – Cargo Tanks Only)

| Brake Condition | Rollover | Percent of All Rollovers |
|--|-----------------|---------------------------------|
| No Brake Defect | 13 | 46.4% |
| Brake System Deficiency | 2 | 7.1% |
| Brakes Inoperative | 1 | 3.6% |
| Brakes Out of Adjustment | 8 | 28.6% |
| Brakes Out of Adjustment and Brake System Deficiency | 4 | 14.3% |
| Brakes Out of Adjustment and Brakes Inoperative | | 0% |
| Brake Defect | 15 | 53.6% |
| Overall | 28 | 100.0% |

Table 2 - 25 Rollover Crash Tire Condition Category Relative Frequency (LTCCS – Cargo Tanks Only)

| Tire Condition | Rollover | Percent of All Rollovers |
|--|-----------------|---------------------------------|
| No Tire Defects | 27 | 96.43% |
| Tire Deficiency Present | 1 | 3.57% |
| Tire Failure Present | | 0% |
| Tire Failure and Tire Deficiency Present | | 0% |
| Any Tire Defect | 1 | 3.57% |
| Overall | 28 | 100.00% |

**Table 2 - 26 Rollover Crash Mechanical Problem Category
Relative Frequency (GES)**

| Category | Percent of All Rollovers | |
|----------|--------------------------|-------------------------|
| | Estimate | 95% Confidence Interval |
| None | 84.33% | (77.4, 89.4) |
| Tire | 2.51% | (0.9, 7.0) |
| Brakes | 1.21% | (0.3, 4.4) |
| Other | 3.85% | (1.3, 10.5) |
| Unknown | 8.1% | (5.4, 11.9) |

2.4 Roadway and Environment Factors

The analysis of the associations between roadway and environmental factors and rollover focused on road type, population area, roadway surface condition, roadway curvature, and location relative to interchange. Miscellaneous roadway and environmental factors such as light condition, roadway profile, access control, and control device were also available; tables on these factors are presented in Appendix A.

2.4.1 Road Type

Tables 2-27, 2-28, 2-29, and 2-30 provide the road type where the truck was traveling prior to the rollover for MCMIS, LTCCS, TIFA, and GES, respectively. A large percentage of rollovers occurred on non-interstate roads. Only 15.5 percent of the truck rollovers in MCMIS occurred on an interstate. Less than half (46.4 percent) of the cargo tank rollovers in LTCCS occurred on interstate highways, and only 17.0 percent of the truck rollovers in TIFA occurred on the interstate.

GES did not break down the road types in the same manner as the other databases. However, only 21.9 percent of truck rollovers occurred on divided highway, the most similar GES category; 66.2 percent of rollovers were estimated to occur on undivided roads.

Table 2 - 27 Rollover Crash Road Type Category Relative Frequency (MCMIS)

| Highway Type | Total Rollovers | Percent of All Rollovers |
|--------------|-----------------|--------------------------|
| Interstate | 45 | 15.5% |
| Primary | 144 | 49.5% |
| Secondary | 100 | 34.4% |
| Unknown | 3 | 1.0% |
| Overall | 291 | 100.0% |

In the project from which these statistics were drawn [Battelle 2005], the highway types were defined as

Interstate: roads designated as interstates or built to interstate standards

Primary: State and U.S. highways not built to interstate standards

Secondary: all other highways and roads including county roads, city streets, township roads

Table 2 - 28 Rollover Crash Road Type Category Relative Frequency (LTCCS – Cargo Tank Only)

| Road Category "Signage" | Rollover | Percent of All Rollovers |
|-------------------------|----------|--------------------------|
| Interstate | 13 | 46.4% |
| U.S. Highway | 7 | 25.0% |
| State Highway | 4 | 14.3% |
| Other | 4 | 14.3% |
| Overall | 28 | 100.0% |

Table 2 - 29 Rollover Crash Road Type Category Relative Frequency (TIFA)

| Route Signing | Total Rollovers | Percent of All Rollovers |
|---------------|-----------------|--------------------------|
| Interstate | 82 | 17.0% |
| US Highway | 120 | 24.9% |
| State Highway | 173 | 35.9% |
| County Road | 62 | 12.9% |
| Township | 5 | 1.0% |
| Municipality | 8 | 1.7% |
| Frontage Rd | 3 | 0.6% |
| Other | 23 | 4.8% |
| Unknown | 6 | 1.2% |
| Total | 482 | 100.0% |

Table 2 - 30 Rollover Crash Road Type Category

| Category | Percent of All Rollovers | |
|-------------|--------------------------|-------------------------|
| | Estimate | 95% Confidence Interval |
| Not Divided | 66.24% | (52.4, 77.7) |
| Divided | 21.87% | (15.3, 30.3) |
| One Way | 6.57% | (2.6, 15.4) |
| Unknown | 5.32% | (1.1, 21.8) |

2.4.2 Population Area

Tables 2-31 and 2-32 provide the population area where the rollover occurred for MCMIS and TIFA, respectively. A large number of rollovers occurred in rural areas. A total of 53.6 percent of the truck rollovers in MCMIS and 83.0 percent of the truck rollovers in TIFA occurred in rural areas.

**Table 2 - 31 Rollover Crash Population Area Category
Relative Frequency (MCMIS)**

| Populated Area | Total Rollovers | Percent of All Rollovers |
|----------------|-----------------|--------------------------|
| Urban | 18 | 6.9% |
| City | 47 | 18.0% |
| Town | 56 | 21.5% |
| Rural | 140 | 53.6% |
| Overall | 261 | 100.0% |

**Table 2 - 32 Rollover Crash Population Area Category
Relative Frequency (TIFA)**

| Area | Total Rollovers | Percent of All Rollovers |
|---------|-----------------|--------------------------|
| Urban | 72 | 14.9% |
| Rural | 400 | 83.0% |
| Unknown | 10 | 2.1% |
| Total | 482 | 100.0% |

2.4.3 Roadway Surface Condition

Tables 2-33, 2-34, and 2-35 provide the surface condition of the road where the truck was traveling prior to the rollover for LTCCS, TIFA, and GES, respectively. A large majority of rollovers occurred when there were no adverse weather conditions. Conceivably, driver vigilance improves when the surface is slippery. Overall, 92.9 percent of the cargo tank rollovers in LTCCS, 86.7 percent of the tank truck rollovers in TIFA, and 82.7 percent of the tank truck rollovers in GES occurred on dry roads.

Table 2 - 33 Rollover Crash Roadway Surface Condition Category Relative Frequency (LTCCS – Cargo Tank Only)

| Road Condition | Rollover | Percent of All Rollovers |
|----------------|----------|--------------------------|
| Dry | 26 | 92.9% |
| Wet | 2 | 7.1% |
| Ice | 0 | 0.0% |
| Overall | 28 | 100.0% |

Table 2 - 34 Rollover Crash Roadway Surface Condition Category Relative Frequency (TIFA)

| Surface Condition | Total Rollovers | Percent of All Rollovers |
|-------------------|-----------------|--------------------------|
| Dry | 418 | 86.7% |
| Wet | 52 | 10.8% |
| Snow or Slush | 6 | 1.2% |
| Ice | 3 | 0.6% |
| Sand Dirt Oil | 1 | 0.2% |
| Other | 0 | 0.0% |
| Unknown | 2 | 0.4% |
| Total | 482 | 100.0% |

Table 2 - 35 Rollover Crash Roadway Surface Condition Category Relative Frequency (GES)

| Category | Percent of All Rollovers | |
|-----------------------------------|--------------------------|-------------------------|
| | Estimate | 95% Confidence Interval |
| No Adverse Atmospheric Conditions | 82.67% | (71.7, 90.0) |
| Rain | 8.38% | (3.0, 21.1) |
| Snow | 7.31% | (2.1, 22.2) |
| Fog | 1.65% | (0.2, 12.3) |

2.4.4 Roadway Curvature

Tables 2-36 and 2-37 provide the (horizontal) curvature of the road where the truck was traveling prior to the rollover for TIFA and GES, respectively. About half of the rollovers occurred among trucks traveling curves. In all, 43.8 percent of the tank truck rollovers in TIFA and 40.9 percent of the tank truck rollovers in GES occurred among trucks traveling curves. Since significantly less than half of the driving mileage is negotiating a curve, the likelihood of a rollover is higher in a curve than a straight (tangent) section. The likelihood is increased sufficiently that similar numbers of rollovers are observed during straight driving and curve negotiation.

**Table 2 - 36 Rollover Crash Roadway Curvature Category
Relative Frequency (TIFA)**

| Alignment | Total Rollovers | Percent of All Rollovers |
|-----------|-----------------|--------------------------|
| Straight | 270 | 56.0% |
| Curve | 211 | 43.8% |
| Unknown | 1 | 0.2% |
| Total | 482 | 100.0% |

**Table 2 - 37 Rollover Crash Roadway Curvature Category
Relative Frequency (GES)**

| Category | Percent of All Rollovers | |
|----------|--------------------------|-------------------------|
| | Estimate | 95% Confidence Interval |
| Straight | 59.07% | (43.4, 73.1) |
| Curve | 40.93% | (26.9, 56.6) |

2.4.5 Location Relative to Interchange

Tables 2-38 and 2-39 provide the location relative to interchange for the truck prior to the rollover for MCMIS and GES, respectively. According to MCMIS, most rollovers (53.2 percent = 19.0 + 34.2) occur not at an interchange or intersection; on undivided highways a large percentage of rollovers occur close to an intersection. Again, according to MCMIS, 7.2 percent of rollovers occur on ramps. GES data estimates that a similar percentage (6.3 percent) of rollovers occur at ramps.

**Table 2 - 38 Rollover Crash Location Relative to Interchange Category
Relative Frequency (MCMIS)**

| Location of Accident | Total Rollovers | Percent of All Rollovers |
|-------------------------|-----------------|--------------------------|
| Close to Interchange | 11 | 4.6% |
| Not at Interchange | 45 | 19.0% |
| On or Off Ramp | 17 | 7.2% |
| Total Divided Highway | 74 | 31.2% |
| Close to Intersection | 82 | 34.6% |
| Not at Intersection | 81 | 34.2% |
| Not on Roadway | 0 | 0% |
| Railroad Grade Crossing | 0 | 0% |
| Total Undivided Highway | 163 | 68.8% |
| Total | 237 | 100.0% |

**Table 2 - 39 Rollover Crash Location Relative to Interchange Category
Relative Frequency (GES)**

| Category | Percent of All Rollovers | |
|-----------------------|--------------------------|-------------------------|
| | Estimate | 95% Confidence Interval |
| Non-interchange | 92.45% | (83.9, 96.6) |
| Interchange | 1.27% | (0.3, 4.5) |
| Entrance or Exit Ramp | 6.28% | (3.0, 12.8) |

2.5 Driver Factors

The analysis of the associations between driver factors and rollover focused on age of the driver, the speed that a driver was traveling when the rollover occurred, and driver errors and distractions right before the rollover. Miscellaneous driver factors such as training and years of experience were also available, and tables on these variables are available in Appendix A.

2.5.1 Age

Table 2-40 provides the driver age at the time of the rollover for MCMIS, TIFA, and GES. The majority of the rollovers occurred among drivers who were 25 to 55. As will be shown in Table 7-2, drivers under the age of 35 do have rollovers in slightly greater proportion than their representation in the professional driver population.

Table 2 - 40 Rollover Crash Age Category Relative Frequency

| Driver Age (years) | MCMIS | TIFA | GES | |
|--------------------|--------|--------|----------|-------------------------|
| | | | Estimate | 95% Confidence Interval |
| <25 | 4.8% | 4.8% | 7.74% | (2.4, 22.4) |
| 25 – 35 | 23.0% | 75.9% | 23.97% | (16.6, 33.3) |
| 35 – 45 | 33.0% | | 32.29% | (14.4, 57.5) |
| 45 – 55 | 20.6% | | 24.83% | (15.4, 37.6) |
| 55 – 65 | 15.5% | 19.3% | 9.18% | (5.6, 14.8) |
| >65 | 2.7% | | 1.98% | (0.7, 5.3) |
| Total | 100.0% | 100.0% | 100.0% | |

2.5.2 Speed

Tables 2-41 and 2-42 indicate if traveling too fast or speeding was a factor contributing to the rollover for LTCCS and GES, respectively. The majority of the rollovers occurred when the trucks were not speeding. Though more than half (52.0 percent of the LTCCS rollovers and 59.7 percent of the GES rollovers) occurred among trucks that were not speeding prior to the rollover, a substantial number were traveling too fast or speeding.

Table 2 - 41 Rollover Crash Speed Category Relative Frequency (LTCCS)

| Speeding | All Trucks | | Cargo Tanks Only | |
|----------------------------------|------------|-------------------------|------------------|--------------------------|
| | Rollover | Percent of All Rollover | Rollover | Percent of All Rollovers |
| Did not realize caution required | 41 | 19.0% | 4 | 16.0% |
| Keeping up with traffic | 3 | 1.4% | 0 | 0% |
| Other reason | 63 | 29.2% | 6 | 24.0% |
| Unknown | 9 | 4.2% | 2 | 8.0% |
| No traveling-too-fast factors | 100 | 46.3% | 13 | 52.0% |
| Overall | 216 | 100.0% | 25 | 100.0% |

Table 2 - 42 Rollover Crash Speed Category Relative Frequency (GES)

| Category | Percent of All Rollovers | |
|--------------|--------------------------|-------------------------|
| | Estimate | 95% Confidence Interval |
| Not Speeding | 59.67% | (42.6, 74.7) |
| Speeding | 38.34% | (23.3, 56.0) |
| No Driver | 1.99% | (0.6, 6.3) |

2.5.3 Driver Errors and Distractions

Tables 2-43 and 2-44 provide the fraction of crashes due to driver errors and distractions from TIFA and GES, respectively. The number of rollovers where the driver was impaired or distracted is greater than the number where vision was obscured. Thus, reducing driver errors due to distractions has more potential to reduce the overall number of rollovers than decreasing the incidence of vision being obscured.

**Table 2 - 43 Rollover Crash Driver Errors and Distractions Category
Relative Frequency (TIFA)**

| Driver Factor | Straight Tank Trucks | | Tractor-Semitrailers | |
|--|----------------------|--------------------------|----------------------|--------------------------|
| | Roll | Percent of All Rollovers | Roll | Percent of All Rollovers |
| None | 26 | 23.4% | 87 | 23.5% |
| Physical or Mental Condition | | | | |
| Inattentive | 13 | 11.7% | 39 | 10.5% |
| Drowsy, Asleep | 3 | 2.7% | 31 | 8.4% |
| Other Physical | 1 | 0.9% | 8 | 2.2% |
| Miscellaneous Driver Errors | | | | |
| Run Off Road | 60 | 54.1% | 203 | 54.7% |
| Driving too Fast | 25 | 22.5% | 102 | 27.5% |
| Erratic/Reckless | 8 | 7.2% | 29 | 7.8% |
| Over Correcting | 17 | 15.3% | 26 | 7.0% |
| Failure to Yield or Obey | 9 | 8.1% | 14 | 3.8% |
| Other Driver Error | 7 | 6.3% | 14 | 3.8% |
| Other | | | | |
| Avoiding, Swerving or Sliding | 11 | 9.9% | 15 | 4.0% |
| Misc. Non-Driver Causes | 2 | 1.8% | 9 | 2.4% |
| Miscellaneous Violations | 4 | 3.6% | 7 | 1.9% |
| Possible Distractions (Inside the Vehicle) | 2 | 1.8% | 7 | 1.9% |
| Vision Obscured | 2 | 1.8% | 5 | 1.4% |
| Total | | | | |
| Total | 111 | | 371 | |

(Note that a driver may have been coded with more than one condition, so the numbers add to more than 100 percent.)

**Table 2 - 44 Rollover Crash Driver Errors and Distractions Category
Relative Frequency (GES) Physical Impairment**

| Category | Percent of All Rollovers | |
|---------------------------------------|--------------------------|-------------------------|
| | Estimate | 95% Confidence Interval |
| None | 83.53% | (78.0, 87.9) |
| Drowsy, Sleepy, Fell Asleep, Fatigued | 6.63% | (4.0, 10.9) |
| Ill, Blackout | 2.50% | (0.7, 8.2) |
| Other Physical Impairment | 0.31% | (0.0, 2.2) |
| Unknown If Physically Impaired | 7.02% | (2.7, 17.1) |

Distracted

| Category | Percent of All Rollovers | |
|-------------------------------|--------------------------|-------------------------|
| | Estimate | 95% Confidence Interval |
| None | 43.94% | (24.9, 64.9) |
| Inattentive | 13.9% | (5.6, 30.4) |
| Sleepy | 6.68% | (4.0, 11.0) |
| Adjusting Music/Other Devices | 1.72% | (0.3, 9.4) |
| Other Person/Object | 1.66% | (0.3, 9.7) |
| Other | 0.19% | (0.0, 0.8) |
| Unknown | 31.91% | (16.3, 52.9) |

Vision Obscured

| Category | Percent of All Rollovers | |
|----------|--------------------------|-------------------------|
| | Estimate | 95% Confidence Interval |
| No | 74.59% | (60.6, 84.9) |
| Yes | 6.35% | (1.5, 23.5) |
| Unknown | 19.06% | (9.8, 33.7) |

2.6 Conclusions Concerning Crash Statistics

The tables in this section and in Appendix A confirmed some suspicions as to the factors present when rollovers occur, but the numbers dispelled some myths, too. One ordinarily thinks of rollovers occurring because a truck took a curve too fast. For untripped rollovers of tank vehicles, taking a curve too fast does indeed account for a large majority (Table 2-8). However, when all cargo tank rollovers, tripped and untripped, are considered, there are many other factors. Certainly, speed is a factor in many rollovers, but there are roughly an equal number of rollovers where speeding was not a factor (Tables 2-41, 2-42, A-75, A-76, A-79, and A-80).

A significant number of rollovers occur at or near the interchange on divided highways, but they are by no means the bulk of the rollover problem. In fact, two-thirds of cargo tank rollovers occur on undivided highway, and fewer than 10 percent occur on freeway entrance or exit ramps (Tables 2-38, 2-39, and A-45).

The primary reason for a majority of rollovers is driver error (74 percent in Tables 2-6 and 2-7). The various databases categorize driver errors in different ways, but decision errors are the most common errors, followed by roughly equal numbers of performance and recognition errors.

Most rollovers occur in single-vehicle crashes (Tables A-12 and A-14). The cause for the rollover is different if the rollover was the first event in the crash or if it followed an earlier event. If the rollover is listed as the first event, which occurs about 10 percent of the time, it is necessary to look at the pre-crash condition to determine the precursors to the rollover event. Again, in the majority of these cases, the pre-crash event is a decision error on the part of the truck driver in a single vehicle accident (Tables 2-5, A-1 and A-2). Since in more than 90 percent of the accidents, rollover is not the first event, then there was some other dangerous event that occurred before rollover. In the case of an accident involving another vehicle, the first event is normally collision with a motor vehicle in transit. For single vehicle accidents, the most common first event is the truck running off the road (Table A-13.)

The data confirmed the expectation that cargo tanks are more likely than van trucks to roll in a crash. The rollover rate for all vehicles is about 20 percent compared to about 32 percent for cargo tanks (Table A-16, see also Table A-20). Liquids in bulk have the highest rollover rate of about 47 percent while gases in bulk, (only one case) combined with solids in bulk, have a rollover rate of 40 percent (Table A-18).

If they are in a crash, straight trucks and combination trucks both roll at about the same rate (Table A-15). A truck-tractor pulling one trailer accounts for about 60 percent of all rollovers, while straight trucks account for only about 30 percent of rollovers (Tables A-15 and A-17).

The benefit-cost analysis in Section 7 will draw on the numbers that have been presented in this section to quantify the number of crashes that can be avoided by the various rollover mitigation approaches. The absolute number of crashes (from Table 2-8), the portion following the action of driving too fast in a turn (also from Table 2-8), the fraction that are combination trucks

(Tables 2-12 and 2-14), and the relative portions of drivers of various ages (Table 2-40) all figure directly in the benefit-cost analysis.

3.0 Driver Training

The statistics in Section 2 showed that a driver error of one form or another figured in about three quarters of cargo tank rollovers. Therefore this section answers the question: “What can be done to reduce accidents through the influencing of human performance?”

Tank truck operators must perform all the tasks that other combination vehicle drivers perform. The additional tasks for tanker operators are more matters of degree than discrete new tasks.

3.1 Introduction

This section will examine several possible interventions to improve the performance of tank truck vehicle operators: training, truck operator monitoring technologies, and carrier operations. The training discussion will be two-fold: the current state of tank truck vehicle operator training by both schools and carriers will be reviewed, based on a survey of managers at tank truck carriers as part of this project. A second survey of truck driving schools and carriers, which was performed for an earlier FMCSA project, provides additional data for this study. Some instructional technologies that could lead to better trained (and presumably safer) drivers will also be examined.

The truck operator monitoring technologies discussion will be a brief overview of various options available to the industry. Finally, carrier operations will be reviewed, to see what effect company policies, procedures, scheduling protocols, and dispatcher performance have on driver performance.

3.2 Task Analysis

The Commercial Vehicle Safety Act of 1986 called for the Secretary of Transportation to establish minimum Federal standards for the states to use in testing and ensuring the fitness of persons who operate commercial motor vehicles. The standards were to include both knowledge tests and driving tests, and required that the driving tests take place in a vehicle that was representative of the type of vehicle the driver operates or will operate. If appropriate, different minimum testing standards were to apply to different classes of commercial motor vehicles. The rule subsequently issued by the FHWA (49 CFR Part 383), containing the minimum standards, stipulates specific knowledge, skills, and abilities which drivers of different types of commercial motor vehicles must possess [Brock et al., 2007]. The research and development efforts to produce those minimum standards produced the best documentation yet of the tasks and knowledge needed to operate commercial vehicles.

CDL knowledge tests were developed that reflected both the general knowledge required of all commercial drivers and the specialized knowledge required of operators of particular classes of vehicles or vehicles hauling particular kinds of cargo. The knowledge tests to be taken by a CDL applicant directly reflected the type of vehicle and he or she operated or proposed to operate. They included:

- A General Knowledge test of safe driving principles
- An Air Brakes test
- A Combination Vehicles test
- A Tanker test
- A Doubles/Triples test
- A Passenger Transport test
- A Hazardous Materials test.

In addition to the knowledge tests, there was also a requirement for the development of three driver skills tests that would determine whether the applicant:

- Had an adequate understanding of how to ascertain the condition of key operational and safety systems of the vehicle
- Had the fundamental psychomotor and perceptual skills necessary to control and maneuver heavy vehicles
- Was capable of safely driving the vehicle in a variety of road environments and traffic conditions.

These tests were designed to be adaptable to different vehicle sizes and configurations. Each met professional standards for reliability and validity, and each measured an important, yet relatively independent, area of driver skill. It is important to note that to receive a CDL endorsement to drive tankers, an applicant must pass the CDL knowledge test on tankers but may use any Class A vehicle for his or her skills tests. In other words, applicants do not have to demonstrate their ability to drive a tanker in order to receive a CDL with the tanker endorsement.

Vehicle operators are to inspect their vehicle before every trip as well as periodically while on the road. Additional inspection tasks for tank truck operators are:

- Inspect tank vehicle's markings, including product ID number, and lessee or owner's name.
- Refer to vehicle's manual to ensure that the particular characteristics of the vehicle are all inspected.
- Check tank's body or shell for dents or leaks.
- Check the intake, discharge, and cut-off valves to ensure that they are in correct positions for each vehicle operation.
- Check pipes, connections, and hoses for leaks, particularly around joints.
- Check manhole covers and vents.
- Ensure that covers have gaskets that close completely.
- Ensure that all vents are clear.
- Ensure that all special-purpose equipment is present and working correctly.
- Find out what emergency equipment is required on the vehicle and ensure that it is in place and in good working order.

In terms of driving, tank truck operators have tasks that are similar to those of any good driver, but the standards for performing those tasks are much higher:

- Adjust the vehicle speed to allow a “Speed Cushion” for maneuvering (at least 10 MPH below the posted speed limit is recommended) when approaching a curve.
- Slow down and downshift early. Don’t shift in the curve.
- Look at both the speed limit sign and the speedometer to ensure that the vehicle is below the posted speed.
- Slowly accelerate out of the curve.
- Maintain a “Space Cushion” (distance between your vehicle and other traffic) so there is a safe maneuvering distance despite misjudgment, weather, road conditions, and poor driving by other motorists.
- Select travel routes that are best suited to the type of vehicle and loads being driven in order to avoid adverse road conditions, such as sharp curves and steep grades that make rollovers more likely to occur.
- If a rollover appears imminent, attempt to straighten out the vehicle and bring it to a gradual stop, even if it means driving off the pavement.
- Drive smoothly.
- Maintain steady pressure on the brakes to minimize surge.
- Avoid oversteering, over-accelerating, and over-braking.

As noted, the tasks required to operate a tanker are the same as for the operation of any Class A vehicle. The major difference for tankers is the proficiency with which the operator must perform those tasks.

3.3 Training Gap Analysis

Staplin, et al. [2004], had the following to say about training to prevent rollover:

Techniques used to train beginning drivers in rollover prevention include classroom training, supplemented by video. One school teaches the “No Lean” policy: if you never go fast enough to cause your cab or yourself to lean, you have less chance to roll over. Another school respondent indicated that in the classroom, they talk about center of gravity, shifting and surging cargo, and speed on curves, and they practice this daily on the road. One school utilizes a high-fidelity simulator to train rollover prevention for standard tractor trailers. A truck carrier with no simulator indicated that a simulator would be a great tool, but hands-on with various loads on a test track works best to let the driver get a feel for the shifting of weight and truck response. This type of hands-on training is risky with an inexperienced driver, so it is imperative that the instructor be competent. This company reinforces the fact that warning sign advisory speed limits are designed for cars and that truck drivers must keep speeds well below postings in curves and on ramps (p. 25).

FMCSA has developed minimum training requirements (49 CFR 380) for operators of double and triple trucks, also known as longer combination vehicles (LCVs). LCV training will consist

of driving and non-driving activities, such as route planning and checking cargo and weight. Because LCV doubles and triples have different operating characteristics, FMCSA established different training courses for each vehicle group. The rule also establishes two types of LCV driver instructors, classroom instructors and skills instructors. Table 3-1 shows the specific content requirements for these special classes of vehicles. Although tanker vehicles do not fall into the specific classes of vehicles for which this curriculum was developed, tanker training practices can be compared to the LCV curriculum serving as a benchmark. With the exception of specific LCV topics (e.g., 1.1 in the table), these general topics apply to tank truck driver students as well.

Table 3 - 1 Course Topics for LCV Drivers

| | |
|-------------------------------------|-------------------------------------|
| Section 1: Orientation | 1.1 LCVs in Trucking |
| | 1.2 Regulatory Factors |
| | 1.3 Driver Qualifications |
| | 1.4 Vehicle Configuration Factors |
| Section 2: Basic Operation | 2.1 Coupling and Uncoupling |
| | 2.2 Basic Control and Handling |
| | 2.3 Basic Maneuvers |
| | 2.4 Turning, Steering and Tracking |
| | 2.5 Proficiency Development |
| Section 3: Safe Operating Practices | 3.1 Interacting with Traffic |
| | 3.2 Speed and Space Management |
| | 3.3 Night Operations |
| | 3.4 Extreme Driving Conditions |
| | 3.5 Security Issues |
| | 3.6 Proficiency Development |
| Section 4: Advanced Operations | 4.1 Hazard Perception |
| | 4.2 Hazardous Situations |
| | 4.3 Maintenance and Troubleshooting |
| Section 5: Non-Driving Activities | 5.1 Routes and Trip Planning |
| | 5.2 Cargo and Weight Considerations |

Rollover prevention is treated under Section 4.2 of the FMCSA minimum standards for LCV drivers as follows:

Unit 4.2-Hazardous situations. This unit must address dealing with specific procedures appropriate for LCV emergencies. These must include evasive steering, emergency braking, off-road recovery, brake failures, tire blowouts, rearward amplification, hydroplaning, skidding, jackknifing and the rollover phenomenon. The discussion must include a review of unsafe acts and the role they play in producing hazardous situations.

In the federal code applicable to hazardous material transportation, driver training is addressed twice:

- 49 CFR 172, Subpart H—Training, and
- 49 CFR 177.816 Driver training.

Although both sections address who is to be trained and what the training's content will be, it is left up to individual carriers to develop specific training programs. The rule in 49 CFR 172, Subpart H addresses all employees who have any connection to the transportation of hazardous materials. As a result, it has no prescriptive regulations unique to driver training generally or anti-rollover training specifically. It does, however, prescribe that persons handling hazardous materials, including drivers have function-specific training in safety. The text of 49 CFR 177.816 addresses the safety of the vehicle more directly. All drivers of hazardous materials must be trained in “vehicle characteristics including those that affect vehicle stability, such as effects of braking and curves, effects of speed on vehicle control, dangers associated with maneuvering through curves, . . . and high center of gravity.” In addition, it recognizes the special needs of cargo tank vehicles and requires that their operators be trained in handling the high center of gravity and the surge of a partial fluid load, including baffled and compartmented tanks. Rollover is not named explicitly in 177.816, but the high center of gravity is mentioned twice, strongly suggesting that anti-rollover training be included.

Staplin, et al. [2004] contains an in-depth description and discussion of current commercial driver training practices in Europe and the United States. That report reviews the work of Horn and Tardiff [1999], which found that private schools most commonly offer a 150-hour curriculum that includes classroom, range, and on-road training. They also found that nonprofit schools tended to offer a more extensive curriculum, with some countries providing 700 hours of training. In France, the curriculum can require up to two years to complete, depending on the entering student's experience and knowledge.

Kuncyte' et al. [2003], compared the training programs for HM drivers in Europe and North America. The authors selected Sweden and The Netherlands to represent Europe, and Canada and the United States to represent North America. The differences among the four countries reflect both various regulatory pressures and diverse cultures. They found: “In Canada and the US, it is the role of the employer to ensure appropriate truck-driver training for the transportation of dangerous goods. In Sweden and The Netherlands, a competent national authority must accredit training institutions or trainers and monitor the examination of truck drivers. However, all training system approaches pursue the same goal: to ensure appropriate training and prevent the accidental release of dangerous goods during transportation. . . . The involvement of national authorities is important for truck-driver training quality and control. Hence, without some standards, training does not always meet actual driver tasks and employer expectations [Kuncyte', et al, 2003, p. 1999].

**Table 3 - 2 Carrier Frequency of Use:
Training Methods (N=23)**

| | |
|-------------------------------|----|
| Lectures | 16 |
| Films/videos | 19 |
| Computer Based Training (CBT) | 4 |
| Web-based training | 2 |
| Textbooks | 6 |
| Restricted In-vehicle | 9 |
| Simulation | 2 |
| Demonstrations | 8 |
| On road driving | 19 |
| Other | 5 |

Battelle team developed a survey (see Appendix E) to determine how training is currently being conducted for new tank truck drivers. The survey specifically asked about training to prevent rollover. The surveys were distributed to all members of the National Tank Truck Carriers. The team received 23 completed surveys from managers or executives of carriers managing tank truck fleets. Only one of these carriers trains aspiring drivers before they have obtained their CDL. Table 3-2 shows the frequency of use of the various available training methods.

All respondents report that they provide specific training in rollover prevention. They all reported using video material in their rollover prevention training. A few companies have developed their own videotape training packages, but most purchase commercial off-the-shelf products that provide both graphic and visual demonstrations of good and bad driving effects on the risk of rollover as well as the consequences of rollover accidents. In addition to traditional training materials, the NTTC provides motivational posters and safety documents on the consequences of tanker rollovers. The three sources of materials most often identified were:

J. J. Keller, the NTTC, and Smith Systems. Other vendors named included the Institute of Driver Behavior, Coastal Training Technologies, Great West Casualty Company, and various other insurance companies. Several also reported receiving some training materials from customers and various state and province associations.

The challenge facing the tank truck industry is that they are trying to modify human performance by imparting information. It is possible to train superior driving habits with a combination of instruction and guided practice. Many of the videos combine motivational materials with visual and graphic presentations of the dynamics of rollovers.

The survey asked each respondent to rate the quality of the instruction from each of the methods. Table 3-3 shows those ratings. Some raters provided their opinions of various materials even when they do not use those materials themselves.

Table 3 - 3 Ratings of Driver Training Materials

| Method | Not Effective | Marginally Effective | Effective | Very Effective | Most Effective |
|-----------------------|---------------|----------------------|-----------|----------------|----------------|
| Lecture | | 1 | 7 | 7 | 1 |
| Films/video | | 3 | 6 | 4 | 3 |
| CBT | | 2 | 2 | | |
| Web Based | | 2 | 1 | | |
| Textbooks | 1 | 2 | 3 | 2 | 1 |
| Restricted In-vehicle | | 1 | 1 | 4 | 1 |
| Simulation | | 1 | 1 | 1 | |
| Demos | | | 1 | 9 | |
| On the Road | | | 1 | 8 | 4 |

Many of the carriers who responded to the survey have identified rollover prevention as more of a motivational issue than a skill acquisition issue. That is, fatigue, distraction, and poor general driving behaviors may have a greater effect on a driver's performance than lack of a particular skill. With one exception the carriers in the survey do not engage in the initial training of the student. Most carriers leave the basic driving behavior training to schools. However, the carriers *evaluate* the general driving skills of each incoming student driver.

The student driver is supposed to acquire skills under the supervision of an experienced driver in the truck cab. One in-truck method that attempts to provide more realistic training to prevent rollover is to affix an outrigger on a tank truck, which prevents the vehicle from completing a rollover when the student driver has exceeded the vehicle's limits. Several schools (but no carriers in the survey) provide areas which, when wetted, provide an area to experience skids. These skid pad and outrigger solutions are expensive and do not completely remove the risk of actual damage to the vehicle or injuries to the driver and instructor. Driver training instructors, therefore, must closely monitor the normal driving performance of the student driver to ensure that he or she is following sound driving practices.

The conclusion from the literature and the survey is that those carriers who responded to the survey and those carriers who are members of professional organizations are aggressively trying to train new tanker drivers to be safe. Included in this training are instruction and practice on avoiding rollovers. Unfortunately, there is no way to practice avoiding rollovers that doesn't include the risk of causing a rollover. This is a risk prudent carriers and drivers avoid. Therefore, the gap that exists between what is optimum for training the new tanker driver and the current training programs is caused by public safety concerns, common sense, and a lack of a safe and reliable technology for providing practice opportunities for modifying driver performance to reduce the risk of rollover crashes.

The gap between what needs to be taught and what is actually taught to reduce the risks of rollovers is relatively small with the tank truck carriers who responded to this survey. This is not surprising: no one gains from rollover accidents. However, there are two critical pieces missing in current practices in rollover prevention training: (1) the technology to allow student drivers to

see the consequences of poor driving without putting either the driver or the general public at risk and (2) a lack of objective measures that carriers can use to determine that a new driver is ready to drive a tank truck.

Rollover prevention training tends to lack instructional opportunities where incorrect driving performance can actually cause a rollover. Even when the training sessions include various tank configurations and loads (full, half full, empty), students and instructors are still limited in what can be accomplished on the road. Students are taught about safe loading practices, load distribution, and the effects that loads have on vehicle dynamics. Hours of service regulations, fatigue countermeasures, and distraction control can all be taught. But the actual driving skills required to avoid rollovers can only be estimated by both the student and the instructor.

3.4 Technologies for Monitoring Drivers

Technologies monitoring driver behavior and detect unsafe patterns fall into two broad categories. The first kind monitors for indications that the driver is fatigued at the moment and should take a break or a nap. The second kind examines patterns of risky behavior over weeks or months. They allow a fleet manager to identify drivers who might benefit from counseling or specialized training to avoid the risky behaviors. The two categories will be discussed separately.

Devices to Detect Fatigue, Inattention, or Drowsiness

The surveys conducted for this research consistently identified driver fatigue and inattention as major contributors to rollover accidents. Tables 2-43 and 2-44 cite inattention as a factor in 12 to 14 percent of cargo tank rollovers. By the time a driver realizes that the vehicle is going out of the lane and off the road, it is often too late to recover and, in fact, any attempt to do so may actually cause a rollover. Therefore, drowsiness or lane-departure warning systems (LDWSs) to alert a driver before the vehicle is at great risk of leaving the road or the intended path should help to reduce rollovers.

Extensive research has been conducted regarding in-vehicle fatigue countermeasure technologies for truckers, and in some cases products have been commercialized. Systems have been developed which monitor and measure eye closures. An Attention Technologies product based on this approach is now being evaluated by NHTSA. The product, dubbed "*Copilot*," is a small device that mounts on the dashboard with a rotating base for easy adjustment. It is powered through vehicle auxiliary power and faces the driver so it can detect eyelid closure patterns, which is a key indicator of drowsiness. Additionally, head movement monitoring has shown very good results, and the HeadTRAK system from Applied Safety Concepts is now being offered to commercial drivers and the general public. Companies in Japan have had success in monitoring driver inputs (steering, brakes, and throttle) to assess fatigue. Most of the research for this product has been completed and the focus is now on commercialization, such as driver-vehicle interface, packaging, and generating cost/benefit data that are compelling to fleet buyers. [Brock et al., 2004].

The most common warning systems are LDWSs. The FMCSA web site has a review of currently available LDWSs [USDOT, FMCSA, 2007]. They are typically forward-looking,

vision-based systems that “use algorithms to interpret video images to estimate vehicle state (lateral position, lateral velocity, heading, etc.) and roadway alignment (lane width, road curvature, etc.). These LDWSs use a forward-facing camera that is mounted to the windshield in the cab of the vehicle. The systems also include an electronic control unit and a warning indicator. Some LDWSs may issue directional warnings to alert the driver to which side of the lane the vehicle is drifting. A directional warning may be audible, such as rumble strip sounds in left or right in-cab speakers, or tactile. LDWSs may graphically indicate on a user interface display how well the vehicle is centered in the lane on a time-averaged basis.” Some LDWSs function as early indicators of fatigue or drowsiness and can alert a driver to get rest. If drivers heed these warnings, the devices can help reduce the number of rollovers that result from fatigue and drowsiness. The warnings of imminent lane departure will help to reduce the number of rollovers that result from single-vehicle road departures followed by impact with roadside furniture or tumbling down an embankment.

3.4.1 Devices to Detect Patterns Risky Behavior Over Time

When a driver trainer rides with a new driver, the senior driver will observe the trainee’s practices for potentially unsafe actions such as following too closely or not beginning to slow soon enough for a curve. Feedback is immediate. During a driver’s long career alone in the cab, bad habits can develop, whether consciously or subconsciously. Programs have been proposed to monitor a driver’s practices and, by various means, encourage better adherence to safe driving practices.

Major vendors of fleet tracking systems (Cadec <http://www.cadec.com/solutions/hardware.html> and Qualcomm <http://www.qualcomm.com/qwbs/solutions/prodserv/fltadvisor.shtml>) provide the capability of recording trips and scanning the data for instances of risky behavior, such as exceeding the corporate speed limit or braking suddenly. Some versions of the electronic aids for roll stability reviewed in Sections 4.2 and 4.3 allow fleet managers to count the number of times the system activates and to associate the activation with individual drivers. Information from electronic stability aids is beginning to be available through the fleet tracking systems.

Figure 3-1 is adapted from Figure 5-4 in [Battelle 2003a]. The data came from a study of cargo tank driver behavior in revenue service. The “proximity to rollover” on the horizontal axis was calculated from the lateral acceleration and the speed of the trucks as they negotiated curves. The quantity approximates how close a truck came to rolling over. A value of 50 percent means that the lateral acceleration (the cornering force) was about half what it would have taken to roll the truck over. The line with solid circles indicates that more severe events occurred less frequently. There were only three events at the 80 percent level in the year-long study. If the line is extrapolated to the lower right, it points roughly to the diamond, which represents the historic rollover rate of the carrier in the study. An electronic stability aid would activate only when the risk of rollover is higher than in most of the maneuvers represented in Figure 3-1, so the data is not directly applicable to interpreting events from an electronic stability aid. The figure does suggest, though, that the rate of near misses is indicative of the probability of a crash.

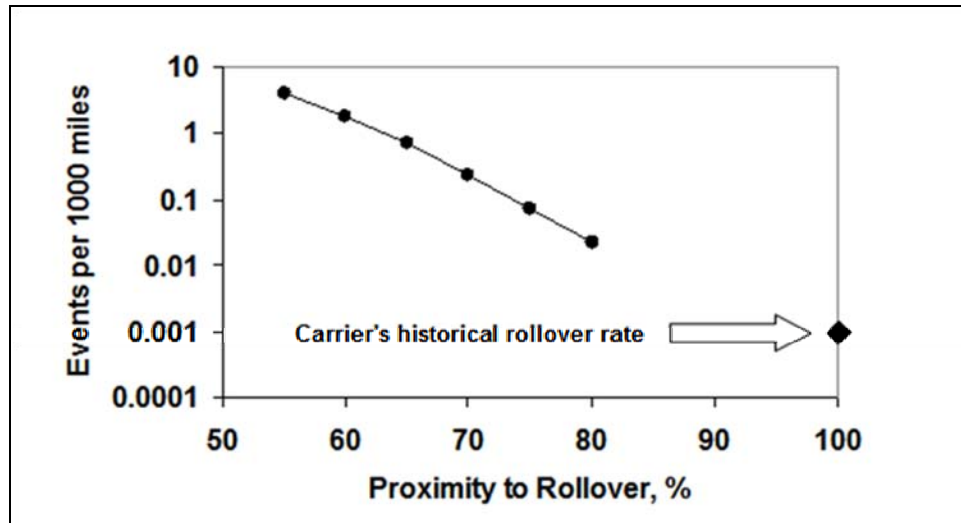

Figure 3 - 1 Data Recorded During a Previous Field Operational Test Indicates that

How the data is then related back to the driver is a matter of corporate policy and agreements with the drivers. Good human relations are necessary to ensure the drivers welcome constructive feedback. Some carriers may post a month's results so all drivers can see their records along with those of others at the terminal. Others have found it beneficial for a driver trainer to meet individually with drivers and discuss specific events. (This is possible because the tracking systems record the exact time and location of the events.) An honest, objective discussion, soon after the event, is a useful training opportunity.

A recent study on the drivers of light vehicles [Toledo and Lotan, 2006] found that objective measures of risky behavior could be correlated with an individual's crash history. Allowing drivers access to their own records produced an improvement in their behavior, but the effect was temporary, at least in part because the vehicles were family cars and there was no manager to ensure continued self-monitoring. An ongoing FMCSA study is evaluating the effectiveness of feedback to commercial vehicle drivers.

3.5 Review of Modern Training Technologies

Although instructional technologies can apply to anything from slide projectors to satellite linked distance learning programs, this discussion will focus on two general technology applications that have the highest probability of directly influencing the training of commercial vehicle operators: Computer-based instruction (CBI) and simulation.

3.5.1 Computer-based Instruction

The power of computers to instruct is significant. A computer can provide graphics, video, and sound. Computers can adapt the pace, mode, and content of an instructional program to meet the learning needs of each student. A well designed CBI program will test each student as he or she progresses through the program and, based on those test results, provide the next appropriate unit of instruction.

The most fundamental question about CBI is: Does it work? Recent research, which has applied meta-analytic techniques to answer that question, suggests that it does [Fletcher, 1995; Kulik, 1994; Kulik and Kulik, 1991]. Meta-analysis is a technique first proposed by Glass [1976]. It basically applies statistical analysis to an accumulation of studies around the category of interest. In a 1995 paper, Fletcher proposes a method by which these statistical findings can be converted to a percentile measurement to compare student performance.

Recent studies in the military services, academia, and large corporations, using the approach presented by Fletcher [1995], have indicated that the appropriate application of CBI across a wide range of a large population of students can lead to a 33 percent increase in the amount of material learned or a 33 percent decrease in the time needed to reach previously established learning criteria [Dodds and Fletcher, 2004].

Table 3-4 identifies the minimum qualities one should find in a CBI program for commercial vehicle operators. It is based on prior work in CBI [e.g., Eberts and Brock, 1987; Brock, 1997; Brock, 2006], driver training [Brock, 1998; Hodell, Hersch, Lonerio, Brock, Clinton, and Black, 2001; Brock, 2006] and commercial vehicle operations [Llaneras, Swezey, Brock, and Rogers, 1993; DTDA, 1996; Brock, Krueger, Golembiewski, Daecher, Bishop, and Bergoffen, 2005]. A complete discussion of the characteristics in Table 6-4 can be found in Brock, et. al. [2007].

**Table 3 - 4 Minimum Qualities for Computer Based Instruction
Commercial Vehicle Operators**

| |
|---|
| Interactive learning |
| Students enter and exit as needed |
| Easy to use |
| Visually rich |
| Can be customized to include company policies, vehicles and drivers |
| High retention by students |
| Information collected on a common data base |
| Students set their own pace |
| Criteria testing |
| Modal consistency |

CBI is popular among users, although its contribution to traffic safety has not been systematically studied. One company has provided over 500,000 hours of training using both CD-ROM based and Web based training since 2001 [Voorhees, 2006]. Some commercially available driver training CBI, whether for commercial drivers or the general public, target specific aspects of vehicle operation (e.g., risk recognition and compensation, defensive driving). Others provide either complete instructional packages (e.g., CDL in a box), or computer-based products that integrate into a complete training course.

According to Staplin, et al. [2004], United Parcel Service (UPS) states that its CD and web-based training programs are much more efficient and yield better results than paper manuals. Smithway Motor Xpress uses a computer-based training program to teach load securement

procedures. The drivers learned the material more quickly with the new program, and the cost to train a driver, originally \$1,000, dropped to \$150 per driver.

Ryder Truck [2000] describes a computer program that delivers 32 1-hour lessons on trucking fundamentals based on a model curriculum produced by the Professional Truck Driver Institute (PTDI) for the basic training of commercial vehicle drivers. Lessons are delivered via a high-speed Internet connection to where the students are, rather than having the students travel to a single location. Thompson [1996] describes a CD-ROM training program implemented by Frito Lay to train drivers about DOT regulations, focusing on alcohol and drug requirements. CD-ROMS and PCs have been placed in 40 company locations throughout the United States. However, a few carriers are measuring the effectiveness of advanced technology training that includes both CBI and simulator-based training, which is discussed below.

3.5.2 Simulation Technology

Simulation is an instructional method that requires students to interact with specific instructional events based on real-world scenarios. Students must see or experience the consequences of their interaction. All interactions should result in similar real-world outcomes or effects. The primary learning outcome of a simulation should be the demonstration of a real-world process, procedure, or specific behavioral change.

As Brock, Jacobs, and McCauley [2001] point out in a study for the Transit Cooperative Research Program, there is a long and rich body of scientific and technical literature on simulators and their use for training that goes back to at least the early 1950s. The literature can be broadly characterized as falling into four main domains: 1) descriptions of simulators, or simulator components, their characteristics, and how they are being used, 2) advice on what characteristics are required in a simulator, 3) results of research on the effects of simulator characteristics on performance, and 4) results of research on the effects of simulator characteristics on training.

Data regarding the effectiveness of simulator training for truck drivers is better documented than that for CBI. In their review of practices in the European Union and North America, Horn and Tardif [1999] state that truck driver training has generally remained low-tech, with the majority of training done using traditional methods of teaching. Although training simulators are appearing in some schools, they will remain the exception for years to come because the trucking industry and the private training schools do not have the resources to invest in these tools. However, where there are simulators there is good record keeping that establishes the value of such costly devices.

Pierowicz et al. [2002] evaluated the adequacy of six simulators for use in a three-part study to determine whether simulator-based training can enhance training effectiveness and improve the performance of tractor-trailer drivers, compared with conventional training methods. The bulk of the Pierowicz et al. [2002] report describes the functionality of the six simulators and their adequacy for use in validation studies. The simulators were evaluated on 183 factors to determine their adequacy in supporting the research design of the three study phases.

Regarding the use of driving simulators for training drivers, Brock et al. [2001] conducted a literature review, surveys, and site visits for the Transit Cooperative Research Program. They concluded that transit bus operator training can be improved with selective use of transit bus simulators. They also noted that a critical feature in the success of simulator training programs is the competence and enthusiasm of the instructional staff.

The Brock et al. [2001] report discussed three current applications of simulator technology: (1) an open-loop video simulator; (2) a low-end simulator, and (3) a so-called midrange simulator. All three simulators are used to train new drivers; they are also often used to retrain more experienced drivers. However, each device trains a subset of the skills required by drivers of transit buses, but none trains them all. Table 3-5 describes these three levels of simulation, which represent the key characteristics of currently available commercial driving simulators. None of the current crop of simulators specifically address either tank truck driving or the specific problems of rollover prevention in tank trucks.

Brock et al. [2001] note that the use of simulation decreased trainee drop-out rates by 35 percent for an agency using the midrange simulator, decreased student failure rates by 50 percent in an agency that uses the open-loop and the low-end simulators, and decreased the collision rate by 10 percent in an agency using a combination of open-loop and low-end simulators. In addition, the use of simulation reduced training time in one agency from 19 days to 17 days by replacing classroom bus training with simulator training. In another agency using just the open-loop system, training time was reduced by 5 days when simulation was employed.

Listed below are the three current driving simulator vendors for the commercial truck and bus industry. Each offers different versions of the three levels of simulation described in Table 3-5. In addition, all three are capable of building driving simulators which provide some motion simulation. None of the companies currently offers an off-the-shelf simulator specifically for tank truck rollover prevention training. However, all three have the capability of designing and developing such a device. One, L3, has developed a simulator with rollover training capability for trucks, generally.

The three vendors are

- Doron Precision Systems, Inc. (<http://www.doronprecision.com/driving.html>),
- MPRI, a division of L3, (<http://www.mpri.com/driver/about.html>), and
- FAAC, Incorporated (<http://www.faac.com>).

Table 3 - 5 Levels of Transit Bus Operator Simulators (From Brock, Jacobs, and Buchter, 2001)

| |
|--|
| <p>Level 1 – Open-Loop Video</p> <p>The most popular method of driver training delivery in use in transit agencies. It uses Open-Loop Video to display traffic and other instructional information. It consists of several student stations, each with a steering wheel, gas and brake pedals, and a rudimentary dashboard. This device is characterized as an “open loop” system because it is non-interactive. Although each station is equipped with a steering wheel, gas pedal, and brake pedal, the student’s engagement of any of these controls will not produce any appreciable effect on the video display.</p> <p>The system, as designed, trains and tests very specific bus operator activities (e.g., reaction time and visual recognition). Stopping distances, road conditions, the relationship of speed to both, and the role of reaction time can be shown and then practiced. Because the instructor station for the system measures performance in each learning station, the instructors can monitor and identify students who are not correctly responding as the scenarios play out.</p> |
| <p>Level 2 – Low-End Simulator</p> <p>The second method of driver training delivery is a model-board system. In this low-end simulation, a miniature camera is installed in a small model of a bus that physically moves about on a small terrain board in an adjoining room. This system replicates the visual, auditory, and vibratory effects of driving a bus in an urban, crowded environment in order to train student operators to maneuver a transit bus in relatively tight and unforgiving situations. The system demonstrates basic maneuvering of transit buses in typical urban areas. Such skills as approaching a bus stop, parking, tight turns, and backing can be taught to a single student without risk of damage to either an actual bus or to platforms, other vehicles, or pedestrians.</p> |
| <p>Level 3 – Midrange Simulator</p> <p>The third driver training delivery method is a mid-range simulator that uses realistic audio and video; including rear projection, to deliver a fuller replication of the driving experience. A larger field-of-view (FOV), on the order of 180 degrees forward, a vertical FOV of at least 45 degrees, and 60 degrees to the rear, distinguishes this simulator from the low-end simulator described above. Additionally, a more sophisticated vehicle model is provided, along with more complex environmental effects (weather, day-night, and road friction), and motion cues to replicate the look and feel of the outside world as seen by a driver looking out of the windows of a bus cabin.</p> <p>One of the very strong features of this device is the fact that the mirrors in the simulated cab are actual mirrors; they can be physically manipulated to reflect the imagery that is projected behind the simulator cab. The visual imagery for this system was developed for the specific driving environment of the transit buses for which the operators are being trained. Therefore, the device provides high fidelity simulation of actual driving situations that trainees are likely to encounter upon completion of the training program.</p> |

Purchasers can expect to spend in the neighborhood of \$300,000, plus construction costs, for a full motion-base simulator. A fixed-base simulator similar to the Level 3 in Table 3-5 retails for \$80,000 to \$100,000.

Driving simulators are also being extensively used in research settings, often with interesting and relevant experimental results. For instance, Strayer and Drews [2005] found that drivers who spent 2 hours in a simulator learning to shift to maximize fuel efficiency were “assessed over a six-month interval using measures of fuel consumption obtained by drivers in their own vehicles driving their normal route. Training increased fuel efficiency by an average of 2.8 percent over the six-month interval” (p.190). These findings held steady even for those drivers who drove vehicles not specifically simulated in the training sessions, suggesting that simulators can be used to teach general driving skills.

It seems clear from reviewing the simulation literature and the current industry use of simulators that the real payoff from simulation technology is in the larger context of a training program. The New York and New Jersey transit training facilities use quite different simulators. Each training program capitalized on the specific capabilities of the individual device. The key similarities of the two training programs were: enthusiasm of the instructors, management support of simulator costs, and careful mentoring of each student as he or she cycles through the training program. However, both agencies also report data supporting the use of simulation technology to reduce accidents and enhance the training experience [Brock et al., 2001].

3.6 Benefits to Advanced Training Approaches

In the survey of tank truck carriers, only one carrier reported training more than 1,000 drivers annually. On the other hand, 25 percent of respondents reported training fewer than 100 drivers annually. These numbers are important because investing in instructional technology has its highest payoffs with high throughput.

The research data from the Department of Defense, universities, and various commercial enterprises are clear: well designed computer based training programs can reduce the cost of traditional training by one-third. The savings come from two factors: (1) Students complete the training at their own pace; many complete the training much more quickly than with conventional lock-step training programs. (2) Fewer instructors are needed. Of course, good instructors are always needed. In a technology-based program, driving instructors can concentrate on student motivation and counseling, measuring performance, and setting professional standards.

Transit agencies have been using driving simulators for close to six years. The agency surveyed in Brock et al. [2001] that used the midrange simulator reported that 90 days after training, 32 percent of their conventionally trained drivers had experienced a crash, compared with 18 percent of their simulator trained drivers. In this agency, simulator training in tasks related to overtaking and being overtaken by vehicles on the left and right sides of the bus resulted in fewer crashes by the students performing these maneuvers in the real world (17 crashes by the simulator-trained students compared with 154 crashes for the non-simulator-trained students).

The transit agencies surveyed by Brock et al. [2001] reported that simulators are also able to replace some of the hours spent in the actual vehicle. This can have a significant effect on training costs, as simulator costs can run as low as \$3 per hour per student versus \$40 per hour per student for in-vehicle training. Results of a survey of bus operator trainers conducted by Brock et al. [2001] indicate a high level of satisfaction with their training simulators. Fifty-eight percent of the respondents indicated that simulator training is more effective than traditional training for teaching certain types of knowledge, skills, or attitudes. In particular, simulator training validates defensive driving techniques taught in the classroom, provides an opportunity to experience hazardous situations without putting the students or the bus at risk, reinforces proper driving habits and defensive driving principles, and allows instructors to check reaction time, eye-hand coordination, and driving skills. Instructors indicated that trainees with little or no experience were better prepared for their initial driving assignment. Seventy-five percent of the drivers surveyed reported that their bus simulation training enhanced their learning

experience, although 6 of the 51 respondents reported motion sickness, dizziness, and disorientation after bus simulation training.

Throughout Europe, driving simulators are becoming an important enhancement for cost-effective, safe driver training [Hartman, et al, 2000]. They are cost-effective because they allow year round training and cost less than behind-the-wheel training. Hartman, et al. [2000] observe that “because simulators cannot capture real-life terrain and vehicle dynamics, the optimal blend of simulator/computer/behind-the-wheel training needs has not yet been determined” (p.5).

The Association for the Development of Professional Training in Transport-Institute of Training and Warehousing Techniques (AFT-IFTIM) in Menchy Saint-Eloi, France, has recently introduced driving simulators as a key component of their comprehensive commercial driver training program. First-year deployment of the AFT-IFTIM’s driver simulator yielded impressive results. Reports indicate both time saving and training effectiveness. Most notable was enhanced maneuvering training. AFT-IFTIM considers 1 hour on the simulator and 4 hours behind the wheel to be more effective than 8 hours behind the wheel [Hartman, et al, 2000].

Schneider National in Green Bay, Wisconsin, has recently implemented an innovative and technology-based training program for entry-level commercial drivers. The training course included traditional classroom instruction, CBI, simulation, behind-the-wheel training, and reading assignments as homework. Since the new program was put into effect, Schneider is reporting that the graduation rate has increased from 75 percent to 81 percent, decreased average time to going on the job by 38 percent, and significantly decreased the 0- to 90-day accident rate from 31 percent to 10 percent. They also estimate that in their program, which trains 10,000 students annually, each one-day reduction in training time saves \$7,000,000 annually.

One manufacturer has developed a simulator for general truck driving that includes a rollover module. The module even simulates an electronic roll stability aid, so students can experience the same scenario with and without the aid. While the simulator is not specific to cargo tank trailers, the characteristics of the trailer, including the height of its center of gravity, can be changed. Simulators are more effective when the eventual user is involved in their design. Therefore, the tank truck carrier community should work with the manufacturers of the large-scale, motion-base simulators to design the ideal training device for tank truck drivers.

A simulator, albeit expensive to procure, can repay its owner if there is sufficient throughput of students to drop the cost per student below that of conventional training using actual vehicles. Even without the savings from having safer drivers and fewer rollovers, simulators in large student populations have proven to be cost-effective through reductions in training time.

The greatest obstacle to implementation is that individual tank truck carriers, like commercial motor freight carriers generally, are training only small numbers of drivers. The vendors of simulators are working to find a viable business model to expand their customer base beyond a few large carriers. Two possible models are:

The Simulation Center Model. Simulation Centers could be established throughout the country. Both schools and carriers could schedule drivers for simulator-based training. If a carrier hauls

only one kind of tank trailer or the student will be driving only one kind of tank trainer, the simulator would train only in those configurations. However, the student could still experience full, half, and empty loads, as well as rain, ice, wind, different levels of traffic, night and day, and mechanical failure in a two- or three-hour session. Specific scenarios could be designed that would let the student experience the visual and physical conditions of a tank truck in a potential rollover situation. The second advantage of such a simulator is that it can precisely measure student performance, providing exact feedback to the student and progress reports to the school or carrier. The downside to such a center would be the need for the carriers and schools to get their students to the center, which could involve overnight travel.

The Portable Simulator Model. Another option would be to install the simulators in trailers which can then be taken to the schools and carriers on a set schedule. Several current and former simulator vendors have had such installations with little or no difficulties. Again, the simulator would have all the same characteristics as described above. Students would be assigned to the simulator when it was at their training facility. Portable simulators can have high fidelity, but they cannot be the full motion-base kind.

A motion-base simulator would be a cost-effective device for training drivers of tank truck vehicles. Such a device could provide guided practice on driving various configurations of tractors, trailers, loads, weather and road conditions, and mechanical failures of tractor and trailer. Such a simulator could provide a successful business and safety model for the tank truck industry.

3.7 Effect of Operations on Rollover Experience

The Driver Training and Development Alliance, an organization of trucking professionals dedicated to improving the safety performance of the trucking industry, has published the *Driver Training and Development Resource Handbook* [DTDA, 1999]. Although the handbook was originally conceived to address driver training, it expanded to include discussions and guidelines on, among other things, carrier operation's effects of driver safety.

In the survey of safety managers at tank truck carriers and in discussions with NTTC members, many of the points of that ten year old resource guide came up again. It is therefore incumbent upon the carriers to avoid putting drivers into situations where those factors grow too large.

The Handbook recommended a set of company activities that could reinforce the idea that drivers are professionals. For tank truck carriers, having a professional driver corps can work to instill the safety attitude that will minimize poor driving and increase the risk of rollover. Some of the recommendations from the *Handbook* are found in current tank truck carrier operations and are discussed below:

- Orientation program. Many of the survey respondents described in some detail the programs they have for newly employed drivers. Safety is emphasized and many of the materials described in the training discussion, above, are used in these early sessions. The message from the very beginning is safety first.

- An active and committed safety program. Given the multiple sources of rollover prevention materials identified in our survey, it is clear that the NTTC members who responded to the survey have active safety programs in effect. Rollover prevention training is one component of those programs, but other components include posters, newsletters, safety briefings, and other reminders of the importance of driving to avoid rollovers.
- Driver recognition programs. Professional drivers are proud of what they do. The tank truck driver should be singled out as representing the top tier of the profession. Among the tank truck carriers who responded to our survey, entrusting experienced drivers to vouch that new drivers are ready to take to the road on their own is a sign of respect and recognition for high professional standards.

But the key factor in day-to-day company operations that can increase or decrease the risk of tank truck rollover lies in the hands of the carriers' dispatchers. Dispatchers, often called by the better descriptor, "Fleet Manager", are at the center of a carrier's operations. This is the individual who must assign specific loads to drivers, track the drivers as they perform their assignment, maintain both regular and opportunistic communications with the drivers on the road, and also coordinate with shippers and receivers.

Besides the surveys we interviewed safety managers and current and former dispatchers. This section also benefits from one of the report authors recently working with dispatchers to develop training programs for their profession.

The last ten years of carrier operations have seen a number of technological aids for dispatcher/driver communications and tracking. Many drivers now receive their assignments, questions, and information over computers in the truck cab. These automatic tracking systems allow the dispatcher to ensure that drivers are in compliance with hours of service regulations and following prescribed routes and schedules.

The tank truck carrier provides special challenges to the dispatcher. Ideally, tank truck drivers should be consistently assigned to the same kind of tractor-trailer configuration for each trip. It is the dispatcher who matches the vehicle to the driver. The dispatcher also needs to know what routes are best for each kind of load. HAZMAT restrictions in various state and country jurisdictions mean that a truck carrying orange juice may have a different route from a truck carrying gasoline, even though both trucks leave from the same place and both have the same destination.

The dispatcher must be able to track the driver's status in meeting hours of service regulations. More importantly, he or she must be able to anticipate when the driver must stop driving and make route and delivery decisions based on that information. Driver fatigue is a major contribution to rollover accidents for tank trucks, according to the survey results for this study. If dispatch operations can prevent fatigue in the driver workforce, this could well be the biggest single contribution the dispatchers can make to rollover prevention. The second thing dispatchers can do is to ensure that each driver's schedule of deliveries does not force drivers to

use excessive speed, since it is the combination of curves and too much speed that produce many rollover crashes.

There are numerous software products to assist the companies in managing their fleet of vehicles. Carriers can identify multiple driver related variables, beyond hours of service and proficiency operating particular vehicle configurations. Personal and emergency information freely provided by the driver can help the driver manage his or her personal life while on the road. A dispatching system that encourages courtesy and open communications between the driver and his or her dispatcher will lead to a driver who feels respected. This is a driver who will be more likely to drive safely, avoiding not only rollovers, but other kinds of accidents as well.

One such system, designed by a carrier to improve traffic operations, functions as follows: A dispatch board is displayed on large 32-inch wide-screen liquid crystal displays for easy viewing and gives dispatchers a clear graphical view of drivers, loads, start time, expected work hours, running hours-of-service (HOS), load details, pick up points, and status of each load with color coding.

Load information is dragged and dropped around the board with the click of a mouse. Load changes, including pin numbers or any traffic or safety conditions, can be forwarded to driver cell phones. HOS records are updated and reflected immediately on the dispatch board through color coding. Should a dispatcher be making changes to a driver's work when the driver is logging in and printing out his work, the dispatcher receives a warning message.

Dispatchers are the point of contact between the tank truck operator and the tank truck carrier. An individual dispatcher cannot stop a driver from performing dangerous practices. But he or she can ensure that the driver is not pushed into those dangerous practices (HOS violations, speeding) through the demands of the route and load assignments.

It is important to remember that the managing and scheduling the tank truck operators is only one part of the dispatcher's job. Other responsibilities include coordinating all daily dispatch functions, coordinating and scheduling equipment, ensuring equipment is in compliance with DOT regulations, and administrative and billing support. Within the context of these functions, the dispatcher can best help prevent rollovers by following these best practices:

- Always be calm and polite when communicating with drivers.
- If communicating by telephone or radiotelephone, ask that the driver repeats back to the dispatcher all information and instructions.
- Ensure, no matter the mode of communications, that load, route, and schedule information is clear, concise, and unambiguous.
- Become aware of any personal issues that may be affecting driver performance (financial difficulties, children or spouse problems, health problems).
- Ensure that HOS limitations are anticipated and accounted for in scheduling and route planning.
- Ensure that every driver is assigned to equipment with which they are familiar and which the carrier has cleared the driver to operate.

- Let the drivers know that although dispatch cannot accommodate every personal need or request, those needs and requests are considered in the scheduling and assignment process.
- Listen to the drivers to keep updated on weather, road conditions, unique and unexpected events on the routes, and any equipment problems.

3.8 Conclusions

This section has discussed three potential interventions to improve the driving performance of tank truck operators – monitoring, skills, and working environment. Driver error is at least a contributing factor to 75 percent of cargo tank rollovers. Errors might be a failure to notice a situation in time, a misjudgment, or driving off the road edge. Clearly, a key to reducing rollovers is helping and supporting the driver.

The tasks required to safely operate a tanker are essentially the same as those to operate another Class A heavy vehicles, but they must be mastered to a greater proficiency. The primary method carriers use to bring drivers to this greater proficiency is to present them information about rollover causations and then have them drive tank trucks under the supervision of an experienced driver/instructor until they are judged ready to drive solo.

Modern motion-base simulators can deliver better training than actual driving because of their ability to simulate dangerous situations without actually posing a danger. The disadvantage of simulators is that they are quite expensive, and there is no demonstrated business model for incorporating them in training for drivers of smaller carriers. Several medium and large carriers, who are early adopters, are currently using fixed-base and motion-base simulators to train new drivers the skills, including in a few instances rollover prevention skills, for dry freight. Their experience has been that training that includes simulator time is both faster and more thorough than conventional training. An initial step to improving the training for cargo tank drivers would be to provide this training for tank drivers. Existing simulators can vary the properties of the trailer, so the next step would be to tailor the dynamics of the simulators to model various cargo tanks. This includes at least the CG height and roll inertia of tanks, but input from experienced tank trainers would be needed to ensure enough effects were captured to produce proper fidelity. Drivers of heavy vehicles should be trained to stay well away from the high-speed conditions that lead to untripped rollover, so simulating these conditions may not be essential. Perhaps a more important use for simulators is to teach proper techniques for recovering from a pavement drop-off.

Given the right subject matter and adequate adherence to instructional principles, providers of anti-rollover training could both improve performance and shave time off the instructional process. There are no “magic bullets” to improve human performance through training. In our survey, carrier safety and training managers cited driving over the road as the most effective training they currently can provide.

Our review for driver performance monitoring systems suggests that such systems can provide early enough alerts to drivers for them to avoid rollovers. Other systems, which record

performance data over time for management review, may serve as databases for driver counseling and additional training to improve general driving abilities.

In terms of carrier operations, we found some evidence that drivers who are satisfied with the way a carrier treats them also maintain a better awareness of safe driving practices. The above discussion listed several organization programs that tend to reduce driver attrition and improve driver safety habits. However, it is the dispatcher who has the most day-by-day influence over the driver's world. A dispatcher who understands the speed limitations of tank trucks will schedule deliveries that do not require drivers to ignore those limits. If speeding on curves causes rollovers, the dispatcher can reduce the motivation for using higher speeds. Human fatigue is also a major contributor to rollover accidents. Dispatchers must track and collaborate with drivers to ensure, first of all, that Hours of Service regulations are adhered to and, secondly, that drivers can get adequate breaks on the road and between shifts.

Improving the performance of tank truck operators will reduce rollover accidents. If training can improve skill proficiency, if warning systems can provide better information, and if the carrier can provide a supportive working environment, the returns on investment to the carrier and the driver will be significant.

In the benefit-cost section to follow, the benefits estimate will be that improved training programs will eliminate 10 percent of the excess rollovers experienced by younger drivers (i.e., those under 35 years of age). Schneider National reported that their new drivers experienced a 68 percent (drop from 31 to 10) reduction in all crashes in the first 90 days. Such a large reduction will not persist over the career of a driver, but the assumption will be that there is an enduring benefit. The benefits estimate for driver training cannot be based on engineering calculations, as were the estimates for vehicle design improvements and electronic stability aids. The benefit-cost analysis section will discuss the sensitivity of the benefits calculation to this estimate.

This Page Intentionally Left Blank

4.0 Electronic Stability Aids

Electronic stability aids automatically slow a vehicle when it is rounding a corner too fast and is in danger of rolling over. They are incorporated into the braking system. These devices are the least expensive to implement among the four approaches. Multiple suppliers are offering them, and all tractor and trailer manufacturers are offering them as options or standard equipment. They are beginning to appear on single-unit trucks as well [Mack Trucks, Inc., 2006]. The development costs of the systems have already been borne by the suppliers, who are now recovering the costs through volume sales. The systems, where they are an option, add on the order of hundreds of dollars to the retail list price of tractor. When vehicles are sold to fleets, they are at negotiated prices, so the actual cost per tractor is probably less.

The discussion and analysis in this section address the question, “*How can modern electronic technologies help prevent rollovers?*” This section describes the electronic stability aids that are on the market. It briefly reviews other kinds of stability aids that provide information to the driver but do not intervene with the vehicle’s control. The crash reduction benefits of the systems are estimated.

4.1 Introduction

Systems to automatically apply foundation brakes are intended prevent the kind of rollover that is most common for tank vehicles—those that result from traveling through a corner too fast. The volume of tables in Section 2 indicates that there is no single reason that trucks roll over. One of the largest single reasons, particularly for cargo tanks, is taking a curve too fast. Because the systems that slow the vehicle in a curve do not change the inherent roll stability of the vehicle, they are not effective for rollovers caused by other situations, such as driving over a pavement dropoff on a straight segment.

4.2 Review of Automatic Stability Systems

Electronic stability aids continuously measure the side-to-side force imposed on the vehicle by cornering. They contain a device called an accelerometer that senses the lateral (sideways) acceleration of the vehicle. When the device determines that a rollover is possible, it gives signals to slow down the vehicle. The aids typically consist of additional electronics and features that are built into the control units for the ABS on a truck.

Some electronic stability aids are mounted on tractors. They slow the tractor by applying the foundation brakes and by sending signals through the vehicle’s internal communication bus (the J1939 standard) to cut fuel to the engine or engage the retarder (e.g. an engine brake) if one is present. The tractor-based roll stability systems will apply brakes on the trailer as well as those on the tractor. With a conventional pneumatic system in the North American market, the control system on the tractor cannot know whether the trailer is equipped with ABS. Therefore, the devices limit the trailer brake pressure and pulse the pressure to avoid locking the trailer brakes. A tractor itself is usually fairly stable in roll; it is a top-heavy trailer that pulls over the vehicle in a rollover. Therefore, a tractor-based roll stability system needs information about the trailer and

its load to avoid being too sensitive or not sensitive enough. The electronic control unit for the stability aid communicates with the engine through the bus. It estimates the trailer's weight, and from there its stability, through measurement of the engine torque and vehicle acceleration.

Trailer-based electronic stability aids sense the impending rollover through measurements in the trailer, and they apply the trailer brakes when warranted. Because the trailer, in nearly all situations, begins to roll before the tractor does, trailer-based systems have a direct indication of the impending rollover when the roll angle becomes too great. The systems on the market today will first briefly apply the brake to ensure there is traction. Then they apply the trailer-axle brakes to slow the vehicle. In a situation of near-rollover, one side of the trailer axles is more lightly loaded than the other, so the device will apply greater torque to the more heavily loaded outside tires. The ABS continues to function to ensure that the wheels do not lock.

The first electronic stability aids to reach the market for heavy vehicles would simply slow the vehicle when a high lateral force was detected. An optional feature in modern tractor-based electronic stability aids, in addition to providing the above functions, is to help to maintain the yaw (turning) stability of the tractor by applying individual brakes when an uncontrolled tractor spin begins. Their purpose is to correct situations of understeer or oversteer, which leads to jackknife in a combination vehicle. Their function is similar to Electronic Stability Control, which NHTSA has recently proposed to require on all light vehicles [U.S. Department of Transportation, National Highway Traffic Safety Administration, April 6, 2007]. Any system that helps a driver maintain control of the vehicle will certainly eliminate some rollovers, especially those that follow other collision events. Yaw stability systems have demonstrated their effectiveness for light vehicles, and they undoubtedly have their place in the heavy vehicle market as well, but analysis of their performance and estimation of their benefits are beyond the scope of this study.

The tractor-based systems can be installed only at the factory as part of the build. They cannot be retrofitted because they need to be integrated with the sensors and internal communication system of the vehicle. They also need to be adjusted for the particular dynamics of each tractor, and that is best done at the factory. The trailer-based systems can be retrofitted to existing trailers.

These electronic control systems for these stability aids have interfaces so that mechanics can communicate with the device using a computer or a proprietary tool. In addition to maintenance and diagnostic information, the devices keep records of when the control systems were activated. The amount of information stored on each activation varies between vendors. This information can be useful for educating drivers when they are approaching the limits of stability, as was discussed in Section 3.4.

Braking regulations in Europe require a form of brake proportioning between the tractor and trailer that is different from requirements in the U.S. The European regulation is met most economically by controlling the brakes through an electronic signal rather than conventional pneumatic pressure. These are still air brakes because brake application itself is accomplished by air pressure; only the control is electronic. These electronically controlled braking systems naturally lend themselves to sophisticated enhancements, including roll stability aids. This is the

primary reason that electronic stability aids first appeared in Europe. There has been research on electronically controlled braking systems in the North America, but the market remains largely pneumatically controlled, and most of the electronic stability aids work with conventional pneumatic systems.

There are three major suppliers of brake components to the North American heavy vehicle market, all three of which offer electronic stability aids. All three are vigorously marketing their products, and, as with other modern electronic devices, advancements in capability are rapid. All three perform the basic functions as described above, but their implementation and features differ. Bendix's stability aid is part of its "Advanced ABS6" product (<http://www.bendix.com/bendix/abs6/>). The Roll Stability Program (RSP) provides the functions described above for slowing the vehicle to prevent rollover. The Electronic Stability Program (ESP®) provides additional features for yaw stability. Meritor WABCO calls its tractor-based product the Roll Stability Control (RSC) (<http://www.meritorwabco.com/rsc.asp>). Their trailer-based product is Roll Stability Support (RSS) (<http://www.meritorwabco.com/rss.asp>). Haldex sells brakes only for trailer axles, and their Trailer Rollover Stability System (TRS) is contained entirely on the trailer (http://www.hbsna.com/en/Products/TRS_-_Trailer_Roll_Stability/).

4.3 Review of Systems that Inform the Driver

Another class of electronic stability aids merely inform the driver of the need for caution and do not take partial control of the vehicle. Some indicate the current cornering load, some warn of curves ahead, and one advises caution after a corner was taken too fast. Only a few of the systems got past the research stage, and they are in limited deployment. Aside from the following few paragraphs, the term "electronic stability aid" in this report refers to the systems that automatically slow the vehicle in an emergency, as described in Section 4.2.

Stability Dynamics Ltd., of Campbellford, Ontario, markets a product called LG Alert™ lateral acceleration indicator. This simple device measures the lateral acceleration of the vehicle, and a multi-colored display indicates the level to the driver. The sensitivity is set manually, so this device is best suited for vehicles that have essentially the same roll stability on every trip. It is marketed to airport fire vehicles, which usually travel with an identical full load. A table in the user manual indicates how to set the sensitivity according to various lateral acceleration levels, which are presumably somewhat below a roll threshold of the vehicle that may have been measured or calculated.

Meritor WABCO, in addition to its RSC system, markets a Roll Stability Advisor (RSA). This device advises a driver, after a curve, that the curve was taken faster than may have been desirable. It calculates and displays a recommended speed reduction for the next trip through a similar curve. The electronics for the RSA are mounted to the frame of the tractor, and the system communicates with the driver message center through the vehicle bus.

An early research attempt at developing a device to increase the driver's awareness of rollover risk was also called the roll stability advisor [Ervin et al., 1998 and Winkler et al., 1999]. The device actually measured the vehicle's roll stability by sensing its roll angle as it went through curves. It continuously displayed to the driver the current lateral acceleration, as a fraction of the

measured roll threshold. As would be expected, the system could measure the roll stability most accurately when it had input from sensors mounted on both the tractor and the trailer. Estimates were somewhat less accurate when information only from sensors at the trailer axles was available. Performance was adequate but further diminished when all instrumentation was on the tractor. This research effort may have inspired some of the devices that came later and it contributed to the knowledge of rollover dynamics, but the equipment was far too complicated to be commercialized in that form at the time.

Electronic stability aids that anticipate the road ahead, rather than reacting to it, have been proposed. A partnership led by Mack Truck began to develop a system called TSA (Trucker Safety Advisory) for a demonstration project [Battelle, January 2006]. The TSA is intended to increase the driver's awareness of surroundings and attentiveness to the driving task in locations where the probability of a crash may be greater. The TSA displays text in on the dashboard and sounds a tone when the vehicle enters a Trucker Advisory Zone (TAZ). A zone is a segment of road up to about 5 miles long that is known to be hazardous (e.g., a segment having an historically high crash rate) or potentially hazardous (e.g., construction zones, potentially icy roads or foggy conditions, sharp curves, steep grades). The TSA requires a database of TAZs. The message stays on the monitor until the truck exits the TAZ. The TSA displays a fixed message for each geographic location; the message does not vary with the vehicle's speed. This system potentially can address all types of crashes associated with TAZs encountered by a truck. While the conventional stability systems that respond to current conditions can be effective at any location, these anticipatory systems depend in part on maintaining up-to-date information on TAZs, which may change over time (e.g., construction zones, road alignment changes, speed limit changes). Anticipatory systems will be more viable in future years, when communication between vehicles and the infrastructure becomes more common.

A separate project conducted by Oak Ridge National Laboratory [Stevens, et al., 2001] had a slightly different idea focused more on rollovers. The concept was to collect roadway design elements of many curves and ramps to be stored in a database on trucks. As a truck approached a road segment, the device would compare the truck's current speed with what it calculated to be a safe speed for the segment. The Trucker Safety Advisory would be able to advise a driver of a potentially difficult road segment farther in advance than the Oak Ridge system, but the Oak Ridge system, by taking the vehicle's present speed and stability into account, would provide more specific warnings.

The reverse of the Oak Ridge system is an infrastructure-based system posted ahead of a dangerous curve that warns trucks if they are approaching too quickly. They detect the presence of a truck by its height and measure its speed with radar. If a tall vehicle is approaching at a speed that is too fast for most trucks, a flashing sign warns the driver to slow down. Such systems have experienced only limited deployment [Strickland and McGee, 1998, and Bola, 1999].

4.4 Estimate of Benefits

The effectiveness of active tractor-based electronic stability aids in preventing rollovers was estimated using a computer simulation and comparison to historical crash statistics. Through an

agreement with one of the vendors, a mathematical description of their system was incorporated in a vehicle dynamics computer model. The behavior of identical tank trucks, with and without the roll stability aid, was simulated as the trucks drove through a series of maneuvers that had been recorded in revenue service in a field operational test on the data collection. The behavior of the model was verified by comparison with test track maneuvers in both projects. Background on data collection and details of the procedure are in earlier reports [Battelle, 2003a] and on the original benefits estimate [Battelle, 2003b].

4.4.1 Approach

During a U.S. DOT-sponsored Field Operational Test as part of the Generation 0 Intelligent Vehicle Initiative, the independent evaluation identified 126 rollover “conflicts” [Battelle 2003a]. These were events that had dynamic characteristics that precede a rollover crash. Specifically, the lateral acceleration measured during the event was a significant fraction of the estimated static rollover threshold of the vehicle at the time of the event. If each of these 126 events were to occur again many thousands of times, each occurrence would differ slightly. For example, the speed may be slightly higher, the load may be a little fuller, or the driving path may be slightly different. These differences can be considered to be perturbations of the actual event. A small fraction of the combinations of these perturbations will result in a rollover crash. It is this fraction that must be calculated to assess the ability of an electronic stability aid to eliminate crashes.

In short outline form, the procedure is:

1. Simulate the conflict exactly as it was recorded in the Field Operational Test (FOT).
2. Simulate the conflict again with the speed 1 ft/s faster, but other conditions unchanged.
3. Keep repeating Step 2 until the vehicle rolls over or can no longer maintain its path.

The result of these three steps is a measure of the severity of the conflict. These steps are carried out separately for each conflict. A statistical procedure then estimates the probability of a rollover crash if all the conflict scenarios were repeated, say, ten thousand times, each time with a small perturbation. This process is illustrated in greater detail below under the heading, “Simulation Example” in Section 4.4.2.

The vehicles were modeled in Vehicle Dynamics Analysis, Non-Linear (VDANL)¹ Version 6.0. This tool has been in development since the 1980s. It has been applied in contracts for various agencies within the DOT, including light vehicle rollover work for NHTSA, and in contracts for private companies. By selecting parameters to describe the vehicle, VDANL can be applied to vehicles from race cars to tractor-semitrailer combinations. This rigid-body model incorporates equations of motion that explicitly describe vehicle dynamics in the longitudinal, lateral, and vertical directions in addition to independent wheel spin modes. The sprung and unsprung mass motions are modeled separately in the pitch, roll, heave, and lateral modes. The longitudinal motions are for the total vehicle, while the sprung and unsprung masses rotate together in yaw.

¹ VDANL, Systems Technology Inc., Hawthorne, California. Phone 310-679-2281. Web page at <http://www.systemstech.com/vdanl1.htm>

The model also contains a model of a two-axle trailer connected to the tractor through a compliant fifth wheel. The model integrates the nonlinear equations of motion, incorporating driver actions and external inputs. The VDANL model, including the equations of motion and the methods for measuring parameters, is documented in Allen et al. [1992].

The procedure was followed first using a simulation model of an ordinary truck—one without the electronic stability aid. The whole procedure was repeated with a simulation model of a truck equipped with the stability aid. The reduction in probability of a rollover attributable to the aid was calculated, and, from this, the expected number of rollovers prevented was calculated based on historical crash data.

The 126 conflict cases identified in the field operational test were used as the basis for a special simulation analysis to determine the efficacy of the electronic stability aid. For each conflict, vehicle speed was perturbed to induce a vehicle rollover. Starting with the speed profile recorded for the conflict, the speed was incremented by 1 ft/s (about 0.7 mph) for the entire maneuver, and the simulation was run. If no rollover was observed, the speed profile was incremented by an additional 1 ft/s and the simulation repeated. Increasing the speed in 1 ft/s increments, each conflict was perturbed until a vehicle rollover was observed.

The simulations quantified the speed perturbations that could be tolerated by the vehicle in each of the conflict cases before it rolled over. The simulated truck equipped with the roll stability aid could enter a curve at speed perturbations *higher* than an identical truck without the aid and not roll over.

4.4.2 Simulation Example

Figures 4-1 through 4-4 illustrate how this process was carried out for one of the 126 conflict events. The first figure is a “bird’s eye view” of the intended maneuver. The truck was coming from the upper left and turned right through two curves before driving off to the south. The black dot in the Figure 4-1 indicates the point of interest—where the highest lateral acceleration was measured during the actual maneuver in revenue service. In Figure 4-2, the lower, lighter line is the speed history of the truck as it drove through the path. It began around 17 mph, sped up gradually, slowed briefly again as it made the curve, and then accelerated out of the curve. In the first simulation of this maneuver, the simulated truck followed the path shown in Figure 4-1 at the speeds shown in the lower line of Figure 4-2—the same path and speed measured on the real truck in the FOT. The black dot on this trace at 18.2 mph indicates the speed at the moment where the peak lateral acceleration was observed. This is the reference speed for calculating the probability of a crash in Section 4.4.3.

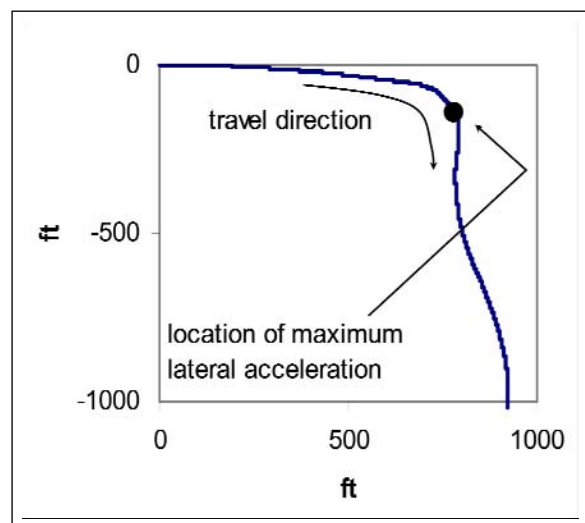

Figure 4 - 1 Path of an Actual Truck in Revenue Service

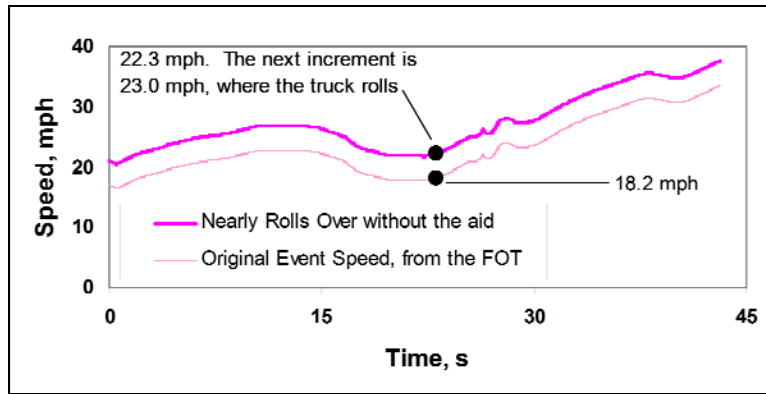

Figure 4 - 2 Speed through the Path of Figure 4-1, as in the FOT and Increased Nearly to the Point of Rollover

The simulation was then repeated through the same path with each subsequent speed increased slightly, until the simulated truck rolled over. The upper, heavier trace in Figure 4-2 shows the speed of the truck when it was 4 mph faster than the original speed. This was as fast as the truck could go through this path without rolling over. At the next speed increment, the simulated truck rolled over. That is the first piece of important information from the simulation: if everything were identical to the actual event, except that the driver entered the maneuver 4.8 mph faster than the actual speed, the truck (without the stability aid) would have rolled over.

The model of the roll stability aid was implemented for the next simulation of this maneuver. When the vehicle was about to roll over, the electronic device called for the brakes to be applied, so an appropriate brake application was simulated. The truck slowed down and did not roll. Figure 4-3 shows how the device affects the speed of the simulated truck. The solid line is the speed of the truck without the device, just below the rollover threshold. The dotted line indicates the speed of the truck equipped with the stability aid. Up to the point of intervention, the two trucks had the same speed. At the point indicated by the arrow, the brakes were applied, the simulated vehicle slowed down, and a rollover was avoided.

Figure 4-4 shows the lateral acceleration calculated at the trailer center of gravity during these simulations. As the acceleration reaches about 0.3 g, the device activates and reduces the rolling tendency of the trailer. The static rollover threshold of the actual vehicle was measured to be about 0.37 g [Figure 4-6, Battelle 2003a]. At the next higher speed increment, the vehicle without the electronic stability aid would have reached a peak trailer lateral acceleration of nearly 0.40 g and rolled over. When the vehicle with the aid was simulated at the next speed increment, the peak lateral acceleration was limited to 0.29 g.

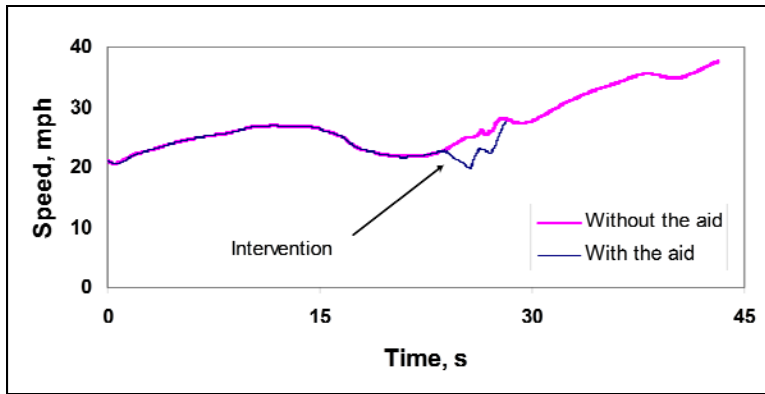

Figure 4 - 3 Simulation of the Electronic Stability Aid to Reduce Speed and Avoid a Rollover

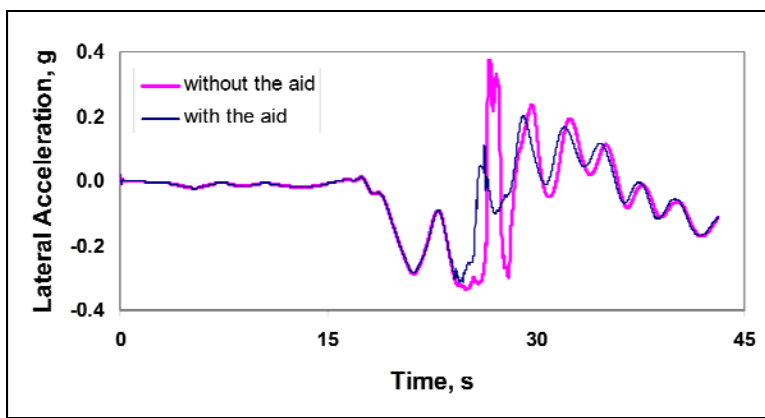

Figure 4 - 4 The Electronic Stability Aid Limits the Lateral Acceleration of the Trailer

Figure 4-5 compares the roll angles of the trailers on the unequipped and equipped vehicles. The plot with the wide swings in roll angle is on the truck without aid. The roll angle reaches about 15 degrees, well beyond the point of safe maneuvering. The roll angle of the trailer on the vehicle equipped with the aid is limited to a much safer 5 degrees.

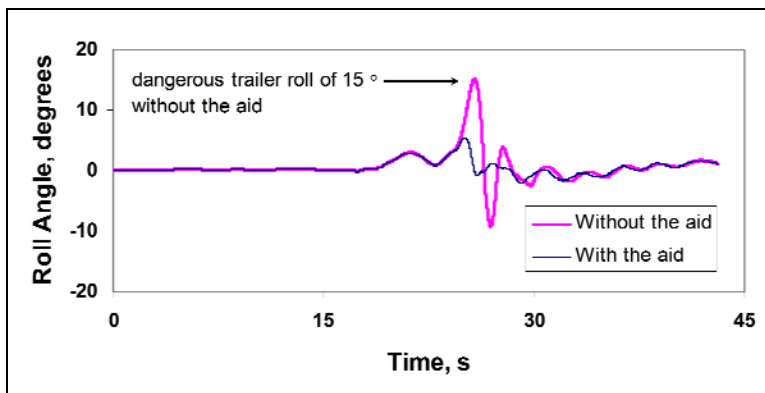

Figure 4 - 5 The Electronic Stability Aid Limits the Roll Angle of the Trailer

Finally, the simulated truck was launched into this same path at successively higher starting speeds until eventually the electronic stability aid could not prevent a rollover. This gave the

second piece of necessary information for the conflict—how much faster than the actual speed would the driver have had to enter the maneuver to roll the truck, had the truck been equipped with the aid. In the maneuver of Figure 4-1, the driver would have had to begin the maneuver at 24.5 mph, 7.5 mph faster than the driver actually did in the FOT, to overcome the benefit of the stability aid and roll the vehicle.

This simulation procedure was repeated for the 126 conflicts. The simulation exercise produced two data points for each of the 126 maneuvers. The first point is how much faster the driver would have to have driven to roll the truck without the electronic aid (4.8 mph in the illustrated case), and the second is how much faster the driver would have had to have been driving to roll the truck with the aid (7.5 mph in the illustrated case).

This example illustrates how the severity of a single conflict was characterized for two conditions—trucks with and without the aid. The next section shows how these results were used to compute how the electronic stability aid reduces the probability of a crash and, from there, how many rollovers it can be expected to prevent.

4.4.3 Probability Calculation

The results of the simulations can be used to calculate the probability of a crash for the conflicts, which is a step toward estimating the overall benefits of the system.

Using simulations such as the one just illustrated, the probability that each conflict would result in a crash was estimated, using the following equation:

$$P(C | S_{1,j}) = 1 - \Phi\left(\frac{\Delta v_{j,R}}{\sigma \times v_{j,M}}\right)$$

where $S_{1,j}$ indicates conflict number j ,

$P(C | S_{1,j})$ is the probability of a crash resulting from conflict j

$\Delta v_{j,R}$ is the increase in speed of conflict j that results in a rollover,

$v_{j,M}$ is the speed during the FOT of conflict j at the peak lateral acceleration, and

$\Phi()$ is the Gaussian cumulative distribution.

The scaling factor, σ , was estimated to be 0.0010 in the independent evaluation [Battelle, 2003a, pages 5-36 through 5-40]. As an example, Equation 1 can be applied to the conflict that served as an example in the previous section. The probability of a crash, given that the conflict occurred, for a vehicle without the roll stability aid, is,

$$P_{no}(C | S_{1,j}) = 1 - \Phi\left(\frac{\Delta v_{j,R}}{\sigma \times v_{j,M}}\right) = 1 - \Phi\left(\frac{4.8}{0.0010 \times 1.1 \times 18.2}\right) = 1.53 \times 10^{-14}$$

The numerator in this equation, 4.8 mph, is the speed increment required for this maneuver to lead to a rollover. The value of 0.0010 is the variance scaling factor, and 1.1 is a units conversion factor. The final value in the denominator, 18.2 mph, is the speed of the vehicle, measured during the FOT, at which the lateral acceleration of the tractor's steer axle reached a peak value. The probability of this conflict resulting in a crash even without the aid is extremely small. Indeed, crashes are rare events, so the probabilities are expected to be remote, and this conflict is among the least likely to result in a rollover.

The second set of simulations, those where the truck was equipped with the aid, yielded a second set of speed increments, . The formula in Equation (4-1) was computed again to determine the probability that a truck equipped with the electronic stability aid would crash, given that it entered one of the 126 conflicts. Again as an example, Equation 4-1 can be applied to this same conflict to calculate the probability of a crash given this conflict for a truck with the aid

$$P_w(C | S_{1,j}) = 1 - \Phi\left(\frac{\Delta v_{j,R}}{\sigma \times v_{j,M}}\right) = 1 - \Phi\left(\frac{7.5}{0.0010 \times 1.1 \times 18.2}\right) \approx 0$$

Thus there were two numbers for each conflict—the probability of a truck without the aid rolling over and the probability of a truck with the aid rolling over.

The difference between these probabilities is the reduction in probability of a crash that is attributable to the electronic stability aid. With the appropriate scaling factors, the probabilities can be summed to determine the total probability of a crash, and multiplied by the number of miles driven by a given fleet, to estimate the number of rollovers the aid will prevent.

4.4.4 Benefits Formula

The prevention ratio is estimated as the ratio of the overall probability of a crash with the aid to the overall probability of a crash without the aid, both given that a driving conflict has occurred. The overall probability of a crash is estimated as the average probability of a crash given the 126 specific conflicts as described in the following equation,

$$PR = \frac{P_w(C | S_1)}{P_{w\â} (C | S_1)} = \frac{\frac{1}{126} \sum_{i=1}^{126} P_w(C | S_{1,i})}{\frac{1}{126} \sum_{i=1}^{126} P_{w\â} (C | S_{1,i})} = 0.47$$

(4-2)

The example illustrated in Section 4.4.2 is now one of the 126 elements in the sum. The value of Equation (1a) is one of the elements in the denominator, where the probability of a crash without the aid is summed. The value of Equation (5-1b) is one of the elements in the numerator. Expressing this equation in words, the probability of a rollover is 47 percent as high for a vehicle

equipped with the aid as it is for a vehicle without the aid. The benefit of the electronic stability aid, therefore, is that it is estimated to prevent about 53 percent of the rollovers resulting from excessive speed in a curve.

Note that this estimate is based on a model of an electronic stability aid as it existed in 2003. These devices have certainly been improved in the intervening years, so the estimate is a conservative lower bound.

4.5 Conclusion

Electronic stability aids can prevent rollovers in two ways. First is their direct intervention in slowing the vehicle as it enters a curve too quickly. But they can also have a training benefit if drivers are made aware of instances where they took a curve with a smaller safety margin than they should have. The training benefit was discussed in Section 3.4.2.

These aids can be inexpensively incorporated with the braking components that are already on modern heavy vehicles. Though they address only a particular kind of rollovers, those cases are a significant fraction of the overall rollover problem and electronic stability aids are quite effective in preventing them. Thanks to the vendors' marketing efforts, which include convincing motion pictures and opportunities to ride in equipped trucks, the devices are already gaining acceptance.

The devices require no training for the driver to use. However, there have been anecdotal reports of drivers complaining of a "loss of power in curves" and not recognizing the safety intervention. A prudent carrier certainly would advise drivers of the presence of the aids so the drivers would understand that a potentially dangerous event occurred and would know how to respond if the aid activated.

The simulation analysis predicted that 53 percent of the rollovers due to excessive speed in a curve can be prevented by the particular kind of electronic stability aid that was modeled. That number, along with the \$619 retail cost of the option, will serve as input to the benefit-cost analysis for these devices in Section 7. Because the prevention estimate was made with a model of a 2003 system and vendors are continuously improving their products, the estimate of the economic benefits of the system will be conservative.

5.0 Vehicle Design

Cargo tank vehicles, particularly semitrailers, tend to be more “top heavy” than other commercial vehicles. That is, they have a relatively high center of gravity, due to constraints on their design. For proper structural strength, the cross section of the tank must be rounded, either a circle or an oval. This shape lifts much of the payload well above the frame rails of the truck. At the same time, the width of the vehicle is limited both by regulation and by practicalities of delivery routes. Nevertheless, improvements are available to be made in the design of cargo tank vehicles to improve their inherent stability. The focus for this part of the study is to address the question: *what are the feasible tank and trailer design changes that can increase the rollover threshold of a tanker?*

5.1 Introduction

The approach was to hypothesize an initial set of design change options prior to contacting tank and trailer manufacturers, and use personal interviews to determine the likely feasibility and costs, both in terms of manufacture and operations. Basic mechanical principles show that rollover threshold is predominantly influenced by the ratio T/h_G [e.g., Winkler et al., 2000] where T is the mean track width and h_G is the height of the center of gravity of the trailer mass above ground – increasing T and reducing h_G reduces the likelihood of rollover in any particular circumstances. Reducing tire and suspension compliances and improving roll damping may also reduce the risk of rollover and are worthy of at least some consideration.

Regarding the desirable changes in T and h_G , there are only limited opportunities to change existing design practices, so the major part of this study is to establish in some detail where opportunities for change are indeed feasible:

- What structural design changes could be made to the trailer or the tank, and what would be the general cost implications?
- What changes could be made to tires and suspension to improve roll stability, and again what are the approximate cost implications?
- What operational constraints, if any, might limit the suggested design changes?

From the interview responses, feasible limits were determined and a number of representative cases extracted. In particular, representative cases of “modest” and “aggressive” design changes were considered for further analysis using simulation.

Roll stability benefits will also depend on the preponderance of cargo tank rollovers found in the field, so a smaller parallel activity was undertaken to gather representative crash data and suggest priorities based on the major tanker types involved; once again this helps focus the study on critical sub-classes of tanker. Based on the above, a small set of feasible design changes can then be prepared and a representative subset put forward for further cost-benefit analysis.

As stated above, it was considered essential to hypothesize a library of plausible design change options, to help achieve a consistent approach when dealing with very different tank trailer

organizations, particularly for structural design. The viable options considered are shown in the left column of Table 5-1, and involve:

- Lowering the center of gravity height of the tank (modest or aggressive – see below)
- Increasing the track width, either with or without increasing the tank width and hence allowing a simultaneous reduction in tank CG height
- Changing suspension type.

Table 5 - 1 Design Change Framework

| Design Options and Assumptions | Comments, Suggestions and Questions |
|--|--|
| 1. Lower the Center of Gravity of Tank Trailers | Lowering the center of gravity is perhaps the most effective way to improve roll stability of a vehicle. How much could the center of gravity of the tank be lowered by the following approaches? What would be the additional costs? How applicable are these changes? Who could use them? Who could not? |
| Modest design changes to lower the center of gravity of the tank trailers. | 1.1 Replace straight-bore tanks with conventional double conical tanks. 1.2 Use low profile 5th-wheel couplers and minimize the height of frame over suspension. |
| Aggressive design changes to lower the center of gravity of the tank trailers. | 1.3 Extreme double conical tank shapes. 1.4 Drop section tanks and/or low-profile tires on the trailer. 1.5 Are there other approaches? |
| 2. Increase Track Width and Tank Width | Widening the track width of a vehicle also improves roll stability. Wider vehicles might also allow lower tanks. For the following approaches, what are the additional costs? Are there weight penalties or advantages? Can tanks be lowered as a result? How much? |
| Assuming 102-inch width became legal on all roads: | 2.1 Replace dual tires with wide-base single tires. 2.2 Replace 96-inch axles with 102-inch axles. 2.3 Increase tank width from 96 to 102 inches |
| 3. Changes in Suspensions | Modern air suspensions typically provide better roll stability than the more traditional highway leaf-spring suspensions. To what extent have air-spring suspensions already replaced leaf-spring suspensions in your trailers? Are there either cost or weight penalties or advantages for using air-suspensions? |

Of course other approaches may be considered, but these three general areas seem the most likely and plausible. Options 2 and 3 in the table are self-explanatory, but in the case of reducing CG height, a number of options were considered possible, and these are developed in the following figures. Figure 5-1(a) shows the dimensions of a standard DOT 406 trailer for gasoline transport, with a 9500 gallon oval-section tank; assuming a specific gravity of 0.7 for (gasoline) content, the gross loaded trailer weight is 63,300 lb and the CG height is 77.3 inches. Two simple variations are then considered, either keeping the basic oval tank unchanged (case (b)) or additionally employing a tapered cross section that increases the tank diameter in the central portion of the tank (case (c)).

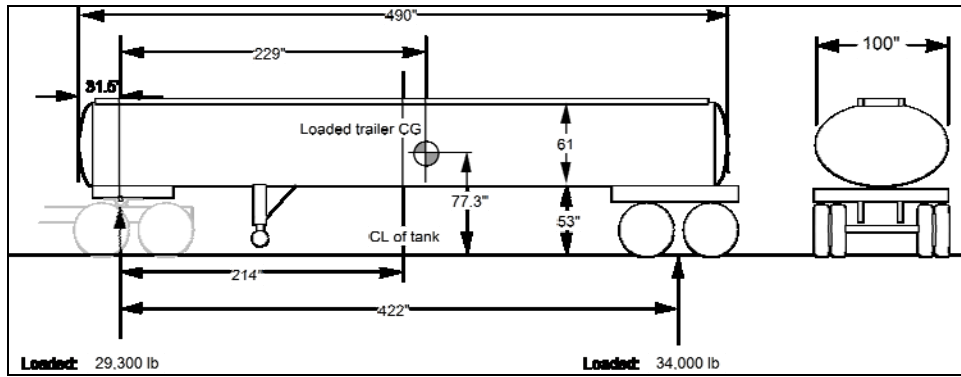

Figure 5 - 1(a) Standard Case (406 oval tank, CG height 77 inches)

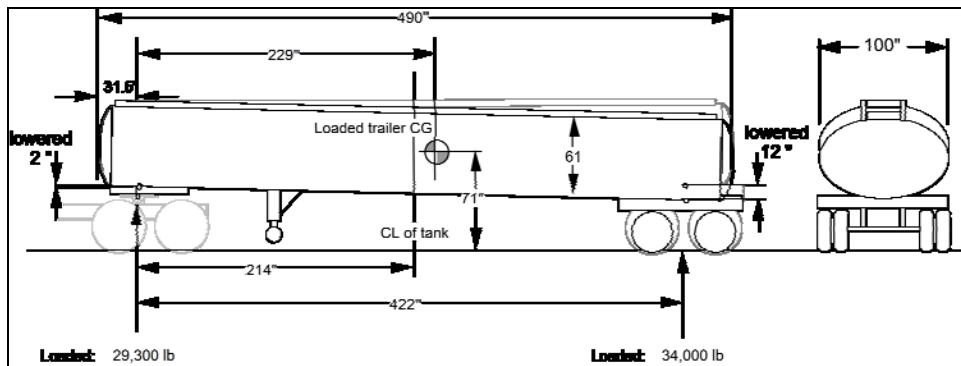

Figure 5 - 1(b) Tank Lowered, No Change to Tank Geometry (CG height 70 inches)

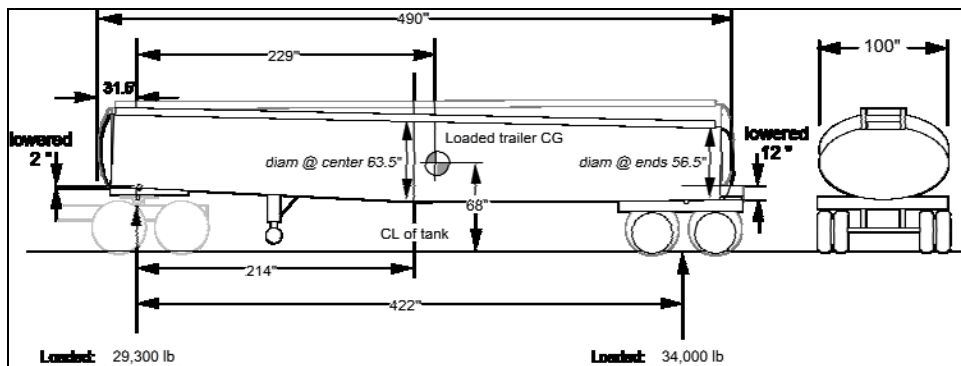

Figure 5 - 1(c) Tank Lowered, Tapered Tank Design (CG height 68 inches)

In case (b) the reduction in CG height is achieved by developing a low-profile 5th wheel (with an estimated 2 inch height reduction at the front of the tank) and low profile tires (215/75R17.5J tires) at the rear, which would enable around 8 inches of height reduction. Adding to this a reasonably compact design to integrate the trailer frame rail with the tank support frame might reduce the rear mounting of the tank by a further 4 inches, giving an expected 12 inches reduction overall at the rear – see Figure 5-1(b). In case (c), a modest geometric change is also proposed, with the central tank diameter some 12 percent larger than at the ends.

Figure 5-2 shows similar design possibilities in a DOT 412 trailer used to transport hazardous waste, acids, or other chemicals. Here the tank has a circular section and the fixed 5200 gallon fluid is assumed to have a specific gravity of 1.2. The results are essentially the same, except

that a further case is considered – in case (d) the cylindrical tank is assumed to hang down between the supporting axles, while maintaining a maximum clearance of 22 inches above the ground (12 inch legal minimum ground clearance per 49 CFR 178.345-8(a)5 plus an estimated 10 inches for pipes and valves). In this case there is clearly no purpose in using a low profile 5th wheel or tires, and the potential reduction in CG height is quite impressive (from 77 inches to 61 inches).

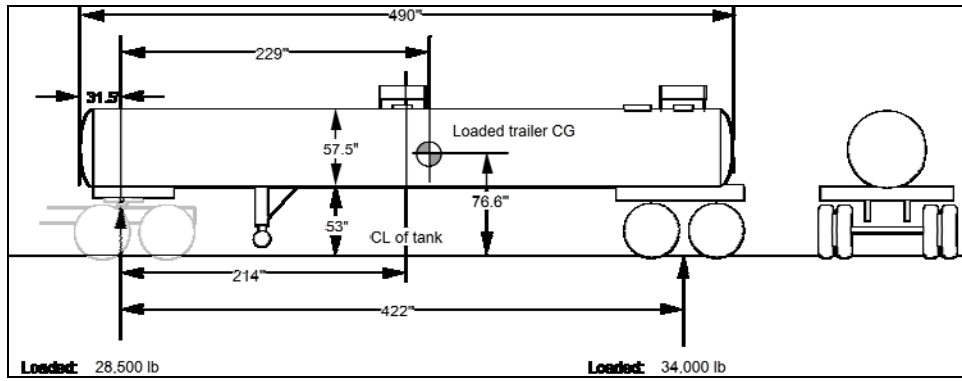

Figure 5 - 2(a) Standard Case (412 circular tank, CG height 77 inches)

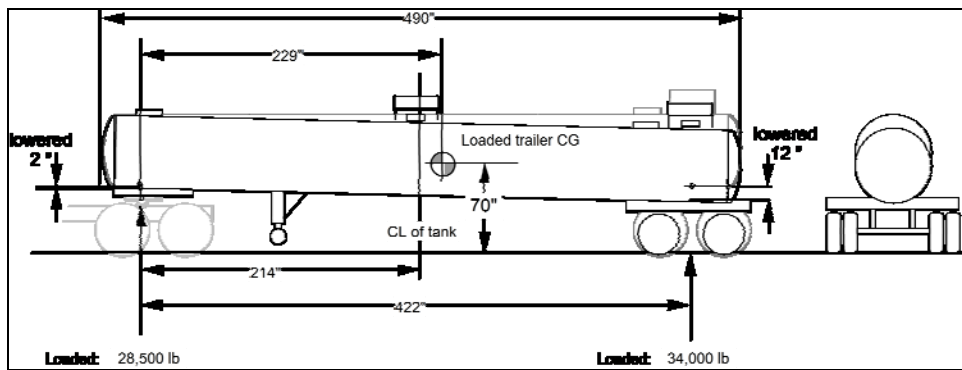

Figure 5 - 2(b) Tank Lowered, No Change to Tank Geometry (CG height 70 inches)

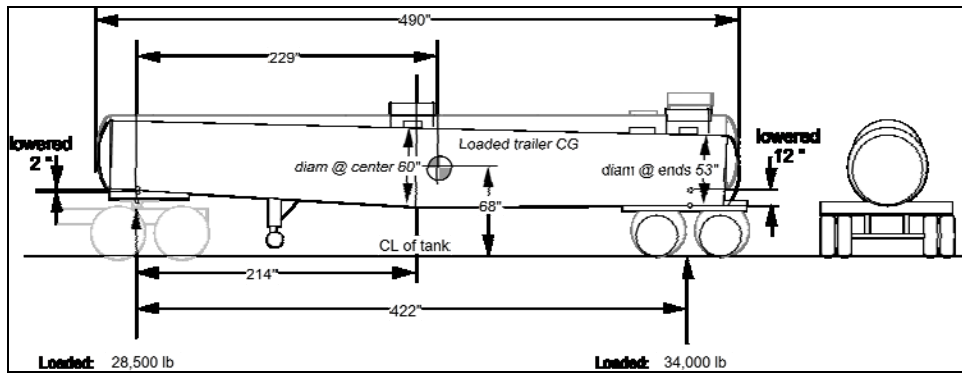

Figure 5 - 2(c) Tank Lowered, Tapered Tank Design (CG height 68 inches)

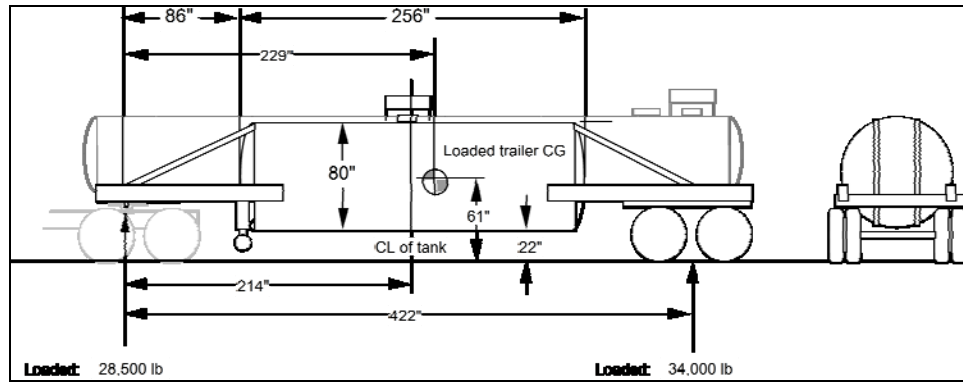

Figure 5 - 2(d) Tank Lowered, Aggressive Drop Design (CG height 61 inches)

5.2 Interviews and Results Summary

Interviews were conducted with some of the largest cargo tank trailer manufacturers in the United States, some medium and very small manufacturers, and representatives of other stakeholders. The aim was to gather information from diverse, experienced viewpoints. To maximize the consistency of responses, an initial framework for possible design changes was undertaken ahead of the interview. The information in Table 5-1 was sent to each of the organizations. Table 5-2, in a similar format, has a digest of the responses.

Table 5 - 2 Interview Response for Design Options

| Design Options and Assumptions | Comments and Suggestions |
|--|--|
| 1. Lower the Center of Gravity of Tank Trailers | |
| 1.1 Replace straight-bore tanks with conventional double conical tanks. | For Gasoline tankers a double <i>taper</i> tank is becoming accepted, with center heights reduced in the range 5-10 inches. Double conical relatively rare but feasible. |
| 1.2 Use low profile 5th-wheel couplers and minimize the height of frame over suspension. | At least two manufacturers produce a trailer that uses this general approach, together with an increased tank width, but without the low profile tire option. It is feasible though not especially popular with customers. Manufacturing issues for smaller companies in integrating tank support and trailer frame rails. Some concern over 5 th wheel kingpin flexibility and fore-aft load transfer. |
| 1.3 Extreme double conical tank shapes. | Feasible but there is some operational resistance to reducing the tank bottom more than 10 inches. In any case 30 inches may be a practical limit on ground clearance. In some cases the double-conical has been applied for packaging advantage, rather than stability improvement. |
| 1.4 Drop section tanks and/or low-profile tires on the trailer. | Possible, and has the advantage of allowing circular section drop tanks. Structural integrity of complex tank geometries a concern for smaller manufacturers. Low profile tires on the tractor also likely to be required (though feasible). Lowering only the rear of the tank, as in Figure 5-1(b), will prevent gravity draining a compartmented tank, so the design will not be accepted by carriers of finished petroleum products. |
| 2. Increase Track Width and Tank Width | |
| 2.1 Replace dual tires with wide-base single tires. | Many advantages if triple rear axle used, but currently only low sales volumes. |
| 2.2 Replace 96-inch axles with 102-inch axles. | Feasible and best case of "low hanging fruit" if legislation permitted on all road classes. |
| 2.3 Increase tank width from 96 to 102 inches | Feasible, but limited appeal currently to operators. Extreme tank ovality may be a problem for manufacturing and structural stiffness. |
| 3. Changes in Suspensions | |
| | Air and composite leaf springs already common – little scope for improvement over current use (on new trailers). Air suspension popular for ride quality and height control on discharge. |

5.3 Tank and Trailer Design Change Analysis

Based on the above considerations, a detailed computational analysis was carried out to estimate the effect on center-of-gravity heights for a number of feasible and representative design changes. *Initially it was assumed that improvements would be made simply from tank shape changes.* The oval tank case was considered, though as seen above the results for circular

section tanks are very similar. Five feasible cases of “double taper” oval tanks were analyzed based on the “center drop” parameter, defined as the difference between the maximum and minimum vertical diameters of the tank. The tank width was kept constant (to fully utilize the available lateral space, either at the standard 96 inches or the wider 102 inches). With the tank length, volume, and width all fixed (see data in Table 5-3) the center drop parameter fully defines the tank geometry. A final constraint is for the mounting heights at the front and rear of the tank – the standard 53-inch tank mounting height is assumed to be applied at reference points 60 inches longitudinally from the end of the tank.

**Table 5 - 3 Basic Assumptions for a DOT406
Semitrailer Design Case**

| Parameter | Value | Units |
|--|-------|---------|
| Fluid (gasoline) volume | 9,500 | gallons |
| Tank wall thickness | 1 | inch |
| Reference point on tank base: height about ground | 53 | inches |
| Reference points on tank base: longitudinal distance from tank ends | 60 | inches |
| Length of tank | 460 | inches |

Table 5 - 4 Tare Weights and Mass Center Heights

| | wt, lb | CG ht, in. |
|--------------|--------|------------|
| axles | 3,600 | 20 |
| landing gear | 500 | 35 |
| 5th plate | 500 | 50 |
| bogy | 800 | 45 |
| heading | 200 | variable |
| tank | 7,500 | variable |
| Total Empty | 13,090 | |
| Sprung Empty | 9,490 | |

The data for the straight-tank cases were derived from a combination of information from the manufacturers’ archive data, and from UMTRI files on geometric measurements of 406 tanks, as well as experiential knowledge of the weights and heights of trailer components – UMTRI has previously partially or totally disassembled trailers for mass measurements. Estimates for all the tapered cases derive from modification of the straight-tank case. The 5-, 8-, and 10-inch center drop cases have been seen in production and can be considered to define a range of typical and modest center of gravity (CG) reduction options. The “aggressive” case of the 26.4-inch center drop corresponds to a 30-inch ground clearance at the tank center, previously noted as a practical lower limit.

The CG height of the cargo was calculated using a spreadsheet “integration” in which the tapered tank is defined by its length, width, center drop, and volume – plus base height as described above. (To be more precise the volume is calculated from the other parameters, and an iterative

selection of tank height is used to derive the prescribed volume.) In the spreadsheet, the double taper tank is “cut” into 200 oval sections, the mass and CG height of each section is calculated, and the results are summed.

Table 5-5 presents the results of these five cases for 96-inch-wide semi tankers and for 102-inch-wide semi tankers, where in the latter case, the tank is assumed to have been widened as well as the running gear.

Table 5 - 5 Heights – Oval Tank Geometry Change Only (height above ground in inches)

| Tank | | Top of Tank | Center of Gravity of | | |
|----------|----------------|-------------|----------------------|--------|-------|
| | | | Tank | Sprung | Total |
| 96 x 65 | straight | 117.0 | 85.0 | 82.6 | 79.0 |
| 96 | 5-inch drop | 115.2 | 83.1 | 81.0 | 77.5 |
| 96 | 8-inch drop | 114.0 | 82.0 | 80.1 | 76.6 |
| 96 | 10 inch drop | 113.3 | 81.2 | 79.4 | 76.0 |
| 96 | 26.4-inch drop | 107.4 | 74.9 | 74.1 | 71.0 |
| | | | | | |
| 102x60.5 | straight | 113.5 | 83.2 | 81.1 | 77.6 |
| 102 | 5-inch drop | 111.6 | 81.4 | 79.6 | 76.1 |
| 102 | 8-inch drop | 110.5 | 80.2 | 78.6 | 75.2 |
| 102 | 10 inch drop | 109.8 | 79.5 | 78.0 | 74.6 |
| 102 | 26.4-inch drop | 103.4 | 72.8 | 72.4 | 69.4 |

Many combinations of feasible design changes are clearly possible, and a complete set will not be presented here. However, it is worth considering the effect of the modest and more aggressive changes to tires and frame considered above, where a compact fifth wheel installation may be combined with structural integration of the tank carrier with the trailer frame rails. Additional height reductions are also possible using low-profile tires, and these are all summarized in Table 5-6, where the basic tank design has been chosen as the modest 10-inch center drop. In the case where a wide track is combined with frame optimization and low-profile tires, a marked reduction in CG height is achieved, from the original 79 inches down to 62.9 inches, and without any radical change in tank geometry.

Table 5 - 6 Heights – 10 inch Center Drop Case from Table 3-6 with Additional Frame Height Reductions (height above ground in inches)

| 96-inch tank with 10-inch drop (59:69 inside minor diameters) | | | | | |
|--|------|------------------------------|------|--------|-------|
| | | Heights above ground, inches | | | |
| Lower tank, inches | | center of gravity | | | |
| Front | Rear | top of tank | tank | sprung | total |
| 3 | 4 | 110.3 | 77.7 | 75.9 | 72.7 |
| 3 | 12.4 | 110.3 | 73.5 | 71.7 | 68.4 |
| 11.4 | 12.4 | 101.9 | 69.3 | 67.5 | 64.5 |
| 102-inch tank with 10-inch drop (59:69 inside minor diameters) | | | | | |
| | | Heights above ground, inches | | | |
| Lower frame by inches | | center of gravity | | | |
| Front | Rear | top of tank | tank | sprung | total |
| 3 | 4 | 106.8 | 76.0 | 74.2 | 71.0 |
| 3 | 12.4 | 106.8 | 71.8 | 69.9 | 66.8 |
| 11.4 | 12.4 | 98.4 | 67.6 | 65.8 | 62.9 |

5.4 Estimate of Benefits

Several possible design modifications to improve the roll stability of cargo tank trailers have been discussed. A commercially available computer model was used to estimate the roll threshold of the three selected cases for use in the benefit-cost analysis of Section 7. This roll threshold was then used to estimate the number of crashes that could be prevented compared to the nominal case.

5.4.1 Approach

The nominal design case and three proposed improved designs were modeled in a commercial simulation package. The four vehicles were simulated as they drove through a curve of constant radius at increasing speed. The point at which the simulated vehicles rolled over was used to estimate the roll threshold of the four designs in a simple maneuver. Then these four thresholds were used, along with historical rollover crash data, to quantify the expected rollover rates of the vehicles. Comparisons of the rollover rates were carried forward to the benefit-cost analysis in Section 7.

An alternative approach to estimating the rollover reductions from the proposed designs would have been to simulate a representative set of maneuvers with all four vehicle models and to compare their crash rates. This approach was actually taken to evaluate the effectiveness of the electronic stability aids, as described in Section 5.4. This alternative approach was appropriate

for the electronic stability aids because their effectiveness is limited to untripped rollovers (i.e., those arising from maneuvering too quickly), and a representative set of maneuvers to evaluate them was already available. Improvements in the basic stability of the vehicle are expected to reduce rollovers arising from all causes, tripped and untripped. No set of roll-inducing maneuvers that includes a representative mix of trips from guardrails, embankments, and other vehicles is available. On the other hand, the relationship between basic vehicle stability and rollover involvement, as evidenced in crash statistics, has been calculated, as is explained in Section 5.5.3. As this relationship accounts for rollovers arising from all causes, it is appropriate to use.

5.4.2 Vehicle Model and Simulation Methodology

The nominal and modified vehicles were modeled in a commercially available simulation tool, VDANL, which was described in Section 4.4.1. The basic VDANL model contains a number of parameters for describing a complete tractor-semitrailer combination. These parameters are easily modified from the base case to simulate the designs that are being studied. The design modifications being studied in this analysis are the height of the trailer and its track width. Table 5-7 shows the four cases that were simulated and the associated values that changed from case to case. All parameters not listed in the table remained the same between cases. These parameters were selected from the cases in Table 5-5. The “nominal” case is the first row in the table, a straight tank on a 96-inch wide chassis. The “Lower CG” case is the “10-inch drop” line in the Table 5-5, and the “aggressive” case is the 26.4-inch drop. The “wider track” case in Table 5-7 is identical to the “nominal” case but with the track widened on both trailer axles by six inches. It does not correspond to any of the cases in Table 5-5 and does not take advantage of the opportunity to lower any of the mass, so the improvement in roll threshold is conservative.

Table 5 - 7 Properties of the Four Design Cases as they were Simulated

| | Nominal | Lower CG | Wider Track | Aggressive Improvement |
|--|----------------|-----------------|--------------------|-------------------------------|
| Trailer Sprung CG height | 82.6 | 79.4 | 82.6 | 74.1 |
| Trailer Sprung CG mass | 59,800 | 59,800 | 59,800 | 59,800 |
| Trailer UnSprung CG height | 18 | 18 | 18 | 18 |
| Trailer UnSprung CG mass | 3,600 | 3,600 | 3,600 | 3,600 |
| Track Width (all 5 axles) | 96 | 96 | 102 | 96 |
| Calculated trailer total CG height | 78.9 | 75.9 | 78.9 | 70.9 |
| Note: Masses are in pounds, lengths are in inches. | | | | |

A constant-radius, increasing speed maneuver was simulated to estimate the roll threshold of the four vehicles. The simulation began with the truck motionless on a large flat surface. The driver model was commanded to follow a constant radius circle as the vehicle slowly increased in speed. The driver model would continue to attempt to hold this curvature as the truck reached higher speeds. At a sufficiently high speed, the lateral acceleration would become great enough that the vehicle could no longer sustain the maneuver and the truck would roll over.

Figures 5-3 and 5-4 show representative data from a simulation. Figure 5-3 simply shows that the speed increased linearly as the simulated truck drove in a circle. Figure 5-4 is the time history x-y coordinates of the trailer's center of gravity, illustrating the constant radius maneuver from a bird's eye view.

The data were then analyzed to determine at what dynamic state the vehicle encountered a rollover. This process was repeated for all four cases. In addition, each case was modeled while negotiating constant-radius circles of several sizes in order to generate several data points to use in correlation with available rollover data. The two data points of primary interest were the forward velocity and instantaneous curvature in the trailer's path at the moment of rollover. These two quantities could be used to calculate rollover threshold according to the following relationship:

$$T_r = \frac{V^2}{r \cdot g} \tag{5-1}$$

Where:

- T_r = Rollover Threshold, g
- V = Velocity at Rollover, ft/s
- r = radius at rollover, ft
- g = gravitational acceleration (32.2 ft/s²).

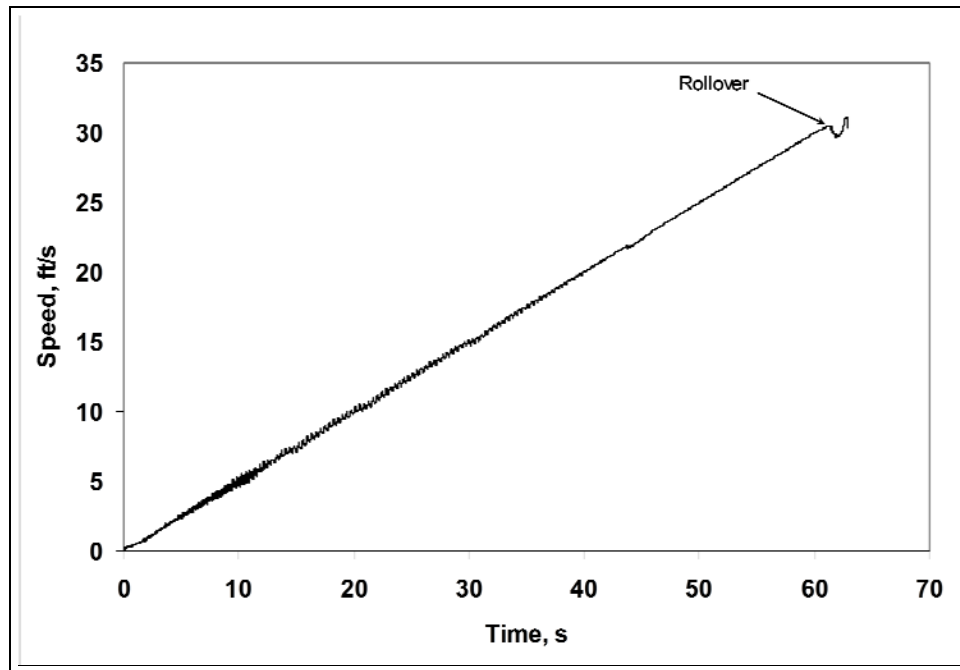

Figure 5 - 3 A Constant-radius, Increasing Speed Maneuver was Simulated to Estimate the Rollover Threshold of the Nominal Trailer Design and Three Proposed Improvements

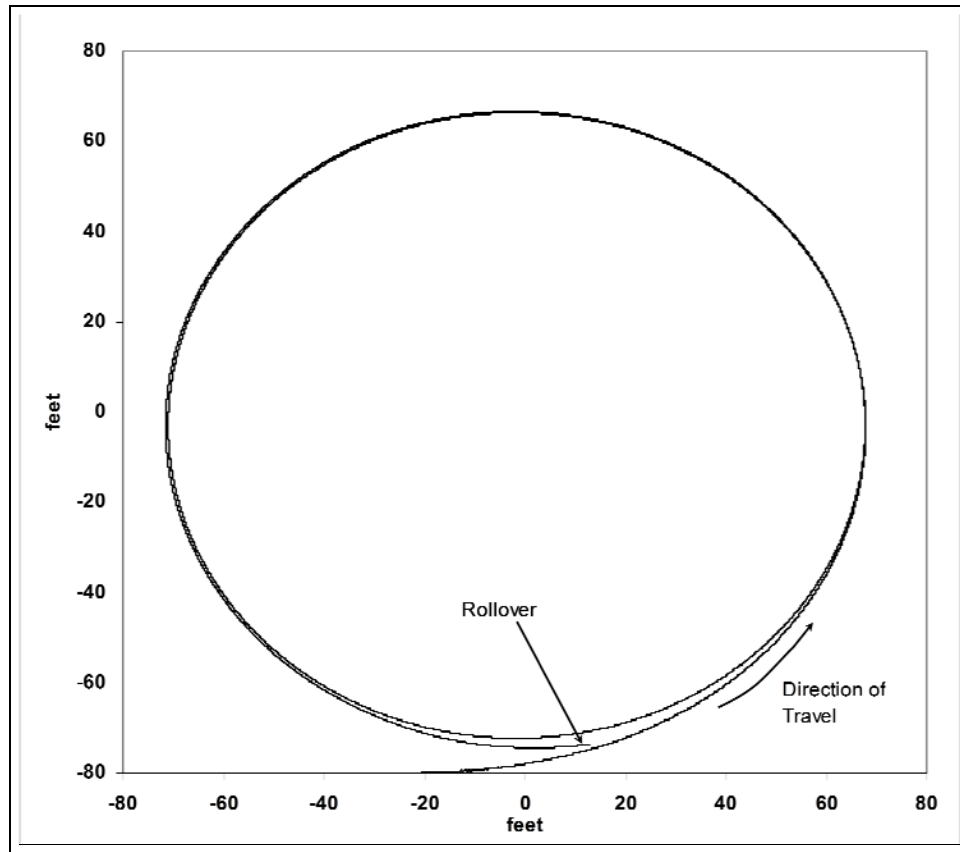

Figure 5 - 4 Time History of Trailer's Path in the Simulated Maneuver

Table 5-8 lists the roll thresholds of the nominal and three improved designs. All designs were simulated in circles of 50- and 75-ft radius. The 75-ft values are more realistic, in part because the driver model is better able to hold the desired curvature. Only the 75-ft nominal radius values were used for further calculation.

Table 5 - 8 Roll Thresholds of the Nominal and Three Improved Designs, as Calculated from the Simulation

| Case | Loaded trailer CG height, in. | Trailer track width, in. | Velocity at rollover, ft/s | Instantaneous radius of the trailer's path at rollover, ft | Roll threshold, V^2/r , g |
|------------------------|-------------------------------|--------------------------|----------------------------|--|-----------------------------|
| Nominal | 78.9 | 96 | 30.5 | 69.1 | 0.418 |
| Lower CG | 75.9 | 96 | 31.1 | 68.1 | 0.441 |
| Wider Track | 78.9 | 102 | 31.4 | 67.9 | 0.451 |
| Aggressive Improvement | 70.9 | 96 | 34.7 | 77.9 | 0.480 |

5.4.3 Estimate of Reduction in Rollovers

The solid curve in Figure 5-5 is based on historical crash data. It is taken from Winkler et al. [2000], where it is Figure 5 on page 5. (The scale is different here because the book uses metric units.) The formula is calculated from a series of rollover crash databases, as explained in Appendix C of that book. It quantifies the rate at which vehicles are involved in rollover crashes and how the rate decreases as the roll stability of the vehicle increases.

The lines in the figure show how the roll rates for the respective trailer designs are estimated from their roll thresholds. The thicker solid line on the figure begins on the x axis at the roll threshold of the nominal case, which is 0.418 g in Table 5-8. The line rises to the solid curve and then moves to the left, where it meets the vertical axis at the value of 0.388. This means that, based on historical crash data, a truck with a roll threshold of 0.418 g would be expected to experience 0.388 rollovers in one million miles (or 388 rollovers in one billion miles). These two numbers appear in the first two columns of Table 5-9.

The finely dotted line in Figure 5-5 is labeled LCG because it represents the trailer with a slightly lowered CG. It begins at 0.441 g on the x axis and ends at 0.441 on the y axis. Lowering the CG from 82.6 in. to 79.4 in. (Table 5-8) raises the roll threshold from 0.418 g to 0.441 g (Table 5-8). According to Figure 5-5, raising the roll threshold by this amount lowers the expected crash involvement from 0.388 to 0.342 rollovers per million miles of travel. The ratio of predicted rollover rates is $0.342/0.388$ or 0.88. That means, for every 100 rollovers of a nominal trailer (CG height is 82.6 in.), the Lower CG trailer (CG height is 79.4 in.) would experience only 88 rollovers. That is a 12 percent improvement because $100 - 88$ is 12. These are the numbers in the next two columns of Table 5-9.

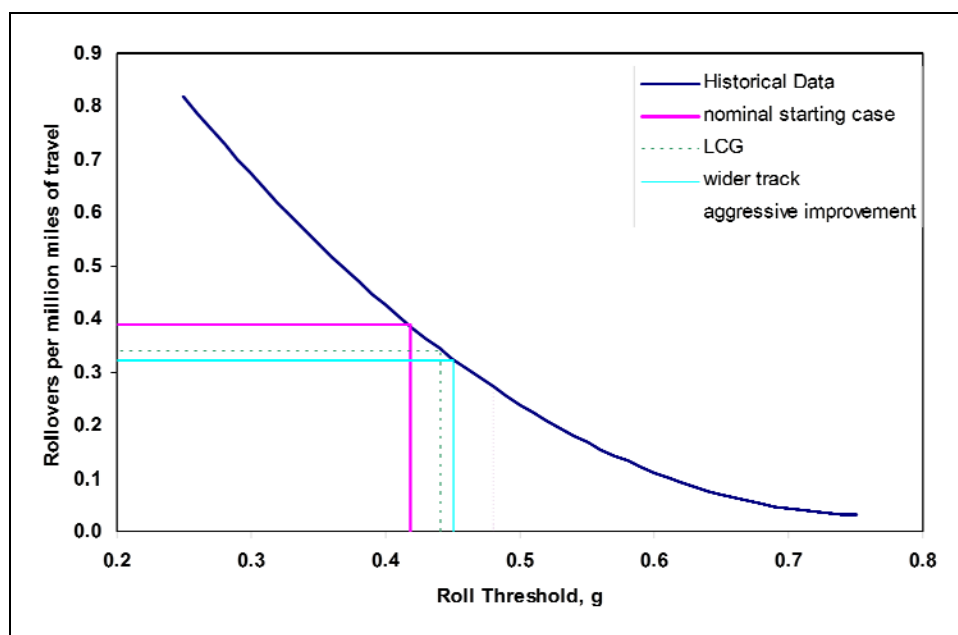

Figure 5 - 5 Expected Rollover Rates for the Four Tank Designs, as Predicted from Estimates of Historical Crash Rates

In Figure 5-5, the fine, solid line represents the roll threshold and expected crash rate for the trailer with a 102-in. track width. The dot-dash line represents the trailer with the aggressive improvement in CG height.

Thus we have used a computer simulation in Section 5.4.2 to estimate the rollover threshold of each vehicle, and we used historical crash data in this section to predict the rollover frequency. All subsequent analysis will be based on ratios, or comparisons to the nominal case, so the minor assumptions required in the analysis are taken out. The numbers in Table 5-9 were carried forward to Table 7-4 for the benefit-cost analysis in Section 7.

The improvements will be considered only individually, not in combination. If a certain portion of the market has already adopted the improvement, then the cost and benefit will be applied to only the remaining portion. Similarly, if a certain portion of the market cannot adopt an improvement, its costs and benefits are excluded, too. This is the case for carriers who deliver gasoline to stores with limited maneuvering room and who cannot tolerate any extra width to their trailers.

Table 5 - 9 Estimated Rollover Rates of the Nominal and Three Improved Semitrailer Designs

| Case | Roll Threshold, g (from Table 5-8) | Estimated Rollover Rate | | | Cost Premium (from Manufacturer Interviews) |
|------------------------|------------------------------------|---|---------------------------|---|---|
| | | Rolls per Million Miles (from Figure 5-5) | Ratio to the Nominal Case | Reduction, Compared to the Nominal Case | |
| Nominal | 0.418 | 0.388 | 1.00 | -- | -- |
| Lower CG | 0.441 | 0.342 | 0.88 | 12% | \$1500 to \$4000 |
| Wider Track | 0.451 | 0.323 | 0.83 | 17% | \$150 to \$800 |
| Aggressive Improvement | 0.480 | 0.272 | 0.70 | 30% | About \$12,000 |

5.5 Conclusion

Feasible approaches to improving the roll stability of cargo tank trailers are already on the market. The advantages of a wider track width (i.e. 102 instead of 96 inches) are appreciated by many, but the benefits of a lowered tank are not as widely recognized. A significantly lowered tank is feasible from an engineering perspective, but is limited by loading rack standards and, more fundamentally, by the drivers' ability to repeatedly bend down to operate them.

Analysis largely focused on structural design changes ranging from modest (e.g., reducing the mean height of the tank by slightly increasing its central diameter) to aggressive (either by radical tank re-design or through a combination of changes to tank, support structure and low profile tires). It is interesting to note that several of the options proposed had already been developed and tested in some form or other. Results for circular and oval tank shapes were very similar, and results presented are for the oval (gasoline) tanker design. Track width increases are feasible, and both manufacturers and operators are receptive to this approach if standards were to permit legal use on all classes of highway. Change in suspension is not a major source of

potential benefit, since air springs are almost universally purchased now. No “other approaches” were suggested in the investigation, leaving just two relatively obvious and major methods of reducing rollover risk by mechanical design: making structural (and tire) alterations to lower the mass center, or increasing the track width, or both. Overall, significant reductions in CG height are feasible compared to current standard designs.

Of the several designs considered, three were selected for a quantitative benefits analysis and inclusion in the economic analysis of Section 7. The model with the modest improvement in the lower center of gravity is similar to a model actually sold by at least two manufacturers. Its cost premium over conventional trailers ranges from \$1,500 to \$4,000, depending on other factors. In Section 7, this modification will be assigned a cost of \$2,000. The aggressive improvement in center of gravity height was estimated by its manufacturer to cost an additional \$12,000. Trailers with wider tandem axles are also on the market as existing products. Manufacturers quoted cost premiums ranging from \$150 to \$800 for 102-inch-wide tandems. The assumed cost in Section 7 is \$500, which was the quote from one manufacturer. The expected benefits of these three trailer modifications are in Table 5-9.

This Page Intentionally Left Blank

6.0 Highway Design

Some rollovers occur in part due to features of the highway itself. Traffic patterns or mixes may have changed since the highway was designed, or drivers unfamiliar with the route may not appreciate the nature of the care required to negotiate a certain segment of the road. This portion of the project undertook the nationwide identification of site-specific elements that may contribute to rollover crashes. The question being answered in this section is “*What lessons can be learned from the ways that difficult geometrics have been handled in the past?*”

6.1 Introduction

Two national databases were used to identify sites of high rollover incidence: the Motor Carrier Management Information System (MCMIS) Crash file and the national Highway Performance Management System (HPMS) database for the years 2003 and 2004. The states with “top-ranking” rollover crash experience, when normalized by the number of road miles per county, were Florida, Illinois, Pennsylvania, and Wyoming. The rollovers in these states geo-located using linear referencing data, and crash clusters were identified. Those states with site-specific crash clustering were Florida and Wyoming. While Illinois and Pennsylvania ranked high due to crash numbers, the crashes did not cluster at specific sites. The Wyoming Department of Transportation (WYDOT) provided the road plans for the cluster sites and supplemental information about past and ongoing improvement measures.

6.2 Site Selection

The search for highway sites with a large number of rollovers began with the MCMIS Crash file. It was selected because it is the only national crash file that both allows crash locations to be identified and includes nonfatal rollovers. UMTRI’s TIFA file can be used to identify specific locations, but the TIFA file is limited to fatal crashes, so the number of rollovers is not sufficient to efficiently identify rollover clusters. There are about 650 fatal truck rollover crashes annually and the rollover is the first event in fewer than 200 of them. Even combining multiple years of data would not result in a sufficient sample to effectively identify clusters. In the two years of the MCMIS Crash file data, there were almost 5,100 first-event rollovers.

The MCMIS Crash file is compiled by the FMCSA from reports by the states of truck and bus crash involvements that meet a specific crash severity. Table 6-1 provides the reporting criteria. The file essentially covers all serious truck and bus crash involvements, though, as will be discussed below, it is known that reporting to the MCMIS Crash file is incomplete. States are required to report a relatively limited set of data about each involvement, though the data are adequate for the purposes here. These data include a simple vehicle configuration variable, which distinguishes trucks from buses and identifies the primary truck configurations; the state and county of the crash; the crash location in the form of a text string in which the states identify the location by any method; and a set of variables that capture the sequence of events. Rollovers that occur as the first event in the crash can be identified, as the MCMIS file includes data fields for the sequence of events.

Table 6 - 1 Vehicle and Crash Severity Threshold for MCMIS Crash File

| | |
|-----------------|--|
| Vehicle | Truck with GVWR over 10,000 or GCWR over 10,000, or Bus with seating for at least nine, including the driver, or Vehicle displaying a hazardous materials placard. |
| Accident | Fatality, or Injury transported to a medical facility for immediate medical attention, or Vehicle towed due to disabling damage. |

The MCMIS Crash file is known to suffer from significant underreporting of cases. UMTRI has evaluated reporting rates for a number of states, and shown that reporting varies widely. Overall, it appears that less than 70 percent of reportable cases are reported, with rates varying by state from 9 percent to about 83 percent [see Green et al. 2005a and 2005b for a representative sample]. The UMTRI evaluations have shown that reporting typically varies by crash severity. The more serious crash involvements are more likely to be reported. Trucks are more likely to be reported than buses, and large trucks are more likely to be reported than small trucks.

However, these defects do not significantly constrain the purpose for this project. The goal here is to identify locations with a high number of rollovers. The reporting bias that has been demonstrated in MCMIS does not prevent this, since the underreporting that has been found is not biased against high-crash locations. In fact, rollovers are actually more likely to be reported than non-rollovers, since a rollover crash is much more likely to be serious. Moreover, there is no reason to think that crashes that occur in clusters are less likely to be reported than other crashes. Non-reporting might limit sample size, but should not bias the identification of rollover clusters.

The goal of this exercise is to identify clusters of truck rollover crashes. A cluster of rollovers may indicate that some characteristic or condition of the infrastructure increases rollover risk. Roadway curvature, lane width, shoulder construction, super-elevation, profile, and improper signage may all contribute to rollovers at a specific location. Note that a cluster does not necessarily indicate a roadway problem. The site may experience higher exposure to high-risk truck configurations or just a higher volume of traffic. Location of an industrial facility or terminal that increases truck traffic at certain sites may also result in more rollovers. The data available in the MCMIS Crash file is not sufficient to sort out the different risks associated with rollover. Nevertheless, identifying clusters of rollovers is the first step to identifying infrastructure characteristics that contribute to rollover.

Two years of the MCMIS Crash file were combined to improve the ability to identify high-rollover locations. Crash files for 2003 and 2004 were used. These were the most recent years available at the time the work was performed. The file was filtered to subset only rollovers that occurred as the first event in the crash sequence. First-event rollovers, rather than those that

follow a collision event, are the most likely to be related to roadway characteristics. All cargo body types and truck configurations were included. Tractor-semi-trailers and tank cargo bodies are more likely to roll more than most other truck combinations, and since the goal is to identify high-risk locations, there is no reason to exclude the rollovers of lower-risk vehicles.

We attempted to increase the chances of identifying rollover clusters by normalizing the number of rollovers by road miles. The logic is that counties that have an unusually high number of rollovers per mile of roadway are more likely to have locations with large numbers of rollovers. Rollovers were counted in the MCMIS Crash file for each county in the country. Estimates of the number of road miles were obtained from the FHWA HPMS data. The number of rollovers per mile of roadway was calculated for each county, by dividing the number of rollovers that occurred over a two-year period by the total number of road miles in the county. The fifty counties with the highest number of rollovers per mile of roadway were identified for further investigation. The twelve top counties are shown in Table 6-2.

Table 6 - 2 The Counties with the Highest Heavy Vehicle Rollover Rates

| Top Ranking Rollover Crashes Ranked by County All Rollover Crashes Were Normalized by the number of road miles in that county | | | | | | | |
|--|--------------|--------------|---------------------|-------------------|---------------------|-------------|----------------------|
| Ranking | State | County Name | State County | Rollovers Crashes | Crashes Geo-located | Total Miles | Rollovers Normalized |
| 1 | Illinois | Cook | IL31 | 80 | 75 | 1872.92 | 0.04271 |
| 2 | Florida | Duval | FL31 | 37 | 31 | 528.36 | 0.07003 |
| 3 | Florida | Polk | FL105 | 30 | 5 | 588.74 | 0.05096 |
| 4 | Florida | Palm Beach | FL99 | 28 | 8 | 701.89 | 0.03989 |
| 5 | Florida | Hillsborough | FL57 | 28 | 8 | 720.05 | 0.03889 |
| 6 | Florida | Broward | FL11 | 28 | 6 | 722.4 | 0.03876 |
| 7 | Wyoming | Platte | WY31 | 25 | 24 | 219.77 | 0.11376 |
| 8 | Pennsylvania | Luzerne | PA79 | 24 | 11 | 554.81 | 0.04326 |
| 9 | Pennsylvania | Berks | PA11 | 23 | 11 | 500.29 | 0.04597 |
| 10 | Wyoming | Carbon | WY7 | 23 | 22 | 515.26 | 0.04464 |
| 11 | Wyoming | Laramie | WY21 | 22 | 20 | 389.52 | 0.05648 |
| 12 | Wyoming | Albany | WY1 | 21 | 21 | 308.97 | 0.06797 |
| Total Rollover Crashes Counties – TOP 12 Counties | | | Total Crashes/ Mile | 369 | 242 | 7622.98 | |
| Percent Geo-located | | | | | 65.58% | | |

While the MCMIS file contains crash location by road name, the record does not include latitude/longitudinal coordinates needed to geo-locate the crashes. The MCMIS field for denoting crash location varies widely, with some states including very specific information while others include broad information or leave the field blank. Knowing precisely where the crashes occurred is essential to identifying clusters and examining the road geometrics.

Using the top fifty ranking counties, the state departments of transportation or traffic crash records offices were contacted to get supplemental information to geo-locate the crashes identified through the MCMIS records. Illinois, Florida, Pennsylvania, and Wyoming provided their official state crash records for the identified crashes. These records contained information allowing for the geo-location of the crashes. In addition to these crash records, states provided information on how to reference the crashes using the geographically referenced state base-map of their public road system. The method and type of information needed to locate the crashes varies among the states and required the coordination of various data sources to geo-locate the crashes.

With the crashes geo-located, clusters were identified. For the purpose of this project a “cluster” was defined to be a location where two or more crashes occurred in 2003-04, along the same section of roadway and within approximately a half mile of each other. This crash clustering criterion was necessary to establish whether the geometrics of the roadway experienced by the driver prior to the crash had any potential influence on the crash event. While there were numerous clusters observed, for example at an interchange, there were many cases the crashes were on different ramps of the same interchange and could not have been caused by the same design element. With the cluster criteria applied, only Florida and Wyoming experienced clustering to suggest that further investigation was warranted. Wyoming crashes that cited “high-severe wind effects” as crash causation were filtered out. This reduced the number of Wyoming crashes to 36. This subset was then examined, and three clusters were identified for detailed study.

Department of Transportation representatives in Wyoming were contacted and details of the research project and nature of the request were discussed. Following these conversations, a detailed request for information for each site was prepared and forwarded to DOT personnel. The request sought road plan details for the identified sections and information on any countermeasures undertaken to alleviate large truck crashes along with the details and cost associated with these efforts. Wyoming staff were most cooperative and were able to relate experience in a variety of highway situations. (The team also contacted other states with potential clusters identified in the analysis or with locations having known rollover history. The other states either did not have sufficient recordkeeping to verify the existence of clusters or were not able to provide timely information.)

6.3 Site Cases

The three sites investigated in Wyoming are:

- I-25 College Drive North Section – Laramie County
- I-80 near Buck Sullivan Spring Road, Telephone Canyon Section – Laramie County
- I-80 Union Avenue, Rawlins-Walcott Junction – Carbon County.

Their locations are indicated in Figure 6-1, and background information on the sites is provided in Table 6-3. The individual discussions of each site include a description of the roadway elements, crash cluster map, aerial photo, and crash details. The discussion of each site concludes with a description of the countermeasures and a projection of their effectiveness.

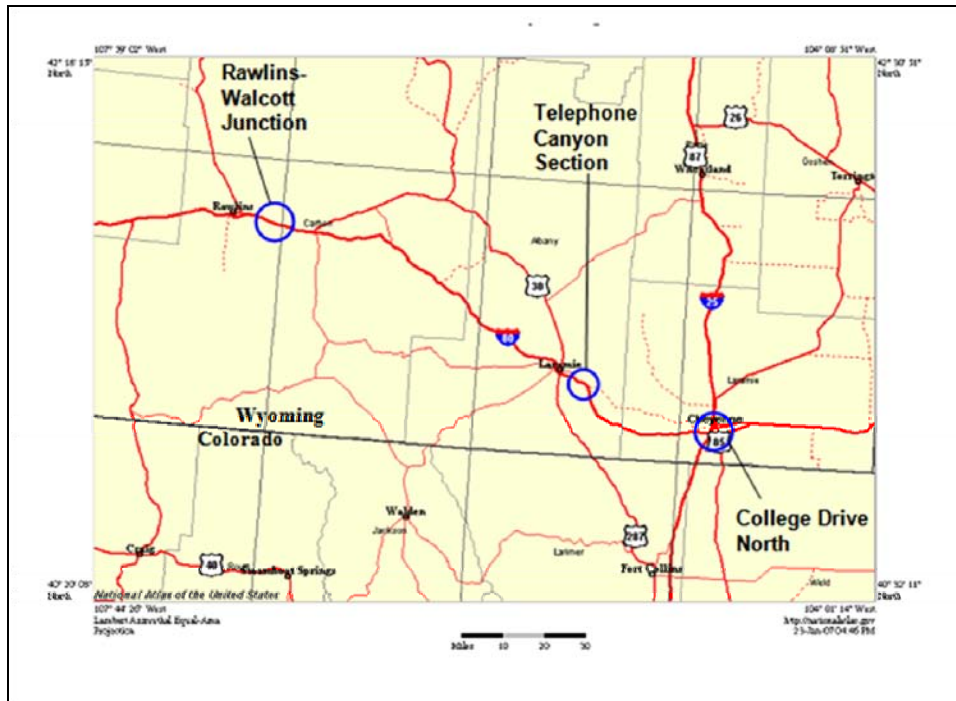

Figure 6 - 1 Map Showing the Three Sites in Wyoming that were Selected for Detailed Study (Map from the National Atlas, U.S. Geological Survey)

Table 6 - 3 Summary of the Three Sites in Wyoming that were Selected for Study

| Location | Name of the Section | Functional Class | Volume (AADT) | Percent Large Trucks | Date of Road Plans |
|---|-----------------------------|---------------------|---------------|----------------------|--------------------|
| I-25 Laramie County | College Drive North | Interstate Urban | 11,000 | +35% | 2003 |
| I-80 near Buck Sullivan Spring Road, Laramie County | Telephone Canyon Section | Interstate Rural | 14,500 | +40% | 1996 |
| I-80 Union Avenue, Carbon County | Rawlins-Walcott Junction | Interstate Rural | 12,721 | +45% | 1999 |

6.3.1 College Drive North Section

Site Description:

During the years of 2003-04, three rollover crashes occurred on I-25 in the College Drive North area along a road section of approximately 2953 ft, which includes a bridge structure passing over US-30. This portion of roadway is a horizontally straight section with 2 vertical curves, a crest vertical curve 1469 ft long and a sag curve 1597 ft in length. The northbound traffic encounters a +1.7 percent uphill grade cresting then followed by a -3.9 percent downgrade. Southbound traffic travel travels a +2.4 percent grade followed by a -1.71 percent grade. The

cross sectional elements of both northbound and southbound travel are 2 12-ft concrete lanes, with paved 4-ft inside and 10-ft outside shoulders.

Table 6 - 4 Crashes in the College Drive North Section

| Truck Cargo | Truck Crash Type | Trailer Body Style | Direction of Travel | Milepost of the Crash | Human Contributing Factor |
|--------------------|-------------------------|---------------------------|----------------------------|------------------------------|----------------------------------|
| General Freight | Rollover | Flatbed | NB | 9.14 | Un-safe Speed |
| Livestock | Rollover/Cargo Shift | Van | SB | 8.8 | Un-safe Speed |
| Empty | Rollover | Dump Truck | NB | 9.0 | Inattentive Driver |

Crash and Countermeasures Cost:

All the crashes occurred in daylight on a dry surface indicating that there were no adverse pavement conditions. No horizontal curves were experienced prior to the crash. This conclusion is based on the crash record, which did not record the vehicles entering or exiting from the ramp near the site. One of the NB crash reports noted that the crash was intersection related; however, since no other vehicle was involved, it is not clear whether the crash involved the on ramp from I-80 or not.

Both vertical curves fall within AASHTO standards. WYDOT staff reported that they are unaware of any pavement surface or other issues that might explain the cluster. WYDOT is currently not considering any truck crash-related countermeasures at this time. The cluster is between two interchange cloverleaves some 2 miles apart.

Conclusions:

Since neither adverse weather nor pavement conditions were noted in the crash reports, it appears that trucks may be having difficulty negotiating the vertical curves along a bridge structure in close proximity of traffic entering and exiting from the nearby interchange ramps. The weaving maneuvers of other vehicles and a significant volume of large trucks may be contributing to the formation of this cluster. The site’s urban location and proximity of two interchanges make reconstruction countermeasures unlikely. Based on this information, a non-construction countermeasure agreeable to WYDOT is the installation of signage warning of large, slow moving truck traffic, which would cost approximately \$10,000 to \$12,000. (Power and communication connections are not included in this estimate).

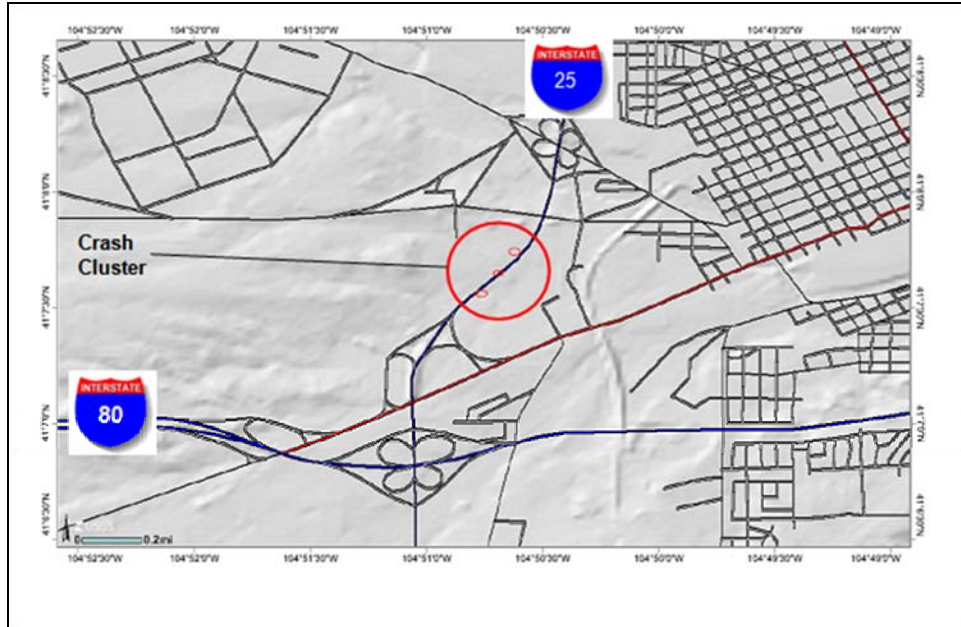

**Figure 6 - 2 I-25 at College Drive North Section
(Map from the National Map, U.S. Geological Survey)**

6.3.2 Telephone Canyon Section

Site Description:

During the years of 2003-04, two rollover and one run-off road crashes occurred on I-80 near Buck Sullivan Spring Road along a 3000 ft section. At the time of these crashes the posted speed was 75 mph. The portion of the roadway experiencing this crash cluster is a continuous downgrade comprised of three vertical curves 400-500 ft long with grades between 4.6 and 5.2 percent. Along this downgrade are four horizontal curves with a design speed of 65 mph. Three of the horizontal curves have radii of 1637 ft (a degree of curvature of 3° 30') and are super-elevated 0.08. The fourth horizontal curve is 3810 ft (degree of curvature of 1° 30') and is super-elevated at 0.046. The westbound cross sectional elements are two 12-ft lanes, with paved 10-ft outside and 4-ft inside shoulders. There is a 42-in. concrete median barrier between the east and westbound lanes. This median height was chosen to help block large truck traffic from losing control and crossing into oncoming traffic. Road plans for the cluster site with the locations of the crashes indicated relative to the geometrics described are included in Appendix K. A 6100-ft acceleration lane is available for eastbound traffic along with outside paved shoulder widths varying from 6 to 10 ft along this section.

Table 6 - 5 Crashes in the Telephone Canyon Section

| Truck Cargo | Truck Crash Type | Trailer Body Style | Direction of Travel | Milepost of the Crash | Human Contributing Factor |
|-----------------|------------------|--------------------|---------------------|-----------------------|---------------------------|
| General Freight | Rollover | Van | WB | 320.0 | Un-safe Speed |
| General Freight | Rollover | Van | WB | 320.3 | Un-safe Speed |
| General Freight | Ran-off Road | Van | WB | 320.56 | Un-safe Speed |

Crash and Countermeasures Cost:

All three crashes involved trucks traveling along a westbound downgrade comprised of 3 sag vertical curves as well as a series of 4 horizontal curves. The environment and pavement conditions for two of the crashes occurred in daylight on a wet surface. The remaining crash occurred at night with dry and clear conditions noted. This two-lane, westbound concrete section of highway is considered by WYDOT as having a significant truck crash problem.

WYDOT is frequently forced to close I-80 due to adverse weather and wind in the mountainous terrain. With no acceptable alternate routes, most truckers are forced to sit out the closures. WYDOT actively monitors I-80 and has come under pressure from the trucking industry to keep it open to traffic. Therefore, to improve safety and respond to the concerns of the trucking industry, WYDOT completed an extensive 40-mile, \$2.7 million ITS initiative in 2006. This initiative included:

| Quantity | Item |
|----------|-------------------------------|
| 48 | Ethernet Radio Antenna |
| 18 | Communication Towers |
| 6 | Remote Video Cameras |
| 7 | Vehicle Monitoring Systems |
| 1 | Highway Advisory Radio System |
| 12 | Dynamic Message Signs |

In advance of the cluster site is a changeable message sign with flashing lights. In addition, the preceding 17-mile westbound stretch has some 14 ITS message sign installations providing drivers a variety of advisory messages such as: road ahead is closed, hazardous conditions are present, or directing drivers to tune to radio station 1610 for traffic alerts. WYDOT also permanently lowered the speed limit from 75 to 65 mph within the last year.

WYDOT has also completed a spot blasting treatment to increase the pavement friction. This treatment did not last long and is not considered a long-term solution to increasing the pavement surface friction. Currently, WYDOT is planning to place a textured overlay along the Telephone Canyon section to create a more durable increase in the surface friction.

Conclusions:

This section of roadway presents both geometric and surface texture challenges. The horizontal curves fall within AASHTO minimums; however, portions of the sag vertical curves exceed the recommended maximum of 5 percent for regions described as mountainous with values of between 5.1 percent and 5.2 percent. Highway design in this mountainous area presented significant challenges. As a result the excess grade was approved as an acceptable deviation from the recommended maximum values and also dictated the downhill vertical and horizontal curve combination. Due to these design constraints WYDOT sought and received approval for a “Non-Conforming Design Criteria Design Exception.” This exception to AASHTO guidelines was prepared by WYDOT engineers, submitted, and approved by the FHWA Division Administrator.

Since the completion of the 1996 highway improvement project, WYDOT has taken an aggressive approach to improving the safety of this roadway. Lowering the posted speed, providing real-time driver information, restricting traffic due to weather conditions, and improving the pavement texture were intended to improve the crash rate and reduce the frequency of road closures. Analyzing the before and after crash figures since the deployment of the ITS initiatives and lowering the speed will help reveal whether these methods will significantly reduce crashes. However, at this time WYDOT is not planning a before/after study. While improving geometric elements is seen as preferred, the reconstruction necessary to address the grade and alignment issues is viewed as cost prohibitive and nearly impossible due to the terrain of the area.

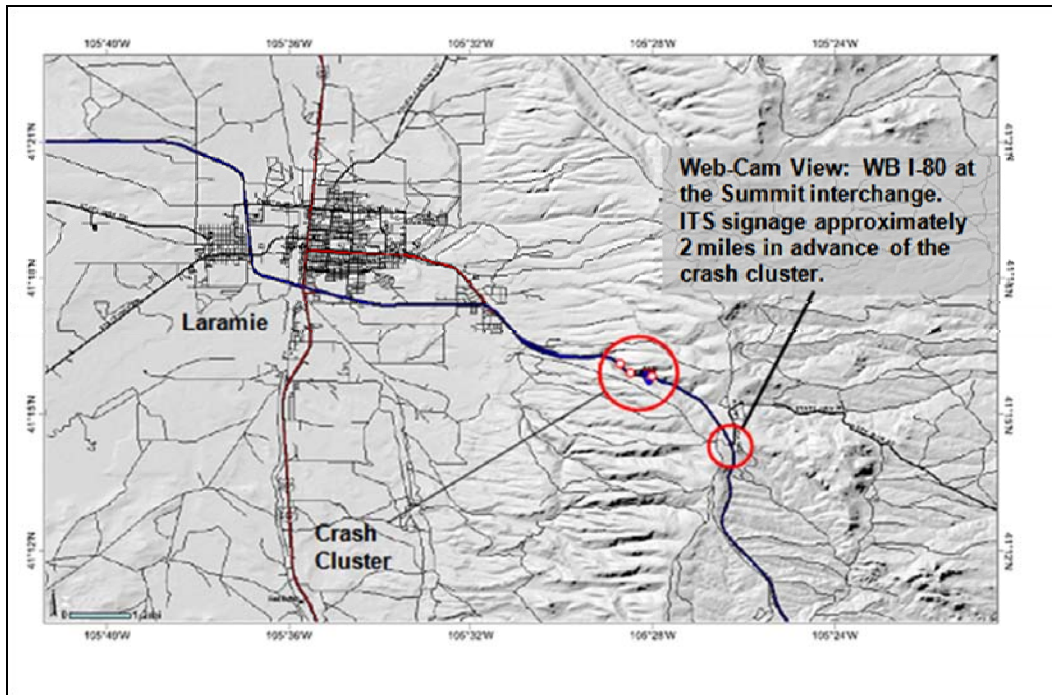
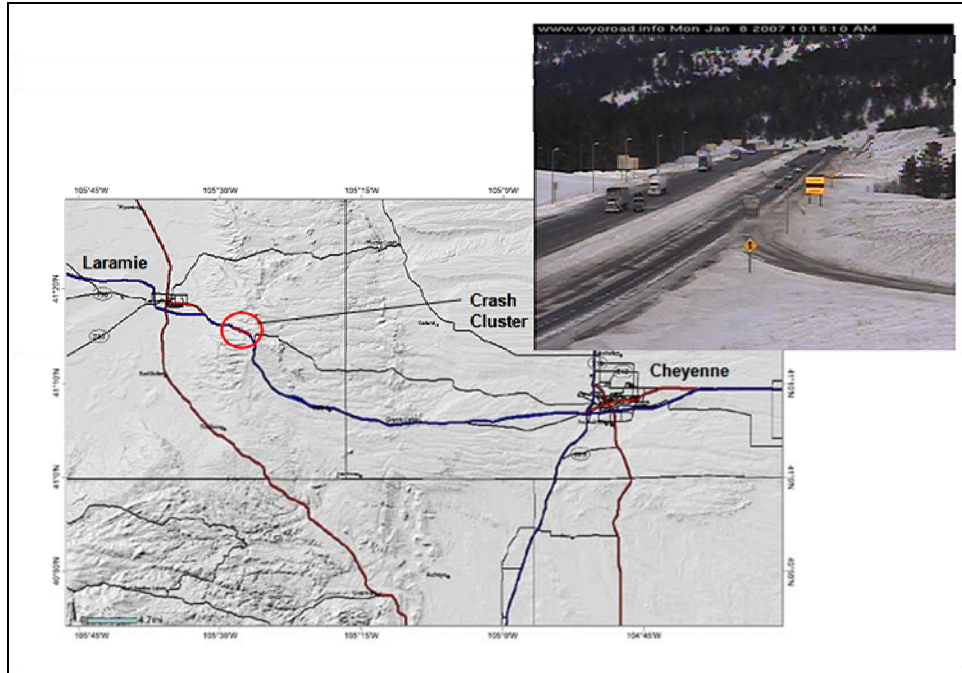

**Figure 6 - 3 Telephone Canyon Section
(Map from the National Map, U.S. Geological Survey)**

6.3.3 Rawlins-Walcott Junction Section

During the years of 2003-04, 3 rollover crashes occurred on westbound I-80 near Union Avenue along an 850-ft section. The portion of the roadway experiencing the crash cluster is comprised of a sag vertical curve with a 1.4 percent downgrade followed by a 1.8 percent upgrade with a length of 656 ft. Along this section is also a horizontal curve with a design speed of 75 mph, a radius of 2249 ft (6° 23' degree of curvature) and a superelevation of 0.08. The westbound cross sectional elements are two 12-ft lanes, with paved 5-ft inside and 10-ft outside shoulders. This westbound bituminous concrete section of highway is also referred to as the Rawlins East Section of Carbon County.

Table 6 - 6 Crashes in the Rawlins-Walcott Junction Section

| Truck Cargo | Truck/Car Crash Type | Truck/Trailer Type | Direction of Travel | Milepost of the Crash | Human Contributing Factor |
|-----------------|----------------------|------------------------|---------------------|-----------------------|---------------------------|
| General Freight | Rollover | Tractor Trailer/Single | WB | 219.76 | Un-safe Speed |
| General Freight | Units Separated | Tractor Trailer/Single | WB | 219.58 | No Violations |
| N/A | Passenger Car | N/A | EB | | Un-safe Speed |
| General Freight | Rollover | Tractor Trailer/Single | WB | 220.0 | Fell Asleep |
| N/A | Passenger Car | N/A | EB | | No Violations |
| N/A | Passenger Car | N/A | EB | | No Violations |

Crash Countermeasures and Cost:

Two of the three crashes occurred on icy or snowy pavements. When matching MCMIS crashes to the WYDOT crash records, a discrepancy was noted. MCMIS indicates that these were single-vehicle crashes. However, the WYDOT crash records indicate that passenger vehicles were also involved and traveling eastbound. The driving activity noted for all vehicles prior to the crashes was traveling straight. Therefore, based on the crash records alone it is unclear whether merging or weaving maneuvers contributed to the crash clustering.

The horizontal and vertical curve elements of this section meet the AASHTO standards. WYDOT is familiar with this area and commented that the horizontal curve is one of the sharpest they have along I-80 and may be contributing to truck crashes in the area. WYDOT completed a study of the interchange, which included modification of the horizontal curvature. However, the area is constrained by other crossroads and railroad tracks, making reconstruction unlikely. The suggested countermeasure is a sign warning of large, slow moving truck traffic that is consistent with other I-80 installations. Upstream of the site, westbound traffic travels through the new ITS safety initiative between mile points 357 and 318.

Conclusions:

Two of the three crashes occurred on icy or snow pavement, and passenger vehicles may have been involved. Therefore, based on the discussions with WYDOT and the crash records it would appear that negotiating this sag and horizontal curve combination, pavement conditions, and the speed differences between large trucks and light vehicles may be posing problems for trucks.

As part of the 2006 ITS initiative variable message signing, web cameras and atmospheric sensors are now located at the I-80 Walcott Junction in advance of the site. Extending this project further to include the crash cluster may help reduce truck crashes. As was noted above for the I-80 Buck Sullivan Spring Road site; this ITS initiative was undertaken to address the crash problems encountered along a significant portion the I-80 section. On average I-80 carries an average 10,000 vehicles per day with 50 percent of this figure being large truck traffic.

6.4 Lessons Learned

A lesson to be learned from this analysis is that special provisions are needed when geography prevents ideal highway geometrics. The highway geometrics that appear to be contributing the most to large truck rollover crashes at the three sites evaluated in Wyoming are the combination of vertical and horizontal curves. Slick pavements and high truck volumes were also factors for the crashes examined.

Constraints to the highway design due to terrain required an exception to the AASHTO guidelines when designing the downhill/curve portion of I-80 near Buck Sullivan Road. Since significant geometric modifications are cost prohibitive along this section, WYDOT is using non-geometric countermeasures to increase traffic safety. These countermeasures include increasing the pavement friction to improve handling on slick roads. Methods to increase pavement friction include spot blasting the pavement or putting down a textured pavement overlay. WYDOT also has installed cameras and atmospheric sensors along 40 miles of I-80 to monitor how weather and wind are affecting the roadway surface and traveling conditions. This information is used to provide timely driver warnings using changeable message signs and to determine whether road closure is necessary. These countermeasures are part of a \$2.7 million ITS traffic safety initiative along I-80.

Wyoming is one of a few states that routinely experiences crashes due to high winds acting upon the vehicle. Winds in excess of 80 mph have been known to snap off power poles and require closing highways, particularly I-80. The Wyoming Department of Transportation (WYDOT) policy is to monitor weather conditions and release travel advisories for light and high-profile vehicles as well as to restrict the travel of trucks carrying hazardous substances and oversized loads. Little can be done with the geometrics of the roadway to mitigate the effects of high winds on vehicles. In a few cases modifying cross sectional grading can be adjusted to keep from trapping winds. Countermeasures to compensate for high winds are related to the direction of travel over the geometric elements of the road itself. For example, a north-south road may be traversing an area known for strong east-west winds and experiencing a significant number of rollover crashes. Windbreaks installed along the roadside will help reduce crash numbers.

However, long expanses of windbreaks are expensive and to date have been cost prohibitive for WYDOT to deploy.

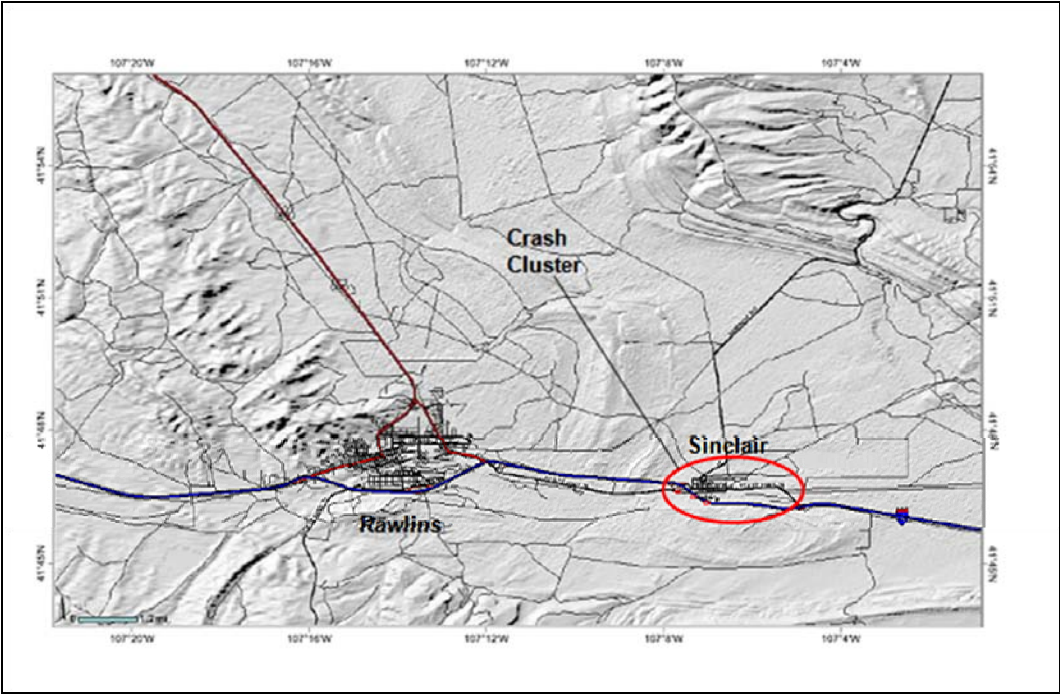

**Figure 6 - 4 I-80 Near Union Avenue, Rawlins-Walcott Junction – Carbon County
(Map from the National Map, U.S. Geological Survey)**

This Page Intentionally Left Blank

7.0 Benefit-Cost Analysis

The final question to be answered in this report is, “*Are the approaches discussed in the report cost effective?*” This question will be answered quantitatively through Benefit-Cost Analysis (BCA), a common and widely accepted analytical technique for evaluating how worthwhile government or other programs or policies are. This is accomplished by carefully monetizing the benefits and costs of the policy or program across a relevant time period. Those monetized values are then discounted to the present for comparison as both benefits net of costs and benefit-cost ratios. As long as the net benefits are positive (comparable to a benefit-cost ratio greater than one), a proposed program or policy creates value for society.

Benefits for all mitigation methods take the form of crashes avoided. Costs are primarily the explicit costs of carrying out the mitigation method for the prescribed set of drivers or vehicles including the cost of purchase of the technology, labor costs, and other one-time and recurrent costs.

Full benefit-cost analyses were conducted for the vehicle design, electronic stability aids, and driver training approaches. The costs of these systems have been listed, and their benefits have been estimated in the previous sections of the report. The highway design approach to avoiding rollovers is fundamentally different from the other three, and it is not discussed in this section.

7.1 General Methodology

The methodology specific to the development of the monetized benefits and costs are discussed in sections 7.2 (benefits) and 7.3 (costs) below. However, the methodology for how the different mitigation approaches are handled moving across time and some assumptions apply across both the costs and the benefits. The values for the costs of each proposed approach and the efficacy of each approach (the fraction of crashes it is expected to prevent) were developed in Sections 3, 4, and 5. Appendix F lists more of the assumptions for the analysis and sources for many of the other numbers used in the calculations.

7.1.1 Common Assumptions

When carrying out BCA for multiple programs or policies, a common set of assumptions is necessary to keep the individual analyses comparable to each other. One of the most important assumptions to hold in common is the rate used to discount the estimated future benefits and costs of each policy to the present. The BCA for each of the three mitigation methods and the different scenarios presented for them use a real rate of 7 percent as suggested by the Office of Management and Budget [White House OMB, 2003], though results are also presented using a 4 percent rate, which is consistent with the discount rate internal to the crash cost estimates discussed in Section 7.2.

The same methodology for monetizing the benefits (crashes avoided) is used throughout, and is described in Section 7.2.3. Finally, while different elements of the fleet and population of drivers are relevant for the different mitigation approaches, the assumptions used are compatible

(for instance, the same ratio of drivers to tractors that pull hazmat tanker trailers is applied in the training analysis as well as in the electronic stability control analysis).

The analyses are presented in real dollars using 2007 as the base year, meaning that no price inflation is computed for either benefits or costs moving forward. Therefore, the only inflation calculations necessary are to bring past estimates (like crash costs) for years prior to 2007 up to the base year level. This is done using the Bureau of Labor Statistic's Producer Price Index (PPI) [U.S. Department of Labor, Bureau of Labor Statistics, 2007], except for wage data, which is adjusted up to 2007 dollars using BLS's Employment Cost Index (ECI). Another important assumption is that none of the methods described will be carried out under the status quo. This is clearly a strong assumption, as some manufacturers are already installing electronic stability controls and some carriers are revising their training programs. Changing this assumption could lead to lower benefits, but also lower costs as the cost of any action that would have been taken voluntarily would not be counted in the analysis.

7.1.2 Common Time Period for Analysis and Timing Assumptions

The time period considered for the benefits and costs must be consistent across the different analyses of the approaches. Generally, the time period for analysis is matched to the economic life of the technology under examination. When considering multiple technologies or approaches, the time period under analysis is often set to be the life of the approach with the longest economic life. The method of deployment also influences what the appropriate time frame should be for the analysis, particularly when, as in this case, full deployment will not be achieved in the first year.

The training approach does not require a fleet profile, but there are new capital expenditures required (simulators) and other logistical considerations that would need to be resolved. An instantaneous 100 percent deployment is unrealistic. For this reason, the training is phased in at 20 percent per year up to five years beyond which 100 percent of new drivers will receive the training. The base number of drivers was calculated as 1.1 drivers per tractor based on a weighted mean from the MCMIS data (see Appendix J). The number of tractors for this per-tractor used was the same for the electronic stability control. While individual carriers may use more or fewer drivers, the carrier-level experience is not explored in this analysis, so the number is reliable for getting to the national number of drivers that correspond to this segment of the trucking industry. Growth in the number of drivers, 2.2 percent, and the replacement rate of drivers including growth and retirement, 4.2 percent, were drawn from a recent study of the labor needs of the trucking industry [Global Insight, 2005]. These rates were directly applied to the population as there was no need in the analysis to track the specific vintage of the drivers across time. These rates were used to calculate the number of new drivers each year for costs. The benefits do not rely on the absolute number of drivers—only the relative proportions of crashes and proportion of drivers receiving the training during the phase-in.

The life of the electronic stability control technology will be the life of the vehicle on which each is mounted. Rapid advances in electronics make it difficult to predict the effectiveness of devices that will be on replacement vehicles entering the fleet in 20 years. As a simplifying, lower-bounding assumption, the replacement devices will be imputed with the same

effectiveness as the original devices. The life of the truck tractors the technology will be installed on is assumed to be 10 years. The same procedure described above for building the fleet profile was used for the trucks. In this case, the VIUS data allowed for the specific identification of trucks that pull HM tank trailers. The age distribution was smoothed and scaled to reflect all trucks being 10 years or younger. A different assumption of a longer life for the trucks or trailers would reduce the costs, but would extend the phase-in time for the technology and thus the benefits. The base number of truck tractors that haul HM tankers assumed for the analysis is 53,450 in 2002 from the VIUS. Appendix H contains a detailed explanation of the development of the fleet profiles for both the vehicle design and electronic stability control.

The analyses assume that the new vehicle designs and the stability technology will be required on all new trucks beginning in 2008. This is why a fleet age profile is necessary—as the existing vehicles age and are gradually retired, with the last vehicles being retired at age 15 for the trailers and age 10 for the trucks, they are replaced with new vehicles. The new vehicles make up not only for the retired vehicles but also for growth in the fleet. Growth in the fleet was assumed to be 1.5 percent annually, which is consistent with the 5 and 20 year averages in gasoline deliveries in the United States as reported by the Department of Energy’s Energy Information Administration. As the fleet grows with new vehicles that have the new designs or technology and as old vehicles are replaced with the new vehicles, the share of the fleet made up of the new vehicles grows until 100 percent deployment is achieved in the year after the last of the vehicles that were bought before the new designs and technology are retired. The share of the fleet that has the new vehicle design or the electronic stability technology is used to modify the efficacy rates described in the next section to reflect the phasing in of the improvements.

Even though many trucks retired from hauling HM go on to have useful lives in other parts of the industry, the benefits of the new trailer designs and the electronic stability technology in that extended useful life are ignored in this analysis. This was necessary because capturing the correct crash statistics in those other parts of the industry would be beyond the scope of this study. However, excluding these benefits leads to a conservative, direct estimate of the crashes avoided.

The life of the tank trailers specific to hauling petroleum products is assumed to be 15 years for the vehicle design approach. The current number of trailers was taken to be 20,000, based on industry estimates (See Appendix G). A fleet profile was constructed using the age distribution of all heavy trucks from the Census Bureau’s VIUS. The proportion of vehicles in each age category were regressed on the age of the vehicles to smooth out the age distribution, thus eliminating “bumps” associated with industry fluctuations. This age distribution was then scaled to reflect 100 percent of the vehicles being 15 years or younger.

While all of the rollover mitigation options discussed in this study will be fully phased in and deployed by the 15th year, setting the time frame for the analysis at year 15 would count only one year in which the longest-lived mitigation approach was in full effect. For this reason, the time period for the analyses was set at 20 years. A 30-year time frame was explored, but extending the time frame exposes the costs and benefits to significant further discounting. As a result of the heavy discounting in the later years, using the 20-year period leads to the same conclusions about the relative merits of the three approaches (meaning the difference in period

does not change any signs on the net benefits or lead to a change in BCRs with respect to whether they are greater or smaller than one).

7.2 Benefits

The analysis for each rollover mitigation approach defines benefits in the same way to allow an “apples to apples” comparison. Each analysis has produced an efficacy rate that, when used together with a subset of the national crash statistics described below, yields an estimated annual reduction in the number of crashes. These efficacy rates are modified year by year in each analysis to reflect both the degree of overall market penetration expected for the mitigation type (in the case of the wide track tank trailers, some markets will not be able to accommodate them) and the degree to which the mitigation type has been phased in, which varies in each analysis (discussed in Section 7.1.2).

7.2.1 Estimating the Pool of Relevant Crashes

Each of the approaches to reducing rollovers works differently and will address a different fraction of the rollover population. The following discussion will select the crashes that are available to be prevented by the approaches in this report and state the assumptions used to select the numbers.

The assumption for driver training is that the improved training will make the performance of new drivers more like that of experienced drivers. New drivers dominate the youngest brackets in the age distribution for drivers. If these younger, new drivers could be trained better in order to perform like more experienced, older drivers, then their crash rates would presumably be more similar. The crashes avoided by the modernized training are based on the proportion of crashes that happen to young drivers above the proportion they represent of the driver population. The calculations to determine this number of crashes is carried out assuming that miles traveled per driver are relatively evenly distributed across the age brackets. (Other sources made the same assumption; none could be found to provide data to indicate otherwise.) Table 7-1 contains the age distribution of the drivers drawn from a recent study of the labor needs of the trucking industry [Global Insight, 2005], as well as two different estimates of the distribution of crashes by the driver’s age. The first is drawn from MCMIS and shows drivers under 35 representing 28 percent (5+23) of the crashes, while they represent only 24 percent (3+21) of the population. The GES data show drivers under 35 representing 32 percent (8+24) of crashes. The GES numbers will be the basis for the upper bound relevant crash estimates.

The assumption is that the training will reduce the number of new-driver rollovers for HM semitrailer tankers. The overall crashes, regardless of age are 405 annually according the GES and 181 according to MCMIS. Calculating the number of crashes that occur disproportionately to the younger age groups requires calculating their share of the relevant rollovers (405 multiplied by each category’s percent of crashes) and subtracting from it the number of crashes that each group would have had, if crashes had been proportional to population (405 multiplied by the percent of drivers who fall into each age category). Table 7-1 contains the results of these calculations.

Table 7 - 1 Disproportionate Crashes by Age

| Age | Percent of Population [Global Insight 2005] | Crashes if Proportional to Population | | Percent of Crashes (Table 2-40) | | Actual Number of Crashes | | Disproportionate Crashes | |
|-------|---|---------------------------------------|---------|---------------------------------|---------|--------------------------|---------|--------------------------|---------|
| | | (GES) | (MCMIS) | (GES) | (MCMIS) | (GES) | (MCMIS) | (Upper) | (Lower) |
| <25 | 3% | 13.8 | 6.2 | 8% | 5% | 31.3 | 8.7 | 17.6 | 2.5 |
| 25-35 | 21% | 85.1 | 38.0 | 24% | 23% | 97.1 | 41.6 | 12.0 | 3.6 |
| 35-45 | 33% | 132.8 | 59.4 | 32% | 33% | 130.8 | 59.7 | -2.1 | 0.4 |
| 45-55 | 26% | 106.5 | 47.6 | 25% | 21% | 100.6 | 37.3 | -6.0 | -10.3 |
| 55-65 | 14% | 56.3 | 25.2 | 9% | 16% | 37.2 | 28.1 | -19.1 | 2.9 |
| >65 | 3% | 11.3 | 5.1 | 2% | 3% | 8.0 | 4.9 | -3.3 | -0.2 |

Summing the less than 25 years category with the 25 to 30 years category produces a lower bound of relevant crashes of 6 and an upper bound of 30.

Electronic aids to roll stability are designed to reduce the speed of a vehicle when it is cornering too fast. They are intended to reduce the number of pre-crash conflicts where a vehicle is traveling too fast through a curve. According to Table 2-8 this is the combination of conflicts 1.4 and 4.4, “Truck is turning or negotiating a curve at excessive speed and loses control.” Untripped rollovers can result from this conflict, and single-vehicle roadway departures (SVRD) can result as well. In Table 2-8, there were 185 SVRD crashes accompanying a rollover from Conflict 1.4 and 55 crashes categorized as “Untripped rollovers” from Conflict 4.4. Within the SVRD crashes accompanying a rollover, 72 had the “untripped” flag set in the GES database and 113 did not. GES does not indicate the sequence of the rollover and the roadway departure. However, it is plausible that the trucks in the “untripped” cases rolled on the highway and then departed the highway. The “tripped” cases may represent crashes where the vehicle departed the road and was tripped by a curb or dropoff as it departed or an embankment after departure. SVRDs accompanied by an untripped rollover will be treated as untripped rollovers, for estimating the benefits of the electronic stability aids. SVRDs accompanied by a tripped rollover, for the purpose of this analysis, will be ignored.

The following analysis, however, applies only to the devices that intervene to slow the vehicle—the number of cargo tank hazardous material rollovers addressed is 72+55 or 127. Within Table 2-8, 54 percent of the cargo tank rollovers involved a hazardous cargo. The number of relevant records in the GES database is too small to reliably estimate a separate ratio for all of the individual kinds of crashes, so this same ratio will be applied to the crashes addressed by electronic stability aids. Also, within Table 2-8, 60 percent of the rollovers are of combination vehicles. To be as consistent as possible with other analyses, the electronic stability aids will be considered for combination unit cargo tank vehicles carrying HM. That is, the number of crashes of the kind that electronic stability aids might prevent is 54 percent of 60 percent of 127, or 41.

For the vehicle design approach, the particular vehicles studied were semitrailers for hauling petroleum, which are currently manufactured according to the DOT 406 specification. As shown

in Table 7-2, in the MCMIS 2002 data, there were 291 cargo tank rollovers. Of these, 112 were Class 3 (flammable material, primarily but not exclusively petroleum) combination unit trucks.

Table 7 - 2 Rollover Crash Frequency by Cargo Type and Vehicle Configuration (MCMIS)

| | Combination Unit Vehicles | All Vehicles |
|---------------------|---------------------------|--------------|
| Class 3 (flammable) | 112 | 168 |
| All Cargo | 181 | 291 |

By GES estimates in Table 2-8, there are 1265 rollovers of all cargo tanks annually. Of these 680 are carrying hazardous material. By Table 2-14, 60 percent (56 percent + 4 percent) of the rollovers are combination vehicles, so 405 rollovers would be combination unit cargo tanks carrying a hazardous material. GES does not have the resolution to determine what fraction of these are petroleum, but the ratio in Table 7-2 of Class 3 to all rollovers of hazmat-carrying combination unit vehicles is 112/181 or 62 percent. Applying this ratio to the GES data yields an estimate of 251 annual rollovers of petroleum combination vehicles. The MCMIS is a count of actual crash reports, so it establishes a minimum annual number. The numbers from GES are estimates, though 251 total would suggest that MCMIS is subject to much more underreporting than it probably really is, so 251 can be taken as an upper bound.

To summarize, the description and number of crashes of the kind addressed by each approach is listed in Table 7-3. All values in the table are limited to cargo tank semitrailers carrying HM. To reiterate, these are the estimates of the number of rollovers of the types that that can be avoided by each of the approaches. Because the efficacies of the approaches are less than 100 percent, not all of these rollovers will actually be avoided. The efficacies are discussed and applied next.

Table 7 - 3 Rollovers Addressed by the Three of the Four Approaches

| Category | Annual Number | Notes |
|---------------------------|---------------|---|
| Overall Rollovers | 680 | All HAZMAT cargo tanker rollovers |
| Semitrailer Base | 405 | Subset that does not include straight trucks |
| Driver Training | | Subset of rollovers that disproportionately occur for younger drivers (under 25 and 25-35) |
| Upper (GES) | 30 | |
| Lower (MCMIS) | 6 | |
| Electronic Stability Aids | 41 | Subset of rollovers that are single-vehicle untripped rollovers where speed in a curve was a factor |
| Vehicle Design | | Subset of rollovers of DOT406 semitrailers |
| Upper (from GES) | 251 | |
| Lower (from MCMIS) | 112 | |

7.2.2 Estimating the Reduction in Crashes

Efficacy rates are obtained by explicit modeling of each of the technologies or techniques, documented in their sections. The efficacy rate for the training comes from an observation by a major carrier who has implemented similar training that they experienced a 10-percent reduction in new driver crashes.

For example, the electronic stability aids are expected to prevent 53 percent of the crashes of the type they address, which are untripped rollovers. The number of untripped rollovers is listed as 41 in Table 7-3. The number of crashes expected to be prevented by the aids is 53 percent of 41 or 22 rollovers every year. However, that number will not be fully realized until electronic stability aids are deployed throughout the industry with new trucks introduced through growth in the fleet and replacements from vehicle retirement. Applying the efficacy rates of Table 7-4 to the subsets of crashes described in Table 7-3 (according the phase-in schedules described in Section 7.1.2) produces the crash reductions over the 20-year period listed in Table 7-5. Note that, after 10 years, when the electronic stability aids are projected to reach full deployment, the annual number of crashes in that column of the table is about 22. (The fractional number of crashes is retained for better precision in the economic analysis to follow.)

Table 7 - 4 Efficacy Rates by Approach

| Approach | Efficacy Rate | Reference |
|--------------------------|----------------------|------------------|
| Training | 10% | Section 3.8 |
| Electronic Stability Aid | 53% | Section 4.4.4 |
| Tanker Design | | |
| Slightly lower CG | 12% | Table 5-9 |
| Wider Track | 17% | Table 5-9 |
| Aggressive Improvement | 30% | Table 5-9 |

7.2.3 Valuing the Reduction in Crashes

The calculation of the dollar value of these benefits follows from Zaloshnja and Miller [2002]. Zaloshnja and Miller examine a wide variety of crashes by different types of trucks and estimate aggregate, per crash, and per victim costs associated with large truck crashes. These costs include not only specific medical and injury related costs, but also include comprehensive costs such as legal costs, the costs of traffic delays, and property damage. Note that,

“These costs represent the present value, computed at a 4-percent discount rate, of all costs over the victims’ expected life span that result from a crash. They include medically related costs, emergency services costs, property damage costs, lost productivity, and the monetized value of the pain, suffering, and quality of life that the family loses because of a death or injury. ... The cost estimates exclude mental health care costs for crash victims, roadside furniture repair costs, cargo delays, earnings lost by family and friends caring for the injured, and the value of schoolwork lost.” [Zaloshnja and Miller, 2002, p1].

Table 7 - 5 Estimated Crash Reductions

| Year | Training | | Electronic Stability Aids | Tanker Design-Upper | | | Tanker Design-Lower | | |
|--------------|-------------|-------------|---------------------------|---------------------|-------------|------------|---------------------|-------------|------------|
| | Upper Bound | Lower Bound | | Lower CG | Wider Track | Aggressive | Lower CG | Wider Track | Aggressive |
| 2008 | 0.1 | 0.6 | 2.6 | 3.4 | 2.4 | 8.6 | 1.5 | 1.1 | 3.8 |
| 2009 | 0.2 | 1.2 | 5.1 | 6.5 | 4.6 | 16.6 | 2.9 | 2.1 | 7.4 |
| 2010 | 0.4 | 1.8 | 7.5 | 9.4 | 6.7 | 24.0 | 4.2 | 3.0 | 10.7 |
| 2011 | 0.5 | 2.4 | 9.8 | 12.1 | 8.6 | 30.8 | 5.4 | 3.8 | 13.7 |
| 2012 | 0.6 | 3.0 | 12.0 | 14.6 | 10.3 | 37.1 | 6.5 | 4.6 | 16.5 |
| 2013 | 0.6 | 3.0 | 14.0 | 16.8 | 11.9 | 42.8 | 7.5 | 5.3 | 19.1 |
| 2014 | 0.6 | 3.0 | 15.8 | 18.9 | 13.4 | 48.0 | 8.4 | 6.0 | 21.4 |
| 2015 | 0.6 | 3.0 | 17.5 | 20.8 | 14.7 | 52.8 | 9.3 | 6.6 | 23.5 |
| 2016 | 0.6 | 3.0 | 19.1 | 22.4 | 15.9 | 57.1 | 10.0 | 7.1 | 25.5 |
| 2017 | 0.6 | 3.0 | 20.5 | 23.9 | 16.9 | 60.9 | 10.7 | 7.6 | 27.2 |
| 2018 | 0.6 | 3.0 | 21.7 | 25.3 | 17.9 | 64.3 | 11.3 | 8.0 | 28.7 |
| 2019 | 0.6 | 3.0 | 21.7 | 26.4 | 18.7 | 67.2 | 11.8 | 8.4 | 30.0 |
| 2020 | 0.6 | 3.0 | 21.7 | 27.5 | 19.4 | 69.8 | 12.3 | 8.7 | 31.2 |
| 2021 | 0.6 | 3.0 | 21.7 | 28.3 | 20.0 | 72.0 | 12.6 | 8.9 | 32.1 |
| 2022 | 0.6 | 3.0 | 21.7 | 29.0 | 20.6 | 73.8 | 13.0 | 9.2 | 32.9 |
| 2023 | 0.6 | 3.0 | 21.7 | 29.6 | 21.0 | 75.3 | 13.2 | 9.4 | 33.6 |
| 2024 | 0.6 | 3.0 | 21.7 | 29.6 | 21.0 | 75.3 | 13.2 | 9.4 | 33.6 |
| 2025 | 0.6 | 3.0 | 21.7 | 29.6 | 21.0 | 75.3 | 13.2 | 9.4 | 33.6 |
| 2026 | 0.6 | 3.0 | 21.7 | 29.6 | 21.0 | 75.3 | 13.2 | 9.4 | 33.6 |
| 2027 | 0.6 | 3.0 | 21.7 | 29.6 | 21.0 | 75.3 | 13.2 | 9.4 | 33.6 |
| TOTAL | 11 | 54 | 341 | 434 | 307 | 1,102 | 193 | 137 | 492 |

Note that this benefit-cost analysis is being conducted from the societal point of view rather than the carrier's point of view. Therefore it includes the cost of emergency response and a monetized cost of traffic delays, which are costs borne by society as a whole but are not paid directly by a carrier. This analysis does not include dollars that might be paid by a carrier that are not a cost to society. For example, a fine is a cost to a carrier, but it is a transfer of money from one entity to another and not a true cost to society.

The Zaloshnja and Miller per crash cost estimates do not have resolution specific to rollover crashes. However, they do estimate crash costs by injury severity. Table 7-6 shows the distribution of crash severities across the relevant rollover crashes drawn from GES (all cargo tank rollovers, as in Table 2-8) and Zaloshnja and Miller's crash costs by injury severity.

Table 7 - 6 Social Cost of Crashes by Severity (2000 dollars)

| | Property Damage | Non-Incapacitating | Incapacitating | Fatal |
|------------------|-----------------|--------------------|----------------|-------------|
| Incidence | 29.39% | 36.92% | 22.82% | 10.87% |
| Cost | \$11,953 | \$70,680 | \$225,507 | \$3,645,273 |

When the percentages from Table 7-6 are applied to the costs in the table, the weighted average social cost of a rollover crash comes to \$477,310. When this is adjusted to 2007 dollars, it becomes \$572,038 per HM tanker rollover crash.

The nature of the cargo can be assumed to have minimal effect on the crash itself, but a significant difference in a HM rollover is the possibility of a spill. While some of this may be captured in the injury and property damage dimensions of the Zaloshnja and Miller estimates, relying exclusively on those aspects would understate the cost of spills related to crashes almost to the point of omission.

The fraction of cargo tank rollovers that result in a spill were obtained from an earlier report on serious incidents involving hazardous cargo shipments, based on MCMIS [Battelle, 2005]. A slight further analysis of the data for that report yielded the following three tables (7-7, 7-8, and 7-9) regarding the frequency of spills in various kinds of cargo tank crashes.

Table 7 - 7 Totals for all Cargo Tank Incidents (Weighted)

| Ran off Road | Rollover | | Total |
|--------------|----------|-----|-------|
| | No | Yes | |
| No | 863 | 96 | 959 |
| Yes | 102 | 189 | 291 |
| Total | 965 | 285 | 1250 |

Table 7 - 8 Totals for all Cargo Tank Spill Incidents

| Ran off Road | Rollover | | Total |
|--------------|----------|-----|-------|
| | No | Yes | |
| No | 30 | 73 | 103 |
| Yes | 15 | 95 | 109 |
| Total | 45 | 167 | 212 |

Table 7 - 9 Spill Percentage by Category

| Ran off Road | Rollover | | Total |
|--------------|----------|-----|-------|
| | No | Yes | |
| No | 3.4 | 76 | 11 |
| Yes | 15 | 50 | 37 |
| Total | 4.7 | 59 | 17 |

The likelihood of a spill given a rollover crash evident from the data in the above table was combined with the proportion of crashes in the following representative HM categories from the same HM cargo study, and a previous study of the cost of different types of HM spills [Battelle, 2001] to formulate per-crash costs of HM cargo spills. The sources of costs that these numbers are built from include explicit clean-up costs, environmental damage, and evacuation costs. The per-spill and per-crash costs are presented in Table 7-10.

Table 7 - 10 Costs of HAZMAT Spills (2007 dollars)

| Type | Per Spill | Per Crash |
|---|-----------|-----------------|
| HM Category/Division 2.1, Flammable Gases | \$11,212 | \$6,609 |
| HM Category/Division 3.0, Flammable Liquids | \$47,427 | \$27,957 |
| HM Category/Division 8.0, Corrosives | \$37,759 | \$22,258 |
| Weighted Average Per Crash | | \$23,177 |

The \$27,957 per-crash cost of flammable liquids is applied to crashes in the analysis of the vehicle designs, since they are restricted to petroleum products. The other cases use the weighted average per crash of \$23,177.

Aggregate benefits are tabulated by applying the per-crash costs developed from Zaloshnja and Miller and the per-crash cost of HM spills to the avoided crashes presented in Table 7-5. These results are presented in Table 7-11. These same results discounted to the present using a 7 percent discount rate are presented in Table 7-12.

Table 7 - 11 Total Benefits, in millions

| Year | Training | | Electronic Stability Aids | Tanker Design-Upper | | | Tanker Design-Lower | | |
|------|------------------|----------------|---------------------------|---------------------|-------------|------------|---------------------|-------------|------------|
| | MCMIS Assumption | GES Assumption | | Lower CG | Wider Track | Aggressive | Lower CG | Wider Track | Aggressive |
| 2008 | \$0.357 | \$0.071 | \$1.560 | \$2.029 | \$1.436 | \$5.159 | \$0.905 | \$0.641 | \$2.302 |
| 2009 | \$0.714 | \$0.143 | \$3.061 | \$3.915 | \$2.771 | \$9.952 | \$1.747 | \$1.236 | \$4.441 |
| 2010 | \$1.071 | \$0.214 | \$4.493 | \$5.659 | \$4.004 | \$14.387 | \$2.525 | \$1.787 | \$6.420 |
| 2011 | \$1.429 | \$0.286 | \$5.848 | \$7.268 | \$5.143 | \$18.478 | \$3.243 | \$2.295 | \$8.245 |
| 2012 | \$1.786 | \$0.357 | \$7.122 | \$8.746 | \$6.189 | \$22.235 | \$3.903 | \$2.762 | \$9.922 |
| 2013 | \$1.786 | \$0.357 | \$8.310 | \$10.100 | \$7.147 | \$25.677 | \$4.507 | \$3.189 | \$11.458 |
| 2014 | \$1.786 | \$0.357 | \$9.411 | \$11.335 | \$8.021 | \$28.817 | \$5.058 | \$3.579 | \$12.859 |
| 2015 | \$1.786 | \$0.357 | \$10.424 | \$12.454 | \$8.813 | \$31.664 | \$5.557 | \$3.933 | \$14.129 |
| 2016 | \$1.786 | \$0.357 | \$11.349 | \$13.464 | \$9.527 | \$34.230 | \$6.008 | \$4.251 | \$15.274 |
| 2017 | \$1.786 | \$0.357 | \$12.186 | \$14.367 | \$10.167 | \$36.526 | \$6.411 | \$4.537 | \$16.298 |
| 2018 | \$1.786 | \$0.357 | \$12.934 | \$15.168 | \$10.733 | \$38.562 | \$6.768 | \$4.789 | \$17.207 |
| 2019 | \$1.786 | \$0.357 | \$12.934 | \$15.870 | \$11.230 | \$40.346 | \$7.081 | \$5.011 | \$18.003 |
| 2020 | \$1.786 | \$0.357 | \$12.934 | \$16.478 | \$11.661 | \$41.892 | \$7.353 | \$5.203 | \$18.693 |
| 2021 | \$1.786 | \$0.357 | \$12.934 | \$16.994 | \$12.026 | \$43.206 | \$7.583 | \$5.366 | \$19.279 |
| 2022 | \$1.786 | \$0.357 | \$12.934 | \$17.425 | \$12.330 | \$44.300 | \$7.775 | \$5.502 | \$19.767 |
| 2023 | \$1.786 | \$0.357 | \$12.934 | \$17.771 | \$12.575 | \$45.180 | \$7.930 | \$5.611 | \$20.160 |
| 2024 | \$1.786 | \$0.357 | \$12.934 | \$17.771 | \$12.575 | \$45.180 | \$7.930 | \$5.611 | \$20.160 |
| 2025 | \$1.786 | \$0.357 | \$12.934 | \$17.771 | \$12.575 | \$45.180 | \$7.930 | \$5.611 | \$20.160 |
| 2026 | \$1.786 | \$0.357 | \$12.934 | \$17.771 | \$12.575 | \$45.180 | \$7.930 | \$5.611 | \$20.160 |
| 2027 | \$1.786 | \$0.357 | \$12.934 | \$17.771 | \$12.575 | \$45.180 | \$7.930 | \$5.611 | \$20.160 |

Table 7 - 12 Total Discounted Benefits, in millions

| Year | Training | | Electronic Stability Aids | Tanker Design-Upper | | | Tanker Design-Lower | | |
|--------------|------------------|----------------|---------------------------|---------------------|-----------------|------------------|---------------------|-----------------|------------------|
| | MCMIS Assumption | GES Assumption | | Lower CG | Wider Track | Aggressive | Lower CG | Wider Track | Aggressive |
| 2008 | \$0.334 | \$0.067 | \$1.458 | \$1.896 | \$1.342 | \$4.821 | \$0.846 | \$0.599 | \$2.151 |
| 2009 | \$0.624 | \$0.125 | \$2.674 | \$3.419 | \$2.420 | \$8.693 | \$1.526 | \$1.080 | \$3.879 |
| 2010 | \$0.875 | \$0.175 | \$3.668 | \$4.619 | \$3.269 | \$11.744 | \$2.061 | \$1.459 | \$5.240 |
| 2011 | \$1.090 | \$0.218 | \$4.462 | \$5.545 | \$3.924 | \$14.097 | \$2.474 | \$1.751 | \$6.290 |
| 2012 | \$1.273 | \$0.255 | \$5.078 | \$6.236 | \$4.413 | \$15.854 | \$2.782 | \$1.969 | \$7.074 |
| 2013 | \$1.190 | \$0.238 | \$5.537 | \$6.730 | \$4.763 | \$17.110 | \$3.003 | \$2.125 | \$7.635 |
| 2014 | \$1.112 | \$0.222 | \$5.861 | \$7.059 | \$4.995 | \$17.946 | \$3.150 | \$2.229 | \$8.008 |
| 2015 | \$1.039 | \$0.208 | \$6.067 | \$7.249 | \$5.129 | \$18.429 | \$3.234 | \$2.289 | \$8.223 |
| 2016 | \$0.971 | \$0.194 | \$6.173 | \$7.324 | \$5.182 | \$18.619 | \$3.268 | \$2.312 | \$8.308 |
| 2017 | \$0.908 | \$0.182 | \$6.195 | \$7.303 | \$5.168 | \$18.568 | \$3.259 | \$2.306 | \$8.285 |
| 2018 | \$0.848 | \$0.170 | \$6.145 | \$7.206 | \$5.099 | \$18.320 | \$3.215 | \$2.275 | \$8.175 |
| 2019 | \$0.793 | \$0.159 | \$5.743 | \$7.046 | \$4.986 | \$17.914 | \$3.144 | \$2.225 | \$7.994 |
| 2020 | \$0.741 | \$0.148 | \$5.367 | \$6.838 | \$4.839 | \$17.384 | \$3.051 | \$2.159 | \$7.757 |
| 2021 | \$0.693 | \$0.139 | \$5.016 | \$6.591 | \$4.664 | \$16.756 | \$2.941 | \$2.081 | \$7.477 |
| 2022 | \$0.647 | \$0.129 | \$4.688 | \$6.315 | \$4.469 | \$16.056 | \$2.818 | \$1.994 | \$7.165 |
| 2023 | \$0.605 | \$0.121 | \$4.381 | \$6.020 | \$4.260 | \$15.304 | \$2.686 | \$1.901 | \$6.829 |
| 2024 | \$0.565 | \$0.113 | \$4.095 | \$5.626 | \$3.981 | \$14.303 | \$2.510 | \$1.776 | \$6.382 |
| 2025 | \$0.528 | \$0.106 | \$3.827 | \$5.258 | \$3.721 | \$13.367 | \$2.346 | \$1.660 | \$5.965 |
| 2026 | \$0.494 | \$0.099 | \$3.576 | \$4.914 | \$3.477 | \$12.493 | \$2.193 | \$1.552 | \$5.574 |
| 2027 | \$0.461 | \$0.092 | \$3.342 | \$4.592 | \$3.250 | \$11.675 | \$2.049 | \$1.450 | \$5.210 |
| TOTAL | \$15.791 | \$3.158 | \$93.351 | \$117.785 | \$83.350 | \$299.452 | \$52.557 | \$37.192 | \$133.620 |

7.3 Costs

Costs for each of the following sections were built up across three categories: direct capital purchase costs, recurrent annual costs, and labor costs. These are discussed below for each mitigation approach. Where direct capital purchase costs were present for capital equipment that would last beyond the time frame of the study, which was the case for each of the approaches, a method needed to be used to distribute the costs across time. Otherwise, all of the costs for additions to the fleet in the last year analyzed would be counted, but benefits in subsequent years would not. This study relies on one of the most common and simple methods for accomplishing this—straight-line depreciation. This means evenly spreading the cost of capital investment across its economic life. Straight-line depreciation usually requires taking the salvage value of the capital equipment at the end of its economic life into account—here we have made the more conservative assumption that the equipment had no salvage value. To the extent to which salvage values do come into play, it is under the assumption that vehicles retired prior to the end of their economic life retain enough value to make this retirement cost neutral with respect to the remaining depreciation. Note that since the benefits tied to the investment are also assumed to draw down to zero at the end of each unit’s economic life, both the small amount of costs and benefits falling outside of the economic life span serve as counterbalancing weights, resulting in little or no impact to the analysis.

Additionally, finance charges were taken into account to reflect the likelihood that carriers would not buy the equipment outright. The rates applied reflect the average yield on A through AAA rated corporate bonds. The ten-year rate (5.5 percent) was applied for the tractors, which had a ten-year economic life, while the average of the ten and twenty year rates (5.7 percent) were applied for the tank trailers which had an economic life of fifteen years. The simulators last considerably longer, but because of the uncommon nature of a thirty year rate for corporate borrowing, the 20-year rate (5.9 percent) was applied. The 20-year corporate bond rate was not very different from the 30-year mortgage rate (which was estimated at 5.85 to 6.14). These rates are higher than necessary for the analysis because they reflect expectations about inflation (while the rest of the analysis is in real terms).

7.3.1 Driver Training

Accurately predicting the difference in cost between existing training methods and the proposed enhancements to driver training is a significant challenge. This is because switching to the proposed training would represent a significant change from labor to capital relative to the existing training. Presently, the hours of instructor time per student driver is estimated at 18.67 hours (40 hours of trainer time with 15 students plus 16 hours of one-on-one training). Under the new approach, this would fall to 13.6 hours, meaning 5 hours of instructor time saved per new driver. The total time a student spends in training is presently estimated at 56 hours and anticipated to fall to 45 hours based on the increased efficacy of the training through the simulators and other technology assisted learning. The 11 hours of student time saving and 5 hours of instructor savings are valued using wage data comparable to that used to value the hour of training required for the electronic stability control [Department of Labor’s Occupational

Employment and Wages Series, for job category 53-3032, “Truck Drivers, Heavy and Tractor-Trailer.”]. However, because trainees presumably earn less than the average driver, and trainer drivers are presumably more experienced and earn more, the 25th percentile wage (\$12.98 in 2005) was used for the trainee and the 75th percentile wage (\$20.55 in 2005) was used for the trainer. Both were adjusted to 2007 and adjusted upward by 30 percent to reflect fringe benefits. The total labor saving per driver is about \$348. Table 7-13 details the hours of training by element.

Table 7 - 13 Training Requirements

| Element |
|-------------------------------------|
| Hours of 15 to 1 training |
| Hours of 1 to 1 training |
| Hours of computer assisted training |
| Hours of simulator training |
| Total Hours of Student Time |
| Trainer Time per Student |

The most costly pieces of capital equipment required for the new training are the simulators, here assumed to cost approximately \$300,000 according to manufacturer and industry interviews. How many simulators required depends on the number of new drivers receiving the training and how many hours of training are required. The analysis assumes that there are 1.1 drivers per tractor—a detailed discussion of the source of this figure follows in Appendix J.

The analysis assumes that each new driver receives three hours of simulator training. Assuming an 8-hour work day with two 3-hour sessions completed per day, and given 52 weeks in a year, less 8 holidays, a single simulator would represent 512 opportunities for students to complete the 3-hour session. Some carriers operate their simulators around the clock to achieve maximum return on their investment in the simulator, so this estimate is quite conservative. The maximum number of new drivers described in the driver profile is 4,196. This means that absent any logistical considerations, eight simulators nationwide could serve all of the new drivers for hazardous-material-carrying cargo tanks. (This is not the total market for truck driving simulators. The number of new Class A CDL drivers is orders of magnitude larger than the cargo tank population. A tank trailer is only a software change from another trailer. As a practical matter, the cargo tank drivers would be sharing a much larger number of simulators with dry freight drivers, but this economic analysis is specific to cargo tank drivers.)

Logistical considerations are significant, however. Any travel by new drivers to a pooled training site would raise costs, and create incentives to have more than the minimum number of simulators to serve the nationwide new driver population. Developing a business model for providing training with simulators that balances travel costs with economies of scale in providing the training to characterize the exact number of simulators required and the magnitude of travel expenses is beyond the scope of this study. However, the labor savings are significant enough that on a per-student basis, a simulator has more than paid for itself in two years--rounding the labor savings dramatically down to \$300 and the annual students served down to 500 per year

produces \$300 times 500 times two years, or \$300,000. The simulators are assumed to last ten years, which makes the potential to build up the stock of simulators over time funded through labor savings significant. Each simulator is assumed to have a recurrent annual \$6,000 maintenance contract after 1 year of warranty coverage.

The simulators are not the only prescribed technology under the training approach. There is also a computer-based element. Costs for the computer-based element are estimated at \$2,000 annually per piece of required equipment including software, reflecting that the computers would not be as durable as the simulators and may be administered under a lease program. Like the simulators, they can be used repeatedly by multiple students per year

Because of the lack of a business model for simulator and computer deployment, and the significant labor savings, costs for the training approach will be considered to not be significantly different from the existing training methods they would replace. The costs presented in Table 7-14 and Table 7-15 are presented to illustrate the labor savings in the context of the minimum investment case for simulators and computers. The minimum investment case reflects the purchase and recurrent costs for the minimum number of simulators and computers required to service the students, ignoring the geographic disposition of the students and equipment. The totals should not be interpreted as precise estimates of the aggregate savings, because the presumption is that the labor savings will fund equipment.

Table 7 - 14 Undiscounted Training Costs, in Millions

| | Purchase | Recurrent | Labor | Total |
|-------------|-----------------|------------------|--------------|--------------|
| 2008 | \$0.022 | \$0.004 | -\$0.185 | -\$0.158 |
| 2009 | \$0.046 | \$0.015 | -\$0.378 | -\$0.317 |
| 2010 | \$0.070 | \$0.026 | -\$0.579 | -\$0.483 |
| 2011 | \$0.096 | \$0.038 | -\$0.790 | -\$0.656 |
| 2012 | \$0.122 | \$0.050 | -\$1.009 | -\$0.837 |
| 2013 | \$0.125 | \$0.058 | -\$1.031 | -\$0.848 |
| 2014 | \$0.128 | \$0.059 | -\$1.054 | -\$0.867 |
| 2015 | \$0.131 | \$0.060 | -\$1.077 | -\$0.886 |
| 2016 | \$0.133 | \$0.061 | -\$1.101 | -\$0.906 |
| 2017 | \$0.136 | \$0.063 | -\$1.125 | -\$0.926 |
| 2018 | \$0.139 | \$0.064 | -\$1.150 | -\$0.946 |
| 2019 | \$0.142 | \$0.059 | -\$1.175 | -\$0.973 |
| 2020 | \$0.146 | \$0.061 | -\$1.201 | -\$0.995 |
| 2021 | \$0.149 | \$0.062 | -\$1.227 | -\$1.017 |
| 2022 | \$0.152 | \$0.063 | -\$1.254 | -\$1.039 |
| 2023 | \$0.155 | \$0.064 | -\$1.282 | -\$1.062 |
| 2024 | \$0.159 | \$0.072 | -\$1.310 | -\$1.079 |
| 2025 | \$0.162 | \$0.074 | -\$1.339 | -\$1.102 |
| 2026 | \$0.166 | \$0.076 | -\$1.368 | -\$1.127 |
| 2027 | \$0.169 | \$0.077 | -\$1.398 | -\$1.151 |

Table 7 - 15 Discounted Training Costs, in Millions

| | Purchase | Recurrent | Labor | Total |
|--------------|-----------------|------------------|--------------|--------------|
| 2008 | \$0.021 | \$0.004 | -\$0.173 | -\$0.148 |
| 2009 | \$0.040 | \$0.013 | -\$0.330 | -\$0.277 |
| 2010 | \$0.057 | \$0.021 | -\$0.473 | -\$0.394 |
| 2011 | \$0.073 | \$0.029 | -\$0.603 | -\$0.501 |
| 2012 | \$0.087 | \$0.035 | -\$0.719 | -\$0.597 |
| 2013 | \$0.083 | \$0.038 | -\$0.687 | -\$0.565 |
| 2014 | \$0.080 | \$0.037 | -\$0.656 | -\$0.540 |
| 2015 | \$0.076 | \$0.035 | -\$0.627 | -\$0.516 |
| 2016 | \$0.073 | \$0.033 | -\$0.599 | -\$0.493 |
| 2017 | \$0.069 | \$0.032 | -\$0.572 | -\$0.471 |
| 2018 | \$0.066 | \$0.030 | -\$0.546 | -\$0.449 |
| 2019 | \$0.063 | \$0.026 | -\$0.522 | -\$0.432 |
| 2020 | \$0.060 | \$0.025 | -\$0.498 | -\$0.413 |
| 2021 | \$0.058 | \$0.024 | -\$0.476 | -\$0.394 |
| 2022 | \$0.055 | \$0.023 | -\$0.455 | -\$0.377 |
| 2023 | \$0.053 | \$0.022 | -\$0.434 | -\$0.360 |
| 2024 | \$0.050 | \$0.023 | -\$0.415 | -\$0.341 |
| 2025 | \$0.048 | \$0.022 | -\$0.396 | -\$0.326 |
| 2026 | \$0.046 | \$0.021 | -\$0.378 | -\$0.312 |
| 2027 | \$0.044 | \$0.020 | -\$0.361 | -\$0.298 |
| Total | \$1.202 | \$0.514 | -\$9.919 | -\$8.203 |

7.3.2 Electronic Stability Aids

The electronic stability control approach has direct purchase costs (retail price of \$619 according to a December 2006 quote from a dealer) that are applied on an annualized per-vehicle basis to new vehicles added to the fleet for replacement or growth, just as the vehicle’s designs did. There are recurrent costs associated with this approach. Because the electronic stability aid would be a new system installed on trucks, a parts failure rate of 0.19 percent is applied, consistent with previous study of the devices [Battelle, 2004]. This represents a recurrent annual cost of \$1.82 per vehicle.

Drivers will receive approximately one hour of training familiarizing them with the device. The hour of training is valued using wage data from the Department of Labor’s Occupational Employment and Wages Series, for job category 53-3032, “Truck Drivers, Heavy and Tractor-Trailer.” In 2005, the average hourly wage was \$19.32. This hourly wage was adjusted upward to reflect fringe benefits (31 percent according to information from FMCSA supplied to support Battelle, 2004) and to reflect wage inflation between 2005 and 2007. The final figure used to

value each hour of driver training is approximately \$31. As for the driver training analysis, there are assumed to be 1.1 drivers per tractor. The training, however, persists in the analysis only until deployment of the electronic stability control has reached 100 percent deployment in the fleet, after which it is assumed that the devices will be familiar to existing drivers and will be incorporated at negligible cost into training for new drivers. Undiscounted and discounted costs are tabulated in Tables 7-16 and 7-17, respectively.

**Table 7 - 16 Undiscounted Costs for Electronic Stability Aids,
in Millions**

| | Purchase | Recurrent | Labor | Total |
|-------------|-----------------|------------------|--------------|--------------|
| 2008 | \$0.579 | \$0.008 | \$0.211 | \$0.798 |
| 2009 | \$1.153 | \$0.017 | \$0.220 | \$1.390 |
| 2010 | \$1.718 | \$0.025 | \$0.228 | \$1.970 |
| 2011 | \$2.270 | \$0.033 | \$0.234 | \$2.537 |
| 2012 | \$2.806 | \$0.040 | \$0.240 | \$3.087 |
| 2013 | \$3.323 | \$0.048 | \$0.246 | \$3.617 |
| 2014 | \$3.820 | \$0.055 | \$0.251 | \$4.126 |
| 2015 | \$4.295 | \$0.061 | \$0.255 | \$4.612 |
| 2016 | \$4.746 | \$0.068 | \$0.259 | \$5.073 |
| 2017 | \$5.172 | \$0.074 | \$0.264 | \$5.510 |
| 2018 | \$5.572 | \$0.080 | \$0.000 | \$5.652 |
| 2019 | \$5.656 | \$0.081 | \$0.000 | \$5.737 |
| 2020 | \$5.741 | \$0.082 | \$0.000 | \$5.823 |
| 2021 | \$5.827 | \$0.083 | \$0.000 | \$5.910 |
| 2022 | \$5.914 | \$0.085 | \$0.000 | \$5.999 |
| 2023 | \$6.003 | \$0.086 | \$0.000 | \$6.089 |
| 2024 | \$6.093 | \$0.087 | \$0.000 | \$6.180 |
| 2025 | \$6.184 | \$0.089 | \$0.000 | \$6.273 |
| 2026 | \$6.277 | \$0.090 | \$0.000 | \$6.367 |
| 2027 | \$6.371 | \$0.091 | \$0.000 | \$6.463 |

**Table 7 - 17 Discounted Costs for Electronic Stability Aids,
in Millions**

| | Purchase | Recurrent | Labor | Total |
|--------------|-----------------|------------------|--------------|--------------|
| 2008 | \$0.541 | \$0.008 | \$0.197 | \$0.746 |
| 2009 | \$1.007 | \$0.014 | \$0.192 | \$1.214 |
| 2010 | \$1.403 | \$0.020 | \$0.186 | \$1.609 |
| 2011 | \$1.732 | \$0.025 | \$0.179 | \$1.935 |
| 2012 | \$2.001 | \$0.029 | \$0.171 | \$2.201 |
| 2013 | \$2.215 | \$0.032 | \$0.164 | \$2.410 |
| 2014 | \$2.379 | \$0.034 | \$0.156 | \$2.569 |
| 2015 | \$2.500 | \$0.036 | \$0.149 | \$2.684 |
| 2016 | \$2.582 | \$0.037 | \$0.141 | \$2.760 |
| 2017 | \$2.629 | \$0.038 | \$0.134 | \$2.801 |
| 2018 | \$2.647 | \$0.038 | \$0.000 | \$2.685 |
| 2019 | \$2.511 | \$0.036 | \$0.000 | \$2.547 |
| 2020 | \$2.382 | \$0.034 | \$0.000 | \$2.416 |
| 2021 | \$2.260 | \$0.032 | \$0.000 | \$2.292 |
| 2022 | \$2.144 | \$0.031 | \$0.000 | \$2.174 |
| 2023 | \$2.033 | \$0.029 | \$0.000 | \$2.063 |
| 2024 | \$1.929 | \$0.028 | \$0.000 | \$1.957 |
| 2025 | \$1.830 | \$0.026 | \$0.000 | \$1.856 |
| 2026 | \$1.736 | \$0.025 | \$0.000 | \$1.761 |
| 2027 | \$1.646 | \$0.024 | \$0.000 | \$1.670 |
| Total | \$40.107 | \$0.574 | \$1.668 | \$42.349 |

7.3.3 Vehicle Design

The costs for the vehicle design approach are direct capital purchase costs—with the cost per vehicle being the expected additional cost of purchase for each type of vehicle (which overstates the cost to society to the extent to which purchase costs include profit for the manufacturer). Estimates or quotes for the costs of each of the three improved designs were obtained from cargo tank manufacturers. Table 5-9 presents the range of costs; Table 7-18 presents the values used in the benefit-cost analysis.

Table 7 - 18 Incremental Purchase Cost for New Vehicle Designs in 2007 Dollars

| Vehicle | Cost |
|------------------------|----------|
| Lower CG | \$2,000 |
| Wider Track | \$500 |
| Aggressive Improvement | \$12,000 |

To tabulate the total costs across the 20-year period associated with these methods, these per-vehicle costs are applied on an annual basis to all new vehicles as they enter the fleet due to growth or retirement, consistent with the fleet profile described in Section 7.1.2. The results of this are presented in Table 7-19. The present discounted values for these costs are presented in Table 7-20.

Table 7 - 19 Undiscounted Purchase Costs for New Vehicle Designs, in Millions

| | Lower CG | Wider Track | Aggressive |
|------|----------|-------------|------------|
| 2008 | \$0.468 | \$0.029 | \$2.809 |
| 2009 | \$0.917 | \$0.057 | \$5.501 |
| 2010 | \$1.345 | \$0.084 | \$8.072 |
| 2011 | \$1.754 | \$0.110 | \$10.523 |
| 2012 | \$2.142 | \$0.134 | \$12.852 |
| 2013 | \$2.511 | \$0.157 | \$15.064 |
| 2014 | \$2.860 | \$0.179 | \$17.160 |
| 2015 | \$3.190 | \$0.199 | \$19.138 |
| 2016 | \$3.500 | \$0.219 | \$20.999 |
| 2017 | \$3.791 | \$0.237 | \$22.743 |
| 2018 | \$4.062 | \$0.254 | \$24.371 |
| 2019 | \$4.314 | \$0.270 | \$25.881 |
| 2020 | \$4.546 | \$0.284 | \$27.276 |
| 2021 | \$4.759 | \$0.297 | \$28.554 |
| 2022 | \$4.953 | \$0.310 | \$29.716 |
| 2023 | \$5.127 | \$0.320 | \$30.761 |
| 2024 | \$5.204 | \$0.325 | \$31.223 |
| 2025 | \$5.282 | \$0.330 | \$31.691 |
| 2026 | \$5.361 | \$0.335 | \$32.166 |
| 2027 | \$5.441 | \$0.340 | \$32.648 |

Table 7 - 20 Discounted Vehicle Costs, in Millions

| | Lower CG | Wider Track | Aggressive |
|--------------|-----------------|--------------------|-------------------|
| 2008 | \$0.438 | \$0.027 | \$2.626 |
| 2009 | \$0.801 | \$0.050 | \$4.805 |
| 2010 | \$1.098 | \$0.069 | \$6.589 |
| 2011 | \$1.338 | \$0.084 | \$8.028 |
| 2012 | \$1.527 | \$0.095 | \$9.163 |
| 2013 | \$1.673 | \$0.105 | \$10.038 |
| 2014 | \$1.781 | \$0.111 | \$10.686 |
| 2015 | \$1.856 | \$0.116 | \$11.138 |
| 2016 | \$1.904 | \$0.119 | \$11.422 |
| 2017 | \$1.927 | \$0.120 | \$11.562 |
| 2018 | \$1.930 | \$0.121 | \$11.579 |
| 2019 | \$1.915 | \$0.120 | \$11.492 |
| 2020 | \$1.886 | \$0.118 | \$11.319 |
| 2021 | \$1.846 | \$0.115 | \$11.074 |
| 2022 | \$1.795 | \$0.112 | \$10.771 |
| 2023 | \$1.737 | \$0.109 | \$10.420 |
| 2024 | \$1.647 | \$0.103 | \$9.884 |
| 2025 | \$1.563 | \$0.098 | \$9.376 |
| 2026 | \$1.482 | \$0.093 | \$8.894 |
| 2027 | \$1.406 | \$0.088 | \$8.437 |
| Total | \$31.550 | \$1.972 | \$189.302 |

No labor costs or recurring maintenance costs are attributed to the vehicles, because there was no reason to think that the new vehicle designs required specific driver training nor any reason to think that the designs significantly changed the maintenance profile of the vehicles.

7.4 Conclusions

Table 7-21 contains the tabulated costs and benefits detailed in the sections above. Additionally, it has the calculation of net benefits (total benefits minus total costs) and the benefit-cost ratio (benefits divided by costs) that are indicators of whether a project creates value for society or not. Benefit-cost ratios greater than one correspond to positive net benefits for society, while ratios less than one correspond to negative net benefits. Note that training costs are not provided in these results because they are assumed to be a “wash,” with no advantage either way, based on the assumption that the significant labor savings will be used to fund the equipment investments as described in Section 7.3.1.

Table 7 - 21 Comparison of Benefits and Costs

| Approach | Total Crashes Avoided | Total Present Discounted Benefits | Total Present Discounted Costs | Net Benefits | Benefit Cost Ratio |
|-----------------------------|------------------------------|--|---------------------------------------|---------------------|---------------------------|
| Training* | | | | | |
| Lower Bound Assumption | 11 | \$3,158,154 | * | \$3,158,154 | * |
| Upper Bound Assumption | 54 | \$15,790,772 | * | \$15,790,772 | * |
| Electronic Stability Aids | 341 | \$93,351,246 | \$42,348,947 | \$51,002,299 | 2.204 |
| Tanker Design (Upper Bound) | | | | | |
| Lower CG | 434 | \$117,784,588 | \$31,550,282 | \$86,234,306 | 3.733 |
| Wider Track | 307 | \$83,349,722 | \$1,971,943 | \$81,377,779 | 42.268 |
| Aggressive Improvement | 1,102 | \$299,452,343 | \$189,301,691 | \$110,150,651 | 1.582 |
| Tanker Design (Lower Bound) | | | | | |
| Lower CG | 193 | \$52,557,266 | \$31,550,282 | \$21,006,985 | 1.666 |
| Wider Track | 137 | \$37,191,908 | \$1,971,943 | \$35,219,965 | 18.861 |
| Aggressive Improvement | 492 | \$133,620,169 | \$189,301,691 | -\$55,681,522 | 0.706 |

All of the approaches analyzed produce value for society, except for one. The aggressive improvement in vehicle design under the lower bound benefits assumption performed the worst in the BCA. However, under the upper bound assumption, its BCR is greater than one, though lower than any others. It also has the highest total benefits numbers, even under the lower bound assumption, of any of the approaches, which makes it clear that its high \$12,000 per vehicle cost drives the result. However, taking net benefits as the criterion, the aggressive improvement vehicle design outperforms everything else in under the upper bound assumption (though it still underperforms everything else in the lower bound). This is because while costs are high for this approach, benefits are high as well—leading to a small proportional difference but large absolute difference. It had the highest efficacy rate of all of the vehicle design methods. While the electronic stability control had a higher efficacy rate, it was applied to a much smaller subset of crashes, producing overall fewer crashes avoided (and lower total benefits).

The best performing vehicle design option, and the best performing over all according to the benefit-cost ratio, was the wider track design. It outperforms any other method with respect to BCR even under the lower bound assumptions. The success of the wider track design is owed in large part to its low cost of \$500 per vehicle, which is lower than for any other mitigation approach (excluding the training for which costs are assumed to be neutral).

The training method, while its net benefits are relatively modest compared to the wider track vehicle design or the electronic stability control, should not be overlooked. If the costs truly are insignificantly different from existing training, the relevant benefit cost ratio for society would have a zero in the denominator and, thus, would be approaching infinity. This should be carefully interpreted to not imply that industry necessarily benefits as greatly from the training, as all of the crash costs used to value the crashes are calculated for society as a whole.

The common wisdom holds that the electronic stability controls pay for themselves. Despite the fact that the relatively small number of crashes they apply to, that common wisdom is confirmed here with a positive net benefits number and a BCR greater than one.

The Zaloshnja and Miller study that serves as the basis for valuation of the potential avoided crashes uses a 4 percent discount rate internally. The rest of the benefit and cost numbers presented here use the 7 percent discount rate recommended by OMB for regulatory analysis. For comparison, Table 7-22 presents the final results of the analysis under a 4 percent discount rate. It should be noted that this variation produces small changes in the BCRs, but does not change any of the conclusions reached by using the 7 percent rate.

Table 7 - 22 Comparison of Costs and Benefits with Alternate Discount Rate (4%)

| Approach | Total Crashes Avoided | Total Present Discounted Benefits | Total Present Discounted Costs | Net Benefits | Benefit Cost Ratio |
|-----------------------------|------------------------------|--|---------------------------------------|---------------------|---------------------------|
| Training* | | | | | |
| Lower Bound Assumption | 11 | \$4,192,617 | * | \$4,192,617 | * |
| Upper Bound Assumption | 54 | \$20,963,087 | * | \$20,963,087 | * |
| Electronic Stability Aids | 341 | \$127,589,982 | \$58,147,135 | \$69,442,847 | 2.194 |
| Tanker Design (Upper Bound) | | | | | |
| Lower CG | 434 | \$161,941,281 | \$43,866,734 | \$118,074,547 | 3.692 |
| Wider Track | 307 | \$114,596,959 | \$2,741,740 | \$111,855,218 | 41.797 |
| Aggressive Improvement | 1,102 | \$411,715,122 | \$263,200,405 | \$148,514,717 | 1.564 |
| Tanker Design (Lower Bound) | | | | | |
| Lower CG | 193 | \$72,260,651 | \$43,866,734 | \$28,393,917 | 1.647 |
| Wider Track | 137 | \$51,134,898 | \$2,741,740 | \$48,393,158 | 18.651 |
| Aggressive Improvement | 492 | \$183,713,521 | \$263,200,405 | -\$79,486,884 | 0.698 |

This Page Intentionally Left Blank

8.0 Conclusions

There are many reasons that lead cargo tank motor vehicles to roll over, and many factors must be addressed to reduce the number of rollovers. There is no one solution to all heavy vehicle rollovers. Four general approaches have been studied in this project, better driver training, electronic stability aids, improvements in the vehicle design, and improvements in highway design. There was no clear “winner” among them. All have their respective merits, and all warrant further attention in a broad program to improve highway safety. Drivers need to realize the diverse situations that can lead to rollover so they can exercise proper care to prevent those situations from developing. Drivers and carriers alike must understand both the benefits and the limits of electronic stability aids. And carriers and manufacturers should appreciate the stability improvements to be gained from even a small reduction in the height of a cargo tank vehicle.

8.1 Driver Training

With driver error of one kind or another figuring in 3/4 of all cargo tank rollovers, a comprehensive rollover prevention program must address the driver. The driver must be awake and alert at all times. To this end, dispatchers must provide reasonable and legal delivery schedules, and drivers must avail themselves of opportunities for sleep. The driver must be trained to perceive and handle dangers arising from the highway, the weather, and from other vehicles.

Drivers need to be aware of the conditions that can lead to rollovers. While one might at first think that most heavy truck rollovers are due to excessive speed on a freeway on ramp or off ramp, these situations actually account for fewer than 10 percent of all cargo tank rollovers. A much more common cause of rollovers is running off the road which, in turn, is often caused by drowsiness, inattention, or speed. Multiple-vehicle crashes with a rollover (which are 1/5 of cargo tank rollovers) are caused most frequently by “the other driver.” Driver training should include not just a presentation of national crash statistics but an explanation of their implications for driver awareness. Drivers should be told to be on the lookout for all pre-rollover situations. Older and larger companies would have a history of rollovers and can personalize the training with accounts of specific events, so the driver will appreciate what situations require care.

Large carriers have experienced reductions in overall crash counts and reductions in training time through the use of modern driving simulators. There are not yet long term studies to demonstrate the benefits of simulator training specifically on rollover prevention. There is good reason to continue development of rollover prevention curricula, as simulators provide the possibility for drivers to experience near-rollover conditions that would be too dangerous to drive even on a test track. When drivers are on ramps, they should stay well enough below the rollover limit that they never feel “the edge,” but safe maneuvers for avoiding other vehicles and recovering from pavement departures can be practiced in a simulator. Simulators can be adjusted so that drivers can feel loads with different roll properties. Simulators can be equipped to model electronic stability aids, so drivers can learn their effects.

8.2 Electronic Stability Aids

These devices, which slow the truck when a driver inadvertently enters a curve at too high a speed, can be remarkably effective in slowing the truck before a rollover occurs. By building on the existing electronics for ABS, they are robust and inexpensive. However, crash statistics and anecdotal counts from carriers consistently show that the majority of heavy vehicle rollovers are caused by reasons other than excessive speed in a curve. According to two of the databases consulted for this study, excessive speed is a factor in about half of cargo tank rollovers. Rollovers result from a single vehicle running off the road, or they follow crashes with other motor vehicles. Electronic stability aids are certainly a part of the overall solution, but decision-makers in the industry must remember that they address only a portion of the rollover population.

Modern sensors and communication technology allow drivers' safety practices to be monitored by the dispatcher or supervisor, almost in real time. Supervisors know whether drivers are adhering to speed limits and company-designated safe routes. A concern has been expressed that drivers might use electronic stability aids as a "crutch" or an excuse to take curves too fast. The stability aids record when they are activated, so supervisors can use these records as a positive learning tool for drivers. If handled properly, the information can reduce risk-taking, and so the aids will have benefits beyond simply slowing the truck in an emergency.

8.3 Vehicle Design

Improving the basic stability of the vehicle itself is the only approach that will help to reduce rollovers resulting from any cause. No new technological breakthroughs are required to achieve rollover benefits through vehicle design. Models with a slightly lower center of gravity than is common and models with wider tracks are available today. The 10-15 percent reduction in rollover experience offered by these trailers will be significant in the long run. These models do have a cost premium. A carrier with a tight operating budget may have to choose whether to spend a little more to buy a more stable trailer or to buy an electronic stability aid. Smaller carriers, in particular, do not see the national crash trends, and carriers do not experience all of the societal costs that were included in the economic analysis.

The greatest improvement that has a regulatory impediment is widening the track width of semitrailers from 96 inches to 102 inches. One carrier remarked during an interview that virtually all new trailers would have 102-inch axles overnight if they became generally legal. Some carriers, however, noted that maneuvering even a 96-inch wide trailer in a tight urban environment is difficult, so there will always be a portion of the DOT 406 trailers that do not convert.

The quantitative benefits analysis for improved vehicle design concentrated on DOT 406 trailers, those that carry petroleum products. The entire cargo tank market is much smaller than the dry van semitrailer market, and aside from petroleum, there is tremendous segmentation of specialty vehicles for specialty products. Modest gains in stability are certainly feasible from an engineering viewpoint, but each trailer would essentially be its own design case.

8.4 Highway Design

The one common lesson from the review of highway design locations is that drivers should be made aware of unusual curves, grades, or traffic patterns. Existing land use or terrain (e.g., mountains) often dictate geometric design decisions. Within these constraints, highway design engineers work to make the best possible choices, and they advise drivers of the conditions.

While carriers can do little to affect the design of highways, they can recognize difficult locations in their delivery area. Experienced drivers become familiar with sites that require special care and pass this information, formally or informally, to new drivers in the company. In many instances, routes can be planned to avoid highway locations that are not amenable to heavy vehicles.

This Page Intentionally Left Blank

References

- Allen, R. W., Szostak, H. T., Klyde, D. H., Rosenthal, T. J., and Owens, K. J. September 1992. Vehicle dynamic stability and rollover. DOT-HS-807 956.
- American Association of State Highway and Transportation Officials. 2001. AASHTO, *A policy of geometric design of highways and streets*. Fourth edition.
- Battelle. 2001. Comparative risks of hazardous materials and non-hazardous materials truck shipment accidents/incidents. Final report. Contract No. DTFH61-98-C-00060. Available online at <http://www.fmcsa.dot.gov/Pdfs/HMRiskFinalReport.pdf>. Related Tech Brief at <http://www.fmcsa.dot.gov/facts-research/research-technology/tech/HAZMAT-Technical-Briefing.htm>.
- Battelle. September 2003a. Evaluation of the freightliner intelligent vehicle initiative field operational test. Final report on Contract No. DTFH61-96-C-00077, Work Order 7718. Available online as http://www.itsdocs.fhwa.dot.gov/JPODOCS/REPTS_TE//13871.html
- Battelle. December 2003b. A simulation approach to estimate the efficacy of Meritor WABCO's improved roll stability control (RSC). Task 5.4 report. Contract DTFH61-96-C-00077, Task Order 7732.
- Battelle. 2004. Analysis and documentation of industry benefits and costs for the improved roll advisor and controller technology. Task 5.5 report. Contract DTFH61-96-C-00077, Task Order 7732.
- Battelle. 2005. Hazardous materials serious crash analysis: Phase 2. Final report. Contract DTMC75-01-D-00003/TO No. 02.
- Battelle. January 2006. Evaluation of the Mack Intelligent Vehicle initiative field operational test. Draft final report, Contract No. DTFH61-96-C-00077, Task Order 7719. Section 1.1.2 and Appendix J.
- Blower, D., and Matteson, A. March 2003. Evaluation of the motor carrier management information system crash file, phase one. University of Michigan Transportation Research Institute, Ann Arbor, Michigan. Sponsor: Federal Motor Carrier Safety Administration, U.S. DOT.
- Blower, D., and Matteson, A. September 2004. Evaluation of Michigan crash data reported to MCMIS crash file. University of Michigan Transportation Research Institute, Ann Arbor, Michigan. Sponsor: Federal Motor Carrier Safety Administration, U.S. DOT.
- Bola, R. S. June 1999. Evaluation of a truck-activated rollover warning system. Report No. FHWA/CA/TE-99/11. NTIS No. PB99-169104.

Brock, J., McFann, J., Inderbitzen, R. and Bergoffen, G. 2007. Commercial motor vehicle driver training curricula and delivery methods and their effectiveness. Commercial Truck & Bus Safety Synthesis Program, Transportation Research Board: Washington, DC.

Brock, J. F. 1997. Computer-based instruction. In G. Salvendy (Ed.), *Handbook of Human Factors and Ergonomics, 2nd. Edition*. New York: John Wiley and Sons, 578 - 593.

Brock, J. F. 1998. Applying ISD to a social problem: Systematic development of a driver training computer-based program. *Proceedings of the Human Factors and Ergonomic Society 42nd Annual Meeting*. Santa Monica, CA: Human Factors and Ergonomics Society, 1393.

Brock, J. F., Jacobs, C. M., and McCauley, M. 2001. Evaluation of simulators as an effective tool to improve bus safety and guidelines for their application. Transit Cooperative Research Program, Transportation Research Board, National Academies of Science, Washington, DC.

Brock, J. F., Krueger, G. P., Golembiewski, G. A., Daecher, C., Bishop, R., and Bergoffen, G. 2005. Motorcoach industry house of service and fatigue management techniques. Commercial Truck and Bus Safety Synthesis Program, Transportation Research Board: Washington, DC.

Brock, J. F. August 2006. Instructional methods for young drivers. Transportation Research Circular E-C101, Driver education, the path ahead. Transportation Research Board Operator Education and Regulation Committee.

Dodds, P. and Fletcher J. D. December 2004. Opportunities for new “smart” learning environments enabled by next-generation web capabilities. *Journal of Educational Multimedia and Hypermedia*.

DTDA. 1999. *Commercial Driver Training and Development Handbook*. Alexandria, VA: Professional Driver Training and Development Alliance.

Eberts, R. E., and Brock, J. F. 1987. Computer-assisted and computer-managed instruction. In G. Salvendy (Ed.), *Handbook of Human Factors* (Chap. 8.4, pp. 976-1011). New York: Wiley.

Ervin, R., C. Winkler, P. Fancher, M. Hagan, V. Krishnaswami, H. Zhang, and S. Bogard. July 1998. Two active systems for enhancing dynamic stability in heavy truck operations. Contract DTNH22-95-H-07002, DOT Report No. DOT HS 808 870, UMTRI Report No. UMTRI-98-39.

Fletcher, J. D. 1995. Does this stuff work? Some findings from applications of technology to education and training. Institute of Defense Analysis: Alexandria, VA.

Glass, G. V. 1976. Primary, secondary, and meta-analysis of research. *Educational Researcher*, Vol. 5, No. 10 (Nov), pp. 3-8.

Green, P. E., and Blower, D. February 2005. Evaluation of New Jersey crash data reported to MCMIS crash file. University of Michigan Transportation Research Institute, Ann Arbor, Michigan. Sponsor: Federal Motor Carrier Safety Administration, U.S. DOT.

Green, P. E., and Blower, D. July 2005. Evaluation of New Mexico crash data reported to MCMIS crash file. University of Michigan Transportation Research Institute, Ann Arbor, Michigan. Sponsor: Federal Motor Carrier Safety Administration, U.S. DOT.

Hartman, K., Pritchard, F., Jennings, K., Johnson, J., Knipling, R., MacGowan, J., Oliphant, L., Onder, M. and Sanft, C. 2000. Commercial vehicle practices—technology and practice in Europe. Office of International Programs, FHWA-HPIP, U. S. Department of Transportation.

Hodell, L., Hersch, R., Brock, J., Lonero, L., Clinton, K, and Black, D. September 2001. Training to improve the decision making of young novice drivers. Volume I: Final Report. National Highway Traffic Safety Administration, U. S. Department of Transportation, Washington, D.C.

Horn, B. E., and Tardif, L. 1999. Licensing and training of truck drivers: new and continuing challenges. *Journal of International Association of Traffic and Safety Services*, Vol. 23(1), pp. 16–21.

Keppler, S. [2004] “Operation Air Brake 2004 Promoted Brake safety and education.” Commercial Vehicle Safety Alliance News Release. October 19, 2004
http://www.cvsa.org/programs/documents/2004_postrelease.pdf .
(See also http://www.cvsa.org/programs/oab_statistics.cfm)

Kulik, J. A. 1994. Meta-analytic studies of findings on computer-based instruction. In *Technology Assessment in Education and Training*, El L. Baker and H. F. O’Neil Jr., Eds. Hillsdale, NJ: Lawrence Erlbaum Associates, Publishers.

Kulik, C-L. C. and Kulik, J. A. 1991. Effectiveness of computer-based instruction: an updated analysis. *Computers in Human Behavior*, 7, 75-94.

Kuncytc’, R. Laberge-Nadeau, C., T. G. Crainic, and Read, J. A. 2003. Organization of truck-driver training for the transportation of dangerous goods in Europe and North America. *Accident Analysis and Prevention*, 35(2):191-200.

Llaneras, R. E., Swezey, R. E., Brock, J. F., Rogers, W. C. and Van Cott, H. P. March 1998. Enhancing the safe driving performance of older commercial vehicle drivers. *International Journal of Industrial Ergonomics*.

Mack Trucks, Inc. January 17, 2006. Mack first to offer stability protection for concrete customers. News release. Available online at
<http://www.macktrucks.com/default.aspx?pageid=1427>. (See also “Mack puts Bendix stability system on cement mixer trucks.” *Concrete Monthly*, February 2006.
<http://www.concretemonthly.com/monthly/art.php?1973>)

Matteson, A., and Blower, D. February 2005. Evaluation of California crash data reported to MCMIS crash file. University of Michigan Transportation Research Institute, Ann Arbor, Michigan. Sponsor: Federal Motor Carrier Safety Administration, U.S. DOT.

Matteson, A., and Blower, D. May 2005. Evaluation of North Carolina crash data reported to MCMIS crash file. University of Michigan Transportation Research Institute, Ann Arbor, Michigan. Sponsor: Federal Motor Carrier Safety Administration, U.S. DOT.

Neighbor, M. B. November 2001. GES driving conflict identification for the IVI generation 0 field operational tests. Paper presented at Society for Automotive Engineers International Truck and Bus Meeting and Exhibition, Chicago, IL, SAE Technical Paper No. 2001-01-2819.

Pape, D.B., Hadden, J.A., McMillan, N.J., Narendran, V.K., Everson, J.H., and Pomerleau, D.A., [1999] "Performance considerations for run-off-road countermeasure systems for cars and trucks." SAE Technical Paper 1999-01-0820.

Pierowicz, J., Robin, J., Gawron, V., Watson, G., Nestor, B., and Murphree, W. 2002. Commercial truck simulators re-assessment and evaluation. U.S. DOT/FMCSA Publication No. MCSART-03-008, 2002.

Research Triangle Institute. 2001. SUDAAN user's manual, release 8. Research Triangle Park, NC: Research Triangle Institute.

Ryder Truck. 2000. A smarter way to train. *Heavy Duty Trucking*, Vol.79 (11), pp. 60-61.

Staplin, L., Lococo, K., Decina, L. and Bergoffen, G. 2004. Training of commercial motor vehicle drivers. Commercial Truck and Bus Safety Synthesis Program, Transportation Research Board: Washington, DC.

Stevens, S. S., Chin, S. M., Hake, K. A., Hwang, H. L., Rollow, J. P., Truett, L. F. March 2001. Truck roll stability data collection and analysis. Center for Transportation Analysis, Oak Ridge National Laboratory. Report No. ORNL/TM-2001/116. Contract No. DE-AC05-00OR22725. Available online at <http://cta.ornl.gov/cta/Publications/Reports/ORNLTM2001116.pdf>.

Strayer, D. and Drews, F. 2005. Simulator training improves driver efficiency: transfer from the simulator to the real world. *Proceedings of the Second International Driving Symposium on Human Factors in Driver Assessment, Training and Vehicle Design*, 190-193.

Strickland, R., and McGee, H. January 1998. Evaluation of prototype automatic truck rollover warning systems. Report No. FHWA-RD-97-124. NTIS No. PB98-131725.

Thompson, J. D. January 1996. Frito-Lay puts spin on training with CDs. *Private Carrier*, pp. 40-42.

Toledo, T., and Lotan, T. 2006. In-vehicle data recorder for evaluation of driving behavior and safety. *Transportation Research Record: Journal of the Transportation Research Board*, No 1953, Transportation Research Board of the National Academies, Washington, DC, pp. 112-119.

U.S. Department of Labor, Bureau of Labor Statistics. 2007a. Producer price index. <http://www.bls.gov/news.release/ppi.toc.htm>

U.S. Department of Labor, Bureau of Labor Statistics. 2007b. Employment cost index. <http://www.bls.gov/news.release/eci.toc.htm>

U.S. Department of Transportation, Federal Motor Carrier Safety Administration. 2007. Commercial motor vehicle safety and security systems technology, lane departure warning systems. <http://www.fmcsa.dot.gov/facts-research/systems-technology/product-guides/lane-departure.htm>.

U.S. Department of Transportation. 1991. National automotive sampling system general estimates user's manual, 1988-1990.

U.S. Department of Transportation. 2004. General estimates system coding and editing manual, 2004.

U.S. Department of Transportation. 2004. National automotive sampling system general estimates user's manual, 1988-2004.

U.S. Department of Transportation, National Highway Traffic Safety Administration. October 7, 2002. Consumer information regulations; federal motor vehicle safety standards; rollover resistance. *Federal Register* Vol. 67, No. 194 pp. 62528-62590. Available online at <http://www.nhtsa.dot.gov/cars/rules/rulings/Rollover/2001Standards/RolloverResistance.pdf>

U.S. Department of Transportation, National Highway Traffic Safety Administration. April 6, 2007. Federal motor vehicle safety standards; electronic stability control systems. 72 FR 17236. Docket No. NHTSA-2007-27662. Available online at <http://dms.dot.gov/search/document.cfm?documentid=464405&docketid=27662>. (See also the NPRM and comments at Docket NHTSA-2006-25801.)

United States Whitehouse Office of Management and Budget (OMB). 2003. Regulatory analysis. Circular A-4. [<http://www.whitehouse.gov/omb/circulars/a004/a-4.pdf>]

Voorhees, James W. Instructional Technologies, Inc. September 2006. Personal communication.

Winkler, C. B.; Blower, D., Erwin, R. D. and Chalasani, R. M. 2000. Rollover of heavy commercial vehicles. Warrendale, PA: Society of Automotive Engineers.

Winkler, C. B., Ervin, R., and Fancher, P. March 1999. Intelligent systems for aiding the truck driver in vehicle control. SAE Paper No. 1999-01-1301.

Zaloshnja, E., and Miller, T. 2002. Revised costs of large truck- and bus-involved crashes. Final report for Federal Motor Carrier Safety Administration. Pacific Institute for Research and Evaluation.

[http://ai.volpe.dot.gov/carrierresearchresults/PDFs/Truck_Crash_Costs_2002_Final.pdf last accessed January 15, 2007]

Appendix A

Detailed Tables Of Crash Statistics

This Page Intentionally Left Blank

This appendix contains nearly all of the data that was examined during the study of rollover statistics. There were many more tables than could be comfortably discussed in the main text.

Nearly all the tables in Section 2 of the main text contain data only for rollover crashes. In this appendix, most tables for the three truck-specific databases (MCMIS, LTCCS, and TIFA) have data for all crashes, so the distribution of factors for rollovers can be compared to those for all crashes. Most of these tables have a column entitled, “percent rollover crashes.” This is a calculation across a row answering the question, “Given that there was a crash, what fraction of the vehicles that crashed rolled over?” NHTSA used an analysis of this type to ascribe a vehicle’s inherent propensity to rollover when it was developing its procedures for light vehicle NCAP (New Car Assessment Program) rollover ratings [USDOT NHTSA, 2002].

Many tables identify whether the rollover was the first event or a subsequent event. These terms are defined differently in TIFA than in GES and MCMIS. If a truck runs off a road but no damage or injury is caused until it rolls over, the first event in MCMIS is running off the road and rolling over in GES and TIFA. Therefore, the number of cases where the rollover is the “first” event will be smaller in MCMIS than in the other databases.

Please refer to the main text, Section 2.1, for an explanation of the databases and how the records were selected.

A-1 Crosscutting Factors

Crosscutting factors are those that include more than one category of vehicle, environment and driver. These tables, perhaps more than any other, provide a perspective on where emphasis should be placed if the number of rollover accidents is to be reduced. They show the relationship between driver, vehicle, and environmental factors.

A-1.1 Primary Reason or Critical Event

Table A - 1 Primary Reasons Assigned to Single Vehicle Accidents (MCMIS)

| Primary Reasons | No Rollover | Rollover 1 st Event | Subsequent Event | Total Rollovers | Total Crashes | Percent Rollover Crashes | Percent of All Rollovers |
|---------------------------|-------------|--------------------------------|------------------|-----------------|---------------|--------------------------|--------------------------|
| Driver Decision Error | 23 | 17 | 75 | 92 | 115 | 79.7% | 41.6% |
| Driver Non-Performance | 11 | 0 | 17 | 17 | 27 | 61.4% | 7.7% |
| Driver Performance Error | 4 | 0 | 23 | 23 | 26 | 86.5% | 10.2% |
| Driver Recognition Error | 17 | 2 | 56 | 58 | 75 | 77.4% | 26.3% |
| Total Driver Errors | 54 | 18 | 171 | 189 | 244 | 77.7% | 85.8% |
| Vehicle Related | 0 | 0 | 9 | 9 | 9 | 100.0% | 3.9% |
| Highway Related | 22 | 0 | 8 | 8 | 30 | 26.8% | 3.7% |
| Weather Related | 2 | 0 | 0 | 0 | 2 | 0.0% | 0.0% |
| Other Vehicle Induced | 1 | 0 | 12 | 12 | 13 | 91.8% | 5.3% |
| Unknown | 0 | 0 | 3 | 3 | 3 | 100.0% | 1.3% |
| Total | 79 | 18 | 202 | 220 | 300 | 73.5% | |
| Driver Error Percentages | 68.5% | 100.0% | 84.5% | 85.8% | 81.2% | | |
| Other Vehicle Percentages | 1.3% | | 5.8% | 5.3% | 4.3% | | |

The driver errors are divided into four types.

- Driver decision error: the driver can decide to perform the wrong evasive maneuver,
- Driver non-performance error: the driver can fail to perform the required maneuver correctly,
- Driver performance error: the driver can be incapacitated in some way and be unable to perform the task,
- Driver recognition error: the driver can fail to recognize the need to make a maneuver that would prevent the accident.

The most common error, contributing to about 40 percent of the driver errors, is driver decision error. This correlation indicates that with better training, the driver might have done something differently and avoided the rollover accident. Driver recognition error was next most common reason.

For multiple vehicle accidents, the primary reason was assigned to the other vehicle in over 70 percent of the cases. In the 12 rollover accidents where the primary reasons were not assigned to the other vehicle, driver error was the primary cause in 11 of the 12 rollover accidents. There were very few accidents assigned to vehicle, highway, or weather related causes and in the case of rollovers, there were no vehicle or highway related causes assigned.

Table A - 2 Primary Reasons Assigned to Multiple Vehicle Accidents (MCMIS)

| Primary Reasons | No Rollover | Rollover 1 st Event | Subsequent Event | Total Rollovers | Total Crashes | Percent Rollover Crashes | Percent of All Rollovers |
|---------------------------|-------------|--------------------------------|------------------|-----------------|---------------|--------------------------|--------------------------|
| Driver Decision Error | 114 | 0 | 7 | 7 | 121 | 5.8% | 16.3% |
| Driver Non-Performance | 2 | 0 | 0 | 0 | 2 | 0.0% | 0.0% |
| Driver Performance Error | 5 | 0 | 0 | 0 | 5 | 0.0% | 0.0% |
| Driver Recognition Error | 41 | 0 | 4 | 4 | 45 | 8.9% | 9.3% |
| Total Driver Errors | 162 | 0 | 11 | 11 | 173 | 14.7% | 25.6% |
| Vehicle Related | 7 | | 0 | | | 0.0% | 0.0% |
| Highway Related | 8 | 0 | 0 | 0 | 8 | 0.0% | 0.0% |
| Weather Related | 1 | | 1 | 1 | 2 | 50.0% | 2.3% |
| Other Vehicle Induced | 321 | | 30 | 31 | 352 | 8.8% | 72.1% |
| Unknown | 6 | | | 0 | 6 | 0.0% | 0.0% |
| Total | 505 | 0 | 42 | 43 | 541 | | |
| Driver Error Percentages | 32.1% | | 26.2% | 25.6% | 32.0% | | |
| Other Vehicle Percentages | 63.6% | | 71.4% | 72.1% | 65.1% | | |

One change was made to the primary reason categories. While the LTCCS lists the first category as “No Driver Error,” it clearly is “No Driver, Vehicle or Environmental Factor.” About half the accidents fall into this category, probably because the driver of the other vehicle is the primary reason for the accident. Table A-3 shows that for the remaining 50 percent of the accidents, driver related factors are the primary reason. They account for 43 percent of the accidents while in the remaining 7 percent, the highway and the vehicle were the primary reasons in one and five percent of the accidents respectively. Table A-3 also shows that 180 of the 252 rollovers, about 71 percent, are related to driver performance (physical factors, driver performance, decision and recognition categories). Physical factors are related to driver health. Only 38 out of the 252 rollovers, about 15 percent, are linked to no driver, vehicle, or environmental factors.

Table A-4, the companion table to Table A-3, is limited to cargo tank truck accidents. The observed trends in Table A-3 are present in Table A-4 as well. About half the accidents are not attributed to driver, vehicle and environmental factors and for about the same percent of the accidents, 44 versus 43 for all vehicles, driver factors are cited as the primary reason. Although the vehicle related factors are lower, 2 versus 5 percent for all vehicles and no highway related factors are cited, the quantity of cargo tank accident data is limited and as a result these differences should not be considered to be significant. Even with the limited data, the cargo tank results are very consistent with the results for all vehicles, 20 out of 28 rollovers, about 71 percent are attributed to driver errors, the same percentage found when all vehicle types are considered. Similarly, 5 out of the 28 or about 18 percent of all the cargo tanks rollovers were not related to driver, vehicle or environmental factors.

Tables A-3 and A-4 clearly show the importance assigned to driver, vehicle and environmental factors. In terms of ratios, the vehicle related factors are about 5 times more important than the environmental factors, 5 percent of all accidents versus 1 percent of all accidents. Similarly, driver related factors are about 9 times more important than vehicle related factors, 43 percent versus 5 percent. When driver factors are examined as a percentage of all rollovers, they clearly dominate the categories being present in about 71 percent of rollovers for both the all truck and cargo tank only cases. Because of the higher percentage of rollovers when driver followed by vehicle factors are cited, ordering the emphasis on these factors should have the greatest effect in reducing both the number of accidents and rollovers for all vehicle categories including cargo tanks.

The corresponding field in the GES database is the “critical event.” The critical event is defined in GES as the event that occurred that made the crash possible or imminent. The GES data show that about 78 percent of the rollovers are related to the driver, confirming the relationships observed in the analysis of the primary reason in the two databases described above.

LTCCS records a “pre-crash event.” The table shows that about 82 percent of the rollover crashes $[(105 + 101)/253]$ were preceded by either the truck going straight or negotiating a curve. In about 41 percent of the rollovers $[101/252]$, the truck was negotiating a curve. For those crashes, about 54 percent of all crashes resulted in a rollover. About 93 percent of rollovers for cargo tank trucks $[(10+19)/28]$ were preceded by the truck either going straight or negotiating a curve. Negotiating a curve accounted for about 57 percent of all rollovers for the tank trucks $[19/28]$. Of the trucks in this category, about 76 percent of the rollovers occurred after the truck was negotiating a curve. There was but a single case in which a stopped truck involved in a crash rolled over.

Table A - 3 Primary Reason for Rollover: All Trucks (LTCCS)

| Primary Reason Category | No Rollover | Rollover | Total Crashes | Percent Rollover Crashes | Percent of All Rollovers | Percent of All Crashes |
|--|--------------------|-----------------|----------------------|---------------------------------|---------------------------------|-------------------------------|
| No Driver, Vehicle or Environmental Factor | 583 | 38 | 621 | 6.1% | 15.1% | 50.0% |
| Driver Physical Factor | 34 | 29 | 63 | 46.0% | 11.5% | 5.1% |
| Driver Decision Factor | 129 | 92 | 221 | 41.6% | 36.5% | 17.8% |
| Driver Performance Factor | 38 | 29 | 67 | 43.3% | 11.5% | 5.4% |
| Driver Recognition Factor | 158 | 30 | 188 | 16.0% | 11.9% | 15.1% |
| Total Driver Factors | 359 | 180 | 539 | 33.4% | 71.4% | 43.4% |
| Environment – Highway | 10 | 2 | 12 | 16.7% | 0.8% | 1.0% |
| Environment – Weather | 4 | 0 | 4 | 0.0% | 0.0% | 0.3% |
| Unknown Reason | 4 | 2 | 6 | 33.3% | 0.8% | 0.5% |
| Vehicle Related Factor | 29 | 30 | 59 | 50.8% | 11.9% | 4.8% |
| Overall | 989 | 252 | 1241 | 20.3% | 100.0% | |

Table A - 4 Primary Reason for Rollover: Cargo Tanks Only (LTCCS)

| Primary Reason Category | No Rollover | Rollover | Total Crashes | Percent Rollover Crashes | Percent of All Rollovers | Percent of All Crashes |
|--|--------------------|-----------------|----------------------|---------------------------------|---------------------------------|-------------------------------|
| No Driver, Vehicle or Environmental Factor | 41 | 5 | 46 | 10.9% | 17.9% | 51.7% |
| Driver Physical Factor | 3 | 3 | 6 | 50.0% | 10.7% | 6.7% |
| Driver Decision Factor | 4 | 14 | 18 | 77.8% | 50.0% | 20.2% |
| Driver Performance Factor | 2 | 2 | 4 | 50.0% | 7.1% | 4.5% |
| Driver Recognition Factor | 10 | 1 | 11 | 9.1% | 3.6% | 12.4% |
| Total Driver Factors | 19 | 20 | 39 | 51.3% | 71.4% | 43.8% |
| Environment – Highway | | | | | 0.0% | 0.0% |
| Environment – Weather | 1 | 0 | 1 | 0.0% | 0.0% | 1.1% |
| Unknown Reason | 0 | 1 | 1 | 100.0% | 3.6% | 1.1% |
| Vehicle Related Factor | 0 | 2 | 2 | 100.0% | 7.1% | 2.2% |
| Overall | 61 | 28 | 89 | 31.5% | 100.0% | |

Table A - 5 Percent of Rollover Crashes by Critical Event (GES)

| Category | Percent of All Rollovers | |
|-----------------------------------|--------------------------|-------------------------|
| | Estimate | 95% Confidence Interval |
| Blow Out or Flat Tire | 1.05% | (0.3, 3.8) |
| Disabling Vehicle Failure | 0.07% | (0.0, 0.6) |
| Non-disabling Vehicle Failure | 0.05% | (0.0, 0.4) |
| Other Vehicle Stopped | 4.54% | (1.9, 10.6) |
| Encroaching Vehicle Left | 13.36% | (6.4, 25.8) |
| Total Vehicle | 19.07% | (9.9, 33.7) |
| Poor Road Conditions | 0.94% | (0.4, 2.5) |
| Total Road | 0.94% | (0.4, 2.5) |
| Traveling too Fast for Conditions | 28.4% | (16.1, 45.1) |
| Other Cause of Control Loss | 4.44% | (2.3, 8.4) |
| Unknown Cause of Control Loss | 0.53% | (0.1, 2.0) |
| Over Lane Line Left | 3.79% | (1.4, 9.9) |
| Over Lane Line Right | 0.67% | (0.1, 3.2) |
| Off Edge Road Left | 12.04% | (6.1, 22.3) |
| Off Edge Road Right | 23.75% | (16.6, 32.8) |
| Turning Left @ Intersection | 0.61% | (0.1, 2.6) |
| Turning Right at Intersection | 0.07% | (0.0, 0.6) |
| Crossing Intersection | 3.73% | (1.6, 8.4) |
| Total Driver | 78.03% | (62.9, 88.2) |
| Animal in Roadway | 1.02% | (0.2, 5.1) |
| Other Critical Event/No Collision | 0.93% | (0.3, 2.8) |
| Total Other | 1.95% | (0.7, 5.3) |

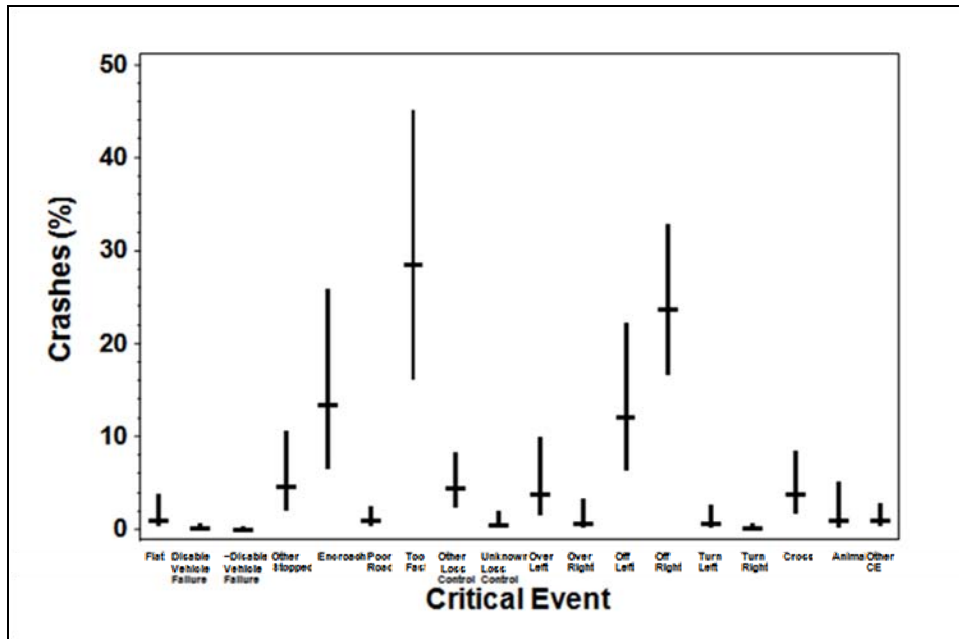

Figure A - 1 Percent of Rollover Crashes by Critical Event (GES)

Table A - 6 Pre-crash Event for Rollovers: All Trucks (LTCCS)

| PreEvent Movement | No Rollover | Rollover | Total Crashes | Percent Rollover Crashes | Percent of All Rollovers |
|--|--------------------|-----------------|----------------------|---------------------------------|---------------------------------|
| Accelerating in Traffic Lane | 17 | 2 | 19 | 10.5% | 0.8% |
| Backing Up (other than for parking position) | 6 | | 6 | 0.0% | 0.0% |
| Changing Lanes | 34 | 5 | 39 | 12.8% | 2.0% |
| Decelerating in Traffic Lane | 59 | 6 | 65 | 9.2% | 2.4% |
| Disabled or Parked in Travel Lane | 2 | | 2 | 0.0% | 0.0% |
| Going Straight | 559 | 105 | 664 | 15.8% | 41.7% |
| Making a U-turn | 1 | | 1 | 0.0% | 0.0% |
| Merging | 5 | 2 | 7 | 28.6% | 0.8% |
| Negotiating a Curve | 87 | 101 | 188 | 53.7% | 40.1% |
| No Driver Present | 16 | 1 | 17 | 5.9% | 0.4% |
| Other (specify) | 12 | 1 | 13 | 7.7% | 0.4% |
| Passing or Overtaking Another Vehicle | 8 | 4 | 12 | 33.3% | 1.6% |
| Starting in Traffic Lane | 7 | 1 | 8 | 12.5% | 0.4% |
| Stopped in Traffic Lane | 122 | | 122 | 0.0% | 0.0% |
| Successful Avoidance Maneuver to a Previous Critical Event | 27 | 13 | 40 | 32.5% | 5.2% |
| Turning Left | 17 | 4 | 21 | 19.0% | 1.6% |
| Turning Right | 8 | 7 | 15 | 46.7% | 2.8% |
| Unknown | 2 | | 2 | 0.0% | 0.0% |
| Overall | 989 | 252 | 1,241 | 20.3% | 100.0% |

Table A - 7 Pre-crash Event for Rollovers: Cargo Tank Trucks Only (LTCCS)

| PreEvent Movement | No Rollover | Rollover | Total Crashes | Percent Rollover Crashes | Percent of All Rollovers |
|--|--------------------|-----------------|----------------------|---------------------------------|---------------------------------|
| Changing Lanes | 4 | | 4 | 0.0% | 0.0% |
| Decelerating in Traffic Lane | 7 | | 7 | 0.0% | 0.0% |
| Going Straight | 36 | 10 | 46 | 21.7% | 35.7% |
| Negotiating a Curve | 5 | 16 | 21 | 76.2% | 57.1% |
| Starting in Traffic Lane | 1 | | 1 | 0.0% | 0.0% |
| Stopped in Traffic Lane | 4 | | 4 | 0.0% | 0.0% |
| Successful Avoidance Maneuver to a Previous Critical Event | | 2 | 2 | 100.0% | 7.1% |
| Turning Left | 1 | | 1 | 0.0% | 0.0% |
| Turning Right | 2 | | 2 | 0.0% | 0.0% |
| Unknown | 1 | | 1 | 0.0% | 0.0% |
| Overall | 61 | 28 | 89 | 31.5% | 100.0% |

A-1.2 Accident Type

Tables A-8 and A-9 show the distribution of accident types for straight truck tanks and tractor-semitrailer tanks in TIFA. The “Collision with other vehicle” category was created from a combination of more detailed categories shown in Appendix B.

- Note that most first event rollovers (71.7 percent for straights) start by running off the road, though overall, only 17.7 percent of all crashes start by running off the road.
- Subsequent event rolls more often are initiated by a collision with another vehicle. This occurs in 63.1 percent of these cases for straight truck tanks and 50.5 percent of the cases for tractor-semitrailer tanks.

Table A-10 and A-11 show the pre-crash maneuver in TIFA. This is what the truck was doing before the crash was initiated. The “Other” category was created from a combination of more detailed categories shown in Appendix B.

- Note the big difference in negotiating a curve between first event and later event. There is also a difference in negotiating a curve between no rollover and overall. Also, most are going straight before a fatal crash, whether it rolled over or not.
- Tractor-semitrailers have a higher rate of negotiating a curve in first event rollover than do straights.

Table A - 8 Accident Type for Straight Truck Tanks (TIFA)

| Straight Truck Tanks | | | | | | | | | | |
|------------------------------|-----------|----------------------------|------------------|---------------|--------------------------|-------------------|----------------------------|------------------|--------------------------|------------------------|
| Accident Type | Frequency | | | | Row Percentage | Column Percentage | | | | |
| | No Roll | Roll 1 st Event | Roll Later Event | Total Crashes | Percent Rollover Crashes | No Roll | Roll 1 st Event | Roll Later Event | Percent of All Rollovers | Percent of All Crashes |
| Ran Off Road | 13 | 33 | 17 | 63 | 79.4% | 5.3% | 71.7% | 26.2% | 45.0% | 17.7% |
| Hit Object in Road | 25 | 0 | 1 | 26 | 3.8% | 10.2% | 0% | 1.5% | 0.9% | 7.3% |
| Collision with Other Vehicle | 179 | 5 | 41 | 225 | 20.4% | 73.1% | 10.9% | 63.1% | 41.4% | 63.2% |
| Untripped Roll | 0 | 8 | 2 | 10 | 100.0% | 0% | 17.4% | 3.1% | 9.0% | 2.8% |
| Unknown | 28 | 0 | 4 | 32 | 12.5% | 11.4% | 0% | 6.2% | 3.6% | 9% |
| Total | 245 | 46 | 65 | 356 | 31.2% | 100% | 100% | 100% | 100.0% | 100% |

Table A - 9 Accident Type for Tractor-semitrailer Tanks (TIFA)

| Tractor-semitrailer Tanks | | | | | | | | | | |
|----------------------------------|------------------|----------------------------------|-------------------------|----------------------|---------------------------------|--------------------------|----------------------------------|-------------------------|---------------------------------|-------------------------------|
| Accident Type | Frequency | | | | Row Percentage | Column Percentage | | | | |
| | No Roll | Roll 1st Event | Roll Later Event | Total Crashes | Percent Rollover Crashes | No Roll | Roll 1st Event | Roll Later Event | Percent of All Rollovers | Percent of All Crashes |
| Ran Off Road | 26 | 99 | 81 | 206 | 87.4% | 2.3% | 65.6% | 36.8% | 48.5% | 13.9% |
| Hit Object in Road | 67 | 1 | 9 | 77 | 13.0% | 6% | 0.7% | 4.1% | 2.7% | 5.2% |
| Collision with Other Vehicle | 866 | 3 | 111 | 980 | 11.6% | 78% | 2% | 50.5% | 30.7% | 66.2% |
| Untripped Roll | 1 | 37 | 5 | 43 | 97.7% | 0.1% | 24.5% | 2.3% | 11.3% | 2.9% |
| Unknown | 150 | 11 | 14 | 175 | 14.3% | 13.5% | 7.3% | 6.4% | 6.7% | 11.8% |
| Total | 1,110 | 151 | 220 | 1,481 | 25.1% | 100% | 100% | 100% | 100.0% | 100% |

Table A - 10 Pre-crash Maneuver for Straight Truck Tanks (TIFA)

| Straight Truck Tanks | | | | | | | | | | |
|-----------------------------|------------------|----------------------------------|-------------------------|----------------------|---------------------------------|--------------------------|----------------------------------|-------------------------|---------------------------------|-------------------------------|
| Pre-crash Maneuver | Frequency | | | | Row Percentage | Column Percentage | | | | |
| | No Roll | Roll 1st Event | Roll Later Event | Total Crashes | Percent Rollover Crashes | No Roll | Roll 1st Event | Roll Later Event | Percent of All Rollovers | Percent of All Crashes |
| Going Straight | 176 | 24 | 42 | 242 | 27.3% | 71.8% | 52.2% | 64.6% | 59.5% | 68% |
| Negotiate Curve | 24 | 18 | 13 | 55 | 56.4% | 9.8% | 39.1% | 20% | 27.9% | 15.4% |
| Other | 45 | 4 | 10 | 59 | 23.7% | 18.4% | 8.7% | 15.4% | 12.6% | 16.6% |
| Total | 245 | 46 | 65 | 356 | 31.2% | 100% | 100% | 100% | 100.0% | 100% |

Table A - 11 Pre-crash Maneuver for Tractor-semitrailer Tanks (TIFA)

| Tractor-semitrailer Tanks | | | | | | | | | | |
|----------------------------------|------------------|----------------------------------|-------------------------|----------------------|---------------------------------|--------------------------|----------------------------------|-------------------------|---------------------------------|-------------------------------|
| Pre-crash Maneuver | Frequency | | | | Row Percentage | Column Percentage | | | | |
| | No Roll | Roll 1st Event | Roll Later Event | Total Crashes | Percent Rollover Crashes | No Roll | Roll 1st Event | Roll Later Event | Percent of All Rollovers | Percent of All Crashes |
| Going Straight | 835 | 46 | 153 | 1,034 | 19.2% | 75.2% | 30.5% | 69.5% | 53.6% | 69.8% |
| Negotiate Curve | 63 | 84 | 50 | 197 | 68.0% | 5.7% | 55.6% | 22.7% | 36.1% | 13.3% |
| Other | 212 | 21 | 17 | 250 | 15.2% | 19.1% | 13.9% | 7.7% | 10.2% | 16.9% |
| Total | 1,110 | 151 | 220 | 1,481 | 25.1% | 100% | 100% | 100% | 100.0% | 100% |

Of the 1,261 hazmat cargo tank accidents selected from MCMIS, only 321 were single vehicle accidents. However, these single vehicle accidents, representing only 25 percent of all accidents, constituted more than 78 percent of the hazmat cargo tank rollovers.

Table A - 12 Single and Multiple Vehicle Accident Rollover Percentages (MCMIS)

| Number of Vehicles | No Rollover | Rollover 1st Event | Subsequent Event | Total Rollovers | Total Crashes | Percent Rollover Crashes | Percent of All Rollovers |
|---------------------------|--------------------|--------------------------------------|-------------------------|------------------------|----------------------|---------------------------------|---------------------------------|
| Single | 92 | 22 | 207 | 229 | 321 | 71.3% | 78.7% |
| Multiple | 878 | 2 | 61 | 62 | 940 | 6.6% | 21.3% |
| Total | 970 | 24 | 267 | 291 | 1,261 | 23.1% | 100.0% |

The rollover is usually not the first harmful event in the crash sequence. When the rollover is a subsequent event, it is instructive to note what was the first event. In the case of an accident involving another vehicle, the first event is normally collision with that other vehicle. For single vehicle accidents, the most common first event is ran off road.

Table A - 13 First Event when The Rollover was a Subsequent Event (MCMIS)

| First Event | Single Vehicle | | Multiple Vehicle | |
|--|----------------|---------|------------------|---------|
| | Count | Percent | Count | Percent |
| Collision Involving Motor Vehicle in Transport | -- | -- | 35 | 61.4% |
| Ran Off Road | 119 | 66.0% | 7 | 12.3% |
| Loss of Control | 17 | 9.4% | | |
| Loss of Cargo or Shift | 12 | 6.6% | | |
| Avoiding | 10 | 5.5% | 12 | 21.1% |
| Collision Involving Fixed Object | 5 | 2.8% | 1 | 12.8% |
| Separation of Units | 4 | 2.2% | | |
| Cross Median Centerline | 4 | 2.2% | | |
| Skidding/Sliding | 3 | 1.7% | | |
| Equipment Failure (Brake failure, blown tires etc) | 2 | 1.1% | | |
| Over Corrected | 1 | 0.6% | | |
| Other | 1 | 0.6% | | |
| Jackknife | 1 | 0.6% | 2 | 3.5% |
| Ditch | 1 | 0.6% | | |

GES records the “manner of collision.” The rollover crashes did not involve a collision with another motor vehicle in transit in 87 percent of the cases. Although the 78.7 percent number for single-vehicle crashes in the MCMIS table is barely outside the confidence interval for the GES figure, the two databases agree that most rollovers occur in single vehicle crashes. For this reason, a number of other tables in the appendix are limited to single-vehicle crashes.

Table A - 14 Percent and Number of Rollover Crashes by Manner of Collision (GES)

| Category | Percent of All Rollovers | |
|---|--------------------------|-------------------------|
| | Estimate | 95% Confidence Interval |
| Not Collide with Motor Vehicle in Transit | 87.32% | (79.8, 92.3) |
| Rear-End | 0.93% | (0.2, 5.0) |
| Head-On | 1.99% | (0.6, 6.8) |
| Angle | 8.71% | (4.9, 15.0) |
| Sideswipe/Same Direction | 0.8% | (0.3, 2.1) |
| Sideswipe/Opposite Direction | 0.25% | (0.0, 1.9) |

A-2 Vehicle Factors

Vehicle-related factors include the design of the vehicle and any defects it had prior to the crash.

A-2.1 Vehicle Configuration

Table A - 15 Rollover Percentages as a Function of the Vehicle Configuration (MCMIS)

| Vehicle Configuration | No Rollover | Rollover 1 st Event | Subsequent Event | Total Rollovers | Total Crashes | Percent Rollover Crashes | Percent of All Rollovers |
|-----------------------------|-------------|--------------------------------|------------------|-----------------|---------------|--------------------------|--------------------------|
| Tractor/Semitrailer | 638 | 16 | 158 | 174 | 812 | 21.4% | 59.8% |
| Tractor, Two Trailers | 18 | 1 | 6 | 7 | 25 | 29.0% | 2.4% |
| Straight Truck, No Trailer | 275 | 5 | 85 | 90 | 365 | 24.7% | 30.9% |
| Straight Truck, One Trailer | 34 | 2 | 13 | 15 | 49 | 30.9% | 5.2% |
| Other / Unknown | 5 | 0 | 5 | 5 | 10 | 46.3% | 1.7% |
| Overall | 970 | 24 | 267 | 291 | 1,261 | 23.1% | 100.0% |

Table A - 16 Percentage of Rollovers Occurring on Highways for each Vehicle Configuration (MCMIS)

| Vehicle Configuration | Interstate | Primary | Secondary | Unknown | All Road Types |
|---------------------------------|------------|---------|-----------|---------|----------------|
| Tractor/Semitrailer | 23.4% | 55.2% | 20.0% | 1.4% | 100.0% |
| Tractor, Two Trailers | 21.1% | 54.1% | 24.8% | | 100.0% |
| Straight Truck, Utility Vehicle | 9.2% | 33.1% | 57.7% | | 100.0% |
| Straight Truck, One Trailer | 20.9% | 62.6% | 16.6% | | 100.0% |
| Other / Unknown | 37.0% | 63.0% | | | 100.0% |
| Overall | 18.8% | 48.6% | 31.8% | 0.8% | 100.0% |

LTCCS records the “general vehicle type,” and the cargo tank vehicles can be further subdivided according to the cargo. The two tables show that cargo tanks roll over in a higher fraction of the crashes studied for the LTCCS. The rollover rate for all vehicles is about 20 percent compared to about 32 percent for cargo tanks. Liquids in bulk have the highest rollover rate of about 47 percent while gases in bulk, (only one case) combined with solids in bulk, have a rollover rate of 40 percent.

The rollover data for all trucks shows little difference between the rollover rate of straight trucks, and tractor semitrailers with one or more trailers. As is the case with the MCMIS data, the great majority of all rollovers occur with tractor trailer configurations. For all vehicles, a truck-tractor

pulling one trailer accounts for about 62 percent of all rollovers while a straight truck only accounts for about 31 percent of all rollovers.

Table A - 17 Vehicle Type Rollover Rate: All Vehicles (LTCCS)

| General Vehicle Types | No Rollover | Rollover | Total Crashes | Percent Rollover Crashes | Percent of All Rollovers |
|--|-------------|----------|---------------|--------------------------|--------------------------|
| Medium/Heavy Duty Pickup Truck | 7 | 0 | 7 | 0.0% | 0.0% |
| Step Van | 2 | 1 | 3 | 33.3% | 0.4% |
| Single Unit Straight Truck | 272 | 79 | 351 | 22.5% | 31.3% |
| Truck-tractor Pulling One Trailer | 638 | 156 | 794 | 19.6% | 61.9% |
| Truck-tractor Pulling Two or More Trailers | 46 | 11 | 57 | 19.3% | 4.4% |
| Truck-tractor with No Cargo Trailer | 24 | 5 | 29 | 17.2% | 2.0% |
| Overall | 989 | 252 | 1,241 | 20.3% | 100.0% |

Table A - 18 Vehicle Type Rollover Rate: Cargo Tanks Only (LTCCS)

| Cargo Tank Vehicle Type | Tank-compressed Gas | Tank-dry Bulk | Tank-liquid | Total Crashes | Percent Rollover Crashes |
|-------------------------|--|---------------|-------------|---------------|--------------------------|
| | Number of Rollovers / Number of No Rollovers | | | | |
| Empty | | 0 / 6 | 0 / 22 | 28 | |
| Gases in Bulk | 1 / 0 | | 1 / 0 | 2 | 100.0% |
| Liquids in Bulk | | | 21 / 24 | 45 | 46.7% |
| Solids in Bulk | | 5 / 9 | | 14 | 35.7% |
| Overall | 1 | 20 | 68 | 89 | 31.5% |

In the TIFA data, tank trucks are shown to roll over at a much higher rate, for both straight trucks and tractor-semitrailers, than vans. About 10 percent of the trucks with the van configuration rolled compared with about 26 percent of the cargo tank vehicles. Table A-19 also shows that straight cargo tank trucks roll over at a slightly higher rate than cargo tank semitrailers. The cargo tank straight trucks have a rollover rate in fatal crashes of about 31 percent compared to cargo tank semitrailers, which have a rollover rate of about 25 percent. Nevertheless, van tractor semitrailers account for almost 80 percent of all rollovers. Tank trucks follow a similar pattern with about 31 percent of the straight trucks rolling over in a fatal crash and about 25 percent of tractor semitrailers rolling over in a crash. Tractor semitrailers account for 77 percent of all of the rollovers for the tank trucks.

The table shows that, in fatal accidents, cargo tank trucks roll over at a much higher rate than vans. This is true both when the rollover is the first event and when it is a subsequent event. When rollovers during a first and subsequent event are combined, approximately 10 percent of vans in fatal accidents roll over, compared to about 26 percent of cargo tank trucks.

Table A - 19 Vehicle Configuration (TIFA)

| Configuration | No Roll | Roll 1 st Event | Roll Later Event | Total Rollovers | Total Crashes | Percent Rollover Crashes | Percent of All Rollovers |
|----------------|---------|----------------------------|------------------|-----------------|---------------|--------------------------|--------------------------|
| Van | | | | | | | |
| Straight Truck | 1,656 | 37 | 178 | 215 | 1,871 | 11.5% | 20.1% |
| Tractor-Semi | 7,669 | 222 | 634 | 856 | 8,525 | 10.0% | 79.9% |
| Total | 9,325 | 259 | 812 | 1,071 | 10,396 | 10.3% | 100.0% |
| Tank | | | | | | | |
| Straight Truck | 245 | 46 | 65 | 111 | 356 | 31.2% | 23.0% |
| Tractor-Semi | 1,110 | 151 | 220 | 371 | 1,481 | 25.1% | 77.0% |
| Total | 1,355 | 197 | 285 | 482 | 1,837 | 26.2% | 100.0% |

Table A - 20 Body Type (TIFA)

| Body Type | No Roll | Roll 1 st Event | Roll Later Event | Total Rollovers | Total Crashes | Percent Rollover Crashes | Percent of All Rollovers |
|-----------|---------|----------------------------|------------------|-----------------|---------------|--------------------------|--------------------------|
| Van | 9,325 | 259 | 812 | 1,071 | 10,396 | 10.3% | 69.0% |
| Tank | 1,355 | 197 | 285 | 482 | 1,837 | 26.2% | 31.0% |
| Total | 10,680 | 456 | 1,097 | 1,553 | 12,233 | 12.7% | 100.0% |

Table A - 21 Presence of Hazmat (TIFA)

| Hazmat Cargo | No Roll | Roll 1 st Event | Roll Later Event | Total Rollovers | Total Crashes | Percent Rollover Crashes | Percent of All Rollovers |
|--------------|---------|----------------------------|------------------|-----------------|---------------|--------------------------|--------------------------|
| Van | | | | | | | |
| Hazmat | 121 | 8 | 14 | 22 | 143 | 15.4% | 2.1% |
| No Hazmat | 9,204 | 251 | 798 | 1,049 | 10,253 | 10.2% | 97.9% |
| Total | 9,325 | 259 | 812 | 1,071 | 10,396 | 10.3% | 100.0% |
| Tank | | | | | | | |
| Hazmat | 359 | 105 | 139 | 244 | 603 | 40.5% | 50.6% |
| No Hazmat | 996 | 92 | 146 | 238 | 1,234 | 19.3% | 49.4% |
| Total | 1,355 | 197 | 285 | 482 | 1,837 | 26.2% | 100.0% |

Table A - 22 Percent of Rollover Crashes by Trailing Units and Body Type (GES)

| Body Type | Number of Trailing Units | Percent of All Rollovers | |
|----------------------------|--------------------------|--------------------------|-------------------------|
| | | Estimate | 95% Confidence Interval |
| Single-Unit Straight Truck | None | 99.63% | (97.1, 100) |
| | 1 | 0.37% | (0.0, 2.9) |
| | 2 | 0% | -- |
| Truck Tractor | None | 0% | -- |
| | 1 | 93.48% | (77.3, 98.4) |
| | 2 | 6.52% | (1.6, 22.7) |
| Medium Heavy Truck | None | 25.36% | (1.9, 85.4) |
| | 1 | 74.64% | (14.6, 98.1) |
| | 2 | 0% | -- |

A-2.2 Vehicle Loading

As expected, the loading of a truck and especially a cargo tank is closely linked with the propensity to roll over.

The definitions of empty, partial, and full were the same for LTCCS as for MCMIS.

- Empty: from completely empty to 20 percent of capacity,
- Partial: from 20 to 75 percent of capacity
- Full: greater than 75 percent of capacity. (Tanks were never completely full because an allowance must be made for thermal expansion and a fully loaded cargo tank of diesel will be at its maximum gross hauling weight when the tank is only about 75 percent of its rated capacity.)

TIFA does not have a variable that could directly indicate partial loads, and even characterize them in terms of percent full by volume and by weight, was unavailable. Instead, TIFA data include the gross combination weight (GCW), empty combination weight (tare), and cargo weight. Cargo weight by itself could not be examined because it excludes a consideration of a truck's size. For example, a 10,000 pound load might fill a class 6 tanker, but leave a semitrailer only 25 percent full. In order to control for truck size, the percentage of the GCW accounted for by cargo weight was calculated. From histograms of the data, three categories were determined: 0 to 10 percent (where the weight of the truck would be expected to dominate handling), 10 to 50 percent (which are most likely partial loads), and over 50 percent (which are most likely full loads).

Table A - 23 Percent of Rollover Crashes by Trailing Units and Body Type (MCMIS)

| Loading | No Rollover | First Event | Subsequent Event | Total Rollovers | Total Crashes | Percent Rollover Crashes | Percent of All Rollovers |
|---------|-------------|-------------|------------------|-----------------|---------------|--------------------------|--------------------------|
| Empty | 93 | | 1 | 1 | 94 | 1.1% | 2.0% |
| Partial | 38 | 0 | 10 | 10 | 48 | 21.4% | 19.6% |
| Full | 67 | 5 | 33 | 38 | 105 | 36.4% | 74.5% |
| Unknown | 9 | | 2 | 2 | 11 | 16.7% | 3.9% |
| Overall | 206 | 5 | 46 | 51 | 257 | 19.8% | 100.0% |

Table A - 24 Rollover Related to Load: All Trucks (LTCCS)

| Loading | No Rollover | Rollover | Total Crashes | Percent Rollover Crashes | Percent of All Rollovers |
|----------------|-------------|----------|--------------------|--------------------------|--------------------------|
| Empty | 377 | 27 | 404 | 6.7% | 10.5% |
| Partial | 178 | 40 | 218 | 18.3% | 15.6% |
| Full | 324 | 149 | 473 | 31.5% | 58.0% |
| Partial & Full | 502 | 189 | 691 | 27.4% | 73.5% |
| Overall | 1009 | 257 | 1,266 ¹ | 20.3% | 100.0% |

Table A - 25 Rollover Related to Load: Cargo Tanks (LTCCS)

| Loading | No Rollover | Rollover | Total Crashes | Percent Rollover Crashes | Percent of All Rollovers |
|----------------|-------------|----------|------------------|--------------------------|--------------------------|
| Empty | 32 | 0 | 32 | 0.0% | 0.0% |
| Partial | 4 | 7 | 11 | 63.6% | 20.0% |
| Full | 33 | 20 | 53 | 37.7% | 57.1% |
| Partial & Full | 37 | 27 | 64 | 42.2% | 77.1% |
| Overall | 73 | 35 | 108 ¹ | 32.4% | 100.0% |

Table A - 26 Load Status (TIFA)

| Load | Van | | | | Tank | | | |
|---|---------|----------------------------|------------------|--------|---------|----------------------------|------------------|-------|
| | No Roll | Roll 1 st Event | Roll Later Event | Total | No Roll | Roll 1 st Event | Roll Later Event | Total |
| Number of Fatal Crashes | | | | | | | | |
| Empty | 2,146 | 22 | 72 | 2,240 | 531 | 7 | 21 | 559 |
| Loaded | 6,765 | 233 | 722 | 7,720 | 808 | 189 | 262 | 1,259 |
| Unknown | 414 | 4 | 18 | 436 | 16 | 1 | 2 | 19 |
| Total | 9,325 | 259 | 812 | 10,396 | 1,355 | 197 | 285 | 1,837 |
| Percentage of Fatal Crashes with/without Rollovers | | | | | | | | |
| Empty | 95.8 | 1.0 | 3.2 | 100.0 | 95.0 | 1.3 | 3.8 | 100.0 |
| Loaded | 87.6 | 3.0 | 9.4 | 100.0 | 64.2 | 15.0 | 20.8 | 100.0 |
| Unknown | 95.0 | 0.9 | 4.1 | 100.0 | 84.2 | 5.3 | 10.5 | 100.0 |
| Total | 89.7 | 2.5 | 7.8 | 100.0 | 73.8 | 10.7 | 15.5 | 100.0 |

Table A - 27 Cargo Percent of GCW (TIFA)

| Cargo Percent of GCW | No Roll | Roll 1 st Event | Roll Later Event | Total Rollovers | Total Crashes | Percent Rollover Crashes | Percent of All Rollovers |
|----------------------|---------|----------------------------|------------------|-----------------|---------------|--------------------------|--------------------------|
| Van | | | | | | | |
| 0 to 10% | 2,636 | 27 | 104 | 131 | 2,765 | 4.7% | 15.4% |
| 11 to 50% | 2,466 | 72 | 212 | 284 | 2,750 | 10.3% | 33.4% |
| > 50% | 2,325 | 110 | 325 | 435 | 2,760 | 15.8% | 51.2% |
| Total | 7,427 | 209 | 641 | 850 | 8,277 | 10.3% | 100.0% |
| Tank | | | | | | | |
| 0 to 10% | 528 | 10 | 22 | 32 | 560 | 5.7% | 8.1% |
| 11 to 50% | 141 | 40 | 41 | 81 | 222 | 36.5% | 20.6% |
| > 50% | 501 | 116 | 165 | 281 | 782 | 35.9% | 71.3% |
| Total | 1,170 | 166 | 228 | 394 | 1,564 | 25.2% | 100.0% |

A-2.3 Cargo Tank Specification

Of the databases used for this study, only the MCMIS database contained adequate data to examine the relationship between cargo tank specification and rollover.

Table A - 28 Rollover Probabilities by Cargo Tank Specification Number (MCMIS)

| DOT Specification Number | No Rollover | First Event | Subsequent Event | Total Rollovers | Total Crashes | Percent Rollover Crashes |
|--------------------------|-------------|-------------|------------------|-----------------|---------------|--------------------------|
| MC306 | 222 | 7 | 54 | 61 | 283 | 21.5% |
| DOT406 | 107 | 0 | 23 | 23 | 130 | 17.3% |
| MC307 | 23 | 4 | 20 | 24 | 47 | 51.0% |
| DOT407 | 23 | 0 | 7 | 7 | 30 | 23.5% |

A-2.4 Mechanical Problems

The LTCCS database is unique among the crash databases in that it includes intensive data related to post crash inspections of brakes. The include data for four types of truck brake problems related to a particular crash. These four types are: brakes out of adjustment, brakes inoperative, brake failure and brakes deficient. Each is described below.

Out-of-adjustment: if any of the brakes were measured as out-of-adjustment, then the variable would be recorded as present.

Brakes inoperative: means the brakes are not working for any reason. If the brakes are inoperative because they are severely out of adjustment, they might be recorded in the out-of-adjustment category.

Brake system deficiency: Braking system deficiency records any problem other than brake out-of-adjustment. It includes the following: worn pads, unmatched brakes, hose connection, air pressure, break fade, etc.

Brake system malfunction (failure): This variable establishes whether or not the vehicle experiences a braking system malfunction (total failure such as pedal to the floor) during the pre-crash phase (may not include a malfunction due to out-of-adjustment). Note: this variable was present in this analysis.

The LTCCS is the only database used for this analysis that provides sufficient data to use to investigate the relationship between tire condition and rollover. Tables A-30 and A-31 show the relationship of tire failure or defects to rollover for all trucks and only the cargo tank trucks in the LTCCS.

About 84 percent of the rollovers in the GES data set are not associated with a mechanical problem. This data is different than that derived from the LTCCS and shown in Table A-30. Brake defects would have been coded in GES only when the defect's responsibility for the crash

was clear or the defect was obvious. Part of the protocol for LTCCS was a detailed field inspection of all trucks, so brake defects in that study were more likely to be noticed.

Table A - 29 Brake System Deficiency and Rollover: All Trucks (LTCCS)

| Brake Condition | Brake Failure | Brakes Out Of Adjustment | Brakes Inoperative | Brakes System Deficiency | No Rollover | Rollover | Total Crashes | Percent Rollover Crashes | Percent of All Rollovers | Percent of All Crashes |
|---|--|---------------------------------|---------------------------|---------------------------------|--------------------|-----------------|----------------------|---------------------------------|---------------------------------|-------------------------------|
| No Brake Defect | Absent | Absent | Absent | Absent | 762 | 142 | 904 | 15.7% | 56.3% | 72.8% |
| Brake System Deficiency | Absent | Absent | Absent | Present | 64 | 33 | 97 | 34.0% | 13.1% | 7.8% |
| Brakes Inoperative | Absent | Absent | Present | Absent | 7 | 4 | 11 | 36.4% | 1.6% | 0.9% |
| Brakes Inoperative and Brake System Deficiency | Absent | Absent | Present | Present | 2 | | 2 | 0.0% | 0.0% | 0.2% |
| Brakes Out Of Adjustment | Absent | Present | Absent | Absent | 122 | 54 | 176 | 30.7% | 21.4% | 14.2% |
| Brakes Out Of Adjustment and Brake System Deficiency | Absent | Present | Absent | Present | 18 | 10 | 28 | 35.7% | 4.0% | 2.3% |
| Brakes Out Of Adjustment and Brakes Inoperative | Absent | Present | Present | Absent | 8 | 3 | 11 | 27.3% | 1.2% | 0.9% |
| Brakes Out Of Adjustment, Inoperative and System Deficiency | Absent | Present | Present | Present | 1 | 1 | 2 | 50.0% | 0.4% | 0.2% |
| Brakes Defective | Present | Absent | Absent | Absent | 5 | 3 | 8 | 37.5% | 1.2% | 0.6% |
| Brakes Defective and System Deficiency | Present | Absent | Absent | Present | | 1 | 1 | 100.0% | 0.4% | 0.1% |
| Brakes Defective and Out Of Adjustment | Present | Present | Absent | Absent | | 1 | 1 | 100.0% | 0.4% | 0.1% |
| Some Type of Brake Defect Present | | | | | 227 | 110 | 337 | 32.6% | 43.7% | 27.2% |
| Overall | | | | | 989 | 252 | 1,241 | 20.3% | 100.0% | 100.0% |
| | Percent of Accidents with Defective Brakes | | | | | | 27.2% | | | |
| | Percent of Rollovers with Defective Brakes | | | | | 43.7% | | | | |

Table A - 30 Brake System Deficiency and Rollover: Cargo Tanks (LTCCS)

| Brake Condition | Brake Failure | Brakes Out of Adjustment | Brakes Inoperative | Brakes System Deficiency | No Rollover | Rollover | Total Crashes | Percent Rollover Crashes | Percent of All Rollovers | Percent Of All Crashes |
|--|----------------------|---------------------------------|---------------------------|---------------------------------|--------------------|-----------------|----------------------|---------------------------------|---------------------------------|-------------------------------|
| No Brake Defect | Absent | Absent | Absent | Absent | 48 | 13 | 61 | 21.3% | 46.4% | 68.5% |
| Brake System Deficiency | Absent | Absent | Absent | Present | 5 | 2 | 7 | 28.6% | 7.1% | 7.9% |
| Brakes Inoperative | Absent | Absent | Present | Absent | | 1 | 1 | 100.0% | 3.6% | 1.1% |
| Brakes Out Of Adjustment | Absent | Present | Absent | Absent | 5 | 8 | 13 | 61.5% | 28.6% | 14.6% |
| Brakes Out Of Adjustment and Brake System Deficiency | Absent | Present | Absent | Present | 2 | 4 | 6 | 66.7% | 14.3% | 6.7% |
| Brakes Out Of Adjustment and Brakes Inoperative | Absent | Present | Present | Absent | 1 | | 1 | 0.0% | 0.0% | 1.1% |
| Brake Defect | | | | | 13 | 15 | 28 | 53.6% | 53.6% | 31.5% |
| Overall | | | | | 61 | 28 | 89 | 31.5% | 100.0% | 100.0% |

Table A - 31 Tire Failure or Defect Related to Rollover: All Trucks (LTCCS)

| Tire Condition | Tire Failure | Tire Deficiency | No Rollover | Rollover | Total Crashes | Percent Rollover Crashes | Percent of All Rollovers |
|--|--------------|-----------------|-------------|----------|---------------|--------------------------|--------------------------|
| No Tire Defects | Absent | Absent | 946 | 225 | 1171 | 19.2% | 89.29% |
| Tire Deficiency Present | Absent | Present | 36 | 20 | 56 | 35.7% | 7.94% |
| Tire Failure Present | Present | Absent | 5 | 6 | 11 | 54.5% | 2.38% |
| Tire Failure and Tire Deficiency Present | Present | Present | 2 | 1 | 3 | 33.3% | 0.40% |
| Any Tire Defect | | | 43 | 27 | 70 | 38.6% | 10.71% |
| Overall | | | 989 | 252 | 1,241 | | 100.00% |

Table A - 32 Tire Failure or Defect Related to Rollover: Cargo Tanks Only (LTCCS)

| Tire Condition | Tire Failure | Tire Deficiency | No Rollover | Rollover | Total Crashes | Percent Rollover Crashes | Percent of All Rollovers |
|--|--------------|-----------------|-------------|----------|---------------|--------------------------|--------------------------|
| No Tire Defects | Absent | Absent | 60 | 27 | 87 | 31.0% | 96.43% |
| Tire Deficiency Present | Absent | Present | 1 | 1 | 2 | 50.0% | 3.57% |
| Tire Failure Present | | | | | | | 0.00% |
| Tire Failure and Tire Deficiency Present | | | | | | | 0.00% |
| Any Tire Defect | | | 1 | 1 | 2 | 50.0% | 3.57% |
| Overall | | | 61 | 28 | 89 | | 100.00% |

Table A - 33 Tire Failure or Defect Related to Rollover: Cargo Tanks Only (GES)

| Category | Percent of All Rollovers | |
|----------|--------------------------|-------------------------|
| | Estimate | 95% Confidence Interval |
| None | 84.33% | (77.4, 89.4) |
| Tire | 2.51% | (0.9, 7.0) |
| Brakes | 1.21% | (0.3, 4.4) |
| Other | 3.85% | (1.3, 10.5) |
| Unknown | 8.1% | (5.4, 11.9) |

A-3 Environment and Roadway

This section discusses crashes grouped by environmental factors. These factors include road type, access, location, rural or urban surroundings, light condition, roadway surface condition, roadway curvature, and roadway profile.

A-3.1 Location of Accident with Respect to Junctions

Table A-34 shows that the overall probability of a rollover on a divided highway is about 20 percent and the overall probability of a rollover on undivided highway is about 30 percent. However, undivided highways account for almost 69 percent of all rollovers while divided highways account for only about 31 percent of rollovers. The table also shows that for divided highways, very few rollovers occur close to the interchange but this low percentage is counterbalanced by the higher percentage of accidents that occur on exit and entrance ramps. On undivided highways, there does not seem to be much difference as to whether or not the accident occurs close to an intersection. A significant number of all rollovers occur at or near the interchange on divided highways, but they are by no means the bulk of the rollover problem.

Table A - 34 Effect of Location on Rollover Probability given an Accident (MCMIS)

| Location of Accident | No Rollover | Rollover 1 st Event | Subsequent Events | Total Rollovers | Total Crashes | Percent Rollover Crashes | Percent of All Rollovers |
|-------------------------|-------------|--------------------------------|-------------------|-----------------|---------------|--------------------------|--------------------------|
| Close to Interchange | 130 | 2 | 10 | 11 | 141 | 8.0% | 4.6% |
| Not at Interchange | 197 | 0 | 45 | 45 | 242 | 18.7% | 19.0% |
| On or Off Ramp | 29 | 0 | 17 | 17 | 46 | 37.4% | 7.2% |
| Total Divided Highway | 355 | 2 | 72 | 74 | 429 | 17.2% | 31.2% |
| Close to Intersection | 189 | 7 | 75 | 82 | 271 | 30.3% | 34.6% |
| Not at Intersection | 183 | 4 | 77 | 81 | 264 | 30.7% | 34.2% |
| Not on Roadway | 8 | 0 | 0 | 0 | 8 | 0.0% | 0.0% |
| Railroad Grade Crossing | 1 | 0 | 0 | 0 | 1 | 0.0% | 0.0% |
| Total Undivided Highway | 381 | 11 | 153 | 163 | 545 | 30.0% | 68.8% |
| Total | 737 | 12 | 225 | 237 | 974 | 24.4% | 100.0% |

The data in Table A-35 from GES also indicate that most rollovers do not occur near an interchange, but GES records an even smaller fraction being at or near an interchange than MCMIS.

**Table A - 35 Percent of Rollover Crashes
by Relation to Junction (GES)**

| Category | Percent of All Rollovers | |
|-----------------|--------------------------|-------------------------|
| | Estimate | 95% Confidence Interval |
| Non-interchange | 92.45% | (83.9, 96.6) |
| Interchange | 1.27% | (0.3, 4.5) |
| Entrance/Exit | 6.28% | (3.0, 12.8) |

A-3.2 Population Area

An Urban area is defined by MCMIS as a city with more than 100,000 residents, a City more than 5,000 residents, and a Town less than 5,000 residents. The accident was assumed to occur in a Rural area if the County where the accident occurred was listed but the City or Place field was left blank. TIFA has two designations, rural and urban.

Table A - 36 Effect of Populated Area on Rollover Probability given an Accident (MCMIS)

| Populated Area | No Rollover | Rollover 1 st Event | Subsequent Events | Total Rollovers | Total Crashes | Percent Rollover Crashes | Percent of All Rollovers |
|----------------|-------------|--------------------------------|-------------------|-----------------|---------------|--------------------------|--------------------------|
| Urban | 157 | 5 | 13 | 18 | 174 | 10.2% | 6.9% |
| City | 271 | 8 | 40 | 47 | 319 | 14.9% | 18.0% |
| Town | 128 | 5 | 51 | 56 | 184 | 30.2% | 21.5% |
| Rural | 325 | 7 | 134 | 140 | 465 | 30.2% | 53.6% |
| Overall | 881 | 24 | 237 | 261 | 1,142 | 22.9% | 100.0% |

Table A - 37 Effect of Populated Area on Single Vehicle Cargo Tank Rollover Probabilities (MCMIS)

| Populated Area | No Rollover | Rollover 1 st Event | Subsequent Events | Total Rollovers | Total Crashes | Percent Rollover Crashes | Percent of All Rollovers |
|----------------|-------------|--------------------------------|-------------------|-----------------|---------------|--------------------------|--------------------------|
| Urban | 7 | 3 | 8 | 11 | 18 | 61.1% | 5.5% |
| City | 12 | 8 | 26 | 34 | 45 | 75.6% | 16.5% |
| Town | 13 | 5 | 42 | 47 | 60 | 78.3% | 23.2% |
| Rural | 46 | 7 | 106 | 112 | 159 | 70.4% | 54.9% |
| Overall | 78 | 22 | 182 | 205 | 282 | 72.7% | 100.0% |

Table A - 38 Rural vs. Urban (TIFA)

| Area | No Roll | Roll 1 st Event | Roll Later Event | Total Rollovers | Total Crashes | Percent Rollover Crashes | Percent of All Rollovers |
|-------------|---------|----------------------------|------------------|-----------------|---------------|--------------------------|--------------------------|
| Van | | | | | | | |
| Urban | 3,197 | 56 | 183 | 239 | 3,436 | 7.0% | 22.3% |
| Rural | 5,948 | 193 | 621 | 814 | 6,762 | 12.0% | 76.0% |
| Unknown | 180 | 10 | 8 | 18 | 198 | 9.1% | 1.7% |
| Total | 9,325 | 259 | 812 | 1,071 | 10,396 | 10.3% | 100.0% |
| Tank | | | | | | | |
| Urban | 377 | 24 | 48 | 72 | 449 | 16.0% | 14.9% |
| Rural | 952 | 172 | 228 | 400 | 1352 | 29.6% | 83.0% |
| Unknown | 26 | 1 | 9 | 10 | 36 | 27.8% | 2.1% |
| Total | 1,355 | 197 | 285 | 482 | 1,837 | 26.2% | 100.0% |

A-3.3 Road Designation or Access Control

In Table A-39 it is not possible to distinguish between primary roads that are built to interstate specifications and two-lane primary roads. Thus, some of the primary road data might better fit with the interstate data and some with the secondary data.

Refer to Table A-16 for the distribution of rollovers across road designations and vehicle types.

Table A - 39 Cargo Tank Rollover and Highway Type (MCMIS)

| Highway Type | No Rollover | Rollover 1 st Event | Subsequent Events | Total Rollovers | Total Crashes | Percent Rollover Crashes | Percent of All Rollovers |
|--------------|-------------|--------------------------------|-------------------|-----------------|---------------|--------------------------|--------------------------|
| Interstate | 282 | 2 | 43 | 45 | 327 | 13.7% | 15.5% |
| Primary | 459 | 14 | 130 | 144 | 603 | 23.8% | 49.5% |
| Secondary | 225 | 8 | 91 | 100 | 325 | 30.7% | 34.4% |
| Unknown | 4 | | 3 | 3 | 6 | 44.3% | 1.0% |
| Overall | 970 | 24 | 267 | 291 | 1,261 | 23.1% | 100.0% |

Although there are more crashes on urban roads than on rural roads, Tables A-38 and A-40 show that a higher percentage of crashes in rural areas result in a rollover than in urban areas. For all trucks, about 18 percent of urban crashes result in a rollover compared to 25 percent of rural crashes. For cargo tank trucks, despite the fact that there are an identical number of rural and urban crashes, 14, about 26 percent of urban crashes result in a rollover compared to 40 percent of rural crashes. Note that the percentage of all rollovers for cargo tanks is evenly split between urban and rural roads.

Table A - 40 Functional Roadway Group and Rollovers: All Trucks (LTCCS)

| Functional Group | No Rollover | Rollover | Total Crashes | Percent Rollover Crashes | Percent of All Rollovers |
|-----------------------------|-------------|----------|---------------|--------------------------|--------------------------|
| Rural Interstate | 109 | 28 | 137 | 20.4% | 11.1% |
| Rural Primary | 71 | 38 | 109 | 34.9% | 15.1% |
| Rural Other | 141 | 41 | 182 | 22.5% | 16.3% |
| Urban Freeway or Interstate | 463 | 105 | 568 | 18.5% | 41.7% |
| Urban Primary | 81 | 17 | 98 | 17.3% | 6.7% |
| Urban Other | 115 | 19 | 134 | 14.2% | 7.5% |
| Unknown | 9 | 4 | 13 | 30.8% | 1.6% |
| Rural Total | 321 | 107 | 428 | 25.0% | 42.5% |
| Urban Total | 659 | 141 | 800 | 17.6% | 56.0% |
| Unknown | 9 | 4 | 13 | 30.8% | 1.6% |
| Overall | 989 | 252 | 1,241 | 20.3% | 100.0% |

Table A - 41 Functional Roadway Group and Rollovers: Cargo Tank (LTCCS)

| Functional Group | No Rollover | Rollover | Total Crashes | Percent Rollover Crashes | Percent of All Rollovers |
|-----------------------------|-------------|----------|---------------|--------------------------|--------------------------|
| Rural Interstate | 5 | 3 | 8 | 37.5% | 10.7% |
| Rural Other | 11 | 6 | 17 | 35.3% | 21.4% |
| Rural Primary | 5 | 5 | 10 | 50.0% | 17.9% |
| Urban Freeway or Interstate | 32 | 10 | 42 | 23.8% | 35.7% |
| Urban Primary | 2 | 3 | 5 | 60.0% | 10.7% |
| Urban Other | 6 | 1 | 7 | 14.3% | 3.6% |
| Rural Total | 21 | 14 | 35 | 40.0% | 50.0% |
| Urban Total | 40 | 14 | 54 | 25.9% | 50.0% |
| Unknown | 0 | 0 | 0 | | 0.0% |
| Overall | 61 | 28 | 89 | 31.5% | 100.0% |

Table A - 42 Road Category "Signage": Rollover for All Trucks (LTCCS)

| Road Category "Signage" | No Rollover | Rollover | Total Crashes | Percent Rollover Crashes | Percent of All Rollovers |
|-------------------------|-------------|----------|---------------|--------------------------|--------------------------|
| Interstate | 505 | 120 | 625 | 19.2% | 47.6% |
| U.S. Highway | 90 | 29 | 119 | 24.4% | 11.5% |
| State Highway | 176 | 53 | 229 | 23.1% | 21.0% |
| Other | 218 | 50 | 268 | 18.7% | 19.8% |
| Overall | 989 | 252 | 1,241 | 20.3% | 100.0% |

Table A - 43 Road Category "Signage": Rollover for Cargo Tanks (LTCCS)

| Road Category "Signage" | No Rollover | Rollover | Total Crashes | Percent Rollover Crashes | Percent of All Rollovers |
|-------------------------|-------------|----------|---------------|--------------------------|--------------------------|
| Interstate | 36 | 13 | 49 | 26.5% | 46.4% |
| U.S. Highway | 3 | 7 | 10 | 70.0% | 25.0% |
| State Highway | 13 | 4 | 17 | 23.5% | 14.3% |
| Other | 9 | 4 | 13 | 30.8% | 14.3% |
| Overall | 61 | 28 | 89 | 31.5% | 100.0% |

Limited access is not directly identified in TIFA. Route signing is somewhat of a surrogate. Interstate roads are all limited access; but some U.S. Highways are limited access, as are a few State highways. County roads are not limited access, however, and typically are in rural areas, and likely more problematic with respect to safety. Township, municipal, and frontage roads are urban and probably lower speed.

Table A - 44 Road Type (TIFA)

| Route Signing | No Roll | Roll 1 st Event | Roll Later Event | Total Rollovers | Total Crashes | Percent Rollover Crashes | Percent of All Rollovers |
|---------------|---------|----------------------------|------------------|-----------------|---------------|--------------------------|--------------------------|
| Van | | | | | | | |
| Interstate | 3,493 | 133 | 384 | 517 | 4,010 | 12.9% | 48.3% |
| US Highway | 2,396 | 45 | 181 | 226 | 2,622 | 8.6% | 21.1% |
| State Highway | 2,168 | 56 | 190 | 246 | 2,414 | 10.2% | 23.0% |
| County Road | 370 | 13 | 29 | 42 | 412 | 10.2% | 3.9% |
| Township | 88 | 1 | 2 | 3 | 91 | 3.3% | 0.3% |
| Municipality | 532 | 1 | 16 | 17 | 549 | 3.1% | 1.6% |
| Frontage Rd | 32 | 3 | 2 | 5 | 37 | 13.5% | 0.5% |
| Other | 142 | 4 | 4 | 8 | 150 | 5.3% | 0.7% |
| Unknown | 104 | 3 | 4 | 7 | 111 | 6.3% | 0.7% |
| Total | 9,325 | 259 | 812 | 1,071 | 10,396 | 10.3% | 100.0% |
| Tank | | | | | | | |
| Interstate | 285 | 29 | 53 | 82 | 367 | 22.3% | 17.0% |
| US Highway | 351 | 49 | 71 | 120 | 471 | 25.5% | 24.9% |
| State Highway | 435 | 68 | 105 | 173 | 608 | 28.5% | 35.9% |
| County Road | 138 | 25 | 37 | 62 | 200 | 31.0% | 12.9% |
| Township | 26 | 4 | 1 | 5 | 31 | 16.1% | 1.0% |
| Municipality | 60 | 3 | 5 | 8 | 68 | 11.8% | 1.7% |
| Frontage Rd | 9 | 1 | 2 | 3 | 12 | 25.0% | 0.6% |
| Other | 37 | 15 | 8 | 23 | 60 | 38.3% | 4.8% |
| Unknown | 14 | 3 | 3 | 6 | 20 | 30.0% | 1.2% |
| Total | 1,355 | 197 | 285 | 482 | 1,837 | 26.2% | 100.0% |

Table A - 45 Type of Trafficway Flow (GES)

| Category | Percent of All Rollovers | |
|-------------|--------------------------|-------------------------|
| | Estimate | 95% Confidence Interval |
| Not Divided | 66.24% | (52.4, 77.7) |
| Divided | 21.87% | (15.3, 30.3) |
| One Way | 6.57% | (2.6, 15.4) |
| Unknown | 5.32% | (1.1, 21.8) |

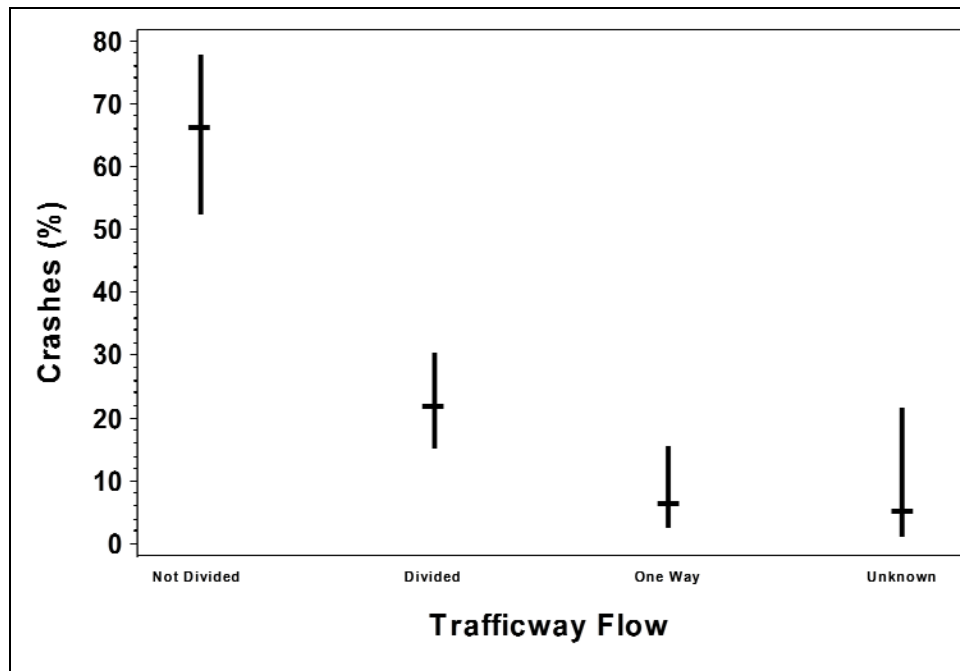

Figure A - 2 Percent of Rollover Crashes by Type of Trafficway Flow (GES)

Table A - 46 Percent of Rollover Crashes by Number of Travel Lanes and Trafficway Flow (GES)

| Trafficway Flow | Number of Travel Lanes | Percent of All Rollovers | |
|-----------------|------------------------|--------------------------|-------------------------|
| | | Estimate | 95% Confidence Interval |
| Not Divided | 1 | 1.82% | (0.2, 14.4) |
| | 2 | 80.19% | (64.8, 89.9) |
| | 3 | 8.57% | (3.1, 21.8) |
| | Unknown | 9.42% | (4.0, 20.7) |
| Divided | 1 | 0.52% | (0.1, 2.4) |
| | 2 | 78.86% | (58.1, 90.9) |
| | 3 | 17.26% | (6.6, 38.2) |
| | Unknown | 3.36% | (0.6, 17.7) |
| One Way | 1 | 89.46% | (65.7, 97.4) |
| | 2 | 4.05% | (1.0, 15.6) |
| | 3 | 1.11% | (0.1, 9.1) |
| | Unknown | 5.39% | (0.8, 28.5) |
| Unknown | 1 | 0% | -- |
| | 2 | 0% | -- |
| | 3 | 0% | -- |
| | Unknown | 100% | -- |

Table A - 47 Highway Access Control: Rollover for All Trucks (LTCCS)

| Access Control | No Rollover | Rollover | Total Crashes | Percent Rollover Crashes | Percent of All Rollovers |
|-----------------|-------------|----------|---------------|--------------------------|--------------------------|
| Full Control | 645 | 150 | 795 | 18.9% | 57.3% |
| No Control | 415 | 112 | 527 | 21.3% | 42.7% |
| Other (Specify) | 1 | | 1 | 0.0% | 0.0% |
| Overall | 1061 | 262 | 1323 | 19.8% | 100.0% |

Table A - 48 Highway Access Control: Rollover for Cargo Tank Trucks (LTCCS)

| Access Control | No Rollover | Rollover | Total Crashes | Percent Rollover Crashes | Percent of All Rollovers |
|----------------|-------------|----------|---------------|--------------------------|--------------------------|
| Full Control | 40 | 15 | 55 | 27.3% | 53.6% |
| No Control | 21 | 13 | 34 | 38.2% | 46.4% |
| Overall | 61 | 28 | 89 | 31.5% | 100.0% |

A-3.4 Traffic Control Devices: GES

Table A - 49 Percent of Rollover Crashes by Traffic Control Device (GES)

| Category | Percent of All Rollovers | |
|-------------------|--------------------------|-------------------------|
| | Estimate | 95% Confidence Interval |
| No Control Device | 75.53% | (62.3, 85.2) |
| Control Device | 23.72% | (14.1, 37.1) |
| Unknown | 0.75% | (0.2, 3.0) |

A-3.5 Lighting Conditions

Three databases show that 2/3 to 3/4 of rollovers occur in daylight.

Table A - 50 Daylight and Rollover: All Trucks (LTCCS)

| Daylight | No Rollover | Rollover | Total Crashes | Percent Rollover Crashes | Percent of All Rollovers |
|-------------------|-------------|----------|---------------|--------------------------|--------------------------|
| Daylight | 733 | 185 | 918 | 20.2% | 73.4% |
| Dark | 101 | 33 | 134 | 24.6% | 13.1% |
| Dark, but Lighted | 120 | 26 | 146 | 17.8% | 10.3% |
| Dawn and Dusk | 35 | 8 | 43 | 18.6% | 3.2% |
| Overall | 989 | 252 | 1,241 | 20.3% | 100.0% |

Table A - 51 Daylight and Rollover: Cargo Tank Trucks Only (LTCCS)

| Daylight | No Rollover | Rollover | Total Crashes | Percent Rollover Crashes | Percent of All Rollovers |
|-------------------|-------------|----------|---------------|--------------------------|--------------------------|
| Daylight | 42 | 19 | 61 | 31.1% | 67.9% |
| Dark | 7 | 3 | 10 | 30.0% | 10.7% |
| Dark, but Lighted | 9 | 3 | 12 | 25.0% | 10.7% |
| Dawn and Dusk | 3 | 3 | 6 | 50.0% | 10.7% |
| Overall | 61 | 28 | 89 | 31.5% | 100.0% |

Table A - 52 Light Condition (TIFA)

| Light | No Roll | Roll 1 st Event | Roll Later Event | Total Rollovers | Total Crashes | Percent Rollover Crashes | Percent of All Rollovers |
|------------------|--------------|----------------------------|------------------|-----------------|---------------|--------------------------|--------------------------|
| Van | | | | | | | |
| Daylight | 5,457 | 133 | 454 | 587 | 6,044 | 9.7% | 54.8% |
| Dark | 2,576 | 91 | 258 | 349 | 2,925 | 11.9% | 32.6% |
| Dark but Lighted | 961 | 21 | 55 | 76 | 1,037 | 7.3% | 7.1% |
| Dawn | 227 | 11 | 33 | 44 | 271 | 16.2% | 4.1% |
| Dusk | 97 | 3 | 11 | 14 | 111 | 12.6% | 1.3% |
| Unknown | 7 | 0 | 1 | 1 | 8 | 12.5% | 0.1% |
| Total | 9,325 | 259 | 812 | 1,071 | 10,396 | 10.3% | 100.0% |
| Tank | | | | | | | |
| Daylight | 862 | 139 | 185 | 324 | 1,186 | 27.3% | 67.2% |
| Dark | 316 | 45 | 66 | 111 | 427 | 26.0% | 23.0% |
| Dark but Lighted | 122 | 7 | 20 | 27 | 149 | 18.1% | 5.6% |
| Dawn | 31 | 4 | 11 | 15 | 46 | 32.6% | 3.1% |
| Dusk | 23 | 2 | 3 | 5 | 28 | 17.9% | 1.0% |
| Unknown | 1 | 0 | 0 | 0 | 1 | 0.0% | 0.0% |
| Total | 1,355 | 197 | 285 | 482 | 1,837 | 26.2% | 100.0% |

Table A - 53 Percent of Rollover Crashes by Light Condition (GES)

| Category | Percent of All Rollovers | |
|------------------|--------------------------|-------------------------|
| | Estimate | 95% Confidence Interval |
| Daylight | 71.42% | (60.8, 80.1) |
| Dark | 21.91% | (12.6, 35.3) |
| Dark But Lighted | 1.83% | (0.6, 5.5) |
| Dawn | 3.1% | (1.2, 8.0) |
| Dusk | 1.74% | (0.3, 9.4) |

A-3.6 Road Surface Conditions

In the larger samples, TIFA, and GES, the portion of rollovers on dry roads is in the 80 percent range. The ratio in LTCCS was higher.

Table A - 54 Road Conditions and Rollover: All Trucks (LTCCS)

| Road Condition | No Rollover | Rollover | Total Crashes | Percent Rollover Crashes | Percent of All Rollovers |
|-----------------|-------------|----------|---------------|--------------------------|--------------------------|
| Dry | 807 | 223 | 1030 | 21.7% | 88.5% |
| Wet | 145 | 26 | 171 | 15.2% | 10.3% |
| Snow or Slush | 11 | 1 | 12 | 8.3% | 0.4% |
| Ice | 19 | 1 | 20 | 5.0% | 0.4% |
| Other (Specify) | 7 | 1 | 8 | 12.5% | 0.4% |
| Overall | 989 | 252 | 1,241 | 20.3% | 100.0% |

Table A - 55 Road Conditions and Rollover: Cargo Tank Trucks Only (LTCCS)

| Road Condition | No Rollover | Rollover | Total Crashes | Percent Rollover Crashes | Percent of All Rollovers |
|----------------|-------------|----------|---------------|--------------------------|--------------------------|
| Dry | 50 | 26 | 76 | 34.2% | 92.9% |
| Wet | 8 | 2 | 10 | 20.0% | 7.1% |
| Ice | 3 | 0 | 3 | | 0.0% |
| Overall | 61 | 28 | 89 | 31.5% | 100.0% |

Table A - 56 Roadway Surface Conditions (TIFA)

| Surface Condition | No Roll | Roll 1 st Event | Roll Later Event | Total Rollovers | Total Crashes | Percent Rollover Crashes | Percent of All Rollovers |
|-------------------|--------------|----------------------------|------------------|-----------------|---------------|--------------------------|--------------------------|
| Van | | | | | | | |
| Dry | 7,331 | 222 | 663 | 885 | 8,216 | 10.8% | 82.6% |
| Wet | 1,493 | 30 | 116 | 146 | 1,639 | 8.9% | 13.6% |
| Snow or Slush | 254 | 1 | 13 | 14 | 268 | 5.2% | 1.3% |
| Ice | 224 | 6 | 17 | 23 | 247 | 9.3% | 2.1% |
| Sand Dirt Oil | 8 | 0 | 1 | 1 | 9 | 11.1% | 0.1% |
| Other | 5 | 0 | 0 | 0 | 5 | 0.0% | 0.0% |
| Unknown | 10 | 0 | 2 | 2 | 12 | 16.7% | 0.2% |
| Total | 9,325 | 259 | 812 | 1,071 | 10,396 | 10.3% | 100.0% |
| Tank | | | | | | | |
| Dry | 1,136 | 180 | 238 | 418 | 1,554 | 26.9% | 86.7% |
| Wet | 161 | 16 | 36 | 52 | 213 | 24.4% | 10.8% |
| Snow or Slush | 30 | 0 | 6 | 6 | 36 | 16.7% | 1.2% |
| Ice | 25 | 0 | 3 | 3 | 28 | 10.7% | 0.6% |
| Sand Dirt Oil | 1 | 0 | 1 | 1 | 2 | 50.0% | 0.2% |
| Other | 1 | 0 | 0 | 0 | 1 | 0.0% | 0.0% |
| Unknown | 1 | 1 | 1 | 2 | 3 | 66.7% | 0.4% |
| Total | 1,355 | 197 | 285 | 482 | 1,837 | 26.2% | 100.0% |

Table A - 57 Percent and Number of Rollover Crashes by Weather (GES)

| Category | Percent of All Rollovers | |
|-----------------------------------|--------------------------|-------------------------|
| | Estimate | 95% Confidence Interval |
| No Adverse Atmospheric Conditions | 82.67% | (71.7, 90.0) |
| Rain | 8.38% | (3.0, 21.1) |
| Snow | 7.31% | (2.1, 22.2) |
| Fog | 1.65% | (0.2, 12.3) |

Table A - 58 Percent and Number of Rollover Crashes by Roadway Surface Condition (GES)

| Category | Percent of All Rollovers | |
|--------------------|--------------------------|-------------------------|
| | Estimate | 95% Confidence Interval |
| Dry | 76.88% | (67.3, 84.3) |
| Wet | 13.61% | (7.0, 24.9) |
| Snow or Slush | 6.45% | (1.7, 21.6) |
| Ice | 2.54% | (0.7, 8.4) |
| Sand, Dirt, or Oil | 0.06% | (0.0, 0.5) |
| Other (Specify) | 0.47% | (0.1, 3.6) |

A-3.7 Roadway Curvature (Horizontal and Vertical)

The TIFA data show that the about half of tank truck fatal involvements on a curve included a rollover and these accounted for about 44 percent of all rollovers. Note that the fraction of first-event rollovers is much higher for tanks on a curve than for tanks on a straight or for vans on either alignment.

Table A - 59 Roadway Curvature (TIFA)

| Alignment | No Roll | Roll 1 st Event | Roll Later Event | Total Rollovers | Total Crashes | Percent Rollover Crashes | Percent of All Rollovers |
|--------------|--------------|----------------------------|------------------|-----------------|---------------|--------------------------|--------------------------|
| Van | | | | | | | |
| Straight | 7,996 | 117 | 607 | 724 | 8,720 | 8.3% | 67.6% |
| Curve | 1,308 | 142 | 202 | 344 | 1,652 | 20.8% | 32.1% |
| Unknown | 21 | 0 | 3 | 3 | 24 | 12.5% | 0.3% |
| Total | 9,325 | 259 | 812 | 1,071 | 10,396 | 10.3% | 100.0% |
| Tank | | | | | | | |
| Straight | 1,143 | 71 | 199 | 270 | 1,413 | 19.1% | 56.0% |
| Curve | 210 | 126 | 85 | 211 | 421 | 50.1% | 43.8% |
| Unknown | 2 | 0 | 1 | 1 | 3 | 33.3% | 0.2% |
| Total | 1,355 | 197 | 285 | 482 | 1,837 | 26.2% | 100.0% |

GES data in Table A-59 show rollover crashes for tank trucks for straight and curved road alignment. The data show that 59 percent of the rollovers took place on a straight stretch of road while 41 percent occurred on a curve.

Table A - 60 Percent and Number of Rollover Crashes by Road Alignment (GES)

| Category | Percent of All Rollovers | |
|----------|--------------------------|-------------------------|
| | Estimate | 95% Confidence Interval |
| Straight | 59.07% | (43.4, 73.1) |
| Curve | 40.93% | (26.9, 56.6) |

The majority of rollover crashes recorded in GES occurred either when the driver was moving straight or negotiating a curve prior to the critical event of the crash.

Table A - 61 Percent of Rollover Crashes by Movement Prior to Critical Event (GES)

| Category | Percent of All Rollovers | |
|---------------------------------------|--------------------------|-------------------------|
| | Estimate | 95% Confidence Interval |
| Going Straight | 41.46% | (28.0, 56.3) |
| Decelerating in Traffic Lane | 1.86% | (0.5, 7.3) |
| Passing or Overtaking Another Vehicle | 1.48% | (0.3, 6.1) |
| Turning Right | 11.69% | (4.7, 26.3) |
| Turning Left | 10.46% | (4.5, 22.6) |
| Negotiating a Curve | 31.77% | (18.6, 48.6) |
| Changing Lane | 0.9% | (0.2, 5.2) |
| Merging | 0.07% | (0.0, 0.6) |
| Other | 0.31% | (0.0, 2.2) |

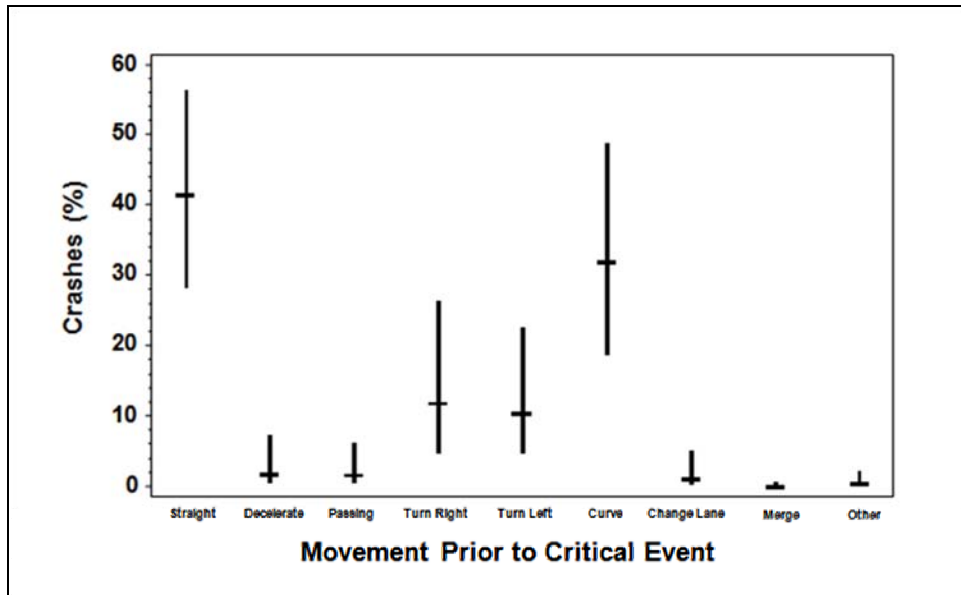

Figure A - 3 Percent of Rollover Crashes by Movement Prior to Critical Event (GES)

The data in Table A-62 show that tank trucks involved in a fatal crash on a grade (slope up or down) are much more likely to roll over, compared with level, hillcrest, or sag. About 40 percent of the fatal tank truck crashes on a grade are involved a rollover and these represent about 39 percent of all the tank truck rollovers. The effect is the same, but much smaller for vans with only about 15 percent of these vehicles rolling over on a grade although these represent 37 percent of all tank rollovers.

Table A - 62 Roadway Profile (TIFA)

| Profile | No Roll | Roll 1 st Event | Roll Later Event | Total Rollovers | Total Crashes | Percent Rollover Crashes | Percent of All Rollovers |
|--------------|--------------|----------------------------|------------------|-----------------|---------------|--------------------------|--------------------------|
| Van | | | | | | | |
| Level | 6,711 | 127 | 508 | 635 | 7,346 | 8.6% | 59.3% |
| Grade | 2,217 | 122 | 275 | 397 | 2,614 | 15.2% | 37.1% |
| Hillcrest | 183 | 4 | 11 | 15 | 198 | 7.6% | 1.4% |
| Sag | 23 | 1 | 2 | 3 | 26 | 11.5% | 0.3% |
| Unknown | 191 | 5 | 16 | 21 | 212 | 9.9% | 2.0% |
| Total | 9,325 | 259 | 812 | 1,071 | 10,396 | 10.3% | 100.0% |
| Tank | | | | | | | |
| Level | 1,010 | 101 | 177 | 278 | 1,288 | 21.6% | 57.7% |
| Grade | 280 | 87 | 99 | 186 | 466 | 39.9% | 38.6% |
| Hillcrest | 33 | 7 | 3 | 10 | 43 | 23.3% | 2.1% |
| Sag | 6 | 0 | 1 | 1 | 7 | 14.3% | 0.2% |
| Unknown | 26 | 2 | 5 | 7 | 33 | 21.2% | 1.5% |
| Total | 1,355 | 197 | 285 | 482 | 1,837 | 26.2% | 100.0% |

GES data show a slightly higher number of tank truck rollovers are on a grade than on level roadway, but the TIFA proportions are within the GES confidence intervals.

Table A - 63 Percent and Number of Rollover Crashes by Roadway Profile (TIFA)

| Category | Percent of All Rollovers | |
|-----------|--------------------------|-------------------------|
| | Estimate | 95% Confidence Interval |
| Level | 47.79% | (28.2, 68.0) |
| Grade | 50.36% | (30.3, 70.3) |
| Hillcrest | 1.66% | (0.5, 5.3) |
| Sag | 0.19% | (0.0, 1.6) |

A-4 Driver Factors

Driver factors include demographics such as age and experience. They include driver actions and inactions such as speeding or judgment of the appropriate speed. The driver's physical condition, such as alcohol impairment or illness, are also included.

A-4.1 Driver Experience

The MCMIS data show that drivers with less than five years' experience account for two-thirds of all rollovers, but the TIFA data is more evenly distributed between the experience categories. No conclusions can be drawn about the rollover rate of drivers with a particular amount of experience, because the distribution of experience among the professional tank truck driving population is not known.

Table A - 64 Driver Experience (Cargo Tank Drivers) (MCMIS)

| Driver Experience (years) | No Rollover | First Event | Subsequent Event | Total Rollovers | Total Crashes | Percent Rollover Crashes | Percent of All Rollovers |
|---------------------------|-------------|-------------|------------------|-----------------|---------------|--------------------------|--------------------------|
| <5 | 57 | 2 | 23 | 24 | 81 | 29.9% | 66.7% |
| >5 | 65 | 0 | 12 | 12 | 77 | 15.5% | 33.3% |
| Overall | 122 | 2 | 34 | 36 | 158 | 22.9% | 100.0% |

Table A - 65 Driver Experience (non-Cargo Tank Drivers) (MCMIS)

| Driver Experience (years) | No Rollover | First Event | Subsequent Event | Total Rollovers | Total Crashes | Percent Rollover Crashes | Percent of All Rollovers |
|---------------------------|-------------|-------------|------------------|-----------------|---------------|--------------------------|--------------------------|
| <5 | 28 | 1 | 11 | 12 | 40 | 31.3% | 70.6% |
| >5 | 28 | 0 | 5 | 5 | 33 | 13.9% | 29.4% |
| Overall | 56 | 1 | 16 | 17 | 73 | 23.5% | 100.0% |

Table A - 66 Driver Experience and Rollovers: All Trucks (TIFA)

| Experience | No Rollover | Rollover | Total Crashes | Percent Rollover Crashes | Percent of All Rollovers |
|------------|-------------|----------|---------------|--------------------------|--------------------------|
| < 2 | 106 | 34 | 140 | 24.3% | 15.2% |
| 2 - 5 | 139 | 30 | 169 | 17.8% | 13.5% |
| 5 - 10 | 164 | 38 | 202 | 18.8% | 17.0% |
| 10 - 20 | 217 | 47 | 264 | 17.8% | 21.1% |
| 20 - 30 | 141 | 30 | 171 | 17.5% | 13.5% |
| 30 - 40 | 62 | 8 | 70 | 11.4% | 3.6% |
| 40 - 50 | 19 | 3 | 22 | 13.6% | 1.3% |
| Unknown | 62 | 33 | 95 | 34.7% | 14.8% |
| Overall | 910 | 223 | 1,133 | 19.7% | 100.0% |

Table A - 67 Driver Experience and Rollovers: Cargo Tanks Only (TIFA)

| Experience | No Rollover | Rollover | Total Crashes | Percent Rollover Crashes | Percent of All Rollovers |
|------------|-------------|----------|---------------|--------------------------|--------------------------|
| < 2 | 4 | 4 | 8 | 50.0% | 15.4% |
| 2 - 5 | 5 | 1 | 6 | 16.7% | 3.8% |
| 5 - 10 | 10 | 8 | 18 | 44.4% | 30.8% |
| 10 - 20 | 24 | 7 | 31 | 22.6% | 26.9% |
| 20 - 30 | 3 | 2 | 5 | 40.0% | 7.7% |
| 30 - 40 | 2 | 1 | 3 | 33.3% | 3.8% |
| 40 - 50 | 4 | 0 | 4 | 0.0% | 0.0% |
| Unknown | 8 | 3 | 11 | 27.3% | 11.5% |
| Overall | 60 | 26 | 86 | 30.2% | 100.0% |

A-4.2 Driver Age

The three databases with driver age all show that middle aged drivers account for most of the rollovers, with the youngest and oldest drivers contributing a smaller number. As with driver experience, without knowledge of the demographics of the entire population, no conclusions about the respective rollover rates of various age groups can be drawn.

If the rollover is listed as the first event, which occurs about 10 percent of the time, it is necessary to look at the pre-crash condition to determine the precursors to the rollover event. In the majority of these cases, the pre-crash event is a decision error on the part of the truck driver error in a single vehicle accident. Since in more than 90 percent of the accidents, rollover is not the first event, then there was some other dangerous event that occurred before rollover. In the case of an accident involving another vehicle, the first event is normally collision with a motor vehicle in transit. For single vehicle accidents, the most common first event is ran off road.

Table A - 68 Age of Driver Involved in Cargo Tank Accidents by Event Sequence (MCMIS)

| Driver Age (years) | No Rollover | First Event | Subsequent Event | Total Rollovers | Total Crashes | Percent Rollover Crashes | Percent of All Rollovers |
|--------------------|-------------|-------------|------------------|-----------------|---------------|--------------------------|--------------------------|
| <25 | 15 | 4 | 11 | 14 | 29 | 49.3% | 4.8% |
| 25 – 35 | 182 | 8 | 59 | 67 | 249 | 27.0% | 23.0% |
| 35 – 45 | 299 | 7 | 90 | 96 | 395 | 24.4% | 33.0% |
| 45 – 55 | 258 | 4 | 56 | 60 | 319 | 18.9% | 20.6% |
| 55 – 65 | 152 | 2 | 43 | 45 | 197 | 22.8% | 15.5% |
| >65 | 65 | 0 | 8 | 8 | 73 | 11.6% | 2.7% |
| Total | 970 | 24 | 267 | 291 | 1,261 | 23.1% | 100.0% |

Table A - 69 Age of Driver Involved in Single Vehicle Cargo Tank Accidents by

| Driver Age (years) | No Rollover | First Event | Subsequent Event | Total Rollovers | Total Crashes | Percent Rollover Crashes | Percent of All Rollovers |
|--------------------|-------------|-------------|------------------|-----------------|---------------|--------------------------|--------------------------|
| <25 | 0 | 4 | 7 | 11 | 11 | 100.0% | 4.8% |
| 25 – 35 | 17 | 8 | 46 | 54 | 71 | 76.0% | 23.6% |
| 35 – 45 | 29 | 5 | 65 | 70 | 98 | 70.8% | 30.6% |
| 45 – 55 | 21 | 4 | 47 | 51 | 71 | 71.2% | 22.3% |
| 55 – 65 | 18 | 2 | 35 | 37 | 55 | 67.7% | 16.2% |
| >65 | 8 | 0 | 7 | 7 | 15 | 45.3% | 3.1% |
| Total | 92 | 22 | 207 | 229 | 321 | 71.3% | 100.0% |

Table A - 70 Driver Age (TIFA)

| Driver Age | No Roll | Roll 1 st Event | Roll Later Event | Total Rollovers | Total Crashes | Percent Rollover Crashes | Percent of All Rollovers |
|-------------|---------|----------------------------|------------------|-----------------|---------------|--------------------------|--------------------------|
| Van | | | | | | | |
| ≤ 25 | 553 | 15 | 63 | 78 | 631 | 12.4% | 7.3% |
| 26 – 55 | 7,347 | 210 | 625 | 835 | 8,182 | 10.2% | 78.1% |
| ≥ 56 | 1,306 | 34 | 122 | 156 | 1,462 | 10.7% | 14.6% |
| Total | 9,206 | 259 | 810 | 1,069 | 10,275 | 10.4% | 100.0% |
| Tank | | | | | | | |
| ≤ 25 | 59 | 9 | 14 | 23 | 82 | 28.0% | 4.8% |
| 26 – 55 | 1,067 | 148 | 217 | 365 | 1,432 | 25.5% | 75.9% |
| ≥ 56 | 221 | 39 | 54 | 93 | 314 | 29.6% | 19.3% |
| Total | 1,347 | 196 | 285 | 481 | 1,828 | 26.3% | 100.0% |

Table A - 71 Percent of Rollover Crashes by

| Category | Percent of All Rollovers | |
|----------|--------------------------|-------------------------|
| | Estimate | 95% Confidence Interval |
| <25 | 7.74% | (2.4, 22.4) |
| 25-34 | 23.97% | (16.6, 33.3) |
| 35-44 | 32.29% | (14.4, 57.5) |
| 45-54 | 24.83% | (15.4, 37.6) |
| 55-65 | 9.18% | (5.6, 14.8) |
| >65 | 1.98% | (0.7, 5.3) |

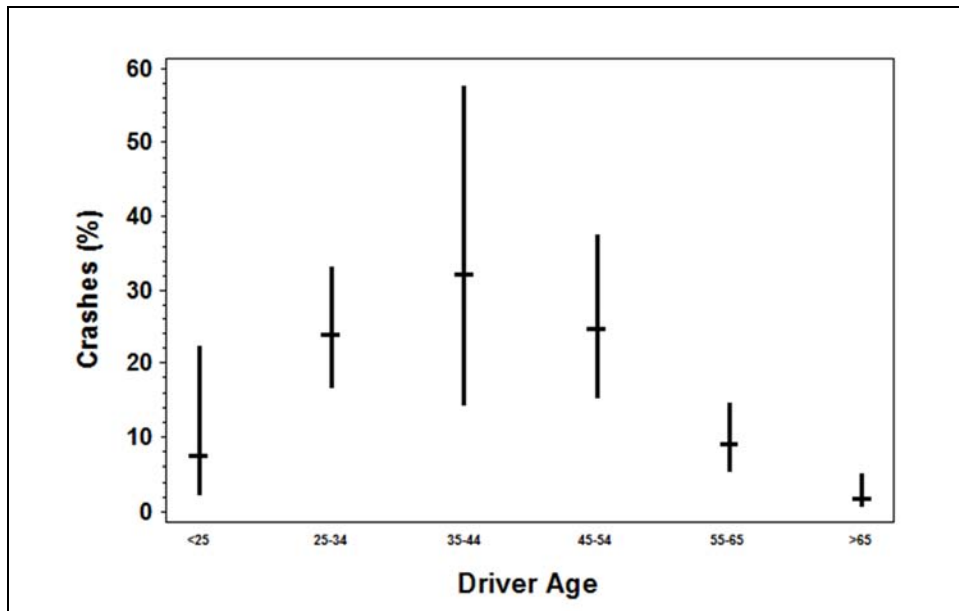

Figure A - 4 Percent of Rollover Crashes by Driver Age

A-4.3 Effect of Speed on Rollovers

In the table with LTCCS data for all trucks (Table A-72), in about three quarters of all crashes, 845 out of 1,114 accidents, speed was not a factor. For those crashes that resulted in a rollover, speed was not a factor 100 out of 216 (46 percent). In the table listing only the cargo tank crashes (Table A-73), more than half (52 percent) were judged to have no speed-related factors. The GES data also indicate that speed was a factor in less than half of the rollovers.

Interestingly, the next GES table (Table A-74) shows that, when the speed was known, the number of rollover crashes is fairly evenly distributed across the range of speeds. Some rollovers even occur at very low speeds. The next table separates the rollovers according to the posted speed limit. A number of rollovers were at speeds above the posted limit, but some were below the limit as well. Again, other factors beside speed can contribute to a rollover.

Certainly, one cannot conclude that speed is not a factor in rollovers—it is a major factor—but there are a substantial number of crashes where speeding was not a factor.

Table A - 72 Speed Driver Traveling Before Crash: All Trucks (LTCCS)

| Speeding | No Rollover | Rollover | Total Crashes | Percent Rollover Crashes | Percent of All Rollovers |
|----------------------------------|--------------------|-----------------|----------------------|---------------------------------|---------------------------------|
| Did Not Realize Caution Required | 50 | 41 | 91 | 45.1% | 19.0% |
| Keeping Up with Traffic | 11 | 3 | 14 | 21.4% | 1.4% |
| No Driver Present | 10 | | 10 | 0.0% | 0.0% |
| No Traveling too Fast Factors | 745 | 100 | 845 | 11.8% | 46.3% |
| Other Reason (Specify) | 54 | 63 | 117 | 53.8% | 29.2% |
| Unknown | 28 | 9 | 37 | 24.3% | 4.2% |
| Overall | 898 | 216 | 1,114 | 19.4% | 100.0% |

Table A - 73 Speed Driver Traveling Before Crash: Cargo Tanks Only (LTCCS)

| Speeding | No Rollover | Rollover | Total Crashes | Percent Rollover Crashes | Percent of All Rollovers |
|----------------------------------|--------------------|-----------------|----------------------|---------------------------------|---------------------------------|
| Did Not Realize Caution Required | 2 | 4 | 6 | 66.7% | 16.0% |
| Keeping Up with Traffic | 1 | | 1 | 0.0% | 0.0% |
| No Driver Present | 0 | 0 | 0 | 0.0 % | 0.0 % |
| No Traveling too Fast Factors | 52 | 13 | 65 | 20.0% | 52.0% |
| Other Reason (Specify) | 2 | 6 | 8 | 75.0% | 24.0% |
| Unknown | 2 | 2 | 4 | 50.0% | 8.0% |
| Overall | 59 | 25 | 84 | 29.8% | 100.0% |

Table A - 74 Percent and Number of Rollover Crashes by Speed Related (GES)

| Category | Percent of All Rollovers | |
|-----------|--------------------------|-------------------------|
| | Estimate | 95% Confidence Interval |
| No | 59.67% | (42.6, 74.7) |
| Yes | 38.34% | (23.3, 56.0) |
| No Driver | 1.99% | (0.6, 6.3) |

Table A - 75 Percent and Number of Rollover Crashes by

| Category | Percent of All Rollovers | |
|----------|--------------------------|-------------------------|
| | Estimate | 95% Confidence Interval |
| <=15 | 4.33% | (1.1, 15.9) |
| 20 | 0.97% | (0.3, 3.5) |
| 25 | 6.18% | (1.6, 21.1) |
| 30 | 5.48% | (2.1, 13.5) |
| 35 | 4.1% | (1.1, 14.5) |
| 40 | 5.26% | (1.6, 16.0) |
| 45 | 4.42% | (1.9, 9.8) |
| 50 | 4.67% | (1.2, 16.2) |
| 55 | 6.17% | (3.6, 10.4) |
| 60 | 1.07% | (0.2, 4.8) |
| 65 | 3.85% | (1.7, 8.7) |
| 70 | 3.09% | (0.9, 9.9) |
| 75+ | 2.27% | (0.6, 8.9) |
| Unknown | 48.14% | (25.7, 71.4) |

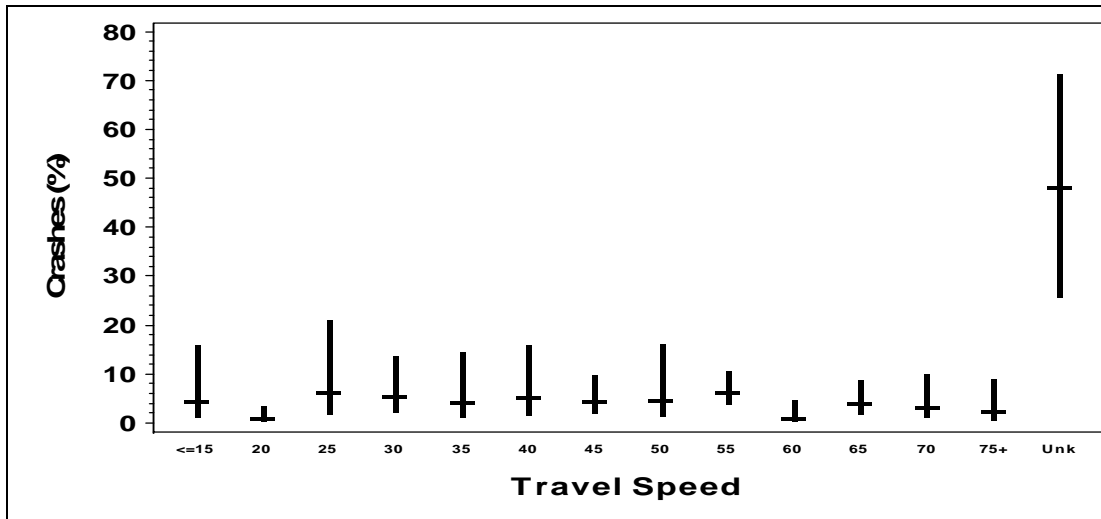

Figure A - 5 Percent and Number of Rollover Crashes by Travel Speed (GES)

Table A - 76 Percent of Rollover Crashes by Number of Speed Limit and Travel Speed (GES)

| Speed Limit | Travel Speed | Percent of All Rollovers | |
|-------------|--------------|--------------------------|-------------------------|
| | | Estimate | 95% Confidence Interval |
| 0-20 | 0-20 | 0% | -- |
| | 21-40 | 0% | -- |
| | 41-60 | 0% | -- |
| | >60 | 0% | -- |
| | Unknown | 100% | -- |
| 21-40 | 0-20 | 16.01% | (5.4, 38.9) |
| | 21-40 | 33.64% | (18.0, 54.0) |
| | 41-60 | 6.64% | (1.5, 24.7) |
| | >60 | 0% | -- |
| | Unknown | 43.71% | (31.3, 57.0) |
| 41-60 | 0-20 | 2.68% | (0.7, 10.3) |
| | 21-40 | 20.46% | (6.7, 48.0) |
| | 41-60 | 19.91% | (10.8, 33.7) |
| | >60 | 7.58% | (2.9, 18.3) |
| | Unknown | 49.37% | (21.2, 78.0) |
| >60 | 0-20 | 0% | -- |
| | 21-40 | 6.19% | (1.0, 29.6) |
| | 41-60 | 17.87% | (3.8, 54.8) |
| | >60 | 28.87% | (8.8, 63.0) |
| | Unknown | 47.07% | (14.4, 82.4) |

A-4.4 Training and Rollover

The LTCCS is the only database that records the type of commercial motor vehicle training that a driver had previous to the crash. Four categories of training are included in Tables A-76 and A-77 as well as other training and no training (none).

Table A - 77 Training and Rollover: All Trucks (LTCCS)

| CMV Training | No Rollover | Rollover | Total Crashes | Percent Rollover Crashes | Percent of All Rollovers |
|-------------------------|-------------|----------|---------------|--------------------------|--------------------------|
| Community College, etc. | 6 | 5 | 11 | 45.5% | 2.2% |
| Driving School | 306 | 77 | 383 | 20.1% | 34.5% |
| Company | 146 | 25 | 171 | 14.6% | 11.2% |
| Military | 27 | 8 | 35 | 22.9% | 3.6% |
| None | 271 | 49 | 320 | 15.3% | 22.0% |
| Unknown or Other | 154 | 59 | 213 | 27.7% | 26.5% |
| Overall | 910 | 223 | 1,133 | 19.7% | 100.0% |

A-4.5 Other Driver Factors

Tables A-78 and A-79 show driver-related factors in the TIFA database. Driver-related factors are those driver conditions or driver errors that were judged to contribute to the crash or that existed at the time of the crash. Up to four such factors can be coded, so a driver can have more than one. The tables show the number coded for selected factors and aggregated categories, such as “other physical.” Appendix B contains tables with all of the available coded factors. The total is the number of trucks involved, so the percentages are the percent of trucks with a given factor coded. The following observations about these data can be made:

- The distribution among the different factors for first event rollover is quite different from when the rollover is a later event.
 - Note the difference in the number for which “none” is coded. For first-event rollovers, some error or driver condition is coded in nearly every case. But in subsequent event rollovers (that is, after a previous harmful event), in 37 percent no error is coded.
 - Most of the first event rollovers are related to speed and running off the road. Overcorrecting is also well marked. These are cases of going off the road and overcorrecting back on.
- The two most frequent factors are exactly the same between straight trucks and tractor-semitrailers.

Table A - 78 Training and Rollover: Cargo Tank Trucks Only (LTCCS)

| CMV Training | No Rollover | Rollover | Total Crashes | Percent Rollover Crashes | Percent of All Rollovers |
|-------------------------|-------------|----------|---------------|--------------------------|--------------------------|
| Community College, etc. | | | | | 0.0% |
| Driving School | 19 | 16 | 35 | 45.7% | 61.5% |
| Company | 12 | 3 | 15 | 20.0% | 11.5% |
| Military | 1 | 1 | 2 | 50.0% | 3.8% |
| None | 14 | 1 | 15 | 6.7% | 3.8% |
| Unknown or Other | 14 | 5 | 19 | 26.3% | 19.2% |
| Overall | 60 | 26 | 86 | 30.2% | 100.0% |

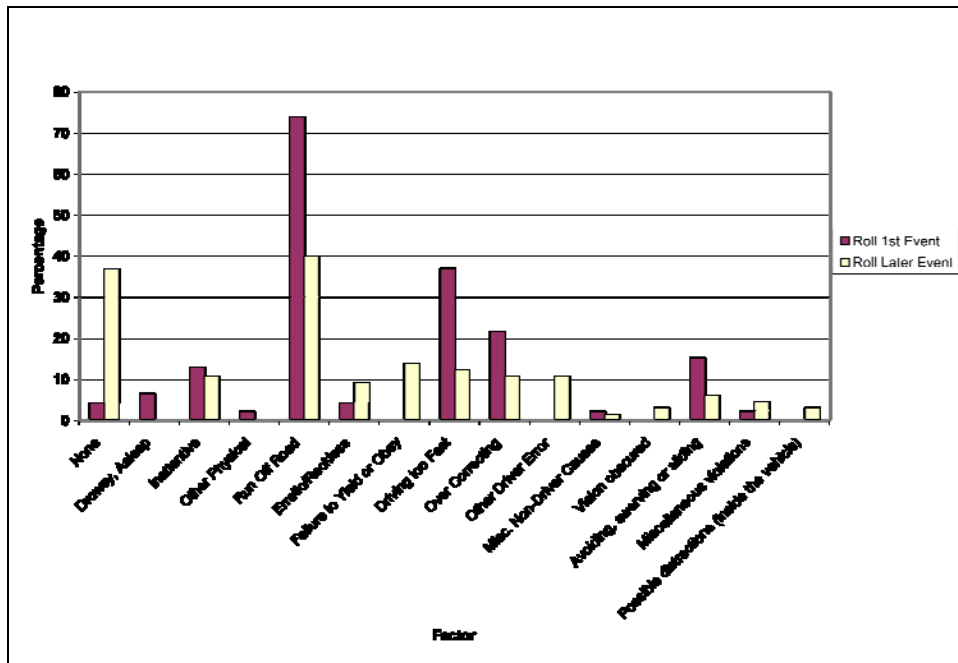

Figure A - 6 Miscellaneous Driver Factors for Straight Tank Trucks (TIFA)

Table A - 79 Miscellaneous Driver Factors for Straight Tank Trucks (TIFA)

| Straight Truck Tanks | | | | | | | | | | |
|--|-----------|----------------------------|------------------|---------------|--------------------------|-------------------|----------------------------|------------------|--------------------------|------------------------|
| Driver Factor | Frequency | | | | Row Percentage | Column Percentage | | | | |
| | No Roll | Roll 1 st Event | Roll Later Event | Total Crashes | Percent Rollover Crashes | No Roll | Roll 1 st Event | Roll Later Event | Percent of All Rollovers | Percent of All Crashes |
| None | 164 | 2 | 24 | 190 | 13.7% | 66.9% | 4.3% | 36.9% | 23.4% | 53.4% |
| Physical/mental Condition | | | | | | | | | | |
| Drowsy, Asleep | 5 | 3 | 0 | 8 | 37.5% | 2% | 6.5% | 0% | 2.7% | 2.2% |
| Inattentive | 9 | 6 | 7 | 22 | 59.1% | 3.7% | 13% | 10.8% | 11.7% | 6.2% |
| Other Physical | 1 | 1 | 0 | 2 | 50.0% | 0.4% | 2.2% | 0% | 0.9% | 0.6% |
| Miscellaneous Driver Errors | | | | | | | | | | |
| Run Off Road | 23 | 34 | 26 | 83 | 72.3% | 9.4% | 73.9% | 40% | 54.1% | 23.3% |
| Erratic/Reckless | 1 | 2 | 6 | 9 | 88.9% | 0.4% | 4.3% | 9.2% | 7.2% | 2.5% |
| Failure to Yield or Obey | 23 | 0 | 9 | 32 | 28.1% | 9.4% | 0% | 13.8% | 8.1% | 9% |
| Driving Too Fast | 11 | 17 | 8 | 36 | 69.4% | 4.5% | 37% | 12.3% | 22.5% | 10.1% |
| Over Correcting | 2 | 10 | 7 | 19 | 89.5% | 0.8% | 21.7% | 10.8% | 15.3% | 5.3% |
| Other Driver Error | 13 | 0 | 7 | 20 | 35.0% | 5.3% | 0% | 10.8% | 6.3% | 5.6% |
| Other | | | | | | | | | | |
| Misc. Non-Driver Causes | 4 | 1 | 1 | 6 | 33.3% | 1.6% | 2.2% | 1.5% | 1.8% | 1.7% |
| Vision Obscured | 3 | 0 | 2 | 5 | 40.0% | 1.2% | 0% | 3.1% | 1.8% | 1.4% |
| Avoiding, Swerving or Sliding | 8 | 7 | 4 | 19 | 57.9% | 3.3% | 15.2% | 6.2% | 9.9% | 5.3% |
| Miscellaneous Violations | 14 | 1 | 3 | 18 | 22.2% | 5.7% | 2.2% | 4.6% | 3.6% | 5.1% |
| Possible Distractions (Inside the Vehicle) | 6 | 0 | 2 | 8 | 25.0% | 2.4% | 0% | 3.1% | 1.8% | 2.2% |
| Total | | | | | | | | | | |
| Total | 245 | 46 | 65 | 356 | 31.2% | 100% | 100% | 100% | 100.0% | 100% |

Table A - 80 Miscellaneous Driver Factors for Tractor-semitrailers (TIFA)

| Frequency | No Roll | Roll 1 st Event | Roll Later Event | Total | Percent Rollover Crashes | No Roll | Roll 1 st Event | Roll Later Event | Percent of All Rollovers | Percent of All Crashes |
|--|---------|----------------------------|------------------|-------|--------------------------|---------|----------------------------|------------------|--------------------------|------------------------|
| None | 809 | 6 | 81 | 896 | 9.7% | 72.9% | 4.0% | 36.8% | 23.5% | 60.5% |
| Physical/mental Condition | | | | | | | | | | |
| Drowsy, Asleep | 7 | 13 | 18 | 38 | 81.6% | 0.6% | 8.6% | 8.2% | 8.4% | 2.6% |
| Inattentive | 33 | 23 | 16 | 72 | 54.2% | 3.0% | 15.2% | 7.3% | 10.5% | 4.9% |
| Other Physical | 3 | 4 | 4 | 11 | 72.7% | 0.3% | 2.6% | 1.8% | 2.2% | 0.7% |
| Miscellaneous Driver Errors | | | | | | | | | | |
| Run Off Road | 47 | 107 | 96 | 250 | 81.2% | 4.2% | 70.9% | 43.6% | 54.7% | 16.9% |
| Erratic/Reckless | 29 | 14 | 15 | 58 | 50.0% | 2.6% | 9.3% | 6.8% | 7.8% | 3.9% |
| Failure to Yield or Obey | 65 | 6 | 8 | 79 | 17.7% | 5.9% | 4.0% | 3.6% | 3.8% | 5.3% |
| Driving Too Fast | 48 | 66 | 36 | 150 | 68.0% | 4.3% | 43.7% | 16.4% | 27.5% | 10.1% |
| Over Correcting | 2 | 17 | 9 | 28 | 92.9% | 0.2% | 11.3% | 4.1% | 7.0% | 1.9% |
| Other Driver Error | 57 | 5 | 9 | 71 | 19.7% | 5.1% | 3.3% | 4.1% | 3.8% | 4.8% |
| Other | | | | | | | | | | |
| Misc. Non-Driver Causes | 16 | 6 | 3 | 25 | 36.0% | 1.4% | 4.0% | 1.4% | 2.4% | 1.7% |
| Vision obscured by weather | 30 | 0 | 2 | 32 | 6.3% | 2.7% | 0.0% | 0.9% | 0.5% | 2.2% |
| Vision obscured by other | 5 | 0 | 3 | 8 | 37.5% | 0.5% | 0.0% | 1.4% | 0.8% | 0.5% |
| Avoiding, swerving or sliding | 29 | 6 | 9 | 44 | 34.1% | 2.6% | 4.0% | 4.1% | 4.0% | 3.0% |
| Miscellaneous violations | 46 | 1 | 6 | 53 | 13.2% | 4.1% | 0.7% | 2.7% | 1.9% | 3.6% |
| Possible distractions (inside vehicle) | 28 | 3 | 4 | 35 | 20.0% | 2.5% | 2.0% | 1.8% | 1.9% | 2.4% |
| Total | | | | | | | | | | |
| Total | 1,110 | 151 | 220 | 1,481 | 25.1% | 100.0% | 100.0% | 100.0% | 100.0% | 100.0% |

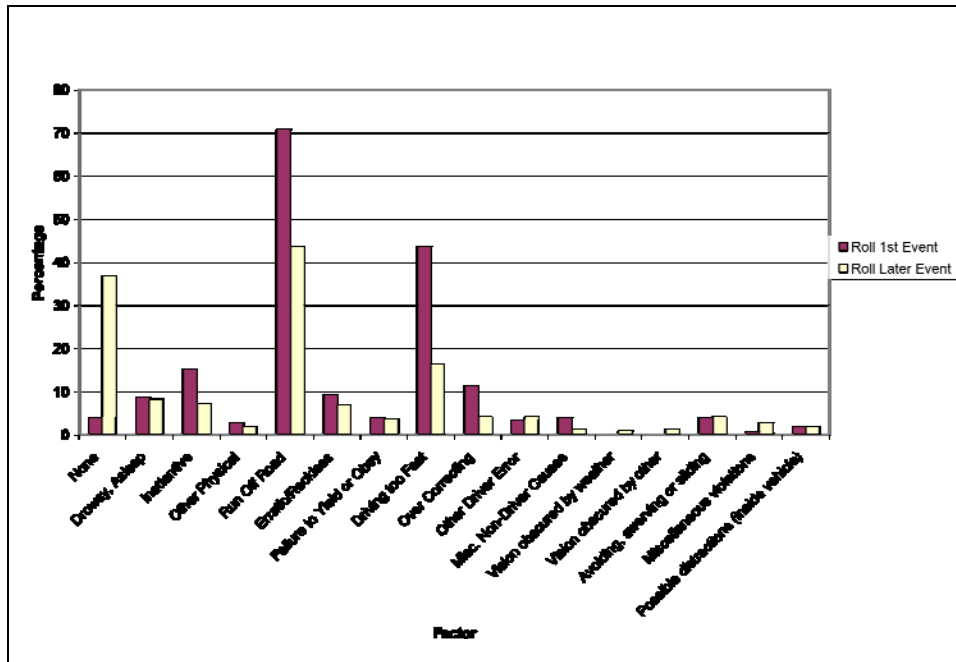

Figure A - 7 Miscellaneous Driver Factors for Tractor-semitrailer Tanks (TIFA)

Table A-81 associates driver physical impairment with rollovers. Transportation safety research has demonstrated that truck crashes are associated with various physical impairments such as diabetes and sleep apnea. Most of the drivers (83 percent) involved in a rollover did not suffer from a physical impairment. Of those with an impairment, most simply fell into the general category of tired.

Table A - 81 Percentage of Drivers with a Physical Impairment (GES)

| Category | Percent of All Rollovers | |
|---------------------------------------|--------------------------|-------------------------|
| | Estimate | 95% Confidence Interval |
| None | 83.53% | (78.0, 87.9) |
| Ill, Blackout | 2.5% | (0.7, 8.2) |
| Drowsy, Sleepy, Fell Asleep, Fatigued | 6.63% | (4.0, 10.9) |
| Other Physical Impairment | 0.31% | (0.0, 2.2) |
| Unknown If Physically Impaired | 7.02% | (2.7, 17.1) |

Table A - 82 Percent of Rollover Crashes by Driver Vision Obscured (GES)

| Category | Percent of All Rollovers | |
|----------|--------------------------|-------------------------|
| | Estimate | 95% Confidence Interval |
| No | 74.59% | (60.6, 84.9) |
| Yes | 6.35% | (1.5, 23.5) |
| Unknown | 19.06% | (9.8, 33.7) |

As with a number of types of crashes, driver distraction and inattention are significant factors.

Table A - 83 Percent of Rollover Crashes by Driver Distraction (GES)

| Category | Percent of All Rollovers | |
|-------------------------------|--------------------------|-------------------------|
| | Estimate | 95% Confidence Interval |
| None | 43.94% | (24.9, 64.9) |
| Adjusting Music/Other Devices | 1.72% | (0.3, 9.4) |
| Sleepy | 6.68% | (4.0, 11.0) |
| Other Person/Object | 1.66% | (0.3, 9.7) |
| Inattentive | 13.9% | (5.6, 30.4) |
| Other | 0.19% | (0.0, 0.8) |
| Unknown | 31.91% | (16.3, 52.9) |

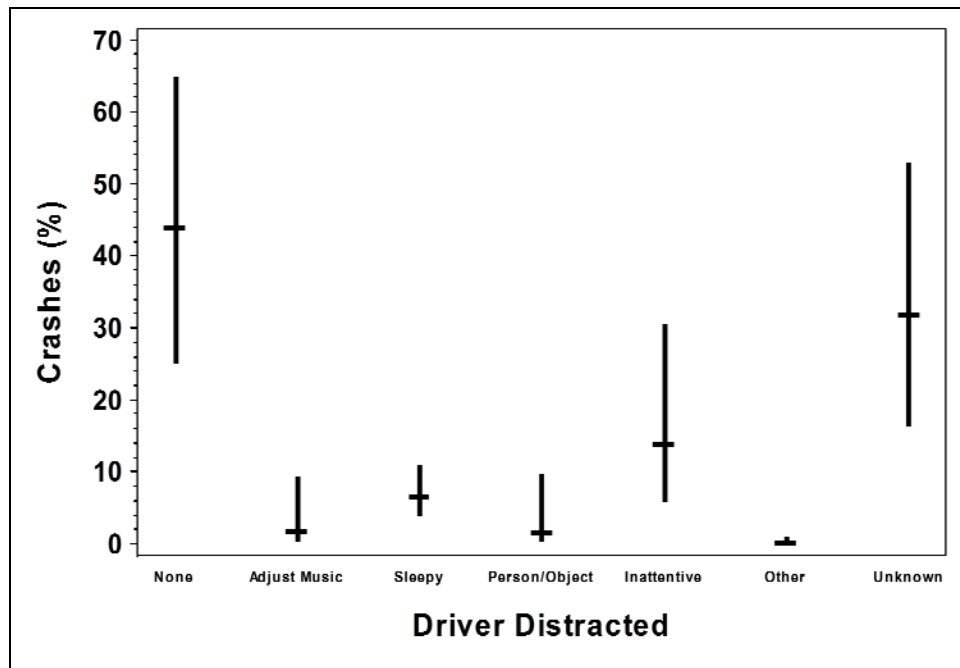

Figure A - 8 Percent of Rollover Crashes by Driver Distraction (GES)

Alcohol and drugs are rarely a factor in commercial vehicle rollovers.

**Table A - 84 Percent of Rollover Crashes
by Driver Drinking in Vehicle (GES)**

| Category | Percent of All Rollovers | |
|----------|--------------------------|-------------------------|
| | Estimate | 95% Confidence Interval |
| No | 87.77% | (74.5, 94.6) |
| Yes | 0.44% | (0.1, 2.7) |
| NA | 11.79% | (5.0, 25.2) |

**Table A - 85 Percent of Rollover Crashes
by Police-reported Drug Involvement (GES)**

| Category | Percent of All Rollovers | |
|--------------|--------------------------|-------------------------|
| | Estimate | 95% Confidence Interval |
| No | 87.9% | (74.7, 94.7) |
| Yes | 0.31% | (0.0, 2.2) |
| Not Reported | 0.8% | (0.2, 2.7) |
| Unknown | 11% | (4.4, 25.0) |

This Page Intentionally Left Blank

Appendix B

Additional TIFA Data Analyses

This Page Intentionally Left Blank

Table B - 1 Miscellaneous Driver Factors for Straight Tank Trucks

| Straight Cargo Tank Trucks | | | | | | | | |
|--|-----------|--------|---------|-------|-------------------|--------|---------|-------|
| Driver Factor | Frequency | | | | Column Percentage | | | |
| | NoRoll | 1stEvt | Subsqnt | Total | NoRoll | 1stEvt | Subsqnt | Total |
| None | 164 | 2 | 24 | 190 | 66.9 | 4.3 | 36.9 | 53.4 |
| Physical/mental condition | | | | | | | | |
| Drowsy, Asleep | 5 | 3 | 0 | 8 | 2.0 | 6.5 | 0.0 | 2.2 |
| Emotional | 1 | 0 | 0 | 1 | 0.4 | 0.0 | 0.0 | 0.3 |
| Inattentive | 9 | 6 | 7 | 22 | 3.7 | 13.0 | 10.8 | 6.2 |
| Other Physical | 0 | 1 | 0 | 1 | 0.0 | 2.2 | 0.0 | 0.3 |
| Miscellaneous causes | | | | | | | | |
| Run Off Road | 8 | 25 | 14 | 47 | 3.3 | 54.3 | 21.5 | 13.2 |
| Improper Loading | 1 | 0 | 0 | 1 | 0.4 | 0.0 | 0.0 | 0.3 |
| W/O Req Equip | 2 | 1 | 0 | 3 | 0.8 | 2.2 | 0.0 | 0.8 |
| Improper Tailing | 2 | 0 | 2 | 4 | 0.8 | 0.0 | 3.1 | 1.1 |
| Run Off Rd/Lane | 15 | 9 | 12 | 36 | 6.1 | 19.6 | 18.5 | 10.1 |
| Imp Entry/Exit | 1 | 0 | 0 | 1 | 0.4 | 0.0 | 0.0 | 0.3 |
| Impr Start/Back | 2 | 0 | 0 | 2 | 0.8 | 0.0 | 0.0 | 0.6 |
| Prohibited Pass | 1 | 0 | 1 | 2 | 0.4 | 0.0 | 1.5 | 0.6 |
| Erratic/Reckless | 1 | 2 | 6 | 9 | 0.4 | 4.3 | 9.2 | 2.5 |
| Failure to Yield | 11 | 0 | 3 | 14 | 4.5 | 0.0 | 4.6 | 3.9 |
| Failure to Obey | 12 | 0 | 6 | 18 | 4.9 | 0.0 | 9.2 | 5.1 |
| Driving Too Fast | 11 | 17 | 8 | 36 | 4.5 | 37.0 | 12.3 | 10.1 |
| Othr Impropr Turn | 1 | 0 | 4 | 5 | 0.4 | 0.0 | 6.2 | 1.4 |
| Wrong Side of Rd | 5 | 0 | 0 | 5 | 2.0 | 0.0 | 0.0 | 1.4 |
| Stopping in Rd | 1 | 0 | 0 | 1 | 0.4 | 0.0 | 0.0 | 0.3 |
| Locked Wheel | 1 | 0 | 1 | 2 | 0.4 | 0.0 | 1.5 | 0.6 |
| Over Correcting | 2 | 10 | 7 | 19 | 0.8 | 21.7 | 10.8 | 5.3 |
| Vision obscured by | | | | | | | | |
| Weather | 0 | 0 | 1 | 1 | 0.0 | 0.0 | 1.5 | 0.3 |
| Glare | 1 | 0 | 0 | 1 | 0.4 | 0.0 | 0.0 | 0.3 |
| Curve,Hill,etc | 1 | 0 | 0 | 1 | 0.4 | 0.0 | 0.0 | 0.3 |
| Tree,Plants | 0 | 0 | 1 | 1 | 0.0 | 0.0 | 1.5 | 0.3 |
| Other Obstruct | 1 | 0 | 0 | 1 | 0.4 | 0.0 | 0.0 | 0.3 |
| Avoiding, swerving or sliding due to: | | | | | | | | |
| Slippery Surface | 0 | 2 | 0 | 2 | 0.0 | 4.3 | 0.0 | 0.6 |
| Flat Tire | 3 | 1 | 0 | 4 | 1.2 | 2.2 | 0.0 | 1.1 |
| Debris in Road | 0 | 0 | 1 | 1 | 0.0 | 0.0 | 1.5 | 0.3 |
| Vehicle in Road | 3 | 2 | 3 | 8 | 1.2 | 4.3 | 4.6 | 2.2 |
| Phantom Vehicle | 0 | 1 | 0 | 1 | 0.0 | 2.2 | 0.0 | 0.3 |
| Water,Snow,Oil | 2 | 0 | 0 | 2 | 0.8 | 0.0 | 0.0 | 0.6 |
| Fishtailing, swaying | 0 | 1 | 0 | 1 | 0.0 | 2.2 | 0.0 | 0.3 |

| Straight Cargo Tank Trucks | | | | | | | | |
|---|-----------|--------|---------|-------|-------------------|--------|---------|-------|
| Driver Factor | Frequency | | | | Column Percentage | | | |
| | NoRoll | 1stEvt | Subsqnt | Total | NoRoll | 1stEvt | Subsqnt | Total |
| Other miscellaneous factors | | | | | | | | |
| Haul Hazmat Impr | 1 | 0 | 0 | 1 | 0.4 | 0.0 | 0.0 | 0.3 |
| Hit and Run | 1 | 0 | 0 | 1 | 0.4 | 0.0 | 0.0 | 0.3 |
| Homicide | 3 | 0 | 1 | 4 | 1.2 | 0.0 | 1.5 | 1.1 |
| Other Violation | 9 | 1 | 2 | 12 | 3.7 | 2.2 | 3.1 | 3.4 |
| Possible distractions (inside the vehicle) | | | | | | | | |
| Cellular Phone | 3 | 0 | 2 | 5 | 1.2 | 0.0 | 3.1 | 1.4 |
| Unknown | 3 | 0 | 0 | 3 | 1.2 | 0.0 | 0.0 | 0.8 |
| Total | 245 | 46 | 65 | 356 | 100.0 | 100.0 | 100.0 | 100.0 |

Table B - 2 Miscellaneous Driver Factors for Tractor-semitrailer Tank Trucks

| Tractor-semitrailer Cargo Tank Trucks | | | | | | | | |
|---------------------------------------|-----------|--------|---------|-------|-------------------|--------|---------|-------|
| Frequency | Frequency | | | | Column Percentage | | | |
| | NoRoll | 1stEvt | Subsqnt | Total | NoRoll | 1stEvt | Subsqnt | Total |
| None | 809 | 6 | 81 | 896 | 72.9 | 4.0 | 36.8 | 60.5 |
| Physical/mental condition | | | | | | | | |
| Drowsy, Asleep | 7 | 13 | 18 | 38 | 0.6 | 8.6 | 8.2 | 2.6 |
| Ill, Blackout | 3 | 1 | 1 | 5 | 0.3 | 0.7 | 0.5 | 0.3 |
| Emotional | 0 | 0 | 2 | 2 | 0.0 | 0.0 | 0.9 | 0.1 |
| Drugs-Medication | 0 | 0 | 1 | 1 | 0.0 | 0.0 | 0.5 | 0.1 |
| Other Drugs | 0 | 2 | 0 | 2 | 0.0 | 1.3 | 0.0 | 0.1 |
| Inattentive | 33 | 23 | 16 | 72 | 3.0 | 15.2 | 7.3 | 4.9 |
| Other Physical | 0 | 1 | 0 | 1 | 0.0 | 0.7 | 0.0 | 0.1 |
| Miscellaneous causes | | | | | | | | |
| Run Off Road | 21 | 73 | 51 | 145 | 1.9 | 48.3 | 23.2 | 9.8 |
| Veh Unattended | 3 | 0 | 0 | 3 | 0.3 | 0.0 | 0.0 | 0.2 |
| Improper Loading | 1 | 2 | 2 | 5 | 0.1 | 1.3 | 0.9 | 0.3 |
| Improper Towing | 2 | 0 | 0 | 2 | 0.2 | 0.0 | 0.0 | 0.1 |
| W/O Req Equip | 7 | 4 | 1 | 12 | 0.6 | 2.6 | 0.5 | 0.8 |
| Improper Tailing | 22 | 0 | 2 | 24 | 2.0 | 0.0 | 0.9 | 1.6 |
| Impr Lane Change | 7 | 1 | 0 | 8 | 0.6 | 0.7 | 0.0 | 0.5 |
| Run Off Rd/Lane | 26 | 34 | 45 | 105 | 2.3 | 22.5 | 20.5 | 7.1 |
| Imp Entry/Exit | 2 | 0 | 0 | 2 | 0.2 | 0.0 | 0.0 | 0.1 |
| Impr Start/Back | 1 | 0 | 0 | 1 | 0.1 | 0.0 | 0.0 | 0.1 |
| Prohibited Pass | 1 | 0 | 0 | 1 | 0.1 | 0.0 | 0.0 | 0.1 |
| Pass Insuff Dist | 1 | 1 | 1 | 3 | 0.1 | 0.7 | 0.5 | 0.2 |
| Erratic/Reckless | 29 | 14 | 15 | 58 | 2.6 | 9.3 | 6.8 | 3.9 |
| Failure to Yield | 42 | 1 | 5 | 48 | 3.8 | 0.7 | 2.3 | 3.2 |
| Failure to Obey | 23 | 5 | 3 | 31 | 2.1 | 3.3 | 1.4 | 2.1 |
| Fail to Obs Warn | 2 | 0 | 0 | 2 | 0.2 | 0.0 | 0.0 | 0.1 |
| Driving Too Fast | 48 | 66 | 36 | 150 | 4.3 | 43.7 | 16.4 | 10.1 |
| Othr Impropr Turn | 10 | 0 | 3 | 13 | 0.9 | 0.0 | 1.4 | 0.9 |
| Wrong Side of Rd | 5 | 1 | 3 | 9 | 0.5 | 0.7 | 1.4 | 0.6 |
| Op Inexperience | 0 | 1 | 0 | 1 | 0.0 | 0.7 | 0.0 | 0.1 |
| Unfamiliar w/Rd | 1 | 1 | 0 | 2 | 0.1 | 0.7 | 0.0 | 0.1 |
| Stopping in Rd | 5 | 0 | 0 | 5 | 0.5 | 0.0 | 0.0 | 0.3 |
| Locked Wheel | 3 | 0 | 0 | 3 | 0.3 | 0.0 | 0.0 | 0.2 |
| Over Correcting | 2 | 17 | 9 | 28 | 0.2 | 11.3 | 4.1 | 1.9 |

| Tractor-semitrailer Cargo Tank Trucks | | | | | | | | |
|---|--------------|------------|------------|--------------|-------------------|--------------|--------------|--------------|
| Frequency | Frequency | | | | Column Percentage | | | |
| | NoRoll | 1stEvt | Subsqnt | Total | NoRoll | 1stEvt | Subsqnt | Total |
| Vision obscured by | | | | | | | | |
| Weather | 30 | 0 | 2 | 32 | 2.7 | 0.0 | 0.9 | 2.2 |
| Glare | 1 | 0 | 0 | 1 | 0.1 | 0.0 | 0.0 | 0.1 |
| Curve,Hill,etc | 2 | 0 | 1 | 3 | 0.2 | 0.0 | 0.5 | 0.2 |
| Bldg,Billboard | 1 | 0 | 1 | 2 | 0.1 | 0.0 | 0.5 | 0.1 |
| Tree,Plants | 0 | 0 | 1 | 1 | 0.0 | 0.0 | 0.5 | 0.1 |
| Obstruct Angles | 1 | 0 | 0 | 1 | 0.1 | 0.0 | 0.0 | 0.1 |
| Avoiding, swerving or sliding due to: | | | | | | | | |
| Flat Tire | 2 | 0 | 0 | 2 | 0.2 | 0.0 | 0.0 | 0.1 |
| Debris in Road | 0 | 0 | 1 | 1 | 0.0 | 0.0 | 0.5 | 0.1 |
| Live Animal | 1 | 0 | 1 | 2 | 0.1 | 0.0 | 0.5 | 0.1 |
| Vehicle in Road | 13 | 3 | 4 | 20 | 1.2 | 2.0 | 1.8 | 1.4 |
| Phantom Vehicle | 4 | 1 | 0 | 5 | 0.4 | 0.7 | 0.0 | 0.3 |
| Pedestrian | 1 | 0 | 0 | 1 | 0.1 | 0.0 | 0.0 | 0.1 |
| Water,Snow,Oil | 8 | 1 | 3 | 12 | 0.7 | 0.7 | 1.4 | 0.8 |
| Fishtailing, swaying | 0 | 1 | 0 | 1 | 0.0 | 0.7 | 0.0 | 0.1 |
| Other miscellaneous factors | | | | | | | | |
| Haul Hazmat Impr | 2 | 0 | 0 | 2 | 0.2 | 0.0 | 0.0 | 0.1 |
| Hit and Run | 5 | 0 | 0 | 5 | 0.5 | 0.0 | 0.0 | 0.3 |
| Homicide | 22 | 0 | 1 | 23 | 2.0 | 0.0 | 0.5 | 1.6 |
| Other Violation | 17 | 1 | 5 | 23 | 1.5 | 0.7 | 2.3 | 1.6 |
| Possible distractions (inside vehicle) | | | | | | | | |
| Cellular Phone | 18 | 0 | 3 | 21 | 1.6 | 0.0 | 1.4 | 1.4 |
| Computer | 0 | 1 | 0 | 1 | 0.0 | 0.7 | 0.0 | 0.1 |
| Unknown | 10 | 2 | 1 | 13 | 0.9 | 1.3 | 0.5 | 0.9 |
| Total | 1,110 | 151 | 220 | 1,481 | 100.0 | 100.0 | 100.0 | 100.0 |

Table B - 3 Accident Type for Straight Tank Trucks

| Straight Cargo Tank Trucks | | | | | | | | |
|----------------------------|-----------|--------|--------|-------|-------------------|--------|--------|-------|
| Accident Type | Frequency | | | | Column Percentage | | | |
| | NoRoll | 1stEvt | Subsqt | Total | NoRoll | 1stEvt | Subsqt | Total |
| ran off road | 13 | 33 | 17 | 63 | 5.3 | 71.7 | 26.2 | 17.7 |
| hit object in road | 25 | 0 | 1 | 26 | 10.2 | 0.0 | 1.5 | 7.3 |
| rearend strike | 5 | 0 | 2 | 7 | 2.0 | 0.0 | 3.1 | 2.0 |
| rearend struck | 23 | 0 | 0 | 23 | 9.4 | 0.0 | 0.0 | 6.5 |
| rearend other | 1 | 0 | 0 | 1 | 0.4 | 0.0 | 0.0 | 0.3 |
| ss sm encro | 0 | 0 | 0 | 0 | 0.0 | 0.0 | 0.0 | 0.0 |
| ss sm o encro | 3 | 0 | 1 | 4 | 1.2 | 0.0 | 1.5 | 1.1 |
| ss sm oth | 1 | 0 | 0 | 1 | 0.4 | 0.0 | 0.0 | 0.3 |
| head encro | 5 | 0 | 4 | 9 | 2.0 | 0.0 | 6.2 | 2.5 |
| head o encro | 43 | 1 | 5 | 49 | 17.6 | 2.2 | 7.7 | 13.8 |
| ss op encro | 7 | 2 | 1 | 10 | 2.9 | 4.3 | 1.5 | 2.8 |
| ss op o encro | 23 | 1 | 2 | 26 | 9.4 | 2.2 | 3.1 | 7.3 |
| ss op other | 4 | 1 | 3 | 8 | 1.6 | 2.2 | 4.6 | 2.2 |
| turn across | 6 | 0 | 3 | 9 | 2.4 | 0.0 | 4.6 | 2.5 |
| oth turn across | 19 | 0 | 4 | 23 | 7.8 | 0.0 | 6.2 | 6.5 |
| str, into oth | 3 | 0 | 5 | 8 | 1.2 | 0.0 | 7.7 | 2.2 |
| str, oth into | 27 | 0 | 9 | 36 | 11.0 | 0.0 | 13.8 | 10.1 |
| str, other | 6 | 0 | 2 | 8 | 2.4 | 0.0 | 3.1 | 2.2 |
| back into oth | 3 | 0 | 0 | 3 | 1.2 | 0.0 | 0.0 | 0.8 |
| untrip roll | 0 | 8 | 2 | 10 | 0.0 | 17.4 | 3.1 | 2.8 |
| unknown | 28 | 0 | 4 | 32 | 11.4 | 0.0 | 6.2 | 9.0 |
| Total | 245 | 46 | 65 | 356 | 100.0 | 100.0 | 100.0 | 100.0 |

Note: ss=sideswipe, sm=same direction, op=opposite direction, encro=encroaching, o=other, oth=other, str=going straight, strike=truck is striking vehicle, struck=truck is struck vehicle.

Table B - 4 Accident Type for Tractor-semitrailer Tanks

| Tractor-semitrailer Cargo Tank Trucks | | | | | | | | |
|---------------------------------------|-----------|--------|--------|-------|-------------------|--------|--------|-------|
| Accident Type | Frequency | | | | Column Percentage | | | |
| | NoRoll | 1stEvt | Subsqt | Total | NoRoll | 1stEvt | Subsqt | Total |
| ran off road | 26 | 99 | 81 | 206 | 2.3 | 65.6 | 36.8 | 13.9 |
| hit object in road | 67 | 1 | 9 | 77 | 6.0 | 0.7 | 4.1 | 5.2 |
| rearend strike | 75 | 0 | 13 | 88 | 6.8 | 0.0 | 5.9 | 5.9 |
| rearend struck | 101 | 0 | 1 | 102 | 9.1 | 0.0 | 0.5 | 6.9 |
| rearend other | 6 | 0 | 1 | 7 | 0.5 | 0.0 | 0.5 | 0.5 |
| ss sm encro | 6 | 0 | 1 | 7 | 0.5 | 0.0 | 0.5 | 0.5 |
| ss sm o encro | 51 | 0 | 7 | 58 | 4.6 | 0.0 | 3.2 | 3.9 |
| ss sm oth | 15 | 0 | 1 | 16 | 1.4 | 0.0 | 0.5 | 1.1 |
| head encro | 11 | 0 | 2 | 13 | 1.0 | 0.0 | 0.9 | 0.9 |
| head o encro | 146 | 1 | 14 | 161 | 13.2 | 0.7 | 6.4 | 10.9 |
| head other | 4 | 0 | 0 | 4 | 0.4 | 0.0 | 0.0 | 0.3 |
| ss op encro | 6 | 2 | 5 | 13 | 0.5 | 1.3 | 2.3 | 0.9 |
| ss op o encro | 111 | 0 | 17 | 128 | 10.0 | 0.0 | 7.7 | 8.6 |
| ss op other | 38 | 0 | 8 | 46 | 3.4 | 0.0 | 3.6 | 3.1 |
| turn across | 48 | 0 | 1 | 49 | 4.3 | 0.0 | 0.5 | 3.3 |
| oth turn across | 63 | 0 | 12 | 75 | 5.7 | 0.0 | 5.5 | 5.1 |
| oth turning | 1 | 0 | 0 | 1 | 0.1 | 0.0 | 0.0 | 0.1 |
| str, into oth | 52 | 0 | 7 | 59 | 4.7 | 0.0 | 3.2 | 4.0 |
| str, oth into | 118 | 0 | 20 | 138 | 10.6 | 0.0 | 9.1 | 9.3 |
| str, other | 7 | 0 | 1 | 8 | 0.6 | 0.0 | 0.5 | 0.5 |
| back into oth | 7 | 0 | 0 | 7 | 0.6 | 0.0 | 0.0 | 0.5 |
| oth back into | 0 | 0 | 0 | 0 | 0.0 | 0.0 | 0.0 | 0.0 |
| untrip roll | 1 | 37 | 5 | 43 | 0.1 | 24.5 | 2.3 | 2.9 |
| unknown | 150 | 11 | 14 | 175 | 13.5 | 7.3 | 6.4 | 11.8 |
| Total | 1,110 | 151 | 220 | 1,481 | 100.0 | 100.0 | 100.0 | 100.0 |

Note: ss=sideswipe, sm=same direction, op=opposite direction, encro=encroaching, o=other, oth=other, str=going straight, strike=truck is striking vehicle, struck=truck is struck vehicle.

Table B - 5 Pre-crash Maneuver for Straight Tank Trucks

| Straight Truck Tanks | | | | | | | | |
|----------------------|-----------|--------|---------|-------|-------------------|--------|---------|-------|
| Pre-crash Maneuver | Frequency | | | | Column percentage | | | |
| | NoRoll | 1stEvt | Subsqnt | Total | NoRoll | 1stEvt | Subsqnt | Total |
| Going Straight | 176 | 24 | 42 | 242 | 71.8 | 52.2 | 64.6 | 68.0 |
| Slowing/Stopping | 6 | 0 | 1 | 7 | 2.4 | 0.0 | 1.5 | 2.0 |
| Starting in Lane | 4 | 0 | 0 | 4 | 1.6 | 0.0 | 0.0 | 1.1 |
| Stopped in Lane | 11 | 0 | 0 | 11 | 4.5 | 0.0 | 0.0 | 3.1 |
| Passing | 1 | 0 | 2 | 3 | 0.4 | 0.0 | 3.1 | 0.8 |
| Leave Parking | 0 | 0 | 0 | 0 | 0.0 | 0.0 | 0.0 | 0.0 |
| Parked | 0 | 0 | 0 | 0 | 0.0 | 0.0 | 0.0 | 0.0 |
| Enter Parking | 0 | 0 | 0 | 0 | 0.0 | 0.0 | 0.0 | 0.0 |
| Avoid Animal,etc | 3 | 2 | 4 | 9 | 1.2 | 4.3 | 6.2 | 2.5 |
| RTOR:Permitted | 0 | 0 | 0 | 0 | 0.0 | 0.0 | 0.0 | 0.0 |
| RTOR:not Legal | 0 | 0 | 0 | 0 | 0.0 | 0.0 | 0.0 | 0.0 |
| RTOR:not Known | 1 | 1 | 0 | 2 | 0.4 | 2.2 | 0.0 | 0.6 |
| Left Turn | 10 | 1 | 2 | 13 | 4.1 | 2.2 | 3.1 | 3.7 |
| U-turn | 1 | 0 | 0 | 1 | 0.4 | 0.0 | 0.0 | 0.3 |
| Backing up | 3 | 0 | 0 | 3 | 1.2 | 0.0 | 0.0 | 0.8 |
| Changing Lanes | 4 | 0 | 0 | 4 | 1.6 | 0.0 | 0.0 | 1.1 |
| Negotiate Curve | 24 | 18 | 13 | 55 | 9.8 | 39.1 | 20.0 | 15.4 |
| Other | 1 | 0 | 1 | 2 | 0.4 | 0.0 | 1.5 | 0.6 |
| Unknown | 0 | 0 | 0 | 0 | 0.0 | 0.0 | 0.0 | 0.0 |
| Total | 245 | 46 | 65 | 356 | 100.0 | 100.0 | 100.0 | 100.0 |

Note: RTOR means right turn on red.

Table B - 6 Pre-crash Maneuver for Tractor-semitrailer Tanks

| Tractor-semitrailer Tank Trucks | | | | | | | | |
|--|------------------|---------------|----------------|--------------|--------------------------|---------------|----------------|--------------|
| Pre-crash Maneuver | Frequency | | | | Column percentage | | | |
| | NoRoll | 1stEvt | Subsqnt | Total | NoRoll | 1stEvt | Subsqnt | Total |
| Going Straight | 835 | 46 | 153 | 1,034 | 75.2 | 30.5 | 69.5 | 69.8 |
| Slowing/Stopping | 37 | 1 | 1 | 39 | 3.3 | 0.7 | 0.5 | 2.6 |
| Starting in Lane | 6 | 0 | 0 | 6 | 0.5 | 0.0 | 0.0 | 0.4 |
| Stopped in Lane | 50 | 0 | 0 | 50 | 4.5 | 0.0 | 0.0 | 3.4 |
| Passing | 7 | 1 | 4 | 12 | 0.6 | 0.7 | 1.8 | 0.8 |
| Leave Parking | 1 | 0 | 0 | 1 | 0.1 | 0.0 | 0.0 | 0.1 |
| Parked | 1 | 0 | 0 | 1 | 0.1 | 0.0 | 0.0 | 0.1 |
| Enter Parking | 0 | 0 | 0 | 0 | 0.0 | 0.0 | 0.0 | 0.0 |
| Avoid Animal, etc | 23 | 4 | 7 | 34 | 2.1 | 2.6 | 3.2 | 2.3 |
| RTOR:Permitted | 2 | 0 | 0 | 2 | 0.2 | 0.0 | 0.0 | 0.1 |
| RTOR:not Legal | 0 | 0 | 0 | 0 | 0.0 | 0.0 | 0.0 | 0.0 |
| RTOR:not Known | 8 | 3 | 0 | 11 | 0.7 | 2.0 | 0.0 | 0.7 |
| Left Turn | 46 | 3 | 1 | 50 | 4.1 | 2.0 | 0.5 | 3.4 |
| U-turn | 5 | 0 | 1 | 6 | 0.5 | 0.0 | 0.5 | 0.4 |
| Backing up | 8 | 0 | 0 | 8 | 0.7 | 0.0 | 0.0 | 0.5 |
| Changing Lanes | 17 | 4 | 2 | 23 | 1.5 | 2.6 | 0.9 | 1.6 |
| Negotiate Curve | 63 | 84 | 50 | 197 | 5.7 | 55.6 | 22.7 | 13.3 |
| Other | 1 | 4 | 0 | 5 | 0.1 | 2.6 | 0.0 | 0.3 |
| Unknown | 0 | 1 | 1 | 2 | 0.0 | 0.7 | 0.5 | 0.1 |
| Total | 1,110 | 151 | 220 | 1,481 | 100.0 | 100.0 | 100.0 | 100.0 |

Appendix C

Model Of The TIFA Data

This Page Intentionally Left Blank

While the tables in the Appendix A provide some insights into the causes of rollover fatal crashes, they are not able to show the effect of combined factors. Therefore, a model of the TIFA was developed to help sort out the separate effect of the factors identified above. The tables can be read to show the effect of the factors, one at a time, but in practice, the probability of rollover is the net effect of many factors working together. A model estimates the individual effect of each factor, holding the other factors equal.

The model is a binary logistic regression model, which assumes that the response variable is either 1 (rollover) or 0 (no rollover). Essentially, logistic regression models the log odds of the response variable by the predictor variables. The odds is defined as $p/(1-p)$ where p is the probability of rollover.

$$\log\left(\frac{\pi}{1-\pi}\right) = \alpha + \beta'x$$

where α is an intercept parameter and β' is the vector of parameters.

Table C-1 shows the variables and levels used in the model. All the variables were considered in the TIFA tables in Appendix A. For example, the configuration variable has two levels, tractor-semitrailer and straight (straight truck with no trailer). In the model tractor-semitrailer is assigned level 0 and straight truck is assigned 1. Table A-19 showing rollover by configuration showed that configuration was associated with the probability of rollover in a fatal crash. For the purpose of the model, each variable that was found to be associated was re-coded into two levels, with the exception of the percent of load category variable, which has three levels. The purpose of the re-code was to define a baseline case with the lowest probability of rollover.

The baseline case is a tractor-semitrailer, with a van cargo body, either empty or with cargo no more than 10 percent of GCW, not carrying hazmat, not on an Interstate, in an urban area, on a straight, level, not dry road. Note that the design variable is set to zero for each factor for the baseline case. The parameters in the model thus show the effect of each variable and interaction relative to the baseline case.

Table C - 1 Model Variables

| Class | Value | Design Variables |
|-------------------------|---------------------|-------------------------|
| Configuration | Tractor-semitrailer | 0 |
| | Straight | 1 |
| Body Type | Van | 0 |
| | Tank | 1 |
| Percent of Load Carried | 0 to 10 | 0 0 |
| | 11 to 50 | 1 0 |
| | > 50 | 0 1 |
| Hazmat | No Hazmat | 0 |
| | Hazmat | 1 |
| Road Type | Not Interstate | 0 |
| | Interstate | 1 |
| Population Area | Urban | 0 |
| | Rural | 1 |
| Road Alignment | Not a Curve | 0 |
| | Curve | 1 |
| Road Profile | Not a Grade | 0 |
| | Grade | 1 |
| Surface Conditions | Not Dry | 0 |
| | Dry | 1 |

Table C-2 show major parameters in the model. These parameters are the statistics of interest. Most of the main effects are statistically significant. There are some that are not but they are included in the model because there are significant interaction terms that are included. For example, the parameter for body (tank) is not statistically significant, but the interaction between body type and percent of load carried is highly significant, so body stays in the model.

For the purposes of model interpretation, note that the baseline case was set up to include all the factors with the lowest probability of roll. The parameters show the effect of the characteristic relative to the baseline case. All the main effects are positive, meaning they increase the odds of rollover. In the case of hazmat, the parameter estimate is 0.3369. This indicates that the main effect of hazmat is to increase the odds of roll. To gauge the size of the effect, exponentiate the estimate ($e^{0.3369}=1.4$) to determine that the straight condition increases the odds of rollover by about 40 percent. Note that there is an interaction between configuration and percent of load carried. This means that the effect of straight varies depending on loading. Loads in a straight have a different effect from loads in a tractor-semitrailer.

Table C - 2 Model

| Parameter | DF | Estimate | Standard Error | Wald Chi-Square | Pr > ChiSq |
|---|----|----------|----------------|-----------------|------------|
| Intercept | 1 | -4.3618 | 0.1641 | 706.5825 | <.0001 |
| configuration straight | 1 | 0.912 | 0.1746 | 27.2812 | <.0001 |
| body type tank | 1 | 0.1815 | 0.2184 | 0.6912 | 0.4057 |
| Percent of load carried 11 to 50 | 1 | 0.7328 | 0.1489 | 24.209 | <.0001 |
| Percent of load carried > 50 | 1 | 1.1712 | 0.138 | 72.066 | <.0001 |
| hazmat hazmat | 1 | 0.3369 | 0.1254 | 7.2194 | 0.0072 |
| road type interstate | 1 | 0.3606 | 0.0726 | 24.6739 | <.0001 |
| Population area rural | 1 | 0.6536 | 0.0828 | 62.3513 | <.0001 |
| Road alignment curve | 1 | 0.2068 | 0.2068 | 0.9999 | 0.3173 |
| Road profile grade | 1 | 0.4024 | 0.0727 | 30.6658 | <.0001 |
| Surface Condition dry | 1 | 0.4375 | 0.0909 | 23.1512 | <.0001 |
| body* Percent of load tank 11 to 50 | 1 | 0.915 | 0.2843 | 10.3583 | 0.0013 |
| body* Percent of load tank > 50 | 1 | 0.8285 | 0.2454 | 11.3989 | 0.0007 |
| Percent of load *align 11 to 50 curve | 1 | 0.7276 | 0.2445 | 8.8556 | 0.0029 |
| Percent of load *align > 50 curve | 1 | 1.1394 | 0.2285 | 24.8564 | <.0001 |
| configuration*Percent of load straight 11 to 50 | 1 | -0.3025 | 0.2201 | 1.8882 | 0.1694 |
| configuration* Percent of load straight > 50 | 1 | -0.8176 | 0.3266 | 6.2661 | 0.0123 |

Table C-3 illustrates how the model can be used to estimate how the odds of a fatal accident including a rollover are increased as certain factors are changed from the baseline case. The probability of a rollover is listed for all of the cases where a single factor is changed from the baseline case and for some of the cases where multiple factors are changed from the baseline. It is impossible to include all combinations of factors because there are millions of possibilities. Therefore, samples of cases that show an increasing likelihood of rollover were selected. One of these cases shows all of the possible road factors combined, while another case shows all of the possible vehicle factors combined. Note that a small number of factors that tend to interact with each other can increase the likelihood of a rollover more than a larger number of other factors. For example, a case that only uses two factors (tank is >50 percent full and there is a curve) has a 30.3 percent chance of rolling over, while the case that uses all five road factors only has a 9.1 percent chance of rolling over. The model shows that the worst case scenario, when all 10 factors are present, is about 335 times more likely to rollover than the baseline case.

Table C - 3 Example Cases from Model

| Case | Odds Ratio for Rollover Compared with Baseline Case | Rollover Probability |
|---|--|-----------------------------|
| Baseline | | |
| Baseline (TS, Van, 0-10% full, No Hazmat, No Interstate, Urban, Straight, Not Grade, Not Dry) | 1.0 | 1.3% |
| Single Cases | | |
| <i>Vehicle Factors</i> | | |
| Baseline except Straight | 2.5 | 3.1% |
| Baseline except Tank | 1.2 | 1.5% |
| Baseline except 10-50% full | 2.1 | 2.6% |
| Baseline except >50% full | 3.2 | 4.0% |
| Baseline except Hazmat | 1.4 | 1.8% |
| <i>Road Factors</i> | | |
| Baseline except Interstate | 1.4 | 1.8% |
| Baseline except Rural | 1.9 | 2.4% |
| Baseline except Curve | 1.2 | 1.5% |
| Baseline except Grade | 1.5 | 1.9% |
| Baseline except Dry | 1.5 | 1.9% |
| Example Combination Cases | | |
| <i>Vehicle Factors</i> | | |
| Baseline except Tank and >50% full | 8.9 | 10.2% |
| Baseline except Straight, Tank, >50% full, and Hazmat. | 13.6 | 14.8% |
| <i>Road Factors</i> | | |
| Baseline except Interstate, Rural, Curve, Grade, Dry | 7.9 | 9.1% |
| <i>Vehicle and Road Factors Combined</i> | | |
| Baseline except Tank, >50% full, Curve | 34.0 | 30.3% |
| Baseline except Tank, >50% full, Curve, Grade, and Dry | 78.8 | 50.1% |
| Baseline except Baseline except Tank, >50% full, Interstate, Rural, Curve, Grade, and Dry | 217.3 | 73.5% |
| Worst Case (all factors opposite of baseline, uses >50% full) | 334.6 | 81.0% |

Appendix D

Vehicle Inventory And Use Survey

This Page Intentionally Left Blank

The Bureau of Census conducts, as one of its quinquennial (every five years) economic surveys, a survey of truck owners. The survey used to be called the Truck Inventory and Use Survey, but in the most recent survey (2002), pickups, SUVs, and other light trucks were added, so it is now the Vehicle Inventory and Use Survey.

The data are collected by means of a mailed survey that is filled out by registered truck owners. Respondents are required by law to complete and return the survey. In 2002, about 98,000 surveys were completed. The VIUS is one of the few sources of detailed exposure data.

In the top half of the table are estimated counts of the number of dry bulk or liquid/gas tankers, divided into tractor-combination vehicles and straight trucks, including straight trucks with trailers. The estimated 26,057 straights with dry bulk tank cargo bodies seems unlikely. It is possible that respondents are including grain bodies and other such cargo bodies. About 19,000 (3/4ths) are coded as being used in agriculture, forestry, fishing, or hunting, so these may not be true dry bulk tankers.

**Table D - 1 Estimates of Vehicles and Miles For Tank Trucks,
2002 Vehicle Inventory and Use Survey**

| Tank Type | TS & Double | | Straights | | Total | |
|-------------------------|-------------|-------|-----------|-------|----------|-------|
| | N | % | N | % | N | % |
| Dry Bulk | 28,296 | 26.0 | 26,057 | 13.5 | 54,353 | 18.0 |
| Liquid/Gas | 80,599 | 74.0 | 166,654 | 86.5 | 247,252 | 82.0 |
| Total | 108,895 | 100.0 | 192,710 | 100.0 | 301,605 | 100.0 |
| Miles (millions) | | | | | | |
| Tank Type | TS & Double | | Straights | | Total | |
| | N | % | N | % | N | % |
| Dry Bulk | 1,855.64 | 25.0 | 191.92 | 8.2 | 2,047.56 | 21.0 |
| Liquid/Gas | 5,565.14 | 75.0 | 2,152.14 | 91.8 | 7,717.28 | 79.0 |
| Total | 7,420.78 | 100.0 | 2,344.07 | 100.0 | 9,764.84 | 100.0 |

The VIUS data includes some information on cargoes carried, but not in a way that allows tanks for gases to be differentiated from tanks for liquids. For example, the “basic chemicals” category is defined to include hydrogen, oxygen, hydrochloric acid, and chlorine. So the above estimate is the most detailed available from VIUS.

This Page Intentionally Left Blank

Appendix E

Survey Of Tank Truck Carrier Training Practices

This Page Intentionally Left Blank

**Commercial Vehicle Operator
Training Survey**

Dear Transportation Industry/Training Company Professional:

The Federal Motor Carrier Safety Administration (FMCSA) is currently working on an effort to gain a better understanding of commercial tank truck operator training programs. As a representative of your company's safety and/or training efforts, we are eager to receive your insights on the following issues. All information will remain confidential. If you are available for potential follow-up questions and/or would like a copy of the final research report, please include your contact information. Please note that all responses will be combined for the final report and your individual surveys will remain confidential.

When you have completed the questionnaire, please fax to John Brock at (202-544-4783). Surveys can also be emailed to: john.brock@gdit.com. Thank you in advance for your time and assistance!

Do you train drivers before they have a CDL? _____

What Endorsements do you train for?

HAZMAT__ Passenger__ Doubles/Triples__ Tanker__

Contact Information (optional)

Company Name: _____

Contact Name: _____

Phone Number and/or Email: _____

Your Title and Department: _____

Your Training Function: _____

Do you include air brake training? YES__ NO__

How many students did you train in: 2002 _____ 2003 _____ 2004 _____ 2005 _____ So far, in 2006 _____

Of all of these students, how many went on to drive cargo tank motor vehicles? _____

Do you have specific training segments on preventing roll overs? _____

If so, please describe them:

If you could train one thing about preventing roll overs, what would it be?

Now, tell us some specifics about your training program:

What is your primary method for training? Lectures__Films/videos__CBT__Web-based training__Textbooks__

| | |
|-------------------------------|-----------------|
| Restricted In-vehicle driving | # of hours_____ |
| Simulation | # of hours_____ |
| Demonstrations | # of hours_____ |
| On the Road driving | # of hours_____ |
| Other (please describe) | |

Do you obtain training materials from one or more vendors? YES__ NO__
If YES, please list:

| <u>VENDOR</u> | <u>MATERIALS/PRODUCTS</u> |
|---------------|---------------------------|
| _____ | _____ |
| _____ | _____ |
| _____ | _____ |
| _____ | _____ |

Please rate the effectiveness of each training method you use. Use the following scale:
1=not effective, 2=marginally effective, 3=effective, 4=very effectively, 5=most effective

| | |
|-------------------------------|-------|
| Lectures | _____ |
| Films/videos | _____ |
| CBT | _____ |
| Web-based training | _____ |
| Textbooks | _____ |
| Restricted In-vehicle driving | _____ |
| Simulation | _____ |
| Demonstrations | _____ |
| On the Road driving | _____ |

We believe that training leads to safer drivers. However, there isn't a lot of hard evidence that this is true. We would like to know if you have any records or data that show that your graduates have better safety records than drivers who have not had your training. Please share as much as you can with us.

Please fax or email completed surveys to:

John Brock
202-548-6865
john.brock@gdit.com

This Page Intentionally Left Blank

Appendix F

Assumptions For The Benefit-Cost Analysis

This Page Intentionally Left Blank

| <u>Element</u> | <u>Data</u> | <u>Source</u> |
|---|------------------------|--|
| General Assumptions | | |
| | | United States Whitehouse Office of Management and Budget (OMB), Regulatory Analysis, Circular A-4, 2003. [http://www.whitehouse.gov/omb/circulars/a004/a-4.pdf last accessed November 17, 2006] |
| Discount Rate | 0.07 | |
| Year to discount to | 2007 | Current year |
| | | Average annual change % change in the Employment Cost Index from Bureau of Labor Statistics (www.bls.gov) (2001-2005) [http://www.bls.gov/news.release/eci.toc.htm last accessed January 19, 2007] |
| Annual Wage Growth (ECI) | 0.0367 | |
| | | Average annual change in the Producer Price Index from Bureau of Labor Statistics (www.bls.gov) (2001-2005) |
| Annual average Inflation | 0.0262 | |
| Rollovers Addressed | | |
| | <i>Number Annually</i> | |
| All Rollovers -- HAZMAT Tankers | 680 | Table 2-8 |
| Tractors pulling HAZMAT tank trailers-GES | 405 | Table 2-8 |
| Tractors pulling HAZMAT tank trailers-MCMIS | 181 | Table 2-8 |
| Tanker Design (Upper) | 251 | Petroleum Tank Trailers, Section 7.2.1, including Table 7-1 |
| Tanker Design (Lower) | 112 | |

| Element | Data | | | | Source | |
|--------------------------|------------------------|-----------------|--------------------|----------------|--|-----|
| Electronic Stability Aid | | | | | | |
| | Untripped | 41 | 40.8 | | | |
| | SVRD with Untripped | 0 | | | Section 7.2.1 | |
| | SVRD with Tripped | 0 | | | | |
| | SVRD without rollover | 0 | | | | |
| | <i>Total</i> | <i>41</i> | | | | |
| | | | | | | |
| Training | | | | | Calculated using the driver age distributions [Global Insight, 2005, "U.S. Truck Driver Shortage: Analysis and Forecasts," prepared for ATA.], driver crash distributions from Table 7-22, and the total rollover number from Table 2-8. | |
| | MCMIS version | 6 | | | | |
| | GES version | 30 | | | | |
| | | | | | | |
| Efficacy Rates | | | | | | |
| Tanker Design | | | | | | |
| | Lower CG | 0.118 | | | Table 3-10 | |
| | Wider Track | 0.167 | | | | |
| | Aggressive Improvement | 0.3 | | | | |
| Electronic Stability Aid | | 0.53 | | | Section 5.4.4 | |
| Training | | 0.1 | | | Estimate based on industry interviews. | |
| | | | | | | |
| Crash Severity | | | | | | |
| | | Property damage | Non-Incapacitating | Incapacitating | Fatal | |
| | All Rollovers | 0.2939 | 0.3692 | 0.2282 | 0.1087 | GES |

| Element | Data | Source |
|--|---------------------|---|
| Cost of Crash Severity | <i>2000 dollars</i> | |
| Property damage | \$11,953 | Zaloshnja, Eduard, and Ted Miller (2002). Revised Costs of Large Truck- and Bus Involved Crashes, Final Report for Federal Motor Carrier Safety Administration. Pacific Institute for Research and Evaluation. [http://ai.volpe.dot.gov/carrierresearchresults/PDFs/Truck_Crash_Costs_2002_Final.pdf] last accessed January 15, 2007] |
| Non-Incapacitating | \$70,680 | |
| Incapacitating | \$225,507 | |
| Fatal | \$3,645,273 | |
| Cost of Spills per Crash | <i>2007 dollars</i> | |
| Clean up, Environmental Damage, and Evacuation cost of HAZMAT spills per crash | \$23,177 | Updated from--From Greenberg FMCSA Report, 3/2001, Tables 30, 33, and 38 of: "Comparative Risks of Hazardous Materials and Non-Hazardous Materials Truck Shipment Accidents/Incidents" |
| Specific to Flammable Liquids | \$27,957 | |
| Fleet Characteristics | <i>2007</i> | |
| Number of Gasoline Tank Trailers | 20,000 | Appendix G |
| Growth of Gasoline Tanker Fleet | 0.015 | Appendix G. 5 and 20 year annual average increase in gasoline deliveries in the US. From EIA [http://tonto.eia.doe.gov/dnav/pet/hist/mgfupus1m.htm] |
| Number of tractors for HAZMAT Tank Trailers | 53,450 | 2002 Vehicle Inventory and Use Survey [http://www.census.gov/svsd/www/vius/products.htm] , count of trucks with "Yes" for Hazmat and Trailer type "12" for Liquid or gaseous tanks. |
| Growth Rate for Tractors for HAZMAT Tank Trailers | 0.015 | Default set to the same rate as the gasoline tanker fleet |

| <u>Element</u> | <u>Data</u> | | <u>Source</u> |
|--|-------------|----------|---|
| Age Distribution of Trailers | Age | Fitted % | Vehicle Inventory and Use Survey [http://www.census.gov/svsd/www/vius/products.html] , model years of heavy trucks, % of fleet regressed on Age, then rescaled to add up to 100% of vehicles being 15 years or younger, and calculated implied retirement rates. See Appendix H for details. |
| | 0 | 10.06% | |
| | 1 | 9.55% | |
| | 2 | 9.04% | |
| | 3 | 8.54% | |
| | 4 | 8.03% | |
| | 5 | 7.52% | |
| | 6 | 7.01% | |
| | 7 | 6.50% | |
| | 8 | 6.00% | |
| | 9 | 5.49% | |
| | 10 | 4.98% | |
| | 11 | 4.47% | |
| | 12 | 3.96% | |
| | 13 | 3.46% | |
| | 14 | 2.95% | |
| 15 | 2.44% | | |
| Fitted Age Distribution of Tractors | Age | Fitted % | Calculated based on distribution of tractors that pull hazmat tankers from 2002 Vehicle Inventory and Use Survey [http://www.census.gov/svsd/www/vius/products.html] , count of trucks with "Yes" for Hazmat and Trailer type "12" for Liquid or gaseous tanks.--regressed % on Age them rescaled to get 100% of vehicles 10 years or younger, and calculated implied retirement rates. See Appendix H for details. |
| | 0 | 0.1357 | |
| | 1 | 0.1268 | |
| | 2 | 0.1178 | |
| | 3 | 0.1088 | |
| | 4 | 0.0999 | |
| | 5 | 0.0909 | |
| | 6 | 0.0819 | |
| | 7 | 0.0730 | |
| | 8 | 0.0640 | |
| | 9 | 0.0551 | |
| 10 | 0.0461 | | |

| <u>Element</u> | <u>Data</u> | <u>Source</u> |
|--|--------------------------|---|
| Market Penetration | | |
| Tanker Design | | |
| | Lower CG | 1 |
| | | Assumption: 100% of new HAZMAT tank trailers |
| | Wider Track | 0.5 |
| | | Assumption: only half of the destinations will be able to accommodate the wider track. |
| | Aggressive Improvement | 1 |
| | | Assumption: 100% of new HAZMAT tank trailers |
| | Electronic Stability Aid | 1 |
| | | Assumption: 100% of new HAZMAT tank trailers |
| | Training | 1 |
| | | Assumption: 100% of new HAZMAT tank trailers |
| Driver Age Distribution & Crashes | | |
| Age Distribution of Drivers | Year: 2000 | |
| | <25 | 0.034 |
| | 25-35 | 0.21 |
| | 35-45 | 0.328 |
| | 45-55 | 0.263 |
| | 55-65 | 0.139 |
| | >65 | 0.028 |
| | <i>Total</i> | <i>1.00</i> |
| | | [Global Insight, 2005, "U.S. Truck Driver Shortage: Analysis and Forecasts," prepared for ATA.] |
| Age Distribution in Crashes – MCMIS | | |
| | <25 | 0.048 |
| | 25-35 | 0.23 |
| | 35-45 | 0.33 |
| | 45-55 | 0.206 |
| | 55-65 | 0.155 |
| | >65 | 0.027 |
| | <i>Total</i> | <i>1.00</i> |
| | | Table 2-40 |

| <u>Element</u> | <u>Data</u> | <u>Source</u> |
|--|--------------|---|
| Age Distribution in Crashes - GES | | |
| | <25 | 0.0774 |
| | 25-35 | 0.2397 |
| | 35-45 | 0.3229 |
| | 45-55 | 0.2483 |
| | 55-65 | 0.0918 |
| | >65 | 0.0198 |
| | <i>Total</i> | <i>1.00</i> |
| Driver population characteristics | | |
| Driver per tractor | 1.14 | Weighted mean from MCMIS data. See Appendix J for details. |
| Replacement rate (growth plus turnover/retirement) | 0.042 | [Global Insight, 2005, "U.S. Truck Driver Shortage: Analysis and Forecasts," prepared for ATA.] |
| Growth in # of drivers | 0.022 | |
| Annual Phase In of Training | 0.2 | Assumption to acknowledge deployment of training will not be instantaneous. |
| Purchase costs | | |
| 2007 dollars | | |
| Alternative Tanker Design | | |
| Lower CG | 2000 | The costs for the lower CG and the wider track are the mid range of quotes from manufacturers who offer such products. The cost for the aggressive improvement is the estimate from a manufacturer who considered designing such a product. |
| Wider Track | 500 | |
| Aggressive Improvement | 12,000 | |
| Electronic Stability Control | 619 | Quote for the option from a tractor dealer. |
| Training Equipment | | |
| Simulator Cost | 300,000 | Quote from a vendor |
| simulator runs per year | 512 | 2 sessions per machine per day * 5 days per week * 52 weeks minus 8 holidays |

| <u>Element</u> | <u>Data</u> | <u>Source</u> |
|--|----------------------|---|
| Recurrent Costs | | |
| Electronic Stability Control | | Failure rate from Battelle, 2003. |
| Annual Parts Failure Rate | 0.0019 | |
| Training | | |
| Annual Cost of PC plus software | 2000 | estimate |
| PC runs per year | 252 | 1 session per machine per day * 5 days per week*52 weeks minus 8 holidays |
| Annual Maintenance Contract on Simulator | 6000 | Quote from a vendor |
| Warranty time in years | 1 | |
| Electronic Stability Control - Training | | |
| hourly | \$19.32 2005 dollars | From the US Dept of Labor's Occupational Employment and Wages Series, for job category 53-3032, "Truck Drivers, Heavy and Tractor-Trailer." |
| fringe benefits | 31.0% | Fringe benefit rate supplied by FMCSA in support of Battelle, 2003. |
| Hours | 1 | From Battelle, 2003. |
| Drivers per tractor | 1.1 | Developed with MCMIS data. See Appendix J for details. |
| Student Driver Wage | \$12.98 2005 dollars | 25th percentile of US Dept of Labor's Occupational Employment and Wages Series, for job category 53-3032, "Truck Drivers, Heavy and Tractor-Trailer." |
| Experienced Driver Wage | \$20.55 2005 dollars | 75th percentile of US Dept of Labor's Occupational Employment and Wages Series, for job category 53-3032, "Truck Drivers, Heavy and Tractor-Trailer." |

| <u>Element</u> | <u>Data</u> | <u>Source</u> |
|---|-------------|---|
| Status Quo Training Hours per student | | |
| Hours of 15 to 1 training | 40 | estimate of current practice |
| Hours of 1 to 1 training | 16 | |
| Alternative Training Hours per student | | |
| Hours of 15 to 1 training | 24 | estimate based on a carrier's experience with simulators |
| Hours of 1 to 1 training | 12 | |
| Hours of technology assisted training | 6 | |
| Hours of simulator training | 3 | |
| Annualizing Costs | | |
| Relevant financing rate | | |
| 10 year interest rate bond yield (A through AA) | 0.055 | Yahoo Bond Center [http://finance.yahoo.com/bonds/composite_bond_rates] provided courtesy of Valubond. |
| 15 year bond yield (A through AA) | 0.057 | |
| 20 year bond yield (A through AA) | 0.059 | |
| Economic Life of Equipment Years | | |
| Vehicle Designs | 15 | life of a HM cargo tank semitrailer |
| Electronic Stability Control | 10 | life of a tractor in the HM cargo tank industry |
| Training Simulators | 30 | estimate |

Appendix G

Population Of Petroleum-Hauling Semitrailers

This Page Intentionally Left Blank

In 2003, the National Tank Truck Carriers surveyed its membership and counted 10,648 petroleum-hauling semitrailers². As their report noted, not all operators of such tankers are members of the organization, so this is a lower bound of the populations. One of the highest estimates in the same docket, 60,000³ would provide a possible upper bound, though several contributors noted that a portion of the counted vehicles were not carrying petroleum but may have been subject to the rule then pending. There is no precise number for the number of semitrailers currently in service delivering petroleum, but all of the numbers proposed were within the same order of magnitude and in fact within a reasonable range. For the purpose of the present study, the number was taken to be 20,000.

For the economic analysis, the growth in the population of these vehicles will be assumed to be equal to a projection of the recent growth rate in petroleum products supplied, as reported by the Energy Information Administration.

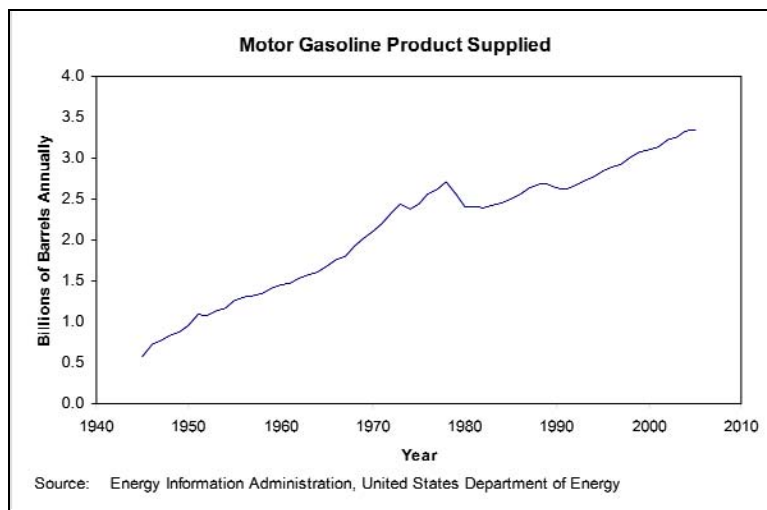

² Thomas P. Lynch, Vice President and General Counsel, National Tank Truck Carriers, Inc. June 10, 2003. Document RSPA-1999-6223-16. <http://dms.dot.gov/search/document.cfm?documentid=245685&docketid=6223>

³ Cindy Gordon, Senior Associate, American Petroleum Institute. June 10, 2003. Document RSPA-1999-6223-22. <http://dms.dot.gov/search/document.cfm?documentid=246150&docketid=6223>

| Year | Motor Gasoline Product Supplied, Billions of Barrels Annually |
|-------------|--|
| 1996 | 2.89 |
| 1997 | 2.93 |
| 1998 | 3.01 |
| 1999 | 3.08 |
| 2000 | 3.10 |
| 2001 | 3.14 |
| 2002 | 3.23 |
| 2003 | 3.26 |
| 2004 | 3.33 |
| 2005 | 3.34 |

<http://tonto.eia.doe.gov/dnav/pet/hist/mgfupus1A.htm>

Appendix H

Historical Profiles For Tractor And Trailer Fleets

This Page Intentionally Left Blank

Phasing in of new tractors and trailers for both benefits (how much of the fleet is covered by the new efficacy rate) and costs (how many vehicles should annualized purchase costs and other costs be applied for) requires understanding the age of the existing fleet which implies something about how vehicles are rotated out of the fleet. The richest data source for this type of information is the Census Vehicle Inventory and Use Survey (VIUS). This data serves as the basis for an approach to profiling the fleet that was applied to the vehicle designs trailers and the electronic stability control tractors.

While the tractors that pull HAZMAT tank trailers can be specifically identified in the VIUS, the trailers themselves are not categorically represented. However, some basis was required to profile the fleet, so the assumption was made that the age distribution for all heavy trucks would not be significantly different from the age distribution of trailers. Using the model year (not to be confused with the purchase year) variable in the VIUS, a distribution of the age of all heavy trucks was constructed for 2002, which is presented in Figure H-1.

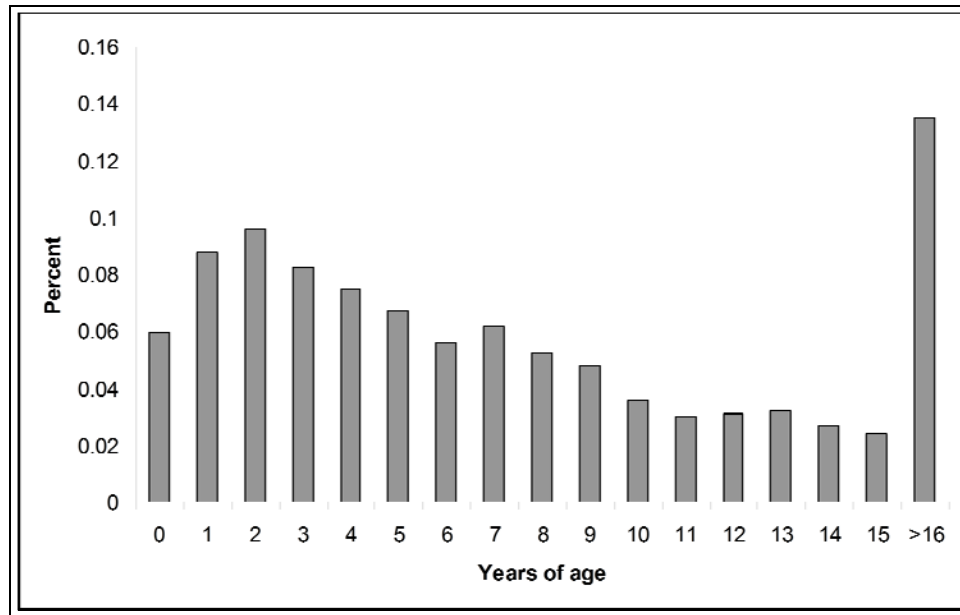

Figure H - 1 Percent of Trucks by Age

The distribution shows a clear decline across age, with bumps attributable to random variation and ups and downs in the industry (carriers by more trucks when times are good). These bumps are irrelevant to this analysis as we are not forecasting business cycles for the industry to incorporate into the analysis. Under this distribution, about 87 percent of vehicles are 15 years old or less. Because we expect that the gasoline hauling tank trailers will be among the newer vehicles on the road, the assumption was made to disregard the tail of the distribution that is in excess of 15 years of age.

In order to smooth out the bumps in the distribution, the percent of vehicles of each year of age up to and including 15 years was regressed on the age. The R-squared for this regression was 0.82. The results are represented in Figure H-2.

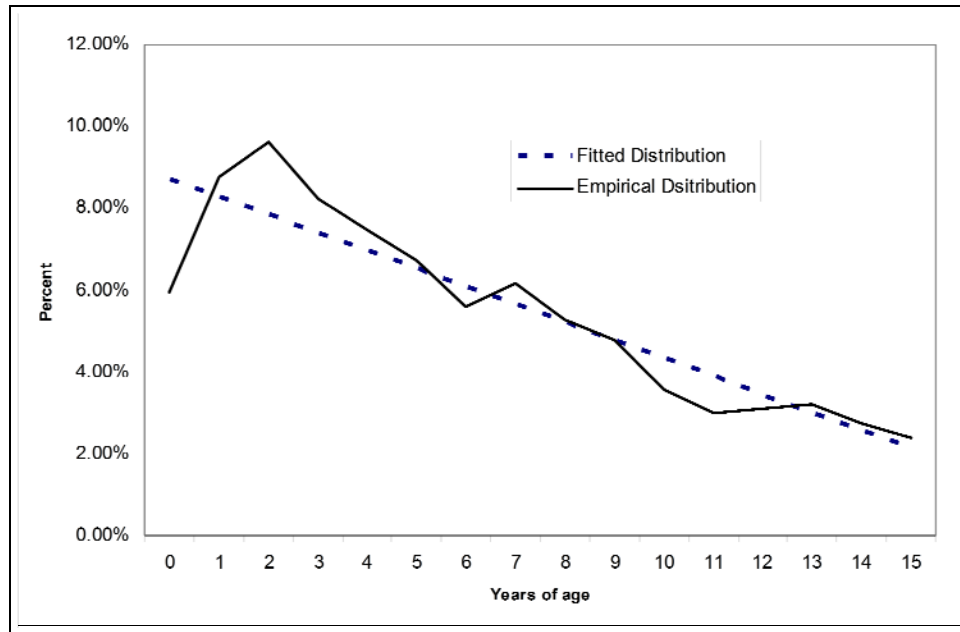

Figure H - 2 Percent of Trucks by Age, Fitted and Actual

The fitted distribution was proportionally rescaled to reflect 100 percent (since the underlying data only summed to 87 percent) and applied to the base number of gasoline hailing tank trailers (described in Appendix G) to form the fleet profile. The year by year retirement rates implied by the fitted distribution were then applied to move the fleet across time for the analysis, with new vehicles of age zero being introduced to make up for both those lost to retirement and growth in the fleet. At the fifteenth year of age the remaining vehicles, which are a relatively small fraction of what they originally 15 years previous in year zero, are all retired for the next period.

The fleet profile was developed and applied in the same way for the tractors that pull HAZMAT tank trailers. However, the HAZMAT status variable and the type of cargo pulled variable in the VIUS allowed for identification of the specific type of vehicle (unlike the generalization required for the gasoline tank trailers). Figure H-3 presents the actual distribution of the ages of these truck tractors.

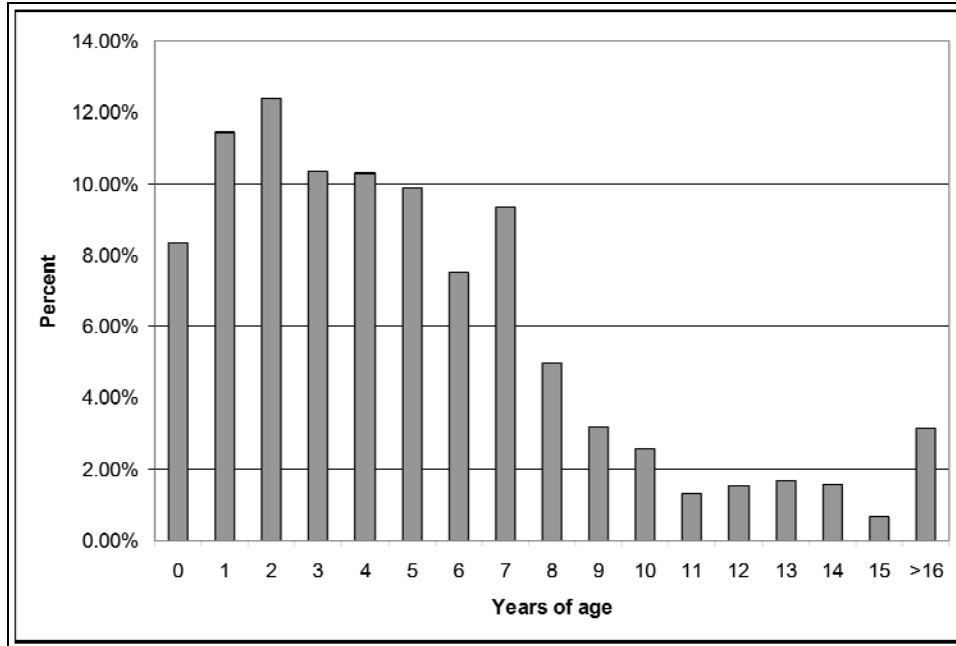

Figure H - 3 Percent of Tractors Pulling Tankers HAZMAT by Age

Here, 90 percent of the trucks are ten years or younger, which is the assumed economic life of these trucks for this analysis. Even though the distribution is cut off for 10 years of age, the aggregate number of trucks in this category is maintained at the observed level (with the remaining vehicles being implicitly reallocated proportionately across the other years when the total number of vehicles is applied to the new distribution). The same types of bumps are present as for the general trucks data, requiring the same regression procedure to smooth the distribution to build the fleet profile. Following are the results of the regression in Figure H-4.

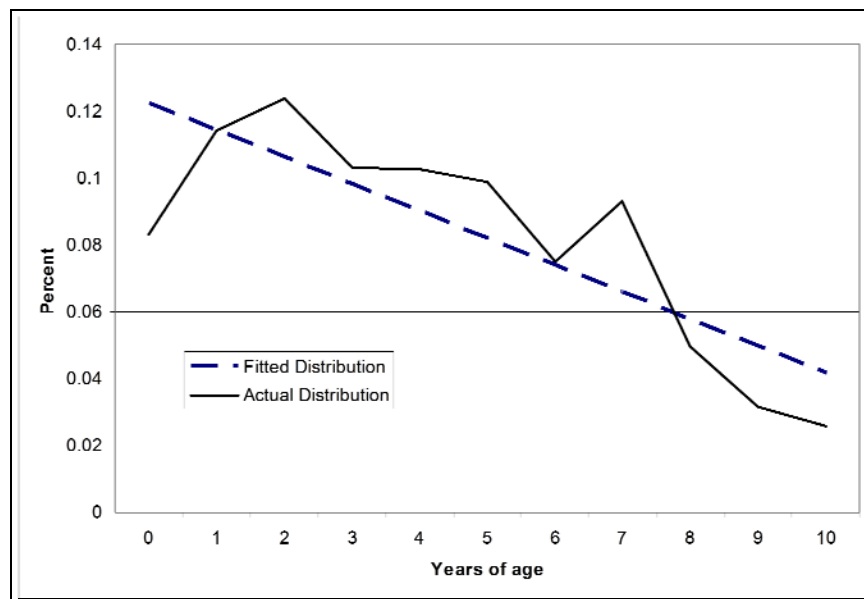

Figure H - 4 Percent of Tractors Pulling Tankers HAZMAT by Age, Fitted and Actual

This data could be considered to be significantly “bumpier,” producing an R-squared statistic of 0.66. This fitted distribution was rescaled and applied to the tractors for the electronic stability control in the same way that the general truck distribution was used for the vehicle designs.

This VIUS data were also the source for the total number of trucks for the electronic stability control approach (53,450). The VIUS data were collected for 2002. This requires that the 2002 number of trucks be adjusted to 2007 (the common year for all base data) according to the same fleet growth factor (based on the growth in gasoline deliveries, 0.015 percent) used for growth in the fleet across time for both the vehicle design and the electronic stability control. This produces a base of 57,581 relevant trucks for 2007.

Appendix J

Number of Drivers for Hazmat-Carrying Cargo Tanks

This Page Intentionally Left Blank

Calculating costs of the training approach requires knowing approximately how many drivers there are of tractors that pull HAZMAT cargo tank trailers. Because the VIUS (see Appendix H) identifies the relevant number of truck tractors, one approach for determining the number of drivers is to determine the number of drivers per truck.

The MCMIS Census data were queried for HAZMAT carriers. Specifically, the query selected carriers with the HM designation and business in either LIQGAS, OILFIELD, or CHEM.

The query was further limited to those that had at least one owned leased regular or HM trailer. The ratio of drivers to power units was figured for each carrier, and the distribution was plotted as Figure J-1. “Large” carriers are those with more than 10 power units.

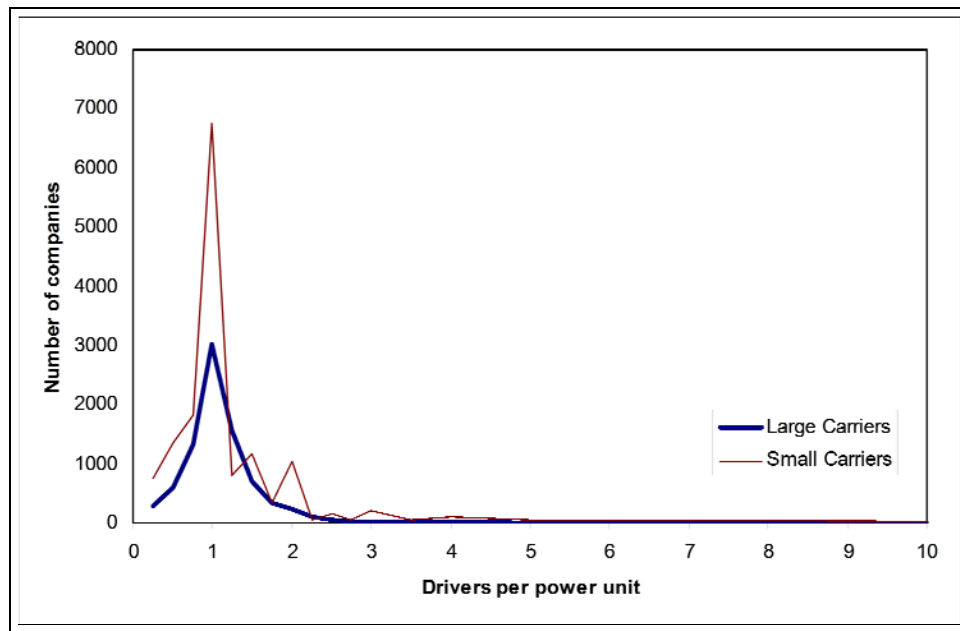

Figure J - 1 Drivers per Power Unit

The data clearly shows that the most common policy is for carriers to have one driver per power unit. Rather than relying just on the apparent mode, the mean was calculated—it came to 1.1 drivers per power unit, which is the number that was used in the analysis. This mean is not weighted by the number of drivers at each carrier—but because the distribution across the larger and smaller carriers is so similar, carrier size is not thought to affect the analysis. Applying the 1.1 drivers per tractor to the relevant 57,581 tractors produces 63,339 drivers for 2007.

The industry representatives interviewed for this project consistently reported the ratio of drivers to power units as higher than 1.1, with 2.5 being a common response. Using a number as high as 2.5 drivers per tractor does not change the relative results of the benefit cost ratios, though it does increase cost slightly for the electronic stability control because it has a small, limited training element. It also increases both cost savings from labor and the cost of required simulators for the training approach.

Appendix K Wyoming Highway Plan

This Page Intentionally Left Blank

STATE OF WYOMING
 WYOMING DEPARTMENT OF TRANSPORTATION
 PLAN AND PROFILE OF PROPOSED
 STATE HIGHWAY
 LARAMIE - CHEYENNE
 TELEPHONE CANYON SECTION
 ALBANY COUNTY

| DATE | BY | REVISION |
|----------|-------------|----------|
| 12-15-58 | W. J. BROWN | 1 |
| 1-10-59 | W. J. BROWN | 2 |
| 3-10-59 | W. J. BROWN | 3 |
| 4-10-59 | W. J. BROWN | 4 |
| 5-10-59 | W. J. BROWN | 5 |
| 6-10-59 | W. J. BROWN | 6 |
| 7-10-59 | W. J. BROWN | 7 |
| 8-10-59 | W. J. BROWN | 8 |
| 9-10-59 | W. J. BROWN | 9 |
| 10-10-59 | W. J. BROWN | 10 |
| 11-10-59 | W. J. BROWN | 11 |
| 12-10-59 | W. J. BROWN | 12 |

CONTRACTOR
 WYOMING DEPARTMENT OF TRANSPORTATION
 144 WEST 10TH ST.
 CHEYENNE, WYOMING 82001
 PROJECT NO. 80-2039
 DRAWING NO. 2039-10



| APPROVED | DATE | BY |
|---------------------|---------|-------------|
| PROJECT DEVELOPMENT | 10-1-59 | W. J. BROWN |
| BRIDGE | 10-1-59 | W. J. BROWN |
| TRAFFIC | 10-1-59 | W. J. BROWN |
| LABORATORY | 10-1-59 | W. J. BROWN |

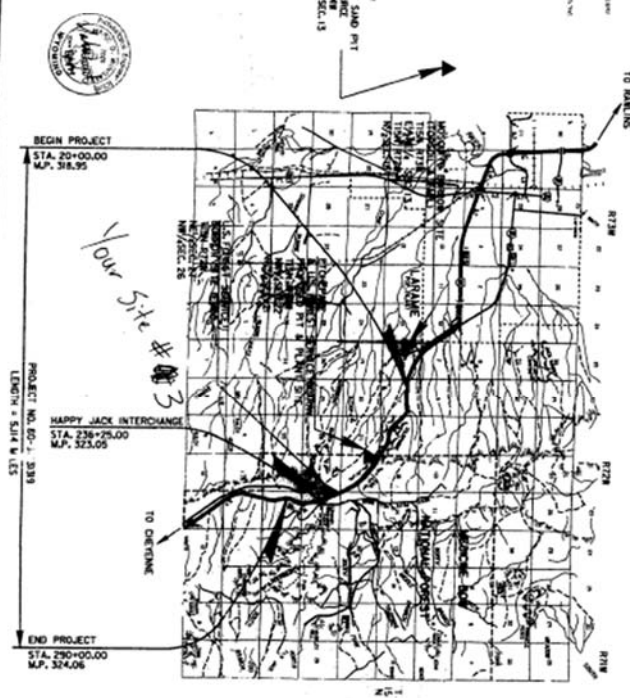

LEGEND
 1. PROPOSED HIGHWAY
 2. EXISTING HIGHWAY
 3. EXISTING RAILROAD
 4. EXISTING CANAL
 5. EXISTING DITCH
 6. EXISTING FENCE
 7. EXISTING POWER LINE
 8. EXISTING TELEPHONE LINE
 9. EXISTING WATER TOWER
 10. EXISTING WINDMILL
 11. EXISTING BUILDING
 12. EXISTING ROAD
 13. EXISTING BRIDGE
 14. EXISTING INTERCHANGE
 15. EXISTING TOWER
 16. EXISTING SIGN
 17. EXISTING LIGHT
 18. EXISTING FENCE
 19. EXISTING DITCH
 20. EXISTING CANAL
 21. EXISTING RAILROAD
 22. EXISTING HIGHWAY

APPROVED: _____ DATE: 3-10-59
 WYOMING DEPARTMENT OF TRANSPORTATION
 CHEYENNE, WYOMING

DESIGNED BY: DONALD S. SQUAD

