

Ageing procedures for big skate (*Raja binoculata*), longnose skate (*Raja rhina*), Alaska skate (*Bathyraja parmifera*), Aleutian skate (*Bathyraja aleutica*) and Bering skate (*Bathyraja interrupta*) at the Alaska Fisheries Science Center

Christopher M. Gburski
Age and Growth Program
Alaska Fisheries Science Center
7600 Sand Point Way NE
Seattle, WA 98115

Introduction

Raja and *Bathyraja* skates are found from shallow inshore waters to deep benthic habitats (Eschmeyer et al., 1983). The big and longnose skates (*R. binoculata* and *R. rhina*) (Figs. 1 and 2) range from Alaska to Baja California. In Alaska, they are found in depths from 50 to 150 m. *Bathyraja* species (i.e., Alaska (*B. parmifera*), Aleutian (*B. aleutica*) and Bering skates (*B. interrupta*) - Figs. 3, 4 and 5) range from Southeast Alaska through the Aleutian Islands and on the Bering Sea slope in depths 50 m to deep benthic areas > 600 m (Stevenson, 2004). Historically, big and longnose skates have been fished off of California since 1916 (Martin and Zorzi, 1993), and only recently in Alaskan waters. A directed fishery for big and longnose skates developed in the Gulf of Alaska (GOA) in 2003 (Gaichas et al., 2003). Due to concerns over increased fishing of sharks, rays, and skates worldwide, an understanding of the age, reproduction, fecundity and overall natural history of elasmobranchs is necessary for their conservation and management. Holden (1974) concluded that elasmobranchs have life histories which would make them susceptible to over fishing with “slow growth rates and low rates of reproduction” and “elasmobranch stocks offer very limited opportunities for long-term exploitation.” In Alaska, it is thought by some that skates may be an “underutilized” resource and that the fishery could expand in the future as in the creation of the Kodiak fishery in 2003.

Life History

Little is known of the early life history characteristics of *Raja* and *Bathyraja* skates in the GOA. *Raja* skates may have more than 1 embryo per egg case (Eschmeyer et al., 1983).

Ongoing studies involving age determination and reproduction could help resolve many of these unknowns.

The big skate is the largest skate found in the northeast Pacific Ocean. Although the big skate can attain total lengths (TL) over 1.8 m with a maximum size of 2.4 m (Eschmeyer et al., 1983), these specimens are rare. However, specimens over 2.0 m were observed in the 2004 Kodiak directed skate fishery. The longnose skate is smaller with observed lengths of 1.6 to 1.7 m. *Bathyraja* species from the GOA range from 84 cm to 1.5 m (Gaichas et al., 2003). Dulvy et al. (2000) concluded from historic catch records that late maturing large skates are especially vulnerable to fisheries exploitation and have a much greater probability of extinction compared with smaller skates.

Age information from GOA skates is limited. A study by Zeiner and Wolf (1993) of big skates collected from Monterey Bay, California, showed that males matured at 1 m to 1.1 m. (fully mature at 10 – 11 yr of age) and females mature at greater than 1.3 m (12 yr of age). Male longnose skates mature at 60 to 70 cm (7 yr of age) and females were mature at 1.0 m at an estimated age of 10 – 12 yr.

In our samples, the maximum age for big skate was 13 yr at a TL of 1.43 m. Longnose skate had a maximum age of 15 yr at 1.14 m. For the *Bathyraja* species the maximum age was 14 yr for the Aleutian skate at 1.47 m, whereas, the Bering skate had a maximum age of 19 yr at 71 cm. All of these ages were from vertebral thin sections. Generally older ages were obtained from thin sections than whole vertebra within the same specimen.

Ageing History

The AFSC's Age and Growth Program began ageing *Raja* and *Bathyraja* species in 2003, principally due to the start of the 2003 Kodiak Island skate fishery in the GOA. Samples were made available by Michael Ruccio of Alaska Department of Fish and Game (ADF&G) and Sarah Gaichas of Alaska Fisheries Science Center (AFSC). It was assumed that a general understanding of skate life history including fish age would assist fishery biologists in stock management. Vertebrae were chosen as a promising ageing structure due to growth zones deposited in vertebral centra (Calliet, 1983). Elasmobranchs do not have ageable otoliths due to insufficient calcification. Other structures have been used for ageing including caudal thorns (Gallagher and Nolan, 1999).

Vertebra Sampling

Thoracic vertebrae were chosen for ageing purposes due to their larger size compared with caudal vertebrae. Potentially, growth bands could be lacking in smaller vertebrae (Calliet et al., 1983). This has been shown in our studies as well. Consistent sampling is necessary for each species and generally 8 or more thoracic vertebrae are excised from the vertebral column. This allows extra samples for experimentation.

Vertebra Cleaning Techniques

After vertebrae have been removed from the vertebral column, they are cleaned depending upon the intended preparation technique. Whole vertebrae to be thin sectioned do not require extensive cleaning beyond their initial preparation: excision from the vertebral column. A scalpel is used to remove the neural and haemal arches from the vertebrae. In doing so, most of the tissue is removed. Tissue between the vertebrae and on the centrum's surface (fascia) is removed when ageing whole vertebrae.

Dermestid Beetle Colony

Dermestid larvae are used to remove excess tissue from whole vertebrae prior to ageing. This technique is useful for ageing whole vertebrae. Vertebrae are placed in trays with their accompanying metal sample tag. A metal tag is required due to the possibility of the larvae eating paper sample tags. Depending upon ambient temperature, vertebrae require 2 to 4 days before all tissue has been removed by the larvae. After removal from the trays the vertebrae and reading surface (centrum) are cleaned with a brush to remove dried particles.

Bleach (6% hypochlorite)

Bleach is effective in removing tissue from vertebrae prior to ageing. However, care needs to be taken. Soaking time should be kept to a minimum due to the decalcification properties of bleach on cartilage. Soak time (3 – 15 minutes) depends upon the size of the vertebrae and amount of attached tissue. Minimal processing with this method is optimal, mainly to remove the fascia on the centrum.

Manual Removal

Vertebral tissue is removed by hand with a scalpel and forceps. Fascia on the centrum is the most difficult to remove and care has to be taken not to scratch or compromise the ageing surface particularly if vertebrae are aged whole.

Vertebra Processing

Thin Sectioning Whole Vertebrae

Whole vertebrae are mounted on a Dennison™ marking tag with a polyester resin (e.g. Artificial Water™). A cross is drawn in the middle of the marking tag to assist in aligning the vertebrae for cutting. Whole vertebrae are submerged in resin and then placed on the marking tag centrum side down with the blade aligned to cut between the neural arches. The resin is allowed to cure (dry) for approximately 8 hours. After curing, the vertebra is ready to section.

Mounted whole vertebrae on the marking tags are inserted into a block on a Buehler Isomet™ low speed saw, ready for thin sectioning (Figs. 6 and 7).

Vertebrae are cut on the sagittal (i.e., longitudinal) axis (Fig. 8). Transverse (i.e., latitudinal) sectioning may cause an underestimation of age particularly in older animals. Condensed growth bands at the outer edge of vertebrae may be misinterpreted (Calliet, 2004).

Two blades (Norton™ 4" blade) are used and thin sections are cut at a speed setting of 7 on the low speed saw. Plastic spacers are used in-between the blades resulting in a thin section thickness of approximately 0.50 mm (Fig. 9). After cutting, the thin section is mounted for ageing.

Mounting Vertebral Thin Sections

Thin sections are mounted on microscope slides with Flo-Texx™ (a liquid cover slip). A small drop of Flo-Texx is placed on the middle of the slide. Next, the thin section is placed on the Flo-Texx and pushed down for adhesion. Curing time is approximately 8 hours and the prepared samples are placed under a chemical fume hood to dry. After curing, the samples are ready for sanding and polishing.

Loctite 349™, an ultraviolet light cured adhesive, is an alternative to using Flo-Texx to mount vertebral thin sections. Curing time is drastically reduced from 8 hours using Flo-Texx to 40 minutes with Loctite 349, reducing the preparation time. Initial trials with this mounting medium have been successful.

Sanding/Polishing Vertebral Thin Sections

After curing, the mounted thin sections are ready for sanding and polishing using a Buehler Ecomet™ table sander (Fig. 10). First, a coarse sandpaper (600 or 800 grit) is used on the mounted thin sections. The slide is held by a suction cup and pressure is applied in a circular motion for a few seconds of sanding. Final thin section thickness should be approximately 0.35

mm after starting with a thickness of 0.50 mm. Polishing is the final step with 1200 grit sandpaper. Mounted thin sections can be viewed under a microscope to determine the appropriate thickness for readability. We are currently experimenting with histopathology stains including alizarin red and crystal violet to enhance growth patterns after sanding and polishing (Fig. 11).

Current Ageing Methods

Whole Vertebra Ageing

Whole vertebrae can be aged depending upon their clarity, with big and longnose skates being the clearest (Fig. 12). A clean centrum is necessary to assist in ageing and ethanol can be applied to remove any residue after being cleaned by the dermestid larvae. Whole vertebrae are aged with a dissecting microscope using reflected light against a dark background. Application of mineral or cedar oil to the centrum surface enhances the readability. Concentric annuli are counted starting at the center or nucleus and then aged out to the edge. Edge type is estimated similarly to otoliths and interpretation can be difficult with whole vertebrae.

Vertebral Thin Section Ageing

After sanding and polishing, mounted thin sections are ready to age. Again, thin sections are viewed with a dissecting microscope using reflected light against a dark background. Mineral or cedar oil can be applied to the thin section to clarify the annuli. Opaque and translucent bands are followed across from the corpus calcareum arm through the intermedialia to the corpus calcareum on the opposite side (Fig. 13). Generally, checks (anomalous growth) will not follow this horizontal pattern across from corpus calcareum to corpus calcareum, therefore these checks can be identified. Brander and Palmer (1985) imply that seasonal changes including environmental conditions, migrations, spawning, etc. can affect growth. Inconsistencies or checks may be due to these seasonal changes with some occurring randomly. Wide opaque bands are

areas of greater growth during the summer and translucent bands are narrow with less growth during the winter.

These seasonal growth patterns vary between skates that inhabit shallow versus deep water. This can affect the growth band spacing and overall growth patterns.

Differences in Age Determination between Raja and Bathyraja Species

Differences exist between the growth of *Raja* and *Bathyraja* species. We observed wider banding patterns in *Raja* skates compared with *Bathyraja* skates (Figs. 14 and 15). This is most noticeable while comparing the thin sections. *Bathyraja* skates have been observed to have more condensed annuli than *Raja* skates. It is thought that deeper water elasmobranchs may have less calcium in their cartilaginous structures possibly due to a more nutrient-poor environment (Calliet, 1990). This may affect growth and make interpretation of annuli more difficult in *Bathyraja* skates.

First Year Determination for Vertebral Thin Sections

The first year is determined by looking for a constriction in the annulus or angle change in the corpus calcareum (Fig. 16). This constriction at age zero indicates when the skate embryo emerged from the egg case and the next strong translucent band would be the first year (Smith, 2004). In some cases, the embryo has been growing for up to 12 months before hatching at time of birth. Early year determination can be difficult due to the degree of faintness of some annuli.

Centrum Edge Type

Temporal periodicity in edge growth can be evaluated for both whole vertebrae and thin sections. A January 1st birth date is assumed and some growth beyond the last annulus (i.e., hyaline zone) is expected especially if samples are collected in the summer. Similar to edge type evaluation for teleost otoliths, vertebral thin sections are evaluated for edge type growth. This validates that the presumed annuli are forming on an annual basis.

Edge Type Designation:

0 = strong annulus on edge

1 = strong annulus with halenation (slight halo of growth)

2 = strong annulus with approx. 1/4 year growth

3 = strong annulus with approx. 1/2 year growth

4 = strong annulus with a full year growth

5 = full year growth with annulus beginning to form



Fig. 1. Big Skate (*Raja binoculata*)-Adult



Fig. 2. Longnose Skate (*Raja rhina*)-Adult



Fig. 3. Alaska Skate (*Bathyraja parmifera*)-Adult

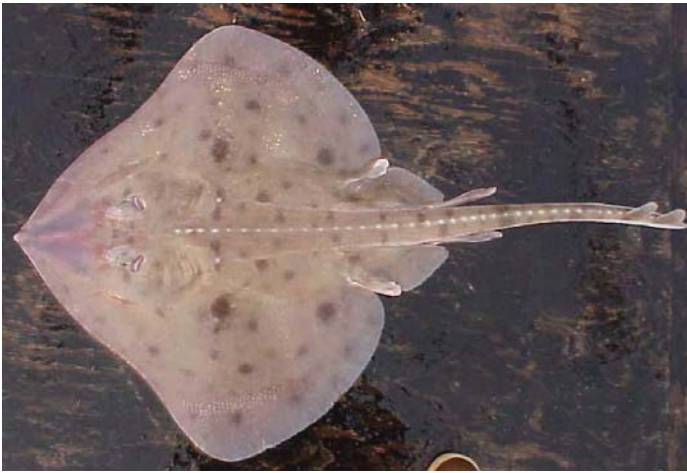

Fig. 4. Aleutian Skate (*Bathyraja aleutica*)-Adult



Fig. 5. Bering Skate (*Bathyraja interrupta*)-Juvenile

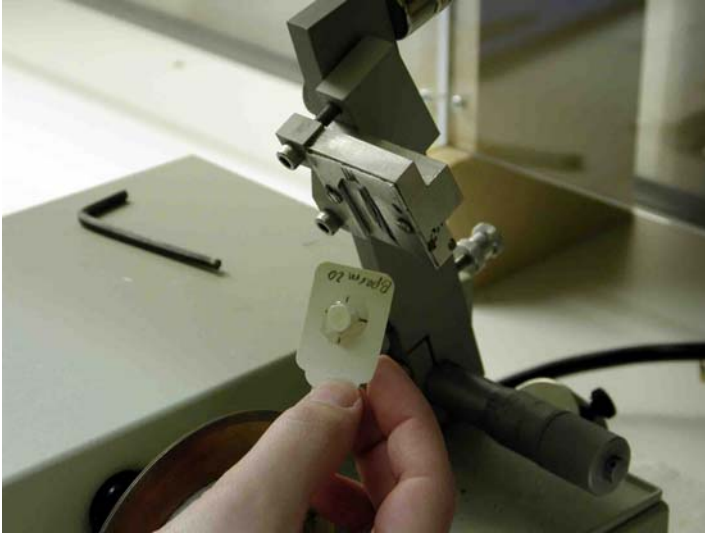

Fig. 6. Mounted whole vertebrae is placed in the block for thin sectioning on the Isomet low speed saw.

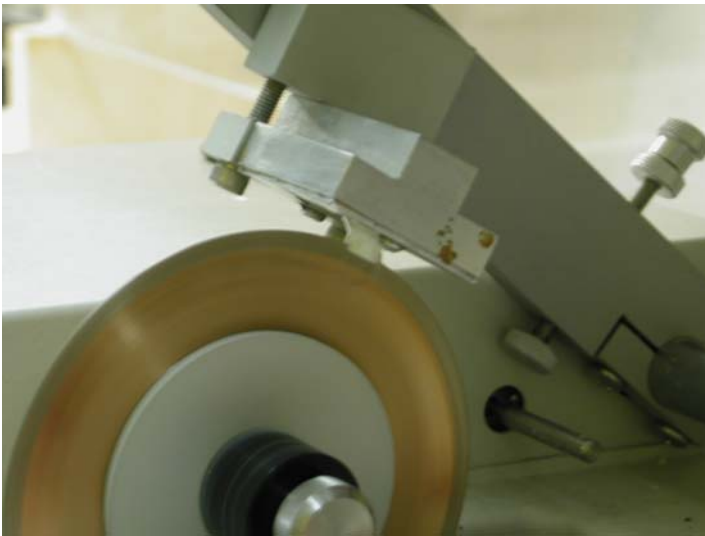

Fig. 7. Thin section being cut from whole vertebrae with two blades and spacers.

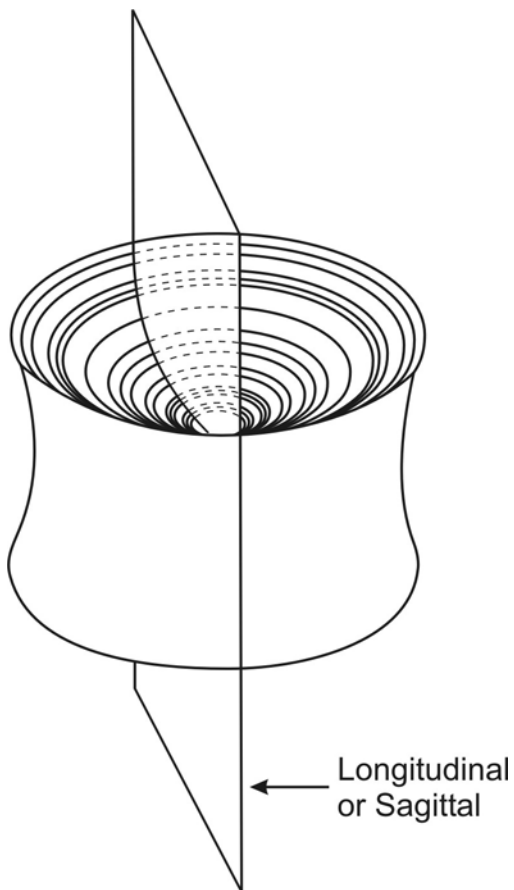

Fig. 8. Sagittal (i.e., longitudinal) location of thin section. Illustration adapted by Wendy Carlson (AFSC Graphics Unit) from G.M. Calliet and K.J. Goldman, 2004, Age determination and validation in chondrichthyan fishes, *Biology of sharks and their relatives*. 596 p.

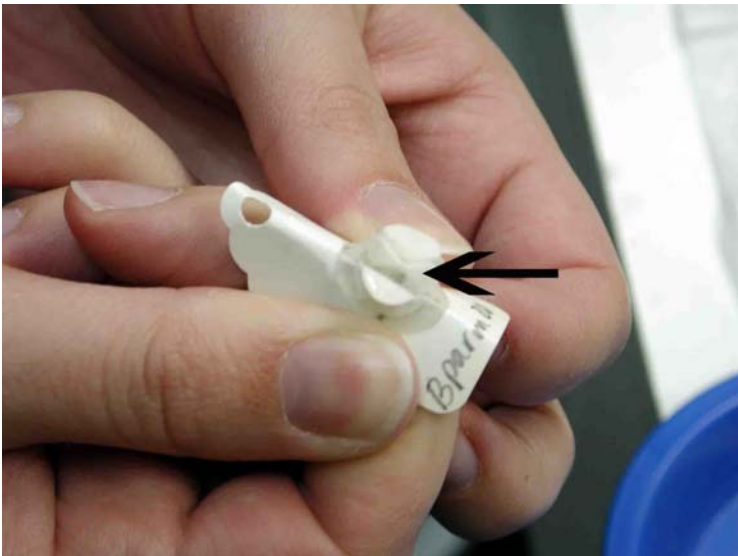

Fig. 9. Sagittal thin section cut and ready for removal.



Fig. 10. Buehler Ecomet table sander for sanding and polishing mounted thin sections.

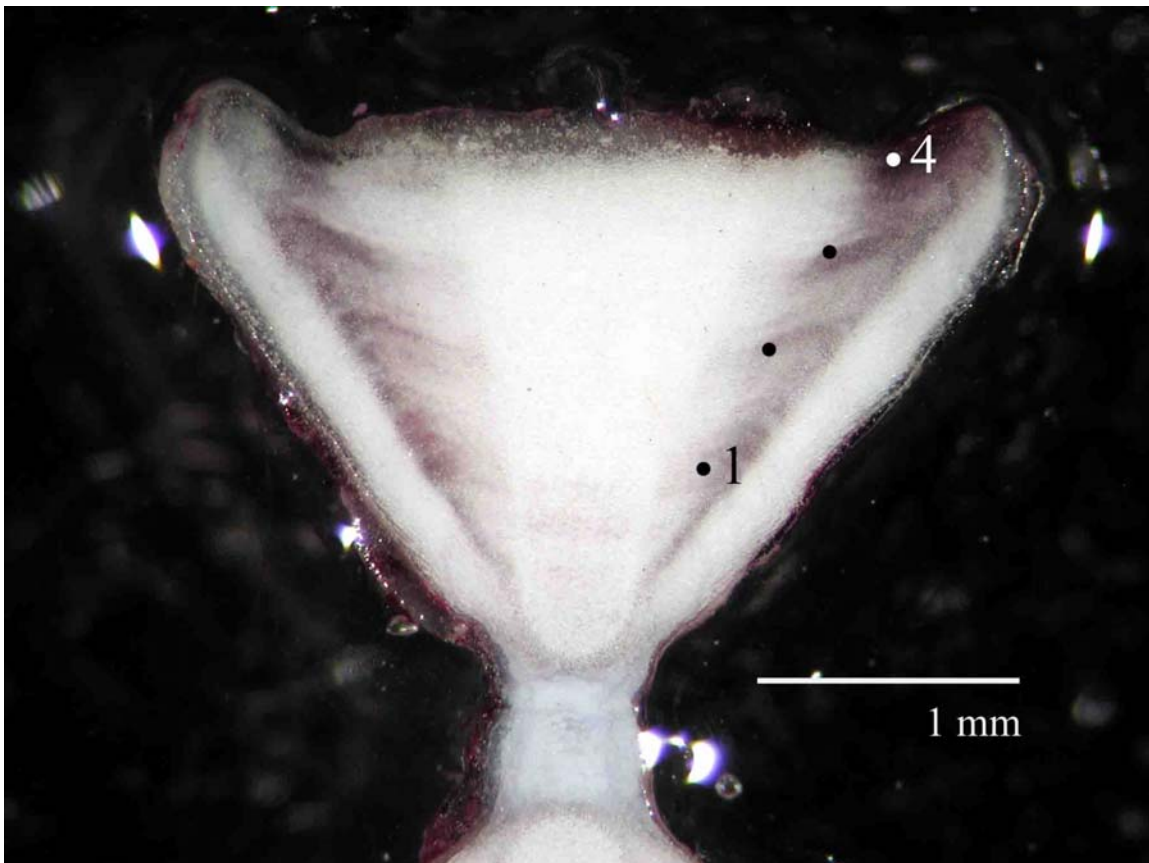

Fig. 11. Mounted vertebral thin section from an Alaska skate stained with alizarin red (age - 4 yr).

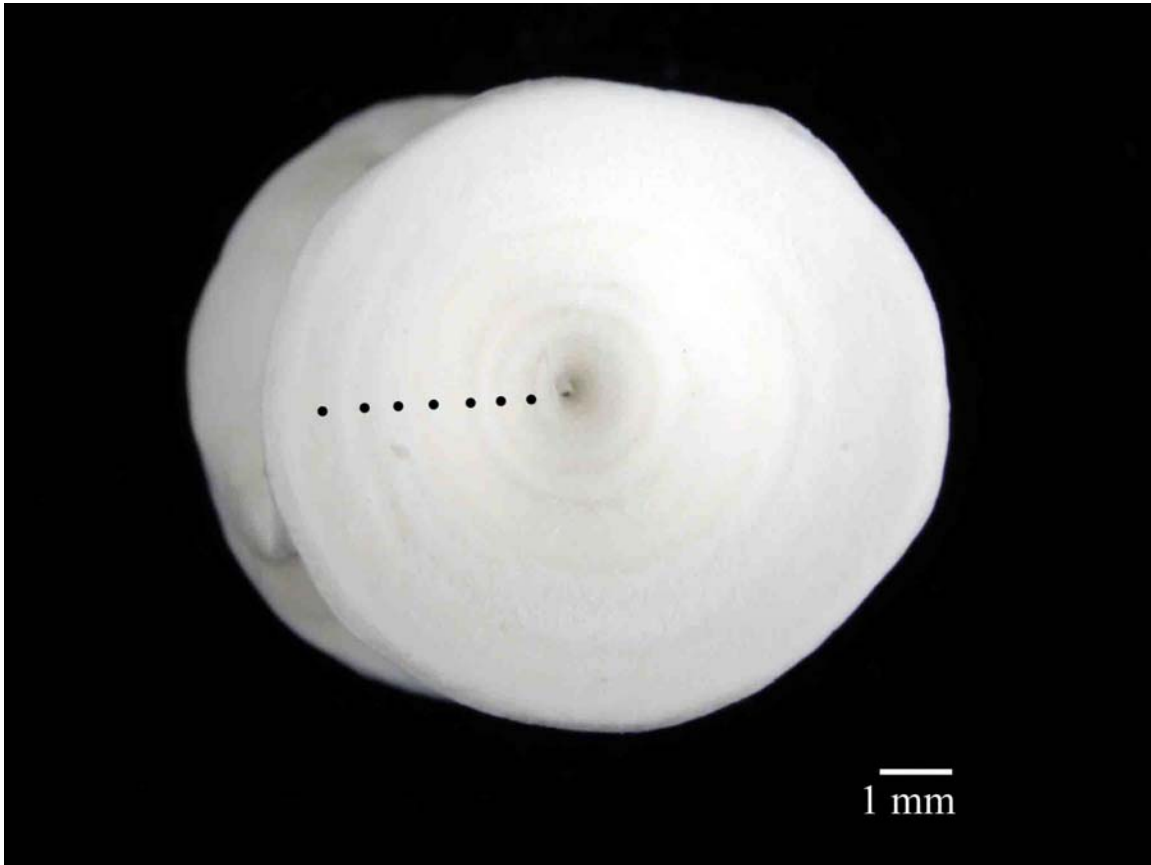

Fig. 12. Big skate whole vertebrae, processed by bleaching, which appears to be age 7 - 8 yr. The edge is difficult to distinguish (reflected light).

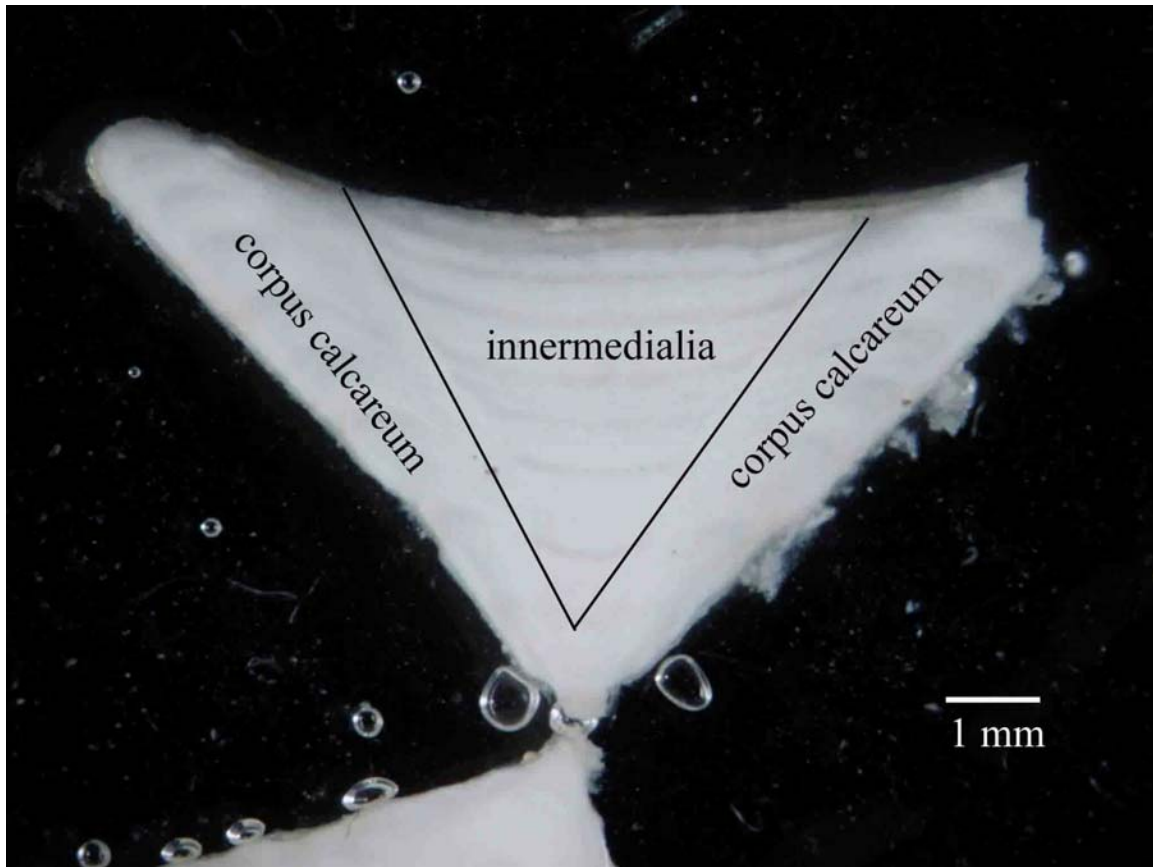

Fig. 13. Big skate vertebral thin section showing location of corpus calcareum and innermedialia (age – 9 yr).

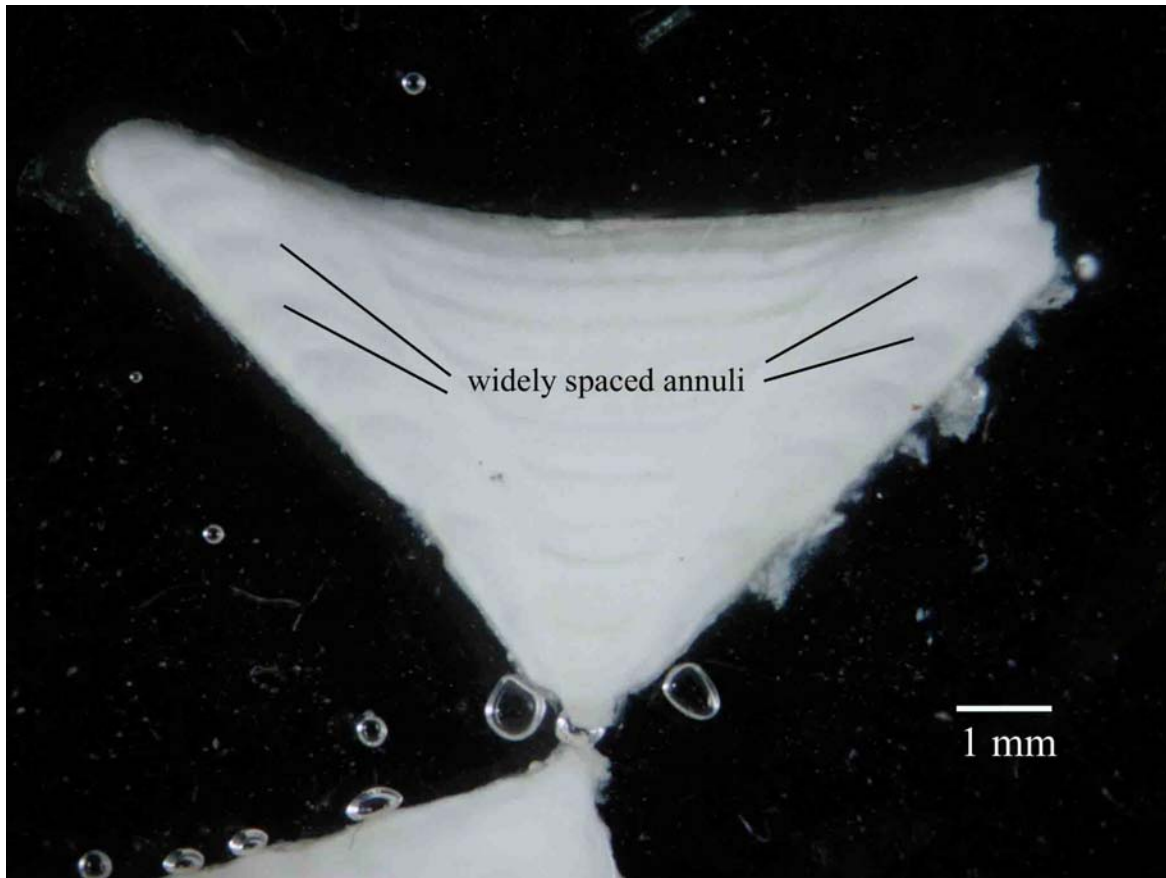

Fig. 14. *Raja* sp.- Big skate with widely spaced annuli evident in the corpus calcareum (age 9 – yr).

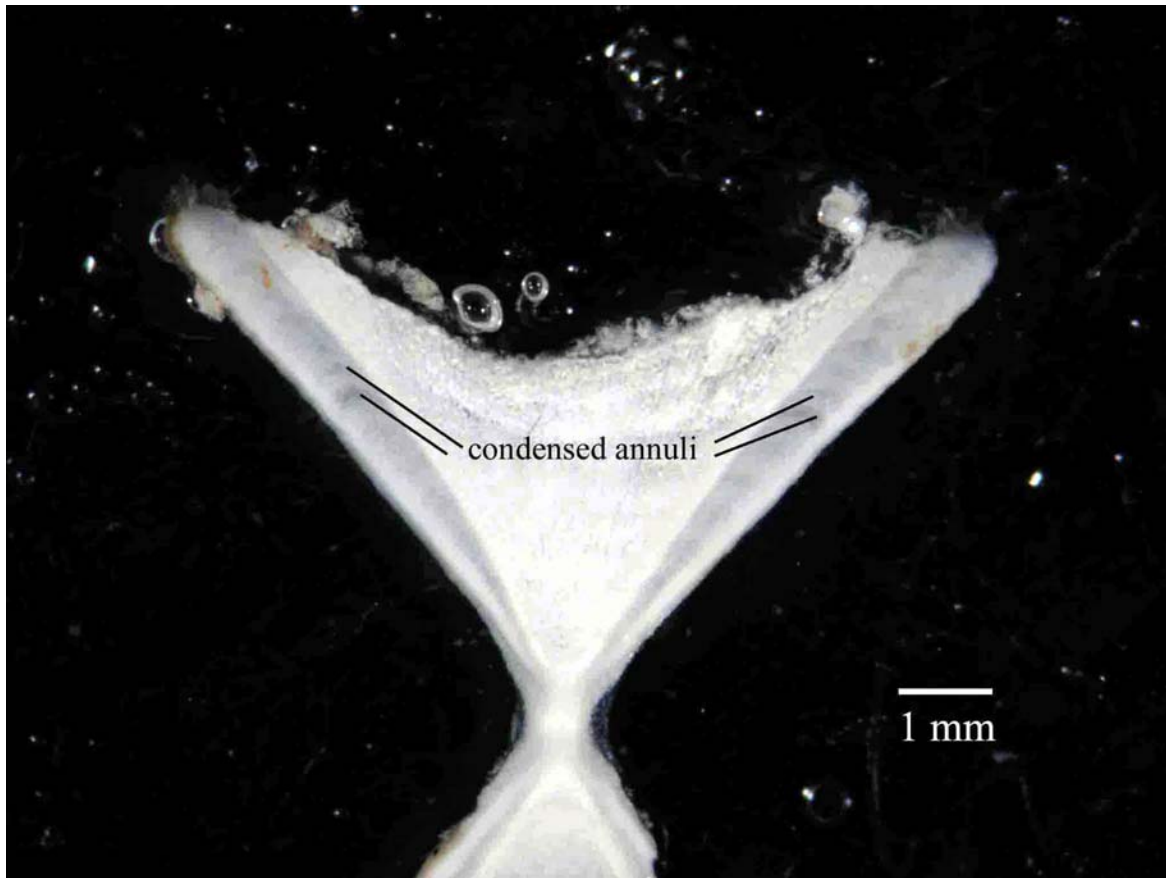

Fig. 15. *Bathyraja* sp.- Aleutian skate, a deeper water species, with condensed annuli (age – 15 yr).

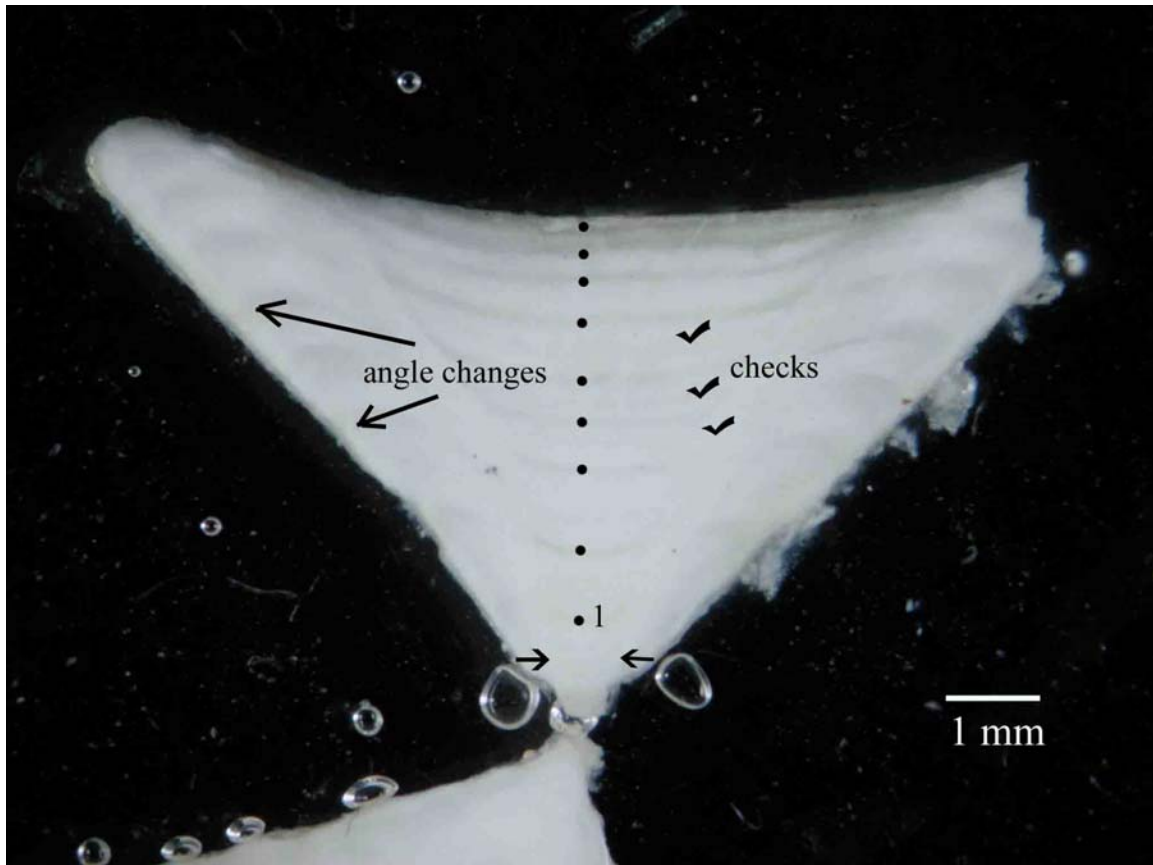

Fig. 16. Big skate vertebral thin section with a clear growth pattern (age - 9 yr). Though difficult to see here, age 0 (birth) is where the arrows are pointing to a visible constriction. Angle changes at the corpus calcareum are annuli. Checks are indicated between the 3rd and 6th year between annuli.

Acknowledgements

Numerous staff and associates, particularly Dan Kimura, of the Alaska Fisheries Science Center (AFSC), Moss Landing Marine Laboratories and Alaska Department of Fish and Game, have assisted and provided support in this project. Their contributions are gratefully acknowledged. Beth Matta and I visited Moss Landing Marine Laboratories for an elasmobranch workshop in March 2004. We worked with Gregor Calliet, David Ebert, Wade Smith, Colleena Perez and Chante Davis on *Raja* and *Bathyraja* vertebra processing, preparation and ageing criteria. Skate images were provided by Resource Assessment & Conservation Engineering at the AFSC.

References

Brander, K., and D. Palmer. 1985. Growth rate of *Raja clavata* in the Northeast Irish Sea. *J. Cons. Ciem.* 42(2):125-128.

Calliet, G.M., and K.J. Goldman. 2004. Age determination and validation in chondrichthyan fishes. *Biology of sharks and their relatives*. CRC Press Boca Raton, London, New York Washington, D.C.: 596 p.

Calliet, G.M. 1990. Elasmobranch age determination and verification: an updates review, in *elasmobranchs as living resources: advances in the biology, ecology, systematics, and the status of the fisheries*, W.S. Pratt, Jr., S. H. Gruber, and T. Taniuchi, Eds., NOAA Tech. Rep. 90:157-165.

Calliet, G.M., L.K. Martin, J.T. Harvey, D. Kusher, and B.A. Welden. 1983. Techniques for enhancing vertebral bands in age estimation of California elasmobranchs, in Proceedings

International Workshop on Age Determination of Oceanic Pelagic Fishes: Tunas, billfishes, Sharks, E.D. Prince and L.M. Pulos, Eds., NOAA Tech. Rep. 90:505-507.

Dulvy, N.K., J.D. Metcalfe, J. Glanville, M.G. Pawson, and J.D. Reynolds. 2000. Fishery stability, local extinctions, and shifts in community structure in skates. *Cons. Biol.* 14: 283-293.

Eschmeyer, W.N., E.S. Herald, and H. Hammann, 1983. A field guide to Pacific coast fishes of North America. Houghton Mifflin Co., Boston: 336 pp.

Gaichas, S., M. Ruccio, D. Stevenson, R Swanson. 2003. Stock assessment and fishery evaluation of skate species (Rajidae) in the Gulf of Alaska. NPFMC Gulf of Alaska.

Gallagher, M., and C.P. Nolan. 1999. A novel method for the estimation of age and growth in rajids using caudal thorns. *Can. J. Fish. Aquat. Sci.* 56:1590-1599.

Holden, M.J. 1974. Problems in the rational exploitation of elasmobranch populations and some suggested solutions. In *Sea fisheries research* (F.R. Harden-Jones, ed.), p. 117-137. John Wiley and Sons, New York.

Martin, L, and G.D. Zorzi 1993. Status and review of the California skate fishery. NOAA Tech. Rep. 115: 39-52.

Stevenson, D.E. 2004. Identification of skates, sculpins, and smelts by observers in North Pacific groundfish fisheries 92002-2003). U.S. Dep. Commer., NOAA Tech. Memo. NMFS-AFSC-142, 67 p.

Smith, W. 2004. Personal Communication. Moss Landing Marine Laboratories.

Zeiner, S.J., and P. Wolf. 1993. Growth characteristics and estimates of age at maturity of two species of skates (*Raja binoculata* and *Raja rhina*) from Monterey Bay, California. NOAA Tech. Rep. 115:87-99.