

ERDC/CRREL TR-08-14

Cold Regions Research  
and Engineering Laboratory



**US Army Corps  
of Engineers®**  
Engineer Research and  
Development Center

# **Assessment of Superstructure Ice Protection as Applied to Offshore Oil Operations Safety**

Problems, Hazards, Needs, and Potential Transfer Technologies

Charles C. Ryerson

September 2008

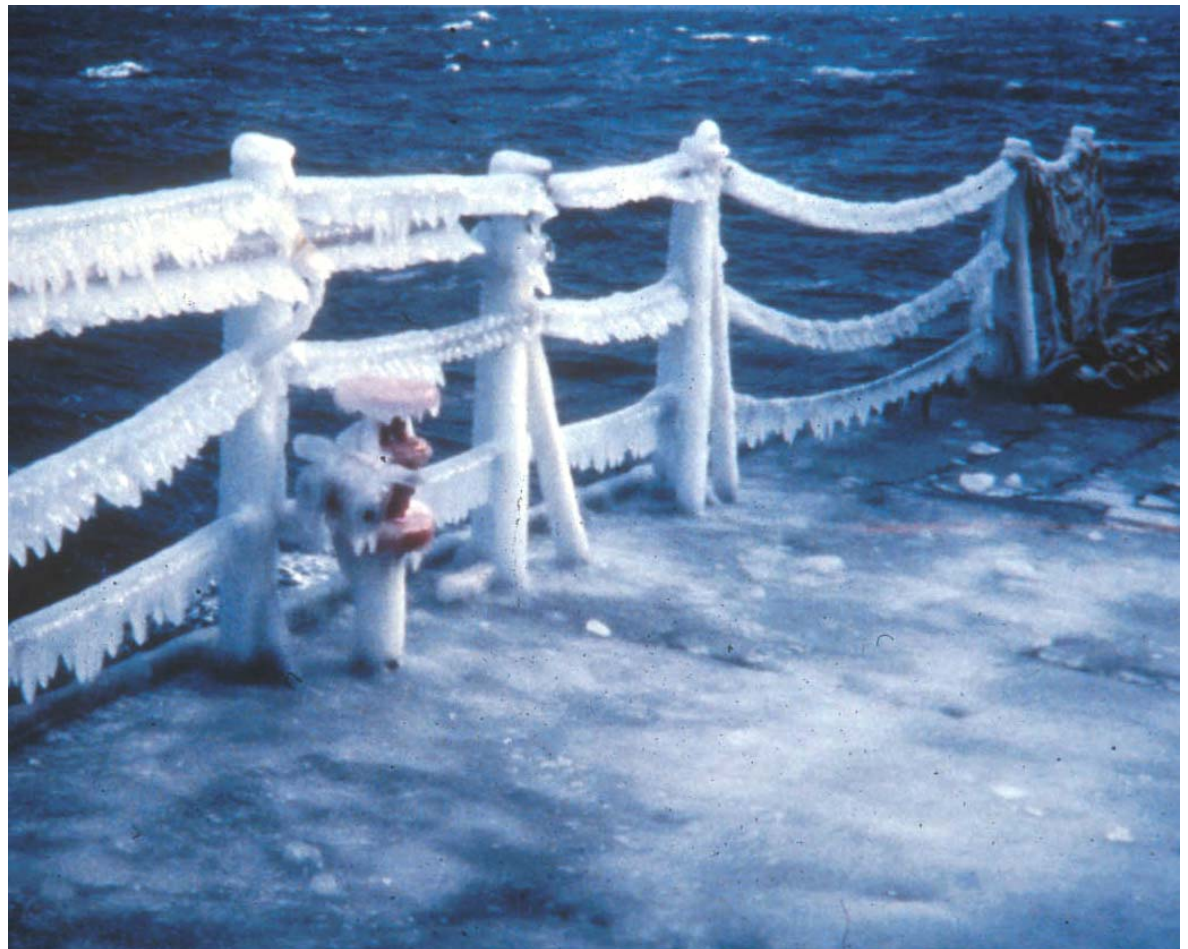

*COVER:* Superstructure ice on Coast Guard Cutter *Midgett*, Bering Sea, 1990.

# **Assessment of Superstructure Ice Protection as Applied to Offshore Oil Operations Safety**

Problems, Hazards, Needs, and Potential Transfer Technologies

Charles C. Ryerson

*Cold Regions Research and Engineering Laboratory  
US Army Engineer Research and Development Center  
72 Lyme Road  
Hanover, New Hampshire 03755-1290*

Report 1

Approved for public release; distribution is unlimited.

Prepared for US Department of the Interior  
Minerals Management Service  
Herndon, VA 20170

**Abstract:** Superstructure sea spray icing and atmospheric icing from snow, freezing rain, freezing drizzle, rime, sleet, and frost reduce the safety of offshore platform and supply boat operations. Though icing reduces safety and reduces operational efficiency, it has not caused the loss of offshore platforms. Supply boats are at greater risk of loss from icing than are platforms. Platforms operating in cold regions are protected primarily by designs that reduce ice accretion, coupled with the selective use of heat. A variety of deicing and anti-icing technologies have been tested on offshore platforms and boats, but with little overall success. New technologies and modern versions of old technologies, now used successfully in aviation, the electric power industry, and on transportation systems in general, may be transferable to the offshore environment. Fifteen classes of deicing and anti-icing technologies are identified, explained, and reviewed, as are numerous ice detection technologies for controlling deicing and anti-icing systems. These technologies are the population from which new marine ice protection systems may be selected.

**DISCLAIMER:** The contents of this report are not to be used for advertising, publication, or promotional purposes. Citation of trade names does not constitute an official endorsement or approval of the use of such commercial products. All product names and trademarks cited are the property of their respective owners. The findings of this report are not to be construed as an official Department of the Army position unless so designated by other authorized documents.

US Minerals Management Service (MMS) staff has reviewed this report for technical adequacy according to contractual specifications. The opinions, conclusions, and recommendations contained in this report are those of the author and do not necessarily reflect views and policies of the US MMS. The mention of any trade name or commercial product in this report does not constitute an endorsement for use by the US MMS. Finally, this report does not contain any commercially sensitive, classified, or proprietary data release restrictions and may be freely copied and widely distributed.

**DESTROY THIS REPORT WHEN NO LONGER NEEDED. DO NOT RETURN IT TO THE ORIGINATOR.**

# Contents

<b>Figures .....</b>	<b>vii</b>
<b>Preface .....</b>	<b>ix</b>
<b>1 Introduction.....</b>	<b>1</b>
<b>2 Critical Superstructure Icing Needs.....</b>	<b>3</b>
Types of Icing .....	3
<b>3 Icing of Rigs .....</b>	<b>11</b>
Snow .....	12
Location .....	12
Magnitude .....	13
Safety.....	13
Glaze Ice .....	15
Location .....	15
Magnitude .....	15
Safety.....	15
Rime Ice .....	16
Location .....	16
Magnitude .....	16
Safety.....	16
Frost .....	16
Location .....	16
Magnitude .....	17
Safety.....	17
Sleet .....	17
Location .....	17
Magnitude .....	17
Safety.....	17
Sea Spray Icing.....	18
Location .....	18
Magnitude .....	18
Safety.....	19
Rig Structures.....	20
Rig Design.....	20
Open Derricks.....	22
Antennas .....	22
Flare Booms .....	22
Air Intakes.....	22
Decks, Stairs, and Catwalks .....	23
Moon Pool.....	24
Cellardeck.....	24

	<i>Legs and Bracing</i> .....	25
<b>4</b>	<b>Accident Reports</b> .....	<b>26</b>
<b>5</b>	<b>Current and Previous Rig Deicing and Anti-Icing Technologies</b> .....	<b>28</b>
	Design .....	28
	Thermal Methods .....	31
	Coatings and Chemicals .....	31
	Mechanical Methods.....	32
	Other Deicing Methods .....	33
<b>6</b>	<b>Icing of Offshore Supply Vessels (OSVs)</b> .....	<b>35</b>
	Current Ship Ice Protection Methods .....	44
<b>7</b>	<b>Technologies That May Address Critical Superstructure Icing Needs</b> .....	<b>46</b>
<b>8</b>	<b>Chemicals</b> .....	<b>48</b>
	Background .....	48
	Technology .....	48
	Application .....	53
	Sources .....	53
<b>9</b>	<b>Coatings</b> .....	<b>56</b>
	Background .....	56
	Technology .....	58
	Application .....	61
	Sources .....	61
<b>10</b>	<b>Design</b> .....	<b>63</b>
	Background .....	63
	Technology .....	63
	Application .....	65
	Sources .....	65
<b>11</b>	<b>Electrical Techniques</b> .....	<b>66</b>
	Background .....	66
	Technology .....	66
	<i>DC Bias Voltage</i> .....	66
	<i>Pulse Electrothermal Deicing</i> .....	67
	<i>Ice Dielectric Heating</i> .....	69
	Application .....	70
	Sources .....	70
<b>12</b>	<b>Expulsive Deicing Systems</b> .....	<b>71</b>
	Background .....	71
	Application .....	72
	Sources .....	75

<b>13 Heat</b> .....	<b>77</b>
Background .....	77
Technology .....	77
<i>Electrothermal Heating</i> .....	77
<i>Hot Air</i> .....	80
<i>Hot Water</i> .....	82
Application .....	83
Sources .....	83
<b>14 Hydraulic and Steam Lance</b> .....	<b>84</b>
Background .....	84
Technology .....	85
Application .....	85
Sources .....	85
<b>15 Infrared Deicing</b> .....	<b>86</b>
Background .....	86
Technology .....	87
Application .....	89
Sources .....	89
<b>16 Mechanical Deicing Methods</b> .....	<b>91</b>
Background .....	91
Technology .....	92
Application .....	93
Sources .....	93
<b>17 Millimeter Wave Technology</b> .....	<b>94</b>
Background .....	94
Technology .....	94
Application .....	95
Sources .....	95
<b>18 Piezometric Crystals</b> .....	<b>96</b>
Background .....	96
Technology .....	96
Application .....	96
Sources .....	97
<b>19 Pneumatic Systems</b> .....	<b>98</b>
Background .....	98
Technology .....	100
Application .....	101
Sources .....	101
<b>20 Vibration</b> .....	<b>102</b>
Background .....	102

Technology .....	102
Application .....	102
Sources .....	102
<b>21 Windows .....</b>	<b>103</b>
Background .....	103
Technology .....	103
Application .....	106
Sources .....	107
<b>22 Cables .....</b>	<b>109</b>
Background .....	109
Technology .....	110
Application .....	112
Sources .....	112
<b>23 Ice Detection.....</b>	<b>113</b>
Background .....	113
Technology .....	114
<i>Ice Mass and Stiffness Sensing .....</i>	<i>114</i>
<i>Ice Imaging .....</i>	<i>115</i>
<i>Ice Mass Sensing .....</i>	<i>117</i>
<i>Dielectric Property Sensing .....</i>	<i>118</i>
<i>Optical.....</i>	<i>120</i>
<i>Ultrasonic.....</i>	<i>121</i>
<i>Latent Heat Detection.....</i>	<i>122</i>
Application .....	123
Sources .....	123
<b>24 Summary .....</b>	<b>125</b>
<b>25 Conclusions.....</b>	<b>128</b>
<b>References.....</b>	<b>129</b>
<b>Report Documentation Page.....</b>	<b>143</b>



# Figures

Figure 1. Glaze on a wire (with rulers in the background) and on a tree limb .....	5
Figure 2. Supercooled cloud drops freeze quickly, trapping air .....	6
Figure 3. Frost forms crystals directly from water vapor and is thickest where cooling is greatest .....	7
Figure 4. Superstructure ice on the Coast Guard Cutter <i>Midgett</i> in the Bering Sea in 1990, on the deck, and on rails .....	8
Figure 5. General locations where atmospheric icing (frost, snow, rime, and glaze) and superstructure ice (sea spray icing) would be expected to occur on a drilling platform such as the <i>Eric Raude</i> .....	12
Figure 6. Chipping ice from Coast Guard Cutter deck in Bering Sea, 1990.....	14
Figure 7. Open structure with large amount of small diameter bracing, such as found with jackups, have the potential to allow large superstructure icing loads .....	21
Figure 8. Open mesh walkways will accumulate ice and fill because of high collection efficiency.....	23
Figure 9. Complex cellar deck on the rig <i>Petronius</i> that would ice readily if located in colder waters.....	24
Figure 10. Semisubmersible GVA 5000 with modern design elements to minimize icing and enhance cold weather operations.....	29
Figure 11. Drill ship <i>Max</i> is designed to minimize cold and icing effects.....	30
Figure 12. Ice being removed with mallets on crab boat in Bering Sea, 2006 .....	33
Figure 13. Typical fishing trawler and oil rig supply boat .....	36
Figure 14. Oil platform supply boats interact actively with the sea, creating abundant spray for superstructure icing.....	37
Figure 15. Spray cloud amidships over a fishing trawler in the Bering Sea, 1990 .....	38
Figure 16. Zones of spray, thermal, and ice accretion processes on ships .....	39
Figure 17. Ice on the upper legs and deck sides of the <i>Ocean Bounty</i> showing probable maximum and thermally limited ice accretion .....	41
Figure 18. Superstructure ice covering life rafts, antennas, and windows of small trawler-size boat.....	45
Figure 19. Residues remaining on aircraft windows after testing a non-glycol-based deicing fluid.....	52
Figure 20. Army Aircraft Cleaning and Deicing System portable pump and fluid recovery system .....	52
Figure 21. Mulherin and Haehnel Zero Degree Cone Test apparatus.....	57
Figure 22. Ice pulled from a coupon .....	57
Figure 23. Drop contact angles on substrates, with lotus leaf effect .....	60
Figure 24. Drops on a lotus leaf and on a simulated lotus leaf at high magnification.....	61
Figure 25. DC bias voltage deicing where electrolysis forms bubbles at the ice/substrate interface as seen diagrammatically in profile and photographically from above .....	67
Figure 26. Deicing a metal plate with pulse electrothermal deicing.....	68

Figure 27. Ice being released from simulated cable by ice dielectric heating method .....	69
Figure 28. EEDS cross section un-actuated and actuated .....	73
Figure 29. IDI EIDI applied to an airfoil .....	74
Figure 30. Cox and Company EMEDS applied to an airfoil leading edge.....	74
Figure 31. IMS EEDS used for removing ice from a simulated navigation lock wall .....	75
Figure 32. Navy Vertical Launch System with electrically heated door edges.....	78
Figure 33. Cross section of Black Hawk helicopter blade showing the ends of heater wires immediately under the leading edge wear strip.....	79
Figure 34. Graphite conductor electrothermal system by Northcoast technologies.....	80
Figure 35. Piccolo tube directing hot bleed air against inside of wing leading edge .....	81
Figure 36. Buddy Start deicing nozzle and system in use on Black Hawk helicopter.....	82
Figure 37. Hot water deicing of Black Hawk helicopter .....	83
Figure 38. Flash flow portable deicing system for ships.....	84
Figure 39. Infrared heaters above CRREL entrance.....	87
Figure 40. Radiant Optics electric infrared focusing heaters .....	87
Figure 41. Ice-Cat during testing at Eglin AFB McKinley Climatic Chamber .....	88
Figure 42. Radiant Aviation Services system for deicing aircraft, and in use for experimentally deicing Army helicopters.....	89
Figure 43. Mechanical ice removal from <i>The Deadliest Catch</i> episode of <i>Man vs. Ice</i> .....	91
Figure 44. Five-point chisel in use by Chief on CGC <i>Midgett</i> , 1990.....	92
Figure 45. Ice being removed from surface coated with piezometric crystals .....	96
Figure 46. Diagrammatic view of deflated and inflated deicing boot.....	99
Figure 47. Residual ice occasionally remains on boots after deicing, as illustrated on the boots of this NASA Twin Otter aircraft.....	100
Figure 48. Electrically heated windows on NASA Twin Otter aircraft .....	104
Figure 49. Typical spinning window used to keep ship bridge windows dry and free of ice on Navy ships.....	105
Figure 50. Ice spinning bridge window on the tug <i>Keokuk</i> .....	106
Figure 51. Pulse deicing as applied to windows .....	107
Figure 52. Rotation of cables during wind-driven icing conditions, caused by asymmetric load, allows ice to eventually envelop the entire cable circumference .....	109
Figure 53. Pneumatic deicing boot developed by Franklin .....	111
Figure 54. Electro-expulsive deicing technology applied to cables .....	112
Figure 55. Rosemount ice detectors for measuring freezing rain or rime ice.....	115
Figure 56. Ice Hawk as originally designed by RVSI, and Canadian infrared detection system.....	116
Figure 57. Pole-ice instrument for representing ice loads on transmission lines .....	118
Figure 58. Conformance of Dedicated Electronics' ice detector to icing surface.....	119
Figure 59. TAMDAR sensor head that senses a variety of atmospheric conditions.....	120
Figure 60. Operation of ultrasonic ice detectors. ....	122

## Preface

This report was prepared by Dr. Charles C. Ryerson, Research Physical Scientist, Terrestrial and Cryospheric Sciences Branch, US Army Engineer Research and Development Center (ERDC), Cold Regions Research and Engineering Laboratory (CRREL), Hanover, New Hampshire.

Funding for this research was provided by US Department of the Interior Minerals Management Service, Herndon, Virginia.

The author thanks L. Zabilansky and M. Ferrick of CRREL for assistance with proposal preparation; E. Smallidge, E. Hoffmeister, and M. Beane for Library support at CRREL; and C. Miller and J. Mullin of the Minerals Management Service and the crew of the Exxon *Heritage* rig for educating the author about offshore platform configuration and operation.

This report was prepared under the general supervision of Dr. Justin B. Berman, Chief, Research and Engineering Division, CRREL; and Dr. Robert E. Davis, Director, CRREL.

At the time this report was published, Colonel Gary E. Johnston was Commander and Executive Director of ERDC. Dr. James R. Houston was Director.



# 1 Introduction

Historically, superstructure icing has been a significant threat to sea vessels, especially smaller vessels such as fishing trawlers operating in cold northern waters (Brown and Roebber 1985, Wise and Comiskey 1980). In the 1970s and 1980s, six to seven trawlers, most with all hands, were lost globally because of the effects of superstructure icing on stability. To this day, the threat to these vessels continues despite improved forecasting of deep Polar Lows often associated with vessel icing events (Crowley 1988, NCEP 2008). For example, on 26 January 2007, the fishing trawler *Lady of Grace* sank 12 miles south of Hyannis, Massachusetts, with all hands (USCG 2008). Many others are threatened and even presented on popular commercial television programs (Discovery Channel 2006).

Statistics of vessel loss due to superstructure icing do not reflect near-losses of ships and, more important, the decrease in safety and, perhaps, loss of personnel overboard due to dangerous on-deck conditions, experienced even on large vessels (Discovery Channel 2006). Technology still has not been applied sufficiently to significantly reduce the icing threat to vessels, including oil industry supply boats, which are similar in size to fishing vessels.

With increased offshore oil exploration and production since the 1970s in cold regions such as the North Sea, Hibernia, Norway, and Alaska, icing also has begun to affect stationary structures. Although to date no offshore rigs have been lost due to icing, superstructure icing is a factor that can add to the complexity of the storm impact and potentially cause loss of a rig. More frequently, superstructure icing makes operations more difficult or causes operations to be slowed or suspended until the icing event and its effects are addressed.

The sale of oil exploration and drilling leases in the Beaufort Sea on 7 February 2008 means that increased activity offshore will expose vessels, rigs, and crews to potential superstructure icing. Expected longer ice-free periods due to global change will be accompanied by longer fetches and, potentially with the increased warmth, stronger Polar Lows that occur farther north than they do today. Frequent and long-duration high winds combined with extended fetch produces greater wave heights and will

make superstructure icing potentially more severe than it is today (Papineau, n.d.).

The objective of this MMS project is to assess the hazards of icing and to provide methods of improving safety on drilling and production vessels and platforms operating and experiencing superstructure icing in the Beaufort and Chukchi Seas. These sea spray and atmospheric ice detection and mitigation methods transferred from other applications use anti-icing, deicing, and low ice adhesion technologies to target specific needs. This research program is addressing the superstructure icing threat to offshore oil structures and supply vessels by assessing how sea spray icing and atmospheric icing affect operations and safety. It also will review technologies available from all disciplines for deicing and anti-icing of structures and indicate how selected technologies can help improve safety on offshore structures. This report, the first of three in this project, identifies ice protection technologies currently in use on marine structures and defines superstructure icing needs. It also identifies ice protection technologies in use and under development from other ice mitigation applications, including electrical transmission, transport, and aviation with regard to ice detection, icephobic coatings, anti-icing and deicing, and structural design. Two subsequent reports will 1) evaluate these technologies to determine those that most successfully can be applied to the marine environment, 2) assess their technology readiness level, and 3) assess how safety may be improved following application of these technologies to drilling and production operations in the marine icing environment. The last report will identify high-priority research needs for development and maturation of technologies for application to the marine environment.

## 2 Critical Superstructure Icing Needs

Identifying safety problems caused by icing on offshore structures requires an understanding of types of ice, where it forms, and how it affects operations. It also requires identification of technologies currently used in the oil industry to combat icing hazards. This assessment provides the framework with which to identify critical superstructure icing safety concerns and needs of drilling and production operations in the Beaufort and Chukchi Seas. Information sources used include open literature, World Wide Web sites, and oil industry and government organizations.

### Types of Icing

Rig and supply boat icing is caused by several phenomena, all a result of liquid drops or frozen precipitation intercepting and adhering to surfaces. All of these fall under the general categories of atmospheric and superstructure icing, and both compromise safety in operations.

Rigs primarily ice as a result of supercooled water drops or frozen precipitation in the form of snow or sleet. They also ice from frost, which is caused by direct deposition from water vapor to ice. Snow and sleet are precipitation and originate from clouds. Supercooled drops can originate either as freshwater from cloud or fog droplets 5–70  $\mu\text{m}$  in diameter, freezing drizzle drops 70–500  $\mu\text{m}$  in diameter, and rain drops 500  $\mu\text{m}$ –several millimeters in diameter. Supercooled drops also can originate from the sea surface as either large drops 14  $\mu\text{m}$ –7700  $\mu\text{m}$  in diameter (average about 295- $\mu\text{m}$  diameter) caused by splash of green water against rig structures (Ryerson 1995), or can originate as spindrift spray ripped from the tops of waves by wind. Jorgensen (1982) reports that sea spray drops can be even larger, 1000–3,500  $\mu\text{m}$  in diameter (average 2400- $\mu\text{m}$  diameter).

Some investigators consider all these methods of delivering liquid or frozen water to a rig or ship as *atmospheric icing*, and others consider the freshwater sources to be *atmospheric icing*, and the salt water sources to be *superstructure icing*. For the purposes of this report we will discuss atmospheric icing and superstructure icing as distinctly different phenomena because the source of the ice accretion affects where it forms on the rig, and fresh versus saline sources cause the physical properties of the ice to differ. The physical properties affect the adhesive strength of the ice to

substrates and brittleness, and thus affect the effectiveness of methods used to either prevent its formation (anti-icing), or to remove it once it forms (deicing).

Atmospheric icing can cause accumulation of snow, sleet, rime ice, and clear ice or glaze from freezing rain on rig surfaces. On ships, atmospheric icing generally is considered to be a very minor cause of ice accumulation (Zakrzewski et al. 1988). However, snow, glaze from freezing drizzle and freezing rain, and perhaps sleet with sufficient accumulation, can cause hazards on rigs, as explained later. Minsk (1984b) and Makkonen (1984) both claim that high ocean structures, such as drill rigs, with their large surface areas exposed well above the sea, may be more threatened by atmospheric ice than by sea spray icing. These higher locations are particularly important because a smaller amount of icing high on the rig may be more important than larger quantities of ice at lower locations because of effects on overturning moment.

In general, dry snow does not accumulate on rigs, but blows off, unless surfaces are wet, and then forms a porous low-strength accretion (Jorgensen 1982). However, wet snow that does accumulate without the benefit of sea spray can form ice underfoot as it increases in density through crushing and refreezing. Drilling locations in the lee of cold land masses could cause accumulation of significant quantities of snow on decks and machinery as cold air picks up moisture, causing, in effect, “lake effect” snowstorms. This phenomenon is known to occur in the Sea of Japan, for example. It is unknown whether it is a problem in the Beaufort and Chukchi Seas, especially under current weather regimes.

Sleet results from raindrops that freeze prior to reaching the surface. Sleet forms ice pellets less than 5000  $\mu\text{m}$  in diameter and can accumulate to depths of 1.3 cm or greater, causing hazards on decks because the pellets can roll like ball bearings on hard surfaces.

The most significant atmospheric icing problems will typically be caused by supercooled drizzle and rain drops. Because drizzle drops and raindrops are relatively large, and because freezing drizzle and freezing rain are less common in very cold temperatures (air temperatures are usually not colder than  $-10^{\circ}\text{C}$  when they occur), they form a nearly clear accumulation of ice called glaze at the Earth’s surface, and called clear ice on aircraft. Glaze has a high density, near  $0.9 \text{ g/cm}^3$ ; it is hard and smooth and



adheres firmly to substrates (Fig. 1). Because glaze freezes relatively slowly, thus causing its clear appearance, it allows the supercooled water to flow around objects before freezing is completed, mechanically locking the ice to objects. Also, especially for freezing drizzle and if winds are high, more ice will accumulate on small-diameter objects, such as railings and antennas, than on larger-diameter objects.

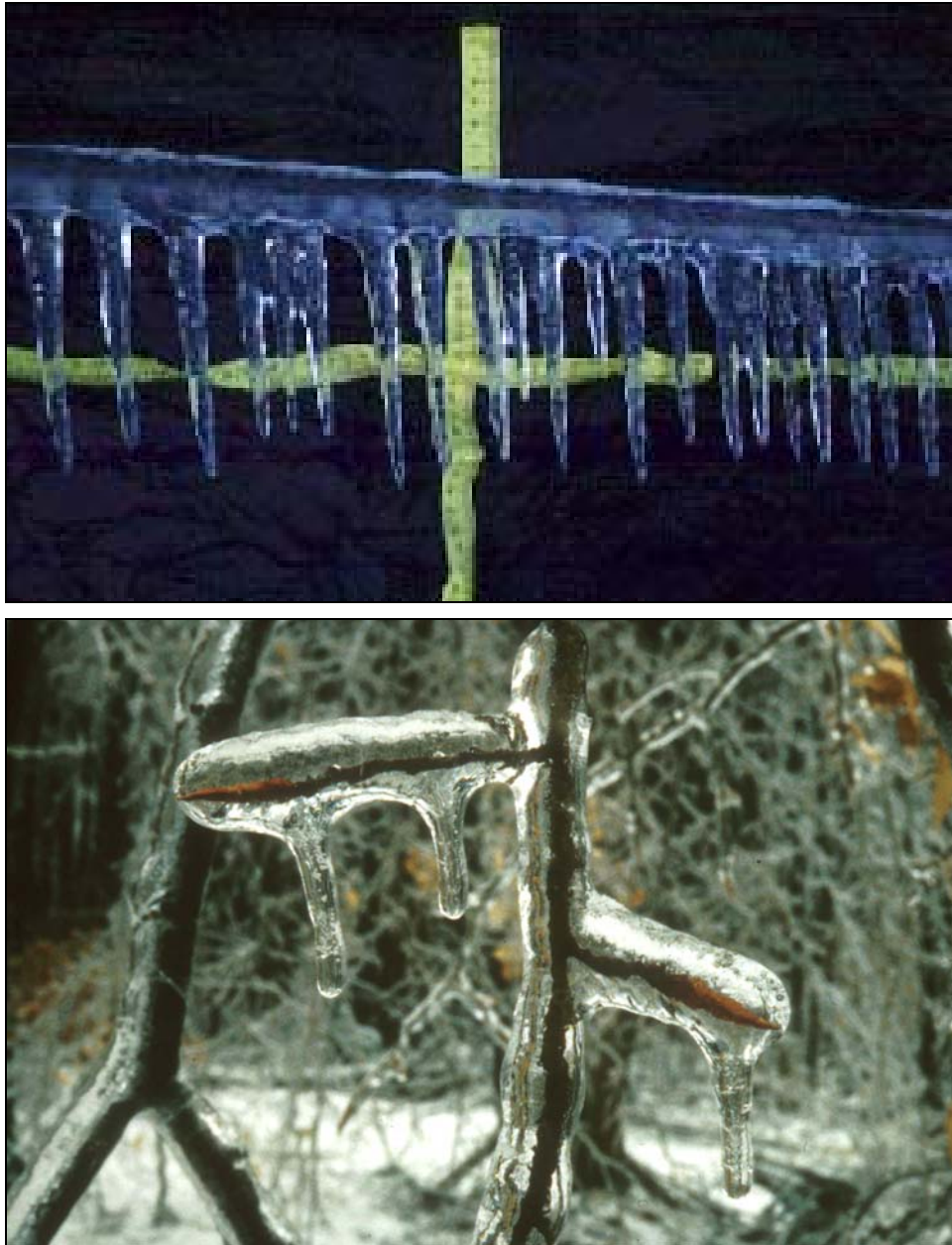

Figure 1. Glaze on a wire (with rulers in the background [top]) and on a tree limb (bottom). Note the clearness of the ice and the icicles, both caused by the slow rate of freezing.

Supercooled fog, sea smoke, and cloud droplets are sufficiently small that they freeze rapidly upon contact with other objects. As a result, the ice that forms, called rime, is typically white in appearance, forms a feather-like appearance on the upwind sides of objects, and is relatively low in density (Fig. 2). Rime ice typically is relatively weak in strength and is brittle. At its lowest density it readily breaks from substrates. However, it can have densities and strengths approaching those of glaze ice. Glaze forms dominantly on the upwind sides of objects and, except in the case of cables that can rotate, rarely wraps around objects as glaze does.



Figure 2. Supercooled cloud drops freeze quickly, trapping air. They form rime feathers on the upwind sides of objects (top) and can form deposits more than a meter thick on towers (bottom).

Frost is a deposit that forms as ice directly from water vapor—there is no intermediate liquid phase. Similar to snow in this regard, frost forms very low density deposits on objects when water vapor pressure is high and objects have cooled below the frost point. Frost typically forms at night on objects exposed to the clear sky (Fig. 3). It also can form when rigs are cold-soaked and a rapid weather change brings warm, moist air over the structure, causing frost to form and remain the longest on objects with the greatest thermal mass—that is, greatest cold-soaking. The author has observed frost formation on ropes, for example, after clear nights at sea.



Figure 3. Frost forms crystals directly from water vapor and is thickest where cooling is greatest.

Atmospheric ice can form at any height on a structure, although sea smoke has been observed to heights of only 10–100 m (Jorgensen 1982) above the water surface. Also, sea smoke doesn't typically form unless sea surface temperature is at least 9°C warmer than air temperature.

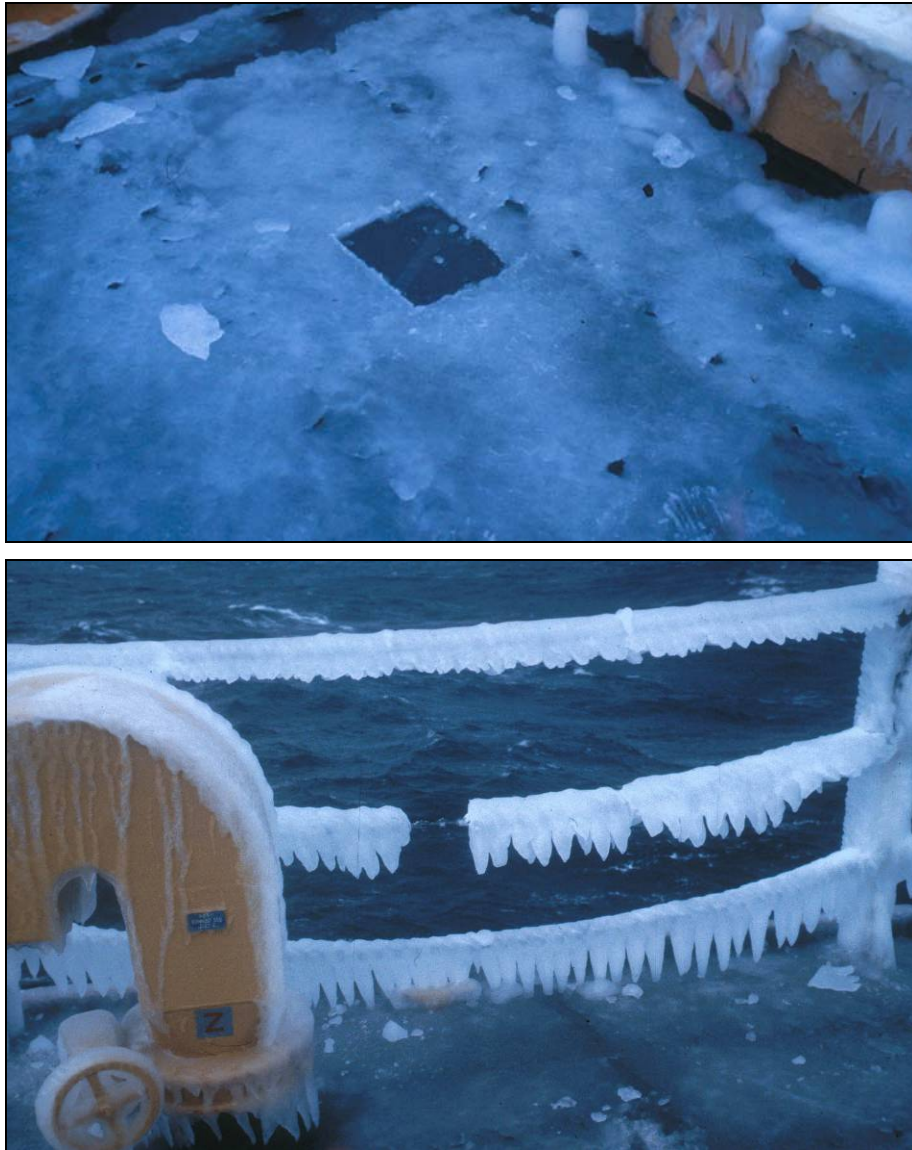

Figure 4. Superstructure ice on the Coast Guard Cutter *Midgett* in the Bering Sea in 1990, on the deck (top, sample removed), and on rails (bottom, sample removed).

Sea-spray-generated ice, or superstructure ice (Fig. 4), has a greater impact on rig and especially supply boat safety than does atmospheric ice. Superstructure ice forms when drops are created from waves splashing against the structural elements of rigs, typically supports below main deck level. For supply boats, spray originates from bow/wave interaction, and is

carried over the ship by relative wind after the spray rises above the deck if the rails are open, or above solid bulwarks. Most sea spray occurs 15–20 m above the sea surface, but it can be lofted as high as 30 m (Nauman 1984) to 60 m (Jorgensen 1982), as reported by helicopter pilots in Alaska. However, liquid water content at the greatest heights will be low and thus presents less of a hazard. Sources have a variety of views regarding the amount of ice (and weight versus thickness is not specified) deposited on rigs and boats by atmospheric ice sources versus sea spray. Zakrzewski et al. (1988) and Makkonen (1984) cite Russian studies indicating that, in most parts of the world, sea spray forms about 90% of the icing on ships. However, in the Arctic, sea spray is only about 50% of the source for ice, the remaining being atmospheric sources (Makkonen 1984). However, Zakrzewski et al. (1988) also indicate that there is no evidence that freezing rain is a significant hazard to rigs offshore. Minsk (1984b) indicates that freezing rain occurs only about 4% of the time in the Barents and Chukchi Seas. Rigs generally are not moving and spray is generated only by wave motion against rig supports; this suggests that atmospheric ice could potentially contribute more to ice-related rig safety than sea spray.

As with certain atmospheric ice, especially rime, sea spray ice accumulates to greater thicknesses on smaller-diameter objects. Jorgensen (1982) indicates that cylinders smaller than 0.5 m in diameter ice fastest for the same reasons that cloud droplets ice smaller-diameter objects faster: smaller objects have a larger collection efficiency (Langmuir and Blodgett 1946). Inertia of droplets within the air stream causes less flow divergence around smaller objects than around larger objects, thus causing a larger percentage of drops to strike smaller-diameter objects. Therefore, collision efficiency and collection efficiency increase as drop size increases, wind speed increases, and object diameter decreases. Liquid water contents also can be very high in sea spray icing events. Ryerson (1995) measured spray event liquid water contents of 1 to more than 1100 g/m<sup>3</sup>, with an average of 64 g/m<sup>3</sup> on the Coast Guard Cutter *Midgett* at a height of 10 m above the water surface and about 25 m aft of the bow. Complete freezing of all drops may not occur at the larger liquid water contents, depending upon air temperature, because of the large quantities of latent heat needing to be liberated. Liquid water contents are likely to be smaller in oil rig spray events, except in the most severe storms, because they are stationary, making splash events smaller and relative wind speeds lower.

Sea spray ice is created from saline water near 33‰ salt content. Because salt is excluded from water as it freezes, brine accumulates in pockets within the ice and, if the ice is located on a non-horizontal surface, the brine will drain over time. Ryerson (1995) and Kultashev et al. (1972) found ice thicknesses on ships to be greatest on horizontal surfaces, with vertical surfaces having only about 77% of the thickness of horizontal surfaces. Because brine also drains most rapidly from ice on vertical surfaces, the mass of ice per unit area on bulkheads was 71% of that on decks and other horizontal surfaces (Ryerson and Gow 2000).

As saline ice ages, brine drains. And, if temperature decreases, more brine drains and the ice becomes less saline and harder, and crystals increase in size. Salinities on the *CGC Midgett* varied from about 7‰ on bulkheads to about 24‰ on decks, and ice on bulkheads was harder than ice on decks. Mean ice crystal dimensions were about 900- $\mu\text{m}$  diameter and were rounded, as would be expected from ice formed from sea spray drops (Ryerson and Gow 2000). These small crystals suggest that the ice may be relatively weak cohesively and more easily broken than ice with larger, elongated crystals, thus affecting the potential for success of mechanical deicing technologies. Adhesion increases rapidly after 1.5–2 hours, especially if temperature and brine content decrease (Jorgensen 1982). Overall, salt water ice is weaker than freshwater ice. Finally, Makkonen (1984) claims that the adhesive strength of sea spray ice increases as droplet impact velocity increases, and may be related to improved mechanical bonding as velocity increases.

### 3 Icing of Rigs

Though there was little direct information about the impact of atmospheric ice on rig operations in 1982, it is known to cause safety and operational problems (Jorgensen 1982). There is strong evidence that hazards identified 25 years ago still, in large part, exist (Fagan 2004). However, atmospheric sources alone are unlikely to produce sufficient ice mass to significantly affect the stability of a floating drill rig. Atmospheric icing will affect primarily equipment and personnel, whereas superstructure ice from sea spray may accumulate with sufficient mass that it compromises rig stability. Overall, however, documented information about the impact of ice on the safety of rig operations is limited.

A search of major databases indicates that neither atmospheric nor superstructure icing has been a primary cause of the loss of any rigs globally (Oilrigdisasters 2008). And, there is no indication that icing has contributed to the loss of any rigs, even though some major rig losses occurred in winter storms. Finally, icing is not a significant problem on oil platforms in the North Sea, despite the area's reputation for severe and cold weather (Jorgensen 1982), though ice loadings in the range of 250–500 tons have occurred on North Sea rigs (Liljestrom 1985, Liljestrom and Lindgren 1983). Other than helicopter operations in the North Sea being affected by inflight icing (Warren 1984), there have not been reports of rig icing problems in the North Sea area in the last 25 years.

Icing, however, can have significant impacts on safety and operational tempo and can in most cases be considered as a nuisance rather than a significant threat. It can be a safety hazard while being a nuisance because it can affect personnel safety. This is underscored by Brown and Mitten (1988) in a study of icing on rigs offshore the Canadian East Coast. They indicate that drilling platform icing events are “quite frequent,” but most icing events accrete less than 20 tons of ice. These events have minimal impact on offshore operations, but also are not extreme events. The largest impact of icing off the Canadian East Coast is on the operation of supply vessels and their ability to maintain a schedule during icing conditions.

However, there have been several cases of significant impacts upon rig safety, and perhaps survival, as a result of icing (Løset 1985, Nauman and

Tyagi 1985). Below we address the potential for, and reported impacts of, each form of icing on rigs, impacts on supply boats, and methods used to deice rigs, and follow with descriptions of current technologies used in many industries for deicing and anti-icing.

## Snow

### Location

In general, snow will be a problem on horizontal surfaces such as decks (Fig. 5). However, snow also will adhere to vertical surfaces such as bulkheads, especially if those surfaces are wet, or if the snow is a wet snow. With regard to height above water level, Fagan (2004) indicates that snow affects all heights on a drill rig. Multiple forms of icing, such as snow and sea spray, also often occur at the same time to cause multiple problems, especially in the lee of intense winter storms (Brown and Agnew 1985, Brown and Roebber 1985). If care is not taken to remove ice loads after each event, the additive effects could threaten trim and stability. Mycyk (1985) reported that combined snow and sea spray icing was such a problem off the Canadian East Coast that it merited further study.



Figure 5. General locations where atmospheric icing (frost, snow, rime, and glaze) and superstructure ice (sea spray icing) would be expected to occur on a drilling platform such as the *Eric Raude*.



## Magnitude

Overall, snow has a relatively minor impact on rig safety. Brown and Mitten (1988) indicate that atmospheric icing conditions were relatively infrequent on the East Coast of Canada and account for only about 6% of icing reports. However, Brown and Agnew (1985) report that more than 60% of trawler spray icing events off of Labrador and Nova Scotia were associated with snow. In February 1985, the *SEDCO 710* crew had to shovel 10 cm of snow from the deck. Liljestrom and Lindgren (1983) estimate, however, that snowfall can cause considerable loads on semisubmersibles. For example, they cite the *GVA 5000* mobile rig, which has a deck area of 80 square meters and can accumulate a load of about 150 tons with a snow depth of 0.3 m. However, Makkonen (1984) indicates that the contribution of wet snow to rig icing is less important than the contributions of glaze ice or rime ice.

## Safety

Snow causes falling accidents because of slippery conditions and obscuration of steps and objects with less height than the snow depth. Snow can add up to 150 tons to a rig. This in itself does not cause instability, but can contribute to potential instability if other forms of icing also occur. However, Kozo (1984) assessed the icing hazard in the Chukchi Sea and concluded, with regard to snow, that it is not a hazard on rigs because it adheres so poorly.

Fagan (2004) specifies that ice on the burner boom must be considered in determining the boom's capacity and measures must be taken to ensure that loads on the boom do not exceed its load rating. A collapsed boom, or clogged nozzles due to ice prior to start-up, can lead to explosion, fire, or accumulation of toxic gases. Snow accumulation on valves may inhibit both their manual operation and the ability to see position indications.

Snow also can affect derrick operations because it can create slippery working conditions, as elsewhere on the rig, but snow also can melt and refreeze. On open lattice structures such as booms and derricks, snowmelt can flow into crotches where multiple structural members are fastened, forming large chunks or balls of ice. When thawing occurs, these ice projectiles are a serious hazard to personnel and equipment. This phenomenon has been observed on land-based communication towers to have

punched holes in the roofs of buildings and smashed windows of vehicles (Mulherin 1987 personal communication).

Ryerson observed snow on the Coast Guard Cutter *Midgett* in the Bering Sea in February 1990. Though only a few centimeters of snow accumulated, it froze as a solid mass on the non-skid deck, creating dangerous footing. Unnecessary personnel were not allowed on deck, and crew members performing mechanical deicing equipment (Fig. 6) found deicing of the snow difficult.



Figure 6. Chipping ice from Coast Guard Cutter deck in Bering Sea, 1990. Mechanical deicing methods damaged deck non-skid material.

## Glaze Ice

### Location

Zakrzewski et al. (1988) report that freezing rain has a relatively high frequency, more than 10%, offshore the Canadian East and West Coasts (though rates are less than 4% in the Barents and Chukchi Seas). Brown and Mitten (1988) indicate that, in Canadian waters, icing from freezing precipitation was greatest in the Gulf of St. Lawrence and in the eastern and western Arctic areas because proximity to land masses caused a shallow cold layer near the surface, producing supercooling and freezing as rain fell through. Brown and Mitten (1988) also indicate that freezing precipitation accounted for only 9% of rig icing reports off of the East Coast of Canada. Supercooled rain and drizzle can cause icing to the top of oil rigs (Jorgensen 1982) (Fig. 5). Baller (1983) claims that atmospheric ice affects derricks, radar, masts, helideck fittings, railings, and other exposed structures with a fairly uniform accretion.

### Magnitude

Zakrzewski et al. (1988) indicate that there was no conclusive evidence (in 1988) that freezing rain is a significant problem for ships or rigs, though they also report that, in Russian waters, spray and rain together cause icing during 41% of icing events. Baller (1983) reports accretion of 10 mm or less of glaze ice on rigs. Brown and Mitten (1988) report glaze accumulations of less than 3.0 cm on trawlers and rigs off of the Canadian east coast. Makkonen (1984) concludes that atmospheric icing is the primary cause of icing on tall stationary sea structures such as rigs, with supercooled precipitation being a major contributor.

### Safety

Brown and Mitten (1988) indicate that 3–5 mm of glaze ice on the *GLOMAR LABRADOR* rig caused decks and gratings to become extremely slippery in February 1985. Kozo (1984) considers freezing rain a particularly dangerous form of icing because, being freshwater, it freezes more rapidly than saline spray ice, and it forms a nucleus around which sea spray icing can accumulate. According to Liljestrom and Lindgren (1983), freezing rain alone could cause up to 300 tons of icing on rigs off of Sable Island on the Canadian East Coast, 140 tons off of Labrador, and 55 tons in the Davis Strait.

## Rime Ice

### Location

Brown and Agnew (1985) found rime icing to be most frequent in the Arctic in Canadian waters, and attribute it to high advection fog frequencies in the eastern Arctic. In the western Canadian Arctic, rime icing is most frequently caused by advection fog and sea smoke (Fig. 5).

### Magnitude

Makkonen (1984) states that atmospheric icing is the primary cause of icing on tall stationary sea structures such as rigs, with rime being a major contributor. Brown and Agnew (1985) report accumulations of up to 5.0 cm on trawlers and rigs in the western Canadian Arctic. Reports of riming rates on ships have claimed 10 cm of ice on decks in 12 hours, and 30 cm on rails during the same period (Fett et al. 1993) in dense sea smoke.

### Safety

Droplet collection efficiency is largest on small-diameter objects, indicating that antennas, railings, cables, and the latticework of booms, derricks, and other structures will ice heaviest. Rime, by filling in open areas, increases sail area of the rig or vessel, making it more sensitive to wind. Also, falling rime is a significant hazard to equipment and personnel when thawing begins and large pieces fall from structures. Rime also makes railings difficult to use, causes antennas to fail as a result of weight and wind loads, and can cause slippery decks if the wind blows across and deposits ice on irregular (such as on nonskid) deck surfaces.

## Frost

### Location

Radiation frost will form on decks, railings, cables, and other materials with poor thermal conductivity or low thermal mass on cold, clear, and calm nights as a result of radiational cooling to the night sky. Frost also will form if the rig is cold-soaked and warmer air is advected in with a frost point warmer than the rig temperature. Frost then will form on all cold-soaked surfaces, especially those with *high* thermal mass.

**Magnitude**

Makkonen (1984) indicates that the contribution of frost to rig icing is minor. Frost can form on all surfaces, but its density is typically less than 0.1 g/cm<sup>3</sup> (Ryerson et al. 1994). Frost will add little weight to a ship or drilling platform. Minsk (1980) indicates that frost produces a negligibly small amount of ice on rigs.

**Safety**

Frost creates personnel safety hazards. Decks, stairs, railings, and handles become slippery, and windows can frost, obscuring visibility. Frost can be several millimeters thick in the humid marine environment, increasing the danger of making surfaces slippery. Frost adds little to the weight of a rig, or to its sail area, thus it does not affect stability. Also, frost provides no material to fall from high structures.

**Sleet****Location**

Sleet is a transition form of precipitation between freezing rain and snow, generally in warm frontal conditions. Sleet has the probability of being most common in nearly the same locations as is freezing rain or glaze formation. Sleet will be most common in proximity to land masses where shallow cold layers can form near the surface, causing freezing rain to become ice pellets before it reaches the surface.

**Magnitude**

Sleet generally will not stick to objects because it hits surfaces as a solid form of precipitation. However, it may form a sufficient layer of round ice pellets on decks and stairs to cause slippery conditions.

**Safety**

Sleet ice pellets roll underfoot and can produce an effect similar to walking on ball bearings. Sleet can create a slipping and falling hazard.

## Sea Spray Icing

### Location

Sea spray icing occurs whenever the air temperature is less than the freezing temperature of seawater, about  $-2^{\circ}\text{C}$ . Typically, the majority of icing of rigs is caused by sea spray. Sea spray has been observed 60 m above the water surface by helicopter pilots, but liquid water content is very low (Nauman 1984). Because rigs are stationary, sea spray typically is found in greatest concentration 5–7 m above the sea surface (Baller 1983), to 10–20 m above the sea surface (Jorgensen 1982, Nauman 1984). Jessup (1985) indicates that splashing of a stationary rig is less intense than splashing of a ship, and that spray rarely carries more than 5–10 m above the sea surface. Makkonen (1984) indicates that spindrift rarely rises more than 4 m above the sea surface when wind speeds are less than  $25\text{ m s}^{-1}$ . A severe icing event off of the east coast of the United States on the semi-submersible *SEDNETH II* in February 1970 resulted in most icing occurring below the main deck (Crowley 1988). Liljestrom (1985) describes ice formation on a semisubmersible platform. Ice forms on sides facing the wind. As it freezes, the ice forms brine pockets, which drain and form icicles. During storms, 10–15 cm of ice can form per day. Above the main deck, accretion rates are lower, up to 5 cm per day. If main deck scuppers are open, 1–3 cm of ice can form per day on the upwind sides of decks, but frozen slush to 30 cm deep can form if scuppers freeze over. Strengthening boxes between the columns and main structure can accumulate considerable ice. On support legs, 1–2 cm of ice readily forms. Even the derrick may accumulate 1–3 cm of ice because of sea spray. Minsk (1975) and Ryerson (1991) both indicate that icing is most common behind cold fronts because of increased wind speeds and cold temperatures.

### Magnitude

Nauman (1984) reports that during six storms observed on the *Ocean Bounty* in Cook Inlet, Alaska, sea spray caused ice as high as 30 m in max 1-min winds to 98 kts, waves 3 m to 9.4 m, and temps from  $-20.5^{\circ}\text{C}$  to  $-2.2^{\circ}\text{C}$ . Ice accumulations from high wind, complex sea state, shallow water, and low temperatures caused 5- to 25-cm ice accumulations per day, curtailing drilling operations (Nauman 1984). *Ocean Bounty* was 30,000 tons displacement. Its stability was affected enough in one storm after accumulating 500 tons of ice that drilling mud had to be dumped (Nauman 1984, Nauman and Tyagi 1985).

Another icing event off the Canadian east coast threatened the stability of the rig *SEDNETH I* when 175–200 tons of spray ice accumulated (Brown and Mitten 1988). Brown and Mitten also indicate that 70% of rig icing cases accumulated less than 10 tons of ice, with maximum thicknesses typically less than 10 cm. Most significant causes of superstructure icing from wind-driven spray are wind velocity, air temperature, sea temperature, and rig characteristics, though sea temperature has a lesser effect when it is colder than 4°C (Crowley 1988, Fett et al. 1993). Freezing spray occurs when the air temperature is colder than the freezing temperature of sea water, about  $-2^{\circ}\text{C}$  depending upon the salinity (Fett et al. 1993).

A severe icing event off of the east coast of the United States on the semisubmersible *SEDNETH II* in February 1970 caused draft to decrease at the rate of 30 cm per hour (Crowley 1988). Liljstrom (1985) indicates that ice accretion on rigs has been reported to range from 200 to 1600 tons, though most sources provide values in the range of 500–700 tons. Mycyk (1985) indicates that the icing rate of the *SEDNETH II* on the Canadian Scotian Shelf caused draft to increase at a rate of 0.3 m per hour during the most extreme portion of the storm. Icing was observed to start 2–5 m above the sea, with most ice forming on sixteen 15-cm-diameter tubular braces supporting the legs. The rig heaved with a period of 2–3 min in  $25\text{ ms}^{-1}$  winds, 5-m waves, and 3- to 4-m swells. Sackinger (1980) attributes initial ice accretion on rigs to frazil ice buildup in sea water that adheres to the rig during wave wash, with additional ice adhering to the frazil. The *Coast Pilot* (NOAA 2007) indicates that very heavy to severe icing is accumulations of 2.5 to 3.8 cm in three hours.

## Safety

Most investigators, except for a few (Makkonen 1984, Minsk 1984b), agree that sea-spray-created superstructure icing is typically the greatest threat to drill rig safety, causing slippery decks, ladders, handrails, icing on helicopter platforms, deck cargo, winches, and other equipment, causing operational delay and cost. Ice on antennas cuts communications and distorts radar signals for navigation. Ice-coated windows, rescue equipment hatches, winches, and cranes reduce safety. Jorgenson (1982) reported 22% of all crew injuries were caused by slipping and falling in Norwegian waters. Added weight during icing decreases stability and buoyancy, and additional sail area causes heeling (Crowley 1988). Bridge windows become covered with ice; winches, windlasses, boats, life rafts, firefighting equipment and valves, and radomes become ice-covered and inoperable.

Salt water ice on antennas bridges insulators, causing arcing and loss of communication (Crowley 1988). Liljestrom and Lindgren (1983) indicate that icing can cause equipment damage, malfunctions, slippery conditions, ice falling from the derrick, and materials handling problems. Kozo (1984) indicates that the impact of superstructure ice accretion is even more serious than suggested by others. Because ice forms on the windward side, it causes an imbalance in the structure—the heeling problem cited by Crowley (1988). However, structural members are designed to take oscillatory stresses due to wave action, and changes in drag, inertia, diameter, roughness, and flexural response caused by ice accretion on these structures could change the structure’s design wave capability. Løset (1985) reported that the semisubmersible rig *TREASURE SEEKER* off the coast of northern Norway accumulated 300 tons of spray ice in April 1981. The ice hampered transfer of materials from a supply boat, caused problems handling anchors, caused an ice accumulation on the derrick, and caused problems with air systems, control systems, life rafts, external emergency ladders, and firefighting systems.

Kozo (1984) has estimated the frequency of icing in the Chukchi Sea by month, and reports that September and October are the months with greatest chance of superstructure icing because temperatures are cooling and fetch is still relatively large. Even during the months of July and August, heavy icing can occur because of the sudden onset of cold fronts and high winds. Sea ice cover reduces icing rates other months of the year.

## Rig Structures

Rig structure can have a large influence on ice accretion. Open structures exposing many small diameters, such as open lattice bracing with large surface area, can accrete large amounts of atmospheric and sea spray ice. Portions of rigs closest to the waterline often accrete less ice because wave wash does not allow rapid liberation of latent heat.

### Rig Design

Jackups are among the most ice-endangered rig designs because of the legs’ lattice structure (Fig. 7). The small diameter of jackup leg elements and large surface area promotes icing, with the possibility that leg structures could fill in with ice, increasing weight and sail area. The *Heritage*, off the Santa Barbara coast, is another design that, if in Arctic waters,



would promote icing with the open bracing and piping below decks (Fig. 7).



Figure 7. Open structure with large amount of small diameter bracing, such as found with jackups (top), have the potential to allow large superstructure icing loads. The *Heritage* rig, (bottom) located off of the Santa Barbara coast, would have serious icing problems with its complex structure if operated in cold waters.

### **Open Derricks**

Open derricks with open lattice framework exposed several hundred feet above the water surface are potential areas for rime icing and for glaze created by freezing drizzle and freezing rain. Collection efficiency of the small-diameter structural elements is high and surface area for ice accretion is large. The lattice structure allows meltwater to run to structural corners and crotches, or water to collect in snow-covered areas, and re-freeze. That ice can later fall when temperatures warm, presenting a hazard to equipment and personnel below.

### **Antennas**

Whip and dipole communication antennas readily collect ice because of their small diameters. Rime ice and glaze both reduce antenna efficiency. However, if water is trapped in the ice, especially if the ice is saline spongy ice with brine pockets, the dielectric constant of the ice increases and signals often will be completely blocked. Also, saline ice can bridge insulators and short antennas, making them inoperable. Radar antenna performance is also compromised by ice accretion, with effects being more serious for saline and wet ice.

### **Flare Booms**

Flare booms are similar to derricks hanging at an angle over the water. As a result, they are exposed to atmospheric icing and, more than derricks, to sea spray icing. Ice and snow loads on burner booms must be considered when designing the capacity of the boom (Fagan 2004). Also, during well testing, ice could be present in nozzles prior to start, thereby causing an explosion, fire, or envelopment of the rig in toxic gases.

### **Air Intakes**

Ventilation is critical on rigs because of the potential concentration of toxic or explosive gases. Carstens (1983) shows photos of air intake icing on a semisubmersible in the Gulf of Alaska after an icing event. Walsh et al. (1993) have demonstrated the effects of sea spray icing on the intake louvers of ships, which may be analogous to louver icing on rigs. Similarly, iced firefighting equipment, life rafts, lifeboats, rescue capsules, and windows will reduce safety.

### Decks, Stairs, and Catwalks

Horizontal surfaces and materials on these surfaces (such as pipe racks and other machinery) are susceptible to precipitation icing from atmospheric sources such as snow, freezing drizzle, freezing rain, and sleet. Frost may form under appropriate conditions, and sea spray, if lofted sufficiently high, may freeze on horizontal surfaces. According to Jorgensen (1982), sea spray was seen on rig decks in the North Sea when waves exceed 10-m height. Decks, stairs, and catwalks may be constructed of bar grating, such as is used on the *Heritage* rig off Santa Barbara (Fig. 8), or they may be a solid painted steel surface or covered with non-skid. Open grids will ice except that water can flow between the grate bars before icing bridges the spaces between the bars. Non-skid coatings ice readily and may be difficult to deice. Maintaining proper drainage is critical for minimizing deck and walkway icing, though only a few millimeters of ice will make them dangerously slippery. Experience also teaches that any oil spilled on ice is especially slippery and hazardous. Railings also will ice, with rime ice also a factor for icing of rails. Figure 4, taken on the Coast Guard Cutter *Midgett* in the Bering Sea in 1990, shows how sea spray ice and icicles can make railings difficult to use. Also, the larger surface area caused by the ice increases wind load on the structure, and thereby can affect stability.



Figure 8. Open mesh walkways will accumulate ice and fill because of high collection efficiency.

### Moon Pool

The moon pool is susceptible to icing from wave splash. Though limited principally to sea spray icing because of its position on and under the main deck, it houses equipment critical to rig safety, and is an active work area during drilling. Baller (1983) indicates that there are wind tunnel effects through the moon pool that could carry freezing spray, and excessive ice accretion should be avoided on slip joints there. This is especially important if the rig heaves in heavy seas during icing events in storms.

### Cellardeck

The cellardeck, with numerous catwalks, piping, braces, and valves, and its proximity to the waterline, will be threatened by sea spray icing (Baller 1983, Nauman 1984). As with the moon pool, it will accrete ice on small-diameter objects and render the entire work area hazardous. Areas with frequent wave wash will ice less severely and may be free of ice because latent heat may not be liberated rapidly enough to freeze wash water. A complex cellardeck such as shown in Figure 7 on the *Heritage* rig on the US Pacific Coast, and the *Petronius* in the Gulf of Mexico (Fig. 9), would ice severely if the rigs were located in cold climates.

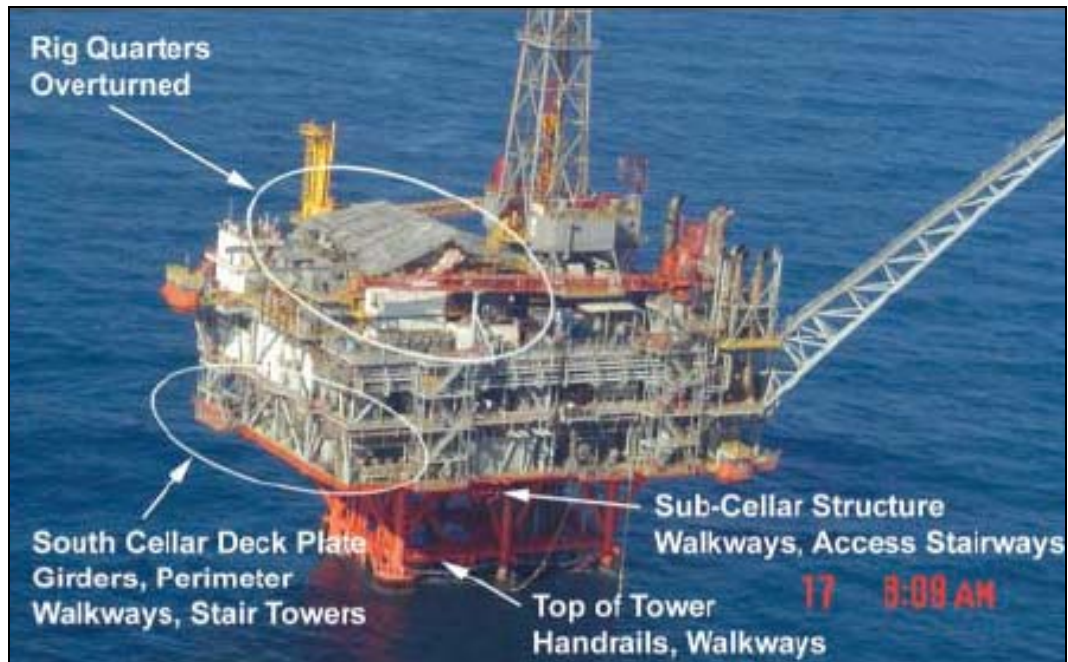

Figure 9. Complex cellar deck on the rig *Petronius* that would ice readily if located in colder waters.

### Legs and Bracing

According to Baller (1983), sea spray icing builds on columns, bracing, blowout preventer guidelines, mooring chains, marine riser, and flexible kill and choke lines in the splash zone 5–7 m above sea level in drilling mode, and 1–2 m higher when the rig is in transit. Sea spray ice builds to a certain thickness and breaks off under its own weight or because of vibrations. In general, small-diameter leg elements with lattice bracing, or similar, ice most severely. However, according to Nauman (1984), in moderate sea states most ice accumulates on platform legs above the water line and may not effect the center of rig gravity seriously. In severe weather, spray ice may accumulate above deck levels (about 40 m above water, such as on the *Ocean Bounty*) and cause stability to deteriorate. According to Liljestrom (1985), icing of legs results from spray and water flowing from higher levels. If the legs are large in diameter, only a few centimeters of ice will form and then drop off because of insufficient loss of latent heat. Also, the parts of legs impacted by “green water” will not have persistent ice accretion.

## 4 Accident Reports

Investigation of accident reports indicates that no rig disasters have been attributed to icing globally (Oilrigdisasters 2008). One rig, the *Ocean Ranger*, was lost while on station in a severe winter storm in the North Atlantic in February 1982. The rig sank because of a failure of ballast control, and that failure was not attributed to superstructure icing. The jackup *Interocean II* sank in a severe storm when being towed in the North Sea in 1989. Icing is not mentioned in the accident description as being an associated factor. The *Rowan Gorilla I* jack-up sank during a tow in a severe North Atlantic storm in December 1988. Severe seas, and not icing, was the suspected cause of sinking. Though rigs have experienced severe icing events—e.g., the *Ocean Bounty*, which had to dump drilling mud to maintain stability during an event—it does not appear in incident or accident databases (Nauman and Tyagi 1985).

The International Association of Drilling Contractors (IADC) requires reporting by members from which it compiles accident statistics. The 2006 *Summary of Occupational Incidents US Water Totals* (IADC 2007) details accident statistics by type of accident, location of accidents on the rig, time of day, month, time in service, and other categories. The statistics do not attribute accidents to weather, icing, or a specific geographic region of the United States except that they are all offshore operations. The only statistics that potentially could be related to icing with any confidence would be slips/falls. Of all time lost to incidents, about 30% in 2006 was lost due to slips and falls, and total recordable incidents by incident type due to slip/falls was about 17%. Because the statistics represent slips/falls in all seasons and all US offshore locations, it is likely that only a small portion of these incidents were caused by ice. Total time lost by all accidents varied by month from about 5.5% to about 15%, with the largest percentage occurring in January. However, when categorized by month for all recordable incidents, the range was about 6%–11%, with the maxima occurring in September and October. Total-time-lost statistics suggest that the larger percentage of January accidents may be due to winter weather. This bears some similarity to Jorgensen's (1982) reporting that 22% of injuries on Norwegian fishing vessels from 1961 to 1975 were caused by slipping and falling.

The Occupational Health and Safety Agency (OSHA) maintains statistics on accidents in the oil and gas well drilling industry. Its database indicates that about 16% of accidents were fall-related in 2003 (OSHA 2004). There is no indication in the database of the fall cause, nor the season. However, it is likely that falls occur in all months, so only a small percentage is likely related to winter operations, and fewer still to falls related to ice or snow.

Brown and Roebber (1985) report on a survey conducted of the offshore oil industry's ice accretion problems. When asked if icing conditions had affected their operations, they indicated that icing affected workboats and affected rigs to a lesser extent. Icing delayed helicopter and supply boat operations for some companies. When asked if icing was expected to be a problem for future offshore operations, answers from industry were almost universally no, with one responder indicating that problems would be location-dependent, and another indicating that rigs would not have problems, but supply boats might. They also requested more information on methods to alleviate the effects of superstructure icing, especially on workboats.

## 5 Current and Previous Rig Deicing and Anti-Icing Technologies

Fagan (2004) indicates that, in regard to testing wells, Arctic operations require rig winterization unless operations are limited to periods of mild conditions. Below are listed the considerations that they recommend with regard to alleviating the effects of superstructure and atmospheric icing:

- Design of the hull, crane pedestals, helideck, and derrick;
- Design of ballast, ventilation, and fire systems;
- Consequences of atmospheric and spray ice loading on equipment and structures;
- Stability under icing conditions;
- Means to ensure availability of escape ways, lifesaving, equipment, and work areas;
- Protection of work areas by wind screens, walls, and heating;
- Operational and contingency procedures.

Crowley (1988) indicated that in the late 1980s there was a need for a breakthrough in anti-icing and deicing technology for rigs and ships. Systems available at the time were high in cost and handled only moderate icing conditions. Leaving ice on a structure for two weeks after it becomes very hard from brine drainage is dangerous because of the increased difficulty of removal.

### Design

Many recommendations for improving rig design were investigated and implemented in the 1980s, and there are numerous examples of more modern rigs designed to reduce the effects of superstructure icing. Liljestrom and Lindgren (1983), Liljestrom (1985), and Crowley (1988) all indicate that there should be a minimum number of braces, columns, and



legs in the wash and spray zones, and inspection platforms and ladders should be minimized as exemplified by the new semisubmersible *GVA 5000* (Fig. 10). New rigs should have four to six circular or streamlined columns with no or few braces (Crowley 1988, Jorgensen 1982). The deck structure should have a smooth bottom with all structural bracing and support inside incorporating a double-bottom upper hull. All exposed equipment, such as winches, pipe racks, derrick, drill floor, cellar deck and the pipe, casing, and riser rack area should be covered to protect equipment and personnel from icing and from falling ice. The new rig *Ocean Odyssey* was constructed with a covered derrick to present fewer exposed surfaces for icing (Nauman and Tyagi 1985). However, areas where gases such as methane and hydrogen sulfide could collect—such as the drill floor, derrick, pipe rack areas, and cellar deck—should be well-ventilated. Liljestrom (1985) and Jorgensen (1982) add that there should be adequate open drains with provision made for steaming drains open.

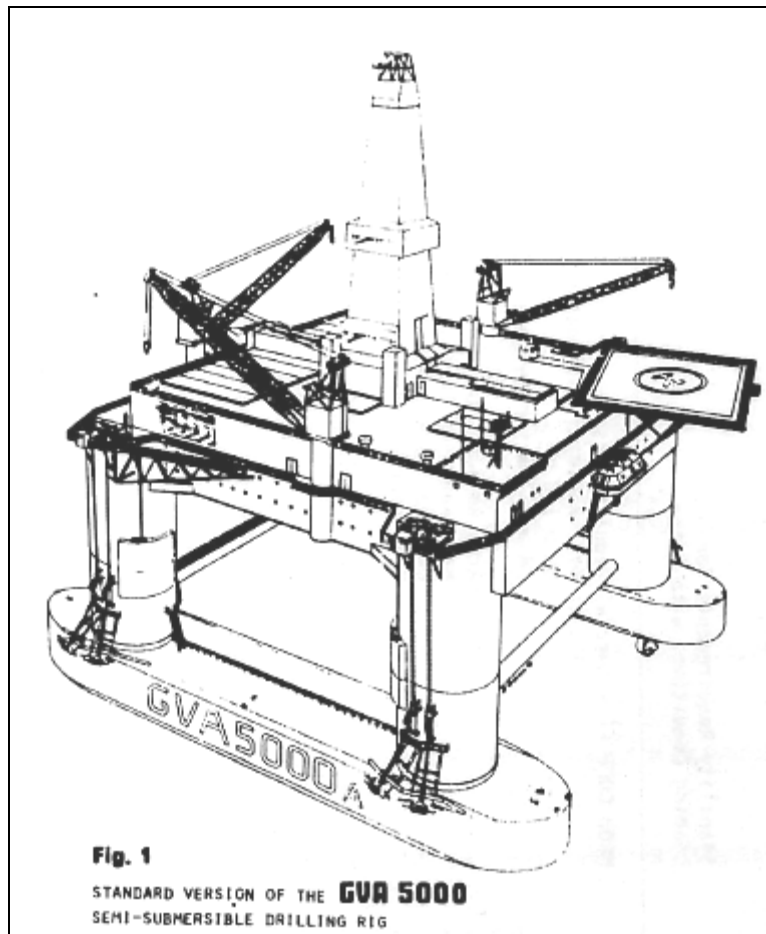

Figure 10. Semisubmersible GVA 5000 with modern design elements to minimize icing and enhance cold weather operations.

Nauman and Tyagi (1985) indicate that in the 1980s there was no practical, adaptable, or economical method to protect a rig from icing or to deice it. They recommended improved ice forecasts and warnings, and rig design to accommodate the additional draft caused by ice.

Today, Det Norske Veritas (DNV 2005) designs ships for Arctic deployment that continuously deice equipment such as navigation aids and firelines. Deicing equipment is installed where some ice accumulation is tolerable. All ships must be equipped to remove ice within a period of 4–6 hours of its accumulation. Statoil of Norway (Eikill and Oftedal 2007) designs its rigs with enclosed working areas, including derrick, drill floor, muster stations, and pipe and rider decks, and equipment and escape ways are heat traced. The *Eirik Raude* is an example of a semisubmersible constructed to withstand polar weather, including superstructure icing (Fig. 5). It has large-diameter legs with little bracing, an enclosed derrick, heated walkways, and windwalls (Ocean Rig, n.d.). Also, the drill ship *Max* has been constructed with special features for cold weather, such as wind walls and electrically driven deicing equipment (Pakarinen 2006) (Fig. 11).



Figure 11. Drill ship *Max* is designed to minimize cold and icing effects (Pakarinen 2006).

## Thermal Methods

Liljestrom and Lindgren (1983) indicate that covered areas such as the derrick, drill floor, and cellar deck, as well as the double inner and outer hull, should be heated. Also, areas below the deck structure that need to be reached during operations should be protected with electrical heat tracing and insulation, or provision should be made to provide steam for deicing. Liljestrom (1985) indicates that ice on rails and ladders should be removed with steam and mechanical methods. Cranes and burner booms should be deiced with steam lances. However, despite Liljestrom's (1985) and Liljestrom's and Lindgren's (1983) recommendation of using heat, they recommend that it and several other methods be avoided because of expense and lack of reliability. Crowley (1988) echoes their concerns about heating by indicating that its first cost maintenance and energy costs are high and it is usually useful for only small, critical, and vital equipment protection. However, he does indicate that steam can be an effective deicing method. Makkonen (1984) indicates that heating is not practical for anti-icing or deicing because of the large amount of energy necessary for latent heat. He does suggest, however, that heat pipes and thermosyphons may be practical, and that they had been used successfully on a Japanese ship at a heat consumption rate of 1 kW/m<sup>2</sup>. He also cites attempts to use current-conducting coatings for small areas such as windows, perhaps combined with icephobic coatings. Jorgensen (1982) recommends electrical heating around door and hatch edges and bridge windows—except that ice bridging (ice covering the window from around the edges) is a problem for windows. He considers hot air to be a poor transmitter of heat unless it is used to heat the back side of decks or bulkheads to keep the opposite surface warm. He indicates that heating of these surfaces should be sufficient only to prevent ice, not to remove it. Finally, he states that electrically conductive paint has mixed reviews, and that infrared technologies had not yet been tested.

## Coatings and Chemicals

Crowley (1988) indicates that there were no long-term coatings to effectively prevent or reduce ice adhesion in the 1980s. Makkonen (1984) also reports that there were no known chemicals in the 1980s that were effective at reducing ice adhesion. Silicone oil, Vaseline, and Kilfrost performed poorly, and materials with a paste-like consistency are easily washed away (Jorgensen 1982). Makkonen (1984) and Jorgensen (1982) also indicate that ethylene glycol and other freezing point depressants may be useful if

application methods could be perfected and if they could be prevented from being washed away. Generally, Makkonen (1984) concludes that chemicals are useful only for small objects such as windows for a short time, or for aircraft immediately prior to takeoff. Jorgensen (1982) concludes that chemicals are a problem operationally because they require storage and handling, are slippery and expensive, and can be a pollutant. Jorgensen (1982) adds that low-adhesion coatings can delay the start of icing, but their effectiveness rapidly declines with succeeding icing events. However, Minsk (1975) cites work by Stallabrass (1970) that indicates that low-adhesion ropes are no more effective for removing ice than steel cable because the lower torsional stiffness of the synthetic material allows it to rotate as ice accretes, making it more difficult to remove because it is wrapped like a pinwheel around the rope.

## **Mechanical Methods**

Manual methods are still the primary technique for removing ice from marine structures, even in recent years (Makkonen 1984). Crowley (1988) indicates that in the mid 1980s, deicing was still largely accomplished with wooden baseball bats, fire axes, hammers, and crowbars, as was done a century earlier on whalers and other craft. Ryerson (1995) conducted superstructure icing research on the Coast Guard Cutter *Midgett* in the Bering Sea and filmed deck hands using wooden baseball bats, crowbars, and shovels to remove ice from bulkheads, davits, and decks (History Channel 2005). Also, the Discovery Channel (2006) reality program *The Deadliest Catch* shows that superstructure ice removal on crab boats is still manual, using mallets (Fig. 12). Mechanical methods are slow and laborious, expose crew to dangerous conditions, and can damage rig components such as machinery and windows. These methods can chip paint and damage newer composite materials that are not resilient to impacts. Jorgensen (1982) warns that highest areas on rigs should be deiced first to reduce effects on stability, and that asymmetries of ice accretion should also be dealt with expediently.



Figure 12. Ice being removed with mallets on crab boat in Bering Sea, 2006.

### Other Deicing Methods

Crowley (1988) indicated that high pressure water jets were experimental in the 1980s, but successful application had not been attained at sea. He does indicate that high pressure sea water washdown to undercut ice can be effective. If a method of heating the seawater is available, it is more effective. Allowing this water to freeze on the ship increases the severity of the problem. Jorgensen (1982) also reports on the use of water jets that cut 75-cm-thick ice at 12 m/min. He recommends that firefighting and cleaning pumps be utilized. However, as seen below, Kenney (1976) experienced freezing of fire water supplies on a tug. Liljestrom and Lindgren (1983) recommend removing ice from outer portions of semisubmersibles with large volumes of heated or unheated seawater. Other concepts that have been considered but not adequately tested include placing nets or platforms around structures to catch spray and ice and submerging them periodically to remove the ice (Makkonen 1984), deflecting droplets using air curtains (Minsk 1977), and using various methods to suppress evaporation or spray generation on the sea surface with floats or oil (Makkonen 1984).

Kenney (1976) reports on deicing and anti-icing technology tests done by the Navy on a large harbor tug in Portsmouth, Maine. A rotary spin window, inflatable and pulsed neoprene tube assemblies on panels, a vibrating

fiberglass panel, constant flowing unheated green water over decks, and three icephobic materials—Teflon fluorinated ethylene propylene, a Teflon dispersion, and high density polyethylene (HDPE)—were tested. Sea spray ice was created at an air temperature of  $-20^{\circ}\text{C}$  to create layers of ice less than 0.5 cm in thickness. The green water flush system did not operate because piping froze, and all other systems except for the pneumatic neoprene tube panels failed to deice or anti-ice successfully. However, Kenney (1976) did assume that the deck flush system would have been successful if supply pipes had not frozen. Power required for the pneumatic system was low, the panels could be fit over surfaces of varying shape including antennas, and most ice was removed. Pneumatic systems also were successfully tested on the British trawler *Boston Phantom*. Jorgensen (1982) recommends that pneumatic methods be used on rails, masts, antennas, and flat surfaces. However, pneumatic systems are expensive, heavy, complex, and easily damaged. They also could be placed on platform legs and stays. Ackley et al. (1977) also demonstrated the effectiveness of pneumatic devices to clear TACAN antennas of rime ice.

Makkonen (1984) reports that attempts were made to use flapping and flexible materials, but with little success. Jorgensen (1982) recommends the use of tarps that vibrate because of ship motion, and reports that tarps have been successful for deicing when provided with the proper coatings. However, Kenney (1976) and Mulherin and Donaldson (1988) report on vibrating devices that were not successful.

## 6 Icing of Offshore Supply Vessels (OSVs)

Offshore supply vessels that transport supplies and personnel between shore and rigs, and among rigs, are also threatened by superstructure icing. Supply boats are typically 45–76 m long, with some exceeding 100 m in length. Fishing trawlers, which are noteworthy for succumbing to superstructure icing, are only about 15–35 m long. Both vessels have little freeboard, however, and both vessels often carry large amounts of equipment on open decks, though the open deck of the fishing trawler is forward, and the supply boat open deck is aft (Fig. 13). Smaller vessels interact more vigorously with the sea and thus create more spray and more icing; this interaction is one reason that fishing trawlers perform poorly in superstructure icing conditions. Fishing vessels also typically have more rigging for ice to accrete upon than a supply vessel. Despite their larger size, supply vessels interact vigorously with the sea and create splashing events that can cause superstructure icing (Fig. 14).

According to Guest (2005), superstructure icing intensity is related to the vessel characteristics of speed; heading with respect to wind, waves, and swells; length; freeboard; handling; and cold-soaking. Higher speed, headings directly into the wind, or a quartering wind that causes dangerous asymmetric icing, higher winds, waves and swells, sea temperatures colder than 5°C, shorter length, and lower freeboard all contribute to greater icing rates. Ryerson (1991) found that icing off the Canadian east coast was most associated with air temperatures between  $-3.5^{\circ}\text{C}$  and  $-12.6^{\circ}\text{C}$ , and most icing events were lee of cold fronts during the passage of low pressure areas. Icing events were most severe when winds came from a nearby cold land mass. This was also true of icing of the semisubmersible *Ocean Bounty* in Cook Inlet, Alaska (Nauman and Tyagi 1985). Seas most often associated with trawler icing off Labrador were swells of about 1.8 m, waves of about 1.5 m, and water temperatures between  $-1.0^{\circ}\text{C}$  and  $3.0^{\circ}\text{C}$  (Ryerson 1991).

The National Oceanographic and Atmospheric Administration (NCEP 2008) makes routine superstructure icing forecasts for Alaskan waters for ships ranging from 20 m to 75 m long, which covers trawlers and smaller supply boats. Icing rates are considered light when less than 0.7 cm of ice accumulates per hour, moderate when 0.7 to 2.0 cm accumulate per hour,

heavy when rates are 2–4 cm per hour, and extreme at greater accumulation rates.

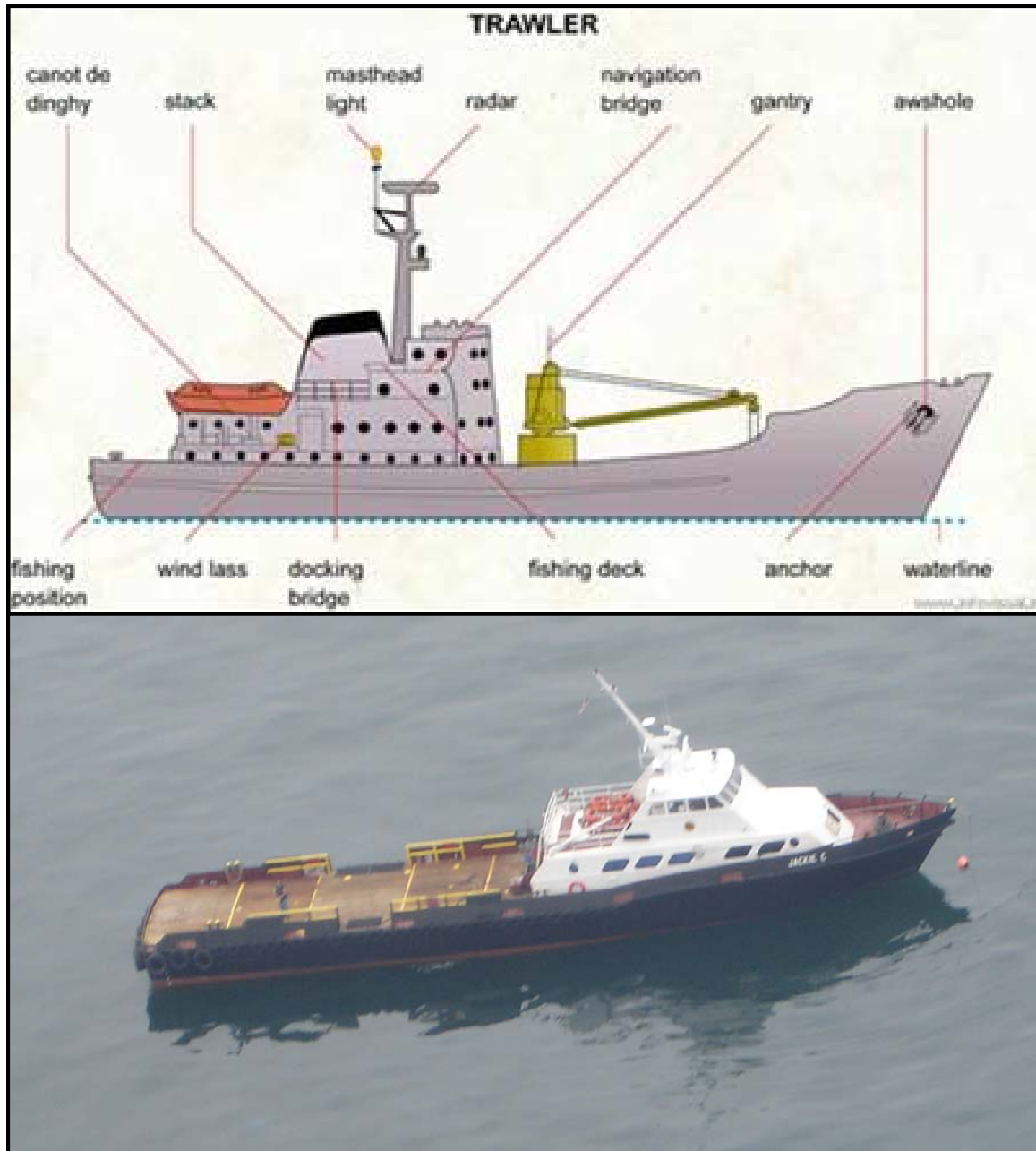

Figure 13. Typical fishing trawler (top) and oil rig supply boat (bottom).





Figure 14. Oil platform supply boats interact actively with the sea, creating abundant spray for superstructure icing.

Considerable research on superstructure icing caused by sea spray and atmospheric sources was conducted primarily by Japanese and Russian researchers in the 1970s and 1980s on fishing trawlers, processing ships, and offshore platforms. Examples include studies by Tabata et al. (1967), Ono (1968), Iwata (1973), and Borisenkov and Panov (1974). In the late 1980s and 1990s, additional research, especially as related to characterization of the icing process, physical and mechanical properties of superstructure ice, and modeling was conducted in the United States and Canada (Ackley 1985; Jeck 1984; Ryerson 1991, 1995; Ryerson and Gow 2000; Lozowski et al. 2000; Zakrzewski and Lozowski 1991). Considerable research was conducted during this period on the icing of drill rigs and other stationary sea structures, as well (Brown and Horjen 1989; Horjen and Vefsnmo 1984; Itagaki 1984; Minsk 1977, 1984a, 1984b).

Icing caused by sea spray can form a layer of ice on both decks and superstructure, and may have a major impact on the stability, safety, and general operation of a vessel. Typical icing problems encountered are the impairment of stability due to the raised center of gravity caused by the ice mass above decks, which increases the rolling moment of the ship; decreased freeboard; and impaired communication, navigation, and radar capabilities caused by antenna icing and ice on wheelhouse windows. Ice accumulation can completely disrupt the functioning of certain deck equipment such as winches, and it may be impossible to access rescue equipment such as lifeboats and life rafts because of iced release mechanisms. Air intakes may become clogged with ice, and gangways, decks, and railings covered by ice make it dangerous and almost impossible to safely maneuver. Scuppers are often reduced in area and may even completely clog, impairing deck drainage and increasing the rate of ice accumulation. Active plunging of the bow into waves and swells and carrying of that spray over the ship by the relative wind, coupled with the much lower freeboard, generally causes ship icing to be more severe than rig icing (Itagaki 1984, Minsk 1984b) (Fig. 15).



Figure 15. Spray cloud amidships over a fishing trawler in the Bering Sea, 1990.

Spray ice accretion rates vary considerably with location on a ship (Ackley 1985). Though most rig icing occurs on the upwind side of rigs as diagrammed by Liljestrom (1985) from icing of the rig *GVA 5000*, the thermo-

dynamic versus water delivery processes occurring on ships during superstructure icing are better understood. Ice accretion rates on ships are determined by the balance of heat delivery by spray, both sensible and latent, and atmospheric heat removal processes. Figure 16 illustrates three icing zones that can occur on all sizes of ships.

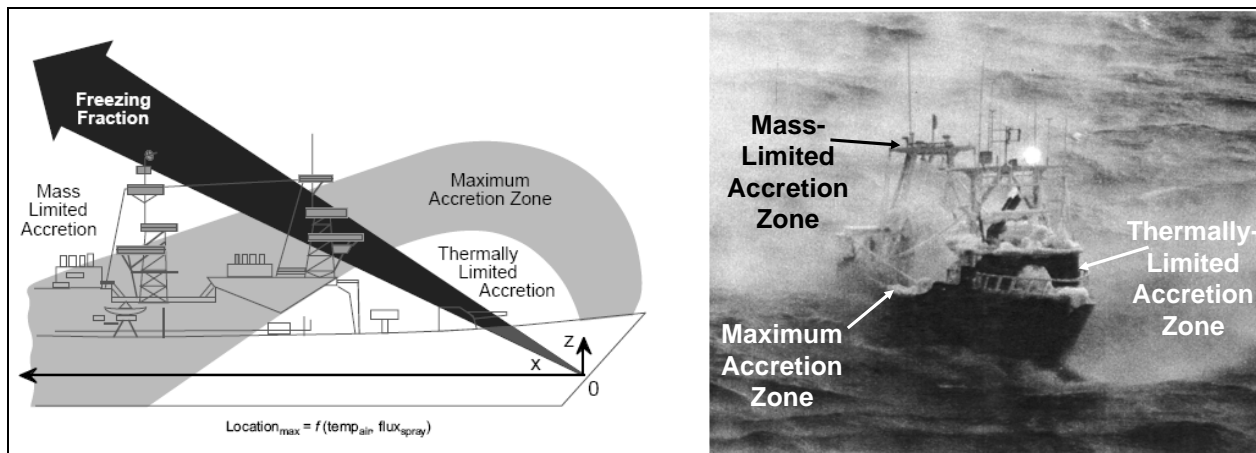

Figure 16. Zones of spray, thermal, and ice accretion processes on ships.

The maximum ice accretion area, amidships in Figure 16, is where spray delivery matches the removal rate of sensible and latent heat from impinging water for all spray to freeze (except for included brine). Maximum accretion also may occur at bow locations exposed to higher relative wind speeds, such as at the top of the bow, the windlass located on the forecastle of the fishing trawler shown in Figure 16, and the wheelhouse roof. During heavy spraying, most ice is likely to accrete amidships on a small boat, or at least aft of the bow. Though the spray flux is smaller amidships than at the bow, the rate of heat removal is such that most, if not all, water that arrives freezes. Maximum accretion is likely to occur higher on the superstructure in forward areas and lower on the superstructure farther aft because spray flux normally decreases with distance aft of the bow and with height above the deck (Fig. 16).

Thermally limited accretion (Fig. 16) takes place where the energy needing removal from the delivered spray to cause freezing, removal of sensible heat and latent heat, exceeds the atmosphere's ability to remove it. Thus, ice accretion rates are smaller than water delivery suggests, and the large volumes of water deliver sufficient heat that ice formation is suppressed where water can drain freely. Large spray fluxes, and thus thermally limited accretion, are normally found only on the bow areas, the forecastle, or along the side if the ship is not in head seas. Figure 16 illustrates thermally

limited accretion restricted primarily to the bow area, the forecastle deck, and the forward bulkhead of a trawler in the Bering Sea in February 1990.

Mass limited accretion, which generally occurs aft and above the maximum accretion zone (Fig. 16), is driven by the decrease of spray flux with distance aft and above the main deck. The mass limited accretion zone is characterized by water delivery rates—and, thus, sensible and latent heat delivery rates—that are smaller than the atmosphere's capacity to remove the heat. Thus, ice accretion in this area is limited by available spray. Figure 15 shows the flux of a spray cloud in transit and at about amidships along the superstructure of an icing trawler in the Bering Sea. Mass limited accretion is most dramatically illustrated by the upper portions of the twin masts on the trawler fantail where ice thickness decreases with height (Fig. 16). The freezing fraction, as defined by the portion of impinging spray water that remains trapped in ice on the superstructure, also increases with distance aft of the bow and with height above the water (Fig. 16).

The three superstructure icing zones are dynamic, with the amount of superstructure covered by each changing as spray delivery rates and patterns, and atmospheric conditions such as relative wind speed and direction, change as seas, ship speed and course, and weather conditions change. Thus, ice may be growing on some portions of the superstructure, while on other areas it may be eroding (Ryerson 1995). Also, depending upon ship size, spray delivery rates, and atmospheric conditions, only one, two, or all three of the zones may be found at any one time on the ship. Often, however, thermally limited accretion occurs in the bow area, transitioning to maximum, and mass limited, accretion zones at higher levels and farther aft.

As indicated, the thermal and hydrodynamics of icing of rigs is not as well-developed as on a ship. However, the same physical principals apply to superstructure icing on a rig as on a ship. However, since a rig is not moving except when in tow, and its freeboard is so large, the *maximum, thermally limited*, and *mass-limited* accretion areas are less well defined. However, photographs and written experiences of observers indicate that the lower portion of rig legs generally will be within the thermally limited zone, the upper portion of the legs and support structure, and the forward face of the structure below the main deck and above the thermally limited zone often will be in the maximum accretion zone. Areas above the main deck

and perhaps in aft areas on the upper portions of the legs and braces will be in mass-limited accretion areas. Figure 17 shows the side of the main deck area of the *Ocean Bounty* semisubmersible after a significant icing event in Cook Inlet. The center of the photo shows probable maximum ice accretion, and the extreme lower left corner of the photo shows thermally limited superstructure icing on a leg.



Figure 17. Ice on the upper legs and deck sides of the *Ocean Bounty* showing probable maximum and thermally limited ice accretion.

Ryerson (1995) measured spray and superstructure ice formation on the 115-m-long Coast Guard Cutter *Midgett* in the Bering Sea in February and March 1990. Though there were few heavy seas and only two light icing events, several useful observations were made. Spray events were measured in 1.5-m waves and 2.4-m swells at a speed of  $11 \text{ m}\cdot\text{s}^{-1}$  for a total of 39 spray events. Spray event clouds had a mean duration of 2.7 s and ranged from about 0.5 to 5.6 s in duration, with the longest events prolonged by light spray created as wind moving up the bow lofted drops from water pouring off of the forecastle deck and through the scuppers. Russians measured spray events to be about 2 s in duration, shorter than most of the *Midgett* events (Borisenkov and Panov 1974). *Midgett* spray event duration may have been longer because the ship, sea, and weather conditions of the Russian and *Midgett* measurements were different, and because the *Midgett* events were measured by imaging drops, a process that may have lengthened events because measurements were made until drops did not arrive for a period of several seconds.

The time period between spray events was not summarized for the *Midgett* spray events, but was a function of the wave/swell periods and the response of the ship to the seas as a function of its length, heading through the seas, and its speed. Often the ship would make spray at every swell for approximately 20 to 30 s, and then a period of approximately 30–60 s would pass with no spray events. This sequence would repeat for as long as conditions remained unchanged.

Drop number concentration of the 39 *Midgett* spray events varied from approximately  $2 \times 10^5$  drops  $\text{m}^{-3}$  to  $10 \times 10^5$  drops  $\text{m}^{-3}$ , with a mean of about  $4 \times 10^5$  drops  $\text{m}^{-3}$  (Ryerson 1995). The mean concentration is about 200 times greater than the concentration of raindrops found in a 25-mm  $\text{h}^{-1}$  rainfall rate thunderstorm, but about 0.04 to 0.002 the concentration of typical droplets in clouds, which are also much smaller. Average drop size was about 0.3-mm diameter, with a range of drop sizes varying from cloud drop size at 0.001- to about 7.7-mm diameter (Ryerson 1995). Russian measurements of spray drop size average about 2.4 mm, and ranged from about 1- to 3.5-mm diameter (Borisenkov and Panov 1974). Spray event liquid water content averaged about  $64 \text{ g m}^{-3}$ , and ranged from about  $1 \text{ g m}^{-3}$  to more than  $1100 \text{ g m}^{-3}$ . Most clouds have less than  $0.5 \text{ g m}^{-3}$  of liquid water.

Ryerson and Gow (2000) assessed the crystalline and physical properties of ice sampled on the Coast Guard Cutter *Midgett* in the Bering Sea in 1990. Though ice thicknesses were small, typically 1–2 cm on bulkheads and 2–3 cm on decks, useful measurements of salinity, density, and crystallography were made, values related to mechanical properties of the ice and thus to the operation of deicing technologies. Ice densities averaged  $0.90 \text{ g m}^{-3}$  on horizontal surfaces during one icing event, and  $0.76 \text{ g m}^{-3}$  on vertical surfaces. During a second event, densities averaged  $0.86 \text{ g m}^{-3}$ , with no significant difference between decks and bulkheads. The *Midgett* densities were similar to densities measured on Russian fishing trawlers (Kultashev et al. 1972, Tabata et al. 1967). Because density is controlled by temperature, position, and time necessary for brine to drain, rigs and platforms should experience ice densities similar to those on ships. Though drop velocity when striking the surface affects the density of freshwater rime ice, it is unknown whether this is a factor for rig and ship icing. If it is, rig ice density could be slightly lower if relative winds are lower during rig icing than during ship icing.

Superstructure ice salinity on the *Midgett* was larger on decks than bulkheads—similarly to density. Salinity on vertical surfaces during the two *Midgett* icing events averaged 11.4‰, and on decks salinity averaged 21.4‰ (Ryerson and Gow 2000). However, salinity on vertical surfaces ranged from 7.0‰ to 16.2‰, and on horizontal surfaces from 13.7‰ to 25.4‰. In all cases, ice was only a few hours old when sampled, and since ice on vertical surfaces becomes less saline with time, the salinities may be high. However, Panov (1972) measured higher salinities about 10–12 hours after ice had frozen on a fishing trawler.

Ice porosity is a measure of the air and brine volumes in ice, and ice with a large amount of pore space, such as saline ice, is known as spongy ice (Blackmore and Lozowski 1998). Sponginess causes ice to be thicker than ice that is fully frozen, and it causes ice thickness to be greater for a given loss of latent heat because some of the water is unfrozen in brine pockets. Both factors affect the strength of the ice and its adhesion to substrates. Though there are no known measurements of the strength effects, there are anecdotal observations and experiences by this author that indicate that spongy ice with brine filling pores adheres less strongly to substrates and is cohesively weaker, and often is flexible when removed from solid substrates. The weaker ice also appears to absorb blows from mechanical deicing apparatus more easily and therefore may make ice removal more difficult.

Total porosity measurements of the *Midgett* superstructure ice showed little correlation with ice orientation (Ryerson and Gow 2000) in two icing events. Ice orientation did, however, cause distinct differences with regard to the percentage of pores that were filled with brine versus air. A larger proportion of pores were filled with brine on horizontal surfaces than on vertical surfaces. As may be expected, on vertical surfaces brine drains more readily from ice pores, which then fill with air. Ice on decks often was saturated with water, allowing little air to enter the pores. Also, a larger proportion of pores was filled with brine in the warmer of the two icing events. Overall, total porosities on all surfaces ranged from 16.1% to 50.4%. Within those total porosities, brine filled 18–80% of pores, with vertical surfaces averaging 44% of pores filled with brine, and horizontal surfaces averaging 77% of pores filled with brine (Ryerson and Gow 2000). In general, the ice filled with brine was softer and yielded more easily to mechanical disturbance. This suggests that mechanical deicing methods

generally may be more effective on vertical surfaces of ships, rigs, and platforms than on horizontal surfaces.

### **Current Ship Ice Protection Methods**

In general, current ship atmospheric and superstructure ice protection methods are sufficiently similar to those presented in the rig summary that they may be applied, with few exceptions, to ships. Mechanical methods using baseball bats and mallets are still most common, as shown in Figure 12 on a crabbing boat in the Bering Sea.

In the 1980s, 10–12 ships were lost annually worldwide as a result of superstructure icing (Crowley 1988). It is not known whether that number has declined today, but it probably has because ships have an ability to navigate away from forecast icing conditions and avoid or minimize exposure to superstructure icing. Rigs and platforms cannot avoid the conditions. Improved weather forecasting, especially of intense Polar Lows around Alaska, allows ships to navigate around these storms or remain in port (Guest 2002, Overland et al. 1986). Guest (2002) suggests that, to avoid icing, ships should remain in harbor, navigate lee of an island or other land area, get close to the sea ice edge, or head downwind, adjusting speed and direction to minimize spray. However, he warns that turning a ship through a trough, especially when the ship is ice covered, may be fatal.

Ships must be equipped for deicing in Arctic waters such that deicing can occur within a period of 4–6 hours. Mejl  nder-Larsen (2006), discussing the design of new ice-class LNG ships by SMM Hamburg, indicates that during superstructure icing, stability and safe navigation are impaired and safety equipment is affected. He indicates, as with rigs, that antennas and radar equipment are taken out of operation, ice accumulates on wheelhouse windows, rescue equipment such as lifeboats and rafts ice, and gangways and railings fill with ice, thereby making safe movement on deck dangerous and almost impossible in some circumstances (Fig. 18). Also, equipment on deck often ceases to function as a result of ice accumulation on anchors, air pipes, and valves. When scuppers in bulwarks clog with ice, shipped water on deck accumulates and eventually freezes.





Figure 18. Superstructure ice covering life rafts, antennas, and windows of small trawler-size boat.

## **7 Technologies That May Address Critical Superstructure Icing Needs**

Deicing is the process of removing accumulated ice from a structure. Anti-icing is the process of preventing accumulation of ice on a structure. Anti-icing technologies are used where continuous operations are required, such as navigational equipment and fire lines. Deicing technologies are used for equipment and areas where some accumulation of ice is tolerable. Both processes protect structures from icing, and the technologies associated with the processes are referred to as ice protection technologies.

Ice protection technologies are common in most disciplines that must cope with the effects of supercooled drops that strike and freeze upon surfaces, or the accumulation of frozen or freezing precipitation. A goal of ice protection technologies, in general, is to keep the process of anti-icing or deicing as much in the background as possible so that operators of systems subject to icing do not need to monitor the conditions. Therefore, ice detection technologies are included in ice protection systems. Too often, operator eyes are the only ice detection methods available. Human observation is being replaced with technologies that detect the presence of icing conditions, or directly measure ice accumulated on a surface.

Ice protection is necessary in many disciplines, and this review of ice protection technologies is drawn from many areas. These include aviation, rail, road, and water transportation systems, electrical transmission systems, communication systems, and other disciplines and research environments where promising technologies may not yet have found application.

This review touches upon most current ice protection technologies that range in development from nascent to mature. The review indicates whether technologies are used for deicing, anti-icing, or ice detection, including a description of the physical principles used, application if any, and potential technological development, if known. The review also will include, if known, current developers or marketers of the technology. The review, however, does not systematically suggest which technologies may be applicable to the marine environment. That analysis will follow in a later report.

The technologies are organized arbitrarily by technology or application. In some cases, such as cables and windows, the applications are unique and are best addressed individually.

The following technologies or applications are reviewed:

1. Chemicals
2. Coatings
3. Design
4. Electrical
5. Explosive
6. Heat
7. Hydraulic and steam lance
8. Infrared
9. Mechanical
10. Millimeter wave
11. Piezometric
12. Pneumatic
13. Vibration
14. Windows
15. Cables
16. Ice detection

## 8 Chemicals

### Background

Deicing and anti-icing chemical development is probably the most active area of ice control research with regard to new products and investment capital. This is because dry and wet chemicals are used in large volumes and at great cost for highway and runway ice and snow control and for airframe deicing and anti-icing.

A complete guide to how to use highway deicing chemicals is available from the Strategic Highway Research Program (Ketcham et al. 1996). Documentation of the effect of chemical runway deicers on aviation and related materials is available from the Air Force Research Laboratory (Cooper et al. 2000). Documentation of the characteristics and use of airframe deicing and anti-icing chemicals is available from the Environmental Protection Agency (EPA 2000) and the Society of Automotive Engineers (SAE 2007).

Chemicals are applied, either wet or dry, before storms for anti-icing and to reduce the adhesion strength of ice to pavements, and during and after storms to break and melt ice, and to reduce its adhesion strength. On airframes, chemicals are applied with hot water to melt ice and snow and to reduce the freezing point temperature to allow it to run off before refreezing. Anti-icers are applied to absorb freezing precipitation and to depress freezing point to prevent freezing or, in the case of snow, to melt the ice.

### Technology

The most widely used deicing chemicals are sodium chloride, calcium chloride, magnesium chloride, potassium chloride, calcium magnesium acetate, and urea. Sodium chloride (NaCl), rock salt, has been used heavily since the 1940s. Sodium chloride is most effective at temperatures warmer than  $-10^{\circ}\text{C}$ , though at a concentration of 23.3% the freezing temperature of NaCl brine is  $-51^{\circ}\text{C}$  (Wisconsin Transportation Center 1997). Rock salt deices rapidly at higher temperatures, but rapidly decreases in effectiveness as temperature decreases. Salt has an endothermic reaction in water and therefore draws heat from ice and snow when causing melting, thus slowing the melt rate (Kirchner 2001, Mishra 2001). NaCl is known for its

corrosiveness to metals. The corrosive capability of chemical deicers is related to the concentration of salt in seawater, the concentration at which it is most corrosive, about 3%. Materials are considered a corrosion inhibiting deicer if they corrode at less than 70% the rate of NaCl (Mishra 2001).

Calcium chloride ( $\text{CaCl}_2$ ) provides an exothermic reaction with water, releasing heat as it melts ice, making it effective to temperatures of  $-32^\circ\text{C}$ , with a eutectic temperature of  $-51^\circ\text{C}$  at a concentration of 29.8% (Mishra 2001). Calcium chloride is available as a liquid or a solid as pellets or flakes, but in pellet form is the fastest penetrating of chemical deicers, because the chemical attracts and retains moisture, allowing it to act faster. As a salt, it accelerates the corrosion of metals (Kirchner 2001).

Magnesium chloride ( $\text{MgCl}_2$ ) is claimed to have a deicing rate similar to that of NaCl, but slower than that of calcium chloride. Magnesium chloride is also nearly as corrosive as NaCl, but can be mixed with anti-corrosion materials that claim to decrease its effects. Nevertheless, despite claims by highway maintainers that their corrosion is reduced, truckers and electric utilities with lines along highways have experienced increased corrosion (Pavek 2001). Snow (n.d.) claims that magnesium chloride also causes increased concrete spalling. Magnesium chloride is sprayed on pavement prior to snow or ice events as an anti-icer, but is also available in pellet form as a deicer.

Potassium chloride (KCl) is of limited use on pavements because of its ability to damage vegetation (Rindels 1996). Potassium chloride is naturally a liquid, as is calcium chloride, so it is often sprayed onto surfaces. It has the highest eutectic temperature ( $-11^\circ\text{C}$ ) and highest practical working temperature ( $-4^\circ\text{C}$ ) of all chemical deicers and is therefore ineffective at low temperatures. As a chloride, it is also corrosive to most metals.

Calcium magnesium acetate (CMA) is a relatively new deicing compound manufactured from limestone and acetic acid, and contains no salts. It causes little damage to concrete and little corrosion to metals (Dalecky et al. 1996, TRB 1991). It is a slower acting deicer than NaCl at temperatures below  $-5^\circ\text{C}$  and must be applied in greater quantities (TRB 1991). Though CMA has few negative environmental effects, it is more expensive than most deicers.

Urea [ $\text{CO}(\text{NH}_2)_2$ ] is available in pellets, but causes damage to vegetation and surface water by adding excessive nitrates. Its eutectic and working temperatures are high,  $-12^\circ\text{C}$  and  $-4^\circ\text{C}$ , respectively. Because it releases ammonia into the air when in contact with water, it is toxic in poorly ventilated locations. It also severely corrodes metals, though it does not harm concrete (Frank 2004).

Among the highway deicers, calcium chloride is most effective as a deicing and anti-icing agent. However, its corrosivity is of concern when used on metal structures.

Deicers and anti-icers used in aviation must be less corrosive than those used for highway snow and ice removal. However, the large volumes of material used are of concern because of environmental impact. There is significant interest within the Department of Defense for developing a non-chemical solution for deicing aircraft, but chemicals are and will continue to be the primary method of keeping runways clear of ice and snow, and aircraft clear of ice and snow before takeoff.

The most common deicing and anti-icing chemicals used on runways, taxiways, and all areas where aircraft operate include ethylene glycol, propylene glycol, urea, UCAR (approximately 50% ethylene glycol, 25% urea, and 25% water by weight), potassium acetate, sodium acetate, sodium formate, and CMA (EPA 2000). Fluids used on aircraft for deicing (Type I) and anti-icing (Type IV most commonly) are typically propylene glycol-based and also include corrosion inhibitors, flame retardants, wetting agents, and dyes (EPA 2000). Ethylene glycol was once also a common base stock for deicing and anti-icing fluids, but is banned for this application in North America today because of its toxicity.

Urea and CMA are also highway deicing chemicals (discussed above). All other highway deicing chemicals are too corrosive for use with aircraft, and even many of the chemicals used with aircraft today are found to damage wiring, fuselage skins, and brake components. Many of these chemicals are under study and already are discouraged for certain applications, especially military aircraft.

Potassium acetate is the most common pavement deicer used at airports (EPA 2000). It, sodium acetate, and sodium formate are approved by the Air Force for use on runways and taxiways (Air Force 2005). These three

chemicals are more acceptable than others environmentally. Potassium acetate is reported as degrading electrical system wiring insulation; sodium formate has the lowest corrosivity of the three chemicals. Potassium acetate is applied as a liquid and has an effective working temperature of  $-29^{\circ}\text{C}$ . Sodium acetate is granulated and has an effective minimum working temperature of  $-12^{\circ}\text{C}$ . Sodium formate has an effective minimum working temperature of  $-15^{\circ}\text{C}$  (Air Force 2005). Despite claims of low corrosion, however, airlines and the Air Force have reported corrosion of carbon brake linings due to potassium, sodium, or calcium. Also, corrosion of infrared laser subsystems have been attributed to acetate deicing chemicals (Air Force 2006).

Propylene glycol (PG) is the base stock for all current aircraft deicing and anti-icing fluids. PG, an alcohol, is manufactured for deicing by adding corrosion inhibitors and fire suppressants. It has a high Biological Oxygen Demand (BOD), causing problems with eutrophication of surface water in streams and lakes. However, it is not regulated as a hazardous substance (Air Force 2005). Propylene has a minimum working temperature of about  $-30^{\circ}\text{C}$ , though it can be taken to  $-48^{\circ}\text{C}$  when the solution is 60% PG ([http://www.engineeringtoolbox.com/propylene-glycol-d\\_363.html](http://www.engineeringtoolbox.com/propylene-glycol-d_363.html)). During aircraft deicing, PG is typically heated to  $80^{\circ}\text{C}$ , making it more effective as an ice melter. The PG solution prevents the runoff from freezing before leaving aircraft surfaces. PG applications for aircraft are regulated by Society of Automotive Engineers Aerospace Material Specifications (SAE 2007) and Environmental Protection Agency regulations (EPA 2000). The Air Force also has conducted extensive materials compatible tests of PG and other aircraft and runway deicing chemicals (Cooper et al. 2000, Gulley 1998). When used for deicing pavements, or surfaces including non-skid, glycols decrease the coefficient of friction and have caused sliding of aircraft on aircraft carrier decks during heavy weather.

Environmental compliance requirements and corrosion have prompted the Air Force and the Army to actively seek deicing fluids based upon stocks different from PG. For example, Battelle, Foster-Miller, and METTS Corporation have attempted to construct fluids based upon stocks derived from organic residues, such as corn residue. The METTS fluid was a successful deicer and passed all SAE requirements for Type I fluids, but it failed Air Force requirements. Failures of all the fluids have been due to problems such as foaming and viscosities that increase as the material dries, causing the material not to shear off at takeoff. This residual mate-

rial, though perhaps protecting the aircraft as an anti-icing material, also has the effect of obscuring visibility through windows (Fig. 19). Though these are serious problems for aircraft applications, they may be acceptable for less rigorous requirements.



Figure 19. Residues remaining on aircraft windows after testing a non-glycol-based deicing fluid.

The Army cannot apply PG to helicopters because it washes grease from rotorhead bearings, causing failure. However, it has designed an Aircraft Cleaning and Deicing System (ACDS) that sprays cleaning solutions and, when available, deicing fluids with low pressure (Fig. 20).



Figure 20. Army Aircraft Cleaning and Deicing System portable pump and fluid recovery system.



## Application

Deicing and anti-icing chemicals are widely available commercially. Most are applied to pavements, including roads, parking lots, sidewalks, runways, and taxiways. Aircraft deicing is the other large application of deicing chemicals. Because chemicals cannot remain on the aircraft when in flight, PG-based Type I deicing fluids and Type IV anti-icing fluids (the most widely used types) are designed to shear off of the wing at takeoff rotation speeds. Cooper et al. (2000) provide comprehensive tables of all current aviation-related deicing and anti-icing chemicals.

Fluid deicing technology also can be utilized in flight. A bleeding wing system marketed by TKS Products pumps glycol-based fluid through small holes in the leading edges of wings, causing the wing to be coated with fluid either prior to icing or during icing (CAV Aerospace 2008). The windshield is protected with a spray and the entire aircraft can be protected for up to three hours. The technology is used on many single engine aircraft, and on the Predator Unmanned Aerial Vehicle (UAV). Makkonen (1984) states that chemicals generally are not practical deicing and anti-icing solutions on marine structures because of the difficulty of applying them in a controlled manner.

## Sources

Dow Chemical Company  
800-447-4369  
989-832-1560

Cryotech Deicing Technology  
6103 Orthoway  
Fort Madison, IA 52627  
800-346-7237 or 319-372-6012  
Fax: 319-372-2662

CAV Main Office  
2734 Arnold Court  
Salina, Kansas 67401  
Phone: 785-493-0946

Glycol Specialists, Inc.  
14 Lakeside Lane  
Denver, CO 80212  
Phone: 303-477-9998 or 303-477-6999  
FAX: 303-458-7050  
Contact: Mr. Rick Silverberg, Mr. Jim Hamilton, or Mr. Lee Durrwachter

Lyondell Chemical  
1221 McKinney Street  
One Houston Center  
Houston, TX 77010  
Phone: 800-321-7000, select option 5  
Contact: Ms. Susan Tanner, Business Manager  
Service: Manufactures ARCOPLUS (Commercial Type I)

Ashland Chemical Company  
IC&S Division  
5200 Blazer Parkway  
Dublin, OH 43017  
Phone: 614-790-3333  
FAX: 614-889-3465  
Contact: Mr. Bob Strawn, Marketing Director  
Contact: Mr. Tony Myhra, Product Manager  
Service: Acetate Product Vendor for Airfield Deicing: Distributor of potassium acetate formulation Cryotech E36 Liquid Runway Deicer, calcium magnesium acetate formulation Cryotech CMA, and sodium acetate formulation Cryotech Clearway 2s.

Old World Industries, Inc.  
4065 Commercial Avenue  
Northbrook, IL 60062-1851  
Phone: 847-559-2000  
Service: Distributor of potassium acetate Safeway KA deicing liquid. Potassium acetate is available by ordering NSN 6850-01-341-9855 (55-gallon drum)

Cryotech Deicing Technology  
6103 Orthoway  
Fort Madison, IA 52627  
[WWW.CRYOTECH.COM](http://WWW.CRYOTECH.COM)  
319-372-6012  
800-346-7237  
[deicers@cryotech.com](mailto:deicers@cryotech.com)

CARGILL DEICING TECHNOLOGY  
24950 Country Club Blvd. Ste 450  
North Olmsted, OH 44070  
800-600-7258

## 9 Coatings

### Background

Coatings are materials applied to the surface of ice-accreting substrates to reduce the adhesion strength of ice to the substrate. There is a common notion that icephobic coatings, coatings that have reduced adhesive strength with ice, prevent or reduce icing. Because icephobic coatings also are often hydrophobic, they do have the potential to reduce icing amounts. However, icephobic coatings typically do not prevent icing (Anderson and Reich 1997, Mulherin and Haehnel 2003), and, in general, hydrophobic coatings (those that repel water) are not necessarily also icephobic.

Development and testing of icephobic coatings is one of the most active areas of anti-icing/deicing research. Coatings are attractive because an ideal coating would prevent icing, would be easily applied over any substrate, would be inexpensive, would require little or no maintenance, and because of its passive nature would require no power. In reality, most hydrophobic coatings have little icephobicity, most do not have longevity (thus requiring frequent maintenance or cleaning to maintain the low adhesion characteristics, especially after numerous icing events), and many are not easily applied and require frequent reapplication. According to Mulherin and Haehnel (2003), ideal coatings will significantly reduce ice adhesion, are durable, are low in cost, and are easy to apply.

Though many methods have been evaluated to test the adhesive strength of ice to substrates, a common method is to freeze a coupon coated with the candidate material into an ice mass confined within a mold, and then either pull or push the coupon out of the ice mass. The force applied when failure occurs provides a measure of the force necessary to remove the ice from the substrate. Haehnel and Mulherin (1998) applied the zero degree cone (ZDC) test to evaluate coating capability (Haehnel 2002) (Fig. 21). Others use flat coupons in a double lap shear arrangement to accomplish the same task, though it is not clear how comparable results are for the different testing techniques (Ferrick et al. 2006a, 2006b, 2008) (Fig. 22). Testing of coatings requires an understanding of how ice and coatings fail, effects of operating at different temperatures, surface roughness, ice relaxation time, and strain rate effects on ice and coatings. Also, water used in tests is typically distilled, deionized, and de-aerated. Many different

methods are used, thus making comparisons between the results of one test procedure and the next difficult.

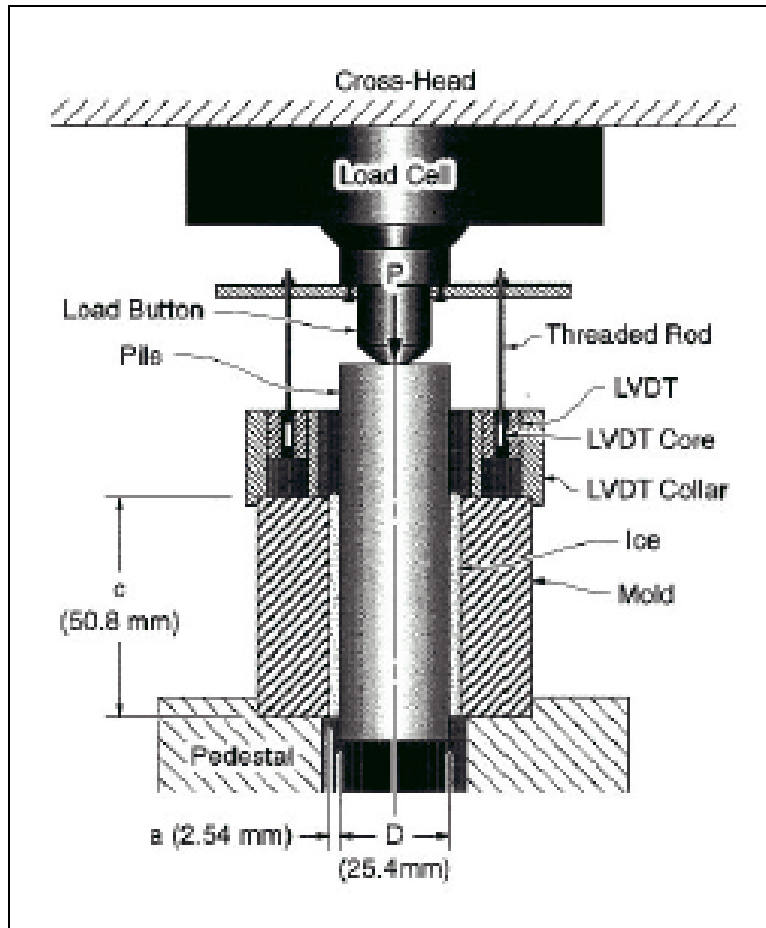

Figure 21. Mulherin and Haehnel (2003) Zero Degree Cone Test apparatus.

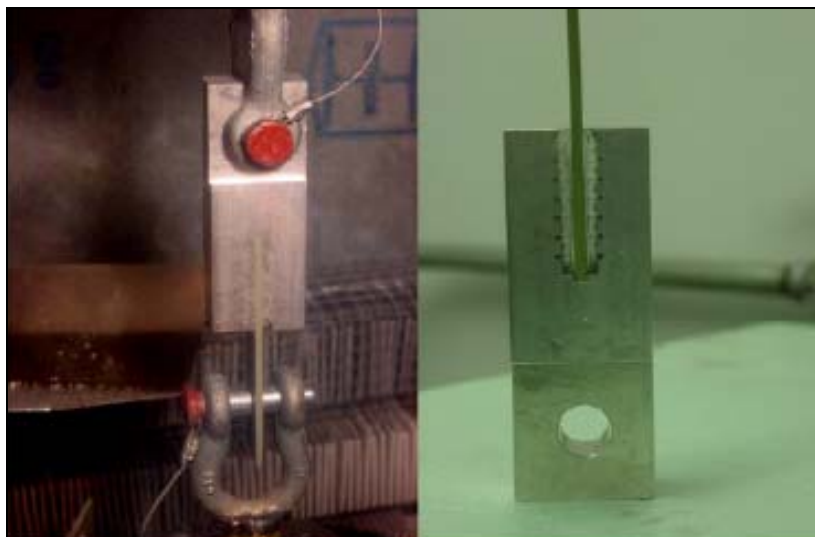

Figure 22. Ice pulled from a coupon (Ferrick et al. 2008).

Mulherin and Haehnel (2003) at CRREL have tested a large number of coatings and have done comparative reporting of strengths. They demonstrate that adhesion strength of ice to substrates varies nearly six times, from about 1200 kPa to 1300 kPa for standard mil-spec and Corps of Engineers lock paints and some commercial icephobic coatings, to about 238 kPa for unweathered Teflon. Several of the coatings have adhesion strengths similar to that of bare paint, and some of the paints have adhesion strengths as low as some of the better coatings. Ferrick et al. (2008) found, using ASTM double lap shear testing procedures at temperatures of  $-112^{\circ}\text{C}$ , much colder than Mulherin and Haehnel's (2003)  $-10^{\circ}\text{C}$ , over an order-of-magnitude range of strengths with a wide mix of coatings. It is unknown whether the Ferrick et al. (2008) results would be similar at warmer temperatures, but it is likely (Ferrick personal communication 2008). Ferrick et al. (2008) also found that the best coating failed within the coating rather than at the ice/coating interface. This pattern repeated for four subsequent tests on the same samples until testing stopped. This suggests that this coating, and likely many, have a finite performance life because a layer of material is taken with the ice at each release.

## Technology

Coating technology varies widely in material properties, chemistry, and design. Most coatings are of a single chemical compound that is applied to surfaces by spraying or brushing. Or, they are materials such as plastics that can be structural materials themselves. As a solid material, Teflon has been found to have nearly the lowest ice adhesion strength of all materials (Frankenstein and Tuthill 2002, Mulherin and Haehnel 2003). Mulherin and Haehnel (2003) also indicate that polyethylene has an adhesive strength similar to Teflon (Boluk 1996). However, Teflon is soft and is not generally a durable structural material. Other non-durable materials that have demonstrated very low adhesion values include Silicone grease (Boluk 1996) and Lithium grease (Laforte et al. 2002). Grease typically readily washes from surfaces, and is often removed with the ice, making it a non-durable coating.

Of more durable materials, the polysiloxanes have among the lowest ice adhesion strengths (Frankenstein and Tuthill 2002). However, some siloxanes, such as Kiss-Cote, were found to increase mean adhesive strength when coated over some paints, and decrease it when coated over other paints (Mulherin and Haehnel 2003). This suggests that coatings cannot be applied blindly to materials with the expectation of a specific perform-

ance. It is prudent to test with the specific materials of interest before making large investments in applications. Also, the effects of weathering on the ice adhesion strengths of coatings should be investigated during testing. Mulherin and Haehnel (2003) reported after a weathering test that, though changes had occurred in specific samples increasing and even decreasing adhesion strength, there was no significant difference in strengths after weathering had occurred.

The lowest adhesion strength ever measured at CRREL was a silicone by NuSil Technology (Sivas et al. 2008). Compared to Teflon's average adhesion strength of 238 kPa, NuSil R-2180 has an average adhesion strength of 37 kPa; another material, Phasebreak B-2, has an average strength of 117 kPa. Even after roughening with sandpaper and weathering to simulate thermal and humidity cycling and salt spray, the adhesion strength of NuSil R-2180 was always lower than that of unweathered Teflon.

Ferrick et al. (2008) evaluated a series of coatings at cryogenic temperatures for the space shuttle fuel tank icing problem. The control was Koropon coated aluminum, as is found on the shuttle fuel tank. Coatings tested included lithium grease, Braycote, and a mix of Braycote and Rain-X with powdered MP-55 Teflon included. The Rain-X with Teflon MP-55 showed adhesion strengths approximately 10% of that of the control with consistent results during repeat testing. They recommend continued testing to refine optimal formulation, application, cure, and durability questions.

In many cases, coatings that only reduce ice adhesion are insufficient. Coatings also require easy field application and often require abrasion resistance. Several companies have proposed developing coatings for Army helicopters that are icephobic and abrasion-resistant. However, only one such coating is in development. It is reported that the Air Force is also funding icephobic coating work.

Developers are still seeking a coating that will prevent ice formation, and at least two approaches have been taken. The first is a nanotechnology approach to embed capsules of anti-icing compound within an icephobic coating material (Microphase 2008). With Air Force Small Business Innovation Research (SBIR) funding, Microphase Coating, Inc., created a coating with low ice adhesion that is erosion-resistant and renewable, and has high adhesion to substrates. The coating is composed of epoxy, silicate mesh, and freezing-point depressants in embedded nano-capsules. As the

coating erodes, the capsules break and ooze freezing point depressant at the ice-coating interface, thereby intending to reduce ice accretion rates.

The other approach to reduce ice accretion with coatings is with new superhydrophobic materials using lotus leaf technology. Superhydrophobic materials have surfaces that are extremely difficult to wet and exhibit water contact angles in excess of  $150^\circ$  (Fig. 23). Two effects, chemical and physical, are believed to cause this hydrophobicity. The chemical effect is like oil and may be caused by wax that coats lotus leaves. The physical effect is caused by surface roughness (Fig. 24). The droplets sit atop micro-bumps and are called “fakir drops,” apparently because rough materials have larger surface areas than do smooth materials, thereby increasing hydrophobicity. Air also can be trapped within the roughness elements, enhancing its hydrophobicity because the drop is then partially sitting on air (Quéré 2002).

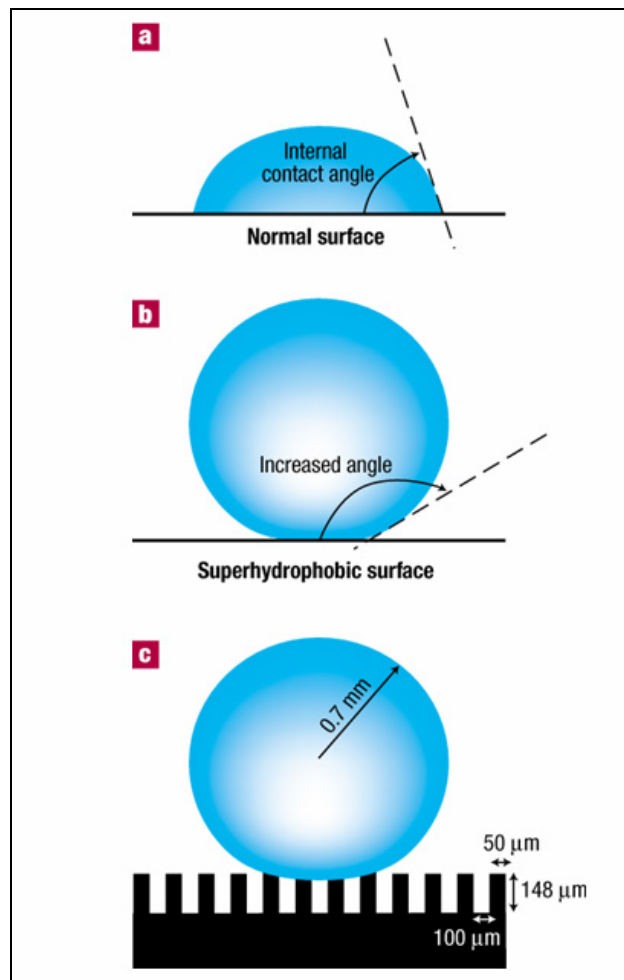

Figure 23. Drop contact angles on substrates, with lotus leaf effect at 23c.



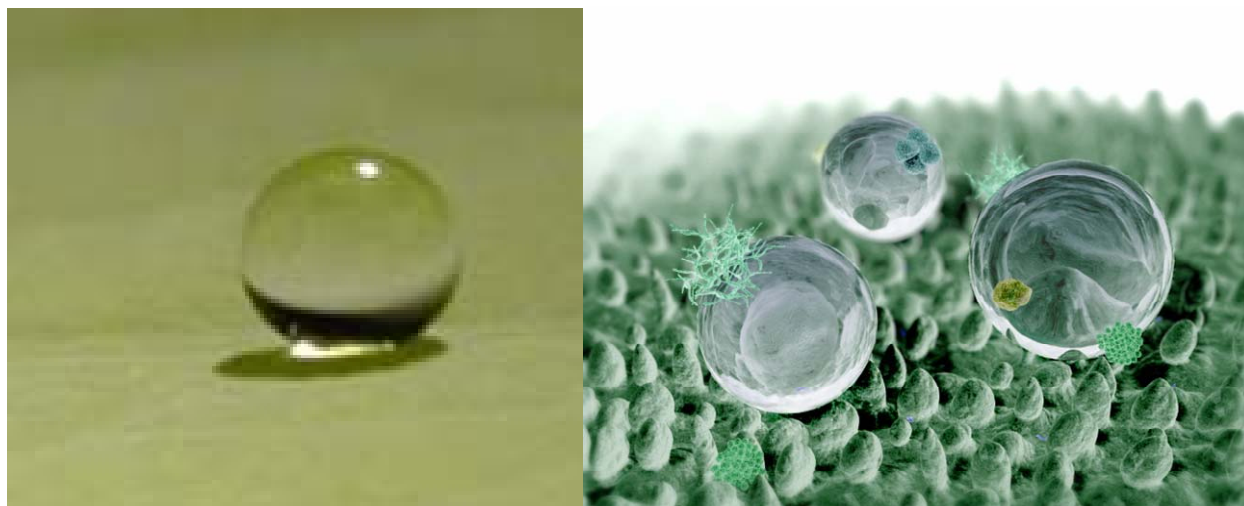

Figure 24. Drops on a lotus leaf (left) and on a simulated lotus leaf at high magnification (right).

Developers are emulating the surface roughness effects of the lotus leaf to induce superhydrophobicity. Though this is not icephobicity, the logic is that when the drops freeze they will not adhere to the surface but will slide off and ice will not accumulate. One Army SBIR developer is taking this approach for helicopter icephobic coatings.

## Application

Current applications include aircraft deicing boots (Anderson and Reich 1997), aircraft engine inlets (Microphase Coatings 2008), navigation lock walls (Frankenstein and Tuthill 2002, Mulherin and Haehnel 2003), and ship hulls (Cape Cod Research 2008). Potential applications include ship superstructures and drill rigs.

## Sources

e Paint Company  
25 Research Road  
East Falmouth, MA 02536  
[www.epaint.net](http://www.epaint.net)

Physical Optics Corporation  
Information Technologies Division  
20600 Gramercy Place, Bldg 100  
Torrance, CA 90501-1821  
[www.poc.com](http://www.poc.com)

Infoscitex Corporation  
303 Bear Hill Road  
Waltham, MA 02451-1016  
[www.infoscitex.com](http://www.infoscitex.com)

Nanohmics, Inc.  
6201 East Oltorf Street  
Suite 400  
Austin, TX 78741-7511  
[www.nanohmics.com](http://www.nanohmics.com)

Microphase Coatings, Inc.  
170 Donmoor Court  
Garner, NC 27529

NuSil Technology LLC  
1050 Cindy Lane  
Carpinteria, CA 93013 USA  
Tel: 805-684-8780  
Fax: 805)-566-9905

Rain-X  
SOPUS Products  
Technical Information Center/Building L-133  
PO Box 4327  
Houston, TX 77210

Cape Cod Research  
19 Research Road  
E. Falmouth, MA 02536

## 10 Design

### Background

Improved design of rigs, drilling platforms, and supply boats can be a significant method of reducing superstructure icing. Of the methods for preventing icing, preventing water from freezing, or preventing liquid water from striking the superstructure, design reduces water from striking the superstructure. Also, optimal design is a passive technology that has minimal operational cost if it does not cause inefficiencies, though it may possibly increase design and construction cost.

### Technology

Numerous examples were supplied earlier of improved design of drilling platforms for cold waters. Ocean Rig (Tollefsen 2006) recommends including an enclosed derrick, heated walkways, wind walls, additional heating facilities, and temporary local shielding around working areas as provided on the *Eric Raude* semisubmersible. Pakarinen (2006) of Stena Drilling recommends drill ships rather than rigs in cold regions. They also recommend wind walls that protect the vessel and the crews, deicing equipment, and a system to constantly flush the deck with warm seawater during icing conditions. All deicing equipment aboard the *Stena Drillmax* is powered by electricity, and systems are designed to operate in temperatures to  $-40^{\circ}\text{C}$ . Also, the overall design must be as “clean” as possible, with few small-diameter elements, enclosed systems, and freeboard sufficient to reduce splashing of deck and other working areas.

Baller and Friedberg (1984) make a wide range of recommendations for rig design for northern waters of coastal Norway. These include enclosing the cellar deck, heat tracing outdoor piping and drains, improving derrick enclosure, and adding heating capacity to the cellar deck. They also recommend adding payload capacity to accommodate any ice loads, and minimizing structure surface imperfections where ice initially forms and adheres most strongly, such as joints, welds, and small-diameter objects.

Baller and Friedberg (1984) identify areas that must be maintained as permanently ice-free, where minor ice accretion can be tolerated, and where ice removal is not required. Areas that must be kept ice-free include

the drill floor, life boat launch stations, helicopter deck, escape passageways, cranes, antennas, and air intakes. Areas that can function with minor ice accretion include roofing on pipe racks, living quarters, winches, covered passageways, and parts of the hull, columns, and bracing. Areas that can tolerate ice continuously include the outside of the derrick enclosure and some vertical hull areas. Also, Baller and Friedberg (1984) specify that winterization of a drilling rig can be broken into five topics, including the outside envelope, deicing and anti-icing, marine and drilling systems, heat supply, and low-temperature-tolerant materials. The outside envelope involves enclosure of the derrick, covering of pipe racks and winches, and minimization of surface area for ice to accrete upon. Recommended deicing and anti-icing technologies are steam, hot air, and electrical traces. They claim that infrared, electromagnetic, and pneumatic technologies have limited applications.

Eikill and Oftedal (2007) summarize Statoil's perspective of Arctic rig design for the Barents Sea. Satisfying Statoil's Arctic ambitions required that rig exposed areas, such as the derrick, drill floor, muster stations, pipe, and riser deck should be fully enclosed; all critical equipment, escape ways, and muster stations should be heat-traced; and utility systems should be placed in enclosed heated voids under deck to avoid environmental damage. Having safety systems, such as well control equipment, is also recommended, and positioning systems, firefighting, and escape systems should be designed for  $-25^{\circ}\text{C}$  in standby mode. There also should be a redundant Automatic Thruster Assist (ATA) positioning system when there are shallow water depths and low satellite coverage, such as in the Barents Sea.

With regard to some of these recommendations, if rigs are constructed with less surface area, there will remain relatively large, flat surfaces. Takeuchi (1979) demonstrates that snow accretion can be minimized on flat surfaces by altering wind flow by shifting the stagnation point and making snow strike the surface at an acute angle and not stick. This technology may be applicable to large flat areas of rigs or ships.

Supply vessels should be constructed with little rigging and mast area, a strongly flared bow to deflect spray, and greater freeboard to minimize spray. Lyle (2001) recommends designing increased buoyancy into supply vessels to accommodate ice accretion. He cites several supply vessels designed to accommodate 0.3 m of accreted superstructure ice.

## Application

Applications are to all elements of a ship or rig that reduce surface area for ice to accumulate, promote drainage of spray before freezing, minimize spray creation, and maximize spray deflection.

## Sources

Ocean Rig ASA  
PO Box 409, Forus  
N-4067 Stavanger  
Norway  
Visiting address:  
Vestre Svanholmen 6, Forus  
N-4313 Sandnes  
Norway  
[oras@ocean-rig.com](mailto:oras@ocean-rig.com)

Stena Drilling Ltd  
Greenbank Crescent  
East Tullos, Aberdeen  
AB12 3BG, Scotland  
Tel 01224 401180  
Fax 01224 897089

# 11 Electrical Techniques

## Background

Recently several innovative deicing technologies have been developed using electrical techniques that are not strictly thermal nor millimeter wave. These techniques cause ice to melt in a thin layer at the ice/substrate interface, melt through the entire ice thickness, or cause erosion of the ice, thereby physically disconnecting it from the substrate. Methods also have been developed for electrical control of ice adhesion to substrates, causing it to either decrease or increase at will. All of these technologies have been developed in association with Professor Victor Petrenko at Dartmouth College.

## Technology

Three fundamental electrical techniques have been developed to modify the adhesion strength of ice to substrates. The techniques are 1) application of a DC bias voltage to the ice/substrate interface, 2) pulse electrothermal deicing, or 3) ice dielectric heating. The inventions evolved from basic research funded by the Army and other federal agencies and engineering development by private industry. Because the more recent engineering work is privately funded, many details are proprietary and are therefore unavailable.

### DC Bias Voltage

The first technique changes ice adhesion strength by applying a small DC current to the ice/substrate interface through interdigitated conductors (Petrenko and Courville 2000, Petrenko and Qi 1999). The strength of the ice/substrate bond can be increased or decreased ten times depending upon the polarity of the voltage applied. Two processes operate to cause this phenomenon. The first process that causes adhesion strength to change is modification of the electrostatic charge holding ice to substrates. A less-than-2-V DC current can modify the electrostatic charges, and the polarity of the charge causes adhesion to either increase or decrease (Petrenko and Courville 2000). If the electrical charge exceeds 2 VDC, electrolysis begins—the second process. Electrolysis is the reduction of water molecules to the component hydrogen and oxygen gases and the creation of pockets of gas in the interfacial area. The pockets of gas form

as a result of interfacial ice being converted to gas, thus eroding ice where it contacts the substrate. The erosion reduces contact area and thus adhesion strength. Petrenko and Courville (2000) found that adhesion strength could be reduced ten times by applying 21 V for 30–60 s. Bubbles that form in the ice are evidence that the process is occurring (Fig. 25); the bubbles are effectively interfacial cracks that help peel the ice away, and pressure from the gas bubbles may provide an assist in removing the ice (Courville and Petrenko 2000). The practical application of the technique is dependent upon two factors: the electrical conductivity of the ice and electro-corrosion of the anode material in the interdigitated circuit (Petrenko and Courville 2000). If ice electrical conductivity is low, higher currents must be applied to the circuit to cause electrolysis. The higher current causes more rapid corrosion of the circuit elements and failure. As a result, Courville and Petrenko (2000) conducted experiments with many different conductor designs and materials to reduce corrosion rates. The technology is being developed by industry and the progress of development is unknown.

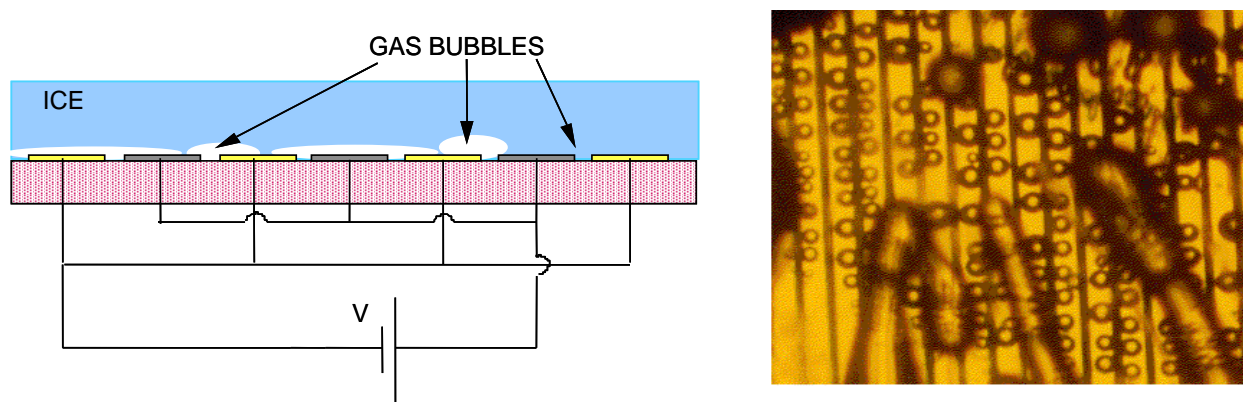

Figure 25. DC bias voltage deicing where electrolysis forms bubbles at the ice/substrate interface as seen diagrammatically in profile (left) and photographically from above (right).

### Pulse Electrothermal Deicing

The second technique is pulse electrothermal deicing (Petrenko 2005, Petrenko et al. 2003). Typical electrothermal deicers provide a certain power density, and thus a thermal rise, for a time period that is relatively long. In general, if the heating rate of interfacial ice is slow because the thermal rise is slow, more heat will be lost in the ice and substrate as a result of thermal conductivity, and more total power will be consumed. Therefore, if a thin film conductor is used and the thinnest layer of ice necessary to cause ice removal is melted, most heat will be used for the neces-

sary work, that of converting a layer of ice to water, and less heat will be lost to the environment. Therefore, as indicated by Petrenko et al. (2003), by shortening the “on” time of the heater and providing the highest power possible instantly, the total energy used is reduced because less heat is lost. The thin film heater must be placed directly at the ice interface to be most effective.

Current systems of electrothermal heating of helicopter blades, for example, place heating wires 1–3 mm inside the rotor blade leading edge under the thermally conductive titanium abrasion shield. This system requires that the abrasion shield be heated before the ice can melt, thus requiring considerably more energy. Short pulses of power to interfacial thin film heaters that provide energy for melting faster than heat can be conducted away reduces power usage. Though Petrenko et al. (2003) advocate the technology’s use for airfoils, ships, and oil rigs, and have demonstrated it on many surfaces in the laboratory, practical application in the operational environment would be more difficult (Fig. 26). The technology is being developed by Goodrich for aviation applications. Goodrich states that they have assessed the technology for offshore structures, do not believe that there is a market, and will share no information (Sweet personal communication 2007). Petrenko et al. (2003) indicate that the power required to remove ice with the pulse method is about 1% of the power required with traditional electrothermal deicing methods.



Figure 26. Deicing a metal plate with pulse electrothermal deicing. The ice sheet on the right was released moments before the image frame was acquired.



### Ice Dielectric Heating

The third electrical method uses high frequency excitation from 60 kHz to 200 kHz to melt ice from electrical transmission cables (Fig. 27). At these frequencies the ice is a lossy dielectric causing the ice to heat (Sullivan et al. 2003). If the high frequency excitation is applied to a transmission line with traps at both ends of the section to be deiced, the heating effect is confined to that section. This also confines and controls the two heating processes, which are sinusoidal in pattern, along the length of line and out of phase, a lossy heating effect and a skin heating effect in the cable caused by resistance. The exact phase of the two heating effects is a function of conductor design and ice thickness. The challenge, demonstrated successfully on a 1-m cold chamber line, is to design a satisfactory resonant inductor for causing the heating effects (McCurdy et al. 2003).

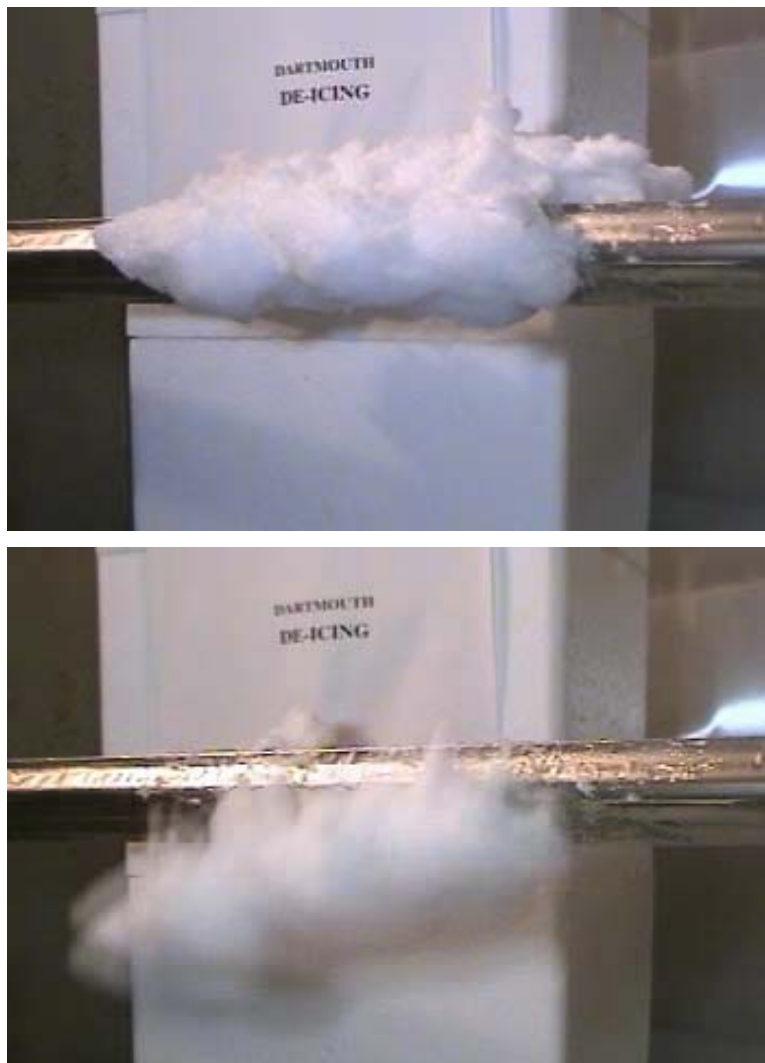

Figure 27. Ice being released from simulated cable by ice dielectric heating method.

## Application

Applications for the electrical deicing methods require a situation where exposed conductors on a surface will not be damaged and where ice is conductive. Lower portions of a drill rig may be appropriate. The pulse deicing method has many potential applications. Some proposed and in development include refrigeration defrosting systems, automobile windshields, aircraft wings, and offshore structures. The cable deicing method, as Petrenko and Sullivan (2007) claim in their patent, has applications for ships and drill rigs, ski lifts, transmission lines, bridge stays, and others.

## Sources

Torvec, Inc.  
1999 Mt. Read Blvd.  
Building 3  
Rochester, NY 14615  
Jim Gleasman, Chief Strategist and Investor Relations  
585-254-1100

Mr. David Sweet, Mgr R & D  
BF Goodrich Aerospace - Ice Protection Sys.  
1555 Corporate Woods Parkway  
Uniontown, OH 44685-7820  
330-374-3707  
330-374-2290  
[dave.sweet@goodrich.com](mailto:dave.sweet@goodrich.com)

## 12 Expulsive Deicing Systems

### Background

Electro-expulsive deicing systems (EEDS) are relatively recent technologies, about 20 years old, that have found limited but specific applications. EEDS utilize a variety of technologies to create a small amplitude, short duration, high acceleration pulse that moves the substrate upon which ice accretes. Rapid deceleration at the end of the EEDS substrate travel causes the inertia of the accumulated ice to overcome its adhesive strength to the substrate. The result is that the ice is “popped” off of the surface and pulverized in the process. When used in a deicing mode, ice is allowed to accumulate on the EEDS surface and is removed when the system is actuated. EEDS may also be used in a quasi-anti-icing mode where the system is actuated with sufficient frequency that little ice is noticed to have accumulated between actuations, thus appearing to be an anti-ice system. Though little mass accumulates in the anti-ice mode, some systems operate with sufficient acceleration and deceleration that even small masses are removed from the substrate surface. System efficiency has been claimed to improve when an icephobic coating is applied to the substrate, thereby reducing the ice-substrate adhesive strength.

### *Technology*

EEDS are manufactured using a variety of technologies. The most common are electrically actuated systems. The most widely promoted system was developed by NASA Ames (Haslim and Lee 1987), with a similar concept by Adams et al. (1989). The system consists of thin layers of dielectric and conductive material. In its current commercial form, the system is flexible, less than 1 mm thick, and can be wrapped around curved surfaces, e.g., the leading edge of aircraft wings (IMS 2007). The material is more effective on flat and convex surfaces than on concave surfaces because of the need for the outer surface to accelerate away from the substrate.

The system consists of interleaved conductors and dielectric material. Figure 28 (top) shows a cross section of an EEDS cuff. Conductors, labeled 54 and 57, for example, are embedded within a flexible dielectric material such as carbon fiber or fiberglass. Voids (52 and 53) are placed between the conductors. The cuff is fastened to a substrate with adhesive. When

operated, a controller charges capacitors. When actuated, current is released into the upper and lower conductors to create magnetic fields that repulse one another for about 2 ms (IMS 2007). The upper and lower layers move apart about 2.5 mm. Because the inner layer is fastened to a surface, all amplitude occurs in the outer layer, causing the ice to be accelerated away from the surface and pulverized. On an aircraft, the ice particles are carried away in the relative wind.

Innovative Dynamics, Inc. (IDI 2007) has developed a system called the Electro Impulse Deicing system (EIDI) for use on aircraft, ships, and highway bridges for ice protection, and which was developed in collaboration with the NASA Glenn Research Center. The system operates by using an electromagnetic coil located behind the substrate that accretes ice and induces strong eddy currents in the metal surface. This causes opposing forces between the coil and the metal skin, resulting in rapid acceleration of the skin debonding the ice (ice layers can be shed as thin as 0.050") (Fig. 29). Cox and Company (Cox and Company 2008, NASA 2002b) have developed a similar system with an actuator behind the substrate upon which ice is accreting that, when actuated, accelerates the surface and removes the ice (Fig. 30). The Cox system, the Electromechanical Expulsion Deicing System (EMEDS), is flying on two business jets.

Development of EEDS has focused in part upon reduction in the mean time between failure (MTBF) because early versions of the invention failed prematurely. Current systems have solved the MTBF problems and are reliable enough for use on aircraft (IMS 2007).

## Application

CRREL has experimented with EEDS to separate ice from navigation lock walls and to remove Zebra mussels from lock walls (Mulherin and Miller 2003). Figure 31 is a sequence on an experimental lock wall at CRREL where several inches of freshwater ice are removed after two pulses of the system. Though a promising application for lock wall deicing, this is not yet in use. A primary application is aviation where EEDS have proven effective for deicing and anti-icing the leading edges of unmanned aerial vehicle (UAV) wings (IDI 2007, IMS 2007). EEDS are planned for use on the Army Warrior UAV, and has been flying on the Lancair 4P turbine-powered aircraft (IMS 2007).

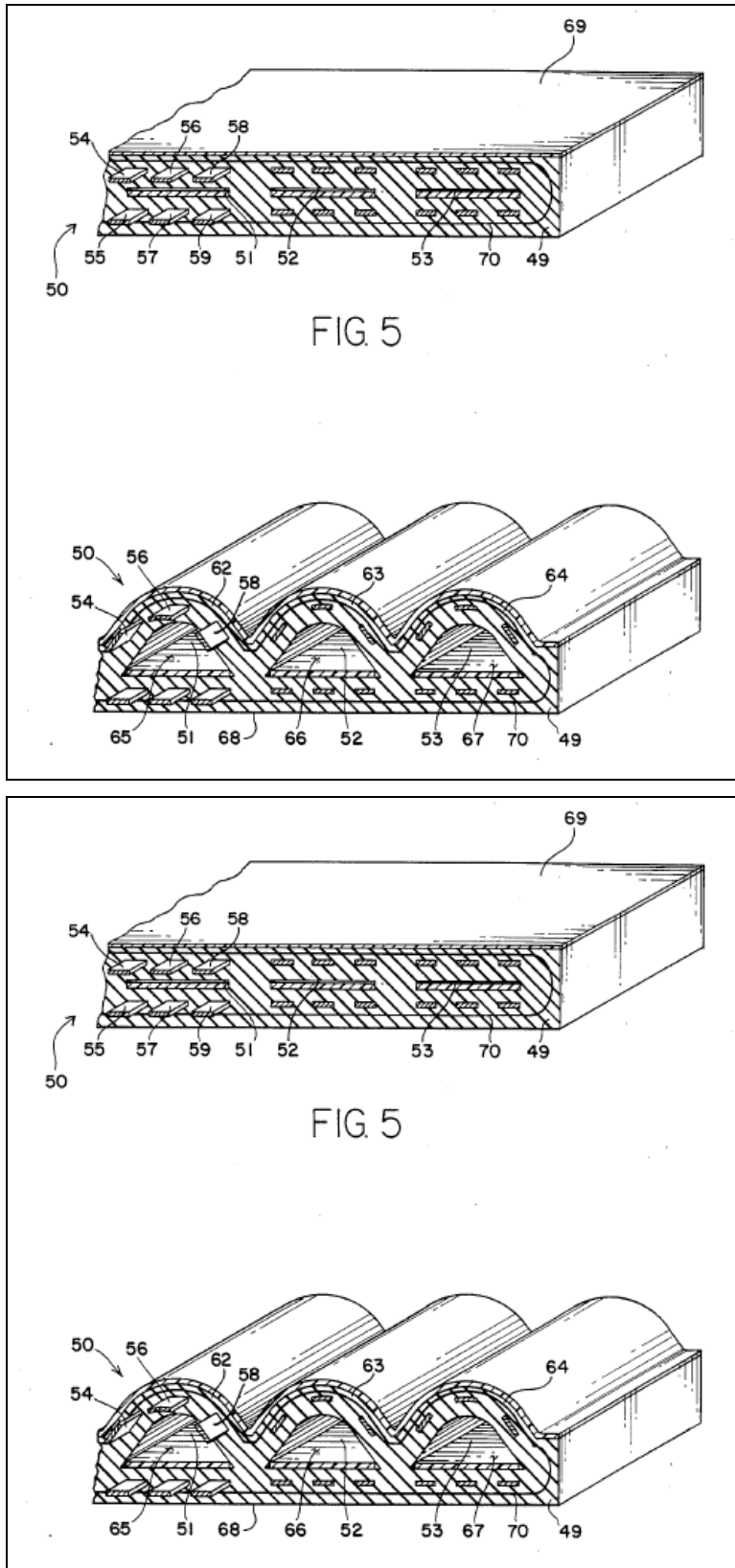

Figure 28. EEDS cross section un-actuated (above) and actuated (below).

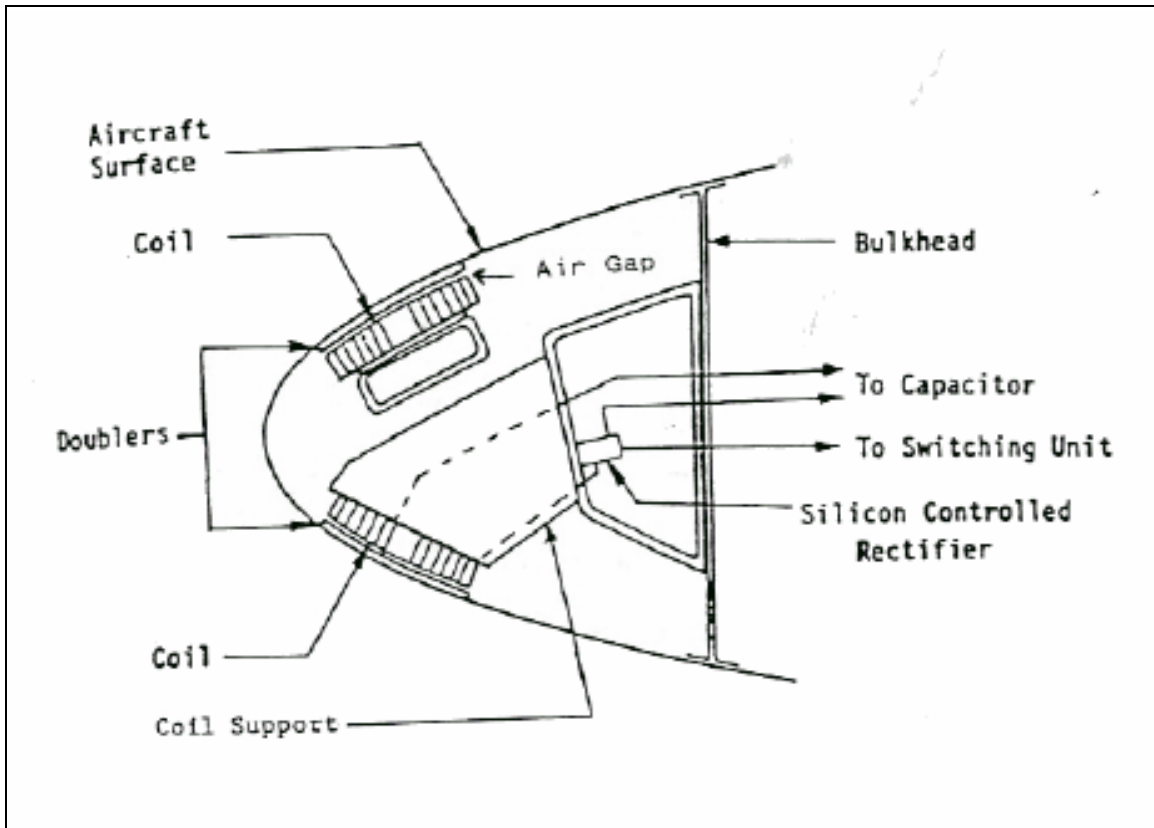

Figure 29. IDI EIDI applied to an airfoil.

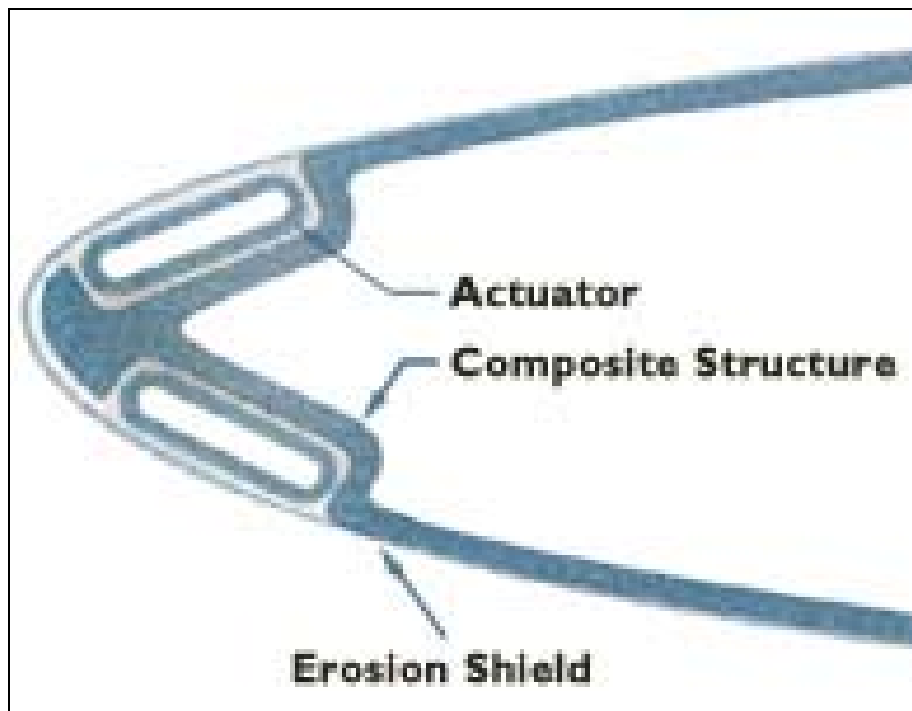

Figure 30. Cox and Company EMEDS applied to an airfoil leading edge.



Figure 31. IMS EEDS used for removing ice from a simulated navigation lock wall.

Embry et al. (1990) and Foster-Miller (2004) have proposed use of EEDS for marine applications. Foster-Miller proposed the use of EEDS on Navy ships to deice composite panels that will not tolerate the forces of traditional mechanical deicing techniques. EEDS (those designed by NASA (Haslim and Lee 1987) and perfected and marketed by Ice Management Systems (IMS 2007) have a low radar cross section, low RF and infrared signatures, require little power, and are broadly applicable. Embry et al. (1990) provide an extensive review of potential EEDS applications to ships and drill rigs, and describe testing of a system on Mount Washington, New Hampshire, and on the Alaskan Patrol Vessel *Woldstad*. Tests on the *Woldstad* were not wholly successful when the 20-cm<sup>2</sup> metallic-coated panels did not expel all ice. This may have been due to the metal covering and an inadequate power supply. They propose EEDS applications to the hatches of the Navy Vertical Launch System located on the forecastle of cruisers and destroyers to replace the current thermal deicing system that is highly visible in the infrared. They also suggest applications to weather deck doors, masts and antennas, gas turbine intakes, flight decks, bridge windows, containers on commercial ships, deck machinery, fishing gear, and safety equipment, such as lifeboats. They cite applications for drill rigs to be bulkheads, and claim that the technology could improve the survivability of rigs in icing conditions. However, there is no evidence that EEDS actually have been applied to ships or drill rigs.

## Sources

Cox & Company, Inc.  
200 Varick Street, New York, New York 10014, USA  
212-366-0200  
Fax: 212-366-0222/0283

Ice Management Systems, Inc.  
42136 Sarah Way  
Temecula, California 92590  
Telephone (951) 676-2751  
FAX (951) 694-0097

Innovative Dynamics, Inc.  
2560 North Triphammer Road  
Ithaca, NY 14850  
607-257-0533  
Fax: 607-257-0516  
[idi@idiny.com](mailto:idi@idiny.com)



## 13 Heat

### Background

There are two methods of preventing icing. One is to prevent liquid water from reaching the surface desired to be kept ice-free. The other is to heat the surface sufficiently that it is anti-iced, or heated periodically after icing to induce deicing. Though costly in energy, heat is often the best and most cost-effective approach with regard to engineering.

For anti-icing or deicing, sufficient heat must be applied to at least cause melt at the ice/substrate interface. Or, heat must be sufficient to prevent latent heat from being released from the water, causing ice. Water releases 334 J/g (334 W/cm<sup>3</sup>) to freeze at 0°C. Therefore, an anti-icing system must supply sufficient heat to prevent a cubic centimeter of water from freezing. Much less energy is required for deicing if melting only a thin layer of water is necessary to release ice from the substrate.

Heat is provided by a wide variety of technologies for many different applications. Provided here is a review of electrothermal, hot air, and hot water deicing.

### Technology

#### Electrothermal Heating

Electrothermal heating results from heat from electrical resistance heating. Not considering the source of electrical power, resistance heating, or joule heating, is 100% efficient—all of the energy conducted through the wires is converted to heat. Heating occurs as a result of electricity conducted through wires, such as Nichrome wires found in electric heaters that are controlled by thermostats, or materials such as carbon layers, which vary in thickness with location and are self-healing and self-regulating.

Ships commonly use heating cables to prevent icing of hatches and bulkhead doors. The Navy uses electric resistance heaters embedded in the edges of the hatch assembly of the Vertical Launch System (VLS) on destroyers and cruisers (Embry et al. 1990). The typical electrical load to

keep hatch door perimeters deiced on a typical destroyer is 190 KW, as reported by Embry et al. (1990) (Fig. 32).



Figure 32. Navy Vertical Launch System with electrically heated door edges.

Electrical transmission lines accumulate ice in freezing rain storms, and as a result of rime icing when they cross high elevations. Examples are extreme ice loads in Iceland (Ryerson and Eliasson 1993) on transmission lines due to icing. Yomaoka et al. (1986) and Personne and Gayet (1986), two examples of many, experimented with joule heating for deicing and preventing ice on transmission lines by using heavy currents to heat the line. Though often effective, heavy currents can damage hardware, but the heating also lengthens the lines, causing the potential for dangerously low ground clearances. Also, once ice has accreted, Yomaoka et al. (1986) found the electrical energy costs to be high, and reported a possible danger of overheating the system where ice had cleared and only air cools the wires.

A classic example of electrothermal deicing is the heating elements bonded to the interior of automobile rear windows. Resistance of the wires to current causes heating, which is locally conducted to the glass. A similar technology is applied to aircraft propellers, and especially to helicopter rotor blades. A variation is also applied to the leading edge of some smaller fixed-wing aircraft.

The leading edges of helicopter blades are rarely equipped with inflight deicing or anti-icing capability because of the complexity of transmitting electrical power through rotating parts into the blades. Also, power requirements require payload-consuming electrical generation equipment, and the slip rings, cables on blades, and other components are high maintenance items. However, the Army Black Hawk helicopter is equipped with an electrothermal system that periodically heats pairs of blades, alternating between inboard and outboard segments to balance blades as ice is removed. A controller system responds to signals from a fuselage-mounted ice detector that then sends power to blade segments. Alternating blade segments reduces peak power demand and balances the power load (SAE 2002). The blades are heated with wires embedded within the composite leading edge of each blade below the external titanium wear strip (Fig. 33). The Apache Model A helicopter had a similar system that was eventually disconnected because of high maintenance demands. In that aircraft, one source of problems was the controller, which would fail and overheat the blades, causing delamination of the leading edge. Propeller blades of aircraft such as the C-130 are deiced in a similar manner.



Figure 33. Cross section of Black Hawk helicopter blade showing the ends of heater wires immediately under the leading edge wear strip.

Northcoast Technologies has developed a thermal deicing system for wing leading edges and propellers using a flexible expanded graphite foil as an electrical and heat conducting layer and surrounded by an electrically insulating but thermally conducting layer. The electrical power required for a thermal rise necessary to melt ice is claimed to be less than that required for metal conductors (Kelly Aerospace 2008, NASA 2002a) (Fig. 34).

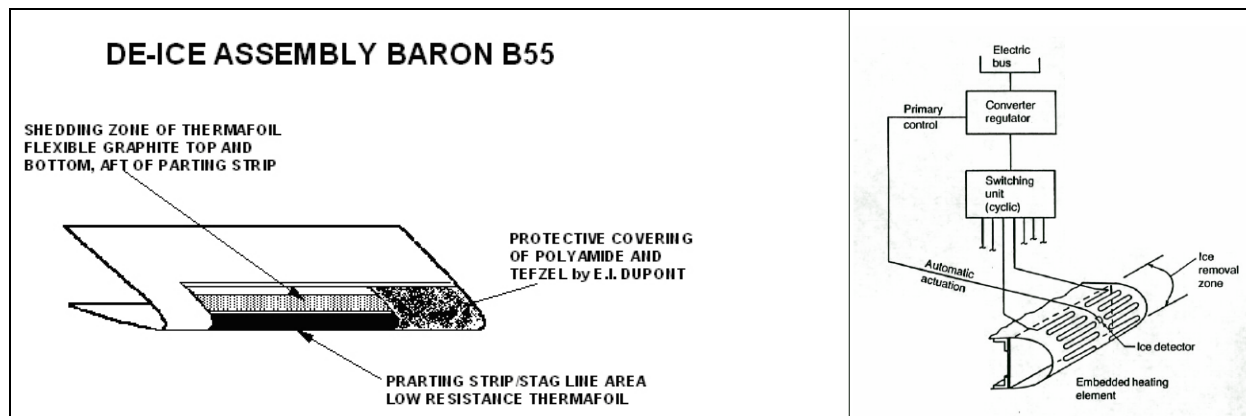

Figure 34. Graphite conductor electrothermal system by Northcoast technologies.

## Hot Air

Another source of heat for deicing and anti-icing is hot air. The automobile windshield defroster is a classic example of deicing using hot air, and illustrates well the relatively modest ability of air to transfer heat to solids. The most common hot air deicing system in aviation is the bleed air system used to heat the leading edges of jet aircraft wings. The leading edges of jet wings operate as anti-icers from temperatures of about 150°C to about 225°C. They are kept sufficiently hot to not only prevent ice, but to vaporize droplets striking the leading edge. Vaporizing drops prevents unfrozen water from running back to unheated areas of the wing and freezing. The source of hot air is bleed air from the jet engines. Air is piped from the engine to piccolo tubes located inside the hollow wing leading edge. The holes in the piccolo tube point forward, causing air to impinge upon and heat the leading edge (Fig. 35). The disadvantage of using bleed air for heating is that it is least available when ice is most serious, on climb-out when full power is required and little bleed air can be spared, and on descent when engines are at idle, producing little heat.

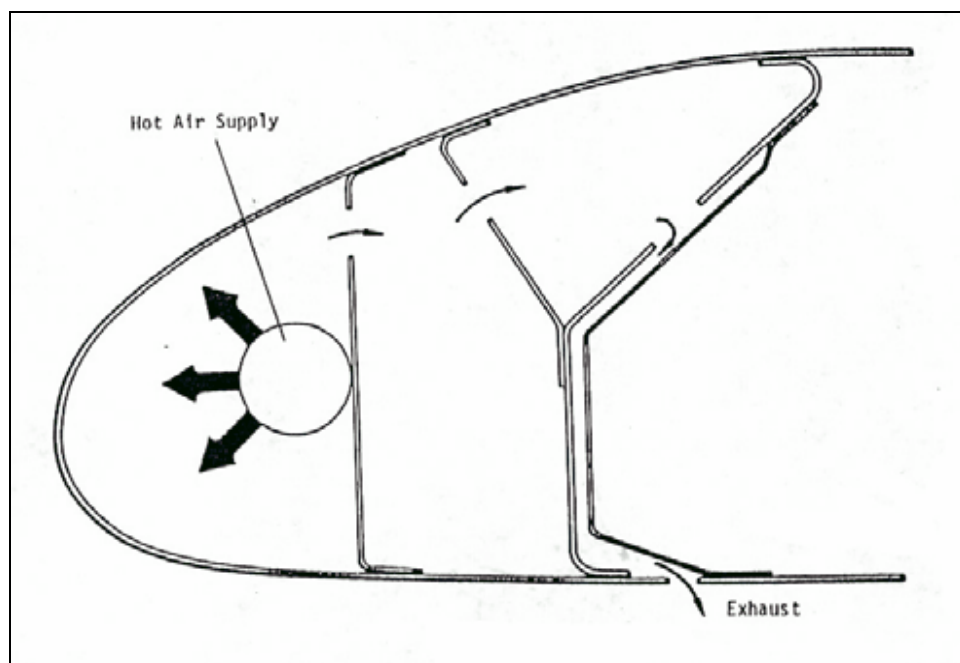

Figure 35. Piccolo tube directing hot bleed air against inside of wing leading edge.

Hot air is also used for limited ground deicing applications (Ryerson et al. 1999). The Air Force has experimented with the use of jet engines mounted on trucks to blow warm air across the wings of iced aircraft. The Navy also has experimented with the use of jet engines mounted on “yellow gear,” equipment used to move aircraft, to deice aircraft carrier decks.

The UH-60 and AH-64 helicopters and the C-130 and C-17 fixed-wing aircraft are equipped with the Rockwell Collins Buddy Start system (Rockwell Collins 2008). The Buddy Start system is intended to use the auxiliary power unit (APU) bleed air and electrical power from a live aircraft to start the APU of an aircraft with no battery power. Bleed air is sent from the live aircraft to the dead aircraft through an approximately 10-cm-diameter fabric hose. A nozzle has been added to the system that will allow deicing, called the Buddy Start Hose Deicing Kit. Costing about \$2000 in the year 2000, the nozzle also can be applied to the hot air hose of an auxiliary ground power unit (AGPU). The deicing kit is a 0.5-m-long handheld aluminum nozzle with a 6.4-cm-diameter nozzle (Fig. 36). A ball valve controls air flow. Air temperatures at the nozzle have been measured as high as 167°C. At a distance of 0.4 m, temperature decreased to about 133°C and to about 100°C at 0.6 m (Ryerson et al. 1999). Though effective at deicing small areas, high pressure air exiting the hose can blow operators off their feet, and the high temperatures have been reported to damage composite helicopter blades.

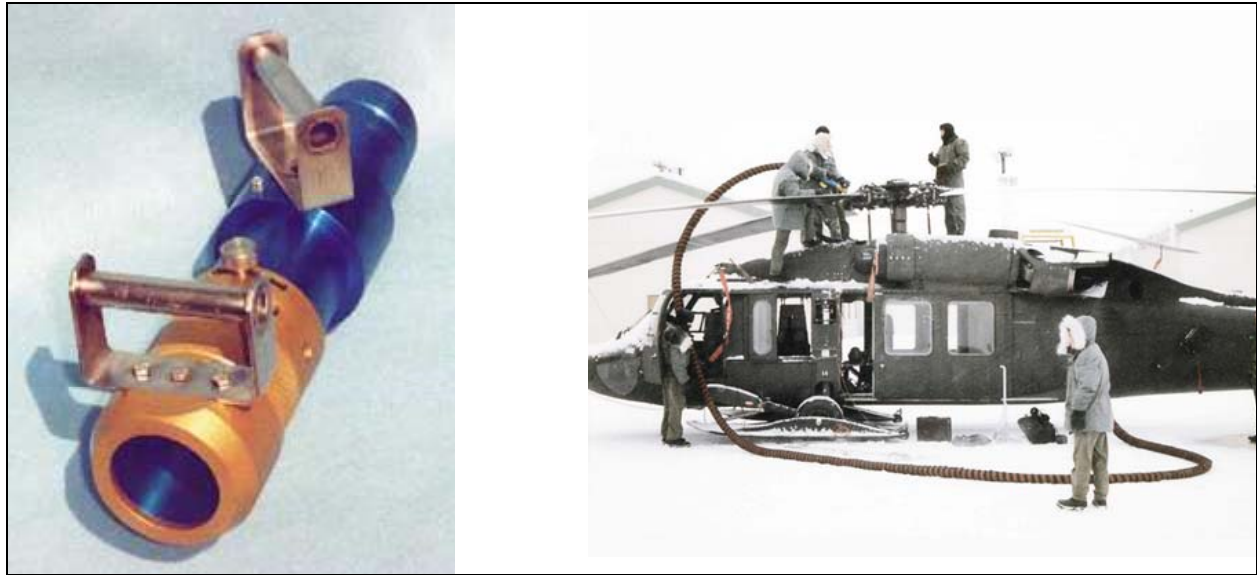

Figure 36. Buddy Start deicing nozzle (left) and system in use on Black Hawk helicopter (right).

### Hot Water

Finally, the Federal Aviation Administration allows the use of hot water to deice aircraft (FAA 2000). In a series of experiments, hot water at a temperature of  $60^{\circ}\text{C}$  was applied to plates contaminated with ice in air temperatures as low as  $-9^{\circ}\text{C}$  at wind speeds of  $2.8\text{ ms}^{-1}$ . Deicing was considered successful if a surface experiencing an ice accretion rate of  $0.25\text{ cm cm}^{-2}\text{ hr}^{-1}$  would deice and remain deiced for 3 min or longer. Hot water performed acceptably, similarly to Type I deicing fluids under the same conditions. Ryerson et al. (1999) also experimented with hot water deicing on Black Hawk helicopter blades at an air temperature of  $-2^{\circ}\text{C}$  with 1–2 mm of clear ice with water at a temperature of approximately  $45^{\circ}\text{C}$  (Fig. 37). These experiments showed water to refreeze on the blade surfaces before running off, and water often ran under the blades and iced the blade bottoms where no ice previously had been.

Several other thermal technologies have been attempted, but with little success. Lasers have been used experimentally to melt ice from transit system rails. The experiment was successful, but was an expensive method to simply melt ice (Gajda 1983). The Navy also assessed the use of Neodymium solid state lasers for the deicing of large open areas and hard-to-reach locations (Mackes 1989). The assessment was that lasers could either melt or shatter ice, and with the proper wavelength choice the laser energy would not penetrate the ice to damage substrate materials such as paint. Lasers were abandoned as a viable option because of cost and safety

concerns. Heat pipes also have been used to attempt to deice ship decks, bulkheads, and rails with pipes filled with an antifreeze solution (Kenney 1976) and ammonia and ethanol (Matsuda et al. 1981).



Figure 37. Hot water deicing of Black Hawk helicopter.

## Application

Applications include components of navigation lock mechanisms (Frankenstein and Tuthill 2002), aircraft airfoil leading edges, ground deicing of aircraft, ship hatches and doors, windows, roof edges, and many other localized deicing requirements.

## Sources

Rockwell Collins ElectroMechanical Systems  
17000 South Red Hill Avenue  
Irvine, CA 92614  
949-250-1015  
Fax: 949.221.5911

Kelly Aerospace Thermal Systems  
1625 Lost Nation Road  
Willoughby, Ohio 44094  
440-951-4744  
Fax: 440-951-4725

## 14 Hydraulic and Steam Lance

### Background

Hydraulic deicing involves the use of high pressure water jets to remove ice from surfaces. The Navy (Mackes 1989) considered high pressure water lances for deicing of ships to be a viable method that was safer and less expensive than alternatives. CRREL has experimented with hydraulic deicing of navigation lock walls because ice narrows the lock and restricts passage. Hanamoto (1977) compared the use of high pressure water jets from a truck-mounted industrial cleaner to chain saws used for cutting coal and lumber, pneumatic devices, and icephobic coatings. He concluded that the chain saws and coatings were most promising, but that the water jet approach, though high in initial cost, deserved additional investigation.

Derbidge et al. (1989) demonstrated an experimental high pressure (75–125 psig) flash flow system for deicing that operated between 122°C and 133°C. The concept was that such a system could operate from the ship fire mains and use a portable heater to raise water temperature (Fig. 38), but not convert the water to steam. Therefore, sea water could be used. The result is a two-phase flow with about 10% steam that, in experiments, removed ice faster than a 4000-psi water jet. Tests showed the ability to remove ice 10 cm thick and up to 186 cm<sup>2</sup> of ice per second. Recommendations were to construct a prototype system for shipboard testing. It is unknown whether this was done.

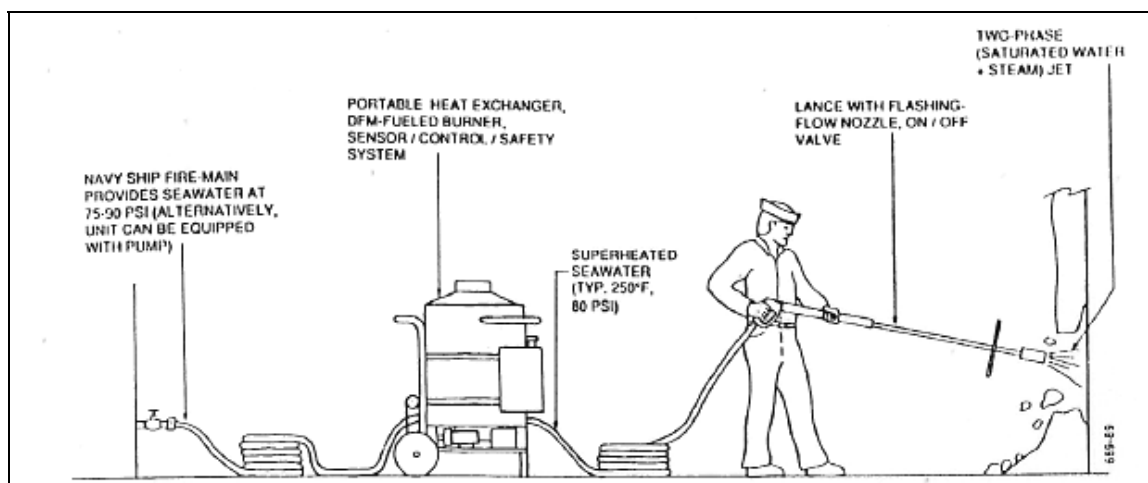

Figure 38. Flash flow portable deicing system for ships.



Larson (1983) assessed the use of high pressure water jets along with other technologies to deice automated guideways for transit systems. The research evaluated whether a water jet would cut through ice on a rail, initiate cracks between the rail and the ice, and cause delamination of the ice, fracturing, and removal. In a test, water at a temperature of about 16°C was sprayed through four 1.2-mm-diameter nozzles at a rate of about 70 L/min. Ice of thicknesses to 8 mm could be removed from rails at speeds up to 32 km/hr.

Steam lances also were commonly used at sea in the past because of the ready availability of steam from engine boilers. Løset (1985), for example, recommends steam as a method of removing ice from ships and drill rigs.

### **Technology**

The technology consists of high pressure pumps and a source of water. Development is needed with regard to nozzle size, nozzle spacing if more than one nozzle is used, flow rates, and the distance that a system can be effective from an ice surface. The latter is critical because many areas that require deicing on marine structures are not readily accessible. And, according to Frankenstein and Tuthill (2002), wind was a factor in decreasing the efficiency of hydraulic systems when clearing lock walls.

### **Application**

All deicing with high pressure hydraulics is still experimental. However, applications that have been tried are ships, transit system rails, and navigation lock walls.

### **Sources**

There are no systems known to be sold as high pressure hydraulic deicing systems.

## 15 Infrared Deicing

### Background

Infrared deicing is a well-proven heating technology and has had some application for deicing. Infrared may be considered a sub-application of deicing technologies using heat. However, it is unique because it is a remote technology; objects are heated through absorption of infrared energy from an emitter that has a temperature allowing it to radiate in the infrared portion of the electromagnetic spectrum. Infrared systems useful for heating and deicing operate from wavelengths of about 1  $\mu\text{m}$  to about 15  $\mu\text{m}$ . According to Planck's Law, the flux of energy at any wavelength is a function of the temperature of the object. The peak energy is emitted at a wavelength described by Wein's Law, where the peak wavelength of emission in microns is equal to  $2897/T$ , where T is temperature in Kelvin degrees. Therefore, an object emitting with 100% efficiency, a black body, at a temperature of  $1500^{\circ}\text{K}$  provides maximum radiative flux at a wavelength of about 2  $\mu\text{m}$ . Most natural objects have an emissivity and absorptivity of about 0.8 and higher, or 80% and higher efficiency. Ice has an absorptivity and emissivity from 8 to 14  $\mu\text{m}$  of about 0.97. Most paints also have emissivities and absorptivities of 90% and higher. Most polished metals, however, have absorptivities of about 10% or less—they absorb 10% or less of the infrared energy reaching them. For many materials, the absorptivity varies over the infrared wavelength range. In general, ice absorbs strongly in wavelengths longer than 3  $\mu\text{m}$  (Ryerson et al. 2004). Therefore, objects cooler than about  $1000^{\circ}\text{K}$  emit peak infrared flux in wavelengths absorbed strongly by ice. Most objects in the environment emit in the infrared, at near 10  $\mu\text{m}$  for a wavelength of peak flux.

The Navy assessed infrared as part of a suite of technologies considered for shipboard applications (Mackes 1989). The Navy examined issues such as exposure of personnel, corrosion resistance, explosion hazards, element shattering due to sudden inundation of emitters with sea spray, and degradation of performance due to accumulation of emitters by salt. No major issues were identified, though experiments were not repeated. Mackes (1989) also indicated that a full Navy system safety review would be necessary before applying infrared technologies to ships.

## Technology

The most common infrared technology used to deice is common electrically powered ceramic heating elements such as are used in electric stoves. For example, CRREL uses electric infrared heaters to deice door entrances at its New Hampshire facility (Fig. 39). Radiant Optics markets electric and gas-powered radiant heaters that use a lens system composed of aluminum slats to focus infrared energy for specific spot heating. CRREL has used these heaters, for example, to demonstrate infrared deicing of helicopter blades (Fig. 40).



Figure 39. Infrared heaters above CRREL entrance.

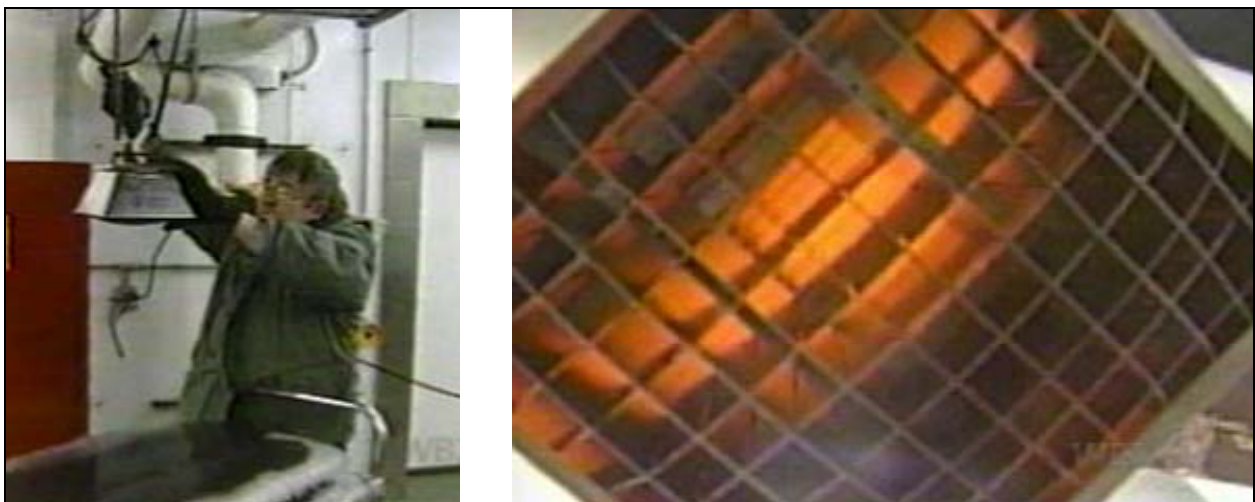

Figure 40. Radiant Optics electric infrared focusing heaters. Larger versions of these heaters warm the entrances of national chain home center stores.

The most dramatic use of infrared energy has been to deice entire aircraft before flight. Two technologies have been developed, tested, and commercialized. The Ice-Cat is a gas-fired catalytic converter infrared panel that is truck-mounted (Davila 2002, Ryerson et al. 2003). The system is portable while operating and the large emitting panel has two-axis maneuverability on a boom and temperature sensors that allow system regulation if the deicing surface warms above preset temperatures (Fig. 41). The latter capability may potentially prevent sensitive materials, such as composites, from overheating if the temperature of the surface being deiced is too high (Ryerson et al. 2003). The infrared panel consists of three independently regulated zones. The temperature of each zone is regulated by a feedback loop between infrared radiometers that sense the temperature of the surface being deiced. Emitting in the mid-wavelength infrared, the wavelengths of maximum emission fall between about  $3.2\ \mu\text{m}$  and  $4.1\ \mu\text{m}$  with the panel operating at temperatures between about  $700^\circ\text{K}$  and  $900^\circ\text{K}$ .



Figure 41. Ice-Cat during testing at Eglin AFB McKinley Climatic Chamber.

The second system, by Radiant Aviation Services, is stationary and is housed within a hangar-like shelter where aircraft are driven through (Fig. 42) (Ryerson et al. 1999). The system consists of gas-fired heaters operated at a temperature of near  $800^\circ\text{C}$  within an enclosed heat exchanger and emits most strongly near  $3.6\text{-}\mu\text{m}$  wavelength (RAS 2008). The place-

ment of heaters and the adjustable power levels of heaters hanging from the hangar ceiling tailor the amount of energy to the vehicle being deiced. CRREL experimented with helicopter deicing in the system and measured heating of composite blade surfaces as they deiced and dried under the infrared emitters (Ryerson et al. 1999). Measurements showed the potential for composite materials to become sufficiently warm that structural integrity was a concern. Similar measurements were made on aircraft metal and composite surfaces in Europe with the system (Sætre and Eian 2006). RAS (Natural Gas Technologies Center 2007) also has an electrically powered infrared deicing system under development.



Figure 42. Radiant Aviation Services system for deicing aircraft (left), and in use for experimentally deicing Army helicopters (right).

## Application

Applications of infrared deicing technologies have been aircraft, door entrances, and other locations where energy needs to be conveyed remotely and absorbed to heat and melt ice. The technology would have certain advantages for deicing open grid stairs and decks on drill rigs, and for keeping equipment on decks deiced.

## Sources

Radiant Optics, Inc.  
19510 144th Avenue NE Suite B7  
Woodinville WA 98072  
425-806-3990  
Fax: 425-806-3991  
[www.radiantoptics.com](http://www.radiantoptics.com)

Trimac Industries, LLC  
Infared Technologies  
1201 Burlington  
North Kansas City MO 64116  
816-421-4422  
800-830-5112

Colonel George Waskosky (Ret.)  
2041 Niagara Falls Blvd  
Niagara Falls, New York 14304  
716-236-1091  
[cdigout@radiantenergycorp.com](mailto:cdigout@radiantenergycorp.com)

## 16 Mechanical Deicing Methods

### Background

Mechanical deicing methods have been, and still are, the most common deicing techniques. Poorly documented except anecdotally, mechanical methods include the use of hammers, mallets, crow bars, and baseball bats to loosen ice from surfaces through impact, and shovels to throw the ice over the side of the rig or ship (Fig. 43). Ice chippers also have been used, such as on the Coast Guard Cutter *Midgett* in 1990 (Fig. 6). Mechanical methods are simple in concept. However, they are dangerous because of the need to work on slippery decks, slow, and damaging to equipment. Also, manual methods are not effective for locations that cannot be readily reached by personnel, such as rigging that is out of reach, and hull area outside of the bulwarks.



Figure 43. Mechanical ice removal from *The Deadliest Catch* episode of *Man vs. Ice*.

The use of modern materials on ships and rigs has necessitated replacement of mechanical methods with deicing techniques that are potentially less damaging. Bulkheads constructed of composite materials, windows, and sensor systems are readily damaged by mechanical methods. For example, newer Navy ships are fitted with helicopter hangars with bulkheads constructed of laminated composite material that is easily delaminated by blows from baseball bats and mallets.

## Technology

The primary tools of mechanical methods are hammers, mallets, crow bars, baseball bats, shovels, and deck hands to use the equipment. Preferred tools are wooden bats to minimize damage to paint and to nonskid deck materials (Chief, USCGC *Midgett* personal communication 1990; Ryerson and Longo 1992). The ice is impacted with a tool until it breaks, is loosened, or is pulverized, and is then shoveled from the deck. This is heavy, wet, dangerous work that often must be done during severe weather conditions.



Figure 44. Five-point chisel in use by Chief on CGC *Midgett*, 1990.

Zadra and Pyle (1990) describe several tools that were applied to two limited icing events on the Coast Guard Cutter *Midgett* in the Bering Sea in 1990. These included a Laconia ice chisel (Fig. 6), a Bricknell chisel, a single-point chisel tool, and a five-point chisel (Fig. 44). The single-point chisel tools were effective at breaking ice on decks, but were too heavy and occasionally damaged non-skid. The five-point chisel was very effective



at removing ice from a five-inch gun housing constructed of a composite material that would not withstand blows from baseball bats. The five-point chisel rapidly removed ice and was the favorite of the deck chief (Ryerson personal observation).

Manual mechanical methods are strongly affected by the physical properties of the ice. Fresh saline ice is softer and more flexible than ice that is older and has experienced cold temperatures (Ryerson 1995, Ryerson and Gow 2000). Therefore, younger, softer ice and ice on decks may be more difficult to remove than ice that is drained of most brine on bulkheads because soft ice is less brittle and more readily absorbs the impacts of tools.

In a related manual, but not labor-intensive, technology, Suzuki et al. (1978) demonstrated that snow or rime ice could be removed from a cylindrical or round antenna radome by rotating it to remove ice through centrifugal force. When rime ice was more tenacious, they placed a brush against the surface to remove the ice. The radome was operated at about 300 RPM to remove ice and snow.

## **Application**

Mechanical methods are use to remove ice from decks, bulkheads, deck equipment, rigging, and railings.

## **Sources**

None: common tools.

## 17 Millimeter Wave Technology

### Background

Millimeter wave technology has been explored for detecting the presence of ice on surfaces, and for deicing. The attraction of deicing with millimeter wave technology, especially microwaves, is increased efficiency when compared to the power requirements of traditional electrical-resistance thermal deicing systems. Also, water readily absorbs microwave energy and heats. Therefore, millimeter wave energy may be an effective method of deicing if electromagnetic interference and radio frequency interference problems can be avoided.

### Technology

Feher (2003) patented a system that directs millimeter wave (MMW) radiation at ice on the leading edge of aircraft wings by placing the emitter in a leading edge slat. Also, a dielectric composite material upon which the ice forms is designed to absorb millimeter wavelength radiation and heat. Feher (2003) claimed the system to be more efficient than bleed air heating systems commonly used in the wings of jet transport aircraft (Feher and Thumm 2006).

Potomac Research Inc. (Guo 2005) proposed to use microwaves to deice pavements. Using technology similar to microwave ovens, a power supply, circuits, and a magnetron would be buried in pavement and oriented such that the microwaves would be absorbed directly by the overlying ice and snow. Guo claimed tenfold improved efficiency over snow removal using mechanical methods, a six-times cost reduction, and reduced environmental impact from reduction in chemical use. Microwave absorption by people on pedestrian crosswalks or streets was claimed to be one-tenth of the government limit for continuous exposure.

Martin (1991) proposed irradiating nickel coatings on aircraft propeller blades with 10-GHz-frequency millimeter waves. Ice and water absorb poorly at 10 GHz, but the nickel absorbs strongly, heating the surface and causing the ice to melt at the ice/substrate interface and be shed. The invention allows a rotating object to be deiced by stationary MMW beams, thus reducing the complexity of conducting energy through slip rings to

heaters on the propellers. The slip rings and heaters are a major cause of maintenance costs and aircraft downtime.

Hansman (1982) patented a unique anti-icing application with micro-waves that is not being used commercially. Most serious icing is caused when drops are supercooled. Heating drops can reduce the freezing rate, especially if they are warmed to temperatures greater than 0°C. Irradiating drops before they strike surfaces with energy in the 2,000- to 24,000-MHz range will cause them to heat and perhaps reduce or prevent icing.

### **Application**

Microwave deicing is applicable to any situation where liquid water is available to absorb energy and heat substrates. Or, it is usable where the microwave energy can penetrate through the ice to a substrate that is then heated by the millimeter waves, which in turn melt ice at the interface, causing deicing. Aviation is an obvious application, as are pavements. Millimeter wave deicing may have application on drill rigs in areas where metal reflectors will not cause difficulty.

### **Sources**

Potomac Research, Inc.  
10618 Tanager Lane  
Potomac MD 20854  
301-279-7751  
Fax: 301-279-8979

## 18 Piezometric Crystals

### Background

Piezometric crystals generate electricity when bent, and bend when electricity is applied to them. Several attempts have been made to apply piezometric materials to deicing where electricity applied to the materials would cause ice to shear from the substrate. Creare (2002) created an experimental piezometric deicing system for NASA's Small Business Innovative Research Program. Aerosonde North America, a division of AAI Corporation, also claims to be developing a piezometric-based deicing system for the UAV (personal communication January 2008).

### Technology

The Creare (2002) experimental system used polycrystalline piezoelectric-based active-fiber composites embedded in a polymer matrix driven by an electronic controller. According to Creare (2002), polycrystalline actuators can achieve strain levels sufficient to remove ice from a substrate. Creare demonstrated the feasibility of using the actuator to prevent ice buildup on aircraft leading edge surfaces in an icing wind tunnel (Fig. 45).



Figure 45. Ice being removed from surface coated with piezometric crystals, left to right.

### Application

According to Creare (2002), piezometric deicing systems applied to aircraft can reduce power requirements and can easily be retrofitted to existing aircraft. The technology also can be applied to non-aircraft applications, such as marine icing environments.

**Sources**

Bruce R. Pilvelait  
Create Inc.  
Etna Road, PO Box 71  
Hanover, NH 03755-0071

## 19 Pneumatic Systems

### Background

Pneumatic systems are a mainstay of inflight deicing of fixed-wing aircraft. Pioneered in the 1920s by Goodrich in Akron, Ohio, pneumatic deicing boots fly on most turboprop aircraft today. Pneumatic deicing systems consist of rubber or other elastomeric boots placed on the leading edge of an aircraft wing or on any surface requiring protection. Accreting ice, if glaze or rime, is brittle and forms a layer over the elastic surface (SAE 1997). When a sufficient thickness of ice has accreted that the ice will break and be carried away by the relative wind or fall away by gravity (usually a 6- to 12-mm thickness is allowed to accrete on aircraft wings), the boot is rapidly inflated, breaking the ice. On aircraft the boot is pulled back down to the wing surface using a vacuum pump to reduce aerodynamic effects (Fig. 46).

Problems with boots have been residual ice that is not fully removed when the boots inflate, and ice bridging. Icephobic coatings are occasionally placed on boot surfaces to reduce ice adhesion and minimize residual ice problems (Hill et al. 2006) (Fig. 47). In general, maintenance costs for boots are high, but they are the only option on aircraft that cannot supply heat to leading edges. Boots also are applied to the air intakes of engines (SAE 1997).

Pneumatic deicing was successfully applied to a TACAN cylindrical radome by Ackley et al. (1977) to remove snow and rime ice. Pneumatic boots are attractive for antenna applications because the boots do not significantly attenuate electromagnetic signals. Also, because the ice is not heated and melted, then water is not formed. Because the dielectric constants of ice and water are about 5 and 60, respectively, melting ice and trapping the water at the ice/substrate interface on an antenna can cause serious signal loss for antennas.

Kenney (1976) investigated the capability of pneumatic boots on the harbor tug *Keokuk*. Called air-pulsated tube assemblies by Kenney, two assemblies consisting of neoprene rubber and urethane-coated Dacron fabric were hung from bulkheads where icing would occur. A timer pulsed the tubes approximately every 10 minutes with 34–55 kPa of air. Of several

technologies evaluated, the pneumatic system was most satisfactory. Kenney (1976) summarized that the assemblies 1) required considerably less power than thermal systems, 2) were lightweight and easily stowed, 3) could cover a large area quickly using pre-positioned attachment points, and 4) did not require special skills to install the system. He also indicated that the tube assemblies could be adapted to cover flat, cylindrical, spherical, and other curved surfaces in addition to horizontal and vertical flat surfaces.

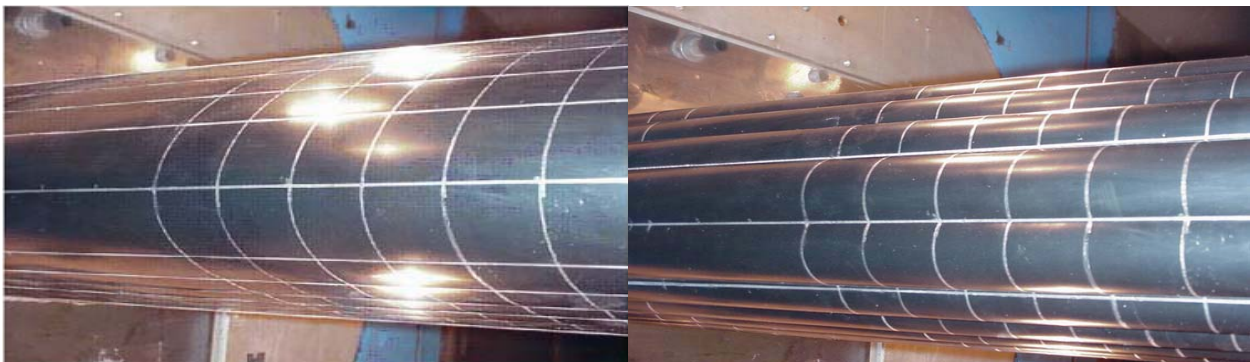
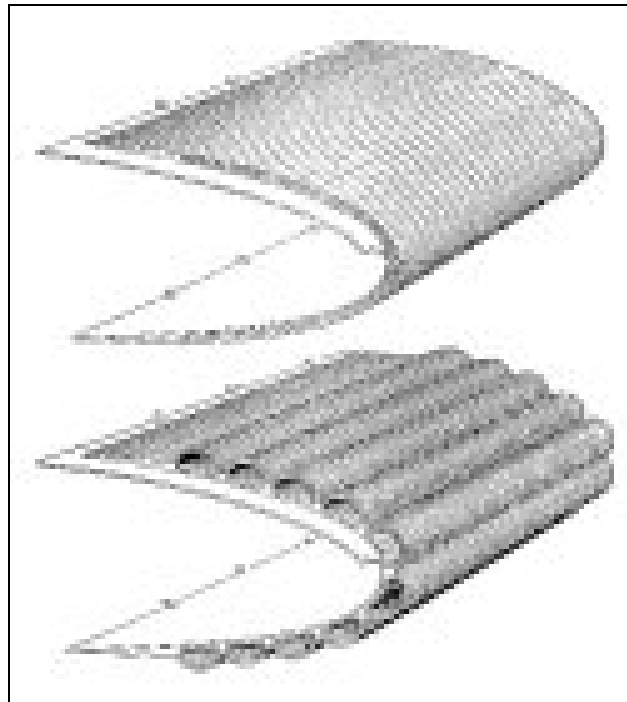

Figure 46. Diagrammatic view (top) of deflated (above) and inflated (below) deicing boot. Bottom: deflated (left) and inflated (right) boots on wing leading edge in wind tunnel.

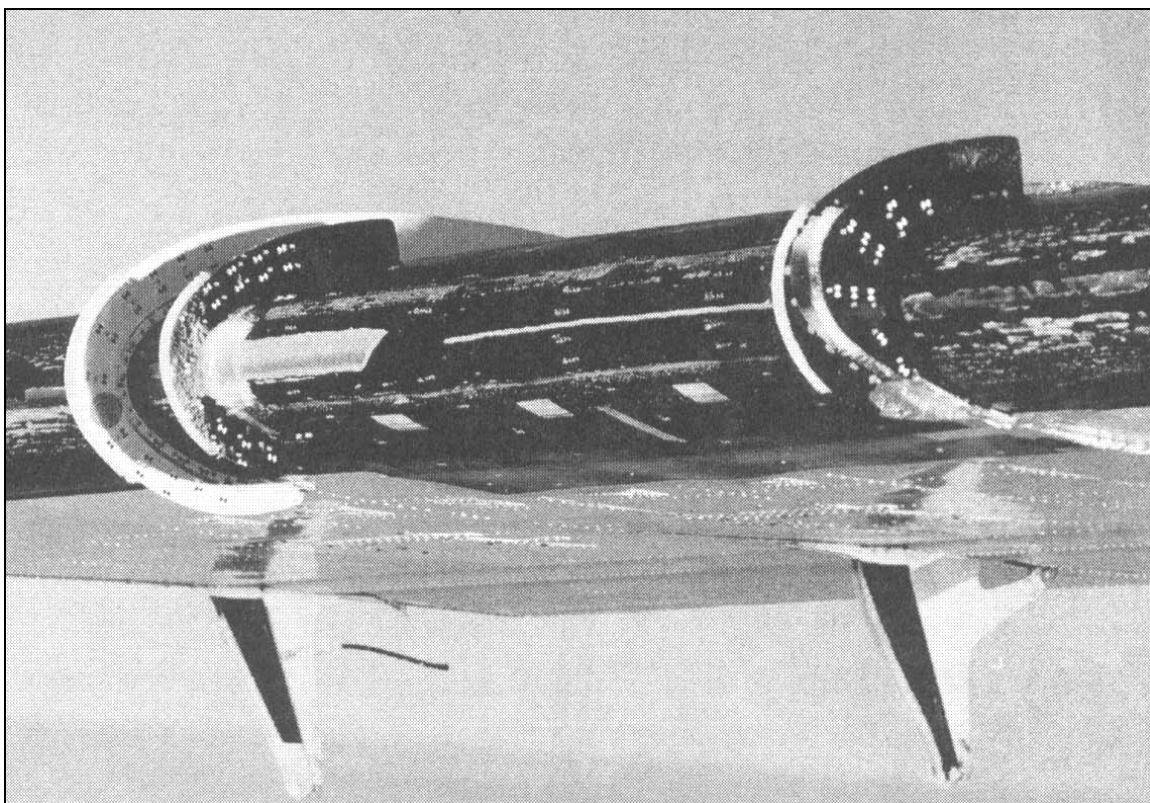

Figure 47. Residual ice occasionally remains on boots after deicing as illustrated on the boots of this NASA Twin Otter aircraft.

It is possible that fresh saline ice will be removed from pneumatic panels less easily than is freshwater ice because of the less brittle nature of saline ice before brine has drained (Ryerson 1995). However, the Kenney (1976) experiments were successful, suggesting that this may not affect performance. Experiments may be necessary to prove viability with ice of different salinity contents.

## Technology

The technology consists of rubber or other flexible material designed with tubes that inflate, thus increasing surface area and breaking the ice and debonding it from the elastomeric substrate. A vacuum pump is used to pull the boots back down to the substrate after deicing. Aftermarket suppliers argue that ozone, sunlight, weathering, oxidation, and pollution attack both natural and synthetic rubber, causing cracking and hardening and reducing strength, elasticity, and wear resistance of boots. Coatings are sold to maintain the rubber's flexibility. Also, pneumatic materials are often coated with icephobic compounds to help with ice release. IceX and RejeX are two materials marketed for coating boots to enhance ice release.



## Application

The primary application of deicing boots commercially is to protect the leading edges of fixed-wing aircraft. Though other applications have been explored, e.g., deicing of ships (Kenney 1976) and lock walls (Hanamoto 1977), there are no widespread commercial applications of deice boots outside of aviation.

## Sources

### AirSuppliers

4200 North Main Street, Suite 220

Fort Worth TX 76161

[www.airsuppliers.com](http://www.airsuppliers.com)

[orders@airsuppliers.com](mailto:orders@airsuppliers.com)

800-888-0431

### Ice Shield

93 Nettie Fenwick Road

Fenwick WV 26202-4000

800-767-6899 (toll-free)

304-846-6636 (local)

<http://www.iceshield.com/>

[info@iceshield.com](mailto:info@iceshield.com)

### Goodrich

Four Coliseum Centre

2730 West Tyvola Road

Charlotte NC 28217-4578

704-423-7000

## 20 Vibration

### Background

Vibration has been a method used experimentally to remove ice (Kenney 1976, Løset, 1985, Mulherin and Donaldson 1988, Zadra and Pyle 1990). In these experiments, objects were mechanically vibrated with a rotating unbalanced mass (Mulherin and Donaldson 1988), using solenoids (Løset 1985), or pneumatic pistons attached to a fiberglass panel (Kenny 1976). Levin et al. (1974), in a patent, proposed to vibrate a cable inductively by pulsing the cable to remove ice. Levin's patent, however, is not reported to have been tested.

Unfortunately, only one of these experiments was successful. Mulherin and Donaldson (1988) vibrated an 18-m-tall guyed tower through a range of frequencies. The tower, coated with freshwater glaze ice, deiced only when vibrated at its resonant frequency. Unfortunately, at that frequency the tower was sufficiently damaged to be unsafe. Kenney's (1976) and Løset's (1985) experiments did not satisfactorily remove ice. Zadra and Pyle (1990) tied sheets of plastic around ship deck components. Sheets vibrated most vigorously by personnel deiced readily whereas sheets tied tightly around deck components could not be vibrated easily and did not deice.

### Technology

Vibration technologies have been only experimental and have consisted of towers with off-balance rotating weights, pneumatic solenoids vibrating fiberglass panels, inductive systems vibrating cables, and plastic sheets vibrated by personnel. The only formal vibration technology is used in ice detectors, and is discussed elsewhere.

### Application

There are currently no formal applications of vibration for deicing.

### Sources

None.

## 21 Windows

### Background

Window deicing and anti-icing technology is commonly available in automobiles, aircraft cockpit windows, and ship bridge windows. Safety requires that windows used to guide vehicles or perform industrial operations be kept free of fog, ice, and snow. Other than the use of materials such as Rain-X, a silicone-based coating that may be applied to automobile windshields to reduce the wettability of the glass, and spinning windows used on ship bridge windows, most window deicing and anti-icing technologies use heat. The most successful systems are those that are placed in large numbers in automobiles and aircraft: electric resistance heating and hot air systems.

### Technology

A variety of technologies are used to deice windows. Automobiles generally use hot air from a liquid-to-air heat exchanger that removes heat from engine coolant. A multi-speed fan blows hot air over the inside of the windshield; such defrosting systems are generally effective for frost and can melt ice and snow if given sufficient time. These systems are more effective as anti-frost systems after ice and snow have been mechanically brushed or scraped from windshields.

A variety of systems have been invented for electrically heating and blowing air over windows that cannot benefit from engine waste heat, and one is described by Liardi (1970). Some Cadillac automobiles have a heat exchanger that uses engine coolant to heat windshield washer fluid to help deice windshields. The Cadillac *Hot Shot* system sprays washer fluid at temperatures between 55°C and 72°C onto the windshield at programmed intervals. Steam is used to initially clear the washer fluid lines if they are frozen (Microheat 2008). NASA Ames Research Center has developed a deicing fluid for automobile windshields that is propylene-glycol-based and similar in formulation to aircraft Type I deicing fluids. It is claimed to work to temperatures as low as -6°C and to clear ice rapidly from windows (NASA 2006). The fluid is marketed under the name *Ice Free*.

Aircraft cockpit windows also are commonly electrically heated at their edges. They rely upon thermal conduction to keep the window free of ice between the edge heating strips, much like automobile electrical resistance window heaters. However, aircraft window heaters are operated at higher temperatures than automobile window heaters and can crack the glass if controllers fail. Figure 48 shows that these systems can be effective even in severe ice conditions, as demonstrated by the clean window despite significant ice accumulation on this NASA Twin Otter icing research aircraft.



Figure 48. Electrically heated windows on NASA Twin Otter aircraft. The windows are edge-heated: note the vertical heating strip on the extreme right side (left side of image) of the windshield.

Transparent electrical heating systems have been proposed for automobiles because a number of resistance heating systems can be fabricated from transparent material. One such system patented by Libbey-Owens Glass sandwiches a conductor within glass and claims to not present a shock hazard should the glass be broken (Felt 1959). Other systems, in which non-transparent thin film resistance heaters are glued to windows, are commonly used to defrost automobile rear windows and lower portions of windshields where wiper blades park. These systems are slow and the conductors can be easily damaged. Koontz and Forr (1993) propose a zone-heated system that is potentially faster than traditional resistance-based electric window heaters.

Ships commonly use spinning windows to keep water and ice from obscuring windows. Spinning windows have a circular frame, and a circular glass pane on the outside of the standard glass window spins rapidly to keep water off the window. These windows are installed in the bridge area (Fig. 49) (Navy 2005). Kenney (1976) found that spinning windows failed to stay ice-free during deicing tests on the tugboat *Keokuk* (Fig. 50).

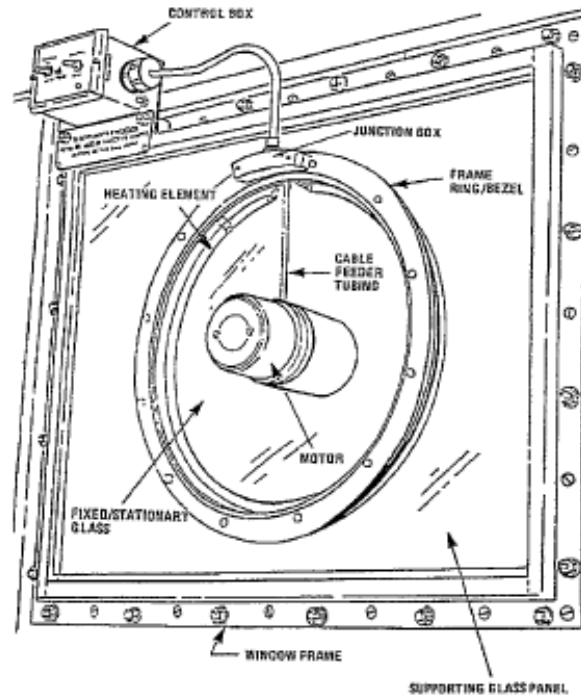

Figure 49. Typical spinning window used to keep ship bridge windows dry and free of ice on Navy ships. Viewed from inside the bridge (top). Spinning window mounted on small supply boat (bottom).

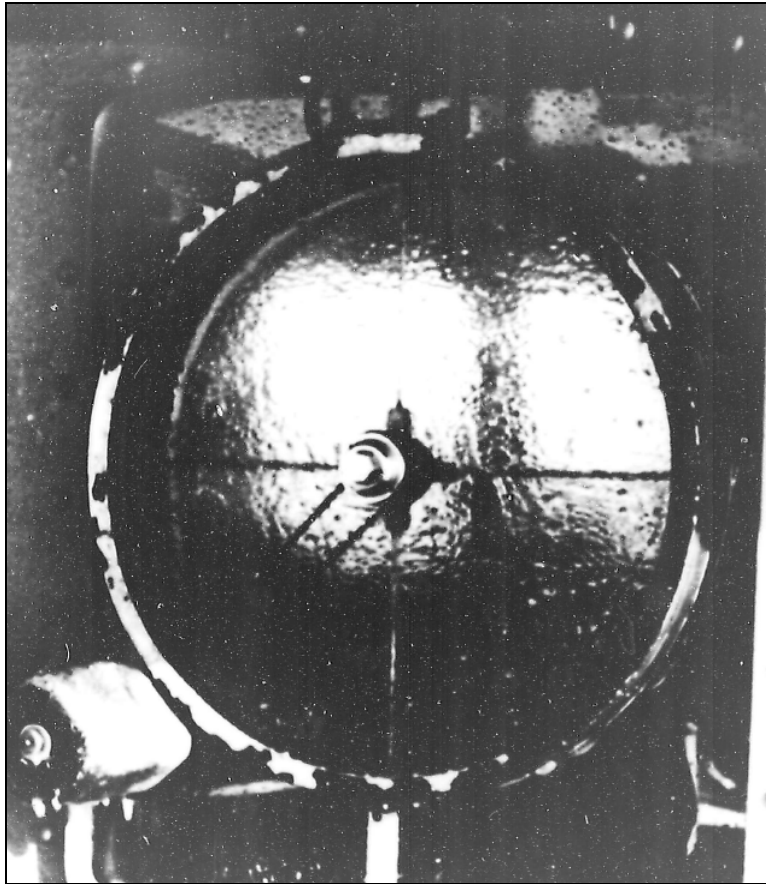

Figure 50. Ice spinning bridge window on the tug *Keokuk*. Spinning failed to keep the window clear.

Torvec (Kirsner 2004) is commercializing Petrenko's pulse deicing technology as applied to windows. Petrenko et al. (2003) demonstrated their system on glass by coating the surface with a transparent conductor. When current was applied for a few seconds, the ice slid off the window. Details of the technology were described under electrical deicing technologies (Fig. 51).

## Application

The technology applied depends upon the environment in which the window operates. Green water splashing a window heated to high temperatures could cause it to crack or break, as could high temperature deicer sprayed on a cold window. Electrically heated systems could allow electrical shock hazards, especially in saline environments, especially if the window cracks or is broken. The technologies described currently are applied to automobiles, aircraft, and ships.

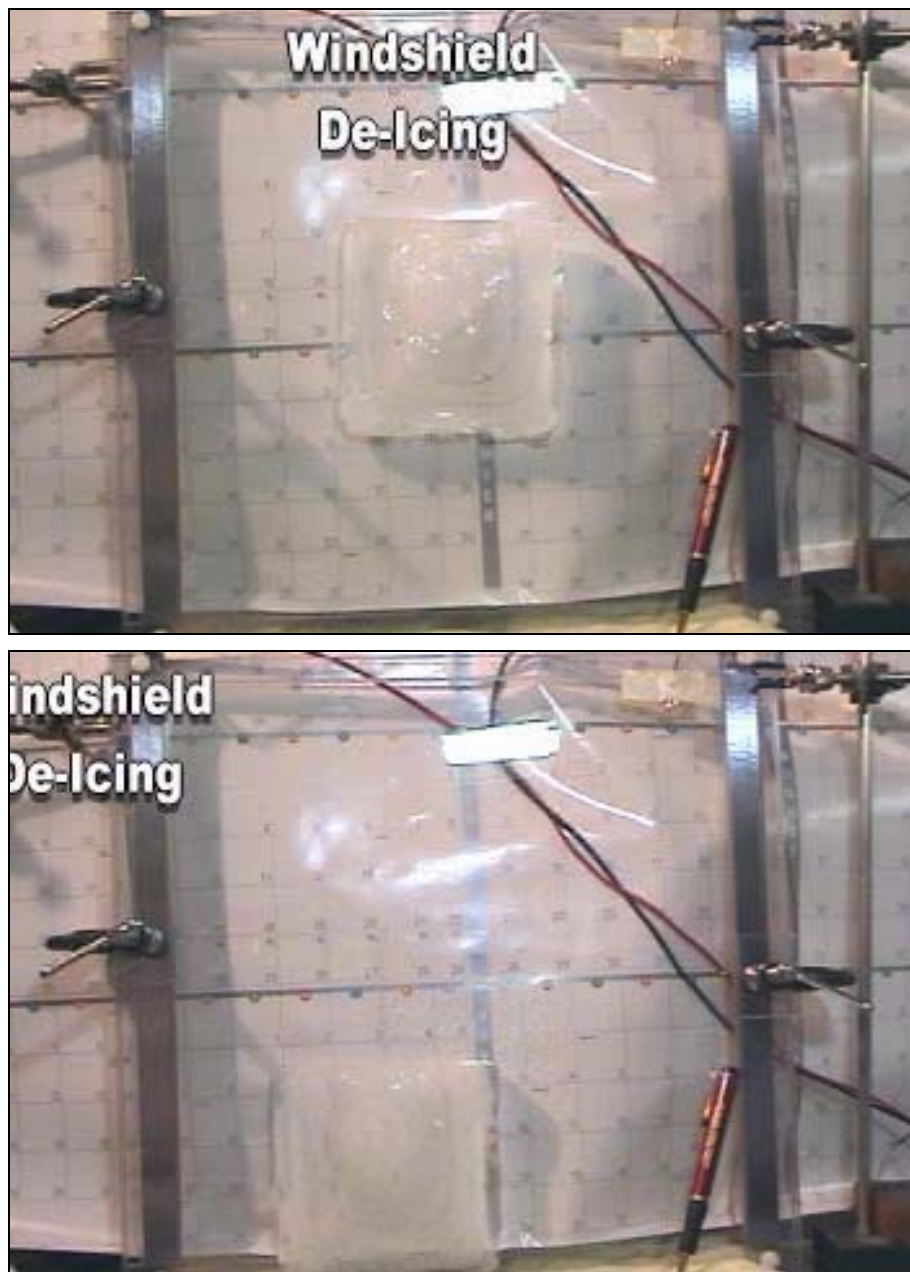

Figure 51. Pulse deicing as applied to windows. The ice sheet in the top image slid from the window after the clear conductor on the glass surface was heated rapidly.

## Sources

Tim Hooper  
800-680-3795, extension 521  
[tjh@hotshotdirectllc.com](mailto:tjh@hotshotdirectllc.com)  
HotShot Direct, LLC  
PO Box 332  
Wilton NH 03086

WORLDSOURCE, Inc.  
41-701 Corporate Way, Suite 6  
Palm Desert CA 92260  
Phillip Tubert: 877-777-WDSC (9372), extension 713  
[phillip.tubert@worldsourceinc.net](mailto:phillip.tubert@worldsourceinc.net)  
949-200-7669  
[info@investsourceinc.com](mailto:info@investsourceinc.com)

Torvec, Inc.  
1999 Mt. Read Blvd, Building 3  
Rochester NY 14615  
Jim Gleasman, Chief Strategist and Investor Relations  
585-254-1100



## 22 Cables

### Background

Cables experience significant icing problems and are a cause of system failure when iced too heavily. Cables ice uniquely, especially when water sources are wind-driven and cables are oriented at nearly right angles to the wind direction. Freezing rain freezes slowly enough that water runs around cables and surrounds them with glaze ice. With rime and sea spray, ice accumulates on one side. The torsionally weak cable then rotates down, or twists, because of the weight of the ice accumulating on the side, and more ice accumulates on the new exposed face. This process, if occurring for a long enough time, can cause cables to rotate multiple times with a spiral of ice enveloping them (Kuroiwa 1965) (Fig. 52).

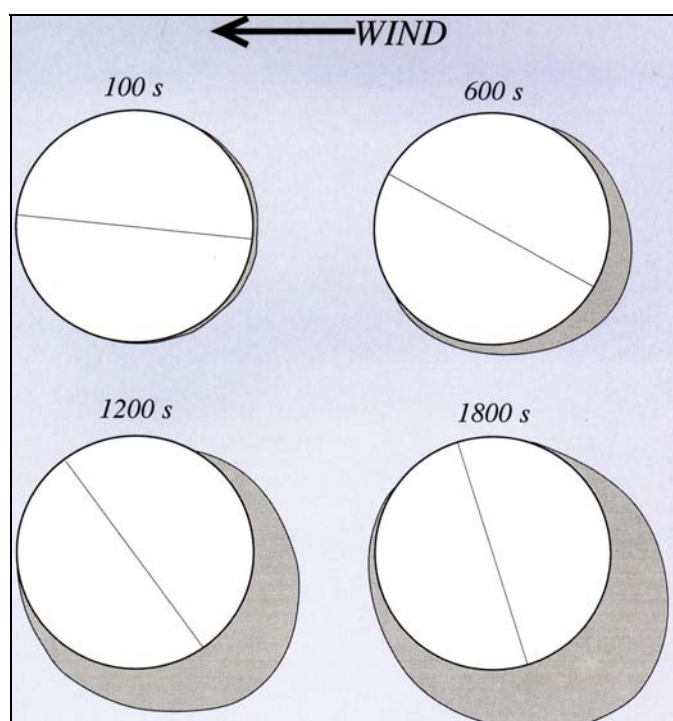

Figure 52. Rotation of cables during wind-driven icing conditions, caused by asymmetric load, allows ice to eventually envelop the entire cable circumference.

Ice can cause cables to derail or flatten wheels on ski chair lifts, jam cranes and anchor chains on ships, and cause towers to collapse when their guy wires break from galloping or when ice slides down the cables and causes the anchors to fail (Mulherin 1986). Transmission lines also fail when

freezing rain coats cables with glaze, increasing their weight. Transmission lines are longitudinally weak, but if they are loaded uniformly they continue to stand because forces on either side of the towers are balanced. However, if a section of line suddenly unloads as a result of an insulator failure, for example, the tower loads are no longer balanced and they fall in the direction of the heavier loads. This can cause cascade failures of lines for distances of more than 100 km as towers fall in succession as imbalanced loads progress down the line.

## Technology

Various technologies can be applied to keep cables free of ice, but the practicality of each technology is a function of the use of the cable. Electrical transmission lines and cables for cranes and winches, for example, often require different technologies. Laforte et al. (1998) provide a comprehensive review of technologies in use or in concept for transmission lines, but they do not review several of the techniques presented below. They conclude that, for transmission lines, among thermal, mechanical, and passive techniques, mechanical methods are most favorable even though thermal methods are best developed. They consider thermal methods too costly for general use.

Joule heating and the Petrenko and Sullivan high and low frequency cable deicing techniques (Petrenko and Sullivan 2003, 2006, 2007) have the potential to keep crane and winch cables free of ice because no special cable coverings are required that would be damaged during equipment operation. However, electrically isolating cables used on rigs and ships on winches, cranes, derricks, and rigging could be very difficult. Also, saline water running across insulators could cause electrical leakage, shorts, shock hazards to personnel, and damage to other electrical equipment.

Two technologies require cables to be covered with materials for deicing. Franklin developed a pneumatic boot that enveloped cables. Inflation of the boot, as in other pneumatic deicing technologies, caused the ice to break and fall from the cable (Fig. 53). Govoni and Franklin (1992) describe experiments with the pneumatic system on a guyed tower on Mount Washington, New Hampshire, in a variety of icing conditions. They found that the cables deiced well when inflated, and operated well as an anti-icing system even when more than 30 cm of ice accumulated on a control cable. Ice also tended to self-shed when not inflated because of possible twisting of the boot on the cable as a result of ice weight.

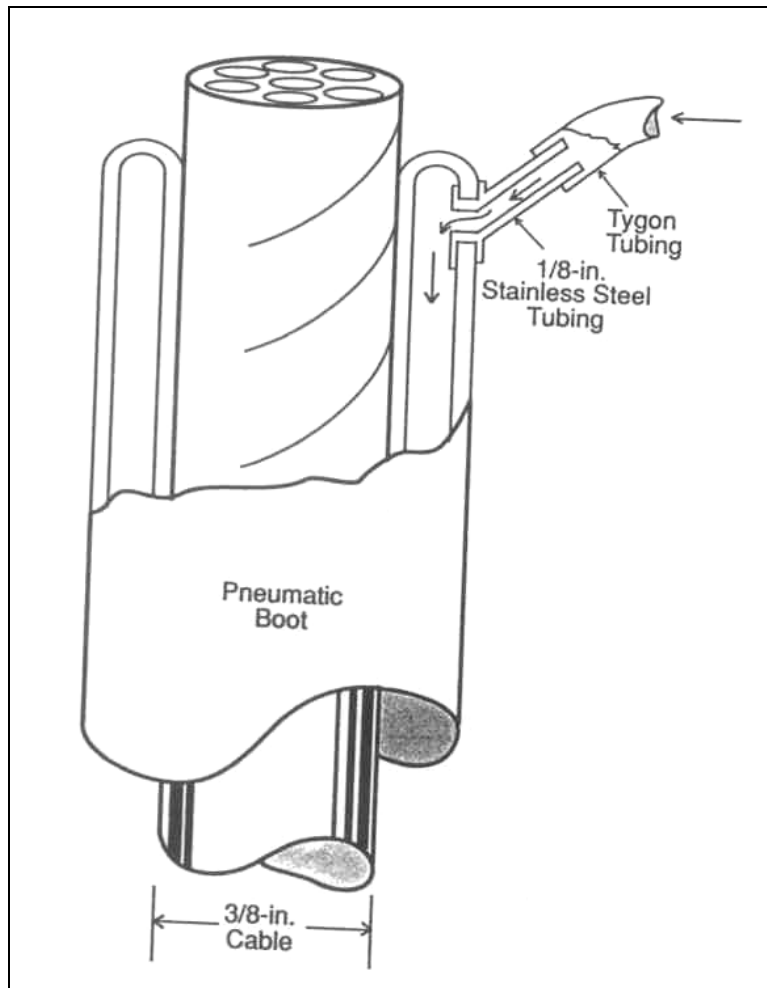

Figure 53. Pneumatic deicing boot developed by Franklin (Govoni and Franklin 1992).

Laforte et al. (1998) suggest that cable twisting methods weaken cables and are difficult to apply. However, Govoni and Ackley (1986) do hypothesize that natural cable twisting did cause some ice shedding of cables on Mount Washington, New Hampshire.

Laforte et al. (1995) have patented an electroexpulsive deicing system for cables that consists of a pair of conductive wires connected to and wound around a cable with the cable wires. The conductive wires are attached to an electronic controller that sends a current through the wires such that they are electromagnetically repelled, causing acceleration that breaks and shatters the ice, causing it to fall from the cable. Figure 54 shows a diagram from the patent and demonstrates a prototype system deicing a transmission line.

Attempts have been made to apply icephobic coatings to cables. For example, Baum et al.(1988) described the use of materials to reduce ice adhesion to cables. However, Laforte et al. (1995) indicated that coatings overall were ineffective in decreasing ice adhesion to cables, and only partially successful in decreasing the adhesion of wet snow to cables.

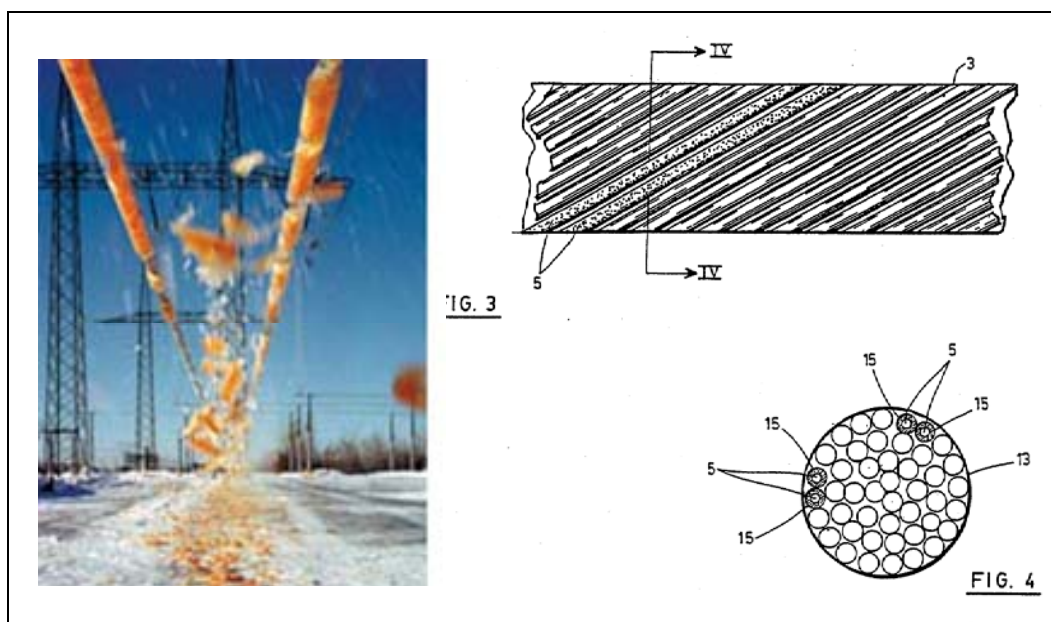

Figure 54. Electro-expulsive deicing technology applied to cables. Image on left shows colored ice falling from cables immediately after system activation.

## Application

The best technologies for cable deicing must be selected in part as a function of cable use. The most useful technologies require little power; are integrated into the cable, allowing it to be used for its intended function without damage; and are safe for personnel. However, there does not appear to be an ideal cable deicing technology for marine environments.

## Sources

Déglçage Industriel DGI Inc.  
 246, rue Régent  
 Chicoutimi (Québec) G7G 2V7  
 CANADA  
 418-690-2472  
 Fax: 418-690-2472  
[jllafort@uqac.quebec.ca](mailto:jllafort@uqac.quebec.ca)

## 23 Ice Detection

### Background

Though not strictly a deicing or anti-icing technology, ice detection systems allow operators to know when icing is occurring or has accreted in a location that is not readily observable. Also, ice detectors typically serve as information sources for automated deicing and anti-icing systems. The classic examples are systems commonly used on sophisticated aircraft.

Ice detection is available in a wide variety of technologies that sense the weight of ice, its solid structure, and its electromagnetic properties. Ice detectors can either indicate that ice is present by its thickness or mass, or that icing is occurring. They can occasionally indicate both active accretion and accumulated mass or thickness. Detectors that detect the presence or thickness of ice are occasionally also capable of determining when a surface is clear of ice as a result of deicing or anti-icing activity, a significant added benefit if the detection system is not negatively affected by the deicing or anti-icing activity.

Ice detectors are ideally placed on the surface that is icing, allowing the device to directly detect the ice. However, they often must be located in a location different from the surface of interest because the design of the ice detection technology may not allow placement on the icing surface of interest. In this case, the ice detector response must be correlated with ice accretion on the surface of interest. A comprehensive review of ice detection technologies for wind turbines is presented by Homola et al. (2006). Their work is applied to wind turbines, but most technologies available are reviewed. SAE Aerospace Information Report 4367 (2004) also presents a comprehensive review of ice detection technologies for inflight aviation applications.

One of the difficulties of ice detection is how to accurately represent the amount of ice accreting on a surface. Most ice detectors are point devices. That is, they measure icing rate, the presence of ice or its thickness at only one location. Yet, the interest of operators is often ice accretion over a large area, such as an antenna or wing. However, large areas are often different mechanically and thermally from the ice detector, and they are also typically different with regard to exposure. Therefore, the ice detector

typically does not accurately represent the entire surface of interest. Users of ice detectors must recognize this problem when selecting detector technologies, when siting detectors, and when interpreting signals from the detector. Also, ice detector technology selection must be compatible with the icing and operational environments in which they will operate. Some detectors are not compatible with glaze icing but are compatible with rime icing, for example. The reverse is true of other detectors. Also, few ice detectors have been tested in the marine environment, so compatibility with that operational environment can only be surmised from knowledge of ice detector performance characteristics.

Ice detectors are designed for detecting ice principally on aircraft airfoils, transmission lines, and road surfaces. Few other applications have required ice detectors, or have made them economically justifiable. The importance of aircraft, transmission lines, and roads as transportation systems, the consequences of their failure due to ice, and their use in remote locations makes them economically justifiable. The review by Homola et al. (2006) for wind turbines suggests that they also fit this situation.

## Technology

### Ice Mass and Stiffness Sensing

The Rosemount ice detector has become the “classic” ice detector. It has found applications in aviation (SAE 2004), automated weather stations such as the National Weather Service Automated Weather Observing System (ASOS) (Ryerson and Ramsay 2007), and communication tower icing (Mulherin 1986). It also was tried on an oil rig (Minsk 1985) and on the Coast Guard Cutter *Midgett* (Ryerson and Longo 1992) to monitor marine icing rates.

The Rosemount icing sensor detects ice by sensing ice mass, and perhaps stiffness, on a 25-mm-long by 6-mm-diameter cylindrical probe that vibrates longitudinally at a nominal 40 kHz when ice-free (Fig. 55). Full operating characteristics of the ice detector are described by Ramsay (1997), Stein (1993), and Claffey et al. (1995). In general, sensor frequency decreases linearly with increasing ice mass.

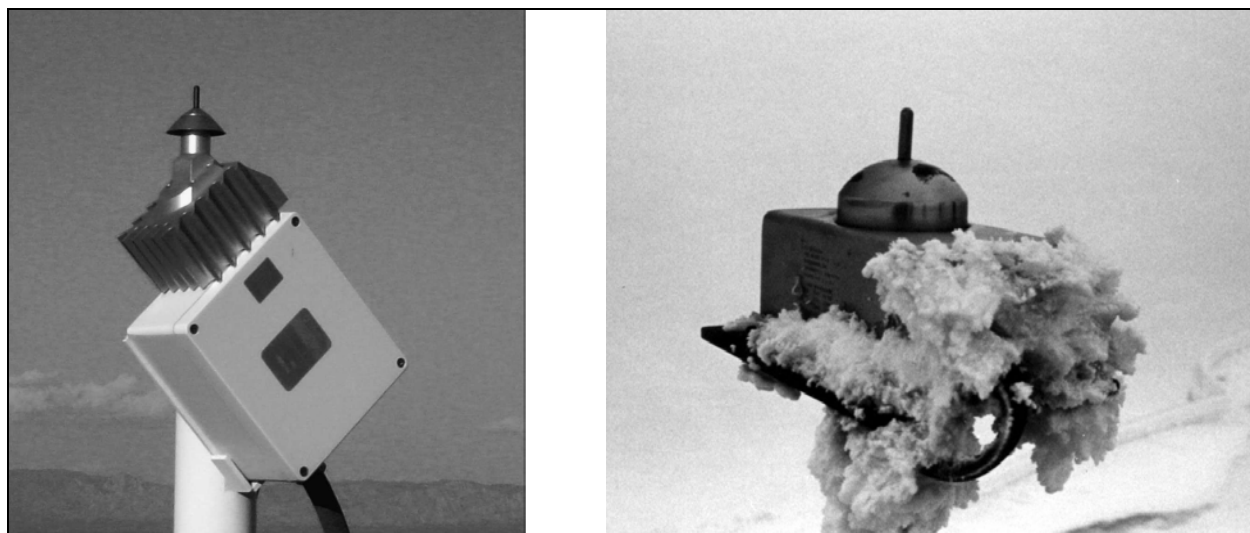

Figure 55. Rosemount ice detectors for measuring freezing rain (left) or rime ice (right).

Thousands of Rosemount ice detectors are in operation in weather reporting and aviation service. They detect ice only when it is accreting and do not represent ice thickness or mass after icing has stopped accreting because the detector periodically deices its ice load and clears the probe of ice. Also, its geometry means that it cannot be embedded into a surface that is icing, but is typically remotely located to represent icing on the surface of interest. Finally, different detector models are more appropriate for specific situations. Aircraft-mounted probes have an airfoil shape and can be mounted in any position because of the speed of airflow around them. Stationary detectors must be mounted with probes oriented vertically for best accuracy. Also, ice detectors intended for freezing rain measurements (Fig. 54 left) do not perform as well in rime icing conditions as does the model intended for that environment (Fig. 54 right).

The Rosemount ice detector signals the presence of icing conditions in two ways. A frequency drop is registered from its nominal dry probe frequency of 40 kHz. A deicing signal can be activated from this frequency drop using a computer or a data logger. A deicing signal also can be triggered by the energizing of the ice detector's internal probe deicing circuit.

### Ice Imaging

Two imaging systems are available that provide a visual indication of the presence of ice and its distribution on a surface. Goodrich markets the "Ice Hawk," originally developed by Robotic Vision Systems Inc. (RVSI). As originally developed, the system operated by scanning the aircraft surface

with an infrared diode laser. Backscatter is digitized, and areas of ice are displayed in white, clean areas in green, and areas out of range in black (Fig. 56 left) in any lighting conditions. It detects ice by analyzing the polarization of the reflected signal. Wherever ice is present, the return infrared signal is unpolarized (Goodrich 2008). The ice imaging system makes operations in reduced light, and with clear ice, more effective than the naked eye. The system worked equally well with thin, 1- to 2-mm-thick clear ice, as with ~1-cm-thick wet snow (Ryerson et al. 1999). Tests of the Ice Hawk by the Air Force showed that the system correctly indicated ice/no ice conditions. However, there were conditions when the imaging systems showed no ice remaining when the operator/observer, using visual and tactile methods, determined that ice remained on test articles. This may have been caused by degradation of the ice signature by the distance and angle of the test articles from the imagers, fog and airborne ice particles in the test chamber, residual foamy fluid on the test articles, and vibration of the camera mount (Wyderski et al. 2003).

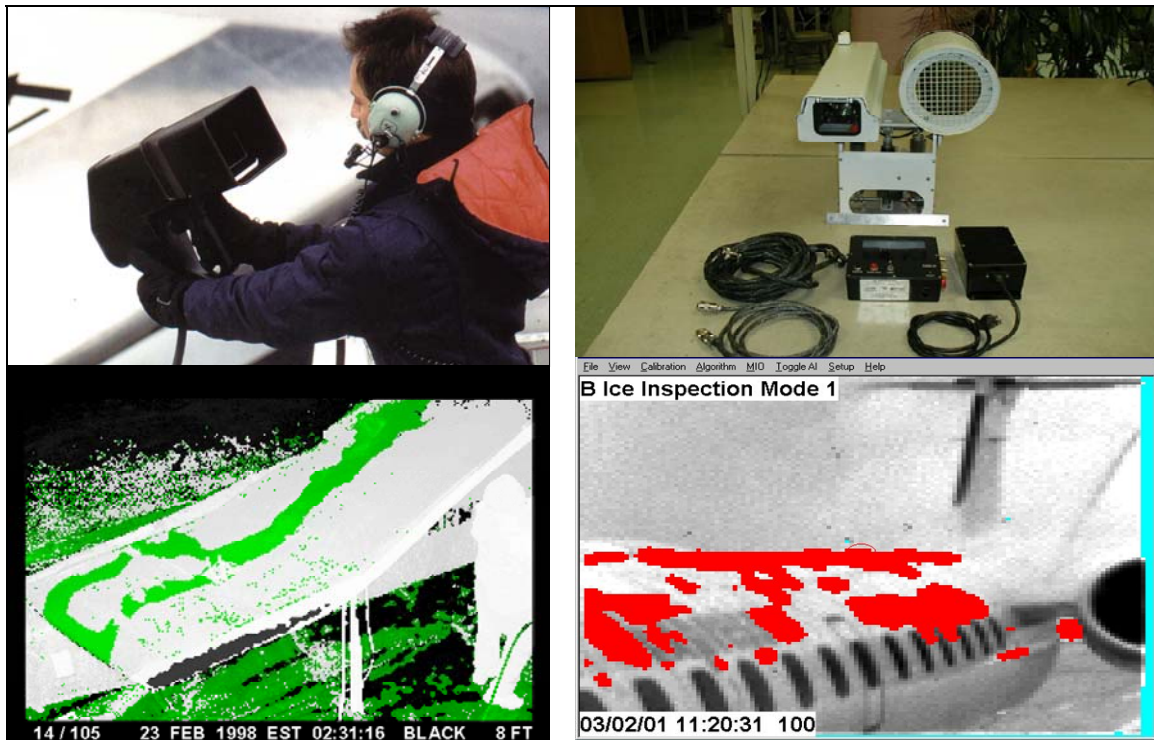

Figure 56. Ice Hawk (left images) as originally designed by RVSI, and Canadian infrared detection system (right images).

Gregoris et al. (2004) describe a Canadian multispectral infrared system for imaging ice on aircraft and other surfaces. Developed by Cox and Company for a short time in the early 2000s, the system (Fig. 56 right) spec-



trally analyzes reflected infrared light from ice-covered and ice-free surfaces and maps the location of the ice. The spectral contrast between bands within the 1- to 1.4- $\mu\text{m}$  near-infrared spectrum is used to extract and enhance the wavelength shift caused by the presence of surface ice. Water and glycol-based Type I, II, and IV deicing and anti-icing fluids give a spectral contrast of zero or negative. Ice gives a positive spectral contrast that increases almost linearly with ice thickness. Therefore, the system can provide both the presence of ice and estimates of the thickness of ice from a minimum of about 0.5 mm to at least 7 mm (Gregoris et al. 2004). The system has been tested on aircraft, roads, and the Space Shuttle.

### **Ice Mass Sensing**

Several technologies have been developed to measure the mass of ice accreted on surfaces using load cells. For example, Valley Group (2008) developed a device called Pole-Ice that uses a pivoted cylinder cantilevered on a load cell to represent ice loads on transmission lines (Fig. 57). Though inexpensive, portable, and more convenient than actually placing load cells on a live transmission line, the unit experienced data noise from wind effects, and there were questions about the representation of measurements made near ground level of transmission lines located many meters higher. However, the system was used to measure ice loads on transmission lines crossing the Appalachian Mountains.

Franklin and Rogne (1991) also developed an ice detector that measured ice mass on a vertical rod such that rime ice would accrete on the surface in horizontal air flow. However, rime ice and glaze ice bridged a space between the collection rod and the instrument base, preventing the full ice load from being sensed by the load cell. Franklin (Franklin and Howe 1986, Franklin et al. 1985) developed a system earlier that sensed ice mass on three supporting strain gauges and periodically pneumatically deiced. It measured ice loads and wind speed, and was somewhat more successful than the later attempt, but ice bridging was also a problem in severe icing conditions, especially glaze ice.

Ice mass is also measured directly on transmission lines. For example, Ryerson and Eliasson (1993) compared ice mass measurements from load cells placed directly on a transmission line and ice mass calculated from a Rosemount ice detector. Seppa (Valley Group 2008) also markets a system that instruments transmission lines with load cells for measuring ice load directly.

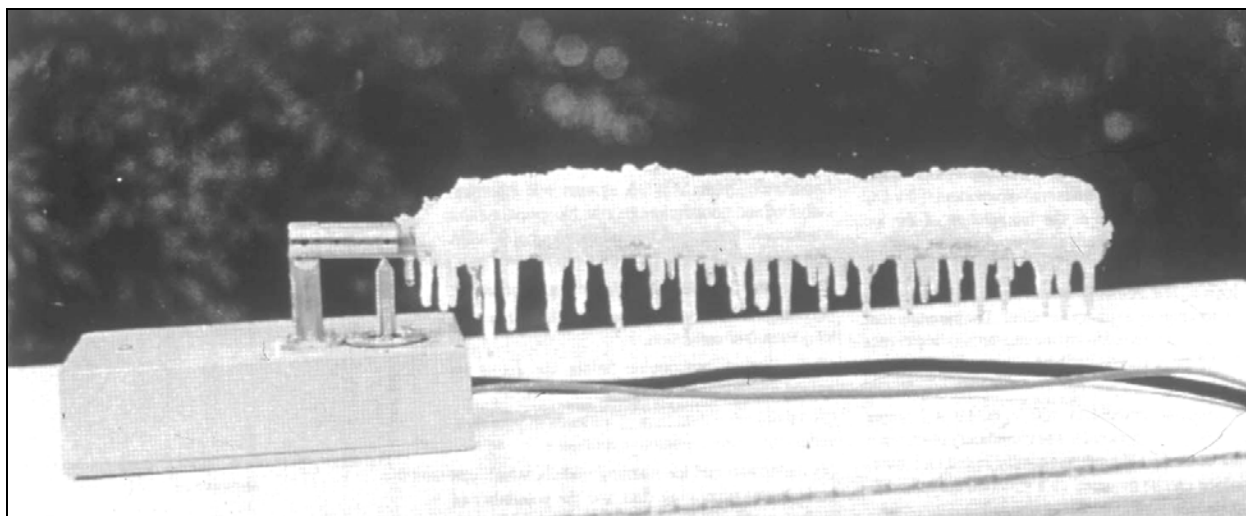

Figure 57. Pole-ice instrument for representing ice loads on transmission lines.

### Dielectric Property Sensing

Several technologies use the dielectric properties of ice to detect its presence. According to AIR 4367 (SAE 2004), “these technologies create an electrical field above the surface of interest and the observed capacitance is changed by the dielectric constant of the ice on the surface.” From this information, thickness and potentially some properties of the ice can be determined.

Innovative Dynamics (Pruzan et al. 1993) developed an ice detector that uses the capacitance differences between ice and other materials to detect the presence of ice. Instrumar developed a similar system called the Clean Wing Detection System (CWDS) that was claimed responsive to ice, snow, water, and deicing fluids (Inkpen et al. 1992, 1995). Both systems consist of electrical conductors that conform to the surface of an icing substrate, and therefore measure directly on the surface that is icing. Tests of the RVSI and the Instrumar systems by APS Aviation (1994) to determine how well ice detection systems detected the failure of anti-icing fluids showed that the RVSI and Instrumar systems correlated well with observed fluid failure times.

Dedicated Electronics, Inc. (Joseph 2002) has developed the Microwave Aircraft Icing Detection System (MAIDS) that uses a waveguide embedded in an icing surface to detect the presence of ice. When tested in the NASA Icing Research Tunnel (IRT) in Cleveland, Ohio, the system was able to indicate the presence of thin ice, a layer of ice with liquid above, ice thick-

ness, and icing rate, and was able to distinguish ice from water and deicing fluids. The system is flush-mounted and detects ice, water and fluids, and the thickness of ice through phase shifts in the millimeter wave signal and the magnitude of the signal (Fig. 58).



Figure 58. Conformance of Dedicated Electronics' ice detector to icing surface.

Yankielun et al. (2002, Yankielun and Ryerson 2003) developed a Time Domain Reflectometry (TDR) ice detection technology that uses a transmission line with two parallel wires embedded in the icing surface. Changes in the dielectric media in the immediate surrounding region cause a change in the velocity of propagation of the signal. Tests in cold chambers in troughs filled with water and ice, and on helicopter blade sections, confirmed that the TDR system would indicate the change in bulk dielectric constant when freezing or thawing occurred. The boundary between ice and air or ice and water was distinct and discernable in the TDR test. However, the boundaries between ice and an adjacent deicing (or anti-icing) solution were less distinct and difficult to determine with the TDR.

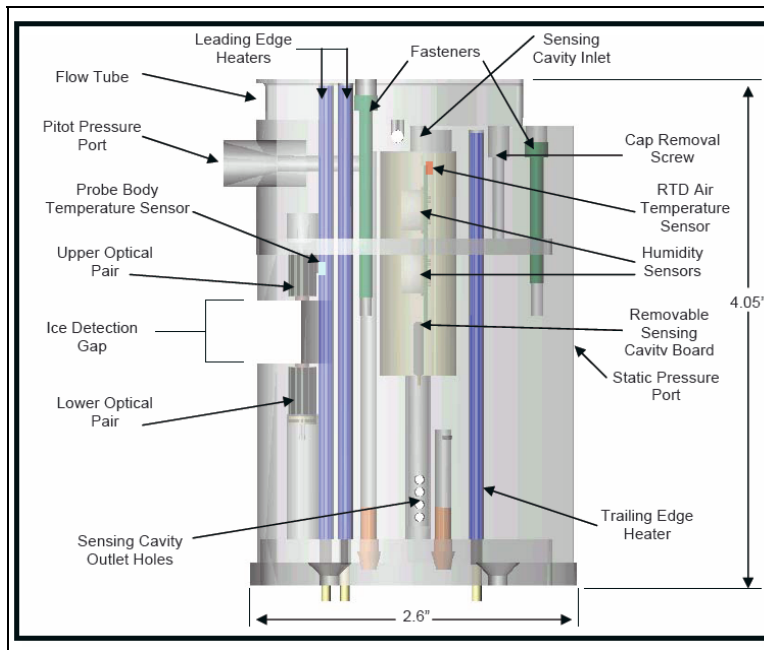

Figure 59. TAMDAR sensor head that senses a variety of atmospheric conditions. Ice sensing is accomplished by light beam interruption in the leading edge notch.

### Optical

Several optical methods have been developed to detect ice. The operational TAMDAR system measures a wide variety of atmospheric conditions including temperature, humidity, static and dynamic pressure, and ice accretion (Fig. 59) (Daniels et al. 2004). Ice is detected by the obscuration of two independent infrared emitter/detector pairs mounted in a leading edge recess of the probe (Fig. 59). Internal heaters melt the ice when the infrared beams are interrupted and the measurement cycle repeats. The

ice detector records 0.5 mm of ice each time the deicing cycle repeats. The icing portion of the detection system has been tested in several icing wind tunnels and has passed Federal Aviation Administration requirements. As with several other sensor technologies, however, the system requires airflow over the sensor from a specific direction to function in its current configuration.

Yankielun et al. (2005) developed an optical system for measuring ice on stationary surfaces. The apparatus is currently a laboratory device, and consists of a prism, a single-axis translation stage, and an optical spectrometer that measure the spatial span between two Fraunhofer line wavelengths in the prism-refracted visible spectrum reflected through a clear ice slab. The distance is proportional to slab thickness. Measurements were made on 8- to 49-mm-thick Plexiglass as well as nearly bubble-free freshwater ice ranging from 28 to 53 mm thick. Results indicated a linear relationship between spectral span and slab thickness. This device may be suitable for detecting and measuring point-location ice thickness on aircraft wings, as well as for other industrial and research purposes. However, additional tests will be required to determine whether the technology is practical in ice that is not absolutely clear and bubble-free.

### **Ultrasonic**

Ultrasonic systems use the reflection of sound at interfaces where materials of different materials contact, such as ice and metal or composites, or ice and air, to determine whether ice resides on a surface, and to determine its thickness (SAE 2004). Frequencies used are in the megahertz range; for example, Hansman has tested the technology at 5 MHz (Morrell 1987). The technology uses a small piezoelectric transducer mounted flush with a surface such as the leading edge of an airfoil. The transducer emits ultrasonic waves at the surface, and if ice is present, sound waves are reflected back to the transducer that now acts as a transducer (Hansman and Kirby 1985) (Fig. 60). Ice thickness is determined from the time delay between pulse emission and receipt of the reflection, and the speed of sound in ice. The technology has been tested successfully in coldrooms, in icing wind tunnels, and in flight in clear ice and in rime icing conditions (Hansman et al. 1990). Hansman et al. (1990) claim measured ice thickness accuracies of  $\pm 0.5$  mm. The technology has an advantage of being a non-intrusive ice detector. Aerazur manufactures a similar flush-mounted ice detection system. These systems are used, for example, to detect ice on the

upper surface of the MD-80 wing when ice forms as a result of condensation in warm, humid air after the wing cold-soaks at altitude (SAE 2004).

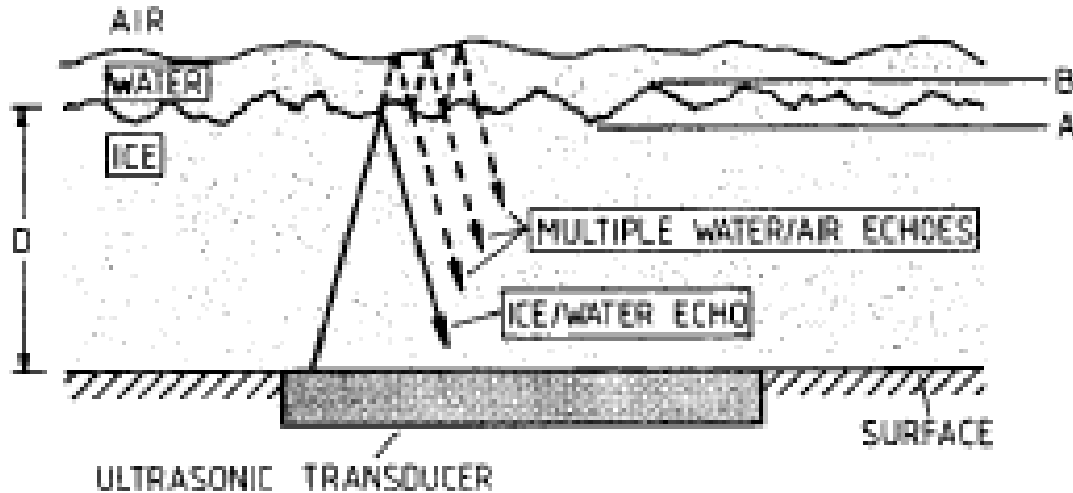

Figure 60. Operation of ultrasonic ice detectors.

### Latent Heat Detection

Several ice detectors sense the latent heat of fusion to determine whether ice is accumulating on structures. The accumulation of ice on an object causes the release of latent heat of fusion, approximately 334 Joules per  $\text{cm}^3$  of ice. One method of detection is to monitor the temperature of a probe as it accretes ice, accomplished by periodically providing a current pulse through a resistance element to heat the probe. If ice has accreted on the probe, the temperature increase will be temporarily halted at  $0^\circ\text{C}$  ( $32^\circ\text{F}$ ). If no ice has accreted, the temperature increase will not halt at  $0^\circ\text{C}$  ( $32^\circ\text{F}$ ) (SAE 2004). This technology monitors icing of the B1 bomber engine inlets.

Latent of nucleation also can be detected with infrared sensors. Visidyne, with NASA funding, used infrared sensors to determine whether a helicopter blade was icing. An upward-staring 3- to 5- $\mu\text{m}$  infrared sensor was mounted on top of a helicopter fuselage, and the sensor measured the temperature profile across the rotor blade as it rotated across the sensor field of view. A germanium lens allowed the sensor to focus on a small spot in the rotor blade plane. When icing occurred, the temperature of the blade leading edge increased (Dershowitz and Hansman 1991).

## Application

Ice detectors have applications on aircraft, communication towers, transmission lines, and roadways. Most roadway sensors measure temperature, wetness, and other parameters, but do not measure ice accretion directly, as do other technologies. They use algorithms to assess from the multiple sensors whether ice is present.

## Sources

Dennis Gregoris, Simon Yu, and Frank Teti  
MD Robotics Limited  
9445 Airport Road  
Brampton ON, Canada, L6S 4S3  
[dgregori@mdrobotics.ca](mailto:dgregori@mdrobotics.ca)

Sensor Systems  
Goodrich Corporation  
14300 Judicial Road  
Burnsville MN 55306-4898  
952-892-4000  
Fax: 952-892-4800  
[www.aerospace.goodrich.com](http://www.aerospace.goodrich.com)

John C. Joseph  
Dedicated Electronics, Inc.  
603-887-3161  
[www.dedicated-electronics.com](http://www.dedicated-electronics.com)

AIRDAT LLC  
5150 McCrimmon Parkway, Suite 407  
Morrisville NC 27560  
919-653-4350

Visidyne, Inc.  
99 South Bedford Street  
Corporate Place, Suite 10  
Burlington MA 01803-5168  
781-273-2820  
Fax: 781-272-1068  
<http://www.visidyne.com/>

Mr. Francis L. Averous, Aerospace Department Manager  
Aerazur  
48 Boulevard Gallieni  
92130 Issy-Les Moulineaux, France  
33 (141) 23-2323 33 (141) 23-2399  
[faverous@zodiac-group.com](mailto:faverous@zodiac-group.com)

Tapani Seppa, Vice President of Operations  
The Valley Group  
871 Ethan Allen Hwy, Suite 104  
Ridgefield CT 06877  
203-431-0262  
Fax: 203-431-0296  
[tap.seppa@cat-1.com](mailto:tap.seppa@cat-1.com)



## 24 Summary

Offshore operations in cold environments must occasionally operate in superstructure icing conditions caused by sea spray, and atmospheric icing conditions caused by freezing drizzle or freezing rain, rime, sleet, snow, or frost. Icing from each source has the potential to create dangerous conditions aboard offshore platforms and supply boats. The frequency and amount of ice created from each source varies with geographic location. The danger to personnel is similar from either source if it coats work areas and equipment. However, superstructure ice has the greatest ability to cause sufficient ice accumulation that the stability of rigs or supply boats is threatened. Sea spray has the potential to cause hundreds of tons of ice accumulation on rigs, thereby causing significant changes in displacement. However, there are no recorded causes of offshore rigs being lost as a result of icing, nor are there records of ice even being a significant contributing factor to the loss of a rig. There are records of operations being slowed or curtailed because of significant superstructure ice accumulation. Atmospheric ice on rigs is an inconvenience and a safety problem, but generally causes no risk to rig stability. However, the potential exists for supply boats to be lost as a result of superstructure icing because they are similar in size and freeboard to fishing trawlers, which are often lost to icing as a result of loss of seaworthiness.

Each type of ice has the potential to effect different parts of rigs. Superstructure ice typically does not accumulate large amounts of ice above the main deck because it is typically located well above the water surface. However, areas below the main deck can accumulate large amounts of ice, especially if there are numerous smaller structural elements such as supports, braces, and piping that are relatively small in diameter and collectively present a large surface area for ice to adhere to. Structural members immediately above the sea surface, however, often have minimal ice accumulation because of the frequent supply of large volumes of relatively warm water.

Atmospheric ice typically impacts areas at and above the main deck most significantly. Precipitation icing such as snow, freezing rain, freezing drizzle, and sleet tend to coat decks and horizontal surfaces except where wind carries them into vertical surfaces. Rime ice usually has minimal effect on

decks but causes ice accumulation on vertical surfaces as a result of wind flow. Therefore, the structure of a platform has a very strong control over where and how much ice of any given type accumulates.

Many methods have been tried for deicing and anti-icing offshore platforms and boats. The most effective anti-icing methods are through design of the structure, and careful use of heat tracing around hatches and along piping and other areas susceptible to freezing. Careful design involves minimizing rig surface area, decreasing the complexity of the surface to minimize smaller-diameter areas that allow more rapid ice accumulation, and enclosure of areas to keep them dry and/or warm. Rigs designed in Scandinavia, such as the *Eric Raude*, meet many of these criteria. Simply towing a rig designed for warm weather operations into a cold region for operation could have disastrous consequences. There are no quick fixes for offshore platform icing problems, especially because the most effective anti-icing measure is through proper design.

Deicing technology for offshore structures has advanced little in more than a century. Though localized use of heat tracing and steam lances has been effective, the primary tools to deice are still wooden baseball bats and mallets. There has been little success in the use of chemicals, low adhesion coatings, pneumatic systems, infrared heat, vibration, and other technologies to anti-ice or deice offshore structures.

Many technologies are mature and in use today for deicing and anti-icing aircraft. Other technologies are used experimentally to deice electrical transmission lines, and yet more technologies are in development. There are two principal methods of preventing icing: keeping surfaces dry or keeping surfaces warmer than the water freezing temperature, which is about  $-2^{\circ}\text{C}$  for seawater. Heat is the most common and most successful deicing and anti-icing technique. Bleed air heats the leading edge of jet aircraft, electricity heats the leading edge of helicopter blades and electrical transmission lines (Joule heating), hot air defrosts automobile windshields, and hot deicing fluids remove snow and ice from aircraft before flight. However, heating is expensive with regard to energy usage, and attempts are being made to make these systems more efficient.

Chemicals and coatings are other common methods of deicing and anti-icing. Chemicals are widely used to deice aircraft, though heat likely is the primary cause of deicing because fluids are sprayed hot, with the chemical

preventing refreeze. However, chemicals are applied to aircraft to anti-ice, and they are applied to roads and runways to either anti-ice or to reduce the adhesion of ice and snow to pavements. Some of these techniques may be useful offshore, but control of chemicals is difficult in offshore environments, and corrosion is a significant problem. Coatings are passive techniques for reducing the adhesion strength of ice to substrates. They can assist active deicing and anti-icing technologies by hastening the release of ice and reducing energy consumption. Though coatings cannot prevent the formation of ice, there is promise that new coatings may be approaching that capability.

Expulsive deicing is a technology that has matured in the last 10–20 years and has certain application in aviation, and potential application to specific areas of offshore structures. There also may be opportunities for limited infrared deicing on offshore structures. Windows and cables, common components of offshore structures and supply boats, require special attention, but currently have only limited solutions.

Finally, ice protection technologies must be controlled. Technologies need not operate when icing is not occurring, and if they do so may fail prematurely or use excessive energy. Ice detection technologies determine whether ice is accumulating on surfaces and, in some cases, provide information about when a surface has been cleaned of ice by an anti-ice or deicing technology. There are a wide variety of ice detection techniques, and several are potentially applicable to offshore marine applications.

## 25 Conclusions

Icing is a certain threat to offshore operations in cold regions because of reduced personnel safety, reduced operational tempo, and risk of loss of supply vessels. Threats are due to both superstructure and atmospheric icing, with the greatest risk potentially being from superstructure icing because it allows accumulation of large masses of ice. Technologies exist that can help ameliorate the problem and perhaps change icing from a hazard to an inconvenience, or less. Many technologies are used in non-marine environments that successfully cope with icing and reduce the hazard to little more than an event to be dealt with. The challenge is determining which technologies may successfully cope with icing in the marine environment safely and economically, and how they may be applied.

## References

- Ackley, S., 1985, Sea spray icing: A review of current models. In *Proceedings, 1985 US Navy Symposium on Arctic/Cold Weather Operations of Surface Ships*, Washington, DC: Deputy Chief of Naval Operations for Surface Warfare.
- Ackley, S.F., K. Itagaki, and M. Frank, 1977, De-icing of radomes and lock walls using pneumatic devices. *Journal of Glaciology*, 19(81): 467–478.
- Adams, L.J., S.C. Simshauser, N. Pisarski, and N.A. Weisend, Jr., 1989, *Electro-Repulsive Separation System for Deicing*. US Patent 4,875,644, 24 October 1989.
- Air Force, 2005, Deicing/Anti-Icing. *Proact Fact Sheet*, Brooks AFB, 3 p.
- Air Force, 2006, Feature Topic-Deicing/Anti-icing. *The Monitor*, Vol. 90, No. 1, No. 06-0425, pp. 11–25.
- Anderson, D.N., and A.D. Reich, 1997, Tests of the Performance of Coatings for Low Ice Adhesion. *35th Aerospace Sciences Meeting & Exhibit, American Institute of Aeronautics and Astronautics*, Reno, 6–10 January 1997, NASA Technical Memorandum 107399, AIAA-97-0303, 16 p.
- APS Aviation, 1994, *Aircraft Ground De/Anti-Icing Fluid Holdover Time Field Testing Program for the 1993–94 Winter Test Results Summary*. Transportation Development Centre of Transport Canada, Report TP 12915E, 119 p.
- Baller, H., 1983, Rig winterization to allow year-round drilling off northern Norway. *Oil and Gas Journal*, 1 August 1983.
- Baller, H., and R. Friedberg, 1984, Statoil Develops Next-Generation Arctic Rigs. *Oil & Gas Journal*, 17 December, pp. 82–83.
- Baum, B., L. Thoma, and T. Kendrew, 1988, Research to develop conductor deicing compounds. In *Proceedings of the Fourth International Conference on Atmospheric Icing of Structures*, 4th, Paris, 5–7 September 1988, pp. 372–375.
- Blackmore, R.Z., and E.P. Lozowski, 1998, A theoretical spongy spray icing model with surficial structure. *Atmospheric Research*, Vol. 49, No. 4, November 1998, pp. 267–288(22).
- Boluk, Y., 1996, *Adhesion of Freezing Precipitates to Aircraft Surfaces*. Transportation Development Centre on Behalf of Civil Aviation Safety and Security, Transport Canada, Report TP 12860E, Transportation Development Centre (TDC), 800 René Lévesque Blvd. West, 6th Floor, Montreal, Quebec, 44 p.
- Borisenkov, E.P., and V.V. Panov, 1974, *Basic Results and Prospects of Research on Hydrometeorological Conditions in Shipboard*. In Investigation of the Physical Nature of Ship Icing, US Army Cold Regions Research and Engineering Laboratory, Hanover, New Hampshire, Draft Translation 411, pp. 1–30, ADA003215.

- Brown, R., and I. Horjen, 1989, Evaluation of State-of-the-Art Drilling Platform Icing Models. Canadian Climate Center Report 89-10, 80 p.
- Brown, R., and P.J. Roebber, 1985, The Ice Accretion Problem in Canadian Waters Related to Offshore Energy and Transportation. Canadian Climate Center Report No. 85-13, AES Downsview, Ontario, 295 pp.
- Brown, R.D., and T. Agnew, 1985, Characteristics of Marine Icing in Canadian Waters. *Proceedings of the International Workshop on Offshore Wind and Icing*, Halifax, Nova Scotia, 7–11 October 1985.
- Brown, R.D., and P. Mitten, 1988, Ice Accretion on Drilling Platforms Off the East Coast of Canada. In *Proceedings, International Conference on Technology for Polar Areas, Trondheim, Norway, 15–17 June 1988*, Vol. 2. Edited by A. Hansen and J.F. Storm, p. 409–421. Publisher: Trondheim, Norway, Tapir Publishers.
- Cape Cod Research, 2008, <http://www.capecodresearch.com/>.
- Carstens, T., 1983, Special Hazards in Open Waters at High Latitudes. *Cold Regions Science and Technology*, Vol. 7, pp. 293–295.
- CAV Aerospace, 2008, <http://www.weepingwings.com/>.
- Claffey, K., K. Jones, and C. Ryerson, 1995, Use and Calibration of Rosemount Ice Detectors for Meteorological Research. *Atmospheric Research*, Vol. 36, pp. 277–286.
- Cooper, T.D., D.M. Forney, and J.K. Sieron, 2000, *The Qualification of Ice Control Materials for Air Force Applications*. AFRL-ML-WP-TR-2000-4149, 85 p.
- Courville, Z., and V.F. Petrenko, 2000, De-icing layers of interdigitated microelectrodes. Materials Research Society, Symposium Proceedings, v. 604, 329–334.
- Cox and Company, 2008, *Electro-Mechanical Expulsion Deicing System (EMEDS)*. [http://www.coxandco.com/aerospace/lowpower\\_ice\\_protection.html](http://www.coxandco.com/aerospace/lowpower_ice_protection.html).
- Creare, 2002, *A High-Efficiency Actuator for Aircraft Deicing*. NASA research proposal A1.04-9235.
- Crowley, J.D., 1988, Cold water effects upon marine operations. *Proceedings, OCEANS '88. A Partnership of Marine Interests*. Publication Date: 31 Oct–2 Nov 1988, pp. 543–548.
- Dalecky, A., K. Temple, and B. Tuccillo, 1996, *Deicing Salt*. Groundwater Pollution Primer, Civil Engineering Department, Virginia Tech.
- Daniels, T., G. Tsoucalas, M. Anderson, D. Mulally, W. Moninger, and R. Mamrosh, 2004, Tropospheric Airborne Meteorological Data Reporting (TAMDAR) Sensor Development. *American Meteorological Society 11th Conference on Aviation, Range, and Aerospace Meteorology*. Paper 7.6, 17 p.

- Davilla, J., 2002, *IceCat Mobile Infrared Deicing Technology, McKinley Climatic Laboratory Testing, 22–26 April 2002, Eglin AFB, Florida*. TASK Q – INFRARED DEICING TECHNOLOGY Task Order To502BM1643, AFRL GSA Federal Technology Service ANSWER Contract GS09K99BHD-0100, 107 p.
- Derbidge, T.C., S.E. Schweizer, and C.A. Powars, 1989, Ice removal using low-pressure flashing flow. In *Proceedings, US Navy Symposium on Arctic/Cold Weather Operations of Surface Ships*, 29 November–1 December 1989. Volume 1, p. 327–338.
- Dershowitz, A.L., and R.J. Hansman, Jr., 1991, Experimental Investigation of Passive Infrared Ice Detection for Helicopter Applications. Joint University Program for Air Transportation Research, 1990–1991. US National Aeronautics and Space Administration. Conference publication, NASA-CP-3131, p. 11–18.
- Discovery Channel, 2006, *The Deadliest Catch, Man vs Ice*. Episode #19, Season #2, first aired 16 May 2006.
- DNV, 2005, Managing cold climate risks. Classification News No. 3 2005, 09 June.
- Eikill, G.O., and B.C. Oftedal, 2007, Statoil ASARig design philosophy key for harsh-environment drilling in Barents Sea, Haltenbanken area. *Drilling Contractor*, March/April 2007, pp. 83–87.
- Embry, G.D., R.W. Eskine, L.A. Haslim, R.T. Lockyer, and P.T. McDonough, 1990, Electro-Expulsive Separation System Shipboard Applications. *Naval Engineers Journal*, September, 1990, pp. 55–66.
- EPA, 2000, *Aircraft Deicing Operations*. United States Office of Water (4303) EPA-821-R-00-016 Environmental Protection Washington, DC 20460, revised, 447 p.
- FAA, 2000, *Hot Water Deicing of Aircraft*. DOT/FAA/AR-00/40, Office of Aviation Research, 79 p.
- Fagan, C., 2004, Safety of Well Testing. MMS JIP Final Project Report, Report No. 4514774/DNV, 15 Nov 2004.
- Feher, L., 2003, *Compact Millimeterwave System for De-icing and Preventing the Formation of Ice on the Outer Surfaces of Shell Structures Exposed to Meteorological Influences*. US Patent 6,642,490, 4 November 2003.
- Feher, L., and M. Thumm, 2006, Design of Avionic Microwave De-/Anti-Icing Systems. in Willert-Porada, M., *Microwave devices*. Springer 792 p., ISBN: 3540432523, pp. 695–702.
- Felt, R.M., 1959, *De-Icing Windows*. US Patent 2,898,433, 4 August 1959.
- Ferrick, M.G., N.D. Mulherin, R.B. Haehnel, B.A. Coutermarsh, G.D. Durell, T.J. Tantillo, T.L. St. Clair, E.S. Weiser, R.J. Cano, T.M. Smith, and E.C. Martinez, 2006a, Double Lap Shear Testing of Coating Modified Ice Adhesion to Liquid Oxygen Feed Line Bracket, Space Shuttle External Tank, ERDC/CRREL TR-06-11, 76 pp.

- Ferrick, M.G., N.D. Mulherin, B.A. Coutermarsh, G.D. Durell, L.A. Curtis, T.L. St. Clair, E.S. Weiser, R.J. Cano, T.M. Smith, and E.C. Martinez, 2006b, Double Lap Shear Testing of Coating Modified Ice Adhesion to Space Shuttle Component Surfaces, ERDC/CRREL TR-06-21, 62 pp.
- Ferrick, M.G., N.D. Mulherin, R.B. Haehnel, B.A. Coutermarsh, G.D. Durell, T.J. Tantillo, L.A. Curtis, T.L. St. Clair, E.S. Weiser, R.J. Cano, T.M. Smith, E.C. Martinez, 2008, Evaluation of ice release coatings at cryogenic temperature for the space shuttle. *Cold Regions Science and Technology*, vol. 52, 224–243.
- Fett, R.W., R.E. Englebretson, and D.C. Perryman, 1993, *Forecasters Handbook for the Bering Sea, Aleutian Islands and Gulf of Alaska*, NRL/PU/7541-93-0006, Naval Research Laboratory, Monterey, California, pp. 302.
- Foster-Miller, 2004, Electro-Expulsive Deicing of Shipboard Composites. NAVY SBIR Proposal.
- Frank, S., 2004, A Pet-Friendly De-icer? *Green Guide*, 11 Feb 2004, <http://www.thegreenguide.com/doc/ask/ice>.
- Frankenstein, S., and A.M. Tuthill, 2002, Ice Adhesion to Locks and Dams: Past Work; Future Directions? *Journal of Cold Regions Engineering*, Vol. 16, No. 2, pp. 83–96.
- Franklin, C.H., and J.B. Howe, 1986, Micro-processor controlled solid-state anemometer and Ice Detector. In *Proceedings of the Third International Workshop on Atmospheric Icing of Structures*, Vancouver, BC, 6–8 May 1986, 3 p.
- Franklin, C.H., and C.O. Rogne, 1991, Ice Accretion and Persistence Measuring Instrument. Franklin Engineering Co., 46 p.
- Franklin, C.H., C.O. Rogne, and C.S. Vinton, 1985, Pneumatically de-iced ice detector. US Army Cold Regions Research and Engineering Laboratory, 32 p. Publisher: Ann Arbor, MI, Franklin Engineering Co. United States. CRREL MP 3279.
- Gajda, W.J., 1983, *Cold Weather Transit Technology Program. Volume 12: Study of laser deicing*. Urban Mass Transportation Administration. Report, UMTA-IN-06-0009-83-12, 40 p.
- Goodrich, 2008, Next Generation IceHawk Wide Area Ice Detection System. Brochure, [www.aerospace.goodrich.com](http://www.aerospace.goodrich.com).
- Govoni, J.W., and S.F. Ackley, 1986, Conductor twisting resistance effects on ice build-up and ice shedding. In *Proceedings of the Third International Workshop on Atmospheric Icing of Structures*, Vancouver, BC, 6–8 May 1986, 8 p. CRREL MP 2108.
- Govoni, J.W., and C.H. Franklin, 1992, Evaluation of a pneumatic guy-line deicing boot. US Army Cold Regions Research and Engineering Laboratory. Special Report 92-04, 7 p.
- Gregoris, D., S. Yu, and F. Teti, 2004, Multispectral Imaging of Ice. *Proceedings of the 2004 IEEE Canadian Conference on Electrical and Computer Engineering*, Niagara Falls, 3–5 May, pp. 2051–2056.



- Guest, P., 2002, *Polar Meteorology*, Powerpoint presentation.
- Guest, P., 2005, Vessel Icing. *Mariners Weather Log*, Vol. 49, No. 3, December 2005, 9 p.
- Gulley, L., 1998, *Testing of Runway Ice Control Products, Materials Compatibility*. AFRL-ML-WP-TR-1999-4040. Wright-Patterson AFB, 187 p.
- Guo, T.C., 2005, *Microwave Deicing of Highways, Commercial Parking, and Pedestrian Crosswalks*. Potomac Research proposal to TEDCO. 13 p.
- Haehnel, R.B., 2002, Evaluation of coatings for icing control at hydraulic structures. US Army Cold Regions Research and Engineering Laboratory, Hanover, New Hampshire, Ice Engineering Information Exchange Bulletin, Number 33, January 2002.
- Haehnel, R.B., and N.D. Mulherin, 1998, The bond strength of an ice–solid interface loaded in shear. Ice in Surface Waters, *Proceedings of the 14th International Symposium on Ice*, 27–31 July 1998, Potsdam, New York. Rotterdam: Balkema Press, p. 597–604.
- Hanamoto, B., 1977, Lock Wall Deicing Studies. US Army Cold Regions Research and Engineering Laboratory, Hanover, New Hampshire, Special Report 77-22, 69 p.
- Hansman, R.J., 1982, *Microwave Ice Prevention System*. US Patent 4, 365,131, 21 December 1982.
- Hansman, R.J., Jr., and M.S. Kirby, 1985, Measurement of ice accretion using ultrasonic pulse-echo techniques, *Journal of Aircraft*, 22(6), p. 530–535.
- Hansman, R.J., Jr., M.S. Kirby, and F. Lichtenfelts, 1990, *Ultrasonic techniques for aircraft ice accretion measurement*. Joint University Program for Air Transportation Research, 1988–1989. US National Aeronautics and Space Administration. Conference publication, NASA-CP-3 63, p. 43–53.
- Haslim, L.A., and R.D. Lee, 1987, *Electro-Expulsive Separation System*. US Patent 4,690,353, 1 September 2007.
- Hill, E., M. Rios, G. Botura, J.T. Riley, C.J. Dumont, D. Pullin, S. Uppulari, A. Broeren, M. Selig, and D. Anderson, 2006, *Investigations of Performance of Pneumatic Deicing Boots, Surface Ice Detectors, and Scaling of Intercycle Ice*. Report DOT/FAA/AR-06/48, 158 p.
- History Channel, 2005, *Modern Marvels, Sub Zero*. Episode #327, Season # 11, first aired 23 Feb 2005.
- Homola, M.C., P.J. Nicklasson, and P.A. Sundsbø, 2006, Ice Sensors for Wind Turbines. *Cold Regions Science and Technology*, Vol. 46, pp. 125–131.
- Horjen, I., and S. Vefsnmo, 1984, *Mobile Platform Stability (MOPS) Subproject 02 – Icing*, Norwegian Hydrodynamic Laboratories Report no. 15, 84002, 56 p.
- IADC, 2007, *Rig ASP Program, 2007: A Summary of Occupational Incidents (Industry Totals)*. Issued 20 June 2007, 27 p.

- IDI, 2007, *Deicing Systems*. <http://www.idiny.com/deicing.html>.
- IMS, 2007, *Electro-Expulsive De-Icing System (EEDS) Technical Description*. Ice Management Systems, Inc., 42136 Sarah Way, Temecula, California, 11 p.
- Inkpen, S., C. Brobeck, and C. Nolan, 1992, Development of a Sensor for the Detection of Aircraft Wing Contaminants. Instrumar Limited, *30<sup>th</sup> American Institute of Aeronautics and Astronautics Aerospace Sciences Meeting and Exhibit*, 6–9 January 1992.
- Inkpen, S., J. Hall, C. Marshall, C. Brobeck, and C. Nolan, 1995, *Device and Method for Identifying and Quantifying Layered Substances*. US Patent 5,394,340, 28 February 1995.
- Itagaki, K., 1984, Icing Rate on Stationary Structures Under Marine Conditions. US Army Cold Regions Research and Engineering Laboratory, Hanover, New Hampshire, CRREL Report 84-12, 13 p.
- Iwata, S., 1973, Ice Accumulation on Ships. *Journal of the Society of Naval Architects of Japan*, Selected Papers, Vol. 11, pp. 60–86.
- Jeck, R., 1984, *Superstructure Icing: Non-Suitability of Current Forecasting Aids for Navy Ships*. NRL Memorandum Report 5377, 17 p.
- Jessup, R.G., 1985, Forecast Techniques for Ice Accretion on Different Types of Marine Structures, Including Ships, Platforms and Coastal Facilities. Unpublished Manuscript. Draft version presented to the 9th session of the WMO Commission for Marine Meteorology, October 1984, 90 p.
- Jorgensen, T.S., 1982, Influence of Ice Accretion on Activity in the Northern Part of the Norwegian Continental Shelf. Offshore Testing and Research Group, Trondheim, Norway, Report Number STF88F82016, 142 p.
- Joseph, J.C., 2002, *MAIDS Microwave Aircraft Icing Detection System*. Dedicated Electronics, Inc. Briefing to SAE AC-9C Inflight Icing Technology Subcommittee.
- Kelly Aerospace, 2008, Thermawing. <http://www.airplanedeice.com/thermaWing/airFoilProtection/>.
- Kenney, W.P., 1976, Trials of the deicing equipment installed on YTB-771 (*Keokuk*).
- Ketcham, S.A., L.D. Minsk, R.R. Blackburn, and E.J. Fleege, 1996, *Manual of practice for an effective anti-icing program: A guide for highway winter maintenance personnel*. US Department of Transportation. Federal Highway Administration. Office of Engineering Research and Development. Report No.95-202, 63 p., CRREL MP 3855.
- Kirchner, H.W., 2001, *Using Deicers Correctly*. <http://www.saltinstitute.org/kirchner-1.html>.
- Kirsner, S., 2004, Hot Ideas for a Winter Nemesis. *The Boston Globe*, 29 March 2004.
- Koontz, H.S., and J.P. Forr, 1993, *Electrically Heated Window*. US Patent 5,182,431, 26 January 1993.

- Kozo, T.L., 1984, *Superstructure Icing in the North Chukchi, South Chukchi and Hope Basin Areas*, Final Report, Outer Continental Shelf Assessment Project, Research Unit 519, 14 p.
- Kultashev, Y., N. Malakhov, V. Panov, and M. Shmidt, 1972, *Spray icing of MFT and MFTF fishing vessels*. In Issledovaniye Fizicheskoy Prirody Obladeniya Sudov, Leningrad. US Army Cold Regions Research and Engineering Laboratory, Hanover, New Hampshire, Draft Translation TL411, 1974, p. 127–139.
- Kuroiwa, D., 1965, Icing and snow accretion on electric wires. US Army Cold Regions Research and Engineering Laboratory, Hanover, New Hampshire, CRREL Report RR 123, 10 p.
- Laforte, J.L., M.-A. André, and M. Farzaneh, 1995, *Deicing Device for Cable*. US Patent 5,411,121, 2 May 1995.
- Laforte, J.L., M.A. Allaire, and J. Laflamme, 1998, State-of-the-art on power line de-icing. *Atmospheric Research*, Vol. 46, pp. 143–158.
- Laforte, C., J. Laforte, and J.C. Carrière, 2002, How a Solid Coating Can Reduce the Adhesion of Ice on a Structure. In *Proceedings of the International Workshop on Atmospheric Icing of Structures*, Brno, Czech Republic, June 2002, 6 p.
- Langmuir, I., and K. Blodgett, 1946, *Mathematical Investigation of Water Droplet Trajectories*. General Electric Company Report RL-225, 1944–1945.
- Larson, A.R., Jr., 1983, *Cold Weather Transit Technology Program. Vol. 5: Third rail deicing system research*. US Urban Mass Transportation Administration. Report, UMTA-IN-06-0009-83-5, 120 p.
- Levin, I.A.S., K.I. Skobelev, L.I. Levkovich, and B.A. Pavljuk, 1974, *Deicing Device*. US Patent 3,835,269, 10 September 1974.
- Liardi, V.L., 1970, *Deicing Apparatus*. US Patent 3,524,044, 11 August 1970.
- Liljestrom, J., 1985, Icing on Semisubmersible Platforms. *Proceedings International Workshop on Offshore Winds and Icing*, Halifax, Nova Scotia, 7–11 October 1985, pp. 313–328.
- Liljestrom, G., and P. Lindgren, 1983, Ice Weight a Hazard to Loaded Semi. *Offshore*, April 1983, pp. 133–137.
- Løset, S., 1985, Investigation and research on anti-icing and de-icing devices for marine application. In *Proceedings, International Workshop on Offshore Winds and Icing, Halifax, Nova Scotia, 7–11 October 1985*. Edited by T.A. Agnew and V.R. Swail, pp. 95–101.
- Lozowski, E., K. Szilder, and L. Makkonen, 2000, Computer simulation of marine ice accretion. *Philosophical Trans of the Royal Society: Mathematical, Physical and Engineering Sciences*, Vol. 358, 2811–2845.
- Lyle, D., 2001, Prepare for the Worst Offshore. *Hart's E&P*, August 2001, pp. 69–72.

- Mackes, J., 1989, Northern latitude logistic support. In *Proceedings, US Navy Symposium on Arctic/Cold Weather Operations of Surface Ships*, 29 November–1 December 1989. Volume 1, p. 451–457.
- Makkonen, L., 1984, Atmospheric Icing on Sea Structures. US Army Cold Regions Research and Engineering Laboratory, Hanover, New Hampshire, CRREL Monograph 84-2, 102 p.
- Martin, A.N., 1991, *Microwave Deicing for Aircraft Engine Propulsor Blades*. US Patent 5,061,836, 29 October 1991.
- Matsuda, S., G. Mikolczy, and J.B. Dunlay, 1981, *Heat Pipe Deicing Apparatus*. US Patent 4,254,821, 10 March 1981.
- McCurdy, J.D., C.R. Sullivan, and V.F. Petrenko, 2003, *Resonant 33 kV, 100 kHz Power Source for Deicing Power Transmission Lines Using Optimized Resonant Inductors*. Final Report to the Army Research Office, Report No. ARO 39152 10-EV, 6 p.
- Mejlænder-Larsen, M., 2006, *Developments with ice class LNG designs*. Managing Risk DNV, <http://www.thedigitalship.com/powerpoints/SMM06/ice/morten%20mejl%C3%A4nder-larsen,%20odnv.pdf>, 38 slides.
- Microheat, 2008, *Hotshot*, <http://www.microheat.com/>.
- Microphase Coatings, 2008, <http://www.microphasecoatings.com/antiicing.php>.
- Minsk, L.D., 1975, Ice accumulation on fixed and floating ocean structures. US Army Cold Regions Research and Engineering Laboratory, Hanover, New Hampshire, CRREL MP 3839, 70 p.
- Minsk, D., 1977, Ice accumulation on Ocean Structures. US Army Cold Regions Research and Engineering Laboratory, Hanover, New Hampshire, CRREL Report 77-17, 46 p.
- Minsk, L.D., 1980, Icing on Structures. US Army Cold Regions Research and Engineering Laboratory, Hanover, New Hampshire, CRREL Report 80-31.
- Minsk, L.D., 1984a, Observation Program on the Semisubmersible Drilling Vessel SEDCO 708. US Army Cold Regions Research and Engineering Laboratory, Hanover, New Hampshire, CRREL Special Report 84-2, 14 p.
- Minsk, L.D., 1984b, Assessment of Ice Accretion on Offshore Structures. US Army Cold Regions Research and Engineering Laboratory, Hanover, New Hampshire, CRREL Special Report 84-4, 12 p.
- Minsk, L.D., 1985, Measurement of icing on offshore structures. In *Proceedings, International Workshop on Offshore Winds and Icing, Halifax, Nova Scotia, Oct. 7-11, 1985*. Edited by T.A. Agnew and V.R. Swail, p. 287–292. Publisher: Downsview, Ontario, Atmospheric Environment Service. Canada. CRREL MP 2010.
- Mishra, S.K., 2001, A Mixture of Snow and Ice. *Roads & Bridges*, Vol. 39, Number 12, 4 p.

- Morrell, F.R., 1987, Joint University Program for Air Transportation Research—1985. Proceedings of a Conference held in Atlantic City, 30 January 1986. *NASA Conference Publication 2453*, 97 p.
- Mulherin, N., 1986, Atmospheric icing on communication masts in New England. US Army Cold Regions Research and Engineering Laboratory, Hanover, New Hampshire, CRREL Report 86-17, 46 p.
- Mulherin, N.D., and R.J.F. Donaldson, 1988, Removal of atmospheric ice from broadcast towers using low-frequency, high-amplitude vibrations. CRREL MP 2538. Presented at 4th International Workshop on Atmospheric Icing of Structures, Paris, September 1988. 7 refs. GeoRef Acc. No: 117171, 6 p.
- Mulherin, N.D., and R.B. Haehnel, 2003, Progress in Evaluating Surface Coatings for Icing Control at Corps Hydraulic Structures. US Army Cold Regions Research and Engineering Laboratory, Hanover, New Hampshire, Ice Engineering Information Exchange Bulletin, TN-03-4, 7 p.
- Mulherin, N.D., and A.C. Miller, 2003, An Experiment in Preventing Zebra Mussel Settlement Using Electro-Expulsive Separation Technology. US Army Cold Regions Research and Engineering Laboratory, Hanover, New Hampshire, Technical Report ERDC/CRREL SR-03-2, 27 p.
- Mycyk, O. (Rapporteur), Session 2: Icing Case Studies, *Proceedings International Workshop on Offshore Winds and Icing*, Halifax, Nova Scotia, 7–11 October 1985, pp. 388–9.
- NASA, 2002a, Aircraft Anti-Icing Heaters Made from Expanded Graphite. *NASA Tech Briefs*, LEW-16895, 14 p.
- NASA, 2002b, Deicing and Anti-Icing Unite, *Spinoff 2002*, pp. 74–75.
- NASA, 2006, Preventing Ice Before It Forms, *Spinoff 2006*, pp. 42–43.
- Natural Gas Technologies Center, 2007, *Radiant Aviation Services—Infrared Heater Testing*. Report Version 2, Project No. 222706, Presented to Radiant Aviation Services Inc. (RAS), 26 p.
- Nauman, J.W., 1984, Superstructure Icing Observations on the Semisubmersible Ocean Bounty in Lower Cook Inlet, Alaska. *Proceedings of the Second International Workshop on Atmospheric Icing of Structures*, Trondheim, Norway, 19–21 June, pp. 71–79.
- Nauman, J.W., and R. Tyagi, 1985, Sea Spray Icing and Freezing Conditions on Offshore Oil Rigs—Alaska Experience and Regulatory Implications. *Proceedings International Workshop on Offshore Winds and Icing*, Halifax, Nova Scotia, 7–11 October 1985, pp. 313–328.
- Navy, 2005, Naval Ships' Technical Manual Chapter 600, Hull Outfitting Equipment. S9086-UF-STM-030, Vol. 3, 44 p.
- NCEP, 2008, <http://polar.ncep.noaa.gov/marine.meteorology/vessel.icing/>.
- NOAA, 2007, *Dixon Entrance, AK to Cape Spencer, AK*. Coast Pilot #8, pp 119–135.

- Ocean Rig, n.d., *Eric Raude*. brochure, 7 p. OCEAN RIG ASA P O BOX 409, FORUS NO-4067 STAVANGER, NORWAY TEL +47 51 96 90 00 FAX +47 51 96 90 99 oras@ocean-rig.com, [www.ocean-rig.com](http://www.ocean-rig.com).
- Oilrigdisasters, 2008, <http://www.oilrigdisasters.co.uk/>.
- Ono, N., 1968, *Studies of ice accumulation on ships, Part 2*. Conditions of icing and ice accretion weights. Low Temperature Science (Teion Kagaku), Series A(22): 170–181. (Translated by E. Hope, National Research Council, Ottawa, Canada, Technical Translation 1319.)
- OSHA, 2004, *Target Industry Profile: Oil and Gas Field Services*, Industry Group 138, 15 p.
- Overland, J.E., C.H. Pease, R.W. Preisendorfer and A.L. Comiskey, 1986, Prediction of vessel icing. *Journal of Climate and Applied Meteorology*, 25, 1793–1806.
- Pakarinen, R., 2006, A Big Drill for the Big Chill, *Inside Marine* 3.06, pp. 62–63.
- Panov, V., 1972, *On calculation of water droplet temperature and ice salinity during spray icing of ships*. In Investigation of the Physical Nature of Ship Icing, Issledovaniye Fizicheskoy Prirody Obledeneniya Sudov, Leningrad. USA, Cold Regions Research and Engineering Laboratory, Draft Translation TL411, 1974, p. 42–48.
- Papineau, J., n.d., *Anatomy of High Wind Events Along Alaska's North Slope*. National Weather Service, Anchorage, AK. ([http://pafc.arh.noaa.gov/papers/brw\\_winds1.pdf](http://pafc.arh.noaa.gov/papers/brw_winds1.pdf)).
- Pavek, J., 2001, *Magnesium Chloride as a De-Icing Agent*. [http://www.usda.gov/rus/electric/engineering/2001/magnesium\\_chloride.htm](http://www.usda.gov/rus/electric/engineering/2001/magnesium_chloride.htm).
- Personne, P., and J.-F. Gayet, 1986, Prevention of Wire Icing by Joule Heating. *Proceedings of the Third International Workshop on Atmospheric Icing of Structures*, 6–8 May, Vancouver, pp. 429–434.
- Petrenko, V.F., 2005, *Systems and Methods for Modifying an Ice-to-Object Interface*. US Patent 6,870,139 B2, 22 March 2005.
- Petrenko, V.F., and Z. Courville, 2000, Active De-icing Coating for Aerofoils. *Proceedings of the American Institute of Aeronautics and Astronautics (AIAA) 38th Aerospace Sciences Meeting and Exhibit*, Reno, NV, 10–13 January 2000. Originator No: AIAA-2000-063, 25 p.
- Petrenko, V.F., and S.G. Qi, 1999, Reduction of Ice Adhesion to Stainless Steel by Ice Electrolysis. *Journal of Applied Physics*, 86(10), p. 5450–5454.
- Petrenko, V.F., and C. Sullivan, 2003, *Methods and Systems for Removing Ice from Surfaces*. US Patent 6,653,598 B2, 25 November 2003.
- Petrenko, V.F., and C. Sullivan, 2006, *Low-Frequency De-Icing of Cableways*. US Patent 7,038,125 B2, 2 May 2006.

- Petrenko, V.F., and C.R. Sullivan, 2007, *High-Frequency De-Icing of Cableways*. US Patent 7,164,100 B2, 16 January 2007.
- Petrenko, V.F., M. Higa, M. Starostin, and L. Deresh, 2003, Pulse Electrothermal De-Icing, Proceedings of the Thirteenth (2003) International Offshore and Polar Engineering Conference, Honolulu, Hawaii, May 25–30, 2003, pp. 435–438.
- Pruzan, D.A., A.A. Khatkhate, J.J. Gerardi, and G.A. Hickman, 1993, *Smart skin technology development for measuring ice accretion, stall, and high AoA aircraft performance. Part 1: Capacitive ice detector development*. Final technical report. US National Aeronautics and Space Administration. Contractor report, NASA-CR-194252, 83 p.
- Quéré, D., 2002, Surface chemistry: Fakir droplets. *Nature Materials*, pp. 14–15.
- Ramsay, A.C., 1997: Freezing rain detection and reporting by the Automated Surface Observing System (ASOS). *Preprints, First Symposium on Integrated Observing Systems*, Long Beach.
- RAS, 2008, <http://www.radiantenergycorp.com/>.
- Rindels, S., 1996, Deicing Materials for Slick Sidewalks and Roads. *Horticulture and Home Pest*, 13 December 1996, pp. 177–178.
- Rockwell-Collins, 2008, *Buddy Start Deicing Nozzle*.  
[http://www.rockwellcollins.com/electromechanical/products/product\\_navigator.asp?NavigatorID=87](http://www.rockwellcollins.com/electromechanical/products/product_navigator.asp?NavigatorID=87).
- Ryerson, C., 1991, Ship Superstructure Icing Climatology of Coastal Eastern North America. In *Proceedings of the Eastern Snow Conference*, Guelph, Ontario, pp. 201–211.
- Ryerson, C., 1995, Superstructure Spray and Ice Accretion on a Large US Coast Guard Cutter. *Atmospheric Research*, Vol. 36, pp. 321–337.
- Ryerson, C., and A. Eliasson, 1993, Ice Detector Prediction of Transmission Line Ice Loads in Northwestern Iceland. In *Proceedings of the 6th International Workshop on Atmospheric Icing of Structures*, Budapest, Hungary, pp. 189–194.
- Ryerson, C., and A. Gow, 2000, Crystalline Structure of Ship Superstructure Spray Ice. *Philosophical Trans of the Royal Society: Mathematical, Physical and Engineering Sciences*, Vol. 358, 2847–2871.
- Ryerson, C., and P. Longo, 1992, Ship Superstructure Icing: Data Collection and Instrument Performance on the USCGC Midgett Research Cruise. US Army Cold Regions Research and Engineering Laboratory, Hanover, New Hampshire, CRREL Report 92-23, 142 pp.
- Ryerson, C., and A. Ramsay, 2007, Quantitative Ice Accretion Information from the Automated Surface Observing System (ASOS), *Journal of Applied Meteorology and Climatology*, (in press).
- Ryerson, C., K. Claffey, and G. Lemieux, 1994, Surface Hoarfrost Measurement and Climatology. In *Proceedings of the 51st Eastern Snow Conference*, pp. 121–130.

- Ryerson, C., T. Gilligan, and G. Koenig, 1999, Evaluation of Three Helicopter Preflight Deicing Techniques, *37th AIAA Aerospace Sciences Meeting and Exhibit*, AIAA-99-0499, 11–14 January, Reno, 9 p.
- Ryerson, C., M. Wyderski, D. Tarazano, and J. Davila, 2003, Objective Evaluation of Fluid, Blower, and Infrared Ground Deicing Technologies. *AIAA-2003-0567, American Institute of Aeronautics and Astronautics 41st Aerospace Sciences Meeting and Exhibit*, 6–9 January, Reno, 10 p.
- Ryerson, C., G. Koenig, F. Scott, and J. Tantillo, 2004, Infrared Aircraft Deicing Performance Assessment. In *Gulley, L., and J. Davilla, n.d., Survey and Evaluation for Alternative Deicing Energy Sources*. Air Force Institute for Operational Health (AFIOH), Contract No. F41624-01-D-9007, Task Order 0007, 74 p.
- Sackinger, W.M., 1980, *Review of technology for Arctic offshore oil and gas recovery, Vol. 1. Second edition*. US Department of Energy Division of Fossil Fuel Extraction, Contract No. DE-AC01-80ET14317. 118 refs. GeoRef Acc. No: 77550, 95 p.
- SAE, 1997, *Deicing System, Pneumatic Boot, Aircraft, General Specification for*. SAE Aerospace Standard AS8804, 21 p.
- SAE, 2002, *Rotor Blade Electrothermal Ice Protection Design Considerations*. SAE Aerospace Information Report AIR1667A, 40 p.
- SAE, 2004, *Aircraft Inflight Ice Detectors and Icing Rate Measuring Instruments*. SAE Aerospace Information Report AIR4367, 28 p.
- SAE, 2007, *Standard Test Method for Aerodynamic Acceptance of SAE AMS 1424 and SAE AMS 1428 Aircraft Deicing/Anti-icing Fluids*. Document Number: AS5900, Revision Number: B, July 2007, Issuing Committee: G-12 Fluids Subcommittee.
- Sætre, T., and P.K. Eian, 2006, *Radiant De-Icing Gerdermoen Measurement of Temperature Rise in Various Materials Exposed for Infra-red Radiation*. Memo No. 1/rev3, Norconsult AS, 10 January 2006, 9 p.
- Sivas, S.L., B. Riegler, R. Thomaier, and K. Hoover, 2008, Silicone-Based Icephobic Coating for Aircraft, *NuSil Technology Newsletter*, 21 January 2008, Vol. 5, Issue 1—Winter 2008, 7 p.
- Snow, P.G., n.d., *Magnesium Chloride as a Road Deicer: A Critical Review*. Burns Concrete, Inc., Idaho Falls, Idaho, 3 p.
- Stallabrass, J.R., 1970, *Methods for the Alleviation of Ship Icing*. National Research Council, Canada. Mechanical engineering report, MD-51, 30 p.
- Stein, P., 1993: Rosemount freezing rain sensor. *Proceedings, Sixth International Workshop on Atmospheric Icing of Structures, Budapest, Hungary, Hungarian Electrotechnical Association*, 121–124.
- Sullivan, C.R., V.F. Petrenko, J.D. McCurdy, and V. Kozliouk, 2003, Breaking the ice [transmission line icing]. In *Proceedings of the Thirteenth (2003) International Offshore and Polar Engineering Conference*, Honolulu, Hawaii, 25–30 May 2003, pp. 49–54.



- Suzuki, M., K. Sha, and T. Tsukawaki, 1978, Countermeasures against snow accretion and icing on radomes. In *Proceedings, International Symposium on Snow Removal and Ice Control Research*, 2nd, Hanover, New Hampshire, 15–19 May 1978. National Research Council. Transportation Research Board. Special report, No. 185, p. 303–307.
- Tabata, T., S. Iwata, and N. Ono, 1967, *Studies of Ice Accumulation on Ships. Part 1*. Defence Research Board, Ottawa, Canada, Translation T 93 J.
- Takeuchi, M., 1979, Snow accretion on traffic-control sign boards and its prevention. In *Proceedings, International Symposium on Snow Removal and Ice Control Research*, 2nd, Hanover, New Hampshire, 15–19 May 1978. National Research Council. Transportation Research Board. Special report, No. 185, p. 101–105.
- Tollefsen, F., 2006, *Experience from Drilling Operations in the Barents Sea*, Eirik Raude. Kristiansandkonferansen 2006.
- TRB, 1991, *Highway Deicing Comparing Salt and Calcium Magnesium Acetate*. Committee on the Comparative Costs of Rock Salt and Calcium Magnesium Acetate (CMA) for Highway Deicing.
- US Coast Guard, 2008, Ice Buildup Likely Caused *Lady of Grace* to Sink. Press Release 25 Jan 2008, 1 p.
- Valley Group, 2008, <http://www.cat-1.com/>
- Walsh, M.R., D.E. Garfield, J.S. Morse, K.V. Knuth, N.D. Mulherin, and G.E. Lemieux, 1993, Icing of turbine intake louvers. US Army Cold Regions Research and Engineering Laboratory, Hanover, New Hampshire. Special Report 93-04, 37 p.
- Warren, D., 1984, North Sea offshore pilot's perspective on helicopter icing. *Rotor & Wing International*, 18(6), p. 40–42.
- Wisconsin Transportation Center, 1997, Wisconsin Transportation Bulletin No. 6: Using Salt and Sand for Winter Road Maintenance. *Road Management Journal*. 1 December 1997, TranSafety, Inc., [info@usroads.com](mailto:info@usroads.com).
- Wise, J., and A. Comiskey, 1980, *Superstructure Icing in Alaskan Waters*. NOAA Special Report, PMEL, 30 p.
- Wyderski, M., C. Ryerson, A. Lozada-Ruiz, J. Davila, and D. Tarazano, 2003, Evaluation of Environmentally Friendly, Glycol-Free Mobile Aircraft Deicing System. *33rd International Conference on Environmental Systems (ICES)*, 7–10 July 2003, Vancouver, British Columbia, Canada, 10 p.
- Yankielun, N.E., and C.C. Ryerson, 2003, *Device, and method of its use, for concurrent real time alerting to accumulation of material upon multiple areas of a surface*. (6,608,489) (ERDC/CRREL MP-03-6085).
- Yankielun, N., C. Ryerson, and S. Jones, 2002, Wide Area Ice Detection Using Time Domain Reflectometry. US Army Cold Regions Research and Engineering Laboratory, Hanover, New Hampshire, Technical Report ERDC/CRREL TR-02-15, 37 p.

- Yankielun, N.E., C.C. Ryerson, and A. Crocker, 2005, Clear Freshwater Ice Thickness Measurement Using Geometric Optics and Spectrometer. *Cold Regions Science and Technology*. Vol 43, pp. 177–186.
- Yomaoka, M., I. Ohtake, and G. Wakahama, 1986, The Countermeasure of Icing on the Transmission Lines by Conducting. In *Proceedings of the Third International Workshop on Atmospheric Icing of Structures*, 6–8 May, Vancouver, pp. 423–428.
- Zadra, D.D., and B.D. Pyle, 1990, *At-Sea Evaluation of Ice Removal Equipment*. David Taylor Research Center, DTRC/SME-90-76, Aug 1990, 45 p.
- Zakrzewski, W.P., and E.P. Lozowski, 1991, Modelling and forecasting vessel icing. In *Freezing and Melting Heat Transfer in Engineering* (K. C. Cheng and N. Seki, Eds.), pp. 661–706. New York: Hemisphere.
- Zakrzewski, W.P., E.P. Lozowski, and R.Z. Blackmore, 1988, Atmospheric Icing of Ships and an Overview of the Research on Atmospheric Icing Modeling Applicable to Ship Icing Modeling. In *Proceedings of the Fourth International Workshop on Atmospheric Icing of Structures*, Paris, France, 5–7 September 1988, pp. 202–208.

# REPORT DOCUMENTATION PAGE

*Form Approved*  
*OMB No. 0704-0188*

Public reporting burden for this collection of information is estimated to average 1 hour per response, including the time for reviewing instructions, searching existing data sources, gathering and maintaining the data needed, and completing and reviewing this collection of information. Send comments regarding this burden estimate or any other aspect of this collection of information, including suggestions for reducing this burden to Department of Defense, Washington Headquarters Services, Directorate for Information Operations and Reports (0704-0188), 1215 Jefferson Davis Highway, Suite 1204, Arlington, VA 22202-4302. Respondents should be aware that notwithstanding any other provision of law, no person shall be subject to any penalty for failing to comply with a collection of information if it does not display a currently valid OMB control number. **PLEASE DO NOT RETURN YOUR FORM TO THE ABOVE ADDRESS.**

<b>1. REPORT DATE (DD-MM-YYYY)</b> September 2008			<b>2. REPORT TYPE</b> Technical Report		<b>3. DATES COVERED (From - To)</b>	
<b>4. TITLE AND SUBTITLE</b>  Assessment of Superstructure Ice Protection as Applied to Offshore Oil Operations Safety					<b>5a. CONTRACT NUMBER</b>	
					<b>5b. GRANT NUMBER</b>	
					<b>5c. PROGRAM ELEMENT NUMBER</b>	
<b>6. AUTHOR(S)</b>  Charles C. Ryerson					<b>5d. PROJECT NUMBER</b>	
					<b>5e. TASK NUMBER</b>	
					<b>5f. WORK UNIT NUMBER</b>	
<b>7. PERFORMING ORGANIZATION NAME(S) AND ADDRESS(ES)</b>  US Army Engineer Research and Development Center Cold Regions Research and Engineering Laboratory 72 Lyme Road Hanover, New Hampshire 03755-1290					<b>8. PERFORMING ORGANIZATION REPORT NUMBER</b>  ERDC/CRREL TR-08-14	
<b>9. SPONSORING / MONITORING AGENCY NAME(S) AND ADDRESS(ES)</b>					<b>10. SPONSOR/MONITOR'S ACRONYM(S)</b>	
					<b>11. SPONSOR/MONITOR'S REPORT NUMBER(S)</b>	
<b>12. DISTRIBUTION / AVAILABILITY STATEMENT</b> Approved for public release; distribution is unlimited.  Available from NTIS, Springfield, Virginia 22161.						
<b>13. SUPPLEMENTARY NOTES</b>						
<b>14. ABSTRACT</b>  Superstructure sea spray icing and atmospheric icing from snow, freezing rain, freezing drizzle, rime, sleet, and frost reduce the safety of offshore platform and supply boat operations. Though icing reduces safety and reduces operational efficiency, it has not caused the loss of offshore platforms. Supply boats are at greater risk of loss from icing than are platforms. Platforms operating in cold regions are protected primarily by designs that reduce ice accretion, coupled with the selective use of heat. A variety of deicing and anti-icing technologies have been tested on offshore platforms and boats, but with little overall success. New technologies and modern versions of old technologies, now used successfully in aviation, the electric power industry, and on transportation systems in general, may be transferable to the offshore environment. Fifteen classes of deicing and anti-icing technologies are identified, explained, and reviewed, as are numerous ice detection technologies for controlling deicing and anti-icing systems. These technologies are the population from which new marine ice protection systems may be selected.						
<b>15. SUBJECT TERMS</b> Anti-icing, Atmospheric icing, Deicing, Glaze, Ice, Ice protection, Marine ice protection systems, Offshore oil rigs and platforms, Rime, Safety, Sea spray icing, Snow, Superstructure ice protection, Superstructure icing, Supply boats						
<b>16. SECURITY CLASSIFICATION OF:</b>				<b>17. LIMITATION OF ABSTRACT</b>	<b>18. NUMBER OF PAGES</b>	<b>19a. NAME OF RESPONSIBLE PERSON</b>
<b>a. REPORT</b>	<b>b. ABSTRACT</b>	<b>c. THIS PAGE</b>	<b>19b. TELEPHONE NUMBER (include area code)</b>			
U	U	U	U	156		

DEPARTMENT OF THE ARMY  
ENGINEER RESEARCH AND DEVELOPMENT CENTER, CORPS OF ENGINEERS  
COLD REGIONS RESEARCH AND ENGINEERING LABORATORY, 72 LYME ROAD  
HANOVER, NEW HAMPSHIRE 03755-1290

Official Business