Cooperative Aquatic Toxicity Testing of Dispersed Oil and the “Chemical Response to Oil Spills: Ecological Effects Research Forum (CROSERF)”

**A Model for Cooperative Research by
Industry and Government**



**Ecosystem Management & Associates, Inc.
Technical Report 07-03**

Cooperative Aquatic Toxicity Testing of Dispersed Oil and the “Chemical Response to Oil Spills: Ecological Effects Research Forum (CROSERF)”

**A Model for Cooperative Research by
Industry and Government**

**Don Aurand and Gina Coelho (Editors)
Ecosystem Management & Associates, Inc.**

Prepared for the American Petroleum Institute

**Ecosystem Management & Associates, Inc.
Technical Report 07-03**

REPORT AVAILABILITY

Copies of this report can be obtained from:
Ecosystem Management & Associates, Inc. website at:
www.ecosystem-management.net

It is also available by contacting:

American Petroleum Institute
Environment, Health and Safety Department
1220 L Street, NW
Washington, DC 20005

CITATION

Suggested Citation:

Aurand, D. and G. Coelho (Editors). 2005. Cooperative Aquatic Toxicity Testing of Dispersed Oil and the “Chemical Response to Oil Spills: Ecological Effects Research Forum (CROSERF).” Ecosystem Management & Associates, Inc. Lusby, MD. Technical Report 07-03, 105 pages + Appendices

SPONSOR

This report was prepared under contracts Number 98-0000-2831 and 99-0000-3878 with the American Petroleum Institute, 1220 L Street, NW, Washington, DC 20005.

TABLE OF CONTENTS

	Page
Executive Summary	1
1.0 Introduction	3
1.1 Background	3
1.2 Report Organization	4
2.0 The Origin and Content of the CROSERF Initiative	5
2.1 Issues Related to the Use of Toxicity Data to Evaluate Dispersant Use	5
2.2 Factors Leading to Establishing CROSERF	7
2.2.1 Initial Toxicity Studies by the California Office of Oil Spill Prevention and Response	7
2.2.2 The Marine Spill Response Corporation Dispersant Research Program	8
2.3 CROSERF	8
2.3.1 CROSERF Program Objectives	9
2.3.2 CROSERF Participants	10
2.3.3 Discussions about Long-Term Research Objectives	11
2.3.4 Essential Elements of a Toxicity Testing Work Plan	12
2.3.4.1 Goals and Objectives for Dispersant and Dispersed Oil Laboratory Toxicity Testing Program	13
2.3.4.2 Development of Testing Protocols and Methods	14
3.0 A Review of Standard CROSERF Protocols	19
3.1 Terminology	19
3.2 Basic Toxicity Testing Equipment List	21
3.2.1 CROSERF Flow-Through Toxicity Chamber	21
3.2.2 Static Exposure Test	22
3.2.3 Flow-Through Exposure Test	22
3.2.4 Analytical Equipment	23
3.2.5 Chemicals	23
3.2.6 Equipment Set-Up	23
3.3 Final CROSERF Flow-Through Toxicity Testing Methods	28
3.3.1 General Toxicity Testing Guidelines	28
3.3.2 Protocol for Preparation of Dispersant-Only Solutions and Spiked Flow-Through Test	29
3.3.3 Guidelines for Dispersant Solution Chemical Analysis	29
3.3.4 Protocol for Preparation of Water-Accommodated Fractions (WAF) and Chemically Enhanced WAF (CE-WAF)	30
3.3.5 Conducting Toxicity Tests	31
3.3.5.1 Spiked Exposure Testing	31
3.3.5.2 Continuous Exposure Testing	32
3.3.6 Guidelines for Chemical Characterization of WAF and CE-WAF Test Solutions	32

3.3.6.1	TPH ($X > C_{10}$)	32
3.3.6.2	Volatiles ($X < C_{10}$)	33
3.3.6.3	Compound-Specific Semi-Volatiles (optional analysis)	33
3.3.7	Guidelines for Animal Aquaculture/Holding.....	35
3.3.8	Guidelines for Statistical Analysis.....	35
3.3.9	Guidelines for Storage of Oil, WAF and CE-WAF Solutions and Dispersants	35
3.3.10	Guidelines for Oil Weathering.....	36
4.0	Results of the Cooperative API/California Testing Program	37
4.1	Background Information.....	37
4.2	Testing Included in this Study	37
4.3	Modifications to the Standard Analytical Protocols Described in Section 3	38
4.3.1	Solution Preparation and Analytical Chemistry Protocols	38
4.3.2	Toxicity Test Details.....	38
4.4	Results.....	39
4.4.1	Chemical Analysis	39
4.4.2	Fresh and Weathered Oil WAF and CE-WAF Toxicity Tests	44
4.4.2.1	Basic Test Conditions.....	44
4.4.2.2	<i>Holmesimysis costata</i> Tests.....	44
4.4.2.3	<i>Atherinops affinis</i> Tests.....	49
4.4.2.4	<i>Menidia beryllina</i> Tests.....	51
5.0	Results of the Cooperative API/Florida Testing Program	57
5.1	Background Information.....	57
5.2	Testing Included in this Study	57
5.3	Modifications to the Standard Analytical Protocols Described in Section 3	58
5.3.1	Solution Preparation and Analytical Chemistry Protocols	58
5.3.2	Toxicity Test Details.....	58
5.4	Results.....	60
5.4.1	Chemical Analysis	60
5.4.1.1	Characterization of Fresh VCO and WAF and CE-WAF Prepared Using Fresh VCO	60
5.4.1.2	Characterization of Weathered VCO and WAF and CE-WAF Prepared Using Weathered VCO	61
5.4.2	Dispersant-Only Toxicity Tests	62
5.4.2.1	<i>Mysidopsis bahia</i>	62
5.4.2.2	<i>Sciaenops ocellatus</i>	62
5.4.2.3	<i>Menidia beryllina</i>	62
5.4.3	Fresh Oil WAF Toxicity Tests.....	63
5.4.3.1	<i>Mysidopsis bahia</i>	63
5.4.3.2	<i>Sciaenops ocellatus</i>	63
5.4.3.3	<i>Menidia beryllina</i>	63
5.4.4	Weathered Oil WAF Toxicity Tests	64
5.4.4.1	<i>Mysidopsis bahia</i>	64
5.4.4.2	<i>Menidia beryllina</i>	64

5.4.5	Fresh Oil CE-WAF Toxicity Tests	64
5.4.5.1	<i>Mysidopsis bahia</i>	64
5.4.5.2	<i>Sciaenops ocellatus</i>	64
5.4.5.3	<i>Menidia beryllina</i>	64
5.4.6	Weathered Oil CE-WAF Toxicity Tests	65
5.4.6.1	<i>Mysidopsis bahia</i>	65
5.4.6.2	<i>Menidia beryllina</i>	65
5.4.7	Summary of Toxicity Testing	65
6.0	Results of the Cooperative API/Texas Testing Program	67
6.1	Background Information	67
6.2	Testing Included in this Study	67
6.3	Modifications to the Standard Analytical Protocols Described in Section 3	67
6.3.1	Solution Preparation and Analytical Chemistry Protocols	67
6.3.2	Toxicity Test Details	68
6.4	Results	69
6.4.1	Chemical Analysis	69
6.4.1.1	Characterization of Fresh and Weathered Arabian Medium Crude Oil	69
6.4.1.2	Water Quality Parameters	69
6.4.2	Dispersant-Only Toxicity Tests	70
6.4.2.1	<i>Mysidopsis bahia</i>	71
6.4.2.2	<i>Cyprinodon variegatus</i>	71
6.4.2.3	<i>Menidia beryllina</i>	71
6.4.2.4	<i>Vibrio fisheri</i>	71
6.4.3	Fresh Oil WAF and CE-WAF Toxicity Tests	72
6.4.4	Weathered Oil WAF Toxicity Tests	72
6.4.4.1	<i>Mysidopsis bahia</i>	72
6.4.4.2	<i>Cyprinodon variegatus</i>	72
6.4.4.3	<i>Menidia beryllina</i>	72
6.4.4.4	<i>Vibrio fisheri</i>	72
6.4.5	Weathered Oil CE-WAF Toxicity Tests	74
6.4.5.1	<i>Mysidopsis bahia</i>	74
6.4.5.2	<i>Cyprinodon variegatus</i>	74
6.4.5.3	<i>Menidia beryllina</i>	74
6.4.5.4	<i>Vibrio fisheri</i>	74
6.4.6	Summary of Toxicity Testing	74
7.0	Results of the CROSERF Initiative	77
7.1	Overview of Programs Not Previously Discussed in This Report	77
7.1.1	Exxon (now ExxonMobil) Biomedical Sciences	77
7.1.2	University of Alaska, Fairbanks	77
7.1.3	University of Maryland, Chesapeake Biological Laboratory	78
7.2	Results of a Round-Robin Chemical Characterization of a Reference Crude Oil	78
7.3	Program Results	78

8.0	Issues and Lessons Learned from the CROSERF Initiative and Their Relevance to Future Research – 2000 and Beyond	95
9.0	References.....	101
	Appendix A: CROSERF Meeting Summaries.....	107
	Appendix B: Experimental Data Sheet Templates	119
	Appendix C: Detailed Data Tables from the API/California Study	125
	Appendix D: Detailed Data Tables from the API/Florida Study.....	153
	Appendix E: Detailed Data Tables from the API/Texas Study	183

LIST OF FIGURES

Figure	Description	Page
3.1	Schematic Diagram of CROSERF Flow-Through Toxicity Test Chamber	21
3.2	Flow-through Toxicity Testing System	23
3.3	Silastic 3-Stop Tubing.....	24
3.4	Stacked Pump Heads.....	24
3.5	Rack System for Holding Multiple Chambers.....	25
3.6	Aspirator Bottle and Magnetic Stirrer.....	26
3.7	Chamber with Tubing	26
3.8	Tubing Set-Up for a Single Chamber	27
3.9	Feeding the Test Animals	27
4.1	Relationship of Volatiles to Oil Loading for both WAF and CE-WAF Solutions Prepared from Fresh (Open) and Weathered (Solid) PBCO.....	40
4.2	Relationship of TPH to oil loading for both WAF and CE-WAF solutions prepared from fresh (open) and weathered (solid) PBCO	41
4.3	Relationship of Σ n-alkanes (C ₁₀ -C ₃₆) to oil loading for both WAF and CE-WAF solutions prepared from fresh (open) and weathered PBCO.....	41
4.4	Relationship of Σ PAHs to oil loading for both WAF and CE-WAF solutions prepared from fresh and weathered PBCO	42
4.5	Mean (\pm SD) concentrations, normalized to loading rate, of volatile compounds from highest concentration treatments of WAF tests before and after weathering of oil.....	43
4.6	Mean (\pm SD) concentrations, normalized to loading rate, of normal alkanes from highest concentration treatments of CE-WAF tests before and after weathering of oil	43
4.7	Mean (\pm SD) concentrations, normalized to loading rate, of PAHs from highest concentration treatments of CE-WAF tests before and after weathering of oil.....	44
4.8	Mysid initial effect dose-response curves for WAF and CE-WAF tests	47
4.9	Mysid 96-hour mortality dose-response curves for WAF and CE-WAF tests	48
4.10	Topsmelt initial effect dose-response curves for WAF and CE-WAF tests	52
4.11	Topsmelt 96-hour mortality dose-response curves for WAF and CE-WAF tests	53
4.12	<i>Menidia</i> initial effect dose-response curves for WAF and CE-WAF tests.....	54
4.13	96-hour mortality dose-response curves for WAF and CE-WAF tests	54
6.1	Characterization of weathered Arabian Medium crude oil.....	70

LIST OF TABLES

Table	Description	Page
2.1	Meetings of CROSERF and available proceedings.....	10
2.2	Basic CROSERF laboratory toxicity test matrix showing the number of times tests should be repeated	16
2.3	Test species included in the CROSERF toxicity testing program, by laboratory.....	17
2.4	Oils used in the CROSERF toxicity testing program, by laboratory.....	17
3.1	General CROSERF toxicity testing considerations.....	28
3.2	Protocols for the preparation of water accommodated fractions (WAF) and chemically enhanced-WAF (CE-WAF).....	30
3.3	Minimum target analyte list for volatile analysis	33
3.4	Minimum target analyte list for optional compound specific semi-volatile analysis	34
4.1	Summary of water quality measurements.....	45
4.2	Initial (<1 hour) EC ₅₀ estimates for spiked-exposure effects experiments using both fresh and artificially weathered Prudhoe Bay crude oil alone and combined with Corexit [®] 9500 (O:D ratio = 10:1). All data are total hydrocarbon concentration (THC) in ppm.....	49
4.3	96-hour LC ₅₀ estimates for spiked-exposure effects experiments using both fresh and artificially weathered Prudhoe Bay crude oil alone and combined with Corexit [®] 9500 (O:D ratio = 10:1)	50
5.1	Summary of hydrocarbon results of alkanes, PAH's, and volatile hydrocarbons found in WAF's and CE-WAF's corrected to a loading rate of 5.0 g VCO/L	60
5.2	Summary of hydrocarbon results of alkanes, PAH's, and volatile hydrocarbons found in weathered Venezuelan crude oil WAF's and CE-WAF's corrected to a loading rate of 5.0 g WVCO/L.....	62
5.3	Summary of toxicity test data	66
6.1	Physical properties of Arabian Medium and Weathered Arabian Medium crude oil.....	69
6.2	Water quality parameters of vertebrate and invertebrate bioassays.....	70
6.3	Toxicity data for dispersant only (Corexit [®] 9500).....	71
6.4	Toxicity data for crude oil solutions.....	73
7.1	Oils and Species used by Laboratories Participating in the CROSERF Program	79
7.2	Toxicity test results for <i>Mysidopsis bahia</i>	80
7.3	Toxicity test results for <i>Holimesimysis costata</i>	82
7.4	Toxicity test results for <i>Crassostrea gigas</i>	83
7.5	Toxicity test results for <i>Chionocetes bairdi</i>	83
7.6	Toxicity test results for <i>Menidia beryllina</i>	84
7.7	Toxicity test results for <i>Cyprinodon variegatus</i>	85
7.8	Toxicity test results for <i>Sciaenops ocellatus</i>	85
7.9	Toxicity test results for <i>Scophthalmus maximus</i>	86
7.10	Toxicity test results for <i>Vibrio fischeri</i> (Microtox).....	86
7.11	Toxicity test results for <i>Atherinops affinis</i>	87
7.12	Toxicity test results for <i>Haliotis rufescens</i>	87
7.13	Toxicity test results for <i>Eurytemora affinis</i>	88
7.14	Average LC ₅₀ Values (in ppm) for Exposure to Dispersant Alone	89

7.15	Average LC ₅₀ Values (in ppm) for Constant Exposure to Fresh Oil Water Accommodated Fraction.....	90
7.16	Average LC ₅₀ Values (in ppm) for Spiked Exposure to Fresh Oil Water Accommodated Fraction.....	90
7.17	Average LC ₅₀ Values (in ppm) for Constant Exposure to Weathered Oil Water Accommodated Fraction.....	91
7.18	Average LC ₅₀ Values (in ppm) for Spiked Exposure to Weathered Oil Water Accommodated Fraction.....	91
7.19	Average LC ₅₀ Values (in ppm) for Constant Exposure to Fresh Oil Chemically Enhanced-Water Accommodated Fraction.....	92
7.20	Average LC ₅₀ Values (in ppm) for Spiked Exposure to Fresh Oil Chemically Enhanced-Water Accommodated Fraction.....	92
7.21	Average LC ₅₀ Values (in ppm) for Constant Exposure to Weathered Oil Chemically Enhanced-Water Accommodated Fraction.....	93
7.22	Average LC ₅₀ Values (in ppm) for Spiked Exposure to Weather Oil Chemically Enhanced-Water Accommodated Fraction.....	93
C.1	CE-WAF #1 Fresh Oil for the Topsmelt <i>Atherinops affinis</i>	127
C.2	CE-WAF #2 Fresh Oil for the Topsmelt <i>Atherinops affinis</i>	128
C.3	CE-WAF #3 Fresh Oil for the Topsmelt <i>Atherinops affinis</i>	129
C.4	CE-WAF #1 Weathered Oil for the Topsmelt <i>Atherinops affinis</i>	130
C.5	CE-WAF #2 Weathered Oil for the Topsmelt <i>Atherinops affinis</i>	131
C.6	CE-WAF #3 Weathered Oil for the Topsmelt <i>Atherinops affinis</i>	132
C.7	WAF Fresh Oil Constant Exposure for the Topsmelt <i>Atherinops affinis</i>	133
C.8	WAF #1 Fresh Oil for the Topsmelt <i>Atherinops affinis</i>	134
C.9	WAF #2 Fresh Oil for the Topsmelt <i>Atherinops affinis</i>	135
C.10	WAF #1 Weathered Oil for the Topsmelt <i>Atherinops affinis</i>	136
C.11	WAF #2 Weathered Oil for the Topsmelt <i>Atherinops affinis</i>	137
C.12	CE-WAF #1 Fresh Oil for the Kelp Forest Mysid <i>Holmesimysis costata</i>	138
C.13	CE-WAF #2 Fresh Oil for the Kelp Forest Mysid <i>Holmesimysis costata</i>	139
C.14	CE-WAF #1 Weathered Oil for the Kelp Forest Mysid <i>Holmesimysis costata</i>	140
C.15	CE-WAF #2 Weathered Oil for the Kelp Forest Mysid <i>Holmesimysis costata</i>	141
C.16	CE-WAF #3 Weathered Oil for the Kelp Forest Mysid <i>Holmesimysis costata</i>	142
C.17	WAF #1 Fresh Oil for the Kelp Forest Mysid <i>Holmesimysis costata</i>	143
C.18	WAF #2 Fresh Oil for the Kelp Forest Mysid <i>Holmesimysis costata</i>	144
C.19	WAF #1 Weathered Oil for the Kelp Forest Mysid <i>Holmesimysis costata</i>	145
C.20	WAF #2 Weathered Oil for the Kelp Forest Mysid <i>Homesimysis costata</i>	146
C.21	WAF #3 Weathered Oil for the Kelp Forest Mysid <i>Holmesimysis costata</i>	147
C.22	CE-WAF #1 Fresh Oil for the Silverside Minnow <i>Menidia beryllina</i>	148
C.23	CE-WAF #1 Weathered Oil for the Silverside Minnow <i>Menidia beryllina</i>	149
C.24	WAF #1 Fresh Oil for the Silverside Minnow <i>Menidia beryllina</i>	150
C.25	WAF #1 Weathered Oil for the Silverside Minnow <i>Menidia beryllina</i>	151
D.1	Toxicity Test Data for Tests Carried Out During Year 1.....	155
D.2	Toxicity Test Data for Tests Carried Out During Year 2.....	156
D.3	Toxicity Test Data for Tests Carried Out During Year 3.....	157
D.4	Alkanes Found in VCO, VCO WAF, and VCO CE-WAF.....	158

D.5	Polycyclic Aromatic Hydrocarbons Found in VCO, VCO WAF, and CE-WAF.....	159
D.6	Volatile Hydrocarbons Found in WAF and CE-WAF of Venezuelan Crude Oil.....	161
D.7	Alkanes Found in WVCO, WVCO WAF and CE-WAF.....	162
D.8	Polycyclic Aromatic Hydrocarbons Found in WVCO, WVCO WAF and CE-WAF ..	163
D.9	Volatile Hydrocarbons Found in WVCO WAF and CE-WAF	165
D.10	Results of Continuous Exposure 96-Hour Dispersant-Only Toxicity Test Using 6 Day old <i>Mysidopsis bahia</i> and Crexit ® 9500.....	165
D.11	Results of Spiked Exposure 96-Hour Dispersant-Only Toxicity Test Using 6 Day Old <i>Mysidopsis bahia</i> and Corexit ® 9500.....	166
D.12	Results of Continuous Exposure 96-Hour Dispersant-Only Toxicity Test Using 12-Day Old <i>Menidia beryllina</i> and Corexit ® 9500	166
D.13	Results of Spiked Exposure 96-Hour Dispersant-Only Toxicity Test Using 12-Day Old <i>Menidia beryllina</i> and Corexit ® 9500.....	167
D.14	Results of Spiked Exposure 96-Hour Dispersant-Only Toxicity Test Using 16-Day Old <i>Sciaenops ocellatus</i> and Corexit ® 9500.....	167
D.15	Results of Continuous Exposure 96-Hour Water Accomodated Fraction Toxicity Test using 6-Day Old <i>Mysidopsis bahia</i> and Venezuelan Crude Oil.....	168
D.16	Results of Continuous Exposure 96-Hour Water Accomodated Fraction Toxicity Test Using 6-Day Old <i>Mysidopsis bahia</i> and Venezuelan Crude Oil.....	168
D.17	Results of Continuous Exposure 96-Hour Water Accommodated Fraction Toxicity Test Using 6-Day Old <i>Mysidopsis bahia</i> and Venezuelan Crude Oil.....	169
D.18	Results of Continuous Exposure 96-Hour Water Accommodated Fraction Toxicity Test Using 6-Day Old <i>Mysidopsis bahia</i> and Kuwait Crude Oil.....	169
D.19	Results of Spiked Exposure 96-Hour Water Accommodated Fraction Toxicity Test Using 6-Day Old <i>Mysidopsis bahia</i> and Venezuelan Crude Oil.....	170
D.20	Results of Spiked Exposure 96-Hour Water Accommodated Fraction Toxicity Test Using 6-Day Old <i>Mysidopsis bahia</i> and Venezuelan Crude Oil.....	170
D.21	Results of Spiked Exposure 96-Hour Water Accommodated Fraction Toxicity Test Using 6-Day Old <i>Mysidopsis bahia</i> and Fresh Venezuelan Crude Oil.....	171
D.22	Results of Spiked Exposure 96-Hour Water Accommodated Fraction Toxicity Test Using 6-Day Old <i>Mysidopsis bahia</i> and Prudhoe Bay Crude Oil.....	171
D.23	Results of Spiked Exposure 96-Hour Water Accommodated Fraction Toxicity Test Using 16-Day Old <i>Sciaenops ocellatus</i> and Venezuelan Crude Oil.....	172
D.24	Results of Continuous Exposure 96-Hour Water Accommodated Fraction Toxicity Test Using 12-Day Old <i>Menidia beryllina</i> and Venezuelan Crude Oil	172
D.25	Results of Spiked Exposure 96-Hour Water Accommodated Fraction Toxicity Test Using 12-Day Old <i>Menidia beryllina</i> and Venezuelan Crude Oil	173
D.26	Results of Spiked Exposure 96-Hour Water Accommodated Fraction Toxicity Test Using 12-Day Old <i>Menidia beryllina</i> and Prudhoe Bay Crude Oil	173
D.27	Results of Spiked Exposure 96-Hour Water Accommodated Fraction Toxicity Test Using 6-Day Old <i>Mysidopsis bahia</i> and Weathered Venezuelan Crude Oil	174
D.28	Results of Spiked Exposure 96-Hour Water Accommodated Fraction Toxicity Test Using 6-Day Old <i>Mysidopsis bahia</i> and Weathered Venezuelan Crude Oil	174
D.29	Results of Spiked Exposure 96-Hour Water Accommodated Fraction Toxicity Test Using 12-Day Old <i>Menidia beryllina</i> and Weathered Venezuelan Crude Oil	175

D.30	Results of Continuous Exposure 96-Hour Chemically-Enhanced Water Accommodated Fraction Toxicity Test Using 6-Day old <i>Mysidopsis bahia</i> , Venezuelan Crude Oil, and Corexit ® 9500	175
D.31	Results of Continuous Exposure 96-Hour Chemically-Enhanced Water Accommodated Fraction Toxicity Test Using 6-Day Old <i>Mysidopsis bahia</i> , Venezuelan Crude Oil, and Corexit ® 9500	176
D.32	Results of Continuous Exposure 96-Hour Chemically-Enhanced Water Accommodated Fraction Toxicity Test Using 6-Day Old <i>Mysidopsis bahia</i> , Venezuelan Crude Oil, and Corexit ® 9500	176
D.33	Results of Spiked Exposure 96-Hour Chemically-Enhanced Water Accommodated Fraction Toxicity Test Using 6-Day Old <i>Mysidopsis bahia</i> , Venezuelan Crude Oil, and Corexit ® 9500	177
D.34	Results of Spiked Exposure 96-Hour Chemically-Enhanced Water Accommodated Fraction Toxicity Test Using 6-Day Old <i>Mysidopsis bahia</i> , Venezuelan Crude Oil, and Corexit ® 9500	177
D.35	Results of Spiked Exposure 96-Hour Chemically-Enhanced Water Accommodated Fraction Toxicity Test Using 6-Day Old <i>Mysidopsis bahia</i> , Venezuelan Crude Oil, and Corexit ® 9500	178
D.36	Results of Spiked Exposure 96-Hour Chemically-Enhanced Water Accommodated Fraction Toxicity Test Using 6-Day Old <i>Mysidopsis bahia</i> , Prudhoe Bay Crude Oil, and Corexit ® 9500	178
D.37	Results of Spiked Exposure 96-Hour Chemically-Enhanced Water Accommodated Fraction Toxicity Test Using 12-Day Old <i>Mysidopsis bahia</i> , Prudhoe Bay Crude Oil, and Corexit ® 9500	179
D.38	Results of Spiked Exposure 96-Hour Chemically-Enhanced Water Accommodated Fraction Toxicity Test Using 16-Day Old <i>Sciaenops ocellatus</i> , Venezuelan Crude Oil, and Corexit ® 9500	179
D.39	Results of Continuous Exposure 96-Hour Chemically-Enhanced Water Accommodated Fraction Toxicity Test Using 12-Day Old <i>Menidia beryllina</i> , Venezuelan Crude Oil, and Corexit ® 9500	180
D.40	Results of Spiked Exposure 96-Hour Chemically-Enhanced Water Accommodated Fraction Toxicity Test Using 12-Day Old <i>Menidia beryllina</i> , Venezuelan Crude Oil, and Corexit ® 9500	180
D.41	Results of Spiked Exposure 96-Hour Chemically-Enhanced Water Accommodated Fraction Toxicity Test Using 6-Day Old <i>Mysidopsis bahia</i> , Weathered Venezuelan Crude Oil, and Corexit ® 9500	181
D.42	Results of Spiked Exposure 96-Hour Chemically-Enhanced Water Accommodated Fraction Toxicity Test Using 6-Day Old <i>Mysidopsis bahia</i> , Weathered Venezuelan Crude Oil, and Corexit ® 9500	181
D.43	Results of Spiked Exposure 96-Hour Chemically-Enhanced Water Accommodated Fraction Toxicity Test Using 12-Day Old <i>Menidia beryllina</i> , Weathered Venezuelan Crude Oil, and Corexit ® 9500	181
E.1	Results of Toxicity Test No. 1	185
E.2	Results of Toxicity Test No. 2	185
E.3	Results of Toxicity Test No. 3	186
E.4	Results of Toxicity Test No. 4	186

E.5	Results of Toxicity Test No. 5	187
E.6	Results of Toxicity Test No. 6	187
E.7	Results of Toxicity Test No. 7	188
E.8	Results of Toxicity Test No. 8	188
E.9	Results of Toxicity Test No. 9	189
E.10	Results of Toxicity Test No. 10	189
E.11	Results of Toxicity Test No. 11	190
E.12	Results of Toxicity Test No. 12	190
E.13	Results of Toxicity Test No. 13	191
E.14	Results of Toxicity Test No. 14	191
E.15	Results of Toxicity Test No. 15	192
E.16	Results of Toxicity Test No. 16	192
E.17	Results of Toxicity Test No. 17	193
E.18	Results of Toxicity Test No. 18	193
E.19	Results of Toxicity Test No. 19	194
E.20	Results of Toxicity Test No. 20	194
E.21	Results of Toxicity Test No. 21	195
E.22	Results of Toxicity Test No. 22	195
E.23	Results of Toxicity Test No. 23	196
E.24	Results of Toxicity Test No. 24	196
E.25	Results of Toxicity Test No. 25	197
E.26	Results of Toxicity Test No. 26	197
E.27	Results of Toxicity Test No. 27	198
E.28	Results of Toxicity Test No. 28	198
E.29	Results of Toxicity Test No. 29	199
E.30	Results of Toxicity Test No. 30	199
E.31	Results of Toxicity Test No. 31	200
E.32	Results of Toxicity Test No. 32	200
E.33	Results of Toxicity Test No. 33	201
E.34	Results of Toxicity Test No. 34	201
E.35	Results of Toxicity Test No. 35	202
E.36	Results of Toxicity Test No. 36	202
E.37	Results of Toxicity Test No. 37	203

LIST OF ABBREVIATIONS, SYMBOLS, AND ACRONYMS

Term	Abbreviation, Symbol, or Acronym
Alaska Department of Environmental Conservation	ADEC
American Petroleum Institute	API
American Society for Testing and Materials	ASTM
Alaskan North Slope	ANS
Benzene, Toluene, Ethylbenzene and Xylenes	BTEX
California Department of Fish and Game	CA DFG
California Office of Oil Spill Prevention and Response	CA-OSPR
Centre for Environment, Fisheries and Aquaculture Science	CEFAS
Chemically Enhanced Water Accommodated Fraction	CE-WAF
Chemical Response to Oil Spills: Ecological Effects Research Forum	CROSERF
Confidence Limit	C.L.
Dissolved Oxygen	DO
Effects Concentration (50%)	EC ₅₀
Exxon Biomedical Sciences, Inc	EBSI
Florida Department of Environmental Protection	FL DEP
Gas Chromatography-Flame Ionization Detection	GC-FID
Gas Chromatography-Mass Spectrometry	GC-MS
Hewlett-Packard	HP
International Oil Spill Conference	IOSC
Kuwait crude oil	KCO
Lethal Concentration (50%)	LC ₅₀
Liter	L
Marine Spill Response Corporation	MSRC
Medium Fuel Oil	MFO
Minerals Management Service	MMS
National Research Council	NRC
None detected	nd
Oil:Water Ratio	OWR
Organisation for Economic Cooperation and Development	OECD
Parts per billion	ppb
Parts per million	ppm
Parts per thousand	ppt
Polynuclear Aromatic Hydrocarbons	PAH
Prudhoe Bay crude oil	PBCO
Texas A&M University	TAMU
Texas A&M University, Corpus Christi	TAMU-CC
Texas General Land Office	TGLO
Total Extractable Organic Carbon	TEOC
Total Hydrocarbon Content	THC
Total Petroleum Hydrocarbons	TPH
Ultraviolet-visible Spectroscopy	UV-VIS

United States Environmental Protection Agency	US EPA
University of Alaska, Fairbanks	UAF
University of California	UC
University of California, Santa Cruz	UCSC
University of South Florida	USF
Venezuelan crude oil.....	VCO
Water Accommodated Fraction	WAF
Weathered Venezuelan crude oil	WVCO

ACKNOWLEDGEMENTS

This project covers work accomplished over a number of years by several institutions, and sponsored by multiple organizations. The work was overseen by the American Petroleum Institute Marine Research Workgroup, whose members from the 1998 through 2000 all contributed to the success of the effort. While many organizations supported CROSERF-related activities, the contributions of the California Office of Oil Spill Prevention and Response, the Texas General Land Office, the Florida Department of Environmental Protection, the Alaska Department of Environmental Conservation and Exxon Biomedical Sciences were particularly important. With respect to the detailed research reported in Sections 4 through 6, the authors recognized the following additional organizations and individuals.

For Section 4, Mr. M.M. Singer and Dr. R.S. Tjeerdema would like to thank Susan Jacobson, Maureen Hodgins, Matthew Stoelting, and Jon Becker of the University of California for their assistance in completion of this work.

For Section 5, Dr. D.L. Wetzel and Dr. E.S. Van Vleet would like to thank Ms. Marge Walsh (Nalco/Exxon Energy Chemicals) for assistance in obtaining and characterizing the Corexit 9500 and Corexit 9527. They also would like to thank Mr. Nelson Garcia-Tavel (Bitor America, Corp) for providing the Venezuelan Crude Oil. They are indebted to Mr. Kevin Riskowitz (City of St. Petersburg Environmental Affairs Laboratory) for carrying out the analyses of the volatile hydrocarbons from their samples. They are especially grateful to the faculty and staff of the Eckerd College Marine Science and Chemistry Departments for the space and facilities made available to them for portions of this work

For Section 6, Dr. Chris Fuller and Dr. James Bonner would like to thank Tom McDonald, Sue McDonald and Susan Dellamea, of the Texas A&M University in completion of this work.

Finally, the editors would like to acknowledge the support of all the participants in the CROSERF meetings, without whose help the program would not have been a success.

EXECUTIVE SUMMARY

This report summarizes the goals, results, and conclusions of a cooperative program to improve the knowledge base related to the toxicity and environmental effects of dispersants and dispersed oil when dispersants are used in oil spill response. It also contains detailed results for three toxicity testing programs co-funded by the American Petroleum Institute and the California Office of Oil Spill Prevention and Response, the Texas General Land Office, and the Florida Department of Environmental Protection. This program was known as the “Chemical Response to Oil Spills: Ecological Research Forum,” or CROSERF.

The purpose of CROSERF was to provide state, Federal, and international agencies, industry, academic researchers and consultants engaged in research on the ecological effects of oil spill response chemicals, especially dispersants, with a forum for the exchange of ideas and coordination of research. Specific objectives of the Forum included:

- Discuss and resolve scientific issues related to ecological effects of chemicals used in oil spill response
- Encourage the standardization of laboratory toxicity test procedures
- Foster cooperative laboratory and mesocosm ecological research programs on oil spill response issues of mutual interest
- Encourage the application of appropriate laboratory data collected under realistic exposure scenarios to the oil spill response decision process
- Contribute to the development of appropriate risk assessment protocols.

The forum included both researchers and regulators, with the intent that scientists could learn what types of research would facilitate dispersant use decisions by regulatory agencies in the United States, and the regulators could gain perspective on ecological effects studies being conducted on dispersants, oil and dispersed oil.

One of the critical issues in the interpretation of laboratory toxicity data for dispersants and dispersed oil is the lack of standard protocols. As one of the main objectives of this program, the laboratory researchers spent considerable time evaluating ways to improve such tests, and ultimately developed a new set of protocols for conducting toxicity tests, focused on providing consistent detailed analytical chemistry, environmentally realistic exposure regimes, and standard methods for solution preparation. These protocols are discussed in detail in the report. These protocols offer a baseline set of standard procedures which may be used by other laboratories to develop comparable data sets.

Overall, the following conclusions are strongly supported by the CROSERF results:

- The research and regulatory community benefit from the judicious use of standardized protocols. Proposed modifications must be weighed against the loss of comparability.
- New data sets developed using new protocols need to be integrated into the existing data set; however, there is no organization which currently fulfills such a role.
- The applicability of the data obtained by using standard national test species is often a regional concern. The data here suggest that the results for the standard test species were not all that different than the results for the regional species selected.
- Exposures to declining concentrations of dispersant alone, oil, or dispersed oil are less toxic than a constant exposure. We believe that for most species the more rapid the dilution the greater the difference. This was tested with one dilution regime over 12 species, 7 oils and 2 dispersants. This relationship appears to be clear for all of the tested species except *M. beryllina*, which seems to be more sensitive to initial concentration, than it is to duration of exposure, suggesting a different mode of action for this species. Overall, however, the data support the conclusion that constant exposure testing does not realistically assess the risk to marine or coastal organisms where rapid dilution is possible.
- The dispersants tested (Corexit[®] 9500 and 9527) appear generally less toxic than oil.
- There were large differences in toxicity between the various oils tested. It may be more important to vary the oils used than the species tested when assessing regional risks to oil spills.
- The toxic mode of action of Water Accommodated Fractions and Chemically Enhanced-Water Accommodated Fractions is potentially very different, due to the presence of bulk oil droplets in the latter, while the former is based on solubility.
- There appears to be no difference in the range of LC₅₀s between constant exposures to dispersed oil or water accommodated fractions. With spiked exposures, the same pattern was observed, indicating that dispersed oil is no more toxic than the water accommodated fraction of undispersed oil at equivalent exposures.
- Differences between the toxicity of water accommodated fractions created using weathered and fresh oil are inconsistent. Weathered oil (WAF) does not appear to be significantly less toxic, for either spiked or constant exposure. In the case of dispersed oil (CE-WAF), constant exposure values for fresh and weathered oil appear similar, but for spiked exposure, dispersed fresh oil was consistently more toxic than dispersed weathered oil. However, the differences were probably not large enough to make the risk from dispersing fresh oil appreciably greater, provided that rapid dilution is possible.
- The range of average LC₅₀ values for spiked exposure to fresh dispersed oil was 2.3 to 48.6 ppm. This suggests that as long as dilution was occurring at least as rapidly as the 2.5 hour half-life used in the CROSERF protocols, a threshold of 1 ppm would probably represent a reasonable level of protection for more sensitive life history stages of animals in the water column.
- It is reasonable to ask if LC₅₀ values are the appropriate measure to use to set thresholds. It might be beneficial to examine the use of “Lowest Observed Effects Level” or other value instead. This is, however, not a simple determination, given that almost all of the extant data reports LC₅₀ values.

Section 1

Introduction

Don Aurand
Ecosystem Management & Associates, Inc.
Ship Point Business Park
13325 Rousby Hall Road
Lusby, MD 20657

1.1 Background

This report presents an overview of the activities of a research coordination committee, referred to as the “Chemical Response to Oil Spills: Ecological Research Forum” (CROSERF), along with detailed information on three laboratory toxicity testing projects co-funded by the American Petroleum Institute (API) as part of the CROSERF effort. These studies were focused on the toxicity of dispersants and dispersed oil to representative marine species. The studies were supported by the API and the following state agencies:

- California Office of Oil Spill Prevention and Response (CA-OSPR),
- Texas General Land Office (TGLO), and
- Florida Department of Environmental Protection (FL DEP).

For each project, progress reports were prepared and updated annually. A summary of the results, along with other related CROSERF material, was presented at a special session during the 2001 International Oil Spill Conference (IOSC) held in Tampa, Florida.

Subsequently, because the CROSERF results were published in a wide array of venues, the API Oil Spill Science and Technology Working Group (sponsored by the API Spills Task Force) which had management oversight for the three research projects decided it would be beneficial to combine the final reports from the last three toxicity projects, along with a summary of the other CROSERF information, so that the results of the initiative could be more easily accessed.

These three projects represented the final research projects conducted for CROSERF, which developed out of a joint industry/government desire to address concerns about the adequacy of laboratory toxicity data to help define the possible effects of using dispersants in marine oil spill response. CROSERF, which was organized in June 1994 and held its first meeting in August, held its last meeting in March 1999, and the final laboratory research

CROSERF

Chemical Response to Oil Spills: Ecological Research Forum

Working group of state, federal and industry representatives focused on improving and coordinating research on chemical tools for oil spill response.

Focused on dispersants.

Initiated in 1994, last meeting held in 1999.

Last research projects (reported in this volume) completed in 2000.

Research protocols and results have become key elements in dispersant use planning.

results (the studies reported here) were completed in August 2000. During these six years, the CROSERF participants developed standard laboratory protocols designed to improve the realism and comparability of laboratory toxicity tests with dispersants and dispersed oil, and completed toxicity tests on a suite of five oils.

1.2 Report Organization

This report consists of nine sections, which address various components of the CROSERF initiative or the details of the three API-supported cooperative projects. The specific sections are:

- Introduction
- An overview of the CROSERF Initiative
- CROSERF protocols for laboratory testing
- Three individual chapters detailing the laboratory research conducted under the API-sponsored cooperative programs
- A summary and interpretation of all CROSERF-related results
- Lessons learned from the CROSERF initiative, and
- References to published literature produced by CROSERF laboratories or related to the CROSERF initiative.

Section 2

The Origin and Objectives of the CROSERF Initiative

Don Aurand and Gina Coelho
Ecosystem Management & Associates, Inc.
Ship Point Business Park
13325 Rousby Hall Road
Lusby, MD 20657

2.1 Issues Related to the Use of Toxicity Data to Evaluate Dispersant Use

“Dispersants” as an oil spill response option first came to widespread notice as a result of the *Torrey Canyon* oil spill in Great Britain in 1967. In that instance, the widespread use of “detergents” both at sea and on the shore in an attempt to remove stranded oil led to extensive impacts along treated rocky shorelines. The result was an adverse characterization regarding the use of chemical agents in spill response in the public press, and was instrumental in the development of a very cautious attitude towards the use of dispersants in many countries (National Research Council (NRC), 1989). However, while many stakeholders developed serious reservations, others continued to believe that more effective and less toxic dispersants could be an important response tool. As a result, there was considerable research to improve dispersants which led to modern formulations that are considerably improved in both respects and are widely available. The concerns for many stakeholders, however, remain the same – do they work and what harm do they do? A great deal of research effort has been expended attempting to resolve these issues, especially with regards to environmental risk, and toxicity data is a key element in the discussions.

Toxicity data have two major values to the oil spill response planner considering the potential value of dispersants. The first is to allow for the screening of potential chemical response agents, i.e. to identify the less toxic products. The second is to help estimate the potential ecological effects of the use of dispersants.

In the first instance, standard toxicity data will allow the ranking of products in order of their desirability, provided that the test conditions and the species used are equivalent. Conceptually, this is the more straightforward of the two issues, but it still requires care on the part of the user. In particular, other considerations such as cost, availability, and breadth of effectiveness across oil products also drive product selection.

Modern dispersants are much less toxic and more effective than the early formulations from the 1960s and 70s, but in many countries stakeholders still have the same concern – will the benefits outweigh the costs?

The publication of the 1989 report “Using Oil Spill Dispersants on the Sea” by the National Research Council identified the major issues with toxicological information that the CROSERF initiative was intended to address.

With respect to the second issue, no one associated with oil spill response planning really needs to know laboratory toxicity values per se. What they need to know is whether or not a proposed action is likely to result in the death or injury of marine organisms or damage to ecological systems of concern, and how these effects compare to those likely with other response options. Studies or observations at other spills, controlled ecological studies on oil spills and oil spill countermeasures (either in the environment or in the laboratory) and laboratory toxicity can all be used to address these environmental concerns. Laboratory toxicity data are the least costly to generate and thus are the most commonly available. So, such information is routinely considered when planners evaluate dispersants.

Unfortunately, laboratory toxicity data is difficult to place in the proper context when trying to discuss ecological effects. There are four major issues associated with the use of toxicity data:

- How do you determine the general quality of the data being presented?
- How do you interpret data between species?
- How do you interpret data between different types of tests, and
- How do you then use laboratory toxicity test data to estimate ecological effects in the environment?

MAJOR ISSUES WITH TOXICITY DATA

- Data quality
- Differences between species
- Differences between test protocols
- How do you use it to estimate ecological effects?

The report by the NRC (1989) made a comprehensive examination of all of the data available on dispersants and dispersed oil and concluded that:

“The best strategy for protecting sensitive inshore habitats (i.e., littoral and shallow subtidal, polar to tropical) is to prevent undispersed oil from contacting them. Dispersion of oil before it reaches these habitats may keep them from becoming oiled, or may reduce the persistence of oil that contacts them. Thus offshore chemical dispersal may be the best technique for reducing overall, particularly chronic, impact of the oil in those habitats.”

However, they also acknowledged that organisms in the water column would be at greater risk if dispersants were used, and recommended that “Additional ecological studies under controlled or established water circulation in shallow environments should be conducted to define the conditions under which dispersant use can be environmentally safe.” As part of the review, they identified a number of problems with existing laboratory toxicity data which had led to confusion and difficulties in interpretation. These included:

- A lack of information as to how temperature affects the toxicity of dispersants
- A poor understanding of both lethal and sublethal effects of dispersants at realistic exposure concentrations

The issue with dispersant use is not whether or not dispersed oil is toxic, it is; but whether or not the risk posed by using dispersants is less or more significant than the risks associated with not using them.

- The frequent use of nominal rather than actual concentrations of oil in experimental systems – which incorrectly included oil floating on the water surface as well as the oil fraction in the water column to which the organisms were exposed
- The tendency for laboratory bioassay data to use exposures which are higher and/or longer (often significantly so) than anticipated exposures in the field, and
- The lack of a commonly accepted technique for comparing laboratory bioassay data with field exposure data

In the same year (1989) that the NRC report was released, the TV *Exxon Valdez* ran aground in Prince William Sound, Alaska and caused the largest oil spill in the United States. Among the consequences of this event was an increased awareness of the need for additional funding for oil spill research on the part of industry and state and federal agencies. This led to the recommendations of the NRC receiving much more attention than would probably have been the case had the accident not occurred.

2.2 Factors Leading to Establishing CROSERF

While there were many factors which led to the development of the CROSERF initiative, two (in addition to the conclusions cited above from the 1989 NRC report) stand out as particularly important in the initiation of the program.

2.2.1 Initial Studies by the California Office of Oil Spill Prevention and Response

In 1985 the State of California appropriated funds for the California Department of Fish and Game (CA DFG) to accomplish three tasks related to the use of chemical agents in oil spill response:

- Survey existing research programs to determine if additional research on the effects of chemical dispersants on wildlife and living marine resources [in California] is necessary,
- Work in cooperation with the California State Water Resources Control Board to revise the list of licensed oil spill cleanup agents, and
- Publish a manual containing the decision process for approving the use of oil spill cleanup agents, along with a list of licensed products, criteria for their selection, and directions for their application.

EARLY EFFORTS

CROSERF grew out of efforts by the State of California, later joined by MSRC, to develop more realistic toxicity testing protocols.

In response to the legislation, CA DFG organized a research team that developed a research plan to address these issues in July, 1986 (Tjeerdema et al., 1990). As part of that research program the CA DFG Marine Pollution Studies Laboratory at Granite Canyon (near Monterey, CA) was expanded to provide the capability to do petroleum toxicity research on aquatic species, and the University of California, Santa Cruz (UCSC)-CA DFG Trace

Organic Analysis laboratory undertook to provide analytical chemistry support for petroleum and dispersant analysis.

The initial toxicity studies focused on the development of chemical analytical protocols for measurement of dispersant concentrations in seawater, the development of a new aquatic exposure chamber for volatile chemicals and aquatic larvae, and initial toxicity tests using the dispersant Corexit[®] 9527 (both constant and declining exposure tests).

While the CA DFG program was not the only relevant oil and dispersant toxicity research being conducted in the early 1990s, it was perhaps the most visible program, and represented the most comprehensive effort to address many of the concerns that had been raised in the NRC (1989) report.

2.2.2 The Marine Spill Response Corporation (MSRC) Dispersant Research Program

When the MSRC Research Program began operation in 1991, a direct result of the Oil Pollution Act of 1990 and the Prince William Sound oil spill, research on dispersants and dispersed oil was one of the priorities for the Research and Development Department. In February 1993 a planning workshop (Science and Policy Associates, Inc., 1993) was held to help disseminate information on MSRC early initiatives, identify the highest priority topics, and to engage other organizations potentially conducting similar research to identify opportunities for cooperative research. The workshop was attended by 21 individuals representing three states (California, Florida, and Texas) which either had or anticipated having research programs, three federal agencies (the US Environmental Protection Agency (US EPA), the Minerals Management Service (MMS) and the Marine Mammal Commission, the NRC Committee which authored the 1989 report and the oil industry (MSRC, API and four individual companies). The workshop attendees were asked to evaluate all aspects of the dispersant use issue, not just biological or ecological effects.

When the workshop was held, MSRC had already initiated cooperative toxicity testing efforts with the CA DFG to continue and expand their effort to define the toxicity of dispersants and dispersed oil. Since the CA DFG effort focused only on CA species, a cooperative program was also underway with Exxon Biomedical Sciences, Inc. (EBSI) using two standard US EPA test organisms and one California test organism to verify the procedures and provide information on additional species.

Toxicity testing per se was not the highest research priority identified by the participants, but access to reliable toxicity data was a necessary component to several of the priority topics. In addition, participants felt that the most productive way to address the priority topics was through some sort of coordinated research program, since none of the organizations alone had either sufficient resources or sufficient scope in their charter to address the broad issues related to dispersant use. MSRC was viewed as a logical focal point for such coordination efforts.

2.3 CROSERF

After the workshop described in Section 2.2 ended, informal coordination continued between the several organizations, but it was not until June 2004 that a concerted effort was made to develop a formal coordination mechanism. Impetus was provided by the initiation of

joint research efforts between MSRC and the CA Office of Oil Spill Prevention and Response (OSPR) (part of CA DFG), TGLO and EBSI, and the likelihood of an additional program with Florida (and possibly others). The first meeting was held in August 1994, beginning a five-year effort at research coordination.

2.3.1 CROSERF Program Objectives

The purpose of CROSERF, as defined at the first meeting (Kucklick, 1994), was to provide state, Federal, and international agencies, industry, academic researchers and consultants engaged in research on the ecological effects of oil spill response chemicals, especially dispersants, with a forum for the exchange of ideas and coordination of research. Specific objectives of the Forum included:

- Discuss and resolve scientific issues related to ecological effects of chemicals used in oil spill response;
- Encourage the standardization of laboratory toxicity test procedures;
- Foster cooperative laboratory and mesocosm ecological research programs on oil spill response issues of mutual interest;
- Encourage the application of appropriate laboratory data collected under realistic exposure scenarios to the oil spill response decision process; and
- Contribute to the development of appropriate risk assessment protocols.

CROSERF OBJECTIVES

- Resolve scientific issues related to dispersant use
- Encourage standardization
- Foster cooperative efforts integrate appropriate laboratory data into the dispersant decision process
- Encourage the development of risk assessment protocols

The forum included both researchers and regulators, with the intent that scientists could learn what types of research could best facilitate dispersant use decisions by the regulatory agencies in the United States, and the regulators could gain perspective on ecological effects studies being conducted on dispersants, oil and dispersed oil.

The group met nine times between 1994 and 1999, with each meeting lasting approximately two full days. Meeting proceedings were prepared for the first eight meetings (Table 2.1). They were not prepared for the ninth meeting, where the decision was made to end the program and present the results at the 2001 International Oil Spill Conference as a special session. The first nine meetings included summary presentations about the activities at each participating research group since the last meeting, as well as discussions of topics of special interest. During the first six meetings there was a heavy focus on developing and discussing protocols for the

Nine CROSERF meetings were held between 1994 and 1999. The group disbanded in 2001 with a special session at the International Oil Spill Conference to present summary results.

laboratory toxicity testing program. The results of these discussions are presented as final protocols in Section 3, while the individual meeting notes can provide details on the discussions. Other topics which were addressed include risk assessment in oil spill response planning, mesocosm testing, the needs of regulatory agencies and information dissemination. Summaries of the discussions at each of the first eight meetings are provided in Appendix A.

Table 2.1 Meetings of CROSERF and Available Proceedings

Meeting	Date	Location	Literature Citation
1	August 9-10, 1994	Santa Cruz, CA	Kucklick, 1994
2	March 21-22, 1995	Baton Rouge, LA	Kucklick, 1995
3	September 13-14, 1995	East Millstone, NJ	Aurand and Kucklick, 1995
4	April 24-25, 1996	Santa Cruz, CA	Aurand and Coelho, 1996
5	September 18-19, 1996	Corpus Christi, TX	Coelho and Aurand, 1996
6	April 3-4, 1997	Fort Lauderdale, FL	Coelho and Aurand, 1997
7	November 13-14, 1997	Santa Cruz, CA	Coelho and Aurand, 1998a
8	March 17, 1998	Anchorage, AK	Coelho and Aurand, 1998b
9	March 4-5, 1999	Seattle, WA	No proceedings prepared
10	2001 International Oil Spill Conference	Tampa, FL	Results from all the laboratories published in the conference proceedings (from API)

Because of funding issues, the research laboratories initiated their final round of experiments in 1999-2000 and prepared their final results in 2001. An overview of the program, and final summary reports from all of the individual laboratories participating in the laboratory toxicity testing program were presented during a special interactive poster session at the 2001 International Oil Spill Conference (Aurand *et al.*, 2001; Singer *et al.*, 2001a, b; Clark *et al.*, 2001; Fuller and Bonner, 2001; Wetzel and Van Vleet, 2001 and Rhoton *et al.* 2001).

2.3.2 CROSERF Participants

The regular participants of CROSERF fell into three categories, Information Users, Program Sponsors, and Participating Laboratories. Participation was unrestricted in all categories. Ultimately, the research group consisted of four state University laboratories and one industry laboratory:

- University of California, Santa Cruz (UCSC)
- Texas A&M University (TAMU)
- University of South Florida (USF)
- University of Alaska, Fairbanks (UAF)
- Exxon Biomedical Sciences, Inc. (EBSI)

Organizations which directly sponsored research projects and the administrative costs associated with the Forum, included:

- Texas General Land Office (TGLO);
- Florida Department of Environmental Protection (FL DEP);
- California Office of Oil Spill Prevention and Response (CA OSPR);
- Alaska Department of Environmental Conservation (ADEC);
- Exxon Corporation;
- American Petroleum Institute (API), and
- Marine Spill Response Corporation (MSRC).

Organizations which have supported only the administrative costs associated with the Forum, included:

- Minerals Management Service (MMS);
- U.S. Environmental Protection Agency (US EPA),
- Office of Response and Restoration, National Oceanic and Atmospheric Administration (NOAA) (analytical chemistry support), and
- Chevron Corporation.

In addition to the organizations listed above, there were several other consultants, state, Federal and international organizations that, as possible, participated in the CROSERF discussions and process. International organizations included Environment Canada, SINTEF Applied Chemistry (Norway), Centre for Environment, Fisheries and Aquaculture Science (CEFAS, England), and AEA Technologies (England).

2.3.3 Discussions About Long-Term Research Objectives

During the fourth meeting (April 1996) of CROSERF participants decided that there needed to be a plan which established multi-year program objectives for the program to be effective (Aurand and Coelho, 1996). Initially, the intent was to create a plan which would integrate laboratory toxicity testing, mesocosm testing, and field studies. At the fifth meeting in September, 1996 the Forum made the first serious attempt to develop the concepts which needed to be discussed in a program plan (Coelho and Aurand, 1996). The discussions at this meeting identified the need for a range of standard protocols, general objectives for laboratory, mesocosm and field experiments, and an information dissemination program. Based on these discussions, a committee consisting of Jim Clark (EBSI) and Don Aurand (Ecosystem Management & Associates, Inc.) was formed to develop a draft outline for discussion at the next meeting.

This outline was presented to the Forum for review at the sixth meeting (April 1997). After discussion, the basic outline was approved, with the understanding that information dissemination (outreach) was a critical element in the CROSERF program. Jim Clark, Don Aurand, Gina Coelho (Ecosystem Management & Associates, Inc.), and Alexis Steen (API) agreed to serve as a committee to prepare a first draft of the plan for review (Coelho and Aurand, 1997).

This draft plan was presented to the Forum for review at the seventh meeting in November, 1997 (Coelho and Aurand, 1998a). After considerable discussion, the participants decided that the scope of the plan needed to be significantly limited, based on the projections of future funding. It was felt that, at best, two or three years of additional funding were likely to be available from the major funding organizations unless a strong case could be made for continued support. This was the result of the generally declining budgets for all spill research in both industry and government.

The decision was made to delete all information on mesocosm and field research programs, since many of the participants were not involved, and focus instead on the aquatic toxicity testing program. This effort involved all of the participants and was the single most critical CROSERF activity. By doing so, the document focused on the basic research objectives of the existing program, providing non-participants a framework for review. Participants felt that future research and funding needs could be developed in subsequent proposals. Accordingly, the sections on cost and future funding were eliminated. It was also decided that, while the outreach program was important, the proposed program was too ambitious, given the existing resources, and should be reduced. The participants then examined the basic structure of the section on laboratory testing on dispersants and dispersed oil, with the goal of ensuring that an appropriate data set could be completed within the projected available funding. As a result, proposed sediment toxicity tests were deleted, and the number of tests with aquatic species was decreased. The participants felt that developing an adequate, but affordable, matrix of anticipated testing was the critical element in the plan and needed additional review. Don Aurand and Gina Coelho agreed to revise the report and to present the revised testing matrix for final approval at the next meeting.

The eighth CROSERF meeting was held in March, 1998 (Coelho and Aurand, 1998b) and developed further revisions to the basic testing matrix, but the participants had no other changes to the scope of the plan. Participants felt that this basic framework could provide guidance to the participating laboratories concerning future research priorities, regardless of the status of CROSERF, and would also provide guidance and background to other organizations that might be considering developing testing programs (see Section 2.3.4).

2.3.4 Essential Elements of a Toxicity Testing Work Plan

This section defines the minimum components of a laboratory toxicity testing program that the CROSERF participants felt was appropriate to provide an improved data set to interpret the toxicity of dispersants and dispersed oil in the marine environment. It was originally developed with input from all of the participating laboratories and major sponsors during several of the scheduled CROSERF meetings. The discussions are documented in the various proceedings, and are generalized below to be relevant to any program under consideration.

General Objectives for the Laboratory Testing Program

- Improve analytical chemistry protocols
- Improve media preparation standards
- Improve exposure regimes
- Document procedures
- Integrated data set
- Weathered vs. unweathered oil
- Run toxicity tests with and without dispersant

2.3.4.1 Goals and Objectives for a Dispersant and Dispersed Oil Laboratory Toxicity Testing Program

Historically, laboratory toxicity data has played an important role in decisions regarding dispersant use during oil spill response. Much of this data set is inappropriate for that purpose or subject to misinterpretation for one or more of the following reasons:

- Use of nominal instead of measured exposure concentrations
- Inappropriate preparation of exposure media (mixing)
- Inappropriate exposure regimes (time and concentration)
- Use of serial dilutions to prepare test solutions
- Inconsistent control of volatile compounds
- Lack of detailed chemistry on the toxicant (oil or dispersant) before and during exposure, or,
- Poor documentation of experimental protocols.

This has made discussions about toxicity of dispersants and dispersed oil in comparison to crude oil difficult at best and misleading at the worst. As a result, in many cases the relevance of the information to real-world situations is unclear, and so very conservative assumptions are made by regulators in order to avoid perceived environmental issues. The NRC (1989) identified most, if not all, of these issues when they reviewed the use of dispersants in marine environments, and recommended that research be undertaken to develop an improved data set.

CROSERF's goal for the toxicity research program was to provide improved scientific data on the toxicity of dispersants and dispersed oil for use by the oil spill regulatory and planning communities. In order to accomplish this goal, a series of factors must be considered when developing a program:

- Identify existing research programs at other laboratories for coordination
- Adopt standard protocols for use by all laboratories to ensure data comparability
- Adopt testing methods which realistically relate to field exposure conditions
- Identify a list of oils for testing, striving for a mix of oil types which are of regional, national, and international significance
- Identify a mix of species for toxicity testing, which includes regional, national and international species of interest
- Conduct laboratory tests which compare any new exposure protocols to data collected using standard 96-hour protocols
- Conduct testing on both fresh and weathered oils
- Encourage regional, national, and international coordination, and
- Communicate the results of the testing program to the oil spill planning and response community, and to other researchers.

These objectives are discussed in detail in the following sections.

2.3.4.2 Development of Testing Protocols and Methods

Early in the development of the CROSERF research effort, the participants made a commitment to document all of the protocols used in the program, and to encourage complete standardization with the approved protocols. This was considered a very high priority effort. The lack of standardization and incomplete documentation on methods has been a serious problem for much of the earlier research on dispersant and dispersed oil toxicity. Because of the inherent difficulties in working with oil in aqueous solution, even small differences in experimental or analytical protocols can make a large difference in results.

The lack of standardization and incomplete documentation on methods has been a serious problem with much of the early research on dispersants and dispersed oil.

Therefore, whenever a new program is under consideration, all protocols must be fully coordinated with all participants, and any discussions related to their content documented. It is particularly important to review and consider any other available protocols (such as those presented in Section 3 of this volume) when designing a new program. Whenever possible, adopt appropriate existing protocols to ensure for data comparability. When protocols are completed, they should be compiled into a standard reference notebook for all participants. In addition, the participants should prepare summary papers for submission to technical journals to enhance their technical credibility and to make the protocols more widely available. The following need to be considered whenever a new oil testing program is designed, and should address similarities and differences with other published protocols:

- List of standard terms and definitions
- Standard chemical and physical characterization of crude oil
- Preparation and handling of water accommodated fractions (WAF) and chemically enhanced-WAF (CE-WAF) (dispersed oil)
- Standardized laboratory testing apparatus for declining exposure testing
- Acceptable protocols for constant exposure and declining exposure 96-hour toxicity tests
- Chemical characterization of test solutions
- Artificial weathering of oil
- Round-robin testing
- Statistical analysis of toxicity tests, and
- Reporting of results.

The CROSERF approaches to each of these elements are presented in Section 3. Additional protocols may be developed if a need is identified.

There were five participating laboratories in the CROSERF program, four university laboratories and one industry. Table 2.2 presents the basic testing matrix which all laboratories agreed to attempt to complete. It represents the consensus as to a minimum desirable data set to provide toxicity information to drive regulatory or planning discussions about dispersant use. The key elements are as follows:

- Each laboratory would focus on one oil typical of the products in their area where dispersant use might be considered. If additional oils are of concern, the matrix should be completed for the first oil before testing begins on the second.
- The dispersant likely to be most available for use should be tested first (if more than one is available).
- Since more than one laboratory was participating, all laboratories agreed to use a standard reference oil and a standard reference species to calibrate their testing results. The reference oil and species should be selected so as to provide a common reference point with existing data as well as between participating laboratories. If only one laboratory is actively involved, they should try to identify a data set which they can duplicate to provide a reference point. Replicate tests using the reference species and reference oil are not necessary unless the results were inconsistent in the initial testing.
- All laboratories would develop information on two species of interest from different taxonomic groups, in order to provide at least a minimum amount of information on variability.
- Tests using spiked exposure were more critical than constant exposure tests; however, at least some information on constant exposure results is valuable for comparison with other data sets. Therefore spiked tests should be run three times, while constant exposure tests need not be repeated.
- Both weathered oil and fresh oil should be tested under spiked exposure conditions, but only fresh oil needs to be tested under constant exposure (since the weathered oil will be considerably less toxic).
- Dispersant only tests do not need to be replicated, but should be run for the reference species and it is recommended that a test also be completed using the reference species and a reference dispersant, which allows calibration with other data sets.

Table 2.3 lists the species being used by each CROSERF laboratory. Table 2.4 lists the oils being used by the various laboratories.

Table 2.2 Basic Laboratory Toxicity Test Matrix Showing the Number of Times the Test Should be Repeated

Species Designation	Fresh Oil Spiked Exposure WAF	Fresh Oil Spiked Exposure CE-WAF	Fresh Oil Constant Exposure WAF	Fresh Oil Constant Exposure CE-WAF	Weathered Oil Spiked Exposure WAF	Weathered Oil Spiked Exposure CE-WAF	Weathered Oil Constant Exposure WAF	Weathered Oil Constant Exposure CE-WAF	Dispersant Only
A	3X R _o	3X R _o	X	X	3X	3X	Not tested	Not tested	Y
B	3X R _o	3X R _o	X	X	3X	3X	Not tested	Not tested	Y
Reference (<i>Menidia beryllina</i>)	R _o	R _o	Not tested	Not tested	X	X	Not tested	Not tested	Y R _D

X = Oil type specific to each laboratory

R_o = Reference oil (US EPA standard PBCO)

R_D = Standard dispersant (Corexit[®] 9500) provided by UCSC reference stock

Y = Laboratory dispersant (Corexit[®] 9500)

Table 2.3 Test Species* Included in the CROSERF Toxicity Testing Program, by Laboratory

Species Designation	UCSC	TAMU	USF	UAF	EBSI
1	<i>Atherinops affinis</i> larvae (topsmelt)	<i>Mysidopsis bahia</i> juveniles (mysid)	<i>Mysidopsis bahia</i> juveniles (mysid)	<i>Mysidopsis bahia</i> juveniles (mysid)	<i>Mysidopsis bahia</i> juveniles (mysid)
2	<i>Holmesimysis costata</i> juvenile (kelp forest mysid)	<i>Scianops ocellatus</i> larvae (red drum)	<i>Scianops ocellatus</i> larvae (red drum)	<i>Chionoecetes bairdi</i> (Tanner crab larvae)	<i>Crassostrea virginica</i> larvae (eastern oyster)
Reference Species	<i>Menidia beryllina</i> larvae (inland silversides juveniles)	<i>Menidia beryllina</i> larvae (inland silversides juveniles)	<i>Menidia beryllina</i> larvae (inland silversides juveniles)	<i>Menidia beryllina</i> larvae (inland silversides juveniles)	<i>Menidia beryllina</i> larvae (inland silversides juveniles)

* Some laboratories ran tests on additional species, but these were the basic test organisms agreed to as part of the basic protocol.

Table 2.4 Oils* Used in the CROSERF Toxicity Testing Program, by Laboratory

Laboratory	Test Oil
UCSC	Prudhoe Bay crude oil**
TAMU	Arabian Light crude oil
USF	Venezuelan crude oil
UAF	Alaska North Slope crude oil**
EBSI	Kuwait crude oil

* Some laboratories ran tests on additional oils, but these were the basic test oils agreed to as part of the basic protocol.

** Prudhoe Bay crude oil refers to the standard US EPA reference oil. Alaska North Slope crude oil comes from the same oil field, but was obtained from current production.

Section 3

A Review of Standard CROSERF Protocols

Gina Coelho and Don Aurand
Ecosystem Management & Associates, Inc.
Ship Point Business Park
13325 Rousby Hall Road
Lusby, MD 20657

One of the priorities of the CROSERF participants was to develop a set of defined protocols which could be broadly applied for research with dispersants, oil and dispersed oil. After extensive discussion and testing, the final protocols were developed and published by Singer *et al.* (2000, 2001b). This section provides a summary of the final protocols. For detailed information on the underlying discussions concerning the final protocols, consult either the CROSERF Proceedings (see Table 2.1) or the two references listed above.

3.1 Terminology

Throughout the course of this project, terms were used that have varying definitions or definitions that have not been clearly defined in the past. The following terms are ones used throughout this project, especially in this section, that may not be commonly understood or clearly defined. CROSERF participants reviewed and adopted the definitions in 1997. These are useful when reviewing CROSERF documents and either of the methods papers (Singer *et al.*, 2000: 2001b).

Chemically Enhanced Water Accommodated Fraction (CE-WAF): A laboratory prepared solution derived from the standard 20-25% vortex mixing of test material and chemical dispersant in which a relatively stable population of bulk material droplets (1-70 micron diameter) is present.

Constant Exposure: refers to a constant exposure in which the aim is a constant concentration. In this type of exposure, the organisms are placed in a chamber and exposed to a test solution for a certain time period. The exposure may be flow-through, static non-renewal, or static renewal (see definitions). The tests are typically carried out for 48 or 96 hours.

Continuous Flow-Through: refers to a constant exposure in which the organisms are placed in full strength test solution in the flow-through test chambers. The pumps are turned on and the chambers are pumped with a constant concentration test solution (i.e., no dilution of the test solution occurs). When performing this type of exposure, care must be taken to assure that components of the test solution are not being lost through the tubing walls.

Internal Standard: A compound added immediately prior to instrumental analysis and used as a quantification standard to correct for instrumental variances (i.e.,-internal standard quantification method).

Physically Enhanced Water Accommodated Fraction (PE-WAF): A laboratory prepared solution derived from high to very high energy ($\geq 25\%$ vortex) mixing of test material and water only (no chemical dispersant) in which a relatively stable population of bulk material droplets (1-70 micron diameter) is present.

Pulsed Exposure: refers to a square-wave concentration exposure. In this type of exposure, organisms are placed in a closed, static chamber with no head space above the test solution. The organisms are left in the solution for a certain time period, then removed and placed in clean water. There is not a specified chamber type in which this type of test must be performed, nor is there a defined time period for the exposure to test solution prior to transfer to clean water. The tests are typically carried out for 48 or 96 hours.

Spiked Exposure: refers to a declining concentration exposure. In this type of exposure, the organisms are placed in full strength test solution in the flow-through test chambers. The pumps are turned on and the chambers are slowly diluted with clean water. The standard flow rate used for dilution in the chambers (designed by UCSC) is 2 mL/min., which relates to an equivalent half-life (for the test solution) of 1.67 hours. The tests are typically carried out for 48 or 96 hours.

Static Non-Renewal: refers to a constant exposure in which the organisms are placed in a closed, static chamber with no headspace above the test solution. The initial test solution is used for the duration of the exposure (i.e.,-no test solution renewal). It should be noted that there may be a potential decline in the test solution concentration over the duration of the exposure. The CROSERF group feels that although this type of exposure has limited value in relation to “real world” spills, this data will link CROSERF data to the current US EPA regulatory testing data.

Static Renewal: Refers to a constant exposure in which the organisms are placed in a closed, static chamber with no headspace above the test solution. The test solution is renewed at regular time intervals (typically 24 hours) with fresh test solution made to the same concentration. The CROSERF group feels that although this type of exposure has limited value in relation to “real world” spills, this data will link CROSERF data to the current US EPA regulatory testing data.

Surrogate Standard: A compound (often deuterated) which is added at the beginning of the extraction and carried all the way through the analysis process. The surrogate is used to establish extraction efficiency and recovery.

Total Hydrocarbon Content: The sum of Total Petroleum Hydrocarbon (TPH) concentration and volatile concentration. Refer to Section 3.3.6 CROSERF “Guidelines for Chemical Characterization of WAF and CE-WAF Test Solutions” for details on how to calculate TPH and volatile concentrations.

Water Accommodated Fraction (WAF): A laboratory prepared solution derived from low energy (no vortex) mixing of test material (an oil or petroleum product) which is essentially free of particulates of bulk material (>1 micron diameter).

3.2 Basic Toxicity Testing Equipment List

This equipment list assumes that general aquaculture equipment (aquaria, animal nets, water filters; aeration pumps and tubing; air stones; food; etc.) and general laboratory equipment (beakers; flasks; standard pipettes; analytical balances; etc.) are available. It also assumes that a seawater source is readily available (many marine species do not tolerate artificial sea salt solutions), as well as filtration systems that can filter seawater to 0.5 microns. Most items on this list are readily available from any laboratory supplier or aquarium supplier.

3.2.1 CROSERF Flow-Through Toxicity Chamber

The testing chamber used for all of the CROSERF flow-through testing was designed by the researchers at UCSC, and was originally described by Singer *et al.* (1990a) and subsequently modified to improve analytical accuracy, convenience of use and organism handling and treatment (Singer *et al.*, 1993). They were specifically designed to facilitate the use of volatile toxicants and early life history stages of aquatic organisms, which are often quite small and delicate (Tjeerdema and Singer, 1991). Figure 3.1 shows the design of the modified chamber.

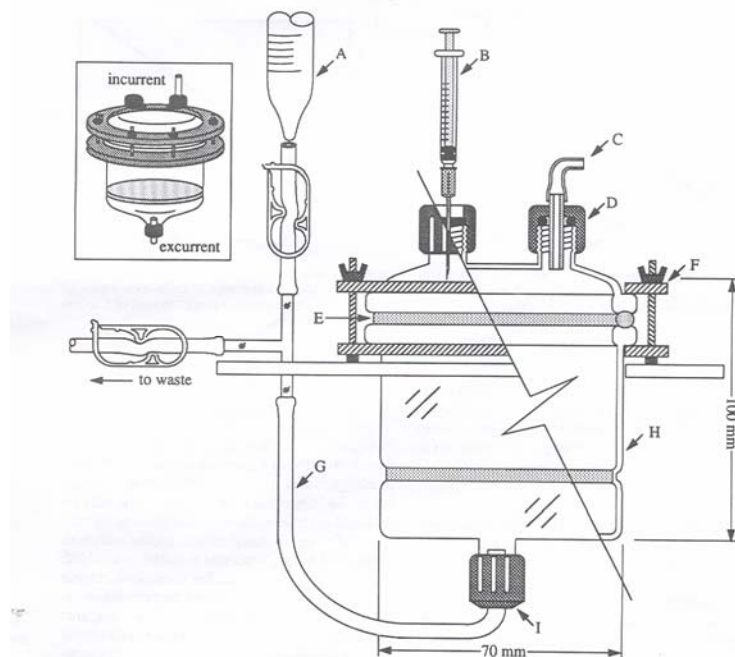

Figure 3.1 Schematic Diagram of the CROSERF Flow-Through Toxicity Test Chamber (after Singer *et al.*, 1993)

A. Pipette for chemistry sampling; B. Syringe for food introduction through septum; C. Seawater inlet; D. Threaded glass fitting with phenolic cap; E. Silicone O-ring-sealed glass flange; F. Full-circumference aluminum flange clamp; G. Silicone tubing; H. Chamber body, and I. Chamber outlet.)

While all of the CROSERF participants used these chambers, they are not commercially available, and so other designs for flow-through testing may be used. If that is the case, researchers need to ensure that spiked exposure regimes are similar to the product concentration half-life when a flow rate of 2 ml/minute is used in these chambers (total volume 240 ml). If the rate of decline in toxicant concentration is not the same, then estimates of toxicity will also vary. Given the very low flow rate, it is difficult to avoid small variations in the dilution rate. The chemical and physical nature of the toxicant as well as the size, number and activity level of the test organisms may also affect mixing, and hence dilution characteristics within the chamber. In verification trials by the CROSERF researchers the time to 50% dilution of the initial concentration of toxicant ranged between 1.5 and 2.8 hours.

3.2.2 Static Exposure Test

- 400 mL Polypropylene beakers (at least 6)
- Stir plate (only one is required for dispersant only testing, but up to six will be needed for oil and dispersed oil testing)
- Teflon magnetic stir bars (2.5 cm length)
- 2-liter glass aspirator bottles w/ stoppers (at least 5)
- Tubing that is correct inner diameter to secure over aspirator bottle port
- Clamps for tubing described above
- Plastic cling wrap
- Gas-tight syringes (need to be able to pipette dispersant at quantities ranging from 50 μ L to 1000 μ L, which will require several gas-tight syringes in different ranges. The following three ranges are very useful: 10-100 μ L; 50-500 μ L; and 100-1000 μ L)
- 5 mL disposable glass pipettes (these are used for aeration)
- Aeration tubing that fits top of pipettes (10 meters minimum)
- Water sample containers (scintillation vials with Teflon lined caps work very well)

3.2.3 Flow-Through Exposure Test

- 18 CROSERF flow-through toxicity testing chambers
- Frames to support the chambers (those shown in the original pictures can hold 12 glass chambers and are made of wood and Plexiglas: the wooden frame is 17.5 cm high, 71 cm long and 53 cm wide; the Plexiglas is 3 mm thick and has twelve 9 cm diameter circular holes cut into the Plexiglas). Any design will work that suspends the chambers at least 4 cm off the surface of the work area.
- Cole-Parmer multihead peristaltic pump
- Cole-Parmer 8-channel, 8-roll pump head (manufacturer # 07623-10; three of these will be needed in order to run 18 chambers at one time)
- Cole-Parmer platinum cured silicon 3-stop tubing (inner diameter 2.79 mm; manufacturer number 95603-48); 18 tubes will be needed; tubing can be re-used for 2-4 experiments depending on duration of each experiment
- 10 L polypropylene carboys; seven carboys total (one for mixing; and six for holding five different dispersant concentrations plus a control)
- 400 micron mesh Nitex screen (this is used in 2x2 cm increments, to block off chamber ports)
- Aquarium-grade silicone sealant
- Aluminum foil
- Stainless steel propeller or a large (approx. 5 cm) Teflon stir bar and stir plate large enough to hold a 10 L carboy during mixing (for dispersant-only solution preparation)
- Gas-tight syringes (need to be able to pipette dispersant at quantities ranging from 50 μ L to 1000 μ L, which will require several gas-tight syringes in different ranges. The following three ranges are very useful: 10-100 μ L; 50-500 μ L; and 100-1000 μ L)
- 5 mL disposable glass pipettes (these are used for aeration)

- Aeration tubing that fits top of pipettes (30 meters of standard aquaria hosing at a minimum)
- Water sample containers (scintillation vials with Teflon lined caps work very well)

3.2.4 Analytical Equipment

- UV/VIS spectrophotometer
- Meters for dissolved oxygen, pH, salinity, temperature
- GC-Mass spectrophotometer

3.2.5 Chemicals

- Dispersants
- Oils
- Formalin for preserving animals (optional)

3.2.6 Equipment Set-Up

Figures 3.2 through 3.9 contain photographs of various components of the toxicity testing apparatus, including brief explanations of equipment and set-up considerations.

Figure 3.2 Flow-Through Toxicity Testing System

This photo shows the flow-through toxicity setup used at the EBSI Laboratory. Notice that EBSI set up the chambers on two different shelves, since they were using 40 chambers at once. It is more ideal to set up all of the chambers at one level. The entire system is located within a constant temperature room.



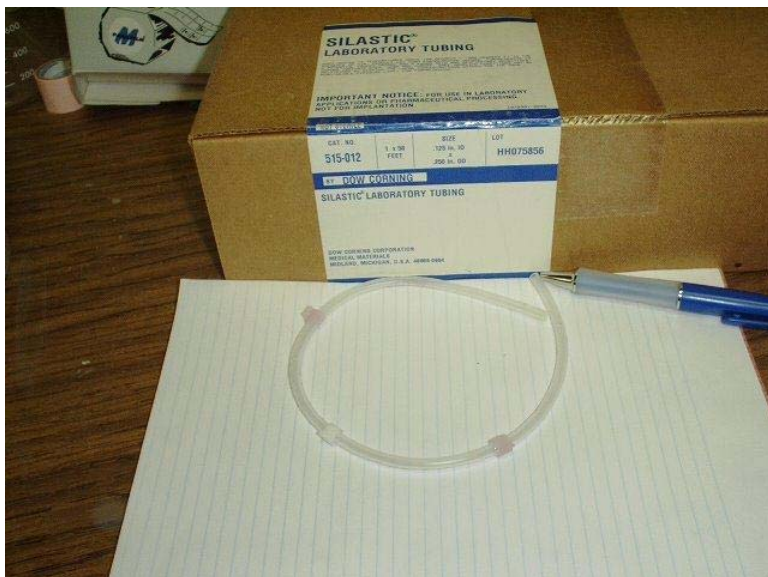

Figure 3.3 Silastic 3-Stop Tubing

This is the only type of three-stop peristaltic pump tubing that we have found works well for the toxicity testing. Tubing type isn't critical for the dispersant-only tests, but is critical when you are doing testing with oil. This is the only tubing we could find (except for glass tubing, which breaks constantly) that did not allow oil to seep through the walls. This tubing is compatible with Cole-Parmer peristaltic pumps.

Figure 3.4 Stacked Pump Heads

The setup up that each of the CROSERF laboratories has used is a series of three 8-channel pump heads that stack together and mount to the front of a peristaltic pump as one unit. This means that you only have to control one master switch for the single pump. Each of the individual channels can be fine-tuned to ensure a consistent flow rate to each chamber. Again, the actual pump is not shown in this photo.





Figure 3.5 Rack System for Holding Multiple Chambers

This setup works well if you have a constant temperature room for conducting the tests. It allows you to keep a group of chambers together, while still being able to see through the Plexiglas stand, and still having clearance under the chambers for the effluent tubing.

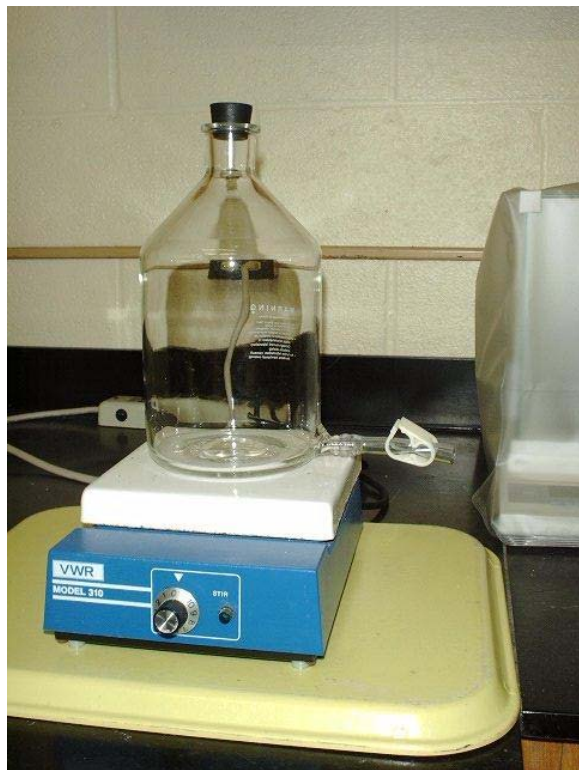

Figure 3.6 Aspirator Bottle and Magnetic Stirrer

This set up is essential when performing the oil and dispersed oil tests (not as important for the dispersant-only tests). This is a 2L-aspirator bottle with a short piece of clamped-off hosing on the aspirator port and a magnetic Teflon stir bar in the bottle. NOTE: Since the dispersed oil (chemically enhanced WAFs) are mixed for nearly a day, it will be important to have at least six of these set ups so that you can run five CE-WAF concentrations at the same time. Five aspirator bottle setups (like the one shown here) will enable you to prepare solutions for 18 chambers (triplicates of five concentrations) plus three pure seawater controls.

Figure 3.7 Chamber with Tubing

Close up of tubing set-up on a single chamber.





Figure 3.8 Tubing Set-up for a Single Chamber

Silastic tubing will run from the diluent, or “source water”, and connects to the three-stop silastic tubing, which runs through the peristaltic pump channel. On the other side of the pump channel, the three-stop tubing is connected to another section of regular silastic tubing, which connects to one of the top ports on the chamber. The other top port has a short piece of clamped-off hosing (aquarium grade tubing) and is used for daily feeding of the animals, if needed. The effluent hose (aquarium grade tubing) connects to the bottom port of the chamber and carries the waste water to a waste collection area. Note that the peristaltic pump head is shown in the picture, although it is not connected to the pump.

Figure 3.9 Feeding the Test Animals

This photo was taken during an experiment, and shows food (algae in this case) being injected through one of the top ports. It is important that all chambers receive the same volume of food each day, so feeding must be done meticulously.



3.3 Final CROSERF Flow-Through Toxicity Testing Methods

3.3.1 General Toxicity Testing Guidelines

Table 3.1 provides general CROSERF guidelines for flow-through tests.

Table 3.1 General CROSERF Toxicity Testing Considerations

Issue	Consideration
Treatment Prep and New Solution Sampling	Do not move the solution mixing vessel (to prevent resuspension of any particulate material); Waste at least 10 mL of solution before filling test chamber. Intermittently draw “initial” analytical samples while filling the test chamber (to avoid sample variation due to stratification in CE-WAF mixing vessel). Water sample should also be drawn for water quality measurements on any new solution (Dispersant Only, WAF, or CE-WAF).
Environmental Conditions	Conduct exposure in a controlled temperature environment (e.g., -constant temperature room, water bath) that is monitored throughout the test.
Chamber Type	“Singer” blown-glass chamber.
Introduction of Animals	Introduce animals to test chamber in one of two methods: 1) Gently introduce solution into sealed chamber through top port and carefully transfer pre-counted, acclimated animals (used for small animals); or 2) Gently introduce solution into open chamber to top of flange and carefully transfer pre-counted, acclimated animals w/ minimal dilution water. Then immediately seal chamber and continue filling through top port.
Dilution Water	Dilution water must be the same as the water used for WAF or CE-WAF preparation (see Protocols for Preparation of WAF/CE-WAF). This should be well-aerated throughout the exposure.
Test Start-Up	Start test and confirm the flow-through rate at 2 mL/minute.
Additional Sampling	Sample water from the FT chamber one or more times during the exposure (in initial 8 hours) to confirm the declining concentration. Use a semi-quantitative method (e.g.,-UV, fluorometry, total carbon analyzer).
Daily Observations	Mortality and other effects observations should be performed daily at a minimum. For microscopic animals, mortality can only be assessed at the end of the experiment.
Mortality	Do not remove dead animals.

3.3.2 Protocol for Preparation of Dispersant-Only Solutions and Spiked Flow-Through Test

Preparation of dispersant-only solutions involves the following:

- Make each of the five solution concentrations separately (do not serially dilute, see Section 8 for a discussion)
- Use aspirator bottle with low side-arm
- Add appropriate amount of 0.45 micron filtered seawater at appropriate seawater strength
- Add stirbar
- Measure dispersant using a gas-tight syringe and record exact amount by weighing the syringe both before and after discharging the dispersant into the diluent
- Inject the dispersant onto the water (holding syringe close to surface)
- Cover bottle and mix solution at 50% vortex for 5 minutes
- Allow the solution to settle for 5 minutes
- Examine the samples for phase separation
- Waste several mL of solution from aspirator arm tube
- Fill the lower half of the three replicate chambers to approximately 1 cm from rim (make sure the effluent line is “closed” before filling); At this time, each fill rate should be set to 2 mL/minute
- While filling the three chambers, intermittently collect an additional sample for chemical analysis; store this sample appropriately until analyzed
- Carefully precount organisms into 15 dishes (randomly) and remove all but the minimum amount of water needed to sustain them
- Randomly transfer animals to chambers and observe for 5 minutes to ensure they were not injured during transfer
- Seal all chambers with feeding ports “open”
- Put chamber intake lines into the dispersant solution
- Turn on pumps to continue filling chamber and check for leaks
- Once water is just below feeding port, “close” the feeding port and “open” the effluent line
- Transfer intake lines to clean, aerated seawater diluent
- Check all flow rates again to ensure 2 mL per minute flow rate and check repeatedly in first two hours
- To feed animals, use a thin pipette. Close effluent line, open feeding port and add food, close feeding port, then open effluent line. Feed all chambers same volume of food
- Make daily observations (data sheet templates provided in Appendix B)
- Be sure to keep diluent seawater container full so chambers do not run dry

3.3.3 Guidelines for Dispersant Solution Chemical Analysis

Chemical analysis of dispersant-only solutions involves the preparation of a series of concentrations of dispersant in seawater solutions to create a calibration curve. A range of 1-1000 ppm using a reference dispersant should be adequate. Note that seawater concentrations can cause interferences, so the calibration series should use the same seawater diluent as used for the toxicity test. Samples should be analyzed within 2 hours of collection on a UV-VIS Spectrophotometer at the

indicated absorbance maximum observed during the calibration curve scan. Once an absorption maxima is determined for a given dispersant, that same peak should be used for all chemical analyses.

3.3.4 Protocol for the Preparation of Water Accommodated Fractions (WAF) and Chemically Enhanced-WAF (CE-WAF)

The preparation of WAF and CE-WAF is outlined in Table 3.2 below. It is essential that these procedures are closely followed to ensure repeatability between different experiments. These protocols were finalized by the CROSERF group in April 1996.

Table 3.2 Protocols for the Preparation of Water Accommodated Fractions (WAF) and Chemically Enhanced-WAF (CE-WAF)

Issue	WAF	CE-WAF
Bottle Size	Based on the volume of WAF required. Minimum is 1 L and maximum is 20 L (because of logistics and geometry affecting protocol). 20-25% headspace when bottle is filled to base of shoulder.	Same as for WAF.
Stir Bar Size	Determined by bottle or stir plate. About 2 inches for 20 L and 1 inch for 2 L.	Same as for WAF.
Vortex	3-4 rps (180-240 rpm), or as low as necessary to avoid vortex (to avoid the issue of settling).	20-25% vortex. Conduct a pre-test on your oil to determine how the oil and dispersant should be added to the water. Do not pre-mix the oil and dispersant.
Addition of Oil or Oil and Dispersant	After mixing has begun, add a known volume of oil onto the center of the container surface by means of gas-tight Hamilton [®] syringes. Calculate delivery mass by difference.	After the vortex is established, add a known volume of oil and dispersant in sequence into the center of the vortex by means of gas-tight Hamilton [®] syringes. Calculate delivery mass by difference.
Mixing Duration	The time period must be based on the oil type and loading rate. Mixing duration must be determined for each oil. Use chemistry as a guide for determining stability.	18 hours is recommended (maximum of 24 hours). This will need to be checked for each oil. Use the same criteria for determining stability as for the WAF.
Settling Time	None. The best approach is to use the WAF immediately after the mixing duration requirement has been met. If you must allow it to sit prior to use, then you MUST use it within 24 hours. Volatile loss may occur with storage periods greater than 24 hours.	Minimum of 3 hours (up to 6 hours). Check stability for each oil. Stability should be measured by particle size.
Headspace	20-25% (bottle should be filled to its shoulder).	Same as for WAF.
Chemistry	On initial oil, do a complete characterization using GC/MS.	Same as for WAF.

Issue	WAF	CE-WAF
	<p>On initial WAF, (prior to toxicity testing) do GC-FID for TPH (C10-C36) and volatiles (C6-C9). If desired, also run PAHs.</p> <p>The same chemistry should be performed at the end of the experiment for static tests. For renewal tests, sample at least once prior to each renewal. For spiked tests, also sample at one or more points during the test.</p>	<p>Same as for WAF.</p> <p>Same as for WAF.</p>
Water Preparation	<p>Minimum filtration is 0.45 µm. It is preferable to use local seawater for testing. Dilute it with deionized water if necessary. Reconstituted seawater is acceptable. Use water type known to consistently and reliably support good survival and health of the test organisms when an uncontaminated supply of natural seawater is unavailable.</p>	<p>Same as for WAF.</p>
Serial Dilution	<p>No. There are a number of different problems which may result.</p>	<p>Same as for WAF.</p>
Mixing Conditions	<p>Seal bottle; Mix in the dark at the test temperature.</p>	<p>Same as for WAF.</p>

3.3.5 Conducting Toxicity Tests

3.3.5.1 Spiked Exposure Testing

Exposure chambers were filled with whole (undiluted) test solution, and then sealed until the introduction of test animals. Animals were added to the chambers in random order at the appropriate density (appropriate to the test animals being used) and test were then initiated by immediate commencement of flushing of all chambers with clean, aerated, 1-µm-filtered seawater at a rate of approximately 2 ml/min. Natural seawater was used for dilution at ambient salinity specific for each test animal. The salinity of each solution was prepared by diluting natural seawater with distilled water. After test initiation, concentrations in all chambers were monitored several times during the first 6-8 hours to verify the concentration decline profile. Over the duration of the test, the test animals, solutions, and equipment were monitored for continuous operation within designated limits.

Two separate endpoints were assessed during testing. The first was a standard lethality endpoint, in which mortality was visually assess daily for 96 hours, coincident with measurement of water quality parameters (pH, dissolved oxygen concentration (DO), and temperature) with 96-hour mortality being used to estimate the LC₅₀. The second was a 1-hour “initial effect” narcosis/moribundity endpoint (Singer, *et al.*, 1998). Observations were made roughly hourly during the first 6-7 h of exposure coincident with chemical sampling for concentration decline profile verification. Moribund animals were defined as those lying on the bottom of the test chamber (often upside-down), that were not roused by tipping and/or gently swirling the chamber. The initial-effect EC₅₀ was estimated using tallies at one-half to one hour following initiation of

the test. Both EC₅₀ and LC₅₀ values were estimated using either probit (probability unit) or Trimmed Spearman-Kärber techniques, depending on which model best fit the dataset. Significant differences between and among median-effect concentration were inferred by comparison of 95% confidence limits.

3.3.5.2 Constant Exposure Testing

As overall guidance, the basic testing protocols of the American Society for Testing and Materials (ASTM) and the Organisation for Economic Cooperation and Development (OECD) are to be followed as far as the routine steps in conducting a toxicity test. Constant exposure tests were carried out in appropriately sized glass containers. After preparation, the appropriate solutions were added to the containers, followed immediately by addition of the test organisms. An air tube was placed in each container, and air was bubbled at a rate of approximately 1-2 bubbles/sec. Containers were covered a glass covering (such as a watch glass on top of a beaker), and the headspace was kept below 20%. Test solutions were replaced after each 24 hour period by gently removing approximately 90% of the old solution from the container and replacing it with fresh solution. The actual concentration of test solution was measured in each fresh batch of solution added to the container, and the average exposure after 96 hours was calculated and used to determine the LC₅₀ values. All tests were carried out in triplicate.

3.3.6 Guidelines for Chemical Characterization of WAF and CE-WAF Test Solutions

The CROSERF guidelines for the chemical characterization of test solutions were finalized in April 1997. They build on basic analytical procedures described in stand methods and regulatory protocols for chemical analyses published by organizations such as ASTM, OECD and EPA, which should also be consulted. Note that analytical results should be presented as TPH and volatile concentrations (in ppm). If the laboratory needs to present a Total Hydrocarbon Content (THC) value, they can do so by summing these other two numbers. These guidelines are presented in three sections (TPH, volatiles, compound specific semi-volatiles):

3.3.6.1 TPH (x>C₁₀)

TPH is to be analyzed via GC-FID by using a common baseline integration technique encompassing those hydrocarbons from C₁₀ - C₃₆. These shall be defined as “TPH”. This definition is equivalent to TEOC. Additionally, resolved hydrocarbons should be reported corresponding to individual compounds (i.e., normal paraffin and other resolved, discrete peaks). This second group shall be defined as “TPH_(resolved)”. If your laboratory needs to sum the n-alkanes, report the value as “Sum of n-alkanes”. The following guidelines should be followed:

- Use at least one surrogate standard: o-terphenyl with 70-120% recovery.
- Use an internal standard (each laboratory can choose an internal standard that will not co-elute with their specific oil).
- If TPH is run by a method other than GC-FID, the laboratory must provide comparability data of the method used to GC-FID.
- TPH should not be corrected for recovery.

- There should be a detection limit of at least 10 ppb for any specific n-alkane that is in the standard.
- For “TPH (resolved)”, the baseline integration technique used should resolve the individual components; do not use the common baseline integration technique used to report TPH.

3.3.6.2 Volatiles ($x < C_{10}$)

Volatile analysis can be performed by GC-FID or GC-MS, provided the laboratory can identify the minimum target analytes presented in Table 3.3. Researchers may exceed this list with additional target compounds. The specific analytical method used in the laboratory should be based on available equipment, provided that they can identify and quantify these compounds (Table 3.3). The following guidelines should be followed when performing volatile analysis:

- Use an internal standard (the choice of this standard is up to the laboratory);
- d-toluene is recommended as the surrogate standard if using GC-MS.

Table 3.3 Minimum Target Analyte List for Volatile Analysis

Saturates:	Unsaturates:
2-methylpentane	benzene
hexane	toluene
cyclopentane	ethylbenzene
2,4 dimethylpentane	p-xylene
cyclohexane	m-xylene
heptane	o-xylene
cycloheptane	n-propylbenzene
octane	C ₃ -benzenes
nonane	

3.3.6.3 Compound-Specific Semi-Volatiles (optional analysis)

Because of the cost and time required for these analyses, compound-specific semi-volatile analyses are NOT required; however, researchers may want to analyze specific target analytes in addition to volatile and TPH analysis. A TPH target analyte list to be used as a guideline by the laboratories is presented in Table 3.4. This is a typical standard list of target compounds used during post-oil spill damage assessments. By following these guidelines, researchers should be able to correlate Forum laboratory results to field data. The specific analytical method used in the laboratory should be based on available equipment, provided that they can identify and quantify these peaks. Specific details for a given method (e.g., - GC-MS column length) should be performance based, and chosen with these target analytes in mind.

Table 3.4 Minimum Target Analyte List for Optional Compound Specific Semi-Volatile Analysis

Compound	Target Ion (m/e)
naphthalene	128
C-1 naphthalenes	142
C-2 naphthalenes	156
C-3 naphthalenes	170
C-4 naphthalenes	184
biphenyl	154
fluorene	166
C-1 fluorenes	180
C-2 fluorenes	194
C-3 fluorenes	208
dibenzothiophene	184
C-1 dibenzothiophenes	198
C-2 dibenzothiophenes	212
C-3 dibenzothiophenes	226
C-4 dibenzothiophenes	240
phenanthrene	178
C-1 phenanthrenes	192
C-2 phenanthrenes	206
C-3 phenanthrenes	220
C-4 phenanthrenes	234
fluoranthrene	202
pyrene	202
C-1 pyrenes	216
C-2 pyrenes	230
C-3 pyrenes	244
C-4 pyrenes	256
benzo(a,h)anthracene	228
chrysene	228
C-1 chrysenes	242
C-2 chrysenes	256
C-3 chrysenes	270
C-4 chrysenes	286
benzo(b)fluoranthene	252
benzo(k)fluoranthene	252
benzo(e)pyrene	252
benzo(a)pyrene	252
perylene	252
indeno(g,h,i)pyrene	276
dibenzo(a,h)anthracene	278
benzo(1,2,3-cd)perylene	276

It is essential that performance criteria are established to ensure valid inter-laboratory comparison of hydrocarbon numbers. Complete the round-robin test on the chemical characterization of a reference crude oil (see Section 2.3.4.2), prior to performing other chemical analyses.

3.3.7 Guidelines for Animal Aquaculture/Holding

Basic animal care requirements outlined in standardized testing methods published by ASTM, OECD, EPA and similar organizations should be followed. General aqua culturing equipment lists vary, depending on the types of animals to be used, amount of time that animals will be kept on site, etc. Laboratories should refer to individual organism suppliers to obtain detailed information for each animal to be used in testing. The following aquaculture considerations should be evaluated prior to conducting toxicity tests:

- Acclimation procedures (i.e.,-allowable salinity and temperature adjustments per day).
- Holding tank salinity and temperature appropriate for the organism.
- Holding requirements (i.e., mortality during holding). Typically, this is <5% mortality during the 48 hours prior to initiation of test.
- Preferred photo-period and light intensities for animal
- Preferred food types for various life stages
- Minimum water quality guidelines (e.g.,-temp., salinity, dissolved oxygen, pH)

3.3.8 Guidelines for Statistical Analysis

CROSERF prepared guidelines for statistical methods used in analyzing toxicity data. Decision trees were compiled (see Coelho and Aurand (1996), Figure 5.1) that outline the logic for using various statistical methods to determine LC₅₀ point estimations when, a) at least two concentrations result in partial mortalities; and b) one or less partial mortalities occur at the various concentrations tested.

1. Use Probit test if the data are normally distributed.
2. Use Spearman-Kärber or Trimmed Spearman-Kärber test for non-parametric distributions (if there is no control mortality).
3. Use the binomial method in situations where there are not partial kills (e.g.,- adjacent concentrations yield 0 and 100% mortalities), or re-run the test using a different range of concentrations.

Report statistical methods whenever presenting LC₅₀ or other toxicity data.

3.3.9 Guidelines for Storage and Handling of Oil, WAF and CE-WAF Solutions and Dispersants

Neat oil samples should be stored in tightly sealed glass or metal containers with minimal headspace in the dark at <5°C. Keeping the oil cold and dark appears to be more critical than the actual amount of headspace, provided it is minimal. With proper storage neat oil can be kept for

several years. Stored oil should be periodically tested against a standard oil to check its composition.

WAF solutions can be stored in Teflon bags. There appears to be no loss of semi-volatiles through the bag linings. The bags, once filled, must be handled carefully to avoid puncturing and rupturing. WAF or CE-WAF solutions or emulsions (which contain water) should never be allowed to freeze, because this causes the waxes/asphaltenes to separate from the rest of the oil. CE-WAF solutions should be used immediately, but appear to be stable for at least 24 hours.

WAF and CE-WAF samples taken for chemical analysis should be immediately acidified and analyzed within 7 days (BTEX) to 14 days (semi-volatiles).

3.3.10 Guidelines for Oil Weathering

Using fresh crude oil in toxicity testing overstates hydrocarbon exposure for many of the scenarios in which dispersants might be used. Therefore, it is necessary to prepare stocks of weathered oil to use in toxicity testing to assess the potential for environmental effects more realistically. Since oil would typically not be treated for a minimum of 6 to 12 hours during an actual oil spill, the CROSERF participants agreed that the weathering target should be equivalent to 6 to 24 hours. While it would be possible to allow oil to weather on its own (for example, in a shallow pan) there are so many variables that this is not a reproducible technique.

Instead, CROSERF examined two standard protocols which are often used. They are American Society for Testing and Materials (ASTM) Method D86-82 (Standard Test Method for Distillation of Petroleum Products) and ASTM D2892 (Test Method for Distillation of Crude Petroleum (15-Theoretical Plate Column)). Both of these have been used by one or more of the laboratories involved in CROSERF. Each has advantages and disadvantages. Without modification Method D86-82 does not produce a very large volume since the procedure starts with a volume of only 100 ml.¹ Method D2892, on the other hand, begins with one to two liters of sample, and yields proportionally more. There was considerable discussion as to which of the two methods more accurately represented weathering at sea; and there was some consensus that the cut points produced by distillation using Method D2892 were too distinctive.

The final decision was to recommend the use of D2892 if enough crude oil is available. The recommended cut point was 218°C (425°F) which roughly equates to 0.5 to 1 day of weathering for most oils. Method D86 is an acceptable alternative, but is not as precise. In either case, the weathered oil must be fully characterized chemically by the same analytical methods used for crude oil. It is recommended that the fractional distillation be done by a commercial analytical laboratory, rather than develop the procedure in-house.

¹ IKU-Sintef has used this method and indicated they had a modified protocol which started with a larger volume.

Section 4

Results of the Cooperative API/California Testing Program

M.M. Singer and R.S. Tjeerdema
 Department of Environmental Toxicology
 University of California
 34500 Highway 1, Granite Canyon
 Monterey, CA 93940

Edited by
 Don Aurand, Michael Hitchings and Corey Plakos
 Ecosystem Management & Associates, Inc.
 Ship Point Business Park
 13325 Rousby Hall Road
 Lusby, MD 20657

4.1 Background Information

The UCSC research team began working with the CA DFG (specifically, OSPR) at the inception of the OSPR dispersant research program in 1986 (see Section 2.2.1), and much of their research was conducted prior to the API/CA cooperative effort, which represented the final stage of this element of the OSPR research program. Initial studies on dispersants alone (including the design of the testing chamber used by CROSERF participants) were reported in Singer *et al.*, (1991, 1995 and 1996); and Tjeerdema and Singer (1991). Beginning in 1993, MSRC and OSPR began co-funding this research, which moved beyond dispersants and into testing with WAF and CE-WAF preparations of Prudhoe Bay crude oil (PBCO) (see Singer and Tjeerdema, 1994; 1995a, b and Singer *et al.*, 1998). The results from all of these studies, as well as the information in this Section, are summarized and discussed in Section 7.

4.2 Testing Included in This Study

Two California and one non-native species were used in this study, which represented the final phase of the UCSC testing program. The kelp forest mysid, *Holmesimysis costata*, is an important member of the nearshore kelp forests of Southern and Central California as a food source for many recreationally and commercially exploited species (Hobson and Chess, 1976; Singer, 1985). The topmelt, *Atherinops affinis*, is also an important food source for many economically important species, and can comprise the majority of biomass in many California bays and estuaries at certain times of the year (Allen, 1982). The inland silverside minnow, *Menidia beryllina*, has been a standard US EPA test species for many years, and was included in this study as part of the University of California's (UC) participation in CROSERF, in an attempt to bridge the gap between region-specific species data and more extensive national databases.

All tests were conducted with PBCO obtained from Resource Technology Corporation (Laramie, Wyoming, USA), and Corexit[®] 9500, obtained *gratis* from Nalco/Exxon Energy Chemicals, L.P. (Sugar Land, Texas, USA).

4.3 Modifications to the Standard Analytical Protocols Described in Section 3

4.3.1 Solution Preparation and Analytical Chemistry Protocols

The test procedures followed by the UCSC research team were consistent with those of the standard analytical protocols, with the following laboratory-specific details:

- Oil Weathering
 - ASTM Method D-86 (1990 modification)
 - Oil was topped to a vapor temperature of 200°C, roughly simulating one day at sea (Daling *et al.*, 1990).
- WAF and CE-WAF preparation
 - Dispersed oil solutions were prepared using an oil:dispersant ratio of 10:1
 - WAF solution was mixed for 24 hours, using 2-liter aspirator bottles and a mixing rate of 200±10 rpm
 - CE-WAF 20-25% vortex obtained at a mixing rate of 360-380 rpm; the settling time was six hours
- Analytical Chemistry
 - Volatile analysis (US EPA Method 8260) included only eight target analytes (benzene, toluene, ethylbenzene, xylenes (o-, m- and p- isomers combined) and four substituted benzenes (butyl-, n-propyl-, 1,2,4-trimethyl-, and 1,3,5-trimethyl)-2
 - For TPH each normal alkane from C10 to C36 plus the isoprenoids pristane and phytane were quantified
 - For optional compound-specific information, a total of 75 target parent and substituted PAHs were measured by GC/MS3
 - Total carbon concentration (TC) was used to track overall test solution concentration changes during the decline phase of initial exposures⁴

4.3.2 Toxicity Test Details

The CROSERF protocols for spiked exposure toxicity tests were used as described in these tests. Spiked-exposure toxicity tests were performed with the early life stages of the kelp forest mysid, the topmelt, and the inland silverside using established CROSERF test procedures and apparatus, with project-specific details as presented in this section. 96-hour tests were used for all three species, and consisted of six treatments; five toxicant concentrations and a seawater control,

² These eight compounds were found to constitute 85% or more of the total volatile concentration obtained from the CROSERF recommended list, therefore analysis was limited to these eight for funding reasons.

³ This list extends beyond that of CROSERF, most notably by adding substituted benzenes, and parent and substituted benzothiophenes and indoles. In this analysis, substituted PAHs were quantified based on parent compound response factors.

⁴ This approach was described by Singer *et al.* (1991) and was used instead of TPH. TC was measured by high-temperature (680°C), Pt-catalyzed combustion with NDIR detection using a Tekmar-Dohrmann DC-190 TOC Analyzer (Cincinnati, OH, US). TC samples were collected by gas-tight syringe directly from each exposure chamber through the Teflon septum and analyzed immediately.

with each treatment having three replicate containers. Constant-exposure *Menidia* tests were performed according to established US EPA methods (Weber, 1993).

Juvenile *Holmesimysis* were obtained from gravid wild females collected from kelp forest canopies near Monterey, California (Anderson *et al.* 1990; Martin *et al.* 1989). Upon release from the females' marsupium, juveniles were isolated by daily cohort and reared for 3 d prior to testing on newly hatched (<24-hours old) *Artemia* nauplii (Argentemia® Gold Label, Argent, Redmond, WA). Larval *Atherinops* and *Menidia* were obtained from a commercial supplier (Aquatic Biosystems, Inc., Ft. Collins, CO). As with mysids, fish larvae were reared on *Artemia* until tested at an age of 10-11 days old.

Animals were added to the chambers in random order at the appropriate density (8 *Holmesimysis* juveniles, 5 *Atherinops* or *Menidia* larvae) and tests were then initiated. Natural seawater obtained at the laboratory was used for dilution at ambient salinity ($\approx 33 \pm 0.5$ ppt (g/L)) in mysid and topmelt tests. A salinity of 20 ppt was used in *Menidia* tests, and was prepared by diluting natural seawater with distilled water. After test initiation, concentrations in all chambers were monitored several times during the first 6-8 hours to verify the concentration decline profile. Duplicate tests were performed for each species/toxicant combination to assess data repeatability. Additionally, as time and resources permitted, or in cases where significant differences were found in duplicate tests' results, a third test was performed whenever possible.

Two separate endpoints were assessed during testing. The first was a standard lethality endpoint, in which mortality was visually assessed daily for 96 hours, coincident with measurement of water quality parameters (pH, dissolved oxygen concentration (DO), and temperature) with 96-hour mortality being used to estimate the LC₅₀. The second was a 1-hour "initial effect" narcosis/moribundity endpoint (Singer *et al.*, 1998). Observations were made roughly hourly during the first 6–7 hours of exposure coincident with chemical sampling for concentration decline profile verification. Moribund animals were defined as those lying on the bottom of the test chamber (often upside-down), that were not roused by tipping and/or gently swirling the chamber. The initial-effect EC₅₀ was estimated using tallies at one-half to one hour following initiation of the test. Both EC₅₀ and LC₅₀ values were estimated using either probit or Trimmed Spearman-Kärber techniques, depending on which model best fit the dataset. Significant differences between and among median-effect concentrations were inferred by comparison of 95% confidence limits.

4.4 Results

4.4.1 Chemical Analysis

Analytical results showed that even when WAF and CE-WAF solutions were similar in overall THC concentration, they were quite different qualitatively. In fresh oil solutions, WAF THC was heavily dominated by volatile compounds (mean % volatiles = 84.4 ± 8.0), whereas CE-WAF solutions generally had a substantially lower proportion of volatile compounds (mean % volatiles = 18.6 ± 12.0). In weathered oil solutions, even though overall volatiles content was greatly reduced, a similar dichotomy was seen (WAF mean % volatiles = 30.4 ± 8.3 , CE-WAF mean % volatiles = 1.5 ± 0.7).

Volatiles concentration was well correlated to oil loading rate in all test solution types (Figure 4.1). Volatiles-loading correlation coefficients ranged from a high of 0.97 in fresh oil CE-WAFs to a low of 0.72 in weathered oil WAFs, with fresh WAF and weathered CE-WAF being

intermediate ($r = 0.86$ and 0.88 , respectively). The volatiles-loading relationship was essentially the same (logarithmic, becoming asymptotic at loadings above 10 ppt) for both WAFs and CE-WAFs within fresh and weathered oil solutions, this was the only analytical parameter to show this trend (Figure 4.1). Conversely, the TPH-loading relationship was markedly different between WAFs and CE-WAFs (Figure 4.2). TPH and loading were well correlated in fresh CE-WAFs ($r = 0.83$) and moderately correlated in weathered oil CE-WAF ($r = 0.73$), but were poorly correlated in both fresh and weathered oil WAFs ($r = 0.52$ and 0.31 , respectively). This was also true for the relationship of Σn -alkanes to loading (Figure 4.3). Again, alkanes and loading were better correlated in both fresh and weathered oil CE-WAFs ($r = 0.80$ and 0.65 , respectively), than in WAFs ($r = 0.34$ and 0.13 in fresh and weathered WAFs, respectively). Total PAHs showed a similar overall relationship to oil loading between WAFs and CE-WAFs (Figure 4.4); i.e., PAHs and loading were fairly well correlated in CE-WAFs ($r = 0.82$ and 0.67 in fresh and weathered, respectively), but not in WAFs ($r = 0.33$ and 0.24 in fresh and weathered, respectively).

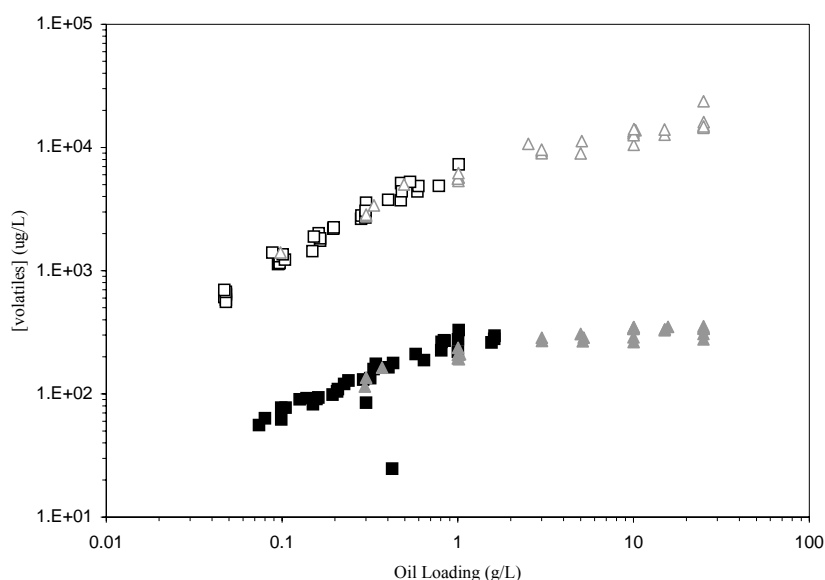

Figure 4.1 Relationship of volatiles to oil loading for both WAF (triangles) and CE-WAF (squares) solutions prepared from fresh (open) and weathered (solid) PBCO

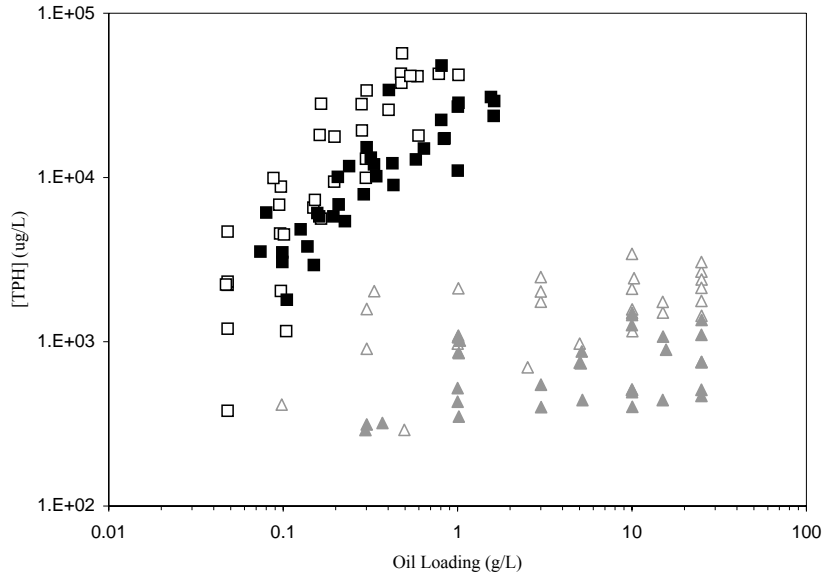

Figure 4.2 Relationship of TPH to oil loading for both WAF (triangles) and CE-WAF (squares) solutions prepared from fresh (open) and weathered (solid) PBCO

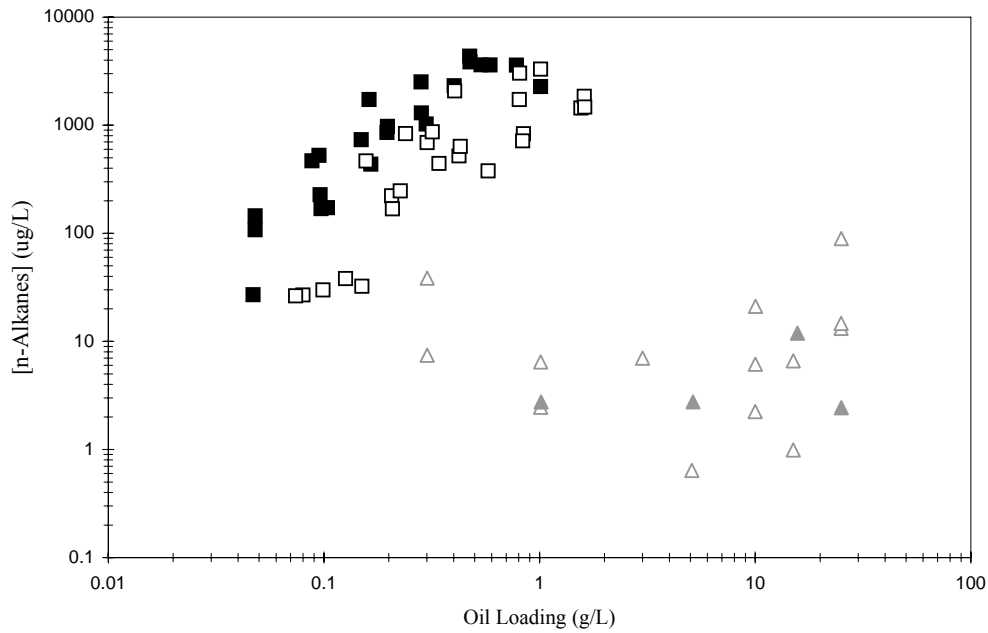

Figure 4.3 Relationship of Σn -alkanes (C_{10} - C_{36}) to oil loading for both WAF (triangles) and CE-WAF (squares) solutions prepared from fresh (open) and weathered (solid) PBCO

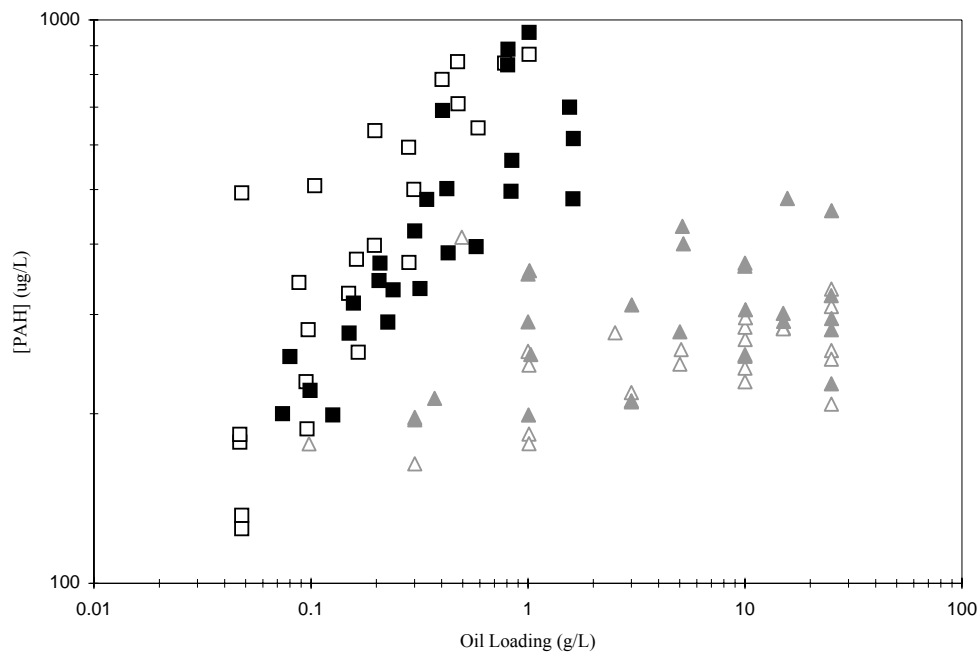

Figure 4.4 Relationship of Σ PAHs to oil loading for both WAF (triangles) and CE-WAF (squares) solutions prepared from fresh (open) and weathered (solid) PBCO

Artificial weathering of PBCO resulted in a marked increase in oil density (from 0.894 before, to 0.935 after weathering). Also, significant loss of volatile compounds was seen (Figures 4.1, 4.5). Losses of other analytical classes measured were much less. Normal alkanes were present only in very low amounts in fresh oil WAFs (less than 0.1 ppm total), and were essentially not detected in weathered oil WAFs. In CE-WAF solutions, losses of alkanes attributable to weathering (after normalization for oil loading rates) ranged from between 75 and 95% in the n -C₁₀ to n -C₁₄ range, and then generally between 30 and 70% for analytes thereafter (Figure 4.6). This same general pattern was seen for PAHs; normalized concentrations in weathered oil CE-WAFs of substituted benzenes were 80-90% lower than in fresh oil CE-WAFs, while two- to four-ring aromatics generally decreased by 30-70% post-weathering (Figure 4.7).

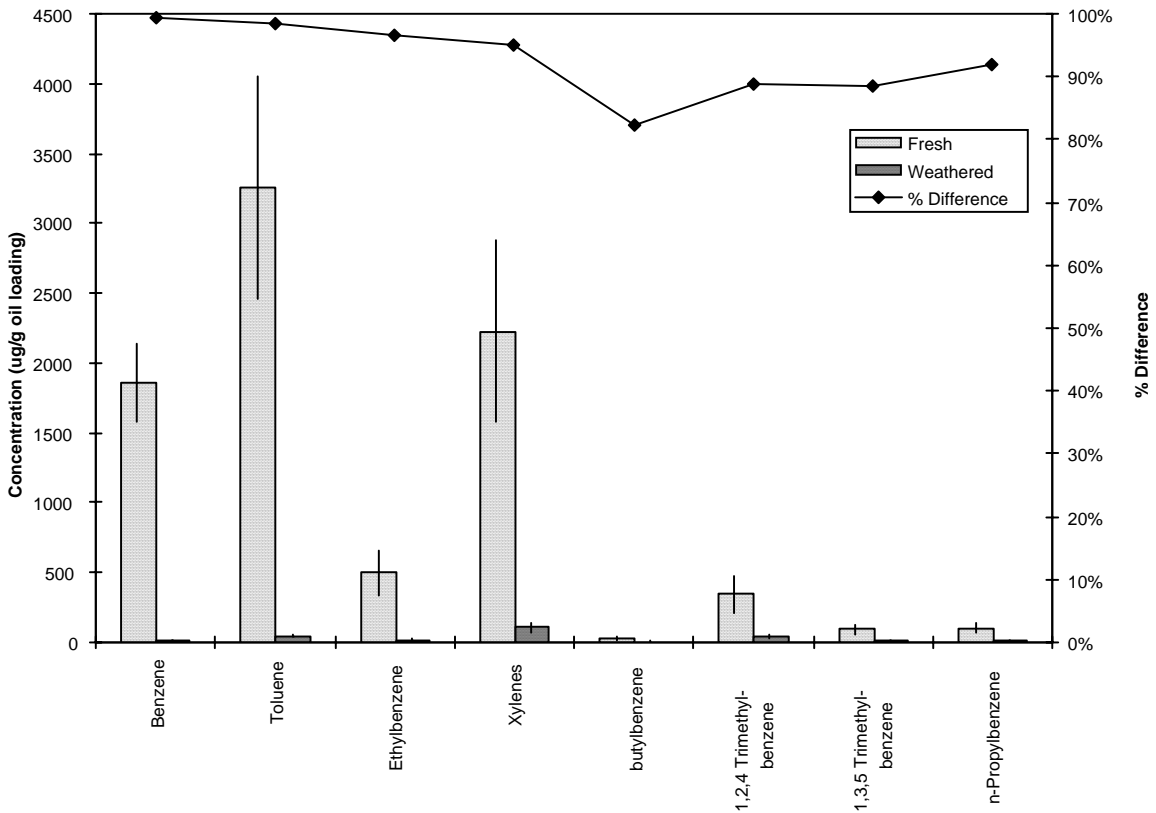

Figure 4.5 Mean (\pm SD) concentrations, normalized to loading rate, of volatile compounds from highest concentration treatments of WAF tests before and after weathering of oil

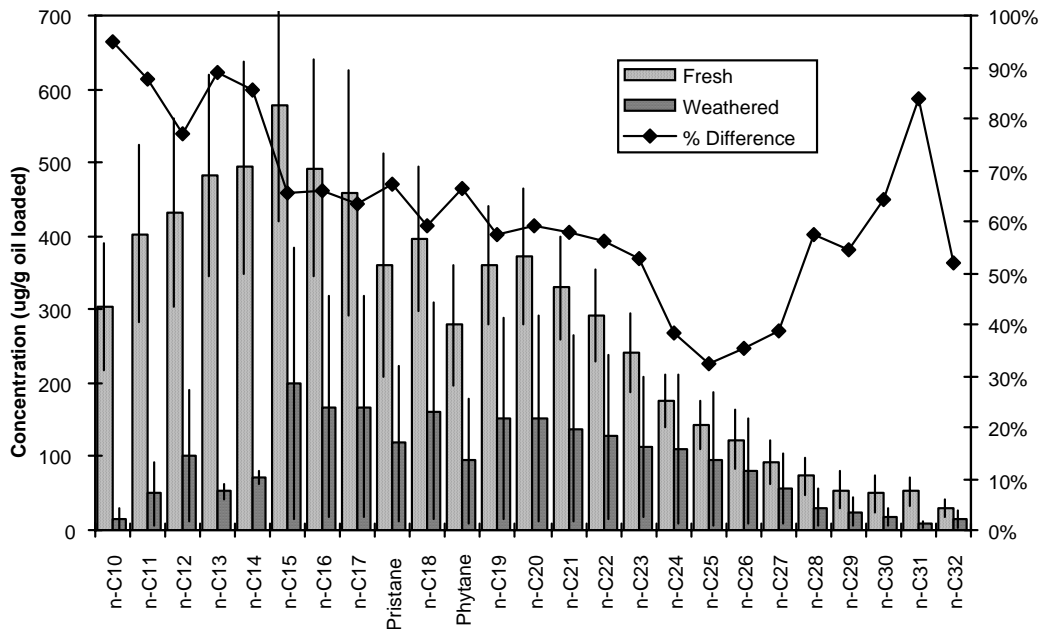

Figure 4.6 Mean (\pm SD) concentrations, normalized to loading rate, of normal alkanes from highest concentration treatments of CE-WAF tests before and after weathering of oil

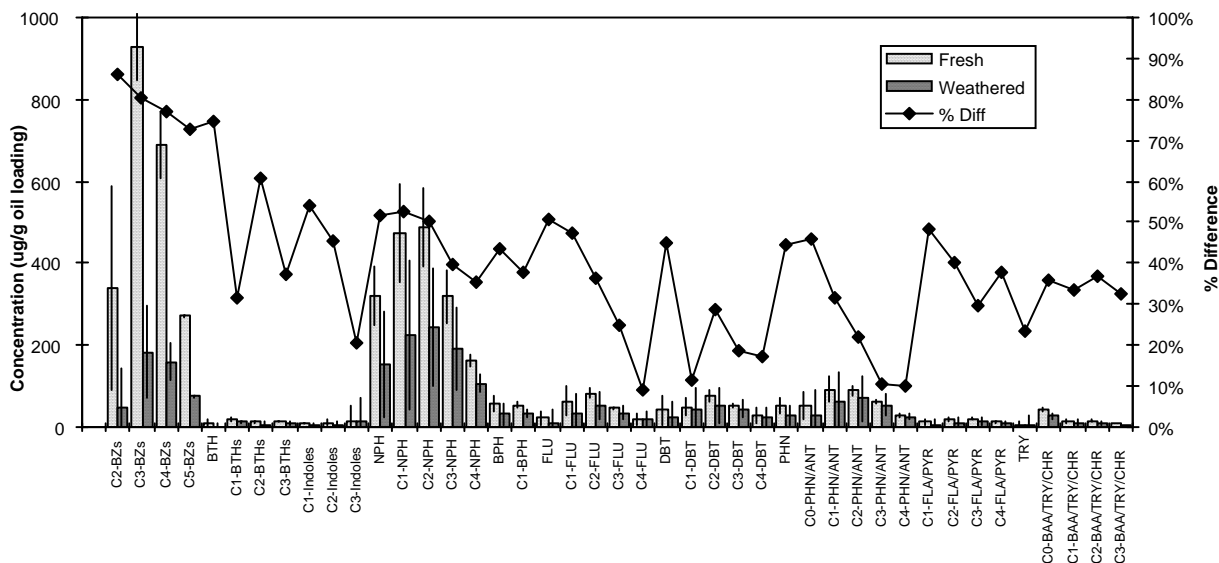

Figure 4.7 Mean (\pm SD) concentrations, normalized to loading rate, of PAHs from highest concentration treatments of CE-WAF tests before and after weathering of oil

4.4.2 Fresh and Weathered Oil WAF and CE-WAF Toxicity Tests

4.4.2.1 Basic Test Conditions

A summary of water quality parameters monitored during testing is presented in Table 4.1. Differences in temperature ranges reflect species-specific requirements, but are highly consistent within each species. In general, pH and dissolved oxygen (DO) were within acceptable limits, however, some deviations did occur, all of which were associated with weathered oil tests. In three cases DO measurements were below 50% saturation, however, these may not be reflective of actual conditions experienced by test animals because of an unacceptably long time between taking of the samples and their analyses (3 to 4 hours). These low DO samples were also directly associated with low pH measurements. Unfortunately, in these cases, the extended length of time samples remained in their sealed sample tubes before analysis may have allowed them to degrade as a result of the increased chemical oxygen demand associated with weathered oil. Two of these cases involved dispersed weathered oil that was so dense that animals inside could not be seen, therefore, since actual water quality conditions at test initiation were not known with certainty, it could not be determined if initial mortalities resulted from oil exposure or water quality. In the cases of the two *Menidia* weathered oil tests, no mortalities coincided with poor water quality values. All other tests had acceptable water quality, with DO remaining above 50% saturation.

4.4.2.2 *Holmesimysis costata* Tests

Detailed hydrocarbon exposure data and toxicity test results for *H. costata* are presented in Tables C.12 through C.21 in Appendix C. Oil loading rates used in mysid tests ranged from 0.296 to 25.01 ppt in both fresh and weathered oil WAF tests, from 0.048 to 0.481 ppt in fresh oil CE-WAF tests, and from 0.080 to 1.012 ppt in weathered oil CE-WAF tests. These loadings resulted in THC concentrations ranging from 0.41 to 17.5 ppm in WAF tests, and from 1.9 to 48.2 ppm in

CE-WAF tests. Weathering of the oil used resulted in significant decreases in THC in WAF solutions (by approximately an order of magnitude), and more modest decreases in CE-WAF solutions (25-50%).

Table 4.1 Summary of Water Quality Measurements

	Temperature (°C)		pH		Dissolved Oxygen (ppm)	
	Minimum	Maximum	Minimum	Maximum	Minimum	Maximum
<u>Holmesimysis Tests</u>						
Fresh oil WAF #1	15.2	15.3	7.99	8.12	6.13	8.24
Fresh oil WAF #2	15.3	15.7	8.05	8.13	7.04	8.28
Fresh oil WAF #3	13.8	14.6	8.02	8.10	7.46	8.20
Fresh oil CE-WAF #1	14.6	15.7	7.98	8.10	6.74	7.99
Fresh oil CE-WAF #2	14.9	15.4	7.96	8.07	6.88	8.09
Fresh oil CE-WAF #3	13.8	15.5	8.02	8.12	6.73	7.98
Weathered oil WAF #1	13.7	14.0	7.98	8.15	7.55	8.51
Weathered oil WAF #2	14.6	15.2	7.88	8.21	7.13	8.05
Weathered oil WAF #3	13.9	15.0	7.73	8.00	7.61	8.09
Weathered oil CE- WAF #1	13.7	14.1	7.95	8.16	6.32	8.39
Weathered oil CE- WAF #2	14.3	15.0	7.92	8.21	4.54	8.01
Weathered oil CE- WAF #3	14.2	15.3	7.87	8.00	7.18	8.02
<u>Atherinops Tests</u>						
Fresh oil WAF #1	19.3	19.5	7.74	8.15	5.89	7.77
Fresh oil WAF #2	18.9	19.0	7.68	7.96	5.97	7.81
Fresh oil WAF #3	20.3	20.8	7.82	7.98	6.29	7.12
Fresh oil CE-WAF #1	18.9	19.2	7.88	8.04	5.67	7.14
Fresh oil CE-WAF #2	19.4	19.6	7.83	8.02	5.44	7.01
Fresh oil CE-WAF #3	19.7	21.1	7.68	7.89	4.64	7.26
Weathered oil WAF #1	20.7	20.9	7.85	7.96	4.56	6.96
Weathered oil WAF #2	19.7	20.3	7.73	8.05	5.59	6.89
Weathered oil CE- WAF #1	19.1	20.6	7.53	8.13	3.30	6.70
Weathered oil CE- WAF #2	19.7	20.3	7.54	8.03	4.14	7.08
<u>Menidia Tests</u>						
Fresh oil CE-WAF #1	24.8	25.2	7.87	8.03	5.31	6.56
Fresh oil CE-WAF #2	24.4	25.4	7.52	8.00	4.47	6.27
Weathered oil WAF #1	24.5	27.7	7.20	7.76	3.10	6.27
Weathered oil WAF #2	24.5	27.4	7.14	7.68	2.51	6.29

In mysid tests, initial effect was seen to truly be a narcotic endpoint, at least in WAF tests, evidenced by the fact that the majority, if not all, effected individuals that were scored as moribund initially were seen to revive and swim normally as time progressed. In CE-WAF tests, though, the majority of moribund animals could not be verified as having recovered to any degree. Initial-effect dose-response was significant and well defined in both fresh oil WAF and CE-WAF tests,

but was non-existent in weathered oil WAF tests, and effectively non-existent in the weathered oil CE-WAF tests (Figure 4.8).

Dose-response relationships for 96-hour mortality were generally better defined in CE-WAF tests than in WAF tests (Figure 4.9). A positive dose response was seen in fresh oil WAF testing, but it could not be considered significant because intra-treatment variability was relatively high, and only partial effect was seen even at the highest concentrations that could be prepared. The two initial weathered oil WAF tests yielded significantly different results (Figure 4.9, Tables 4.2 and 4.3). Therefore, a third, confirmatory test was conducted. This test produced results very similar to the first, and thus, the results from test #2 were deemed unreliable. Both fresh and weathered oil CE-WAF tests yielded positive, clearly defined dose-response relationships, even in tests where within-treatment variability was high.

Comparison of initial-effect results between fresh and weathered oil WAFs was difficult because the overall exposures (in terms of THC concentration) were not directly comparable (Figure 4.8). No initial effect at all was seen in weathered oil WAF tests, but exposures were also lower than in fresh oil tests. A similar situation was seen in regards to 96-hour mortality as well (Figure 4.9). The degree of initial effect seen in the first and third weathered oil WAF tests at THC concentrations of 0.5–1 ppm were similar to those seen in fresh oil WAF tests at 5–10 ppm, however, without overlapping exposure concentrations no direct comparison can be made. The high degree of effect seen in the second weathered oil WAF test was accompanied by low initial dissolved oxygen concentrations at test initiation, possibly caused by the chemical oxygen demand of the weathered oil, and thus results of this test were likely not representative of the oil's toxicity. In CE-WAF tests, neither fresh or weathered oil solutions elicited much initial effect below about 10 ppm, but above that concentration, weathered oil was significantly less toxic (Figure 4.8). In terms of 96-hour mortality, fresh and weathered oil CE-WAF appear to be similarly toxic on average (Figure 4.9 and Table 4.2). However, high comparability between weathered oil CE-WAF tests #2 and #3 suggests that results of test #1 may be atypical. This would then suggest slightly higher toxicity in weathered oil CE-WAF in the 8–11 ppm THC range (Figure 4.9 and Table 4.2).

Median-initial effect concentrations in mysid tests ranged from around 5 to over 48 ppm THC (Table 4.2). Fresh oil WAF was significantly more toxic than weathered oil WAF in the first hour of exposure, with fresh EC_{50} s being lower than weathered by a factor of three to five. Similarly, fresh oil CE-WAF was substantially more toxic than weathered oil CE-WAF in the early hours of exposure. Median-lethal concentrations in all mysid tests ranged from about 0.95 to 33 ppm THC (Table 4.3). Fresh oil WAF LC_{50} s were somewhat higher than those for fresh oil CE-WAF, indicating somewhat less toxicity, however considerable fiducial limit overlap existed. Comparison of weathered WAF and CE-WAF LC_{50} s was problematic because of non-overlapping exposure concentration ranges, along with the lack of effect in the first and third weathered oil WAF tests.

In addition to the spiked-exposure tests performed, a single constant-exposure static-renewal test with fresh oil CE-WAF was conducted as “bridge” to more extensive datasets using traditional methods. All water quality parameters in this test were within acceptable limits throughout the test. However, 100% mortality was experienced in all treatment of this test (lowest concentration = 1.04 ppm). Operational restrictions precluded the repeating of this test at lower concentrations.

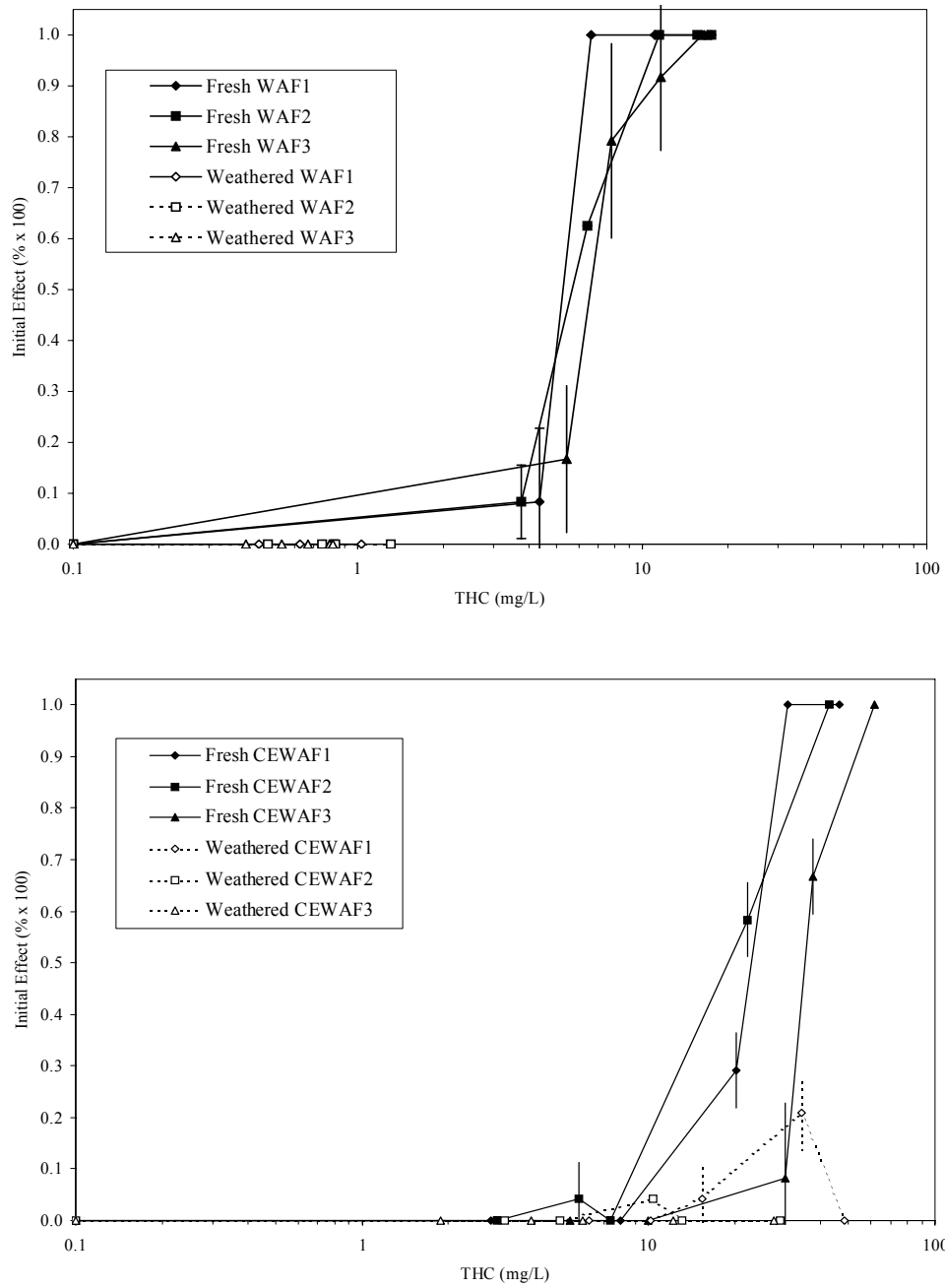

Figure 4.8 Mysid initial effect dose-response curves for WAF (upper) and CE-WAF (lower) tests

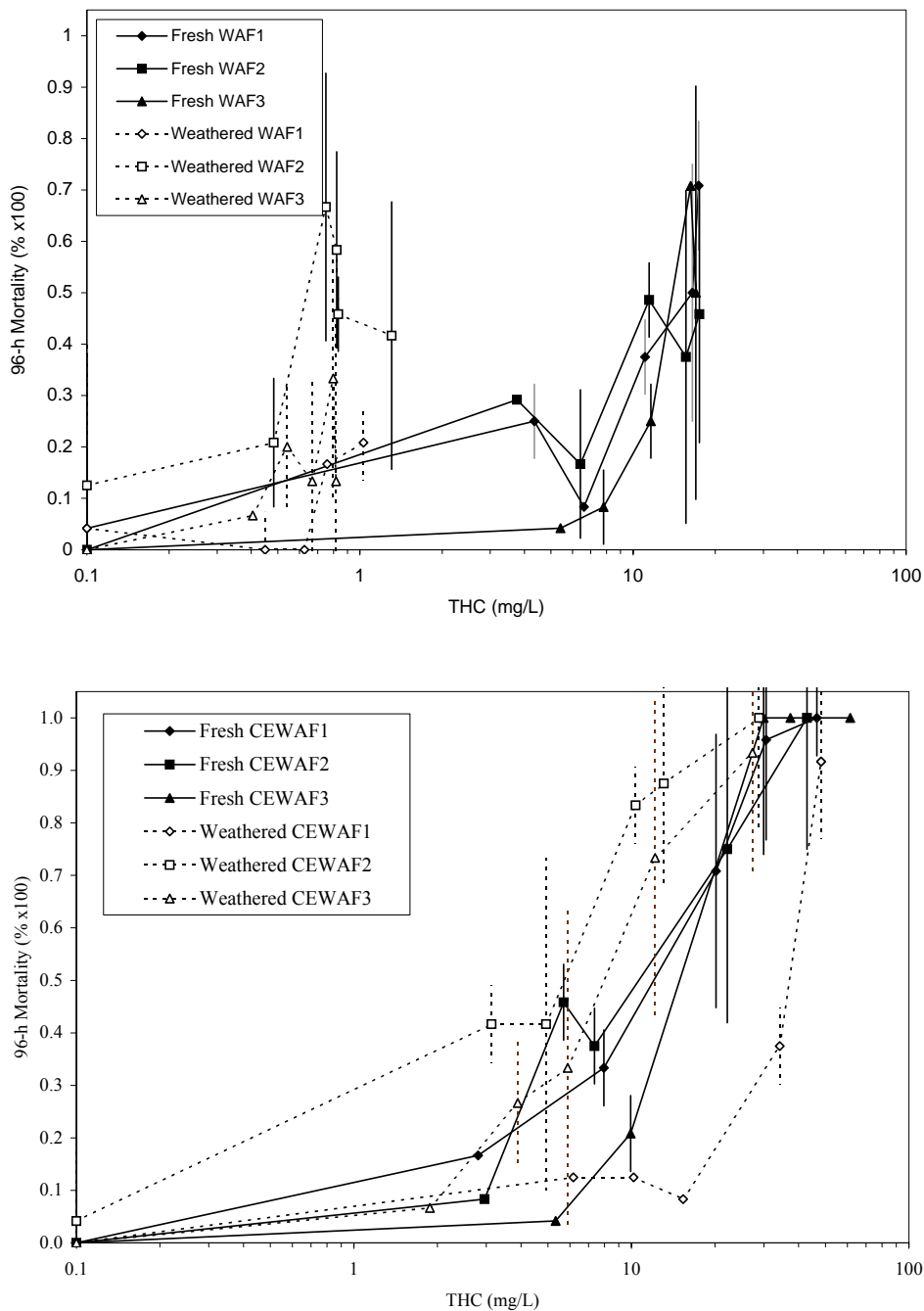

Figure 4.9 Mysid 96-hour mortality dose-response curves for WAF (upper) and CE-WAF (lower) tests

Table 4.2 Initial (<1 hour) EC₅₀ Estimates for Spiked-Exposure Effects Experiments Using Both Fresh and Artificially Weathered Prudhoe Bay crude oil Alone and Combined With Corexit[®] 9500 (O:D ratio = 10:1). All Data are Total Hydrocarbon Concentration (THC) in ppm.

Toxicant/Test	<i>Holmesimysis</i>		<i>Atherinops</i>		<i>Menidia</i>	
	EC ₅₀	95% C. L.	EC ₅₀	95% C. L.	EC ₅₀	95% C. L.
WAF						
Fresh Oil 1	5.32	_b	>18.49		14.03	8.92, 22.05
Fresh Oil 2	5.83	5.10, 6.67	>16.69			
Fresh Oil 3	6.61	6.08, 7.18				
Weathered Oil 1	>1.03 ^a		>1.60		>1.80	
Weathered Oil 2	>0.82		>1.45			
Weathered Oil 3	>0.82					
CE-WAF						
Fresh Oil 1	20.39	18.00, 223.1	30.31	24.76, 37.10	32.93	26.47, 40.98
Fresh Oil 2	17.99	14.97, 21.63	15.00	3.31, 68.04		
Fresh Oil 3	35.68	32.23, 39.51	12.46	10.73, 14.47		
Weathered Oil 1	>48.24		24.95	22.98, 27.08	19.89	17.75, 22.28
Weathered Oil 2	>28.81		20.52	-		
Weathered Oil 3	>27.28		>15.19			

^aEC₅₀ estimated to be above highest test concentration.

^bConfidence limits not reliably calculable.

4.4.2.3 *Atherinops affinis* Tests

Detailed hydrocarbon exposure data and toxicity test results for *A. affinis* are presented in Tables C.1 through C.11 in Appendix C. Oil loadings in topsmelt tests were similar to those used in mysid tests, and ranged from 1.0 to 25.1 ppt in both fresh and weathered oil WAF tests, from 0.047 to 0.781 ppt in fresh oil CE-WAF tests, and from 0.074 to 1.613 ppt in weathered oil CE-WAF tests. Verified THC concentrations from these oil loadings ranged from 6.6 to 18.5 ppm in WAF tests, and 0.9 to 47.7 ppm in CE-WAF tests.

Initial effects seen in the first hour of exposure in topsmelt tests could not be verified as narcosis because no moribund animals were ever observed to return to normal activity as the test progressed. Also, qualitative observations indicated that moribund animals were likely dead. Fresh oil WAFs elicited a relatively low amount of effect in the first hour of exposure at even the highest concentrations used (Figure 4.10). However, CE-WAFs elicited significant effect in the same time period, and this response was well correlated to concentration. Weathered oil WAF elicited no initial response at any concentration tested. Conversely, weathered oil CE-WAF did elicit a significant initial response, which was similar to, but somewhat lower than, that of fresh oil CE-WAF.

Table 4.3 96-hour LC₅₀ Estimates for Spiked-Exposure Effects Experiments Using Both Fresh and Artificially Weathered Prudhoe Bay crude oil Alone and Combined with Corexit[®] 9500 (O:D ratio = 10:1). All Data are Total Hydrocarbon Concentration (THC) in ppm.

Toxicant/Test	<i>Holmesimysis</i>		<i>Atherinops</i>		<i>Menidia</i>	
	LC ₅₀	95% C. L.	LC ₅₀	95% C. L.	LC ₅₀	95% C. L.
WAF						
Fresh Oil 1	14.23	11.58, 17.50	12.13	10.80, 13.62	11.83	6.62, 21.18
Fresh Oil 2	>17.50 ^a		9.35	—		
Fresh Oil 3	14.72	12.77, 16				
Weathered Oil 1	>1.03		>1.60		N/A ^c	—
Weathered Oil 2	0.95	— ^b	>1.45			
Weathered Oil 3	>0.82					
CE-WAF						
Fresh Oil 1	11.01	7.73, 15.68	17.70	14.58, 21.49	32.47	28.76, 36.66
Fresh Oil 2	9.46	7.22, 12.39	7.27	4.99, 10.61		
Fresh Oil 3	14.40	12.29, 16.87	12.46	10.73, 14.47		
Weathered Oil 1	33.27	28.32, 39.09	17.73	15.78, 19.92	20.28	18.05, 22.80
Weathered Oil 2	5.72	4.27, 7.65	16.86	14.40, 19.75		
Weathered Oil 3	7.43	5.45, 10.12	18.06	—		
Fresh Oil CE-WAF Constant Exposure	<1.04		1.07	0.90, 1.27		

^aLC₅₀ estimated to be above highest test concentration.

^bConfidence limits not reliably calculable.

^cLC₅₀ not calculable with any standard model.

Ninety-six hour mortality presented much the same overall picture as initial effect (Figure 4.11). In WAF tests, fresh oil data showed significant (>50%) mortality, but this was highly variable, and not concentration-related. Weathered oil WAF exposure resulted in little, if any, mortality, and response was again not correlated with exposure concentration. In CE-WAF tests, dose-response relationships in both fresh and weathered oil tests were positive and well defined. As with initial effect, weathered oil resulted in similar, but somewhat lower, 96-hour mortality at concentrations up to about 10-12 ppm THC. Qualitative observations of factors such as media opacity and droplet density suggested that high levels of effect in both endpoints at the highest weathered oil CE-WAF loadings were likely the result of physical effects associated with extremely high droplet concentrations, rather than chemical toxicity.

Median-initial effect estimates (EC₅₀) could not be calculated for either fresh or weathered oil WAF tests, as 50% effect was never reached (Table 4.2). CE-WAF test EC₅₀s ranged from 15.0 to 30.3 ppm THC. Initial-effect results from fresh oil CE-WAF tests showed high variability. Fresh and weathered oil CE-WAF initial effect estimates were generally similar as a result of this. LC₅₀s in WAF tests ranged from 9.4 to 12.1 ppm THC, but could not be calculated for weathered oil CE-WAF because of low mortality (Table 4.3). Fresh oil WAF LC₅₀ estimates obtained were generally lower than fresh oil CE-WAF LC₅₀s, which ranged from 7.3 to 17.7 ppm THC. With the exception of the second fresh oil test, fresh and weathered CE-WAFs were similar and had overlapping fiducial limits.

These data suggest that topsmelt are slightly more sensitive to WAF, but slightly less sensitive to CE-WAF than mysids. However, substantial overlap of EC₅₀ and LC₅₀ 95% confidence limits suggest these differences were minor.

As with mysids, a single constant-exposure topsmelt fresh oil CE-WAF test was performed for comparison to traditional datasets, as well as other CROSERF laboratories. Learning from earlier difficulties in the constant-exposure mysid test, oil loading procedures were refined to allow smaller amounts of oil to be used; loadings in this test ranged from 0.010 to 0.085 ppt (0.194 to 1.627 ppm THC). Dose-response in this test was positive and well defined, and the LC₅₀ was estimated at 1.07 ppm THC (Table 3-3). These data also show topsmelt to be substantially less sensitive to constant exposure than mysids, as a concentration of 1.31 ppm THC elicited only 73.3% mortality, versus 100% mysid mortality at 1.04 ppm THC.

4.2.2.4 *Menidia beryllina* Tests

Detailed hydrocarbon exposure data and toxicity test results for *M. beryllina* are presented in Tables C.22 through C.25 in Appendix C. Only a single test of each oil solution type was performed with this species. All *Menidia* tests were performed at 20 ppt salinity. Treatments for silverside tests were prepared at loading rates of 0.1 to 25.0 ppt in WAF tests, and 0.05 to 1.6 ppt in CE-WAF tests. Verified exposure concentrations ranged from 1.1 to 25.2 ppm THC in WAF tests, and from 2.9 to 49.4 ppm THC in CE-WAF tests.

Fresh oil WAF and CE-WAF dose-response relationships for both initial effect and 96-hour mortality were positive and fairly well defined (Figures 4.12 and 4.13). In weathered oil WAF tests, no initial effect was seen at any THC concentration, and 96-hour mortality was variable and not correlated with dose. Response in weathered oil CE-WAF tests was more typical, but as in topsmelt tests, it is likely that the complete response seen in the highest loading treatment was the result of extremely high droplet densities. Also, as with topsmelt (a close taxonomic relative), no identifiable narcosis was seen in silverside tests.

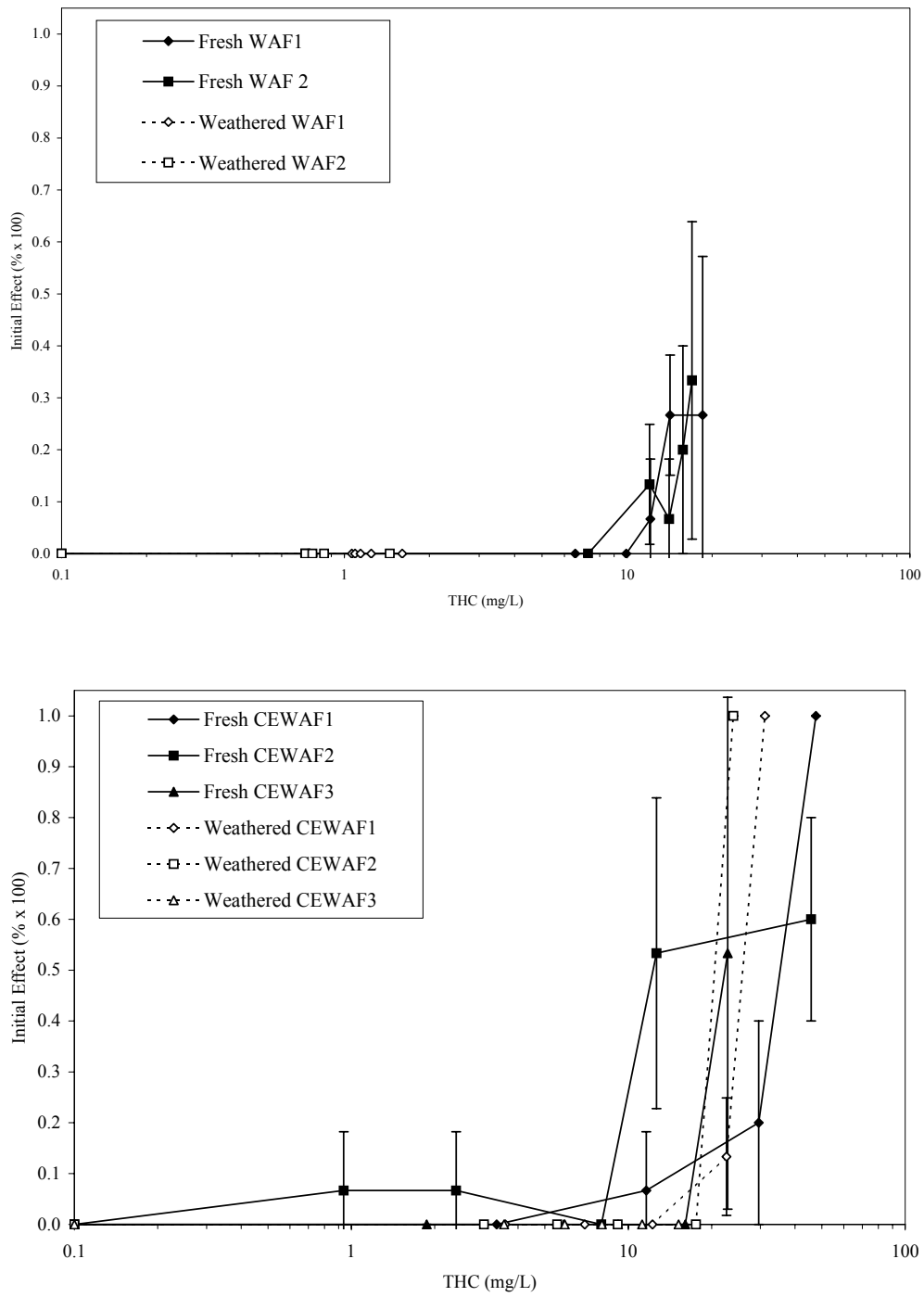

Figure 4.10 Topsmelt initial effect dose-response curves for WAF (upper) and CE-WAF (lower) tests

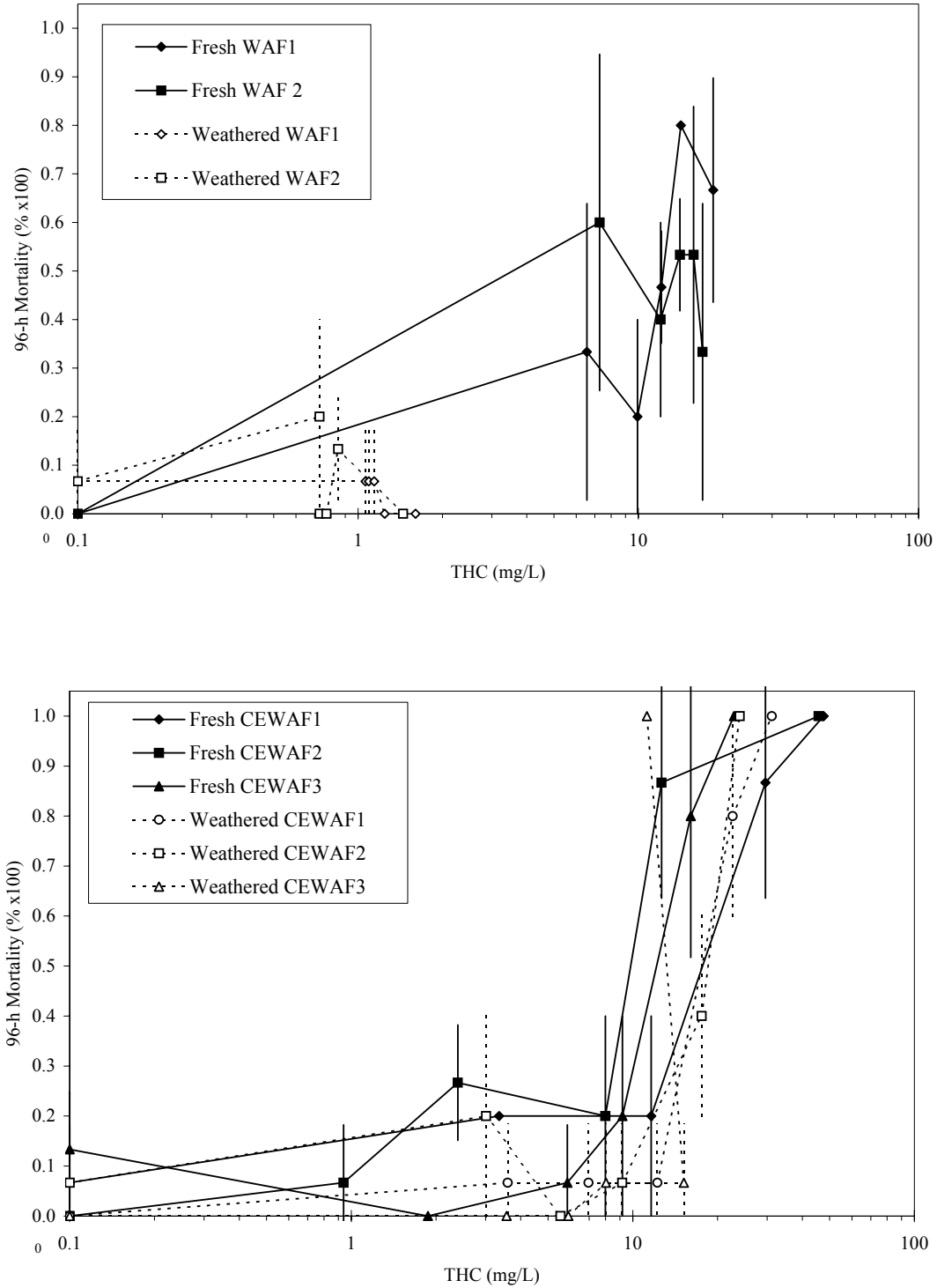

Figure 4.11 Topsmelt 96-hour mortality dose-response curves for WAF (upper) and CE-WAF (lower) tests

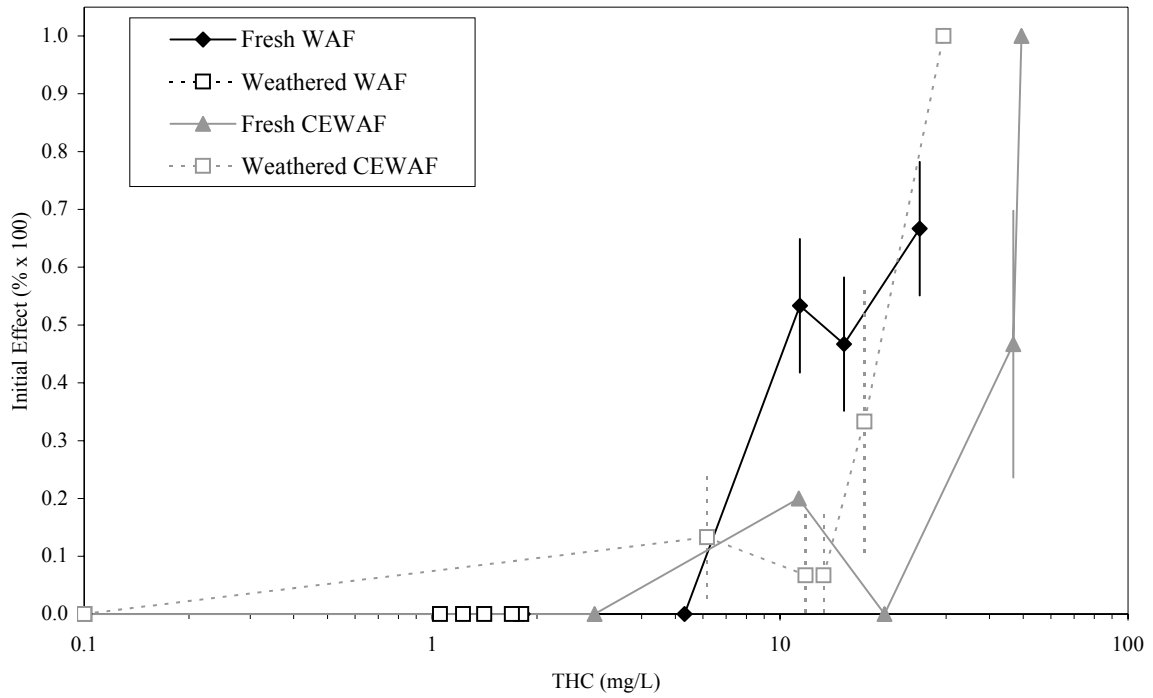

Figure 4.12 *Menidia* initial effect dose-response curves for WAF (upper) and CE-WAF (lower) tests

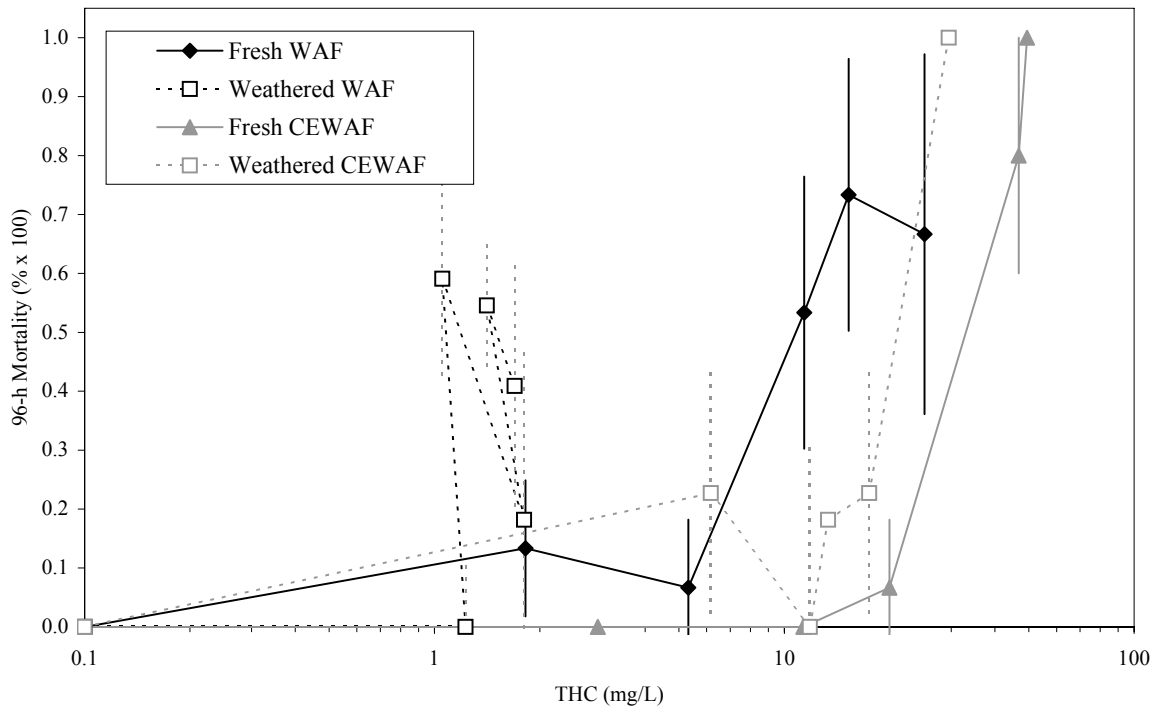

Figure 4.13 *Menidia* 96-hour mortality dose-response curves for WAF (upper) and CE-WAF (lower) tests

Median-effect estimates from fresh oil tests showed WAF to be significantly more toxic (both endpoints) than CE-WAF, with EC/LC₅₀s about 30 to 50% lower than in CE-WAF (Tables 4.2, 4.3). *Menidia* fresh oil WAF sensitivity was intermediate to mysids and topsmelt in terms of initial effect, and was generally no higher than either species in terms of mortality. Fresh oil CE-WAF sensitivity was similar, but somewhat lower than both mysids and topsmelt in terms of initial effect. However, in terms of mortality, this species was significantly less sensitive to fresh oil CE-WAF than either of the others tested. In weathered oil tests, this species was similar in response in WAF tests, somewhat more sensitive than the other two species tested in terms of initial CE-WAF response, and intermediate in sensitivity in terms of CE-WAF mortality.

Additionally, as part of the ongoing quality control program among all CROSERF-participating laboratories, a single spiked-exposure, dispersant-only test was performed using Corexit[®] 9500. Results of this test showed a positive dose-response, but control mortality (33%) exceeded standard acceptability criteria (20%). However, results from the concurrent potassium chloride reference toxicant test showed the test population to be of acceptable sensitivity and health. Thus, being that this test was simply an interlaboratory check, and since the test animals appeared acceptable, and the resulting toxicity estimate (LC₅₀ = 88.7 ppm, 95% C.L.s = 52.9, 148.7) compared favorably to other CROSERF laboratories (Bragin, 1998; Coelho, 1998), the test was not repeated.

Section 5

Results of the Cooperative API/Florida Toxicity Testing Program

D.L. Wetzel⁵ and E.S. Van Vleet
College of Marine Science
University of South Florida
140 7th Avenue South
St. Petersburg, FL 33701

Edited by

Don Aurand, Michael Hitchings and Corey Plakos
Ecosystem Management & Associates, Inc.
Ship Point Business Park
13325 Rousby Hall Road
Lusby, MD 20657

5.1 Background Information

The state of Florida, represented by FL DEP (formerly the Florida Department of National Resources), Marine Research Institute (St. Petersburg, FL) joined CROSERF at its inception in 1994 and indicated a desire to participate in the cooperative toxicity testing program. Planning was underway for a joint effort with MSRC when the MSRC research program was ended and API assumed those obligations. As a result, all of the actual toxicity testing done by the USF team is included in this Section.

5.2 Testing Included in this Study

The objectives for Year 1 of the study were to construct and test a flow-through toxicity testing apparatus similar to those used by other members of the CROSERF working group, and to carry out a series of toxicity tests using VCO, Corexit[®] 9500 oil dispersant, and two standard US EPA test organisms (*Mysidopsis bahia* and *M. beryllina*). The objectives for Year 2 of the study were to carry out further toxicity tests on the standard US EPA test organisms as well as on the redfish (*Sciaenops ocellatus*) using various combinations of unweathered Venezuelan Medium crude oil, PBCO, and Corexit[®] 9500.

The VCO (Leona 22 - CAS # 8002-05-9) was obtained from Bitor America, Corp. (Boca Raton, FL). The weathered VCO used in Year 3 was prepared by Intertek Testing Services Caleb Brett, Houston, Texas, using distillation method D2892. Kuwait crude oil (KCO) was used for an intercomparison of toxicity data with EBSI. PBCO was used during Year 2 as a reference oil for carrying out identical studies in all CROSERF laboratories. The PBCO used in our study was obtained directly from Resource Technology Corporation (Laramie, Wyoming).

⁵ Address after 1999 (Year 3): Mote Marine Laboratory, 1600 Thompson Park, Sarasota, FL 34236

Dispersants were obtained from Nalco/Exxon Energy Chemicals (Sugar Land, TX). The two dispersants used were Corexit[®] 9500 and Corexit[®] 9527. Based on the Materials Safety Data Sheets (MSDS) for the two dispersants the main difference is that Corexit[®] 9500 is dissolved in a paraffinic solvent carrier, while Corexit[®] 9527 is dissolved in an aqueous carrier. Corexit[®] 9527 has been used for many years as a primary type of chemical dispersant for oil spills in the United States. However, the availability of Corexit[®] 9527 is declining as it is replaced by Corexit[®] 9500 in response stockpiles. In early studies, members of the CROSERF working group used Corexit[®] 9527 in their toxicity tests. However, since this product is going to be replaced over the next few years, USF chose to focus primarily on Corexit[®] 9500. In the initial stages of the project, USF conducted calibration tests using both Corexit[®] 9527 and 9500 so that results could be compared with the earlier work of other laboratories.

5.3 Modifications to the Standard Analytical Protocols Described in Section 3

5.3.1 Solution Preparation and Analytical Chemistry Protocols

The test procedures followed by the USF research team were consistent with those of the standard analytical protocols, with the following laboratory-specific details:

- Dispersant-only solution preparation
 - Volumetric flask used for mixing and dilution (various sizes)
 - Mixing was accomplished by inverting and shaking the flask (duration not specified)
 - Solution poured directly into testing chambers from the volumetric flask
- WAF and CE-WAF preparation
 - WAF solution was mixed for 24 hours, with a settling time of 5 minutes or less
 - CE-WAF solution was mixed for 24 hours; with a settling time of two to three hours
- Analytical Chemistry
 - Prior to extraction, 100 µg of 5 α -androstane and 40 µg of ortho-terphenyl were added to 400 mL of each WAF or CE-WAF solution as an internal standard
 - TPH analyses were carried out on a Hewlett-Packard 5890 GC equipped with a flame ionization detector, a 30 m DB-5 fused silica column, and hydrogen as a carrier gas. The GC oven temperature was initially held at 50° C for 2 minutes and then programmed from 50° C to 300°C at 6°C/min where it was held for 10 minutes
 - Semi-volatile hydrocarbons were analyzed by GC-MS using a Hewlett-Packard 5971 MSD. Conditions were the same as for GC-FID analysis except that the carrier gas was helium

5.3.2 Toxicity Test Details

The following changes to or details concerning the CROSERF toxicity testing protocols were noted by the authors:

- Flow rates were specified as 1 to 2 mL/minute
- Reservoirs used to hold seawater solutions for delivery to the test chambers were fluorinated 20-L Nalgene containers, continuously aerated with a small aquarium pump

All seawater used to prepare the test solutions was natural seawater obtained from Tampa Bay, Florida. Prior to use, the seawater was filtered through a 5 µm charcoal filter, a 5 µm cellulose filter, and a 1 µm cellulose filter.

The two standard US EPA test organisms used for this study were obtained from Marinco Bioassay Laboratory (Sarasota, FL). Marinco is a US EPA audited laboratory and is certified to perform bioassays by FL DEP and the Florida Department of Health and Rehabilitative Services (copies of all certificates and approvals are available upon request). The two standard species used for the toxicity work were 6-day-old *M. bahia* (Opossum Shrimp - invertebrate) and 12-day-old *M. beryllina* (Inland Silverside - vertebrate). Organisms used for the current tests were cultured at Marinco Bioassay Laboratory and were transported to the laboratory on the morning that each test was initiated (approximately 1 hour transport time). All organisms were transported in insulated containers and tests began immediately after arrival in St. Petersburg. In addition to the standard US EPA test species, tests were also carried out on 16-day-old redfish, *S. ocellatus*. All redfish used in this study were hatched and grown by FL DEP (at either their Stock Enhancement Research Facility [Palmetto, Florida] or their Crystal River Mariculture Center [Crystal River, Florida]).

Specific conditions for all toxicity tests during this three year study are reported in Appendix D, Tables D.1, D.2 and D.3. Dispersant-only toxicity tests were conducted using selected concentrations of Corexit[®] 9500 in filtered seawater of salinity = 20 or 25. Tests utilized 6-day-old *M. bahia*, 12-day-old *M. beryllina*, or 16-day-old *S. ocellatus*. Both constant exposure (constant concentration) and spiked exposure (decreasing concentration) dispersant-only tests were conducted using *M. bahia* and *M. beryllina*. Only spiked exposure tests were conducted with *S. ocellatus*. Constant exposure dispersant tests were carried out in 400 mL glass beakers. Otherwise, both constant exposure and spiked exposure tests were conducted according to the protocols in Section 3.

Toxicity tests using WAF were carried out using selected concentrations of VCO, weathered VCO, KCO, or PBCO in filtered seawater of salinity = 20 or 25. Tests were conducted on 6-day-old *M. bahia*, 12-day-old *M. beryllina*, or 16-day-old *S. ocellatus*. *M. bahia* and *M. beryllina* were utilized in both constant and spiked exposure WAF tests while *S. ocellatus* was utilized in spiked exposure WAF tests only. Constant and spiked exposure tests were conducted in a similar manner to the dispersant-only tests.

Toxicity tests using CE-WAF were conducted using selected concentrations of VCO, weathered VCO, or PBCO and Corexit[®] 9500 in filtered seawater of salinity = 20 or 25. Tests were conducted on 6-day-old *M. bahia*, 12-day-old *M. beryllina*, and 16-day-old *S. ocellatus*. Both constant exposure and spiked exposure CE-WAF tests were conducted with *M. bahia* and *M. beryllina*, while only spiked exposure tests were conducted with *S. ocellatus*. Test protocols for the CE-WAF tests were consistent with the other tests.

All calculations were carried out using the Trimmed Spearman-Kärber or Probit test (calculated using ToxCalc 5.0, Tidepool Scientific Software).

5.4 Results

5.4.1 Chemical Analysis

5.4.1.1 Characterization of Fresh VCO and WAF and CE-WAF Prepared Using Fresh VCO

VCO was characterized by GC and GC-MS. Analysis of the semi-volatile fraction indicated that the boiling range of VCO was from approximately nC₁₀ to nC₃₄. Compound specific analysis of CROSERF target analytes gave concentrations of each compound in the VCO. Total alkanes accounted for 65.5 mg/g of oil, with the n-alkane maximum occurring at nC₁₀ (Appendix D, Table D.4). PAH accounted for approximately 20.5 mg/g of oil (Appendix D, Table D.5). The major PAH compounds present were naphthalene, phenanthrene, and dibenzothiophene and their C₁-C₄ alkylated homologs. Smaller amounts of the higher ringed components were also present.

GC-MS results of the analysis of alkanes, PAH's, and volatile hydrocarbons found in the WAF of VCO are reported in Appendix D, Tables D.4, D.5 and D.6, respectively. As can be seen from Table D.4, no alkanes were observed in the water-accommodated fraction at a loading rate of 4.8 parts per thousand (ppt). At this same loading rate, the total PAH concentration was 0.3 ppm in the WAF. WAF PAH's were dominated by the naphthalene series, with only minor amounts of the other PAH's being present. This is due to the lower solubility of the higher molecular weight aromatics (≥ 3 rings). Volatile hydrocarbons (C₅-C₁₀) were present in the WAF at a concentration of 1.2 ppm at a loading rate of 0.41 g VCO/L (Table D.6). If all of these data are converted to the same loading rate (5.0 ppt), the results indicate that the volatiles account for about 98% of the hydrocarbons in the WAF, while the PAH's make up the other 2% (Table 5.1). Therefore, under low mixing conditions (zero vortex), the water-accommodated hydrocarbons are clearly dominated by the volatile fraction.

Table 5.1 Summary of Hydrocarbon Results of Alkanes, PAH's, and Volatile Hydrocarbons found in WAF's and CE-WAF's Corrected to a Loading Rate of 5.0 g VCO/L. (nd = none detected)

Hydrocarbon Fraction	WAF (ppm)	CE-WAF (ppm)
Total Alkanes	nd (0.0%)	4.8 (6.8%)
Total PAH's	0.3 (2.0%)	2.0 (2.8%)
Total Volatiles	14.6 (98.0%)	63.6 (90.3%)

GC-MS results of the analysis of alkanes, PAH's, and volatile hydrocarbons found in the CE-WAF of VCO are reported in Tables 5.1, 5.2 and 5.3. Unlike the WAF fraction, alkanes were present in significant quantities in the CE-WAF fraction (Table D.4). The concentration of total alkanes was 4.8 ppm at a loading rate of 5.0 ppt. At this same loading rate, the total PAH concentration was 2.0 ppm, with the distribution again being dominated by the naphthalene series.

Higher concentrations of the higher ringed aromatic compounds were observed in the CE-WAF than were seen in the WAF. Volatile hydrocarbons were present in the CE-WAF at a concentration of 1.4 ppm at a loading rate of 0.11 g VCO/L (Table D.6). If these CE-WAF data are converted to the same loading rate (5.0 ppt), the results indicate the volatiles account for about 90% of the hydrocarbons in the CE-WAF, while the PAH's make up almost 3%, and the alkanes make up approximately 7% (Table 5.1). Therefore, with dispersant (Corexit[®] 9500) added to the oil/water mixture using a vortex of 20-25%, the oil is significantly mixed down into the underlying seawater in all fractions.

5.4.1.2 Characterization of Weathered VCO and WAF and CE-WAF Prepared Using Weathered VCO

Weathered VCO (WVCO) was also characterized by GC and GC-MS. Analysis of the semi-volatile fraction indicated that the boiling range of WVCO ranged from nC₁₁ to nC₃₄. Compound specific analysis of CROSERF target analytes gave concentrations of each compound in the WVCO. Total alkanes accounted for 78.6 mg/g of oil, with the n-alkane maximum occurring at nC₁₄ (Appendix D, Table D.7). The total targeted PAH concentrations amounted to 26.3 mg/g oil (Table D.8). The dominant PAH's in the weathered oil were the naphthalenes, dibenzothiophenes, phenanthrenes and the fluorenes. There were also some contributions of the higher ringed pyrenes, benzo(a)anthracene, chrysenes, benzo(k)fluoranthene and dibenzo(a,h)anthracene.

GC-MS results of the analysis of alkanes, PAH's, and volatile hydrocarbons found in the WAF of WVCO are reported in Tables D.7, D.8 and D.9. As can be seen from Table D.7, no alkanes were observed in the water-accommodated fraction at a loading rate of 9.6 ppt. The total PAH concentration was 0.3 ppm in the weathered WAF. As was observed in the fresh VCO, the PAHs in the weathered oil WAF were dominated by the naphthalene series, with only a minor amount of phenanthrene present. This is again due to the lower solubility of the higher molecular weight aromatics (≥ 3 rings). Volatile hydrocarbons (C₅-C₁₀) were present in the WAF at a concentration of 7.0 μ ppt at a loading rate of 9.6 g WVCO/L (Table D.9). If all of these data are converted to the same loading rate (5.0 ppt), the results indicate that the volatiles account for 4.5% of the hydrocarbons in the WAF, while the PAH's make up the remainder of the hydrocarbons with 95.5% (Table 5.2). Therefore, with the WVCO, under the same low mixing conditions (zero vortex) used in the fresh VCO WAF, the water-accommodated hydrocarbons found in the weathered oil are dominated by the PAH fraction and not the volatiles as was seen in the fresh oil WAF.

GC-MS results of the analysis of alkanes, PAH's, and volatile hydrocarbons found in the CE-WAF of the WVCO are reported in Tables D.7, D.8 and D.9. While there were no alkanes found in the WVCO WAF, alkanes were present in significant quantities in the WVCO CE-WAF fraction (Table D.7). The concentration of total alkanes was 4.6 ppm at a loading rate of 5.0 ppt, almost exactly the amount (4.8 ppm) as the fresh VCO CE-WAF at the same loading rate. The total PAH concentration was 2.0 ppm, with the distribution dominated by the naphthalene series, again, comparable to values found in the CE-WAF fraction of the fresh oil for the same loading rate. Higher concentrations of the higher ringed aromatic compounds were observed in the CE-WAF than were seen in the WAF. Volatile hydrocarbons were present in the CE-WAF at a concentration of 7.0 ppm (μ g/L) at a loading rate of 5.0 g WVCO/L (Table D.7) which were significantly lower than the amount of volatiles found in the fresh oil CE-WAF. The volatiles

normalized to a loading rate of 5.0 ppt, account for <0.1% of the total hydrocarbons, PAH's constitute 30.3% and the alkanes make up the majority of hydrocarbons with 69.6% (Table 5.2).

Table 5.2 Summary of Hydrocarbon Results of Alkanes, PAH's, and Volatile Hydrocarbons Found in Weathered VCO WAF's and CE-WAF's Corrected to a Loading Rate of 5.0 g WVCO/L. nd = none detected.

Hydrocarbon Fraction	WAF (ppm)	CE-WAF (ppm)
Total Alkanes	nd (0.0%)	4.59 (69.6%)
Total PAH's	0.15 (95.5%)	2.00 (30.3%)
Total Volatiles	<0.01 (4.5%)	<0.01 (0.1%)

5.4.2 Dispersant-Only Toxicity Tests

5.4.2.1 *Mysidopsis bahia*

Raw data for the dispersant-only tests exposing *M. bahia* to various concentrations of Corexit[®] 9500 are shown in Appendix D, Tables D.10 and D.11. Results of the constant exposure test, indicated a 96 hour LC₅₀ value of 37.2 ppm (95% CI 28.1-49.1) for *M. bahia*. Results of the spiked exposure dispersant-only test for *M. bahia* indicated a 96 hour LC₅₀ value of 1038 ppm (95% CI 838-1286). Clearly, Corexit[®] 9500 is more toxic to *M. bahia* under constant exposure than under spiked exposure conditions.

5.4.2.2 *Sciaenops ocellatus*

Data for the spiked exposure dispersant-only test exposing *S. ocellatus* to various concentrations of Corexit[®] 9500 are shown in Table D.14. Results of the spiked exposure test indicated a 96 hour LC₅₀ value of 744 ppm (no 95% CI calculated) for *S. ocellatus*.

5.4.2.3 *Menidia beryllina*

Data for the dispersant-only tests exposing *M. beryllina* to various concentrations of Corexit[®] 9500 are shown in Tables D.12 and D.13. Results of the constant exposure test (Table 2.12) indicated a 96 hour LC₅₀ value of 85.1 ppm (95% CI 64.5-112) for *M. beryllina*. Results of the spiked exposure dispersant-only test for *M. beryllina* (Table D.13) indicated a 96 hour LC₅₀ value of 21.6 ppm (95% CI 19.1-24.3).

5.4.3 Fresh Oil WAF Toxicity Tests

5.4.3.1 *Mysidopsis bahia*

Three replicate toxicity tests were carried out to assess constant exposure toxicity for *M. bahia* using the VCO WAF. Data for these three WAF tests are shown in Tables D.15, D.16, and D.17. Results of the three replicate WAF tests yielded 96 hour LC₅₀ values of 0.24 ppm (95% CI 0.16-0.31), 0.40 ppm (95% CI 0.29-0.54), and 0.15 ppm (95% CI 0.09-0.24).

Constant exposure toxicity tests were also conducted on *M. bahia* using a WAF prepared from KCO obtained from EBSI. Data for these WAF tests are shown in Table D.18. These tests indicated a 96 hour LC₅₀ value of 0.54 ppm (95% CI 0.32-0.90).

Three replicate spiked exposure toxicity tests were carried out on *M. bahia* using fresh VCO WAF and one spiked exposure WAF test was carried out using PBCO. Data for the three VCO tests are shown in Tables D.19, D.20, and D.21. Results of these replicate tests yielded 96 hour LC₅₀ values of 0.65 ppm (95% CI 0.57-0.74), 0.89 ppm (CI not calculated), and 0.59 ppm (CI not calculated).

An additional spiked exposure test was carried out using PBCO WAF (the reference oil established for use by all CROSERF laboratories). Data for this test are shown in Table D.22. The LC₅₀ value measured for *M. bahia* using this oil was >6.86 ppm (CI not calculated). This value is much higher than our previous results using the fresh VCO. This would indicate that the WAF fraction of PBCO is not as toxic to these organisms as that of VCO. The PBCO used for this experiment was obtained directly from Resource Technology Corporation (RTC), and was not opened until directly prior to making up the WAF solutions.

5.4.3.2 *Sciaenops ocellatus*

Data for the spiked exposure WAF test using *S. ocellatus* and VCO are shown in Table D.23. Results of this spiked exposure test indicated a 96 hour LC₅₀ value of 0.85 ppm (no CI calculated) for *S. ocellatus*.

5.4.3.3 *Menidia beryllina*

In the constant exposure WAF test using *M. beryllina*, all organisms died at the lowest concentration possible to prepare (Table D.24), however all organisms survived in our controls. The lowest crude oil loading rate which could be prepared accurately was approximately 8 ppm. This corresponded to a TPH concentration of 0.11 ppm. Therefore, the LC₅₀ for *M. beryllina* exposed to the water-accommodated fraction of VCO is <0.11 ppm TPH (no CI calculated).

One spiked exposure WAF test was run on *M. beryllina* using VCO, and another was run using PBCO. Results of the VCO spiked exposure WAF toxicity test for *M. beryllina* (Table D.25) indicated a 96 hour LC₅₀ value of 0.63 ppm TPH (95% CI 0.53-0.74).

An additional spiked exposure test was carried out on *M. beryllina* using the water accommodated fraction of PBCO. Data for this test are shown in Table D.26. The LC₅₀ value measured for *M. bahia* using this oil was >6.86 ppm (no CI calculated). This value is much higher than our previous results using VCO. This would again indicate that the WAF fraction of the PBCO used in this test is not as toxic to these organisms as that of VCO.

5.4.4 Weathered Oil WAF Toxicity Tests

5.4.4.1 *Mysidopsis bahia*

Two replicate 96-hour spiked exposure toxicity tests were conducted on *M. bahia* using the weathered VCO WAF. The data for these two WAF tests are shown in Tables D.27 and D.28. The highest TPH concentration obtained was 0.83 ppm at an oil loading rate of 10 g/L, the CROSERF suggested maximum. There was no mortality in either test, so no LC₅₀ could be calculated, but was in excess of the highest measured TPH concentrations, 0.63 and 0.83 ppm.

5.4.4.2 *Menidia beryllina*

Only one spiked exposure test using the weathered VCO was carried out for the inland silverside *M. beryllina*. The data for this test are shown in Table D.29. An LC₅₀ value of >1.06 ppm (no CI calculated) was obtained by using the maximum loading rate of 10 g/L WVCO. No mortality was observed as a result of exposure to the WVCO WAF.

5.4.5 Fresh Oil CE-WAF Toxicity Tests

5.4.5.1 *Mysidopsis bahia*

Three replicate toxicity tests were carried out to assess constant exposure toxicity for *M. bahia* using VCO CE-WAF. Data for these three CE-WAF tests are found in Tables D.30, D.31, and D.32. Results of the three replicate CE-WAF tests yielded 96 hour LC₅₀ values of 0.53 ppm (95% CI 0.41-0.69), 0.50 ppm (95% CI 0.41-0.59), and 0.52 ppm (no CI calculated).

Three replicate spiked exposure toxicity tests were carried out on *M. bahia* using VCO CE-WAF. An additional test was carried out on *M. bahia* using PBCO. Data for the three replicate VCO CE-WAF tests are shown in Tables D.33, D.34, and D.35. Results of the three replicates yielded 96 hour LC₅₀ values of 12.6 ppm (95% CI 5.2-160.7), 10.2 ppm (95% CI 8.3-12.6), and 18.1 ppm (95% CI 13.1-25.1).

An additional spiked exposure test was conducted on *M. bahia* using the CE-WAF fraction of PBCO. Data for this test are shown in Table D.36. The LC₅₀ value measured for *M. bahia* using this oil was 15.9 ppm (95% CI 5.4-46.8). Based upon this result, it appears that the toxicity of the CE-WAF fraction of PBCO to *M. bahia* is similar to that of VCO CE-WAF.

5.4.5.2 *Sciaenops ocellatus*

Data for the spiked exposure CE-WAF test using *S. ocellatus*, VCO and Corexit[®] 9500 are shown in Table D.38. Results of this spiked exposure test indicated a 96 hour LC₅₀ value of 4.23 ppm (no CI calculated) for *S. ocellatus*.

5.4.5.3 *Menidia beryllina*

Results of the constant exposure CE-WAF toxicity test (Table D.39) indicated a 96 hour LC₅₀ value of 0.68 ppm TPH (95% CI 0.48-0.97) for *M. beryllina*.

Spiked exposure CE-WAF tests were run on *M. beryllina* using both VCO and PBCO. Results of the spiked exposure CE-WAF toxicity tests for VCO (Table D.40) indicated a 96 hour LC₅₀ value of 2.84 ppm TPH (95% CI 1.96-4.11).

An additional spiked exposure test was carried out on *M. beryllina* using the CE-WAF fraction of PBCO. Data for this test are shown in Table D.37. The LC₅₀ value measured for *M. beryllina* using this oil was 18.1 ppm (95% CI 7.83-41.8).

5.4.6 Weathered Oil CE-WAF Toxicity Tests

5.4.6.1 *Mysidopsis bahia*

Two replicate spiked exposure tests were carried on *M. bahia* using WVCO and Corexit[®] 9500 to create the CE-WAF solutions. Data for these two replicate tests are shown in Tables D.41 and D.42. The LC₅₀ values for these replicate tests were 72.6 ppm (95% CI 67.5-78.0) and 120.8 ppm TPH (95% CI 109.7-133.0) respectively.

The LC₅₀ values determined from the spiked exposure toxicity tests carried out by USF with this organism and the CE-WAF fraction of the unweathered VCO and Corexit[®] 9500, indicate levels of much higher toxicity (LC₅₀ values of 12.6, 10.2 and 18.1 ppm TPH in Section 5.4.5.1) than the weathered VCO CE-WAF fractions. This difference in toxicity is likely the result of the loss of the toxic volatile fraction during the weathering process. This same observation was also made for the WAF of the weathered vs. unweathered VCO toxicity tests.

5.4.6.2 *Menidia beryllina*

One spiked exposure CE-WAF toxicity test was carried out on *M. beryllina* using the weathered VCO and Corexit[®] 9500. The data from this test are found in Table D.43. The LC₅₀ value for this single exposure test was 30.8 ppm TPH. The WVCO CE-WAF fraction appears to be significantly less toxic to *M. beryllina* under spiked exposure conditions than the unweathered CE-WAF VCO which has an LC₅₀ value of 0.68 ppm TPH (see Section 5.4.5.3). This again implies that the loss of the volatile fraction from the weathering process has substantially decreased the toxicity of the VCO.

5.4.7 Summary of Toxicity Testing

A summary of all toxicity results for this study appears in Table 5.3. While most tests were run using VCO, limited testing was done using PBCO and KCO to relate the results to other participating laboratories. The WAF of unweathered VCO was consistently more toxic to the species tested than the WAF of unweathered PBCO. The CE-WAF fraction of unweathered VCO appears to be less toxic than the corresponding WAF fraction for *M. bahia*, *M. beryllina*, and *S. ocellatus*. Both the WAF and the CE-WAF fractions of the weathered VCO are much less toxic to *M. bahia* and *M. beryllina* than the unweathered VCO in spiked exposure tests. This can be explained by the loss of the highly toxic volatile fraction during the weathering process. The toxicity of oils and oil dispersants were generally lower in the spiked exposure tests, which are more representative of oil spilled under natural environmental conditions, than in the constant exposure tests previously used in most studies.

Table 5.3 Summary of Toxicity Test Data

Type of Test	Organism	Exposure	96 Hour LC ₅₀ (ppm)	95% Confidence Interval (ppm)
Dispersant-Only	<i>Mysidopsis bahia</i>	Constant	37.2	28.1 – 49.1
		Spiked	1038	838 – 1286
	<i>Menidia beryllina</i>	Constant	85.1	64.5 – 112.0
		Spiked	21.6	19.1 – 24.3
	<i>Sciaenops ocellatus</i>	Spiked	744	not reported
WAF	<i>Mysidopsis bahia</i>	Unweathered Oil Constant	0.24 ^a	0.16 – 0.31
			0.40 ^a	0.29 – 0.54
			0.15 ^a	0.09 – 0.24
			0.54 ^b	0.32 – 0.90
	Unweathered Oil Spiked	0.65 ^a	0.57 – 0.74	
		0.89 ^a	not reported	
		0.59 ^a	not reported	
	>6.86 ^c	not reported		
Weathered Oil Spiked	>0.63 ^a	not reported		
>0.84 ^a	not reported			
<i>Menidia beryllina</i>	Unweathered Oil Constant	<0.11 ^a	not reported	
<i>Menidia beryllina</i>	Unweathered Oil Spiked	0.63 ^a	0.53 – 0.74	
>6.86 ^c	not reported			
<i>Menidia beryllina</i>	Weathered Oil Spiked	>1.06 ^a	not reported	
<i>Sciaenops ocellatus</i>	Unweathered Oil Spiked	0.85 ^a	not reported	
CE-WAF	<i>Mysidopsis bahia</i>	Unweathered Oil Constant	0.53 ^a	0.4 – 0.69
			0.50 ^a	0.41 – 0.59
			0.52 ^a	not reported
		Unweathered Oil Spiked	12.6 ^a	5.2 – 160.7
	10.2 ^a		8.3 – 12.6	
	18.1 ^a		13.1 – 25.1	
	15.9 ^c		5.4 – 46.8	
	Weathered Oil Spiked	72.6 ^a	67.5 – 78.0	
		120.8 ^a	109.7 – 133.0	
<i>Menidia beryllina</i>	Unweathered Oil Constant	0.68 ^a	0.48 – 0.97	
	Unweathered Oil Spiked	2.84 ^a	1.96 – 4.11	
		18.1 ^c	7.83 – 41.8	
Weathered Oil Spiked	30.8 ^a	not reported		
<i>Sciaenops ocellatus</i>	Unweathered Oil Spiked	4.23 ^a	1.68 – 10.65	

a = VCO.

b = KCO.

c = PBCO.

Section 6

Results of the Cooperative API/Texas Testing Program

Chris Fuller and James Bonner
Conrad Blucher Institute
Texas A&M University-Corpus Christi
6300 Ocean Drive
Corpus Christi, TX 78412

Edited by

Don Aurand, Michael Hitchings and Corey Plakos
Ecosystem Management & Associates, Inc.
Ship Point Business Park
13325 Rousby Hall Road
Lusby, MD 20657

6.1 Background Information

The state of Texas, represented by TGLO, joined CROSERF at its inception in 1994 and indicated a desire to participate in the cooperative toxicity testing program. Planning was underway for a joint effort with MSRC when the MSRC research program was ended and API took over those obligations. As a result, all of the actual toxicity testing done by the TAMU-CC team is included in this Section.

6.2 Testing Included in this Study

This study compared the relative toxicity of weathered crude oil (Arabian medium crude oil), dispersant, and weathered crude oil plus dispersant. Only limited tests were run using fresh crude oil. This study included the luminescent marine bacteria (*Vibrio fischeri*) (Microbix Microtox[®] System), two marine vertebrates (*C. variegatus* and *M. beryllina*), and one invertebrate test species (*M. bahia*). The dispersant was Corexit[®] 9500. The Microtox[®] System was included in order to evaluate its potential as a possible screening protocol.

6.3 Modifications to the Standard Analytical Protocols Described in Section 3

6.3.1 Solution Preparation and Analytical Chemistry Protocols

The test procedures followed by the TAMU-CC research team were consistent with those of the standard analytical protocols, with the following laboratory-specific details:

- Oil Weathering
 - weathered in an enclosed-but-vented tank by air stripping the volatile fraction

- final volume was 30 to 35% less than fresh oil volume (see Page et al., 2000)
- Dispersant-only solution preparation
 - Volumetric flask used for mixing and dilution (various sizes)
- WAF and CE-WAF preparation
 - Dispersed oil solutions prepared using an oil:dispersant of 10:1
 - Either 2- or 4-liter glass aspirator flasks were used
 - WAF solutions were mixed for 48 hours, CE-WAF solutions were mixed for 24 hours
- Analytical Chemistry
 - Dispersant concentration was measured using UV spectroscopy at a wavelength of 240 nm and samples were analyzed on the day of preparation
 - Hydrocarbon extraction used liquid-liquid extraction with methylene chloride
 - Hydrocarbon measurements were done by GC-MS analysis on a HP 5890 II GC coupled to an HP 5972A MS integrated with HP MS Chemstation (Hewlett-Packard, Palo Alto, CA)

6.3.2 Toxicity Test Details

The following changes to or details concerning the CROSERF toxicity testing protocols were noted by the authors:

- Flow rates were specified as 2 mL/minute
- Each triplicate set of chambers were connected to one 10 L dilution water reservoir, which was refilled daily.
- For macro organism tests, there were five organisms per test container.
- Static renewal constant exposure tests followed standard US EPA (1985) protocols and conducted in 500 mL amber glass jars with Teflon lined lids. Every 24 hours 75% of the test solution was replaced.
- Tests were run at 25° C.

M. bahia and *M. beryllina* (7 days old) were purchased from Charles Rivers, Inc. formerly Aquatic Research Organisms, in Hampton, New Hampshire. The organisms were acclimated for 3 days in a 40 liter glass aquarium with salinity adjusted (20 ppt) sea-water. The organisms were fed *Artemia sp. nauplii* (24-48 hour old) *ad libitum*.

C. variegatus (3 day old) larvae were purchased from Aquatic Biosystems in Fort Collins, Colorado. The organisms were acclimated overnight in 20 ppt test water. They were fed *Artemia sp. nauplii ad libitum*. *C. variegatus* were exposed to test conditions at 4 days old.

The Microbics Microtox® system was used to evaluate the microbial toxicity of the dispersant only, WAF, and CE WAF solutions. All tests used the 100% protocol outlined in the Microtox® Manual (Microbics, 1992). Filtered seawater with an equal osmotic strength to the Microtox® diluent, 20 ppt, was used to prepare all WAFs. Thus, no osmotic adjustments were necessary to test the WAF solutions. Additionally, the seawater was substituted for the diluent in the test 100% test protocol. Each assay was run in duplicate with 2 controls and 8 test concentrations. The highest test concentrations were 98% of the initial solutions. The 7 remaining concentrations were prepared by serial dilution (dilution factor = 1.5). Median effective concentrations (EC_{50S}) were determined at 15 minutes.

6.4 Results

6.4.1 Chemical Analysis

6.4.1.1 Characterization of Fresh and Weathered Arabian Medium Crude Oil

Table 6.1 gives the physical characteristics of both fresh and weathered Arabian medium crude oil (Simon, 1998).

Table 6.1 Physical Properties of Arabian Medium and Weathered Arabian Medium Crude Oil

Properties	Units	Weathered Arabian Medium	Arabian Medium	Method
Specific Gravity		0.9129	0.8724	
API Gravity	API deg	23.5	30.7	ASTM D 287
Reid Vapor Pressure	KPa	2.1	2.5	ASTM 323
Viscosity				
@15	CST	102.4	21.45	ASTM D 445
@20	CST	80.7	19.12	ASTM D 445
Pour Point	Deg C	-14	-23	ASTM D 97
Sulfur Content	Weight %	2.96	2.58	Dohrmann Oxidative-Microcoulometry

The histogram in Figure 6.1 shows the relative concentrations, by GC-MS analysis, of 66 resolved and unresolved component mixtures found in the Arabian medium crude oil used to prepare all WAF and CE-WAF solutions. This plot shows the oil is rich in N-alkanes, and has significant amounts of naphthalene and dibenzothiophene derivatives.

6.4.1.2 Water Quality Parameters

The water quality parameters for all macro organism tests are shown in Table 6.2. The pH for all tests ranged from 7.0 to 7.9. Test temperatures for all macro organism tests were 25±2° C. As per US EPA recommendations, dissolved oxygen concentrations should not drop below 40% saturation for a warm water test (US EPA, 1985). At a test temperature of 25° C, the oxygen saturation limit is 8.9 mg/L in water. Hence, the minimum allowable oxygen concentration is 3.6 mg/L. For all macro organism tests, allowable dissolved oxygen (DO) concentrations were maintained with the exception of CE-WAF constant exposures at relatively high nominal oil loadings. Observations of preliminary CE-WAF static renewal (*C. variegatus*) tests showed high mortality in chambers with high nominal oil loadings; however this response may be a factor of deficient oxygen concentration and may not be directly related to CE-WAF. The low DO concentrations appear to be a function of both organism oxygen consumption and biological oxygen demand. This problem was rectified in the *C. variegatus* test by limiting the nominal oil

loadings to levels for which DO concentrations could be maintained at adequate levels between solution renewals. In declining exposure tests (WAF and CE-WAF) DO levels were maintained near the saturation point by the constant influx of saturated dilution water. Similarly, the dispersant only constant exposures were supplied aerated solutions throughout all tests.

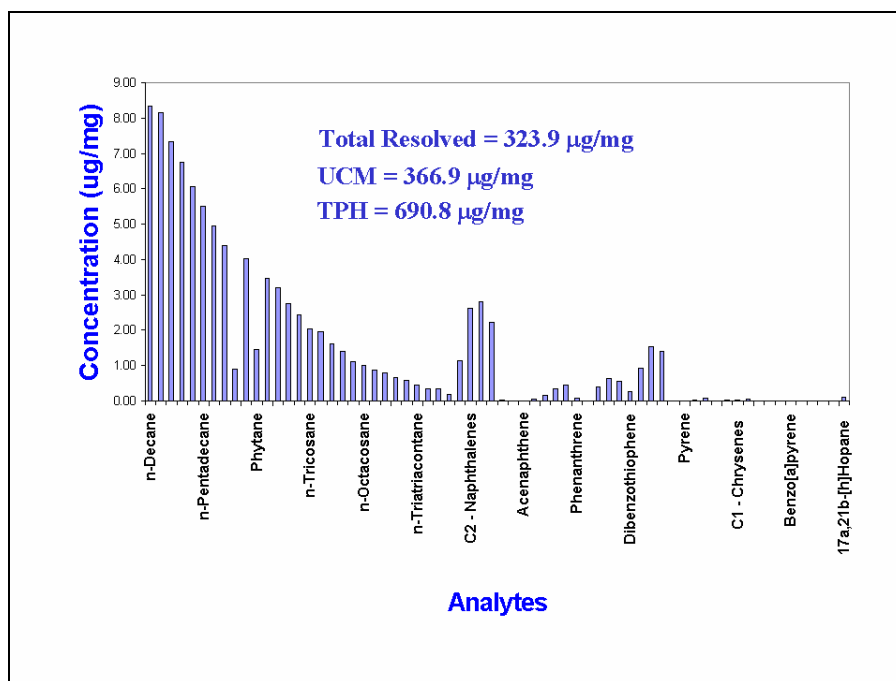

Figure 6.1 Characterization of Weathered Arabian Medium Crude Oil

Table 6.2 Water Quality Parameters for Vertebrate and Invertebrate Bioassays

Test	pH	Temperature (°C)	DO (mg/L)
Dispersant Constant Concentration	7.3-7.5	22-26	7.0-8.8
Dispersant Declining Concentration	7.0-7.6	23-25	6.9-8.9
PE-WAF Constant Concentration	7.1-7.9	25	5.0-7.4
PE-WAF Declining Concentration	7.3-7.5	23-26	6.6-8.7
CE-WAF Constant Concentration	7.7-7.9	25	3.3-7.3
CE-WAF Declining Concentration	7.4-7.6	22-25	7.2-8.8

6.4.2 Dispersant-Only Toxicity Tests

Results from all Corexit[®] 9500 dispersant only toxicity tests are shown in Table 6.3. Corexit[®] 9500 reaches its solubility limit in water at approximately 1000 ppm. Thus, all dispersant only tests were limited to maximum loadings of 1000 ppm.

6.4.2.1 *Mysidopsis bahia*

Data from the *M. bahia* constant exposure tests provided a mean LC₅₀ value of 32 ppm (n=2). The *M. Bahia* spiked exposure tests resulted in a mean LC₅₀ of 902 ppm.

6.4.2.2 *Cyprinodon variegatus*

Tests with *C. variegatus* (4 day old) resulted in a mean LC₅₀ of 182 ppm (n=2) and 672 ppm for constant and spiked exposure tests respectively.

6.4.2.3 *Menidia beryllina*

Tests conducted on *M. beryllina* (*M. beryllina*) resulted in mean LC₅₀ (ppm) values of 79.1 (n=2) and 75.95 (n=3) for constant and spiked exposures respectively.

6.4.2.4 *Vibrio fisheri*

Microtox® assays resulted in a mean EC₅₀=166 ppm (n-4), which is relatively similar to results obtained from the macro-organism tests.

Table 6.3 Toxicity Data for Dispersant Only (Corexit® 9500)

Organism	Exposure Regime	Replicate	LC ₅₀ (ppm)	LC ₅₀ 95% CI in ppm
Menidia	Constant	Test #1	85.4	72.9-99.3
		Test #2	72.6	53.9-91.1
	Spiked	Test #5	116.6	96.1-141.4
		Test #6	70.5	NA
		Test #7	40.5	29.5-52.2
Mysid	Constant	Test #3	33.3	25.7-51.9
		Test #4	31.4	24.8-43.8
	Spiked	Test #8	500.6	275.5-10575.9
		Test #9	1305.1	736.8-19471.1
Cyprinodon	Constant	Test #34	170.5	NA
		Test #35	193.28	165.6-225.7A
	Spiked	Test #36	593.5	416.8-1009.4
		Test #37	750.7	681.5-827
V. fisheri	15 minute	Test #1	242	165-353
		Test #2	104	102-106
		Test #3	123	106-144
		Test #4	197	168-232

6.4.3 Fresh Oil WAF and CE-WAF Toxicity Tests

Only four spiked exposure tests were run using fresh Arabian medium crude oil, all using *M. beryllina*. Two replicate tests were run for WAF and CE-WAF (Table 6.4). Solutions denoted as fWAF and fCE-WAF indicate solutions prepared with fresh, un-weathered oil.

6.4.4 Weathered Oil WAF Toxicity Tests

Results from both WAF and CE-WAF toxicity tests are shown in Table 6.4. Note that all references to WAF and CE-WAF indicate solutions that were prepared with weathered crude oil. The different experimental conditions tested permits evaluation of variances due to different exposure regimes, organism sensitivity, and test solutions. However, comparing declining exposure WAF sensitivities between the test species was difficult since LC₅₀s were greater than the highest concentrations (GTHC) for both *Menidia* and *Cyprinodon*.

6.4.4.1 *Mysidopsis bahia*

The mean WAF spiked exposure LC₅₀ for the two *M. bahia* tests was 55 ppm. Linear interpolation was used to estimate the continuous WAF LC₅₀s for *M. bahia* as it showed 100% response to the lowest test concentration. When continuous WAF exposures were evaluated, *M. bahia* had a mean LC₅₀ of 0.65 ppm.

6.4.4.2 *Cyprinodon variegatus*

For the WAF bioassays, GTHC was reported for *C. variegatus* spiked exposure tests. In this case, high WAF concentrations were limited by the solubility of crude oil in the water column. When continuous WAF exposures were evaluated, *C. variegatus* had a mean LC₅₀ of 4.1 ppm.

6.4.4.3 *Menidia beryllina*

For the WAF bioassays, GTHC was reported for *M. beryllina* spiked exposure tests. In this case, high WAF concentrations were limited by the solubility of crude oil in the water column. When continuous WAF exposures were evaluated, *M. beryllina* had a mean LC₅₀ of 5.2 ppm.

6.4.4.4 *Vibrio fisheri*

Evaluation of Microtox[®] data gave a mean EC₅₀ of 1.0 ppm for WAF Tests.

Table 6.4 Toxicity Data for Arabian Medium Crude Oil Solutions

Organism	Test Solution	Exposure Regime	Replicate	LC ₅₀ (ppm)	LC ₅₀ 95% CI	
<i>Menidia beryllina</i>	Weathered Oil WAF	Continuous	Test #10	5.5	3.4-1.1E+7	
			Test #11	4.9	2.8-144.3	
		Spiked	Test #14	GTHC (>14.5 ppm)		
			Test #15	GTHC (>32.2 ppm)		
	fWAF	Spiked	Test#40	0.42	0.37-0.50	
			Test#41	0.63	0.52-0.80	
	Weathered Oil CE-WAF	Continuous	Test #18	2.5	1.6-3.8	
			Test #19	1.5	0.6-3.6	
		Spiked	Test #22	24.9	21.0-1.0E+7	
			Test #23	36.9	NA	
	fCE-WAF	Spiked	Test#38	8.9	2.0-12.7	
			Test#39	10.9	8.2-14.6	
<i>Mysidopsis bahia</i>	Weathered Oil WAF	Continuous	Test #12	0.56	NA	
			Test #13	0.67	0.54-0.76	
		Spiked	Test #16	26.1	NA	
			Test #17	83.1	NA	
	Weathered Oil CE-WAF	Continuous	Test #20	0.64	NA	
			Test #21	0.65	NA	
		Spiked	Test #24	56.5	38-294	
			Test #25	60.8	55.1-110.4	
<i>Cyprinodon variegatus</i>	Weathered oil WAF	Continuous	Test #30	4.2	3.9-4.3	
			Test #31	3.9	3.2-4.9	
		Spiked	Test #28	GTHC (>6.1 ppm)		
			Test #29	GTHC (>4.7 ppm)		
	Weathered Oil CE-WAF	Continuous	Test #32	GTHC (>9.7 ppm)		
			Test #33	GTHC (>10.8 ppm)		
		Spiked	Test #26	31.9	NA	
Test #27	39.5		NA			
<i>Vibrio fisheri</i>	Weathered Oil WAF	15 minute	Test #1	1.0	0.0-6.1	
			Test #2	0.7	0.0-2.8	
			Test #3	1.2	0.0-2.4	
			Test #4	1.3	0.0-2.5	
	Weathered Oil CE-WAF	15 Minute	Test #1	12.8	0.7-24.9	
			Test #2	27.9	22.4-33.4	
			Test #3	16.2	14.3-18.1	
			Test #4	13.9	12.0-15.8	

6.4.5 Weathered Oil CE-WAF Toxicity Tests

6.4.5.1 *Mysidopsis bahia*

In spiked CE-WAF exposures, *M. bahia* resulted in a mean LC₅₀ level of 59 ppm. In continuous CE-WAF exposures, *M. bahia* showed a mean LC₅₀ level of 0.84 ppm.

6.4.5.2 *Cyprinodon variegatus*

In spiked CE-WAF exposures, *C. variegatus* resulted in a mean LC₅₀ of 39 ppm. For the *C. variegatus* continuous exposure tests with CE-WAF, GTHC was also the reported result.

During trial experiments with *C. variegatus* and CE-WAF, the solutions in the continuous exposure chambers were found to become oxygen deficient (less than 2 ppm O₂) within 24 hours. Thus, there was concern that observed mortality was due to low oxygen concentrations and not CE-WAF toxicity. To address this concern, a solution series was prepared and monitored for oxygen depletion over a 24-hour period (the time span between required solution exchanges). The results showed oxygen levels dropped below acceptable levels at CE-WAF loadings of 0.40 ppt and above. Therefore, the highest oil loading for CE-WAF constant exposure tests was limited to 0.25 ppt. No observed toxicity effects resulted from exposure to solutions prepared at the low oil loads. However, it was possible to dispel concerns of effects due to oxygen depletion.

6.4.5.3 *Menidia beryllina*

In spiked CE-WAF exposures, *M. beryllina* resulted in LC₅₀ levels of 34 ppm. In continuous CE-WAF exposures, *M. beryllina* showed a mean LC₅₀ level of 2.0 ppm.

6.4.5.4 *Vibrio fischeri*

Evaluation of Microtox[®] data gave a mean EC₅₀=17.7 ppm for CE-WAF Tests.

6.4.6 Summary of Toxicity Testing

Comparisons between the WAF and CE-WAF solutions showed no significant toxicity differences between the macro test organisms that had mean LC₅₀s of 16 and 25 ppm for WAF and CE-WAF respectively. Conversely, a single tailed ANOVA ($\alpha=0.05$) indicates that WAF solutions were significantly more toxic to *V. fischeri* than CE-WAF with mean LC₅₀s of 1 and 18 ppm respectively. Similarly, a single tailed ANOVA ($\alpha=0.05$) showed that fWAF was more toxic to *M. beryllina* than fCE-WAF with mean LC₅₀s of 0.5 and 10 ppm respectively.

The majority of the tests presented used weathered crude oil. The rationale behind this experimental design is that oil at sea quickly loses its volatile hydrocarbon components before chemical dispersants can be applied to the oil slick. Thus, dispersant testing with fresh oil was deemed unnecessary. However, limited toxicity testing was conducted with fresh un-weathered oil to allow comparison with the results from the weathered oil toxicity assays. Solutions of fCE-WAF and fWAF were tested only with *M. beryllina* under spiked exposure conditions. BTEX analysis was added to TPH analysis conducted on all solutions prepared with fresh crude oil to account for the higher volatile hydrocarbon fraction expected in the fresh crude oil. However,

toxicity results have been calculated only on the basis of TPH to allow direct comparison to results from the weathered oil test. This comparison showed that the fCE-WAF LC_{50} of 10 ppm is less than the CE-WAF LC_{50} of 31 ppm by a factor of 3. Similarly, the fWAF LC_{50} of 0.52 ppm was lower than the WAF LC_{50} =23 ppm by a factor of 44. Thus, both the fWAF and fCE-WAF are considerably more toxic than their weathered counterparts. This observed toxicity increase is likely the result of the higher volatile component fraction, represented as BTEX, in the fresh relative to the weathered oil.

Finally, the two different exposure regimes, spiked and continuous static renewal regimes were evaluated. Continuous exposure data for both WAF and CE-WAF were combined and compared to the combined WAF and CE-WAF spiked exposure data to evaluate the toxicological variances in exposure regimes. The combination of WAF and CE-WAF data was done only after an ANOVA ($\alpha=0.05$) test showed there was no significant toxicity variance between WAF and CE-WAF test matrices in the macro-organism assays. This comparison showed that the mean continuous exposure LC_{50} =2.5 ppm was significantly lower than the mean spiked exposure LC_{50} =45 ppm. Such results demonstrate the need to fully characterize and understand the exposure regimes used to generate toxicological data for proper interpretation.

Section 7

Results of the CROSERF Initiative

Don Aurand and Gina Coelho
Ecosystem Management & Associates, Inc.
Ship Point Business Park
13325 Rousby Hall Road
Lusby, MD 20657

7.1 Overview of Programs Not Previously Discussed in this Report

While there were a number of participating organizations that attended CROSERF meetings and also ran research programs with similar interests, only three other organizations actively participated in the CROSERF toxicity testing program. The data from each are included in the summary tables in this section.

7.1.1 Exxon (now ExxonMobil) Biomedical Sciences

The EBSI team was one of the founding organizations for CROSERF and had been working with MSRC and UCSC on a cooperative testing program beginning in 1993. The results of the MSRC-funded research is presented in Pace and Clark (1993), Bragin *et al.* (1994), and Bragin and Clark (1995). When the MSRC Research and Development Program ended in late 1995, EBSI continued to participate in the CROSERF program. Later toxicity testing results were reported in Clark *et al.*, 2001.

The EBSI laboratory conducted Toxicity bioassays with both Corexit[®] 9500 and Corexit[®] 9527, used three different oils and five different species (see Table 7.1)

7.1.2 State of Alaska/University of Alaska Fairbanks

The State of Alaska, represented by the Department of Environmental Conservation, began participating in CROSERF in April 1997. At that time they had already initiated a research program at the University of Alaska, Fairbanks, which involved graduate student research. As a result, the API contributed partial funding to support the completion of a Master's Thesis (Rhoton, 1999) which used the CROSERF protocols to examine a cold-water species of interest to Alaska.

The project conducted toxicity bioassays with Corexit[®] 9500 and WAF and CE-WAF prepared with fresh and weathered Alaska North Slope (ANS) crude oil. The test organisms were Alaskan tanner crab larvae (*Chionoecetes bairdi*) under cold-region conditions and the reference species, *Mysidopsis bahia* and *M. beryllina*, and *Vibrio fischeri* (Microtox[®] bioassay). The results from this study are included in Section 7.3. Details on the project are available in Rhoton (1999).

7.1.3 University of Maryland Chesapeake Biological Laboratory

In 1995, the University of Maryland received a contract from MSRC to begin participating in CROSERF as a representative East Coast university. They began dispersant-only testing using Corexit 9500 and three species, *Holmesimysis costata*, *Menidia beryllina* and *Mysidopsis bahia*. The intent was to continue the program for crude oil for the same species, along with a copepod, *Acartia tonsa*, and the oyster, *Crassostrea gigas*. Unfortunately, matching state funds were not available, and so the University could not continue to participate when the program shifted over to the API. The initial toxicity results were reported in Coelho and Aurand (1996).

7.2 Results of a Round-Robin Chemical Characterization of a Reference Crude Oil

As part of the CROSERF Protocols, all of the participating laboratories were shipped vials of reference oil (a solution spiked with 2.0 mg/L total ANS crude oil, from a single source container). Each laboratory was asked to analyze the sample using the protocols described in Coelho and Aurand (1997). The purpose was to confirm that the results being obtained in the various laboratories were within acceptable limits. All laboratories reported TPH values that fell within +/-25% of the “mean value.” This is considered to be an acceptable range, given the difficulties associated with hydrocarbon analysis, and indicates that the laboratory results can be directly compared.

7.3 Program Results

Table 7.1 provides a complete listing of all of the oils and species used by the various participating laboratories. Tables 7.2 through 7.13 present all of the toxicity testing results, by species. The source of each data entry is indicated, so that the original references can be identified.

Table 7.1 Oils and Species Used by Laboratories Participating in the CROSERF Program

Organization	Oil(s) Tested	Species Tested
California Program (University of California at Santa Cruz)	Prudhoe Bay crude oil	<i>Holmesimysis costata</i> (kelp forest mysid – adult) <i>Atherinops affinis</i> (topsmelt/fish – larvae) <i>Menidia beryllina</i> (inland silversides/fish – larvae) <i>Haliotis rufescens</i> (abalone – larvae)
Alaska Program (University of Alaska, Fairbanks)	Alaska North Slope crude oil	<i>Vibrio fisheri</i> (Microtox test/bacteria) <i>Chionocetes bairdi</i> (Tanner crab – larvae) <i>Mysidopsis bahia</i> (mysid – adult) <i>Menidia beryllina</i> (inland silversides/fish – larvae)
Florida Program (University of South Florida)	Venezuelan crude oil Prudhoe Bay crude oil	<i>Mysidopsis bahia</i> (mysid – adult) <i>Menidia beryllina</i> (inland silversides/fish – larvae) <i>Sciaenops ocellatus</i> (redfish – larvae)
Texas Program (Texas A&M University – Corpus Christi)	Arabian medium crude oil	<i>Vibrio fisheri</i> (Microtox test/bacteria) <i>Cyprinodon variegatus</i> (sheepshead minnow – larvae) <i>Menidia beryllina</i> (inland silversides/fish – larvae) <i>Mysidopsis bahia</i> (mysid – adult)
ExxonMobil Program	Kuwait crude oil Forties crude oil Medium fuel oil (MFO)	<i>Crassostrea gigas</i> (Pacific oyster – larvae) <i>Holmesimysis costata</i> (kelp forest mysid – adult) <i>Menidia beryllina</i> (inland silversides/fish – larvae) <i>Mysidopsis bahia</i> (mysid – adult) <i>Scophthalmus maximus</i> (turbot/fish – larvae)

Table 7.2 Toxicity test results (in ppm) for *Mysidopsis bahia* (mysid - adult)

Test Medium	Exposure	LC50	95% CI	Laboratory	Reference
Dispersant Only (9500)	Constant	33.3	25.7 - 51.9	TAMU	This report, Table 6.3
		31.4	24.8 - 43.8	TAMU	This report, Table 6.3
		37.2	28.1 - 49.1	USF	This report, Table 5.3
		35.9	32.2 - 41.3	EBSI	Clark et al., 2001
		29.1	24.9-34.0	UAF	Rhoton, 1999, Table 1-6
	Spiked	500.6	275.5 - 10575.9	TAMU	This report, Table 6.3
		1305.1	736.8 - 19471	TAMU	This report, Table 6.3
		1038	838 - 1286	USF	This report, Table 5.3
		>789	NA	EBSI	Clark et al., 2001
		330.1	NA	UAF	Rhoton, 1999, Table 1-6
Dispersant Only (9527)	Constant	29.2	26.4 - 32.3	EBSI	Clark et al., 2001
	Spiked	25.3	21.0 - 30.4	UMCBL	Coelho and Aurand, 1996
Arabian crude oil					
Fresh oil WAF	Constant				
	Spiked				
Weathered oil WAF	Constant	0.56	NA	TAMU	This report, Table 6.4
	Spiked	0.67	0.54 - 0.76	TAMU	This report, Table 6.4
Fresh oil CE-WAF	Constant	26.1	NA	TAMU	This report, Table 6.4
	Spiked	83.1	NA	TAMU	This report, Table 6.4
Weathered oil CE-WAF	Constant	0.64	NA	TAMU	This report, Table 6.4
	Spiked	0.65	NA	TAMU	This report, Table 6.4
Weathered oil CE-WAF	Constant	56.5	38.2 - 294	TAMU	This report, Table 6.4
	Spiked	60.8	55.2 - 110.4	TAMU	This report, Table 6.4
Venezuelan crude oil					
Fresh oil WAF	Constant	0.24	0.16 - 0.31	USF	This report, Table 5.3
		0.4	0.29 - 0.54	USF	This report, Table 5.3
		0.15	0.09 - 0.24	USF	This report, Table 5.3
	Spiked	0.65	0.57 - 0.74	USF	This report, Table 5.3
		0.89	NA	USF	This report, Table 5.3
Weathered oil WAF	Constant	0.59	NA	USF	This report, Table 5.3
	Spiked	>0.83	NA	USF	This report, Table 5.3
Fresh oil CE-WAF	Constant	>0.63	NA	USF	This report, Table 5.3
		0.53	0.41 - 0.69	USF	This report, Table 5.3
		0.5	0.41 - 0.59	USF	This report, Table 5.3
	Spiked	0.52	NA	USF	This report, Table 5.3
		12.6	5.2 - 160.7	USF	This report, Table 5.3
		10.2	8.3 - 12.6	USF	This report, Table 5.3
Weathered oil CE-WAF	Constant	18.1	13.1 - 25.1	USF	This report, Table 5.3
	Spiked	72.6	67.5 - 78	USF	This report, Table 5.3
Weathered oil CE-WAF	Constant	120.8	109.7 - 133.0	USF	This report, Table 5.3
	Spiked			USF	This report, Table 5.3
Kuwait crude oil					
Fresh oil WAF	Constant	0.54	0.32 - 0.90	USF	This report, Table 5.3
	Spiked	0.63	NA	EBSI	Clark et al., 2001
Weathered oil WAF	Constant	>2.93		EBSI	Clark et al., 2001
	Spiked				Clark et al., 2001
Fresh oil CE-WAF (9527)	Constant	>0.17	NA	EBSI	Clark et al., 2001
	Spiked	0.65	0.52 - 0.82	EBSI	Clark et al., 2001
		17.1	NA	EBSI	Clark et al., 2001
		13.2	10.3 - 16.2	EBSI	Clark et al., 2001
		24.8	16.0 - 75.6	EBSI	Clark et al., 2001
Weathered oil CE-WAF (9527)	Constant	23.8	NA	EBSI	Clark et al., 2001
	Spiked	0.11	0.09 - 0.14	EBSI	Clark et al., 2001
Weathered oil CE-WAF (9527)	Constant	111	80.4 - 158	EBSI	Clark et al., 2001
	Spiked			EBSI	Clark et al., 2001

Table 7.2 Toxicity test results (in ppm) for *Mysidopsis bahia* (mysid - adult), continued

Test Medium	Exposure	LC50	95% CI	Laboratory	Reference
Prudhoe Bay crude oil					
Fresh oil WAF	Constant				
	Spiked	>6.86	NA	USF	This report, Table 5.3
Weathered oil WAF	Constant				
	Spiked				
Fresh oil CE-WAF	Constant				
	Spiked	15.9	NA	USF	This report, Table 5.3
Weathered oil CE-WAF	Constant				
	Spiked				
Alaska North Slope crude oil					
Fresh oil WAF	Constant	2.61	1.40 - 3.24	UAF	Rhoton <i>et al.</i> , 2001
	Spiked	8.21	7.05 - 9.27	UAF	Rhoton <i>et al.</i> , 2001
Weathered oil WAF	Constant				
	Spiked				
Fresh oil CE-WAF	Constant	1.4	1.40 - 1.88	UAF	Rhoton <i>et al.</i> , 2001
	Spiked	5.08	3.13 - 8.26	UAF	Rhoton <i>et al.</i> , 2001
Weathered oil CE-WAF	Constant				
	Spiked				
Forties crude oil					
Fresh oil WAF	Constant				
	Spiked				
Weathered oil WAF	Constant				
	Spiked				
Fresh oil CE-WAF	Constant	0.42	0.34 - 0.52	EBSI	Clark <i>et al.</i> , 2001
	Spiked	15.3	13.6 - 17.9	EBSI	Clark <i>et al.</i> , 2001

Test Medium	Exposure	LC50	95% CI	Laboratory	Reference
Dispersant Only (9500)	Constant				
	Spiked	158	103.1-242.0	UCSC	Singer et al., 1996
		245.4	207.5-290.1	UCSC	Singer et al., 1966
		223.70	188.3-265.7	UCSC	Singer et al., 1966
Dispersant Only (9527)	Constant	7.06	5.97-8.77	UCSC	Singer et al., 1990b
		7.26	6.13-8.53	UCSC	Singer et al., 1990b
		4.26	3.28-5.37	UCSC	Singer et al., 1990b
		9.74	7.39-13.8	EBSI	Clark et al., 2001
		15.30	13.3 - 17.7	UMCBL	Coelho and Aurand, 1996
	Spiked	163.40	140.8-189.5	UCSC	Singer et al., 1991
		136.40	109.5-169.8	UCSC	Singer et al., 1991
		120.40	89.3-162.5	UCSC	Singer et al., 1991
		195.00	135-282	EBSI	Clark et al., 2001
Kuwait crude oil					
Fresh oil WAF	Constant	0.10	0.08-0.13	EBSI	Clark et al., 2001
	Spiked	>2.76	NA	EBSI	Clark et al., 2001
Weathered oil WAF	Constant				
	Spiked				
Fresh oil CE-WAF (9527)	Constant	0.17	NA	EBSI	Clark et al., 2001
	Spiked	5.04	3.64-5.08	EBSI	Clark et al., 2001
		1.73	1.4-2.33	EBSI	Clark et al., 2001
		1.30	0.02-1.66	EBSI	Clark et al., 2001
Weathered oil CE-WAF	Constant				
	Spiked				
Prudhoe Bay crude oil					
Fresh oil WAF	Constant				
	Spiked	14.23	11.58-17.50	UCSC	This report, Table 4.3
		>17.5	NR	UCSC	This report, Table 4.3
		14.72	12.77-16.0	UCSC	This report, Table 4.3
		>34.7		UCSC	Singer et al., 1996
		>25.5		UCSC	Singer et al., 1996
>28.6		UCSC	Singer et al., 1996		
Weathered oil WAF	Constant				
	Spiked	>1.03	NR	UCSC	This report, Table 4.3
		0.95	NR	UCSC	This report, Table 4.3
		0.82	NR	UCSC	This report, Table 4.3
Fresh oil CE-WAF	Constant	1.04	NR	UCSC	This report, Table 4.3
	Spiked	11.01	7.73-15.68	UCSC	This report, Table 4.3
		9.46	7.22-12.39	UCSC	This report, Table 4.3
		14.40	12.29-16.87	UCSC	This report, Table 4.3
Fresh oil CE-WAF (9527)	Constant				
	Spiked	10.54	9.08-12.25	UCSC	Singer et al., 1996
		10.75	9.45-12.22	UCSC	Singer et al., 1996
		10.83	NA	UCSC	Singer et al., 1996
Weathered oil CE-WAF	Constant				
	Spiked	33.27	28.32-39.09	UCSC	This report, Table 4.3
		5.72	4.27-7.65	UCSC	This report, Table 4.3
		7.43	5.45-10.12	UCSC	This report, Table 4.3

Table 7.4 Toxicity test results (in ppm) for *Crassostrea gigas* (Pacific oyster - larvae)

Test Medium	Exposure	LC50	95% CI	Laboratory	Reference
Dispersant Only (9527)	Constant	3.09 3.10	3.06-3.12	EBSI UMCBL	Clark et al., 2001 Coelho and Aurand, 1996
	Spiked	13.90	9.17-31.1	EBSI	Clark et al., 2001
Dispersant Only (9500)	Constant	5.20		UMDCBL	Coelho and Aurand, 1996
	Spiked				
Kuwait crude oil					
Fresh oil WAF	Constant				
	Spiked				
Weathered oil WAF	Constant				
	Spiked				
Fresh oil CE-WAF (9527)	Constant	0.50	0.05-1.74	EBSI	Clark et al., 2001
	Spiked	1.92	0.94-6.16	EBSI	Clark et al., 2001
Weathered oil CE-WAF	Constant				
	Spiked				
Forties crude oil					
Fresh oil WAF	Constant				
	Spiked				
Weathered oil WAF	Constant				
	Spiked				
Fresh oil CE-WAF 9500	Constant	0.81	0.52-1.39	EBSI	Clark et al., 2001
	Spiked	3.99	3.07-5.45	EBSI	Clark et al., 2001
Weathered oil CE-WAF	Constant				
	Spiked				
Medium fuel oil					
Fresh oil WAF	Constant	>1.14		EBSI	Clark et al., 2001
	Spiked	>1.83		EBSI	Clark et al., 2001
Weathered oil WAF	Constant				
	Spiked				
Fresh oil CE-WAF 9527	Constant	0.53	cnc	EBSI	Clark et al., 2001
	Spiked	2.28	1.69-3.35	EBSI	Clark et al., 2001
Weathered oil CE-WAF	Constant				
	Spiked				

Table 7.5 Toxicity test results (in ppm) for *Chionocetes bairdi* (Tanner crab - larvae)

Test Medium	Exposure	LC50	95% CI	Laboratory	Reference
Dispersant Only	Constant	23.4	19.3-28.4	UAF	Rhton, 1999, Table 1-6
	Spiked	1266.8	1030.9-1556.8	UAF	Rhton, 1999, Table 1-6
Alaska North Slope crude oil					
Fresh oil WAF	Constant	2.54	N/A	UAF	Rhton, 1999, Table 1-6
	Spiked	9.73	8.83 - 10.68	UAF	Rhton, 1999, Table 1-6
Weathered oil WAF	Constant	0.27	0.24 - 0.28	UAF	Rhton, 1999, Table 2-5
	Spiked	0.4	0.33 - 0.51	UAF	Rhton, 1999, Table 2-5
Fresh oil CE-WAF	Constant	1.3	N/A	UAF	Rhton, 1999, Table 1-6
	Spiked	10.72	9.08 - 12.72	UAF	Rhton, 1999, Table 1-6
Weathered oil CE-WAF	Constant	0.37	N/A	UAF	Rhton, 1999, Table 2-5
	Spiked	2.36	1.66 - 9.66	UAF	Rhton, 1999, Table 2-5

Table 7.6 Toxicity test results (in ppm) for <i>Menidia beryllina</i> (Inland silversides/fish - larvae)					
Test Medium	Exposure	LC50	95% CI	Laboratory	Reference
Dispersant Only (9500)	Constant	72.6	53.9 - 91.1	TAMU	This report, Table 6.3
		85.4	72.9 - 99.3	TAMU	This report, Table 6.3
		85.1	64.5 - 112	USF	This report Table 5.3
		54.7	46.7-62.9	UAF	Rhoton, 1999, Table 1-6
	Spiked	21.6	19.1 - 24.3	USF	This report, Table 5.3
		116.6	96.1 - 141.4	TAMU	This report, Table 6.3
		70.55	NA	TAMU	This report, Table 6.3
		40.5	29.5 - 52.2	TAMU	This report, Table 6.3
		88.7	52.9-148.7	UCSC	This report, page 49
		115.8	105.7-125.5	UAF	Rhoton, 1999, Table 1-6
Dispersant Only (9527)	Constant	33.5	30.2 - 37.2	UMCBL	Coelho and Aurand, 1996
		54.6	28.5 - 77.2	TAMU	This report, Table 6.3
	52.3	47.9 - 57.1	EBSI	Clark et al., 2001	
	Spiked	58.3	55.6 - 61.1	EBSI	Clark et al., 2001
Arabian crude oil					
Fresh oil WAF	Continuous				
	Spiked	0.42	0.37 - 0.50	TAMU	This report, Table 6.4
Weathered oil WAF	Continuous	0.63	0.52 - 080	TAMU	This report, Table 6.4
		4.9	2.8 - 144.3	TAMU	This report, Table 6.4
	Spiked	5.5	3.4 - 1.1E+7	TAMU	This report, Table 6.4
		>14.5	NA	TAMU	This report, Table 6.4
Fresh oil CE-WAF	Continuous				
	Spiked	8.9	2.0 - 12.7		This report, Table 6.4
Weathered oil CE-WAF	Continuous	10.9	8.2 - 14.6		This report, Table 6.4
		2.5	1.6 - 3.8	TAMU	This report, Table 6.4
	Spiked	1.5	0.6 - 3.6	TAMU	This report, Table 6.4
		24.9	21.0 - 1.0E7	TAMU	This report, Table 6.4
		35	NA	TAMU	This report, Table 6.4
Venezuelan crude oil					
Fresh oil WAF	Continuous	<0.11		USF	This report, Table 5.3
	Spiked	0.63	0.53 - 0.74	USF	This report, Table 5.3
Weathered oil WAF	Continuous				
	Spiked	>1.06		USF	This report, Table 5.3
Fresh oil CE-WAF	Continuous	0.68	0.48 - 0.97	USF	This report, Table 5.3
	Spiked	2.84	1.96 - 4.11	USF	This report, Table 5.3
Weathered oil CE-WAF	Continuous				
	Spiked	30.8		USF	This report, Table 5.3
Kuwait crude oil					
Fresh oil WAF	Continuous	0.97	0.83 - 1.29	EBSI	Clark et al., 2001
	Spiked	>1.32		EBSI	Clark et al., 2001
Weathered oil WAF	Continuous	0.14	cnc	EBSI	Clark et al., 2001
	Spiked	>0.66		EBSI	Clark et al., 2001
Fresh oil CE-WAF (9527)	Continuous	0.55	0.41 - 0.74	EBSI	Clark et al., 2001
	Spiked	6.45	3.94 - 10.7	EBSI	Clark et al., 2001
Weathered oil CE-WAF (9527)	Continuous	1.09	0.96 - 1.28	EBSI	Clark et al., 2001
	Spiked	10.9	9.89 - 12.0	EBSI	Clark et al., 2001
Prudhoe Bay crude oil					
Fresh oil WAF	Continuous	14.81	9.79 - 68.75	UAF	Rhoton, 1999, Table 1-6
	Spiked	>6.86		USF	This report Table 5.3
		11.83	6.62-21.18	UCSC	This report, Table 4.3
		>19.86	NA	UAF	Rhoton, 1999, Table 1-6
Weathered oil WAF	Continuous				
	Spiked				
Fresh oil CE-WAF	Continuous				
	Spiked	18.1	7.83 - 41.8	USF	This report Table 5.3
Fresh oil CE-WAF	Constant	32.47	28.76-36.66	UCSC	This report, Table 4.3
		4.57	4.16 - 5.02	UAF	Rhoton, 1999, Table 1-6
Weathered oil CE-WAF	Spiked	12.29	10.9 - 13.86	UAF	Rhoton, 1999, Table 1-6
		20.28	18.05-22.80	UCSC	This report, Table 4.3

Table 7.6 Toxicity test results (in ppm) for *Menidia beryllina* (Inland silversides/fish - larvae), cont.

Test Medium	Exposure	LC50	95% CI	Laboratory	Reference
Alaskan North Slope crude oil					
Fresh oil WAF	Constant	15.59	13.98 - 17.38	UAF	Rhoton, 1999, Table 1-6
	Spiked	26.36	25.54 - 27.22	UAF	Rhoton, 1999, Table 1-6
Weathered oil WAF	Constant	0.79	0.32 - 0.83	UAF	Rhoton, 1999, Table 2-5
	Spiked	>1.13	N/A	UAF	Rhoton, 1999, Table 2-5
Fresh oil CE-WAF	Constant	12.42	11.4 - 13.54	UAF	Rhoton, 1999, Table 1-6
	Spiked	12.22	7.79 - 19.17	UAF	Rhoton, 1999, Table 1-6
Weathered Oil CE-WAF	Constant	0.65	0.10 - 1.25	UAF	Rhoton, 1999, Table 2-5
	Spiked	18.89	15.78 - 24.71	UAF	Rhoton, 1999, Table 2-5
Forties crude oil					
Fresh oil WAF	Constant				
	Spiked				
Weathered oil WAF	Constant				
	Spiked				
Fresh oil CE-WAF (9527)	Constant	0.49	0.40 - 0.59	EBSI	Clark et al., 2001
	Spiked	9.05	7.7 - 10.2	EBSI	Clark et al., 2001

Table 7.7 Toxicity test results (in ppm) for *Cyprinodon variegatus* (Sheepshead minnow - larvae)

Test Medium	Exposure	LC50	95% CI	Laboratory	Reference
Dispersant Only	Constant	170.5	NA	TAMU	This report Table 6.4
		193.3	165.6 - 225.7	TAMU	This report Table 6.4
	Spiked	593.5	416.8 - 10009.4	TAMU	This report Table 6.4
Arabian Medium crude oil	Fresh oil WAF	Constant			
		Spiked			
Weathered oil WAF	Constant	4.2	3.9 - 4.3	TAMU	This report Table 6.4
		3.9	3.2 - 4.9	TAMU	This report Table 6.4
	Spiked	>6.1		TAMU	This report Table 6.4
Fresh oil CE-WAF	Constant	>4.7		TAMU	This report Table 6.4
		Spiked			
Weathered oil CE-WAF	Constant	>9.7		TAMU	This report Table 6.4
		>10.8		TAMU	This report Table 6.4
	Spiked	31.9	NA	TAMU	This report Table 6.4
		39.5	NA	TAMU	This report Table 6.4

Table 7.8 Toxicity test results (in ppm) for *Sciaenops ocellatus* (Redfish - larvae)

Test Medium	Exposure	LC50	95% CI	Laboratory	Reference
Dispersant Only	Constant				
	Spiked	>744.0		USF	This report, Table 5.3
Venezuelan crude oil					
Fresh oil WAF	Constant				
	Spiked	0.85		USF	This report, Table 5.3
Weathered oil WAF	Constant				
	Spiked				
Fresh oil CE-WAF	Constant				
	Spiked	4.23	1.68 - 10.65	USF	This report, Table 5.3
Weathered oil CE-WAF	Constant				
	Spiked				

Table 7.9 Toxicity test results (in ppm) for *Scophthalmus maximus* (Turbot/flatfish - larvae)

Test Medium	Exposure	LC50	95% CI	Laboratory	Reference
Dispersant Only 9500	Constant	74.70	57.6-10.1	EBSI	Clark et al., 2001
	Spiked	>1055		EBSI	Clark et al., 2001
Kuwait crude oil					
Fresh oil WAF	Constant				
	Spiked				
Weathered oil WAF	Constant				
	Spiked				
Fresh oil CE-WAF 9527	Constant	2.00	1.74-2.31	EBSI	Clark et al., 2001
	Spiked	16.50	cnc	EBSI	Clark et al., 2001
Weathered oil CE-WAF	Constant				
	Spiked				
Forties crude oil					
Fresh oil WAF	Constant	0.35	cnc	EBSI	Clark et al., 2001
	Spiked	>1.33		EBSI	Clark et al., 2001
Weathered oil WAF	Constant				
	Spiked				
Fresh oil CE-WAF 9500	Constant	0.44	0.39-0.49	EBSI	Clark et al., 2001
	Spiked	48.60	35.9-109	EBSI	Clark et al., 2001
Weathered oil CE-WAF	Constant				
	Spiked				

Table 7.10 Toxicity test results (in ppm) for *Vibrio fischeri* (Microtox - bacteria)

Test Medium	Exposure	EC50	95% CI	Laboratory	Reference
Dispersant Only		242	165 -353	TAMU	This report Table 6.3
		104	102 - 106	TAMU	This report Table 6.3
		123	106 - 144	TAMU	This report Table 6.3
		197	168 - 232	TAMU	This report Table 6.3
Arabian crude oil					
Fresh oil WAF					
Weathered oil WAF		1	0.0 - 6.1	TAMU	This report Table 6.4
		0.7	0.0 - 2.8	TAMU	This report Table 6.4
		1.2	0.0 - 2.4	TAMU	This report Table 6.4
		1.3	0.0 - 2.5	TAMU	This report Table 6.4
Fresh oil CE-WAF					
Weathered oil CE-WAF		12.8	0.7 - 24.9	TAMU	This report Table 6.4
		27.9	22.4 - 33.4	TAMU	This report Table 6.4
		16.2	14.3 - 18.1	TAMU	This report Table 6.4
		13.9	12.0 - 15.8	TAMU	This report Table 6.4
Prudhoe Bay crude oil					
Fresh oil WAF		3.7	± 0.29	UAF	Rhoton, 1999, Table 3-3
Weathered oil WAF					
Fresh oil CE-WAF		1.9	± 0.09	UAF	Rhoton, 1999, Table 3-3
Weathered oil CE-WAF					
Alaska North Slope crude oil					
Fresh oil WAF		4.2	± 0.25	UAF	Rhoton, 1999, Table 3-3
Weathered oil WAF		0.37	± 0.03	UAF	Rhoton, 1999, Table 3-3
Fresh oil CE-WAF		2	± 0.17	UAF	Rhoton, 1999, Table 3-3
Weathered oil CE-WAF		6	± 1.1	UAF	Rhoton, 1999, Table 3-3

Table 7.11 Toxicity test results (in ppm) for *Atherinops affinis* (Topsmelt/fish - larvae)

Test Medium	Exposure	LC50	95% CI	Laboratory	Reference
Dispersant Only (9527)	Constant	27.9	22.5 - 34.8	UCSC	Singer et al., 1990b
		25.5	19.8-47.7	UCSC	Singer et al., 1990b
		40.6	32.3-51.0	UCSC	Singer et al., 1990b
	Spiked	59.2	41.4-84.6	UCSC	Singer et al., 1991
		103.5	85.5-125.2	UCSC	Singer et al., 1991
		86.2	68.6 - 108	UCSC	Singer et al., 1991
Prudhoe Bay crude oil					
Fresh oil WAF	Constant				
	Spiked	12.13	10.8-13.6	UCSC	This report, Table 4.3
		9.35	NR	UCSC	This report, Table 4.3
		16.34	14.57-18.55	UCSC	Singer et al., 1996
		40.2	38.68-41.45	UCSC	Singer et al., 1996
35.73	9.37-46.85	UCSC	Singer et al., 1996		
Weathered oil WAF	Constant				
	Spiked	>1.6 >1.45	NR NR	UCSC UCSC	This report, Table 4.3 This report, Table 4.3
Fresh oil CE-WAF	Constant	1.07	0.90-1.27	UCSC	This report, Table 4.3
	Spiked	17.7	14.6-21.5	UCSC	This report, Table 4.3
		12.46	10.7-14.5	UCSC	This report, Table 4.3
Fresh oil CE-WAF (9527)	Spiked	7.27	5.0-10.6	UCSC	This report, Table 4.3
		28.6	17.49-46.76	UCSC	Singer et al., 1996
		74.73	62.30-89.60	UCSC	Singer et al., 1996
Weathered oil CE-WAF	Spiked	34.06	30.24-38.37	UCSC	Singer et al., 1996
		17.73	15.8-19.9	UCSC	This report, Table 4.3
		16.86	14.4-19.8	UCSC	This report, Table 4.3
		18.06	NR	UCSC	This report, Table 4.3

Table 7.12 Toxicity test results (in ppm) for *Haliotis rufescens* (Abalone - larvae)

Test Medium	Exposure	EC50	95% CI	Laboratory	Reference
Dispersant Only (9500)	Constant				
	Spiked	19.7	19.5-20.0	UCSC	Singer et al., 1996
		12.8	12.4-13.1	UCSC	Singer et al., 1996
Dispersant Only (9527)	Constant	13.6*	13.4-13.7	UCSC	Singer et al., 1996
		1.96	1.89-2.02	UCSC	Singer et al., 1990b
		2.2	2.04-2.36	UCSC	Singer et al., 1990b
	Spiked	1.6	1.50-1.69	UCSC	Singer et al., 1990b
		13.6	12.9-14.3	UCSC	Singer et al., 1990b
		18.1	16.8-19.5	UCSC	Singer et al., 1990b
Prudhoe Bay crude oil	Spiked	1.6	15.9-16.4	UCSC	Singer et al., 1990b
Fresh oil WAF	Constant				
	Spiked	>34.03		UCSC	Singer et al., 1996
		>46.99		UCSC	Singer et al., 1996
Weathered oil WAF	Spiked	>33.58		UCSC	Singer et al., 1996
	Constant				
Fresh oil CE-WAF (9527)	Constant				
	Spiked	19.09	18.9-19.28	UCSC	Singer et al., 1996
		32.7	32.11-33.30	UCSC	Singer et al., 1996
Weathered oil CE-WAF	Spiked	17.81	17.65-17.96	UCSC	Singer et al., 1996
		Constant			

* Average of three trials

Table 7.13 Toxicity test results (in ppm) for *Eurytemora affinis* (copepod - adult)

Test Medium	Exposure	LC50	95% CI	Laboratory	Reference
Dispersant Only (9500)	Constant	5.2	5.0 - 5.6	UMCBL	Coelho and Aurand, 1996
	Spiked				
Fresh oil WAF	Constant				
	Spiked				
Weathered oil WAF	Constant				
	Spiked				
Fresh oil CE-WAF	Constant				
	Spiked				
Weathered oil CE-WAF	Constant				
	Spiked				

Comparing the results for the twelve species and all of the possible combinations of the seven oils and two dispersants is a difficult task. Unfortunately, only a partial set of the desired data is available for most of the species tested. It is possible, however, to make several generalizations concerning the results. We did this by preparing a series of tables (Tables 7-14 through 7-22) which present the average values for each exposure and species. These are essentially summaries of the data presented by species in Tables 7-2 through 7-13. It is then possible to search for pairs of data between the various tables and make broad generalizations. No attempt was made to do statistical comparisons.

First, if the average results for both constant and spiked exposures using dispersant alone (Table 7-14) are examined, there appears to be little difference in the results for Corexit[®] 9500 and 9527. Further, the spiked exposure values are consistently higher (less toxic) than the constant exposure values, with the exception of the inland silversides (*M. beryllina*), where the values are essentially the same. This suggests a difference in the mode of action for this species. Finally, the most sensitive species appear to be the copepod (*E. affinis*) and the oyster larvae, followed by the two mysids and the three fish species. The national test species (*M. bahia*, *C. variegatus* and *M. beryllina*) showed results similar to those of the regional species of concern from the same taxonomic groups. Overall constant exposure LC₅₀s ranged from 2 to 166 ppm, while spiked exposure LC₅₀s ranged from 11 to >1055 ppm.

With respect to the relative toxicity of the various fresh (unweathered) oils tested (Tables 7-15 and 7-16), spiked exposure LC₅₀ values are generally higher (less toxic), but the differences are not as clear as for dispersant alone, and are highly species-specific. Overall, PBCO and Alaskan North Slope crude oil appear to be the least toxic of the oils tested, with the Arabian Medium crude oil and the VCO being the most toxic and the others intermediate. The available data is not sufficient to make comparisons between national test species and regional species of concern, with the possible exception of *M. bahia* appearing less sensitive than *H. costata*. The data do not support an overall difference between invertebrate and vertebrate species. Overall constant exposure LC₅₀s ranged from <0.11 to 15.6 ppm, while spiked exposure LC₅₀s ranged from 0.52 to >38.2 ppm. Most of the values for the fresh oil are lower, often much lower (more toxic) than those observed with the same species for dispersant alone.

Tables 7-17 and 7-18 show the results for constant and spiked exposures to weathered oil WAF. As can be seen from the tables, spiked exposure toxicity values are still higher (less toxic) than constant exposure values. However, weathered oil WAF does not appear to be consistently less toxic when compared to fresh oil WAF with the same exposure profile. For constant exposures, there were two pairs of averages, and in both cases the LC₅₀ values were lower (more toxic) for the weathered oil. For spiked exposures, there were seven pairs of average values, in two

cases the LC₅₀ value for fresh oil was lower (more toxic), in four cases the value for weathered oil was lower, and in one they were essentially equivalent.

Tables 7-19 and 7-20 show the results for constant and spiked exposures to fresh oil CE-WAF, respectively. When the constant versus spiked exposures are directly compared, the spiked exposure LC₅₀ was higher (less toxic) 16 out of 17 times. One time the averages were essentially equivalent, for *M. beryllina*, which also showed an anomalous response in several other instances. If the average constant exposure CE-WAF LC₅₀ values (Table 7-19) are compared to the constant exposure WAF values (Table 7-15), there is a tendency for the WAF to be more toxic, but most values are well within the variability of the tests, indicating WAF and CE-WAF toxicities are equivalent. A similar pattern holds when the average spiked exposure LC₅₀ values are compared between fresh WAF and CE-WAF results (Table 7-16 versus Table 7-20). Out of 16 pairs of averages, the CE-WAF values were higher (less toxic) ten times, four times the WAF average was higher (less toxic) and two pairs were essentially equal.

Tables 7-21 and 7-22 show the results for constant and spiked exposure to weathered oil CE-WAF, respectively. Spiked exposure LC₅₀s are consistently lower (all seven pairs of values) and the differences are usually fairly great. When the LC₅₀s for constant exposure CE-WAF for fresh oil (Table 7-19) are compared to those for weathered oil (Table 7-21) there is little difference in the five pairs of values. However, when the LC₅₀s for spiked exposure to CE-WAF (Table 7-20 versus Table 7-22) are compared, nine out of ten times the fresh oil CE-WAF was more toxic (lower) than the weathered oil CE-WAF.

Table 7.14 Average LC₅₀ Values (in ppm) for Exposure to Dispersant Alone

Species	Corexit 9500		Corexit 9527	
	Constant	Spiked	Constant	Spiked
<i>Mysidopsis bahia</i>	33	792	27	>1014
<i>Holmesimysis costata</i>		209	9	175
<i>Crassostrea gigas</i>	5		3	14
<i>Chionocetes bairdi</i>	23	1266		
<i>Menidia beryllina</i>	75	76	48	58
<i>Cyprinodon variegatus</i>	182	672		
<i>Sciaenops ocellatus</i>		>744		
<i>Scophthalmus maximus</i>	75	>1055		
<i>Vibrio fischeri</i>	166			
<i>Atherinops affinis</i>			31	83
<i>Haliotis rufescens</i>		15	2	11
<i>Eurytemora affinis</i>	5			

Table 7.15 Average LC₅₀ Values (in ppm) for Constant Exposure to Fresh Oil Water Accommodated Fraction

Species	Arabian crude	Venezue crude	Kuwait crude	Prudhoe Bay	ANS crude	Forties crude	MFO
<i>Mysidopsis bahia</i>		0.3	2.0		2.6		
<i>Holmesimysis costata</i>			0.1				
<i>Crassostrea gigas</i>							1.1
<i>Chionocetes bairdi</i>					2.5		
<i>Menidia beryllina</i>		<0.1	1.0	14.8	15.6		
<i>Cyprinodon variegatus</i>							
<i>Sciaenops ocellatus</i>							
<i>Scophthalmus maximus</i>						0.35	
<i>Vibrio fischeri</i>				3.7	4.2		
<i>Atherinops affinis</i>							
<i>Haliotus rufescens</i>							
<i>Eurytemora affinis</i>							

Table 7.16 Average LC₅₀ Values (in PPM) for Spiked Exposure to Fresh Oil Water Accommodated Fraction

Species	Arabian crude	Venezue crude	Kuwait crude	Prudhoe Bay	ANS crude	Forties crude	MFO
<i>Mysidopsis bahia</i>		0.7	0.6	>6.9	8.2		
<i>Holmesimysis costata</i>			>2.76	>22.52			
<i>Crassostrea gigas</i>							>1.83
<i>Chionocetes bairdi</i>					9.7		
<i>Menidia beryllina</i>	0.5	0.6	>1.32	12.9	26.4		
<i>Cyprinodon variegatus</i>							
<i>Sciaenops ocellatus</i>		0.9					
<i>Scophthalmus maximus</i>						>1.3	
<i>Vibrio fischeri</i>							
<i>Atherinops affinis</i>				22.8			
<i>Haliotus rufescens</i>				>38.2			
<i>Eurytemora affinis</i>							

Table 7.17 Average LC₅₀ Values (in ppm) for Constant Exposure to Weathered Oil Water Accommodated Fraction

Species	Arabian crude	Venezue crude	Kuwait crude	Prudhoe Bay	ANS crude	Forties crude	MFO
<i>Mysidopsis bahia</i>	0.6						
<i>Holmesimysis costata</i>							
<i>Crassostrea gigas</i>							
<i>Chionocetes bairdi</i>					0.3		
<i>Menidia beryllina</i>	5.2		0.1				
<i>Cyprinodon variegatus</i>	4.1						
<i>Sciaenops ocellatus</i>							
<i>Scophthalmus maximus</i>							
<i>Vibrio fischeri</i>	1.1						
<i>Atherinops affinis</i>							
<i>Haliotus rufescens</i>							
<i>Eurytemora affinis</i>							

Table 7.18 Average LC₅₀ Values (in PPM) for Spiked Exposure to Weathered Oil Water Accommodated Fraction

Species	Arabian crude	Venezue crude	Kuwait crude	Prudhoe Bay	ANS crude	Forties crude	MFO
<i>Mysidopsis bahia</i>	54.6	>0.7	>0.2				
<i>Holmesimysis costata</i>				0.9			
<i>Crassostrea gigas</i>							
<i>Chionocetes bairdi</i>					0.4		
<i>Menidia beryllina</i>	>23.4	>1.06	>0.7		>1.13		
<i>Cyprinodon variegatus</i>	>5.4						
<i>Sciaenops ocellatus</i>							
<i>Scophthalmus maximus</i>							
<i>Vibrio fischeri</i>							
<i>Atherinops affinis</i>				>1.5			
<i>Haliotus rufescens</i>							
<i>Eurytemora affinis</i>							

Table 7.19 Average LC₅₀ Values (in ppm) for Constant Exposure to Fresh Oil Chemically Enhanced-Water Accommodated Fraction

Species	Arabian crude	Venezue crude	Kuwait crude	Prudhoe Bay	ANS crude	Forties crude	MFO
<i>Mysidopsis bahia</i>		0.5	0.7*		1.4	0.4	
<i>Holmesimysis costata</i>			0.2*	1.0			
<i>Crassostrea gigas</i>			0.5*			0.8	0.5*
<i>Chionocetes bairdi</i>					1.3		
<i>Menidia beryllina</i>		0.7	0.6*	4.6	12.4	0.5*	
<i>Cyprinodon variegatus</i>							
<i>Sciaenops ocellatus</i>							
<i>Scophthalmus maximus</i>			2.0*			0.4	
<i>Vibrio fischeri</i>				1.9	2.0		
<i>Atherinops affinis</i>				1.1			
<i>Haliotus rufescens</i>							
<i>Eurytemora affinis</i>							

* C9527

Table 7.20 Average LC₅₀ Values (in PPM) for Spiked Exposure to Fresh Oil Chemically Enhanced-Water Accommodated Fraction

Species	Arabian crude	Venezue crude	Kuwait crude	Prudhoe Bay	ANS crude	Forties crude	MFO
<i>Mysidopsis bahia</i>		13.3	19.7	15.9	5.1	15.3	
<i>Holmesimysis costata</i>			2.7*	11.6			
<i>Crassostrea gigas</i>			1.9*			4.0	2.3
<i>Chionocetes bairdi</i>					10.7		
<i>Menidia beryllina</i>	9.9	2.8	6.5*	12.3	12.2	9.1*	
<i>Cyprinodon variegatus</i>							
<i>Sciaenops ocellatus</i>		4.2					
<i>Scophthalmus maximus</i>			16.5*			48.6	
<i>Vibrio fischeri</i>							
<i>Atherinops affinis</i>				12.5			
<i>Haliotus rufescens</i>							
<i>Eurytemora affinis</i>							

* C9527

Table 7.21 Average LC₅₀ Values (in ppm) for Constant Exposure to Weathered Oil Chemically Enhanced-Water Accommodated Fraction

Species	Arabian crude	Venezue crude	Kuwait crude	Prudhoe Bay	ANS crude	Forties crude	MFO
<i>Mysidopsis bahia</i>	0.6		0.1*				
<i>Holmesimysis costata</i>							
<i>Crassostrea gigas</i>							
<i>Chionocetes bairdi</i>					0.4		
<i>Menidia beryllina</i>	3.0		1.1*		0.7		
<i>Cyprinodon variegatus</i>	>10.3						
<i>Sciaenops ocellatus</i>							
<i>Scophthalmus maximus</i>							
<i>Vibrio fischeri</i>	17.7				6		
<i>Atherinops affinis</i>							
<i>Haliotus rufescens</i>							
<i>Eurytemora affinis</i>							

* C9527

Table 7.22 Average LC₅₀ Values (in PPM) for Spiked Exposure to Weathered Oil Chemically Enhanced-Water Accommodated Fraction

Species	Arabian crude	Venezue crude	Kuwait crude	Prudhoe Bay	ANS crude	Forties crude	MFO
<i>Mysidopsis bahia</i>	58.7	96.6	111*				
<i>Holmesimysis costata</i>				15.5			
<i>Crassostrea gigas</i>							
<i>Chionocetes bairdi</i>					2.4		
<i>Menidia beryllina</i>	30.0	30.8	10.9*	20.3	18.9		
<i>Cyprinodon variegatus</i>	35.7						
<i>Sciaenops ocellatus</i>							
<i>Scophthalmus maximus</i>							
<i>Vibrio fischeri</i>							
<i>Atherinops affinis</i>				17.6			
<i>Haliotus rufescens</i>							
<i>Eurytemora affinis</i>							

* C9527

Section 8

Issues and Lessons Learned from the CROSERF Initiative and Their Relevance to Future Research – 2000 and Beyond

Don Aurand and Gina Coelho
Ecosystem Management & Associates, Inc.
Lusby, MD 20657

Jim Clark
ExxonMobil Research and Engineering
Fairfax, Virginia 22037

In many respects, the CROSERF Initiative was highly successful; however it did not meet all of the initial objectives of the sponsors. Despite the best efforts of all involved, the initial work plan for the amount of toxicity testing to be accomplished was far too ambitious, and the actual number of toxicity tests that were completed was much less than originally envisioned. On the other hand, the data set detailed in Section 7 represents, by far, the largest and most comprehensive set of oil and dispersed oil toxicity data currently available. The issues which constrained the group were largely financial. It is very expensive (and also time consuming) to conduct the type of toxicity testing program envisioned by CROSERF. Most of the cost is associated with the absolute necessity to do detailed hydrocarbon chemistry in support of the toxicity tests. This issue will be discussed at more length, but it is not possible to work with oil in water exposures without the supporting chemistry. On the other hand, the potential now exists for additional testing, using the protocols detailed in this report, to supplement the existing information. There is benefit in doing so, but the decision to add additional species or oils or exposure profiles should not be taken lightly. It will never be possible to cover all possible permutations for this data set, and carefully considered “value added” determinations need to be made when deciding on considering additional testing.

In addition to the value of the toxicity testing, the CROSERF approach offered a unique opportunity for the participants to learn from each other in a non-confrontational environment. The opportunity for regulators to interact directly with scientist was also a significant benefit. As a result, the CROSERF Proceedings contain discussions about a wide range of issues that move well beyond the actual toxicity data. It would be valuable to have more forums for this kind of interaction, but unfortunately they are expensive to maintain and coordinate. We would recommend that the API and appropriate agencies consider whether or not such meetings could be somehow connected with and supported by the periodic oil spill conferences that already exist.

Overall, we believe the following conclusions are strongly supported by the CROSERF results:

- There is a significant benefit to using standardized protocols. While we would not suggest the CROSERF protocols cannot be improved, the benefits of having clearly comparable data appear to us to outweigh the potential benefits of modifying the technique.
- That said, there would be a benefit to a concerted effort to make sure that new data sets collected using these methods are somehow integrated with the data included in this report. We do know that the CROSERF protocols have been used in New Zealand and in Brazil to

support national programs to evaluate dispersant approval, but we do not currently have access to the results. It would be useful for an organization, such as the API, to actively encourage such interaction.

- The applicability of the data obtained by using standard national test species is often a regional concern. The data here suggest that the results for the standard test species were not all that different than the results for the regional species selected. This is not to say that there are not dramatic differences between species, but continually expanding the data base just to test one or a few local species may not result in much value-added.
- Declining exposures to dispersant alone, dispersed oil or oil water accommodated fractions are less toxic than a constant exposure. We believe that the more rapid the dilution the greater the difference, although we only tested one dilution regime. This relationship appears to be clear for all of the tested species except *M. beryllina*, which seems to be more sensitive to initial concentration than it is to duration of exposure, suggesting a different mode of toxic action. This is an issue that might be worth additional investigation. Overall, however, the data support the conclusion that constant exposure testing does not realistically assess the risk to marine or coastal organisms when rapid dilution is possible.
- The two dispersants tested appear to be much less toxic than oil.
- There were large differences in toxicity between the various oils tested. It may be more important to vary the oils used than the species tested for assessing national and regional risks.
- The mode of action of WAFs and CE-WAFs is potentially very different, due to the presence of bulk oil droplets in the latter, while the former is based on solubility of oil constituents.
- There does not appear to be a difference between constant exposures to dispersed oil or water accommodated oil, they are equally toxic using measured exposure concentrations. With spiked exposures, the same pattern was observed, indicating that dispersed oil is no more toxic than the water accommodated fraction of undispersed oil at equivalent exposures.
- Differences between the toxicity of water accommodated fractions created using weathered and fresh oil are inconsistent. Weathered oil does not appear to be significantly less toxic, for either spiked or constant exposure. In the case of dispersed oil, constant exposure values for fresh and weathered oil appear similar, but for spiked exposure dispersed fresh oil was consistently more toxic than dispersed weathered oil. However, the differences were probably not large enough to make the risk from dispersing fresh oil appreciably greater, provided that rapid dilution is possible.
- The range of average LC₅₀ values for spiked exposure to fresh dispersed oil was 2.3 to 48.6 ppm. This suggests that as long as dilution was occurring at least as rapidly as the 1.67 hour half-life used in the CROSERF protocols, a threshold of 1 ppm would probably represent a reasonable level for protection of more sensitive life history stages of animals in the water column.
- It is reasonable to ask if LC₅₀ values are the appropriate measure to use to set thresholds. It might be beneficial to examine the use of “Lowest Observed Effects Level” or other value instead. This is, however, not a simple determination, given that almost all of the extant data reports LC₅₀ values.

In August, 2005 the National Research Council of the National Academies “Committee on Understanding Oil Spill Dispersants: Efficacy and Effects” published its review of issues related to the potential for expanded dispersant use in the United States (NRC, 2005). As part of the review, the Committee examined the CROSERF initiative and made some suggestions concerning the protocols. Their basic conclusions were as follows:

Refinements to the CROSERF protocols may be warranted for future toxicity testing of dispersants and dispersed oil, either to address specific concerns with the current test procedures (as highlighted below) or to provide greater site-specificity for risk assessment purposes (e.g., dispersant use in near-shore areas). For example, several refinements to the CROSERF procedures have been proposed to adapt the test to subarctic conditions, including changes in WAF preparation, exposure and light regimes, analytical chemistry, and use of subarctic test organisms (Barron and Ka’aihue, 2003). However, the potential benefits of altering test protocols from the CROSERF procedures should be carefully weighed against the implications for potential loss of data comparability and reproducibility.

The Committee did recommend several areas where they felt it was possible to consider possible refinements. The major issues raised in the report are briefly summarized below, along with our conclusions about each issue.

The Committee noted that there are two basic ways to prepare exposure solutions. You can vary the oil loading into a specified water volume and make separate solutions for each dilution (called variable loading), or you can make one concentrated oil loading and then dilute the resultant WAF or CE-WAF (commonly called serial dilution). Since individual hydrocarbon compounds have different aqueous solubilities, the two approaches will not yield exactly the same exposures to individual compounds. The CROSERF approach uses a variable oil loading. The second issue is mixing energy (based on the mixing, or stirring, regime). The CROSERF protocols call for no vortex for WAF preparation (to avoid droplet formation) and a 20 to 25% vortex for CE-WAF preparation. The Committee recommended that equal energies be used for both.

The issue of variable oil loading versus serial dilution was seriously debated by the CROSERF participants before we decided on the former approach. It is a more important issue for the production of WAF, where much of the exposure is due to soluble compounds, than for CE-WAF, where most of the oil ends up as droplets in the solution, but is an issue. Our conclusion, as noted by the NRC (2005) was that the variable oil loading was more representative of what would happen in an oil slick at sea, where the thickness was inconsistent. Ultimately, the Committee concluded that they could not recommend one method over the other.

For the second issue, exposure regimes, the most important criticism was the use of closed exposure chambers. The Committee felt that the used of a closed system created a situation, especially when using fresh oil solutions, where the role of natural evaporation would be underestimated, and so the toxicity of the test solutions would be (potentially significantly) higher than would be likely in the field. This issue was also a concern for the CROSERF participants but our conclusion was that losses due to evaporation in open containers, while potentially more realistic, would be too variable given the sensitivity to laboratory conditions. This would make both intra- and interlaboratory comparisons much more unreliable. By using a closed exposure chamber we did potentially create a higher than normal exposure, but that is balanced by better

experimental control. In addition, the comparison of weathered versus fresh oil solutions offers insight into the effects of evaporation. Since the results using closed containers represent a conservative estimate, we believe that the interpretation of the results, overall, benefits from this decision.

A secondary concern about the exposure regime related to the specific decline curve used in the chambers. The CROSERF protocols are based on being able to compare constant 96-hour exposures (to connect to the historical data base) to a declining exposure with an approximate 2.5-hours half life. That rate produces a 95% decline in initial concentration in approximately 12.5 hours. The concern of the Committee was that this rate might not accurately represent exposure in nearshore, restricted waters, although they did believe it was reflective of offshore conditions.

We take a somewhat different view, and believe that the protocol is appropriate for a wide range of situations, but not necessarily just based on location. For example, it is not nearly rapid enough to represent small or moderate sized spills offshore, it would probably be accurate for a moderate spill in a large estuary, and would underestimate exposure from a very large spill in a small or moderate sized estuary. The point is, the factors contributing to the rate of dilution are very complex and include the volume dispersed, the dilution potential of the receiving water, the energy regime at the time of the spill and the hydrographic conditions. We would, however, agree with the Committee that there could be a real benefit to running additional tests at different dilution rates, and believe that this might be the most useful modification to the existing protocols. However, it would be extremely expensive to do more than one or two different regimes, and the best approach would be to reproduce as much of the existing data set with one additional decline rate, perhaps with a five- to ten-hours half life to simulate a somewhat slower dilution potential.

While not a concern of the Committee, we believe that using the standard CROSERF exposure chamber may represent an unnecessary expense for some laboratories. The chambers were custom designed to meet the criteria of the California program. While it would be best if similar chambers were used in future experiments, we would recommend only that similar exposure conditions be maintained in whatever flow-through system is used. If a different chamber is used, we believe that it should be tested with a standard CROSERF organism and oil so that a direct comparison can be made with the original exposure regime.

The Committee also made several suggestions for improving the methods of quantifying hydrocarbon exposure, including specifying the point in the toxicity test chemical analyses were performed and explaining exactly how these measurements were used to calculate the toxicological endpoints. They also recommended the investigation of using toxic units to summarize the toxicity of various active components of dispersed oil preparations. We believe these suggestions are valuable and worth investigating, however, almost all existing data is reported as TPH and so ultimately it is probably valuable to retain that convention. It is one of the basic issues in oil pollution studies; however, that there is no consistent definition of what compounds are included in that metric, and normally it is very difficult to discern the results for individual toxic components. The specific CROSERF protocols for hydrocarbon chemistry are documented in Section 3, and in any future work we strongly recommend that they be used. Additional analyses can be added, but the TPH calculation should be based on the analyte list used by CROSERF to ensure comparability.

The last issue raised by the Committee was a concern over the possibility of photo enhanced toxicity. This was an issue not addressed by CROSERF (see Barron *et al.*, 2004) and may need to be addressed for the reasons stated in their report. We remain concerned, however, that the potential effects of UV light are very limited in actual field situations, and while we support the clarification of the issue we do not see the need for extensive testing to resolve it.

In summary, then, the CROSERF project was highly successful in developing an extensive, comparable database. As appropriate, researchers are encouraged to expand this data set by testing additional oils and species. In so far as possible, the original protocols should be adhered to in order to ensure comparability. The most useful modification would probably be the addition of perhaps one, less rapid, exposure dilution protocol. Detailed analytical chemistry is critical, even though expensive. One of the strengths of the program, the integration of regulators (state and federal), industry and scientists, needs to be encouraged in other research activities, but requires a long-term financial commitment to support the coordination activities.

Section 9 References

References printed in red indicate Marine Spill Response Corporation (MSRC) or Ecosystem Management & Associates, Inc. (EM&A) reports directly related to the CROSERF initiative. References printed in blue indicate peer-reviewed journal articles published by CROSERF participants.

MSRC's "Technical Report Series" can be obtained online from the Linda Hall Library at www.lindahall.org. Information on obtaining EM&A reports is available from the Ecosystem Management & Associates, Inc. website (www.ecosystem-management.net).

Allen, L.G. 1982. Seasonal abundance, composition, and productivity of the littoral fish assemblage in upper Newport Bay, California. *Fishery Bulletin* 80:769-790.

Anderson, B.S, J.W. Hunt, S.L. Turpen, A.R. Coulon, M. Martin, D.L. McKeown and F.H. Palmer. 1990. *Procedures manual for conducting toxicity tests developed by the Marine Bioassay Project*. CSWRCB Publication 90-10WQ. California State Water Resources Control Board, Sacramento, CA, USA.

Aurand, D. and J.H. Kucklick (eds.). 1995. *Proceedings of the Third Meeting of the Chemical Response to Oil Spills: Ecological Effects Research Forum*. Marine Spill Response Corporation, Washington, DC. MSRC Technical Report Series 95-018, 69 p.

Aurand, D.V. and G.M. Coelho (eds.). 1996. *Proceedings of the Fourth Meeting of the Chemical Response to Oil Spills: Ecological Effects Research Forum*. April 24-25, 1996 Santa Cruz, California, USA. Ecosystem Management & Associates, Purcellville, VA, Report 96-01, 50 p.

Aurand, D.V., R. Jamail, M. Sowby, R.R. Lessard, A. Steen, G. Henderson and L. Pearson. 2001. Goals, objectives, and the sponsors' perspective on the accomplishments of the Chemical Response to Oil Spills: Ecological Effects Research Forum (CROSERF). Proceedings, 2001 International Oil Spill Conference. Global Strategies for Prevention, Preparedness, Response, and Restoration. API Publication No. 4686B (same number used for the 1999 Proceedings). American Petroleum Institute, Washington, D.C. pp.1257-1261.

Barron, M.G. and L. Ka'ahue. 2003. Critical evaluation of CROSERF test methods for oil dispersant toxicity testing under subarctic conditions. *Mar. Poll. Bull.* 46(9): 1191-1199.

Bragin, G.E., J.R. Clark and C.B. Pace. 1994. *Comparison of Physically and Chemically Dispersed Crude Oil Toxicity under Continuous and Spiked Exposure Scenarios*. Marine Spill Response Corporation, Washington, DC, Report 94-015.

Bragin, G. 1998. Personnel Communication, March 1998. Exxon Biomedical Sciences, Incorporated. East Millstone, NJ.

Bragin, G.E., and J.R. Clark. 1995. *Chemically Dispersed Crude Oils: Toxicity to Regional and National Test Species Under Constant and Spiked Exposures*. Marine Spill Response Corporation, Washington, DC. MSRC Technical Report Series 95-023, 43 p.

Clark, J.R., G.E. Bragin, E.J. Febbo and D.J. Letinski. 2001. Toxicity of physically and chemically dispersed oils under continuous and environmentally realistic exposure conditions: Applicability to dispersant use decisions in spill response planning. Proceedings, 2001 International Oil Spill Conference. Global Strategies for Prevention, Preparedness, Response, and Restoration. API Publication No. 4686B (same number used for the 1999 Proceedings). American Petroleum Institute, Washington, D.C. pp.1249-1255.

Coelho, G.M. and D.V. Aurand (eds.). 1996. *Proceeding of the Fifth Meeting of the Chemical Response to Oil Spills: Ecological Effects Research Forum*. September 18-19, 1996. Corpus Christi, Texas, USA. Ecosystem Management & Associates, Purcellville, VA, Report 96-03, 60 p.

Coelho, G.M. and D.V. Aurand (eds.). 1997. *Proceedings of the Sixth Meeting of the Chemical Response to Oil Spills: Ecological Effects Research Forum*. April 3-4, 1997. Fort Lauderdale, Florida, USA. Ecosystem Management & Associates, Purcellville, VA. Report 97-01, 69p.

Coelho, G.M. 1998. Personal Communication, February 1998. Ecosystem Management & Associates. Solomons, MD.

Coelho, G.M. and D.V. Aurand (eds.). 1998a. *Proceedings of the Seventh Meeting of the Chemical Response to Oil Spills: Ecological Effects Research Forum*. November 13-14, 1997. Santa Cruz, California, USA. Ecosystem Management & Associates, Purcellville, VA, Report 97-02, 53 p.

Coelho, G.M and D.V. Aurand (eds.).1998b. *Proceedings of the Eighth Meeting of the Chemical Response to Oil Spills: Ecological Effects Research Forum*. Ecosystem Management & Associates, Purcellville, VA. Technical Report 98-03, 30 p.

Daling, P.S., P.J. Brandvik , D. Mackay, and Ø. Johansen. 1990. Characterization of crude oils for environmental purposes. *Oil & Chemical Pollution* 7:199-224.

Fuller, C. and J.S. Bonner. 2001. Comparative toxicity of oil, dispersant, and dispersed oil to Texas marine Species. Proceedings, 2001 International Oil Spill Conference. Global Strategies for Prevention, Preparedness, Response, and Restoration. API Publication No. 4686B (same number used for the 1999 Proceedings). American Petroleum Institute, Washington, D.C. pp.1243-1248.

Hobson, E.S. and J.R. Chess, 1976. Trophic interactions among fishes and zooplankters near shore at Santa Catalina Island, California. *Fishery Bulletin* 74:567-598.

Kucklick, J.H. (ed). 1994. *Proceedings, First Meeting of the Chemical Response to Oil Spills: Ecological Effects Research Forum*. August 9-10, 1994. Santa Cruz, California, USA. Marine Spill Response Corporation. Washington, D.C. MSRC Technical Report Series 94-017, 83 p.

Kucklick, J.H. (ed.).1995. *Proceedings of the Second Meeting of the Chemical Response to Oil Spills: Ecological Effects Research Forum*. Marine Spill Response Corporation, Washington, DC. MSRC Technical Report Series 95-009, 30 p.

Martin, M., J.W. Hunt, B.S. Anderson, S.L. Turpen and F.H. Palmer. 1989. Experimental evaluation of the mysid *Holmesimysis costata* as a test organism for effluent toxicity testing. *Environmental Toxicology and Chemistry*. 8:1003–1012.

Microbics Corporation. 1992. Microtox Manual; Volume 2 Detailed Protocols.

NRC, 1989. *Using Oil Dispersants on the Sea*. National Academy Press, Washington, DC, USA.

NRC, 2005. *Oil Spill Dispersants Efficacy and Effects*. The National Academies Press, Washington, DC

Pace, C.B. and J.R. Clark. 1993. *Evaluation of a Toxicity Test Method Used for Dispersant Screening in California*. Marine Spill Response Corporation. Washington, D.C. MSRC Technical Report Series 93-028. 34p.

Page, C., Bonner, J.S., Sumner, P.L., McDonald, T.J., Autenrieth, R.L., and Fuller, C.B. 2000. "Behavior of a Chemically-Dispersed Oil and a Whole Oil on a Near-Shore Environment," *Water Research*, 34(9): 2507-2516

Rhoton, S.L. 1999. Acute toxicity of the oil dispersant Corexit[®] 9500, and fresh and weathered Alaska North Slope crude oil to the Alaskan Tanner crab (*C. bairdi*), two standard test species, and *V. fischeri* (Microtox[®] Assay). Master's Thesis. University of Alaska Fairbanks. Fairbanks, AK. 187 p. + Appendices.

Rhoton, S.L., R.A. Perkins, J.F. Braddock and C. Behr-Andres. 2001. A cold-weather species' response to chemically dispersed fresh and weathered Alaska North Slope crude oil. *Proceedings, 2001 International Oil Spill Conference. Global Strategies for Prevention, Preparedness, Response, and Restoration*. API Publication No. 4686B (same number used for the 1999 Proceedings). American Petroleum Institute, Washington, D.C. pp.1231-1236.

Science and Policy Associates, Inc.1993. *MSRC Workshop Report: Research on the Ecological Effects of Dispersants and Dispersed Oil*, February 24-25, 1993, Washington, DC. Marine Spill Response Corporation, Washington, DC. MSRC Technical Report Series 93-014, 34 p.

- Simon, M.A. 1998. Evaluation of Two Commercial Bioaugmentation Products for Enhanced Removal of Petroleum from a Wetland. Thesis Texas A&M University, College Station, TX.
- Singer, M.M., 1985. Food habits of juvenile rockfishes (Sebastes) in a central California kelp forest. *Fishery Bulletin*. 83:531-541.
- Singer, M.M., D.L. Smalheer and R.S. Tjeerdema. 1990a. A Simple Continuous-Flow Toxicity Test System for Microscopic Life Stages of Aquatic Organisms. *Water Research*. 24(7):899-903.
- Singer, M.M., D.L. Smalheer, R.S. Tjeerdema, and M. Martin. 1990b. Toxicity of an Oil Dispersant to the Early Life Stages of Four California Marine Species. *Environmental Toxicology and Chemistry*. 9:1378-1395.
- Singer, M.M., D.L. Smalheer, R.S. Tjeerdema, and M. Martin. 1991. Effects of Spiked Exposure to an Oil Dispersant on the Early Life Stages of Four Marine Species. *Environmental Toxicology and Chemistry*. 10:1367-1374.
- Singer, M.M., S. George, D. Benner, S. Jacobson, R.S. Tjeerdema and M.L. Sowby. 1993. Comparative toxicity of two oil dispersants to the early life stages of two marine species. *Environmental Toxicology and Chemistry*. 12:1855–1863.
- Singer, M.M. and R.S. Tjeerdema. 1994. Dispersed Oil and Dispersant Fate and Effects Research: California Program Results for 1993-1994. Department of Chemistry and Biochemistry, University of California, Santa Cruz. Marine Spill Response Corporation, Washington, DC. MSRC Technical Report Series 94-010, 46 p.
- Singer, M.M., S. George, S. Jacobson, I. Lee, L.L. Weetman, R.S. Tjeerdema and M.L. Sowby. 1995. Acute toxicity of the oil dispersant Corexit[®] 9554 to marine organisms. *Environmental Toxicology and Chemistry*. 32:81–86.
- Singer, M.M. and R.S. Tjeerdema. 1995a. Dispersed Oil and Dispersant Fate and Effects Research: California Program Results for 1994-1995. Department of Chemistry and Biochemistry, University of California, Santa Cruz. Marine Spill Response Corporation, Washington, DC. MSRC Technical Report Series 95-012, 36 p.
- Singer, M.M. and R.S. Tjeerdema. 1995b. Dispersed Oil and Dispersant Fate and Effects Research: California Program Results for 1995-1996. Department of Chemistry and Biochemistry, University of California, Santa Cruz. Marine Spill Response Corporation, Washington, DC. MSRC Technical Report Series 95-016, 48 p.
- Singer, M.M., S. George, S. Jacobson, I. Lee, L.L. Weetman, R.S. Tjeerdema and M.L. Sowby. 1996. Comparison of the acute effects of the oil dispersant Corexit[®] 9500 with those of other Corexit[®] series dispersants. *Ecotoxicology and Environmental Safety* 35: 183-189.

- Singer, M.M., S. George, I. Lee, S. Jacobson, L.L. Weetman, G. Blondina, R.S. Tjeerdema, D. Aurand and M.L. Sowby. 1998. Effects of dispersant treatment on the acute toxicity of petroleum hydrocarbons. *Arch. Environ. Contamin. Toxicol.* 34: 177-187.
- Singer, M. M., D. Aurand, Bragin, G.E., Clark, J.R., Coelho, G.M., Sowby, M.L. and R.S. Tjeerdema. (2000). "Standardization of the preparation and quantitation of water-accommodated fractions of oil for use in toxicity testing." *Marine Pollution Bulletin.* 40(11):1007-1016.
- Singer, M.M., S. Jacobson, R.S. Tjeerdema and M. Sowby. 2001. Acute effects of fresh versus weathered oil to marine organisms: California findings. Proceedings, 2001a International Oil Spill Conference. Global Strategies for Prevention, Preparedness, Response, and Restoration. API Publication No. 4686B (same number used for the 1999 Proceedings). American Petroleum Institute, Washington, D.C. pp.1263-1268.
- Singer, M.M., D.V. Aurand, G.M. Coelho, M. Sowby, G.E. Bragin, J.Clark, R.S. Tjeerdema. 2001b. Making, measuring, and using water-accommodated fractions of petroleum for toxicity testing. Proceedings, 2001 International Oil Spill Conference. Global Strategies for Prevention, Preparedness, Response, and Restoration. API Publication No. 4686B (same number used for the 1999 Proceedings). American Petroleum Institute, Washington, D.C. pp.1269-1274.
- Tjeerdema, R.S., M.M. Singer, G.M. Scelfo, D.L. Smalheer, L.M. Swall, G.E. Croston, D.M. Fry and M. Martin. 1990. Oil spill cleanup agent research in California. Final report to the California Department of Fish and Game, Office of Oil Spill Prevention and Response, Sacramento, CA.
- Tjeerdema, R.S. and M.S. Singer. 1991. Closed flow-through aquatic toxicity testing and microscopic organisms: Not necessarily incompatible. *Mar. Poll. Bull.* 22(2): 59-61.
- US EPA. 1985. Methods for measuring the acute toxicity of effluents to freshwater and marine organisms EPA/600/4-85/013.
- Weber, C.I. (Ed.).1993. Methods for measuring the acute toxicity of effluents and receiving waters to freshwater and marine organisms. Publication No. EPA/600/4-90/027F. United States Environmental Protection Agency, Washington, D.C.
- Wetzel, D.L. and E.S. Van Vleet. 2001. Cooperative Studies on the toxicity of dispersants and dispersed oil to marine organisms: A 3-year Florida study. Proceedings, 2001 International Oil Spill Conference. Global Strategies for Prevention, Preparedness, Response, and Restoration. API Publication No. 4686B (same number used for the 1999 Proceedings). American Petroleum Institute, Washington, D.C. pp.1237-1241.